

# QST

DEVOTED ENTIRELY TO

# AMATEUR RADIO

*Published by the American Radio Relay League*

## How To Build An Inexpensive Low-Power Crystal-Controlled Transmitter

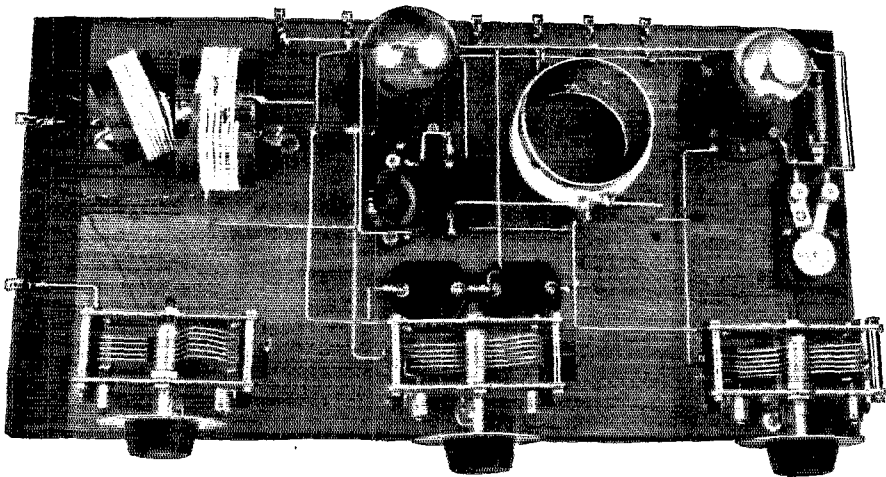

COMPLETE DETAILS IN THIS ISSUE

*January  
1927*



# Cunningham RADIO TUBES

Since 1915—  
Standard for all sets



1 type in 1915  
2 types in 1920  
15 types in 1926

RADIO progress has set a fast and exacting pace these past few years. One single type of tube seemed adequate ten years ago. Four years ago two types apparently served the purpose. And today, with its greater and more exacting demands for improved radio reception, the research and engineering talent back of Cunningham Radio Tubes contributes its share to radio progress with fifteen perfected special purpose types, each one efficiently mastering its particular task.

To know the individual and special task of each one of these tubes when used in your set will bring to you an appreciation of increased radio enjoyment and more realistic tone reproduction.

Consult your nearest Cunningham Radio Tube dealer—learn how the right combination of Cunningham Radio Tubes will bring your present radio equipment up-to-date. Be sure that your receiver has the right combination of detector, voltage amplifier, power amplifier, and rectifier tubes to give it present day standards of performance in sensitiveness—in selectivity—in tone value.

[ Fifteen Types  
All in the Orange and Blue Carton ]

*C. J. Cunningham, Inc.*

NEW YORK CHICAGO SAN FRANCISCO

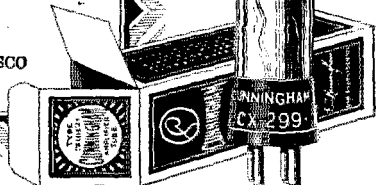



## more distance on the same set

Want more stations on that storage battery set of yours? Want the far away ones you get now to come in more easily and regularly? The Radiotron laboratories have developed a *super detector* that slips right into the socket where you have a Radiotron UX-201-A now. Just change that one to a Radiotron UX-200-A.

It makes your set sensitive to fainter signals—reaches out to further stations—picks up weaker ones you couldn't get before. It makes a big change for a very small cost!

Bring your *storage battery set* to *UX-200*  
 a genuine RADIOTRON UX-201 or UX-202  
 a genuine RADIOTRON UX-201-A  
 and RADIOTRON UX-201-A for all-round quality.

Bring your *dry battery set* to *UX-200*  
 a genuine RADIOTRON UX-125  
 and RADIOTRON UX-125 for all-round quality.

RADIO CORPORATION OF AMERICA  
 New York Chicago San Francisco

## HEATING METAL INSIDE OF GLASS

EVERYONE knows that glass melts easily, and metal requires a high temperature. Yet, at the Radiotron laboratories, the experimenters can put a Radiotron in the coil of a "high frequency furnace" and melt the metal *inside it* without melting the glass. This is done by an electric current that is induced inside the glass bulb, right through the glass.

This extraordinary furnace is not only used for experiment. In manufacture, every single Radiotron goes for a moment through such a furnace, just after the air has been exhausted out of it. The inside metal is heated red hot in the vacuum, and the tiny air bubbles boil right out of the metal and the glass, and are pumped away. Never before could such an exhaust be obtained.

This means *real performance* when the Radiotron gets into your set. And it adds another reason for insisting on a genuine RCA Radiotron with the RCA mark on the base and the glass. There are Radiotrons for every purpose.



# RCA Radiotron

MADE BY THE MAKERS OF THE RADIOTRON

SAY YOU SAW IT IN QST—IT IDENTIFIES YOU AND HELPS QST

# AMATEURS

Standardize on

# GENERAL RADIO

## Apparatus in Your Short-Wave Receivers and Transmitters

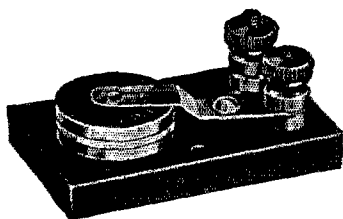

### Type 276-A—Quartz Plates

Quartz plates for crystal controlled transmitters are available at random frequencies in the 150-170 meter band. These plates provide harmonics in the 20, 40, and 80 meter bands, and may be used for transmitters on these wavelengths. Calibration is to 0.25%. All plates are guaranteed to oscillate when used as directed. The only licensed plates available to amateurs.

Type 276-A Amateur Quartz Plate, unmounted, \$15.00  
Type 356 Crystal Mounting, 1.00

### Type 358—Amateur Wave Meter

This instrument is particularly designed for amateur use in checking wavelengths. Consists of a coil mounting directly on the binding posts of a shielded condenser of 125 MMF capacity. A small lamp serves as a resonance indicator.

The 358 wavemeter is supplied with 4 coils, a calibration chart and wooden carrying case.

The coil ranges are as follows:

Coil A .....	14 to 28
Coil B .....	26 to 56
Coil C .....	54 to 114
Coil D .....	105 to 224

Wavemeter complete ..... Price \$22.00

### Type 349—UX-CX Tube Socket

This socket is made of moulded Bakelite and designed for UX and CX base tubes. Positive contacts are made with double gripping springs of Phosphorus bronze to the sides of the tube prongs.

Type 349 Socket ..... Price \$5.00

### Type 334—Transmitting Condensers

The types 334-T and V condensers are similar in appearance and assembly to all other Type 334 condensers except that they have double spacing for use in short wave transmitting on voltages up to 2000. They have metal end plates with shielded rotor. Plates of the rotor and stator groups are soldered to insure perfect electrical contact. The type 334 transmitting condensers are supplied with counter weights only.

Type 334-T Capacity 100 MMF Price \$4.25  
Type 334-V Capacity 50 MMF " 3.75

### Type 277—Low Loss Coils

The type 277 coils are wound on moulded Bakelite forms, and the ratio of diameter to length so proportioned that they have very low losses. They are available in various ranges of wavelengths from 50 to 900 meters, and are supplied with single winding and with primary and secondary windings closely coupled. For ranges and prices, see Bulletin No. 925.

Write for Folder 276-A on Quartz Plates and Parts Bulletin 925-A

**GENERAL RADIO CO. :: CAMBRIDGE, MASS.**



# Section Communications Managers of THE COMMUNICATIONS DEPARTMENT, A. R. R. L.

Eastern Pennsylvania 8BQ  
Maryland-Delaware-District of Columbia 3AB  
Southern New Jersey 3EH  
Western New York 8PJ  
Western Pennsylvania 8XB

## ATLANTIC DIVISION

H. M. Walleze 597 No. James St. Hazleton  
A. P. Goodall 1824 Ingleaside Terrace Washington, D. C.  
H. W. Densham 140 Washington St. Collingswood  
C. S. Taylor 598 Masten St. Buffalo  
G. L. Crossley State College

## CENTRAL DIVISION

Illinois 9AAV  
Indiana 9CYQ  
Kentucky 9ARU  
Michigan 8ZZ  
Ohio 8BYN  
Wisconsin 9VD

W. E. Schweitzer 4264 Hazel Ave. Chicago  
D. J. Angus 310 N. Illinois St. Indianapolis  
D. A. Downard 116 No. Longworth Ave. Louisville  
C. E. Darr 187 Hill Ave. Highland Park, Detroit  
H. C. Storck 894 Carpenter St. Columbus  
C. N. Crapo 443 Newton Ave. Milwaukee

## DAKOTA DIVISION

North Dakota 9EFN  
South Dakota 9BDW  
North Minnesota 9EGH  
South Minnesota 9BYA

G. R. Moir 618 11th Street, South Fargo  
F. J. Beck Milbank  
C. L. Barker Henning  
D. F. Cottam 3538 Third Ave. So. Minneapolis

## DELTA DIVISION

Arkansas 5AIP  
Louisiana 6UK  
Mississippi 6AKP  
Tennessee 4KM

Leonard Chipyard 2498 North Pierce St. Little Rock  
C. A. Freitag 129 Camp St. New Orleans  
J. W. Gullett 1708 23rd Ave. Meridian  
L. K. Rush 4 Second St. Bemis

## HUDSON DIVISION

Eastern New York 2ADH  
N. Y. C. & Long Island 2CWB  
North New Jersey 2WE

Earle Peacor Box 113 Yonkers  
F. H. Marston 117-11 140th St., So. Ozona Park, L. I.  
A. G. Wester, Jr. 50 Princeton St. Hilton

## MIDWEST DIVISION

Iowa\* 9BKV  
Kansas 9DNG  
Missouri 9RR  
Nebraska 9BYG

A. W. Kruse University Heights Akron  
F. S. McKeever 3010 Mercier St. Lawrence  
L. B. Lazure 3006 S. 32nd Ave. Kansas City  
C. B. Deihl Omaha

## NEW ENGLAND DIVISION

Connecticut 1BM  
Maine 1BG  
Eastern Massachusetts 1BVL  
Western Massachusetts 1DB  
New Hampshire 1ATJ  
Rhode Island 1BVB  
Vermont 1AJG

H. E. Nichols 32 Elmwood Ave. Bridgeport  
Frederic Best 13 E. Crescent St. Augusta  
R. S. Briggs 393 Ashmont St. Dorchester  
A. H. Carr 30 Yassar St. Worcester  
V. W. Hodge 227 Main St. Claremont  
E. B. Fancher 22 Summer St. Westley  
C. T. Kerr Poultry

## NORTHWESTERN DIVISION

Alaska\* 7FD  
Idaho\* 7ST  
Montana\* 7NT  
Oregon\* 7IT  
Washington\* 7FD

L. H. Machin Box 452 Cordova  
Henry Fletcher 1107 State St. Boise  
A. R. Willson Ramsey  
A. C. Dixon, Jr. 1350 East 36th St. Portland  
Otto Johnson 4340 30th St. W. Seattle

## PACIFIC DIVISION

Hawaii\* 6UO  
Nevada 6BUIR  
Los Angeles 6NX  
Santa Clara Valley 6ZW  
East Bay\* 6EX  
San Francisco 6CBS  
Sacramento Valley\* 6ANO  
Arizona\* 6ANQ

John A. Lucas Box 1142, Fort Shafter Oahu  
C. B. Newcombe Yeaington  
L. E. Smith 340 No. Painter Ave. Whittier  
F. J. Quement 51 Pleasant St. San Jose  
P. W. Darr 362 35th St. Oakland  
G. W. Lewis 748 14th St. San Francisco  
C. F. Mason 2530 N. St. Sacramento  
D. B. Lamb 229 W. First St. Mesa

## ROANOKE DIVISION

North Carolina 4JR  
Virginia 3CA  
West Virginia 8BSU

R. S. Morris 413 Broad St. Gastonia  
J. F. Wohlford 118 Cambridge Ave. Roanoke  
C. S. Hoffman 126 Chantal Court Wheeling

## ROCKY MOUNTAIN DIVISION

Colorado 9CAA  
Utah-Wyoming 6RM

C. R. Stedman 1641 Albion St. Denver  
Don C. McKee 214 Belvedere Apts. Salt Lake City

## SOUTHEASTERN DIVISION

Alabama 5AJP  
Florida 4QY  
Georgia-South Carolina-Cuba-Porto Rico-Isle of Pine 4KU

A. D. Trum 217 Catoma St. Montgomery  
W. P. Grogan Box 816 Ft. Myers  
H. L. Reid 11 Shadowlawn Ave. Atlanta

## WEST GULF DIVISION

Northern Texas 5AJT  
New Mexico\* 5APG  
Oklahoma 5YK  
Southern Texas

W. B. Forrest, Jr. 502 Royal St. Waxahatchie  
K. M. Ehret 2904 N. Robinson St. Oklahoma City  
E. A. Sabm 146 N. Academy St. New Braunfels.

## MARITIME DIVISION

Newfoundland 8AR  
New Brunswick 1ET  
Nova Scotia 1DD  
Prince Edward Island 1BZ

Loyal Reid Avaton House St. Johns  
T. B. Lacey c/o N. B. Power Co. St. John  
W. C. Borrett 14 Sinclair St. Dartmouth  
W. A. Hyndman 25 Fitzroy St. Charlottetown, P. E. I.

## ONTARIO DIVISION

Ontario 0BJ

W. Y. Sloan 167 Close Ave. Toronto

## QUEBEC DIVISION

Quebec 2BE

Alex Reid 202 Birch Ave. St. Lambert

## VANALTA DIVISION

Alberta 4GT  
British Columbia 5BJ

A. H. Asmussen 2133 18th St. W. Calgary  
E. S. Brooks c/o Forestry Dept. Radio Court House, Vancouver

## PRAIRIE DIVISION

Manitoba\* 4DE  
Saskatchewan 4FC

F. E. Rutland, Jr. 452 St. John Ave. Winnipeg  
W. J. Pickering 514 19th St. W. Prince Albert

\*Temporary officials appointed to act until the membership of the SCMs by the nomination and election.

Section concerned choose permanent

# Quality Always Pays



"Good words gain you honor in the market place; but good deeds gain you friends among men."

It is performance that gains the Synchronphase praise and friendship from its owner.

*Daniel Miller*

**B**UYING a radio receiver is investing in pleasure, entertainment, information. You get what you pay for. If you want true radio happiness that will endure, then you'll choose a Synchronphase.

For Synchronphase reception is unusually superior because of several Grebe developments: *Colortone, Binocular Coils, S-L-F Condensers, Low-Wave Extension Circuits, etc.*

If you want to know *why* they combine to produce such reception as, perhaps, you've never realized was possible,

Write for Booklet Q

A. H. Grebe & Co., Inc., 109 W. 57th St., N. Y.

Factory: Richmond Hill, N. Y.

Western Branch: 443 So. San Pedro St., Los Angeles, Cal.

The **GREBE**  
**SYNCHROPHASE**  
TRADE MARK REG. U.S. PAT. OFF.



All Grebe apparatus is covered by patents granted and pending.

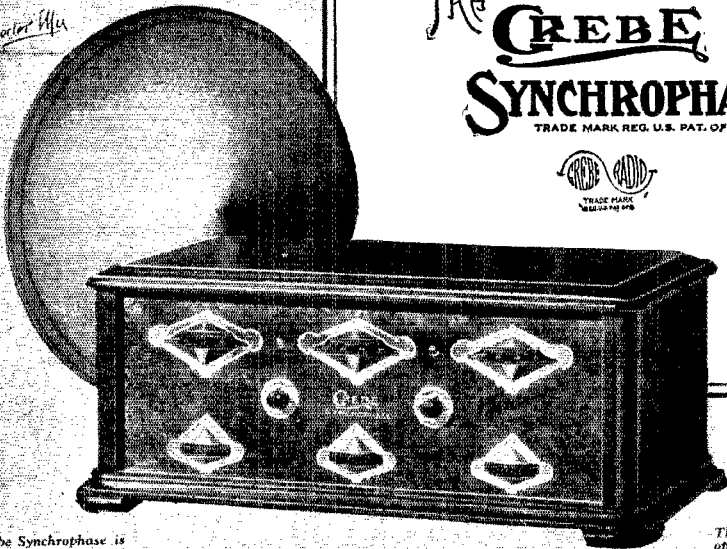

The Grebe Synchronphase is supplied in the standard cabinet model, with and without battery base, and in five beautiful console models.

This Company owns and operates stations W.A.H.G. and W.B.Q.; also low-wave rebroadcasting stations, Mobile W.G.M.U. and Marine W.R.M.U.



# QST



## The Official Organ of the A.R.R.L.

VOLUME XI

JANUARY, 1927

NUMBER 1

Standard Frequency Schedules .....	8
Developments in Tuned Inverse Duplex .....	9
The 1926 Elections .....	13
Low-Powered Crystal-Controlled Transmitters .....	14
Volunteer Wanted .....	18
A Direct Radio-Control Relay .....	19
A Radio Factory .....	22
How Our Tube Circuits Work .....	27
A.R.R.L. Information Service Rules .....	31
Experimenters' Section Report .....	32
New Transmitting Condensers .....	33
Standard Frequency Transmissions in Australia .....	34
5-Meter Receivers .....	36
A Short-Wave Super-Regenerative Receiver .....	40
A Short-Wave Precision Wavemeter .....	43
The UX-213 Rectron and the UX-374 Voltage Regulator .....	44
Amateur Radio Stations .....	47
I. A. R. U. News .....	51
The First Annual Rocky Mountain Division Convention .....	55
Calls Heard .....	56
Correspondence Department .....	59
Ham-Ads .....	91
QST's Index to Advertisers .....	94

QST is published monthly by The American Radio Relay League, Inc., at Hartford, Conn., U. S. A.  
Official organ of the A.R.R.L. and the International Amateur Radio Union

**Kenneth B. Warner** (Secretary, A.R.R.L.),  
Editor-in-Chief and Business Manager

**F. Cheyney Beekley**  
Managing Editor and Advertising Manager

**Robert S. Kruse,**  
Technical Editor

**John M. Clayton,**  
Assistant Technical Editor

**David H. Houghton,**  
Circulation Manager

Subscription rate in United States and Possessions, Canada, and all countries in the American Postal Union, \$2.50 per year, postpaid. Single copies, 25 cents. Foreign countries not in American Postal Union, \$3.00 per year, postpaid. Remittances should be by international postal or express money order or bank draft negotiable in the U. S. and for an equivalent amount in U. S. funds.

Entered as second-class matter May 29, 1919, at the post office at Hartford, Connecticut, under the act of March 3, 1879. Acceptance for mailing at special rate of postage provided for in section 1103, Act of October 3, 1917, authorized September 8, 1922. Additional entry as second-class matter, acceptable at special rate of postage provided for above, at Springfield, Mass., authorized September 17, 1924.

Copyright 1926 by the American Radio Relay League, Inc., Title registered at United States Patent Office.  
Member of the Radio Magazine Publishers' Association.

# THE AMERICAN RADIO RELAY LEAGUE

The American Radio Relay League, Inc., is a non-commercial association of radio amateurs, bonded for the promotion of interest in amateur radio communication and experimentation, for the relaying of messages by radio, for the advancement of the radio art and of the public welfare, for the representation of the radio amateur in legislative matters, and for the maintenance of fraternalism and a high standard of conduct.

It is an incorporated association without capital stock, chartered under the laws of Connecticut. Its affairs are governed by a Board of Directors, elected every two years by the general membership. The officers are elected or appointed by the Directors. The League is non-commercial and no one commercially engaged in the manufacture, sale or rental of radio apparatus is eligible to membership on its Board.

"Of, by and for the amateur", it numbers within its ranks practically every worth-while amateur in the world and has a history of glorious achievement as the standard-bearer in amateur affairs.

Inquiries regarding membership are solicited. A bona fide interest in amateur radio is the only essential qualification; ownership of a transmitting station and knowledge of the code are not prerequisite. Correspondence should be addressed to the Secretary.

## OFFICERS

### *President*

HIRAM PERCY MAXIM  
Hartford, Conn.

### *Vice-President*

CHAS. H. STEWART  
St. Davids, Pa.

### *Treasurer*

A. A. HEBERT  
Hartford, Conn.

### *Secretary*

K. B. WARNER  
Hartford, Conn.

### *Communications Manager*

F. E. HANDY  
Hartford, Conn.

## DIRECTORS

### *Dakota Division*

C. M. JANSKY, JR.  
Dept. of Elec. Eng., U. of M.  
Minneapolis, Minn.

### *Delta Division*

BENJ. F. PAINTER  
424 Hamilton Nat'l Bank Bldg.  
Chattanooga, Tenn.

### *Hudson Division*

DR. LAWRENCE J. DUNN  
480 East 19th St.,  
Brooklyn, N. Y.

### *Midwest Division*

PORTER H. QUINBY  
Box 184A, Route 6,  
Omaha, Neb.

### *New England Division*

DR. ELLIOTT A. WHITE  
4 Parkway,  
Hanover, N. H.

### *Northwestern Division*

K. W. WEINGARTEN  
3219 No. 24th St.,  
Tacoma, Wash.

### *Pacific Division*

ALLEN H. BABCOCK  
65 Market St.,  
San Francisco

### *Roanoke Division*

W. TREADWAY GRAVELY  
503 Main St.,  
Danville, Va.

### *Rocky Mountain Division*

PAUL M. SEGAL  
c/o District Attorney  
West Side Court Bldg.,  
Denver, Colo.

### *Southeastern Division*

HARRY F. DOBBS  
c/o Dobbs & Wey Co.,  
Atlanta, Ga.

### *West Gulf Division*

FRANK M. CORLETT  
2515 Catherine St.,  
Dallas, Tex.

### *President*

HIRAM PERCY MAXIM  
Drawer 4  
Hartford, Conn.

### *Vice-President*

CHAS. H. STEWART  
St. Davids, Pa.

### *Canadian General Manager*

A. H. K. RUSSELL  
5 Mail Bldg.  
Toronto, Ont.

### *Atlantic Division*

Dr. EUGENE C. WOODRUFF  
234 W. Fairmount Ave.  
State College, Pa.

### *Central Division*

GLYDE E. DARR  
187 Hill Ave., Highland Park,  
Detroit, Mich.

Address General Correspondence to Executive Headquarters, Hartford, Conn.

# EDITORIALS

**I**N THE *I.A.R.U. News* in this issue will be found an announcement of the greatest interest to all amateurs—the new list of international intermediates, announced by the International Amateur Radio Union to go into effect at 0000 G.M.T. on February first next. An official revision of the intermediate list has been needed for some time, and for months the Executive Committee of the Union studied the problem. Various systems were examined. It was proposed that if the governments of the world would kindly cooperate by assigning calls that, within each continent, indicated the nationality, a simple system of one-letter intermediates to indicate the continent would then tell the complete story. But it hardly seemed the province of the Union to say how calls should be issued and the Union's duty seemed rather one of devising an intermediate system that would identify nationality regardless of nature of call.

The "official" intermediates have numbered about thirty, and there have been something more than that number of "unofficial" ones, the list "just growing", without rhyme or reason. The one-letter phonetic system (F for France, N for Netherlands, etc.) was quite all right when we had only a few stations to consider, but with nearly seventy places now to care for, and the number rapidly increasing, a more logical system became imperative. It had to be designed for the future too, as a glance at the old method showed that in five years it would be a hopeless mess. The old method of some one-letter intermediates and some of two letters was also capable of great confusion. A general plan of two-letter intermediates seemed indicated. They might, for example, be arranged in groups by continents, the first letter indicating the continent and the second the nation within that continent. Of course it might be argued that the majority of the amateur stations of the world exist in countries now enjoying one-letter intermediates and that it would be more advantageous not to encumber that operation with two-letter intermediates, but the benefits outweigh that objection and it was also necessary to look ahead—surely no logical system for the future could embody both one-letter and two-letter intermediates.

Pursuing this idea, why stop with those countries actually now on the air, making it

necessary to assign and announce a new intermediate each time a new country opened up? Why not make a complete system that assigned an intermediate for every existing country, so that new amateurs in a new country would know what intermediate to use and so that all of us would identify him the first time we heard him? It was done, and that is the plan now announced by the Union. Now we are all set for a long while, we hope, so that only a repartitioning of the countries of the world will make further revision necessary. It looks good to us. Of course we wish we didn't have to have a longer intermediate, but it was certain to come to that and there has seemed to be no other logical way out. Remember the date, 6 P. M. Central Standard Time, January 31, and meanwhile familiarize yourself with the new list so that you will be all ready to shoot then on the new system.

For A.R.R.L. members in the United States and possessions and Canada who do not want to cut the page of intermediates out of *QST*, we have made some reproductions on cardboard which will be sent upon the receipt of four cents in stamps to cover handling costs. Canadian members can send Canuck stamps—we'll send 'em up to Keith Russell for the use of the Canadian S.C.M.'s.

**W**E owe a lot of apologies to a lot of people about the delay in the appearance of our Handbook. We're sorry. The book turned out to be just two and a third times as big as we contemplated when we made the announcement, and that's the reason. It is at best a hard job to handle a proposition of that size in a busy organization that has no slack in it. We printed the handbook in *QST* fashion because we wanted to keep the price at a minimum, and in that form it doesn't look so big. It took us so long to put it thru, tho, that we got suspicious and started counting up. We found to our surprise that it has nearly twice as many words as Ballantine and considerably more illustrations, and that if it had been printed in normal book fashion it would be a big husky book of five hundred pages or so. We were honored by a sale of several thousand copies before the book appeared, so we were quite as uneasy about the delay as were the customers. At this

writing, happily, all the orders have been filled, and we only hope that the book's readers will feel that it was worth waiting for.

We have another profound apology to make. We offer it most abjectly for the unfortunate appearance of November *QST* on the stands some days before the members got their copies. It is always our aim to regulate the mailing so that the newsstands do not anticipate the arrival of members' copies. Our actual mailing of copies is done by our printers, and we dispose of the subject with the least pain when we say that he slipped. We're awfully sorry, fellows; it is not our normal method; we

certainly appreciate how you feel about it, and it won't happen again.

Speaking of newsstand versus members' copies, we wonder if our newsstand readers realize that there are two breeds of *QST* and that only the members' copies contain the Communications Department news—a separate 16 pages which they are not getting in their newsstand copies? This is hot stuff but it goes only to the members. If interested (and you are), you should join the League and get *QST* mailed to you each month, including the C. D. news. As usual, there's a convenient blank in the aft portion of this issue.

K. B. W.

## Standard Frequency Schedules

THESE schedules are for the months of January and February 1927, with the cooperation of the following stations (known as OWLS-SF): 1XM, Communications Div'n., Mass. Inst. Tech. and M. I. T. Radio Society, Cambridge, Mass., 9WI, Gold Medal Station Anoka, Minnesota.

(Figures are frequencies in MEGACYCLES per sec.; approx. wavelengths in parentheses)

Friday Evening Schedules				Sunday Afternoon Schedules			
Eastern Standard		Time for 1XM		Eastern Standard		Time for 1XM	
Time (PM)	Schedule No. A	Schedule No. B	f λ	Time (PM)	Schedule No. C	f λ	f λ
8:30	3.50 (85.7)	6.50 (46.1)		3:00	10.0 (30.0)		
8:42	3.60 (83.3)	6.75 (44.4)		3:12	12.0 (25.0)		
8:54	3.75 (80.0)	7.00 (42.8)		3:24	14.0 (21.4)		
9:06	3.90 (76.9)	7.25 (41.3)		3:36	14.5 (20.7)		
9:18	4.00 (75.0)	7.50 (40.0)		3:48	15.0 (20.0)		
9:30	5.70 (52.6)	7.75 (38.7)		4:00	15.5 (19.3)		
9:42	6.50 (46.1)	8.00 (37.5)		4:12	16.0 (18.7)		
9:54	7.00 (42.8)	8.25 (36.3)		4:24	18.0 (16.7)		
10:06	7.50 (40.0)	8.50 (35.3)		4:36	20.0 (15.0)		
10:18	8.00 (37.5)	8.75 (34.3)					
10:30	8.50 (35.3)	9.00 (33.3)					

Date	Sched.	Sta.	Date	Sched.	Sta.
January 7	A	1XM	February 18	B	1XM
January 14	A	9X?	February 25	B	9X?
January 21	B	1XM	January 9	C	1XM
January 28	B	9X?	January 16	C	9X?
February 4	A	1XM	February 6	C	1XM
February 11	A	9X?	February 13	C	9X?

### Division of Time

The above dates for February are tentative and are here given for the benefit of readers who receive this magazine late in the month.

3 minutes—*QST QST QST* u (Station call letters).

3 minutes—5 sec. dashes broken by (station call letters) every half minute.

1 minute—announcement of frequency in megacycles per second (8.75 megacycles per sec. is sent as "8 r 75 MC").

1 minute—announcement of next frequency in megacycles per sec.

Note—9WI will very probably have another call when the schedule is sent. The station will therefore sign both 9WI and the new call.

While the accuracy that may be expected of these transmissions is 0.1% from 1XM and 0.5% from 9X?, no financial responsibility therefore is assumed by the League, the Bureau of Standards, nor the co-operating stations. Schedules from these OWLS-SF will be checked at intervals by the OWLS Committee, and by the M. I. T. Communications Laboratory; schedules not meeting the required accuracy will be suspended immediately.

### Special Notice

The schedules here given for 1XM are approved by the Bureau of Standards and the A.R.R.L. O.W.L.S. Committee as well as by the cooperating stations. The frequency values are based upon the standards of the Bureau of Standards, and have also been checked by the Cruft Laboratory of Harvard University and the Communications Laboratory of the Massachusetts Institute of Technology.

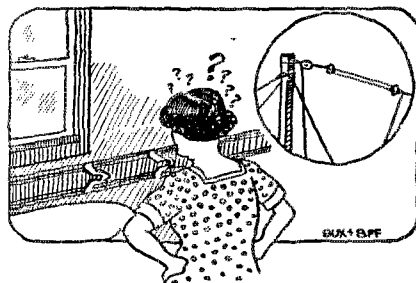

# Developments in Tuned Inverse Duplex

By David Grimes\*

Part I†

**I**N our haste to improve radio we have thrown aside valuable principles that we could ill afford to do without. Circuits and receivers have been abandoned because of minor defects though inherently sound.

An ever increasing number of broadcast stations has forced the question of superselectivity to the front, while the improvement in loud speakers for faithful reproduction of both bass and treble has made necessary the entire redesign of the electrical circuits of the receiver to permit it to do likewise.

Tuned radio frequency swept all before it, because it provided the required selectivity. The regenerative receiver for instance was left by the wayside because the regenerative receivers that existed were relatively broad, also because they whistled and disturbed the reception of the entire countryside. Several "old timers", however, realized that regeneration had inherent advantages too valuable to be discarded. The problem was to retain these advantages while overcoming the weaknesses of the old regenerative receivers. This was done and there resulted combinations of regeneration with tuned r.f. amplification, retaining the good points of each. Such highly popu-

lar circuits as those of Browning-Drake and Hammarlund-Roberts are fine examples of the improvements that were made by refusing to abandon a receiver but instead applying sound engineering to it.

Now, the purpose of these two articles is to discuss the limitations of the old reflex and Inverse Duplex systems and to show how they also have been overcome during

the development work of the past two years. At the close of this discussion it will be possible to show how a receiver with highly desirable characteristics may be constructed by using the results of this development work in combination with the improved practices as to audio amplification and tuning.

QST was the first magazine in the country to recognize the fundamental soundness of

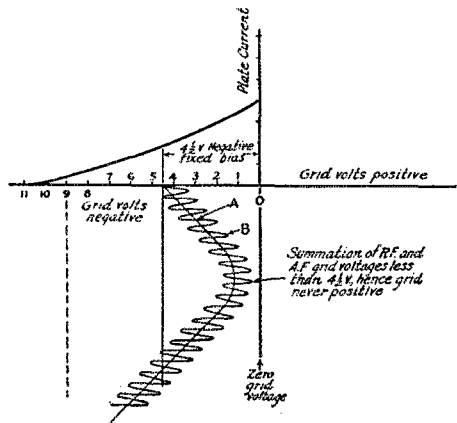

FIG. 2 REFLEXED TUBE OPERATING NORMALLY. AUDIO VARIATIONS ARE SHOWN BY CURVE A AND RADIO VARIATIONS BY CURVE B

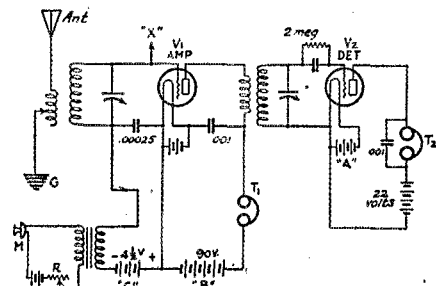

FIG. 1 CIRCUIT TO TEST THE SOUNDNESS OF REFLEXING

Inverse Duplexing<sup>1</sup> and accordingly published an article by Boyd Phelps in the March issue 1923. This article described what was then an up-to-date Inverse Duplex set. This set employed the 201 type tubes and fixed radio frequency transformers.

The ink was barely dry in this issue when the 201 tube was replaced by the 201-A and the number of broadcast stations increased to the point where fixed radio frequency amplification was not sufficiently selective. Several of the ordinary reflex sets at this time controlled their volume by a potentiometer across the tube filament, adjusting the operating bias of the grids from minus filament to plus filament. This meant that the grids were always operated with some positive potential, which, of course, raised havoc with the life of both tubes and batteries. The Inverse Duplex Circuit shown in March, 1923, QST<sup>1</sup> avoided this. It controlled the volume without this potentiometer, thus allowing the grids to return to

\*Grimes Radio Engineering Co. Inc., Grasmere, Staten Island and Long Island City, N. Y.

†The first of two articles—the second to appear in an early issue.

1. The "I. D. S." principle is shown in Fig. 6.—Tech. Ed.



minus filament at all times. The life of both tubes and batteries were thus as long as in any set employing the same number of tubes.

Be that as it may, the fact that most reflexes used up tubes and batteries at a terrific rate, combined with the fact that the

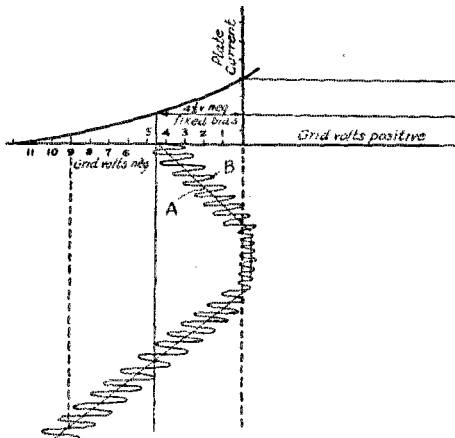

FIG. 3 REFLEXED TUBE OVERLOADED

fixed radio transformers did not permit selectivity, soon caused all such circuits to pass into the background. Fixed radio frequency nevertheless had several advantages and it is like other abandoned devices again being used here and there, in combination circuits, for the sake of those advantages.

Reflexing, as such, has been determined to be scientifically sound. Reflexing, within the operating limits of the tubes, has nothing whatsoever to do with selectivity, tone quality, or length of life of tubes and batteries. All of the atrocities laid at the reflex door have been no faults of innocent reflex but have been due to members of his household—the circuits used. Reflex is no stronger than its weakest circuit. There have been some attempts in the past to correct the evils of a poor radio and a poor audio circuit by merely reflexing them, based on a blind belief that the mere act of mysteriously reflexing the circuits would act as a cure-all. Of course, when it didn't, reflexing was blamed. The radio and audio circuits have therefore been studied and the best obtainable have been incorporated in the modern Inverse Duplex, giving superselectivity, excellent tone quality, good sensitivity, plenty of volume and long life of tubes and batteries.

#### Reflex Soundness

Having adapted tuned radio frequency and high-quality audio circuits to the Inverse Duplex, it then remained to prove conclusively that reflexing or duplexing did

not, in some unaccountable manner, hopelessly mix the frequencies beyond all redemption. It is quite difficult to understand an individual who firmly believes that both radio and audio (or several) frequencies cannot be passed successfully through a vacuum tube without interfering with each other and yet, at the same time, admits that that very thing takes place in an audio amplifier in reproducing an orchestra or band. He grants that no interference takes place between the different frequencies in the orchestra but says that, in some nebulous way, audio frequencies object to associating with radio frequencies in the same tube.

A very simple experiment was worked out to test this very point. By referring to Figure 1, you will note one stage of r. f. amplification and a detector. In the output of the detector is located a pair of telephones T2, for picking up the broadcast program. The radio frequency tube is also connected with a telephone microphone M and a pair of telephones; T1. At the point "X" on the grid of the amplifying tube was connected, as desired, a vacuum tube voltmeter for measuring the peak values of both audio and radio currents and an oscillograph for watching the audio currents.

A local broadcasting station was first tuned in and the volume reduced by detuning the antenna. The maximum or peak voltage of the r. f. was reduced so as to be less than 1 volt. The program was detected loudly in the telephones T2 but *could not be heard in the phones T1*. Then a 1000-cycle tone was supplied to the microphone M and its peak value regulated by the rheostat R until the peak voltage was

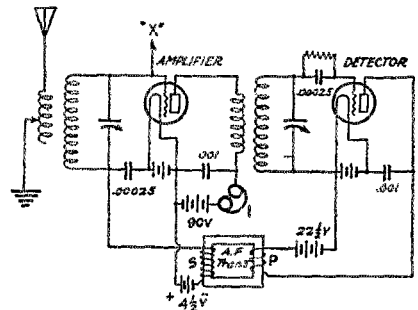

FIG. 4 ONE STAGE REFLEXED TEST CIRCUIT

about 3 volts. The amplifying tube was operated on 90 volts "B" battery and  $-4\frac{1}{2}$  volts "C" battery. The 1000-cycle tone was heard clearly and loudly in the telephones T1 but *was not distinguishable in T2*. We thus had both audio and radio currents passing through the amplifying tube V1 simultaneously without interference—the audio passing through its special filtering

input and output circuits and the radio likewise. Any reduction in the voltages of the two currents caused no trouble.

Ordinary speech was then impressed on the microphone "M" and as long as the peak voltage of this talking did not exceed about 3 volts on the grid of tube V1 all was satisfactory as before. The speaking did not interfere with the broadcast program heard in the telephone T2, nor was the program to be heard in telephone T1. The operating conditions of the tube are shown in Fig. 2.

**Overloading**

However, as soon as the instantaneous summation of the radio and audio voltages was sufficient to run the grid into a positive bias, trouble immediately resulted. The r.f. amplification greatly decreases due to the changed condition of the grid circuit. The grid, by swinging plus, has become conductive and is no longer a pure condenser as when operating on a minus bias. The change shifts the tuning resonance and at the same time reduces the resonance peak—both actions resulting in decreased radio amplification. The radio wave is therefore modulated and carries on to telephones T2 the original program as well as the modulation caused by the amplifying tube over-

the tube. It was found that the instantaneous grid potential was always the algebraic sum of the radio, audio and "C" battery voltages, just as represented in Fig. 2 and 3.

**The Practical Case**

All of the discussion so far has been considering different sources of r.f. and a.f. currents for the purpose of simplifying the

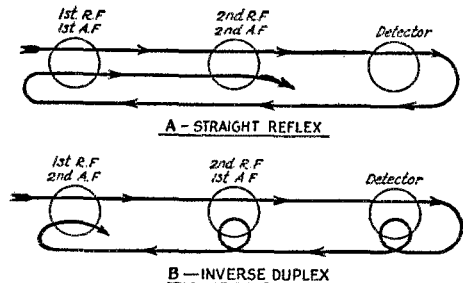

FIG. 6 DISTINCTION BETWEEN INVERSE DUPLEX AND STRAIGHT TWO-TUBE REFLEX

analysis. The audio emanates from the detector output, which in turn is controlled by the modulation on the carrier wave itself. The circuit of Fig. 4 was accordingly set up to permit the further study of duplex operation.

With the radio frequency and audio frequency vacuum tube voltmeters connected to the amplifier grid at "X" the set was tuned into a local station and the incoming energy adjusted by means of the antenna tuning until the maximum audio voltage surges ran around 4 volts. In considering tube or grid overload, the peak voltages must always be considered. All references are therefore to peak values and not to r.m.s. values. The r.f. voltage was very small, much less than the 1/2-volt margin on the 4 1/2-volt C-battery bias. Under these conditions no difficulty was experienced and fair output was obtainable.

The detector plate voltage was then increased to 45 volts and the radio input also somewhat increased by means of the antenna tuning. By this means, the audio voltage was raised slightly to about 4 3/4 volts. At this point self modulation set in showing that the audio was starting to interfere with the radio energy. By previous experiment, this could only happen as the grid actually passed the zero position and became slightly positive, but a different condition of overload took place here than that experienced when using independent sources of r.f. and a.f. current. A very decided strong medium pitched *howl* was created and continued until the incoming energy was reduced to such a point that the grid once more operated solely on the minus side of the zero position.

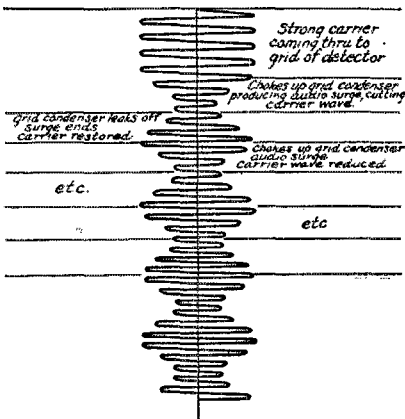

FIG. 5 ANALYSIS OF OVERLOAD HOWL

loading. The voice at microphone M is thus heard in the telephones intended only for the radio program. Under these conditions, mixing or confusion does result. This is shown in Fig. 3.

**Experimental Confirmation**

This theory was checked by means of vacuum tube voltmeters calibrated to read peak voltages of both the radio and audio currents. The potentials on the grid of the amplifying tube at the point marked "X" were measured while sine wave radio and audio oscillations were impressed upon



the negative side before cut-off is reached than it can in the positive direction before the "plus" position is encountered. Figure 5 shows an overload howl on a carrier wave.

### Multi-Stage Reflexing

So far, the analysis has been rather simple. It has, however, been necessary as preparation for the next step. The first fundamental reflex ever devised was a one tube proposition involving the problems just outlined. No refinements were then known so we find the original circuits back in 1914 with no indication of C-battery bias. Within a very short time of the original conception, the general principle of reflexing was applied to more than one tube and we find Marius La Tour working it out in France, during the war, on two reflexed stages. All of these early attempts employed the straight sequence whereby the audio energy progressed through the tubes in the same direction as the radio sequence.

As soon as a second tube is added to the line up as illustrated in Fig. VI, the problems really become serious, as the radio energy can no longer be neglected in the second r.f. amplifying tube. By means of the additional amplifying tube and the step-up in voltage in the tuned coupling circuit, the voltage has reached a value which must be taken into the calculations upon tuning into a strong local station. Meanwhile if this same second r.f. tube is also used for the second stage of audio amplification, the possible audio output is proportionately reduced by the r.f. voltage since the algebraic sum of the two voltages at any instant must not exceed the 4½-volt grid bias. Thus, much less volume is possible from this "two amplifying tube" arrangement as compared with only one reflexed amplifying tube, before the overload howl sets in! Analysis of Fig. 6 A will make this clear.

The foregoing analysis only substantiates the experimental results secured during the war when the Inverse Duplex was developed to overcome this and several other difficulties of straight reflex. The Inverse Duplex outlined in Fig. 6 B places the maximum audio voltage in the tube carrying the least radio voltage, so that good audio voltage levels are possible from the two stages. There is no need here to amplify on the advantages that I.D. has over "straight" reflex as they have been covered many times before. The thing that does need emphasis though, is that multiple tube "straight" reflex was abandoned by engineers as far back as 1918 because it was inherently incapable of good audio output. It should never have been brought to life a few years ago for broadcast use as it only had to be relegated *once more* to hopeless obsolescence. Unfortunately I.D. has been confused with "straight" reflexing. It is the object of these two articles to demonstrate the

soundness of single tube "straight" reflex and multiple tube Inverse Duplex.

The Improved Inverse Duplex System has incorporated recent engineering developments so as to employ the best possible radio and audio circuits. In addition a fundamentally new radio frequency circuit has been worked out that makes special use of one of the audio connections in such a way as to give practically uniform amplification over the entire broadcast band as well as giving *equal selectivity* over the band. This last feature is somewhat revolutionary as the ordinary systems used to obtain equal amplification at the long waves have the effect of broadening the tuning on those waves, usually by increased coupling.

The new I.D.S. circuit is shown in Fig. 7. The next article will discuss the radio and audio peculiarities of this circuit, giving operating curves, etc. These articles are being submitted especially to the readers of QST because of the helpful suggestions received from them at the time of the original I.D.S. release in March, 1923. Some of the present improvements came through their efforts.

---

## The 1926 Elections

The November elections of 1926 occurred in seven A.R.R.L. Divisions, from all of which the current Directors were re-elected to the Board for the 1927-28 term. In four of the Divisions, the Central, Northwestern, Roanoke and Rocky Mountain, the incumbents were the only eligible candidates, and thus were declared re-elected by the Executive Committee without balloting by the membership, as provided in our amended by-laws. Thus Messrs, Darr, Weingarten, Gravely and Segal continue, respectively, to represent the above Divisions.

In the other three Divisions there were contests and, accordingly, balloting. As intimated above, however, Dr. Dunn, Dr. White and Mr. Corlett continue to represent their respective Divisions, the Hudson, New England and West Gulf. The ballot count in these three Divisions was as follows:

### HUDSON DIVISION

Dr. Lawrence J. Dunn, 2CLA .....657  
 Dr. A. L. Walsh, 2BW .....317

### NEW ENGLAND DIVISION

Dr. Elliott A. White, 1XAV-1YB .....432  
 C. J. Green, 1ASU-1BCO .....196

### WEST GULF DIVISION

Frank M. Corlett, 5ZC ..... 167  
 G. N. Witting, 5HE ..... 72

—K. B. W.

# Low-Power Crystal-Controlled Transmitters

By John M. Clayton, Assistant Technical Editor

**T**HERE are so many possible combinations of crystal control and low power, one hesitates to recommend a specific layout as being the simplest arrangement for fear that from the count-

Accordingly this article is presented to the new man (and some of the older ones, too) who would like to take a fling at crystal control. Apologies are offered to those of you who have progressed to the 50-and 250-watt stage.

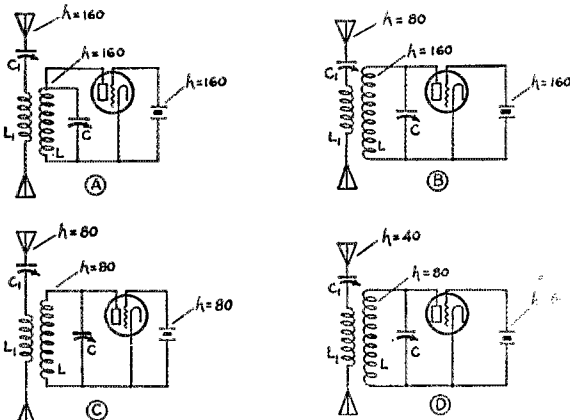

FIG. 1

SOME POSSIBLE OSCILLATOR-CRYSTAL COMBINATIONS

A few general considerations before dropping into specific details are necessary. In the type of transmitters we are going to describe there are several different ways in which the desired wavelength can be secured. In Fig. 1 at A the whole system is tuned to 160 meters to get a 160-meter signal in the antenna from a tube controlled by a 160-meter crystal. At B an 80-meter signal gets out into the air. Note that L-C in the crystal plate circuit is tuned to 160 meters, the 2nd harmonic (half wavelength) being picked off by tuning the antenna to 80 meters. At C an 80-meter crystal gives an 80-meter signal from the antenna, while in D the antenna is tuned to 40 meters to pick off the 2nd harmonic from the crystal. Note that in all of these cases the plate circuit is tuned to the wavelength of the crystal.

less users of crystal control some gentleman will arise to say, "You are all wet—here is the way it should be done"; nevertheless there is a demand for a description of a

the crystal.

From the above do not assume that the antenna has to be tuned to 160, 80 or 40 meters. It is perfectly possible to work the

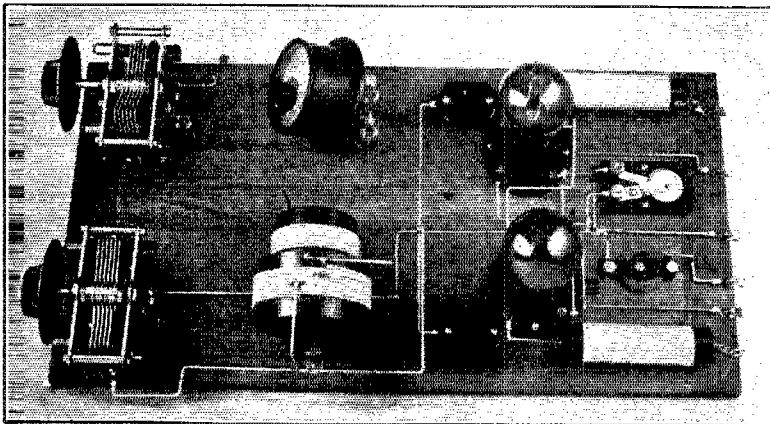

Fig. 2 THE A. C. 210 TRANSMITTER

simple low-power crystal transmitter, if one is to judge by the number of inquiries which reach our Information Service on the subject.

antenna at some of its harmonics (preferably the odd ones) with the result that the case D antenna may actually have a fundamental of 120 meters, and the 3rd harmonic

of the antenna will be picking up the second harmonic in the 80-meter plate circuit, resulting in a 40-meter signal in the air. The new man is urged to consult the antenna-counterpoise curve shown on page 46 of the May, 1926 issue of *QST*, and design his antenna and counterpoise so that the combination will yield a wavelength *slightly above*

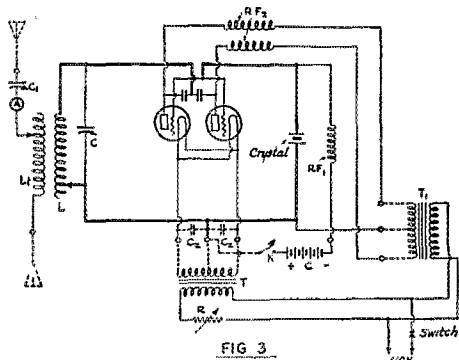

FIG. 3  
THE CIRCUIT OF THE A. C. TRANSMITTER

the wave on which the transmitter is to be operated.

Two general types of transmitters will be described. The first uses a.c. throughout and the second a.c. on the filaments of the tubes and d.c. on the plate. The a.c. set appears in Fig. 3. A glance at the illustration will show that the set is nothing but simplicity; all broken out with it. It can be put together in a few hours and when operated intelligently on an appropriate antenna system will give a range comparable to that secured from two tubes working with the same input but without the crystal control. The a.c. type has the advantage that the wave is extremely steady and yet not so sharp that it loses itself when severe fading occurs. An a.c. operated set of this type will *not* give a d.c. note, but it will give a note much superior to the usual run of self-rectified sets, and the wave is much steadier than that put out by almost any other type of transmitter. The advantages of crystal control have been dealt with at such length in past issues of *QST* it hardly seems necessary to emote further. Let's see how cheaply it can be done!

**The Damages**

- 1 Baseboard about 1/2 x 12 x 24 (these dimensions not critical) ..... \$0.75
- 2 UX Tube Sockets ..... 1.50
- 2 Cardwell 250-µµfd. receiving variable condensers ..... 1.50
- 2 General Radio type 310 Dials ..... 1.20
- 2 Sangamo 1,000-µµfd. fixed mica condensers ..... .80
- 2 R. F. Chokes, Radio Engineering Labs ..... 2.00
- 9 Brass Angles 1/2 x 1 inch ..... .25
- 1 General Radio type 356 Crystal Holder ..... 1.00
- 1 Oscillating crystal ..... 15.00
- 1 H. R. or Bakelite tube 3" diameter 2 inches long ..... .20
- 1 H. R. or Bakelite tube 2 1/2" diameter 1 1/2 inches long..... .15
- 1/4 pound No. 16 d.c.c. magnet wire.. .20
- 1 Home-made grid choke ..... .30
- 1 0-2 1/2 amp. G.E. thermo-ammeter .. 5.00
- 8 Fahnestock binding post clips ..... .40
- Miscellaneous wood screws ..... .15
- Bus wire ..... .40

About \$30.80

The crystal can be obtained from either Scientific Radio Service of Mount Ranier, Md., or General Radio Company of Cambridge, Mass. It is suggested that no power less than that afforded by two UX-210's is very much worth monkeying with. The tubes cost \$9.00 per each. The two radio frequency chokes (RF2 of Fig. 3) can be home-made. They should be wound on a 1/2-inch form 2 1/2 inches long, and should be

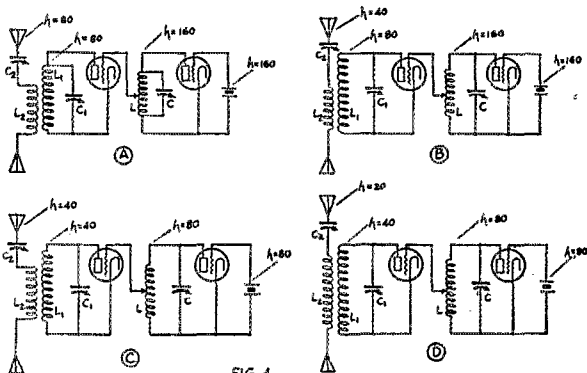

FIG. 4  
SOME OF THE OSCILLATOR-AMPLIFIER COMBINATIONS

No. 30 to No. 34 d.c.c. magnet wire. No mention has been made of plate or filament transformers. Choose your own pet brand. There are any number of good transformer manufacturers (see classified ads in *QST*). Be sure that the plate transformer will give

center-tap, and the filament transformer from 350 to 400 volts on either side of the 7½ volts at the filament terminals. If the filament transformer is not supplied with a primary rheostat one of the small Bradley Radiostats should be procured. A small telegraph key will serve admirably as the amount of current to be broken by the contacts is quite small.

Referring to Fig. 2 (and the circuit in Fig. 3) it will be noted that the variable condensers are mounted on the angles, as is also the meter and the two inductances L and L1. The antenna condenser C1 is at the rear of the baseboard to the left, with the plate condenser C at the left-front. The plate coil L is the larger of the two coils to the right of C. For a 160-meter crystal this coil should have 18 turns tapped every 3rd turn, wound on the 3-inch form. If your crystal has a fundamental in the 80-meter band the coil should have 10 turns tapped every 3rd turn after the 4th. The smaller coil L1 has 8 turns of the No. 16 d.c.c. wire on the 2½-inch form. Variable mechanical coupling is possible if the bracket to which the antenna coil is attached is either rotated on the supporting screw in the baseboard, or is moved toward and away from the plate

short it may be necessary to put in the filament supply by-pass condensers C2-C2 shown in dotted lines. These condensers can be ordinary fixed receiving ones having capacities from 1,000-to 6,000- $\mu$ fd.

The choke coil RF1 is scramble wound on a ¾-inch form. Unfortunately it is impossible to give specific winding data. The natural period of this coil *when in the set* should correspond closely to the natural period of the crystal in use. The best way to approximate this is to wind up a coil with 60 turns (if an 80-meter crystal) and after the set is perking, take off a few turns at a time until the crystal oscillates unstably or the antenna current drops. Then put back five or six turns on the choke. Note that the choke is small (physically) and placed well away from the fields of the main inductances.

Tuning and adjusting data will be supplied later. Suffice to say here that the C-battery voltage will be around 45 volts when two UX-210s are used with 250 volts on the plates. To be safe not over 400 volts should be used when the plate supply is a.c. There is really no entirely satisfactory keying method to use with a crystal oscillator alone. Grid or plate keying is impossible since most

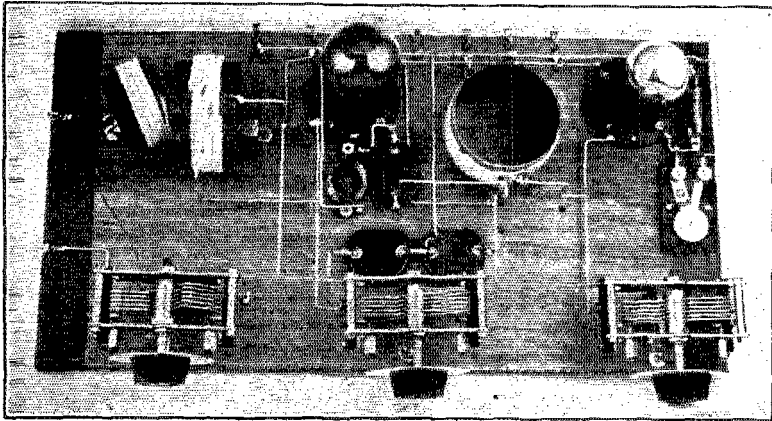

Fig. 5 THE D. C. POWER AMPLIFIER JOB

coil. Once an approximate position has been found, all "coupling" can be accomplished by means of the antenna condenser C1.

When wiring the transmitter the leads shown in heavy lines in Fig. 3 should be made as short as possible. Particular care should be taken to see that the lead from the crystal to the two grids is attached at a point midway between the grids. Also the plate lead from condensers C-C should be at the middle of the connection between these condensers, and the leads from the condensers to the tube plates should be equal in length. If the heavy leads are not very

crystals have so much inertia they will not pick up and oscillate at keying frequencies. The method shown in Fig. 3 is to key in the C-battery biasing battery circuit, not an altogether satisfactory method but perfectly workable. An alternative would be to key in the antenna or counterpoise directly. As the currents here are quite small it is possible to key in this fashion. A relay whose contacts are right in the antenna circuit is the best bet since your body does not get mixed up in the scramble and ball things up.

#### The D.C. Set

The d. c. set is superior to the a. c. layout



in several respects. In the first place it uses a 201-A crystal oscillator tube with a moderate plate voltage, and a UX-210 power amplifier on which much higher than normal voltage can be applied. With the 210s as oscillators (and with no power amplifier) the output in the antenna is limited by the input the crystal will stand. Not so with the power amplifier arrangement by means of which the little 201-A with low and safe input (to the crystal) serves the 210 operating with lots of input.

Then the d.c. set (minus plate supply

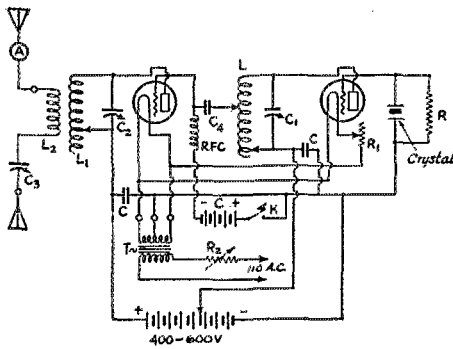

FIG 6

CIRCUIT OF THE OSCILLATOR-AMPLIFIER

which will vary to suit your conditions) is slightly cheaper than the a.c. model.

To get the picture straight let's refer to Fig. 4. If we are to avoid neutralization and possible shielding the power amplifier must work on the second harmonic of the crystal oscillator. At A we have a 160-meter crystal oscillator feeding a power amplifier whose plate circuit is tuned to 80 meters and in turn is coupled to the antenna tuned to 80 meters also. Obviously this will give an 80-meter signal. At B the 160-meter crystal oscillator feeds the amplifier whose plate is tuned to 80 meters, but here the antenna is tuned to 40 meters. In C an 80-meter crystal gives a 40-meter signal and at D the 80-meter crystal oscillator winds up in a 20-meter signal. Remember that we want to take off the *second* harmonic of the crystal oscillator and we do this by tuning the *plate* circuit of the *power amplifier* to half the wavelength of the oscillator. Again, the plate circuit of the *oscillator* is tuned to the same wave (approximately) that the crystal oscillates at.

It is not necessary to repeat the list of material for the d.c. job. An inspection of Fig. 5 and the diagram in Fig. 6 will reveal all of the parts. An additional inductance and another 75-cent Cardwell variable condenser are the major items of difference in the d.c. set.

The antenna tuning condenser C3 appears

at the extreme left of the illustration. The middle condenser is the amplifier plate tuning condenser C2 and the right hand one the oscillator condenser C1. The inductance at an angle is the antenna coil L2, coupled to the plate coil in the amplifier L1. Coil L2 should have 8 turns of No. 16 d.c.c. on a 2½-inch form. Assuming 80-meter operation with a 160-meter crystal, L1 should have 10 turns of the same wire on a 3-inch form, taps being taken off at every 3rd turn. The coil mounted vertically is the oscillator plate coil L which, for a 160-meter crystal, should have 18 turns of the 16 wire also on a 3-inch form. For operation at 40 meters from the 160-meter crystal the layout is the same, the antenna being proportioned so that it will hit 40 meters satisfactorily.

If an 80-meter crystal is used for 40-meter work, L2 remains the same, L1 has 5 turns and L 10 turns tapped every 3rd turn.

The r.f. choke in the oscillator grid circuit is scramble wound. It appears in front of the amplifier tube, the left hand tube.

The coupling condenser C4 has a capacity of 1,000 µfd. It is a Sangamo receiving condenser. The two plate by-pass condensers C are also Sangamos having a capacity between 2,000 and 6,000 µfd. These condensers should be placed as close to the part of the circuit they by-pass as possible.

Instead of a biasing battery in the crystal circuit, the grid leak R is used. This is a metallized filament type having a resistance of 80,000 ohms.

With a 201-A oscillator and a 210 power amplifier and with 150 volts on the oscillator and 500 on the amplifier the C battery on the amplifier should have a voltage of 90. If the antenna circuit is to be tuned to the second harmonic of the power amplifier this biasing voltage can be increased materially. Its main purpose in life is to distort the wave form excessively, causing a more pronounced second harmonic.

Resistance R1 is a rheostat to regulate the filament voltage of the 201-A, assuming that both tubes are to be operated from the same source of A battery supply.

### Adjusting the Set

With only a single meter in the whole layout it will be a difficult job to adjust the transmitter unless a good amateur wavemeter is available. You should have one anyway. A good one can be purchased for less than what the meters would cost, and it can be used forever! The meter should have some current indicating device. If not, a lamp on a single loop of wire inductively coupled to the meter will suffice.

The first thing to do is to get the crystal to oscillate. When you get the crystal you will know its wavelength pretty accurately. By means of the wavemeter tune your receiver to *twice* the wavelength of the crystal, leaving the receiver oscillate. Then slowly

vary condenser C1 (Fig. 6) at the same time wiping over the approximate neighborhood of the crystal in the receiver. If the clear bell-like whistle is not picked up, cut out a few turns in L and try again. Be sure that the crystal and the mounting plates are clean. Dip them in Carbona if they are not.

When the whistle has been picked up continue to increase the capacity of C1 until the crystal ceases to oscillate. Then back up slightly on the condenser. Right before the crystal breaks out of oscillation is the point you want to work at.

Now, jumping to the a.c. job and Fig. 3, increase the coupling between L and L1, making it as close as possible. With the crystal running, slowly vary C1 (and the taps on L1 if necessary) until the antenna meter shows some current. If you can't find the place couple the wavemeter to L1, set the wavemeter at half the oscillator wavelength and again vary L1 and C1. When the point of maximum antenna current is found again adjust the condenser C (Fig. 3) and at the same time C1 until maximum current with stable operation is secured.

If the coupling between L1 and L is too close the crystal will cease to oscillate when the two circuits approach resonance. Loosening the coupling between them by detuning the antenna circuit will eliminate any trouble of this nature.

Now going back to Fig. 6 and the power amplifier job, when the crystal is running o.k. attach C4 to L and by means of the

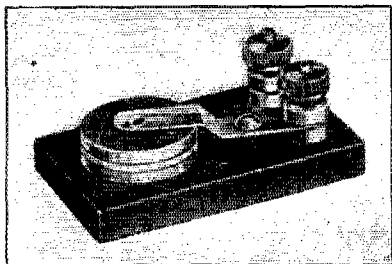

THE NEW GENERAL RADIO TYPE 356 CRYSTAL HOLDER

wavemeter (coupled to L1) adjust condenser C2 until the wavemeter shows that L1-C2 is tuned to half the wave of the crystal. Do not couple the wavemeter so closely to L1 that the second harmonic from the oscillator itself will get through to L1. After this step has been reached proceed as mentioned above in adjusting the transmitter to the wave desired.

After either of the sets are in operation it will pay you to monkey with the biasing voltages. It is impossible to specify definite biasing voltages for all of the com-

binations which will be used, and since these transmitters are built as simply as the writer can put them together, no meters are provided for any circuits save the antenna.

Either of these sets should whet the appetite of crystal control hounds, and either of them should make a first-class entrée into the crystal game. More power to you!

---

### Volunteer Wanted for Pacific Coast Standard Frequency Station

A suitable station is wanted to transmit standard frequency signals under A.R.R.L. auspices on the Pacific Coast. Schedules would be transmitted at the same dates and times as those from 1XM (see schedule this issue QST) except that this station would be summarized somewhat as follows: (1) Accuracy of 0.1% guaranteed; (2) Some organization to insure regularity of schedules, *one man cannot do it alone*; (3) The transmitter should be controlled by an organization or institution widely and favorably known so that even without the backing of the O.W.L.S. Committee of A.R.R.L. public confidence in the accuracy of its signals would be had.

Further, (but not absolutely essential) characteristics would be (1) Central location on Pacific Coast; (2) 250 watts output power; (3) Ability to transmit an extra schedule early Sunday morning once a month for the benefit of far Eastern stations. The A.R.R.L. cannot furnish any apparatus for this purpose, but will arrange through the courtesy of Mr. Clapp of 1XM for the calibration of a piezo-crystal submitted by the prospective O.W.L.S.-S.F. to a degree of accuracy considerably better than that required of the signals to be transmitted. Anyone interested or able to suggest a suitable station is requested to write to K. V. R. Lansingh, in Charge of Standard Frequency Stations 2227 Lake Shore Ave, Los Angeles, California.

—K. V. R. L.

---

### Strays

"The Canadian Government Direction Finding Station at Belle Isle, located in the Belle Isle Straits at the north end of Newfoundland, closes down every winter. The four operators, sole inhabitants of the place for a year, must do without mail. E. Davey, one of the ops, has a ham set using the call 9 DA. He is operating in the 40-meter band. If the gang will keep an ear tuned to 9DA and give these chaps a lift with messages and news, t'will be a deed well done."—R. L. Bunt, U. G. F. P.

# A Direct Radio Control Relay

By Robert S. Kruse, Technical Editor

**T**HE following description is written from notes compiled for *QST* by the Electron Relay Co., and from a few rather hurried experiments with a pair of relays given to me. A considerable portion of the following is direct quotation. The development work on this relay was done by Mr. Samuel Ruben. Mr. Ruben will be remembered as the inventor of the dry rectifier used in the Elkon trickle charger described by us.

This is interesting enough—but how is one to heat a strip inside a vacuum tube? This is done by electron bombardment. The grid serves to vary the intensity of the bombardment in any vacuum tube, therefore it can be used in the Ruben Relay to control the bombardment which will heat the plate enough to cause a contact to be made. Under normal conditions the plate voltage and grid bias are so controlled that the electron bombardment (plate current) is insufficient to cause the plate contact to touch the stationary contact. When a voltage is impressed on the grid (r.f., a.c. or positive d.c.) the increased flow of electrons causes the plate to heat a trifle more, whereupon it bends enough to close the contacts.

In an experiment made here it was possible to cause the contacts to close in about  $1\frac{1}{2}$  seconds by tuning in the local 500-watt broadcasting station WTIC at a distance of about 5 miles. This was without any r.f. amplifier ahead of the device. When the signal was detuned the contacts opened in about 6 seconds. The antenna used was about 30 feet long. The contacts were being used to light a 100-watt 110-volt lamp. When one compares this with the

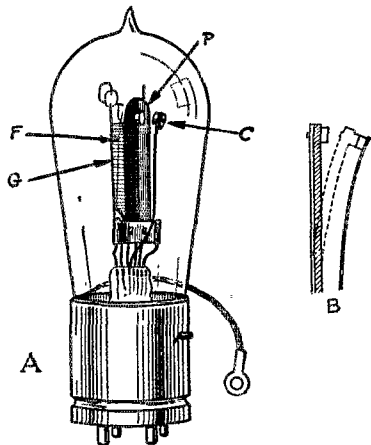
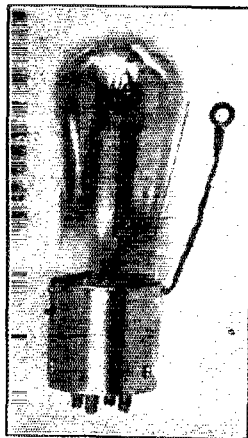

FIG. 1 CONSTRUCTION OF TYPE "U" CONTACT RELAY

The Ruben relay seems at first sight to be a vacuum tube of the usual receiving type. A second look shows that the plate is of unusual construction, also that there is present an additional electrode. The arrangement of these parts is as shown in Fig. 1A. F is the usual filament surrounded by the usual grid G. P is the plate which is flat and not of the usual "washboiler" shape. Back of the plate is the wire W carrying at its upper end a contact which is placed opposite the contact carried by the plate.

The relay action depends on the fact that the plate is made of two sheets of metal welded together as shown in Fig. 1B. When such a "bi-metallic strip" is heated the one metal (shown colorless) expands more than the other (shown cross-hatched) and as a result the strip bends, assuming the position shown by the dotted lines and thereby bringing its contact against the stationary contact carried by the wire W. Thru an error in drawing, the two metals of the strip are shown of different thickness.

1. Electron Relay Company, 83 Fourth Ave., New York City.



ONE OF THE CONTACT TYPE RELAYS

usual ticklish devices using several tubes and an electro-mechanical relay the device certainly seems interesting.

### Use in a Receiving Set

The size, base and electrical characteristics of the relay are such that it can be fitted into receiving sets without any special

change. It can be used as an ordinary vacuum tube for r.f. amplification, detection or a.f. amplification and whenever a strong enough signal is supplied the contacts will operate. The two functions do not interfere with each other particularly. Figure 2 shows how the tube may be used in a normal receiving set. An ordinary electric call-

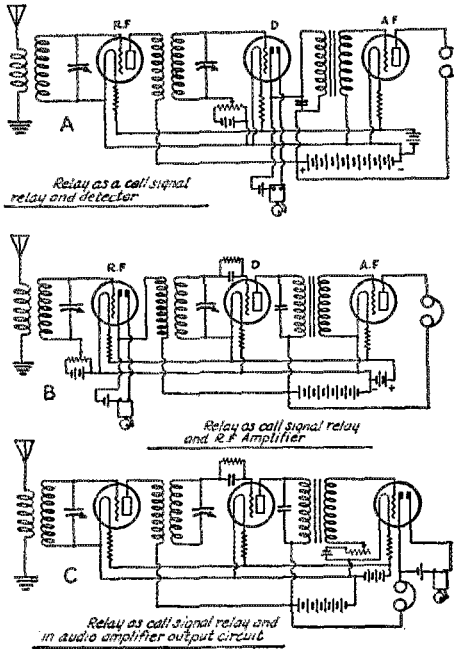

FIG 2

bell has been shown connected to the contacts but any device not drawing over 1 ampere at 110 volts may be operated. The vacuum cuts down contact sparking so that this load can be handled satisfactorily. Since the power in each tube of a radio receiver is greater than in the previous tube the most positive operation is obtained if the relay is placed in the last audio socket. It will operate here because it does not discriminate between audio and radio frequency alternating voltages.

A comparatively small alternating voltage will operate the relay because the plate heats more rapidly when the grid is on the positive half of the a.c. cycle than it is able to cool when the grid is on the other half of the a.c. swing. Thus with the tube biased to a normal plate current of 1½ mils the contacts will remain open and if the grid bias is changed to raise the normal plate current to 2 mils they still do not close. However, if r.f. is applied so as to give a reading of 2 mils (on a d.c. instrument) the contacts will close in 1 second.

**A.C. Operation**

The relay may be operated on a.c. supply as shown in Fig 4B or on d.c. as shown in Fig 4A. In either case the filament current is .48 ampere at an e.m.f. of 5.5 volts. The plate voltage may be from 130-150 volts and the bias battery on the 400-ohm potentiometer should supply 4.5 volts. All of this refers to the type U relay which has been made and used in some numbers.

**Uses**

In general the relay is useful where a load of less than 110 watts is to be handled at 110 volts or less, the control being by a small alternating voltage—r.f. or commercial a.c. Specifically the relay can be used to operate radio call signals, to control devices at a distance by radio, to operate wired wireless signalling or switching schemes, to detect storms and give an alarm, to operate as a sensitive telephone relay, to handle signals and radio or audio amplification at the same time and finally in connection with railway signal work.

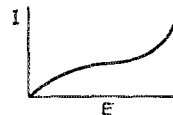
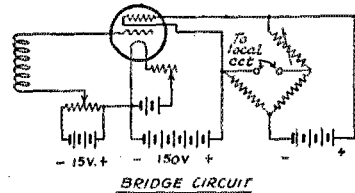
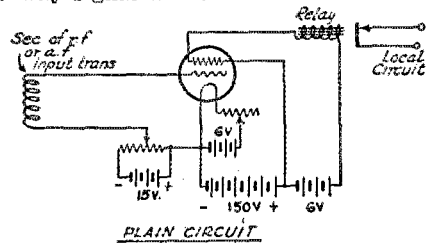

ANODE RESISTANCE CHARACTERISTIC

FIG. 3 CIRCUITS AND CHARACTERISTICS OF THE HIGH-SPEED CONTACTLESS RELAY

The two diagrams show the manner in which the relay is used. The curve shows the I-E relation for wire such as that used in the anode. Inspection of this curve will show that slight heating by bombardment will produce a large change in current thru the anode and therefore thru the armature-type relay which is being controlled by the tube.

When higher speed of contact operation is needed a special type of the relay is used in which the plate operates at a higher temperature so that it may cool off faster.

The device described can be operated at intermittent speeds of 12 cycles; but for positive control a speed of 2 cycles is preferred. An input potential of 1 volt to the grid is adequate for such control.

In general it appears that the relay offers an opportunity for development in the field of radio dynamics because of the simplification of the local circuit control obtained by its use.

**A High Speed Type**

In some instances, as for commercial uses where higher speed is required, another type has been developed, termed the "contactless" type. This has a speed in the order of 25 cycles. It has the filament, grid and an anode in structure somewhat like a grid. This anode (for it is not a plate) is made of wire of small diameter having a very high resistance coefficient within a certain temperature range. The current normally flowing thru the wire plate element is of such an order as not to increase the resistance of this wire materially; but the effect of the electronic bombardment is to increase the temperature to such an extent as to increase the resistance of the wire more than tenfold (40 to 400 ohms) so that a relay of the ordinary armature type can easily be operated by the current flowing thru the anode wire by use of the control obtained by variations in the applied grid potential.

This high-speed relay has been developed for such applications as cable work

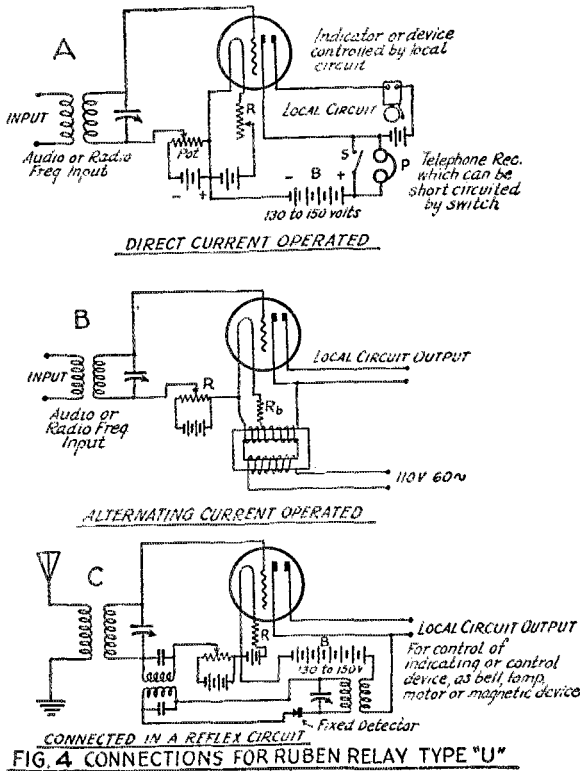
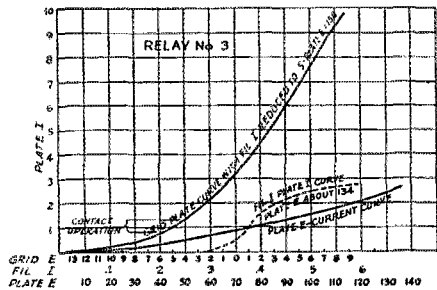

**FIG. 4 CONNECTIONS FOR RUBEN RELAY TYPE "U"**

The relay will operate on a smaller input though slowly as explained in the WTIC test.

Some of the applications for which they have proved themselves adapted are:

1. Railway signal and automatic train control, the relay being employed to pick up a carrier wave from the tract circuit and to operate a master relay which controls signals and brake mechanism.
2. For remote control of lighting circuits by using the relay to pick up a carrier wave, this device controlling a rugged electromagnetic relay.
3. For general call signal operation when radio or carrier wave oscillations are impressed upon a tuned grid circuit.
4. For educational purposes by the dynamic effect of the electron bombardment is readily demonstrated by the movement of the anode.



**FIG. 5 OPERATING CHARACTERISTICS OF A REPRESENTATIVE RELAY OF THE CONTACT TYPE**  
In this case a change of 1/10 volt in the grid bias operated the contacts. The bias was 2 volts when operating at a filament current of .45 ampere.

requiring a Bridge type of circuit, also where extreme vibration makes it difficult to use the contact type. The impedance  
(Concluded on Page 31)

# A Radio Factory

By Robert S. Kruse, Technical Editor

**T**HIS is a story of one angle of radio which has been neglected in *QST*, although a very large part of our family of reader-members is directly interested in it. We have given much space to the first step in the making of a radio device, the experiments and calculations. We have given less to the subject of reducing this work to the preliminary model, but we

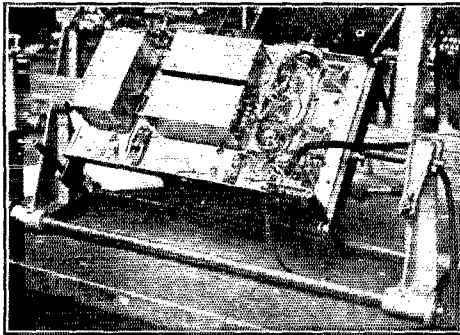

ASSEMBLED CHASSIS IN CARRIAGE SHOWING HOW CHASSIS MAY BE INVERTED AND CLAMPED IN THAT POSITION

The large copper cans are the transformer shields.

have given almost no space to the very important and intensely interesting story of the actual manufacture of the apparatus, the process which multiplies the model by hundreds and by thousands. This, then, is an attempt to set down the process by which a representative radio receiver is made, the precautions taken during the process and the tests made at its conclusion.

Now it would doubtless be very fine if one could tell everything about the way all receivers are made and do it in less than three volumes. If such a story *can* be written it must be by some one else. As for me, I have picked a representative shielded five-tube set and have followed it thru the factory. Here and there in the following story I have made a few comments about the methods of other manufacturers, but mainly the methods described are those of the American Bosch Magneto Corporation. Their factory has the very important advantage of being located within 27 miles of the *QST* office, so that it is possible to check over the story as to correctness without falling still further behind in the endless race with the tireless question askers who make up A.R.R.L.

Mr. Average Man's set today appears to be the five-tube set and therefore that type interests more people and has been chosen for this story in preference to the more elaborate 7-tube set made by the same factory. Because *QST* readers want to know definitely just what sort of set is being talked about, we will begin by saying that this one uses a circuit having as its foundation the R.F.L. circuit which has previously been described in *QST* in its original form. This is a circuit of the "true bridge" type, using two stages of radio frequency amplification. The photographs will show that the shielding has been made rather thorough, as is the modern trend. Neither the makers of "three handed sets" nor the maker of the single control variety can be greatly offended by

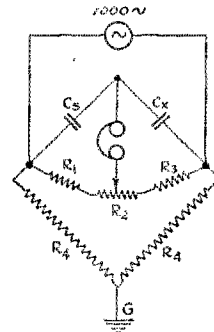

FIG. 1 THE CONDENSER BRIDGE

The resistances  $R_1$ ,  $R_2$  and  $R_3$  constitute the resistance arm of the bridge, balance being obtained by adjustment of the test condenser with the slider set at center-scale of the resistance arm. The extra resistances  $R_4$  constitute a so-called "Wagner ground" and are so adjusted that a good null point can be gotten in the phones, after which this connection is fixed.

this set, for it lies half way in between. The designer has begun by admitting that heaven alone knows what sort of antenna will be connected to the set and that it is therefore nearly impossible to arrange things so that the three tuned circuits will "run together." That is a long-winded way of indicating that the antenna tuning condenser is operated by a separate control knob. When one is working with two stages of tuned R.F. one can hardly afford to throw away part of a stage by permitting mistuning in the first circuit. For greater convenience the two knobs may be (and in

this case are) concentric so that they may be operated as one, when desired. The second and third tuned circuits are "ganged," which is quite all right if one takes the precautions which we will speak of as we go along. So much for the set, now let's start making it.

### The General Scheme

The general procedure is to prepare a frame on which everything will be mounted later and at the same time, in other parts of the factory, to get ready the various parts which will be put on this frame. When the parts have been tested electrically they are fastened to the frame and at each point in the proceedings at which this is conveniently possible the assembly is inspected to make sure that nothing has gone wrong up to that point. When the receiver is completed it is balanced (adjustment of the bridge circuits) and a final check is made to insure that the set operates as it should. The details of all this will come out as we go along. First let us get some of these parts made.

### The Variable Condensers

The set uses three tuning condensers of which one is independent, while the other

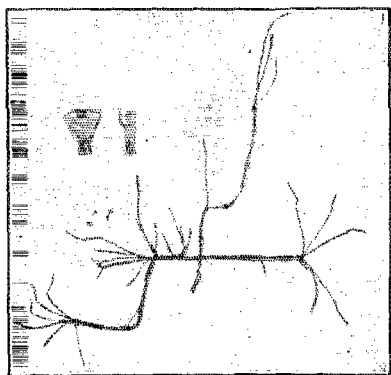

THE COLOR-CODED WIRE ASSEMBLY AND THE TWO-PIECE CONDENSER COUPLING

The wire assembly comes off the board in approximately the correct shape, that is with each lead about where it will be needed.

two must run together. This means that accurately paired condensers are necessary and the process of manufacture must be one which will make them alike and the design one which will keep them alike afterwards. The condensers are made by the well-known General Radio process. The plates are punched from sheet brass, each plate having a number of ears which are bent over and soldered to the next plate. This soldering is done while the plates are standing in a rigid steel jig so that the spacing and

alignment are almost automatic. After soldering, the plate assemblies are chemically cleaned and lacquered. When these plate assemblies are made up into condensers one would think (if he had not been thru the mill himself) that they would all be exactly

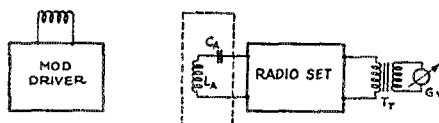

Fig. 2 The arrangement used to adjust the balancing condensers, and the alignment condenser, also to measure the overall amplification of the receiver. The parts inside the dotted line constitute a dummy antenna. The transformer  $T_r$  is used to adjust the  $4\frac{1}{2}$ -ohm thermogalvanometer to the high impedance of the last tube's plate circuit.

alike. Every condenser manufacturer knows that this is the last thing which will happen. With the most careful work in the making it is still necessary to classify the finished condensers into "high," "standard" and "low" capacity condensers with an occasional reject. There are several possible ways of doing this. In one factory it is done by bending adjustable plates in the number two and number three condensers after the receiver has been assembled and after a preliminary adjustment has been made by slipping the couplings between the condensers. In the present case, the condensers are classified before being put into the receiver and for any one receiver both of the paired condensers are taken from the same class while the input tuning condenser can be anything except a reject. The process of matching condensers is simple enough. The two condensers are now connected to the 1000-cycle bridge shown in Fig. 1. The slider of the resistance arm is set at center scale and the test condenser rotated until a null point (no sound in the phones) is obtained.  $C_x$  now equals  $C_s$ . Now the condenser shafts are locked together by a chuck and the two rotated together over the whole scale. A difference of 1% between the two condensers at any point will unbalance the bridge, cause a sound in the phones and rejection of the condenser. When  $C_s$  is at the top of its range the position of the rotor of  $C_x$  determines if  $C_x$  is to be classified as "standard," "high" or "low".

Naturally a gang condenser must have couplings of some sort between its units unless they are initially built on a single shaft and a single frame—which is a process having some large griefs of its own. In the circuit used here this coupling does not require insulation, which is a great mercy.



It must, however, make the condensers run exactly together without causing them to bind in their bearings. One of our photographs shows a coupling devised to accom-

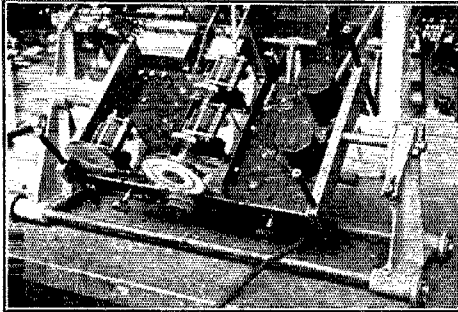

#### ASSEMBLED CHASSIS ON ITS CARRIAGE

Note that the frame carrying the chassis is so built that it can be lifted from the carriage and stacked up with other frames if that becomes desirable during the process. At the left front is the antenna tuning condenser, belt driven from one of the concentric knobs and using one of the concentric dials. The gang condenser occupies the center of the chassis. The audio transformers are at the right.

plish this and at the same time to permit ready assembly. There are several points about the design of the condenser which are interesting in themselves, but have no direct connection with the problem of gang tuning.

#### The Coils

The ordinarily unpleasant problem of building the radio frequency transformers is in this case somewhat aggravated by the presence of a third winding. The aggravation is not as great as one would think, because this third winding has very few turns and they are so located as to have small effect in disarranging the tuning of the secondary if any slight error does occur. One can make radio frequency transformers alike by using very carefully moulded forms of bakelite and winding the wire into carefully-made grooves which fit it exactly. That process is used in a number of seven- and eight-tube receivers, including one made by the makers of the set now under discussion. Manifestly such a transformer cannot be highly precise and also inexpensive. For the five-tube arrangement it is equally satisfactory to build transformers by the usual scheme of winding wire on impregnated tubing and securing it with a good varnish. With decent care the transformer is entirely permanent and reasonably like its mates. One then classifies these transformers by an r.f. inductance test and in any one set uses transformers of the same class

#### Assembling

The audio transformers are assembled by processes that are to some degree familiar to every reader. Frankly, I do not know what tests are made at the Bosch factory—it didn't occur to me to ask. At other factories various tests are used to make sure that the windings are correct as to continuity, number of turns and connections, also a few make tests for short circuited turns. These tests, of course, depend on the extent to which the set maker thinks them necessary. In the process used here it would not be fatal if a bad transformer did manage to sneak by—the final tests would catch it before the customer ever saw it.

Very well—the principal parts are at hand, the condensers, the r.f. transformers in their copper cans (each tagged as to classification), the a.f. transformers and, of course, such small deer as sockets, binding posts, etc. The wire has been worked up into a cable assembly by magicians who work with a batch of spools of colored wires and a board with projecting pegs around which these wires are hooked and bent before being "laced" into a small cable with waxed cord. The completed cable is stripped off the pegs, the ends skinned and the thing is done. It has taken less time than the telling—much less than it would take one of us to do it. Now these parts must go together and become a set.

#### The Traveling Carriage

The bare metal chassis that is to carry the set is now clamped to a sort of metal carriage to which the chassis is attached

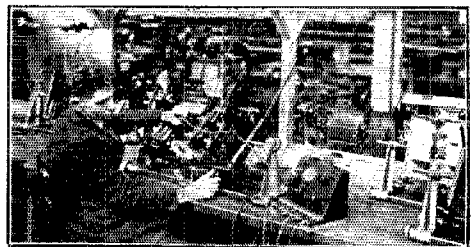

#### THE CIRCUIT TEST

The ends of the battery cable are put in the spring clips at the front of the test panel and the plug on the end of the flexible cable is successively plugged into different sockets. By operating the switches on the test panel every connection except those to the tuning condenser stators is tested.

in such a manner that it can easily be inverted without touching anything and yet can be clamped in any position in a moment. Chassis and carriage now start at one end of a slowly-moving belt which runs along before the people who will make the set. The carriage stands crosswise of the

belt—that is to say, the carriage wheels are so turned that the operators (before whom the belt passes) can wheel the sets off and on the belt readily, but not along it—the belt does its own lengthwise transporting.

The exact order of the procedure from here on does not matter to us. It is enough to know that the first operator hauls the chassis off the belt, attaches a few things and pushes the carriage back on the belt which carries it off sidewise to the next operator, where another contrivance or two is put on. So the carriage progresses down the long table and arrives as a set—all complete but the case. This is known as progressive assembly. Progressive assembly has become rather general in modern manufacture because each operator performs some operation and none other, thereby becoming very quick and skillful. It is, of course, important to divide the whole process into such separate operations that each will take the same time, thereby permitting the product to flow smoothly thru the plant. The mechanical inspections and electrical tests must progress at the same speed—and yet be thorough. At three points along the belt there are mechanical inspections. If anything is wrong the in-

**Final Tests**

Another test is made at the end of the long table, where the set is received by an operator who has a set of spring clips, a battery and a voltmeter, all of which can

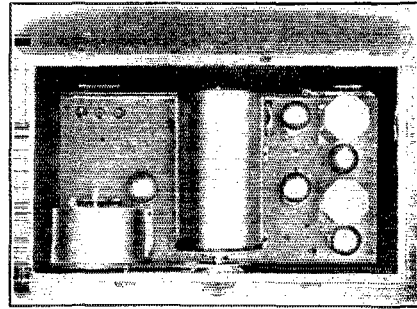

**A VIEW SHOWING THE COMPLETELY SHIELDED SET**

be connected to the battery cable of the set by very few motions. By operating the switches on his test panel this operator can very rapidly check thru all the continuities of the set and locate any mistakes or damage which may have occurred during assembly. In this way it is possible to catch injuries which would be very puzzling to the user. I am referring to such things as “rosin joints” which look all right, but don’t carry electricity to fixed condensers which tested o.k. before assembly, but were damaged in soldering and to accidental misconnections which may simply cause the set to be unsatisfactory instead of actually “dead.”

This may seem like a very gloomy picture. The reader should not get the impression that a constant search for trouble necessarily indicates that trouble is always being found. Quite the contrary; the more careful and frequent the inspection processes the better are the chances of finding trouble before it ever occurs, in other words, finding out what causes the trouble to creep into the process. That is why expensive inspection appears to be considered the most economical kind in the making of modern radio receivers, and most other manufactured things for that matter. Errors inside a factory are expensive, but they hurt much worse if they ever get outside and that is why any manufacturer who has any regard for the future or any pride in his product

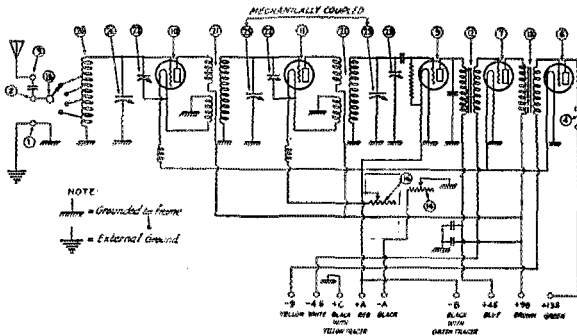

**FIG. 3. THE SCHEMATIC CIRCUIT DIAGRAM**

- 1 Ground terminal post.
- 2 Short antenna post.
- 3 Long antenna post.
- 4 Loud speaker terminals.
- 6 2nd audio tube.
- 7 1st audio tube.
- 9 Detector tube.
- 10 1st r.f. tube.
- 11 2nd r.f. tube.
- 12 & 13 Audio transformers.
- 14 Filament rheostat.
- 15 Antenna tap switch.
- 16 Amplifier control. (Filament rheo for 2nd r.f.)
- 20 Tapped antenna input coil.
- 21 R.F. transformers.
- 22 R.F. balancing condensers.
- 23 Detector aligning condenser.
- 24 Input circuit tuning condensers.
- 25 Mechanically coupled tuning condensers.

spector looks at the identifying card attached to the set and returns the set to the operator at fault, who must remedy the error.

will supplement all of the other inspections with a very thorough final inspection. If one is talking about radio receivers the inspection should naturally be designed to make sure that the receiver will receive.

#### Amplification Test

Walking along sideways on the belt after escaping from the circuit test man the carriage takes the set thru a little window into a sort of solitary cell, where an operator adjusts the two balancing condensers. He also adjusts an equalizing condenser which is connected across the third tuning con-

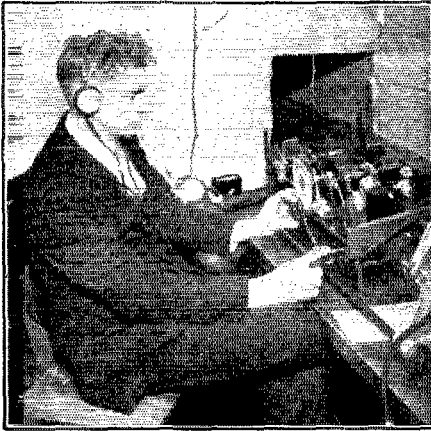

**THE BALANCING AND GAIN-TEST BOOTH**  
After the operator has made the balance and alignment tests his headset is disconnected and the output meter used instead.

denser so that the two sections of the gang condenser can again tune exactly together after having been somewhat upset by the wires and other things which have been connected to them and by the adjustment of the balancing condensers. The two balancing condensers are adjusted, one at a time, until neither stage oscillates. The process of doing this is not particularly different from the well-known neutrodyne adjustment and need not be described here even though the principle of operation is materially different.

The receiver is now in an operative condition, but one still does not know if its sensitivity and selectivity are up to par. It is, for instance, just conceivable that something may have gone wrong in one of the radio or audio transformers whereby the gain in that stage will be much reduced, as will also the selectivity if it happens to be a radio stage. Possibly one of the fixed condensers is not all it should be or perhaps a socket spring or grid leak clip makes poor contact. None of these things are easy to see, even when one has a great

deal more time than is available in a busy factory. Besides that, it is very easy (this is one of the things that worries factories the most) for a product gradually to get more and more away from a standard, the thing happening by such slow degrees that it is hardly noticed until too late. These things very thoroughly excuse a careful final test under performance conditions.

Do not imagine the factory manager taking a truck load of sets home every night to try them on the evening's broadcast programs. Even if it were humanly possible to handle such a test one would learn nothing except in the rare case of a completely dead set. What one needs is a standard signal that will be the same day after day and that will always be on tap. That is why the laboratory moves into the factory, adapts its methods to quick action and sets the apparatus up in the solitary cell, where the balancing is done. Because of the balancing process the set is already connected into the circuit of Fig. 2. Here a true radio signal is being fed to the set, therefore it is only necessary to set the balancing condensers and then to run up the volume control (fil. rheo. of second r.f. tube) and to measure (not listen to) the output of the last audio tube by the scheme shown in Fig. 2. This is done at 250 and 500 meters. If the output is not satisfactory the set goes to the trouble bench. Here the trouble is identified and cured, after which the set must face the final tests and inspections once more.

After that the set is also listened to, the combination leaving a negligible chance that anything is wrong. The choice of a low modulation frequency is made to assist in exposing the rare defective audio transformer thru which a high-pitched signal might pass fairly well.

The set, as a manufacturing proposition, is now almost thru. It is ready to go into a case, after which the output is measured once more as above, though in other booths. Then the set is packed and shipped. When that happens it has come into the field of merchandising and I am quite certain that some one else must tell its story.

**Strays**

In cooperation with a number of radio manufacturers and dealers, the National Better Business Bureau, Inc., has prepared tentative standards of radio advertising and selling for the purpose of keeping this business in a healthy condition. The proposed standards are available in booklet form by addressing the Bureau at 383 Madison Avenue, New York City.

# How Our Tube Circuits Work

## No. 2—The Armstrong and Meissner Circuits\*

By Robert S. Kruse, Technical Editor

**T**HE first article of this series started to be short and wound up by being long. That was necessary because it took so long to get the tube oscillating; it always takes longer than one expects. This time we have it going and can make our circuit changes without ever letting it stop for more than a few minutes. This should save time and therefore it may be possible to talk about two circuits that are almost the same in action at short waves, though they are not the same in theory.

First we will go back to the "plain audion" circuit of Fig. 1A, which is the same circuit shown under that number in the first article. You will remember that we turned circuit 1A into circuit 1B and then we turned circuit 1B into 1C and then made 1C oscillate. If you have not read the first article we only need to say that 1C is the familiar receiving arrangement which was first shown in *QST* in 1917, then forgotten for a few years and finally turned up again all over the world as a "new circuit". We all know it oscillates and that's all that matters here. Figures 1C and 1D are the same thing, as some of you will remember, except that we have made it over into a transmitter—a "one mouse-power" transmitter. You will remember that Figures 2 and 3 in the first article showed how these circuits could be turned into Hartley circuits for transmission. Now let us turn to Fig. 4 and see how the same thing can be turned into a Meissner circuit. We start with 4A which is our familiar plate-tickler circuit of which we just spoke. This will oscillate as we know. If we move  $L_2$  away as shown in Fig. 4B the oscillations stop. It is easy to see why. You will remember that the tube oscillated because we had  $L_1$  and  $L_2$  close enough together so that they acted like a transformer, passing power from  $L_2$  back to  $L_1$ . Of course if we get the two coils far apart as in Figure 4B they stop working as a transformer. As soon as this happens, the whole thing stops business.

### Building the Meissner Circuit

Now it happens that there are several ways of making the tube start oscillating again *without* putting  $L_2$  back again. This may not sound sensible but is easy enough.

Suppose, for instance that we make such arrangement as shown in Fig. 4C. Now we have a transformer-combination at

\*The second of a series. The next will appear in an early issue.

$L_2-L_3$ . The plate coil (that is to say  $L_2$ ) passes power to  $L_3$  and a current flows thru the pair of wires to  $L_4$ . Now  $L_4$  and  $L_1$  make up a second transformer-combination which passes the power to  $L_1$ . Everything then proceeds as before and the tube oscillates. The weakness of this arrangement is that the "link circuit" with its two coils is not a tuned circuit and therefore the high frequency currents do not flow easily thru the link circuit. We can improve this matter by tuning the link circuit as shown

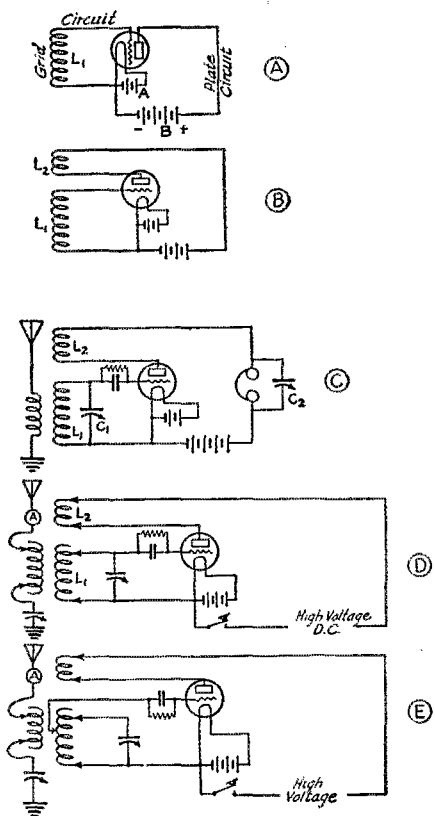

FIG. 1

in Fig. 4D—and then we have the Meissner circuit with a tuned grid coil.

You will remember that in Figure 1 we said that the wavelength at which the tube oscillates is set (fixed, or determined) by the tuning of the grid coil. Now we have

two tuned circuits and must set them together to make the tube oscillate. If we are to use the tube to feed an antenna this will be a great nuisance because then we will have *three* circuits to tune, the grid

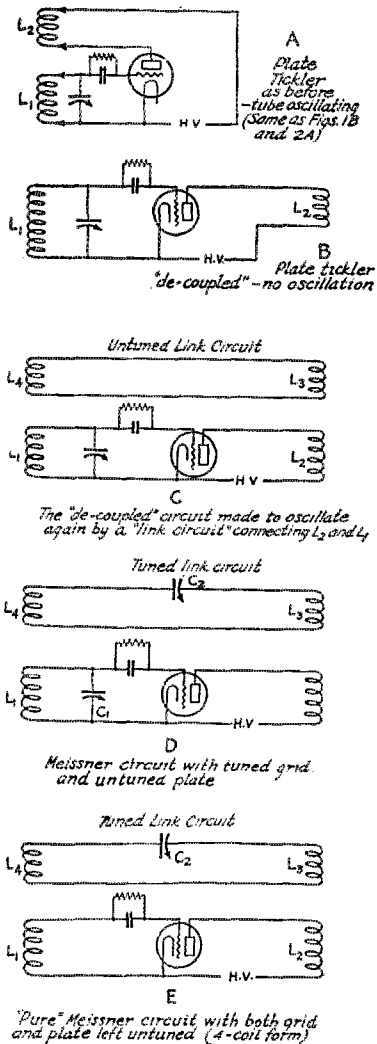

FIG. 4 DEVELOPING THE MEISSNER CIRCUIT  
FROM THE PLATE-TICKLER-CIRCUIT

circuit  $L_1$ - $L_3$ , the link circuit  $L_3$ - $C_2$ - $L_4$  and finally the antenna circuit. We simply **MUST** get rid of one of those tuned circuits. Now we already know that we can work with the link circuit untuned and the grid-circuit-tuned—this was shown in Fig. 4C and we decided it was not a good arrangement. Let us instead try the scheme

of Fig. 4E where *neither* grid nor plate is tuned—the only tuning being in the link circuit. It turns out that this works very well and that the link circuit controls the wavelength very nicely if one does not try to work on too short a wavelength. Just how far down the circuit will work depends on the tube used. The 203-A will not go very much below 80 meters before beginning to make trouble but the 204 (not the 204-A on which I have no information) will get down easily to 50 meters while the old 202 will work down to 30 meters quite easily and to 20 with a little urging. The 210 gets down almost as well.

### How the Meissner and Hartley Circuits Go Wrong

Naturally one wonders *why* the circuit will not go down below a certain limit and as the answer is almost the same for the Hartley and Meissner circuits we may as well talk about it here.

Suppose that we begin with the fundamental Hartley circuit of Fig. 2, which we are showing again as Figure 5A. We will now try to see how far down as to wavelength we can make this thing work. We will move grid clip 1 down and plate clip 3 up until the tube refuses to stand more of this operation. Then we will cut down the capacity of  $C_1$  and finally we will disconnect it and take it away—but the tube will keep on oscillating, even when we have cut it down to the bare fragment shown in Fig. 5B.

Now what keeps it going? Where is the tuning condenser? Easy enough—the tuning condenser is the small capacity between the grid and plate of the tube itself; the little capacity located where the arrow points in Fig. 5B.

We are down to 15 meters or so now if this is a 202, perhaps 18 meters if it is a 204 and finally we might even persuade a 203-A down into the 20-meter band. We can cut down a little bit more by some tricks but the tube performance will not be anything to brag about—also there are better ways to do the thing.

Now let's try the same thing on the Meissner circuit, beginning with the "Pure Meissner" which we will show again as Fig. 5C. To cut this down we will make all 4 coils small and make the tuning condenser  $C_2$  smaller. As we come on down something finally happens—the tube keeps on oscillating but the condenser  $C_2$  no longer controls the tuning. Below a certain wavelength the tuning condenser simply has no further effect—the tube works at one wavelength and no other. Now what has happened? Simply this—the tube has gone to work in another fashion, a fashion in which it is controlled NOT by the link circuit but by

the series circuit thru the tube itself. We have been saying that the grid and plate circuits are not tuned, and that was near enough right when we were working at a fair wavelength but now we find that it IS tuned to a SHORT wave because the coils  $L_1$  and  $L_2$  are connected across the plate-grid capacity we talked about just a moment ago in connection with the Hartley circuit. No matter what we do to the link circuit we can't make the tube circuit work any further down.

So much for this particular snag—now let's move on to the more profitable business of making the Meissner circuit practical.

### The Practical Meissner Circuit

It is rather easier to make the Meissner circuit practical than was the case for the Hartley circuit of the last article—provided one does not care to work below the 80-meter band. Below that, the circuit is troublesome because the capacity between the different coils makes up all sorts of

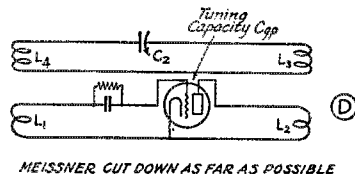
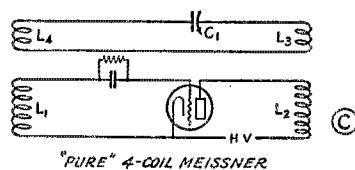
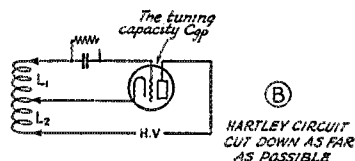
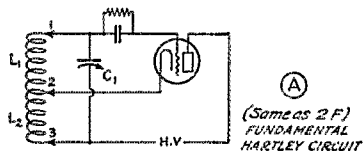

FIG 5 HOW THE HARTLEY AND MEISSNER CIRCUITS GO WRONG

extra circuits that one cannot see and that are a great nuisance.

Figure 6B shows the use of the antenna itself as the link circuit. This does not

work very well unless the antenna is loaded—and very few antennas work that way these days. For this reason we need the link circuit and keep it as shown in the following circuits. With this one change the dimensions shown in Ballantine's "Radio Telephony for Amateurs" can be used on any 150-200-meter transmitter. The ones

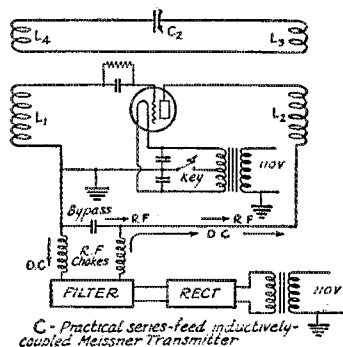
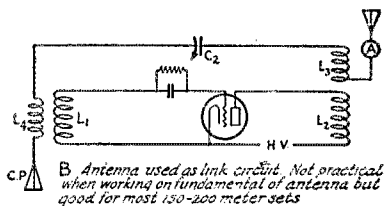
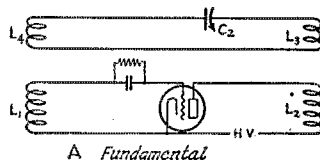

FIG 6 - DEVELOPING THE PRACTICAL MEISSNER CIRCUIT

working in the 80-meter band will use somewhat smaller coils and condensers. Ballantine by the way, shows the "3-coil" form in which  $L_3$  and  $L_4$  are combined into a single coil. This is alright at 150 meters but almost unworkable in the 80-meter band.

Figure 6C shows a practical series-feed Meissner transmitter of the inductively-coupled sort. Compare this with the series-feed Hartley circuit shown in Fig. 3D of the first article. There is very little difference. The antenna is purposely not shown in either circuit. It can be coupled to the coil  $L_2$  by any one of the 49 different methods we have a habit of using.

No shunt-feed method is shown because the series method is just as good for the Meissner circuit, and simpler.

Sometimes it will be found that better operation can be gotten by connecting a

variable condenser across the plate coil. It will generally not act as a proper tuning condenser but will simply make the tube take more power as the capacity is increased. Which way it acts depends on the tube, the antenna, the coils and the coupling. Try it, if your Meissner set does not seem to work just right.

### The Armstrong Circuit

Probably you have been wondering all this time what has become of the Armstrong circuit. Suppose that we start to "develop" it. Since it is beginning to be a habit to

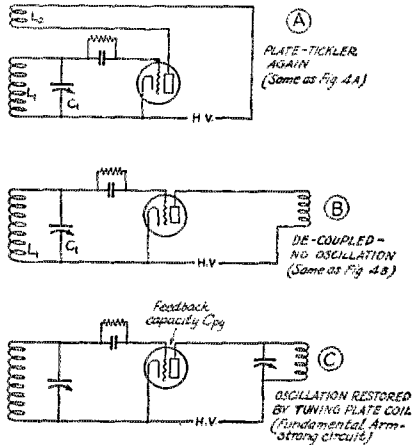

FIG. 7 DEVELOPING THE ARMSTRONG CIRCUIT FROM THE PLATE TICKLER

start with the plate-tickler arrangement we may as well do that again. It therefore appears once more as Fig. 7A. When we de-couple  $L_1$  and  $L_2$  as in Fig. 7B, oscillations stop as before. This time we will start them in a new way—which is really the oldest way of all the ones we have shown so far. This time we do the thing by so simple a thing as connecting another condenser  $C_2$  across the plate coil and tuning that also. There isn't the least doubt in the world that the tube oscillates—the very poorest sort of a tube will generally manage to start with this circuit (tho its performance may be unsatisfactory)—but it isn't at all clear at the moment *why* the thing oscillates. There isn't any such transformer action as we had in the Hartley circuit or the Meissner circuit and there must be some new sort of action, even tho the circuit looks almost like that of Meissner. The bug under the chip is the same old grid-plate capacity that was getting us into trouble a little while ago. This time it is helping.

### How the Armstrong Circuit Operates

Suppose that we use a UV-202 tube and tune the  $L_1$ - $C_1$  circuit to 180 meters. (I am

perfectly willing to tune it to 3 meters if you say so because this circuit is a star at getting down to short waves.) The tube does not oscillate. Now we start turning the condenser  $C_2$  and after a while the tube starts oscillating. We will find that the wavelength isn't far from 180 meters and that the plate circuit (meaning  $L_2$ - $C_2$ ) is tuned fairly closely to this same wavelength.

What has happened is something like this. Our tube has somehow had a little current surge in the grid circuit. Any little surge will do and they are always present in every circuit. Being a good amplifier, the tube promptly passes this surge on to the plate circuit—but amplified. So far, so good—but the surge does not die there, it sets the  $L_2$ - $C_2$  circuit to oscillating and a little of the high-frequency energy from there passes back to the grid by way of the little grid-plate condenser (the capacity between the plate and grid) that we just spoke of. If the  $L_2$ - $C_2$  circuit is tuned to the same wavelength as the  $L_1$ - $C_1$  circuit, then this "amplified and returned" energy will arrive at just the right moments to get the grid circuit to swinging heartily—and the tube is oscillating.

### Practical Modifications

As usual, when one starts to put the circuit to work several difficulties turn up. The first of these (especially for the 203-A tube in the 40- and 20-meter bands) is that the tube takes far too much plate current when the two circuits are tuned to the same wavelength. The difficulty is probably caused by the large grid-plate capacity of this particular tube which permits excessive feedback, which causes the grid to be over-excited. This seems especially likely since a prompt cure is usually possible by the modification shown in Fig. 8A. Since the grid condenser is in series with the grid-plate capacity it can be used to cut down the excessive feedback. The grid leak has been connected direct to the filament so as to keep from shunting the condenser—but this is probably not a good idea, especially as it calls for an r.f. choke and none of us seem to know anything about them. Incidentally, I am not too sure of the reasoning as to the excessive feedback—but the cure works very well.

Of course a very simple way to get around this thing of having an excessive plate current is to mis-tune the plate circuit or grid circuit. The trouble with this is that one has a good chance of having the tube go scurrying from one wave to the other, frantically trying to accommodate both circuits and either managing to be unsteady and to produce a rough note or else producing two wavelengths, both of them unsteady.

At wavelengths below 30 meters, one begins to notice more and more another



effect which isn't in the book. This is an unreasonable wish on the part of the tube to ADD the capacity of  $C_1$  and  $C_2$  before deciding what wavelength it prefers to work at.

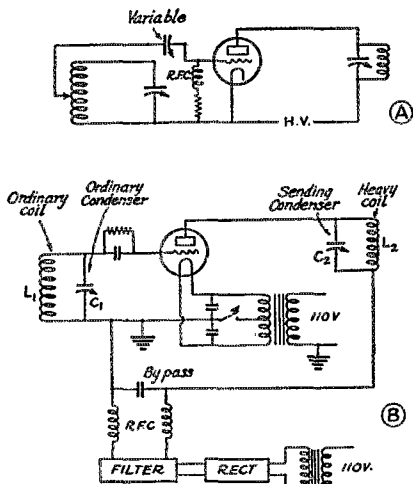

FIG. 8 PRACTICAL ARMSTRONG CIRCUITS

As far as the tube is concerned it will work at 6 meters with  $C_1$  at 30 and  $C_2$  at 70 or with  $C_1$  at 80 and  $C_2$  at 20—or with both of them at 50 or one at 0 and the other at 100. This annoying effect becomes very prominent below 15 meters, both with the Armstrong circuit and with the Vallauri-Mesny circuit, which is a circuit we will come to later. At 5 meters things act exactly as if the two condensers were in parallel and the readings of the condenser scales become almost senseless, therefore we have found it desirable to go to the ancient "Ultraudion" which has only one tuned circuit and will work at least as far down as the Armstrong circuit—2 meters easily with a UX-210 tube. That circuit also we will get at later.

In the Armstrong circuits used in Amateur stations the two tuned coils are usually made almost alike. There is no special need for this as the power in the grid coil is much smaller so that a small coil tuned by a more compact (tho just as good) condenser is perfectly O. K. For instance the little General Radio 247-W trap and wavemeter makes a good tuned-grid circuit for 5 and 50 watters while a sending helix and sending condenser must be used in the plate circuit. This at the same time gives one the working wavelength automatically—provided one has first made sure that the "capacity adding effect" isn't present. Usually it isn't at 80 meters and it is quite unlikely to be very bad at 40. In the 150-meter

band it isn't noticed, I think. At 5 meters we have no wavemeters, so everything is alright except in the 20-meter band.

The dotted arrow in Fig. 8A is supposed to indicate that at times it is better to connect the grid to a point somewhat below the top of the grid coil. This sometimes helps to reduce the power taken by the tube.

The circuit of Fig. 8B is a practical transmitting circuit. It will be seen to look very much like the Meissner circuit of 6C. This is quite as it should be; all of these sending circuits are related and with a few exceptions any one of them will do all the jobs any other one will do—and do them just as well.

## A DIRECT RADIO-CONTROL RELAY

(Continued from page 21)

of a sample tube of this sort is 10,000 ohms, the filament draws  $\frac{1}{4}$  ampere at 5 volts, the amplification constant is 9 and the plate resistance varies thru the limits mentioned above.

Circuits for use with this sort of tube are shown in figure 3, which also shows the I/E characteristics of the wire used to make the grid which serves as anode, taking the place of the usual plate. It will be seen that this is wire having "ballast resistance" characteristics.

## A.R.R.L. Information Service Rules

Please help us by observing the following rules:

1. Keep a copy of your questions and diagrams and mention that you did so.
2. Number the questions and make a paragraph of each one.
3. Make diagrams on separate sheets and fasten them to the letter.
4. Print your name and address (not merely your radio call) on your letter. Don't depend on the return address on the envelope as this is destroyed when the letter is opened.
5. Don't ask for a comparison of the various manufacturers' products.
6. Before writing, search your files of QST—the answer probably is there.
7. Address all questions to Information Service, American Radio Relay League, Inc., 1711 Park Street, Hartford, Conn.
8. It is not essential to enclose an envelope as long as you supply postage and PRINT CLEARLY your name and address on your letter.

# Experimenters' Section Report

**T**HE management of the O.W.L.S. system has not changed although the "center of gravity" of the system has suddenly shifted to the west coast. K. V. R. Lansing, in charge of the standard frequency stations has removed to California and may be addressed 2227 Lakeshore Ave., Los Angeles. D. C. Wallace, chairman of the O.W.L.S. committee has also moved to "the coast" and may be addressed at 109 West 3rd street, Long Beach, California. The loud signal signing 6AM is backed by the same equipment that formerly worked at 9ZT.

—R. S. K.

## 20 Meters Transferred

There seems to be practically no experimental set building and test work in the 20-meter band (problem 29). What work is being done is purely of a contact and traf-

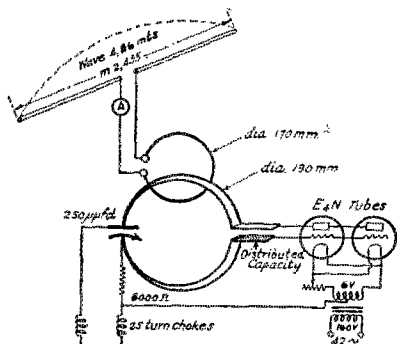

FIG 1

TRANSMITTER CIRCUIT USED AT 1ER. EXACT WAVE 4.86 METERS

fic-handling nature and it is believed that this can be much more effectively handled by the department which is designed to deal with such contacts. Reports on such work will hereafter be handled by the Communications Department which is in better position to do work of that nature.

We regret very much the fact that no more interest was shown in transmission tests and in the design and construction of receiving equipment. Most of the members devoted their time to unorganized transmission and while this was in a way important the improvement of receivers was considerably more so.

In its present form we believe the problem will receive its greatest impetus under the Communications Department and we are therefore cancelling it as an active X-section problem. Those members listed

under T-29 will be sent the bulletins of the Communications Department concerning this kind of transmission and reception. We would like to have any suggestions you may make on this subject.

—H. P. W.

## References on Directive Transmission

A most interesting description of the new 26-meter Marconi "beam" station appears

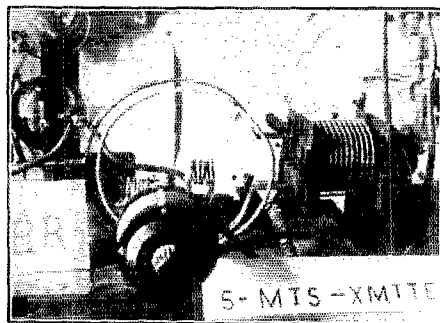

5-METER TRANSMITTER AT 1ER

in the November 3 issue of Wireless World. It should not be overlooked by anyone working in the 20- or 5-meter bands. This is a station of the type having two straight rows of vertical antennas, the one set being excited while the other set acts as reflectors. The transmission is at right angles to the lines of antennas.

The parabolic type of reflectors has been discussed in several articles appearing in QST and other radio publications. Of these the 5-meter and 20-meter experimenter may

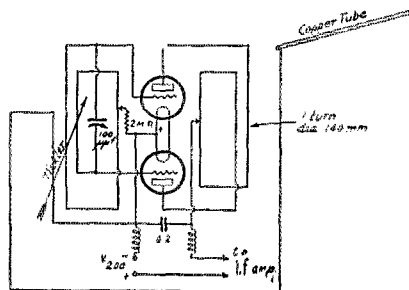

FIG 2

RECEIVER USED BY CAPTAIN FILLIPINI

find the following useful. 3-meter and 5-meter reflectors may be based on the article appearing in the leading position of the

QST for May 1925 or the one on page 13 of Radio for November 1925. The leading article of November 1925 Radio discusses both the parabolic and the parallel row systems.

For those who read German readily there is a very excellent article on the general subject of directive transmission in the September 1926 issue of the Jahrbuch der Drahtlosen Telegraphie und Telephonie. The article is by A. Meissner of the Telefunken company and contains information of the greatest practical interest. The article will be abstracted in the next issue of QST.

#### The 1ER Results Confirmed

Herewith are photographs and circuit drawings giving details of the 5-meter transmitter and receiver used in the tests from Italy to Tripoli which have been reported before and which are now definitely con-

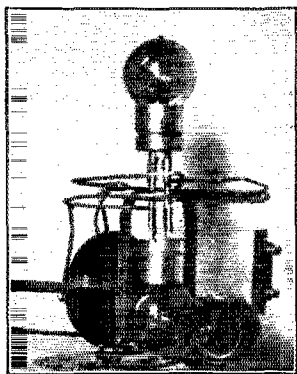

5-METER RECEIVER AT 1ER. A SIMILAR ONE WAS USED BY CAPTAIN FILLIPPINI

firmed. Ing. Santangeli Mario is very anxious to obtain further 5-meter schedules of some duration with stations that intend to keep strictly to the schedules. Such schedules should be made 6 weeks ahead and this Section notified so that bulletins may be mailed. Remember the *start* of the schedule should be 6 weeks after we are notified. The tests may run for any time that is desired though about 30 days is usually enough. Letters to 1ER will be forwarded through this office if desired.

#### 5-Meter Work in General

Evidence is gradually accumulating as to the things we may expect from 5-meter waves. They seem likely to have communication value when used at the proper time and for the proper distances. As soon as these things are a bit more definite they will be presented through QST. An article on some workable receivers appears elsewhere in this issue. A bulletin on a calibration method for 5-meter wavemeters is being prepared for mailing to all 5-meter men and will be sent on request to others also. —R. S. K.

## New Transmitting Condenser

THE two condensers shown in the illustration are the new adaptations of the General Radio type 334 receiving condenser, made for amateur transmitting

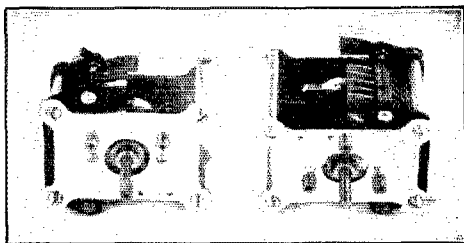

circuits. The condensers are double-spaced 334 receiving ones, having a capacity of 50 and 100  $\mu\text{fd}$ , respectively. They are of the aluminum end-plate type with hard rubber insulation. The plates are of lacquered brass with the familiar General Radio soldered plate construction. A counterweight is supplied, it being impossible to use the G-R vernier of the rear-end gear type on a transmitting condenser. As the plates are widely spaced they make excellent short-wave receiver condensers, the capacities remaining quite constant. They will withstand a voltage of 2,000 and are very compact.

—J. M. C.

## Strays

From Madison, Wis., comes the announcement of the engagement of Miss Josephine Schaub of the Burgess Battery Company to one Donald H. Mix of 1TS-WNP fame, and now 9EK-9XH. Mix first became famous when operating 1TS at Bristol, Conn., several years ago. He almost always turned in the longest list of Calls Heard to QST—so much so that he soon became dubbed "The Sleepless Wonder". As operator on the first McMillan-Bowdoin-North Pole expedition he was first to carry amateur radio toward the North Pole, where he distinguished himself gloriously. Since his return from the Bowdoin's first radio-equipped trip Don has been with the Burgess people, both at Burgess Isle and at Madison. Our heartiest congrats to both.

SMG has taken up aviation. It is reported that he is going to get some first-hand information about this Heaviside Layer business.

1BGC calls our attention to a Ham-Ad in which a swap of a B. C. L. receiver for a shotgun is offered. Wonder who the ham is!

## Standard Frequency Transmission in Australia

By H. A. Stowe\*

**H**AVING noticed pieces in *QST* regarding the transmission of standard frequency signals in the U. S. A. I thought perhaps the amateurs over there might be interested in what we are doing in that line.

Australian 2CX is a medium power station employing a pair of twenty-watt Phillips 22A tubes with an input of approximately 50 watts. The plate supply is taken from the a. c. mains, transformed to 1200 volts and rectified by a pair of ZG2A Phillips rectifier tubes. The transmitter employs a modified Colpitts circuit with the addition of grid modulation for telephony. All condensers, transformers, etc. (also one of the meters) are home-made. The transmitter was designed to carry out the standard frequency work of the Wireless Institute of Australia, before the Institute's own station 2WI was built, hence it had to cover a large frequency range. The station has had little time for long distance work although it has been heard on both c. w. and phone in all states of the Commonwealth and N. w Zealand, also recently in the U. S. A.

The Institute's own station 2WI is constructed for service rather than experimentation. It employs a Hartley circuit magnetically coupled to the antenna. Two Marconi 250-watt tubes are used,

amplifier employing a transformer-coupled 201-A is used for phone work. Provision is made for l. c. w. and also for connections

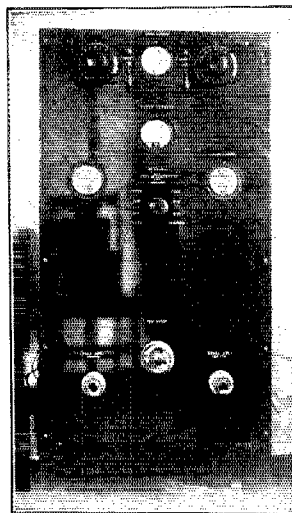

THE NEW 2WI TRANSMITTER

to land line, if required for broadcast work.

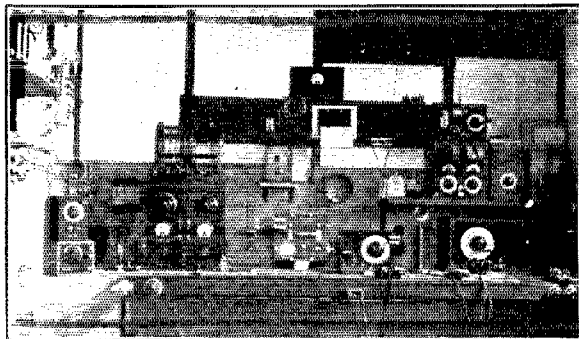

AUSTRALIAN 2CX AND SOME OF THE EQUIPMENT USED FOR CALIBRATION WORK

one as an oscillator and one as a modulator, using the Heising system. The plate supply is from a. c. and is rectified by two Marconi MR1 rectifiers. A speech

\* "Rawene," Royal Street, Chatswood, N. S. W., operator Australian 2WI and owner Australian 2CX.

This station was the first in Australia to send out calibration waves for the benefit of experimenters. It was done under the auspices of the New South Wales division of the Wireless Institute of Australia. It is now handling standard frequency work and general traffic between the various divisions of the Institute. At present standard frequency signals are sent out one night a week at ten p. m. S. M. T. on c. w., buzzer and phone as shown in the schedule further along in this article.

The changing of wavelengths during the standard transmissions takes about 60 seconds. This, I think, compares favorably with the work in other countries. A clockwork key is used to send the schedules. It is supplied with the disc bearing the letter for that particular schedule and is allowed to run during the schedule. Those hearing the schedule can identify it by the constant repetition of the one letter.

The station is housed in a separate building specially built for the job. This building is also the official calibration sta-

there is a single wire from the top of the mast straight into the cabin for receiving. A common three-wire counterpoise is used for both transmitting aerials.

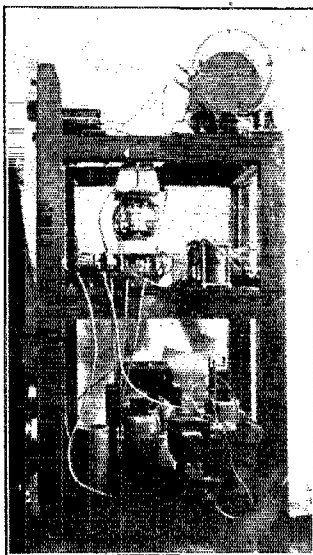

**SIDE VIEW OF THE 2WI TRANSMITTER**

The S-tubes shown on the lower shelf have now been replaced by the MRI rectifiers mentioned in the text, to permit the use of higher power.

tion of the New South Wales Division of the Institute and contains a Jewell valve-testing set, besides a General Radio pre-

**Schedule of Standard Frequency Transmissions from 2WI**

	Wave length. Meters	Code Letter	K. Cycle Rating.
1st Tuesday in Month	260	R	1157
" " " "	240	P	1250
" " " "	220	O	1364
2nd " " " "	200	N	1500
" " " "	180	M	1667
" " " "	160	L	1875
" " " "	140	K	2144
" " " "	120	J	2500
3rd " " " "	100	G	3000
" " " "	80	F	3750
" " " "	60	D	5000
" " " "	40	Y	7500
5th " " " "	30	B	10,000
" " " "	20	A	15,000

cision wavemeter and the oscillators necessary for wavemeter calibration. Another wavemeter near the receiver is used for checking the wavelengths of other transmitters that are heard. The receivers consist of a short-wave c. w. receiver and a honeycomb coil broadcast receiver. A two-stage audio amplifier can be used on either set.

As the range of frequencies covered is considerable the station has three aerials suspended from a 96-foot mast. One is a two-foot cage 200 feet long for the 250-meter band, another is a single wire 60 feet long for the 90-meter band and finally

**Strays**

Don Wallace of 9ZT-9XAX fame has moved to the West Coast, being now located at Long Beach, California. His new call is 6AM (not 6AN, as mentioned in November QST) about which Wallace says, "6AM is local standard time, the best time to work 6AM is 6AM LST regardless of whether you are in Singapore, Africa or other foreign countries such as the East Coast." Hi!

Howard Mason of the Seattle Radio Lab (and 7BU) tells us that he is building a 7½-watt transmitter of the plug-in variety for the 7th District Supervisor of Radio's office, the first ham transmitter to be in a Radio Inspector's office we have heard of. The call will be 7RI.

G-2BMM warns us that all British amateurs with a 2-plus-three-letters call are licensed to use artificial or dummy antenna only. So do not write any of them for schedules.

On page 24 of December QST we ran a Stray announcing a free log distributed to amateurs by the Burgess Battery Co. So many requests from non-amateurs or would-be amateurs have been received that "FS" out at Burgess' requests us to say that the log can be sent only to licensed radio amateurs who include their calls when writing.

"Dear Eddie: What part of a transmitter is most likely to cause trouble — The nut that holds the key."

The UG, US, UR, UW short wave calls being heard every night belong to stations of the Tropical Radio Telegraph Company (United Fruit Company). Most of these stations are in Central America. It is understood that the big UniFruit station at New Orleans (WNU) is about to do some short wave transmission also.

It seems that some fellows never tire of pounding brass. Ralph Venegas for five years has been manager of WSA one of the busiest 600-meter stations in the world. Venegas pounds brass at WSA all day long then goes home and makes his 2WH do its stuff. Incidentally, 2WH cleared an enormous amount of KEGK's traffic. Venegas says its a whole pile of fun to work hams on short waves and handle traffic with them, knowing that he could not cover the same distance on 600 no matter what power was used.

## 5-Meter Receivers

By Robert S. Kruse, Technical Editor

**T**HERE is no special reason why a 5-meter receiver needs to be a freak, though enough of us have built freaks that we hardly care to show. The needs of a 5-meter receiver are the same as for a 40-meter receiver with such differences as result from multiplying the frequency by 8. These differences are real enough and on the whole make the building of the tuner more troublesome than is the case at longer wavelengths. Just how each

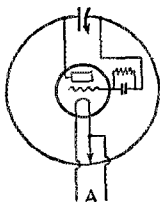

FIG. 1 FIVE METER HARTLEY CIRCUIT

one comes in can be found out most easily by thinking out the construction of a 5-meter tuner that seems to show some promise—and then trying the idea.

Boyd Phelps and I have been through this performance many times, and have watched others at it. We finally have some receivers that are workable in the same manner that the usual 40-meter set is. One of them is shown in the photographs but one must understand that the following is a complete story, attempting to talk about a variety of receivers (about 50) tried by us and others.

### "Hand Capacity"

Most builders of 5-meter receivers start out by worrying about the hand capacity effects that will be met. Just why everyone gets so worked up about this I do not know. It is the very least of the troubles of the 5-meter man and can be dropped *completely* out of the picture by shielding or extension controls. Personally I prefer shielding because it permits a compact set and most of our listening is in the field. It is certainly effective; in the set shown by the photographs one can tune in a battery-driven "pure c.w." oscillator and let go of the knobs without the slightest shift in the beat note. The hands can be laid across the panel without producing any effect at all. Observe that this is true though there is nothing like a complete shield, only a 1/16" brass sheet bent to form both panel and base. This has the incidental advantage

that much wiring can be omitted, the panel serving as a return for the negative B and the positive A lines. If desired a part of the tuned circuit may be run through the panel which is of large area, has extremely low inductance accordingly and therefore sometimes permits convenient changes in construction without especially loading the tuned circuit.

### Concerning Losses and Tuning Range

While a decent amount of care is appropriate in any tuned circuit there seems to me to be very little reason why one should worry about r.f. losses in a 5-meter job, except only in the bearings of the variable condenser of the tuned grid circuit. The coil will always be 1 or 2 self-supporting turns of heavy wire and since the receiver is oscillating the resistance here seems not worth worrying about. The condenser is really worth thinking about, though not just in the way that one would expect. We had a horrible time with the first 20 receivers until it began to dawn on us that one absolutely must not use a condenser with two bearings in metal end plates for the very good reason that the bearings both have some resistance and the resistances change as one turns the condenser. As a result the r.f. current goes

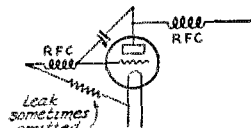
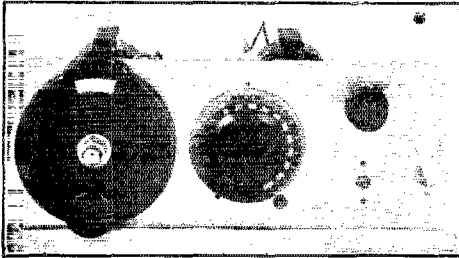

FIG. 2 5 METER ULTRAUDION

sometimes through one bearing and sometimes through the other. This does not matter at 600 meters, it does not do much harm at 40, but at 5 it is fatal for the inductance of the two paths though the condenser frame is not the same and therefore the *tuning* jumps about horribly. So far the best thing we have found is a single-bearing condenser with a phosphor-bronze "pigtail" shunting the bearing so as to keep it out of the argument as much as possible. Unless the pigtail is covered with insulation it must be kept clear of the shaft. In most condensers the pigtail winds around the shaft and when that happens there are fearful noises in the headset. It is easy to see why this is so—the *tuning* jumps about some 10% when 1/4" of pigtail cuts itself in and out of the circuit. Even with the pigtail insulated or

held clear of the shaft, this arrangement is not ideal by any means and must be improved before we are done. Unless the pigtail is very wide it will have enough inductance to cause serious loading in a circuit where the whole wire-length is quite likely to be less than 3 inches. The condensers we have found do not allow room for a wide pigtail. In addition to this even the wide flexible leads do not seem to shunt out the bearing well enough so that we have tried bearings in which the material used

advisable to have such a range as 4.5 to 5.5 meters, and even that calls for something like a 50 picofarad (max.) condenser. One dislikes exceedingly to admit this and perhaps it will not long be necessary, for our good friends in the industry are working up some *real* 5-meter wavemeters of which the first will be ready before this is printed. When they come through we will know the tuning range better and need to allow less slack to make up for inaccuracies. This will permit tuned circuits with a bit more inductance and a bit less variable capacity—the fixed capacity unfortunately will stay fixed until we can get some special tubes. It would be nice if someone were to build an underground railway for the importation of the little Marconi peanuts, “Q tubes” or “V 24 tubes”—I don’t remember which.



ONE OF THE 5-METER RECEIVERS

Front view showing nothing except the fact that the set looks like any other hurry-up compact set. This is a General Radio “standard panel” which is drilled so that almost any G.R. part will fit. This accounts for the extra openings. The panel is not on the market.

is of an insulating nature. So far these have not been well-made but they do seem to be the answer to the noise-bearing problem.

The capacity of the variable condenser to be used depends on the tuning range; naturally. I have several times said that it should be very small, but there is something to be said on the other side as well. Suppose first that we consider a broadcast-range receiver. This will go from 200 to 600 meters with a condenser capacity of 400 picofarads max. When tuned to 200 we find that there is still left a minimum capacity (condenser, socket, wiring and tube) of 25 picofarads. Thus we are getting a tuning range of only 3/1 with a capacity range of 16/1 which should do much better. The difference is due to the distributed capacity of the coil for we are talking about a bad and old-fashioned receiver. Suppose we now start to make a 5-meter receiver and find that when the condenser is turned down to zero on the scale we are tuned to 4 meters, also that the fixed capacity in the circuit is 10 picofarads. Now if we have things no better planned than the broadcast receiver just mentioned it will take a max. capacity of 160 picofarads to carry the tuning up to 12 meters. Of course it isn’t desirable to cover that tuning range for the territory is inhabited by too many kilocycles. However, the inaccuracies of our wavelength standards are such that it really is quite

Mechanical Vibration

The last thing most of us thought of is the thing that has made by far the most trouble in 5-meter work. We assumed that a reasonably rigid job would be o.k. As a rule it is not. In the receiver shown in the photo the secondary circuit is fairly well behaved, being made of a single turn of 1/8” copper tubing screwed to a 50 picofarad

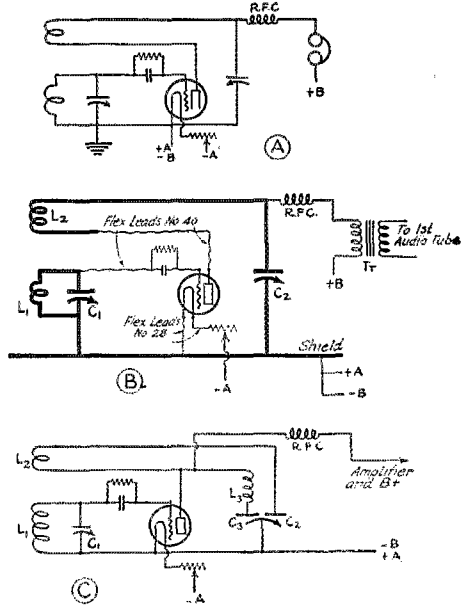

FIG 3

Hammarlund “vernier” condenser. This tubing was heated and dropped into water to make it soft so that it has less tendency to vibrate. The rather “hay wire” plate coil normally surrounds a wooden form which holds it in place—it is rather bad as

shown in the photo. The rule seems to be that the coils must either be wound on a form with wire too soft to have much spring or else wound self-supporting of soft tubing or some such thing. The dimensions, etc., will be taken up later.

Perhaps there has occurred to the reader the possibility of trouble occasioned by vibrations reaching the tube. It is a good guess; unless cushioned well the detector tube is very noisy. The tube in the photo was not well enough cushioned and has since been raised to admit a 1" cushion cut from a rubber bath sponge. Naturally if the tube must be cushioned and the tuned circuit rigidly mounted to the condenser it follows that flexible leads must connect the two. As C. H. West has pointed out, these leads must be very flexible. A few No. 36 wires are about right, especially if made into a loose spiral about 1-16" in diameter, in which shape they have less tendency to vibrate. The circuit should be one such that the leads to the tube are outside of the tuned circuit—at least as far as possible. The receiver in the photo uses the ordinary tickler circuit with the regeneration controlled by a variable bypass condenser. The leads to the detector tube can be struck with a glass rod with no more result than a brief and soft "prrrr." If the detector tube itself is hit there results a terrific row that does not stop for 5 minutes. Hitting the panel produces little effect of any sort.

### Choosing the Circuit

Practically all the circuits tried had bad interlocking between the tuning and the regeneration controls, or else called for a sliding contact which introduced noises that were unbearable after passing through a 2-stage audio amplifier.

For instance there is the Hartley-circuit arrangement shown in Fig. 1. This seems to be very popular in Europe but we have failed completely to get any good work

from it. The slider noise was excessive even with a laminated diagonal-contact slider, also any shift of the slider threw the calibration off hopelessly. This would not have been bad if we had been able to get satisfactory oscillation without moving the slider at every tuning change, but that

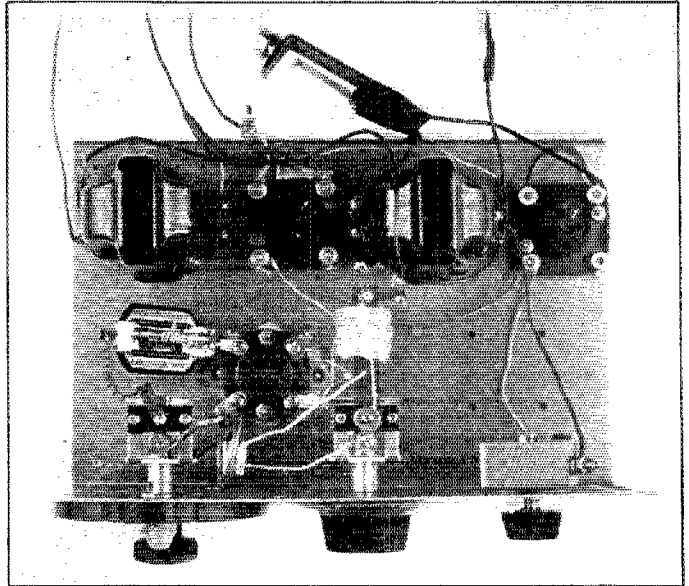

### AND THE TOP VIEW

The same set tilted forward to show the layout. The apparatus at the rear edge of the panel is an ordinary 2-step audio amplifier. The essential part of the 5 meter arrangement is the system at the left front. The vernier dial carries one of the Hammarlund vernier condensers on which is mounted the single-turn grid coil of copper tubing. The plain dial drives the regeneration control condenser on which is mounted a strip of bakelite carrying the R.F. choke and the tickler. The latter is normally wound on a wooden core screwed to the panel. The tickler has 6 turns  $\frac{1}{2}$  the diameter of the grid coil. When the photograph was taken the jack was unmounted since the proper number of audio stages was still unsettled. The grid condenser and leak which seem to rest on the metal base are really carried by the grid terminal of the detector socket.

seemed impossible unless the two halves of the inductance were made into coils and these put near each other for increased coupling—and then the slider had no chance to work.

The Ultraudion of Fig. 2 was given a great deal of a chance. It is beautifully simple, oscillates easily and calls for only one tuned circuit—also has a chance of getting down easily because the tuning capacity is in series with the tube capacity. Unfortunately it seems to necessitate resistance control of regeneration and that in turn produced intolerable noises though these schemes seem to work well enough at longer wavelengths. The absorption-circuit idea was tried but the result was just what one always gets when resonating a wavemeter



to an oscillating circuit—a “click” and silence, all of a sudden.

In the same way the other circuits were tried one after another until it boiled down pretty well to the Armstrong tuned-plate-tuned-grid arrangement and the plate tickler circuit with regeneration controlled by a variable bypass condenser as customary in amateur receivers. The Armstrong circuit is by far the easiest to get action from; almost any tube will oscillate at even 2 meters with this circuit—but the set cannot be calibrated—there are two tuning controls and one never knows if the one is listening at 4.5 meters or at 5.3—it is all guesswork.

### The Circuit Used

The present circuit is the familiar one of Fig. 3A. The actual arrangement in the set is shown in 3B where the extra rigid wiring is shown in heavy lines and the extra flexible wiring in very light lines. The circuit as shown has a share of the usual difficulty, that the tickler condenser C2 has some tuning effect. Three cures for this have been worked out. The first one was the usual one of a small-diameter tickler. This is the scheme used in the set of the photos. The second scheme was to interweave the tickler and secondary so closely that one can “set-and-forget” the tickler over the tuning range. This was done in the Boyd Phelps tuner which is like this one. The third scheme was devised by Phelps and is shown by Fig. 3C. In this arrangement there are two r.f. plate circuits in parallel. One of them is through L2 and C2 and is coupled back to the grid coil L1. The other path is through L3 and C3 and this is not intentionally coupled back. The regeneration-control condenser is a Cardwell two-section affair in which the double rotor has been “jimmied” so that the capacity of one section goes up as the other goes down. The effect is to change the reactance of the two r.f. paths inversely as the condenser is turned but to leave the plate load more nearly the same. The theory of this may be a bit leaky but the practice seems amply good enough so that the device deserves attention at wavelengths well above 5 meters. When using a construction in which the capacity between L1 and L2 was high this arrangement permitted turning the regeneration control for its complete half-turn without ever driving the beat note of a d.c. oscillator out of audibility. Very few 40-meter sets stand that test. Either this scheme or the one of 3B is workable and satisfactory. In addition to this super-regeneration has been tried on the set of the photos but the results have not been entirely satisfactory because of the wearying effect of the steady “variation frequency” howl. Some fairly good results have been gotten with a “variation fre-

quency” of 30 Kc. obtained from a tube and a General Radio “tuned transformer” but the coupling between this and the oscillating detector must be changed and as one can not hear the 30 Kc. oscillation it is hard to tell when the correct adjustment has been made. This is especially true when one is hunting for a “5-meter” signal that is likely to tune in anywhere between 4 and 5.5. This is not quite true super-regeneration anyway. The detector never stops oscillating but only changes the intensity of its oscillations as they are modulated by the 30 Kc. tube.

### Small Parts

In the shunt-fed circuits (such as those shown here) the operation is good only if the r.f. choke coil is good and is solidly fastened down so that it does not vibrate. Various coils have been tried but nothing so far has been an improvement on the little basket-weave coil shown in the photograph. Curiously, solenoids of small wire (spaced apart or close wound) have not been as good as a rule.

The grid condenser seems important. One of about 50 picofarads capacity works well if it happens to be good. Some makes are not reliable while others seem to be steadily good.

The grid leak is a matter of cut and try. Tubes act very much unlike. A general rule is to start with a handful of gridleaks of various resistances and try them until one is found that is quiet and at the same time has the right resistance to give smooth operation.

The antenna may be coupled in as shown for C. H. West's receiver in the December issue or else may be connected to a point of the tuned circuit  $\frac{1}{2}$ " from the low-voltage end of the tuned circuit. In the set shown in the photos the antenna is simply connected to the condenser frame and the coupling is obtained by the drop through the condenser frame to the panel. The antenna may be a long one or a short affair working near the fundamental. Antenna tuning can be added if desired. The long antenna seems to work better if one is to use the condenser method of coupling shown in the West receiver.

### Strays

2EM sends us a neat little cabinet tip which is made of a wood screw having a very large and thick felt head. When screwed into the bottom of a baseboard or cabinet there will be no danger of scratching the highly polished dining room table on which the apparatus may be mounted. The tips are called “Bassick Feltoid Tips” and are obtainable from almost any hardware store.

# A Short-Wave Super-Regenerative Receiver

Edwin B. Dallin\*

**T**HE super-regenerator described in this article is considerably different from the original Armstrong circuit in several ways. Before giving the details of the circuit used, a few words on the theory of operation will be given.

In using a regenerative set of the ordinary type there are two conditions under which it is used. First it is used to receive modulated signals and broadcast programs, where the circuit is not oscillating, but is operated just at the "spill over" point where the sensitivity is at the highest degree.

This gives very great sensitivity but as all of us know the best sensitivity is obtained

amateur. In this case the greatest sensitivity is obtained by reducing the regeneration until the tube is just ready to stop oscillating. By careful design such a set can be made reasonably free from interlocking between the regeneration control and the tuning control—that is the tuning effect of the tickler can be cut down very greatly. Unfortunately this calls for a new tickler for each small band of wavelengths so that the tickler must be changed when the secondary coil is changed. In addition to that, the beat note and the tuning change together—which may be an advantage or a disadvantage, depending on one's views.

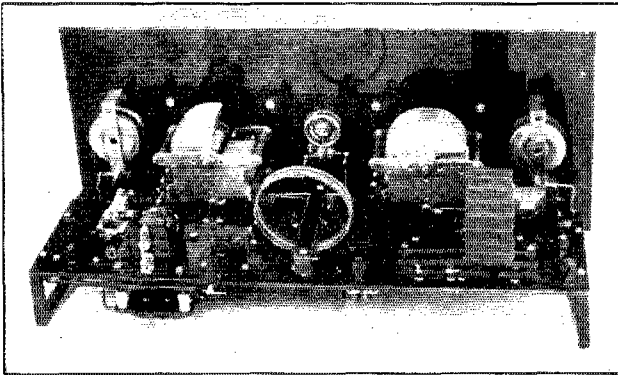

THE DALLIN-HALCO RECEIVER, EMPLOYING THE PRINCIPLES DISCUSSED HERE WITH SOME CHANGES IN THE CIRCUIT

when the tube is just ready to begin oscillating and the regeneration control at this point is very critical, besides varying with wavelength. The sensitivity drops very rapidly as the critical point is departed from. A very desirable improvement on this sort of receiver would be obtained if it were possible to do away with the ticklish regeneration adjustment and to maintain the detector at maximum sensitivity in some other fashion. This would result in a set with a single adjustment—tuning—unless the device for maintaining the detector sensitive had some adjustment.

The second way in which the regenerative detector is used is in an oscillating condition for the reception of c.w. signals. Here the frequency generated by the oscillating tube beats with the incoming frequency to make an audible note. This is the usual receiver used by the transmitting

An ideal combination of the two sorts of receivers would seem to be obtained if we could somehow separate the various adjustments so as to get a receiver that acted about this way.

A—Tuning control having no effect on beat note or sensitivity.

B—Note control having no effect on tuning or sensitivity.

C—Sensitizing device, either automatic or operated by still another control.

Control B could then be used to cut out the beat-note device when one wished to receive modulated matter or radio-phone broadcast where a note is neither needed nor wanted. When receiving c.w. one would

put this device into action. The detector circuit could be tuned without alternating the beat-note and the operation would be extremely stable and satisfactory.

The super-regenerative circuit to be described will accomplish the above and the sensitivity is extraordinary on short wavelengths. Before going any further it will be well to review the meaning of "super-regeneration". In the ordinary receiver we have a tube with controllable regeneration and (as has just been said) we obtain the beat c.w. sensitivity with the tube barely oscillating and the best telephone sensitivity with the tube just below oscillation. Now if a tube is non-oscillating and we increase the feedback suddenly there will be a very small part of a second during which the tube will be extremely sensitive and will give great amplification of very weak signals—but almost immediately it will "flop" over into oscillation. If we now back off the regeneration and repeat the perform-

\* Cruft Laboratory, Harvard University, Cambridge, Mass.

ance we can obtain another split second of great amplification—but again the tube “flops” into hard oscillation. Here would be a good way of obtaining great sensitivity if we would only work the tickler back and forth enough hundreds or thousands of times per second. Perhaps one could do the equivalent thing with a motor-driven regeneration-control condenser, but the receiver would be a rather terrible thing. Fortunately the equivalent thing can be done by wiggling the bias of the detector tube back and forth at a high enough rate, thus throwing the tube in and out of regenerative condition very rapidly. This rate must be rather high because each of the little periods of “super regeneration” is very short and one must immediately afterward take the tube back and get it set to repeat the performance. This “variation voltage” for the grid of the detector tube is provided by an extra tube oscillating at the “variation frequency” that is desired. Some of the energy of this extra tube (which we will call the modulator) is fed into the grid circuit of the detector. The sensitivity increases as the square of the frequency, so that on very short waves the results are amazing, and tuning at 13 meters is as easy as at 80 meters.

The super-regenerative detector circuit is controlled by the modulator which periodically allows the detector circuit to build up in regeneration, almost to the oscillating point and then stops it and allows it to start over again. If the modulator is of low enough frequency the circuit has time to build up to a considerable amplitude before the modulating frequency cuts it off. The choice of the correct modulation frequency (which we called the “variation frequency” above) depends on several things. If it is too high the super-regenerative action does not have time enough to develop before the detector is again cut off. The proper time depends on the wavelength for if the wavelength is short (40 meters for instance) many more oscillations can occur in the same amount of time, therefore the super-regenerative effect can develop much faster. At ordinary broadcast wavelengths (frequently of about 545-1200 Kc.) the super-regeneration is incomplete and the sensitivity poor unless the modulation frequency is kept well below 15,000

cycles (even as low as 200 cycles) and a complicated filter used to get rid of the resulting “squal”. If any modulation frequency much below 15,000 cycles is used a

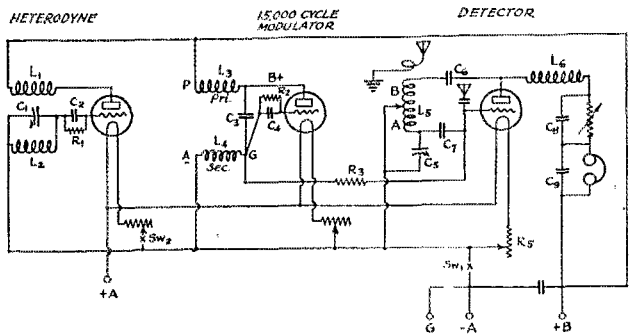

DIAGRAM OF THE SET

- L1 35 turns of No. 26 wire on a  $3\frac{1}{2}$ " tube.  
 L2 53 turns of the same wire on the same tube and close to L1.  
 L3 and L4 windings of a 30 Kc. Acme transformer with 2 sides of the core removed, otherwise two coils of 15 millihenry inductance.  
 L5 Depends on wavelength to be tuned in. See text.  
 L6 R.F. Choke. See text.  
 C1 500  $\mu$ fd. variable.  
 C2 250  $\mu$ fd. fixed.  
 C3 2000  $\mu$ fd. fixed.  
 C4 500  $\mu$ fd. fixed.  
 C5 500  $\mu$ fd. variable.  
 C6 10,000  $\mu$ fd. fixed.  
 C7 250  $\mu$ fd. fixed.  
 C8 1 microfarad bypass condenser.  
 C9 5000  $\mu$ fd. fixed.  
 C10 1 microfarad bypass condenser.  
 R1 50,000 ohms grid leak.  
 R2 5,000,000 ohms ( $\frac{1}{2}$  meg.) grid leak.  
 R3 50,000 ohms.  
 R4 variable high resistance of type used for plate control of tubes.  
 R5 Filament rheostat suited to tubes used.  
 R6 Ballast resistors, such as Amperite.  
 None of the fixed condensers except C3 are critical. The grid condensers may be a little smaller and the others larger than shown. All of these are of mica except C8 and C10 which may be paper condensers of the usual bypass kind. Two antennas are shown to indicate that the antenna may be coupled inductively or thru a small condenser.

steady “peanut roaster whistle” will be heard. This is very tiring and spoils the reception.

At short waves the super-regeneration is very much more rapid in action and a much higher modulation frequency may be used while still getting good sensitivity. This permits placing the modulation frequency at 15,000 cycles where it will not be heard well enough to be offensive.

Under the conditions we are talking about, the detector never really oscillates and will not give a beat note from a steady carrier wave. It is extremely sensitive, however, to any modulated carrier, even when the modulation is slight so that many alleged c.w. stations may be heard because of the imperfect smoothing in their filter systems. This way of receiving is not recommended, however, except for voice or music or for

i.c.w. telegraphy. For good c.w. work a separate heterodyne tube is used. This tube provides the beat note, which is adjusted independently of the detector tuning.

### The Detector

In the diagram shown below, the detector circuit is shown as a very persistent oscillator circuit, a necessary condition for operation. The modulator circuit is coupled to the detector grid through a high resistance

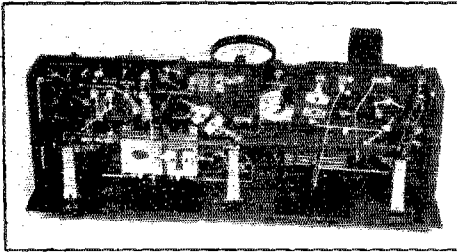

THE CONNECTIONS AND APPARATUS BELOW THE BASE OF THE DALLIN-HALCO RECEIVER of 50,000 ohms, which reduces the effect of the capacity (distributed and lumped) of the modulator circuit, making it possible to operate the detector on a very short wavelength.

The detector circuit is similar to the "throttle" type of receiving circuit but with much larger plate condenser  $C_2$  than is usual for receiving purposes. The coil  $L_2$  is one continuous winding, divided into two parts, A and B. The number of turns will be given further on. The wire should be of a fairly large cross section and the turns should be close together since the coupling is more important than the losses in this circuit.  $L_3$  is a radio frequency choke and so far the Samson Number 85 radio frequency choke is the only one I know of that has no "dead spots" from 15 to 100 meters.  $R_1$  is important and must be smooth in operation. The "Clarostat" gives the best results of any tried as yet.  $C_3$ ,  $C_4$  and  $C_5$  are by-pass condensers to prevent any radio frequency from going into the batteries or phones. The antenna may be coupled by means of a single untuned turn near the set or by means of a *very small* condenser in series between the grid end of the coil and the antenna, but in any case the coupling must be *very loose*.

### The Modulator

The modulator circuit is made up of constants designed to give about 15,000 cycles. The easiest way to make it is to use for  $L_1$  and  $L_2$  an Acme 30 Kc. transformer, originally designed for a super-heterodyne intermediate frequency transformer, but by tak-

ing out the top half of the iron core, which is in two sections, the circuit oscillates at about 15,000 cycles when connected as shown in the diagram. The frequency may be increased by sliding the core out a little from the winding if desirable.  $R_2$  and  $C_1$  insure steady operation and minimum drain on the B battery.

### The Heterodyne

As was said before, when c.w. is to be received a note must be created by the use of a separate heterodyne. The heterodyne oscillator is built into the set, being the tube at the left of the set.

The heterodyne oscillator circuit is coupled to the detector only by being connected to the same batteries as the remainder of the set. The peculiarity of this circuit is that it is tuned to a very much longer wavelength than the detector circuit, if the heterodyne circuit were tuned to the detector circuit the strength of oscillation would be too great and the detector would be paralyzed by the strong oscillations. By operating the heterodyne at a much greater wavelength the comparatively weak harmonics of these wavelengths may be used. When received signals are strong, the lower values of tuning capacity  $C_1$  are used since the circuit will oscillate more strongly at the lower capacity, but when weak signals are to be picked up, the condenser  $C_1$  may be increased in value where the oscillations are weak and the harmonics still weaker and where the sensitivity is accordingly the greater.

The values of wavelength for the heterodyne are not critical and the values used for broadcasting are useful, especially if any calibration is desired, for the harmonics may be easily computed, unless there is an objection to using the broadcast wavelengths where there is a B.C.L. receiver in the same house. A range of wavelengths a little above the broadcast ones may then be used. The grid condenser  $C_2$  and leak  $R_1$  are used to obtain more steady operation of the oscillator and incidently to reduce the drain on the B-battery. A switch  $Sw2$  turns on the heterodyne filament when changing from modulated to c.w. signals.

### Operation

The operation of the set is very simple. With the switch  $Sw2$  open and the proper coil inserted at  $L_1$ , close to the switch  $Sw1$ , thereby turning on the detector and modulator tubes. Now gradually decrease  $R_1$  from a high value until a slight hiss is heard in the phones. As  $C_1$  is tuned many stations will be heard and most of them will merely alter the intensity of the hiss unless they are poorly filtered, when the unfiltered component of the wave will be heard Any

short-wave broadcast or modulated telegraph signals will now be heard and the only adjustments are the tuning and the variable resistance  $R_v$ . This resistance merely controls the sensitivity and volume. The adjustment of  $R_v$  should stay fixed over a large range of frequencies.

To receive unmodulated c.w. signals turn on the heterodyne oscillator by closing switch Sw2 and turn condenser  $C_1$ , starting from a low value until a point is reached where the hiss disappears, now increase  $C_1$  and several places will be heard where the hiss is reduced, each one as  $C_1$  is increased, affects the hiss less and less. Then when the detector tuning condenser is tuned to a station, adjust  $C_1$  until a beat-note is heard, the strength of it being determined by the particular harmonic that is being obtained from  $C_1$ .

When a station is heard and a good beat-note is obtained, it will stay remarkably steady, providing the transmitting station has a steady frequency. Any alteration in detector tuning or in control resistance will not affect the beat-frequency, and the detector circuit may be touched with the hand without affecting the note though the signal strength will, of course, drop.

If the set should sound like a flock of canaries, there is too much antenna coupling or too high losses in the detector circuit. There should never be any heterodyning or squealing at any adjustment when the switch Sw2 is open.

The main tuning condenser  $C_2$  may be a 500- $\mu$ fd condenser as the tuning is not at all critical and the larger condenser will give a greater range unless it is desirable to limit the range. The heterodyne condenser should also have a capacity of 500- $\mu$ fd as it is desirable to have many points where a station may be heard so that the strength of the harmonics may be varied over a great range. A very high ratio vernier dial or a two-plate vernier condenser connected in parallel with  $C_2$  is recommended. No shielding is necessary if metal end plate condensers are used for the heterodyne and detector circuits.

Data for Coil L

Wavelength	Turns-A	Turns-B	Diameter
55-90	10	12	3 1/2
28-55	3	4	3 1/2
19-30	2	2	3 1/2
13-22	2	2	3 1/2

The above values are appropriate. The form should be three and one-half inches in diameter except for the shortest wavelength where it should be three inches in diameter.

The 201-A type of tube is recommended for use in this circuit. The smaller tubes give a more limited range of wavelength.

A B-battery voltage of 45 is sufficient. For head phone reception it is not necessary to use any audio frequency amplification, but an audio frequency amplifier may be used without any trouble if the modulation frequency is high enough. Do not expect very good results above 150 meters, as the amplification rapidly becomes low on the higher wavelengths.

A Short-Wave Precision Wavemeter

THE popular General Radio type 224 precision wavemeter has recently been made available in short-wave ranges. The new instrument is pictured in the cut herewith. It has the general characteristics of the 75-24,000-meter 224 model but has

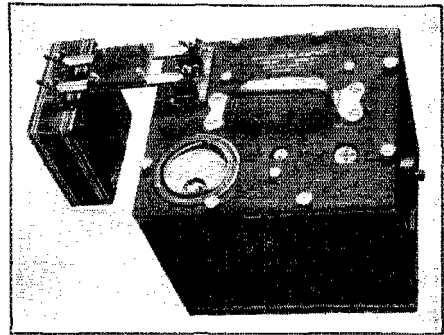

been re-designed to cover the amateur and broadcast bands.

The new meter is known as the type 224L. It has a wavelength range of from 15 to 600 meters, six coils being provided to cover this band. The condenser has a maximum capacity of 250  $\mu$ fd., there being both fewer plates and wider spacing in the new one. The condenser is insulated by Isolanite strips placed in a very weak and uniform electrostatic field. The instrument is provided with a main scale with 25 divisions, and an auxiliary scale attached to a very high ratio vernier. By means of the auxiliary scale the instrument can be read directly to one part in 2,500.

The coils are space-wound on deeply threaded forms, and are enclosed in walnut cases. Each case has a terminal strip which is engraved with the wavelength range of that particular coil. The coil and meter terminals are fitted with posts which do not allow any coil to be inserted in the mounting supports in a reversed fashion.

A Weston thermo-galvanometer is built into the meter. It is connected in series with the condenser and coil and is so wired

(Continued on Page 46)

## The UX-213 Rectron and the UX-874 Voltage Regulator

By O. W. Pike\*

**A**S is well-known, the problem of supplying d. c. to the plates of a vacuum tube from an a. c. source of power may be divided into three separate parts. It is necessary first to rectify the alternating current, second, to remove the "ripple" which always exists after simple rectification, and, third, in many cases, to provide some means of maintaining the correct output voltage re-

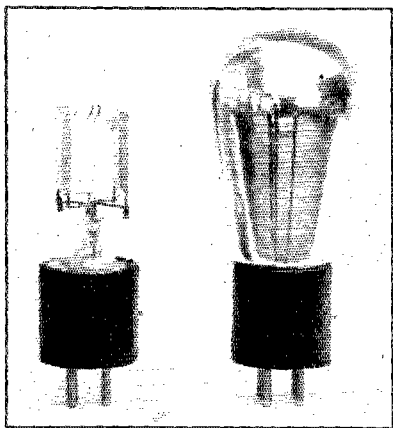

FIG. 1. THE UX-213 RECTIFIER TUBE

The tube has two separate plates. Inside of each there is a 5-volt, 2-ampere "XL" tungsten filament. The plates are insulated from each other, the filaments being connected in parallel. Footnote 1 explains the difference between this tube and the similar UV-196.

gardless of the output current or variations in the a. c. supply voltage.

The rectifiers most widely used for eliminators are of the full-wave type, consisting of a step-up transformer and either two half-wave or one full-wave rectifier.<sup>1</sup> There

is available a full-wave vacuum tube rectifier designed for use in "B" eliminators and known as the UX-213 Rectron. This Rectron has two separate plates and two filaments connected in parallel. Externally, the tube is similar to the UX-210 Radiotron. Figure 1 shows the internal and external appearance.

The filament of this tube is of the X-L tungsten type and has a rating of 5 volts, the current being approximately 2 amperes. At first thought, the 10 watts consumed by the filament may seem high, but this power is drawn from the a. c. line, which is an economical source of supply. The high wattage results in long life and ample emission over a variation in filament voltage of from 4.5 to 5.5 volts. The UX-213 has a maximum a. c. supply rating of 440 volts RMS between anodes and a maximum d. c. output rating of 65 milliamperes. This rating is based upon two limiting factors—first, that of the impressed a. c. volt-

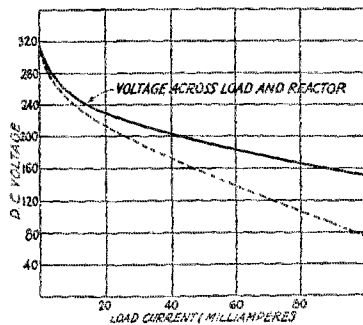

FIG. 2. AVERAGE PERFORMANCE CURVE OF A UX-213 FULL-WAVE RECTIFIER SUPPLYING A FILTER AND LOAD

The applied voltage is assumed to be 220-per-plate and 5 for the filament, all at 60 cycles. The solid curve shows the output voltage of the tube. The dashed curve has been added by the editor to show the voltage that would be available after the output had passed thru a 750-ohm filter. In practice the available voltage would be somewhat higher than this curve, the exact value depending on the filter constants and load. The practical voltages therefore lie between the two curves.

age, which in turn is limited by the insulation between elements and by the effect of positive ion bombardment on the electron emission from the filament—second, that of the d. c. output current which results in anode heating due to electron bombardment. The latter is practically independent of the voltages used.

\* Research Laboratory, General Electric Company, Schenectady, N. Y.

1. The old "S" tube was a half-wave rectifier of the gaseous discharge type. Two were necessary, "one on each side of the cycle". The little "Raytheon" tube is a small version of the same thing but works on both sides of the cycle—i. e. is a full-wave rectifier. Coming to the kenotrons we have a whole family of half-wave rectifiers of the hot-filament, cold-plate variety. The best known are the 1500-volt, 1/5-ampere, UV-217-A and the "20-watt" UV-216 and UX-216-B. Lately there have been added two small full-wave tubes, the General-Electric (R. C. A.) UX-213 and the Westinghouse (R. C. A.) UV-196. The former uses two separate plates but has the "XL" filaments connected together. The latter uses one plate and requires a separate filament transformer secondary for each of the oxide-coated filaments.—Tech. Editor.

The characteristics of the UX-213 tube, when used with a full-wave rectifier connection as described, are illustrated in Figure 2. From this figure it can be seen that with the maximum d. c. load a current of 65 milliamperes at 180 volts is available for filter and load voltage.

Considerable variation is allowable in the design of a filter for a "B" eliminator.

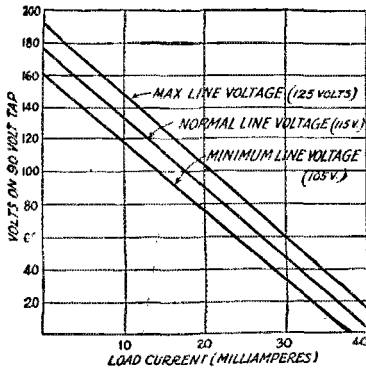

FIG. 3. PERFORMANCE OF A TYPICAL RECTIFIER AND FILTER WITHOUT A STABILIZER

A very satisfactory one consists of two chokes in one side of the line with condensers to the opposite line from both sides of the chokes. It is possible to eliminate one stage of the filter and use only one choke and two condensers, although the inductance of the one choke must be large for equivalent results. The UX-874 voltage

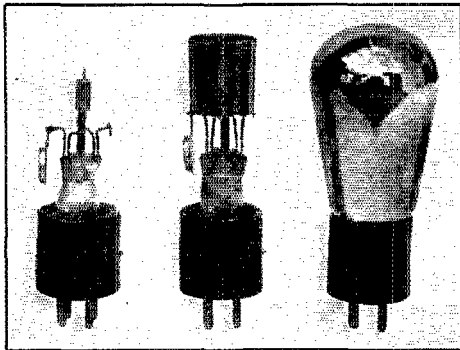

FIG. 4. THE UX-874 REGULATOR TUBE

The view at the left shows the central pointed electrode with its short insulating shield while the central picture shows the plate in place. The tube was discussed in more detail on page 32 of our June issue.

regulator, to be described later, is a considerable aid to filtering.

Unless the filter chokes are made very

large, their resistance is usually as great as that of the rectifier itself, and the result is a voltage drop across the filter which is often greater than the drop in the rectifier. Because of this drop in the rectifier, the d. c. output voltage from the filter will vary when the eliminator is to be used with miscellaneous receivers taking different amounts of current. This condition is illustrated by Figure 3 for the 90-volt tap of a typical eliminator with no corrective adjustment. An effective method of overcoming this condition is to use the UX-874 Radiotron.

**The UX-874 Regulator**

The UX-874 is a voltage regulator tube making use of ionized inert gases at low pressure for the conduction of current between the electrodes. The unique and useful property of this tube is that when placed in series with a resistance the voltage drop across the tube remains practically constant at 90 volts over a range of current values from 10 to 50 milliamperes. Approximately 125 volts d. c. is necessary

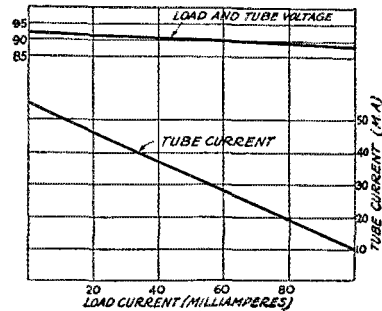

FIG. 5. OPERATING CHARACTERISTICS OF THE UX-874 IN A TYPICAL RECTIFIER-FILTER SYSTEM WITH DIFFERENT LOADS

to start the gas discharge after which the voltage drops to the regulation voltage. Fig. 4 shows the appearance of the tube. By arranging the filter so that it has a pair of 90-volt output terminals and connecting the UX-874 across these terminals it is possible to keep this voltage practically constant, the filter supplying the required series resistance. Figure 5 illustrates this condition.<sup>2</sup>

The filter action of the regulator tube is due to the inherent low impedance which is characteristic of the gas discharge tube in

2. Since the regulator is connected to the 90-volt tap, it seems at first sight as if the higher-voltage taps are left free to vary at will. Brief consideration will show that the effect of the tube is to provide the rectifier and filter with a constant-current load thereby tending to stabilize all the voltages involved. Unfortunately the maximum voltage of the system cannot be run up indefinitely or the device would be excellent for amateur transmitters, tending to remove the wearisome "yoop-yoop" effect from the note of the set.—Tech. Ed.

question. In other words, the UX-874 tends to absorb even the voltage variations due to the a. c. supply and therefore acts somewhat like the condenser in the filter in smoothing out the rectified voltage. In the case of the condenser, one way of explaining the smoothing out effect is to state that it has a very high d. c. resistance and a low a. c. impedance. In this way the d. c. component of rectified voltage is not affected, whereas the a. c. component is practically short circuited and so greatly lowered in value.

In the case of the glow tube, the d. c. resistance is fairly high (1800 to 10000 ohms) while the impedance to changes in voltage (a. c. component) is quite low. The low impedance follows from the fact that there is practically no change in voltage drop across the tube for relatively large changes in current through the tube.<sup>3</sup>

Figure 6 shows the diagram of connections for a suggested built-up "B" eliminator set. The transformer should have a

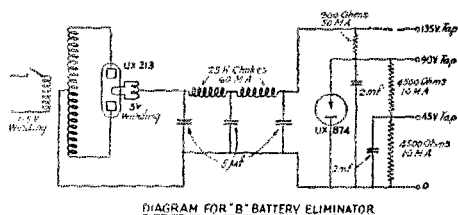

FIG. 6. A CURRENT-SUPPLY SYSTEM SUITABLE TO RECEIVERS

115-volt primary and 440- and 5-volt secondaries, both with center taps. If desired, the return to the 5-volt winding may be to either end rather than to the center. The plate winding should have a current capacity of 40 milliamperes while the filament winding should, of course, carry the two-ampere filament current safely. It may be easier to obtain separate transformers for the filament and plates and just as satisfactory results are obtained by this method.

The filter chokes should have at least 25 henrys inductance and if the total resistance of the two chokes is greater than 750 ohms the capacity of the set will be limited to some extent. If one choke is used this should have at least 50 henrys inductance.

3. When the device is used for low-power transmission, the filter will be rather less complex than the one shown in Fig. 6, in fact the last condenser, middle condenser and second choke may all be left off, the filtering being good enough with one condenser, one choke and the 874 tube. Even the first condenser need not have a capacity of over 2 microfarads. In addition to this, the 2-microfarad condensers across the resistors may be omitted.—Tech. Ed.

The condensers should have at least 5  $\mu$ d. capacity and be satisfactory for 250-volt operation.

The resistance values shown are calculated for correct voltage distribution with 750-ohm resistance in the two chokes. If chokes of greater resistance are used, the 900 ohms between the 135- and 90-volt taps should be increased, although this will reduce the current output obtainable from the various taps.

As illustrated, the set will deliver 10 milliamperes from the 135-volt tap, 40 milliamperes from the 90-volt tap and detector tube current simultaneously. The UX-874 will maintain the 90 volts practically constant at any load up to 40 milliamperes.

Once constructed and properly adjusted, this set will, within the range of the device, supply the required voltages *without adjustment* regardless of the variations in supply voltage or the current drain of the receiving set supplied.

## A SHORT-WAVE PRECISION WAVE-METER

(Continued from Page 43)

that the rotary plates of the condenser, the condenser shield, the galvanometer and the outside end of the coil are at low potential. The condenser and meter are mounted on a quarter-inch aluminum panel, and are housed in a walnut cabinet which is shielded with sheet copper. Hand capacity effects are, consequently, zero.

The meters are supplied with mounted calibration curves for each coil. A condenser capacity curve can also be had. Each meter is individually calibrated from a standard which, in turn, is checked from quartz crystals whose fundamentals have been determined by checking harmonics from a standard clock.

Where a precision wavemeter covering the amateur and broadcast bands is desired, the type 224L leaves nothing to be desired. Mechanically and electrically it is a beautiful job.

—J. M. C.

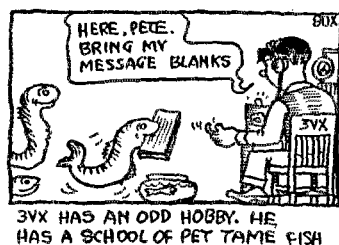



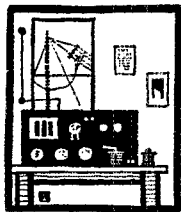

# Amateur Radio Stations

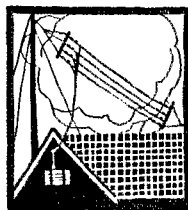

## 1AAO, Newton Centre, Mass.

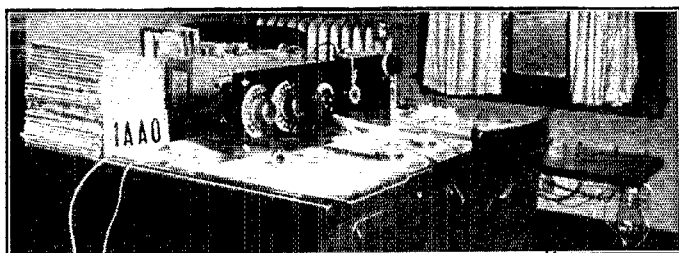

ONE need never have heard of 1AAO to know that this station has communicated with amateurs in *all* corners of the globe. A look at the QSL cards plastered on the wall above the transmitter tells the whole story of 1AAO's DX. Every card is an acknowledgement of two-way communication, and not a "QSL heard" or a "QSL tks for your card" type.

1AAO is owned and operated by H. H. Cooley. The station is located at Newton Centre, Mass., about eight miles west of Boston. The main transmitter uses one 250-watt tube which is always operated quite a way below normal rating. The tube runs stone cold at all times. The circuit is a Hartley type with Hertzian antenna. Plate supply is rectified a. c. obtained either from a 120-jar chemical rectifier and filtered or from a synchronous rectifier which is carefully cradled below the transmitter table. On account of the Herculean task of keeping the chemical rectifier cleaned and in order it is rarely used. For a long time the transmitter and receiver were operated from the same room but as the operator was cool when the weather was likewise and hot when summer came along, the receiver was dropped to the floor below, and a remote control arrangement installed. All live parts of the transmitter are mounted on Pyrex insulation.

Separate antennas are used for receiving and transmitting. A ground or counterpoise is not used on either antenna. The

transmitting wire has an average height of 35 feet and the receiving one a height of 20 feet. On the operating desk are located the receiver, control switches for the



transmitter, straight key, home-made side swiper and two lamps used as primary rheostats. The receiver is of the usual detector and one stage of audio frequency amplification type. A recount of 1AAO's

DX reads like a roll-call of the League of Nations, as the League of Nations would like to see it. In fact if all of the countries IAAO has worked belonged to the League (of Nations) there never could be another war. The list is interesting. Here it is: Algeria, Argentina, Australia, Belgium, Bermuda, Brazil, Canada, Chile, Costa Rica, Cyprus, Cuba, Czechoslovakia, Denmark, England, Finland, France, Greenland, Holland, Irish Free State, Honolulu, India, Italy, Labrador, Madeira, Mexico, Morocco, New Zealand, Palestine, Panama, Philippines, Porto Rico, South Africa, Spitzbergen, Sweden, Spain, Tasmania, Germany, Dominica, North Ireland, Newfoundland, Luxembourg, Poland, New Caledonia, Uruguay, Portugal, Jugo Slavia, Nicaragua, Jamaica, Faroe Islands (near Iceland), and Austria. And all of these countries have been worked by this station. Some DX!

IAAO's communication activities are not confined to DX alone. His traffic total is

a good one and he is a member of the R. C. C., also and quite needless to say, he owns a WAC Club certificate.

Such kick-rendering events as telephoning a message and receiving the answer while an operator of some Arctic expedition stands by in anticipation at the North Pole; accepting a message announcing to the world the arrival of some expedition at its destination; establishing communication with two continents at once, such as the z4AM, g2LZ, uIAAO (New Zealand, England and U. S. A.) hook-up which was pulled off seven consecutive nights; cultivating fast friendships in all parts of the world with fellows never seen, these and countless others constitute one of the formula for amateur radio's being one of the biggest things in the world, and these things will make amateur radio carry on forever and should do much to create peace and understanding between nations.

## 2SC, Governor's Island, New York



**T**HIS well-known station is the net control station for the 2nd Corps Area Army-Amateur Radio Net. Captain James L. Autrey is the officer in charge and Sgt. Massey is 2SC's Chief Operator.

The outfit is crystal-controlled using two "5-watt" tubes as crystal oscillators and two Army VT-4B tubes as power amplifiers. The latter tube is quite similar to the UV-203-A except that it has a much lower plate impedance.

Referring to the photo of the transmitter (and the diagram of the layout) it will be seen that the complete set, exclusive of plate and filament sources, is mounted on top of a table enclosed in glass to keep out dust and moisture. The crystal mounting appears at the extreme left in the foreground. A 154-meter (1947 Kcs) crystal is normally used. To the right of the crystal mounting is the 0-2.5 ampere thermo-couple ammeter (A1) in the tank circuit of the oscillator tubes. The latter are connected with grids and plates

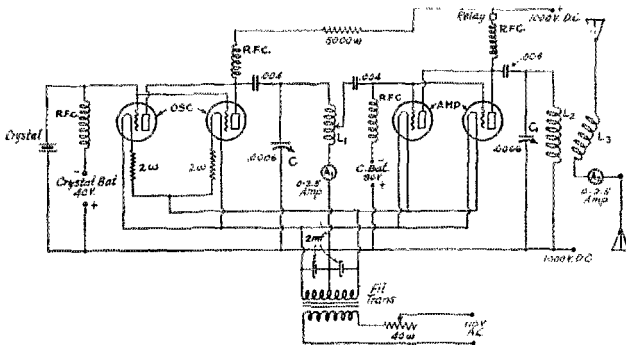

together and filaments in parallel. They are of the well-known VT-2 type. The oscillator plate inductance (L1) consists of five turns of edgewise wound copper strip taken from an old Murdock "oscillation transformer". This inductance appears directly to the right of the oscillator. This coil (as well as the coils L2 and L3) has been replaced since the photo was taken by a set of REL flat-wise wound coils with noticeable improvement in output.

The condenser between the two meters at the left is the plate tuning condenser C, and the other condenser at the right is the plate circuit of the amplifier stage.

The central meter is a filament voltmeter, while the one at the right is a 0-2.5 Weston thermo-couple antenna ammeter (A2). The power amplifier tubes are also connected in parallel and the amplifier is tuned either to the frequency of the oscillator or to twice its frequency for 154- or 77-meter operation.

The two inductances at the right are L2 and L3, the power amplifier plate inductance and the antenna coupling coil respectively. Keying is done in the positive high-voltage lead to the power amplifier tubes. Plate supply comes from a 1000-volt generator, a 5,000-ohm resistance being connected in series to get the proper plate voltage for the VT-2s. The filaments are all heated

from the same transformer, fixed resistance units being in the circuit of the two VT-2s.

Under normal working conditions the crystal bias battery has a voltage of 40 and the power amplifier 90. The primary filament rheostat is of the cylindrical type and is mounted on the front of the table.

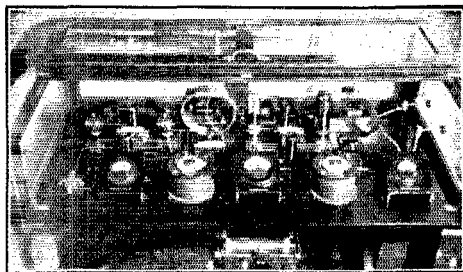

The set was designed and built at the Signal Corps Repair Shop at Brooklyn. Note the very neat layout—everything accessible, with the meters mounted on panels and brackets so that they can be read easily. The other photograph shows the operating table with Sgt. Massey at the key.

2SC is in operation every night from 7 p.m. until midnight. While the station's primary function is Army-Amateur work, the list of DX is a respectable one.

## 9DTK, Milwaukee, Wis.

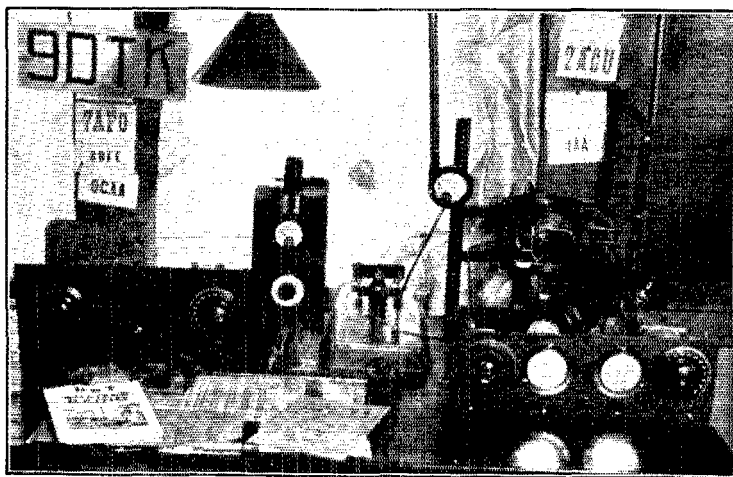

**T**HE present layout at this station, which is the product of Fred Catel of 711 Kenwood Avenue, has been on the air for about a year. 9DTK is much older than this, however, dating back to March of 1922. The transmitter in use now uses

a coupled Hartley circuit with a 250-watt tube, normally operated with an input of about 900 watts. In the general view of the station the synchronous rectifier is just discernable at the extreme right on the floor. On the right hand end of the table

is a small panel carrying appropriate control switches by means of which the plate voltage can be varied in 500-volt steps from 500 to 3,000 volts. On the front of the table are mounted (from right to left) an ash receiver (operating without any form of detector) a Bradleystat in the primary of the filament transformer circuit, and two control switches for starting and stopping the rectifier and turning on the filament of the tube.

The transmitter is at the right of the table. Next, to the left is the antenna transfer switch which is an old style Murdock affair removed from its original wooden base and fastened to an inverted Pyrex dish, and at the extreme left is the short-wave receiver which uses a circuit similar to the one described by Hoffman of 9EK. Plug-in coils have been used in receivers at 9DTK since 1924.

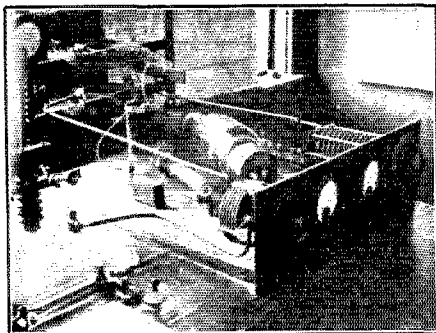

The other photo shows a close-up of the transmitter. The primary tuning condenser is a National type DX 7000 having a flashover voltage of 7,000. This is the condenser at the right of the transmitter panel. The antenna series condenser is an old Coto receiving condenser. The meters on the panel are filament voltage and plate current. At the rear of the transmitter breadboard are the primary and secondary inductances. As seen in the photo these are spirally wound with wide brass ribbon. A rather novel arrangement is used to secure steadiness in the coil mounting system, two upright strips punched with holes at regular intervals serving as supports to which the coils are bolted, once the optimum coupling position has been found.

The antenna is supported by a 55-foot mast at the far end and a 35-foot pole at the near end. It is a four-wire flat-top about 65 feet long and is insulated with glass towel bars. The counterpoise is a fan type directly underneath the antenna and about ten feet off the ground. The counterpoise is also insulated by means of towel bars. The lead-ins are of one-inch brass tubing passing through the window

panes. The antenna lead-in bushing was made by a friendly policeman who shot a hole in the pane with a 38-calibre revolver. A good hailstorm and a Lucky Strike punched the counterpoise lead-in hole in the lower window pane. Hi!

The DX call at 9DTK includes England, Italy, South Africa and France worked, and reports of being heard in almost all civilized countries in the world. 9DTK has won numerous local sups and medals and prizes for his traffic handling feats. In 1924 Catel was asked by the Wisconsin Department of Markets to transmit the daily "Butter Cheese and Egg Market" reports of Milwaukee to the Department's broadcasting station at Stevens Point, Michigan. This broadcasting station is operated by 9DKS. Ever since the inauguration of this service 9DTK has been keeping regular daily schedules. Six months after the service was started the "Daily Live Stock Market" was added. The farmers of Wisconsin now get up-to-the-minute market reports via amateur radio and broadcast station about fifteen minutes after the market closes at noon. FB!

### *Strays*

Speaking of the Sesqui-Centennial Exposition's radio exhibit, a new release says, "A model of the P-5 Marconi code set is also shown and demonstrated. This model will be loaned to the City of Baltimore in the winter to keep the Chesapeake Bay free from ice." We knew they were rock crushers but ice manipulators is a new term.

When addressing Headquarters it will greatly facilitate matters if you will address inquiries or letters to different departments on separate sheets. DON'T enclose a check for renewal of your membership with a letter to the Info Svc., and don't attach a check to your Calls Heard.

4JK has a very classy QSL card which he designed, the printing being done by the Greenville (S. C.) Chamber of Commerce. You fellows are overlooking an opportunity. The Chambers of Commerce in almost any city should welcome the opportunity of advertising their city by printing your QSL cards gratis, and including a little squib about the state, on the card.

9SZ suggests that an old B.C.L. vario-coupler with about half the wire removed from rotor and stator makes an excellent variometer (when the coils are connected in series) for use in the plate circuit of a crystal oscillator. Crystals of different frequencies can be used in the oscillator, and the extra tuning condenser (normally across the plate coil) is dispensed with.



# I.A.R.U. NEWS

**C**ONTINUING from previous data\* foreign contact information with the we are concluding the tables giving list shown below. Practically all countries in the world will have been covered with this list in print.

Country	Wavelengths Assigned	Best DX Band	Best Time (GMT) for QSO USA	Traffic Handling Allowed
Australia	150-250 85 32-35 (Special)	32-35	800-1400	Experimental
France	All except 105 75 45 25 9	32-38 & 50	2200-0600	Experimental
Indo-China	All that do not QRM Commercials	33-35	1700-2200	Experimental
Japan	None	35-37.3	0700-1000 1300-1500	No
China	None	38	1200-1400	Yes
Uruguay	None	35	from 2200 on	Yes
Madeira	None	30-40	2200 on	Experimental
Germany	All to 100	40	0300-0700	Experimental
S. India	25-30 and above 300	25-30	2300-0100	Experimental

The best U.S. band for contact with any of these countries is the so-called 40-meter one.

\* See I.A.R.U. News Section of following QST's for 1926; August, September and October.

### Broadcast to the World

At the suggestion of Mr. R. Oxenham of oA4L at Capetown, South Africa, arrangements were made with the G. E. people at Schenectady whereby the A. R. R. L. officials put on a broadcast program from station 2XAF at Schenectady, the Headquarters folks journeying to 2XAF on the night of November 27th. Our I. A. R. U.-A. R. R. L. President, Mr. Maxim, acted as "toastmaster" delivering a talk and introducing Secretary Warner, A. R. R. L. Communications Manager Handy, A. R. R. L. Treasurer Hebert and Ross Hull of the Wireless Institute of Australia. Short words of greeting were put across to ama-

teurs in all parts of the globe by all of these distinguished amateurs. 2XAF was in operation on a wavelength around 32 meters and it is hoped that the whole world heard all these I. A. R. U.-A. R. R. L. folks giving them the glad hand.

### Springbok Competition

The Springbok Competition closed on October 31st. As these lines are being pounded out the official announcement of the award cannot be made, sufficient time not having elapsed for the South African judges to check the cards that have been forwarded with the South African logs. The International Committee must then announce the award. The "official score" as kept at the



i-ACD, u-3CDQ AND i-IER at MILAN, ITALY

U. S. end seems to indicate that 6CTO is first with 28 contacts, 1CMX next with 24, 6BMW third with 19 and 6ZAT following with 17. The South African leaders are oA5O with 126, oA3B with 95, oA3E with 59 and o1SR with 47. It is hoped that an announcement of the awards can be made in the next issue of QST.

Information received from QSL-cards that came in during the last few weeks of the contest was necessary to enable the American members of the International award

Committee to see their way clear to vote on what seemed at first to be a tie.

#### Raven-Hart Visits Headquarters

During the latter part of October we were pleased to have Major R. Raven-Hart, late ch9TC, later a resident of Italy and now on his way back to South America, with us for several days at A. R. R. L. Headquarters. The Major proved to be a very interesting person. He left a trail of friends after his too brief stay in the States.

#### A Young Convention

Several months ago Miss Elizabeth Zandonini of u3CDQ made a trip abroad. We are showing a photograph taken in Italy during a three-cornered Convention of three famous amateurs. Ducati of ACD, Miss Zandonini, and Santangeli of the well-known iER. The "convention" was held in Milan. Since returning to the States 3CDQ has been QSO iER several times.

#### New Hebrides

From 6ZAT we have received a message from pi-1BD announcing a new station nh-HVW whose QRA is F. H. Harvey, Vila Radio, New Hebrides. 1BD and HVW were QSO—his first DX contact. HVW can

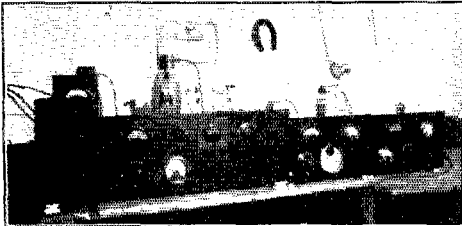

COMPLETE LAYOUT AT k-4YAE. FIRST k CRYSTAL CONTROLLED

be found around 34 meters. He asks that all amateurs watch out for his signals and send a QSL if actual radio contact is not established at the time. The New Hebrides are one of a group of islands in a long chain in the west Pacific known as Melanesia.

#### FLASH!

Just as we are going to press we have received a radiogram from b-3AA via z-3AR and u-9CXC which says, "Belgian hams now licensed, QRH is 43 to 47 meters stop call is figure '4' followed by two letters stop old b-3AA is now b-4RS". Fine Business, and our heartiest congratulations. Other countries please note!

#### Denmark

We have received an announcement from Denmark of the experimental transmissions from station OXZ taking place on a wavelength of 42.0 meters every evening from 2100 to 2400 (GMT) (4 p. m. to 7 p. m. EST). From 0400 to 0700 (GMT) (11 p. m. to 2 a. m. EST) OXZ is trying to establish communication with stations in different parts of the world. All amateurs are asked to cooperate and answer CQs coming from this station. QSL of signals received will be welcomed and should be sent to C. Wamberg, Walkendorfsgeade 2, Copenhagen, Denmark.

#### New QRAs

From K. E. B. Jay of g2BMM we have received the following QRAs which should be of interest to all DX people.

bg-1JT, J. Tasker, 61 Hadfield Street, Georgetown, British Guiana.

lit-1B, W. Hinentalis, Aukst, Karin, Kur-sai, Kaunas, Lithuania, QRH about 40 meters with d.c.

r-2WP, W. N. Paramonow, Neglimmey pr 14, Moscow, Russia.

CVPE, A. Gariso, B. M. R. Telegraphs, Villa Pery, Portugese East Africa.

#### Germany

The first crystal-controlled transmitter in operation in Germany is the product of Rolf Horkheimer of k-4YAE at Rottenburg. Unfortunately the photo which shows the best view of the nice layout is not sufficiently clear to reproduce in the magazine. We are, however, showing two views of the set. One is a rear view of the oscillator itself which uses a Mueller MS IV 5-watt tube normally operated with 450 volts of unfiltered d.c. on its plate. Plate supply comes

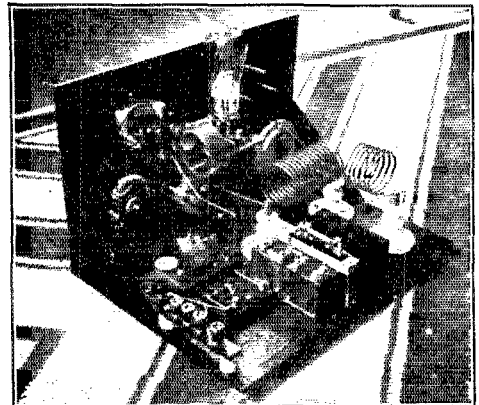

CRYSTAL OSCILLATOR AT k-4YAE

from a small motor-generator. The round crystal is seen on top of the mounting at the left of the baseboard. The crystal mounting itself is unusual. A heavy brass

plate is used as the bottom plate. A bakelite square frame is bolted to this bottom plate. The bakelite piece has a window cut in it, the opening being the size of the top plate which rests on the crystal. Note that all of the h.f. circuits are supported on porcelain insulators. The other view shows the complete layout. The crystal oscillator is at the extreme right. Filament ammeter, plate ammeter and tank circuit meter are mounted on the front of the oscillator panel. The center panel holds the controls for the first stage of amplification which is also a frequency doubler. The tube in this circuit is a Telefunken RS5 30-watt tube supplied from the same motor-generator. The last panel holds the 500-watt Mueller MS1 tube. This tube operates at the frequency of the first amplifier. The tube is supplied with 1250 volts from a Wehnelt neon gas rectifier tube. The rectifier tube is operated from a 500-cycle 220-volt alternator (through a step-up transformer) of 1.5 k.w. size, driven by a three phase 3 H.P. motor. The first contact established with this set was with y-2ZX in India. Since that time almost every country in the world has been worked. 4YAE only lacks Africa to have worked all continents.

### New Zealand

From z-2XA via u8GZ we understand that two large whaling ships will be in the Antarctic this year. AQE, well-known from last year's trip, is operating on about 22.6 meters and ARDI, the other ship, at present is on 36 meters but probably will run down to 33 or 34 meters soon. AQE is the *Sir James Clark Ross* and ARDI is the *Larsen*, both from Norway. Both of these ships are anxious to communicate as often as possible with amateurs in America and Europe.

z-2AC has been doing good work on 20 meters and lower, having been QSO England and France on 20 from 0400 to 1500 quite regularly. z-2XA has been QSO England on 20 meters also. 2XA, Senior, is going to Australia for a month but 2XA, Junior, will keep the station on the air.

### Long Wave Schedules

Harry Washburn of New York City calls attention to the fact that members of the I. A. R. U. residing in foreign countries will find it of advantage to have a copy of the U. S. Hydrographic Bureau's book "Radio Aids to Navigation", their catalog number 205, and obtainable from the Superintendent of Documents, Government Printing Office, Washington, D. C., for ninety cents. Remittances should be in international money order. This volume gives weather, hydrographic information, fog signals, time navigation warnings, etc., for stations all over the world. Schedules are found in it which cannot be found in any other book.

### Maurice Island

On November 4th Strout of 2NZ speared a new station in a new "country" when he worked w-3XB, A. W. King, 33 Virginia Avenue, St. Paul, Maurice Island. 2BSL intercepted both sides of the QSO and subsequently 1RF, 8ALY and 4NH were in communication with 3XB. 2NZ reports his signals as being R4, a.c. note and his wavelength around 33 meters. 3XB was using an input of 60 watts at the time of his 2NZ QSO. Maurice Island is near Madagascar. F.B. and welcome to the International DX ranks, OM.

### Singapore

From u7IT we have received the following message from ss2SE, "A few amateur licenses issued in Malaya at last, for 30-watt input and wavelengths of 20 and 350 meters only. Reception here better now." We wish the authorities would adopt some wavelength ruling in the Straits Settlements, and stick by that ruling. Poor ss2SE has been switched from one wave to another so much one can never keep track of where he will be put next.

### 20-Meter Band

It is hoped that much effort will be put into 20-meter operation soon. Many stations are in operation both in the U. S. and in several other countries in this band. A number of the u's and several Europeans can be heard plugging away every Sunday afternoon. g-5HS requests the fellows to watch for him on 22.8 meters. 4SI-4TN reports f-8CT, f-8JN and n-PCUU regularly on 20. A nice low-power stunt was recently pulled off when Grindle of Hammond, Indiana, put over a string of signals to G. W. Mitchell of London. Grindle was using a single 201-A tube operating on 21.3 meters, with an input of 0.78 watt. F.B.

### South Africa

At a recent conference of the S. A. R. R. L.

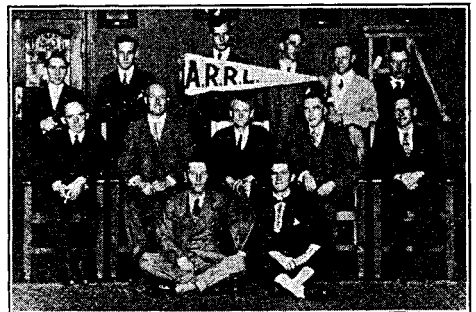

PROMINENT SOUTH AFRICAN AMATEURS AT CONFERENCE

held in Johannesburg a photograph of a number of prominent South African ama-

## NEW INTERNATIONAL INTERMEDIATES, EFFECTIVE 0000 G.M.T., FEB. 1, 1927.

## EUROPE

EA—Austria  
 EB—Belgium  
 EC—Czechoslovakia  
 ED—Denmark and Faroe Ids.  
 EE—Spain and Andorra  
 EF—France and Monaco  
 EG—Great Britain and Northern Ireland  
 EH—Switzerland  
 EI—Italy  
 EJ—Jugo-Slavia  
 EK—Germany  
 EL—Norway, Spitzbergen and Franz Josef Land  
 EM—Sweden  
 EN—The Netherlands  
 EO—Irish Free State  
 EP—Portugal, Madeira Ids., and the Azores  
 EQ—Bulgaria  
 ER—Rumania  
 ES—Suomi (Finland)  
 ET—Poland, Esthonia, Latvia, Courland and Lithuania  
 EU—U. S. S. R. ("Russia"), including Ukraine  
 EV—Albania  
 EW—Hungary  
 EX—Luxemburg  
 EY—Greece  
 EZ—Zone of the Straits

## ASIA

AA—Arabia  
 AB—Afghanistan  
 AC—China (including Treaty Ports), including Manchuria, Mongolia, and Tibet.  
 AD—Aden  
 AE—Siam  
 AF—French Indo-China  
 AG—Georgia, Armenia and Azerbaijan  
 AH—Hedjaz  
 AI—India (and Baluchistan) and Goa  
 AJ—Japan and Chosen (Korea)  
 AK—(Unassigned)  
 AL—(Unassigned)  
 AM—Federated Malay States (with Straits Settlements)  
 AN—Nepal  
 AO—Oman  
 AP—Palestine  
 AQ—Iraq (Mesopotamia)  
 AR—Syria  
 AS—Siberia, including "Central Asia"  
 AT—Turkey  
 AU—(Unassigned)  
 AV—(Unassigned)  
 AW—(Unassigned)  
 AX—(Unassigned)  
 AY—Cyprus  
 AZ—Persia

## NORTH AMERICA

NA—Alaska  
 NB—Bermuda Id.  
 NC—Canada, Newfoundland and Labrador  
 ND—Dominican Republic  
 NE—(Unassigned)  
 NF—Bahama Ids.  
 NG—Guatemala  
 NH—Honduras  
 NI—Iceland  
 NJ—Jamaica  
 NK—(Unassigned)  
 NL—Lesser Antilles  
 NM—Mexico  
 NN—Nicaragua  
 NO—British Honduras  
 NP—Porto Rico and Virgin Ids.  
 NQ—Cuba and Isle of Pines  
 NR—Costa Rica  
 NS—Salvador  
 NT—Haiti  
 NU—United States of America  
 NV—(Unassigned)  
 NW—(Unassigned)  
 NX—Greenland

NY—Panama  
 NZ—Canal Zone

## SOUTH AMERICA

SA—Argentina  
 SB—Brazil, Trinidad Id., and St. Paul Id.  
 SC—Chile  
 SD—Dutch Guiana  
 SE—Ecuador and Galapagos Archipelago  
 SF—French Guiana  
 SG—Paraguay  
 SH—British Guiana  
 SI—(Unassigned)  
 SJ—(Unassigned)  
 SK—Falkland Ids. and Falkland Dependencies  
 SL—Colombia  
 SM—(Unassigned)  
 SN—Ascension Id.  
 SO—Bolivia  
 SP—Peru  
 SQ—(Unassigned)  
 SR—(Unassigned)  
 SS—(Unassigned)  
 ST—(Unassigned)  
 SU—Uruguay  
 SV—Venezuela and Trinidad  
 SW—(Unassigned)  
 SX—(Unassigned)  
 SY—(Unassigned)  
 SZ—(Unassigned)

## AFRICA

FA—Abyssinia  
 FB—Madagascar, Reunion Id., Comoro Id., etc.  
 FC—Belgian Congo, Ruanda, Urundi  
 FD—Angola and Kabinda  
 FE—Egypt  
 FF—French West Africa, including French Sudan, Mauritania, Senegal, French Guinea, Ivory Coast, Upper Volta, Dahomey, Civil Ter. of the Niger, French Togoland, etc.  
 FG—Gambia  
 FH—Italian Somaliland  
 FI—Italian Libya (Tripolitania and Cyrenaica)  
 FJ—Somaliland Protectorate and Socotra  
 FK—Kenya, Zanzibar Protectorate, Uganda, Anglo-Egyptian Sudan, and Tanganyika Territory.  
 FL—Liberia  
 FM—Tunisia, Algeria, Morocco (including the Spanish Zone), Tangier  
 FN—Nigeria  
 FO—Union of South Africa, Northern and Southern Rhodesia, Bechuanaland Protectorate, and Southwest Africa  
 FP—Portuguese Guinea and Cape Verde Ids.  
 FQ—French Equatorial Africa and Cameroons  
 FR—Rio de Oro and adjacent Spanish Zones, Ifni, and Canary Ids.  
 FS—Sierra Leone  
 FT—Eritrea  
 FU—Rio Muni (Spanish Guinea) and Fernando Po  
 FV—French Somaliland  
 FW—Gold Coast Colony, Ashanti, Northern Territories and British Togoland  
 FX—Seychelle Dependencies  
 FY—(Unassigned)  
 FZ—Mozambique

## OCEANIA

OA—Australia (and Tasmania)  
 OD—Dutch East Indies\*  
 OE—Melanesia\*  
 OH—Hawaiian Ids.  
 OI—Micronesia\*  
 OO—Polynesia\*  
 OP—Philippine Ids.  
 OQ—New Zealand

\* To be further partitioned when activity warrants.

## SHIP STATIONS

Ship stations with amateur calls will place an X before their usual intermediate. E. g., Australian 3AA at sea, calling U. S. 1AW, would send "1AW NUXOA 3AA" The reply would be "3AA XOANU 1AW"



teurs was taken. It is reproduced herewith. From left to right there appear (front row) Heywood, A3E, of Durban; R. N. Coombs, Hon. Secretary, Johannesburg; (middle row) Streeter, A4Z, Cape Town; Pleass, A4M; Dixon-Bennett, A3V, Bloemfontein; Green of A4V; and Marks of A3B. In the rear row there are Goodman, A4R of Durban; Jacobs A5X, Goodman of A6A, Innes of A43, Calvert A3C and Collins of A4Q.

### a3JU Visits Us

A.R.R.L. Headquarters was honored in late November by a visit from Mr. Ross A. Hull, Honorary Federal Secretary of the Wireless Institute of Australia, who is touring the States, visiting amateurs and studying radio conditions here in general. He attended a meeting of the A.R.R.L. Executive Committee at Hartford, at which plans for increased coöperation in communication activities between W.I.A. and A.R.R.L. members were laid.

## The First Annual Rocky Mountain Division Convention

**T**HE first annual Rocky Mountain Division Convention was held at Denver, October 29th and 30th. The convention was called to order at the Argonaut Hotel at 2 p. m. by Mr. Hebert, A.R.R.L. representative at the convention. After the preliminary talk the meeting was turned over to Mr. Stedman, 9CAA, SCM of Colorado, as the meeting was primarily a traffic session. Mr. M. O. Davis, 9CDE of La Junta, Colorado gave a very enlightening talk on traffic conditions and also urged all present to try and have some kind of an emergency transmitter going in case the power should go off during a storm. LaCroix of 9DKM and chief route manager for Colorado then outlined Colorado's needs in routes and asked the help of the gang in lining things up. Next, the main speaker of the afternoon, W. W. Pullman of the Western Union, gave a very interesting and detailed talk on commercial traffic handling. Mr. O'Halloran of the Associated Press then asked what the amateurs could do in the way of news service should wires go out, and was promised the entire cooperation of the gang present. An incident that happened with the railroads about four years ago was brought to light in which the hams participated. In the evening a technical meeting was held and 9BXQ, Mr. H. M. Williams presided. Mr. Hebert gave a very interesting talk on skip distances in radio work.

This was followed by a talk on receivers by Glen Ernhart, 9CHV. He explained a trap circuit for getting rid of foreign noises, and had a receiver all hooked up to prove that it works f. b.. Mr. Conover Blackwood, testboard man for the district office of the American Tel. and Tel. Co., then gave us some dope on vacuum tubes and their use in telephone lines and carrier currents. This was all new stuff to most of the gang and was certainly appreciated. Mr. O'Connor of the gas and electric company then told us of his troubles as official QRM silencer on the company's power lines. The meeting was then adjourned 'till the next day.

The following morning a large part of the gang was on hand to take the exams for licenses, as the Dep't. of Commerce was kind enough to have an inspector here for the convention. The exams were preceded by a code speed contest to determine the Rocky Mountain champion. This was captured by Stedman of 9CAA, and now he has a fine key to show for his work. Ex 9AMB was a close second. In the afternoon a 70-mile trip thru the mountains was cancelled due to slippery roads, a show being substituted. The closing event in the evening in the form of a banquet was held. Numerous YLs were among those present, including 9BDF, the second op of 9CBH and 9CHV (all three possess familiar fists) and wives of other delegates. Mr. Segal, Director of the Division, acted as toastmaster at this session. Mr. Hebert spoke again, and Mr. Turner, the R. I. gave us a lot of dope on ham conditions. Following this, all out-of-town delegates were called on. SRA was from the most distant point with many other out-of-state men to keep him company. Then the grand finale was pulled off, the initiation into the Royal Order of the Wouf Hong. The convention ended at midnight with each and everyone feeling that he had received great gain from this trip to Denver, especially 9DKM and 9DGJ who went home with valuable prizes. All present were unanimous in the desire to be present at the next convention.

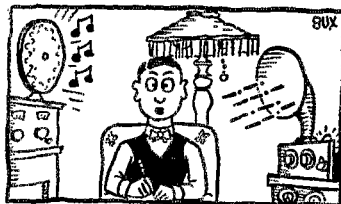

TERRIBLE PREDICAMENT OF THE RADIO FAN WHO WAS INTENSELY INTERESTED IN BOTH BROADCASTING AND AMATEUR RADIO.

# Calls Heard



6AWQ, R. M. Stapp, General Hospital, San Bernardino, Calif.

40 Meters  
 laae lalp lamd lanu lawe laxa lazd lbhs lboq  
 lbtr lkk lqc lru ltk 2kv 2apd 2apv 2arm 2brb 2buy  
 2evu 2gy 2lm 2md 2mu 2nv 2rm 2tp 2uo 2xg 3ab  
 3acm 3afq 3ahl 3bms 3ceb 3kr 3wg 3yp 3zo 4ag 4ei  
 4gi 4hl 4iz 4lb 4mj 4qj 4rm 4si 4tn 8afq 8amt  
 8bal 8bb1 8bct 8hcp 8eih 8dmm 8drd 8gb 8rh a-1ba  
 a-2bk a-2cg a-2cs a-2cy a-2dk a-2no a-2sh a-2so a-2tm  
 a-2tw a-2vi a-2wb a-2wm a-2en a-2ls a-2my a-2tm  
 a-3xo a-4an a-4cg a-4cm a-4eo a-5bt a-5bx a-5da  
 a-5kx a-5rm a-5wh a-7ca a-7cw a-7dx a-7gh a-7la  
 bn-8k2 c-2kp c-2sb c-4et c-4hh c-4ng c-4nq ch-2ak  
 ch-2ar ch-3ag ch-3ij ear2 g-3am g-5dh j-1aa j-lpk  
 j-lam j-lts j-ltt j-1aa j-3az m-lj m-ln m-9a o-1sr  
 o-a8b o-a8e o-a4c o-a4t o-a4x o-a5o pi-1at pi-1au pi-1dl  
 pi-1hr r-bal r-ha2 ss-2se z-lax z-1fq z-2ac z-2ae  
 z-2ag z-2bc z-2bx z-2xa z-3ai z-3aj z-4aa z-4ac z-4ah  
 z-4am.

6 CCT, 5529 Fleming Avenue, Oakland, California

40-Meter Band  
 a-2bb a-2bk a-2ck a-2cm a-2cs a-2ds a-2dy a-2io  
 a-2no a-2rg a-2rx a-2sh a-2tm a-2uk a-2yb a-2yi  
 a-3ao a-3bd a-3bm a-3bq a-3bx a-3ef a-3en a-3kb  
 a-3ls a-3tm a-3xo a-3xy a-4an a-4bd a-4cx a-4cm  
 a-4mm a-4rb a-5bg a-5bj a-5ba a-5da a-5hg a-5kn  
 a-5lf a-5lo a-5mu a-5rm a-5wh a-7ca a-7dx a-7gh  
 a-7la a-7lr a-7rs au-7bh au-7hw au-7kn au-7xk au-7mn  
 bz-1ak bz-1aw bz-1ib bz-2af bz-2ag ch-leg ch-2ah  
 ch-2as ch-2ld earl ei-pkl ie-pk7 ie-ane f-8ab f-8fj  
 fi-8qq g-2lz g-2nm g-2sz g-2jf hu-6acg hu-6aff  
 hu-6ahh hu-6buc hu-6duc hu-fmi hu-fxl hu-wyi j-1aa  
 j-lar j-lit j-lpp j-lsm j-lts j-ltt j-lzb j-3kk j-3yz  
 joc jkzb m-laa mln m-lj m-5j m-9a m-bx m-cx5l  
 nc-8xz o-1ar o-a3b o-a8e o-a4c o-a4m o-a4t o-a5o  
 p-9aa pi-lau pi-lbd pi-1dl pi-1dr pi-1hr o-3af r-aa8  
 r-af1 r-dw4 r-ha2 vkn vqx x-2bg x-4gs y-1br y-led  
 y-2ak z-lao z-lax z-lxz z-lac z-2ae z-2br z-2gc  
 z-2xa z-2ag z-3ai z-3aj z-3ar z-4aa z-4ac z-4ag z-4am  
 z-4ar z-4as z-4av aa7 ab1 auw awl bn bam ban bn1  
 cw4 cx7 dl4 ddt dx3 fa6 fu9 g9y glvh gebt gldy  
 glky kg pl1 oot poz prr rxy skl sk2 vjil xc55 xc57  
 knt kfuh kfvm kgtc kdxd wwdo nar naw xe newk  
 ngej nirs nixx nkf nnc noh not noyq npa npc npg  
 npl npm npu npo npp nra nuag wik wva wvc  
 wvr wxv wyo wzd lad 8em 113.

7AAT, Orville W. Viers, 402 N. Broadway, Red Lodge, Montana

40-Meter Band  
 laqy lmy 2lm 2nz 2rs 3ab 3wu 4f 4jk 4si 4tn  
 5ad 5ap 5apq 5atf 5auz 5di 5z1 6agr 6ahs 6akm 6alq  
 6ano 6are 6ars 6arx 6ary 6atu 6awg 6bdl 6bge 6bhc  
 6bix 6bls 6bmw 6bql 6bth 6bvd 6bvm 6bwy 6bxc  
 6cdw 6ehm 6chy 6elk 6euw 6exz 6dca 6ddo 6dea 6kb  
 6lj 6rj 6rr 6yd 7ae 7aaw 7ab 7adm 7ais 7bg  
 7bt 7dd 7df 7fe 7fh 7fl 7if 7ny 7pu 7ti 7tx 7uo 7uw  
 7wc 8aj 8aly 8amb 8amc 8cve 8cwt 8dcp 8dgv 8adk  
 9ado 9aef 9aiz 9amm 9amp 9anz 9aon 9apa 9ara  
 9ari 9azq 9bab 9bbw 9bdi 9bdq 9bdt 9bht 9bhz 9bly  
 9biw 9bnu 9bqa 9bac 9bcz 9bco 9bhw 9brz 9brq  
 9bvc 9caa 9caj 9caw 9cef 9cdq 9eds 9ect 9ewz 9cfr  
 9cfl 9cg 9cy 9eku 9en 9enc 9eso 9otz 9evn 9evy  
 9ewq 9eyr 9daw 9dax 9dbw 9dec 9diz 9dkm 9dms  
 9djp 9dr 9dvl 9dwd 9dwn 9dza 9dzt 9dzl 9eea 9ec  
 9eev 9eev 9ewb 9ees 9en 9nw 9ay 9sj 9sv 9wo 9zk  
 c-4af c-4cc c-4gt m-9a a-7cs o-a8e kdef nkf npu.

8VE, F. B. Westervelt, 5306 Westminster Place, Pittsburg, Penna.

a-2ij a-2nd a-2sh a-2yi a-3em a-3en a-3ls a-3yx  
 a-5bx a-5da a-7cw b-3aa b-4zz bz-1ad bz-1ak bz-1am  
 bz-1an bz-1ao bz-1aw bz-2ab bz-2af bz-2ia bz-5aa  
 bz-6qa bz-6cb bz-9qa c-1an c-1ar c-1ax c-4dw c-9bc  
 ch-2ab ch-2ah f-8ab f-8cl f-8cs f-8ct f-8di f-8fj f-8gi

f-8gm f-8ix f-8kf f-8fmr f-8rbp f-8ssw f-8tis f-8yor  
 fa-8ip g-2pz g-2wj g-5pw i-1bw i-1ma jm-2pz k-4abf  
 k-4uuh m-jh m-ln m-9a o-a3b o-a3m o-a5o o-a8l  
 r-lak pr-4ja q-8kp r-af1 y-1bu y-2ak z-1ax z-3ai  
 z-4am zoh npe wnp wvz fxl glq bb3 aa7 abl oedj  
 kel ngd nmd niss rxy npi wvr 98x sect wvdo npm  
 oerb nem ex7 ardi pell peuu pkj npg not nba nau.

9ARA, Robert Henry, 307 West Pine Street, Butler, Missouri

a-2dy a-2by a-2bx a-2no a-2bb a-2cs a-2tm a-2yi  
 a-2cy a-2cg a-3en a-3em a-3bd a-3kb a-3tm a-3wm  
 a-3my a-3xo a-4an a-4cm a-4ac a-4am a-4ag a-5bg a-5bx  
 a-5wv a-5dx a-5lf a-5ma a-5nb a-5wh a-5rm a-6kr  
 a-6am a-7cs a-7cw a-7dx a-7gh a-7la a-7rs a-vkl  
 be-laa bz-lak bz-lad bz-lar bz-laq bz-lam bz-law  
 bz-2ag bz-2ab bz-2vi bz-sq4 bz-6cb bz-9aq f-actn  
 hu-6axw hu-6asr hu-6buc hu-6dcu hu-fxl i-1co ch-2ab  
 ch-2ah ch-2ar ch-4ag j-lts j-dzj pi-lhr pi-lbd pi-lau  
 o-a5o o-1ar o-1-1 o-a3b o-a6n r-ocp y-lcd y-2ak z-1ao  
 z-1ax z-2ac z-2bx z-2ac z-2xa z-3ar z-3ai z-3am  
 z-3bx z-4aa z-4av z-4am z-4ac.

9DAU, MacDougal Brothers, Nichols, Iowa

October and November  
 c-3hp c-3gg c-3ni f-8cl g-2cc g-2kz g-5dh gh-lfg  
 jm-2pz m-lj m-ln m-9a m-jh m-6h m-cyy z-2aq  
 z-2xa z-3ar z-4ak bz-lak bz-lam bz-laq bz-lar bz-law  
 bz-lbi bz-2af bz-2ag bz-2ao bz-2ad bz-9qa o-a3b o-a5o  
 r-c88 r-nw4 ch-2ar ch-2as ch-2ld q-2jt q-3kp.

c 9AL, Keith Russell, 5 Mail Building, Toronto, Canada

a-3dc a-4yn a-5wh b-3aa b-y8 bz-law bz-lib bz-2ab  
 bz-5aa bz-sqix f-8jn f-8ec f-8cl fm-ocrb g-5hs gi-6mu  
 i-acd jm-2pz k-4abf m-cyb m-bno o-a5o p-2bx gh-lfg  
 au-wwdo pell perr pic du4 ap4 rk pett lhs.

c-3JL, Woodroffe, Ontario, Canada

4aar 4cz 4ee 4iz 4nh 4wi 5aab 5avq 5avv 5ev 5ls  
 6cuw 6cuu 7ob b-4ax b-o8 b-u8 c-8aw f-3ba f-8fj  
 f-8lm fa-8ip g-2cc g-2kx g-5jo g-5pm g-5uz  
 g-6ok k-4abg n-ogm n-opm nrrg bam xg-6mu skl.

y-1CG, W. Figueira, 1070 Magallenes St., Montevideo, Uruguay, S. A.

1aao 1abe 1abt 1alw 1bf 1bp 1bx 1bz 1ch 1cp  
 1cp 1cmx 1cv 1ed 1fl 1fw 1ux 1xv 1zs 2aao 2acp  
 2ahm 2a- 2ab 2aim 2ap 2avo 2erb 2ff 2gk 2nf  
 2or 2tom 2xrb 3dua 3edk 3l 3lw 3op 3ot 3zo 4kb 4pi  
 4rm 4tu 5vb 6ahn 6aij 6aio 6ary 6ayv 6axw 6ba 6baq  
 6buc 6bvd 6bxz 6bzd 6cae 6clj 6ctv 6cm 6cuv 6do  
 6fp 6jp 6or 6rp 6tq 6vz 6aj 6aq 6bq 6bc 6cd  
 6cl 6dt 6nx 6adk 6ek 6ctd 6pmp 6exz 6gac 6ds  
 6ff 6gz 6iu a-2yi b-4zz g-2cc g-2it g-2nm g-2wy g-5dh  
 g-5pz g-5yd i-1bk i-1co i-1kw i-8di f-8ez f-8fr  
 f-8k f-8jn f-8kf f-8qr f-8wnm a-2co a-2nm a-muk  
 k-6k hu-6axw hu-6clj j-lqj j-lzj j-3pk p-lae z-2ak  
 z-2bg z-2gc ac8 ibo octn ocdt pty upk.

bz-2AJ, J. R. Baccarat, 504 Avenue C, Nebias, Santos, Brazil

1aao 1alr 1btr 1hvx 1ccz 1cp 1cmx 1my 1xv  
 2ai1 2amd 2byg 2ctf 2erb 2ff 2gk 2vz 2rv 2rz 2sacj 8bva  
 3lv 3zo 4ni 5dl 5ql 5wi 5zaz 5aud 5bce 5brc 5cd  
 8dbb 8don 9zt b-aa1 b-aa3 b-mmcc b-o8 b-h7 c-lar  
 c-led earl f-8fr f-8jn g-2it g-5da g-5xy g-6mu i-lgw  
 i-lre i-ldo j-8aa z-2bg z-2br z-3ai z-4am.

bz-6QA, A. A. Santos, P. O. Box 53, Maranhao, Brazil

40 Meters  
 laae lads laep laga laxa laxo lbhm lbqt lch  
 lcjh lcmx lgc lue lvy lzx 2afz 2avv 2bqh 2bvh  
 2eaz 2cbg 2cel 2eth 2evu 2cyq 2cxl 2nz 2om 2cu



2AYJ, Oyster Bay, New York

6aak 6aal 6aap 6agh 6agk 6agr 6ajn 6ake 6alp 6ahp 6aah 6aak 6aax 6aac 6aur 6avr 6avj 6ayw 6bak 6bbn 6bch 6bec 6bfj 6bgk 6bhi 6bhn 6bia 6bil 6bjl 6bjv 6bvw 6bmw 6bne 6boc 6bq 6brf 6bhm 6bvo 6bva 6bvz 6bxr 6hvx 6bza 6bzf 6bzm 6cel 6ceu 6cdl 6ceg 6chy 6ckf 6ckh 6cku 6ckv 6clf 6clm 6clt 6cnk 6cpf 6err 6ear 6ear 6emu 6eod 6eta 6etm 6etz 6eua 6euc 6euv 6evr 6eyh 6ezy 6dan 6def 6deh 6ddo 6ddn 6dn 6eb 6er 6ew 6ez 6ih 6il 6jn 6ku 6lh 6lj 6uw 6oi 6or 6va 6zb 7aek 7de 7dc 7ek 7eo 7fh 7gv 7ld 7pu 7ri 7uw 7wu 7zu a-2ay a-2cm a-2jy a-2tm a-2yh a-3hl a-4cm b-h5 b-n33 b-y8 bz-1aa bz-laf bz-lag bz-lai bz-lak bz-lam bz-lan bz-lao bz-lar bz-law bz-lbi bz-2ab bz-2ad bz-2af bz-2ag bz-2ak bz-2ao bz-4zg bz-5aa bz-5ad bz-6qa c-4aq c-4dq c-4ea c-8aw ch-2ar cs-2un (qra?) ear3 ear16 ear26 f-8bq f-8bw f-8ca f-8cl f-8cs f-8ds f-8e f-8fi f-8gj f-8hn f-8jn f-8jo f-8jr f-8jt f-8pm f-8pr f-8ssw f-8tis f-8tuv f-8zet f-8zw f-oeng f-octn f-ocgy fm-8ma fm-8mb fm-ocrb fo-pm g-2rg g-5bs g-5hs g-5if g-5ma g-6pm g-5pz g-6br g-6lj g-6m g-6nf g-6td g-6yb g-6yd gh-1fc gh-lfg gi-2it i-1au i-law i-1co i-1er i-1gw i-1ma i-act i-og-lj jm-2pz k-i2 k-r8 k-4abf k-4xad m-laf m-le m-lf m-lg m-lh m-lj m-lk m-lm m-ln m-9a m-cyy m-jh m-xam n-opm n-owe n-pb3 o-a3b o-a3c o-a3l o-a5o o-a5r o-o5a o-lcr p-lak pr-4ja q-8kp r-bal w-3xb w-3xj y-layw y-lcg y-2ak y-yv z-lag z-lak z-2cm z-2xa z-3ai z-3xb z-4aa z-4ac z-aufz xal ank awl.

2BSL, Frank Jacobs, 8427-105th Street.

Richmond Hill, N. Y. September and October 6hav 6bmw 6eel 6chy 6cli 6eub 6or 6zat 7ju a-5ma b-3aa b-2ab bz-1ab bz-lao bz-law bz-2af bz-2ag bz-2aw c-lar c-lam c-2fo c-3cs c-3ni c-3ur c-3xi c-4du c-4dw cr-ker f-8cl f-8cs f-8fi f-8gj f-8ix f-8jf f-8kf f-8kt f-8ur f-8yor i-1co k-i2 k-ohl m-cyy m-ij o-2ld pr-4nf pr-4sa q-8kp w-3xb y-2ak z-lax z-4ak.

3LW, Robinson, Silver Lake Farm, Willow Grove, Penna.

6ahs 6aji 6cqw 6cto 7uw a-2bb a-2cg a-2dy a-2ij a-2rc a-2yi a-3bd a-3bq a-3em a-3en a-3bk a-3mm a-3my a-3xo a-4cm a-4bq a-4bw a-4dx a-5ma a-5nb a-5wh a-7ew a-7dx bz-lan bz-lar bz-law bz-lbi bz-2ab bz-2ad bz-2af bz-2ag bz-5ad c-8rg c-8ry ch-2ah ch-2ar cz-fr5 f-8mk f-2nm g-2xy k-i2 m-jh m-lm m-cyy o-a3b o-a3k pr-4ja q-8kp r-afi y-lbr y-lcd y-2ak z-lax z-2ac z-2bg z-3ai z-3ag z-3xb z-4aa z-4ac z-4am aqe abl av7 bb3 nad nba voq wjh wvr xda oeng.

3OQ, Emerson T. Showell, Absecon, N. J.

a-2bk a-2ga a-2sh a-2yi a-5kn a-5kz bz-lac bz-lam bz-lan bz-lao bz-laq bz-lar bz-law bz-lbc bz-lbd bz-lbi bz-2ab bz-2ad bz-2ag bz-5ad ch-2ab ch-2ah ch-2ar f-8gm f-8ix f-8jf f-8jn f-8jj f-8ku f-8yor fm-8ma g-2bz g-2kf g-6td hu-6atm i-lau i-lbb i-lcv ki-2i m-lm m-cyy n-owe o-a3b pi-lbd pr-4ja pr-4sa q-8kp r-a8 y-lbr y-lcd y-2ak z-4ac z-4am bb3 6nl bal pda.

4LK, Lee & Ffoulkes, 502 Spearing St., Jacksonville, Fla.

6abg 6ako 6amm 6arj 6asm 6axu 6bba 6bfl 6bia 6bj 6cgk 6cqa 6cqm 6cua 6cub 6dat 6dl 6ew 6or 7sf 7wu a-2bk a-2sh a-2yi a-3ef a-7dx bz-lav c-lar c-2be c-3jw c-3xi c-4bt f-8fr f-8fu f-8gm f-8ix f-8jf f-8jn f-8kf f-8rbp g-5dh hu-6aj hu-6buc i-lay i-1co i-lgw m-laf m-9a z-lav z-lax z-2ac z-2ae z-2ax z-4aa z-3ak z-4am z-4dn aa7 abl av7 cv6 ipl prxy aqc vd fw glq ktx kflf wsk wimr xda nav naj nar naw nem niss nit nvx.

5KC, V. L. Rosso, Plaquemine, La.

September and October a-2bb a-2bk a-2cs a-2no a-2sh a-2so a-2tm a-2yi a-3am a-3ef a-3kb a-3ls a-3wm a-3xo a-5bx a-5wh a-5xl a-6sa a-7cw a-7dx b-4zz bz-lab bz-5ab bz-6qa bz-8pc ch-lsr ch-3ar ch-nad f-8ef f-8ix f-8jn f-8kf f-8tby f-8yor fm-8ma g-9yg gh-lfg hu-6du i-1do i-1ap i-lau i-lrm jm-2pz m-lj m-lk m-ln m-6c m-9a m-cyy m-ih m-xcd m-xci m-xc6l m-xda o-a3b pr-4ja q-8kp y-2ak z-lao z-lax z-2ac z-2bg z-2gc z-3ai z-3aj z-3xb z-4aa z-4am z-4ar aa7 abl aq8 bb3 cv6 dx8 9gx rxy vyz wcp nkf wvy fw bam ocjd glq wvr vwq fbvy widk ocn nem ardi gidy arex vj wwdo fxl.

Charles Justice, 433 South 17th Street, Columbus, Ohio

a-2tm bz-lan bz-law bz-lbi bz-2ag bz-2aj bz-2ao bz-5ab bz-5ad bz-8pc bz-9qa c-4bc c-4fc c-4gt c-5ct c-5gl ch-2ah ch-2ar ch-2ld ch-3ij cz-99x cz-fr5 nba f-8kf f-8jn f-8yor g-2kf g-2nm g-5dr g-6yd hu-6buc hu-fxl i-1co m-laa m-laf m-lg m-lj m-lk m-lm m-5b m-6c m-9a m-jh m-xc5l xda pr-4ja pr-4je pr-4kt pr-4sa pr-4ur q-2mk q-8kp y-lcd z-lao z-lax z-2ac z-2ae z-2xa z-3ak z-3am z-3ar z-4ac z-4am z-4ay kgbb wnp voq nite niss nisq rxy nerf fw hik glq.

8AGO, Biddle Arthurs, Jr., 3046 Centre Ave., Pittsburg, Pa.

5abq 5aen 5aio 5api 5arf 5aur 5aur 5ev 5ra 5sw 5zaf 6abm 6ae 6agr 6ako 6aoy 6arv 6asd 6avb 6bbi 6bbu 6bcm 6cn 6cm 6bh 6bl 6bn 6bhv 6bvc 6cax 6cd 6cew 6cht 6ck 6cmc 6cpl 6cto 6cua 6cuc 6dal 6ddo 6dea 6dn 6fa 6jn 6mu 6np 6vr 6vz 7alk 7ab 7vh 9ad 9bz 9hud 9cw 9cdw a-2yl a-5bg b-3aa bz-lad bz-lam bz-lak bz-laq bz-law bz-lay bz-lbi bz-2ab bz-2af bz-2ag bz-2aj bz-2al bz-6ub c-lar c-lay c-4du c-9a f-8aq ch-2ah ch-2as f-8ct f-8di f-8ix f-8kf f-8kv f-8ma f-8ssq f-8yor fa-8ip i-lau i-lay i-1co i-1ma k-4uah m-lh m-lj m-lm m-lw m-6b m-9a o-a3b q-8kp r-afi y-lcd y-2ak z-lax z-3ar aa7 abl av7 nar niss rxy wvr.

3CVJ, D. F. Langham, 107 North Street, Auburn, N. Y.

6aij 6ajm 6am 6ann 6aoy 6asd 6asm 6aye 6bam 6bay 6bn 6bhg 6bhk 6bia 6bjv 6bm 6bpm 6bhm 6btm 6bve 6bn 6bxl 6bxi 6bxn 6bya 6bdz 6bzl 6cel 6cd 6edj 6chy 6clt 6cpl 6cqm 6csm 6ct 6etz 6cua 6daq 6ddo 6dn 6ea 6el 6ew 6ge 6ih 6kb 6kd 6mm 6mu 6or 6py 6ud 6za 6zj 7aib 7ajn 7ap 7ek 7l 7jo 7ju 7wu a-2bb a-5bg b-3aa b-3ab b-8xb bz-lac bz-lad bz-lag bz-lak bz-lam bz-lao bz-law bz-lay bz-lbi bz-lbc bz-lbi bz-1ib bz-2ab bz-2af bz-2ag c-lak c-lam c-lar c-2ax c-2bb c-2bv c-2co c-2fa c-3ad c-3ct c-3el c-3he c-3iw c-3ri c-4aq c-4bb c-4dq c-4dy c-4ai c-4cd ch-2aj ch-2ah f-8ck f-8cl f-8cs f-8ct f-8di f-8ds f-8gi f-8hu f-8ix f-8jf f-8kf f-8sw f-8ud f-8yor g-2bz g-2od g-2wj g-2xg g-6qa g-6td gh-lfg gi-lb i-act i-lau i-lay i-lbb i-1co i-lgw i-1ma jm-2pz k-4abf m-le m-lj m-lm m-6c m-9a o-a3b o-a4z pa-6ra q-2lc q-8kp r-bal c-eh8 v-hl v-rk v-8vy y-lbu y-2ak y-2yj z-lax z-2ae z-3ai z-3ar ev8 fb6 fr8 glq jtgw.

8KF, W. R. McShaffrey, Monessen, Penna.

o-a3b o-a5o o-a5n o-lar fm-8ma z-4ac z-4av z-lax z-2xa z-lao z-2ac cf-5ef a-2tm a-2sh y-2ak f-8m f-8jf f-8gm f-8tis f-8kf f-8kf f-8lf f-8lx f-8m f-8di f-8vc i-lma i-lau i-ler i-lrm i-act i-1co i-lgw bz-lam bz-2ab bz-2bg g-2lx g-2xv g-5nm m-lm m-jh m-9a m-cyy m-xc5l jm-2pz pr-4ja q-8kp gh-lfg b-3aa aa7 abl o-whn av7 wdyc agb npu gerr perr vvx rxy wva.

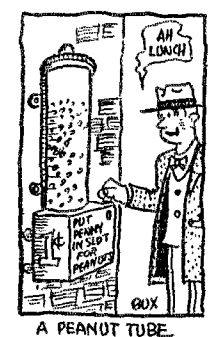

# Correspondence

The Publishers of QST assume no responsibility for statements made herein by correspondents



## Navy Day

Navy Department,  
Washington, D. C.

Editor, *QST*:

It was with great pleasure that I received your telegram conveying the best wishes of the American Radio Relay League to me and to the Naval Service on the occasion of Navy Day.

I wish to assure you of our admiration of your excellent organization and of our appreciation of the splendid cooperation we have always received from you.

The number of your members who are affiliated with the Navy is showing a most pleasing increase, and I feel that this connection with the Navy in behalf of Naval Communications is most essential to us, in peace as well as in war.

With best regards,

Yours very sincerely,

Curtis D. Wilbur,

Secretary of the Navy.

## Splendid Navy-Amateur Work

Note:—The following letter from Admiral E. W. Eberle, U. S. N., to Gifford Grange of 4HZ, So. Jacksonville, Florida, was sent to 4HZ after his splendid emergency work immediately following the recent hurricane disaster in Florida.

—J. M. C.

From: Chief of Naval Operations  
Gifford Grange, Radioman 2c,  
To: U. S. Naval Reserve  
Via: Commandant, Seventh Naval District  
Subject: Appreciation of services rendered.

1. The Commandant, 7th Naval District, Key West, Florida, reports it was largely through your efforts that communication was finally established between Miami, Florida and the outside world during the recent hurricane in the Florida area. He further reports that your work was of the highest order and that it was through your radio station in Jacksonville that early requests were made for relief and other emergency assistance.

2. It appears from the report as a whole that you have displayed commendable devotion to, and zeal in the performance of your self-imposed duties. The Navy Department considers it very for-

unate that this opportunity to render an invaluable service should have been presented to a Naval Reservist who was so capable of rising to the requirements of the emergency.

3. I wish to extend to you my appreciation and thanks for your services which reflect credit not only upon you, but upon the Navy.

—E. W. Eberle.

## c4AG and ex c4AG

325-24th Ave., W.,  
Calgary, Alta.,  
Canada.

Editor, *QST*:

It has been my intention to bring to your notice at an earlier date than this, some confusion which has arisen from your editorial "Part of the Game" in the August issue, and the publication of my letter in the same issue.

It was rather a coincidence that in the same issue you should have published an editorial relating to some good work done by the former owner of the call c4AG in the year 1923, (for which he was awarded a medal) and my letter which was signed "F. E. Macdonald, c4AG". I have received congratulations from my friends, and in being so modest about my achievements I have taken a step higher in their estimation. Your editorial was the first I ever heard about it, and I was more astonished than they! It has told me though, that I have a reputation to keep up, and I wish to assure the former owner of c4AG that I'll not do anything to mar the good name which he has made.

—F. E. Macdonald, c4AG

## A Good Suggestion

Washington, D. C.

Editor, *QST*:

I am very much interested in the subject of the letter from 8DOY appearing in November *QST* under the caption, "Help to the New Man". I whole-heartedly concur in what 8DOY says about his experience in getting started on the air. My station

3GP was dedicated to hamdom on October 3rd of this year. I endeavored to install the best equipment procurable, having a crystal-controlled transmitter with 50-watt master oscillator and 250-watt amplifier.

I have had some of the most pleasant experiences of my life since I got started, so my letter should not be considered as a broadside at any one or all of the amateurs at large. However, my observations so far have led me to the firm belief that our brother amateurs can properly be classified in three groups, viz: (1) Experimenters; (2) Traffic seekers; (3) Social or friendly operators. All three classes serve a most useful purpose and I will not venture an opinion as to which is most important to (1) the League, (2) radio in general, or (3) the world at large.

Personally, being no youngster in years and having what I believe to be the best outfit that I can work out, I am only incidentally, or sympathetically, interested in the first class. I am interested, and very much so, in the second and third classes. My present difficulty, and it also appears to be the difficulty of 8DOY, is that classes 2 and 3 cannot be segregated insofar as CQs are concerned, from class 1.

I have handled so far about 30 messages, all for the Pacific Coast. I have called "CQ West" many times, believing that the designation would indicate that I am looking for more than a signal report. However, time after time, I have received responses and the "CUL" was heard so fast that my head almost reeled. The other evening I tried to put through an important message to the Coast and "CQed West". A station in Dallas, Texas, responded. As a matter of courtesy I am withholding the call of the station. He said he would QSR and I gave him the message as precisely and carefully as I could. He had previously reported audibility of R5. After transmitting the message he asked for repeats on some unusual phrases, trade brands and trade names. I filled in the doubtful transmission carefully, doubling the unusual phrases and trade brands, and then asked if OK. That was the last of my QSO. He never came back, although I asked him three times. When I was about to give up I heard him "CQing DX". I answered his CQ but no response.

Now what I have in mind is this: If that station was not prepared to make even a slight effort to QSR he should certainly not have undertaken to do so. He did not have to undertake a QSR; it was up to him. The very least he could have done was to come back and finally tell me that he would not QSR. I would then have known whether to consider the message on its way or not. I felt obliged to pass the message to someone who was prepared to exert just a little effort to carry out our ambitions and the

wishes and ambitions of our League to which we all gladly belong.

As a possible solution of the beginners (and perhaps graduates) problem, I would suggest that when CQing and only interested in signal reports, some special designation be appended. The amateurs conscientiously looking for traffic and social chats invariably are prepared to go slow as 8DOY suggests. I am prepared to handle all the traffic which I am offered, as it serves a very useful purpose and gives the amateur the best possible practice, which he should be looking for. I am also prepared to chat with fellow amateurs, as the practice and contact is invaluable.

I would like to see some constructive move made to designate the CQs of the signal hounds, as I have chosen to name them, and the above is submitted to the amateurs at large for their criticisms and suggestions.

—W. M. Smith, 3GP.

## V. T. Relays

231 Clinton Avenue,  
Oak Park, Ill.

Editor, QST:

This is with reference to the article "A Sensitive Vacuum Tube Relay" by Schnell and Hoffman in the November issue of QST. It occurs to me that although the authors make mention of a recent article in the *Wireless World* they have omitted reference to an article which I feel is of prime interest to working with vacuum tube relays or recorders. F. W. Dunmore, of the Bureau of Standards, presented a paper at the 1922 convention of the A. I. E. E. entitled "A Relay Recorder for Remote Control by Radio". This paper appears in the *Transactions of the A. I. E. E.*, Vol 41, page 242. Dunmore's paper contains many interesting facts and he describes methods of eliminating static and induction disturbances which operate the relay. He also describes several audio tuning devices which materially increase the relay's selectivity.

With 10 milliamperes in the plate circuit of the Dunmore relay, the relay operated at 48 contacts per second. With one milliampere in the plate circuit the relay was operated at a speed of 19 per second. By using two relays in series across the output terminals of a single radio receiving set, two messages sent on practically the same wavelength have been accurately received simultaneously.

Another relay of interest, because of its novelty, is described in Mr. Lewis's paper on "Sensitive Radio Frequency Relay" appearing in the *A. I. E. E. Transactions*, Vol. 43, page 802. All the working parts of this relay are enclosed in a glass tube similar to the ordinary vacuum tube.

—W. O. Nangle.

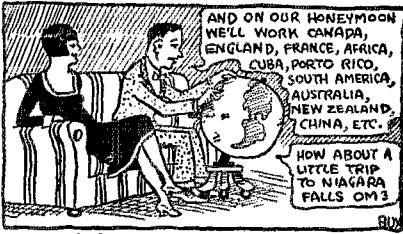

AND ON OUR HONEYMOON  
WE'LL WORK CANADA,  
ENGLAND, FRANCE, AFRICA,  
CUBA, PORTO RICO,  
SOUTH AMERICA,  
AUSTRALIA,  
NEW ZEALAND,  
CHINA, ETC.

HOW ABOUT A  
LITTLE TRIP  
TO NIAGARA  
FALLS ON?

THE ENGAGED HAM WITH THE 204 TUBE  
PLANS HIS HONEYMOON WITH HIS Y.L.

## Nonoise Variable Grid Leak



Operates on a new principle. Retains adjustment.  
Noiseless. Range  $\frac{1}{2}$  to 7 megohms.  
Set Manufacturers who do not skimp  
on equipment use it in their sets.  
If your dealer does not stock them  
send us 85c and we will send you one.

**RADIO FOUNDATION, Inc.**

25 West Broadway, - - - New York, N. Y.

## Special Colored Official League Emblems for Section Communications, Managers and Official Relay Stations

See mention in Communications Department—this issue

Red Background (for S.C.M.'s only) }  $\frac{1}{2}$  in. Size  
Blue Background (for O.R.S.'s only) }

**\$1.00 ea.**  
Postpaid



American Radio Relay League, 1711 Park Street, Hartford, Conn.

# HAMMARLUND Precision PRODUCTS

Are Officially Specified for These Fourteen Popular New Circuits

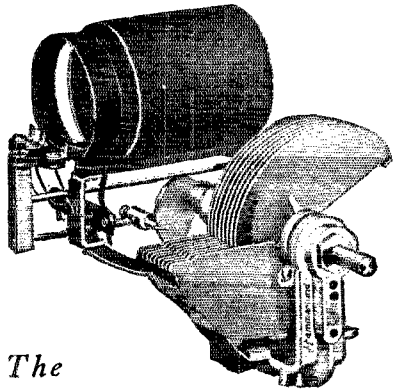

COCKADAY "LC27"  
LOFTIN & WHITE  
ST. JAMES SUPER  
LACAULT "LRA"  
MORRISON "VARION"  
SARGENT "INFRADYNE"  
POPULAR SCIENCE  
MONTHLY "POWERFUL"

BROWNING-DRAKE  
VICTOREEN SUPER  
PACENT "ULTIMAX"  
NEW HARKNESS  
HENRY-LYFORD  
CARBORUNDUM SUPER  
HAMMARLUND-ROBERTS  
"HI-Q"

Most good radio stores sell Hammarlund-Precision Products—if yours doesn't, write us direct.

HAMMARLUND MANUFACTURING CO.

424-438 W. 33rd Street, New York

The  
"AUTO-COUPLE"

A scientific assembly of Space-Wound Coil, "Midline" Condenser and Aluminum Shield, giving automatic, graduated primary coupling at every condenser setting and insuring maximum transfer of energy at each wavelength.

Officially specified for use in the new Hammarlund-Roberts "HI-Q" Receiver, but equally efficient in any other receiver of similar characteristics.

For Better Radio

**Hammarlund**  
PRECISION  
PRODUCTS



---

---

# BROWNING-DRAKE RADIO

---

---

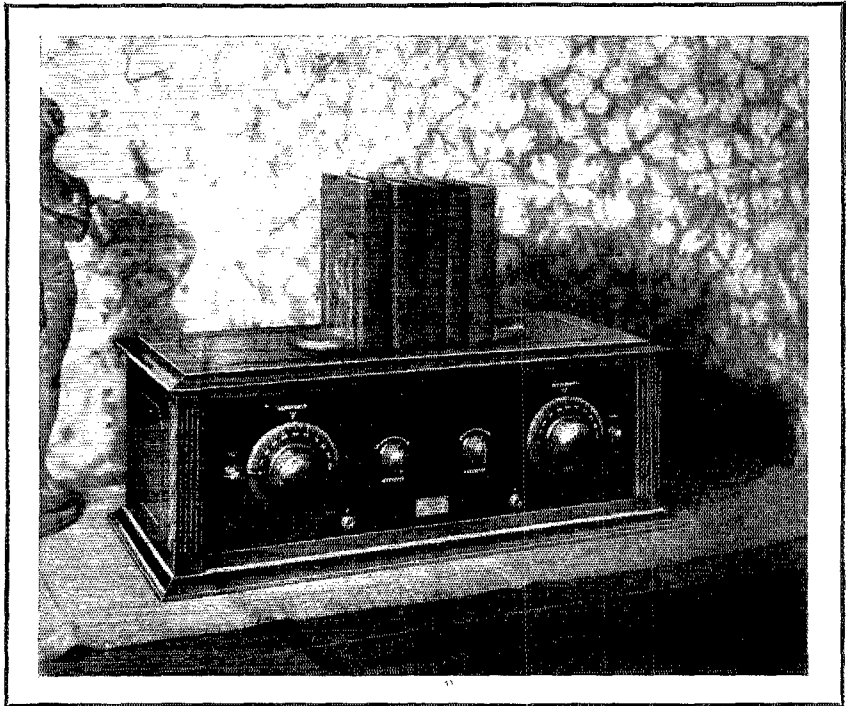

## “Get a Browning-Drake”

**T**HE radio amateur holds a unique position in his community. In radio his opinion is based upon exhaustive research and careful tests supported by his keen, technical analysis. For that reason his recommendation in the purchase of a receiver commands unusual respect.

Ever since Glenn H. Browning and Frederick H. Drake set a mathematical standard of design for radio frequency transformers, during the summer of 1923 at Cruft Laboratory of Harvard University, Browning-Drake Radio has won the praise and good will of thousands of radio amateurs. Much of the Browning-Drake success has been due to the fact that when he has been asked to recommend a reliable radio receiver, the amateur has replied, “Get a Browning-Drake.”

Browning-Drake builds only one model complete at its Brighton laboratories. Its price of only \$95 is as astonishing as its performance. Hear it *Today*.

*[DEALERS: Don't overlook the Browning-Drake opportunity. Every Browning-Drake dealer has made money and every customer has been permanently pleased. Write or wire TODAY for proposition.]*

**BROWNING-DRAKE CORPORATION, BRIGHTON, MASSACHUSETTS**



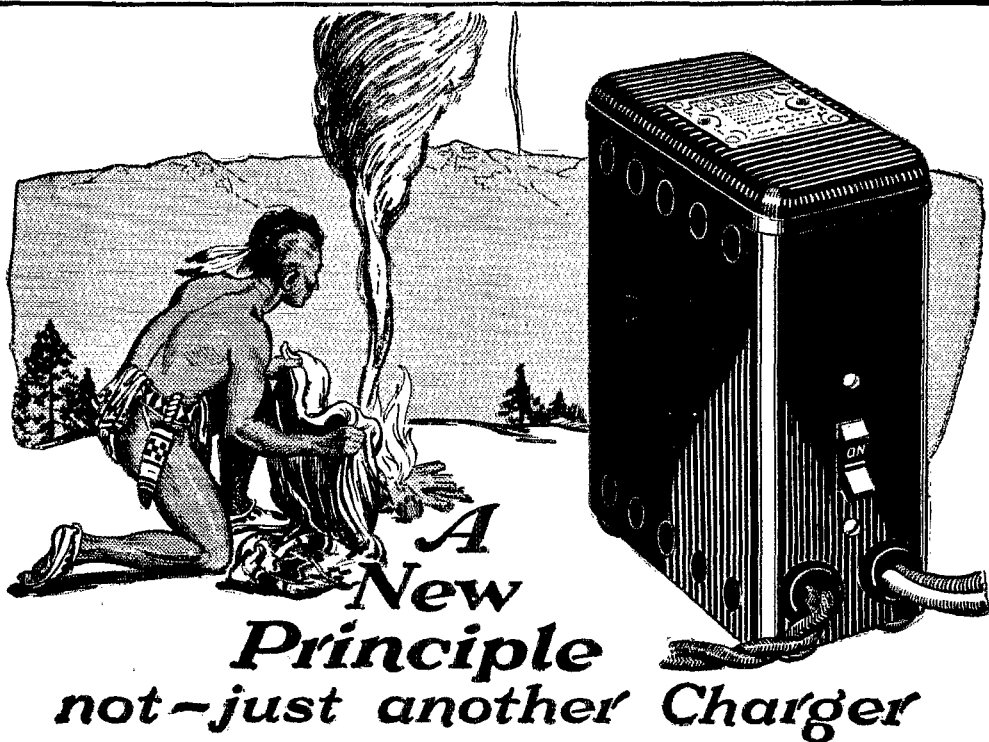

**T**HE ELKON TRICKLE CHARGER is as different from earlier attempts at "A" battery charging as Radio Signalling is from the signal fires of the Indians. All the former expedients necessary to secure current rectification are done away with. Two small discs, of dissimilar substances, in pairs, replace all the water, the acids, the alkalis, tubes and oscillating devices hitherto resorted to. And they not only rectify in a positive manner, but do so without interference, without noise, without heat, *and without attention.*

The Elkon Trickle Charger will operate in *any Position.* Short circuiting cannot harm it. It cannot overcharge for it tapers automatically from 0.7 amps to practically zero. It is full wave.

*Install it . . . set it . . . forget it . . . Your "A" battery charging becomes a perfunctory matter, entirely automatic and dependable, and your time is freed for more important work. You need one.*

Operates from 105-120 v., 50-60 cycles, direct from A. C. **(\$15.00 complete with switch)** 25-40 cycles also available at a slightly higher price

**ELKON WORKS**  
 Subsidiary of P. R. Mallory & Co. Inc.  
**ELKON WORKS**  
 Weehawken, N. J. Inc.

Sole licensees under patents pending to Samuel Ruben

**ELKON TRICKLE CHARGER**

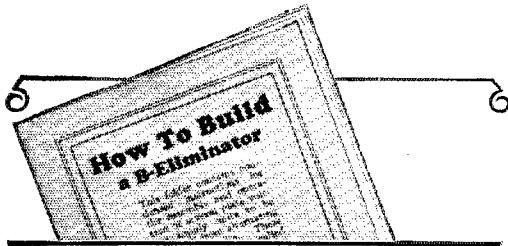

**SEND FOR THIS RADIO FOLDER!**

Contains seven hookups for B-Eliminators published in a prominent radio magazine.

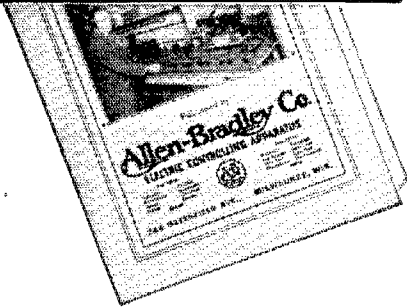

**When You Build a B-Eliminator**

*Use Bradleyohm-E for Variable Resistors and Bradleyunit-A for Fixed Resistors*

**ALWAYS** insist that Bradleyohm-E and Bradleyunit-A are included with your B-Eliminator kit, if you want to be assured of perfect voltage control. The leading manufacturers of B-Eliminators have long since adopted these Allen-Bradley variable and fixed resistors as standard equipment for their B-Eliminators. In fact, Bradleyohm-E is used almost as universally as the Raytheon tube, itself.



**Bradleyunit-A**

Solid molded fixed resistor that can be soldered. Unaffected by temperature or moisture.

**Bradleyohm-E**

Variable resistor made in several ranges. Sold in checked carton.

You cannot afford to risk the use of inferior substitutes for the scientifically-treated discs used in Bradleyohm-E. This remarkable variable resistor handles the strenuous requirements of B-Eliminator service without the slightest strain. Ask your dealer for Allen-Bradley Perfect Radio Devices, today.

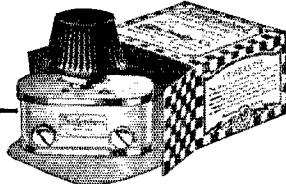

Allen-Bradley Co.,  
277 Greenfield Ave.,  
Milwaukee, Wis.

Please send me, FREE, your radio folder with seven B-Eliminator hook-ups.

Name .....

Address .....

**World's Finest Radio BUG**  
Improved Martin

Reg. Trade Marks  
Vibroplex  
Bug  
Lightning Bug

**VIBROPLEX**  
Trade Mark Reg. U. S. Pat. Off.

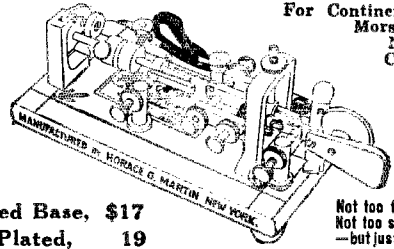

Japanned Base, \$17  
Nickel-Plated, 19

Not too fast  
Not too slow  
—but just right

**Get This BUG Now!**

Now is the time to get your BUG. Be up-to-date—enjoy the many advantages of sending with this improved BUG. You'll be amazed to find how easy it is to learn and to operate. Nothing can compare with this BUG in EASE and PERFECTION of sending. Over 100,000 users. Saves the arm, prevents cram and enables the "ham" to send with the skill of a expert.

**Special Radio Model**

Equipped with extra large specially constructed contact points to break high current without use of relay. Not too fast—not too slow—but just right. Sent anywhere on receipt of price. **\$25**  
Money order or registered mail.

**THE VIBROPLEX CO., Inc**  
825 BROADWAY NEW YORK



**Short-Wave Receiver  
Short-Wave Transmitter  
Plug-In Coils  
Crystal Controlled  
Transmitter**

*Write for Specifications*

**TECO PLUG-IN COILS**

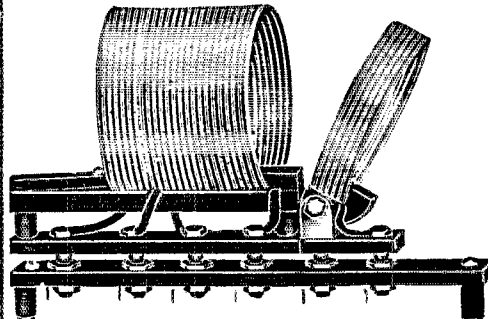

**COMPLETE SET - \$12.00**

**TRANSMITTING EQUIPMENT CO.,**  
19 Stuart Street Boston, Mass.

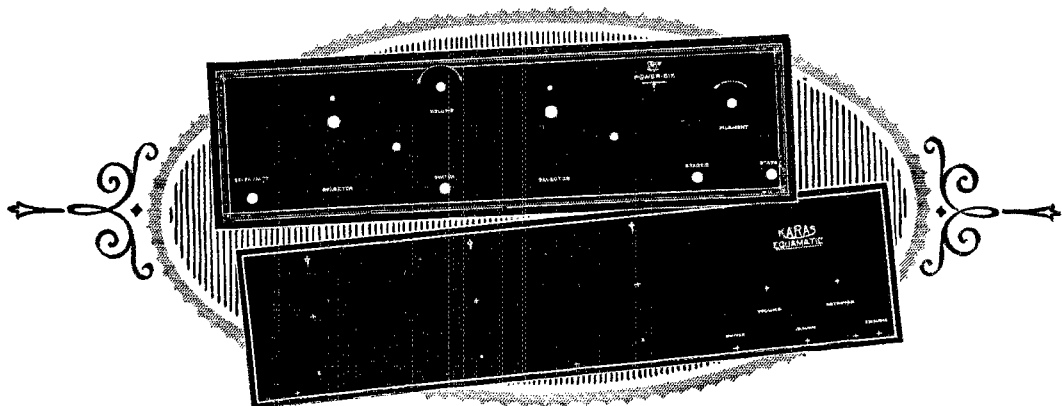

## Power Six, Karas, H. F. L.

**A**DDED to the list of handsomely Veri Chromed Formica kit panels are now the Bremer Tully Power Six, Karas Equamatic front and sub panels, H. F. L. Nine in line Superheterodyne with sub panel, Victoreen Universal single dial control. There are also Infradyne 7 x 28, and 7 x 30, Aerodyne, St. James 8 Tube, Bremer Tully Counterphase, Browning Drake National, Madison Moore Superheterodyne, Camfield Duoformer. They are sold by leading jobbers and dealers.

Special panels cut to size and Formica tubing are also available for Amateurs

THE FORMICA INSULATION COMPANY

4620 Spring Grove Avenue

Cincinnati, Ohio

Hear the  
FORMICA  
Orchestra Tues-  
day 9 to 10  
over WLW

**FORMICA**  
Made from Anhydrous Bakelite Resins  
**SHEETS TUBES RODS**

Formica has a  
Complete Service  
on Insulating  
Material  
for Radio  
Manufacturers

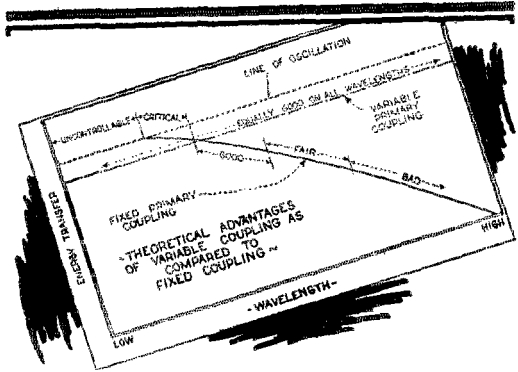

## Even Amplification on All Wave Lengths!

ONE of the reasons for the tremendous popularity of the New Shielded Hi-Q Receiver is shown in the above chart—the result of Automatic Variable Coupling, which effects EVEN and MAXIMUM amplification over the entire tuning range.

This important new feature, plus a marvelously efficient circuit, plus the most modern Foundation Unit yet perfected and plus a group of finest parts selected by ten leading radio engineers for their ideal synchronization, produces a receiver which establishes totally new standards of radio efficiency. Remarkable selectivity and utter absence of oscillation. Distortion eliminated. Tone quality like the natural unbroadcast signal.

Parts Complete  
(less cabinet)  
**\$63.05**

The "How to Build" Book explains all features in detail.



Get a copy from your dealer or send 25 cents direct.

# Hammarlund ROBERTS Hi-Q

\*High ratio of reactance to resistance  
High ratio—Great Selectivity—Loud Signals  
**HAMMARLUND-ROBERTS, Inc.**  
1182-H BROADWAY NEW YORK

# Faradon

## "UNIVERSAL" Capacitor Block

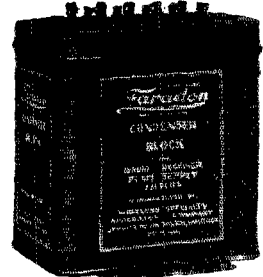

Designed especially for operation in connection with generally used Battery Eliminator Circuits. Total capacitance 14.2 Mfd., connected to fixed terminals in convenient units permitting ready wiring in desired capacity combinations.

High factor of safety to withstand possible high voltage surges.

Model W S-3750. Price \$10.50

Also By-Pass and Filter Units in individual containers.

If your dealer has not the Capacitor Block on hand advise us.

**WIRELESS SPECIALTY APPARATUS COMPANY**  
Established 1907  
Jamaica Plain Boston, Mass., U. S. A.

## Heavy-Duty RADIOHM

for Simple Control of B-Battery Eliminator

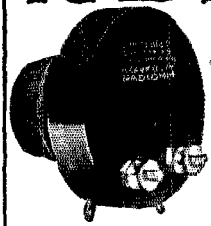

A Centralab Heavy-Duty Radiohm insures efficiency. Full resistance variation with a single turn of knob, allowing panel marking for proper setting to provide various voltages. Tested and approved by the Raytheon Laboratories. Resistance remains permanent as adjusted—no carbon particles or discs. Insulation withstands 1500 volts. The smooth, noiseless operation greatly improves any set.

\$2 At your dealer's, or mailed direct, \$2  
**CENTRAL RADIO LABORATORIES**  
20 Keefe Ave. Milwaukee, Wis.

Makers of a full line of variable resistances 69 manufacturers of leading standard sets.  
Australian Representative—United Distributors, Ltd., Sydney. Canadian Representative—Irving W. Levine, Montreal. Great Britain Representative—R. A. Bothermel, Ltd., London.

# Centralab

# AMERTRAN RADIO PRODUCTS

Sold only at  
Authorized AmerTran  
Dealers

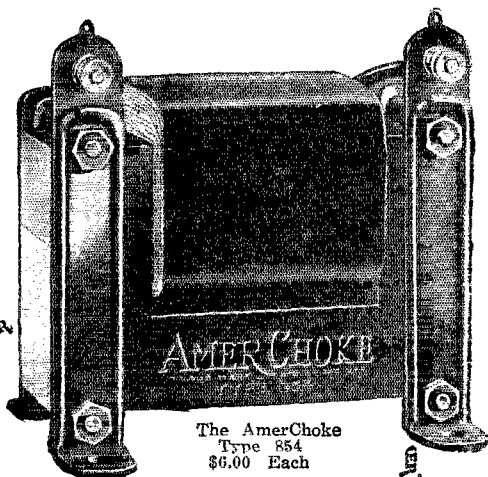

The AmerChoke  
Type 854  
\$6.00 Each

## The Essentials of a Good Choke Coil

A good choke should have high inductance, low direct-current resistance, and should be constructed so that the iron core will not readily saturate. These features can only be obtained in a choke of generous proportions. That is why the AmerChoke is so successful in the filter circuits of "B" Eliminators. In the AmerChoke magnetic saturation from direct current is prevented by two butt joints in the iron core. The air gap between the butt joints can be adjusted to obtain the maximum inductance for any given value of direct current up to 60 milliamperes. Without this feature harmonics would develop and produce a hum in the speaker.

Together with the AmerTran Power Transformer, the AmerChoke will be found useful in the construction of a high-grade power amplifier that will prove both dependable and efficient.

The wide recognition and adoption of AmerTran Products in fine circuits, and power supply units is evidence of their superior design and performance. They will give permanent satisfaction.

Send now for free booklet "Improving the Audio Amplifier" and other interesting technical data.

### American Transformer Company

178 Emmet Street Newark, N. J.

"Transformer Builders for Over 26 Years"

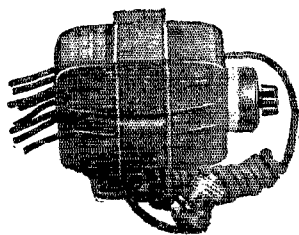

The AmerTran  
Power Transformer  
Type 52  
\$18.00 Each

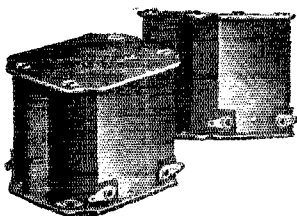

The AmerTran  
De Luxe  
Audio Transformer  
Made in two types for  
1st and 2nd stages.  
\$10.00 Each

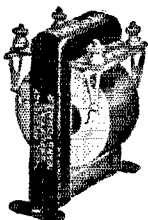

AmerTran Audio Trans-  
formers AF-7 and AF-6  
for two stages. \$5.00 Each

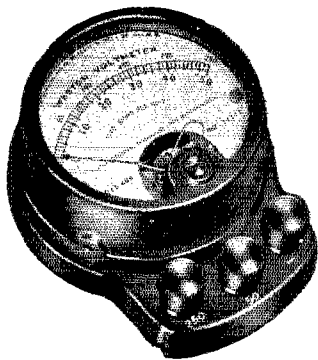

## WESTON High Resistance Battery Eliminator Voltmeter

**A** GAIN Weston provides an instrument to meet a new condition—the more widespread use of battery eliminators. This new voltmeter requires only one milliampere for full scale deflection—it has a self-contained resistance of one thousand ohms per volt—and will indicate the true value of the voltage delivered. ¶ It is made in double range combination of 200/8 or 200/50-50 volts, handsomely enclosed in Bakelite and supplied with a pair of 30 inch flexible cables. ¶ You know the radio performance given to every make and model of radio set by Western Radio Instruments. You know that they give better reproduction, save tubes and effect economies, at the same time giving you greater radio pleasure. ¶ Use th's new Weston device to insure the best results from battery eliminators. Moderately priced at \$28. ¶ For full information address

WESTON ELECTRICAL INSTRUMENT CORPORATION  
158 Weston Avenue, Newark, N. J.

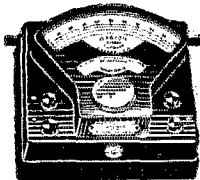

STANDARD THE WORLD OVER

# WESTON

Pioneers since 1888

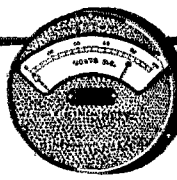

**SM**

**635  
Short Wave  
Kit**

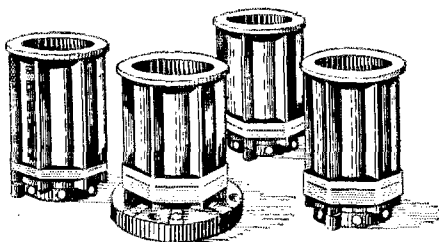

Specified by the most prominent engineers in the country today. Carried by Commander Dyott in his expedition of exploration to the River of Doubt, his receiver being supplied and recommended by RADIO BROADCAST—need more be said about the "sure fire" dependability of the S-M short wave assembly?

The 635 Short Wave Kit consists of four coils, a coil socket, two short wave condensers and an antenna condenser. The price is \$23.00. Type 117 Short Wave Coil set consists of 4 plug-in coils covering 18 to 150 meters, using any standard .00014 condensers, and can be bought for \$11.00, if you will simply ask your dealer for the S-M Short Wave Kit.

**Silver-Marshall, Inc.**

858 West Jackson Blvd.

Chicago, U. S. A.

## It helped to win WORLD'S FOREIGN RECEPTION RECORD

*Robert Davies writes:*

"I used Model N, X-L Vario Denser on my 4 tube, home made set when I received my six foreign stations besides QUE, Sidney, Australia, 9000 miles away, and 1RC, Rome, Italy. I have used several condensers but an X-L tops them all."

This is it

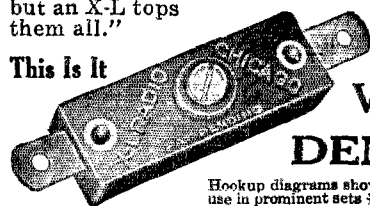

**X-L  
VARIO  
DENSER**

Hookup diagrams showing methods of use in prominent sets SENT FREE.

**X-L RADIO LABORATORIES**

2428 N. Lincoln Avenue

Chicago, Ill.

## New Learners Buzzer Practice Set

on base board, consists of key and buzzer, \$1.00; U. S. Sigma Corps. Field Telephone sets \$3.00; Cutting & Washington Airplane quenched spark transmitter panels, type R. W. 2; maker Mare Island Navy Yard, at \$17.50 each. Just a sample of our bargains. Get our new and latest reduced price list, for 2c stamp. We bought \$10,000 worth of United States Government Radio Transmitting and Receiving Sets and Parts. Mail orders sent all over the world.

WEIL'S CURIOSITY SHOP, 20 South 2nd St., Philadelphia, Pa.

# QUALITY **REL** PRODUCTS

**The New  
REL**



**Catalog  
is Here!**

**C**OMPLETE, comprehensive, invaluable information that is kept absolutely up to the minute by our sending you, from time to time, the latest data sheets "hot off the press."

The only cost to you is the initial payment of twenty-five cents.

Contains pages on Tuned Grid, Master Oscillator, Crystal Control and a number of other subjects ready to send to every devotee of Short Wave Radio.

First come, first served. Send for yours today. Remit P. O. money order or U. S. currency.

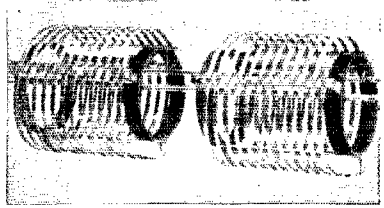

## THE INDUCTANCES THAT YOU WILL EVENTUALLY USE

REL Transmitting Inductances are Flatwise Wound on Glass. Designed for Short Wave C. W. Transmission, their efficiency is unsurpassable. They are built of flatwise wound copper nickel plated ribbon mounted on crystal glass spacers. Adaptable to all circuits using from 1-1000 watts.

Type L—(40, 80, 150 meters wave lengths)

Type S—(20 meters and less)

Single Unit, either type with three clips.....\$ 5.50

Double Unit, either type with six clips and two glass coupling rods 11.00



REL OWNS AND OPERATES EXPERIMENTAL STATION 2XV ON 16.1 METERS, 19867 KILOCYCLES, CRYSTAL CONTROLLED.



## Radio Engineering Laboratories

27 Thames Street, N. Y., N. Y.

At **WGN**  
**SANGAMO**  
 Mica Condensers  
 Prevent  
 Shifting of Frequency Bands



**B**ECAUSE the Sangamo condenser is solidly molded in bakelite, mechanical movement of the positive and negative plates is impossible. This is one important factor in the permanent accuracy of the Sangamo.

No one has greater need for condenser accuracy than a great broadcasting station like WGN. Read Mr. Leverett's comment:

"Last June I used Sangamo Mica Condensers in a multiple band pass filter. This has been in use for some time, and has given the best of results, showing no shifting of the frequency band. This permanency I believe is due entirely to the consistency of these condensers, there being no apparent change in capacity nor leakage across them. I cheerfully recommend them wherever a constant capacity is required.

(Signed) Geo. H. Leverett, Asst. Engineer"  
 Station WGN Chicago



**Sangamo Condenser Blocks**

American-made condensers, wound under uniform tension to eliminate air or ozone bubbles that cause breakdowns.

- Handy sizes:  
 12 mfd. tapped 8, 2, 2 mfd.  
 14 mfd. tapped 8, 2, 1, 1 mfd.  
 14 mfd. tapped 4 (high voltage),  
 4, 2, 1, 1, 1, 1 mfd.

Also separate condensers; special capacity blocks to order.

**Sangamo Electric Company**  
 6132-22 Springfield, Illinois

RADIO DIVISION, 50 Church Street, New York  
 SALES OFFICES—PRINCIPAL CITIES

**CROSLLEY**

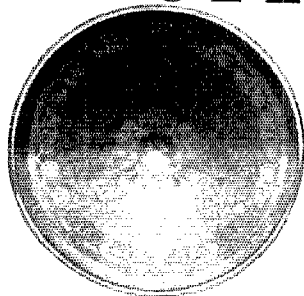

**Super MUSICONE**

\$14.75

Now replacing hundreds of thousands of old-type loud speakers Crosley patented actuating unit, not the cone shape, is the secret of an unmatched tone.



**MUSICONSOLE**

28 inch solid mahogany chassis with built-in Musicone. Spare for all accessories. Splendid piece of furniture, matches surroundings easily. Prices slightly higher on west coast. \$32.00

CROSLLEY RADIOS—\$9.75 to \$90  
 Write Dept. 18 for catalog.

THE CROSLLEY RADIO CORPORATION  
 Cincinnati, O. - Powel Crosley, Jr., Pres.

REGISTERED THE BALL BEARING U.S. PATENT OFFICE  
**MICRO-COUPLER**  
 "MAKES THE ROTOR OBSOLETE"

The Only Tuner With Precision Control!

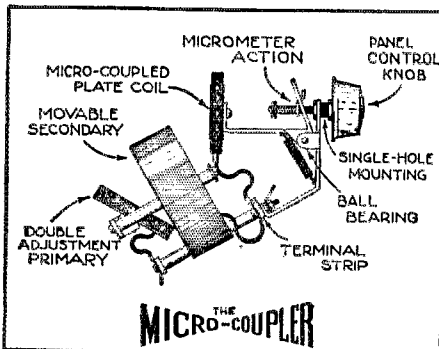

Replace your present tuner, whether of fixed or variable 2 or 3 coil type, and get wonderful results. Adjustable for **SELECTIVITY, VOLUME, DX.** Positively controls oscillation. \$8.00, postage prepaid on cash orders. Sent on 5 days' approval,—unconditionally guaranteed.

Write for full particulars, free hook-ups.  
**SIMPLEX RADIO DEVICES, Inc.**  
 231 Mulberry St., Newark, N. J.



# Mass Production

methods and tremendous purchasing power brought to Amrad and applied to building Neutrodyne a year ago by Powel Crosley, Jr., make available to the public a 5 tube Neutrodyne at \$60.

In this 5 tube battery type Neutrodyne at \$60 great engineering skill is manifest in the splendid performance of the set. Cabinet and trimmings are all any purchaser could ask—beautifully finished and appointed. Recessed dials behind windows and delicately adjusted vernier controls are distinctive features.

**\$60**

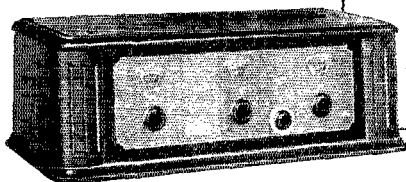

**Cone Table**  
for tablemodels S-622 and AC-5 with Crosley Musicone built in. Ample room for batteries or power unit.  
**\$32**

## And a light socket operated Neutrodyne at \$150

This is Amrad's crowning achievement. A power unit, using a current direct from your light socket on wall or from table lamp furnishes A, B and C current direct to the 5 tube Neutrodyne pictured at the right. This power unit is pictured directly behind the set.

No batteries—nothing to charge. An entirely new development in power supply. Amazing Mershon Condensers contribute to its great efficiency and compactness. **TESTED BY CONSTANT USE IN HOMES FOR OVER A YEAR.** Price of receiver \$65. Price of power unit separately \$85.

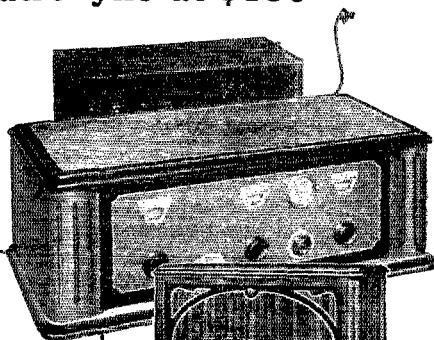

### Add a Mershon Condenser to your B eliminator for Super-B Current supply 30 MFD · DUOTYPE

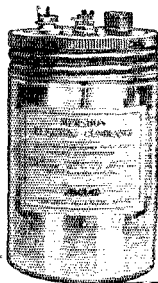

Filtering out light socket current hum is but part of the job. Eliminators must have STORAGE capacity to prevent "chopping off" of loud or sustained notes. The Mershon Condenser acts as a reservoir and STORES energy for sudden heavy drains on plate current. Does the work of expensive storage battery electrically rather than chemically. B eliminator connected with this condenser gives the excellent tone reproduction of fresh B batteries.

Mershon Electric Condenser 15 mfd's capacity each half. 30 mfd's total capacity. Type D-15-30. Maximum rating 300 volts D. C. If punctured can be repaired and need not be thrown away.

**\$8**

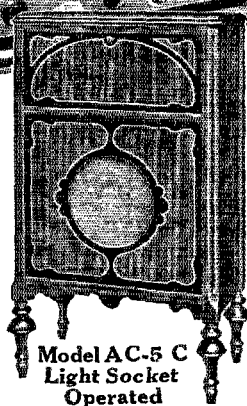

**Model AC-5 C**  
Light Socket Operated

### 5 Tube Console

A beautiful cabinet in two tone finish mahogany. Stands 40 inches high. Genuine Crosley Musicone built in. Equipped with 5 tube battery type set \$110—with lamp socket set and power unit

**\$200**

# AMRAD

**AMRAD CORPORATION**  
Medford Hillside, Mass., Harold J. Power, Pres.  
Write Dept. 4A7 for Descriptive Literature

**NEUTRODYNES**

# THE SUPER SYNC

## The Synchronous Rectifier That Can Be Filtered

The Super Sync is the only synchronous rectifier that can be filtered with ordinary type of filter. Tests show that it will stand up under constant use without giving the least bit of trouble.

When you install a Super you can rest assured that a constant voltage will be delivered to your transmitter thus eliminating one of the main causes for unsteady waves.

This rectifier will handle any voltage up to 4000 volts very efficiently, with practically no voltage drop. The Super rectifies practically the full wave there

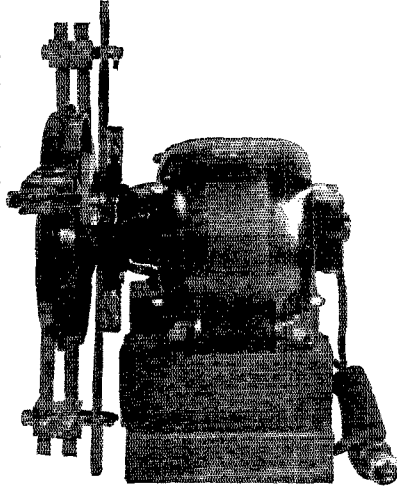

being only a 3 degree break on each side of the commutator. This is made possible only by the insulating ridge which prevents the voltage from jumping between segments. There is no other mechanical rectifier made which will rectify 354 degrees of the entire wave at the rated voltage of this machine.

The motor which is supplied with this rectifier is for 110 volts 60 Cy. Motors with other name plate ratings can be supplied but will require a slight delay in shipment.

PAT. PENDING

PRICE \$75.00 F. O. B. ST. LOUIS, MO.

MARLO ELECTRIC CO., 5241 Botanical Ave., St. Louis, Mo.

## Bradley Amplifier

Resistance-Coupled  
PERFECT AUDIO AMPLIFIER

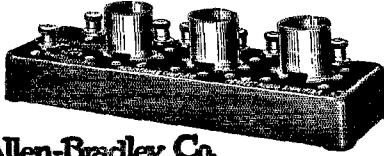

Allen-Bradley Co.

Electric Controlling Apparatus  
277 Greenfield Avenue

Milwaukee, Wis.

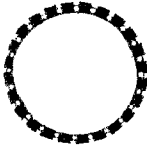

### "JACOBS' ANTENNA SPREADER"

DIAMETER 7 IN. Pat. Sept. 8, 1925; Sept. 7, 1926

Made of metal for erecting either 4, 6 or 8 wire Cage Antenna Systems. J. C. Haltzinger, 334 writes: "I am using the Spreaders in a 6 wire Antenna and Counterpoise System and achieve very fine results from a phone transmitter on 176 meters. Beside being very efficient, it makes a mighty fine appearance." Price \$3.00 per dozen; \$2.75 for a half dozen. Circular upon request.

CHARLES F. JACOBS (2EM)  
279 Park Place Brooklyn, N. Y.

## SET BUILDERS!

We furnish jobs for you. (No fee.) Competent men needed today in every community to build LC-27 and Hammerlund-Roberts Sets. Big money for you if you can qualify. Register NOW, giving particulars, experience, references.

ALLEN-ROGERS, Inc.  
118 E. 28th St., New York City

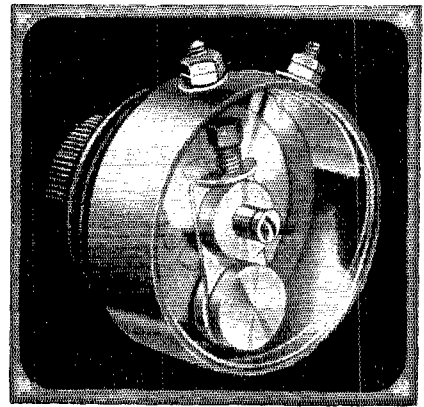

## Note the difference!

INSTALL FROST RADIO Super Variable Resistance Units in your new set and *note the difference!* Nearly all of the new radio circuits call for one or more of these new non-inductive high resistance units. They are smooth and noiseless in operation and give any degree of resistance from zero to maximum without steps or jumps. Type 880 (2 terminals) is supplied in resistances of 50,000, 100,000, 200,000 and 500,000 ohms; type 890 (3 terminals) in 400, 2,000, 50,000, 100,000, 200,000 and 500,000 ohms. Both types, list \$1.25 each. Your dealer has them.

HERBERT H. FROST, Inc.

160 N. LaSalle Street  
New York CHICAGO Los Angeles

# Supreme in MUSICAL PERFORMANCE!

Tschaikowsky, Beethoven, Brahms — would you listen with rapture to the rendition of their master pieces by the "hungry six" corner band? You would not!

Then why distort the masterful programs of the better broadcasting stations to the "hungry six" type of reception when Thordarson transformers are available at every dealer's? Thordarson transformers are found in the majority of quality receivers, where musical performance is the first consideration — A conclusive proof of the musical supremacy of Thordarson amplification.

## THORDARSON RADIO TRANSFORMERS



### R-200 Amplifying Transformer

The transformer for the musical epicure. Has unusually faithful reproductive powers. Specified on such quality receivers as Zenith, Kennedy and Howard... \$8.00



### Standard Amplifying Transformer

A good reproducing transformer suitable for the requirements of the average ear.  
2 to 1 ratio ..... \$3.00  
3 1/2 to 1 ratio ..... 4.00  
6 to 1 ratio ..... 4.50



### Autoformer All Frequency Impedance Amplifier

Amplifies every note in the musical scale. An impedance with a step-up ratio, giving the even amplification of the impedance with the amplification increase \$5.00 of the transformer.....



### R-210 Power Compact

A complete foundation unit for power simplification and B-supply. Contains a power supply transformer and two chokes for power amplifier using UX-210 \$20.00 power tube.....



### R-171 Power Compact

Similar to the R-210 type but designed for UX-171 power tube and Raytheon rectifier. Contains buffer condensers as well as power supply transformer and \$15.00 chokes.....



### R-197 Power Supply Transformer

A Power Supply Transformer designed for B-supply using the R. C. A. UX-213 type full wave rectifying tube. Will \$7.00 supply up to 180 volts B.....



### R-196 30 Henry Choke

Designed either as a filter or an output choke. Completely shielded. Current carrying capacity 80 MA. Inductance 30 henries. D. C. resistance 200 \$5.00 ohms.....



### R-76 Speaker Coupling Transformer

An output transformer designed as a protective device to keep the high direct current voltage of power amplification out \$6.00 of the speaker unit.....



**THORDARSON ELECTRIC MANUFACTURING CO.**  
*Transformer Specialists Since 1895*  
**WORLD'S OLDEST AND LARGEST EXCLUSIVE TRANSFORMER MAKERS**  
4140 and Kingsbury Streets — Chicago, Ill. U.S.A.

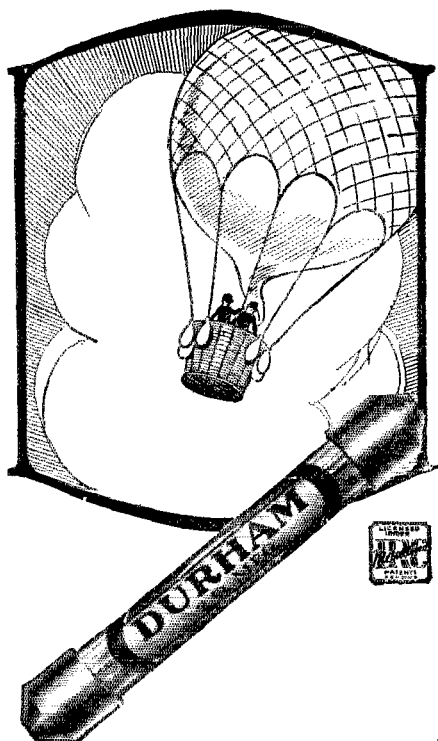

# Noiseless!

**H**AS your receiver become a miniature Babel of strange noises? Look to your grid-resistor.

The Durham Metallized Resistor is scientifically built to function as noiselessly as the balloon gliding silently towards the sky. Fixed in resistance value, and temperature-proof.

500 ohms to 10,000 ohms.....	\$1.00
Above 10,000 ohms to .24 meg.....	.75
.25 meg. to 10 meg.....	.50

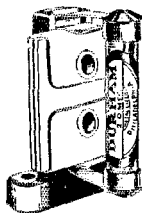

## RESISTOR MOUNTING

Made of moulded insulation of exceptionally high resistance. Best quality, tension-spring, bronze contacts. Only upright mounting made.

Single Mounting.....	50c
For Condenser.....	65c

# DURHAM

METALLIZED

# RESISTORS

INTERNATIONAL RESISTANCE CO.,  
Dept. B Perry Bldg., Philadelphia, Pa.



Operate your radio set from the light socket with the new Balkite Combination—with your "A" battery it supplies all radio power automatically

Ask your radio dealer

FANSTEEL PRODUCTS CO., INC.  
North Chicago, Ill.

## 'SMATTER KID?

Blow your blocking condenser?

Dry them tears and get our UC 1015.

Cause Why? 1. Stands 7500 Volts.



2. Sulphur and Mica insulation.
3. Eleven capacities in one.
4. Small capacities best for short waves.

5. Handy in all parts of circuit.
6. Only \$1.25 each.

### And Grids Will Leak—

With our General Electric enamelled wirewound gridleaks for all tubes up to two 250 watters.

5000 ohms, \$1.00. 15,000 ohms, tapped at 5000 and 10,000, \$1.50.

## UTILITY RADIO COMPANY

80 Leslie Street

East Orange, N. J.

Patents Procured to Protect Inventions

McLANAHAN & BURTON  
PATENTS

AND  
TRADEMARKS

Union Trust Building

Washington, D. C.

Reliable

# LONG DISTANCE COMMUNICATION

on

1 meter to 200 meters

Thanks to the co-operation of members of the A-R-R-L, De Forest has further developed the Type-H tube to a point where it fills *all* the requirements of amateur transmission. The result is still more uniform performance with extended filament life.

### Technical Data

#### INPUT RATING 150 WATTS

Plate Voltage	500—3000
Plate Current	40-50 MA.
Fil. Voltage	10
Fil. Current	2.35A

### HR Thermionic Rectifiers

Will operate 4 H Tubes

Fil. Voltage	10
Fil. Amperes	2.35
Plate Voltage A. C.	2000
Plate Mill Amps.	250 Max
Voltage Drop	400 at 250 MA
PRICE	\$16.00

Price, \$18.00  
Parcel Post Prepaid

Sold and Shipped Direct  
Upon Receipt of Money Order

# DE FOREST

# TYPE-H

# TRANSMITTING TUBE

139 Franklin St.

DE FOREST RADIO CO.

Jersey City, N. J.

SAY YOU SAW IT IN Q S T—IT IDENTIFIES YOU AND HELPS Q S T

# TOBE

## Interference Filter No. 1



For the reduction of Radio-interference caused by oil-burner, refrigerator and other household motors and appliances, up to and including 1/4 H.P.—Tobe Deutschmann Company has produced its Radio-interference Filter No. 1.

This is a choke and condenser combination, designed to be cut into motor leads as close to the offending motor as possible. It is not intended for attachment to Radio sets, but to the source of interference. A special arrangement reduces the possibility of pitting the commutator or collector rings by keeping down the current in the sparks from condenser discharge. Dimensions are 9 inches long by 2 inches wide by 2 inches high.

**Price \$18.50**

Write us for Pamphlet Q on this  
Interference Filter

**Tobe Deutschmann Co.**

Engineers and Manufacturers of  
Technical Apparatus  
Cambridge, Mass.

# SALE!

OF BARGAINS FROM THE GREAT-  
EST HAM STOCK IN AMERICA!

### Radio Blinker Practice Set

Ideal for learning the code. Equipped with both a high frequency buzzer and a blinker light, either of which may be switched on for practice.  
SPECIAL, \$2.95.

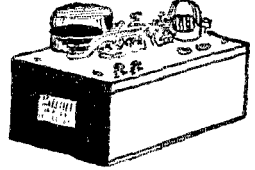

C. R. L. POWER RHEOSTAT for 7-12 watt tubes. 75c

### QUARTZ CRYSTALS

For crystal controlled transmitters. Made of the finest lens quartz. The natural frequency varies between 180 and 520 meters, but with an ordinary optometrist wheel a crystal may be ground to any specifications. S P E C I A L L Y P R I C E D. \$19.00.

HONEY-COMB COILS. 75, 90 or 100 turns. 25c

GLASS TUBING for R. F. chokes. 10c

ALUMINUM BRACKETS. per pair, 75c

MINIATURE LAMPS for wavemeters. 15c

GLASS INSULATORS 3-inch, 15c 4-inch, 25c

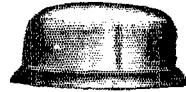

### BUZZERS

High frequency buzzers, desirable for testing crystals and for practicing code. Gives a sound resembling C.W. SPECIAL 75c

TELEGRAPH KEYS' Silver contacts; made to sell for \$1.75

ELECTROSE INSULATORS, 12-inch or 18-inch SPECIAL \$1.00

UNIVERSAL MOTOR, 1-32 H. P., speed 1800 r.p.m. SPECIAL \$3.95

MAGNAVOX 3-Stage AMPLIFIER, list \$75 SPECIAL \$16.50

COMMERCIAL TYPE HELIX, easily converted for the Hartley circuit \$2.95

7x24 CABINETS, solid walnut, slant front \$7.50. Bakelite panel, 85c



### TRANSFORMERS

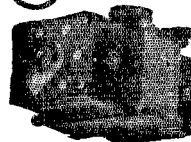

UP-1016, Power Transformer, (pictured), List, \$38.50. OUR PRICE, \$31.50. RCA FILAMENT TRANSFORMER, UP-1556 (75 watt), List, \$15.00. OUR PRICE, \$9.50. RCA A T T E N U A T I O N TRANSFORMER, UV-712, 9/1 Ratio, List, \$7.00. OUR PRICE, \$1.00.

### CARDWELL CONDENSERS

King-Cardwell Transmitting Condenser, Factory Rebuilt for 3000 volts, \$2.95.  
King-Cardwell 41-plate Condenser, easily double-spaced, 85c.  
King-Cardwell 11-plate Condenser, 95c.  
King-Cardwell 15-15 plate dual condenser, used in grid meter drive, \$1.95.  
King-Cardwell 11-11 plate Condenser, \$1.50.

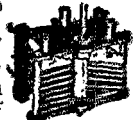

### RADIO SURPLUS CORP.

250 Washington St. Boston, Mass.



**N**O Radio Unit is any better than its Coil! Every Engineer and Manufacturer realizes this. While it is true of all Electrical Apparatus it is more true of Radio.

The performance of Battery Eliminators, Audio Transformers, Loud Speakers, and all other Radio Units is in exact ratio to the efficiency of their winding. *It's the coil that does the work!*

The great DUDLO Plants at Fort Wayne, Indiana, have specialized on fine Magnet Wire and Windings for many years, and DUDLO is to-

day the chief source of supply to manufacturers in the Radio Industry.

DUDLO Engineers and Manufacturing Facilities provide you with the widest experience and knowledge and the finest methods of production. The DUDLO plants, the largest of their kind in the world, and equipped with miles of special machinery and an immense organization of trained specialists, produce better coils and windings for your product than any other source of supply—and do it more efficiently from your standpoint.

It is probable that you already are using DUDLO Coils and Magnet Wire. If not, we will promptly make up samples and quote on your requirements. No obligation—it is part of DUDLO Service. Correspondence invited.

# DUDLO

**DUDLO MANUFACTURING CORPORATION, FORT WAYNE, INDIANA.**

412 Chamber of Commerce Bldg., NEWARK, N. J.    160 North La Salle Street, CHICAGO, ILL.    4153 Bingham Ave., ST. LOUIS, MO.    274 Brannan St., SAN FRANCISCO, CALIFORNIA

SAY YOU SAW IT IN Q S T—IT IDENTIFIES YOU AND HELPS Q S T

**LAST MINUTE SPECIALS!!!**

1. CROSLY SETS. We are just unpacking 12,000 Crosley 51, 2-tube sets, Maybe you're not interested in simple B.C.L. material yourself, but you must know someone who'd like one of these sets at \$3.95.

2. SIGNAL UV SOCKETS. 10¢.

3. MAGNAVOX Phonograph Transmitter TONE ARM. Converts your phonograph into the latest type of electrically operated machine.

**SPECIAL \$22.50.**

**RADIO SURPLUS CORPORATION**  
250 Washington St.,  
Boston, Mass.

**Ward Leonard**  
**VITROHM**  
**RESISTORS**



5000-ohm tapped center grid leak for tubes up to and including 1000 watts input. Mounting brackets supplied. Postpaid \$2.90.

5000-ohm tapped center grid leak for transmitting tubes up to and including 50 watts input. With brackets. Postpaid \$2.10.

20,000-ohm grid leak for De Forest Type H tubes. Postpaid \$6.35.

50,000-ohm grid leak for De Forest Type P tubes. Postpaid \$3.60.

Vitrohm Resistors are wire-wound on refractory tubes enclosed and permanently protected by Vitreous Enamel.

Practically indestructible; permanently accurate; non-inductive; zero temperature coefficient.

**YOUR DEALER STOCKS VITROHM RESISTORS**

**Ward Leonard Electric Company**



Mount Vernon, N. Y.

7131-6

**FERRANTI**  
**AUDIO FREQUENCY TRANSFORMERS**  
**FOR ANY CIRCUIT**

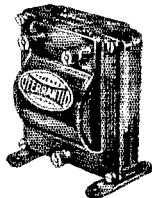

Ferranti Transformers stand supreme in that they pass on to the loud speaker an uncensored message. All the notes... bass notes and treble notes... are there.

**FERRANTI, Inc.**  
130 West 42nd St., New York, N.Y.

FERRANTI, LTD. FERRANTI ELECT., LTD.  
Hollinwood, England 26 Noble St., Toronto, Canada

**Never Before At This Sacrifice Price**

**HIGH VOLTAGE**  
**KENOTRON RECTIFYING TUBES**  
**MODEL U. V. 217**



A. C. Plate Voltage 1500 volts. Filament Voltage 10 volts.

Used with U. P. 1016 Power Transformer or similar Transformer.

These Genuine R.C.A. U. V. 217 Tubes are very efficient Rectifiers and they will pass plenty of current and voltage for 50 watters and H Tubes and also can be used for 250 watters. **Every tube is brand new and packed in original carton.**

List Price \$26.50 ea.  
**AMERICAN SALES COMPANY**

**EXTRA SPECIAL, \$12.50 EA.**

**21 WARREN STREET, NEW YORK CITY**





# Why Is the B-T Better?



Maximum capacity 150 volts at 60 mils. Adjustable to sets requiring less by the exclusive B-T method. Price, East of Rockies complete with Raytheon tube \$49.50.

THE B-T B-Power Unit introduced a type of design which we believe will grow continuously in favor as it becomes better understood.

There are no variable Resistances,—no knobs to turn,—we believe it won't be long until there is no other type of Eliminator.

It is with sets using power tubes that B-Eliminators are advisable as well as economical.

Power tubes are used in sets of six or seven or more tubes,—with consequent large drain.

Cheaply constructed Eliminators may handle small sets, but it is on the larger ones that they are really needed,—and that is where the quality and efficiency of the B-T begins to be appreciated.

Save money and worry by buying a B-Power Unit good enough for a good set.

—and here's what a radio editor published about the B-T POWER-SIX (Kit):

*"The new B-T Power-Six is without question the best set I have ever built, seen, heard or tuned."*

The price of P-6 Kit containing the essential parts is

**\$41.50**

**BREMER-TULLY MFG. CO.** 520 So. Canal St.  
Chicago, Ill.

# Hoyt

## Radio Rotary Meter

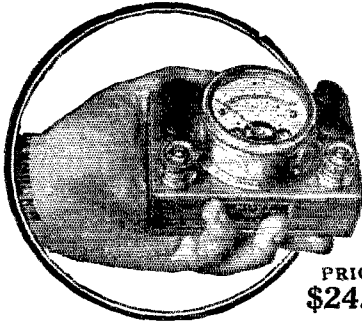

PRICE  
**\$24.00**

This is a unique 5-range precision moving coil voltmeter, made especially for the Radio Service Man, Dealer and Owner. It will make all tests necessary on Radio Receiving Sets, tubes, batteries and battery eliminators. It is rugged and will last a lifetime, yet will retain its extreme accuracy. Operation is simple and accident-proof.

### BURTON-ROGERS CO.

857 Boylston Street Boston, Mass.

Sales Dept. for Hoyt Electrical Instrument Co.

HOYT makes a complete line of Radio Meters. Send for booklet, "HOYT Meters for Radio."

# ADVANCE

## "Sync" RECTIFIER the favorite with amateurs

Although lower in price, the ADVANCE Sync Rectifier is far superior in quality—as proven by its prevailing use in international transmitting. It actually does what other rectifiers claim to do. Meets all requirements for heaviest duty. Can be easily and quickly filtered. Speedy starting because of Advance Bakelite wheel. Requires no attention—always ready.

Revolving disk is moulded bakelite six inches in diameter. Nickel plated brush holders with adjustable gauze copper brushes. Convenient control handle. Disk, aluminum brush arm support and brush holders perfectly insulated.

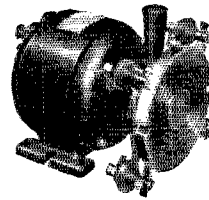

Price complete with Westinghouse 1/4 H. P. Synchronous Motor .... \$40  
Rectifying wheel with complete brush assembly and mounting ring to fit your own motor .... \$15

We Pay All Transportation Charges in U. S. A.

**ADVANCE ELECTRIC COMPANY**

1260-1262 West Second St., Los Angeles, Calif.

# FREE RADIO GUIDE

## Short Wave Equipment SPECIAL AMATEUR DEPARTMENT

The Barawik line features this season the Special Amateur Dept. in charge of F. J. Marco, 9ZA. It presents the latest in short wave equipment, transmitting and receiving supplies and everything necessary for the amateur and experimenter. Special attention has been given to short wave kits. It will pay you to get our catalog.

The new 1927 edition of the Barawik Catalog and Guide also gives a comprehensive listing of the radio sets, parts, kits, supplies and accessories necessary in all work. It contains 164 pages of radio's newest developments. Standard equipment of the best-known manufacturers at tremendous savings.

Write today for your free copy of the 164-page guide. Also please include name of other fans you know would be interested.

**BARAWIK CO., 540-571 Monroe St., CHICAGO, U.S.A.**



# THE RADIO LOG

## New and Improved Log Book For Hams

KEEP A COMPLETE LOG OF STATIONS WRKD AND HEARD. NO OTHER RECORD NEEDED. DETAILS COMPLETE FOR REFERENCE. SPACE FOR ALL THE DOPE.

A LONG NEEDED WANT AMONG AMATEURS. NUFF SED.

PRICE 50 CENTS EACH, OR 5 FOR \$2.00 SPECIAL DEALERS' PRICES.

BUSINESS-LIKE QSL CARDS IN 2 COLORS AT REASONABLE RATES. ANY QUANTITY. SEND FOR SAMPLE PAGE OF LOG—ALL ORDERS POST PAID.

Radio Records Publishing Co., 200 West 42 Place, 6DDO Los Angeles, Calif.

# 5 IN 1 CONNECTOR

Licensed under Pat. 1,557,948

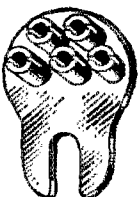
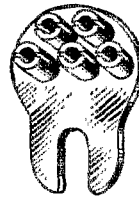

With this ingenious and inexpensive device attached to positive and negative phone binding posts you can use from one to five pairs of phones on any radio receiving set. The spring sockets grip any phone tip. Loose contact is impossible. Works while loud speaker is in operation.

If your dealer cannot supply you we will mail you a pair on receipt of 25 cents. DEALERS QUOTED ON REQUEST.

**SNOW & COMPANY**  
Dept. QST. 149 Church St., New York

# Cardwell



dg-1XL

*"Univ. of Michigan Greenland Expedition, 1926.*

*To A. D. CARDWELL Co. in appreciation of kind interest and co-operation.*

*P. C. Oscanyan, Jr., In Charge Expedition Radio."*

## SUPREMACY



UPREMACY in any part of the Radio Field is difficult, and supremacy among the Amateurs is well nigh impossible. Only the products of careful research and painstaking manufacture can be sold in this field at all, and to be acknowledged "The Best" by the Amateur, is the greatest compliment a radio instrument can achieve. *W W* it is our proud boast that more Cardwell Condensers are used in Amateur installations than all other makes combined. *W W* every expedition to the far corners of the earth uses Cardwells. *W W* when you buy a Cardwell Condenser, you *know* you have the best.



*These Booklets are available to you for only the trouble of requesting them:*

- "A SHORT WAVE RECEIVER"
- "A SIMPLE TRANSMITTER"
- "CATALOGUE OF CARDWELL CONDENSERS"

*(A Complete Handbook)*

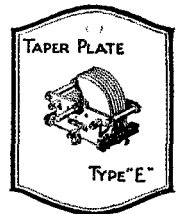

**The Allen D. Cardwell Manufacturing Corporation**

81 PROSPECT STREET

BROOKLYN, N. Y.

# Condensers

**"THE STANDARD OF COMPARISON"**

SAY YOU SAW IT IN Q S T—IT IDENTIFIES YOU AND HELPS Q S T



"used  
in the  
LC-27"

# AEROVOX

"Built Better"

## FIXED CONDENSERS

are Specified in

**LC ~ 27** by L. M. Cockaday  
 Diamond of the Air " Herman Bernard  
 To be announced soon (?) " John Rider  
 Raytheon "B" Eliminator " Raytheon Mfg. Co.  
 Ultradyne " R. E. Lacault  
 To be announced soon (?) " R. E. Lacault

AEROVOX fixed condensers have been approved  
 by M. I. T. and Yale Universities.

**AEROVOX WIRELESS CORP.**  
 489-491-493 Broome Street, New York

## AGAIN WE ANTICIPATE YOUR WANTS

### The New "WINDHAM" Universal Condenser

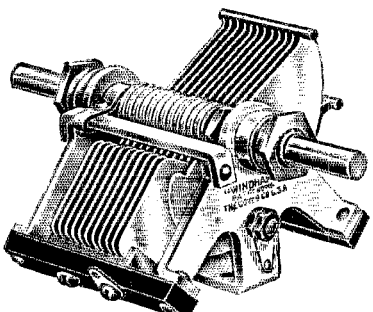

Independent Removable 1/4" shaft of  
 desired length passes through a Hollow  
 Spindle permitting clock or counter  
 clock-wise rotation with all the other  
 Windham features so well known to the  
 trade. Single or double spaced 3 to 23  
 plates panel or test board mounting.

Send for Catalog  
**THE GOYER COMPANY, Willimantic, Ct.**

## THE CRICKET KEYS

Although Among the  
**LATEST IMPROVEMENTS IN RADIO**

are already in use in Canada, Central America, Mexico, and the far away Philippine Islands as well as  
 all over the United States.

**CALL THEM UP**

and see what they say—see how they work. They will give you a GOOD FIST. You don't have to repeat  
 words and thus gain SPEED—and avoid being cussed. They are fast in every way. They are easy and  
 pleasant to work and keep you from having a GLASS ARM.

**THEY ARE THE KEY FOR THE GANG.**  
 The beginner's best friend and the old ham's delight.

**AND PRICES ARE REASONABLE.**

Our new No. 15—it's a "beaut"—Silver contacts, \$10.50 pre-  
 paid.  
 No. 25 "Universal", adapted to Radio or LINE WORK, with  
 through line switch, Silver contacts, \$15.50 prepaid.  
 No. 5. The Portable. Silver contacts, \$11.75 prepaid.



**F. F. MACE & SON, 132 Sunset Ave., Dallas, Texas**

## QST Oscillating Crystals

### New Low Prices Effective January 1st, 1927

We will grind a crystal for power use for use in the 80 meter  
 band for \$25.00. With this crystal we give its frequency ac-  
 curate to better than a tenth of 1%.  
 For use in the 150-170 Meter band \$15.00. Frequency stated  
 accurate to better than a tenth of 1%.

**Attention Owners of Broadcasting Stations**

We will grind you a crystal, ground to your assigned fre-  
 quency accurate to better than a tenth of 1% for \$50.00. This  
 crystal is so ground so as to be capable for use in POWER  
 circuits, besides being excellent for use as a frequency standard.  
 Crystals ground to any frequency between 50 and 10,000 Kcs.  
 Let us quote on your requirements.

**SCIENTIFIC RADIO SERVICE**  
 The Crystal Specialists  
 Box 86, Dept. F Mount Rainier, Md.

## RECEIVERS TRANSMITTERS - EQUIPMENT

Ensall Radio Laboratory Equipment is built to a Quality  
 Standard. All Apparatus is fully Guaranteed. The Highest  
 Quality Parts are employed in our Wavemeters, Receivers,  
 Transmitters, Master Oscillators, etc. Special Equipment  
 built to order. Quotations furnished upon receipt of data  
 on the Equipment you desire. We build any Equipment  
 you desire from your parts or we can furnish same. All  
 Equipment fully Tested and sold with a Dual Guarantee.

### Ensall Radio Laboratory

1208 Grandview Ave., Warren, Ohio  
 "Pioneer Builders of Short Wave Apparatus"

# EVERY AMATEUR NEEDS THIS AERO INTERCHANGEABLE SHORT WAVE KIT!

1. Positive contact is secured through General Radio plugs and jacks.

2. With 3 Coils, continuous, gapless range is secured from 140 to 16 meters. One of the 20-40-80 meters amateur bands is located in the middle of the tuning range of each of the 3 coils. (For this a SFL Condenser, 140 mmfd. max. cap. is essential.)

3. Operation of regeneration condenser has no effect on the tuning; the 2 controls are completely independent.

4. Antenna coupling is adjustable; by a primary coil

and not through a condenser. Secondary coils are specially constructed so that setting of primary coil does not need to be changed when secondaries are exchanged.

5. Coils are space-wound solenoids on skeleton frames.

6. Both tickler and antenna coil are at filament end of the secondary.

7. These coils cover the 3 U. S. Amateur Bands, all European Amateur Bands, Short - Wave Broadcast, U. S. Naval and Commercial Short-Wave Stations, etc.

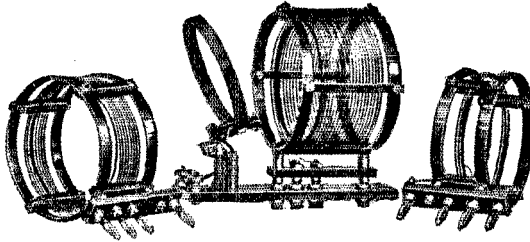

The Kit Illustrated Covering 15 to 133 Meters Complete **\$12.50**

Coil No. 4, 125-250 M

Price \$4.00

Coil No. 5, 235-550 M

Price \$4.00

*Get these coils from your nearest dealer,  
or order direct from the factory*

**AERO PRODUCTS INCORPORATED, Dept. 16, 1768-1772 Wilson Ave., Chicago, Ill.**



## RADIO Instrument

Of course, you are putting a voltmeter on your new set for controlling the filament voltage as without it your reception would be rather haphazard—certainly as far as filament voltage was concerned.

Our pattern No. 135, illustrated, and our pattern No. 135-B, which is similar but has a double scale and a convenient push button switch mounted in the rim for shifting from the low to the high, B-battery scale, are popular instruments with set builders and set manufacturers. They are both small, (two inch diam.), good looking and complete instruments in every way.

*Write for our new free radio instrument catalogue No. 15-c.*

**Jewell Electrical Instrument Co.**  
1650 Walnut St. Chicago

*"26 Years Making Good Instruments"*

### A Quality Instrument

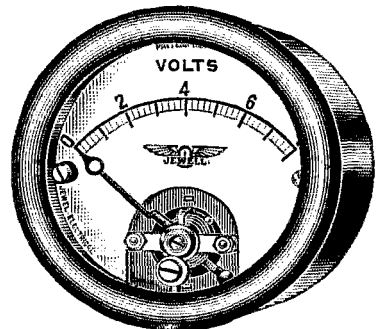

*Pattern No. 135  
0-8 volt, 2 inch round  
Panel Mounting Voltmeter*

Silvered scale with black characters  
Silvered movement parts  
Sapphire jewel bearings  
D'Arsonval type movement  
Zero adjuster  
Black enameled case  
Special mounting feature.



# CARTER

## New "Midget" Rheostat



50c

(Half Size)

Smallest rheostat made. Self-cooling, all-metal frame absorbs and radiates heat. Resistance element clamped in place, cannot move and short. Made in all resistances including R.M.A. Standards. A good clean cut job, and one you'll find fits your circuit requirement. Specified in all of the really popular circuits. Also in Potentiometer form: 200 or 400 ohms—75c; 2000 ohm \$1.25.

Any dealer can supply

In Canada — Carter Radio Co., Limited, Toronto.



Have You Tried the New  
**OUTPUT TUBE**  
TYPE J-71

Will handle sufficient power to operate the largest loud speakers at full volume. Does not require high voltage plate supply. At 90 volts it will give twelve times the undistorted power of the ordinary "A" type filament 5/2 volt.—1-2 amp.

PRICE  
\$4.50

The Tube  
of  
Longer  
Life

A Type  
for Every  
Radio Need

Makes a Good Receiver Better

Write for Complete Data Sheet

C. E. MFG. CO. Inc. . . . PROVIDENCE . R. I.

# ACME

## FLEXIBLE CELATSITE

Flexible, stranded wire for point-to-point and sub-panel wiring. Non-inflammable "spaghetti" covering. In black, yellow, green, red and brown; a color for each circuit. Put up in 25-ft. coils.



### Celatsite Battery Cable

— a silk-covered "cable" of vari-colored Flexible Celatsite wires, for connecting batteries to set. Prevents "blowing" of tubes; gives your set an orderly appearance.

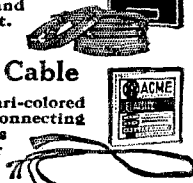

Send for Complete Acme Wire Products Folder  
ACME WIRE CO., DEPT. S, NEW HAVEN, CONN.

# ACME WIRE

## MAKES BETTER RADIO

### Become a Radio Operator

See The World. Earn a Good Income. Avoid Hard Work.

Learn in the Second Port U. S. A.

Radio Inspector located here. Positions plentiful. Splendid Climate. Other advantages to the student unequalled in any other American port.

Nearly 100 per cent of operators graduating on Gulf during past four years trained by MR. GLEMMONS, Supervisor of Instruction. Every graduate secures position. Write for Circular. Day and Night Classes; enroll anytime.

**Gulf Radio School** 844 Howard Avenue, New Orleans, La.

# LYNCH

## METALLIZED

WARRANTED FIXED RESISTORS

THE vital importance of a silent, accurate resistor cannot be over-estimated. Comprising a concentrated metallized deposit one-thousandth of an inch thick, upon a glass core and sealed forever within the tube, each Lynch Resistor is warranted absolutely noiseless, permanently accurate, dependable! Guaranteed accuracy—10%; in production they average 5%. .25; .5; 1; 2; 3; 4; 5; 6; 7; 8; 9; 10 Meg., 50c. .025; .09; .1 Meg., 75c. Single mounting 35c; Double, 50c. If your dealer cannot supply you, send stamps, check or money order. We ship postpaid same day order is received.

Dealers—Get on our mailing list; we keep you posted on new developments. Write us today!

ARTHUR H. LYNCH, INC. MEMBER R.M.A. 426 Q 250 W. 57th St. New York, N.Y.

THE BEST \$1 YOU EVER SPENT!

Hey, I am—  
Have u ordered ur copy of  
Andy's  
Handbook?

PUBLISHED BY  
AMERICAN RADIO RELAY LEAGUE  
1711 PARK ST., HARTFORD, CONN.

for  
**Christmas!**



**Kingston**

**"B" Battery Eliminator**

Guaranteed to remove the battery nuisance and deliver clearer tone and increased volume. Provides three different voltages at the same time. Each tap adjustable over a wide range, making possible any desired voltage from 5 to 150, absolutely harmonizing "B" current supply to your set. Raytheon tube used as rectifier. No noise or vibration. Contains no acid or solution and will not get out of order. Operating cost negligible. A REAL Christmas gift.

At Your Dealer's

Price, complete **\$35.00**  
with Raytheon tube

**KOKOMO ELECTRIC COMPANY**  
KOKOMO, INDIANA

**ELECTRAD**

Your Set is as  
Good as  
Your Parts



**N**O doubt about that. If you know radio you know how important your Grid Leaks are. Use Electrad Metallic Leaks and Resistors. New—totally different. No carbon, paper, varnish, fiber. The metallic resistance element is fused to the inside of a glass tube.

Capped with the exclusive Electrad ferrule. Paraffined under high vacuum. Six points of superiority: Noiseless, Constant, Accurate, Non-hydroscopic, Non-inductive, Unvarying under any weather or working conditions. Great current-carrying capacity without overheating or change of resistance. Make this test—try these leaks in your own set. Hear the improvement in reception. Sizes 5000 ohms to 10 meg-ohms. Price: U. S. 60c; Canada 85c.

Use **ELECTRAD**  
Certified Condensers

Without hesitancy we claim the Electrad Certified Six Point Fixed Condenser to be without equal. Here is why: Uniform pressure insured by rigid binding at six points. Sheet copper, not tinfoil. Soldering iron can't hurt it. Certified electrically and mechanically. Guaranteed to remain within 10% of calibration. Standard capacities. All types. Prices: U. S., 30c to 75c. Canada, 45c to \$1.50. In sealed packages at all good radio stores.

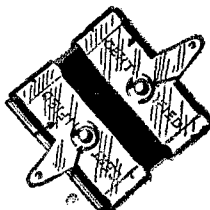

For perfect control of tone and volume use the Electrad 500,000-ohm compensator. For free hookup write 428 Broadway, New York City.

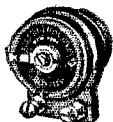

**ELECTRAD**

QUALITY **DONGAN** PRODUCTS

No. 1582

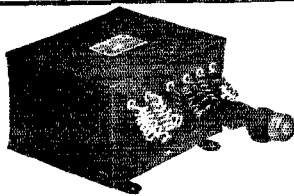

**A Conspicuously Successful B-Eliminator**  
 Incorporates  
**Dongan Radio-Power Unit No. 1582**  
 For Use With the Raytheon Tube

Thousands of these B-Eliminators have been built and are giving 100 per cent satisfaction. Dongan No. 1582 consists of 1 Transformer and 2 Chokes, designed in conjunction with Raytheon engineers. The Radio-Power supply is quiet, smooth and consistent all the time. Built into handsome black metal case—very durable. Complete instructions for building. Send check or money order at once.

No. 147 transformer designed for use in connection with the output circuit avoids the loss of B voltage due to the high resistance of the loud speaker and eliminates all risk of damage to the speaker. Last . . . \$4.50

Special Transformers for Trickle Chargers  
**Dongan Electric Manufacturing Co.**  
 2999-3001 Franklin St., Detroit, Mich.

**TRANSFORMERS of MERIT for FIFTEEN YEARS**

**HALCO**  
**MAIL ORDER SERVICE**  
 For Radio Transmitting Equipment  
**DALLIN-HALCO SUPER**

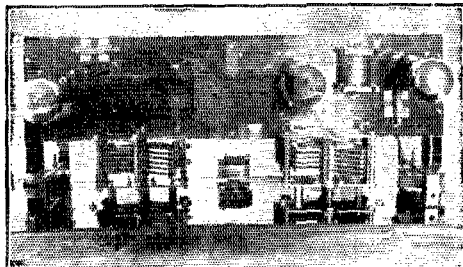

A new super-regenerative short-wave receiver designed by E. B. Dallin of the Cruft Laboratory, Harvard University, of extreme sensitivity and ease of operation. The third tube is an oscillator, for use with C, W.

Price of complete kit \$47.00

Write us for descriptive pamphlet Q

**Halco Mail Order Service**  
 132 Hanover Street Boston, Mass.

**Lowest Wholesale Prices**

**On Everything for Radio**  
 If Your Set Needs It—  
 We Stock It!

3-Hour Shipping Service on Every Advertised Accessory—Popular Circuits—LC-27, Hammerlund-Roberts, Ultradyne LR-4, Intradyme, Alden Tru-phonie—As Well As All Those Hard-to-Get Parts! Our Goal—the Lowest Prices in America—Get this Free Book—and See for Yourself Whether We've Reached It!

New 1927 **BUYING GUIDE** for Radio Dealers and Set Builders—100 Pages of Lowest Prices—Just off Press—One Copy is YOURS! (If You Send for it NOW).

Direct Representative of the Committee  
 of 21 Manufacturers  
 Address Dept. Q.

**Allen Rogers**  
 Incorporated  
 Kit Headquarters  
 118 East 28th St., New York, N.Y.

**RADIO OPERATORS WANTED**

THE EASTERN RADIO INSTITUTE can train you quickly and thoroughly because:

MODERN AND EFFICIENT METHODS  
 THOROUGH INSTRUCTION under staff of  
 LICENSED COMMERCIAL OPERATORS  
 MODERN APPARATUS including SHORT WAVE  
 TRANSMITTER

FOURTEEN years a RADIO SCHOOL  
 THE OLDEST, LARGEST and MOST SUCCESSFUL  
 school in New England. RECOMMENDED BY THE  
 A. R. R. L.

Day or Evening Classes Start Every Monday.

SPECIAL CODE CLASSES

Write for Illustrated Prospectus

**EASTERN RADIO INSTITUTE**  
 899 BOYLSTON STREET BOSTON, MASS.

Laboratory Product



**CRESCENT**  
**LAVITE**  
**RESISTANCES**

for Distortionless Amplification.

Dual resistance for DeForest "H" tube \$2.50. Consists of two units mounted on bakelite and connected in parallel.

Please specify if your "H" tube requires 50,000 ohms or 20,000 ohms.

All amateur apparatus in stock. Let us drill and engrave your name.  
**CRESCENT RADIO SUPPLY CO., 1 Liberty St., Jamaica, N. Y.**

FAMOUS "BH" TRANSFORMER

**BH VIVAPHONIC**

For quality of amplification, use the only Low-Loss, Shield Structure Audio transformer made. (Patented) Write for Catalogue Illustrating Audio and Transmitting Transformers.

**BENJAMIN HUGHES ELECTRIC CO.**

298 Lagauchetters St., W. Montreal, Canada  
 Transformer Builders Since 1910

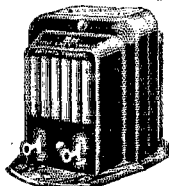



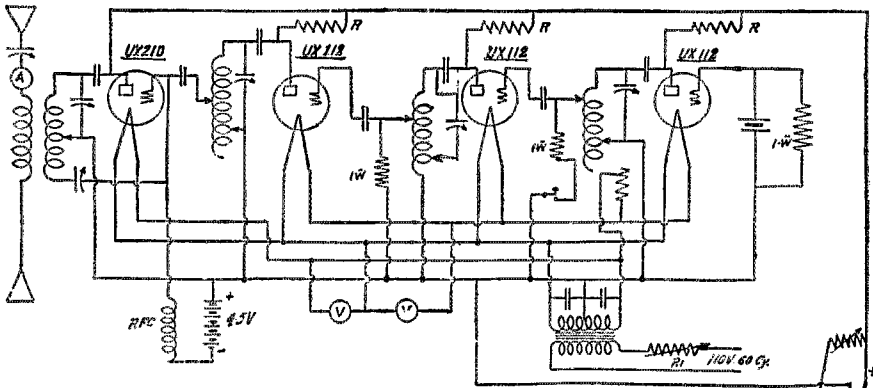

THIS is the third of a series of five "hook-ups" for crystal control transmitters using "ESCO" Maximum miles per watt Power Supply. The crystal oscillator is a UX112 controlled by a 320 meter crystal for 80 meter operation or 160 meter crystal for 40 meter operation. A 320 meter crystal can be used for both 80 and 40 meters, with slightly reduced output in the 40 meter band. Assuming a 320 meter crystal—the first UX112 oscillates at 320 meters. The second UX112 has its plate circuit tuned to the second harmonic of the crystal tube—160 meters. It amplifies at this wave length. The third UX112 has its plate tuned to the second harmonic of the preceding tube or 80 meters. The last amplifier is a UX210 which is tuned to the wave of the last UX112. Neutralization in the last stage is then necessary, as is shown. Plate supply comes from Item 8 operating from DC or AC supply. The filaments are heated by a 110 volt 60 cycle transformer. Plate circuits of all tubes except the 210 have resistance [R] to drop the plate voltage to not over 250 volts. The 210 has the full 500 volts from Item 8.

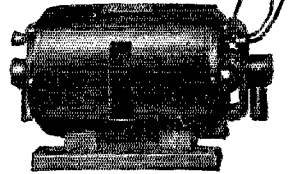

## ELECTRIC SPECIALTY COMPANY

225 South Street

TRADE "ESCO" MARK

Stamford, Conn., U.S.A.

Manufacturers of Motors, Generators, Motor - Generators,  
Dynamotors and Rotary Converters for Radio and other purposes

# 90 VOLT "B" POWER UNIT \$12.75

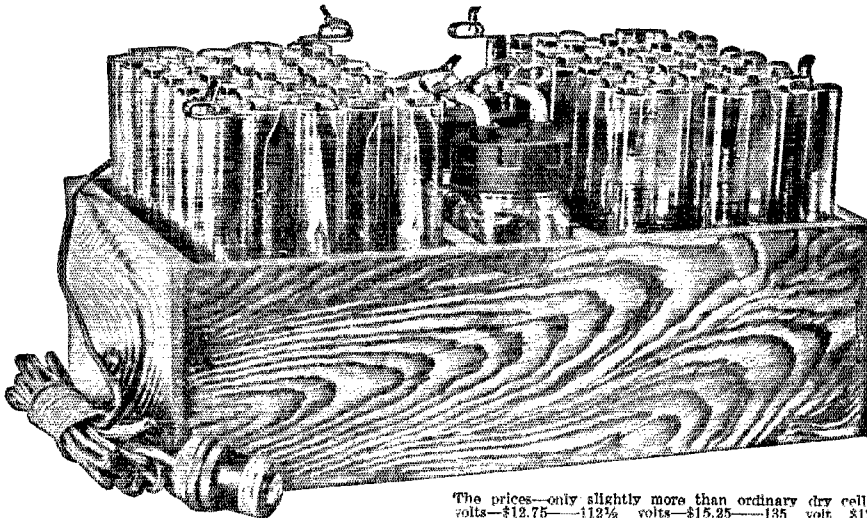

RUMOR has had it this NEW HAWLEY ADVANCED Storage "B" batteries was coming—and here it is. Hawley and the same quality—the same standard of workmanship comprise this unit with its new ingenious hook-up and built-in-charger giving the utmost in B-Eliminator simplicity. Positively guaranteed not to give the slightest find or trace of a hum or line noises. Simply plug it into your electric socket—and forget it. Any inexperienced person can hook it up in 2 minutes, as all voltages including those for any kind of detector are all plainly marked. Operates any 1 to 10 tube set. Does not contain any acid. It's so good—such true snatching value—that my 5 year old 30 day trial offer refund applies. You've got to see it—hear its operation to fully appreciate this statement.

The prices—only slightly more than ordinary dry cells 90 volts—\$12.75—112½ volts—\$15.25—135 volt \$17.50. For 105 to 120 volts, 25 to 130 cycle alternating current only. Special sizes to order of any voltage. Knockdown kits at still greater savings. All complete as above—nothing to purchase extra. Further covered in my regular 2 year guarantee. Ample stocks—all packed—same day shipments and your order is all I need to speed it on its way to you. Simply say—ship C.O.D.—pay expressman its cost plus small transportation charges—and you'll thank me later—or write for my free literature, testimonials, etc.

**B. HAWLEY SMITH,**

324 Washington Ave., Danbury, Conn.

U. S. A., Mfr. of—"A" Power Units, "B" Power Units, "A" Storage Batteries, "B" Storage Batteries and A & B Chargers including Tricklers.

## Broadcasting Station Accessories

Push-Pull Transformers for 7½ w. 50 w. and 250 w. speech input circuits.

Microphone Mixing and Amplifier Output Transformers. A complete line of retards and transformers for amplifier circuits.

Variable and Fixed Air Condensers of any size required.

High voltage Plate Generators up to 30 k. w.

Broadcast Station erecting, rebuilding and general engineering.

**J. E. Jenkins & S. E. Adair, Engrs.,**  
1500 No. Dearborn Parkway, Chicago

## Bradleyometer

THE PERFECT POTENTIOMETER

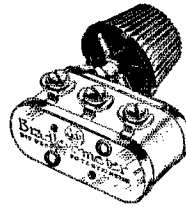

Uses graphite disc resistors which are noiseless and not affected by atmospheric conditions. Metal parts are nickel plated. One hole mounting. Finish and knob match Bradleystat. Made in 200 and 400 ohm ratings.

**Allen-Bradley Co.**

Electric Controlling Apparatus  
277 Greenfield Avenue  
Milwaukee, Wis.

### To Our Readers Who Are Not A. R. R. L. Members

Wouldn't you like to become a member of the American Radio Relay League? We need you in this big organization of radio amateurs, the only amateur association that does things. From your reading of *QST* you have gained a knowledge of the nature of the League and what it does, and you have read its purposes as set forth on page 6 of every issue. We would like to have you become a full-fledged member and add your strength to ours in the things we are undertaking for Amateur Radio, and incidentally you will have the membership edition of *QST* delivered at your door each month. A convenient application form is printed below—clip it out and mail it today.

.....1927

American Radio Relay League,  
Hartford, Conn., U. S. A.

Being genuinely interested in Amateur Radio, I hereby apply for membership in the American Radio Relay League, and enclose \$2.50 (\$3 in foreign countries) in payment of one year's dues. This entitles me to receive *QST* for the same period. Please begin my subscription with the.....issue. Mail my Certificate of Membership and send *QST* to the following name and address.

.....  
.....  
.....

Station call, if any .....

Grade Operator's license, if any .....

Radio Clubs of which a member .....

Do you know a friend who is also interested in Amateur Radio, whose name you might give us so we may send him a sample copy of *QST*?.....

Thanks!

**UNIVERSAL**  
Covers every  
resistor  
requirement

current  
carrying  
capacity  
20  
watts

wherever a  
variable  
resistance  
is  
specified

From  
practically  
0 to  
5,000,000  
ohms

noiseless  
one-hole  
mount

**CLAROSTAT** \$2.25

Wherever a Resistance  
is Specified Pin Your  
Faith on

**CLAROSTAT**

*the greatest variable  
resistor!*

That's **59** leading  
what **B Eliminator**

manufacturers are doing. After ex-  
haustive tests, they are convinced that  
only CLAROSTAT acts as the perfect  
voltage control because it

has a range of from practically zero to  
5,000,000 ohms.....

has a current carrying capacity of 20  
watts—greater than that of any vari-  
able resistor—without the slightest  
danger of packing, arcing or crackling  
noises.

Have you sent for your copy of "The GATEWAY  
TO BETTER RADIO"? The edition is limited  
and you can't afford to be without it. 32 pages  
covering everything—reception, transmission,  
amplification and battery elimination. Send 25c  
in stamps or coin to Dept Q

**American Mechanical Labs., Inc.**

285 N. 6th Street

Brooklyn, N. Y.



**YAXLEY**  
APPROVED RADIO PRODUCTS

*Special  
Switches*

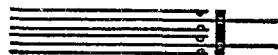
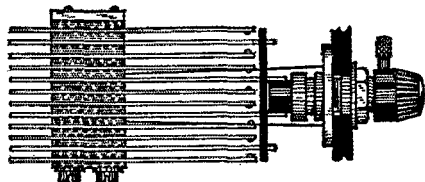

**Bracket Type**

Nearly every builder of radio equip-  
ment is confronted at some time or other  
with the need of special switches to take  
care of some particular requirement.  
With this in view, Yaxley Switches were  
designed with the purpose of filling  
practically every radio need. With the  
Bracket Type Switch, shown above,  
most any spring arrangement from a  
double pole, double throw switch with  
six springs to a four pole, double throw  
switch with twelve springs is possible.  
Furnished as a two position or a three  
position switch as desired, either lock-  
ing or non-locking.

In writing for prices on special  
switches, please give as much informa-  
tion as possible, together with sketch  
of spring arrangement wanted and  
thickness of panel.

**YAXLEY MFG. CO.**

Dept. S, 9 South Clinton Street

Chicago, Ill.



George Electric Company  
**"B POWER UNIT"**  
 TYPE M

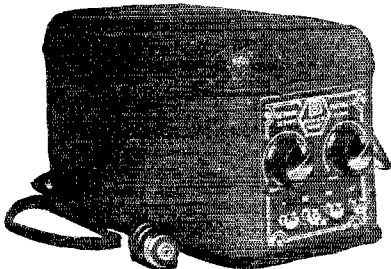

**Complete With Tube \$29.50**

Our patented filter circuit is most efficient, delivering absolutely pure direct current, free from any hum or distortion. The Type M Unit is sturdily constructed, and will last as long as the best receiving set.

Variable resistances permit the selection of voltages to make your set work efficiently at all times. You can bring in distant stations with more volume, and your locals with purer tone.

This unit operates on 110 volt, 60 cycle A.C. It will deliver 150 volts, with plenty of current for a ten tube set or sets equipped with power tubes.

—FULLY GUARANTEED—

Our dealer will be glad to give you a demonstration. Write for further information.

**GEORGE ELECTRIC COMPANY,**  
 756 Carleton Ave., St. Paul, Minn.

Dealers and Agents! Write today for attractive agency proposition

**A Shielded, Variable  
 Audio Transformer**

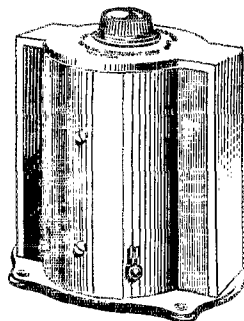

Another  
 Pace-Setting  
 G. I. Product

A transformer that really matches the characteristics of the tube. For use in any set — in detector circuit, and any or all stages of amplification.

**Easily Adjustable**

Merely turn the knob until reception is clearest and sharpest. No squeals, no howls; just perfect reproduction.

Write for complete literature on all  
 G. I. Products

**GENERAL INSTRUMENT CORP.**  
 477 Broadway, New York City

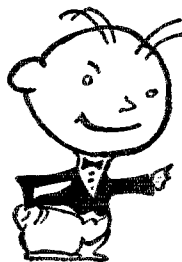

**Howdy  
 Gang!**

Did you receive a copy of our new catalogue? If not,

drop us a line and we will be glad to shoot one of 'em along to you. Ham apparatus is our business and we carry a full stock of both transmitting and receiving parts.

*(Dynex for DX)*

**Nicholson Electric Co.**

1407 First North St.

Syracuse, N. Y.

**FOR EVERY BEGINNER**

THE SIGNAL  
 PRACTICE SET

Complete in every detail with high grade key, true tone adjustable high pitch buzzer and brass code plate. R68 \$3.40



**SIGNAL WIRELESS KEYS**



R48

Strongly made with coin silver contacts. Brass parts polished and lacquered. Very reliable units.

R48-1/4 in. K.W. \$2.50 R62-3/4 in. contact \$5.50

R63-3/4 in. " \$5.70

R64-3/4 in. " \$5.90



R62

Signal Buzzer



R60

Small neat high frequency type. Has standard resistance of 2 ohms. Black or stalized lacquer finish. Special resistances on quality orders.

R60 \$1.25

We manufacture a complete line of telegraph instruments.  
**SIGNAL ELECTRIC MFG. CO., Menominee, Mich.**

**Broadcast Motor Generator for Sale:**

- 1 Crocker-Wheeler Motor Generator Outfit, Motor 225 Volts D. C., 1000 R.P.M., 5 H.P., Generator Supplying 1200 Volts D.C., 2.5 Amperes, 1000 R.P.M., 1-1/4 K.W.
- 1 Crocker-Wheeler Motor Generator Outfit, Motor 225 Volts D.C., 1100 R.P.M., 3 H.P., Generator Supplying 30 Volts D.C., 50 Amperes, 1100 R.P.M., 1-1/2 K.W.

**PAUL J. LARSEN, Care Radio Corporation of America**  
 70 Van Cortlandt Park South, New York City.

**Hey, Ham—**  
 Have u ordered ur copy of  
**Handy's  
 Handy  
 Handbook?**

THE BEST \$1 YOU EVER SPENT!

PUBLISHED BY  
 AMERICAN RADIO RELAY LEAGUE  
 1711 PARK ST, HARTFORD, CONN.

# HAM-ADS

## NOTICE

Effective with the July issue of QST the policy of the "Ham Ad" Department was altered to conform more nearly to what it was originally intended that this department should be. It will be conducted strictly as a service to the members of the American Radio Relay League, and advertisements will be accepted under the following conditions.

(1) "Ham Ad" advertising will be accepted only from members of the American Radio Relay League.

(2) The signature of the advertisement must be the name of the individual member or his officially assigned call.

(3) Only one advertisement from an individual can be accepted for any issue of QST, and the advertisement must not exceed 100 words.

(4) Advertising shall be of a nature of interest to radio amateurs or experimenters in their pursuit of the art.

(5) No display of any character will be accepted, nor can any typographical arrangement, such as all or part capital letters, be used which would tend to make one advertisement stand out from the others.

(6) The "Ham Ad" rate is 7c per word. Remittance for full amount must accompany copy.

(7) Closing date: the 25th of second month preceding publication date.

THE life blood of your set—plate power. Powerful, permanent, infinitely superior to dry cells, lead-acid Bs, B eliminators. Trouble-free, rugged, abuse proof, that's an Edison Steel-Alkaline Storage, B-Battery. Upset electrically welded pure nickel connectors insure absolute quiet. Lithium-Potassium solution (that's no lye). Complete, knock-down kits, parts, chargers. Glass tubes, shock-proof jars, peppy elements, pure nickel, anything you need. No. 12 solid copper enameled permanently perfect aerial wire \$1.00; 100 ft. Silicon steel laminations for that transformer 15 lb. Details, full price list. Frank Murphy, Radio 8ML, 6406 Carl Ave., Cleveland, Ohio.

PEPPY "B" batteries. Build yourself a powerful plate supply unit with genuine Edison elements. Good peppy elements per pair 4 cents, drilled  $4\frac{1}{2}$  cents, perforated hard rubber insulator  $\frac{1}{2}$  cent each, pure nickel wire 1 cent per foot, shock proof glass tubes 3 cents each, complete sample cell 20 cents, lithium potassium to make 5 pound solution, \$1.25. Completely assembled "B" battery in beautiful highly finished cabinet with panel and series, parallel switch for charging, voltage taps, etc. 100 volts \$10.95, 130 volts \$14.25. Complete "B" battery charger \$2.50. Cash with order or C.O.D. Martin, 706 S. Ashland, Chicago, Ill.

25% to 35% discount to amateurs on receiving parts, no sets. Our weekly data sheets give you more dope than all the radio magazines together. 20 weeks trial \$1.00, 52 weeks \$2.50. Over two pounds data, circuits, catalog, prepaid 25c. Fred Luther Kline, Kent, Ohio.

OMNIGRAPHS, vibroplexes, transmitters, tubes, "S" tubes, receivers, chokes, meters, transformers, batteries, eliminators, sync rectifiers, wave meters, plug-in coils, chargers, speakers, electrical instruments, testing instruments, motors, motor generators—bought, sold, exchanged. L. J. Ryan, 9CNS, Hannibal, Missouri.

SELL Leach relay 110 volt DC type \$20, also complete set of parts for power amplifier of No. 104 loud speaker. Best offer takes outfit. 2AOJ, 439 West 123rd Street, New York City.

NAVY standard compass receivers, SE1440A-150-1250 meters equipped with detector, 3 stages audio, ideal for commercial work and broadcasting stations, \$275. 10/350 volt Navy dynamotors \$25.00. Navy 900 cycle alternators self-excited \$25. Western Electric tubes. UV204 \$95. Dubilier Mica Condensers .004-8500V at \$8. Western Electric 2B Superheterodyne receiver, complete, new \$240. U. S. Navy, Western Electric, Submarine chaser CW936 transmitter, receiver, new, original case, \$225. Long wave navy receivers CN240, \$65. Navy precision wave-meter 100-4000 meters \$100. Arthur Faske, 1515 Eastern Parkway, Brooklyn, N. Y.

SAY YOU SAW IT IN Q S T—IT IDENTIFIES YOU AND HELPS Q S T

MOTOR bargains,  $\frac{1}{4}$  h. p. \$6.75, six volt storage batteries, \$2.25, 824 North Fifth St., Philadelphia, Pennsylvania.

FOR sale—superheterodyne ten tube Golden-Leutz model C-10, Apco eliminator, Radiola 1825 speaker, 100 ampere storage battery, all or any part. Henry Leeb, South Orange, N. J.

GENERATORS for real pure DC reports, unusual commutation. General Electric 24/1500 volt .233 ampere new \$35.00. With shaft extension for battery or external drive \$38.00. Original cost to Navy \$92.50 in hundred lots. GE 12/350 volt .143 ampere \$15.00 with filter. Westinghouse-Navy SE 1012 Short Wave Receivers range 50-10000 meters unused \$45.00. Used \$35.00. High grade Navy Wavemeters \$45.00. Navy Keys with blinker light \$2.00. Cost \$16.50. 500 cycle generators and motor generators. Henry Kienzle 501 East 84th Street, New York.

STB for sale. Complete fifty watt station, kenetrons, transformers, meters, condensers. Parts or entire outfit. Write for particulars. Chas. E. Gardiner, Jr., Johnstown, N. Y.

SELLING 5 watt transmitter and low wave receiver. Write for particulars. Carroll M. Loper, Port Jefferson, N. Y.

SELL—two "H" tubes never used. 9ALT

SPECIAL—Hams, builders, fancy cabinets finished in mahogany or walnut, sloping or straight front, only \$2.50. Standard sizes. Guaranteed satisfactory. H. W. Nielsen, 914 N. 48th Avenue, Omaha, Nebraska.

FOR sale—complete fifty watt transmitter with tube, motor-generators, relay, vibroplex and receiver. A modern \$300 outfit for \$175. 7NC, 727 North C St., Tacoma, Washington.

DODGE Radio Shortcut with appendix and hints for better key work \$3.50 U. S. and Canada—elsewhere \$4.00. Registered mail. None COD. Money order only. Fixes signals in mind to stick. Kills hesitation. Speeds up on reception. Users' reports tell the story—on request. C. K. Dodge, Mamaroneck, New York.

PURE aluminum and lead rectifier elements, holes drilled, brass screws and nuts, pair  $1/16"$ ,  $1" \times 4"$ , 13c,  $1 \times 6$  15c,  $1\frac{1}{4} \times 6$  17c,  $1\frac{1}{2} \times 6$  19c. Sheet aluminum  $1/16"$  \$1.00,  $\frac{1}{8}"$  \$1.90. Lead \$1.00 square foot all prepaid. Silicon transformer steel cut to order .014". 10 lbs. 25 cents, 5 lbs. 30 cents, less than 5 lbs. 35 cents per lb. 4 cubic inches to the lb. Postage extra.  $\frac{1}{2}$  cash with order—balance C.O.D. Edgewise wound copper ribbon .350" wide;  $3\frac{1}{4}"$  outside diameter 10c turn,  $4\frac{1}{4}"$  13c turn,  $5\frac{1}{4}"$  15c turn,  $6\frac{1}{4}"$  17c turn,  $7\frac{1}{4}"$  20c turn, prepaid. Geo. Schulz, Calumet, Michigan.

UP-1658 Filament Transformers 75 watt output 7.5v, \$6.00 ea.—UP-1558 Filament Transformers 150 watt output 10v, \$8.00 ea.—UV-712 audio transformers ratio 9/1, \$1.50 ea.—Genuine Cardwell Variable Condensers, type 123-B .0005 mfd, \$2.00 ea.—Signal R-48 Telegraph Keys, \$2.25 ea.—Jewell meters, send for cat—Amrad Lighting Switches, \$1.50 ea.—W. E. Mikes 349-BW, \$4.00 ea.—Acme Modulation Transformers \$4.50 ea.—G. R. type 334-T 2000v Variable Transmitting Condensers \$4.00 ea.—Fleron Stand-off Insulators, 3 inch .75c ea.—All new and Guaranteed. Radio 1-CPE 223 Weld St., Roslindale, Mass.

QSL cards \$1 per 100, highest quality, orders filled immediately. COD or cash with order. William Green, 207 Cathedral Parkway, N. Y. C.

HAMS: Get our prices and samples on printed call cards made to order as you want them—9APY. Hinds, 19 S. Wells St., Chicago, Ill.

MOTOR—generator brand new—3 unit 1000 volt  $\frac{1}{4}$  ampere with separate exciter. Will equip with 3600 r. p. m. motor for 2000 volts. Write for prices. D. A. Snick, 110 Marion Ave., Mansfield, Ohio. 8BZ.

BETTER Edison elements. Welded connections, 7c pair. Sample cell 10c. Paul Mills, Woodburn, Oregon.

YOUR call letters painted on fancy showcard 7x10 with glass frame, \$1. Send remittance with order. 2LB.

OFFER complete 40 meter transmitter with all short wave receiver and broadcast receiver, meters, and kenetron power unit for 100 bucks. Might sell parts separately. I have several brand new short wave receivers, with new type plug-in coils, with cabinet, for \$25.00. Write H. R. Hollyday, 1421 Arch Street, Philadelphia, Pennsylvania.

BARGAIN—1000 volt 100 watt 110 volt 60 cycle Esco motor-generator. Good as new, \$50. R. W. Ballard, 652 E. 89 Place, Chicago, Ill.

SALE—Real bargains. 2PX selling out. Weston, Roller-Smith, Jewell, meters, tubes, 204A, 203A, 210, Esco 500V M. G. R. E. L. inductances, transformers, reactors, quartz crystal plates, guaranteed 150 to 165 meters, \$10. What do you need OMS? Ask me. 2PX, R. F. D. No. 5, Schenectady, N. Y.

MG set for sale. Double wound generator—7½ volts, 1½ amps and 400 volts, 60 mils. 110 volt 60 cyc single phase motor. Direct connected on iron sub-base. Will demonstrate. Price \$25. John Lodge, 71 Oakwood Ave. Upper Montclair, N. J. Telephone 8453.

ONE power transformer 5 to 60 watts \$7.00. 4NZ.

HERE y'are, Gang. Westinghouse Cooper-Hewitt Mercury arc rectifiers, PB for steady note and DX. New and guaranteed, \$11.75 ea. plus express and insurance. Shipped via express only. Photo and blueprints with all details 25c, refunded on purchase. Limited number, first come, etc. Wilbur Gemmill, 434 N. Beaver St., York, Penna. u3AAO.

SPECIAL! Tobe 50,000 ohm grid leaks for deForest "H" Tube \$1.00. Also Bradley Radiostats for primary of filament transformers, \$6.50; 2,000-30,000 ohm Bradley variable grid leaks, \$5.00. The new General Radio Wave-meter covering all bands, Type 358, \$20.00. REL radio frequency chokes, special at \$1.00. Complete line of General Radio and Radio Engineering Laboratories equipment carried. Write for special prices Postage prepaid three zones. G. F. Hall, 133 East Gorgas Lane, Philadelphia, Pa.

WANTED—forty volt generator. 9ARJ.

WANTED—Grebe CR18 for cash. Lewis C. Chapman, Rt. 1, Columbus, Mississippi.

WANTED—Transmitting equipment in exchange for brand new 90 HP LeRhone airplane motor and \$300 worth extra parts as propellers. Fine outfit for motor sled. What have you? H. C. Wing, Greenfield, Mass.

WESTERN Electric CW936 telephone set complete, transmitting and receiving parts and sets. Special short wave apparatus to order. Write for quotations. 6AGE-6CYK, S. T. Runyon, Walnut Grove, Calif.

WANTED—one horse single phase motor. A. R. Uelege, Jackson, Missouri.

NEW Generators 275 volts, 120 watts direct current gives up to 500 volts \$3. 1016 RCA transformers \$11.50. 1803 RCA condensers 50c. 1831 variable transmitting \$1.50. Honey-comb mountings geared \$1.50. Microphones \$1. Used generators ½ KW 500 cycle \$15. 200 watt \$10. 30 volt dc input output 300 volts dc \$8. New 500 cycle motor-generators ½ KW and 1KW 110 volt dc drive. ½ KW direct coupled to gasoline engine, 500 cycle transformers spark. Stamp for list. R. Wood 46-20, 102 St. Corona, New York.

1KW, 2500 volt, new type Esco, speed 1450, like new. \$135. Cost \$240. 1 KW tube used but serviceable, \$25. 1 h. p. 25 cycle motor \$60, cost \$115. 35 henry choke, capacity ½ amp. \$15. Sell entire station. 8UE.

WANTED:—Omnigraphs, vibroplexes, 50-watters, S-tubes, Grebe CR18. Price Griffith, 1109 Eighth Avenue, Fort Worth, Texas.

HAM HEADQUARTERS—Potter 2000-volt 1-mfd condensers \$2.50; 2500-volt 1-mfd condensers \$3.25. Aerovox 1500-volt 1-mfd condensers \$1.75. Federal buzzers \$2.75. Mueller 150-watt input tubes \$15.00. No. 12 Enameled wire 160-ft. \$1.00. Currgri-Co 5 watt DX Babies \$3.15. New "ham-list" 4c. R. Curtis, 1109 Eighth Avenue, Fort Worth, Texas.

OMS start the New Year right. Line up with a real ham store, and get the service you pay for anyway. General Radio wavemeters and plug in coil parts, stand-off insulators. Jewell meters. Acme transformers and chokes, Allen Bradley rheostats, National transmitting double spaced condensers, Ward Leonard grid leaks. Aero short wave coils. Sheet lead, aluminum, ammonium phosphate, high test filter condensers. Get our ham list. It's worth money to you. Harris, 5RM, 104 East 10th St., Ft. Worth, Tex.

SEND for your copy of the new "Ham-List", price 4c. Curtis-Griffith 250-watt power-filament transformers 550 each side \$12.50. Thordarson 650-volt power-filament transformers for 5-7.5-watters \$6.90. Thordarson power transformers 350-550 each side \$11.00; 1000-1500 each side \$16.00. Edgewood copper strip 6-inch, turn 12c, 4-inch turn 10c. Aluminum square foot 85c; Lead square foot 85c. Jewell 0-15 voltmeters \$7.50; 0-500 milliammeters \$7.50. New "Ham-List" 4c. James Radio Curtis, 5—A—Q—C, 1109 Eighth Avenue, Fort Worth, Texas.

TWO new W. E. fifty watters \$27.00. Amertran PF52 transformer \$15.00. Pair Amertran DeLuxe audio transformers, \$15.00. 2BYJ.

WESTERN Electric Three-stage power amplifier No. 7A with tubes, Federal modulation transformer and Type MT-4 Magnavox tone arm with transmitter \$48.50. New Brandes Superior phones \$2.79. New Brandes Navy phones \$3.79. Signal Variable condensers .78. Get my bargain list for the ham. 9MV Store City, Iowa.

WE want every ham to have a copy of our Hamalog, the most complete catalog and handbook of its kind published. It's free for the asking. Be sure to get it. We handle De Forest transmitting tubes. Type "H", \$18.00; type "D", 10 watts, \$9.00; type "P", 250 watts, \$110.00; also special on 20 watters, \$12.00. Some specials: General Radio wavemeters, type 247W only, 25% off, while they last. UC-1831 condensers, \$1.20. Copper strip ¼" x 1-16", 4c per foot. New fall Amateur call-books, 75c. ARRL Handbooks, \$1.00. Don't forget to write for the Hamalog, O.M. E. F. Johnson, 9ALD, Waseca, Minnesota.

BARGAINS—Aero Short Wave Tuner Kits \$9.97; Tuned R.F. Kits \$9.78; R.E.L. Inductances 40-80-150 \$8.92; Hammarlund dual .000275 condensers \$6.27; National Tuning Units, 1B \$4.92; 2 B \$11.20; Jefferson Concertone \$4.78; Tobe 4 mfd. 300 working volts \$2.68; 4 mfd. 600 volts \$5.78; 2mfd. 600 volts condensers \$4.00; Remler .00035 condensers \$4.18; Thordarson chokes 30 H. \$4.18; National Impedaformers \$4.68; Samson A. F. Transformers 6-1, 3-1 \$4.18; Jewell meters 135 panel mounting 6-100 \$6.27. M. B. Spinoza 27 School Street, Boston, Mass.

BJW LABORATORY at this time announces the Inductance Transmitting Rheostat in successful operation. Resistance variation by plunger with set screw works like a charm. High current capacity. Practical in design, compact, neat. See later QST. Rheostat priced \$3.00 postpaid. \$1.50 higher West Coast and Canada. E. E. Hare, 9BWJ, Paintsville, Ky.

OMNIGRAPH wanted, state type, number of plates, condition and price. E. Clark, Oak Bluffs, P. O. Manitoba, Canada.

START the New Year right by wearing an A.R.R.L. sweater emblem. They are diamond shaped 5"x8" and made of best quality yellow and black felt. Only \$1.00. Eric Robinson, 135 Jefferson Road, Webster Groves, Missouri.

HAM wavemeters, any band \$7.50, additional bands \$2.50 each. Station type, mahogany cabinet, solidly built, with flash lamp indicator. With galvanometer, \$12.50 additional. Blue print curves furnished. Constructed and calibrated by graduate electrical engineering students. Accuracy within ½ of 1% guaranteed. Wm. P. Stevens 5MG, Box 128, Faculty Exchange, A. and M. College College Station, Texas.

BANK of nine 1 mfd. Western Electric Condensers \$4.50. 530 volt 150 watt generator coupled to 110 volt 60 cycle single phase motor \$35.00. 750 volt 200 watt generator coupled to 110 volt 60 cycle single phase motor, \$45.00. 2500 volt 2 kilowatt generator double commutator coupled to three phase 220 volt 1750 speed motor. 2500 volt 60 watt double commutator generator coupled to 110-220 60 cycle single phase motor, 1750 speed. Prices F.O.B Chicago. James Smat, 1734 West Grand Ave., Chicago.

## Q R A SECTION

50c straight, with copy in following address form only:  
CALL—NAME—ADDRESS.

1BMG—Charles H. Stevens, 94 Prospect St., Stafford Springs, Connecticut.

1BUX—D. H. Borden, Sea-View Ave., Touisset, Massachusetts.

1GP—Sumner H. Foster, 190 Harvard St., Brookline, Mass.

1PV—Harry A. Livingston, 107 Brookline Ave., Holyoke, Mass.

2AGP—John Sammons, 24 N. Swan St., Albany, N. Y.

2CC—Albert E. Scarlett, Jr., 11 Cooley Place, Mount Vernon, New York.

2CWR—F. H. Mardon, 117-11 140th Street, South Ozone Park, Jamaica, L. I., N. Y.

2HO—William Vollkommer, 48 Windsor Place, Brooklyn, N. Y.

2MK—E. F. Reynolds, Central Valley, Orange County, New York.

4CV—Heman Beckwith, 721 So. Boulevard, Tampa, Florida.

4FO—C. A. Davis, P. O. Box 668, Winter Haven, Florida.

4OB—Guy L. Carter, 507 W. Duval Street, Jacksonville, Florida.

4TK—Robert H. Reid, 507 W. Duval St., Jacksonville, Fla.

5AHT—F. E. Fisher, Drawer O, Breckenridge, Texas.

6ALZ-6AGH—Ellwood W. Munger, 642 N. Washington Ave., Whittier, California.

6AM—Don C. Wallace, 279 Molino Ave., Long Beach, California.

7AJ—P. Fakkema, Oak Harbor, Washington.

8DIC—Lester G. Landerkin, 409 West King Street, Martinsburg, W. Virginia.

8RD—C. H. Vincent, 12694 Northlawn Ave., Detroit, Michigan.

9ADQ—A. L. Branom, 106 S. 6th Street, Belleville, Illinois.

9BGQ—Clemente Carducci, 169 E. 24th Street, Chicago Heights, Illinois.

9BL—Val W. Walter, 510 Deming Place, Chicago, Illinois.

9CEY—Amos Utterback, 512 John St., Whiting, Indiana.

9UZ—F. H. Schnell, 1915 Sherman Ave., Madison, Wisconsin.

c2CC—J. W. Barnaby, 2047 Theodore St., Montreal, Canada.

c4BB—A. E. Sharp, Holdfast, Saskatchewan, Canada.

c4DC—T. B. Kingsford, Box 311, Young, Saskatchewan, Canada.

chaNQT—U. S. S. Pampang, c/o Postmaster, Hongkong, China.

N-OWC—W. H. and C de Beaufort, den Treek, Leusden (U) Holland.

The following stations belong to members of the A.R.R.L. Headquarters gang. Mail for them should be addressed care A.R.R.L., Hartford, Conn.

1MK Headquarters	1DQ John M. Clayton
1AL H. P. Westman	1ES A. A. Hebert
1BAO R. S. Kruse	1KP F. Cheyney Beekley
1BDI F. E. Handy	1OA R. S. Kruse
1BHW K. B. Warner	1SZ C. C. Rodimon

SAY YOU SAW IT IN Q & S T—IT IDENTIFIES YOU AND HELPS Q & S T

## Test "B" Power Output Voltage—this New Sterling Way!

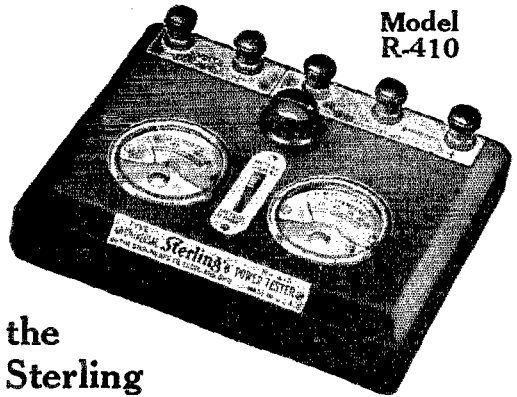

Model R-410

the Sterling "B" Power Tester answers these vital questions:

What is maximum voltage output of the "B" Power—its total capacity to deliver at no load?

What voltage will it deliver at say, 20—40—60 mills, or at any load up to 100?

How many milliamperes will any particular receiver pull when in operation?

Which kind of "B" Power gives sufficient plate voltage at that load? How much to spare, if a power tube were added?

Is any tube socket not receiving plate voltage due to trouble in the circuit? Which one is "open"?

What plate volts in the detector, Amplifier or Power tube? What voltage has any dry or storage "B" battery or combination of them up to 300 volts?

In addition you can check the output of any D. C. generator such as is used in transmitting sets; find out the load in any circuit or determine battery polarity.

"B" Powers—Eliminators—are here to stay. Your problem is how to judge them and how to service them.

This New

# Sterling

## "B" POWER TESTER

enables this to be done quickly and accurately—  
it is an indispensable part of the equipment of  
every radio service man.

List Price \$40.00

The Sterling Manufacturing Co.  
2848 Prospect Avenue  
Cleveland, Ohio



*Pacent Universal  
Cushion Socket  
No. 83*

## A Cushion Socket of Real Efficiency

Pacent Engineering skill and finest materials are the factors that have made the Universal Cushion Socket an outstanding success for short wave work and positive reliable contact.

Sockets of genuine Bakelite phosphor bronze solder tabs, with one-piece spring member, insures good connections at all times. Also positive non-microphonic cushion effect is made certain by special spring design.

**Price 65c**

*Inquire at your dealer,  
or write to us for full in-  
formation.*

**PACENT ELECTRIC CO., INC.**  
91 SEVENTH AVENUE NEW YORK CITY

*Canadian Licensed Manufacturer :*  
White Radio Limited, Hamilton, Ont.

*Manufacturing Licensees for Great Britain and Ireland:*  
Igran Electric Co., Ltd., London  
and Bedford, England

# Pacents

## RADIO ESSENTIALS

## FOR YOUR CONVENIENCE QST'S INDEX OF ADVER- TISERS IN THIS ISSUE

Acme Wire Co. ....	84
Advance Electric Co. ....	80
Aero Products, Inc. ....	83
Aerovox Wireless Corp. ....	82
Allen-Bradley Co. ....	64, 72, 88
Allen-Rogers, Inc. ....	72, 86
American Mechanical Labs. ....	89
American Sales Co. ....	78
American Transformer Co. ....	87
Amrad Corp. ....	71
A.R.R.L. Emblem Pins ....	61
A.R.R.L. Handbook ....	84, 90, 3rd Cover
A.R.R.L. Application Blank ....	88
Barawik Company ....	80
Bremer-Tully Mfg. Co. ....	79
Browning-Drake Corp. ....	62
Burgess Battery Co. ....	4th Cover
Burton-Rogers Co. ....	80
C. E. Mfg. Co. ....	84
Cardwell Mfg. Co., Allen D. ....	81
Carter Radio Co. ....	84
Central Radio Labs. ....	66
Crescent Radio Supply Co. ....	86
Crosley Radio Corp. ....	70
Cunningham, Inc., E. T. ....	2nd Cover
DeForest Radio Co. ....	75
Deutschmann Co., Tobe ....	76
Doncan Electric Co. ....	86
Dudlo Mfg. Corp. ....	77
Eastern Radio Institute ....	86
Electwad, Inc. ....	85
Electric Specialty Co. ....	87
Elkon Works, Inc. ....	63
Ensall Radio Lab. ....	82
Fansteel Products Co. ....	74
Ferranti, Inc. ....	78
Formica Insulation Co. ....	65
Frost, Inc., Herbert H. ....	72
General Instrument Co. ....	90
General Radio Co. ....	2
George Electric Co. ....	90
Gover Co. ....	82
Grobe & Co., Inc., A. H. ....	4
Gulf Radio School ....	84
Halco Mail Order Service ....	86
Hammarlund Mfg. Co. ....	61
Hammarlund-Roberts ....	66
Hughes Electric Co., Benj. ....	86
International Resistance Co. ....	74
Jacobs, Chas. F. ....	72
Jenkins and S. F. Adair, J. E. ....	88
Jewell Electric Instrument Co. ....	83
Kokomo Electric Co. ....	85
Larsen, Paul J. ....	90
Lynch, Inc., Arthur H. ....	84
Mace and Son, F. F. ....	82
Maple Electric Co. ....	72
McLanahan and Burton ....	74
National Carbon Co. ....	95
National Co. ....	96
Nicholson Electric Co. ....	90
Pacent Elect. Co. ....	94
QST Binders ....	3rd Cover
Radio Corp. of America ....	1
Radio Engineering Labs. ....	69
Radio Foundation, Inc. ....	61
Radio Records Publishing Co. ....	80
Radio Surplus Corp. ....	76, 78
Sangamo Electric Co. ....	70
Scientific Radio Service ....	82
Signal Elect. Mfg. Co. ....	90
Silver-Marshal, Inc. ....	68
Simplex Radio Devices, Inc. ....	70
Smith, B. Hawley ....	87
Snow and Co. ....	80
Sterling Mfg. Co. ....	93
Thordarson Elect. Mfg. Co. ....	73
Transmitting Equipment Co. ....	64
Utility Radio Co. ....	74
Vibroplex Co. ....	64
Ward-Leonard Elect. Co. ....	78
Well's Curiosity Shop ....	88
Weston Elect. Instrument Corp. ....	88
Wireless Specialty Apparatus Co. ....	66
X-L Radio Labs. ....	68
Yaxley Mfg. Co. ....	89



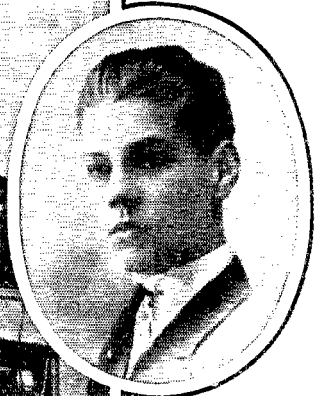
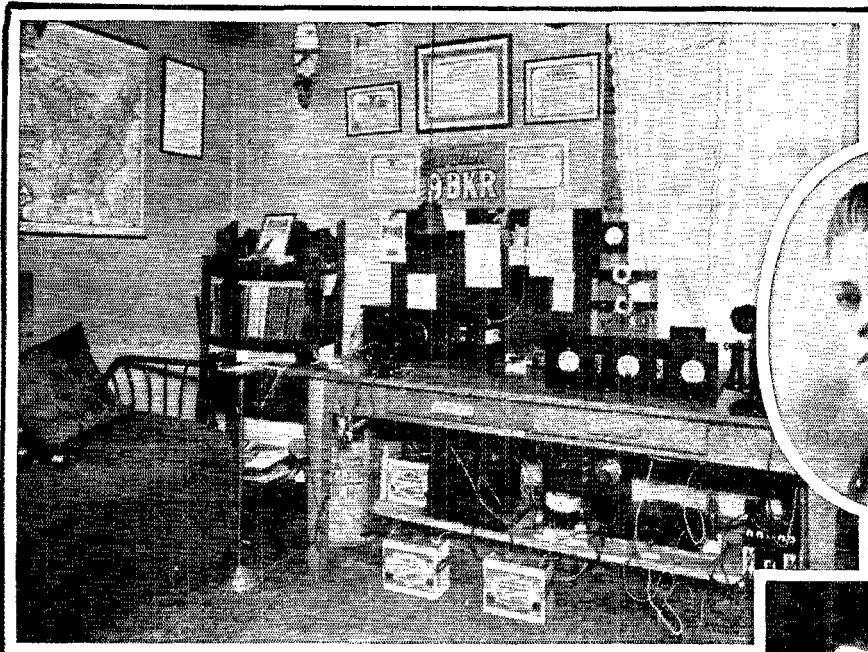

Mr. J. M. MEYER



Mr. FRED CATEL, *President*  
MILWAUKEE RADIO  
AMATEURS' CLUB, Inc.

## 9BKR at Milwaukee Show used Eveready Layerbilt "B" Batteries

ALL who worked 9BKR during the week of the Milwaukee Radio Show, September 25th to 29th, know what a pure DC note that station transmitted. It was heard from New York City on the east to California on the west, in practically continuous operation daily from 2 to 10.30 P. M., handling an immense amount of traffic to all points in the United States.

The plate supply consisted of a bank of Eveready Layerbilt "B" Batteries, putting 1000 volts on the plate of the 50 watter. Plate current, 80 milliamperes, generally considered a tremendous overload

for even the Layerbilt. Yet at the end of the show, when Fred Catel, president of the Milwaukee Radio Amateurs' Club, and John M. Meyer, 9BKR, dismantled the station to return it to Mr. Meyer's home, the Layerbilts each tested a full 45 volts.

"This was our first experience in testing your batteries out on this kind of service," says Mr. Catel, "and you can note that the results were very gratifying." They were not only gratifying but significant. The Eveready Layerbilt stands up even under conditions that amount to abuse, which is why transmitting amateurs are not

only recommending it to BCL's but are using it themselves on low power transmitters. The Layerbilt is, we believe, the longest lasting and most economical of "B" batteries.

*Manufactured and guaranteed by*  
NATIONAL CARBON CO., Inc.  
New York San Francisco  
Canadian National Carbon Co., Limited  
Toronto, Ontario

Tuesday night is Eveready Hour Night—  
9 P. M., Eastern Standard Time, through  
the WEAF net

# EVEREADY

## Radio Batteries

*—they last longer*

SAY YOU SAW IT IN Q S T—IT IDENTIFIES YOU AND HELPS Q S T

# NATIONAL POWER AMPLIFIER

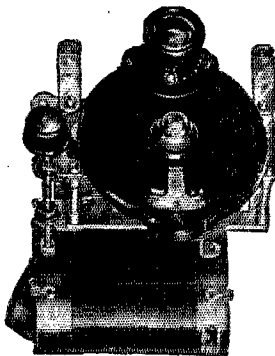

NATIONAL TUNING  
UNITS—

comprise the wonderful BROWNING-DRAKE R. F. Coils and Transformers with their SLOTWOUND primary and SPACEWOUND secondaries, EQUICYCLE wide-spacing condensers and VELVET VERNIER Dials. They make good Radio sets.

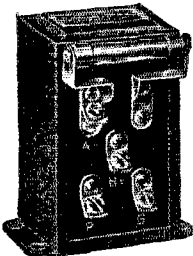

NATIONAL IMPEDA-  
FORMER—Type B—

includes in one case audio choke coil 0.1 Mfd. TOBE Condenser, mounted Lynch Resistor,—for modern audio amplification.

Price—\$5.50 each

**M**AKES your present Radio Set the last word in Fidelity of Reproduction,—and supplies all B and C current from the lamp socket.

Designed on sound engineering principles in collaboration with Arthur H. Lynch and James Millen, combines a B power-supply and complete audio amplifier of the highest type. It is made to use either the Raytheon BH or Rectron Rectifying Tube. Each unit is newly designed for heavy and continuous duty, built to established NATIONAL standards.

The NATIONAL Power Amplifier is designed to plug directly into the detector output of any Radio set and has one stage of NATIONAL Impedformer and two stages of resistance coupling with Lynch Resistors. Output from the UX-171 semi-power tube is through a NATIONAL Tone Filter, protecting the loud speaker and still further improving quality. All of the parts mount on a drilled and cored metal base.

Sold in complete kit form, including Raytheon BH Tube and every accessory and piece of wire required (except audio tubes). Easily assembled in an evening.

Price—\$85.00

Price of kit as above but completely assembled ready to run—\$95.00

The units are sold separately.

For home and professional set-builders—for dealers and custom trade.  
The NATIONAL POWER AMPLIFIER.

NATIONAL products are built to engineering standards of excellence. Anyone who has ever built a set using NATIONAL BROWNING-DRAKE Coils and Transformers knows what that means. Send for Bulletin 116-Q.



National Co. Inc., Engineers and Manufacturers, W. A. Ruddy, Pres., Cambridge, Mass. Makers of NATIONAL, BROWNING-DRAKE Coils and R.F. Transformers, Impedformers, Condensers, Power Transformers, etc., for Radio.

# Preserve your 1926 copies in the new *QST* Binder.

*Just Fits Twelve  
Issues of QST*

Get a set to hold all your back issues of *QST*—you know how they deserve preservation.

**QST**  
1711 PARK STREET  
HARTFORD, CONN.

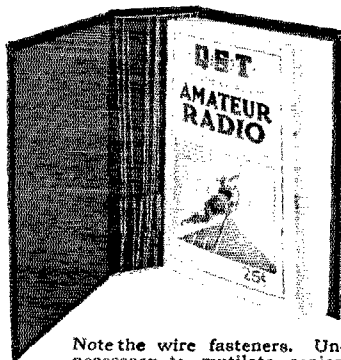

Note the wire fasteners. Unnecessary to mutilate copies. Opens and lies flat in any position.

Maroon Buckram with title stamped in pure gold.

SENT POSTPAID

**\$1<sup>50</sup>**—ea.

# RECEPTION R9!

"*The Radio Amateur's Handbook*" has met with such enthusiastic reception that the first printing—which we expected to last a year—is sold out. A second printing of the same number of copies has now been made.

You cannot afford to be without this book if you have the slightest interest in radio.

"*The Radio Amateur's Handbook*," in its 224 pages, contains *twice* as much material as the average book because it is printed in *QST's* close style. If printed in regular book fashion it would have to sell for at least \$3.00. It is the biggest dollar's worth of radio literature ever published. *Send for your copy today.*

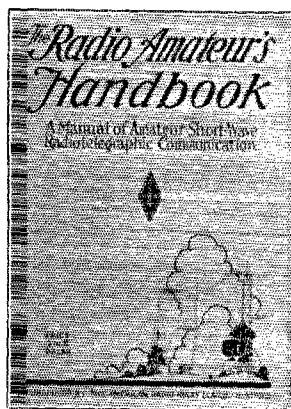

**\$1** postpaid

American Radio Relay League, 1711 Park St., Hartford, Conn. .

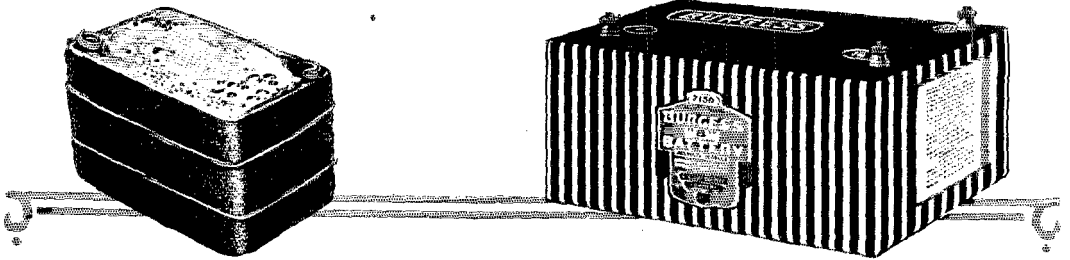

# Here's the oldest and newest

Representative of the wide use of Burgess Batteries is this list of calls of amateur radio stations in which Burgess Batteries are used. Next month will be the last issue of QST in which these calls will appear as there is insufficient space to list them all.

## Burgess Batteries are used in these "ham" stations

Byrd	IBUB	2AET	2JK	4DD	5AVG	6BYH	7RL	8BKM	3DRD	9ARJ	9CCO	9DIG	9HB
Godley	IBVB	2AEU	2KG	4DK	5CUC	6BYW	7TM	8BMR	3DTQ	9ARU	9CDO	9DK	9HD
Mac-	IBVL	2AEV	2LE	4DM	5EH	6BZW	7VH	8BMW	3EU	9ASC	9CDO	9DRK	9JT
Milian	ICJX	2AGO	2NZ	4EK	5ER	6GCR	7VM	8BNM	3EW	9ATN	9CDZ	9DKS	9KL
Wil-	ICKK	2AKK	2PF	4EO	5GW	6GJA	7XW	8BPD	3GX	9AVJ	9CEL	9DLK	9KM
kins	ICKP	2ALS	2QU	4FD	5HR	6CKG	7ZO	8BPV	3JB	9AVL	9CET	9DMA	9LE
IAAC	ICKQ	2ANB	2TD	4EJ	5HF	6CMQ	8AAJ	3BQW	3KE	9ACZ	9CF	9DNG	9LI
IAAG	ICMP	2APB	2TL	4EM	5KL	6COD	8ACU	3BRA	3MU	9AYO	9CFU	9DOA	9MC
IAAP	IGTL	2AON	2UM	4HN	5KR	6COS	8ACS	3BRC	3OL	9AZN	9CHE	9DDE	9NK
IABP	ICUW	2AON	2UO	4JR	5LC	6CSA	8AEA	3BSA	3PL	9AZQ	9CK	9DOI	9ME
IACA	IDB	2ARX	2WG	4KD	5MS	6CSG	8AGI	3BSN	3OP	9BAG	9CKG	9DRG	9MN
IAER	IDO	2ASB	2WM	4KF	5MS	6GTP	8AGU	3BSR	3RB	9BRX	9CLD	9DRD	9PJ
IAFA	IEF	2AUP	3AAI	4KM	5PI	6DBH	8AHC	3BTI	3SV	9BDW	9CLJ	9DRS	9QS
IAHN	IES	2AVP	3AB	4LI	5RG	6DAI	8AHH	3BYN	3VE	9BE	9CMA	9DTG	9RH
IAID	IFD	2AVV	3ACN	4LK	5SI	6DDF	8AHT	3CCN	3XE	9BHT	9CN	9DTK	9RK
IAII	IFN	2AWQ	3ACP	4LL	5TO	6DDN	8AJ	3CFQ	3ZE	9BTT	9CNJ	9DUV	9RR
IAIT	IFS	2AX	3AEA	4NB	5VD	6DDZ	8AKF	3CGT	3ZG	9BIZ	9CNV	9DVS	9RS
IAJK	IGA	2AYU	3AF	4ND	5WD	6EB	8AM	3CI	3ZZ	9BJR	9CP	9DWN	9RT
IAJH	IGI	2AZU	3AHL	4PP	5XBF	6HU	8AMA	3CIB	9AAW	9BJS	9CPK	9DWR	9SD
IAJO	IP	2BAR	3AJQ	4PX	5YK	6IH	8AMB	3CLS	9AGU	9BKV	9CPO	9DYV	9SJ
IASU	IKP	2BBC	3ALV	4SI	5ZAI	6MS	8AMD	3CM	9AD	9BLE	9CPY	9DZI	9UA
IAUJ	IKZ	2BBW	3AN	4TN	6ABG	6RO	8ANB	3CMY	9ADN	9BLO	9CRM	9EAH	9UX
IAUG	ILM	2BEE	3APF	4ZA	6ADM	6TO	8AOP	3CN	9AEB	9BMX	9CRW	9EBJ	9UZ
IAVL	IMO	2BLM	3APV	5AAV	6AP	7AAB	8ART	3COR	9AEL	9BNA	9CSB	9ECG	9VD
IAW	IMY	2BNL	3AQT	5AC	6AKD	7AAV	8ATI	3CU	9AFZ	9ROJ	9CVL	9EDU	9VY
IAWW	IPY	2BO	3AW	5ACL	6AKM	7ABV	8ATV	3CVJ	9AGG	9BPB	9CSZ	9EEZ	9WI
IAZZ	ISZ	2BOW	3BAY	5ADA	6ALH	7ADP	8ATX	3CVO	9AGU	9BOO	9CWA	9EF	9ZA
IBBM	ITX	2BV	3BDZ	5ADD	6ALR	7AGI	8AVG	3CWR	9AGV	9BSK	9CWX	9EFO	9ZAF
IBCO	IYZ	2CKA	3BGJ	5ADD	6AM	7AW	8AUB	3CYM	9AIV	9BSQ	9CXN	9EGH	9ZDI
IBDB	IWO	2CLA	3BNU	5ADY	6BEE	7BG	8AVS	3DBM	9AK	9BSJ	9CG	9EGU	9ZBE
IBEZ	IXAM	2CP	3BNU	5AF	6BBO	7BM	8AZC	3DDI	9AKM	9BVB	9CYN	9EHK	9ZABC
IBGC	IXG	2CQZ	3BWJ	5AFM	6BEH	7FD	8AZD	3DDN	9ALJ	9BVB	9CVO	9EHO	9ZCR
IBGO	IYB	2CRB	3BWT	5AJJ	6BFO	7IT	8AZU	3DDU	9ALM	9BWO	9DAY	9EJI	9ZCT
IBHM	IZS	2CTH	3CA	5AJP	6BGO	7IV	8BAD	3DED	9ALW	9BWX	9DB	9EK	9ZCA
IBIG	2AAN	2CVR	3CKL	5AKV	6BH	7JF	8BAJ	3EIA	9AMI	9BXF	9DCX	9EKT	9ZCH
IBIZ	2ABE	2CWR	3EH	5AML	6BHI	7MC	8BRAY	3DJG	9AO	9BZ	9DDF	9ELT	9ZCH
IBLW	2ACY	2CYX	3QL	5ANL	6BHZ	7MR	8BC	3DJX	9AOK	9BZM	9DDP	9EP	9ZCI
IBMK	2ACX	2DO	3QP	5APG	6BJX	7NC	8BDE	3DJY	9APM	9CAA	9DDS	9EJ	9ZCT
IBNL	2ADH	2EP	3TI	5APL	6BMC	7PD	8BDG	3DKK	9APY	9CAG	9DCM	9EZ	9ZCT
IBNX	2ADI	2EV	3UZ	5ASK	6BNC	7PH	8BDG	3DME	9AQ	9CB	9DHI	9EY	9ZCT
IBOD	2AEF	2EY	3BW	5ASM	6BNT	7PU	8BEG	3DPA	9AQB	9CBY	9DHI	9GR	9ZCT
IBOQ	2AER	2JC	4DA	5AUS	6BUR	7RE	8BHM	3DOZ	9AQQ	9CCK	9DHP	9GX	9ZCT

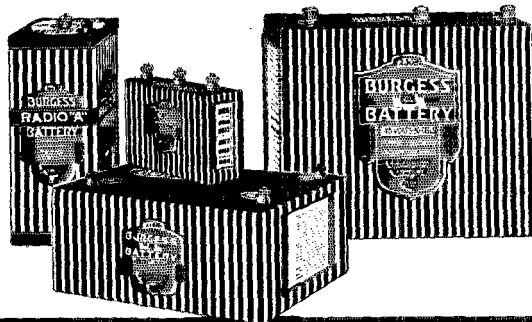

# BURGESS

## RADIO BATTERIES

# The Communications Department

F. E. Handy, Communications Manager  
1711 Park St., Hartford, Conn.

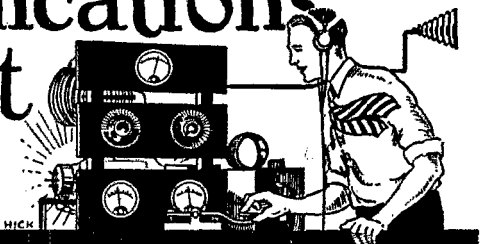

## A New Stunt in Relaying

THREE good stations recently pulled off a nice bit of unusual work—as pretty a piece of *three way* communication and amateur cooperation over the air as one could possibly want. 8AYP (Huntington, W. Va.) and 9DXY (Omaha, Neb.) got to chewing the rag. The eastern station casually asked the mid-west station to be on the lookout for a west coast ham and to hook him up with the coast if possible. Following this conversation 8AYP “stood by” while 9DXY gave a CQ WEST. 7IF at Marshfield, Ore., right on the coast, answered the CQ. After a few minutes of chatter, 9DXY told 7IF on what wavelength he should look for 8AYP, asking him to QRX while he got 8AYP on the job. Next 9DXY called 8AYP giving him the necessary information and telling him to call 7IF. The operator at 7IF picked up 8AYP without difficulty despite of bad interference from the local Navy “spark” (NPF).

At this point it seemed that the contact was going to fall through. 8AYP listened but was unable to pick up the west coast station. 9DXY got in some further work at this stage, however. Sizing up the whole situation he copied 7IF, repeating the conversation to 8AYP with a split-second lag so that as soon as 7IF had finished, 8AYP had copied all of the transmission and was in a position to go back at 7IF. 7IF was R-3 at 9DXY. Nevertheless the use of a good BREAK-IN system made it possible to copy 7IF while transmitting to 8AYP. Each time 7IF started transmitting, 9DXY acted the part of a relay for him, operating receiver and transmitter simultaneously. Everything worked out FB all around, though 7IF did not learn until afterward how 8AYP was getting the sigs. Everyone concerned got a good kick out of the experience. No DX records were broken. The new radio friendships formed and the novel and interesting angle involved in the friendly relaying of signals between transcontinental stations must be regarded as more important than any new distances covered.

Any low-power station or high-power station working under “skip-distance” difficulties can be relayed in this manner. In the instance cited 9DXY used two UX-210's. 7IF had just a single UX-210, and 8AYP was trying out a couple of new 203-A's. Such stunts as these are vy FB!! Let's have more of them. Why not try a few tricks that are out of the ordinary at your own station, OM? Put in a good BREAK-IN system using a separate receiving antenna and going to remote control if necessary. Adjust everything for maximum effectiveness, and then open up for some real sport. Using the method explained, transcontinental messages could be relayed almost as quickly as by direct work between stations on the opposite coasts.

## A New Expedition—KNT

By Wilford Deming, Jr., 6JX

THE Schooner “Fisherman”, owned by Zane Grey, eminent novelist, sailed from Long Beach, Calif. on Tuesday, November 9, and communication was at once established by 6DDO, 6AM, and 7PP. Preparations have been under way for the past year, and the party will be in the nature of a semi-scientific and fishing trip. KNT is bound for Auckland, N. Z., where about seven months will be spent in fishing around the South Sea Islands.

A very interesting and complete radio outfit has

been installed on the schooner. The picture shows the layout of the operating room. On the left is the transmitter which uses two quarter Kw. tubes in a 500-cycle self-rectifying circuit. The wavelength range is from about 15 to 60 meters. Along the operating table may be seen the receiving equipment, which was carefully selected in order to cover the entire range of wavelengths now in use. Above the receivers is the power control panel. Everything was

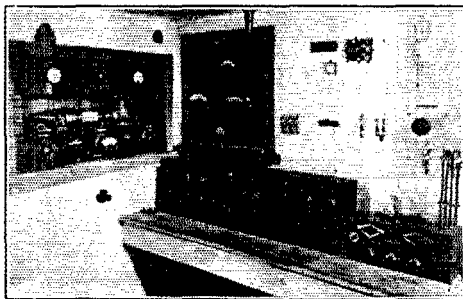

designed with neatness and efficiency as of equal importance. The complete installation was made by The Radio Installation Co., 6JX-ZU, of Los Angeles.

The antenna, at first, presented quite a problem. On the foremast, a cross spar as wide as the boat, was installed. From this the antenna was dropped directly to the transmitting room on the starboard side of the ship. Operation is on the fourth harmonic of the antenna.

The power supply is from a one Kw. 500-cycle generator, and the filaments are heated by 60-cycle a. c., from a Rotary Converter.

Mr. Karl E. Zint, 6ZCB, was chosen as the operator of KNT. He has had a great deal of experience, both amateur and commercial. He will have the “Fisherman” on the air day and night, and is a glutton for QSO's. Listen for KNT on about 40 meters, and also around 33, until he finds where he can work best, after which the wave will not be touched.

This winter, and almost a year to come, will find the air full of traffic to and from the “Fisherman” via amateur channels. A good bit of commercial work will be carried on, also, as the ship carries a commercial transmitter as well as the amateur one described. Schedules will probably be maintained with NKF.

The expedition will wander around in the South Seas, and it is expected that some large specimens of fish will be caught and stored aboard in specially built tanks.

At present there is no mailing point at which KNT may be reached, so all reports should be addressed care of The Radio Installation Co., 1404 Magnolia Ave., Los Angeles, Calif. Also, remember that QST wants to hear of any QSO's with the expedition.

9AIK worked WWDO, the Lighthouse Tender Cedar when she was at Ketchikan, Alaska Nov. 14. WWDO's wavelength was 23 meters.

GSB is the call used by a transmitter located at Pangnirtung, Southern Baffinland. GSB works on 40 meters and the QRA is simply, Geological Survey, Baffinland.

**BRASS POUNDERS' LEAGUE**

Call	Orig.	Del.	Rel.	Total
1BIG	261	182	810	1253
1AAP	863	43	103	1009
1BMS	79	111	650	840
1ATJ	24	51	702	777
8CNX	208	86	296	590
1AIT	18	60	494	572
1KL	88	15	451	554
8EU	50	54	430	534
1ATV	147	54	326	527
6BBQ	66	31	395	492
1UE	60	48	364	472
8XE	69	28	334	431
1AOX	80	63	248	391
2AFV	38	15	338	391
1AHV	25	64	302	391
1BFZ	104	52	218	374
1OC	140	46	168	354
9IX	19	27	306	352
8AYX	6	9	329	344
9D'FK	51	62	221	334
6BJX	59	134	134	327
8AYP	102	66	153	321
1AID	81	63	169	313
3BWT	59	621	172	293
9DXY	71	27	192	290
8DNE	58	9	199	266
9AGG	64	31	166	261
9EPX	100	74	72	246
8DIX	14	8	220	242
1AYI	32	31	175	238
8CMO	19	10	194	223
1BVB	57	28	186	221
8AYB	76	5	136	217
8AWK	21	27	156	204
9DWN	21	43	130	194
1AFL	17	34	138	189
1KY	27	84	76	187
3ADE	38	11	138	187
1AJM	84	12	91	187
9BKV	53	18	112	183
1NK	19	19	144	182
3CAB	151	16	14	181
8ADQ	83	22	72	177
7JF	100	20	56	176
9CZC	4	24	144	172
3AWT	38	62	72	172
7BB	79	6	86	171
1FP	67	28	74	169
2BCB	32	28	102	162
9DXZ	7	32	122	161
2ABF	56	17	87	160
6RW	39	121	—	160
8CGZ	7	19	134	160
9CAA	16	25	118	159
9BEQ	10	31	44	157
1IP	34	27	76	137
1HB	21	21	95	137
8BYR	36	5	94	135
2ANX	9	31	84	134
8SX	116	1	16	133
8CWT	16	31	84	131
6AJM	22	27	82	131
8AKO	6	10	114	130
1GA	—	1	124	125
8CGG	10	11	103	124
7JO	16	20	82	118
1BIV	27	19	72	118
8GI	2	36	80	118
2AJC	6	9	100	115
9BWN	15	3	94	112
1AAL	33	15	64	112
9BTX	44	64	2	110
9BJR	24	9	77	110
7ABB	90	11	8	109
8BSZ	7	16	86	109
6ZBJ	62	13	33	108
1BMG	100	1	6	107
8CNT	1	4	102	107
9APY	66	20	18	104
9RR	5	7	92	104
3CFG	22	10	72	104
9DGR	6	9	88	103
8CFO	11	15	76	102
9AFB	9	88	5	102
9DOE	12	18	71	101
5ANL	8	7	86	101
3LM	5	14	82	101

\*\*\*\*\*  
 \* Frederick Best—1BIG \*  
 \* 13 E. Crescent St. \*  
 \* Augusta, Maine \*  
 \* Orig. 261 Del. 182 Rel. 810 Total 1253 \*  
 \*\*\*\*\*

**1BIG WINS THE TRAFFIC TROPHY**

Just look at the long list of B. P. L.'s this month! Ninety-four stations made the honor roll for message-handling work. Once again 1BIG comes to the fore as the individual operator handling and reporting more traffic than any other amateur operator in the whole country. This is the third consecutive month that he has made the starred rectangle, thus winning the Traffic Trophy first offered the most consistent brass-pounder in February, 1925, QST.

Mr. Best's message files have been checked at A.R.R.L. Headquarters so that the "rubber-stamp" messages (having the same text for several addresses) and those held longer than 48 hours might be thrown out. 69 "rubber-stamp" messages and three messages on the hook more than 48 hours were thrown out of 1BIG's message files before making the final count. The result of the count follows showing Mr. Best to be well ahead of all other competitors even after throwing out a number of messages. Congratulations on the FB work, "SF"!

	Orig.	Del.	Relayed	Total
September	81	108	435	624
October	213	110	326	649
November	261	182	810	1253

It will be noted at once that a good number of deliveries were made each month and that the proportion of originated messages is not unduly large. Good relaying on schedule with other reliable consistent stations seems to be largely responsible for the consistent performance. Schedules were kept on both 40 and 80 meters at different times during the three months mentioned and both waves were equally useful for traffic work. The point to be remembered is that SCHEDULES were in the main responsible for the consistent records that were made. But a few hours each day devoted to keeping schedules to the dot and pounding the key with traffic, rolled up the totals given.

Mr. Best's message files were kept in very fine shape and the only reason for the "rubber-stamp" messages was that they were originated at other points and accepted for relaying. Those held 48 hours were held only on account of sickness. All the messages in the file were kept on mimeographed blanks of uniform size and quite similar to the standard A.R.R.L. blanks. This is a mighty fine suggestion for everyone and will somewhat cut down the operating expenses—use mimeographed blanks. Here is a further suggestion that helps one to keep the station records accurately and makes it easy to figure out the totals for the report on the 26th of the month. A mimeographed record sheet was used (several can be made with ruler and pencil) with headings like those given below.

Msg. No.	Rec'd Fm	Time	Sent to	Time	O	D	R	Date
107	1BMS	7.20p					x	11/23/26
10	8DNE	6.45p				x		11/24/26
107			8DNE	6.50p			x	11/24/26

Counting the check marks readily enables one to correctly total the different classes of messages handled without painfully digging the information from the more complete log or without counting over ALL the messages which is usually necessary. Note how easily the count of relayed messages is kept based on the principle that a message counts EACH time it is HANDLED by radio. Both an operator and his station are responsible for good traffic work. Next month we hope to present details of 1BIG's outfit in "Station Descriptions" and to show a photograph of the Traffic Trophy with the winning message files if it can be obtained in time.

The quantity of traffic handled this month hit a high mark again and is 25% greater than last year at this season. Message totals for the entire country follow: Orig. 7858 Del. 5196 Relayed 23085 Total 36188. More messages were originated this month but deliveries were poorer than for some time, both from the standpoint of the number of deliveries and from

the percentage delivery. The average delivery conditions during the last six months of 1926 show an improvement over the same period of 1925, however. If every reader of these columns will accept personal responsibility for DELIVERY of messages, conditions will show a marked improvement. An influx of "rubber-stamp" messages originated by a certain few stations is believed to be responsible for the slump in deliveries this month. Worthwhile messages of importance get through in good shape as usual. The conclusion to be drawn is that we must somehow kill the rubber-stamp messages at their source, delivering all good messages promptly and not counting the rubber-stamps when figuring out totals for the report under the honor system.

The standing of the several leaders in the B.P.L. is clearly indicated by the totals given there. All the New England Division S.C.M.'s have been trying to put that part of the country over the top. The number of stations in the B.P.L. speaks for itself indicating their success in putting it over. IKY and IAID are still making the B.P.L. too. Come on, you other Divisions and show the New England S. C. M.'s some competition. Don't let 'em walk off with all the honors. Get your R.M.'s on the job lining up some traffic routes and schedule-keeping stations, too.

6HJ has been appointed R. M. for the San Francisco Section and wants to hear from Eastern stations desiring schedules with the West Coast. Don't forget to include all the information on wavelength and time when you write him.

5AT has just returned from a several years' trip as sea-going op. He is starting to pound brass on short waves again and says he hopes to remain at it forever. You can get in touch with 5AT by writing Mr. Guy S. Craig, 3702 Loyola Ave., New Orleans, La.

Paul Fenner, 6PB, first suggested the "Five-point system" of arranging schedules with stations north, east, south and west from a given point. Now that the R.M.'s are lining up traffic nets the same scheme continues to be useful. Just think of the fun—and fun is the essence of our game—to sit down at, say, exactly 6:58 P.M., turn on the receiver, tune to a marked spot and at 7:00 P.M. hear your "point-man" east calling you just as per schedule. No waits, no delays,—real business! Hit-or-miss operation wastes too much time. Let's log the dial settings for every station worked and have a number of five-point schedules for traffic work arranged individually or in cooperation with the R.M. 6PB says it's "better business" and "more fun" to spend the evenings talking or pushing traffic than in wasting time for everyone with the eternal CQ.

2NZ has been copying GMD, the Dyott-Roosevelt expedition, in the operating hours of 3 to 5 A.M. E.S.T. and expects to QSO before long if given good luck. GMD is about R-3 with a D.C. note on 37 meters. Mr. P. J. Aubin of Putnam, Conn. also copied GMD. NKF has worked two-way with the expedition several times. The party has been threatened by bandits who were finally pursued across the Bolivian frontier by Brazilian government forces. The party consists of 4 whites, 5 comrades, 5 mules, 24 bullocks, 22 dogs and 2 covered wagons and has pushed forward to Utiarity. The portable transmitter was again put on the air about December 10.

#### OFFICIAL BROADCASTING STATION CHANGES AND ADDITIONS (Local Standard Time)

Call	Days of Transmission		
	7.00 pm	10.30 pm	12.30 pm
1BZ	38.5	—	—
2BBX***	—	—	—
4JB	83	—	—
5AJP**	—	—	—
6ANO*	—	—	—
8DME	84.3	—	—
9BQD	40-180	—	—
9CNL	—	40	—
9CZC	—	76	—

\* 7.30 p.m., 41 meters

\*\* Sun. 10 a.m., 39 meters

\*\*\* Sat. night 6 p.m., Sun. 10 a.m.

QST FOR JANUARY, 1927

#### 80-METER TRAFFIC HANDLERS TRY THIS ONE!

A new suggestion for improving hit-or-miss traffic handling has been made by Mr. Wayne Conger ex-3BDY. It's really worth a try, gang.

The idea is to divide the eighty-meter band into nine small bands, each one being allotted to one radio district. There is no particular object in doing this for anyone except those interested in traffic handling. Here is how the thing works. Suppose a station in the sixth district has a message for one in the ninth. He will send "CQ 9," as might be expected. So far so good. When he has finished his CQ, instead of having to search over the entire eighty-meter band, he will have only a range of one meter to go over. Knowing where to look on the tuner, the chances of raising a good traffic man in the desired part of the country will be increased greatly. His time will not be wasted listening to a "five" or an "eight" calling him. A table showing the bands allotted to the various districts follows:

Dist.	Wavelength (meters)	Frequency (Kcs)
9	85.7-84.4	3500.0-3555.5
8	84.4-83.2	3555.5-3611.0
7	83.2-81.7	3611.0-3666.5
6	81.7-80.5	3666.5-3722.0
5	80.5-79.6	3722.0-3777.5
4	79.6-78.2	3777.5-3833.0
3	78.2-77.0	3833.0-3888.5
2	77.0-76.0	3888.5-3944.0
1	76.0-75.0	3944.0-4000.0

This is going to mean some close figuring, fellows, so get out your wavemeters. In using this method, we might go even farther, and "CQ 9 N," meaning of course that we have traffic for the northern part of the ninth district. You can decide on that for yourselves.

It would be a good idea to put a piece of paper over your receiver dial, and mark the various district wavelengths on it to facilitate tuning. Usually it will be accurate enough to mark the upper and lower edges of the 80-meter band, dividing this sector into nine equal parts.

Attention, traffic men! Let's adjust our transmitters to the wavelength given for our district and give this scheme a chance to prove its worth. Try it out for a month starting when you receive this QST and let us know the results here at Headquarters. If it seems worthy of permanent use it can be made a part of A.R.R.L. standard practise.

#### IMK ON THE AIR!

A.R.R.L. Headquarters is regularly operating and QRV for your 80-meter traffic. The present set uses two 50-wattors with a self-rectified a. c. plate supply and may be found close to 76.0 meters wavelength. A big m. e. is in the process of installation and additional sets working on 40-meters and shorter wavelengths will be in operation as soon as arrangements can be made. The quota of schedules is nearly filled but a few more schedules with RELIABLE stations that collect traffic for HQ will be added. IMK is open for general amateur contact and is operated on different shifts by nearly every member of the HQ-gang. If you have something coming Headquarters' way, shoot it along direct to IMK or QSR through IKY, 1AWQ, 2ALL, 90X, 1YK, 1OC, 1UE, 1IBG, 2CXL or 3BWT. Direct QSO is most likely at the following hours: Noon to 1.00 p.m., 5.00 p.m. to 8.00 p.m., 8.30 a.m. to 9.00 a.m. (times given are all E.S.T. and effective daily excepting Saturday and Sunday). Also a 10.30 p.m. to 2.30 a.m. schedule is kept three nights a week, this schedule beginning at 10.30 on Tuesday Thursday, and Saturday nights. In cooperation with local B/C listeners with non-selective receivers quiet hours are observed between 8.00 and 10.30 p.m.

To all A.R.R.L. Members of the Los Angeles Section of the Pacific Division:

Mr. L. Elden Smith (6BUR) has been forced to resign as your Section Manager due to the pressure of college work. During his term of office he has built up activities in the Section, establishing high standards of achievement for the Section to maintain that had not been reached previously. Smith's resignation will be keenly felt by all members of the Section and in addition the C. M. is going to miss the pleasant monthly letters and progress reports that have always come through so regularly from S.C.M. Smith. Because of this resignation it becomes the duty of members of the Section to elect a successor to "carry on" the good work of the Section.

Nominating petitions are hereby solicited in order that an election for an A.R.R.L. Section Communications Manager for the next two year term of office may be held in the Los Angeles Section in accordance with the Constitution. Five or more A.R.R.L. members living in any section have the privilege of nominating any member of the League in their Section as candidate for Section Communications Manager. The nominee and signers of the petition must be members of the League in good standing. There is no limit to the number of petitions that may be filed but no member shall sign more than one such petition. The proper form for nomination was shown on page 45 of April, 1926 QST. All such nominating petitions must be filed at League Headquarters, Hartford, Conn., by noon of April 2, 1927 for the petition to be valid. Members are urged to take initiative and file nominating petitions immediately for the man of their choice.

—F. E. Handy, Communications Manager.

#### ARMY-AMATEUR NOTES

2ND CORPS AREA—Increased interest in A-A work has brought in many new applications for appointment. There are so many stations in the Brooklyn Net that the last one in the "order of operation" has to QRX half an hour to clear his traffic. There is still room for many stations in other nets. Amateurs in the Bronx, Manhattan, Long Island, Eastern and Western New York are invited to send their applications for appointment as Army-Amateur Radio Station to David Talley, 2PF, 2222 Ave. O, Brooklyn, N. Y. All N. C. S. should report activities to 2PF each month in addition to reporting to the Signal Officer so there can be suitable mention in QST. 2ARM, 2AVR, 2ADO, 2AND and 2PT kept all their net schedules during the month. 8HJ and 8VW were QSO 2SC almost nightly with traffic from the W. N. Y. Net. 2UF resigned and 2ASE replaces him at P. N. C. S. 2AAN is now the alternate N. C. S. 2APV has been handling 2GYX's schedules with 2SC while the latter is on the road. While 2APD was dismantled he kept the net schedules from 2CRB, 2EV and 2KS are lining up Manhattan and New Jersey Nets. As soon as a few more amateurs are in the nets, regular schedules will begin.

4TH CORPS AREA—During the temporary shut down of 4IO, the Corps Area Control station, 4RM, the P. N. C. S. of the Governor's Net of the State of Georgia has been meeting all schedules with 2CXL, Fort Monmouth, N. J. Since last report certificates have been issued to 5ADG, Principal, Hq. and Hq. Battery, 427th Field Artillery, Shreveport, La., 4JE, Principal, Howitzer Company 120th Infantry, Gastonia, N. C., 4PP, Principal, Co. H, 120th Infantry, Waynesville, N. C., 4BX, Principal, Hq. and Service Company, 105th Engineers, Charlotte, N. C., 4QH, Alternate, 30th Signal Company, N. C. N. G., Canton, N. C.

5TH CORPS AREA—Army Amateurs work here is coming along FB! Windom, 8GZ, is getting things in shape again. All stations already appointed should drop a card to 8GZ so he can know when and on what wavelength to look for them and arrange schedules. 8BYN, 5th C. A. Army-Amateur Representative, will work in conjunction with 8GZ, by radio and otherwise. AK4, the station of the 37th Signal Corps, O. N. G. will also stand ready to handle A-A traffic out of Columbus at all times.

8TH CORPS AREA—The Signal Office is still working on the nets in Arizona and Colorado. Traffic is being moved over the Governor's nets in Texas, Oklahoma, and New Mexico in fine shape. 8AIN (the C. A. control station) is reaching out in great style keeping a 16-hour daily watch with about twenty operators on duty gladly handling any messages for QSR.

BRITISH COLUMBIA—The British Columbia Amateur Radio Association recently elected c5HB, c5GO, and c5BJ as its officers for the coming year.

CALIFORNIA—The Santa Clara County Amateur Radio Association recently held an election, with the result that 6CSX, 6KG, 6AJZ, and 6CKV will head the club's activities for the coming year. Plans are being discussed for a new club house.

The Whittier Union High School Radio Club held a hamfest and banquet which was attended by about forty-five hams. Talks were given by 6AM, 6BUE, and 6BMA, followed by entertainment by 6BMA, 6ALZ, and 6CHZ. 6ACI, 9ZT and 6EI won prizes.

ILLINOIS—The Chicago Radio Traffic Association held a very enjoyable banquet. 9RK, 9BYD, and 9QD, were on the entertainment committee. A real feed was followed by several interesting talks and some entertainment. The club is now putting out a semi-monthly publication.

The New Trier Radio Club of Wilmette have been having interesting lectures at their meetings. Some trouble has been experienced with the transmitter, but it is hoped that the club will be on the air soon.

LOUISIANA—The Caddo Radio Club held a hamfest for Mr. Hebert, who gave a talk on Headquarters. The club is always glad to welcome any visitors at their clubhouse.

Manitoba—The Winnipeg Radio Traffic Association has been devoting a great deal of energy toward bringing about efficient traffic handling. Talks on amateur radio through CKY are a regular feature. These have brought several hundred inquiries from prospective amateurs.

MICHIGAN—All Southern Michigan and Northern Ohio amateurs are invited to meet at the Midway Music Cafe, Monroe, Mich., Sun. P. M. Jan. 23, 1927 for a hamfest. A \$1.50 dinner will be served at 6:30 p. m. Send your reservations to Dallas Wise, 8CEP, Telephone Cedar 3781-M, Detroit. The Radio Research Club of Detroit and the City of the Straits Radio Club operated a station at the Detroit Radio Show, with the call 8AGR. A 50-watt R. E. L. transmitter was supplied with power from Exide and Burgess batteries. 8MF's Grebe CR-18 was used, and about 200 messages cleared, many through 8SX, 8CEP, and 8FY. Most work was done on a 40-meter wave. A bunch of out of town fellows registered, including 1GL, 8AGO, 8AKW, 8BGN, 8ATP, 8BWR, 8CZO, 8DCL, 8DNI, 8IX, 8XD-NF, 8ZH, 8ZT-AFX, 8CPY-DKC, 9BD, c3FU, c3MW, c3IE, c4AJ, and c4ER. 8FX did some peppey work at the booth, extending the glad hand to visitors. The show management was pleased with the display, and has invited the gang to take a prominent part in the next show.

NEW YORK—About 200 amateurs attended a get-together, with entertainment provided by the Hudson and Staten Radio Clubs. Talks were given by 2CZR, 2ALS, 2GL, and 2CWR, followed by "eats" that were enjoyed by everyone.

OHIO—The Ohio Northern Radio Club has been organized, with ex3BGN, ex8COU, and 8QO as its officers.

At a banquet given by the Fort Hamilton Radio Association, it was decided to install a new transmitter. At the banquet, each member of the club gave a talk, and plenty of good food was to be had.

ONTARIO—The Toronto gang put over an interesting exhibition at the Toronto Radio Show. An interesting picture transmitter built by c8AZ was the most interesting feature. Rather unusual was the running of a telephone magneto as a synchronous motor to revolve the cylinders.

PENNSYLVANIA—The Amateur Transmitters' Association of Western Pennsylvania is working out a new code instruction scheme. FB! The enrollment of the club is increasing very rapidly, and the enrollment is expected to be doubled by the end of next year.

9ASJ says that he has repeatedly heard stations send "SK" and their own call, signing off in accordance with standard practise but immediately thereafter breaking into a long winded CQ instead of tuning completely across the band to see if another station was calling. By listening for stations calling, more stations can be put down in the "WKD" column of the log, and more of the stations who have patiently stood by to clear their book would succeed. The moral pointed out by 9ASJ—SLIDE OVER THE BAND AFTER YOU FINISH WITH EACH STATION.



**TRAFFIC BRIEFS**

Amateurs at Rensselaer Polytechnic Institute (2SZ) are doing some fine work this year in sending complete play by play scores of games played at Troy direct to the station of the other college participating in the game. They have already made a good start, and hope to accomplish a good deal along these lines this year. This scheme is worthy of consideration by other college stations, and cooperation on their part would be greatly appreciated by Rensselaer.

1BEZ was agreeably surprised when he was presented with a new YL operator for his station. Oct. 10 was the big day. Congratulations, OM.

A message to Landskrona, Sweden, starting from 6BYV September 8, travelled via p1IAU, LA 1 X (Norge), and SMUK and was delivered in about 48 hours from filing time. Some route—will somebody please figure out how many miles per hour the message made? Not so bad!!

and be ready for the next evening's traffic. Why not try it for a month and watch the traffic figures grow—especially if schedules with good stations are kept at these hours?

Say, OM, do you realize that when a station sends CQ NEW YORK, the operator wants to work a station in New York state and not one in South Carolina or some other place in an entirely removed location? The directional CQ is a great time-saver in handling traffic when it is properly used. The way it is sometimes used at present, it doesn't mean much more than the well-known "straight" CQ serving principally to separate the good traffic man from the chap who is after nothing but DX QSOs or QSL-cards. Let's use this directional CQ for what it is worth and get the benefits it has to offer, fellows. Also, for the love of good operating, let's sign our calls more frequently when calling. It's impossible to get any operator to listen to you for five minutes to find out who you are. You can make a better impression and just as many QSO's by signing more frequently. More stations than ever will be able to log you and place you on their list of stations operated with good judgment—hence more wall paper will come your way and you will be better known in ham circles than ever. So please use the directional CQ more for pushing traffic and sign frequently when calling and working.

At the Cleveland convention it is reported that S. C. M. Storck of the good old Buckeye State let slip the information that among the recent messages handed by him was a proposal of marriage, which, he adds, was accepted by the young lady in the case! SZE says, "What is this but the STOR (C)K in a new role, that of CUPID?" This is especially significant to the fellows in the Ohio Section of the Communications Department. Better watch out or traffic will be taking a slump. Hi!

1AWQ at North Lovell, Maine, has three 50-watt outfits one working on each of the upper amateur wavelengths bands. 1AWQ regularly carries on a lot of his lumber business and friendly correspondence by radio. Among other things handled, have been messages relayed from Hudson Bay Trading Posts to points nearer their destination. One message even kept a man out of jail!

With an outfit like this that works on ANY amateur band you can make full use of your short-wave privileges and readily QSO whoever you hear, no matter what band he is using. If you haven't but one fifty watt or even one fiver, you can use all bands just the same by making plug-in coils for the transmitter. If this offers difficulties build some flatwound interchangeable coils having the same over-all length or fitted with supports so that each may be mounted the proper distance from the antenna coupling coil. Mark the points where the "best" clip adjustments for each coil and wave-length are found. Then it will be easy to change coils quickly and to find that permanent spot in each wavelength band that you should try to get recognized on everyone's tuning controls as YOUR OWN location on the dial.

Did you ever think of using your set to brush up on a knowledge of foreign languages? Even though English is the business language of the world and will undoubtedly remain in use by radio amateurs in all countries for international communication, it is quite possible to have some interesting times trying to work foreign amateurs in their own language. W9SJ and Mexican IN have a regular schedule for this new and beneficial use of amateur radio. On one night Spanish is used exclusively and on the next night English is used for all conversation. Sometimes it is necessary for MIN to prolong his calls before connecting as 9SJ is troubled with intermittent QRM from the Chicago elevated that runs within a few blocks of his antenna. However, there is seldom any difficulty, once QSO is established.

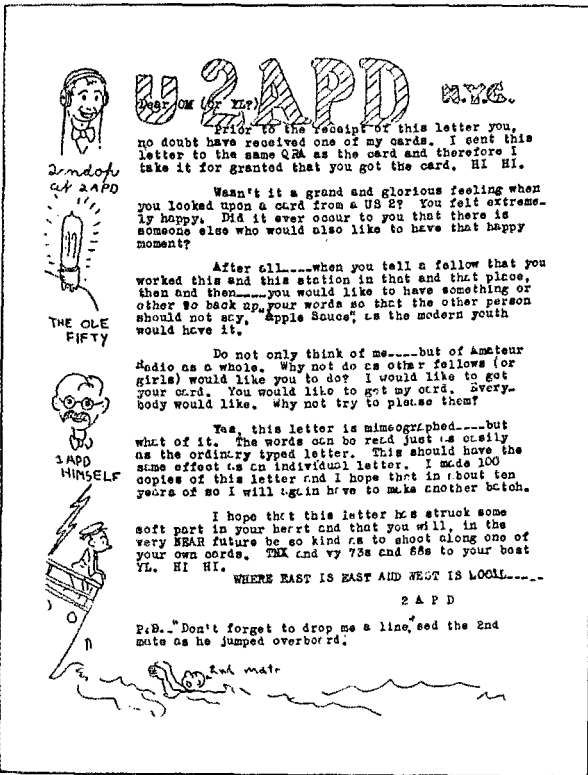

2APD finds a mimeographed letter like the one shown brings him excellent results. If you don't get a good percentage return on the QSL-cards you send out, why not try the same stunt, OM? F.B. 2APD!

Most amateur message traffic is being handled on 80-meters over moderate distances during the early evening hours when interference conditions are rather bad. In the early morning hours and also at noon there are relatively few stations operating on "eighty" despite the fine opportunities for good coast-to-coast traffic work in early morning until well after day-break. Eighty meters is also fine for local message handling over short distances at noontime but the log at 1MK shows that there are fewer stations on at noon than was the case one year ago. The eighty-meter band does not deserve to be left so deserted during the early morning and daylight hours. The lack of QRM is surprising and the "sixes" and "sevens" on eighty meters pound in on the east coast just before day-break as well as ever. Let's make some traffic schedules for this time of day. From five o'clock on in the morning there is a fine chance to clear the hook

The cable-count check is simply the sum of the word count of address, text, and signature. The use of a check on amateur messages is optional but important messages should be checked to insure accuracy. It is a good plan to check messages just for the practice obtained which will come in handy if you some day plan to take out a commercial "ticket."

Though the subject of cable-count check has been covered in back numbers of QST, and is mentioned briefly in the Rules and Regulations of the Communications Department (sent free on request), it is most completely explained with examples in the new A.R. R.L. Handbook, just off the press. The use of the proper Q signal makes it easy to get the right check. QTB? Are you in accord with my check? Please repeat first letter or figure of each counted word. QTB I am not in accord with you in your statement of the number of words. I repeat the first letter or figure of each counted word.

#### WITH THE U. S. N. R.

The first drill in the 3rd Naval District's USNR Communication Division went out Nov. 16 from 1DQ. On the following Tuesday drill No. 2 was successfully conducted. All Reservists in the 3rd Naval District are again urged to get in touch with the Communication Division Commander, USNR, 1711 Park St., Hartford, Conn. and sign up for the drills. Instruction pamphlets are mailed to all participants and when used in connection with the code and cipher reception by radio give a thorough training in Navy Procedure and operations. It is expected that a Naval call will be given the Division Headquarters station soon.

In the 7th Naval District the drills are transmitted from NRRG regularly using both 40 and 81 meters wavelength. Five new radiomen have applied for enrollment and others are in the office. The drill from 1DQ was copied at both NRRG and IBIG. NRRG and other leading stations on the Navy Day Honor Roll (see Dec. QST) have received letters of commendation from the Secretary of the Navy for their good work. The Chief of Naval Operations was incorrectly mentioned in this connection last month.

1BTR, the Amateur Master Control Station at Wellesly, Mass., has been assigned the call NRRA for Naval drill work. He opens up each Tuesday at

8 p. m. on 72.4 meters sending a message broadcast and getting confirmation from each unit commander after which each unit carries on in similar fashion with the stations in each unit area. Stations in the reserve use the regular amateur call and wavelength, adopting naval procedure with drill in tactical work after the several units get under way. Mr. G. C. Barney has been appointed Executive Officer of the new Providence unit and interested amateurs in that vicinity should get in touch with him at 21 Whiting St., Providence, R. I.

A Naval Reserve Communication Division is now being formed in the Sixth Naval District. Lieutenant Harry F. Dobbs, USNR, (4ZA) has been appointed as its Communication Officer. All amateurs interested in Navy work are requested to communicate with him.

Another Naval Reserve Unit is being formed in Modesto, Calif., which is expected to be in operation shortly. Those interested should communicate with Lieutenant Elvyn J. Beall, USNR, (6VY) Box 246, Newman, Calif.

#### NEW A.R.R.L. PINS FOR O.R.S. AND S.C.M.'S

Whoopee! At last we have suitable insignia so that everyone can know everyone else when we meet at hamfests and conventions or when we visit with out-of-town hams.

For a long time there has been a definite need for particular recognition for the different officials and appointees of the Communications Department. The C. M. not long ago took the problem to one of the regular meetings of the League's Executive Committee. After some discussion a motion was passed authorizing special insignia for Communications Department workers. The new pins are provided in two colors—red for Section Managers—blue for Official Relay Station appointees. They bear the design of the standard A.R.R.L. membership pin but the background is red or blue instead of black. All the new pins are about 2/3 the size of the older type of membership pin which is so well-known, making a very neat and attractive appearance and distinguishing the office held at a glance.

The new pins are advertised elsewhere in this issue. Don't forget to include your O.R.S. certificate number when ordering, OM.

## DIVISIONAL REPORTS

### ATLANTIC DIVISION

**E**ASTERN PENNSYLVANIA—SCM, H. M. Wal-  
leze, 8BQ—We have nine in the BPL this  
month. 3ZO, who hit heavy the last few  
months, shut down for an unexplained reason. 3AWT  
claims to be the first BP in the city of Phila. since  
rubber stamp msg's, were canned. FB, 8EU went  
strong and is hard at work lining up scheds. Don't  
write Maneval for skeds with HIM. He has a load  
now, but wants to hear from you in order to line  
you up with someone else. 35% reporting were on  
80 M. and handled 65% of the traffic. 45% on 40  
M., 20% and the balance on both bands.

3ADE made the BPL on 40 again, but worked  
a few skeds on 80, too. 8BFE is back in PRR work  
along with 8EU. 3AIY'S rig perks FB since re-  
tuning. Kenetrons went up for 3BFL. A new  
CC station on 40 belongs to 3ALE and one to  
3CC. 8BRT now signs WKBY on 200 m—b/c stuff.  
3AIG is still QRW at 8XE. 8AVK talks of a MO-PA  
rig now. FB, OM. The gale took 3LM'S stick down.  
8CMO is going to QRO and QSY to 40 (goodbye  
BPL credits, OM). 8BIR and 3NP are busy on  
both bands. 8AVL is revamping his rig. 3HD  
handled stock reports and an insurance deal. The  
St. Louis Radio Show passed 3BIT a load of 'em.  
8CGZ is DXing on 40 and 8Pping on 80. 8RT  
sticks to his good DX on 40 as does 3BUV, 3AY  
and 8CCQ. DX favors 3BLC, he says. A tuned  
grid—tuned grid plate makes 3VF step out. Pan-  
cakes are in favor with 3JN. 8LW delivers his  
pronto. 3ZM still insists that he has good cider on  
tap. (How about a hamfest in Media, gang?)  
Business kept 3PY off a lot. 3BMS is going strong.  
Ex-8AHU of spark fame, is back with c.w. signing  
8AYG. 3BLP is operating his xtal rig remote con-  
trol. The ole set at 3BQP continues to step. School

QRM caused 3QY to request his ORS QSKed. While  
8BSZ made BPL credits, he QSKed all skeds for the  
same reason. Sorry, men, but vacation will come  
some day. 8ADQ works both bands with success,  
made the BPL, rebuilt and moved into a new  
shack. FB, 8BQ lost a haywire antenna. Now  
for a good one! Guess we socked the Pacific gang  
this month. Keep it up, gang! The best wishes  
of the season to all!

Keep your traffic file in shape. Each month I  
call on different stations to produce their traffic  
file (for any or all months from date of issuing  
ORS) for checking. YOU may be next. Don't be  
caught without it—or ZOWIE!—no more ORS!!

Traffic: 8EU 534, 8CMO 223, 8AVK 204, 3ADE  
187, 8ADQ 177, 3AWT 172, 8CGZ 160, 8BSZ 109,  
3LM 101, 3BIT 56, 8BFE 51, 3ZO 39, 8BIR 37, 8BSM  
34, 3HD 31, 3AIY 27, 8QR 25, 8RT 17, 3AIG 16,  
3AUV 16, 3ALE 15, 3VF 14, 3BLP 12, 3AY 10, 3LW  
8, 8BRT 8, 8CW 7, 3NP 7, 8AVL 7, 3BUV 6, 3JN  
6, 3BLC 6, 3PY 5, 3BFL 5, 3BQP 5, 3ZM 3, 8CCQ 2.

**MD-DEL-DIST. OF COLUMBIA—SCM, A. B.**  
Goodall, 3AB—Delaware: No active reports have  
yet been received from the state. Delaware has  
always been a difficult state to work into. Won't  
any stations, ORS or otherwise, in Delaware, drop  
a card to the SCM advising him of activity?

**MARYLAND—3BCK, a YL** in Baltimore, won't  
forsake the A band. If she'd only drop down to the  
80- or 40-meter band once in a while so we could  
meet her. Incidentally, 3AHA has been trying out  
the 200-meter band—results unknown. 3VI was  
heard lately during PRR tests with the same old  
punch. 3ACW is getting out consistently. 3OP is  
still running a spark at sea. 3RF reports just  
celebrating his 210s birthday—one year old. 3BUR  
reports his station ready for duty at last.

District of Columbia—3GP, who was reported last

month as having installed a brilliant layout, is now getting the system into swing and is turning in a lot of traffic work. 3NR is on 40 chiefly and is holding consistent schedule with 8ADE. 3CAB is still pounding away at a high monthly traffic total. 3BWT has a 50 watter going on 175 meters. 3AB is chiefly on 80 meters for schedule work. A single wire horizontal antenna has been added to the vertical rainpout antenna with increase in antenna efficiency. 3CDQ has at last realized her life's ambition, to work Europe and her native land at that.

Traffic: 3BWT 293, 3CAB 181, 3AB 99, 3GP 59, 3NR 29, 3RF 5, 3BUR 1.

SOUTHERN NEW JERSEY—SCM, H. W. Densham, 3EH—3BP, 3DH, 3AIH, 3BCO, 3CB, 3SK, 3CHH, 3AS, 3JW have had their ORS appointments cancelled for failure to report. 3UT, 3SJ and 3IS are now ORS. 3BEI has a brand new junior operator. 3KJ's father is operating now. 3UT is on 80 meters most of the time. 3CPG has made the BPL. 3BWJ is rebuilding. 3XAN has been experimenting with short wave phones.

Merry Xmas to the gang—SCM!  
Traffic: 3CFG 104, 3UT 62, 3BWJ 7, 3KJ 5, 3CO 2, 3BEI 1.

WESTERN PENNSYLVANIA—SCM, G. L. Crossley, 8XE—On the average, the reporting was better this month than it has been for some time. The message totals and the percentage of ORS reporting was a bit higher than last month. Several ORS certificates were cancelled this month because of failure to report, and several for another reason—failure to return the certificate for the SCM's signature within a reasonable time (3 months and after three letters requesting the return). Fellows, I believe there is quite a lack of interest in League affairs when a man can't return the new certificate within two weeks (except in special cases where a man is out of town, etc.). The SCM believes that now he has eliminated all the dead wood from the ORS group and he hopes that all the present ORS will stand by him and report on time every month and at the same time do a little traffic work. These stations are recognized as traffic-handling stations. Then why don't they handle traffic? It is my thought that the stations continually handling only 6 messages and some report 0 and even as much as 10 messages a month are not even attempting to handle traffic or else there is something wrong. Time after time, I receive letters or notes in their reports that they can't find traffic on 40 meters. Why, of course, 40 meters doesn't have near the traffic that 80 has. The moral for you fellows to take is to go to 80 if you can't find it on 40. The SCM is getting weary reporting such low traffic figures and besides it takes no more paper to report all of the ORS in the BPL than it does to report a few as it has been since the SCM has been on the job. Now, gang, let's all remember that traffic-handling is the thing an ORS is supposed to do and get down to business and do it and forget DX until we have handled a little traffic.

3CFT, 8BX and 8BRM report too much work and too little DX but will be on again soon. 3AGO, 3VE, 3CEO, 8BRC and 8XE report PRR work. 3AGO is the Headquarters Army-Amateur station for the 99th Div., USSC. 3CEO is now using the 3rd harmonic on a Marconi type grounded antenna current feed. 8XE is on the air for traffic with 19 operators. 8BRM is again on the air. 8SF says you can't handle traffic on 40 without schedules. 8GK blew his filters. 8ARC has a new sync. 8CWT is selling the present set and putting in a TP-TG. 8CYP and 8AGQ are rebuilding. 8BBL has installed a UV-211-50 watter. 8CKM will be on soon with a 250-watt set. 8AYH is making a few changes in his transmitter. 8BW is having trouble getting his H-tube to work. 8CRK shot his 5-watter so he bought some new ones and is putting in a 7½-watt phone set besides. 8CMH is at college—hence not operating, while 8JW is at college and operating at the Swathmore College station. 8AXD is on 40 and 80 meters and 8AJU is on 41.75 meters.

Take a hint, gang, and put a set on 80 and see how much traffic you can handle and you would be surprised at the traffic in the A band.

Traffic: 8XE 431, 8CWT 131, 8GI 118, 8CEO 102, 3AGO 52, 8BRC 50, 8VE 39, 8AJU 28, 8BBL 26, 8ABW 23, 8SF 18, 8AGQ 17, 8AYH 16, 8CRK 8, 8GK 7, 8ARC 6, 8AXD 6, 8BW 6, 8BW 3, 8CYP 2.

WESTERN NEW YORK—SCM, C. S. Taylor, 8PJ—Well, gang, Western New York is still strong. Any of you who want to try your luck with the U. S. Coast Guard, write your SCM or Mr. Henry Coyle, USCG, New York City, at once. Radio operators are needed but you don't have to have a commercial ticket.

8CNX leads the traffic bunch. 8DNE, 8DHX and

8CNT have also qualified for the BPL. 8DNE has daily schedules with 1BIG, 1AHV and g-5WV. 8DHX handles traffic with Texas and has schedules with 8EU, 1ATJ and 2AFV. 8CNT has quite a record for relay work. 8BHM fell short of a hundred messages. 8AHC handled some traffic. 8AHK handled traffic from 8FCT. 8DNE, 8CDB worked 5FJ and is rebuilding. 8BQR has been heard in Greenland. 8CYB has moved to RD No. 1, Stanley, N. Y. 8ANX handled some traffic, many messages being furnace orders. 8QB handled traffic for PRR with 8BRC. 8CNH is busy with school. 8BCZ has just finished a new transmitter. 8DME also handled some traffic this month—to such an extent that the BCLs were gone to have him arrested. 8AVJ fell short this month with only a few messages. 8BLP has schedules with 8BRD and is an Army net station. 8UL is still at it, pounding out traffic. 8DDL has worked Ship Warrior in Mid-Atlantic. 8ABG wins the Booby prize for handling one message for the month, and it was delivered so it was one, anyway, and 100% perfect. 8ARG worked Alaska and has been heard in Greenland. 8DRJ still works foreigners. 8SD-ex8DPL handled many messages this month. 8APK and 8BMJ are handling traffic. 8HJ has been handling PRR, Army and Navy work. 8CVJ says traffic is dull. Why, OM? 8VW was in NYC and before leaving he handled traffic with 2SC and worked South African 83N. 8AOB is now 8TH and his QRA is 56 Hedley Pl., Buffalo. 8AYB had an awful grouch on this month because his report failed to reach the SCM and thought he'd lose his ORS. He is an old timer, though. 8BBK is now operating WKBW. 8CAN is sore at the gang for not relaying and delivering his messages. What's the matter, boys? 8BFW is a new one at Avoca, N. Y. 8BMJ is another new one out for an A-A appointment. 8ADG handled 7 foreign messages this month. The call 8BZP is reassigned to a new ham in Saratoga Springs, NY, who has become an Army net station. 8DBG has a bunch of bottles on the way.

Now, fellows, don't forget your chance to get in the USCG, as operator. Write Mr. Henry Cocycle or your SCM for details.

Some of the newly appointed broadcast stations have failed to send in a month schedule to HQ of the hours your station is on the air, etc. Please do this.

Traffic: 8CNX 590, 8DNE 266, 8DHX 242, 8CNT 107, 8BHM 78, 8AHC 66, 8SD 55, 8CYB 52, 8BQK 41, 8DRJ 38, 8BCZ 32, 8DME 31, 8APK 27, 8ANX 26, 8DDL 25, 8QB 22, 8UL 21, 8HJ 20, 8VW 18, 8CVJ 18, 8CDB 9, 8CNH 7, 8AVJ 6, 8AHK 4, 8ARG 2, 8BLP 2, 8ABG 1.

#### CENTRAL DIVISION

INDIANA—SCM, D. J. Angus, 9CYQ—9BK is going with 2-50 watters on 76 meters. 9AHB is working all districts on a Ford coil plate supply. 9DHJ is still operating on the Lakes and also reports traffic. 9DJL is working the sixes on 20 meters. 9BSE on 20 and 5 meters, worked TUK and England. 9EF got an R8 report from the Pacific coast using 300 watts on a fivev. 9AMI is in a hospital just outside of South Bend. 9ASX is collecting the South Bend reports temporarily. 9BB's outfit works fine when worked. He is at Purdue most of the time. 9OG occasionally shoots. We miss his regular sigs. 9ASX works them all with a 201-A on 40 meters. 9DLM, a new ham, worked NZ and fell off the chair. 9AUX using a 7½-watt and kenotrons is strong on both coasts. 9TL, ex 8AXR, is rebuilding. 9BEI is a new station in the Music Shop at Elkhart operated by 9ABP. 9ABP has a new layout using a 50. 9DHM is on all the time with a 50 and kenotrons on 80. 9BQH blew his new 50 watter when it was only 5 minutes old so is back to the 7½-watt now. 9ASN is now on the road with the Miami lucky seven orchestra. 9DVE also pounds Morse for NYC. 9CEM is now a fireman and says that he is going to put up a ham outfit at the fire brigade's headquarters. 9AIV is working a 5-watter to death. 9BYI is only using 50 watts on his 50-watt because it recently had a stroke of paralysis. 9CP is going good on 20 and 40. 9QR makes meters when not operating. 9DRS is moving so can't report for a couple of months. 9CNC is building a 100-watt BC station. 9BZP sold out to get cash for YLs theater tickets. 9DPI is now building a crystal set. 9AZG is on fone now and says 80-meter fists are too fast for him. 9WO is back on the air again. 9BCM is on both 40 and 80 and wants schedules. 9EBW is the only surviving ham in Evansville. YLs are vicious there. 9GO is just getting started

in Evansville. 9CMJ is changing over to Hertz antenna and expects great things. 9DDZ has ordered an H-tube. 9AXO is going strong at Terre Haute and collecting the reports there for the SCM. 9ES and 9DUC are operating the BC station at Rose Polytech. 9CPI had his call changed to 9BBL. 9EDT is on regularly now. 9DKE is starting up with a new 50-watt outfit this month. 9BJR is going strong on 80 with a 50 watter. 9AIN has a new generator. 9AYO on 40 meters, reports good QSO. 9ABW is setting up for 40-meter operation. 9ADJ worked Chicago with a 201-A and an amplifying transformer for plate supply. 9EJU works on 179 and 80 meters. The SCM wants all stations that feel that they can hold down an ORS appointment to apply at once. Help your state by increasing your radio activity!!! 9BKJ is having trouble with a once-ham.

month whether you handle any messages or not. Stations wishing to secure ORS appointments should report to the SCM regularly.

9AAE has been operating 9NV, the Armour Institute station. 9AAW has been experimenting with crystal control. 9AFB is using a Hertz. 9AFF is handling all the Army work through Chicago keeping schedules with stations in Wisconsin, Nebraska, Ohio, Michigan, Mass. and Connecticut. 9AGG is fixing his transmitter for remote control. 9AHJ is starting up on 150 meters. Let's keep him company, gang. 9AJM worked South Africa. 9ALJ has two 250 watters and is going strong. Write 9ALK for schedules. He'll take all you can give him. 9APY worked f-8YOR and has schedules with 2CC, 9SJ, 9BKJ and 5ANL. 9AYB has an H-tube going. 9UB, 9BBA and 9CWC have rebuilt. 9BIZ found that use of the Armstrong circuit gives a steady signal. 9CYN, 9CIA, 9ARM and 9EHM are not on a great deal. 9BHT is getting some new tubes. 9BPX reports 9BNX opening up in Canton. He is also teaching a bunch of new hams the art of radio communication. 9BRX is ready for traffic. 9BTX made the BPL. It is reported he had to buy a new hat. 9BVP worked JXIA. 9BWL had difficulty making a Hertz work on 40. Better read QST, OM. 9CCR and 9CCZ are new hams opening up in Cicero and Chicago. 9DQR and 9CNB are pounding brass again. 9CEH is on 80 meters and has schedules with 8EVK and 9AYK. 9CMX, 9BOA, 9AIF are the operators of 9CL, the transmitter at Crane Technical High School. 9BFP and 5ASD are attending the Junior College. 9ASB worked f8YOR and is keeping schedules with 9DWN, 9MI, 8DKX and 9CVE. 9CXC worked South Africa. 9DXG, 9BDI and 9DGA are attending college. 9DLG has a schedule with 9QD. 9DXZ is trying crystal control. 9DYD keeps schedule with 3EEL and 7IF. His UX-210 is working well. 9DZR is on 80 meters. 9EHK is on both 40 and 80 meters. 9EHZ is using crystal control. 8IX is going out of operation. Hope to see you in again next month, OM. We need your traffic report to boost the Illinois section. The Chicago Fire Dept. came with its hook and ladder and hoisted a rope through the 80 foot mast pulley at 9NV without much difficulty. 9QD is handling a lot of traffic. 9RK is working a mercury arc rectifier. 9SK hasn't found much foreign DX.

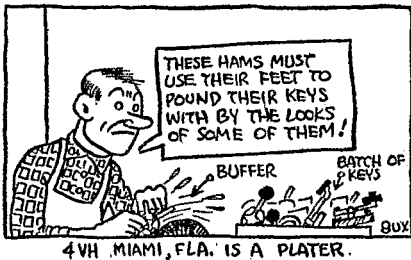

9ASJ has a new dynamotor that QRMs some of the neighboring BC sets. 9CLO, another new ORS, is handling PRR now. 9CRV has finished school and works at an architect's so has more time for radio. 9DSC is on all the time on 80 meters. 9EJI is still doing the DX here. 9CBT is going good on 80. 9APG is going good on 80 and taking a hand at teaching the code for the code school. 9AXH has trained his fist and now gets reported R3 by 6's. 9DJX is working at WBBZ BC station. 9CJQ is now using d.c. m.g. 9ALH says that he gets R3 reports anywhere. 9CLO is working both 40 and 80 now.

Traffic: 9BJR 110, 9CMJ 12, 9EBW 39, 9BCM 23, 9CNC 18, 9EJU 12, 9AIN 19, 9AYO 18, 9ABW 7, 9ADJ 1, 9DDZ 21, 9AXO 8, 9DRS 1, 9QR 6, 9ASJ 72, 9CRV 37, 9DSC 30, 9EJI 30, 9CBT 24, 9APG 16, 9AXH 8, 9DJX 4, 9CJQ 8, 9ALH 2, 9CLO 2, 9BK 4, 9BBJ 10, 9DHJ 9, 9ASX 25, 9DUZ 41, 9AUX 9, 9BQH 11, 9AEB 7, 9DHM 6, 9BYI 8, 9CYQ 26, 9DPJ 24, 9BKJ 21.

KENTUCKY—SCM, D. A. Downard, 9ARU—9DTU and 9BWJ are new ORS. 9ABR, our Route Manager, paid the SCM a brief visit recently. Get in touch with 9ABR, 208 Carr St., Fulton Ky., and give him all the dope you have on your wave, schedules, etc. 9A1M is keeping several schedules. 9OX is working the 6th and 7th districts on 80 meters. 9BWJ says he will be in the BPL next month. Go to it, OM! 9MN is QRW getting WLAP to perk. 9CVR is still on 40 meters. 9DVI is a new one at Mayfield using an H tube. 9LH is back on 40-80 meters. The U. of K. at Lexington is back on the air again. This sounds like old times! 9ATV and 9CRJ live next door to each other! Why don't you consolidate, OM? 9EIP is QRW with school. 9EP left for a trip through the south and will visit South American and Panama. 9BPB got married (I'll tell you like they told me, 'OM—teach her to be second op—or first—at 9BPB') 9EI is getting out on his new crystal control. 9CIS says he is moving from 40 to 80. QRM, OM? 9CSO is back on the air on 80. 9BIQ is home from Boston and is getting started again on 40. 9BCL (why don't you get that call changed, OM) is keeping a couple of men busy digging graves for the tubes passing out at his station. 9BMH is a new one at Irvine. 9ARU paid 5UK, SCM La., a visit on Thanksgiving.

Traffic: 9OX 58, 9ATV 40, 9BWJ 36, 9ABR 27, 9DTU 21, 9ALM 19, 9BAZ 14.

ILLINOIS—SCM, W. E. Schweitzer, 9AAW—With winter coming on, traffic is again moving well. All stations should report to the SCM, promptly on the 26th of each month, so the report will reach Headquarters in time for next QST. Many new stations are handling traffic. I am sorry to find on checking up that many Illinois ORS will lose certificates soon for not reporting regularly. Be sure and report every

Traffic: 9IX 352, 9AGG 261, 9DXZ 161, 9BTX 110, 9APY 104, 9AFB 102, 9QD 81, 9CEH 81, 9CSB 61, 9BWL 58, 9DYD 51, 9AFF 45, 9DOX 40, 9UB 36, 9NV 29, 9CIA 26, 9ALK 25, 9DGA 22, 9RK 19, 9CZX 18, 9DXG 17, 9EIN 16, 9CNB 14, 9BVP 13, 9SK 13, 9AAE 12, 9BIZ 8, 9EPX 8, 9ALJ 7, 9CYN 7, 9EHK 7, 9BBA 7, 9AAW 7, 9DQR 6, 9CXC 6, 9CWC 6, 9DLG 6, 9BHM 5, 9DZR 4, 9ELR 2, 9AJM 1.

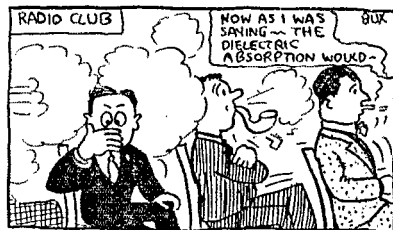

MICHIGAN—SCM, C. E. Darr, 8ZZ—8CCM is on with B-battery plate supply. 9ANT wants to put the northern peninsula back on the map. Come in and help him, gang. He says 9EAY is a true League member, having started 9CSI and 9ANT on the air. 8CQG does most of his work on low power with B-battery supply. 8JG is on the air again. He is just married and is teaching the wife the code already. 9CFQ will be on after Xmas with a 500-cycle plate supply to a 250-watter. 8ZF is also on the air again. 8AUB has been getting after delinquent report stations and they are coming thru OK now. Fine work, OM. He is working on 40 and 80 meters. 8CWK, 8WO, 8ZZ are crystal controlled now and other stations are going to install them soon.

Traffic: 8SX 133, 8CQG 124, 8AUB 51, 8CCM 22, 8CPM 22, 8ZZ 13, 8DAG 15, 8CWK 12, 9CE 12, 9ANT 7, 8KN 6, 8JG 4.

OHIO—SCM, H. C. Storek, 8BYN—8AVX comes thru and takes honors this month, for Ohio at least.

SAVB also turned in a nice total. FB1 8BVR woke up and came on the air after an absence of two years. 8AKO is just turning the corner for an ORS. 8CQU keeps schedules. 8DSY worked hard to get more than 40 and was heartbroken when he only landed 38. 8CAU has been rebuilt and is on with Xtal control. 8CPQ is on 80 with 10 watts and with 250, and wants anyone who wants schedules to drop him a card. 8BSA, a faithful ORS, has moved to Detroit, to take up the game there. Sure sorry to lose you, OM, and hope you get along fine. 8RJ turns in a nice total but never says anything about himself. Hi. 8SI is doing good relay work on a UV-201. 8AOE has a new transmitter. 8DIA is keeping regular schedules and promises to blossom out as a real relay station if he keeps it up. 8ANM is still waiting for his new 210. 8AYO is now on with a 50-watter. 8DMX rebuilt and is now out for traffic. 8GZ says traffic is getting less and less but there are quite a few stations on 20 meters now. 8BFA, 8COB, and 8CMB, the Three Musketeers, have taken several more comrades-in-arms unto themselves, namely, 8CHZ and 8BQF. All are on the air. 8CMB says that 8CHZ rolled a 250 off the table onto the floor at his house but that it still works and now they call the bottle "Hercules". Hi. 8BNW came thru with his first report towards an ORS. 8BSC is on 40 and 80. 8AEU is on 40, 80 and 180 and keeps a flock of schedules. 8BF was a DX bug the last month. 8CLR can't do much because of power leak trouble. 8PL is another of the old-timers who can't seem to find any traffic. 8BKM bought a Lizzie and his total dropped. Hi. 8DQZ has tried every type of antenna known and can't get out. Old 8DFC comes back with us again. 8ADH is QRW school. 8AWX went back up to 80 so he could get away from DX and handle traffic. 8CBI has been busy with the YLs but promises to be on regularly. 8AHH is very busy with school work and can't seem to QSO east, so he has plenty of trouble on hand. 8DHS is rebuilding. 8BCE wants another op. 8RY at 2EP says for you fellows to help out 8DEF all you can, because he is going to make a good relay man. 8AZU is still waiting for another 50. 8BOP has local QRM from carpenters and can't work his set until the house is finished. 8DRX is another who can't seem

on 20 meters. Regular schedules are kept. 9BIB, 9AZN, 9DCX report a good bit of traffic. 9BPW applied for an ORS certificate. 9BWO was QSO Tasmanian 7GH. 9EHM has a new set, and plans to drop to 20 meters soon. 9AGV reports traffic scarce on 40 meters. He works a schedule with 9AXX. 9EGW says two new hams will be on shortly from Beloit. 9COI is on more often now that the football season is over. 9EEM lost his "fiver". 9CDT has a new crystal. 9SA is installing a "fifty". 9BJY and 9EAN have not been on much this month. 9DLD is doing fine work and had a bunch of schedules. At present, however, his only schedule is with 9DTK.

Traffic: 9DTK 334, 9EK-XH 246, 9BIB 75, 9DLD 71, 9AZN 43, 9BPW 33, 9BWO 20, 9EHM 18, 9EGW 8, 9SA 8, 9AGV 7, 9COI 5, 9EEM 3, 9CDT 2, 9EAN 2.

### DAKOTA DIVISION

**N**ORTH DAKOTA—SCM, G. R. Moir, 9EFN—9DKQ has two separate master oscillators working on 40 and 80 meters. 9BJV helped xc55 get QSO 2UO. He does most of his work on 40 meters. 9EFN is repairman for the Radio Equipment Corp. and is kept pretty busy these days but works both coasts once in a while on 40 meters.

Traffic: 9BJV 4, 9DKQ 1.

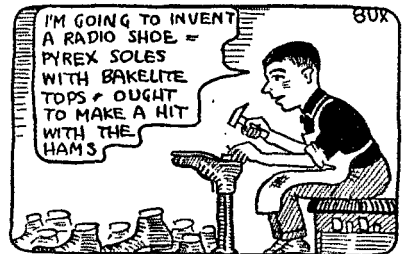

CAN. JMS POUNDS NAILS IN A SHOE FACTORY WHILE NOT POUNDING BRASS



5BX, DALLAS, IS A COLLEGE SOPH AND A DX FIEND AT THE SAME TIME

to get out on 40 meters. He says he's going back to 80. 8KC has been too QRW to be on and 8DEM is very QRW with school work. He has one advantage, tho—he pounds brass at O. S. U. Radio Club station, 8CSV.

The SCM fell at last and is now the proud possessor of a 250-watt ether-buster and working in spare moments and burning the midnight-electricity, has finally rebuilt the set to accommodate it.

The reports are rolling in here regularly, and many of them. The SCM wishes to thank the loyal ORS for their whole-hearted support, renews his promises of his support and wishes one and all of his OHIO GANG a Happy, Prosperous and FB New Year, radio and otherwise.

Traffic: 8AVX 344, 8AVB 217, 8BVR 135, 8AKO 130, 8CQU 62, 8DSY 38, 8CAU 34, 8CPQ 31, 8BSA 27, 8RJ 26, 8SI 21, 8AOE 18, 8DIA 18, 8ANM 16, 8AYO 10, 8DMX 10, 8GZ 10, 8CMB 10, 8BNW 8, 8BSC 8, 8AEU 8, 8BF 7, 8CLR 6, 8PL 5, 8APZ 4, 8BKM 4, 8DQZ 3, 8DCF 3, 8ADH 3, 8AWX 2, 8CBI 2, 8BKQ 2, 8AHH 1.

WISCONSIN—SCM, C. N. Crapo, 9VD—9DTK has lined up a route map connecting Milwaukee with Madison, LaCrosse, Akron, Chicago and the East, using daily schedules. 9EK-XH, and 4DM are going

**N**ORTHERN MINNESOTA—SCM, C. L. Barker, 9EGU—9APF is giving the tuned plate tuned grid circuit a tryout. 9BXM is not going very heavy, he's waiting for his crystal as others of us are. Hi. 9DKR works out well in the States but says he has to rebuild his wavemeter. 9EHO works on both 40 and 80 meters and is now going full blast. 9KV complains of transmitter trouble, but promises hot activity. 9ADF changed to Kenotrons on his 50-watter. 9CKI built two new transmitters and neither of them worked. Hi. 9DUV brought back a nice doe the first day of deer hunting season and finds a UX-210 much better than the old 202. 9CWA visited several southern Minn. hams and says that they are real good sports. 9BMR found a way to tune his transmitter with a yard stick and gets out much better. Hi! 9CTW keeps schedules with 9CWA, 9EHO and 9CUW on 40 and 80 meters. 9EGU keeps three regular daily schedules, showing a good increase in traffic. He is the first 9 to work J-1TS.

Traffic: 9EGU 74, 9CTW 27, 9BMR 26, 9EEP 24, 9CWA 23, 9DUV 18, 9CKI 12, 9ADF 10, 9KV 10, 9EHO 7, 9DKR 5, 9BXM 3.

**S**OUTHERN MINNESOTA—SCM, C. L. Barker, 9EGU—9XI is going full blast again with a staff of 24 operators—keeping all night watch. 9IG and 9NF moved in from Lake Minnetonka and is going strong. 9CAJ works on 20-, 40-, 80- and the 150-200 meter bands, using fone occasionally on 170 meters. 9CFM lost his jug so is on with low power for the time being. 9DGE reports having the new call of 9ZT, a 250-watter, and a good staff of operators. 9BYA was too busy to be on the air much. 9BKX reports that his large transmitter is ready and has ex-9BBF with him again this winter. 9DHP keeps schedules with 9CDE, 8CLP and 5ADO. 9DZA changed his location and also got his blue ticket when the RI was in the southern part of the state. 9BHZ is on occasionally. 9DWO is busy working at 9WI for the standard frequency transmissions. 9COS has a new tube and a DC note, and 100 watts input with a completely rewired set. 9AIR keeps up his old pace. 9DMA attends the U. of Minnesota and is on only when he gets home. All active Southern Minn.

stations should report to the new SCM, Mr. D. F. Cottam, 5538 Third Ave. So., Minneapolis, Minn., on Dec. 26th.

Traffic: 9XI 73, 9DBW 54, 9IG 52, 9CAJ 49, 9CPM 36, 9DGE 8, 9BYA 8, 9DEQ 7, 9BKK 4, 9DHP 4, 9DZA 4, 9GH 2, 9BHZ 1, 9DWO 1, 9COS 1.

**SOUTH DAKOTA**—SCM, F. J. Beck, 9BDW—9BDW is high traffic man again. He does most of his work on 80 meters which is becoming very popular with the gang. 9DGE, 9DBZ and 9DKL are working on the state convention. 9DBZ lost his fifty and is misusing a 201A. 9ALN works Mexicans regularly. 9DB-9DDW works on all bands. 9CKD and 9CJS run

Charleston on 80 meters. 4FI is an old commercial op back in the game. 4DK also wants an ORS. 4CU had an accident on his motorcycle and is in the hospital with a leg broken in four places. 4KM shot two 100-volt Esco generators, and has a 2000-volt, 1 1/4-k.w. on the way to fill in.

Traffic: 4HL 14, 4FA 14, 4FD 5, 4KM 32.

**MISSISSIPPI**—SCM, J. W. Gullett, 5AKP—5QQ and 5ANP have applied for ORS certificates. They are on 80 meters. 5FQ and 5AKP are doing fine work in relaying messages. 5QZ applied for an ORS certificate for the 80-meter band. 5ALZ-5ARB is off the air due to his YL and school work. Watch your step, gang! The SCM is going to cancel two ORS soon.

Traffic: 5AKP 48, 5ANP 30, 5API 26, 5QZ 24, 5AGS 12, 5AQU 2.

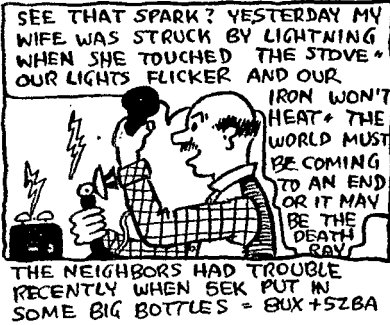

### HUDSON DIVISION

**NEW YORK CITY AND LONG ISLAND**—SCM, F. H. Mardon, 2CWR—As many know, the new ORS certificates are now being issued. As a warning to all, did you notice what action the SCM of Eastern New York took last month? Keep on your guard for the same thing is going to happen here in this Section to ORS appointees who remain inactive. The RMs are doing all in their power to get interborough relay routes going. What say, fellows? Let's go! Cooperate with your RM. ORS in the five boroughs who fail to cooperate with the RM will have their appointment cancelled. I consider failure to help the RM lack of interest and don't want any disinterested ORS in this Section. In the future ORS certificates will be delivered to prospective appointees at either the Hudson Division or E. R. C. meeting each month.

Bronx: 2ALP did some fine 20 meters work. 2AWU, a new reporting station, made a good start. 2BBX still holds his own on low power.

Brooklyn: 2CRB is now on 75 meters for traffic, also on 40. Says DX is pretty good. 2BO is now using crystal-controlled UX-200 feeding a UV-203-A. 2PF is busy with Army-Amateur Radio. 2APD is putting in kenotron 50s and says everything is FB. 2AVR had his set at the Brooklyn Radio Show under the call 2AZT and handled a lot of traffic there. 2BRB has a key in R.F. feeder with excellent results—even the family can listen to BC without any clicks. FB.

Staten Island: 2AKR is busy keeping schedules. 2ABO is using a 201A turned in a real traffic report. He will make some of the higher power stations step on it. Congrats, OM. 2AKK is using two 5 watters on 40 and 80 meters. Wow, take a look at 2AFV's traffic reports this month. I don't need to say anything that speaks for itself. Congrats, Roberts. 2ATQ is with us doing fine work. Keep it up, OM.

Long Island: AWX is sure letting the world know he is alive—has been three months in the BPL. Keep it up! 2ABF reported direct to HQ with some total. Lizzie and QRW traffic now, she says. FBI 2AVB's transmitter had some feedback in power lines but is going OK now. 2AYJ is QRW school but pounds brass nights between 5 and 7 p. m. 2AAS worked his first 5 and 6 and got a good kick. 2BSL is installing tubes instead of slopiars for rectifiers and will be on regularly soon. 2WH put up an 80 ft. mast a la QST—watch his speed. 2AJE was laid up with a football injury—the reason for the big traffic jump. Hope all's well now. OM. 2CLG is an Army station, and very QRW with work. 2GY is doing good work. 2BDI is on an oil tanker bound for Texas. 2AXI put a T in front of his call and now he is an auto op instead of a radio Op.

Manhattan: 2ANX is eligible for the BPL—for a new Op he is a wow. 2BCB finds time to pound brass and turn in good totals. 2LD is doing fine. 2BNL needs no introduction—Wilbur is always there. 2LM has about seven hams within two blocks of him but manages to get out well. 2AIS uses crystal control on 20, 40 and 80 meters with a 50 watt. 2KR just got back from Calif. and is going strong. 2ALL is getting a mercury arc rectifier going. 2EV is very QRW work and expects to remain so for another month.

Traffic: Manhattan: 2ALL 33, 2KR 14, 2LD 12,

2ANX 134, 2BCB 162, 2EV 10, 2BNL 18, 2LM 18, 2ALS 18, 2ALP 36, 2AWU 34, 2BBX 48. Brooklyn: 2CRB 55, 2AVR 80, 2BO 58, 2PF 12, 2APD 17. Richmond: 2AFV 391, 2ATQ 10, 2AKR 25, 2ABO 19, 2AKK 5. Long Island: 2AUL 36, 2AAS 9, 2BSL 2, 2WH 2, 2AJE 115, 2CLG 27, 2ABF 71 (portable) 2ADG 19, 2AWX 155, 2GY 2, 2AVB 10, 2AYJ 4, 2ABF 160. Additional Brooklyn Traffic: 2BRB 26.

broadcasting stations. 9BRF has a crystal controlled transmitter going. 9TI has a new receiver and transmitter. 9DID is collecting storage B's for a low power set. 9ACL is again on 80 with crystal control. 9DIY says his 203 is no more. 9DNS is putting in more power. 9DZL is holding his annual sale of transmitter. 9BKB has a new QRA. 9CNK has a mercury arc rectifier. 9NM's OW wants to go to the convention. 9AZR is still waiting for parts for new set. 9DAJ is editor of the "S. Dak. QRM". 9DXR is busy putting up a broadcasting station.

Traffic: 9DWN 194, 9DGR 103, 9ALN 39, 9DB 27, 9DBZ 17, 9CJS 10, 9BBF 6.

### DELTA DIVISION

**LOUISIANA**—SCM, C. A. Freitag, 5UK—5NJ, 5RH and 5LA (ex5ABH) are on the air again with some good signals. 5QJ reports best results from the Zeppelin type antenna. 5LA insists on loading a poor little fiver with 750 volts plate juice and filament supply 9 to 10 volts. He is consistent in burning up tubes. 5AGJ is using an E-tube on 80 meters. 5ML has sold his low-power set and is going on the 80-meter band with 150 watts c. w., i.e.w and fone. 5EB is installing a filter system with "S" tubes with 750 volts on a UV-203-A. Weather conditions have improved somewhat in this Section, but foreign stations are not coming through. It is seldom we hear from Europe. Traffic: 5ANC 86, 5UK 54, 5NJ 40, 5QJ 31, 5EB 13, 5ML 12, 5LA 10, 5RH 5.



**TENNESSEE**—SCM, L. K. Rush, 4KM—At last someone has come to life in Middle and East. Tenn. and ARE ACTIVE. Some of the ORS are lagging and the axe will be used again if these reports do not show up. Our Director came through Memphis and the SCM and several hams met him and had a few hours of ragchewing and settled several points. 4HL suffered from school and football QRM. 4FA works the Aussies. FB. 4FD is a new station at

**NORTHERN NEW JERSEY—SCM, A. G. Wester, 2WR**—All ORS in Northern New Jersey will receive their new certificates in January and there will be some old timers who will not receive same as their reports have been unsatisfactory to warrant an ORS. There will also be certificates issued to new stations who have been reporting each month. 2AZU has had his call changed to 2ADL. He intends to visit the Washington gang during Xmas.



2BQQ has been QSO f8SSW. 2ALM has just completed a new receiver. 2AVK lost a mast during a gale which dented his neighbor's roof. 2KA is off due to blown bulbs. 2BW reports his crystal control now perking better than ever. 2ABE is another "off due to blown tubes." 2ANQ has deserted the ham ranks to become a BCL. Hi. 2DY has the motto "Where the WJZ Bunch Hang Out." Their fine station was QSO 166 stations for the month. FB. 2ADU is back from college and is heard daily. 2CP is handling considerable traffic for the Army. 2FC has no trouble in working all stations with his new Hertz. 2ASZ is one of the busiest hams in Asbury Park. 2IS has received his ORS certificate. 2CGK has installed a new aerial and counterpoise. 2AT is all set for a good winter with a fine transmitter. 2CW is experimenting with an indoor Hertz. 2FG has had fine results with his indoor Hertz. 2CTQ has remote controlled his transmitter. 2GV is handling the bulk of Army work while the new set at 2WR is getting QRV. 2WR has installed a 50 and a self-supporting mast and will be jamming the ether by the first of January. 2CDS has just returned from Chile. He was operator on KJEU plying between NY and Chile. 2AER has been doing too much experimenting which keeps his traffic figures low. 2QI is planning to build everything on a neat panel with hopes that the same will work.

Traffic: 2ADL 31, 2BQZ 2, 2ALM 48, 2AVK 11, 2KA 2, 2BW 5, 2ANB 7, 2DY 54, 2CP 84, 2FC 5, 2IS 54, 2AT 204, 2CW 34, 2CTQ 51, 2GV 18, 2AER 11, 2QI 2.

**EASTERN NEW YORK—SCM, Earle Peacox, 2ADH**—"Much Ado About Nothing." That's the trouble with this Section. The SCM is thru talking about this section thru a three-stage power amplifier. The truth is that the E. N. Y. hams are dead from the shoulders down when it comes to brass pounding. Reasons vary: DX, YXr9, QRW and many other reasons. Active stations are so few and YLs so numerous that little better can be expected. 2QU is one exception. He kept four daily schedules and makes the BPL. FB. 2ASE has honestly acquired a fifty water. 2UF has been changing QRA, hence the poor total. 2CYM has been taking things easy on the air (QRW elsewhere as usual). 2ANV wonders where his ORS is. He has a schedule with 1AWQ. 8DFI is at RPT signing 2AHJ on a fifty. Welcome, OM. 2AML QSYd to 40 on account of the QRM to BCLs on 80. 2BM has been sending his reports to 2PV. Hw? 2PV has a prayer meeting with c-3BL every Sun. A.M. 2BOW has gone to the how-owns. He blew a WE 50, UX-210, two UV-202s, four UV-216s, and then he turned the air blue. Wow! 2ANM is little KFUW with 60 cycles. Just a few Aussies, that's all. 2CTH-2ACX knocked down a few foreigners and is trying 20 meters. 2SZ sent another play-by-play

score of a football game to Clarkson College thru 8UF. Lots of DX, too. 2LA got in on a 24-hour Calif. to Ct. relay. 2DD is on regularly at last. He has not received any cards from Siberia yet. 2CYH reports little exercise for his crystal set. 2ADH is not using a crystal transmitter contrary to reports received. 2AGQ was down to the A.R.R.L. meeting. FB, OM. 2AG was laid up with the grip but ran a remote control line to the transmitter. 2CTF's mast blew down but they threw a hamfest and now its up again. 2ANN has a new fifty. (Still good at this writing). 2CUZ-4UG expects to get a set going soon. 2CNS worked a YL but didn't know it till she QSLd. Call letters upon request. 2APT is sorely missed. He says Florida is the place for him. Wish you luck, OM.

Traffic: 2QU 185, 2ADH 91, 2ASE 68, 2UF 57, 2CYM 50, 2AHJ 31, 2AML 30, 2BM 15, 2PV 9, 2BOW 9, 2ANM 8, 2STH 4, 2SZ 4, 2LA 12, 2DD 1.

**MIDWEST DIVISION**

**NEBRASKA—SCM, C. B. Diehl, 9BYG—9DXY** reports good traffic and 21 schedules per week. 9AL and 9AWS are busy with Army work. 9EEW says he is too busy to devote much time to radio. 9DFR is experimenting with QSB. 9BYG is still standing by. 9EHW is rebuilding and almost stumped with MO-PA. 9ASD is hitting the breeze with army work. 9ROQ is anxious for schedules. 9CGQ reports business light. 9DEC has a good report and asked for more schedules. 9DUH is at it again and turned in a good report. 9BBS is busy with railroad work and also rebuilding to get more wallop out of his 199 (hi). 9AGD is still poking out beautifully. 9BQR is coming to life for winter's work. 9EBL is at it worse than ever. FB. 9CJT is rebuilding. 9DUO will be back with us again soon.

Report of Chief Route Manager—Traffic is moving very nicely and all stations are working smoothly, only



regret that we cannot get more schedules in adjoining sections as our men are anxious for schedules in all four directions. Anything in regard to this will be gladly received. Action is desired—Not schedules enough to fill orders now on file.

Chatter—Neilson is rebuilding. Cox says he hasn't time to be on his station as business prevents. Badgerow says he is radiating 15 amps in his Army work. Henry is tinkering with filters and expects to have a much improved note before he is done. Crozier has trouble with the power amplifier of his master-oscillator, it wants to oscillate along with the oscillator. Williams is sure hitting the breeze with his National Guard Net and is making things hum. Magnuson is ready for traffic. Jones is just handling traffic. Larimore is very busy on his railroad. Stillinger is sure walking out with his xmitter. Chesley works army schedules mostly. Clim Cumminnig sure is knocking 'em this month. 9EW is very busy. 9BFG says that he is QRT for a while.

Traffic: 9DXY 290, 9EBL 73, 9AGD 41, 9ASD 36, 9DUH 26, 9DEC 27, 9DFR 25, 9BBS 16, 9AL 15, 9EEW 10, 9BOQ 10, 9BYG 4, 9AWS 4, 9CGQ 4, 9BQR 3.



IOWA—SCM, A. W. Kruse, 9BKV—Greetings to all! First of all, I want to thank all the fellows for their fine cooperation in reporting on time. FB. November finds Iowa well organized with routes and schedules. Mr. B.E. McElwain, 9CZC, Blencoe, Iowa has been appointed Chief Route Manager to fill the vacancy caused by 9BKV's resignation as CRM. Give him your hearty cooperation, fellows, and he will appreciate it. More good stations are wanted on the routes. Better write him and get lined up.

More ORS are wanted and also reports from active non-ORS. Write the SCM if interested. Mr. Huber notched the axe up a bit, but I have it all sharpened up again and ready for those lagging ORS, so WATCH YOUR STEP, OM! The 80-meter stations handled 65% of the traffic, the 40-meter stations trailed with about 30%, and the rest on the other two bands. Your SCM is on the air every night on 75.5 meters and will be glad to QSO anytime, and don't be afraid to write letters.

9BKV leads the Section in traffic handling: 9CZC follows a close second. 9BWN keeps Des Moines on the map. FB. 9DAU says traffic nil on 40 meters and is coming up to 80. 9CGY and 9AED keep traffic moving on schedule. 9BPF is busy at college, but manages to handle traffic on week ends. 9CS moves traffic with the old spark. 9EGS finally came to life and moved a few. 9DMS is QRW with KOIL. 9DSL is busy teaching school but finds time to move some traffic. 9AAD blew his generator so no traffic. Look at our list in the BPL, OMS, and then get busy.

Traffic: 9BKV 183, 9CZC 172, 9BWN 112, 9DAU 41, 9CGY 89, 9AED 37, 9BPF 22, 9CS 18, 9EGS 12, 9DTZ 12, 9DSL 10.

KANSAS—SCM, F. S. McKeever, 9DNG—9CET leads in traffic and has done excellent DX work. Several of the Topeka gang lack only Asia to get in the WAC club. 9DEK keeps several schedules. 9AEK is doing good work as OBS and was the leading 9 in the African tests. 9DNG has been keeping schedule with KXIB in the Atlantic. 9CKV is on both 40 and 80 meters. 9BDQ and 9CVL are attending college. 9BGX is the new RM for Kansas. He is on 89 meters. 9BHR has changed his QRA. 9LN and 9CLR are on regularly. 9AVM and 9AEY are handling a goodly number of messages. 9CV worked A-C-H-Z and Y.

MISSOURI—SCM, L. B. Laizure, 9RR—9BEQ leads in traffic this month, followed by 9DOE, both on 40 meters. 9DLB worked schedule with 5ANC on 80 meters. 9DUD was QSO with bi-2ZZ. 9AAU-ZK is back on the air again with a new shack and transmitter. 9AAU and 9DOE are pushing PRR. 9CRM reports being BCL, but may return to 80 meters soon. 9CDF is busy at school. 9DKG on 77 meters kept schedule with 5ANP. 9DMT, on 79 meters handles traffic regularly with both coasts. 9DIX reports job QRM and trouble in raising anyone. 5GG and 9EBV will operate 9DIX Xmas. 9AQB is moved to new local QRA. 9DJI is working for 9AQB selling BCL sets. 9BGO is a new ham in Carthage. 9AYK has a good month for traffic, keeping schedules with 9DVF, 9AED, 9CEH and c3NJ. 9DVF kept schedules with 9DUZ, 9AED and 9AYK. 9BSE not doing much on account of job QRM and power line QSS. 9DAE is still off. 9DWK still keeping OBS schedules on 200. 9ARA and 9CVY continued traffic work but did not report totals. 9BUE continued schedules with 5ES on 176-meter fone. 9BSH and 9BDS still off the air.

A few ORS in the eastern end of Jackson County are in danger for not reporting. 9ZD is rebuilding, but works a 210 on 40 and 20 meters occasionally. 9ACX is on 40 and 80. 9DRD is back on the Missouri side for the winter, signing 9AHU. 9DAQ, 9DRY and 9WV took a hand in traffic this month. 9DVU has been heard occasionally. 9ADR says traffic nil but DX fine on 20 meters. 9ACA is resting from his exertions of last month. 9BKK and 9BJC have been at sea. 9ELT reports DX but no messages. 9BKO is running his own BC station WLDP. 9RR rebuilt his receiver and is keeping schedule with 9DXY. RCC matches are held when opportunity permits. 9RR is running some antenna tests with the assistance of 9DXY, 9ZD, 9EBL and c4HH.

Traffic: 9BEQ 157, 9DOE 101, 9RR 104, 9DUD 18, 9DLB 24, 9DKG 81, 9CDF 11, 9BSE 1, 9AYK 72, 9DVF 28, 9AQB 5, 9DMT 32, 9DIX 2, 9DAQ 7, 9WV 2, 9DRY 2, 9DVU 1, 9ACX 29, 9AHU 1.

MAINE—SCM, Fred Best, 1BIG—Maine certainly did herself proud handling about 4000 messages with eight members in the Brass Pounders' League, four exceeding the 500 mark easily. FB, gang! Hearty congratulations for the fine work and the splendid co-operation! 1AAT handled an impressive total, leading IKL, 1ATV and 1BFZ to the wire in the order named, but not without a struggle! Fine work, OMs. In justice to 1BFZ we mention that he had an obnoxious power leak, preventing him from running well over five hundred also. 1AYJ is going full speed now and the above-mentioned OMs had better look to their laurels. 1FP with his B-battery set made the BPL with plenty to spare. FB, OM. 1HB made the BPL, too, and will bear watching also. 1BUB is now on 40 as well as 80 and turned in his usual fine report. 1AQL is gradually hitting his stride and is a prospective BPL member. 1BHR spent the month moving but reported a few to swell our total. Do your stuff next month, Art. 1EB is busy at college but finds time for traffic. He suggests that all Maine hams get together on a band one meter wide on both our traffic frequencies, thus making it easier to find each other when we have traffic. A good idea, OM. 1COM is through with football and has turned to traffic work. We hope he will gain the BPL soon.

1VF, 1BNL and 1KL all were QSO either New Zealand or Australia during the month which shows that Maine had time for DX as well as traffic. FB, OMs. 1VF has the most consistent DX record working among others NGD at Corinto, Nicaragua, and z-3AR, as well as pulling off some good work on the 20-meter band. He has applied for an ORS which he plans to obtain shortly. 1CFO, a newcomer, is using a current feed Hertz in arrangement that gets out well. He reports activity on the increase around Portland. 1CZ of Houlton, 1GQ of Castine, and 1ATV of Skowhegan, are all newcomers who are doing fine work and from whom we shall welcome a traffic report soon.

Traffic: 1BIG 3772, 1AAT 572, 1KL 554, 1ATV 527, 1BFZ 374, 1AYJ 238, 1FP 169, 1HB 187, 1AQL 46, 1BUB 41, 1EF 42, 1BHR 17, 1EB 16, 1UW 15, 1COM 12, 1VF 10, 1CFO 9, 1BNL 2, 1ADI 2.

RHODE ISLAND—SCM, D. B. Fancher, 1BVB—YEOW!!!! Just havva look at 1AAP's total. He made a close bid with 1BIG for the Trophy honors.

Providence: 1AID hits the BPL again this month with a big increase. She has schedules too numerous to mention. The SCM and his OW visited 1AD recently, most of the ORS dropped in and we had a regular convention and bang-up good time. 1CKB is a new ORS and will make a good one or the SCM will treat. 1AEI has been experimenting with a loop transceiver and has done good DX with the big set. (Let's have some traffic next time, OM.) 1AWE has a fine new receiver using plug-in coils. 1AMU is a prospective ORS. 1AAU and 1BIE are running along as usual.

Westerly: 1AAP neglected his duty as OO this month but will be excused as he sure broke RT's traffic record a couple of dozen times. Great work, Cliff, and you can bet we are backing you to win. 1BLW is stepping on the gas moving traffic with a 201-A. 1BVB moved a few this month, also. Watch the smoke of the three Westerly stations next month.

Newport: 1BQD is punching a mighty hole in the air. He worked all districts. As he has a schedule with g-ZSW twice a week, route your European traffic into RI and it will be QRRed promptly.

Traffic: 1AAP 1009, 1AID 318, 1BVB 221, 1BLW 54, 1AMU 39, 1BQD 27, 1AWE 17, 1CKB 4, 1BIE 2, 1AAU 2.

EASTERN MASSACHUSETTS—SCM, R. S. Briggs, 1BVL—1BMS ground out over 800 messages with 1UE and 1AHV following as our top-notch brasspounders. Stations wishing schedules should write to 1UE, the Route Manager. A number of schedules have been made and traffic moves faster than before. FB, Gang!

1KY is again in the BPL using 77 and 41 meters. Let's have some more YL brasspounders and we can handle a million messages. HL 1JL expects to go to sea soon. 1NK handled a bunch of traffic with his trick UX-210 which to date has blown out and recovered 50 times. 1AWB and 1AUF are now operating a new 500-cycle outfit at 1YS. 1BCN put up a new mast and vertical antenna. 1GA had a schedule with g2NM. Both of these stations use crystal control and handle a bunch of foreign traffic. There are about a dozen operators at 1XM to help move traffic. 1CJR has a schedule with 1BIG from



1XM. 1AGS says he worked a bunch of DX using a 199 with 750 volts on the plate. What next! 1BKV is using a rectifier now. 1AXA worked RQP in Iceland and rebuilt his transmitter. 1AIR has a new fifty and did some fine DX. 1AYX says that Nantucket is to give us two new hams soon. 1ADM works everyone he hears and has a new 60 foot stick. 1OU is QRW so does not get on the air very often. He would like to see some of the gang. 1AVY just put up a new antenna. 1LM says he is rolling along with 1 or 2 good schedules. 1BBM is coming to life again. Congrats, OM. 1BMS is experimenting with 20 meters. 1UE handled a few foreign messages along with the rest. 1AHV has been quite active. 1BVL expects to open up full blast again with Xtal control. 1ALP took a brass-pounders' vacation and did a great deal of bowling. 1BUO is using an H tube until his fifty arrives. 1RF did a lot of fine DX work being QSO with W-3XD, O-ARB and Y-1FB. 1PB is a newcomer. 1ON is installing a crystal control set. 1MR had a couple of tubes go west. 1SL says that golf weather is getting bad so he will have time to pound brass. HI. 1DI blew a CX310 after working 14 countries.

Traffic: 1BMS 840, 1UE 472, 1AHV 391, 1KY 187, 1NK 182, 1GA 125, 1ON 69, 1MR 67, 1BKV 63, 1LM 57, 1JL 48, 1YC 45, 1CJR 27, 1BVL 25, 1AYX 22, 1AGS 20, 1ABA 19, 1AWB 18, 1SL 17, 1BUO 14, 1DI 12, 1AVY 11, 1BCN 6, 1RF 5, 1AIR 5, 1OU 4, 1ALP 4, 1ADM 4, 1AXA 3, 1ACJ 2.

CONNECTICUT—SCM, H. E. Nichols, 1BM—Well, fellows, the good old radio season is here in earnest and the signals are just dying to jump across the continent and the feeling that our old set still able to reach out, all helps us to keep on trying harder to beat the other station. If our interest was ever worth anything, it ought to be topnotch right now, so let's do our best.

1AOX enters the Brass Pounders' League with a substantial total which is a very creditable record. His station will be an Official Broadcast Station soon. 1MK is rapidly getting under way and no doubt will be a most desirable outlet for our eastern traffic. 1MY worked Austrian OOOE-HL which is a brand new one to the SCM and he wonders if this might be some of that phonetic spelling to save space in our column or possibly some static. 1BHM reports wonderful activity in traffic work in New Haven and the reports show this to be a pleasing fact. 1BEZ and the rest of the Stamford stations are keeping traffic going through their Section. 1IV has to do his relaying in the daytime, since he is occupied evenings operating a broadcast station. 1BM is getting out a little and has hopes of getting into active traffic handling soon. 1FD is still unable to operate due to illness and our best wish is for your speedy recovery, OM.

Traffic: 1AOX 391, 1BMG 107, 1MK 74, 1AUK 69, 1CJX 42, 1MY 24, 1ACD 23, 1IV 22, 1FD 19, 1BHM 19, 1BJK 18, 1BCA 17, 1CTI 14, 1BEZ 10, 1BLF 10, 1CKP 8, 1BGC 8, 1BQH 2.

NEW HAMPSHIRE—SCM, V. W. Hodge, 1ATJ—The SCM wishes to thank the fellows for turning in such a fine report. 1OC, 1IP and 1ATJ are in the BPL this month. 1IP has been appointed ORS. 1AER's pet power leak is still bothering. He was QSO all districts but the 7th in 2½ hours, tho. 1AOQ is going to try a new circuit. 1OC has schedules with 7 stations (FB, OM). He uses 1OC on 80 and 1BT on 40. 1YB will have their ORS cancelled if they don't report. 3 stations are on 40, 2 on 80 and 2 on both 40 and 80 meters. Suggestions for improving the Section will be welcomed by the SCM.

Traffic: 1ATJ 777, 1OC 354, 1IP 137, 1AVL 64, 1AOQ 58, 1AER 32, 1JN 8.

VERMONT—SCM, C. T. Kerr, 1AJG—Well, fellows, now you are coming across. Keep it up, notice I beat you all in traffic totals. That was due to 1BBJ being down for repairs, tho. 1BEB is slamming them out, too. 1AC will never make the BPL if he doesn't brush up. 1APU must be ill. 1BDX is busy with the BCLs. 1BIQ is on at 1YD. Say, Charles, how about the traffic up there. 1FN operates when not selling sets.

Traffic: 1AJG 48, 1BEB 19, 1BBJ 6.

WESTERN MASSACHUSETTS—SCM, A. H. Carr, 1DB—1AAL, 1APL, 1BIV and 1AJM made the BPL this month. Your SCM is much elated and now believes he made an idle boast when he said that Western Mass. would go over the top.

1AAE says he worked 23 foreigners this month. Our RM, 1AAL, works the Pacific every day besides holding down his RM job with credit. It must get hot around a BPL station because 1AJM burned his transmitting condensers right thru the insulation. 1AOF is our new OBS so watch out for news from his station, who, by the way has been conducting some very fine fone tests. 1APL blew 4 fivers making the BPL but guess it was worth it. 1ASU is in competition with 1AAE and worked 24 Europeans. 1AWW has got 50 ft. of a 70 ft. pole done and we haven't heard whether he will use guys or not. 1AZW reports QRM on his report from a YL but there are others in the same boat. 1BIV says he makes his best DX at 7.00 a.m. FB. 1GR says not much traffic on the air. Some of you fellows ought to make him eat that statement. 1XZ has been rebuilt and we expect great things from them. 1UM says he heard a Portugese but can't speak the language so neglected to QSO. He is a dentist so he ought to be able to speak anything. 1JH, a newcomer, passed a radio school exam with honors so more power to him. 1LC is working on some original ideas. 1VZ sent a fellow named Chas. Rice who owns the station way out to Frisco to hear his own signals. 1ARE and 1VC will be on the air soon. 1CLN is giving his station and time to our future army, the Nat. Guard. 1BSJ writes that the boys at Springfield have their own clubhouse and station now. That sure is FB, and they have our best wishes. 1AZD is a new ORS looking for schedules. You'll hear more about us all next month.

Traffic: 1AAL 112, 1AJM 187, 1APL 189, 1BIV 118, 1AAE 29, 1AJK 37, 1AKZ 17, 1AMZ 4, 1AOF 5, 1ASU 25, 1AWW 12, 1AZW 21, 1DB 18, 1GR 1, 1JV 32, 1XZ 4, 1UM 13.

#### NORTHWESTERN DIVISION

IDAHO—SCM, H. H. Fletcher, 7ST—7JF, the new RM, made the BPL and won the subscription to QST, offered by the B. H. S. radio club. He was off the air for two weeks getting his portable 40-meter set ready to relay the Idaho-WSC game over KWSC. 7ABB made the BPL. 7YA nearly made it but lost out due to ops cramming for the R. I. There are now 5 new hams in Boise and 2 in Nampa. 7UD made a second and 7T made a first grade commercial 7GW will be on 80 the rest of the winter. 7QC has 2-UX-210s on 80 and an H-tube on 40. 7PS got on the last day with a new H-tube. 7ZN and 7PJ are still doing their stuff. 7ZN is on 20, 40 and 80 meters. 7GC is at Salt Lake City studying telegraphy. He hopes to sign a 6 soon and wishes to communicate in American Morse. 7ST spends most of his time at 7YA, hence the small traffic total.

Traffic: 7JF 176, 7ABB 109, 7YA 90, 7QC 44, 7ZN 32, 7PS 18, 7GW 12, 7ST 4.

OREGON—SCM, A. C. Dixon, Jr. 7IT—Hooray! 7JO, comparatively a newcomer, made the BPL. It took some work to do it thru our heavy November rains so he deserves a lot of credit. The H. F. is generated at 7JO by one 203-A.

7FE, 7VH, 7JO, 7PP, 7AV and 7EP are holding down the Portland end. 7SY and 7EO are on occasionally. 7FE has one of 6RW's bullet-proof five watters. 7VH has worked Brazil. 7JO gets steady reports on his Hartley; something he could never do with tuned grid-plate. 7EF is another believer in a good 120-cycle note. 7PP tried a Hertz with no luck.

Traffic: 7JO 118, 7AV 8, 7EO 8, 7VH 14, 7FE 22, 7EF 18, 7PP 13.

WASHINGTON—SCM, Otto Johnson, 7FD—The gang is getting their reports thru late again. Let's snap out of it, fellows! 7BB turns in the high traffic totals. The eastern section of the state seems to be on the job. 7UL at WSC is being run by 7RL, 7NH and many others. They have pulled off many nice stunts, such as relaying football returns etc. 7MZ and 7MP are back on the job. 7VL is still doing consistent work. 7EK is coming on with a new 80-meter set. 7TX, 7UQ, 7AM and 7OY are helping put Seattle back on the map. 7AG is working much DX. Frank Mueller is now building a new 50-watt transmitter. 7FD and 7BU are pressed with work.

Traffic: 7UL 52, 7EK 40, 7MZ 31, 7VL 26, 7OY 14, 7MP 12, 7RL 6, 7UQ 3, 7BB 171, 7TX 14, 7AP 7

MONTANA—SCM, A. R. Willson, 7NT—7PU has not yet received his new fifty but kept on the air over week-ends out to the ranch with his five. The SCM paid him a visit while in Hamilton and had a fine time. 7DD keeps regular schedules with 9CAA. 7AAT rebuilt his station this month and is getting out fine. 7AAW, the new station at Bonner, is developing into a good station. 7NT was not on much this month due to being out of town a large part of the time.

Traffic: 7DD 59, 7PU 32, 7AAT 21.

#### PACIFIC DIVISION

NEVADA—SCM, C. B. Newcombe, 6UO—6CRV is getting great results with his 2QA transmitter. 6ZO has rebuilt his set and is using RAC with 216 B tubes feeding a fifty. 6ABM is changing his location and hopes to reach out better. 6OU lost his mast in the big storm and is using low aerial which seems to reach out OK.

Traffic: 6UO 17, 6ABM 16.

HAWAII—SCM, John A. Lucas—6AXW reported direct to HQ this time.

Traffic: 6AXW 33.

SANTA CLARA VALLEY—SCM, F. J. Quemont, 6NX—Activity increased this month and 6AMM, 6BVY and 6BYH are hitting a stride which should put them in the BPL next month. Several new ORS started up with a bang and promise to give the old timers plenty of competition. 6AMM was high traffic man again this month. He has many schedules, which accounts for it. 6BVY, with low power, was second. 6BYH, a newcomer, maintaining schedules with 9BYC and 9BWN, handled quite a few. 6BCH, using mercury arc rectifier, is reaching out FB. 6AZS is another mercury arc station always QRV for traffic. 6CLP is just back from Chile—watch the traffic now. 6BMW, thru the death of 6TQ, lost his main traffic route. 6BMW and 6ZAT work lots of DX. 6CEI was QSO Pi-1BD. 6CSX is holding down the traffic end in fine shape. 6BTJ, 6BLT and 6AJZ handled their usual amount of traffic and are QRV. 6CJD and 6MP are QRV at University of Calif. 6NX has a separate Hertz for each wave now and finds them FB.

Traffic: 6AMM 62, 6BVY 61, 6BYH 51, 6BCH 36, 6AZS 24, 6CLP 23, 6BMW 16, 6CEI 12, 6CSX 7, 6BTJ 5, 6BLT 4, 6AJZ 2, 6NX 1.

SAN FRANCISCO SECTION—SCM, G. W. Lewis, 6EX—6RW is the star station. He works with pi-1BD. 6HJ has been appointed RM for the San Francisco Sect. 6AXC is a new ham and will rate an ORS soon. Two OBS are needed—apply to the SCM, please. 6PW is a new ORS going strong on traffic. 6EX could not find time for relay work this month but managed to get on 20 meters with 6RW and doing nice DX. 6VR is back in town and will pile up traffic for next month on that crystal note. 6KW can't get a set to hold up under his tube. 6CLS, 6CHE, 6BAA, 6CHEL, 6BLA and 6GK come on the air once in a while to say hello to their old friends. 6GW is still trying to get 100 watts working. 6BAF is coming along. 6BYS and 6ADM are busy holding down their jobs. 6RW reports pi-1HR is trying to QSO the States Sun. a. m. on 20 meters.

Traffic: 6RW 160, 6PW 60, 6HJ 39, 6CCR 27, 6HH 19, 6BAF 4, 6AXC 3.

LOS ANGELES SECTION—SCM, L. E. Smith, 6BUR—It is with regret that the SCM announces his resignation. He feels that he is unable to devote enough time to the work and to keep in close enough with the gang. Therefore, fellows, send in your nominating petitions.

Several local A. R. R. L. events are now in progress; a radio program over KWTC, the biggest banquet yet held and the working out of our new traffic net. Traffic has fallen a little, fellows, but we are sure that it will soon recover with the better weather and the traffic net.

SAN DIEGO—The fellows in this Section are now organizing a Section of their own but as it will not be functioning for some time yet, all reports will be handled as before. They are working upon a traffic handling system which will, of course, be worked in conjunction with that of Los Angeles. 6AJM has schedules with 6ZBJ, 6RJ, 6JTS and pi1BD. 6DAU and 6AKZ have been very busy re-

building, etc. The RM, 6CGC, has been doing good active work getting the ORS together. 6BQ has been home but little but has been doing fine work as Official Observer. 6SB and 6BAS are experimenting.

LOS ANGELES—6DDO is the new RM for L. A. and is sure starting things off with a bang. 6BBQ leads the Section in traffic this month. 6BJX comes in second. 6BBQ is on every a. m. from 5 to 7. Our old friend, 6BJX comes to the front to maintain that YLs and radio do go together. 6AWQ and 6CRZ are keeping San Bernardino on the map. 6BYZ is developing some good schedules. 6BGV is back with a new set. 6BGS has moved to Seattle. 6BBV keeps going altho very busy. 20 meters is being tried by 6IH. 6CSW says he's not on much find much time on the air but do their bit. 6CTO and 6CSW both are headed for 20. 6CPT worked traffic for his YL's "old man" as he puts it. 6DAQ ch. z, c and hu on an A tube. 6RF and 6OF don't but he has a DX list a block long. 6CQA handled wins the Springbok Trophy! FB! A one-KW bottle is in use at 6CYH but it is on low power now. A new 50 is perking at 6BHL 6BUX is improving every month. 6AHP is still at it consistently. 6CMY is doing good work in the a. m. 6BGC is home from the sea and on again. 6BHR keeps a schedule with pi1AU. Saturday and Sunday are the only days 6DAJ gets on. 6DEG has remote control on his set. Underground antennas are the bunk, says 6ANN. 6BVO handles his share. 6DDO, the new RM, keeps about ten schedules, covering a good corner of the map. FB. Hertz antennas won't work for 6CCO. 6CLK has lost his power transformer. He says it turned into smoke. 6CT has traffic for France. 6AM has his 500 watt, mercury arc outfit going. 6ANQ and 6CNK pound brass consistently. 6OR handled traffic concerning the Iowa-Calif. football game. 6BXD is a new OBS. 6NP has been doing good work with 6BUC. 6ZBJ breaks into the BPL and promises to stay. He solicits messages in radio stores, auto camps and the Y. M. C. A. FB. 6AOY, the owner of KWTC, wants the A. R. R. L. Los Angeles Sect. to put on a program over his broadcasting station. 6AJM made the BPL this month.

FRESNO—6BVM reports someone stole two of his best DX cards. A new style of thieves, OM. 6CCL works all over the state on phone. 6ASV is moving his outfit and promises to be on stronger than ever.

Traffic: 6BBQ 492, 6BJX 327, 6AJM 131, 6ZBJ 108, 6AOY 13, 6NP 40, 6BVM 10, 6BXD 27, 6OR 13, 6CNK 1, 6AM 68, 6CT 10, 6CLK 23, 6CCO 18, 6DDO 61, 6BVO 16, 6ANN 16, 6DEG 19, 6CDY 6, 6BQ 7, 6AHP 14, 6DAJ 10, 6BHR 21, 6ANQ 2, 6CMY 31, 6BUX 45, 6BHI 31, 6CYH 66, 6AKX 27, 6RF 6, 6CPT 9, 6OF 8, 6SB 3, 6DAQ 15, 6CQA 18, 6CCL 13, 6CSW 21, 6IH 16, 6BTM 4, 6BBV 7, 6BGV 12, 6BYZ 32, 6CRZ 14, 6CGC 6, 6NW 10.

#### ROANOKE DIVISION

VIRGINIA—SCM, J. F. Wohlford, 3CA—3UX is on again with two transmitters, one spark coil c.w. on 40 meters and 15 watt on 80 meters. 3CKA sends in a report but has had no time for ham radio. 3BMN is still QRV the radio shop. 3AEV applied for a license. Ex-3CBQ is starting up in Richmond. 3CEL is working on both 40 and 30 meters. 3BGS handled one from I-ACD thru 4T for 3CDQ. 3RX says bad weather stopped the outside work on the station, but is getting things in good shape now and will be on the air shortly. He started on a visit to see the SCM but got swamped by some YLs and never arrived. 3BZ says other conditions are rotten and very unsatisfactory operating. 3CKL seems to get out all over the lot and does FB on the DX. 3BDZ is QRV with autos, but will be on after Xmas.

Traffic: 3BGS 6, 3CEL 4.

WEST VIRGINIA—SCM, C. S. Hoffman, Jr., 8BSU—Message totals are up and general reporting better, although DX is hampered by QRM on the 40-meter band. 8CBR is using remote control, his set being 1,000 feet from his house.

Several important changes in calls and QRAs—SAXP changed to 8VZ. 8CBR changed to 8VJ. 8AMD cancelled and he and 8SV building a new station together. 8BFW, Huntington Amateur Club, being reorganized and will have a new call, too. Looks like a clean-up. Hi! 8AVZ, 8BNZ, 8BJG and 8DEW touring southern part of state. A-A net represented by 8AMD, 8SV, 8BJG, 8AMX and 8CDV.

8ALG has a new 600-watt m.g. and new 50-watt set going. 8ACZ blew the works. 8BDF worked NAU. 8AWV is home for the holidays. 8AGF reported via radio. 8CYR visited the Sequi at Phila. 8IT is coming home from lake operating—reports ahead bring many valuables in his suitcase. Hi. 8AUL is now on 19.8 meters. 8CDV worked four f's. Weimer, 8ZW, is on the staff at WCAE. 8BSU is too busy with SCM stuff to show much activity.

Traffic: 8AYP 321, 8ACZ 50, 8CDV 29, 8BSU 28, 8BJG 17, 8ALG 14, 8AUL 5, 8AGI 18.

**NORTH CAROLINA**—SCM, R. S. Morris, 4JR—4NJ will be off the air until March as he is going to his winter home in Summerville, S. C. 4MI sold his crystal to 4GW so he is now using the old straight oscillator again. 4NH has a schedule with g-6BY every Sunday. 4TS is now back on the air. 4RF will be on by Nov. 23. 4PR reports little work—experimenting, says he—with YL, say we. 4BX is on only a little as he has QRM from business. 4EL and 4UV are going strong in Greensboro with 50 watters on 80 meters. 4SJ is showing promising signs at Ridgeway. 4OH, another new one for Gastonia, is making every effort to get going. 4JR is doing good work on 80 by having schedules. 4PP has applied for ORS appointment.

Traffic: 4JR 73, 4MI 63, 4SJ 13, 4NH 9, 4PP 5, 4TS 5, 4NJ 5, 4EL 2.

### ROCKY MOUNTAIN DIVISION

**COLORADO**—SCM, C. R. Stedman, 9CAA—Denver, 9CAA leads the state this month for traffic handled. 9QL has joined 9AOI and 9CAA in the business of working nights for a living. 9DSY says if he reverses the leads on his r.f. feeder line, it reverses the directional effect of the antenna. 9CAW worked India. 9BQO is moving to a new QRA and may consolidate with 9DLA. 9BQO has applied for ORS. 9EEA is on 40 quite regularly. 9DLA is doing good work. 9CNL has been experimenting with antennas and is getting results. 9DDF has handled no traffic but is getting out good. 9BXQ shot his beloved 250. 9CJP worked Iceland and Panama. 9DWZ says the gang won't keep the schedules they make. 9OO is off the air temporarily. 9CJY is building a new receiver. 9AOI gets on once in a while. 9BYC has 4 schedules working OK. 9CDE is working hard with the set. 9DUI is overhauling the station. 9CLD is back with us and says 20 meters is FB for traffic. 9CFY has asked to have his ORS cancelled as he has sold everything and may not be back in Colorado 'till next spring. Sorry to lose you, OM.

Traffic: 9CAA 159, 9BQO 78, 9CLD 88, 9BYC 40, 9CAW 39, 9DUI 27, 9CDE 25, 9EEA 24, 9DWZ 18, 9DSY 18, 9OO 14, 9CJY 10, 9CNL 11, 9CJP 8, 9DLA 5, 9QL 5, 9AOI 2.

**UTAH-WYOMING**—SCM, Art Johnson, 6ZT—6AIK, a new station in Ogden is always prompt with reports. He is on 39 meters. 6BTX is operating on 82 and 41 meters. He keeps schedule with 9CAA. 6BUV is on the west coast for the time being. 6CVA is on 40 meters. He is on the job anytime from 8 a.m. to 10 p.m. and is arranging schedules. 6RV leads with a total of 93 messages handled—he is on 40 meters, keeps schedule with hu-6CLJ.

Wyoming stations are asked to apply to their SCM for ORS certificates. Stations are needed in this territory.

Traffic: 6RV 93, 6BTX 47, 6CVA 28, 6AIK 7.

### SOUTHEASTERN DIVISION

**ALABAMA**—SCM, A. D. Trum, 5AJT—Alabama hams are forging ahead in old time shape, and the SCM is well pleased with activity. We want more pictures and special stories of activity in QST. Send all you can with your monthly report to the SCM.

5AV is handling traffic like a veteran. He thanks 5AUH, 5DI, 5EV, 4DD, 4EI, 4HA and 9BQH for their wonderful co-operation. 5DJ is on with a 7½-watt bottle. 5DL has a live gang in Mobile. 5DL and 5AC just got their first class commercial tickets. FBX 5AR and 5AAD will be on the air in full rig soon. 5AAD wants schedules on 80. 5EV and 50A are strutting fine DX and traffic. 5DF is still struggling along. 5EV worked aBW and o-A50. 5YB is still in the experimental stage. 5DF put the crepe on another fiver. 5DT has been trying to copy the famous "Clancy" AC note. He has a fine punch behind the sigs. 5AWF blew his tubes. 5ASH has been giving 'em fits with low power. 5AKK made some new records with his 210. 5AX with his canary note, gets the applause from

QST FOR JANUARY, 1927

the Aussies. The old familiar 5MI is heard on the air. FB, OM! Hope you are back to stay. 5AFS is working f.b. handling quite some traffic. 5ADA, the transformer specialist, is kept busy winding 'em for the gang. 5AJP relayed messages and replied between 2CQU and Montgomery giving 30-minute service regularly for two weeks. He gave five-minute service between Charlotte (4BX) and New Orleans (5UK). I. J. Jones, 5JY, is a newcomer in the game who promises fine material as a ham. Welcome, brother.

Traffic: 5ADA 26, 5AFS 28, 5AJP 42, 5AWF 7, 5AAD 14, 5DF 11, 5DT 5, 5DL 28, 5EV 31, 5AKK 3, 5AX 22, 5AV 9.

**FLORIDA**—SCM, W. F. Grogan, 4QY—4IU-4XE reports that NRRG has moved to Orlando and USNR drills are held on Thursday night on 81 meters. 4FS, 4LK, 4RA and 4BA have joined the USNR. 4NU was married on Nov. 30th. Congrats and best wishes OM. 4TK kept a schedule with 6OR. 4UA has moved his station to Orlando. 4HY is still pounding the DX and was QSO gf-1FG. 4IG has been on the sick list. 4OB reports good DX. 4DD says he wishes the Florida hams would throw a good convention. Let's hear from you boys regarding the convention. 4LG, ex 9CLJ, is ready for traffic. 4QY has moved to the country now and will be on the air regularly. 4CK reports that when he is QSO stations and tells them he has traffic, they QRT—funny business, gang. Say, boys, let's get going and send that traffic report each month. Report what that ORS certificate says on the face of it. 4LK lost some tubes and grid leaks.

Traffic: 4IU 37, 4DD 35, 4HY 28, 4OB 17, 4TK 14, 4LK 11.

**GEORGIA—SOUTH CAROLINA, CUBA, P. R., Isle of Pines**—SCM, H. L. Reid, 4KU-4KD, at San Juan, Porto Rico, sent us his written application for ORS appointment. The only way to get one, fellows, is to make a formal application in writing to the SCM. As it now stands, we have only one ORS that has been authorized by the SCM. All others are void until you make the proper request and get a new one issued. 4AAM at Charleston, S. C. is also writing for his ORS. 4AV is high traffic man. 4KU and 4AAH have rebuilt. 4KL is doing good work. 4IO has a model shack and warns the gang to watch his smoke. 4BW is ready for some good work. 4AG, 4RM, 4SI and 4EI are doing fine work. 4BQ is on 40 meters. All enjoyed Mr. Hebert's visit and trust that we will have the benefit of his inspiring talks more often. 4DV is on the air and QRV traffic.

Traffic: 4AV 52, 4AAH 20, 4AA M17, 4PG 18.

### WEST GULF DIVISION

**NORTHERN TEXAS**—SCM, W. B. Forrest, 5AJT—Reports are coming in slow but traffic figures are fairly small. Several new stations are reporting for the first time. FB, OM.

5NW-5MZ has moved to Pampa, Texas (Box 682), and will soon have the portable set working. 5PH reports bad QRM from a YL. Looks like a bad case. 5ACL is using tuned grid and plate circuit with 150 watts on 20-40-80-meter band. He reports good DX with o-ZUR. 5AQ is just getting started in the game and is to be congratulated on the fine showing for his station in the traffic figures. 5AJJ is now at 6918 Pasadena Ave., Dallas. 5RG reports DX is good and he is getting a good number of mgs to handle. 5AUA wants to get in touch with someone interested in some work on 5, 10, 20 meters. 5AKN is now using crystal control on 38.9 meters. 5AMT is on 38 meters.

Traffic: 5PH 2, 5VW 10, 5SP 19, 5HY 13, 5ACL 8, 5AQ 25, 5RG 39, 5AUA 4, 5AKN 6, 5AMT 3.

**SOUTHERN TEXAS**—SCM, E. A. Sahn, 5YK—There seems to be considerable activity but traffic is slight. Message figures for the number of stations reporting are small. 5AHP, a new ORS, sends a nice traffic report in. 5HC has been appointed ORS for this district. 5ABQ is one of our newest ORS—says he burned out a UX-20 but believes the other fellow's receiver did it. Hi. 5RR is still waiting to get his receiver shipped from Canada. 5ALH wants schedules with the gang. 5EW is still very busy with KWVG but he has his new 250-watt transmitter ready. 5ARF-AVI had considerable trouble in getting down to 20 meters, but he finally succeeded.

Let me add a last call—all ORS that do not report will be cancelled without wasting further postage to

notify them—read it and weep! Your failure to meet your obligations relieves us of ours.

Traffic: 5ABQ 19, 5AHP 8.

**OKLAHOMA**—SCM, K. M. Ehret, 5APG—5AAV is busy with YLs and Sat. night "previews" but finds time to play around on 20 meters. 5ZAV is putting out a nasty signal from his 50-watt M.O. set. 5QL is still herding DX through his set and claims to work everything he hears. 5ARD is working hard to rebuild his transmitter so that it will look as well as it works. 5SW is not on much but gets nice results from his 15-watt M.O. 5APG works on both 40 and 80 meters with a M.O. set. 5MD works all districts on 40 meters. 5DQ reports for the third time and doesn't boast of DX but says he gets there just the same. Because he can't work Marj, 5ADO claims his transmitter is on the blink. 5ASK drew a blank this month due to strenuous efforts to acquire an education. 5ANL thought traffic dull and didn't realize he made the BPL until he counted his messages. 5VM, owned and operated by the Alpha Sigma Delta Radio Fraternity, will be on about Xmas. 5AVB and 5AVF expect to be going by the time this appears in print. 5FJ was QSO JNI, M-CYY and BZ-1AW.

Traffic: 5DQ 13, 5ADO 37, 5ANL 101, 5APG 16, 5ZAV 2, 5AAV 2, 5FJ 30.

## CANADA

### ONTARIO DIVISION

**ONTARIO**—SCM, W. Y. Sloan.—9BJ—9AL and 3FC do great daylight transatlantic work on 20 meters. Things humming in Southern District. Conditions during the month were as nearly ideal as one could wish resulting in new DX records and increased traffic totals.

Southern Dist.—3CS is the start of this district. He is an ORS and has old 3DU as 2nd op. 3FU worked f-JHP and g-6NX. 3IA is keeping the 80-meter band warm and on the job for QSR. 3DH kept the old bottle steaming while home from college for Thanksgiving.

Central Dist.—This month all stations have shown quite a burst of activity. Hamilton seems to be making a real bid for a place on the radio map. 3HR is working on 40 meters. 3HT is off for a time but is expected on again shortly. 3CT is trying 40 meters in place of 80. 3BT has been really active on both 40 and 80 meters but has not yet got his big set going. 3AI is acting as second op at 3BT. 3BZ is active and is using a Zeppelin antenna which is letting him get out. 3BT reports that a bunch of new stations are on the way. 3CR has rebuilt and is now using break-in. 3CC is in the throes of rebuilding. 9AL has his m.g. in commission again and is hard at it keeping several schedules. 3BY has been having some legal difficulties but has worked a G and an F, however. 3BR is using a sync rectifier and has worked another local station by remote control from 3BR. 9CD, 8AO, 3CK, 3NJ and 8AZ are on spasmodically. 3EL is rebuilding and putting up a Hertz. 3DR is now on despite lots of bad luck and faulty apparatus. We are still waiting to hear 8VH once more but fear the YL's have got him. 3CH is on right along on low power. 9BJ is still on low power, using B bats but clobbered with v-1FB using 15 watts input. 3FC has been pounding brass at every opportunity and succeeded once again in spreading his signals all over the map. The Toronto Gang had a booth at the Toronto Radio Show and installed a small transmitter and receiver. Over 100 messages were handled.

Northern Dist.—3NT's familiar fist is indeed welcome back on the air. Great credit is due to 3HP for the way in which he carried on and cooperated in forwarding the traffic reports during 3NT's absence. 3AAZ is beginning to reach out, having changed his antenna to a series feed Hertz.

Traffic: 9AL 38, 9BJ 45, 3BR 57, 3FC 60, 3BY 12, 3CS 128, 3HP 55, 3NI 15, 3HT 21, 3CC 2, 3IA 6, 3DH 2, 3FU 2.

### MARITIME DIVISION

**PRINCE EDWARD ISLAND**—SCM, W. A. Hyndman, 1BZ—Reports are scarce in Prince Edward Island and no traffic has been handled.

**NEW BRUNSWICK**—SCM, T. B. Lacey, 1E1—1AK is high man this month in traffic handling with 1AM running him a close second. 1AX is on the air every day as is 1AD. 1AI is in the hospital.

Traffic: 1AK 17, 1AM 12, 1AN 5, 1AQ 7, 1E1 2.  
**NEWFOUNDLAND**—SCM, Loyal Reid, 8AR—The SCM reports things livening up for the wintch but little traffic handling yet. The Government has advised that existing amateur licenses are not to be renewed when they expire. Newfoundland amateurs are tak-

ing this matter up with their Government with a view to having them listen to reason. Two new stations are due on the air shortly.

**NOVA SCOTIA**—SCM, W. C. Borrett, 1DD—Things look brighter here now. Starr now has a "1" call and is known as 1AB Wolfville. We expect much from him—he is an ORS. 1ED of Sydney Mines is at Kings College and hence the silence. He will be on during holidays. 1DD finds Hertz antenna FB and has QSO'd Europe many times this month. 1DQ has a new Hertz but it refuses to budge off 28 meters although built for 38. H11 The Halifax County Radio Assn. has a class of over 30 members learning the code, including three ladies: Now you upper Canadians, try and QSO Halifax this winter. H1. 1AR is still at it but short on reports. Come on, Joe OM, tell us what you are doing. It is rumored that 1DJ might leave us soon for other parts. 1CX, the star of Cape Breton, is on regularly. 1CO, Liverpool, is at college.

Traffic: 1CX 2, 1DD 4.

### VANALTA DIVISION

**BRITISH COLUMBIA**—SCM, F. E. Batt, 5GR—The SCM would be pleased to have all report cards in his hands not later than the 15th of each month. 5GF has sold his old transmitter and is now building a new one. 5AU is a new ham and has purchased 5BM's old set. 5PK and 5AZ are also new hams and are working between themselves at present.

A new station will soon be on the air at Blackwater Lake, working on 80 meters. 5HB has been closed for a short period and it is expected to have him on the air again soon with fifty or a hundred perking. 5GO is well-known to all and when his new apparatus is completed, will again renew old acquaintances. 5BJ has moved to a new location and is getting the old set into working order again. He is also Amateur R. I. for this district and has also just been nominated SCM for British Columbia.

**ALBERTA**—SCM, A. H. Amussen, 4GT—DX conditions in the past few weeks have been the best, this together with the news of new stations coming on the air should help to put Alberta on the map. 4HM is doing good work and may be the star of the North. 4DG expects to get his xtal control going very soon. 4GL now has a new H-tube and we are looking for big stuff from him. 4CS gets his report in too late but his sigs are FB. 4DQ, the OW, gets R8 and R9 reports from the east coast. 4AF lost both poles and was off for a week but hands in the best message total. 4IO is in the north for his holidays looking for big game and we all wish him luck. 4GT is still working on an indoor antenna.

Traffic: 4AF 25, 4IO 7, 4DQ 6, 4GT 2.

### PRAIRIE DIVISION

**MANITOBA**—SCM, F. E. Rutland, 4DE—Activity is again back to normal with all stations aspiring for the Brass Pounders League. Schedules have been worked out by a committee to suit all ORS which should be a speedy method of clearing traffic. Two new ORS have been appointed this month and several more stations have made application. DX conditions seem to be very favorable and many foreign stations are being copied nightly. 52-meter activity seems to be centered on Wed. nights when it is centered at all. Code lectures through the local B. C. stations has brought hundreds of inquiries from interested parties all over the country which is resulting in many enrollments into amateur ranks.

Traffic: 4AW 22, 4DW 32, 4DY 23, 4DU 15, 4DT 12, 4EK 11, 4EA 9, 4EH 5, 4FO 8, 4FZ 8.

### QUEBEC DIVISION

**QUEBEC**—SCM, Alex Reid, 2BE—Seventeen live stations are on the air, each handling its share of traffic. Some very fine schedules are being kept. An oldtime hamfest was held Nov. 18th at 2BM's station besides the regular ragchewing and eats, some real business was transacted. 2AX was elected treasurer and the boys were surprised to know that the Section was in such good financial standing.

2HV, 2FO, 2AX, 2BV, 2CC, 2AL, 2DO, 2BB and 2BG, are all getting out well. 2AX has added a number of countries to his total. 2BV is now eligible to join the ROTAB. 2AL has a morning schedule with 9AL. 2HV has two UX-210s and is getting some fine reports. 2AX has a new T250. 2DO has his new set going. 2BM will be on with a new set shortly. 2BN has a new antenna. 2HT, 2EQ and 2EV are using fone on 180 meters. 2CG is on the air again and is our first crystal controlled station. A report from every ORS—fine work, gang, keep it up!

Traffic: 2BV 19, 2AL 14, 2BB 8, 2AU 6, 2DO 4, 2BE 12, 2BG 7, 2AX 25.