

QST

DEVOTED ENTIRELY TO

AMATEUR RADIO

Published by the American Radio Relay League

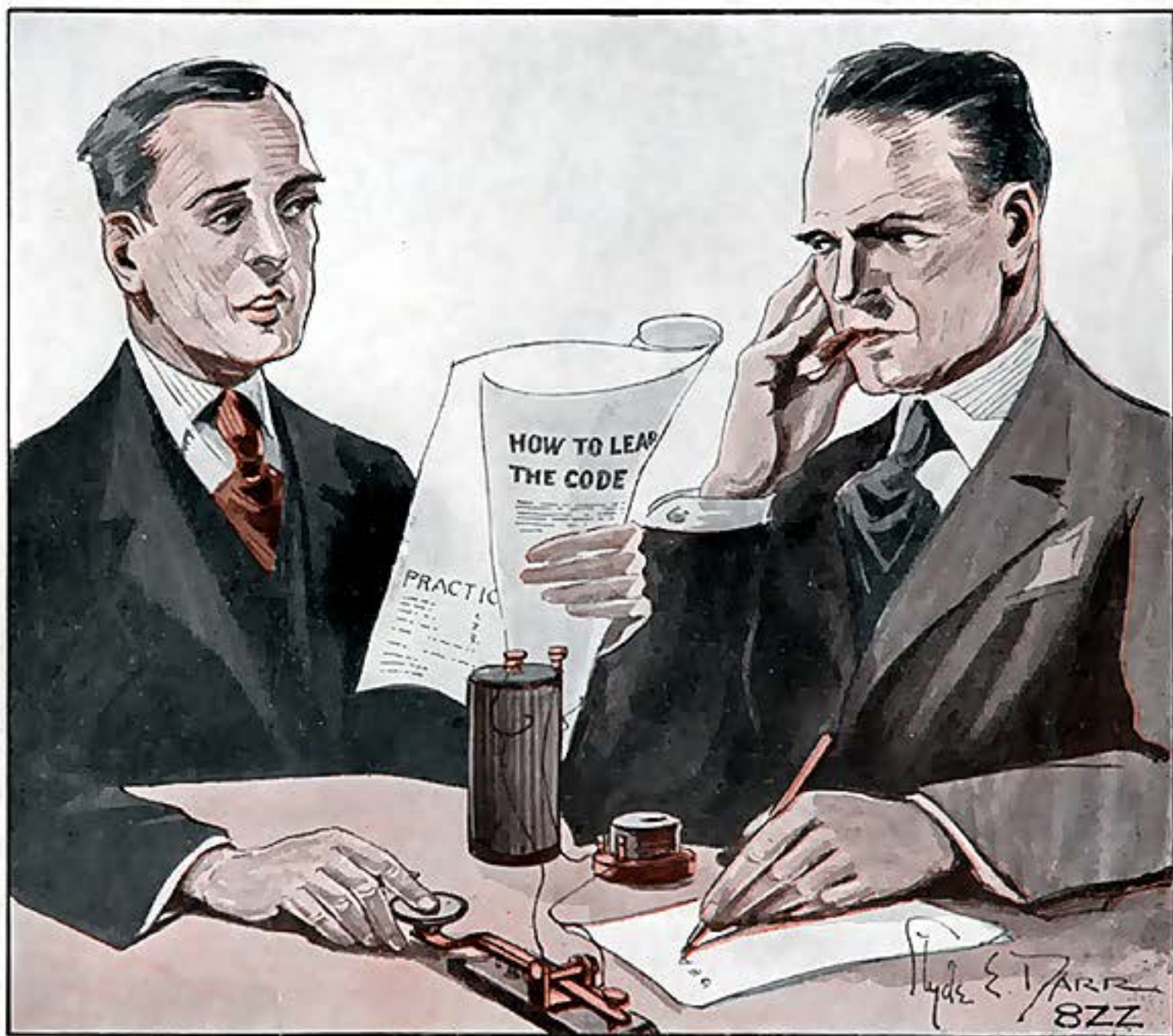

JUNE
1926

25¢

Cunningham

RADIO TUBES

Since 1915—
Standard for all Sets



Stamina --

There is no wavering, no swerving, in Cunningham's original steadfast purpose of creating radio tubes to bear successfully the brunt of hour upon hour of the severest service.

But endurance has never been the sole aim. Today you find combined with it in these tubes that quality which makes for absolute fidelity to the pure source-tone—

Sensitiveness

R. J. Cunningham, Inc.

New York

Chicago

San Francisco

Manufactured and sold under rights, patents and inventions owned and/or controlled by Radio Corporation of America

Cardwell Condensers

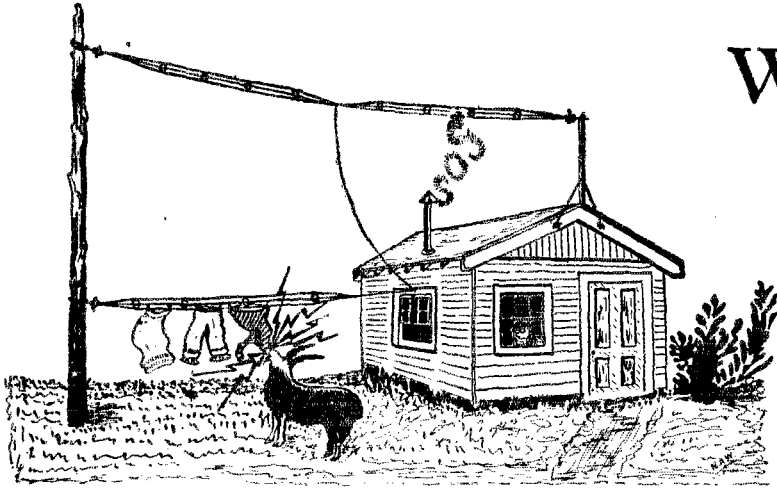

WON'T
WASH
CLOTHES



But who wants them to? They do everything they are expected to, and more. For transmitting and receiving, they have been the ham's choice ever since they have been made, and that *proves* their quality. And now, to help along, we have made a

NEW FIXED AIR CONDENSER.

Why not use a LOW-LOSS condenser for blocking as well as tuning? Both grid and plate blocking condensers are at high R. F. potential—they can waste nearly as much current as a tuning condenser. Let's save the waste, and make the whole set right! And if they spark over—you don't have to throw them away.

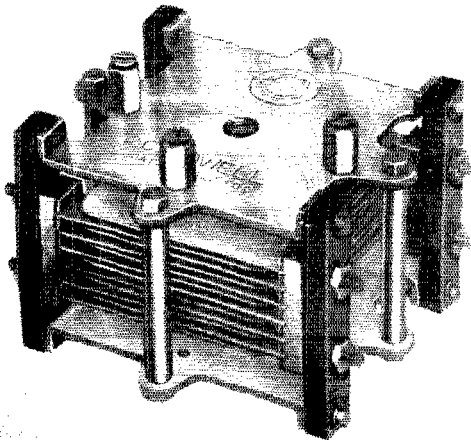

SPECIFICATIONS

TYPE NUMBER	CAPACITY M M FD.	FIXED		PRICE (RUBLES)*
		VOLTAGE	BREAKDOWN	
501	250	3000		\$4.50
502	440	3000		\$7.00
503	966	3000		\$10.00
504	250	5500		\$13.00
VARIABLE				
164 B	220	3000		\$7.00
147 B	440	3000		\$10.00
183 B	156	5500		\$15.00
166 B	297	7500		\$70.00

*U. S. MONEY

Receiving condensers of all types—four to five bucks. But send your QRA for 36 page handbook and catalogue. Ask, too, for the folder on the "Tuned Grid—Tuned Plate" Transmitter. Maybe you've heard it from 2QA. 73's O.M. Pse QSL.

The Allen D. Cardwell Mfg. Corp.
51 PROSPECT ST. BROOKLYN, N. Y.

2QA is on the air on 40 meters every weekday 11. to 12. and 4.30 to 5. E. S. T.

"THE STANDARD OF COMPARISON"

SAY YOU SAW IT IN QST—IT IDENTIFIES YOU AND HELPS QST

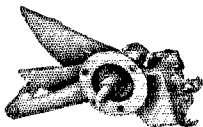

No. 251-S 3-plates
6.2Mmf. Min-50Mmf. Max
Price \$2.75

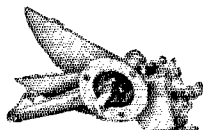

No. 251-T 5-plates
6.7Mmf. Min-90Mmf. Max
Price \$2.75

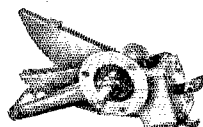

No. 251-U 7-plates
7.0Mmf. Min-135Mmf. Max
Price \$2.75

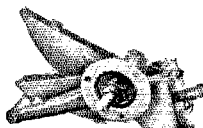

No. 251-W 9-plates
7.5Mmf. Min-175Mmf. Max
Price \$3.25

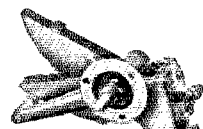

No. 251-X 11-plates
8.5Mmf. Min-220Mmf. Max
Price \$3.25

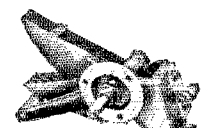

No. 251-Y 13-plates
9.0Mmf. Min-260Mmf. Max
Price \$3.25

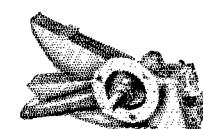

No. 251-Z 15-plates
9.7Mmf. Min-300Mmf. Max
Price \$3.25

Pacents

True Straight Line Frequency Condensers *for* Short Wave Work!

THE PACENT LABORATORIES now offer to radio fans interested in short wave experiments, a complete line of TRUE Straight Line Frequency Condensers, ranging from 3 to 23 plates, from which you can select the condenser for your exact requirements.

The Pacent TRUE Straight Line Frequency Condenser is a precision instrument built for precision work because—from start to finish—it is built to the strict standards usually associated only with laboratory instruments.

You can be absolutely sure of perfect straight line frequency operation with wide, accurate spacing of stations when a PACENT CONDENSER is installed in your set.

Ask your dealer or write us direct about these and other Pacent Radio Essentials

Pacents Electric Company, Inc.
91 Seventh Avenue, New York City

Washington
Birmingham
Cleveland

Chicago
Jacksonville
San Francisco

Buffalo
Boston
St. Louis

Minneapolis
Philadelphia
Pittsburgh

Canadian Licensed Manufacturers: White Radio Limited, Hamilton, Ont.
Manufacturing Licensees for Great Britain and Ireland:
Igranic Electric Co., Ltd., London and Bedford, England

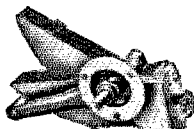

No. 251-B 17-plates
12.0Mmf. Min-350Mmf. Max
Price \$3.50

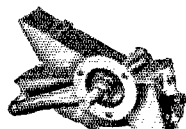

No. 251-C 23-plates
14.7Mmf. Min-500Mmf. Max
Price \$4.50

THE COMMUNICATIONS DEPARTMENT, A. R. R. L.

A.D.M. D. of C.	3AB	ATLANTIC DIVISION	A. B. Goodall	1824 Ingleside Ter.	Washington
A.D.M. Maryland	3HG	G. L. Deichmann, Jr.	Chapel Gate Lane	Ten Hills, Baltimore	
A.D.M. So. N. J.	3EH	H. W. Deusham	140 Washington St.	Collingswood	
A.D.M. West. N. Y.	3PJ	C. S. Taylor	308 Masten St.	Buffalo	
A.D.M. East. Pa.	3FM	J. F. Rau	1551 So. 58th St.	Philadelphia	
A.D.M. West. Pa.	3ZD	P. E. Wiggin	714 Johnston St.	Wilkesburg	
A.D.M. Delaware	3AIS	H. H. Layton	505 Washington St.	Wilmington	
Manager	3ZZ	CENTRAL DIVISION	C. E. Darr	137 Hill Ave., Highland Pk.	Detroit, Mich.
A.D.M. Michigan	8ZH	W. D. Fallain	321 First Ave.	Flint, Mich.	
A.D.M. Ohio	9AAW	W. E. Schweitzer.	4264 Hazel Ave.,	Chicago	
A.D.M. Illinois	9VD	G. N. Crapo	443 Newton Ave.	Milwaukee	
A.D.M. Wisconsin	9CQ	D. J. Angus	310 N. Illinois St.	Indianapolis	
A.D.M. Indiana	9CYQ	J. C. Anderson	Glensary Farm	Lexington	
A.D.M. Kentucky	9EI	DAKOTA DIVISION	D. C. Wallace	54 N. Penn. Ave.	Minneapolis, Minn.
Manager	9ZT-9XAX	C. L. Barker	M. J. Junkins	George R. Moir	Hennepin
A.D.M. Minnesota	9EGU	B. P. Painter	324 Hamilton Nat. Bank Bldg.	Chattanooga, Tenn.	
A.D.M. So. Dak.	9CJN	J. W. Gullett	219-230th Ave.	Meridian	
A.D.M. No. Dak.	9EPN	Dr. L. M. Hunter	207 1/2 Main St.	Indian Rock	
Manager	4MM	L. K. Rush	4 Second St.	Hemlo	
A.D.M. Mississippi	5AKP	C. A. Freitag	8520 Forshey St.	New Orleans	
A.D.M. Arkansas	5KAB	HUDSON DIVISION	E. M. Glaser	845 E. 13th St.	Brooklyn, N. Y.
A.D.M. Tennessee	4KN	A. G. Wester, Jr.	1075 Chancellor St.	Irvington	
A.D.M. Louisiana	5UK	F. H. Mardon	1309 W. Farms Rd.	Bronx	
Manager	2RRR	H. N. Ammenheuser	178 Quail St.	Albany	
A.D.M. No. N. J.	2WR	MIDWEST DIVISION	P. H. Quinby	Box 134A, Rt. 6	Omaha, Nebr.
A.D.M. N. Y. C.	2CWR	C. B. Diehl	3006 S. 32d Ave.	Ames	
A.D.M. East. N. Y.	2PV	D. E. Waits	116 Highland Ave.	Kansas City	
Manager	9DXY	L. B. Lazrus	8920 Mercer St.	Yates Center	
Asst. Secy. to DM.	9ARZ	C. M. Lewis	512 E. Rutledge St.	Omaha	
A.D.M. Iowa	9RR	H. A. Nielson	4708 N. 39th St.	Springfield, Mass.	
A.D.M. Missouri	9CJS	NEW ENGLAND DIVISION	T. F. Cushing	78 College St.	Westerly
A.D.M. Kansas	9CCT	D. B. Fancher	86 Franklin St.	Manchester	
A.D.M. Nebraska	9CJT	C. P. Sawyer	41 Stark St.	Pouliny	
Manager	1AWW	C. T. Kerr	C. V. Green	6 Arille St.	Worcester
A.D.M. R. I.	1BYV	Miss Gladys Hannah	2 Summer St.	Cambridge	
A.D.M. N. H.	1GL	H. E. Nichols	60 Benham Ave.	Bridgport	
A.D.M. Vermont	1AJG	S. B. Coleman	11 James St.	Bangor	
A.D.M. W. Mass.	1ASU	NORTHWESTERN DIVISION	Everett Kick	Everett, Wash.	
A.D.M. E. Mass.	1KJY	A. R. Wilson	Otto Johnson	Ramsey	
A.D.M. Conn.	1BAM	Ashier C. Dixon, Jr.	4940 30th West	Seattle	
A.D.M. Maine	1UU	K. S. Norquest	1541 Albin St.	Portland	
Manager	7EK ex TABB	Leo H. Machin	Weather Bureau	Boise	
A.D.M. Montana	7NT	J. E. Smith	Box 452	Cordova	
A.D.M. Wash.	7PD	W. S. Wiggins	340 N. Painter Ave.	Whittier, Calif.	
A.D.M. Oregon	7TP-XAF	R. L.	K. I.	Whittier	
A.D.M. Idaho	7GB	D. B. Lamb	229 W. First St.	Mesa	
A.D.M. Alaska	7DE	P. W. Dann	562-35th St.	Oakland	
Mgr. Southern Section	6RUE	F. J. Quement	51 Pleasant St.	San Jose	
A.D.M. Dist. 1, 2, 3	6CHZ	George Becker, Jr.	2375 Fruitvale Ave.	Oakland	
A.D.M. Ariz.	6ANO	St. Clair Adams	C. B. Newcomb	Yerington	
Mgr. Northern Section	6NX	K. A. Cantin	1593 Pilkot St.	Honolulu, T. H.	
A.D.M. Dist. 4	6NX	W. H. Friedly	1825 Dole St.	Honolulu, T. H.	
A.D.M. Dist. 5	6RHP	ROANOKE DIVISION	W. T. Gravely	Danville, Va.	
A.D.M. Dist. 6	6BAF	C. S. Hoffman, Jr.	126 Chantal Court	Wheeling	
A.D.M. Nevada	6TO	J. F. Wolford	418 Cambridge Ave.	Roanoke	
Mgr. Hawaiian Section	6TO	R. S. Morris	413 S. Broad St.	Gastonia	
A.D.M. Hawaii	6BCG	ROCKY MOUNTAIN DIVISION	N. R. Hood	1022 S. Ash St.	Casper, Wyo.
Manager	2RZ	C. R. Steedman	1841 Albin St.	Denver	
A.D.M. West Va.	3RSU-AKZ	Art Johnson	247 E. 7th South St.	Salt Lake City	
A.D.M. Virginia	3CA	SOUTHEASTERN DIVISION	A. D. Trum	Montgomery, Ala.	
A.D.M. No. Carolina	4JR	A. Dupre	296 Wofford Campus	Spartanburg	
Manager	7CA	H. S. Brownell	Box 731	Birmingham	
A.D.M. Colorado	80A	W. F. Grogan	Box 316	Pt. Myers	
A.D.M. Utah	8ZT	J. Morris	58 Frederica St.	Atlanta	
Manager	5AJP	Luis Rexach	Box 319	San Juan	
A.D.M. S. C.	4RR	WEST GULF DIVISION	F. M. Corlett	2515 Catherine St.	Dallas, Texas
A.D.M. Alabama	5AX	K. M. Ehret	2904 N. Robinson St.	Oklahoma City	
A.D.M. Florida	4GV	E. Salm	Box 569	New Braunfels	
A.D.M. Georgia	4IO	W. B. Forrest, Jr.	503 Royal St.	Waxahachie	
A.D.M. Porto Rico	4OI	MARITIME DIVISION	W. C. Borrett	14 Sinclair St.	Dartmouth, N. S.
Manager	5ZC	W. Hyndman	T. B. Lacey	c/o N. B. Power Co.	Charlottetown
A.D.M. Oklahoma	5APG	ONTARIO DIVISION	W. V. Sloan	167 Close Ave.	Toronto Ont.
A.D.M. So. Texas	5AJT	A. R. Williams	P. A. C. Harrison	56 Madison Ave.	Toronto
A.D.M. No. Texas	5AJT	J. A. Varey	Wm. Sutton	181 Hopewell Ave.	Ottawa
Manager	1DD	QUEBEC DIVISION	Alex Reid	43 York St.	St. Catharines
A.D.M. P. E. I.	1BZ	VANALTA DIVISION	A. H. Asmussen	223 2nd Ave. N. E.	Pt. William
A.D.M. N. B.	1ET	PRAIRIE DIVISION	F. E. Rutland	452 St. John Ave.	Winnipeg
Manager	9RT	F. J. Maynard	F. E. Rutland, Jr.	452 St. John Ave.	Morse
A.D.M. Cen. Ont.	9VH	WINNIPEG DIVISION			Winnipeg
A.D.M. East. Ont.	8APP				
A.D.M. So. Ont.	8ZB				
A.D.M. No. Ont.	3NT				
Manager	3BE				
Manager	4GT				
Manager	4DE				
A.D.M. Sask.	4CB-9BX				
A.D.M. Manitoba	4DE				

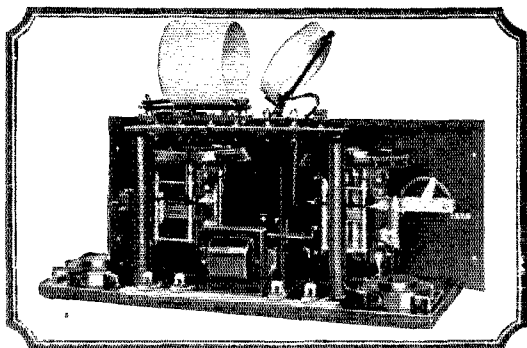

General view of interior CR-18

Front view of CR-18 with 200 meter coil intake and additional coil for 10, 20, 40 and 80 meter bands

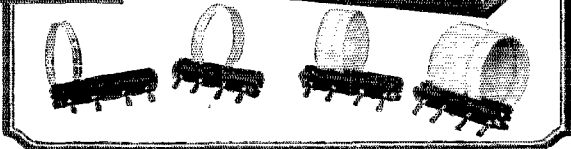
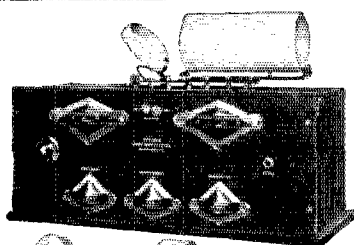

An Exceptional Receiver

for High Radio Frequency Reception

BEHIND the new Grebe CR-18 Low-Wave Receiver are seventeen years of experience in manufacturing radio apparatus. This modern coupled regenerative circuit is adapted for the reception of frequencies between 1500 and 30,000 kilocycles (10-200 meters). It has several outstanding features:

An *Antenna Coupling Coil* which provides variable electro-magnetic coupling between antenna and grid circuit. Permits of harmonic tuning to increase signal strength, gives greater selectivity and reduces interference and induction noises.

Losses are reduced to a minimum.

Plug-in Coils allow rapid change from one frequency to another.

Grebe S-L-F Condensers insure ease

of tuning and maximum signal strength.

Beat Frequency Control permits tuning to a fraction of a kilocycle.

Plate Circuit gives smooth control of regeneration without affecting wave-length calibration and tuning.

Cushion Sockets eliminate microphonic noises.

Six Self-Supporting Air Dielectric Coils are instantly interchangeable.

Write for detailed description of this, the last word in low-wave receivers.



A. H. Grebe & Co., Inc., 109 West 57th Street, New York

Factory: Richmond Hill, New York

Western Branch: 443 So. San Pedro St., Los Angeles, Cal.

It is written:

"Talking about virtue is not so good as practising it."

It is better to test the CR-18 for yourself than to rest with our recounting of its virtues.

Walter H. H.

The **GREBE**
CR-18

This Company owns and operates stations WAHG and WBOQ; also low-wave rebroadcasting stations, Mobile WGMU and Marine WRMU, and stations 22V and 2NE.



All Grebe apparatus is covered by patents granted and pending.



QST



The Official Organ of the A.R.R.L.

VOLUME X

JUNE 1926

NUMBER 6

Editorials	7
WWV May Suspend Transmission	8
Polarized Transmission	<i>Robert S. Kruse</i> 9
Of, By and For the Beginner	<i>J. T. McCormick</i> 17
High Adventure in the Northland	22
The Grebe CR-18	24
Amplifier Ins and Outs	<i>C. T. Burke</i> 25
Central Division Third Annual Indiana State Convention	28
A Multi-Stage Crystal-Control Transmitter	<i>John M. Wells & E. G. Tiltner</i> 29
The UX-874 Regulator Tube	32
Experimenter's Section Report	33
The West Gulf Division Hamfest	39
The Taurenwerfer Beam	<i>Morris Taurenwerfer</i> 40
Buying Inductances by the Inch	42
An Oscillator Without Battery or Transformer	<i>Allan T. Hanscom</i> 43
A.R.R.L. Standard Frequency Station 1XM	<i>Killian V. R. Lansingh</i> 45
The Maritime Division Convention	48
Amateur Radio Stations 4BY, c4GT, 7AY	49
The New England Division Convention	52
I. A. R. U. News	53
Volunteer Wanted for Standard Work	57
Pacific Division, Southern Section, Hamfest	57
Calls Heard	58
A.R.R.L. Information Service Rules	61
Correspondence	62
Ham Ads	89
QST's Directory of Advertisers	93

QST is published monthly by The American Radio Relay League, Inc., at Hartford, Conn., U. S. A. Official organ of the A.R.R.L. and the International Amateur Radio Union

Kenneth B. Warner (Secretary, A.R.R.L.),
Editor-in-Chief and Business Manager

F. Cheyney Beekley
Managing Editor and Advertising Manager

Robert S. Kruse,
Technical Editor

John M. Clayton,
Assistant Technical Editor

David H. Houghton,
Circulation Manager

Subscription rate in United States and Possessions, Canada, and all countries in the American Postal Union, \$2.50 per year, postpaid. Single copies, 25 cents. Foreign countries not in American Postal Union, \$3.00 per year, postpaid. Remittances should be by international postal or express money order or bank draft negotiable in the U. S. and for an equivalent amount in U. S. funds.

Entered as second-class matter May 29, 1919, at the post office at Hartford, Connecticut, under the act of March 3, 1879. Acceptance for mailing at special rate of postage provided for in section 1103, Act of October 3, 1917, authorized September 8, 1922. Additional entry as second-class matter, acceptable at special rate of postage provided for above, at Springfield, Mass., authorized September 17, 1924.

Copyright 1926 by the American Radio Relay League, Inc., Title registered at United States Patent Office.
Member of the Radio Magazine Publishers' Association.

THE AMERICAN RADIO RELAY LEAGUE

The American Radio Relay League, Inc., is a non-commercial association of radio amateurs, bonded for the promotion of interest in amateur radio communication and experimentation, for the relaying of messages by radio, for the advancement of the radio art and of the public welfare, for the representation of the radio amateur in legislative matters, and for the maintenance of fraternalism and a high standard of conduct.

It is an incorporated association without capital stock, chartered under the laws of Connecticut. Its affairs are governed by a Board of Directors, elected every two years by the general membership. The officers are elected or appointed by the Directors. The League is non-commercial and no one commercially engaged in the manufacture, sale or rental of radio apparatus is eligible to membership on its Board.

"Of, by and for the amateur", it numbers within its ranks practically every worth-while amateur in the world and has a history of glorious achievement as the standard-bearer in amateur affairs.

Inquiries regarding membership are solicited. A bona fide interest in amateur radio is the only essential qualification; ownership of a transmitting station and knowledge of the code are not prerequisite. Correspondence should be addressed to the Secretary.

OFFICERS

President
HIRAM PERCY MAXIM
 Hartford, Conn.

Communications Manager
F. E. HANDY
 Hartford, Conn.

Vice-President
CHAS. H. STEWART
 St. David's, Pa.

Treasurer
A. A. HEBERT
 Hartford, Conn.

Secretary
K. B. WARNER
 Hartford, Conn.

DIRECTORS

President
HIRAM PERCY MAXIM
 Drawer 4,
 Hartford, Conn.

Vice-President
CHAS. H. STEWART
 St. David's Pa.

Canadian General Manager
A. H. K. RUSSELL
 6 Mail Bldg.,
 Toronto, Ont.

Atlantic Division
DR. EUGENE C. WOODRUFF
 234 W. Fairmount Ave.,
 State College, Pa.

Central Division
CLYDE E. DARR
 137 Hill Ave., Highland Park,
 Detroit, Mich.

Dakota Division
C. M. JANSKY, JR.
 Dept. of Elec. Eng., U. of M.,
 Minneapolis, Minn.

Delta Division
BENJ. F. PAINTER
 424 Hamilton Nat'l Bank Bldg.,
 Chattanooga, Tenn.

Hudson Division
DR. LAWRENCE J. DUNN
 480 East 19th St.,
 Brooklyn, N. Y.

Midwest Division
PORTER H. QUINBY
 Box 134A, Route 6,
 Omaha, Neb.

New England Division
DR. ELLIOTT A. WHITE
 Dartmouth College
 Hanover, N. H.

Northwestern Division
K. W. WEINGARTEN
 3219 No. 24th St.,
 Tacoma, Wash.

Pacific Division
ALLEN H. BABCOCK
 65 Market St.,
 San Francisco

Roanoke Division
W. TREDWAY GRAVELY
 503 Main St.,
 Danville, Va.

Rocky Mountain Division
PAUL M. SEGAL
 c/o District Attorney,
 West Side Court Bldg.,
 Denver, Colo.

Southeastern Division
HARRY F. DOBBS
 c/o Dobbs & Wey Co.,
 Atlanta, Ga.

West Gulf Division
FRANK M. CORLETT
 2515 Catherine St.,
 Dallas, Tex.

Address General Correspondence to Executive Headquarters, Hartford, Conn

EDITORIALS

de AMERICAN RADIO RELAY LEAGUE



The Problem of Regulation

IF THERE is any more bedeviled an art than radio we want to know what it is. For eight unhappy years there has been an unceasing effort to secure a modification of the admittedly inadequate radio act of 1912 but still "ND". There is a fine mess of fish now created by the Government's test case against Zenith, with the implications the end whereof no man can guess. Anything can happen now. But, judging the legislative future by the past, it isn't likely that anything will happen, at least not very soon.

The Court's decision in the Zenith case disclosed a large and husky Senegambian who had been carefully concealed in the Department of Commerce's woodpile. Not that the Department and some of the more intelligent radio people like ourselves (ahem!) didn't know that he was there, but never before had the wood been neatly stripped away to leave him blinking in the sunlight before the gaze of the whole radio public. This mysterious personage was disclosed by the decision of Judge Wilkerson that it manifestly had been the intent of Congress, in framing the 1912 radio law, to specify in the regulations in Section 4 all of the regulations that could be applied to radio administration, and that, except in the few cases of specific discretionary power given the Secretary of Commerce, he is not authorized to apply and enforce the numerous other restrictions and regulations governing power, wave lengths, operating hours, and so on, with which we have become so familiar in recent years.

But is all now lost save honor, is chaos now upon us? Not by several picofarads! Fortunately the nature of the few cases of specific discretionary power given the Secretary is sufficient to preserve control of 98% of the broadcasting of the country, and that is where it was feared the bad boys of radio might be found. Let us look into this Zenith case a bit more. The thing revolved around Regulation Fifteen of Section 4, which says that no private or commercial station not engaged in commercial radio communication or in experimentation in connection with the development and manufacture of radio apparatus for commercial purposes shall use a wavelength over 200 meters except by special authority of the Secretary. The Zenith company held that they were engaged in the kind of experimentation mentioned, and therefore were

exempt from the necessity of having the Secretary's permission to use a certain wavelength, and that they therefore were entitled to follow the provisions of Regulation One which requires every such station to designate its normal sending wave, which shall not exceed 600 meters or shall exceed 1600 meters. The Court upheld their contention, and Zenith is thus free to select any wave it wants except between 600 and 1600 meters. However, this does not mean that all the applecarts are upset. By far the great majority of the broadcast stations, 98% of them it is said, are not engaged either in commercial radio communication or in the type of experimentation mentioned, and therefore get to operate in the present broadcast band only by the discretionary special authority of the Secretary, and thus remain in his control as much as ever.

But some of the implications of this decision are somewhat disconcerting to the amateur. For instance, it is emphasized that the garden variety of broadcasting station falls within that class of stations whose normal sphere of operation is the waves below 200 meters, and that any such station is entitled without more ado to invade the the short waves, provided in the process it can avoid running afoul of some other regulation or technicality. It is also made clear that the Department of Commerce has no legal right to impose on the stations eligible to operate below 200 meters any additional regulations not expressly written into Section 4 of the 1912 law or provided for therein. Thus wavelength assignments in narrow bands, quiet hours, limitations on types of apparatus—all may be held to be without legal standing. This applies not only to us amateurs but to every other class of station found entitled to operate on waves below 200 meters.

This situation has been no secret to the officers and the Legislative Committee of the A.R.R.L. They have known of it for years. In common with other radio interests, however, they have realized that the art has far outstripped the 1912 law, that the demand for radio channels is so pressing that no one interest has a right to more than it needs, and that as long as adequate legislation is withheld by the procrastination of politicians it is necessary to govern the art by extra-legal agreements arrived at in a spirit of mutual consideration and good-will. The national radio conferences of Secretary Hoover have provided that opportunity.

Now that it has been thoroly aired that the regulations applied to amateur radio at present are extra-legal, it seems necessary to do some very plain talking in these columns. We want to say that, law or no law, the American Radio Relay League stands four-square and solidly for the "gentlemen's agreements" of the Fourth National Radio Conference to which it is a party. It believes that the progress of the art and the changes in it in recent years have been so great as to indicate clearly the necessity for applying to radio administration some regulations that are in extension of the powers given the Secretary of Commerce under the 1912 law, and it subscribes to Secretary Hoover's plan of annual unofficial agreements within the art for that purpose so long as we have a hopeless radio law. All hands must admit that there is no other way out. The League believes that the agreements made at those annual conferences have a greater moral weight than would a claim to wholesale privileges invoked under the technicality that the 1912 law is still on the books. The amateur has fared well at those conferences; we have all the territory in the radio spectrum which we need, and about all to which we are morally entitled. Any amateur, therefore, who might be so foolish as to think that he can get away with operation on a wave length outside of the presently-authorized amateur bands is just begging for trouble—and it is very certain to hit him in the neck with a strength of R9.

Meanwhile there's a grand racket on in Congress about new legislation. In addition to the White and Dill bills, Senator Borah presented a somewhat similar bill providing

for regulation by an independent commission and containing very strong anti-monopoly provisions, so strong in fact that it is doubtful if the bill will find many friends. Then Senator Dill revamped his bill and now, instead of providing an advisory committee as proposed by Congressman White and in his own original bill, he has switched over to the idea of a governing commission, similar to the Interstate Commerce Commission, which would take radio control from the Department of Commerce and run it independently, reporting direct to the President. Nobody knows what is going to happen to all these bills. The Coolidge Administration wants the White Bill, with radio remaining under the Secretary of Commerce, with the commission and advisory one to the Secretary; the other bills are anti-administration. Politics is now controlling the situation. It will control both the choice of a bill and the decision whether there will be any action at all or not before Congress adjourns. This is election year and the boys are hot to get home and pass out the cigars. The fight over whether radio administration shall remain with the Secretary of Commerce or shall go to an independent commission promises to be a bitter one, and the best observers in Washington are of the opinion that nothing will eventuate before adjournment about early June. The League is studying the situation carefully to determine its action. It is sincerely to be hoped that matters have gone far enough now to impress upon the Fathers on the Hill the extreme desirability of early but well-thought radio legislation—but we doubt it.

—K. B. W.

WWV May Suspend Transmissions

WE are advised that the standard frequency transmissions from WWV may be suspended on the ground that the Radio Section of the Bureau of Standards feels that the work is no longer necessary. The Bureau feels that enough calibration services are now available so that WWV's work is less valuable than formerly, also that the coming of the crystal oscillator has reduced the need for WWV's work.

In view of the great enthusiasm with which 1XM's short-wave transmissions have been met this seems doubtful, especially as

there has just begun a movement to take greater care in the exact location of amateur transmitting wavelengths. The Technical Editor of *QST* feels that the loss of WWV would be serious. Furthermore, most of our sources of Piezo quartz crystals have just been closed, and very few laboratories are able to furnish accurate calibrations on our shorter wavelengths.

In view of these things it seems imperative that all A.R.R.L. members using the service from WWV notify the Bureau at once, sending a copy of the letter to the Technical Editor of *QST*. The Bureau may be addressed as, "Radio Section, Bureau of Standards, Washington, D. C."

—R. S. K.

Polarized Transmission

An Interview with Dr. E. F. W. Alexanderson*

By Robert S. Kruse, Technical Editor, QST

THE title of this paper, after the fashion of titles, is not exact for it suggests that ordinary radio transmission is *not* polarized. For the purposes of this paper, however, it is convenient to think of all radio transmission as being polarized, horizontally, vertically or otherwise.

As soon as that is said one automatically asks for the meaning of these terms; what does a vertically polarized radio wave look like—how does it differ from a horizontally polarized radio wave? Unfortunately it is practically impossible to draw pictures that will show the thing understandably, although one could make wire models to show it tolerably well. The best way of getting straight on the matter is to start with some familiar thing and work that to the polarized waves we are talking about.

Suppose that we consider the ordinary vertical antennas shown in Fig. 1a and 1b. At 1a we have a vertical Hertzian antenna suspended some distance above the earth. This antenna is supposed to have gone through several oscillations and is at this instant in the condition of having the greatest current at its center (at B). The shells surrounding it represents the electrical field. At the same time there is present a system of magnetic whirls about the antenna and these are shown at 1b. We will begin by calling this sort of thing a vertically polarized radiation, remembering that *both* the electrical field of 1a and the magnetic field of 1b are present at the same time, also that both are spreading in all directions, the diameter of the fields increasing with enormous speed. For instance the right hand edge of the magnetic field is rushing to the right at a speed of 300,000,000 meters per second.

The Electrical and Magnetic Fields

This point must be thoroughly straightened out before we proceed—we can *investigate* either the R. F. electrical field or the R. F. magnetic field but neither can *exist* without the other. The electrical field is sometimes mis-called the "static field" but that term is entirely incorrect for it means "stationary field" and is certainly not correct to speak of "static" fields when things are moving with the speed of light.

If that point is straight we can proceed to the reasonably plain statement that such

a combined field can be received (which means noticed) by means of either a loop or a Hertzian antenna. This point was considered in the paper on Dr. Pickard's ex-

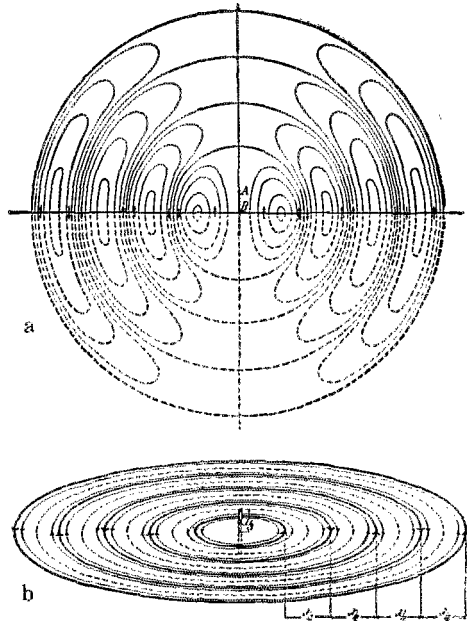

FIG. 1. THE FIELDS ABOUT A VERTICAL HERTZIAN ANTENNA
a—The electrical field, sometimes mis-called the static field.
b—The magnetic field.
Both are present at the same time and place; both are expanding with the speed of light.—Zenneck-Seeling "Wireless Telegraphy".

experiments in horizontal reception.' For convenience we can consider the loop as working on the magnetic part of the field and the Hertzian (straight rod) collector as working from the electrical field. This is shown in Fig. 2 which also shows the positions the two devices will assume for best reception near the sending station."

Marconi Antennas

Now we have fairly clearly in mind the thing we call a "vertically polarized radiation," but we have been thinking of a

* Consulting Engineer, General Electric Company and Chief Consulting Engineer, Radio Corporation of America.

1. February 1926 QST, Page 9.
2. At a considerable distance from the sending station these results are modified as explained in Dr. Picard's article referred to above.—Tech. Ed.

Hertzian sending antenna such as that shown in Fig 3a, neither end of the system being near the earth. When we use a Marconi antenna like that of Fig. 3b the lower half of the electrical field (the part dotted in Fig 1a) will be missing, because

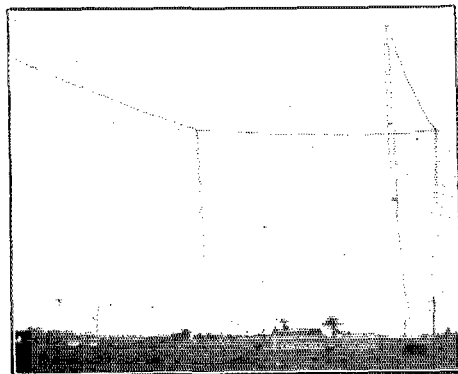

A VERTICAL AND A HORIZONTAL ANTENNA USED FOR COMPARISONS AT THE SOUTH SCHENECTADY DEVELOPMENT STATION

What appears to be a T antenna is really a horizontal Hertzian antenna fed by a 2-wire R.F. line which does not radiate appreciably—leaving the horizontal top alone to radiate.

Photos courtesy Mr. W. T. Meenam, Publicity Dept., General Electric Company.

it is cut off by the earth. This may be thought of as meaning that the advancing wave "drags its feet on the ground," there-

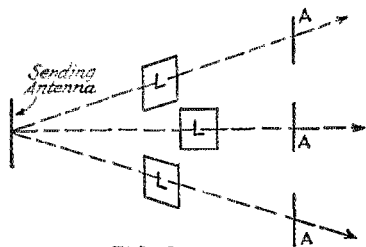

FIG. 2

RECEPTION FROM AN ORDINARY VERTICAL HERTZIAN ANTENNA

L L L Loops set for strongest signal.
A A A Small Hertzian receiving antennas set for strongest signal.

by wasting energy and slowing itself down a trifle. More of that later.

Effective Height

For years we have been using antennas that were grounded or else that had counterpoises rather close to the ground. These antennas were worked with more or less loading and under these circumstances (at

least if wavelengths of 300 meters or more were used) it was mainly the *height* of the antenna that mattered. Radio texts accordingly fell into the habit of stating that the vertical part of the antenna radiated while

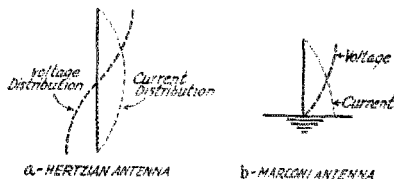

FIG 3 - ANTENNAS

VERTICAL ANTENNAS

- a Hertzian antenna which would have a field like that of Fig. 1.
- b Marconi grounded vertical antenna which would have the upper half of the field shown in Fig. 1 plus some earth current in the ground under the antenna.

the horizontal part (if there was one) did nothing but act as a loading capacity.

Very probably some of my readers have tried to understand this sort of statement and have wondered why it should be possible for a *vertical* wire with R. F. current in it to lose energy to the ether but the same wire placed *horizontally* (with the same sort of ether around it and the same sort of R. F. current in it) should suddenly be unable to lose energy to the ether. The explanation is simple—it isn't so. The texts did not state an untruth, they were merely careless in the way that they put their statement. What they meant to say

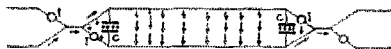
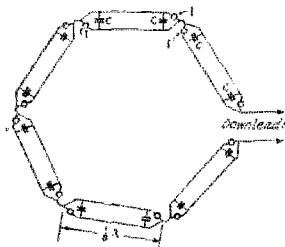

FIG. 4

CONSTRUCTION OF THE SPECIAL HORIZONTAL LOOP

C C C Condensers constructed as shown in photograph.

I I I Insulators breaking up each section.

The current flows thru the antenna as shown transferring from one wire to the other in each section. This series capacity neutralizes the inductance of the section at the resonance frequency.

was that with the sort of wavelengths we were then using and with the sort of antennas we were then using it was the vertical part of the antenna that produced the "distance effect." The horizontal part of

the antenna lost energy to the ether (radiated) also, but not in such a fashion as to have much useful effect at the receiver—in other words the horizontal wire did not contribute to the “distance effect” except by reason of the effect it had in causing more current to flow in the vertical wires—which is the capacity loading effect previously referred to.

Horizontal Radiation

Now it is not pretended that all texts were guilty of the statements just referred to but many were—and for that matter the statement fitted our old conditions—of

A—Loaded antennas.

B—Fairly long waves

C—Ground connection or fairly high-capacity counterpoise.

However as we went down as to wavelength a variety of peculiar effects began to be noticed. Some of us found, in tests with NSF, that some wavelengths could not be heard well close to the station but could be heard well at a distance. 1XAQ at Silver Lane, Conn., could not be heard at 1XAM, at S. Manchester, Conn., but got into Washington D. C. in good shape. We also found that wavelengths below 50 meters were quite likely to be *better* by daylight than by night. We began to notice all sorts of irregular effects. One of the newer of these effects has been that of receiving 40-meter signals *better* with a horizontal antenna than with the regular vertical antenna—as was explained in the article on Dr. Pickard’s work. Here was reception with an antenna having NO “effective height at all”—a thing which should not work if the waves were traveling as shown in Fig. 1. As was explained in that paper,

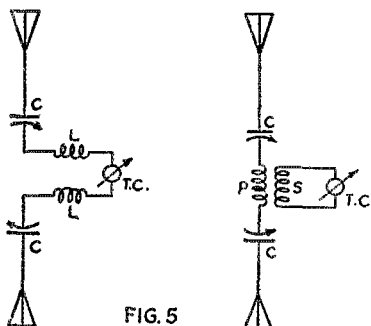

FIG. 5

CIRCUIT OF THE EXPLORING ANTENNAS
T.G. Thermo galvanometer.
C.C. Tuning condensers.

the only possible explanation was that the wave was either partly or wholly twisted around so that its axis was horizontal instead of vertical. Before this time a number of amateur stations had been sending

with horizontal Hertzian antennas (instead of the usual vertical or bent ones) and had been getting very decent results—which again was not in line with our notions on the ways radio waves act.

Dr. Alexanderson’s Experiments

These facts seem to hitch together plainly enough now, but at the time everyone seems to have overlooked what was going

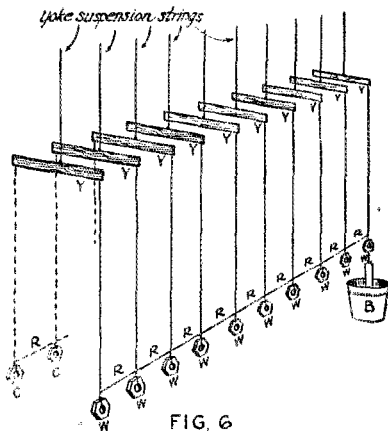

FIG. 6

THE POLARIZED WAVE MODEL

- W W W Brass nuts representing particles of ether.
- C C C Brass nuts acting as counterpoises to remove effect of gravity.
- R R R Rubber bands representing the elastic attraction between the particles of ether.
- Y Y Y Wooden yokes suspended to permit free vertical oscillations of W W W W.
- B Water bucket containing wooden paddle fastened to last weight. This water absorbs the wave and prevents it from being reflected back. The action is exactly similar to that of the resistance at the end of a Beverage wire.

on—namely that we were actually able to carry on 40-meter radio transmission and reception with sending and receiving antennas having zero “effective height,” showing rather plainly that the waves were *not* traveling in the fashion suggested by Fig. 1.

Dr. Alexanderson’s attention was called to these things by some effects which were noticed near the double loop antenna shown in one of our photographs. (Page 13) This antenna system was being operated for another purpose when it was noticed that the electrical field near the antenna was apparently of a “horizontally polarized” nature—that is it was possible to receive the signal with a loop laid down flat, in which position the loop will not pick up ordinary signals at all.

Work at different distances showed some additional peculiar effects and it was thought

worth while to put up an antenna system which would give out radiations almost entirely "horizontally polarized."

The Horizontal Loop

A special horizontal loop was built and tuned to 50 meters wavelength. This special loop is shown in the photograph on page 15. It will be seen that this is a very large loop for 50 meters. The size was made possible by the construction shown in Fig. 4. The series condensers are shown in the photograph (Page 13). The condensers are made of a pair of copper "cymbals" placed on a rod of treated wood or "mycalex" with a spacing of $\frac{3}{8}$ " between the flanges, giving a capacity of about .00035 microfarad (350 micromicrofarad).

Transmission Methods

With this antenna—or loop—a variety of peculiar effects was observed. To investigate these things still further a horizontal half-wave antenna was erected at the South Schenectady test station where it was occasionally used to transmit at 380 meters, using the regular WGY programs and getting reports on reception from broadcast listeners. In addition to this, various horizontal Hertzian half-wave antennas were put up in different places, these antennas being fed by 2-wire R. F. lines to make sure that only the elevated horizontal part radiated. At present there is also in operation a commercial station with a horizontal elevated Hertzian half-wave antenna fed by a 2-wire R. F. line. This station operates at approximately 16 meters wavelength and seemingly contradicts the skip-distance conclusions with regard to that wavelength. This station is located at "Radio Central", on Long Island, New York and with a power of about 10 K.W. handles commercial traffic to Monte

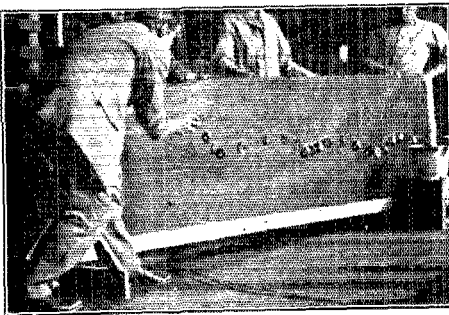

DR. ALEXANDERSON OPERATING POLARIZED WAVE MODEL

Grande in Argentina, about 18 hours per day. It can also be heard at some points

where there should be silence according to the skip-distance figures usually accepted.

The various effects referred to above need some explanation and that explanation can be given most easily by considering one example—namely the special 50-meter loop shown in the photograph and in Fig. 4. This loop was operated during the writer's visit to Schenectady and Dr. Alexanderson was kind enough to give more than a day and a half to some field demonstrations of the things that had been found out. The field near the antenna was explored with some "exploring antennas" somewhat like those shown in the photograph with the same caption. Being of later type these "exploring antennas" used improved connections as shown in Fig. 5. The scheme of using these things is simple enough. One tunes the circuit at the center to the operating wavelength and then maneuvers the "exploring antenna" around until the meter shows the greatest deflection, at which time the length of the exploring antenna lies along the lines of the electrical field at that point. If the antenna field is quite powerful this operation does not distort it too much. On the day at which we explored the space near the horizontal loop the electrical field showed an inclination of 45 degrees to the right of the vertical as one faced the transmitting station. This can also be stated in another way—namely that there was a vertical radiation and a horizontal radiation of about the same strength and that the two were in phase.

Corkscrew Waves

The next thing was to show what happens when one goes away from the antenna. Of course the exploring antennas will not work very far away from the station, even though there are several kilowatts of antenna energy. Therefore a loop receiver was used for explorations at greater distances. This set, operated by Messrs. Rockwood and Snyder, is of sufficiently unusual construction so that it deserves description in a later issue of QST. For the present it is enough to say that it is a thoroughly shielded 4-tube job with one stage of R. F. amplification and interchangeable tuning systems—and so built that it can readily be calibrated and therefore used to give field strengths in microvolts-per-meter. Dr. Alexanderson now turned his car into a radio exploration car and took us to various points where the set could be used a little ways off the ground. Some of these points were on bridges, others at the edge of sharp drops in the surface of the state of New York—places where the waves probably would not be especially deformed by objects near them, before reaching the receiving set.

Quoting from a paper by Dr. Alexanderson—"The composite picture which was ob-

tained from this test was a continuously twisting plane of polarization with alternate points of plane and circular polarization.

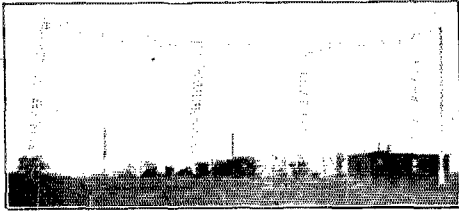

DOUBLE LOOP ANTENNA

The existence of horizontal radiation was first suspected when this signal put strong signals into "Radio Central" on Long Island although ordinary receivers near the station showed no response.

The plane polarization was indicated by sharp direction bearings while circular polarization was indicated by equal intensity from all directions. The observations indicating plane polarization sometimes gave bearings toward the transmitting station and sometimes at right angles. Besides these measurements around the vertical axis other observations were made with the loop in the horizontal plane. On flat fields the horizontal position gave nearly zero response. At the top of a steep hill and a high bridge the response in the horizontal plane was equal to the vertical. These results indicate the presence of a horizontal and a vertical wave component WITH DIFFERENT VELOCITY OF PROPAGATION.

Whenever the two waves (H & V) are in phase, they give plane polarization. When they are 90 degrees out of phase they give circular polarization. The observation with

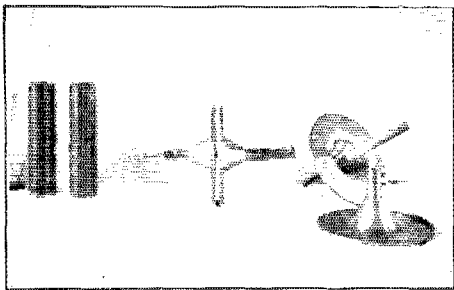

TUNING COILS AND CONDENSERS

The tuning coils are used in the downleads of the multiple-tuned antenna shown in another picture. The condensers are used in the multiple tuned antenna, also in the special horizontal loop and other special antennas.

the loop in the horizontal position on the top of the hill and the bridge show that even a moderate elevation is sufficient with short waves to reach the point where the hori-

zontal electromotive forces are not short circuited by the ground.

Making the Corkscrew Wave Visible

Again we have arrived at a point where we would like to have a picture of the thing we are talking about. This time the thing is possible—the picture can be shown. The newspapers have made familiar the apparatus shown in our photograph, "Dr. Alexander Operating the Polarized Wave Model" but have not furnished much of an explanation of its action. Unfortunately the photograph shows very little of the apparatus which is therefore shown in the sketch Fig. 6. Here the weights W W W W represent small portions of the "ether" we transmit through. Now these particles are supposed to hang in space but to be free to oscillate to some extent in any fashion, always being drawn back to their normal positions as if they were suspended in a rubber sponge or a jelly. It is therefore necessary to make the brass weights have inertia—which they naturally have—but to keep them from falling. Each weight is accordingly hung by a string from a light wooden yoke on the other end of which is hung an exactly

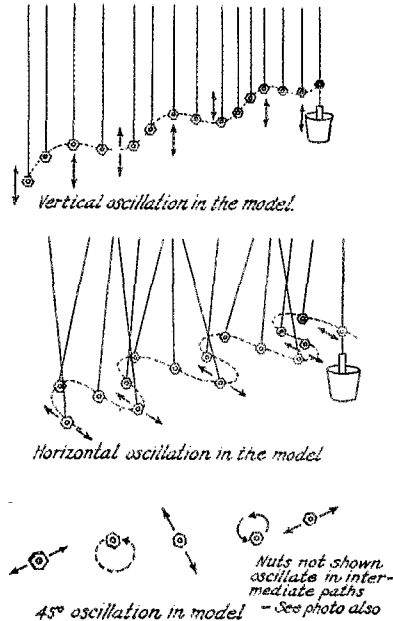

FIG. 7
EFFECT OF SENDING VARIOUS KINDS OF WAVES ALONG THE MECHANICAL ETHER-MODEL

similar weight C C C C C which is merely a counterpoise or gravity neutralizer. Thus each of the weights W can oscillate up and

down by rocking its yolk or can swing back and forth in any direction (because it is hung on a string). We have now made the weights free to oscillate in any fashion, just as can our theoretical particles of "ether". "A screen is set up so as to hide the counterweights and avoid confusion in observing the wave motion." To complete the model it is only necessary to imitate the elastic connection between the particles of "ether" and this is done by connecting the weights W W W W by means of rubber bands, R R R R R. There are 22 weights altogether, making a series long enough to observe the effects that have been tested in actual transmission by radio.

Dr. Alexanderson demonstrated the action of the model to the writer and explains it as follows.....

"We will assume that the medium through which the radio waves pass has such characteristics that the velocity of propagation for a vertically polarized wave differs slightly from the velocity of the propagation for a horizontally polarized wave. It is not necessary for the present purpose to try to explain the reason for this difference in velocity. We may assume that the reason for it is the electro-static or magnetic earth-effect or a retarding effect due to the closeness of the earth. Whatever the cause may be we may assume that such a difference of velocity exists and the mechanical model has been constructed so as to reproduce such conditions. The weights on both sides are tied together with rubber bands. Wave motion in the horizontal or vertical planes can thus be studied independently and these two wave motions may be adjusted for different velocities. A wave started in the vertical plane maintains itself vertically and a wave started horizontally maintains itself horizontally—(See Fig. 7.). "If, however, a wave is started in a plane 45 degrees between the V. and H. it is found that the wave motion proceeding therefrom assumes the shape of a spiral. (See photo of model.) The straight-line oscillation of the first weight is passed along as an elliptical motion which gradually (as it passes successive weights) widens into a circle. Then this circle narrows down again (as it passes still more weights) to an ellipse and finally a straight line at right angles to the original line of oscillation. (See Fig. 7.) This is exactly in accordance with the theory. The point where the wave has shifted its plane of polarization 90 degrees, is the point where the faster of the two waves is half a wavelength ahead of the slower wave. From this point on the wave proceeds, repeating this peculiar spiral motion. The fact that the twisting of the waves is due to different velocities in the two planes of polarization can also be demonstrated by this model. For this purpose rubber bands are added to the counter-

weights. The effect of this is to change the velocity of propagation in the vertical plane whereas the velocity in the horizontal plane has not been effected because only the vertical motion is transmitted to the counterweights by the suspension yokes. The system can thus be adjusted so that the velocities in the horizontal and the vertical planes are exactly equal. After this has been done it is found that the tendency to spiral motion disappears and the wave remains strictly in the plane in which it has started.

While this mechanical experiment does not bring out any facts that were not known

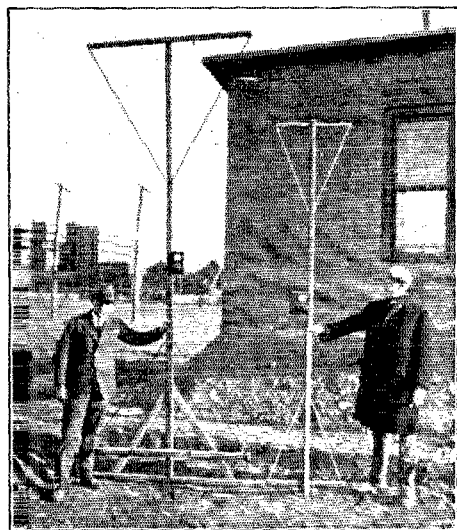

EXPLORING ANTENNAS. THE CIRCUIT FOR THE LATEST TYPE IS SHOWN IN FIG. 5

from the classical theory of wave motion it helps us to visualize the main phenomena in the radio wave propagation which we are trying to explain. The phenomenon of constantly shifting plane of polarization which we discovered experimentally in the tests between Schenectady and Long Island can thus easily be explained. This conception of the wave motion is also a help in explaining the phenomena of fading. There is much experimental evidence that fading is a phenomenon of wave interference. In other words the fading is due to the fact that the radio waves arrive at a certain point through two paths. The waves will sometimes add to each other and sometimes neutralize each other (more or less completely). If we keep in mind the observations on the mechanical model to the effect that the waves in two planes can be traced through separately and distinctly we may

conclude that the two paths of the radio wave which produce fading are not necessarily two separate physical paths but may be the two paths in the horizontal and the vertical plane of polarization. It is not hereby suggested that his mechanical equivalent is sufficient to explain the fading in actual radio transmission. It is offered for whatever it may be worth as a help to interpret the many observations in actual radio transmission which are being accumulated."

The Practical Effect

There are some things in radio that need explanation but which do not have such explanation at present. Dr. Alexanderson suggests that the irregularities of radio compasses (especially at sunset and sunrise), the failure to obtain a proper line of direction on an airplane which is sending with a trailing antenna and flying at a direction other than straight to or from the compass, the failure of these seeming errors of direction to show up when receiving with a Beverage wire—that all these things can be recognized as being the characteristics of waves partially polarized in a horizontal sense.

"The observation that the wave seems to come straight down from above (compass

case there is no direction indication, and the wave appears to come in from above this is also an illusion.

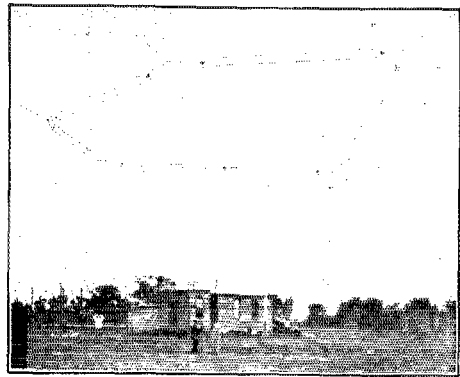

SPECIAL LOOP FOR SENDING HORIZONTALLY POLARIZED WAVES

The construction is shown in Fig. 4. The double downloads neutralize each other, leaving only the top to radiate. Current rush around this top in one direction and then in the reverse, producing a circular "drag" on the ether. Directly under the center of the loop (where Dr. Alexanderson is standing) there is no effect on the exploring antenna. The masts are of wood and the supporting ropes of tarred hemp to prevent distortions as far as possible.

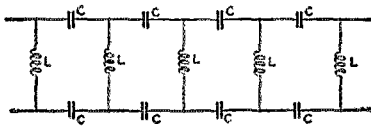

FIG. 8

THE CONNECTIONS OF THE MULTIPLE-TUNED ANTENNA SHOWN IN THE PHOTOGRAPH

C C C Condensers coupling the different sections.
L L L Tuning coils for adjusting the sections to operate in phase.

Note that the system acts as if it consisted of a number of T antennas end to end, each one having an inverted T counterpoise. The end section in this case is of L form, though it may be of T form. The currents in all downloads are in phase and practically equal although energy is fed to only one.

can be rotated about usual vertical axis without effect on signal) suggested an explanation that wave components radiated directly upward had been reflected down by the Kennelly-Heaviside layer. This explanation seems however less likely in view of the other facts to be considered. Putting all these facts together it seems now that the old observation on the long wave, the airplane and our recent work on the horizontal loop can all be explained as a characteristic behavior of the horizontally polarized wave. In all three cases the wave appears to come in from unexpected directions but actually it does not. When in the third

The question is: *what really does happen?* This is a problem on which the experiment with the mechanical model can throw some light. We must for this purpose return to the idea that the radio wave is a mechanical wave motion in the elastic medium ("ether"). In the model the weights represent the mass and the rubber bands the elasticity of this medium and the vertical as well as horizontally polarized wave can easily be reproduced, but when we are to imitate a wave motion over the surface of the earth, we must also in some way imitate the Presence of the earth. The earth is a conductor and therefore the elastic strains represented by the rubber bands cannot exist in the earth. Displacement currents in the electrical medium can, on the other hand, induce conduction currents in the earth. These currents are electrons in motion which can be represented by weights which are not tied together by rubber bands in the horizontal plane, whereas they are electrically associated with the electric medium above. To imitate this condition, additional weights may be hung from the weights W W by vertical rubber bands so that they are elastically associated by the wave medium but are not connected to each other. If now a horizontally polarized wave is sent through this system it is found that the wave motion is propagated to the vertically suspended weights producing elastic strains in the vertical rubber bands. We must now re-

member that the elastic strains represent E.M.F.s. and these strains so produced are of the same character as if they were a part of a vertically propagated wave motion. Actually no such wave motion exists and these strains are only the electromotive forces which produce currents in the ground!! A receiving loop set broadside to the advancing wave will not collect energy but the ground currents produced by the wave will put energy into the loop. The test for horizontally polarized transmission near the earth then becomes the ability to receive with a loop set broadside to the advancing wave—at right angles to the direction of the station. If this theory is correct the effect should disappear at some distance above earth and the horizontally polarized wave should show a line of direction if observed—for instance—from an

means that the irregularities of direction finder indications recorded on long waves



THE FIELD SET IN ACTION

Dr. Alexanderson is standing at the right. The loop is being maneuvered by Norman Snyder. The half-frozen person illustrates the way a Hartford citizen feels in up-state New York. Spring weather.

Photo courtesy Mr. Rockwell.

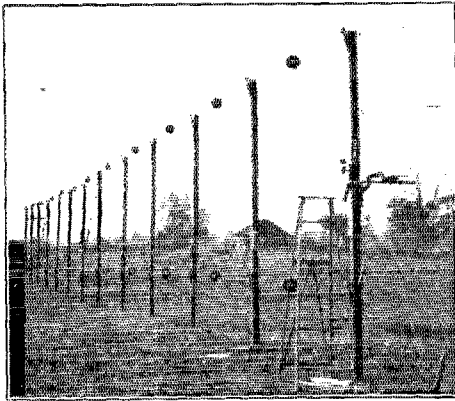

A MULTIPLE TUNED ANTENNA FOR SHORT WAVES

The connections are shown in Fig. 7. This type of antenna is also referred to as the "infinite velocity type" since the energy fed to one download appears in the same phase in all the other downloads. Note the condensers and inductance coils which are shown also in another photograph.

airplane. Using short waves the necessary distance from the earth can be gotten with apparatus as simple as a 60-foot wooden telegraph pole and this sort of test has been made at Schenectady. The results seem to confirm the suggestion just made. It is hoped that it will be possible to make airplane tests.

Concerning Long Waves

"Direct observation of horizontal polarization at long waves could be made only at great heights but indirect observations through the effect of ground currents can be made by ordinary direction finders at any wavelength. If this theory is correct it

can be explained by the presence of horizontally polarized wave components."

The Various Velocities

Some of my readers will doubtless be troubled by the suggestion that there are several speeds of travel for radio waves. We have become used to thinking of a fixed speed of 300,000,000 meters per second—or more correctly 299,820,000 meters per second. We know, however, that there are such effects as reduced wave velocities on wires, as is seen in the familiar Beverage wire where the advancing wave is able to build up the energy in the wire for only a certain distance and then gets ahead of the "wired wave" so that a longer wire is of no further use and a great increase in the wire length will actually result in a decreased signal. The reverse thing happens in the Alexanderson "Multiple-Tuned Antenna", such as shown in one of our photographs and also in Figure 8. Here the energy is fed into one of the downloads yet the currents in all the downloads are in phase if proper adjustment is made. Another way of looking at this is that an electrical wave motion has been sent through the system *instantly* so that it is at all downloads at once.

In this way one can see that the speed of waves in free space is one thing, while their speed when associated with a conductor is another thing entirely. This makes it seem quite plausible that horizontal and vertical polarization may produce different wave-speeds since they are not associated with the earth in the same degree.

Of, By and For the Beginner

By J. T. McCormick*

THIS article is meant for beginners and is written by a beginner. Old timers who need a good laugh are welcome. Come on in!

The writer (the beginner of the first part) has had poor luck in securing advice from old timers. They have *tried* hard enough, goodness knows! The difficulty lies in their not getting the beginner's point of view. Beginner's problems simply are not problems to the old timer—and there you are!

I recently began to "get out" with my first little "peep peep" station. I believe that an account of my experience in "getting on the air" will prove rather helpful to the fellow who is just a jump or two behind me.

My first crystal set worked "right off the bat" but my first transmitter has, er—taken some of the conceit out of me. Before receiving my license, I knew everything—yes, everything! I had built a neat little outfit, transmitter and receiver combined, somewhat as it appears in the photographs, but not quite! Changes have been made.

Trouble Begins

The original transmitting hookup was a master-oscillator power-amplifier affair, using a 96-volt storage B-battery for power supply. 201-A tubes were used. I fondly hoped to neutralize this thing on forty meters! I suppose it could have been done by using enough shielding, time and, possibly, separate batteries for each tube. I did not have sufficient patience, however. Neutralization not being entirely necessary, it remained unneutralized.

My license finally arrived and I set out to "knock 'em dead" with low power. I had no meters and so was using the usual flashlight bulb to indicate resonance in the antenna circuit. I had no difficulty in tuning the plate circuit of the power amplifier to resonance with the master oscillator. A flashlight bulb shunted across the antenna pick-up coil did the trick. When I tried to tune the antenna to resonance, however, I ran into difficulties. I did not have enough antenna current to light the bulb. I had forgotten the radiation resistance!

I finally conceived the idea of placing the bulb in the tuned plate circuit of the power amplifier. The bulb, by the way should be inserted in the lead going from the variable condenser to the plate of the tube. If it is placed in the other condenser lead, the current is too great and it will burn out. When the antenna circuit was then tuned more or less to resonance the bulb went out.

Simple! The bulb was then short-circuited by means of a switch provided for that purpose. Fine! I now knew, at least, that I was radiating *some* energy.

Next, I wanted to know what my station sounded like on the air. I tuned my receiver to forty meters. There was nothing but a "swish" to indicate that my transmitter was oscillating. I had expected this, however. The transmitter oscillations being comparatively strong, the receiver was drawn into unison with the transmitter. I next tune the receiver to twenty meters. Ye gads! the wave was afflicted with St. Vitus dance! I loosened the antenna coupling. Much better! I loosened it still more.

I next made a discovery. I listened on eighty meters and found that the wave seemed much steadier than when I listened on twenty. A little thought solved this mystery. For every change in frequency made by the transmitter its second harmonic goes through a change of frequency twice as great. When I listen on twenty meters I was listening to the second harmonic of my transmitter and things sounded twice as bad as they really were. When listening on eighty meters I was listening to the

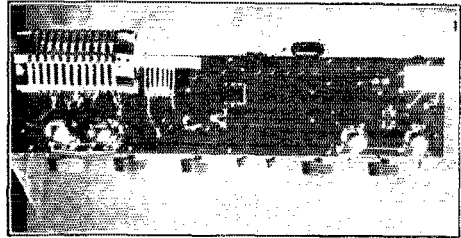

TOP VIEW SHOWING THE VARIOUS SWITCHES REFERRED TO IN THE DIAGRAM

main wave of the transmitter *with* the second harmonic of my receiver.

All this sounds as if I had been holding the key down for hours. Not so. I believe that a fellow ought to have some sort of an idea as to what he is trying to find out before he starts to test. If I do not hear what I want to hear within a minute or two, it is time to "shut 'er off" and think it over again.

I next tried working the key. Another problem! My note had a terrible "tweet". By "tweet" I mean that the wave "skidded" every time I pressed the key, so that I heard only the dots and the beginning of the dashes or else heard only the tail end of the dashes—depending upon how I tuned

* 9BHR, 1221 Monroe St., Topeka, Kans.

the receiver. I knew, in a general manner, the cause of this, but try, as I might, I could not eliminate that "tweet". It seemed that the tube impedance began to change the instant the plate current started to flow and continued to change for a considerable fraction of a second. While the tube impedance was changing, the frequency was also changing. I did not try to "work" anybody. No one could have read such a note—though lots of folks never seem to think of that.

A Simpler Set

I suppose I should have "stuck to my bush", but I did not. I decided to work with something simpler and so discarded the whole master oscillator scheme.

I had been using a C-battery in the old hookup and continued to use it in the new one.

Grief and more grief! The same old "tweet" persisted. Moreover, I now had no means of tuning my antenna to resonance. I decided to light up that antenna "ammeter" or go broke. I went to the nearest radio store and spent thirty dollars for another 96-volt storage B-battery and two dollars for a Bradleyohm to serve as a grid leak.

Glory be! My "ammeter" lit! The variable leak eliminated the "tweet". When the leak was properly adjusted, my note began to "toot", as it should, instead of "tweeting". If you do not understand what I am trying to say about "tweeting" and "toot-

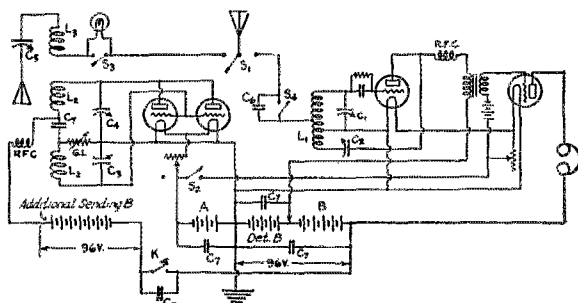

THE TRANSMITTER-RECEIVER DIAGRAM OF CONNECTIONS

- C1 Tuning condenser for receiver secondary.
 - C2 Feedback or regeneration condenser of receiver.
 - C3 and 4 transmitter primary tuning condensers. These really should be the two halves of a double condenser.
 - C5 Antenna-tuning condenser of the transmitter.
 - C1, C2, C3, C4 and C5 are all receiving-type condensers with plates of a shape to give an approximate straight-line of setting against frequency. Their capacity is about 250 micromicrofarads each, though that can be changed to suit one's personal notions as to proper tuner ranges.
 - L1 Receiving tuner coil—in this case having 18 turns on a 3-inch diameter with a filament tap at the 13th turn and an antenna tap at the 12th turn. Other coils can be used for other wavelength ranges.
 - L2 The split sending helix, best described by the photos.
 - L3 The antenna helix, 5 turns of No. 14 cotton-enameled wire.
 - S1 and S2 The two blades of the send-receive switch, which may be seen on the top of the cabinet in the photographs. The blade marked S1 transfers the antenna while the blade marked S2 cuts off the receiving filaments whenever the switch is on the sending side.
 - S3 Antenna-lamp shorting-switch, to be seen on the top of the set in the photographs.
 - S4 Switch to short out small fixed condenser in series with the antenna. Opening or closing this switch shifts the antenna tune and avoids difficulty in making the receiver oscillate. This switch can be seen on the cabinet near the receiving coil.
- The condenser C6 may have a capacity of 250 micromicrofarads (.00025 microfarads) or thereabout.
- All the other small fixed condensers marked C7 may have any capacity above 300 micromicrofarads (.0003 microfarads).
- K—Key.
- RFC Conventional R. F. chokes of 1" diameter with single-layer winding of finest wire available—no bigger than No. 30.
- GL Variable gridleak—a fixed one may be used.

I chose the series-feed balanced Colpitts circuit popularized by Hoffman of the Burgess Laboratories and used in the set which was built for the Wilkins north-pole expedition. This hookup was simple and would use all three of the variable condensers which were already mounted in my outfit. I did not use a grid leak, however.

ing", listen to the crystal control stations—they "toot".

I was now nearer than ever before to having a real station, but was still far from the goal. The wave was swinging much worse than had been the case when using the master-oscillator power-amplifier arrangement. I loosened the coupling until it looked

actually foolish. The swinging was improved by this, but not nearly enough. My next act was to give the neighboring BCLs a treat. I went out and guyed my aerial and counterpoise at short intervals with cotton string. (If you laugh, it shows that you don't know anything about "forty meters", so there!)

I tested again. Eureka! The wave was not entirely steady, but was good enough to try. Now to work someone! Anyone! I was really not very confident of the result. An interval of two months or so had elapsed by this time since receiving my license. Little things—such as continuous failure—have a way of undermining a fellow's faith.

I spent the remainder of the afternoon and evening trying to "raise" somebody. I called CQ (properly); I answered other fellows' CQ's, but without response. It was finally time to go to work (I work at night) and failure was still mine. (No sleep that day, of course.)

All night long, while at work, I pondered over the problem. I remember what the old-timers have told us so often—that the amount of antenna current is no indication of how well we are getting out. I had noticed, while adjusting the set, that oscillation did not seem to be very strong at the high frequency end of the forty meter band.

I had supposed this to be due to the peculiarities of the choke coil—or some such thing. I now viewed the matter in a different light. "Perhaps," I thought, "oscillation is just as strong at this end of the band as at the other, but the antenna current is less because of increased radiation resistance!"

The following day I tuned the set as near to the short wave end of the forty meter band as I dared. It was necessary to couple the antenna coil closely in order to find resonance, afterward loosening the coupling until the wave was sufficiently steady.

Success at Last!

9CFN was on the air. I called him with as much outward confidence as if I was in the habit of working the antipodes daily, but I had an inward conviction that my signals were having a struggle to cross the county line. I threw the switch to the receiving side—expecting nothing.

I want to tell you, fellows, that the sound of my own call letters zipping through my phones was the sweetest music I had ever heard in my life! I shall never forget it during the rest of my days. The music in Heaven will doubtless prove to be a distinct disap-

pointment to me, provided, of course, that I—

Habit kept my pencil going, but my thoughts danced about in chaotic ecstasy. (I am getting poetic, but dang it! I have to express myself, don't I?) 9CFN had finished and was waiting for my answer. I grasped the key. Something was wrong! It had turned into a "bug" key! I sent a string of dots at about sixty per. Perhaps I was nervous. I tried using both hands. This only made it twice as bad.

Horrors! I could not answer him! I wept and overturned my chair in excitement. My wife came running—convinced that lightning had struck the shack at last! She found me leaning weakly against the

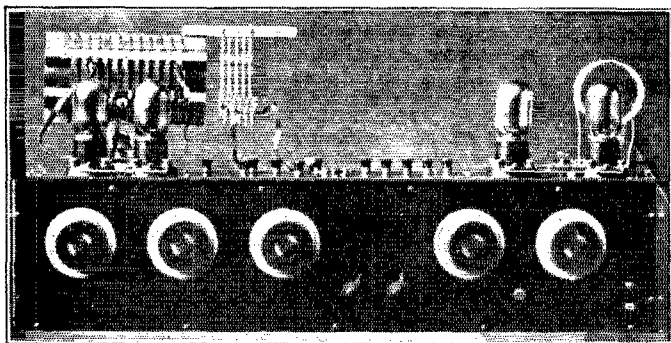

FRONT VIEW OF THE TRANSMITTER-RECEIVER

From left to right the controls are, the two primary-tuning condensers of the transmitter, the antenna-tuning condenser of the transmitter, the rheostats of the sending and receiving sets respectively, and finally the receiver tuning and regeneration condensers.

wall, gasping for breath. I grinned an idiotic grin. "Gosh! Mom", I sputtered, "I worked a fellow!"

Sure, go ahead and laugh, but see what happens when you work your first station.

I was working too near to the edge of the forty meter band to be absolutely sure that I really was inside of it. Therefore, I went out and added a few feet of wire to my antenna for the purpose of increasing the radiation resistance in the middle of the band. I intend to stick right there—in the middle of the band until I know my "stuff" better.

After working a few stations, I made another discovery. I found, while testing for "swinging", that a goodly portion of the unsteadiness was caused by my wife walking under the electric light fixtures. Experiment showed that the signal disappeared completely when the fixture was actually touched with the hand. This was true of any fixture in the house—and I lived in an apartment house! I solved the difficulty by establishing a local "ground" for the lighting circuit by grounding it through a condenser taken from a Ford Coil. This is as good as an actual ground so far as radio frequencies

are concerned and it will not blow your fuses if a plug happens to get turned around.

I worked more stations. By the time I had worked an "8", nearly a thousand miles distant, I was growing more and more proud of my outfit and more and more ashamed of my operating ability. Learning the code and the Q signals does not make an operator. My station has been "off the air" for some

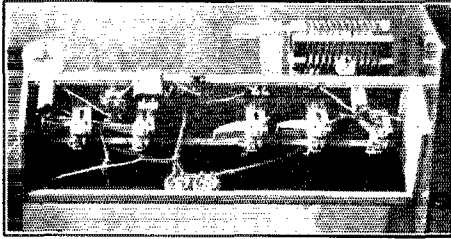

THE SET ROLLED OVER FORWARD SHOWING THE GENERAL CONSTRUCTION

time. At present, I am just listening to the other fellows while I try to learn something about good operating-practice. Try to learn something about operating while you learn the code, fellows, it will save you time and embarrassment.

The Transmitter-Receiver Combination

My outfit, taken as a whole, probably will not appeal to many of you. It contains some ideas, though, that are worth passing along. The most outstanding feature is the "top-panel" idea.

I had never liked cabinet sets. Parts are usually too crowded and many things which should be accessible are far from being so. Bread-board sets have the disadvantage of being hard to keep clean—variable condensers especially.

The "top-panel" arrangement solves these difficulties. Condensers are under cover, out of the dust, and there is no danger of their adjustment being spoiled by accidentally striking the rotor plates. The top panel provides a place to anchor your variable condensers when setting them back from the front panel—and they should be set back. Merely grounding the rotor plates is not sufficient on the short waves. Condensers should be set back and provided with an extension shaft made of some insulating material. I use celluloid knitting needles. (They call 'em "amber".) These needles are sufficiently flexible to take care of any slight misalignment. The metal dials shown are not grounded. They are allowed to "float free".

Coils, tubes and sockets are out in the open where you can get to them. Necessary controls, such as switches, grid leaks etc., are accessible and yet are not on the front

panel where they would cause body capacity effects.

The bulk of the wiring is out of the way beneath the panel so that the set is easily kept dusted by means of a soft paint brush which is kept on hand for that purpose.

All parts are held high above the table and are fastened to the rubber panel—a good dielectric. Rubber panels are O. K. if care is taken to so locate the set that the sun never shines directly upon it.

Square wooden end pieces and wooden strips to re-enforce the panel edges form all the "cabinet" that is necessary.

The combination of both transmitter and receiver in one unit may be considered to be a poor idea by some, but I like it. My old short-wave receiver being a makeshift affair, it was necessary that I build a new receiver when I built my transmitter. By combining the two, I saved time and expense. No matter what kind of transmitter I eventually keep for regular use, this outfit will always serve for emergency use. Since it operates from the same batteries as the receiver, it is always ready.

One of the little "kinks" in the set is the use of glass eye-cups to support the inductances. These cups may be purchased at the corner drug store. They are fastened to the panel by means of three brass machine screws placed in a circle about the base of the cup. The receiving inductance merely rests in the hollow of the cup, four leads being carried to four binding posts on the panel. A plug-in arrangement would be handier. The primary transmitting inductance is lashed to its cup with cotton thread. The secondary (antenna coil) supported by the primary, being held in place by rubber bands.

This secondary coil is wound with number 14 cotton-enamel wire over six celluloid strips. (Larger wire would be better.) The primary is wound with copper ribbon taken from a Ford magneto. The construction has been previously described in *QST*. The same copper ribbon, slightly twisted, is used for flexible leads. It is also used for all the wiring in the radio frequency circuits of the transmitter.

Most of the parts used came from the "junk box." Two of the dials came from a "defunct" super-heterodyne; three from a neutrodyne. That is how the transmitter happens to be equipped with vernier dials. Straight-frequency-line condenser are, of course, unnecessary in a transmitter, but this type happened to fit best into the mounting scheme. A great deal of cheap apparatus has been used. Cheap parts are sometimes good, but it is always good policy to "work them over" because they are usually carelessly assembled.

The diagram shows the manner in which the same batteries are used for both transmitting and receiving. Placing the key in

the position shown eliminates much unnecessary switching. In fact, no switches at all are needed if a separate antenna is used for receiving—although you may find the clicking of the key in the 'phones too annoying.

Two switches are necessary if the same antenna is used for both transmission and reception. These two switches are shown separately in the diagram for the sake of simplicity, but are in practice, combined in the form of a D.P.D.T. switch. S2 prevents the receiver from howling when S1 is thrown to the transmitting side.

The filament current is left turned on in the transmitter at all times to keep the set from being off-wave when first starting transmission. When it is desired to have both transmitter and receiver operating simultaneously for testing, the switch is thrown to the transmitting side and S2 is short circuited by means of a spring filing clip, such as is used in office work.

Please take note of the switch which shuts the flashlight bulb in the antenna circuit. Even if the resistance of this bulb was constant, we would not want it in the circuit. The resistance, as you know, increases as the filament heats and this, alone, will put a serious "tweet" in the note.

The conductive coupling used in the receiver is undesirable if you are bothered with local interference. Capacitive coupling can, of course, be used without adding additional coils, but I find that its use either gives diminished signal strength or else cuts down the tuning range of a given coil—depending upon the amount of capacity used. Loose inductive coupling is probably the best. In case you wish to use the conductive type, remember that a little goes a long way. One fourth of one turn is more than ample on forty meters; one turn is more than enough for eighty, etc.

I have but one antenna, a forty-meter affair (more horizontal than vertical), which is used for all wavelengths in receiving. This means that thirty turns of primary are necessary for broadcast reception—which is unsatisfactory, even then. A push-pull amplifier is plugged in in place of the 'phones and a loud speaker added when the need for music is felt.

The two binding posts at the right on the front panel are used for attaching the key instead of using a jack. A jack sometimes provides an uncertain contact. In the key circuit, the loose connection is not instantly discernable, as is the case with a 'phone jack. The 'phone jack, by the way, would be better located if placed farther to the left. The 'phone cord is eternally in my way when copying.

Battery leads should be cabled. A closed loop, formed by these leads, can absorb a lot of energy. If the A negative lead goes to a rheostat, carry the A positive right

along with it and right past the rheostat. Long battery leads sometimes cause howling on the shorter wavelengths. The remedy is to shunt all leads with fixed condensers at the set.

Any conclusions that I may make should not be taken too seriously. They should be taken for what they are—the conclusions of a newcomer in the transmitting game.

I believe that a beginner should start with low battery-power, not because that happens to be what I am doing, but for real reasons. Such an outfit may be harder to get into action, but that only means that the beginner will learn things *now* which will have to be learned sooner or later, anyway.

A beginner starting with a lot of power and a raw AC note is going to spoil the fun for somebody. The power will provide plenty of key-clicks to annoy the BCLs and the rotten note is going to keep some other fellow from working DX or building his message total. We are green, fellows, and we may even get off of our legal wavelengths and interfere with some other service. That means trouble for everyone.

I think that the majority of the old-timers are glad to have us come into the game. Let us do everything possible to help them keep that attitude. We are going to be old timers ourselves some day.

HOT DOG! I'M RADIATING
A HALF-INCH BLISTER!



302 HAVING NO RADIATION
METER ADJUSTS HIS FIVER
UNTIL HE GETS THE BEST
BURN

Strays

When old Fred Schnell left Hartford we thought that the call, 1MO, would leave us too. Not so. Miss Dorothy Menk, formerly Fred's "secretary," and now Heavy Man to Handy, is a full-fledged ham operator, and she was tickled pink when the supervisor gave her 1MO as a station call.

High Adventure in the Northland

This Summer's Arctic Expeditions Depend on Short-Wave Amateurs For Their Contact With Civilization

ABOUT the most interesting thing in short-wave radio this summer is the several Arctic expeditions racing to be the first to visit the Pole by air and the first to explore the vast unknown area which lies between Alaska and the Pole. Chief among these are the Detroit Arctic (Wilkins) Expedition, the Byrd Expedition, and the Amundsen-Ellsworth Expedition.

It takes so long between the time a story is written for a monthly magazine and the time it reaches the reader that it is almost hopeless to present an interesting account of developments, but there are things about the radio activities of these expeditions which are of the highest interest to us, so we shall try.

The Wilkins party has continued to have its share of thrills. Their overland party, with Waskey as radio operator, finally reached Point Barrow on April 26th after a heart-breaking trek of 600 miles, which took them seven weeks. Believe us, Bob Waskey will know he has been someplace when he gets home! The party ran short of grub and had to shoot some of their dogs, either because they could not feed them or, one report had it, because they had to eat the dogs for food. Finally they succeeded in killing enough game to revive both men and dogs (the dogs that were still alive, we mean) and pushed on. The gas-engine generator for the permanent set at Barrow (ex-NRRL) however was abandoned 160 miles out of Barrow, and a special fast party is being sent out from Barrow to retrieve it. Then there will be real communication down to the States, and something we can all listen for.

During the overland party's seven-weeks mush, Waskey was in communication almost every night with Mason, back in Fairbanks, using the little battery-operated set which Mason had built, on a portable aerial. This set has two 201-A tubes, supplied by Burgess batteries. It is certainly wonderful the way those batteries lasted, particularly in the temperature of 35 below. The marvel is not that Waskey occasionally failed to get thru but that his set did so well over a length of time much greater than planned on.

Meanwhile Wilkins has been freighting gasoline and supplies between Fairbanks and Barrow in the small Fokker, carrying the Hanson-built radio set. On his third trip the radio went out after three hours and nothing more was heard of Wilkins for two weeks, while an anxious world wondered about his fate. We learn that he burnt out

his wind-driven generator and so was unable to communicate. He arrived at Barrow safely but that night the tent hangar burned down, damaging the propeller of the plane so badly that two weeks were required to repair it with the limited facilities available. When the overland party was known to be approaching, a fast sledge was sent out to get Waskey and his set and bring them into Barrow in advance of the main party, and it was through Waskey and his little set that the world first learned that Wilkins was safe!

At this writing the big 3-engined Fokker is ready to shove off from Fairbanks, and then Mason will move to Barrow too, contact thereafter being from the main station at Barrow either to Fairbanks and thence

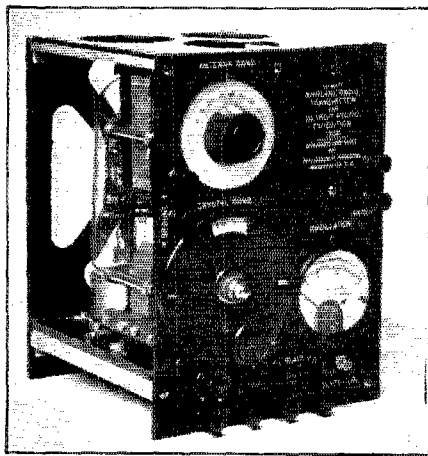

THE AIRPLANE TRANSMITTER built by Malcolm P. Hanson for the Detroit Arctic Expedition. It has a power of 50 watts, is crystal controlled, and weighs but 7 lbs. complete with tube and crystal.

by cable, or, if conditions permit, direct with U. S. amateurs, particularly 9EK-9XH. For his communication with Waskey, Mason has been using the Burgess-built portable set described in our columns, and this set probably will be installed on the big Fokker when it leaves Fairbanks.

Mr. Malcolm P. Hanson, ex-9XM, has kindly supplied us with a description of the airplane set he built for the smaller Fokker, and which on the first two round-trips to Barrows provided constant contact with Fairbanks, 560 miles air-line. This is a 50-watt crystal-controlled set, operating on

46 and 61 meters (6518 and 4915 Kc.). A wind-driven generator supplies 10 volts for the filament of a UV-203-A and 400 volts for the plate. Low voltage must be used because of the limitation placed by the crystal, but a heavy plate current may be drawn and an output of 30 to 35 watts is obtained. A hand-driven gear arrangement with a speed ratio of 50-to-1 is also provided for emergency driving of the same generator in the event of a forced landing and engine failure. However, it is all one man can do to supply the power for a 50-watt for one minute with this arrangement, and so for such emergency communication a UX-210 7.5-watt with a 50-watt base is carried. The set is keyed in the C-battery line of the grid circuit, and is inductively coupled through pancake inductances to the aerial circuit. When operating on the ground, on an aerial suspended from the wing-tip, an aerial condenser is used and the coupling is adjustable; in flight, however, the coupling is tightened and no condenser is used, the aerial being tuned by adjusting the length of the trailing-wire antenna. The antenna ammeter is located in the hollow center of the antenna reel. This set is 9 $\frac{1}{2}$ " high, 7 $\frac{1}{2}$ " wide, 6 $\frac{1}{2}$ " deep, and weighs but seven pounds with tube and crystal. The complete installation, with generator, emergency hand-gear and three spare antenna weights, weighs 58 pounds. Many very nifty constructional features are embodied in the set, which we regret space does not permit us to describe in more detail. We understand that Mr. Hanson has supplied an exact duplicate of this set, except that the shorter wave is 43 meters, (6973 Kc.) for the big Fokker plane of the Byrd Expedition as well.

The Byrd Expedition at this writing has just arrived at King's Bay, Spitzbergen, and unloaded its airplane. KEGK, the "Chantier", base ship of the expedition, continues to dump fine signals into the States. The receiver on the "Chantier" is one of the new Grebe short-wavers but the transmitter again is the work of Mr. Hanson, who is making quite a reputation for himself as the designer of short-wave apparatus for exploring parties. Mr. Hanson accompanied KEGK across the Atlantic, making final adjustments and tests of the equipment, and has now returned. KEGK has two 250-wattors supplied with 500-cycle juice. On the 40-meter band the set uses a tuned-grid tuned-plate circuit after the fashion of KFUH, with the tubes in parallel, but for 20 and 13 meters it uses a radio-frequency push-pull ("back-to-back") circuit with floating filaments. The main ship's antenna is used, operating at harmonics, against a variable single-wire counterpoise.

In addition to the airplane set for the Fokker which Hanson built, the expedition also has a combined transmitter and receiver donated by Robert D. Russell of

Wellesley, Mass., which will be used either on the smaller plane, a Curtiss "Oriole", or for the advanced base or for lifeboat use.

Many stations have worked KEGK, mostly on the 37.5-meter wave. Our description of the equipment is taken from a 300-word message Mr. Hanson sent to the Editor via 1AMD, Providence, as KEGK approached the shores of England.

KEGK Schedules

Now that the "Chantier" has reached Spitzbergen, regular operation is being undertaken on the shorter waves. The location of a powerful set at a respectable distance, anxious to communicate with this country, gives us short-wave amateurs an ideal opportunity to try some of the shorter waves. Several rather scrambled sets of advices have reached us from the "Chantier" but from which it seems that KEGK will now pursue daily the following schedule of short-wave operation *in addition to all previously-announced schedules*. Experimental schedule daily on 12 meters (25000 Kc.) at 1720 G.M.T. or 12:20 p.m. E.S.T. Experimental schedules daily on 20 meters (15,000 Kc.) at 2020, 2220 and 0020 G.M.T., or 3:20 p.m., 5:20 p.m. and 7:20 p.m., E.S.T. In these 12- and 20-meter schedules, KEGK will call "CQ Test" for five minutes, then listen for five minutes, so on alternating for a half hour on each schedule. From 0220 G.M.T. on (from 9:20 p.m. E.S.T., on) KEGK will be on 25.7 meters (11,670 Kc.), presumably for regular traffic work. We have received no advices, however, of the abandonment of the normal wave of 37.5 meters (8000 Kc.). News bulletins for "The New York Times" are to be broadcast daily. League members receiving such messages are requested to wire the "Times" to that effect, whereupon if the message has not already been received from other sources the paper will be glad to arrange for its transmission to them at their expense.

Meanwhile the Amundsen expedition is ready at King's Bay to receive its dirigible, the "Norge", in which it is planned to fly across the Pole and the unexplored area to Pt. Barrow, Alaska. Unfortunately the "Norge" carries no short-wave radio, as far as we have been advised. Instead she is equipped for various commercial wavelengths which we seem to remember as fitting between 600 and 1600 meters. This is too bad, as such waves probably will prove useless during the time when they may be most needed. "The New York Times" is greatly interested in this expedition and has taken out a license for a station at Pt. Barrows, chiefly in this connection. The call is KDZ and the station is licensed for 21.4, 42.08, 74.77 and 149.2 meters (14,000, 7125, 4010 and 2010 Kc.). We understand that at this writing a cor-

respondent and an operator are mushing to Barrow to operate this station, still being some two weeks out.

It looks like it's going to be a great summer for the folks on the top of the earth, and we may expect to get in on it. As usual, please report any contact or interception to Headquarters, so that we may keep the story up to date.

—K. B. W.

The Grebe CR-18

THE latest addition to the short wave family is the set manufactured by Grebe and called the CR-18. It is an addition we have been looking forward to and expecting for some time.

A glance at the photographs and the circuit will show you that the "18" is an old friend of ours; plug-in coils, throttle condenser, regeneration control, variable primary coupling, spacewound coils, low capacity grid condenser and correspondingly high grid leak resistance, a detector and a stage of audio amplification. In place of the usual R.F. choke in the primary of the amplifying transformer a 25,000 ohm "grid leak" resistance is used.

The secondary tuning condenser C has a maximum capacity of 130- μ fd. It is shunted by a vernier condenser consisting of a single plate widely separated from another single rotor plate. The maximum capacity of the vernier condenser is about

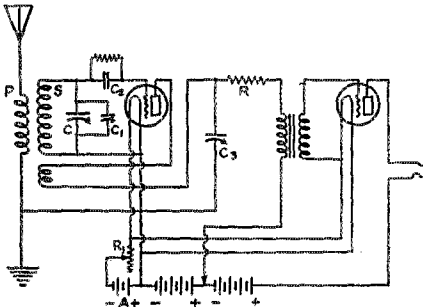

FIG. 1. THE CR-18 CIRCUIT
 C—Maximum of 130 μ fd.
 C1—Vernier of 3 μ fd. maximum capacity.
 C2—40 μ fd.
 CR—226 μ fd.
 R—25,000 ohms.
 R1—10 ohms.

3- μ fd. The throttle condenser as well as the tuning condenser is of straight frequency line type, the Grebe condensers being quite small with correspondingly restricted fields. The grid condenser has a capacity of 40- μ fd. and is shunted by a

7-megohm leak. The tube slides into oscillation smoothly with a barely perceptible "plop." The regeneration control is remarkably smooth and free from dead spots.

The coils are of the Hammarlund spacewound type using No. 16 S.C.C. magnet wire, space wound on a transparent dielectric. The turns are spaced ten to the inch. Secondary and tickler coils are mounted on the same plug-in block fitted with G-R plugs. The primary coupling coil has eight turns. The coil is hinged so that the coupling can be varied. With the five coils available the tuning range is from 8.5 meters (35,000 K. C.) to 216 meters (1,380 K.C.).

By means of the very small vernier condenser quite accurate tuning can be accom-

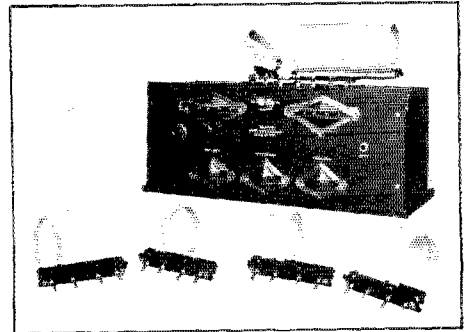

FIG. 2. THE RECEIVER WITH ALL COILS
 Note that the coils are plugged in way up in the air, and that the lid of the cabinet does not have to be opened to accomplish this.

plished with the minimum amount of conformation. We wish that the tickler coil had been made much smaller and that the antenna coupling coil had been placed at the same end of the secondary as the tickler.

The receiver operates entirely satisfactorily and the workmanship is of the usual Grebe excellence.

—J. M. C.

Strays

Speaking of that low power transmitter, a nice form of plate supply with rectifiers can be obtained by using a Kenotron rectifier tube operating from a step-up transformer. The model 216 is available through the American Sales Company for \$1.85. At this price one can afford to use this tube in a B-battery eliminator, as a rectifier for low power sets and even paralleled for higher power operation. Single tubes will safely handle up to 600 volts at 50 or 60 milliamperes.

Amplifier Ins and Outs

By C. T. Burke*

IN designing an amplifier, two things are to be considered; what goes in, and what it is desired to have come out. Barring set noises, no more can get out than went in. Lots that goes in does not come out. This is frequently a blessing. We have heard amplifiers that almost completely eliminated the saxophone from an orchestra. This was distortion, but the effect was most pleasant.

The broadcast listener, being a glutton for punishment, usually wants to hear the music just as it is produced at the studio, saxophone and all. That is, he is after "quality" (the term applies to the production, not the entertainment.) The amateur on the other hand is interested only in noise. Quality requires even production of all frequencies. In telegraph work, the received signal is at a single frequency. A transformer intended for this purpose only, should amplify only a narrow band of frequencies, so that interfering noises at other frequencies are cut out. A recent QST article dealt with this type of transformer.¹

An audio transformer may be reduced to the filter circuit of Fig. 1 which is a band pass filter. The inductances are the coil and leakage inductances. The capacities are coil capacities, tube capacities across the primary and secondary, and any condensers that may be added. By properly proportioning the constants of this circuit, a band as wide or as narrow as desired may be passed. This is not as easy as it looks,

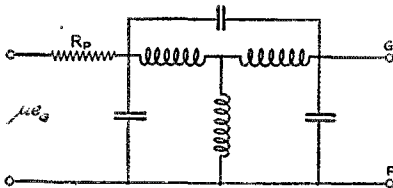

FIG. 1

FILTER CIRCUIT EQUIVALENT TO AUDIO TRANSFORMER

By proportioning the constants a band of desired width may be passed.

however, as the constants are not generally independently variable, and changing one in the direction you want to go usually sends all the others the opposite way. For broadcast work the band should extend roughly from 100 to 5000 cycles. For tele-

graph work, it should be from 800 to 1200 cycles approximately.

With the transformer design established, the characteristic may be changed a good deal by external tuning. This is generally ruinous to broadcast quality, but may be helpful in telegraphic work. This is discussed at greater length in the latter portion of this article.

The problem of "quality," by which is meant the accurate and faithful reproduc-

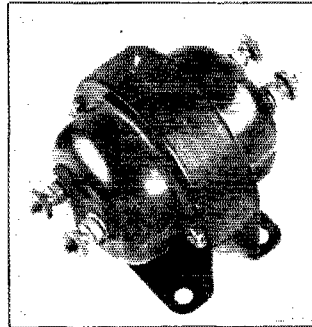

Transformer A. The familiar General Electric "distortion transformer," designed for 500-cycle spark reception or other signals giving a 1000-cycle tone. Also known as UV-712.

tion of the matter sent into the air at the broadcasting station, is three-fold; embracing tubes, transformers, and loudspeakers. As each phase of the subject is worthy of individual consideration only the second, that of transformers, will be considered here. The other two should not be forgotten, however, for the amplifier cannot be much better than its poorest element. Perfect transformers will not compensate for improperly biased, overloaded tubes or a squawky loudspeaker.

As magazines are printed, not broadcast, it is necessary to compare transformers on paper. The means of doing this is to reproduce the "amplification curve." The data for this curve is obtained by measuring the amplification at a number of frequencies. A curve is plotted of amplification against frequency, and as the principal source of transformer distortion is unequal amplification of different frequencies, a study of this curve shows even more definitely than the ear could, just what is the relative rating of two amplifiers. It is not necessary to have the curve a straight horizontal line, which would indicate the perfect amplifier. A variation of twenty-five

* Engineer, General Radio Company, Cambridge, Mass.

1. Page 29, April, 1926.

percent would not be perceptible to the average ear. The frequencies above five thousand may be lost without serious loss of quality. The curve should remain high for frequencies at least as low as one hun-

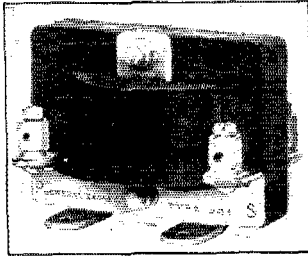

Transformer B. General Radio Type 231. The transformer used to obtain the "B" curves was actually of another make but had properties similar to the one shown.

dred cycles. Probably the most interesting part of the curve is that between one hundred and five hundred cycles. Most of the older transformers failed to amplify in this range, and its full amplification is essential to natural sounding music. In order to study this part of the curve, which is crowded at the lower end, a special method of plotting the curves has been resorted to. Instead of making the distance along the frequency scale proportional to frequency, it has been made proportional to the logarithm of the frequency. The effect is similar to that obtained with the "straight line frequency" condensers now so popular. The lower end of the curve is opened up, spread over more space.

Just how much transformers have improved during the last few years is apparent from the curves of Figure 2, which

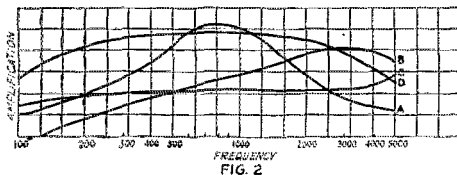

CURVES OF REPRESENTATIVE TRANSFORMERS UNDER NORMAL CONDITIONS

A and B are older types. A being deliberately designed to produce an 800 cycle peak. Peaks similar to those of A and B are sometimes produced unintentionally by an inferior design.

show the characteristics of four transformers of different vintages. Transformers A and B are of the older type, designed before the period of development of quality reproduction. No's. C and D are both "new

era" transformers. The difference between the new and the old is very noticeable. A has a marked peak at about eight hundred cycles. This frequency would be amplified to a much greater extent than those above and below, resulting in bad distortion.² B lets through practically nothing under one hundred cycles and has but half its maximum amplification at four hundred cycles. Many frequencies that go into this amplifier do not come out. The result of this type of distortion, the loss of the low frequencies, is to give music a harsh mechanical sound. The transformers of curves C and D are a vast improvement over these earlier types, and are typical of several transformers making their appearance during the past year. The deviation of the maximum and minimum from the average amplification over this range is so slight as to be barely noticeable to the ordinary ear.

An interesting and important fact is discovered when the turns ratio of these four

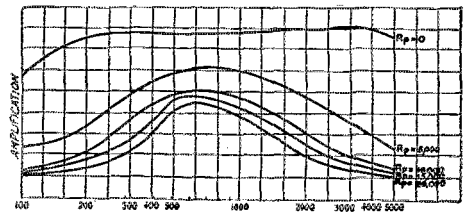

FIG. 3

THE EFFECT OF VARYING THE PLATE IMPEDANCE OF THE PLATE WORKING INTO TRANSFORMER A, WHICH HAS A LOW PRIMARY IMPEDANCE

When the plate impedance equals that of the ordinary receiving tube (12,000 to 15,000 ohms) the curve is very peaked.

transformers is considered. A had 8.5:1, B 3:1, C 2:1, D 6:1. Note that the 8.5:1 transformer has a lower amplification than the 6:1 over practically the entire frequency range, and at both ends passes below even the 2:1. Another interesting point is that the 3:1 transformer distorts to a much greater extent than the 6:1, despite the popular idea that low ratio transformers necessarily have better characteristics than those of high ratio.

It was not entirely without reason that high ratio transformers have been viewed with some suspicion. Notice again the curve of the 8:1 transformer. This is typical of the older style high ratio transformers. The loss of the high frequencies is easy to understand. The coil capacity acts as a by-pass for these frequencies, short-circuiting them to the ground. The loss of the low notes is due to the fact that the

2. Or else in good distortion—depending on the viewpoint. This transformer was originally produced for reception from 500-cycle spark sets. Such sets produce a 1000-cycle tone, practically in the peak of the transformer.—Tech. Ed.

primary turns were kept low in order to get a high turns ratio with a small coil. The result of this practice may be explained with the assistance of the curves of Figs. 3 and 4.

In the audio amplifier, the transformer primary is connected in series with the plate impedance of the tube, which is about 15,000 ohms for the common types of receiving tubes. A considerable portion of the voltage supplied by the signal is used up in this impedance. The portion of the voltage left across the transformer primary depends upon the relation of transformer impedance to the total impedance of transformer and tube. Thus if the tube impedance is 15,000 ohms and the transformer impedance 30,000, two-thirds of the voltage will be impressed across the transformer primary. It will now be seen why a high ratio transformer sometimes gives less amplification than one of low ratio. Suppose a 5:1 transformer had 150,000 ohms impedance at a certain frequency. Another transformer with an 8:1 ratio has but 15,000 ohms impedance in the primary. Both are used with a 15,000-ohm tube, with 10 volts available. The 5:1 transformer will have 150,000/165,000 of 10 volts or 9.3 volts across the primary. Assuming no losses the secondary voltage would be 47 volts. Only 15,000/30,000 or 5 volts will be

former varies over the frequency range. This, of course results in distortion (unequal output of different frequencies). Distortion due to this cause can be reduced by means of a high primary impedance. The input to the transformer cannot be greater at any frequency than the tube voltage. If at the lowest frequency it is intended to amplify, the transformer impedance is three times the tube impedance, the input will not

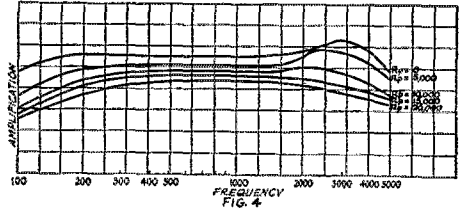

THE EFFECT OF PLATE IMPEDANCE ON THE OPERATION OF TRANSFORMER, D WHICH HAS HIGH PRIMARY IMPEDANCE

The curves of Fig. 3 and 5 show the importance of making measurements with a resistance in series with the transformer primary. Otherwise an entirely false impression may be conveyed.

less at any frequency than 75% the tube voltage, that is, not more than 25% difference in amplification of different frequencies can occur. On the other hand, if the transformer has but half the tube impedance at this frequency, the difference will be 65%.

The curves of Figure 3 were taken on transformer A, using different values of plate resistance. If the plate resistance could be reduced to zero, even this transformer would give little distortion. The curve becomes more and more peaked as the value of R_p is increased, and the amplification per stage is greatly lessened. In Figure 4 is shown a similar group of curves for transformer D. This is a transformer of high primary impedance, 155,000 ohms at 1,000 cycles as compared to 15,000 for A. It will be seen that while the curve is better for the lower plate resistances the difference is much less marked than in the case of A. The advantage of a tube of low impedance is obvious. That is one of the advantages of the new R.C.A. tubes.

We have shown the essential requirement of equal amplification of all frequencies to be a high and nearly equal impedance of all frequencies. This is accomplished by the use of many turns of wire, with a large core of high permeability steel, and by proper coil design, avoiding capacity that acts as a by-pass for high frequency. This requirement may be met in a transformer of high ratio as well as one of low.

So far we have been dealing with the problem of the manufacturers. They have met it with surprising success, as several of the new transformers show. It is up to the builder to make the best use of the

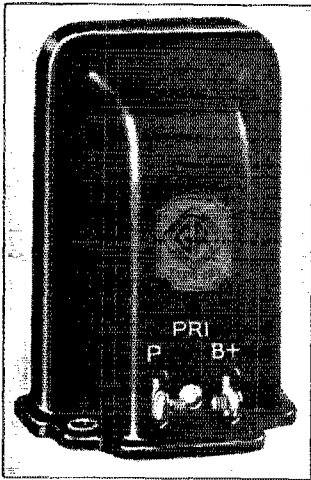

Transformers C. and D.—Modern "flat core" transformer used in making the C and D curves. C is general Radio Type 285L, having a turn ratio of 2:1 which D is type 285, having a turn ratio of 8:1.

impressed across the primary of the 8:1 transformer, with a secondary voltage of 40.

As the transformer impedance varies with frequency, while the tube impedance remains constant, the input to the trans-

manufacturers' efforts and not spoil the result by touches of his own.

Many radio builders think it an advantage to shunt their transformers with condensers or grid leaks. While this practice sometimes helps to improve quality with the old type transformers, with a transformer of good design it generally ruins quality.

A condenser across the primary of the first audio transformer is usually advisable, and may be as large as .005 microfarads without affecting the faithfulness of reproduction. Devices across the secondary are particularly harmful. Fig. 5 shows the effect of several sizes of condensers and grid leaks across the secondary. The effect of the condensers on transformer A (shown in the upper half of the figure) is to make still more marked the peak in the central portion of the curve. The high frequencies are cut off with increasing effectiveness as the sizes of the condensers are increased. It is interesting to note that at some frequencies resonance effects carry the curves with shunting condensers above the normal curve.³ The use of grid leaks improves the quality with this poor transformer. With a leak of 1.5 megohms, a curve similar to B of Fig. 2 is obtained. This curve is poor but somewhat better than the normal one. When the shunting resistance is reduced to 200,000 ohms a very flat curve is obtained, but the 8:1 transformer gives less amplification than a 2:1.

The effect of shunting condensers across

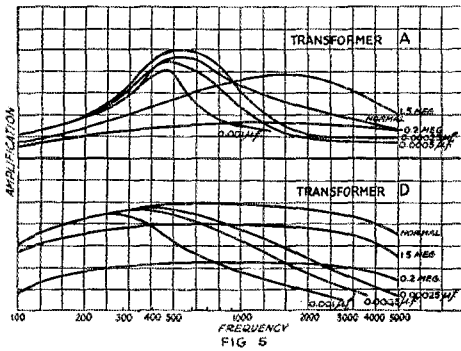

A GROUP OF CURVES SHOWING THE EFFECT OF SHUNTING VARIOUS DEVICES ACROSS THE TRANSFORMER SECONDARY

The upper group was taken with transformer A, the lower on transformer D. Note that the distortion transformer can be made to give a flatter curve with lesser amplification but that the same devices applied to the transformer D caused the curve to become both lower and more peaked.

the secondary of transformer D is similar to that observed in A. The amplification of high frequencies is greatly reduced, with

3. This is helpful when the transformer is used in radio telegraphy. The .00025 condenser produces a noticeable improvement for this service. C. T. B.

the point at which the curve falls coming farther toward the low frequencies as the condenser size is increased. The improvement in quality gained by shunting the secondary with a resistance is not so marked as with the badly peaked transformer. A great loss of volume is caused by this practice. With the 200,000-ohm resistance across the secondary the amplification is cut approximately in half, with no great improvement in quality.

The radio set can be made to reproduce music as faithfully as the average phonograph, or even more so. If this is to be accomplished the whole amplifying and reproducing system must be laid out with this purpose in view. Good transformers must be used, in the way the manufacturers intended them to be used. Tubes must be properly biased, and not overloaded, and finally, all other precautions are in vain unless a good reproducer is used.

Central Division, 3rd Annual Indiana State Convention, July, 30-31, 1926

AT South Bend, Indiana, under the auspices of Old Timers Radio Club, this will be held. Take notice ye Hams of Indiana and neighboring States ye are cordially invited to attend this third A.R.R.L. Conclave to be holden in Ye Hotel LaSalle. Special hotel rates of \$1.50 to \$2.50 have been offered by ye management.

Ye Committee desires to say it is planning a real hamfest full of A.R.R.L. spirit as it was and is. Sight-seeing tours, swim at nearby lake including a "feed" and good meetings are all a part of the program.

Send in your reservation to A. R. Kahn, 9-CCL, Convention Secretary, 1069 Riverside Drive, South Bend, Indiana.

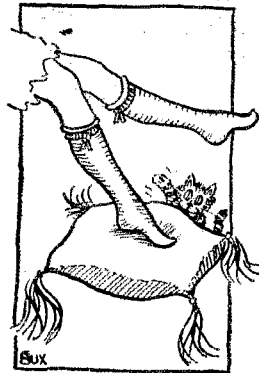

CUSHION SOCK-ETS

A Multi-Stage Crystal-Controlled Transmitter

By John M. Wells* and E. D. Tillyer**

The authors explain the construction and adjustment of a crystal controlled transmitter in which a thick crystal is used to control a low-power tube. Amplification is carried on through two low power stages operating on harmonics of the crystal oscillator. Such a transmitter gets around a lot of difficulties which may be experienced when using a relatively thin crystal, and amplifier stages operating at the crystal frequency.—Asst. Tech. Ed.

MUCH has been said and written lately on the subject of crystal controlled transmitters. It might not be amiss, however, to review briefly the distinct advantages of this form of transmission before going into details of the transmitter herein described.

In the first place when using crystal con-

ceiver stays the same pitch, assuming of course, that the receiver stays constant. This means that the signals will be much more readable than is usually the case with the present day short-wave amateur transmitter.

In the second place, the use of crystal control is *very* helpful in obtaining a *splendid* note.¹ It is com-

mon for an amateur to find that, on short waves, his note becomes very rough and hard to read in spite of the fact that a direct current generator is being used, or a source of well rectified and filtered A. C. is on hand. Such has been the case at 1CAK. Using filtered motor generators the note has been reported as being anything from "fair A. C." to "raw A. C." at the receiving end. With the advent of crystal control the note has always been reported as "pure D. C." In fact many amateurs have asked if storage battery plate supply was being used. Since crystal control has been used at this station there has been no change in the previous plate supply.

The answer to this phenomenon is probably found in the fact that the cause of most poor notes on short waves is not necessarily

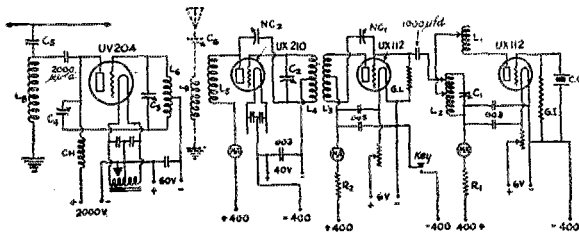

FIG. 1. THE THREE-STAGE POWER-AMPLIFIER CRYSTAL-CONTROLLED CIRCUIT

- R1, R2 12,000 ohm Lavite units.
 C.O. Piezo-electric crystal. About 320 meters for operation in 80-meter band; 160 meters for 40-meter operation. Using 2nd harmonics throughout.
 L1 200 turns No. 24 D.C.C. wire on form 2 3/4 inches in diameter. Coil tapped at 5 places.
 L2 13 turns No. 18 bare wire on form 3 inches in diameter, spaced 12 turns per inch, and tapped in the center and also 3 turns from one end.
 L3 8 turns No. 26 D.S.C. wire wound over exact center of L4, Empire cloth insulation between. A tap is taken off at the center.
 L4 8 turns No. 18 bare wire on 3 inch form, spaced 12 turns per inch with a tap at center.
 L5 3 turns No. 26 D.S.C. wire wound over exact center of L6, Empire insulation, and tapped in center.
 L6 7 turns No. 16 bare wire 3 inch form, spaced 6 turns to the inch and tapped in center.
 L8, L9 Antenna inductance for antenna you use.
 C1 G-R 500- μ fd.
 C2 ditto 250- μ fd.
 C3 Cardwell 450- μ fd. transmitting condenser.
 C5 Small antenna coupling condenser for Hertzian antenna.
 C6 Antenna series condenser, maximum of 100- μ fd.
 NC1 Small neutralizing condenser.
 NC2 Pyrex tube and brass rod condenser. Must stand oscillating voltage.
 C4 Neutralizing condenser, maximum capacity around 70- μ fd. Use a G-R midget vernier immersed in automobile oil.
 CH Radio frequency choke for parallel feed.
 G1 Varies with crystal. Usually around 1/4 megohm.
 GL About 1 megohm.

control, the emitted frequency remains absolutely constant when the circuit is properly set up, irrespective of any changes in the antenna or tube circuits. The note in the re-

* 1CAK, 17D, 1XAX of Southbridge, Mass.

** Research Laboratory, American Optical Company, Southbridge, Mass.

¹ Anyone who has heard NKF, 4BY, 2WC, 1AXA, 4FM, 4BK, 4XE as well as 1CAK will testify to the beautiffulness of the crystal controlled note.—Asst. Tech. Ed.

in the poor plate supply but is due to *changes in frequency* in the transmitter. These changes take place for a number of reasons. Vibration of the building and the apparatus plays an important part. Any changes in the plate voltage tend to create variations in frequency. Probably irregular heating of the tube filaments by alternating current supply has an effect upon the constancy of the frequency. The use of crystal control

Another trouble experienced by a great many transmitter builders is that it is difficult to control a large tube with a small master oscillator. In the case of a crystal-controlled transmitter this can be done if the circuits are designed and set up with care. As will be shown later the transmitter used here is controlled by a $7\frac{1}{2}$ -watt oscillator which feeds a 250-watt power-amplifier with normal plate voltage but somewhat increased plate current in the oscillator tube.

Due to the fact that each power-amplifier tube (except the last one) is tuned to a harmonic of the preceding tube self-oscillation troubles are eliminated to a large extent. This makes the set unusually stable for a power-amplifier type of transmitter.

Contrary to expectations it was found to be quite simple to shift from one waveband to another, it merely being necessary

to change the crystal and retune the circuits with the condensers. If content with slightly reduced output on 40 meters, the 320-meter crystal can be left in place and the shift from one band to another becomes even simpler. The only real difficulty in tuning is in the original set-up and proper adjustment of inductance and neutralizing condensers, which remain fixed (except in the last stage) when once properly tuned.

The Various Circuits

In order to set up a transmitter of this type there is only one way to proceed in order to get quick results. Take each tube circuit separately before starting to build the next one. Make the crystal oscillator work before you build any of the amplifiers,

obviates these effects. With crystal control and a moderately good source of plate supply, the note will be pure.

There are several difficulties encountered when one constructs a crystal controlled transmitter. Some of these have been eliminated in the present set. First of all it is difficult to obtain satisfactory crystals for transmission purposes. They are expensive to buy and if one attempts to cut and grind them the work is difficult and the certainty of good crystals is not sure.² When one comes to crystals which oscillate in the 40- and 80-meter bands the problem becomes worse. Also at these frequencies the trouble of breakage becomes important. The trouble with thin crystals can be eliminated by the use of relatively thick ones even though the set is operated in the 80-40- and even 20-meter bands. For 40- and 20-meter work crystals oscillating around 160 meters are used, and for 80-meter transmission crystals having a wavelength near 320 meters are employed. As a matter of fact crystals oscillating around 320 meters or 240 meters can be used to work in the 40-meter band with slightly reduced outputs. Using a 320-meter crystal the writer has put 300 watts into a 250-watt tube on 40 meters.

² In addition it is understood that quartz as found in the U. S. is not suitable for piezo-electric crystals. Most of the crystals we know of have been extracted from quartz coming from Brazil or Madagascar. The U. S. quartz is usually too full of flaws, cracks, bubbles, phantoms and twins.—Asst. Tech. Ed.

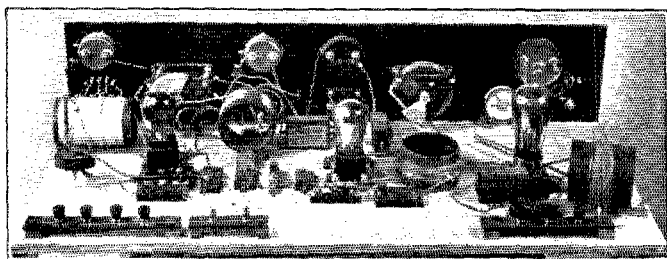

FIG. 2. CRYSTAL TUBE AT LEFT, 1st POWER AMPLIFIER STAGE IN CENTER AND SECOND AMPLIFIER AT RIGHT

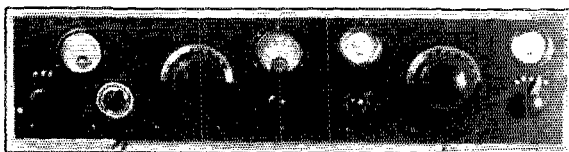

FIG. 3. FRONT VIEW OF SET SHOWN IN FIG 2. NOTE THAT ALL IMPORTANT CIRCUITS HAVE METERS

and after the C. O. is perking add a stage of amplification; after this is working put on another stage and so on. The photographs, diagrams and diagram explanations should be sufficient to give the constructional details. The complete circuit is shown in Fig. 1. The crystal oscillator is a UX-112 with 400-volt generator supplying plate voltage through a 12,000 ohm resistance. The second tube is also a UX-112

with the same plate voltage. The third tube uses a UX-210 with 400 volts direct to the plate. These three tubes are shown in Fig. 2. These three tubes in the circuit shown make a very excellent low-power crystal-controlled transmitter—one that anyone can afford to build. The unit comprising the circuit thus far described should be the start of almost any kind of crystal-controlled transmitter. Any additional stages of amplification one desires can be added to this original unit. As a low power set this unit makes an excellent 'breaking into crystal transmission' layout. A 50-watt can be added later on, and can be substituted for the 204 power amplifier to be described later on. The antenna is coupled to the inductance L5, as shown in the dotted lines.

Going back to the circuit, the inductance L1 may have to be tuned with a variable shunt condenser in some cases. The grid leak may have to be varied, also, with some crystals. The crystal holder consists of two parallel brass plates between which the crystal is placed. About one quarter of a millimeter spacing is left between the crystal and the top plate. The original crystal holder was mounted to hang from a hook, suspended by rubber bands, but later this was found to be unnecessary.

The inductance L2 is tuned by condenser C1 to a harmonic of the crystal. When working in the 80-meter band, using a 320-meter crystal, this coil is tuned to 160 meters. For 40-meter transmission, with a 160-meter crystal, this coil is tuned to 80 meters. It can also be tuned to 80 meters when using a 240-meter crystal for 40-meter transmission. If a 320-meter crystal is used for 40-meter transmission we have found in practice that it is *much better* to use the following set-up: oscillator tube tuned to 320 meters, first amplifier tuned to 160 meters, second amplifier tuned to 80 meters and the final stage to 40 meters. As a crystal oscillator tube it was found that the UX-112 provided greater stability than 201-A when using full power.

The first amplifier also employs a UX-112 tube. For best results it has been found necessary to neutralize this tube in spite of the fact that only harmonics are being used. The grid leak value is not critical. Keying is done in the negative lead of the first amplifier. The fact that there is a high resistance in series with the plate of this tube makes keying relatively easy, and also helps to eliminate key clicks.

The second amplifier tube is a UX-210. The same 400-volt generator is used here with full voltage on the tube. The neutralizing condenser is a Pyrex tube with a brass rod inside and a copper sleeve outside. The condenser must stand considerable electrical strain. The inductance L4 is tuned by condenser C2 to some harmonic (usually the 2nd) of the preceding tube.

When using the 250-watt power amplifier in the last stage the power from the UX-210 is fed to the big tube by means of induct-

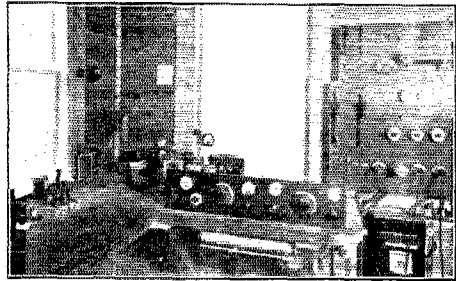

FIG. 4. COMPLETE TRANSMITTER AT 1CAK. THE 204 POWER AMPLIFIER STAGE IS IN THE REAR OF THE CRYSTAL-OSCILLATOR POWER-AMPLIFIER PANEL

ance L5. The antenna may be coupled to L5 through C6 and L9 for operation directly from the UX-210 stage. The last stage is the most difficult to put into operation. Great care must be used in the proper placing of the coils and the neutralizing condenser adjustment is also very important.³ This condenser is subjected to *very great* strains. The one used here consists of a General Radio midget vernier condenser immersed in a sponge glass full of automobile engine oil. If content with outputs of about 125 watts, the 250-watt amplifier stage can be tuned to a harmonic of the UX-210 by means of condenser C3 and inductance L6. If this is done the adjustments are much less critical. For full power, however, the last stage *must* be tuned to the wavelength of the 210 tube. With care power inputs to the 250-watt have been as high as 600 watts.

It might be interesting to outline the adjustment of a transmitter of this type for 40-meter operation when using a 160-meter crystal.⁴ First make sure that the crystal tube is oscillating vigorously. This will be indicated by a sharp drop in plate current of this tube. Adjust L1 and the grid leak so that this drop will be as large as possible. Next tune the first amplifier to approximately 80 meters by means of condenser C1. Vary this condenser gradually until the plate current in this tube drops to a *minimum* with the condenser set to tune the coil to exactly half the wavelength of the crystal tube. This is with grid leak control of the grid bias.

Now tune the UX-210 circuit to approximately 40 meters by varying condenser C2. This condenser is also varied until the plate current in this tube is at a *maximum* with

³ We desire to point out again that complete shielding (when not operating on harmonics) is very desirable. More complete neutralization can be had, and the adjustments are much easier to make.—Asst. Tech. Ed.

⁴ See also QST for May, page 43.—Asst. Tech. Ed.

the condenser set to tune this circuit to 40 meters, or the 4th harmonic of the crystal. The grid bias in this stage is obtained from a C-battery.

Tune the 204 circuit in the same manner as the UX-210 was tuned. In this case, however, the antenna circuit should also be tuned at the same time as its tuning has some

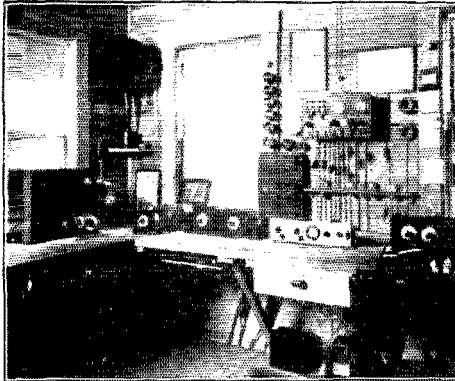

FIG. 5. A CORNER OF THE OPERATING ROOM AT ICAK. TRANSMITTER NOT SHOWN BUT IS AT EXTREME RIGHT ON TABLE

effect on the tuning of C3. After all of these adjustments have been made, return each of the circuits by means of C1, C2, C3 and C5, beginning with C1, to get maximum antenna current.

It must be understood that before any of the preceding tuning can be done, the neutralizing condensers must be adjusted and the correct location of the taps on coil L2 must be found. Once set, these controls do not have to be changed, with the possible exception of the neutralizing condenser C4 which is very critical.

This set is still in the experimental stage. It has not been operated very many times. During the few hours it has been on the air, however, very enthusiastic comments have been received from all amateurs worked. Two French stations have been worked on 40 meters. Their reports were "R7-R8, pure D. C. very steady". bz2AB has been worked and GVC was communicated with when he was 1,500 miles north of Ottawa. Numerous U. S. and Canadian amateurs have been worked also.

The time spent in building and adjusting a crystal controlled transmitter of this type will repay itself many many times over for there is a great satisfaction in knowing what your note will be like at the receiving end, and in knowing that if the signal is strong enough to copy at all, the receiving operator will have no trouble in reading you.

The UX-874 Regulator Tube

WE present herewith photograph of the UX-874 regulator tube which was described in detail in the "new tubes" story appearing on page 33 of our May issue. The photographs were not available at that time.

As can be seen the tube contains a reinforced tubular plate supported from the glass stem by several wires. Attached to the lower rim of this plate is a sort of tiny frying pan which contains the chemical "getter" used to complete the exhaust, or perhaps some material which generates gas of a kind and amount suited to the requisite glow action of tube. In the samples that

have been examined this frying pan has its lid firmly fastened except at the lower edge which is open somewhat so that gases could escape into the tube. At any rate phosphorus is seemingly used for a "getter" since a momentary phosphorus fire of tiny proportions occurred on the stem next the little pan when the glass of the tube was broken away. This accounts for the missing corner of the stem, which the little pinpoint of flame managed to crack off. Don't be alarmed, though—the fire-works were almost too small to be seen and probably would not happen in most tubes—besides which one isn't in the habit of breaking tubes into a powder keg.

Looking at the top view of the tube we can see the central stem inside of which is the other electrode—a wire of small diameter. This wire is surrounded by an insulating sleeve of some such material as lavite but projects a quarter inch or more. Almost touching this projection is a wire from the plate, leaving only a small gap across which the glow discharge starts—shifting immediately to the plate and with increasing loads covering larger areas of the plate as described in the writeup previously referred to.

—R. S. K.

Strays

3LD fell from the top of his 80 foot mast without even scratching himself. He says he was wearing his light fall coat.

Experimenters' Section Report

ENROLLMENTS in this Section have been coming in steadily at a rate that has changed very little since the re-enrollment was begun. Our estimates as to the outlines which would be in greatest demand were wrong but all have been taken care of now—the first time in the history of the Section.

Outline Changes

The outlines that have been sent are meant to be changed. The only reason for the existence of the Experimenters' Section is to exchange ideas between the members. If no ideas come in there will be none to exchange—we do not generate much experimental information at 1711 Park street, since we have neither the time nor the equipment. Therefore, by all means, begin at once to give us your ideas as to useful changes in the "outlines." It will also be very useful to tell us what you are doing or planning to do on your particular subjects. Only if we are kept constantly in touch with your work can we be of the most use to this section.

Correspondence

One of the main reasons for the existence of a "Section" is to provide contact between the men enrolled in the same problem. For this reason we have issued lists of the members, classified by problems. In the past these lists were great 14-page affairs that included all men and all problems. This has been dropped in favor of a separate list for each problem, so as to make more frequent revision possible. By all means get into correspondence with the other men on your problem. If the list has not reached you, ask for it.

Laboratory Tests

The outlines that have been sent have tried to avoid suggesting laboratory methods in much detail, since we feel that it will be better to let each man devise his own methods and apparatus. Naturally we are willing to pass on any additional information that we may have or can get. It will also be helpful to write to the other men on the same problem—but most of all it will help to keep the Section constantly advised of anything that you may have found out. It is not necessary to wait until the job is altogether done and a finished engineering report made. Frequently it is a needless piece of labor to do that. Almost always the result will be to let the information die of old age.

Radio Surveys—Problem G-12

The weather—the barometer—the moon—the sun—any number of things are likely to have an effect on radio transmission. To study them takes time and patience, system and organization. Recording the received signals is only a very small part of the whole job. For that reason the men enrolled in this problem will be put in touch

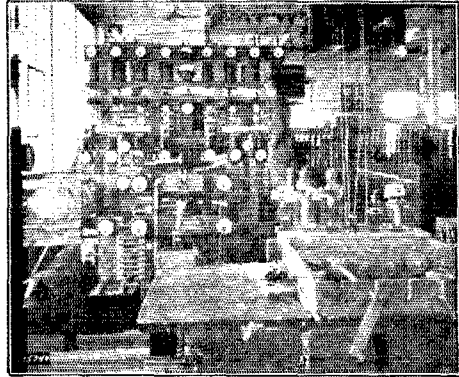

2XAG—THE HIGH-POWER WGY.

The wooden "grind organ" at the front right controls the tuning, couplings etc. The main thing to be noted here is the mere size of the set and the fact that it is almost completely insulated with treated maple wood.

with such organized tests as the "April Tests" of the General Electric Company. In general we will take part in someone else's tests because A.R.R.L. Headquarters is not equipped to handle the big job of analyzing thousands of records of reception.

Several other tests are now being planned by the General Electric and others. The "G-12" men will be notified as soon as possible.

South Schenectady and the April Tests

THROUGH the courtesy of Mr. W. T. Meenam of the Publicity Department of the General Electric Co. there follows a description of the radio test plant from which the April tests were sent for the A.R.R.L. observers. A portion of this material is from publicity releases, a portion from interviews with Mr. Meenam and the operating staff at South Schenectady, while that part relating to the 32-meter station was written for *QST* by one of the men at that building.

The Plant as a Whole

Reference to page 41 of our April issue will show that tests were sent at the same time at 15, 26.4, 32.79, 51.9 and 65.16 meters wavelength with powers from .6 to 10 kilowatt. If one happens to prefer larger numbers this corresponds to 20,000; 11,370; 9,150; 5775 and 4600 kilocycles. To carry on these transmissions at the same time calls for quite a radio plant, but South Schenectady not only did that, but in addition carried on high-power broadcasting at 380 and 1560 meters wavelength. By this time one begins to get some idea of the size and complexity of the test plant which occupies a 54-acre plot about 2 miles southwest of Schenectady at a place that seems to be called indifferently "South Schenectady" or "Mariaville."

On the plot is a main building 60 x 100 feet and a variety of small frame buildings housing various transmitters. The main building contains the power equipment, in-

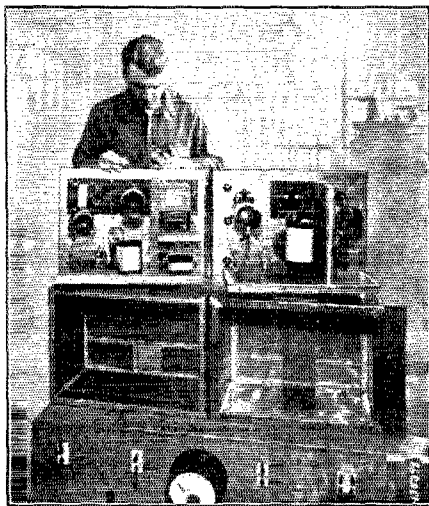

BY WAY OF CONTRAST

This is the crystal-controlled 7.5 watt master-oscillator which actuates and stabilizes the big 50-kilowatt 2XAG set. The operator holds the crystal and mounting. Just to his left (the reader's right) is the 50-watt stage following the master stage. Both normally work inside the copper-lined boxes, the panels of the two stages being of brass and connected to the box lining.

cluding the plate supply rectifiers and filters, also the big modulator which supplies modulated plate power to stations in the smaller buildings, so that these stations do not need either a modulator or an amplifier when telephony is to be used—the same

matter can be sent on all wavelengths at once. At the same time it is possible to put

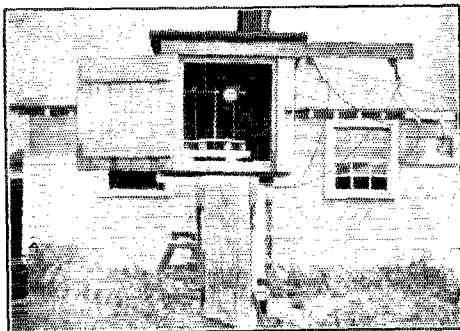

THE TUNING BOX AT THE LOWER END OF THE 2XAF ANTENNA

Note the two-wire R. F. line feeding this tuning box. The antenna goes upward from the box as shown in the diagram of Fig. 1.

the modulator out of commission and to send C.W. from the various transmitters. A few of the short-wave sets also have separate plate supply so that they can send CW, while most of the stations are being modulated. When telephony is being used it is usually sent down via an underground line which begins at the WGY studio on the G.E. grounds, or at some of the usual outside pickup points.

Plate and Filament Supply

There are three rectifiers, each being able to supply 150 K.W. at 15,000 volts. In addition there are generators operating at 2,500, 4,000 and 12,000 volts for the plate circuits of the various smaller tubes as well as the modulating tubes. Filament current is generated at 33 volts by a 300-ampere and a 1000-ampere generator, each constructed so as to reduce the commutator and slot ripples.

The "Superpower WGY"—2XAG

In the main building is the 50-kilowatt 379.5 meter (790.05 K.C.) transmitter which on certain days each week takes the place of the lower-powered (though still large) station WGY which is at the Schenectady plant. This set is shown in one of the photographs. The antenna slants to the top of one of the 300-foot towers.

The 1560-Meter Set—2XAH

2XAH resembles the Superpower WGY in all ways except that the output is 40 K.W., that the R.F. amplifiers are of the push-pull type and that the antenna is a larger affair. This antenna is unusual and must be described, as it cannot be seen in the general photograph. It looks like a single turn loop 300 feet high, hung be-

tween two of the big towers. (See Fig. 2). Actually the downleads of the "loop" terminate in tuning houses and things are so adjusted that the two downleads operate in phase—i. e., the antenna is of the 2-downlead multiple-tuned variety. The power is fed into the system by means of a 2-wire R.F. transmission line which runs from the main building to one of the tuning houses, a distance of several hundred feet.

The 109-65.5-Meter Station — 2XK

With 2XK we arrive at the stations that were concerned in our tests. The antenna of 2XK is a peculiar triple-T affair which can be understood from the photograph if the ropes and wires do not look too nearly alike when the cut is printed. A counterpoise is used here for the first time—the longer-wave stations working against ground. The general nature of the set at 2XK is very much like that of 2XAF, hence no details are given. At this point it is well to say that 2XK and all stations from this point on are licensed to work at a

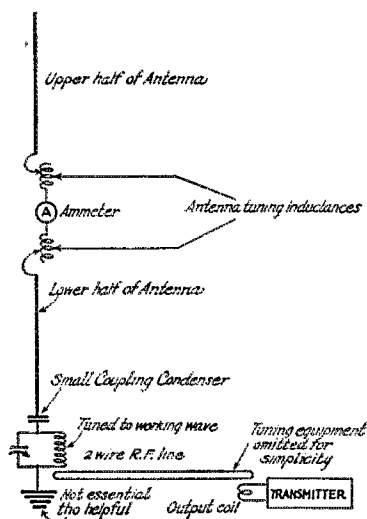

FIG 1
THE ANTENNA SYSTEM AT 2XAF

To shift the wavelength it is necessary to re-adjust both the helices at the center of the antenna, retune the circuit at the base and finally retune the set in the station. Needless to say 2XAF does not QSY at request. The system can be modified to permit easy tuning from the station. Such a scheme will be described in QST.

variety of wavelengths. They shift waves frequently, also changing antennas, power and circuits. For that reason the description given here fits the April tests—but is quite likely wrong at this moment.

2XAC — The 50-Meter Station

Unlike most of the other stations, 2XAC was on a wavelength of 51.9 meters (5775 K.C.) and was operated self-oscillating in-

stead of crystal-controlled, partly because this wavelength was not to be used a great deal, partly because the time before the tests



"WATCH CASE" CONDENSER USED IN THE 2XAH INSTALLATION

The name is not a joke but refers to the way in which the metal discs are sprung into their rims—just as a watch-crystal snaps into the watch case. In the great condenser just back of the operator six treated maple upright rods hold the metal discs, odd ones being held by rods 1, 3 and 5, even ones by rods 2, 4 and 6. This type of condenser is used in almost all the tuned circuits at South Schenectady.

was short. Little is to be said that was not stated in the April schedule—the wavelength was approximately the same and since the plate supply was independent this station sent CW, using the hand key. The wavelength was shifted slightly during the test.

2XAF — The 32.79-Meter Station

Concerning 2XAF little will be said here—the complete description comes a bit later. This station has operated at various wavelengths was the same and approximately lengths in the 30-40 meter region, or if one prefers, in the 7500-10000 K.C. region.

2XAD — 26.4 Meters

Of 2XAD not a great deal is known at this writing. This wavelength did not come down to Hartford during the tests (as far as the writer knows) and that leaves little to say except that in general this station resembles 2XAF, though the power is considerably lower.

2XAW — 15 Meters

It was an open question whether we should pay the most attention to 2XAW or

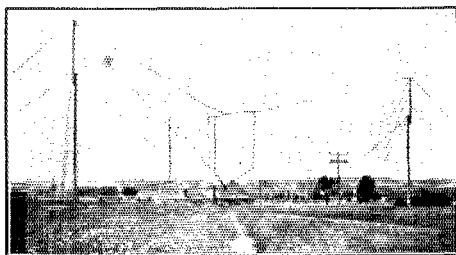

THE TRIPLE-T ANTENNA AT 2XK

Ropes from the three 80-foot masts are stretched toward a central point, the last 40 feet or so of each rope being replaced by a wire. These three wires meet at the center and are connected. From the center of each wire a download is dropped and these join a short way above the station roof.

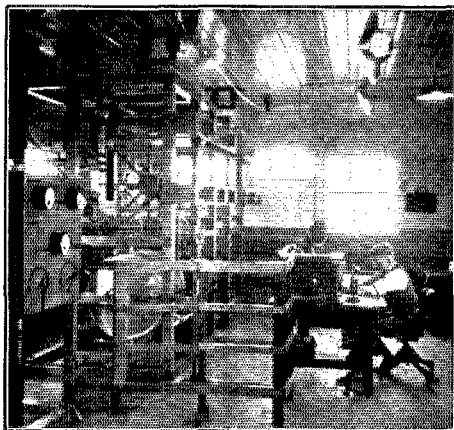
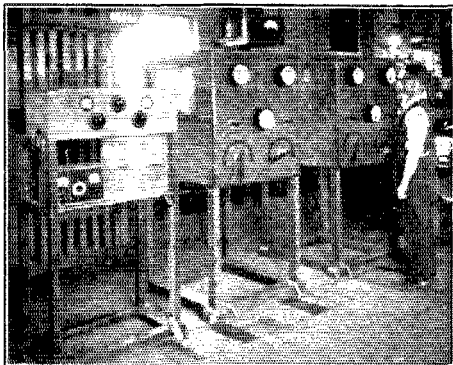

TWO VIEWS OF THE 109-65.5 METER TRANSMITTER, 2XK.

From left to right we have the crystal controlled-master oscillator, then several stages of screened R. F. stages (some of which are push-pull), then the big final stages which operate at high voltage and are therefore surrounded by a fence to prevent accidents. Note the characteristic "watch case" condensers in the large stages, also the neatness secured by dropping all filament and plate supply leads into the wiring gutter below the floor level.

2XAF in this story. Finally the decision was made in favor of 2XAF because it operates near an amateur band, and because it is crystal-controlled. 2XAW is self-excited, using one of the familiar push-pull oscillators and feeding a vertical antenna which is hung from a rope stretched from one of the 300 foot towers. This antenna

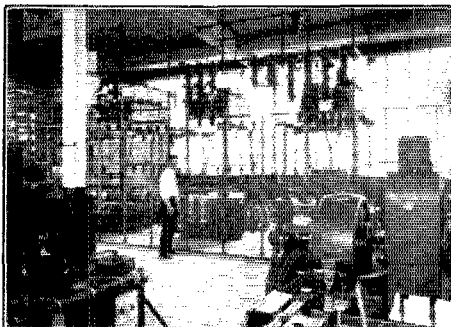

PLATE-SUPPLY RECTIFIERS OPERATING AT 15,000 VOLTS

In each of the three units the filter chokes and transformers stand on the floor, the filter condensers stand on the top of the frame. The kenotrons are at the front of the frames in two sets of three for each frame. The lower trio is at the level of the man's hands, the upper trio a bit above his head. They are rather hard to make out in the picture. At the right front is one of the filament supply machines.

seems to be operating in the same fashion as the one at 2XAF with the difference that the antenna is large enough so that it works at a harmonic.

Having run through the series of stations we can now return to 2XAF, the station that most nearly meets the conditions of amateur transmission. It will be described by one of the men associated with the station.—R. S. K.

Station 2XAF

By K. B. Austin *

THE original transmitter at 2XAF was put into operation early in the summer of 1925. It was one of the master oscillator-power amplifier type operating on a wavelength of 40.5 meters and with a power output of approximately one kilowatt. During August, 1925, the transmitter was modified by adding a crystal oscillator and amplifier chain but still retained the same output as before. The wavelength, 41.9 meters, was obtained by taking the fifth harmonic of a 1432 K. C. crystal and amplifying that harmonic through a chain of neutralized push-pull amplifiers until the desired output was obtained. In February, 1926, the power output was increased to between 10 and 20 kilowatts by the addi-

* Radio Department, General Electric Co., Schenectady, N. Y.

tion of a neutralized push-pull amplifier using two UV-207 (20-Kilowatt) water-cooled tubes. Recently the wave was changed to 32.79 meters using a system

to the second harmonic of the preceding stage or the fourth harmonic of the crystal oscillator. The output of this tube is the desired frequency, 9150 K. C. or 32.79 meters and is great enough to swing the grids of UV-204-A's which are connected in push-pull and neutralized. These in turn excite two watercooled UV-207's which are also



TUNING EQUIPMENT OF THE 32.79 METER 2XAF ANTENNA LOWERED FOR ADJUSTMENT
The helix frames and the central insulator of the meter-frame are of "mycalex," a material recently put into extensive use at South Schenectady for H. F. insulation where ordinary materials fail.

of obtaining the desired harmonic from a crystal that would be very suitable for amateur use. Following is a description of the transmitter.

The crystal oscillator tube is an SA-14 or high mu UX-210. The tank circuit¹ of this tube is tuned to the fundamental of the crystal or 2287.5 K. C. The next tube is also an SA-14 and is capacity-coupled to the tank of the crystal oscillator. The tank of the second tube is tuned the second harmonic or double the crystal frequency. The second harmonic is accentuated by using a higher bias than normal on the grid of the tube in which the harmonic is taken. The third tube in the crystal control amplifier is a UV-211². It is also capacity coupled to the preceding tank and its tank is tuned

1. Meaning the tuned circuit connected to the plate of the tube.—Tech. Editor.
2. The previous tubes in the series are "7-½ watt" tubes. This one is a "low mu" 50-watt tube very similar to the 203A. The next pair of tubes is of the ¼ K. W. size while the last pair (UV207) is of 20 K. W. output rating.

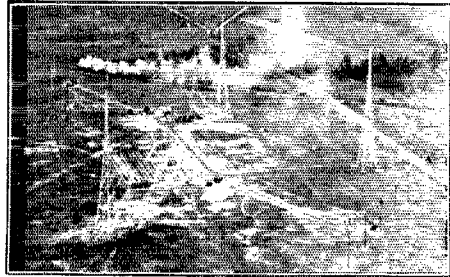

THE SOUTH SCHENECTADY EXPERIMENTAL RADIO STATIONS

Ignoring the small tower in the background, the two 300-foot towers farthest from the reader support the 1560-meter antenna the tuning houses for which can be seen between the towers. The present super-power WGY antenna is of the T-type, and is suspended between two of the 300-foot towers, one of which also supports one end of the 1560-meter antenna. Near this tower is the main building containing the power plant, also the sets feeding the two antennas just mentioned. This is the largest building in the picture. Coming from this toward the reader we find the 2XAD station house almost at the center of the triangle of towers. From this a road slants forward to the right, terminating at the 2XAW station-house next which is a row of 5 poles carrying a system of horizontal loops used in connection with 2XAC at wavelengths from 40-100 meters. Going to the left rear of the picture we find 2XK with its triple T antenna supported by three white masts. Directly in front of that are the small building and black mast of 2XAF which is described in detail in the text.

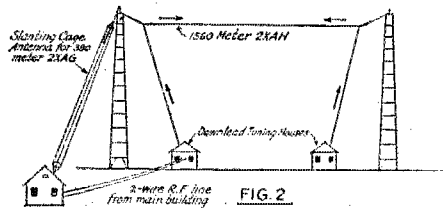

THE MULTIPLE-TUNED ANTENNA FOR THE 1560-METER STATION

The drawing is not to scale but represents the arrangement. The arrows are to indicate that at a moment the currents in both leads go in the same direction, not opposite as would be the case for a loop. This system acts as two "L" antennas in parallel.

connected in push-pull and neutralized. Plate modulation utilizing four UV-207's is used on the last stage when telephony is wanted. Thus it is seen that for CW only seven tubes are required by this system to

obtain a crystal controlled output of 20 kilowatts and that only two neutralized stages are employed.



THE ANTENNA SYSTEM AT 2XAF

The dark spot half way up the antenna is a split tuning coil with the antenna ammeter between—See Fig. 1. The ammeter is read by means of a surveyor's transit set out in the field—sometimes in 4 feet of snow.

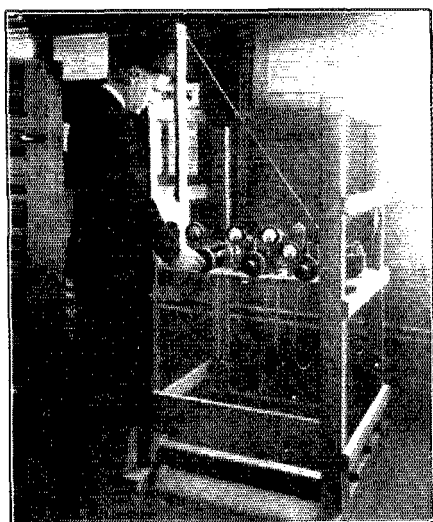

CRYSTAL CONTROL OF THE 32.79 METER STATION 2XAF

A short time before the photo was taken there was being used a carefully shielded arrangement with some plain stages and some push-pull stages, all of which were neutralized. The much simpler device in the picture is now used. It is described in the text.

This is an ideal system for amateur use in that by the use of one 160-meter or one

80-meter crystal one can have a crystal controlled transmitter for use on 20, 40 and 80 meters with the minimum number of tubes and neutralized stages.

The antenna used at 2XAF is a halfwave vertical antenna, no ground or counterpoise being employed. The output of the trans-

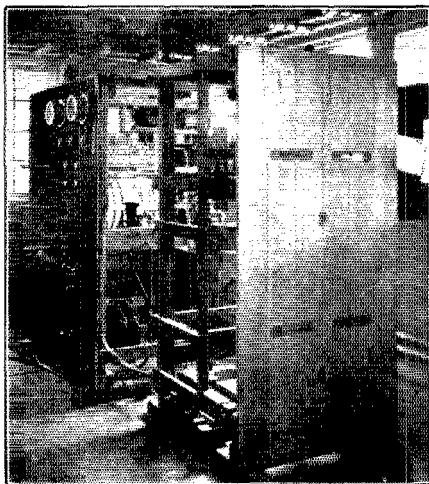

INTERMEDIATE AND FINAL STAGES OF THE 2XAF TRANSMITTER

Behind the "barndoor" panel is the UV-204-A stage. Tuning condenser control discs project thru the slots in the panel while meters are located far enough behind the circular openings to be safe from accidental contacts. At the left is the final stage with a pair of 20-K. W. UV-207 tubes in push-ball arrangement. Note that the water-cooling jackets of these tubes are mounted on springs to absorb vibrations which would cause a "burr" on the outgoing signal. Such sounds are often heard on these short-wave Schenectady stations but they are caused by audio fading after the signal leaves.

mitter is not coupled directly to the antenna but is carried over a transmission line about thirty feet long to a tuning house directly at the base of the antenna. A tank circuit is coupled to the end of the transmission line, the lower end of the antenna being coupled to one side of the tank by a very small coupling condenser.

2XAF has been rebroadcasted very successfully on several occasions in Johannesburg, South Africa and also in England. It has been heard with loud speaker volume in New Zealand in broad daylight.

A.R.R.L. Work in the Tests

Of the letters sent out by the Radio Engineering Department of the General Electric Co. about 22% secured observers for the "April tests." This refers only to the

3. This is what we would call a Hertzian antenna working at its fundamental. The details are shown in our Photographic illustrations and Fig. 1.—Tech. Ed.

2000 letters sent to men whose names were suggested by the writer—that is to say, the Technical Editor of *QST*. This percentage is unusually good.

Needless to say the returns are not yet complete as this is being written on the 20th of April. Even after all reports have arrived there will be a huge amount of work ahead before any results can be announced. Only those who have taken part in such a job can understand fully what a terrifying amount of time is required to finish the job. Do not be too impatient for information—very probably months will pass before the analysis is complete.

The Rest of Our Report

Because of the space consumed by the station description the rest of the "X" report must be dropped out this month. It will appear in the next issue.

The complete list of the stations at South Schenectady is as follows, the list being

Thru the courtesy of Mr. Alan Rockwood we are able to present the complete list of the stations at South Schenectady.

Station Call	Wavelength assigned	Wavelength April 27
South Schenectady		
2XAD	10-50	26.00
2XAF	10-50	32.79*
2XAG (Super WGY)	379.5	379.5*
2XAH	1000-400	1560*
2XAK	100-200	—
2XAW	32-0	16
2XAZ	100-200	—
2XH	50-150	—
2XK	50-150	85*
2XO	10-50	****

At Schenectady

2XI	Unlimited
	Broadcast service to Oakland, Cal. 20.50
	Propagation experiments 53.00

* Broadcasting the regular WGY programs.

The West Gulf Division Hamfest

THERE ain't no picture BUT—we got 'em told big boy, we got 'em told! Down here in this neck of the woods, where you ride all day before you can see your nearest neighbor, radio hams are not as prolific as they are in the more densely populated sections of the North and East, and consequently such things as "ham-fests" and Division Conventions cannot be had quite as often or quite as easily as elsewhere.

However, the germ of "get-together" has been silently leavening the radio mixture in and about Dallas for two years and spontaneous combustion took place and we blew most of the roof off of The Hilton, one of Dallas' leading hotels, March 27th.

The Dallas Radio Club sponsored the idea and worked hard for two months to pull the first Amateur Hamfest ever held

in the West Gulf Division. Lots of 5-watt bottles had their bases melted off while somebody was being told about the affair and being urged to come.

5NW held a three day argument with 5ZA and finally 5ZA told him he was catching the last train out to Dallas with the OW under one arm and the baby under the other. When 5ZA was introduced as coming a long way to attend a good thing, as being a winner of the Hoover Cup and as being persuaded by 5NW, he brought down the house.

Inspector McCabe gave examinations all day and got more enjoyment out of the blow-out than a half dozen others. The Dallas Radio Club certainly appreciate the courtesy extended by the fifth district inspection department in arranging to have Inspector McCabe attend. While there was an arranged program, the meeting turned out to be more of a love feast than anything else and ham gossip thoroughly saturated the atmosphere between the splendid talks of Division Manager Corlett, Assistant Division Manager Forest, Inspector McCabe and several others that lack of space prohibits mentioning.

It is to be realized that great distances had to be covered by a portion of the two hundred who attended. There were amateurs from Beeville and Corpus Christi, Tex.; Magnolia, Arkansas; Norman, Oklahoma; Roswell, New Mexico, and possibly one or two other distant points and practically everybody that could get away from work or school within a hundred mile radius of Dallas. We were even favored with the presence of Senor R. A. Carranza, in charge of short wave communication in the Mexican Army.

5FC, operated by Whitaker and Lovelady, was represented by a glass-mouthed, silver-plated 40-meter transmitter of very excellent design. Part of the program was devoted to an explanation of transmitters in general by Mr. Lovelady. 5VF was represented also by a 40-meter silver-plated artistically arranged transmitter, which was also described by its owner, Mr. Hardy. There were so many more things crowded into the three or four hours following the banquet that they cannot be mentioned, but all served to make the meeting a success. A resolution was introduced and passed with great acclamation that Dallas make a bid for the National Convention next year. This resolution followed a very excellent talk by Z. E. Black, convention manager of the Dallas Chamber of Commerce.

The Dallas Radio Club thanks each and every one in attendance, individually, for the help and cooperation given.

The Hilton Hotel helped us very graciously and placed their every service at our disposal.

—"Rip" Bennett.

The Taurenwerfer Beam

By Morris Taurenwerfer, Associate Editor

Editors Note: Readers of QST will recall with pleasure the interesting article by Mr. Taurenwerfer in the January 1925 issue of QST. Shortly after we staged this scoop Mr. Taurenwerfer left our organization (not at our request) to enter the Research Department of the Chinese Telephone Company. It is indeed a great pleasure to have him back with us as an Associate Editor of QST after his eight successful months in China, where several revolutionary things were unearthed.

COUNTLESS hundreds of amateurs have written me for advice on transmitters. They assumed from the fact that I know a great deal about receiving circuits, I also must know the transmitting game equally as well. Frankly, my knowledge of amateur transmitters was extremely limited at the time I left here to go to China. While in China, however, I had a lot of time to investigate the mysteries of transmitters and transmitting circuits and, having an excellent basic knowledge of radio, it was but the work of a short while until I had mastered the transmitter. During the process of learning about transmitters I stumbled upon several new things, which other great minds, apparently, had overlooked.

One of the first problems I tackled was this business of beam transmission. Many people (notably Marconi, the R.C.A., Round and others) have gone at the problem in a perfectly normal and orthodox fashion. Not I. I do not do things in such fashion. I preferred to attack the beam transmitter from an entirely unlooked-at angle. And as is customary with me, I succeeded notoriously.

In the first place it is a well-established fact that the rays from an electric lamp or arc lamp when properly focussed in a parabolic reflector will be reflected into a beam of light which can be pointed in a particular direction.¹

Light will be transmitted in one direction only. Here is exactly what we want in a radio beam transmitter transmission in a particular direction; concentration of light energy.

Let us pause for a moment and see exactly what light is. There are two popular concepts of light. One, the emission theory, would cause us to believe that particles of the light-giving body actually travel out into space and are actually hurled from the light source to the receiver. To my mind this theory is absolutely and unmitigatedly the bunk. It is inconceivable to me that when I look at a Ford car particles of this car actually fly out at me. I take the Ford

as an example because if any substance is in a condition in which it might fly out at anyone, the Ford product is in that shape better than anything else. Going a step further, assuming that this theory is the correct one, if I looked at the Ford long enough, the particles would continue to fly off from said "car" until it was no longer

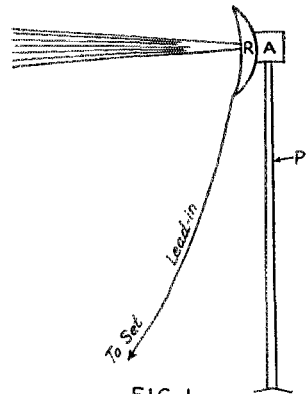

FIG. 1

THE TAURENWERFER BEAM REFLECTOR AND TRANSMISSION POLE

where I first saw it but actually became a part of me. Admittedly impossible.

The other theory is called the undulatory theory. It assumes that the ether (which no one as ever seen, tasted, heard, measured or actually known of) is set into rapid and violent oscillation by the illuminating object (the sun is a shining example), and that said ether is filled with waves which travel from the light source to the observer. This is the logical light theory—the theory which I have accepted without reservation. I have gone a step further and have combined, in practice, the theories of light and wave propagation and have succeeded in establishing beam transmission from China to the United States when using a tube with a negative B-battery voltage of 8.61 volts.

Turn to Fig. 1. A few words will expose my simple beam transmission system which

* Radiotrician & Assoc. Member A.R.R.L.

1—M. Taurenwerfer, "Light and Darkness," S. African Radio News, Mar. 1899.

I have called, out of respect to a great engineer and research worker, "*The Taurenwerfer Beam*". An ordinary D.C. arc lamp (A) is attached to the top side of a 42-foot steel pole P. To the arc lamp (A) the reflector R is clamped. The pole is hollow and is mounted on a revolving platform so that it, the arc and the reflector can be rotated through one complete revolution. Through the hollow portion of the pole the arc feeder wires are run. The arc is a series affair operated in series with the commutator of a 2,125 R.P.M. 500-volt D.C. machine. When the arc is turned on it is obvious that the reflector will emit a beam of light, and that the direction of this beam can be changed by rotating the pole.

I have previously shown that the light beam from the reflector is merely a vibration of the ether in that direction. In other words the ether is highly excited. If I now couple a radio transmitter to the light source so that the radio frequency is applied to the center of the reflector, the radio frequency waves will set up vibrations along the light path, and as the ether along this path is already regenerative due to the light vibrations, the super-imposed R.F. will cause the ether to become highly conductive and the radio waves will travel readily and quite rapidly along this light beam.

The theory of the Taurenwerfer Beam was tested in the Laboratory at first and was found to be correct. I was worried for a while as to what would happen when the radio excitation reached the end of the light ray. I reviewed all available literature on the subject and found that the solution had been found years ago.² The light beam allows the radio wave to get a good start and

ordinary directly coupled Hartley circuit, the coupling being accomplished by several gadgets in the lead-in. In order to suppress as many harmonics as possible, and at the same time eliminate key clicks, I had to resort to some new tricks. The primary inductance L1 is completely shielded from itself. I found that most of the BCL interference was caused from direct pick-up from the primary. This was eliminated by winding L1 in the following fashion: The conductor itself is number 28 magnet wire. This

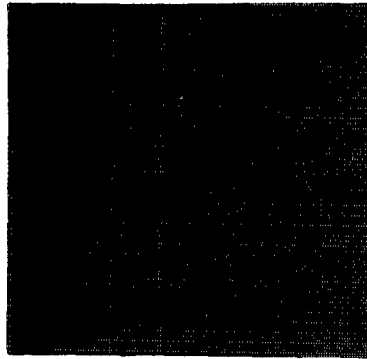

FIG. 3

MR. TAURENWERFER OPERATING HIS BEAM TRANSMITTER—BEAM SHOOTING NORTH

wire has a much smaller external field than any other wire made. In order to make the No. 28 carry the enormous current I used, I enclosed it inside a three quarter inch brass pipe filled with oil. This pipe is insulated from the No. 28 wire which is the conductor by the oil. The pipe, in turn, is grounded through a non-inductive resistance tuned to twice the second harmonic of the working wave. All direct magnetic or static fields about coil L1 have been eliminated by this type of construction.

Interference, mush, sidebands, carrier waves, static, doubly suppressed carrier waves with no side bands and re-radiation in the antenna were all eliminated by that equipment shown in the dotted lines at the left. For the want of a better name I have called this a Taurenwerfer Suppressor. The condenser C is insulated to withstand ten thousand volts, and will carry two hundred amperes on 46 meters. The inductance L is a coil of number 24 D. C. C. magnet wire wound on an iron core made of .0002 mil audio-frequency brass, and the resistance R has a value of .01052 megohms. The capacity of C will vary according to the well-known Austin-Cohen formula (incidentally developed independently by the writer while at the BuStan). Its capacity will be found

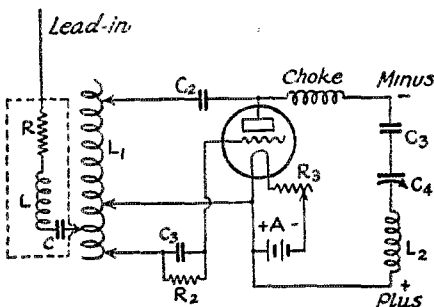

FIG. 2

THE TAURENWERFER CIRCUIT

the radio wave travels on and on after it has left the end of the light, and still goes forward as a circularly polarized wave.

Several novel things will be found in the diagram of my transmitter used in connection with the Taurenwerfer Beam. The circuit, at a casual glance, appears to be an

² J. H. Newman, "Lead Kindly Light."

to be between .002 μ fd. and .00204 μ fd. when the 46-meter wave is used.

It will be noted that I use a negative potential on the plate of the tube. This is made possible through the judicious use and choice of C3, C4 and L2. When these units

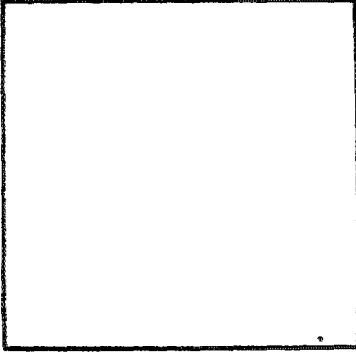

FIG. 4

THE TAURENWERFER BEAM WORKING IN A SOUTHERLY DIRECTION. MR. TAURENWERFER CAN BE SEEN AT THE RIGHT OF THE TWO TALL TREES AT THE LEFT, RIGHT BETWEEN THE PALE GREEN ELEPHANTS

are properly used and installed, regeneration in the tube is so strong that the tube takes full advantage of the negative resistance phenomenon, and operates with a negative voltage on its plate so long as the oscillations in C3-C4 and L2 circuit are 90 degrees in phase with the voltage of the A-battery, in which case the current lags by a phase difference of one hour and ten minutes.

As I have a patent application on this latter feature I would request that the amateurs do not experiment with this feature of the circuit. You can rest assured that there is no chance of your being able to improve upon the circuit as I have gone all through all the possible ideas for improvement and this is the circuit in its final form.

At a later date I hope to be able to explain to the waiting world several other things I discovered while in China. Although there only eight months I succeeded in doing a lot of new things which the radio press has not been advised of. You, as readers of QST are entitled to a first hand account of all of these discoveries as long as I am connected with this organization. They will be divulged later on.

Buying Inductances By the Inch

A NEW type of receiving inductance is now available. The coils are wound on a thin sheet of transparent dielectric .005 inch thick. Turns are spaced a distance equal to the diameter of the wire. At present two stock sizes are obtainable. For receiving coils the inductance is three inches in diameter and is wound ten turns to the inch with number 16 cotton-silk insulation. The coils are extremely strong, it being almost impossible to compress them out of shape. For R.F. chokes and ticklers in amateur short wave receivers inductance material of a different type can also be had. This inductance takes the form of a coil one and one-half inches in diameter, wound with number 36 single silk covered wire. The wire is wound ninety turns to the inch, the spacing being about equal to the diameter of the wire.

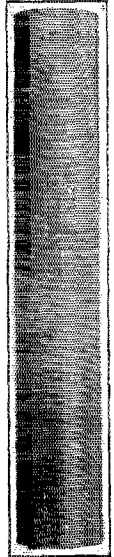

If you are an amateur and will give your call letters, either type of inductance may be purchased by the inch in lengths up to 20 inches. These coils should make excellent S.W. receiver material. They are made by and can be purchased from the Hammarlund Mfg.

Co. of New York City.

In order to have as much short wave data on the products they make, Hammarlund is also offering a 25% discount to amateurs, on all of their receiving and transmitting condensers suitable for amateur work. When writing you *must* give them your call letters as they will sell only to bona fide amateurs.

—J. M. C.

Strays

The 300, 600, and 706 meter waves of Great Lakes land stations and ships have been replaced by a 715 and 876 meter wave. The gulf land stations have moved up to 750, 900 and 925 meters and the ships from 650 to 700.

If the owner of a station will go to the post office of his city and register his station call with his address, all mail addressed only with his call and city will come to him and the dead letter office will be robbed of a few morsels.

An Oscillator Without Battery or Transformer

By Allan T. Hanscom*

THE writer has designed a convenient portable oscillator for laboratory work and receiving set testing. It can be operated from 110 volts A.C. without the use of any batteries.

Figure 1. represents the conventional Hartley transmitting circuit. By properly proportioning the inductances L1 and L2 and the condenser C. the tube will be made to oscillate throughout a 3 to 1 range of frequencies. For any given range the experimenter will know from experience what size of coil and condensers to use. It is usually satisfactory to center-tap the coil.

Figure 2. The same circuit with 110 volts A.C. applied to the plate circuit of the tube. In this case the tube will act as a rectifier although it will still continue to oscillate at a frequency governed by the constants above mentioned. Figure 3 shows

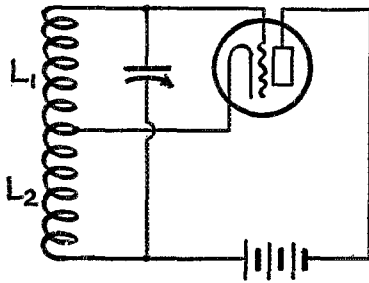

FIG. 1

a method of heating the filament of a tube with 110 volts A.C. which requires no transformer. By combining Fig. 2 and 3 we have Figure 4 in which the filament and plate supply are both from the same source. The resistance R. in the filament circuit consists of a 25-watt lamp and the voltage drop through this lamp is 105 volts when connected in series with a standard 201-A tube. It will be noticed that the grid return of the tube is connected to the opposite side of the 110-volt line from the plate return.

The rectified plate current is a series of impulses and because 60 cycles a second is an audible frequency, the frequency of oscillation is modulated so that an audible signal is produced in a receiving set placed within 50 feet of the oscillator. The reason for connecting the grid return as indicated is that the end of the filament to which it is connected is negative at the

time that the plate of the tube is positive and this is the only time that plate current is flowing.

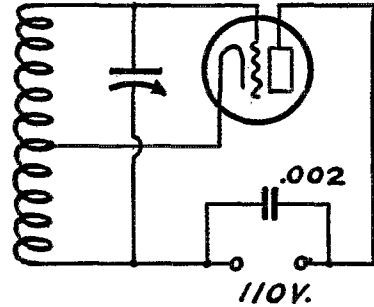

FIG. 2

When a 201-A is used in this oscillator the total plate current, as measured by a D. C. milliammeter, is less than two milliamperes. Using a 6-tube Superhetrodyne on a loop, the signal of this little oscillator has been picked up at a distance of 500 feet, although the practice of using this tester as a transmitter is to be discouraged because the tone is that of "raw A.C.," moreover, in the standard commercial form of the tester, the circuit constants are arranged so that the wavelength range is from 180 to 575 meters. If 110-v D.C. supply is available the tone will be good and a neat little transmitter of the "fractional watt" type results when one uses a condenser and coil proper for one of the

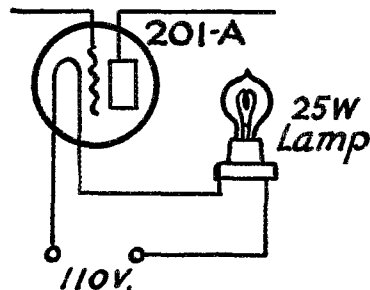

FIG. 3

amateur bands. Coupled to an antenna such a set should work around town fairly well!—tho it would not be possible to operate an antenna meter—not even a thermo-galvanometer. One would need to use a plate meter (0-5 milliamperes)

* Hanscom Radio Devices, Woonsocket, R. I.

and go by its readings. Of course, the reliable range of any set with an input of 2/10 of a watt is not likely to be astonishing but freaks are possible.

It will be noted from the diagram Figure 4 that the A.C. supply lines are connected at the low potential end of the system. Even though this is the case radio frequency currents seem to follow the lighting

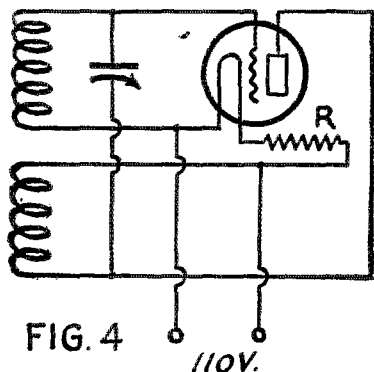

supply lines.¹ For this reason it is sometimes better to test the receiving set with the ground disconnected, except in the case where the antenna and ground form a

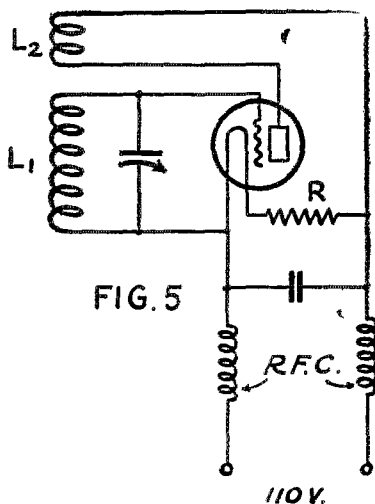

tuned circuit and one is obliged to put up with this uncertainty.

All radio repair men will welcome this device for its ability to provide a clear

1. A Common source of interference. The R. F. of amateur transmitters (especially those using "voltage feed" to the antenna) frequently gets into the 110-volt line and runs all over the neighborhood, arguing with the harmonics of the superheterodynes it meets.—Tech. Ed.

signal on any wavelength, and this wavelength can be varied to suit the operator by means of the tuning condenser.

The dial has wavelength indications on it and while the device is not intended for a wave meter the readings are accurate enough to form a good indication of the wavelength range of a set.

In the Hartley circuit as indicated in

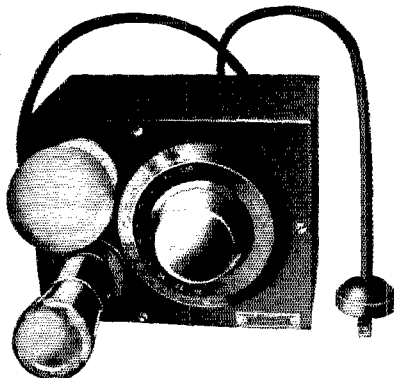

THE COMMERCIAL FORM OF THE OSCILLATOR This device is called the "Superunit set tester" and has a wavelength range of 200-575 meters. The dial carries both a wavelength scale and a 1 0-100 scale.

Figure 1 there is a tendency for the oscillations to cease when C reaches a certain value. It is therefore to some advantage to use a circuit of Figure 5 in which a tuning condenser is placed across the grid coil only. The inductance of L1 should be sufficient to cover the wavelength band when used with an .0005 condenser and L2 should have sufficient turns to insure the oscillation of the tube at the high wavelength settings. The coupling between L1 and L2 can be extremely close. It is also possible to insert chokes in the supply line as indicated in Figure 5. In this case the radiated signal will be much less and the effect on the neighbors will be less in proportion.

Strays

The long awaited revision of Ballantine's *hambible* is not to be. In the meantime a reprint of the last edition is going on and once more "Ballantine" is available. The price is \$2.00 and it is well worth ten times that much. Our Book Department will get it for you.

Starting at 8:50 p.m. E.S.T. 8ZU at Cornell University copied *fifty-one* CQ's from 9BDQ, all of them in a string and with no let-up. Honestly, gang, how long is this punk operating going to last?

A. R. R. L. Standard Frequency Station 1XM

By Killian V. R. Lansing*

1 XM is the experimental station of the Massachusetts Institution of Technology Radio Society.

The Radio Society has two main activities, technical meetings and its experimental station. This article will describe the latter. Technical meetings are addressed by members of the M. I. T. faculty, advanced students, and speakers from the outside, many of them nationally known in radio and allied fields. The present organization of the M. I. T. Radio Society was started shortly after the war by a group of students, many of whom had been in the Government signal service during the World War.

The Station and Location

The station is located in the second story of a three-story steel framework building. Next door is the M. I. T. power house, whose smokestack, only about seventy-five feet from the station window, makes a conven-



FIG. 1
THE OPERATING BENCH
Standard Frequency Transmitter at the right.

ient mast upon which to fasten antennas. The presence of the power house, however, is thought at least partially to account for the rather poor receiving conditions that seem to exist. A railroad beside the building accounts for additional QRM.

Though the station has always possessed transmitters that were abreast of the times, it was in 1921 that the station first became well-known due to the installation of a 500-watt 500-cycle ICW transmitter, of the type which later became so well known as 2RK-2FP, 8AWP, 9ZN, and others. At this time transmission by the use of vacuum tubes was unknown to a large number of amateurs, and many inquiries were received asking how we obtained such an extremely sharp wave with our 500-cycle spark.

The majority of the apparatus of 1XM

* Room 10-189, Massachusetts Institute of Technology, Cambridge, Mass., Standard Frequency Committee M. I. T. Radio Society, Member A. R. R. L. official wavelength station committee in charge A. R. R. L. Standard Frequency transmissions, Experimenter's Section A. R. R. L.

is owned by the Society or its individual members. Quarters (general views of which may be seen in Figures 1 and 2) and power are furnished by the Mechanical Engineering Department of the institute; the Electrical Engineering Department, the Communications Laboratory, and the Department of Military Science occasionally help out with the loan of some needed apparatus. The power is obtained from 110 and 220-volt, 60-cycle, alternating current mains of the Institute; direct current is also available up to 10 P. M.

Due to the experimental nature of the station frequent changes in apparatus are made, and only the station as it happens to exist at present can be described here. No regular operating schedules are maintained and so the number of reports from distant points is not large, though in proportion to the amount the station is on the air the reports are very satisfactory.

The receivers in use at the station, one of which may be seen in the center of Figure 1, are similar to those in use at most good amateur stations and need not be described here. The particular one shown has plug-in coils and is arranged for the 15,000, 7,500 and 3,750—KC bands. One stage of audio

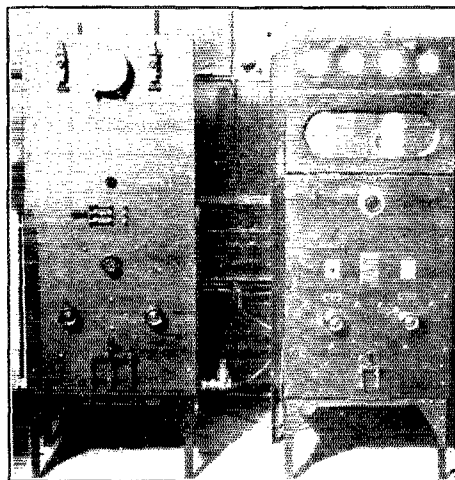

FIG. 2
POWER PANEL AND 100-WATT TRANSMITTER

amplification is generally used for amateur reception. The receiving antenna is one of about 30-foot length on the roof of the building, purposely short to minimize pick-up of the many kinds of QRM from the power house and the varied electrical ap-

apparatus in use at a great scientific institution.

The main transmitting antenna is suspended nearly vertical from the top of the powerhouse smokestack and consists of a

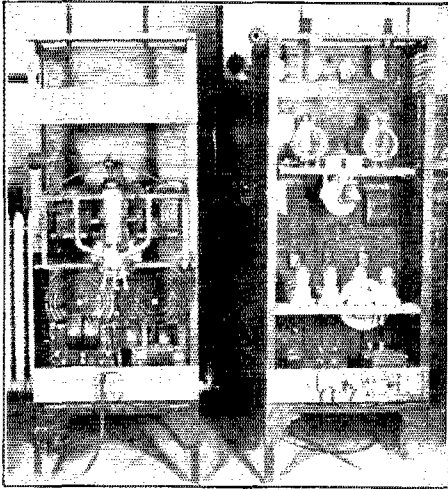

FIG. 3
REAR VIEW OF POWER PANEL AND 100-WATT TRANSMITTER

Note arc-shaking solenoid at upper left of power panel. In the 100-watt panel the filament and plate transformers stand in the bottom of the frame, the "S" rectifier tubes on the first shelf and the oscillator equipment on the top shelf.

single enameled copper wire. The counterpoise is a horizontal wire directly beneath the antenna, and about twenty feet above the ground. A smaller antenna is suspended from a point part way up the smokestack. The same counterpoise is used with both. The fundamental of the larger system is about 2800 KC, a series condenser being used for operation in the 3750-KC band; the third harmonic of the system is used for transmission in the 7500-KC band. The fundamental of the smaller system is about 5000 KC; its fundamental is used for the transmission of Standard Frequencies on the Canadian exclusive frequency of 5710 KC, and the third harmonic for the 15000-KC band.

Figure 1 is a general view of the operating bench with the Standard Frequency transmitter in the background. A duplicate operating position with another receiver and duplicate transmitter controls is located just to the left of the telephone.

The Power Panel and 100-watt Set

Figures 2 and 3 show the front and back views of the power panel and the 100-watt transmitter. The left hand panel in Figure 2 contains the power supply for the Standard Frequency transmitter which will be described later.

The right hand panel of Figure 2 contains the 100-watt transmitter. This transmitter uses the push-pull circuit shown in Figure 4. This should not be confused with the usual "back-to-back" scheme used in many amateur stations. The circuit is rather unusual in amateur stations, but is strongly recommended as very flexible and efficient. The single variable condenser shown will vary the frequency from about 9000 to 3000 KC; the only additional change necessary to QSY is the adjustment of the antenna circuit. The adjustment of the coupling will be found rather critical, but once adjusted the set will be found to function smoothly within the frequency limits indicated.

The two tubes are of Westinghouse make, rated at fifty watts output, and especially built with the plate leads coming out of the tops of the tubes.

The power supply for the 100-watt push-pull transmitter is obtained through an S-tube rectifier set and using full-wave rectification, located on the same panel as the transmitter. The voltage range is variable from 700 to 1500 volts.

The Standard Frequency Transmitter

Transmitter No. 2 was built especially for the Standard Frequency schedules. A very clear idea of this set may be gained from the photographs of Figures 5 and 6. The circuit employed is the familiar tuned-plate tuned-grid or Armstrong circuit, and is given in Figure 7. The tube is a General Electric type "P" pliotron, somewhat similar to the Radio Corporation UV-204, ex-

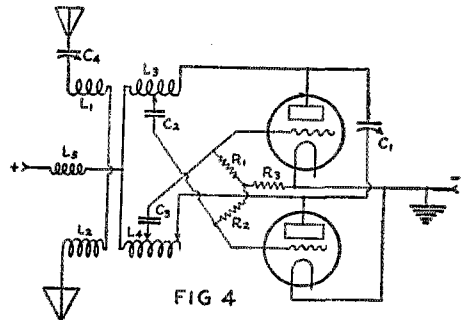

FIG 4
CIRCUIT OF 100-WATT PUSH-PULL TRANSMITTER AT 1XM

- L1, L2—3 turns edge wound copper ribbon
- L3, L4—6 turns, ditto
- L5—R. F. Choke, 150 turns
- R1, R2—5 megohms
- R3—10 megohms
- C1—1500 μ fd. double-spaced
- C2, C3—2000 μ fd. fixed Faradons
- C4—500 μ fd. variable

cept for the heavy plate. Glass towel bars from a local five-and-ten-cent store make very convenient mountings for the coils which are made of $\frac{3}{8}$ " seamless copper tub-

ing. The plate-tuning condenser and the two grid-tuning condensers shown have $\frac{3}{4}$ " spacing, and were especially designed and built for the Standard Frequency service by the National Company of Cambridge, Mass. Though normally rated at 250 watts output, the tube is generally operated at from 200 to 300 watts input. This seems to "get out" just as well and minimizes frequency changes. This set has proved very flexible over the frequency range included in the Standard Frequency transmissions though it has more controls than the push-pull transmitter. It holds its calibration extremely well as will be noted in text to follow.

The Mercury Arc

So many inquiries have been received regarding the Mercury arc that its essential circuit is reproduced in Figure 8. The "pi" section filter shown may be cut in or out at will. The filter is generally used with the 60 cycle supply, but is sometimes cut out when the output of the 500-cycle motor-generator is supplied to the arc in order to get a 1000-cycle "overtone."

The Standard Frequency Work

Since it is the Standard Frequency schedules that have recently brought the station into prominence again, some description of the method by which they are adjusted may be of interest. All Standard Frequency transmissions are referred directly to the Standard Frequency meter which is kept in the M. I. T. Communications Laboratory. A small receiving set is adjusted to the exact frequency which it is desired to transmit by

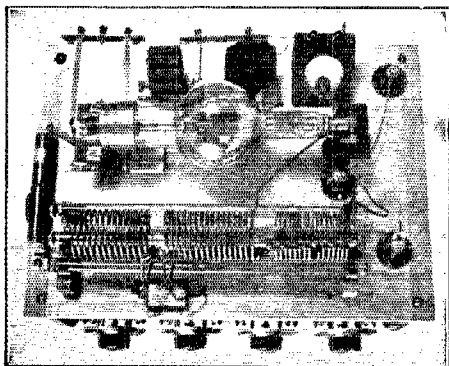

FIG. 5
TOP VIEW OF STANDARD FREQUENCY
TRANSMITTER

tapping the box of the meter and varying the receiver controls until the sound is heard in the headphones. Once the receiver has been approximately calibrated this method proves faster than the common grid-reaction meter method, and fully as precise. The output of the receiver in addition to going into the headphones is sent over an or-

dinary telephone line to the transmitting station several hundred yards distant. The head-and-breast-set worn by the operator as he adjusts the transmitter controls and does the keying, may be seen on the hook in Figure 1. The Standard Frequency meter

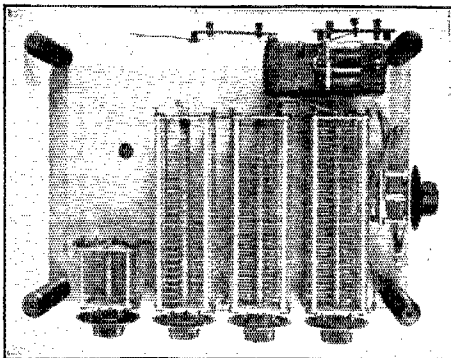

FIG. 6
BOTTOM VIEW OF STANDARD FREQUENCY
TRANSMITTER SHOWING LARGE 250 μ fd.
SPECIAL NATIONAL CONDENSERS

is shown in Figure 9. The coils, as may be seen, are made of very heavy copper tubing; the condenser is a General Radio Precision type with worm and gear drive for making close adjustments. The condenser is thoroughly shielded and grounded as is the entire heavy table to which the meter is permanently fastened. The transmitter having been adjusted to approximately the desired frequency by previous calibration, it is merely necessary for the operator to make vernier adjustments until he hears the signals coming back over the line. To avoid "broad" signals in the laboratory, the receiver uses neither antenna nor ground, and was especially constructed with a view to minimizing pick-up.

Precision

The transmitter holds its calibration so well, and the method of setting the receiver is so precise, that, with rare exceptions, an audio frequency beat note between the transmitter and the receiver can be heard coming over the line the first time the key is closed. It is then merely necessary to adjust to approximately zero beat. It is planned in the near future to adjust the receiver to the proper harmonics of an approximately 250 KC quartz crystal oscillator which has been furnished through the courtesy of the General Radio Company, and may be seen in Figure 10. This method will probably be in operation by the time that this appears in print, so that the "announced frequency" may then be expected to have an accuracy of 0.01 or 0.02 of 1%, thus making these signals of use to the laboratories as well as amateurs.

Clapp, (1BYX) an M. I. T. instructor, for many practical suggestions in putting this service into operation; to Messrs. Snyder (9BNO), Dresser (1BOB-1VT), Hilton (ex-

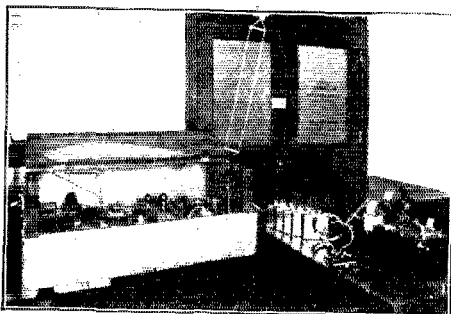

THE STANDARD FREQUENCY METER

1BRQ) who, with the writer, have done the actual operating of the schedules; to Mr. Briggs (1BVL-1GW) who did a large portion of the construction of the Standard

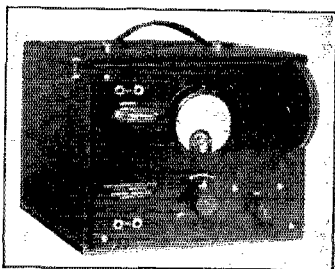

GENERAL RADIO CRYSTAL OSCILLATOR

Frequency transmitter; to Mr. Snyder who built the power panel and did a large portion of the wiring; to Mr. Dyson who built the 100-watt transmitter; and to numerous others who have helped at times.

We have just been informed that the Plotron has at last burned out. It has been replaced by a Mueller MS-1 tube rated at 500 watts output but operated at inputs of 100-400 watts depending upon the frequency that is being transmitted. This tube is available for this work thru the courtesy of the Tobe Deutschmann Co., Cornhill, Boston, Massachusetts.

—R. S. K.

The Maritime Division Convention

ANOTHER of those fine little conventions has been pulled off. The Canadian Maritime Division held its third convention in St. John N. B. on April 23rd and 24th. It was a convention typical of the kind we used to have in numbers, years

ago; a collection of keen brass-pounders intent upon having a good time, transacting some business and enjoying an excellent banquet.

The convention was staged by "skipper" Atkinson, c1AK. Representatives from all the Maritime Sections save Labrador were present. Reid of c8AR came all the way from that distant Newfoundland country; Bill Borrett (need we say c1DD) and Campbell, c1DJ came from Halifax, Hyndman c1BZed represented Prince Edward Island and the gang from N. B. was both large and lively.

The first afternoon was taken up in getting acquainted. The banquet was held during the first night in the Admiral Beatty Hotel. Atkinson presided. Mayor Frink of St. John opened the fireworks by welcoming the gang to the city. Palmer of c1AM accepted the welcome. The Mayor then presented this years Murphy Cup award to Joe Fassett. As Joe was not with us Bill Borrett accepted. Then followed a series of talks, a wire untying contest, a nose key-punching contest, a diagram reading and correcting contest, a best Liars contest and several other prize winning features. Between and between, the gang ate a delicious meal. Reid gave a short talk advertising the wonders of Newfoundland and then the initiation into the Royal Orders of Transatlantic Brass-pounders was staged for the benefit of six novices who having previously crossed the Atlantic via Radio were taken across the burning desert partaking of the Sacred Worms en route and finally emerging full-fledged ROTAB members.

The next morning the St. John street-car was chartered and the town was given the once-over.

That afternoon a business and technical session was held. Maritime Division business was transacted, Bill presiding. Two excellent technical papers by Prof. Ritchie were read by Borrett and a general ham-fest followed. The night session took place in the hotel rooms, part of the gang listening on Bills S/W receiver, part trying to make his S/W low power transmitter transmit and the rest chewing the sock.

All in all this was the type of convention we love to attend. Enough fellows to make it most interesting and not so many fellows that personal contact with all was impossible. A most convivial and congenial gang of darn good sports. F.B. OM's. Long live Canada and QLC, but especially *Vive La Maritime!*

—J. M. C.

Strays

The A.R.R.L. Communications Manager, Mr. F. E. Handy, and Miss Winifred G. Richardson, formerly of A.R.R.L. Headquarters, were married in Hartford on April 17th, and have been receiving congratulations from the gang.

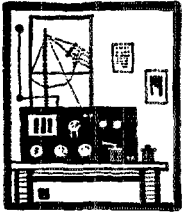

Amateur Radio Stations

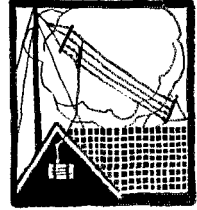

4BY, Savannah, Georgia

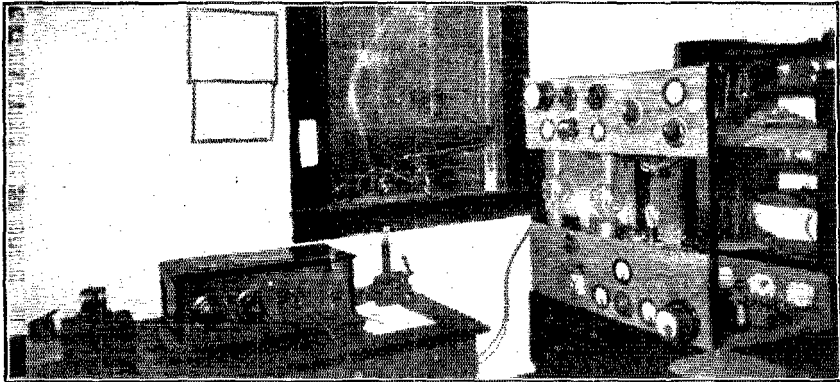

THIS is the crystal-controlled station of J. E. Hodge, 143 Bull Street, Savannah, Georgia. 4BY is an old timer and has been described in *QST* previously. The former station used two 204's built in as compact a set as possible. The present 4BY is the reverse of the old one—there is plenty of room for a couple 1 K.W. tubes and still space for one to crawl into the set and not have to tear down the whole works to change a grid leak!

4BY was one of the first crystal-controlled stations in the country. The present set uses a UX-210 crystal oscillator and two 204 power amplifiers. The frame work and panels are of poplar boiled in paraffine for half an hour. The crystal and oscillator tube are located conveniently on the small shelf between the two panels. The crystal oscillator's filament voltmeter, high frequency ammeter and tuning condenser are directly beneath the UX-210. The crystal oscillator grid inductance (small picture) is directly to the right of the oscillator tube. This inductance is an 8 turn coil of No. 14 wire, spaced by means of knotted flax thread. The turns are spaced 1/16th inch and are 4 inches in diameter. Plate voltage is 400, with a grid bias of 22½ volts.

The power amplifier inductances are cut away R.C.A. helices spaced with glass beads and supported on glass rods. For 80-meter

work 12 turns are used in both helices. For 40 meters the helix in the last power am-

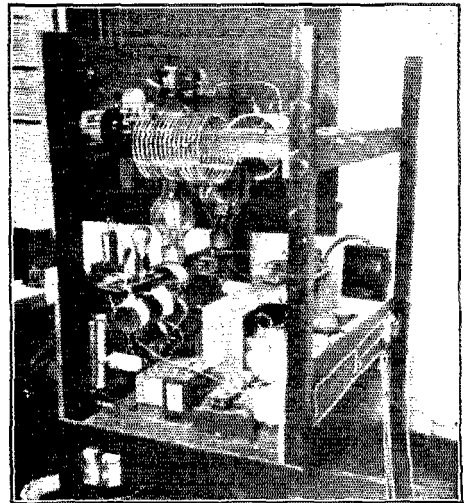

REAR VIEW OF TRANSMITTER. PLENTY OF ROOM HERE FOR ANY EXPERIMENTAL WORK

plifier circuit has only 5 turns, the first power amplifier remaining on 80 meters. Normally 1,000 volts are used as plate

voltage for the two power amplifier tubes. With a 90-volt grid bias the plate current is 125 milliamperes per tube.

Three separate filament heating transformers are used. With this arrangement, a master rheostat (on the front of the panel) can be used to adjust all filaments at the same time.

The change-over switch shown on the table is the only switch used. This on the send side, connects the antenna and counterpoise to the transmitter, starts the M. G. set which is in the garage, turns on 220 volts to two of the filament transformers and 110 volts to the other transformer, and also sets the relays that are used for keying. Keying has been done in a variety of places. Keying the last power amplifier bias circuit and the antenna simultaneously gives no back-

wave but gives rise to fierce key thumps. Keying in the center tap circuit of both power amplifiers results in less key thump and still keeps out the objectionable back-wave which is due to the crystal oscillator running all of the time.

As this is an experimental station the note varies directly as the crystal in use at the moment. At times the note is not good but invariably the wavelength stays put and the note steady.

Neutralizing of the power amplifier circuits has been tried with negligible success. This is probably due to the fact that the input to the power amplifiers is so far below normal rating that serious feedback rarely occurs. The circuit is more or less the standard one, with no shielding of the crystal oscillator grid coil.

c4GT, Calgary, Alberta, Canada



THIS very excellent station is the product of years of work on the part of A. H. Asmussen, owner and chief operator. The station started off with the two 250-watt DeForest tubes hanging on the wall. Due to a heavy overload they passed out of the picture soon, and were replaced with a single Northern Electric (W. E.) 250-watter. This latter tube has been used regularly for over two years and a half. Asmussen has made a careful study of low input into over-size tubes, and believes that the main trouble with amateur operation is overloading the tube in the transmitter. The input to the 250-watt tube has never exceeded 200 watts. Some of the stations very

best DX has been done with an input of only 120 watts.

The transmitting circuit is the familiar Reinartz type. Six variable condensers are used. In fact the only fixed condensers in the transmitter are the filament and plate by-pass condensers. The inductances consist of twelve turns of 3/16 inch copper tubing wound to a diameter of six inches. The turns are spaced by glass beads threaded on a string. Plate voltage is supplied to the tube from a 1100 volt power transformer, via a synchronous rectifier. The filament transformer has a center tap to which grid and plate returns are connected. In addition there is a 300 ohm potentiometer

connected directly across the filament leads, the arm being connected to the filament center-tap. 4GT says that this helps materially in clearing up the note. The filament rheostat is a home-made carbon pile compression type.

There are five different aerials at the station. One of them is a thoroughly insulated wire buried in the ground. Three separate ground connections and two counterpoises are also provided. By means of the switches on the panel at the extreme right, any combination of antenna, counterpoise or ground can be picked up.

The receiver mostly used is a Reinartz-Weagant-Schnell-Austin-Young type rebuilt, remodified and refashed every now and then. Directly behind the receiver is a small A-and B-battery panel. By means

of the Jones plugs and jacks on this panel any B-battery voltage from 2 to 200 can be readily plugged in and the A-battery (two 6-volt ones) can be put on the set or on charge. The Ultradyne superheterodyne on the shelf above the receiving tube rack is used for short wave work occasionally, although it is not as good as the standard short wave one on the table.

The DX at this station has been exceptional. Schnell on NRRL reported c4GT's signal as one of the most wicked, if not the strongest, he regularly heard. QSO with Australia and New Zealand goes on almost as regularly as clockwork. The station log is always kept up to the minute and is arranged so that the operator can tell in a short while exactly when a certain station was heard or worked and what the signal was like. A fine job, indeed, OM.

7AY, Eugene, Oregon

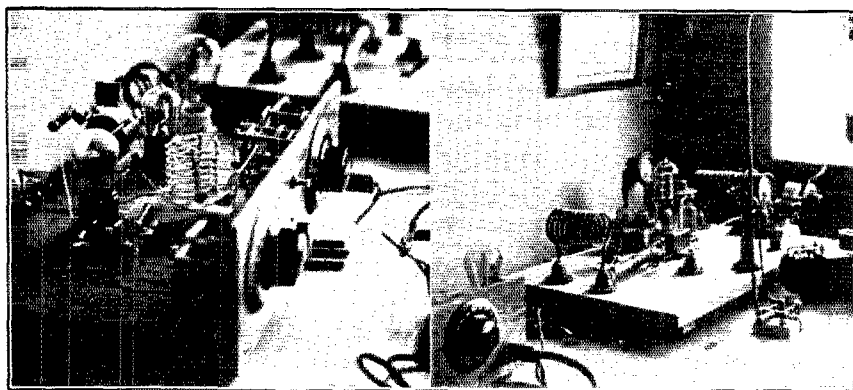

THIS station has been in operation for about one year. It is manned by W. E. Slauson, an old timer hailing originally from Monticello, Iowa in the pre-war spark days.

The transmitter consists of one 203-A tube operating in tuned-grid tuned-plate circuit. Parallel feed is used and the plate supply, 1000 volts of rectified A. C., is supplied by a transformer and two "S" tubes. Regulation of the input to the "S" tubes is provided for by a three way switch, a sixty watt, 110-volt lamp being connected in series with the primary of the power transformer to warm up the "S" tubes before the evenings operation starts. A filter of 4- μ fd. by-pass condensers and a 50-henry choke are used. The note is reported as being almost pure D. C.

The transmitting inductances are made of copper tubing. Eight turns are used in the

grid coil, nine turns in the plate coil and five and a third turns in the antenna coupling coil, for 40-meter operation. The coils can be interchanged almost instantly. Three turn coils can be substituted for the eight and nine turn ones for 20-meter work. Two 140-turn R. F. chokes are used, one in each high voltage supply line. The chokes are of number 30 wire on forms an inch and an eighth in diameter. The transmitter is operated a little below the fundamental for 40 meters and on the second harmonic for 20 meters.

The antenna and counterpoise lead-ins come in through the windowpane at the right of the transmitter. The antenna is a four wire vertical cage, 37 feet long. It is supported by a 57-foot self-supporting pole. The counterpoise is a "t" affair about 50 feet long. Plate glass insulation, and plenty

of it, is used in both antenna and counterpoise.

The receiving set is also a tuned-grid tuned-plate set, using 201-A tubes. It has one stage of audio frequency amplification. Plug-in coils are provided to cover all wavelengths between 10 and 90 meters. The National condenser on the right of the panel is trimmed down to 4 plates. This is the secondary tuning condenser. The regeneration condenser is a 250 μfd . Bremer-Tully, at the left of the panel.

The transmitter and receiver are mounted on shock-proof pads. Care has been taken in the choice and location of all insulation and in the arrangement of apparatus in order to get best results. A Seattle Radio Lab wavemeter is almost indispensable.

7AY has worked (on 40 meters) 14 countries, has been reported in 3 others, has worked AQE near the South Pole and has been heard by ships in East India, China and East of Madagascar in the Indian Ocean. Eugene is a very unfavorable location for reception of African and European stations.

The New England Division Convention

BRIGHT and early Friday, April 9th, delegates from all sections of New England began to arrive and registration at the Hotel Biltmore, Providence, R. I., showed a total attendance of 250 by Saturday afternoon. The Hudson Division had ten members present and a few from other Divisions were in evidence.

Chairman Young welcomed the delegates at the first meeting and then turned the meeting over to A. A. Hebert from headquarters, who acted in the absence of Division Manager Cushing, who was late in arriving. A detailed explanation of the new Communications Department was given and discussions took place afterwards. A very good address was given by Mr. Roger Williams of the Ceco Co. of Providence on Vacuum Tubes.

The first evening was given entirely to entertainments and a number of worth-while stunts put on. The Boston fellows had a skit that provoked some mirth; the P.R.A. String Quartette, assisted by one of their Y.L's, played Hawaiian Dance music. "Dark Waves, or the Providence Radio Assn. in 1960," was well staged and Maney was F.B. in his "technical talk." The time-honored Cracker Eating contest produced as much fun as ever, and for the first time in our knowledge was participated in by the Y.L's; 1KY and 1AID showed themselves real "hams." The Liar's contest was pulled off, but the platform evidently made the competitors self-conscious and it was not until 2BW (Doc. Walsh) got started that competition became strong. All honors were car-

ried by Doc. Walsh, and to quote from one of the newspapers, "such an exhibition should land him in the General Assembly."

Saturday was certainly a full day with examinations for licenses by Inspector Butterworth; a trip to WJAR and the afternoon lectures so well handled by the different speakers. Prof. C. W. Miller of Brown University spoke on "The Contribution of Radio Amateurs to Pure Science;" Doctor Elliott White of Dartmouth College was interesting in his topic: "Transmitting Tube Adjustment." Mr. S. N. Read, ICRI, gave us something to think about on, "Radio Pictures," and if our experimenters will only get busy now it will not be long before we can see each other at our sets.

Both Johnny Reinartz and Fred Schnell made everyone feel envious of their respective trips so well described, and there is no doubt that future expeditions will have no trouble finding men to go along as radio operators.

The Banquet, with Director White as Toastmaster, was unusually good. Our President, Hiram Percy Maxim and Mrs. Maxim, both gave us two very fine talks. Other addresses were made by Treasurer Hebert, Radio Supervisor Kolster and D. A. O'Connor, President of the Providence Radio Association, under whose auspices the convention was held.

The Grand Finale was a 3-act play, "How it All Began," written by 9DIP, and well staged by the Radio Transmitter's Association of Hartford, who deserve a lot of credit for the hard work put into this play, and which was enjoyed by everybody. (F.B., Hartford Gang).

It was agreed by all that this convention was the best ever held in New England and the thanks and appreciation of all delegates go to Messrs. Young, Kenyon, O'Connell and other members of the Providence Radio Association for making it such a success—and not forgetting all those loyal manufacturers and dealers, whose names appear on the programme, for the prizes contributed.

HARTFORD NEXT YEAR, fellows.

—A. A. H.

Strays

The Southern California Radio Association have formed a sorority addition which is called "The She-W Club." Next! The line forms on the right of the one with the marcel.

4DZ and 4AW have organized the "Palm Beach Radio Co." and have a station at Palm Beach with the call WOE. This will be interesting to brother A.R.R.Lers in the commercial game at sea. They have a 500-cycle kit, but they can also use a 60-cycle "sink" for those who want to hear that old familiar roar. WOE is located on a pier 500 feet from the shore.



Amateur International Intermediates

A—Australia
 AU—Alaska*
 B—Belgium
 BE—Bermuda
 BZ—Brazil
 C—Canada and Newfoundland
 CH—Chile
 CR—Costa Rico
 D—Denmark
 E—Spain
 F—France
 FI—French Indo-China*
 G—Great Britain
 GI—Ireland*
 H—Helvetia (Switzerland)
 HU—Hawaiian Islands
 I—Italy
 IC—Iceland*
 J—Japan
 K—Germany
 L—Luxembourg
 LA—Norway*
 M—Mexico
 N—Netherlands
 O—South Africa
 P—Portugal
 PE—Palestine*
 Q—Cuba
 R—Argentina
 S—Scandinavia (Denmark, Finland, Sweden)
 SR—Republic of Salvador
 U—United States
 Y—Uruguay
 Z—New Zealand

*These intermediates have been self-assigned and are unofficial. They are in more or less general use, however.

A New One

On the morning of March 29th u6OI connected with a new station o (zero) 1SR at Salisbury, Rhodesia. Contact was held for

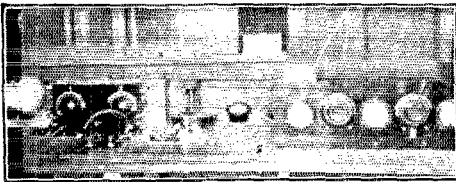

THE NEW 250-WATT TRANSMITTER AT 6OI

forty-five minutes, a message of greeting to the ARRL being transmitted. 1SR's wave was 31 meters. Following this initial

work 6OI and 1SR connected several times more, working "both ways around". F.B! 6OI has a new transmitter using a 250-watt tube. A photo of the new set is shown herewith. On April 2nd Borden of u1CMX and o1SR were QSO. Their QSO was also for about forty-five minutes although contact was broken up by QRN and QRM. o1SRs full QRA is J. W. Davidson, Box 580, Salisbury, Rhodesia.

Java

This boy Wentworth is hard to keep up with. As fast as he works a new station or a new country he comes back the next night and does a better job of the next one. The latest (up till time of going to press) is ANDIR the Military Airdome, Andir, Java. He and 6OI connected on the morning of April 2nd. ADIR was on 37 meters with 500-cycle note.

Crystal Controlled

u1CAK and g2SZ, both crystal-controlled, connected on April 12th for the first transatlantic two-way crystal controlled work. g2SZ was on a wavelength of 50 meters with D. C. supply and u1CAK was on 42.5, also with D. C. supply.

Australia

V1S and u9ZT connected recently. V1S is First Squadron, Australian Air Force, Point Cook, Victoria, Australia. It is expected that several other Air Force stations will be QSO on short waves soon.

Austria

A number of S/W ham stations are in operation in Austria now. Their intermediate is the German O (—). The following are in operation: AF, AR, AW, BE, BH, CP, DA, FG, FH, FL, HF, HI, HR, JA, JL, KH, KK, LA, LM, LP, MH, NA, OA, OP, RF, RH, SF, SJ, SV, TA, TM, TO, TW, WA, WM. QSL's should be sent to Oesterreichischer Versuchs sendeverband, Klubsaal des Hotel de France, Schottenring 3, Wein 1, Austria. We are indebted to 8DTO for much of the above information.

The WAC Club

Have you applied for your WAC Club certificate yet? A photo of the first certificate

is shown herewith. The following stations have submitted applications and have been entered on the rolls of the WAC Club as full-fledged members: u6OI, u6HM, u1AAO,

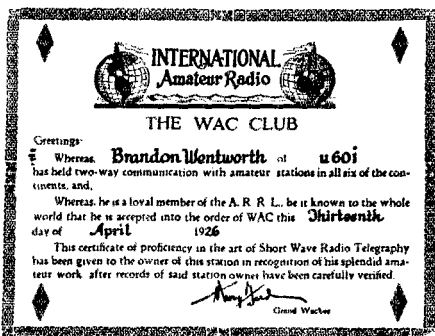

THE FIRST WAC CLUB CERTIFICATE. YOURS IS WAITING HERE, OM

e4GT, pr4SA u9ZT-9XAX, b4YZ and gi5NJ. The rules for applying for membership are few. You must have worked an amateur station in each of the six continents (see pg 54 of the May QST) and you must send QSL cards received from these stations to ARRL Headquarters addressed to the WAC Club. The cards will be returned promptly and if you have qualified for membership you will receive your certificate at the same time.

Chile

Major Raven Hart, ch9TC, one of the pioneer DX men in Chile has left that country and is now located in Barcelona, Spain. The Major says that a short wave receiver will be in operation in Spain very soon and he hopes he can get a transmitter going also. Good luck, OM es, CUL.

ch3AN (ex ch1GW) J. Gachelin will be in the States for several months and is anxious to meet as many of the U. S. gang as possible. He can be reached care Delco Light Company, at Dayton, Ohio.

The QRA of ch2RM-chC3AO is Rodolfo Mebus, Casilla 3208, Santiago, Chile. His QRH is around 37 meters and he is anxious to get QSO as many amateurs as possible. QSL cards addressed to the above address will receive prompt replies.

China

Several new contacts in China have been established. ch1TM, giving his QRA as Tangku, China (about 80 miles southeast of Peking) and 6OI connected recently. 1TM was on a wavelength of 37 meters and 6OI reported him R6. 8ATX worked a station hk3Z who gave his QRA as Colonel Warren, Pekong Street, Hongkong, China, on April 25. 3Z's QRH was 30.7 meters. He was using a 5-watt tube at the time and u8ATX was using a 250 wattier.

Great Britain

Due to business pressure M. G. Dixon has resigned as Secretary of the British Section of the I.A.R.U. and F. A. Mayer has been appointed in his place.

g2KF in London and a2CM at Sydney, Australia were recently QSO via telephony. 2KF's signal were reproduced on a loud speaker at a2CM by means of a short wave superheterodyne. a2CM tried telephony to 2KF and while the signals were audible in England it was well nigh impossible to understand a2CM, so most of his work was done on telegraphy. g2OD at the same time established telephone contact with a2CM.

An error in call books is causing cards addressed to g5YI to wander all over England before reaching their destination. The QRA is A. L. Goodliffe, 17 Malvern Road, Mapperley, Nottingham, England.

Hawaii

Another very excellent piece of DX work has been pulled off, hu6CLJ Masayuki Misamoto, at Honolulu recently worked oA3B in Johannesburg, South Africa. hu6CLJ was using a 50-watt tube with an input of 39.5 watts, operating on a wavelength of 38 meters. The distance is around 14,000 miles. The sun was shining brightly in South Africa while 6CLJ was waiting to eat his supper! This boy 6CLJ deserves a lot of watching. He is going to make a lot of the DX hounds look to their laurels. With only 2.5 watts input to a 202 he has been QSO ch3IJ, about 6,000 miles away and with either a 202 or a 201-A he has been QSO several times with rDB2. With the 50-watt tube he and BAM in Papeete Tahiti have been exchanging chats several times. BAM by the way has the following QRA: George Bambridge, Papeete, Tahiti, French Ocean. The 50-watt transmitter at 6CLJ has also been used to work HVA in Indo-China. Hisamoto is a High School student, working after school as radio operator, receiving broadcast press news from JAA for the Nippu Jiji Publishing Company. We wish we had a photo of 6CLJ. Maybe we will have one before long.

A Request

Amateurs in foreign countries will confer a great favor upon the hams in the States, who are doing their best to operate in the correct manner, by paying no attention to the U. S. amateurs who are operating off their correct wavelengths. If you hear any "Us" out of their band please disregard their calls.

India

We understand there is a new ham station in operation in South India. The call is 2JL and the station is run by Captain R. J. Hobbs, 2nd Armoured Car Company, Ashley Park, Bangalore, South India.

Please let us know as soon as you are QSO 2JL.

u6OI has had a schedule for some time with GEFT, *h.m.s. Concord*, on a regular run from Singapore to Southampton. They have been swapping QSO's ever since GEFT left Singapore. If you want to QSL communication with GEFT address him Petty Officer Telegraphist McTaggart, *h.m.s. Concord*, G.P.O., London.

Ireland

"Licenses for transmission were only granted in June 1925, but since that time Irish stations have been in communication with amateurs in all parts of the world. 5NJ has worked Australia, New Zealand, North and South America, South Africa, India, French Indo-China, Phillipines, Egypt and many other countries, besides putting good speech into a3BQ. 2IT is also QSO many parts of the world. 6YW has worked USA on 2 watts input, a record for Irish DX. 6MU is often QSO Australia, USA, Brazil and most of Europe. Other active stations are 6TB, 2WK, 6SQ, 6QD."—5NJ.

5NJ was the first licensed station in North Ireland. Maximum power is 100 watts. Both an 8-tube superhet and a two-tube

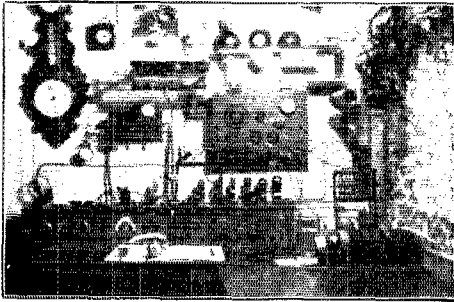

5NJ, THE FIRST LICENSED STATION IN NORTH IRELAND

regenerative receiver are used for short wave reception. The transmitter operates in a Hartley circuit working into a Hertz antenna.

Japan

Good of u6AJM-6CJP worked j3WW, Tabagawa, 4 Yamamoto St., Kobe, Japan, with a 210 tube. The actual input was 38 watts and j3WW reported him R5. 3WW's QRH was 38.6 meters at the time.

2AER has been copying commercial jJRA handling traffic with JJC on 35 meters.

hu6CLJ was QSO j1SK whose QRA is Shunichi Takata, Shimoshizu, Hikogakko Chiba, Japan.

Madeira

Madeira and Portugal use the same intermediate signal, P. The Madeira stations

have calls beginning with 3, while all the Portuguese calls start with a 1. Madeira is an island off the coast of Morocco. There are three active stations we know of there, p3GB, G. de Bianchi, Quina da Paz, Funchal, Madeira; p3CD, A.C. de Oliveira, c/o The Western Telegraph Co., Funchal, and p3FZ, J. Ferraz, Rue Ste. Maria 263, Funchal. 6OI in common with a number of East Coast U. S. and Canadian Stations has been QSO p3GB who seems to be the best DX getter of the 3 Maderia stations.

Mexico

We are pleased to show a photograph of m9A one of the most prominent ham stations in Mexico. The transmitter uses a single 203-A obtaining plate supply from four "S" tubes. The antenna is a single vertical wire 38 feet long. A single wire

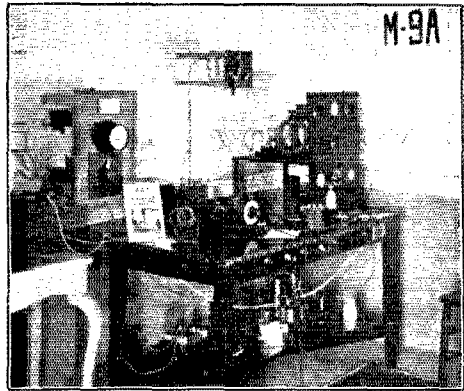

M9A, ONE OF THE BEST MEXICAN DX GETTERS

counterpoise 30 feet long is used. The station operates regularly on 38 meters. A Reinartz receiver with one stage of audio frequency amplification and two BC Ultradyne receivers (not shown in the photo) comprise the receiving equipment. m9A has a splendid list of DX to his credit, although receiving conditions are usually pretty poor in his locality.

Morocco

A new station in Morocco was communicated with recently, and gents 1MK the A.R.R.L. Headquarters station was the fellow to work him! He is fm8MB, L. Bensimhon, Box 19, Case Blanca, Morocco, Rodimon was at the transmitting lever at 1MK when this communication was pulled off. fm8MB has previously been reported as being heard by u3CHG but we believe this is his first U. S. contact.

New Zealand

Via radio from 5ZAI we received the following news bulletin from z3AF: "The

Whaler *Sir James Clark Ross*, AQE, has left New Zealand regions QRD home, and by now should be in Europe. In a few months AQE will return again to the antarctic and no doubt will be glad to QSO hams in all parts of the world. Last winter did not seem to be very good for reception of American 40-meter signals, the summer (which is just ending) being much better as far as this part of the country is concerned. A month ago DX was good but lately fewer stations have been heard here. There is a new station open in this city this month. It is z3AC, The Radio Society of Christ church. A fifty wattter with an input of 75 watts is being parked on the fifth harmonic of a big antenna. z3AC was QSO the States the first night of operation. The ops would like to have some 20-meter schedules with American stations. z3AF has worked German k18 three times and the QSO is good. k18 uses an input of 50 watts. z2AC has been working Portugal and other European countries and was recently QSO with SGC the motorship *San Francisco* in the Atlantic Ocean. He has also been QSO NRL in Russia on 35 meters. England is still being worked regularly, but very few Canadians are being listed.—z3AF. 9ZT sends us this dope from z2AC: "z2AC was first station in New Zealand to be QSO p3GB and Russian NRL Also z2AC has a daily schedule with f8JN f8JN's QRH is 33 meters and he can be heard every morning at 7 G.M.T. He is the loudest f heard in nz and sometimes he is QRK R8! Some time ago z2AC was QSO fe8CM in China. His QRA is Elecmeconi Factory, nr 544, Route de Zikawei, Shanghai, China. His QRH is about 35 meters, pure D. C."

Norway

The Norwegian amateurs have formed the NORSE Radioforbund, the central organization of all radio clubs in the country. It has about 35 members. QSL cards should be sent to Norsk Radioforbund, Oslo, Norway. Transmitters are using 20 watts input on wavebands as follows: 2 to 5 meters; 29 to 35 meters; 69 to 81 meters and 100 to 120 meters. Both telegraphy and telephony are allowed in all bands. The intermediate is LA the calls being 1B, 1C etc.

Philippine Islands

Elser of pi3AA has just pulled off some splendid DX reception. He has worked g5HA when the latter was using an input of only 5.4 watts! On March 19th at 7 a. m. he overheard u9AX calling 8EO and then a CQ for several minutes. The distance between u9AX and pi3AA is about 14,600 miles! pi3AA has been in operation since January 20th. Twenty fours after the station was in operation communication was held with Brazilian stations. Very shortly after that Elser left for Manila and has

just gotten back to Baguio where 3AA is located. The transmitter at 3AA consists of two 50 watters in a coupled Hartley circuit. The usual operating wave is 38 meters. His power supply is obtained from a small hydroelectric plant and the 110-volt 60-cycle supply varies both up and down. Keep a watch for pi3AA from now on!

"I. A. R. U. Press"

A number of the fellows have been sending in IARU News Press Bulletins via radio. This is splendid. Not only are several months delay avoided but also the messages so handled are of the best type there are going through the air today. u5ZAI, u9ZT, u9XI, z2XA, z2AC, z3AF, a2YI and several others are to be commended highly for their great help. In this connection we would like to point out that there is no way on earth in which we can find the QRA of the many new stations in new countries that you fellows have had QSO's with unless you write us. The IARU News form closes on the 20th of each month. We would like to have a line of news from every country on the globe. If you cannot make it by radio, shoot it in through the mails. The news should contain data on new stations, new contacts between your country and other countries, any exceptional DX work, account of expeditions about to sail or under way, account of any exceptional traffic handling feats, dope on new laws and regulations in your country and any other ham dope which will be of interest to the rest of the ham world.

Ship to Land

The photo shown is an interior view of GDVB the motor liner *Aorangi* whose sig-

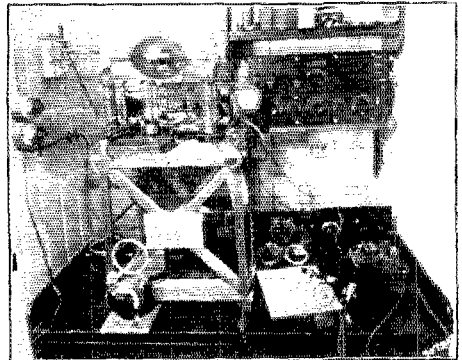

GDVB. THE FAMILIAR CALL OF THE MS AORANGI

Photo by Signal Corps, U. S. Army

nals are familiar to all the hams on earth. A. E. Hay is the GDVB's chief operator and holds experimental amateur license g2KG.

The first assistant operator is g2KC. GDVB is the largest motor liner in the world (23,000 tons) and is commodore ship of the fleet of seventy vessels comprising the stock of the Union Ship Company of New Zealand. The *Aorangi* runs regularly between the Antipodes and the American continent via Honolulu. Much experimental work has been done on the ship on wavelengths between 22 and 49 meters with power inputs ranging from 50 watts to 3 K.W. After exhaustive tests it has been found that the best short wave signals have been pumped out when the long and high T ships antenna, having a fundamental of 435 meters, is used. The normal short wavelengths of GDVB are 36 and 38 meters. Ordinarily very bad induction trouble is caused when working the receiver as there are over 2,000 K.W. on board for electrical power purposes. GDVB is also very busy on 600 and the longer commercial wavelengths, which accounts for the fact that the short wave work is cut short at times. The operators will certainly appreciate any and all QSL's either of communications or receptions of GDVB's signals. They can be sent either to Sydney N.S.W. or Vancouver.

Volunteer Wanted for Standard Work

A VOLUNTEER station is wanted to send standard frequencies from some point in the central portion of the United States, distance north or south being a secondary consideration. The best location for such a station would be in the Midwest, Dakota or West Gulf divisions although the Rocky Mountain, Delta and Central divisions are not too far removed to be out of question. The requirements are somewhat as follows:

1--The transmitter should be controlled by an institution or individual widely and favorably known so as to inspire public confidence.

2--Accuracy better than 1/10 of 1% is necessary.

3--Ability to send standard frequency schedules one evening each week plus one schedule every third or fourth Sunday afternoon.

4--Ability to undertake the work for a considerable period of time, preferably in the summer as well as the winter.

5--Some sort of organization to insure that the schedules will be sent regularly; one man cannot do the job.

For further information see the various OWLS (SF) schedules of 1XM also the description of that station in this issue. The A.R.R.L. cannot furnish apparatus for this purpose but 1XM, thru the courtesy of

Dr. G. W. Pierce of Cruft Laboratory at Harvard University will arrange for the calibration of a quartz crystal submitted by the prospective SF station. The accuracy of calibration will be better than the ability of the crystal to retain the same excepting under absolutely constant conditions.

Please communicate with K. V. R. Lanning, in charge A.R.R.L. SF stations, 226 Elderwood Avenue, Pelham, New York.

—R. S. K.

Pacific Division, Southern Section, Hamfest

ONE of those jolly hamfests was again pulled off by the Southern Section, at the Elite Confectionery in Los Angeles on April 9th. With an attendance of seventy members present it really had the dignity of a real convention.

Director Babcock came over from Frisco and gave us a complete report of the annual board of directors meeting and explained the recent changes in the Communications Department and the reasons therefor. We now feel that better contact will exist between the ORS' and those interested in traffic, and Headquarters.

Mr. R. B. Ashbrook of the Southern California Edison Co., who is in charge of power-line-QRM-elimination, gave us a short talk in which he expressed the willingness of the company to co-operate to the fullest extent in clearing up such interference.

Miss Flora Turner, 6BXA, the only "YL" present, received a hearty welcome. It is always a pleasure to have the "YL's" at our meetings; their presence has a benign influence upon us. "May their tribe increase!"

Another visitor was Mr. B. T. Withers, z3AM, who told us of amateur radio conditions in New Zealand. Ben McGlashan, 6PI, also of KFWB, made the pleasing announcement about the Warner Studios' program, which is to be carried out under their auspices with the assistance of the A.R.R.L. Southern Section. More will be reported on this later.

At the conclusion of the Banquet, 6CNL rendered a few selections on his "uke," and 6CHZ played a \$25,000 (?) composition of his on the piano. After the "gang" heard that, they all went home, but not before L. Elden Smith, Section Manager, said that this was the most successful meeting held in some time, and it was a "loud speaking" evidence that we are all pulling together, and let's hope we will continue to do this.

—6CHZ—A.A.H.

Calls Heard



u1APV-1JR, Leach & McCarroll, Wrentham, Mass. 40-meter band

6awt 6hek 6hls 6hsc 6egw 6eic 6eto 6eow 6dah 6dat
 6dax 6dbf 6eb 6fz 6gk 6hm 6ih 6ij 6oi 6qi 6rn 7ay
 7bb 7gi 7no 7tq 7sk 7sca 7sca 7sdc 7sdi 7sgra 7sfp
 7spx 7svor foeng g2kl g2ll g2od g2qb g2vq g2wj
 g2sz g5ls g5wq g6nf g6og g6td h4qa, h4yz hb2 bd2
 bt2 by8 ilas ilay ilbw ilcr iler ilgw ilrm ilno bz1aa
 bz1ab bz1ac bz1af bz1al bz1an bz1ap bz1aw bz1ib
 bz2ab bz2ab rb1 rb2r rfa rfb1 rfb5 rfb4 ch2ld ch3ag
 ch3an ch3ij ch3tc x1ao x2ac x2xa x3ad x3af x4aa x4ac
 x4al x4ar x4xa a2ad a2bk a2tm a2yi a3bd a3ef a3tm
 a3xo a3yx a3ay a3bg oa3b oa4l oa4r "oa6n" c3ar cz99x
 p2fz p3gb ear21 ear22 mlk mlj m9a m9k 19k yied
 yjep ky8 k4lv hu6buc ank bam ber ntt sgc sgt.

u1BFT-1CO, C. B. Evans, 80 N. State St., Concord, N. H.

a2cg 2es 2tm 2yi 2yz 3ad 3hd 3ha 3kb 3xo 5bg b3ad
 b2 beher ear8 ar22 ar24 foeng f8bf 8bx 8ca 8dp 8si
 8ix 8sp 8ww 8ip 8xm 8iz 8pm see 8vor 8um g2kf
 2iw 2oc 2qd 2xy 2ma 2qm 2lz 2od 2nh 2nm 5dh 5fg
 5lh 5rz 5is 5hs 6lj 6td 6vd 6ya 6nj 6ry 6al ilno lgw
 lbw las lwr lbd lad lbb lma lny y8 19k m9a ij
 npb3 peij pcell 2pk oa3b 4az a6n p3bk pr4je 4kt 4ri
 4sa 4ur q2lc 2mk 6kw r2a2 asrd uxx xz bw9 f8z f9c
 v (naval) ngq npg nwd nar nise nsm nisp njar
 napg ntt nes nni others z4ac g5vb kfuh eh9te de
 (Commercial) wvc wvy wrz kcl fw hyc byz afe kio
 ?77 dio sgr oiaa ohaa vet utm jae cbp ca. bz1ab
 lac laf lai laq law lib zab 5aa 5ab. All crds qsl'd.

1BAD, H. A. Chinn, 30 Coral Avenue, Wintthrop, Mass.

6aak 6aao 6abg 6adt 6adw 6ajt 6ajj 6ajm 6ako
 6akv 6amn 6api 6apc 6ank 6aun 6avj 6avp 6awt 6ay
 6bad 6bay 6bci 6bek 6bck 6bgv 6bhz 6bcz 6bpb
 6bq 6bql 6bsf 6btm 6bu 6buv 6bvy 6cae 6cbj 6ccl
 6cdw 6cge 6chx 6cix 6cuf 6cqa 6cat 6cns 6crz 6ctk
 6ctf 6ess 6cvp 6daa 6dah 6dai 6dam 6daq 6dat 6dax
 6do 6fa 6hm 6hv 6is 6ky 6lr 6ob 6rn 6sb 6wt 6vf
 6vt 6rr Taek 7aif 7df 7ek 7it 7kg 7ki 7ny 7ps 7nj
 7oy 7ru 7tm 7vh 7wu 7xf a2bk a2cs a2rj a2as a2aw
 a2im a2yi a2yh a3ad a3bd a3bm a3hl a3kb a3lm a3oh
 a3ot a3ah a3xo a3yx a3em a3kn a3ay a3da a3bg a3ag
 a7bc a7hl a7pf bb2 b32 bo8 bp7 bt2 bu8 bw1 b4yz
 beher bz1ab bz1ac bz1an bz1ap bz1ib bz2ab bz2ak
 bz2ni ctan clcx c2ac c2bg c2cg c3ad c3ek c3do c3en
 c3he c3jl c3jw c3ka c3xi c4bt c4vf c5go c5ar ch2ld
 ch2tc c5okl q7ec ear2 ear20 ear24 f8aif f8bf f8ca
 f8ct f8fd f8dk f8dp f8ec f8gl f8gr f8hu f8ip f8id
 f8jf f8jm f8mn f8oz f8pm f8st f8sx f8yd f8yor f8zo
 foeng g2ec g2fm g2fv g2kf g2kr g2nb g2nm g2od
 g2qb g2sz g2wjl gbat g5dh g5gv g5hs g5lf g5ls g5mh
 g5mo g5pm g5sz g5vl g6ab g6al g6kk g6rm g6td
 g6tm g6yd h9ad hu6aft hu6bf hu6bh hu6bd ilas ilad ilay
 ilbw iler ilm ilno ilrm ilrp ilrt k18 ky5 ky8 19k
 mlj mlk mln m5e m9a mdh npej npeu n3gp npb7
 oa3b oa4l oa4v oa4z oa6n p3co p3gb p3op pr4r
 pr4ur pilfn pilhg pilxl pilhr q2jt q2lc q8kp rbal
 reb8 sskk sscx smmy sard zlad zlaa zlak zlfq z1wa
 z2ac z2bl z2xa z3af z3as z4ac z4ak z4al z4ar z4as
 z4av ane aqe cbpz bam bbx kfuh jb jhm jow nem
 ntt rrrd xda.

u2AGI, Karl Rossbach, 620 Wyoming Avenue, Elizabeth, N. J.

4ax 4cu 4fl 4gy 4hu 4tx 4vl 5ael 5acy 5agn 5ajk
 5alz 5amg 5ann 5ao 5apo 5aqy 5arn 5att 5auz 5ce
 5dq 5fe 5gq 5jd 5jw 5ke 5nq 5qa 5qh 5sp 5sw 5uk
 6aaf 6afg 6apc 6asd 6ash 6bil 6bt 6bvs 6cbp 6ecz
 6ei 6elz 6emi 6enn 6esw 6euk 6dqc 6ddx 6fz 6js 6jy

6uf 7ab 7df 7ek 7gi 7ig 7ya 9aiz 9arr 9avr 9bhi. 9bjn.
 9bse 9cgh 9cld 9eye 9dde 9dwd 9eag 9ean 9eb 9egh
 9egn 9if 9gn 9gx 9kd 9nk 9xn c1ar c4hh c5go g2cc
 g6ox ilad ilas.

u2GX, 40 Broad Street, Newark, N. J.

a2cm a2vi bt2 bw1 bw2 b4yz bz1ab bz1an bz2ab
 bz5aa ch3ij d7ec ear2 ear6 ear8 ear9 ear22 f8aif
 f8tav f8dd f8dk f8ee f8gi f8gx f8jd f8ja f8jf f8oz
 f8ww f8xp g2bz g2cc g2kw g2lz g2nb g2ob g2om
 g2rb g2vl g2yo g2xy g2zd g5pm g5pb g6nf g6td g6yu
 h9ad ilac ilas ilay ilbd ilco ilgw iler ilrm 19k
 m9a oa3b oa3m oa4l oa4z oa6n g2co p3gb p6yx raa8
 sskk sscg smzs z1ao z2ac z2gc z2xa z4ag

u3VA, Fred Link, 40 S. Beaver St., York, Penna. 40 meter band

a2an, a2cs, a2cx, a2bk, a2ij, a2mh, a2ss, a2tm,
 a2yi, a2yv, a2yh, a2gq, a2rc, a2zn, a2im, a2rm, a2cg,
 a2bb a2yx, a3hl, a3xo a3rj a3wm a3bh a3ad a3tm
 a3qa a3sn a3bq a3bd a3lm a3yn a3ls a3ef a3bm a3kb
 a4an a4rb a4da a4kn a4ay a4ag a4bg a4bq a4cs a4ew
 a4gt a7hl bww b4ra b4yz beher c3ar c3wm ear9 ear20
 ch2d ear21 ear22 f8ca, f8ca, f8jf, f8st f8rb f8va
 f8jn f8gi g2ec g2sz g5lf g5lj g6td g5qv g2lz g6tm
 g6uz g2qb g2kz g6qb g6al g6ym g2yq g6yu ilau
 ilas ilbd ilbw ilma ilno ilgw iler ilay kys m9a
 mlj mjh oa3b oa3e oa4l oa4v oa4z oa6n p3bk p3co
 pilhr p18aa q2by q2lc rfh4 smzs z1ac z1aa z1ao z1ax
 z1fm z1cd z1af z2ac z2ae z2bc z2bz z2gc z2ak z2ga
 z2bx z2ad z2mb z2av z2xa z2gj z3ad z3ae z3af z3al
 z3ai z3aj z3ld z3ac z4aa z4ac z4ar z4as z4am bz1ab
 bz1ac bz1af bz1ap bz1aw bz1ag bz1al bz1ai bz1ad
 bz1ib bz2ab bz2af ch3ij hu6asu hu6tq pr4ur pr4rl
 pr4sa c4dW c4dq c4gt kfuh nida sgc.

u4BL, The Bryant Twins, 315 W. Hillcrest Drive, Lakeland, Florida 40-meter band

a2bb a2bk a2cg a2cm a2cs a2dg a2dj a2ds a2gp
 a2ij a2jm a2jw a2kl a2lm a2mh a2re a2se a2tm
 a2yh a2yi a2yx a3ad a3af a3aj a3bd a3bc a3dc a3ef
 a3hl a3kb a3lp a3ls a3my a3ot a3wm a3yn a3yx
 a4an a4as a4rb a4ay a4da a4kn a4lf a4vz a5rm
 a6kx a6wi a7cs a7ew a7dx a7gt a7hl avls an3s
 b4qq b4rs b4yz bp7 bw1 bz1 beher bebes bz1ab bz1bc
 bz1al bz1am bz1an bz1ap bz1ar bz1aw bz1bd bz1bh
 bz1ia bz1ib bz1ic bz2ab bz2ad bz2af bz2ni c5go ch2ah
 chear ch2ld ch3ij ch9tc chvad cre ear9 ear20 ear21
 ear22 ear23 f8bx f8ca f8cs f8dk f8dp f8ee f8en f8eu
 f8gi f8gr f8hc f8if f8jn f8jw f8nn f8nx f8rbp f8rn
 f8tk f8xp f8yor fonn f8qg fm8ma g2bz g2cc g2fm
 g2fu g2go g2kf g2kz g2lj g2mb g2nm g2ob g2qb g2sz g2vq
 g2wj g2xy g5am g5da g5dc g5dh g5hs g5ls g5ma g5rz
 g5si g5sz g5vl g6al g6iv g6jv g6kk g6nf g6og g6ox
 g6rg g6su g6uz g6yd g6yu hu6aff hu6buc hu6bd
 hu6df hu6xl ilad ilas ilay ilbw ilco iler ilfp ilow
 ilma ilno ilrg k18 lljw mjh m72en nofp npeu oa4
 olar p2sl p3co p3bz p3co p6zk p18aa p18cd pineq
 pr4je q2jt rb2 rfb5 u7aaj y1cd y3gg y1cp z1aa z1ao
 z1ax z1fz z2ac z2ak z2bd z2ga z2gc z2xa z3ae z3af
 z3ai z3aj z3am z4aa z4ac z4ak z4al z4am z4ar z4av
 zgdbv zjrf zkfuh. Misc. fw geft kft Morocco maroc
 pt3 pt5 pt3af (qra?) 73bd (qra?) ntt at Malta and
 Cnst'npole.

u3RF, E. Petersen, 1 Cold Spring Avenue, Baltimore, Md.

f8fr f8gi f8gk f8jf f8jtc f8vor f8zo g5lb g6kk ilas
 ilay ilbd ilgw ilno ilrm mjh mlj mlk m8st npb7
 oa3b oa6n p3co p3gb pr4ur q2jt q2lc q2at z4am ank
 bes fl ntt scc wjq srd.

u5KC, V. L. Rosso, Plaquemine, La.

a2ij a3bq a4an bzlab bzlar bzlib bzlic bz5ab bzrzt c1ei c2au c3br c3pk c3mf c3mv c3xi c3zb c4ea c4ez c4fv ch2ld ch3ag ch3an ch3ij ch3tc f8eu f8jn f8nz g2lz hu6clj hu6est hu6dbi lldi iler ilgw ilno ilrm m1j m9a mjh mxda o3bb o4v o4z pr4rj pr4ri q2jo rbal r1zr ssgc ssic ssmy yled yjep z1aa z1ao z1ax z2ac z2ae z2xa z3af z4ac z4ak z4al z4as z4ia cz99X. Miscellaneous hu6g gdvc pcuu pt3.

u6BBV, J. Barsby, 1010 Bates, Hollywood, Calif. 40-meter band

labt laju lazd lga lid lig luw lvc 2aj 2bqh 2eqz 2kg 2nz 2sq 3mp 3wm 4fb 4lk 5agu 5aiu 5ako 5dq 5ef 5kk 5rg 5zo 7af0 7dc 7hv 7vr 7wb 7wy 7xf 7zm 8ded 8dx 8kw 8qb 8xe 9abo 9abt 9adn 9agy 9ara 9bdd 9bvh 9bvs 9hwn 9bwo 9cjq 9cej 9gn 9che 9ckm 9cs 9cz 9ldu 9dxz 9ebj 9elt 9ff 9hb 9kd c4dq hu6buc hu6edf yfuz z2ac z2af z2bx z3af z3aa z4ac z4ar z4xa a2cg a2cm a2cs a2ds a2yi a2zn a3bd a4an a5da a5kn a7cj ch2ld j1aa Tahiti bam pilhr nkf npu npg wvc npm agb.

u7LQ-7L, W. C. Mock, Jr., 1200 Brazee St., Portland, Oregon 40-meter band

a2ay a2bb a2bk a2cg a2cm a2cs a2dj a2ds a2ij a2jm a2jw a2lk a2lm a2rc a2tm a2yi a3s a3ai a3bd a3bm a3bq a3ef a3hl a3kb a3lm a3lp a3tm a3xo a3xx a3yx a4an a4rb a5ah a5ay a5bg a5bm a5da a5lf a5rk a5rm a5ag a7cw a7gt a7pf z1aa z1ao z1ax z1qf z2ac z2ae z2ak z2ap z2ga z2gr z2xa z3ac z3af z3aj z4aa z4ac z4ak z4am z4ar z4av z4xa kfuh hu6aff hu6aj hu6buc hu6clj hu6fl hu6fn hu6fw pilau pilau pilhr pilcw pil8a picd8 pija2 pinajd pineqj pinab j1aa. China: glub. Borneo cepc. Java: ane anf. ch3ij. Straits Settlements: greeq ss2se. bz2ab cz99x. Samoa: g2ac numm. oa3e oa4v ssmy pow fw f8lbt f8lqq.

u8AVO, A. G. Waack, 611 Madison Street, Lansing, Michigan

a2bd a2cm a2ds a2jm a2yi a3bd beber bzlab bzlac bzlad bzlaf bzlan bzlar bzlib bzlin bzslq bz5ab ch2ld ilgw m1a m1aa m1af m1b m1x m5c m9a npejj oa3b oa3e oa4z oa6a pr4kt pr4je pr4ri q2it rbal z1ao z1ax z2ac z4ar z4ki raas kfuh g2ac npu nism ntt nkf.

u8BKM, Wilburt C. Gross, 453 Mill Street Conneaut, Ohio 20-40-and 80-meter bands

6ac1 6ada 6adt 6aed 6ahs 6aig 6ais 6ajm 6a1p 6akm 6alv 6alx 6anw 6aon 6aos 6apc 6apw 6aqp 6asd 6asy 6awt 6bcn 6bgo 6bgu 6bhg 6bhi 6b1h 6bis 6bln 6bmp 6btx 6bvo 6cbj 6cbp 6cco 6ces 6cgv 6cng 6chk 6cin 6c1v 6crr 6esk 6ect 6eto 6etx 6euc 6evc 6euw 6eva 6eww 6daj 6dat 6dau 6dax 6dh 6dxv 6eb 6ei 6fg 6ga 6gj 6ha 6hj 6hv 6ih 6kg 6kn 6oe 6oi 6py 6rf 6sz 6vr 6wd 6xg 6yb 7ac1 7afj 7afz 7aif 7ay 7bo 7cy 7df 7dm 7ef 7en 7ez 7ef7 7fq 7gw 7ib 7if 7ko 7ku 7mp 7mz 7no 7nl 7ok 7or 7ou 7ox 7y 7zj 7rp 7sb 7sc 7sp 7tj 7un 7uz 7vl 7vn 7vr 7vw 7w1 7w2 7wv 7ww a2bg a2es a2jl a2tm a2yi a3bd a3kb a3ah a3tm a3wm a3yx a5bg a5kn bzlab bzlib bzlar bz2ab bz2af bz5aa bz5ab ch2ld ch3ag f8bx f8dk f8hu f8y9 f8zo g2fm g2nm g2qm g5sz hu6aff hu6buc hu6edf hu6fl hu6fw ilas m1af m1b m5n m9a oa3b o33b p8xj pr4je rf4 z2ac z2aq z2xa z3ad z3af z4ac z4ar z4av gdvb jaf kfuh nar1 nba npl nqk1 nqz2 smyy y9x. All cards qsl'd.

u8CCQ, 311 Jerome Avenue, Williamsport, Penna.

U. S. 4uf 4ai 4ar 4av 4cl 4fj 4ft 4jk 4js 4jv 4lk 4oy 4mi 4pz 4rm 5ada 5ado 5afd 5afu 5agn 5ain 5akl 5akz 5alz 5amb 5apj 5atf 5atp 5auh 5auw 5eq 5ie 5mi 5mq 5ql 5rg 5sp 5yb 6adt 6aem 6afa 6aw 6ano 6akt 6apc 6awt 6az 6bav 6ben 6bhz 6bil 6bs 6bpb 6bqt 6hvg 6eah 6ecv 6cgv 6cix 6cis 6cpg 6csw 6cto 6dad 6dab 6dag 6dam 6dax 6ay 6hq 6bc 6cq 6ct 6eb 6fa 6hr 6ih 6rj 6rm 6rn 6sb 6uy 7adq 7dd 7df 7ek 7nc 7no 7pr 7ps 7im 7uz 7wu 7xf 7ya 7zn g2bz g2cc g2kw g2nb g2od g2qb g2sh g2sv g2vq g2xy g2zy g2yq g2dh g5hs g5nn g5pm g5rz g5sz g6bd g6iv g6kk g6lj g6td g6yu f8ca f8cs f8hu f8ip f8jg f8jf f8mb f8nn f8pm f8xp f8zm f8rbp f8vaa f8y9 ilau ilas

ilay ilbd ilco ilgw ilno ilrm bzlab bzlac bzlaf bzlaw bzlan bzlib bzlisq bz2ab bz5ab bz6qu bzani oa3b oa3e oa4z oa6n oa6r raf2 rbal rf4 hu6aj hu6buc hu6edf npb3 npb7 n2pz mlg m1c m5c m9a mjh esok-1 smmsz bb2 bj2 bo8 bwv bu3 b4yz p3co p3bg k18 pr4bj v99x z1ao z1ax z2ac z2xa z3af z4ac z4am a2bk a2cg a2es a2yi a3bd a3kb a3wm a3xo a4an a5da a5kn ch2ah ch2ld ch3tc ear9 ear20 ear2 c1an c1ak c1dd c1dq c1dj c1dm c2ax c4gt c5ef c5go c8ar by4 wvc wva sgc ntt rrp kpl kegk pkx pwa nidk ftz. All cards answered.

u8DCW, Saranac, Michigan 40-meter band

6aak 6uai 6adw 6ael 6aem 6afs 6aja 6aji 6ajj 6akm 6akt 6akw 6alo 6alt 6aia 6amm 6anc 6ano 6anq 6aaz 6api 6apc 6asd 6awt 6axe 6bac 6bad 6bav 6bdw 6bea 6bfe 6bgl 6bgo 6bha 6bhh 6bhr 6bhw 6bim 6bil 6bmj 6bo1 6boo 6bpa 6br 6bry 6bse 6b1tm 6bts 6bvg 6bvs 6bwn 6bwt 6cab 6cae 6ccb 6cek 6cel 6cd1 6cdw 6cfr 6cgl 6cgv 6chl 6cho 6cib 6ck 6clp 6cls 6cmq 6cof 6cpl 6cpg 6cz 6csv 6ctd 6ctk 6cto 6ctp 6cuk 6cux 6cva 6evp 6gq 6dl 6fa 6ge 6gh 6hv 6jn 6kd 6la 6np 6rj 6rn 6rv 6rw 6ta 6uf 6ur 6vr 6vs 6yb 6dah 6daa 6dax 6dbe 6dbg 6dbw 6dcq 6ddo 6ddz 7af 7df 7hb 7jx 7lq 7ok 7pu 7w 7aw 7im 7uz 7wu 7xf 7yc 7ym 7zaj 7adg 7aek 7ajj a2bk a2cs a2ij a2mh a2as a2ai a3wm a3yx a4an a5kn a7gt bebam bzlab bz1aw bzlib bz5ab clam c1dm c2al c4ac 4al c4cb c4cc c4zbd c4dy e4ea c4hf c4hh c5ba c5ef c5go ch2ld ch3ij f8hm f8jn f8tk g2nm g5lf g5pf (Scotland) hu6aff hu6buc hu6clj hu6dbi hu6edf hu6f1l hu6wq iart mlg m1j m1k m1n m5c m9a mjh oa3b oa4v oa6n pr4x pr4m q2jt yjep z1ao z1ax z2ac z2ae z2xa z3am z4ac z4av zkufu aqe bg fw f8z gdvb kfai mdo? nisx npm pcll pjc pow pt1 pt2 pt5 sgl sgt vad xam xda x7u.

u9CN-9CXC, Chicago, Ill.

U.S.A.—6aak 6akm 6alt 6asd 6apc 6avj 6ahp 6ay 6bcs 6bfg 6bil 6ber 6bsd 6baw 6boo 6bcn 6btx 6bwn 6b1n 6vp 6evk 6cpg 6chl 6csw 6cto 6cpl 6csx 6cae 6erz 6eur 6env 6ecl 6elj 6esv 6erp 6cl 6das 6daa 6dad 6dat 6dab 6ddo 6ea 6ew 6ha 6kb 6kv 6jq 6oi 6on 6rh 6rm 6sb 6uf 6vr 6vz 6sk 6py 6zbe 7aek 7akv 7alk 7ek 7gr 7hi 7mz 7nf 7ok 7ps 7uz 7vn 7wo 7op r-fa4 rabl bz2af bz1aw c1ar c4ez c4ez c4dy c4fy c4gt c5gt chleg ch2ld ch3tc c1ra cz99x czafe g2yb g5nn m1aa m1k m1j m5c m9a mjh pr4kt pr4sa pr4oi q2jt q2rm srrd sxxmy wva y75 z-kfuh npm npl npr npu nqr nrt ntt nvg a1aa a2cm a2cs a2ar a2jr a2tm a2mh a3bd a2yx a3ad a3bp a3kb a3xo a5bg a5hr a5rm z1aa z1ax z2ac z2ga z2ga z2xa z3af z3ad z4ar z4rb z4al z4ac z4as z4ak.

u9DWC, J. A. Geissman, 185 Biddle Street, Milwaukee, Wis.

6abg 6agk 6ajj 6akm 6akx 6akz 6amm 6aqp 6atv 6awt 6avj 6azl 6aum 6bau 6bgb 6bbv 6bvg 6bhz 6bjx 6bjv 6bjd 6bvk 6bol 6bqu 6bdn 6bmw 6brv 6bur 6bvs 6eah 6ceg 6cgv 6che 6cig 6cmq 6cpl 6css 6csw 6cto 6cub 6cqa 6cbj 6dad 6dag 6dah 6dal 6dam 6dat 6dax 6ew 6hw 6js 6ml 6ox 6tc 6ts 6ur 6si 6se 6vc 6ws 6xad 6xag 6xav 7abb 7ac 7aek 7aif 7au 7df 7zb 7ek 7is 7iu 7ok 7uq 7uz hu6aff hu6buc hu6dbi clar c2bg c3gs c4aa c4gt c5ef c5go pr4ll pr4sa m1aa mlg m1k m9a m5c bzlab z2kf a2yi a4an a5bg a5kn z1aa z2ac z3af z4ak z4am npr npm ntt ktfl (qra?) nkf wgo wiz wir wry (qra?) nisr.

pr4KD, E. W. Mayer, USN Radio, San Juan, Porto Rico 40-meter band

ladi laja lasu latv law Jay lbdg lber lrhs lbig lbf1 lcep lcki lcpf lja lkl lmk 2ael 2aev 2a1w 2aql 2arm 2awf 2bbw 2bhf 2bkl 2brk 2bl 2box 2bqj 2bjz 2bl 2bul 2bv 2bxj 2byj 2cab 2cc 2c2c 2c3s 2eft lchh 2cjd 2c1j 2erb 2ctm 2cua 2cun 2fo 2jn 2mk 2oc 2os 2py 2uk 2zc 2bcn 2bs 3gd 3hu 3sh 4dm 4fh 4kp 4oy 4ap 5ayn 5akn 5atz 5rv 5sp 5tp 5za 6aj 6azq 7df 7el 8ahk 8air 8apo 8avk 8bp 8ekh 8erm 8dan 8dft 8dh 8gk 8jw 8ek 8wv 8zae 9apn 9bi 9hm 9bna 9baa 9buq 9bhv 9ekm 9cpm 9evu 9eag 9ny 9og 9ox 9wi 9za blbz bu3 bz1ac bz1an bz1ia bz2ga c1dd c3xi q2lc g5hs g5mq g5rz g6f g6vc g6zi f8bf f8fh f8ix f8jn f8nn f8gra k4iv npb3

bzlau bzlaw bzlib bz2ab bz2ad bz2af bz2bi bzsqi
ciak clar c8kp ch3ij ch9tc yerp yjcp jlaa pebyx
pe6zk pe6zm pilhr pr4je pr4rx pr4sa rbal rdb2 ripz
x2m (qra7- z1ax z2ac z2av z3af z4ac z4as z4vr z4xi
z5ai bm2cq hva hw hzg kvo kwo.

g16YW, T. P. Allen, 19 Ardgreenan Drive,
Strandtown, Belfast, N. Ireland
Below 50 meters

labz lahb lahl laiu lav lala laof lapz lben lbqt
lbz lcal lc1j lcmp lga lgr lrd lrr lsw lxm lxx
2acp 2ahm 2arm 2ate 2av 2brb 2eel 2epd 2erb 2cxl
2ev 2or 2uk 2xbb (?) 3brw 3bqj 3cah 3chg 3jw 3mv
3pf 4bl 4gf 4kt 4rx 4rz 4sa 4tf 4tv 4ur 6awt 8ccq
8dbb 8dgo 8zr 9dqu pilhr pineqq pi4aa(.) pi3aa
oa4z oa6n bzlab bzlac bzlad bzlaf bzlak bzial bzlan
bz1ao bz1ap bzlar bzlib bzlic bzlib bz2ab bz2aa bz2qa
bz6ya bz1 q bzsmi ch3ij ch2ld ch9tc rdb2 a2bk a2cm
a2ds a3bd a3bq a4rb a6af clar c1dd c2ax y2bg fi8qq
fi8lt. Various gefit n6k not ntt nrk tuk reri. Qrk
g16yw? All cards answered.

Truxillo Railroad Co., Telegraph Department,
Puerto Castilla, Honduras.

laao lamd lar lawe lco 1pl 2acp 2ahm 2b 2box
2mu 2nz 2wh 2xaw 2xu 3aa1 4aa 4ac 4av 4bl 4fs
4ft 4fx 4jr 4ok 4tv 4xa 5aab 5aad 5aaq 5ak 5ahp
5ain 5ahp 5ame 5apm 5fc 5ft 5gn 5nq 5sd 5zl 6abg
6bhi 6bhz 6bjd 6bqt 6cae 6cass 6cuw 6kb 6xi 8aul
8byn 8cco 8csr 8don 8gk 8jn 8xe 9aac 9aot 9bbw
9bhd 9beg 9bjz 9dzi 9ckm 9ent 9cxc 9dbw 9drs 9eez
9eff 9im 9kg 9mm 9oo 9zt mbx miw min q2lc
zero-2ld pr4sa pr4je g2as s3jh plae h8kp agb agz
byz fw gbl ca kbh kdka lpz nar nba nkf pkx ug ur
wgy wvb wvc wvf wvy xam xda.

ch9TC, Los Andes, Chile

laao lbce lf3 2akb 2apv 2ans 2cxl 3ab 4ai 4rm
4rz 5ain 5amw 5aqz 5atx 5aw 5dh 5dq 5fc 5ms 5nz
5sd 5sp 5za 6aff 6afz 6aiv 6ajm 6apx 6asy 6axw
6bam 6bfe 6bhd 6bil 6bfj 6btk 6bjl 6bjx 6bl 6bol
6bpg 6buc 6bvg 6ccz 6cdw 6cia 6eic 6eja 6et 6eto
6euk 6eur 6daz 6dar 6dau 6dax 6dgb 6fa 6ii 6mb
6ml 6nx 6oi 6av 6uf 7df 7en 7nf 8xe 9adk 9ado
9aot 9axx 9bkj 9bmd 9cet 9che 9ck 9etg 9cxc 9ded
9dqr 9dqu 9dur 9ebj 9nv 9oo 9pn a2bk a2rd bb2
b4yz g2bz g2ce g2mm ilas ligw mij m9a oa3e oa3f
z1ao z2ak z2bz z3ai. Unknown aqe bam pt.

11ER, Santangeli Mario, via S. Eufemia No. 19
Milan, Italy
New Calls

lapv layl lbad lben lbmd lcfi lch lkj lii lij lwy
2aep 2aev 2aje 2alz 2ate 2atk 2auh 2av 2bum 2cwr
2cvi 2im 2cu 2pc 2px 3acm 3ajn 3bqj 3brw 3cgs
3py 3tp 4aae 4bj 4bl 4fj 4ft 4kl 4pi 4rx 4si 4se
5ael 5mak 5sd 5vb 6mu 7bu 8afq 8aqz 8aj 8aol 8axx
8bcm 8bad 8bfn 8bkm 8bv 8cbi 8cvg 8dbb 8doy 8eb
8ew 8fp 8lik 8ul 9bac 9cul 9eyr 9ek a2ac a2ij a3ef
a4an bzla bzial bz1ao bzlar bzlaw bzani c2ac z2pe
q2lc m8a m5c pi3aa pied8 rdb2 z2ae z3af z4ac. Miscel-
laneous: gefit 3kp kw9 mt sgt nmr.

SQ2 Livio G. Moreira, Paula Gomes 6,
Curitiba, Brazil

laao lbqg lcaw lckp 1yb 2ahm 2ape 2apy 2blm
2bvc 2zk 3ahl 3ft 3mv 4bu 4dm 4rz 5ah 5xau 5yd
6hzh 6buc 6cgr 6oyp 7df 8aly 8bpl 8cau 8dpa 8oq
8vx 9adk 9bpb 9cur 9dqu 9dca bz1ab bz1ac bz1af
bz1ah bz1aj bz1al bz1an bz1ao bz1aq bz1ar bz1aw
bz1ax bz1ay bz1bc bz1bd bz1bg bz1ia bz2ab
bz2ae bz2af bz2ak bz2sp bz2sa bz2sb bz2qa bz2qi
bz2qd c9cx ch2ar ch2ld ch3ag f8jn pinajd oa3b raas
ras7 rbal rba2 rba3 rdd7 rde2 rdia rds rdxl rfb5
rfc6 rfg 7 rfh 4 rfh5 yjcp yekw. Miscellaneous: fw
nkf npl kdka pell pcuu wgy wiz wqo.

z2BN, S. Hislop, 8 Fitzroy Road, Napier, N. Z.

laep 1al 1bux 1ci 1ck 1uw 1yb 2abk 2agq 2ahm
2amp 2ap 2bw 2cg 2cxl 2ezn 2me 2xac 3agq 3bwt
3cjin 3ld 3sk 4bu 4rz 5ahg 5akl 5dz 5fc 5hy 5nw 5qa
5vm 5xau 5zal 6abg 6adw 6aed 6ajj 6aka 6akm 6ait
6aos 6aps 6arw 6avj 6bbz 6bil 6boa 6btx 6cwg 6che
6cin 6cmz 6csx 6ct 6ctx 6cur 6dar 6dau 6dl 6fg
6hj 6hm 6hv 6if 6ji 6kb 6nw 6ob 6oi 6rd 6rm 6rv
6uf 6vq 7aaJ 7adm 7ay 7hb 7ho 7it 7no 7vq 8alf

8bww 8ccb 8ded 8dri 8er 8gz 8nx 8pl 8xe 8zk 9aac
9aap 9aon 9bn 9bsc 9bsg 9bta 9bz1 9cet 9civ 9civ
9cn 9coo 9cz 9cyy 9dez 9dge 9dkq 9dr 9dud 9eel 9eji
9ela 9eli 9fj 9iim 9kb 9nk 9uq 9vq 9wi 9zt Alaskan
7sm c8afp c3fc c3nc c5ag f8bf f8cv f8jn f8tk f8qq
hu6aff hu6buc hu6cst hu6dof hu6fl ilas ilgw ilrm
ilma mijj m5c nosn pilhr pi3aa aqe bam naj yicd.

J. da Rocha Saraiva, Lourenco Marques,
Portuguese East Africa

laei lah lair lain lamd lan laof lbgg lbgi lbsd
1bst lby lcaik lcaw lcmp lqx ljr lmy lsi zagb zaim
2ain 2aky 2als 2amj 2aul 2bse 2cey 2cft 2crb 2ds
2qw 2mk 2mu 2op 2um 2wh 2xt 3agz 3bmz 3bwj
3de 3hg 3pb 3pf 3po 3pz 3wb 3xt 4aa 4aah 4ac
4av 4cu 4dk 4eg 4er 4fr 4in 4iz 4je 4jk
4jn 4js 4nw 4pl 4pz 4se 4xe 5aa 5adl 5adz
5akl 5am 5ard 5atp 5fc 5hi 5jf 5mi 5gs 5nd 5se
5ux 5zai 5zl 6aak 6ab1 6ael 6aje 6an 6ana 6ano 6ans
6app 6ase 6at 6au 6azp 6beo 6bis 6bgz 6bgl 6btd
6cav 6cbb 6cgb 6cco 6chx 6cin 6cix 6cnn 6cpf 6cqa
6cqw 6et 6ctd 6cuw 6dad 6dgm dam 6eb 6fe 6ha 6hu
6ih 6ji 6kg 6oa 6oi 6tg 6ut 6sr.
Sada 8am 8ame 8atv 8av 8avl 8avo 8awa 8bu
8bds 8ben 8bf 8bhh 8bg 8bf 8bt 8bww 8cau 8cbr
8ccq 8cgo 8cyi 8daj 8dan 8dem 8dgs 8djf 8dm 8dzz
8dw 8dzm 8eb 8edq 8eq 8kc 8mc 8nx 8si 8sj 8ul
8za 8zk 8zr 9aay 9aj 9ay 9aim 9aiy 9akf 9alf 9amd
9avj 9axx 9bht 9bme 9bmm 9bpb 9bwe 9cca 9cel
9cip 9ctg 9cva 9eyi 9dct 9dp 9dpl 9dud 9ece 9hp
9mx 9ny 9oz 9oo 9po 9sw 9uk 9vo 9wo 9xi 9xh 9zd.
(20 meter band) lel lrd 2xi 6xg.

z2GA, J. Johnson, Brooklyn, Wellington, N. Z.

lcin luis lcmp 1aao 1yb 1ani 2tp 2acs 2csi 5agn
5zai 5uk 5ay 5iif 6csk 6ap 6bon 6bol 6buc 6alt 6des
6cfn 6btm 6cah 6chk 6bls 6cxz 7aay 7aek 9oo 9bmm
9rm 9xi 9ave 9zt 9hj 9dmz 9bz1 9uo pilhr ilno
hu6fl hu6aff hu6cst hu6aje hu6ct hu6tl hu6wjl p2lz f8jn
f8hf f8tk ch2rm ch9tc bz1ib bzsmi a2mh a2wm a2yk
a2yh a2eg a2rm a2cm a2gn a2os a2so a2wm a2hk
a2ns a2lm a2vb a2ds a2bn a2ij a3hl a3so a3ef a3ap
a3kb a2yp a3ah a3bd a3wm a3kj a3ad a3ag a3tm
a3ym a3cd a4an a4rb a5da a5aj a5kn a5dx a7dq
aqe kfuh wvc wpm bam via fw npm npu neqq.

A.R.R.L. Information Service
Rules

- 1—Before writing, search your files of QST. You will probably find the answer there.
2—Do not ask for comparisons between advertised products.
3—Be reasonable in the number and kind of questions you ask.
4—Put questions in the following form:
A—A standard business size (not freak correspondence size) stamped, self-addressed envelope must be enclosed.
B—Write with typewriter or ink on one side of sheet only.
C—Make diagrams on separate sheet and fasten all sheets together.
D—Number each paragraph and put only one question in a paragraph.
E—Keep a copy of your letter and your diagrams.
F—Put your name and address on each sheet. We cannot spend time digging your address out of the callbook.
G—Address all questions to Information Service, American Radio Relay League, 1711 Park Street, Hartford, Connecticut.

Correspondence

The Publishers of QST assume no responsibility for statements made herein by correspondence



Greeting to the High Schools

(The following radiogram from Honolulu has been received at Headquarters via 7AFO, R. G. Olson, Tacoma, Wash., originating at 6CLJ, the station of Masayuki Hismato, Honolulu. Incidentally, this is quite a message to come over that distance.—Ed.)

McKinley High School,
Honolulu, Hawaii.

Greetings to all mainland high school students via the American Radio Relay League, Inc., Hartford, Conn.:

On behalf of the two thousand students of McKinley High School, Honolulu, Hawaii, I send greetings to high schools in all parts of the United States.

We feel very near to you all, right now, in spite of the more than two thousand miles of water separating us from the mainland. In spite of our location and the great diversity of races, we are progressing in our student body. We are Americans both by birth and choice. The races represented in our student body are: Anglo-Saxon, Spanish, Portuguese, Japanese, Hawaiian, Chinese, Porto Rican, Korean and others.

Our high school has now four splendid new buildings, with an auditorium seating approximately two thousand students, to be built this year. Our courses and subjects are much the same as those taught all over the United States. Just now we are re-organizing our student body government. We take part in all kinds of athletics and support our teams with as much loyalty as that shown by any other high school. Our high school paper, the "Pinion," goes to all parts of the U. S.

We extend a warm Aloha to you all.

Miles E. Cary,
Principal, McKinley High School.

Sulphur Insulation

1311 Spring Road, N. W.,
Washington, D. C.

Editor, QST:

Sulphur is a useful insulator for many purposes. It has its weak points, however. Sulphur exposed at summer temperature in a laboratory where mercury is present will acquire an invisible and conducting coating of a sulphicide of mercury. This impairs the insulation. The coating can be removed

with sandpaper. This effect was called to the writers attention several years ago in a course on radium by Dr. Herman Schlundt of the University of Missouri. It is not difficult to melt and cast sulphur. This can be accomplished with little or no odor if care is taken. Use a large tube or deep vessel. Do not heat too hot. Sulphur melts and runs fairly freely, and then at a higher temperature becomes stiffer and turns dark temporarily. There is considerable shrinkage in sulphur castings, pipes or holes forming in the interior. By pouring carefully and following up the shrinkage by additions of more melted sulphur, a more solid piece may be secured.

Sulphur is a good insulator for electrostatic charges, as for instance in electroscopes. It was interesting to learn from QST that it also has small dielectric losses. Melted sulphur has been poured under the bases of heavy machinery to set and hold it. Sulphur, however, will crack under some kinds of mechanical shock. Experience with it in radio should be carefully noted.

—C. A. Briggs, 3CAB

A Good Suggestion

56 Humber Road,
Blackheath, S. E. 3,
London, England.

Editor, QST:

I have just finished an hours watch listening to you fellows in the U. S. A. calling CQ and CQ Europe. It appears that much of the trouble in getting QSO is due to the fact that we are uncertain what wave-band you chaps are going over to listen on, with the result that we may be shooting perfectly good juice into the sky and you are listening many meters off our waves. The real trouble lies in the fact that whilst all you fellows are around about the same wavelength, the European amateurs vary widely, especially in the continent. Then there are the BZ's and others on your side, some above and some below your bands. I would put forward as a suggestion for the consideration of the hams that the wavelength or wavelengths on which you will listen be indicated during the CQ call, and a new QR signal be manufactured for this purpose. Thus: 'QRHH 30 45' would mean that when you finally get through CQing you will listen on the band between 30 and 45 meters.

The result, I am sure, would be more QSO's. For instance, on one occasion I

heard a BZ on 35 meters calling a U whom I had heard just before. The BZ goes over and gets no reply, and I heard that he didn't. On other occasions I have chanced calling him, wondering all the time whether this bird will be looking around at all, and if so whether on *my* wavelength, 45 meters. If I *knew* he would be listening around my wavelength I could call and be reasonably sure of a QSO. The above QRHH should be used only when calling or answering a CQ, and not otherwise. Hw, OM's?

—R. Bloxam, g5LS—

Rotten QSR

1476 Broadway,
New York City.

Editor, QST:

Sometime ago we decided that if we could get a shack on top of a prominent hotel we could accomplish a lot of DX and relay work. It was intended to use the shack as a station and also as a meeting place for hams. We put the proposition up to the management of the hotel. Their verdict was sure and exact. If we could *prove* the value of amateur radio in relaying some of the guest's messages to distant points then the hotel was ready to allow us to use their roof and even provide a shack for it. We solicited messages. We received messages for Germany, France, British Columbia and other DX points. Not having sufficient power ourselves we relayed them to 2FK whose records show they were sent on their way.

Days passed. We sent out tracers. More days went by. Still no answers. These messages are on the hook or in the wastebasket in some ham station, and are staying there. Our shack is no more a possibility. Amateur radio has received a serious setback in the eyes of over 300 B.C.L.'s who had begun to think that brass pounding was done by really serious thinking men. Evidently we can relay over pre-advertised, prearranged schedules at prearranged times but otherwise our efforts are wasted and we become mere tinkers with our "Hws the note, OM?", "Wts my QRH, OM?" "Pse send card, OM" and other such stuff which we term doing relay work.

Something *has* to be done. This sort of stuff simply *has* to stop, or amateur radio will always be the nervewrecking muddle of mere nothing that it is now. *Send out your messages within 48 hours and not 48 days.* Then and only then will amateur radio be on the footing it was in the good old days long past.

—L. M. Horowitz, 2AIA

—K. A. Kopetzky, 2AIA

Better Multiplex Work

At Sea,

—ss West Jester, KUDG.

Editor, QST:

In connection with the article "Multiplex Reception" in March QST, the following might be of interest: Here aboard ship I am obliged to keep a fairly sharp watch on 600 meters while at sea, and at the same time I frequently want to copy long wave

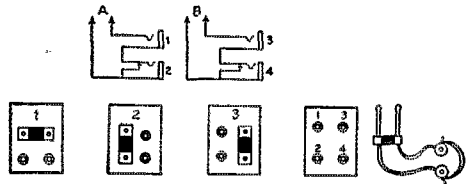

FIG. 1

press or short wave ham stuff. The duplex stunt was originally accomplished with a plug and jack transfer scheme as shown in Fig. 1. Four jacks were mounted at the corners of a square on a piece of bakelite, and two plugs were tied together so that they fitted the jacks, either across or up and down. With the double plug in position 1 a separate phone is connected to each receiver. Turning the plugs upside down in the same pair of jacks "change ears". In position 2 both phones are in series on receiver A only, and in position 3 both receivers are in series on receiver B.

Later on I substituted two 4 pole double throw anti-capacity switches for the plug

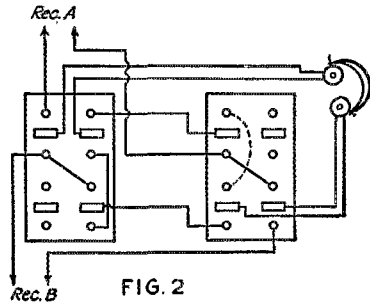

FIG. 2

and jack arrangement. The hookup is shown in Fig. 2. With both switches up both phones are in series on receiver A, while when both switches are down the two phones are in series on receiver B. With the left switch up and the right one down the duplex arrangement with one phone on each receiver is secured. Remember that the switch handles move in a direction opposite to the blades on the anti-capacity switches, though.

—L. O. Doran, KUDG

P. R. R.

Operating Department,
Pennsylvania Railroad System,
Philadelphia, Penna.

Mr. Hiram P. Maxim,
American Radio Relay League,
Hartford, Conn.

Dear Sir:—

The period of the A.R.R.L. emergency service for which we arranged with you is over for this season. Fortunately there were no emergencies which developed during this time that made it necessary to call on the League members for assistance, but from the tone of some of the correspondence, it is evident that some of the enthusiasts would have enjoyed handling some real messages just to prove that they were equal to the occasion; and we believe that they could have done it from the results of the tests toward the latter part of the period.

The League organization and the members who participated in these tests, also those who stood by in readiness to bridge a gap or handle such messages as might be assigned to them, are to be commended for the excellent results in handling the test messages, and for their loyalty in standing by the League, doubtless sacrificing their own pleasure for the sake of carrying on.

This service is in the nature of insurance against interruptions to our communication system caused by severe storm conditions which usually may be expected to hit us somewhere during the winter months. Prompt and accurate communication is essential in transportation work, especially during emergencies when assistance is necessary for the relief of passengers or the prompt handling of perishable freight, etc. This kind of communication, handled promptly and with accuracy is what the tests were intended for, and there was a noticeable improvement in the later tests.

It is hoped that the pleasant relations established through the medium of this emergency work will have proved beneficial from every standpoint and that they may continue in the future, also that arrangements may be made this fall for a resumption of these activities.

With kind personal regards and best wishes to you and all the members of your organization who participated in any way in this emergency work.

—J. J. Johnson,
General Superintendent Telegraph.

Shut In?—Not with a S. W. Set

208 N. Jackson Ave.,
Kansas City, Mo.

Editor, QST:

For three or four months I have been one of the many who have been causing QRM on 40 meters. I am what is generally known as a "shut-in", but I do not feel shut-in any more. I have to lay flat on my back all of the time, and can use only my left arm. Last November 9ADR made and installed a 5-watter transmitter for me. He also made a change-over switch to be operated by means of two strings. He put a six foot extension cord on the key and put a switch in the primary of the power transformer. I can work the set very easily and I can usually get back on the air as quickly as the other fellow, 9BMP gave me the tube for my transmitter and 8EQ made my receiver.

The first station I worked was 5ATX and when I heard him calling me I got so excited I didn't get a single word he was sending. I asked him to repeat and he did, but I didn't do any better the second time. 6BQ was the second station I worked. Since then I have worked many stations. I usually operate in the morning or in the afternoon and find no trouble in connecting with a lot of fellows who will "chew the rag" with me.

9ADR is the call of Ray Scrivener. He is a regular "ray of sunshine", too. Whenever anything goes wrong with the transmitter or receiver he always comes over and fixes me up. You hams are a mighty fine bunch of fellows and I am mighty proud to join your ranks.

—Max J. Colwin, 9WV

An Italian Contest

Viale Maino 9,
Milan, Italy.

Editor, QST:

The National Radio Club of Italy has organized a contest for Italian hams. This contest will occupy the period of April 1st to December 31st 1926. A prize is to be awarded for each of the following accomplishments: (1) Greatest distance for communication on wavelengths below 5 meters; (2) Greatest distance obtained in 10 radio-telephonic communications; (3) Shortest wavelength produced and received in a radius of 200 km; (4) Greatest number of two way communications with stations over 5000 Km. away. In all cases the power input must not exceed 200 watts.

All foreign amateurs are kindly requested to send their QSL directly to the amateurs in the contest or to Ernesto Montu Sec'y General, R.C.N.I., Viale Majno 9, Milan, Italy. We would especially draw the at-

tention of the foreign amateurs to the fact that QSL to the radiotelephonic transmissions will only count when the speech was received perfectly clear and was perfectly comprehensible. The QSL card should be so worded that this will be apparent.

—Ernesto Montu, 1RG

The Tone Meter

20 Duryea St.,
Springfield, Mass.

Editor, QST:

With reference to my article in the January issue of QST, "The Tone Meter", the following has been called to my attention. With the rectifier and filter system on no load, the tone meter should read zero. This is because the filter condensers build up to the peak rectified voltage value and the voltage remains constant there. However, if the meter does give a reading, it is an indication of leakage current, either back-current through the rectifier or leakage through the filter condensers. Therefore if the meter reads other than zero on no load, a very bad condition exists as leakage or back-current tends to destroy filtering action. A small back current with chemical rectification has to be tolerated.

Perhaps this information will be helpful to readers of QST.

—L. J. Wolf, 9DKT

NOTE

The cuts reproduced below were omitted from Mr. Tannat's letter which we printed in this Department last month.

Strip for upper window frame to rest on.



FIG. 1

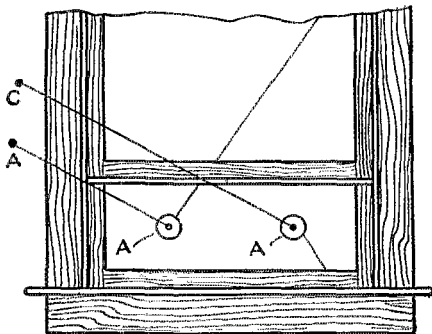

FIG. 2



YES SIR, ERETRIA, WHEN I CALLED BABYLONIAN
ZAZ ON MY UV.199 HE CAME RIGHT BACK AT ME.

FILAMENT AND
PLATE TYPES



Famous BH Transformers Transmitting Transformers

We manufacture a complete line. Our transformers are ideal for low wave transmission.

Write for Our Catalogue

Benjamin Hughes Electric Company

298 Lagouchetiere St. W., Montreal, Can.

Transformer Builders Since 1910

BECOME A RADIO EXPERT

Our unique home-study course in practical radio engineering makes you an expert in 30 days. You receive spare-time lessons by mail. You show us how to save as you learn, to get into the big money. Send on the ground floor. Full equipment furnished free, including Supertron Twin radio set. Our training is superior. Or, write us to make money from the start. LEARN HOW TO GET THIS COLLEGE EDUCATION. Our annual plan shows you how you can get the course free, with good people besides. Whether you know radio now or not, we'll give you a full. If you can read this ad you can study our easy, simple, illustrated lessons and get a diploma as a radio engineer. Instruction is practical with good money open to you. There is the field that will make you rich. You make good. Get our book, "Millions Unthought of." It tells you the way and tells how to make \$10 to \$25 a week. T. J. Mendel, AMERICAN RADIO ENGINEERS, Dept. 213, Hearst Sq., Chicago, U.S.A.

why The ADVANCE "SYNC" RECTIFIER

is preferred by amateurs all over the world

1. The ADVANCE Sinc Rectifier actually does what any other rectifier claims to do.
2. Can be easily and quickly filtered.
3. Meets all requirements for heaviest duty.
4. Speedy starting because of Advance Bakelite wheel.
5. Requires no attention—always ready.

Its prevailing use in international transmitting is evidence that, although lower in price, the advance Sinc Rectifier is superior in quality.

Revolving disk is moulded bakelite six inches in diameter. Nickel plated brush holders with adjustable gauze copper brushes. Convenient control handle. Disk, aluminum brush arm support and brush holders perfectly insulated.

Price complete with Westinghouse 1/4 H. P. Synchronous Motor . . . \$40
Rectifying wheel with complete brush assembly and mounting ring to fit your own motor . . . \$15



We Pay All Transportation Charges in U. S. A.
ADVANCE ELECTRIC COMPANY
1260-1262 West Second St., Los Angeles, Calif.

THE SUPER-SYNC

The Synchronous Rectifier That Can Be Filtered

The Super Sync is the only synchronous rectifier that can be filtered using ordinary type of filter circuit. Tests prove that the Super will stand up under constant use without giving the least trouble. The only attention required is an occasional oiling of the motor bearings.

The Super is rated at 4000 volts 250 M. A. This

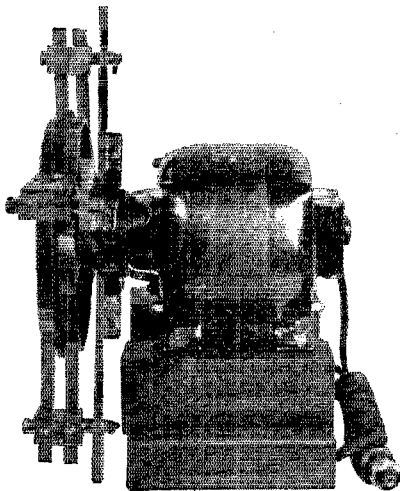

is usually sufficient to supply the average amateur transmitter.

The commutator on the Super is eight inches in diameter and is turned at a synchronous speed by a ¼ H. P. Synchronous Motor. This motor can be supplied for either 110 or 220 Volts 50 or 60 Cy.

PAT. PENDING

PRICE \$75.00 F. O. B. ST. LOUIS

MARLO ELECTRIC CO., 5241 Botanical Ave., St. Louis, Mo.

BREMER-TULLY

will soon offer

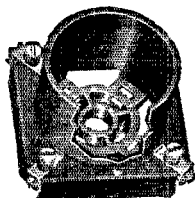

Type UL Socket 75c.
Takes both old and new type base tubes.

A New Non-Microphonic Tube Socket

The new B-T socket is a further development of the B-T Silent Socket which many fans welcome as the best remedy for microphonic tube noises.

Look for further announcements on B-T.

B Battery Eliminators Complete
B " " " Parts

New models of factory-built receivers.

Circulars ready about July 1st.

Bremer-Tully Mfg. Co.
532 So. Canal St. Chicago, Ill.



Powel Crosley, Jr., has developed in the **CRESCENDON** a device that gives this

4 TUBE RADIO performance expected in sets of much greater cost

\$29

4-29

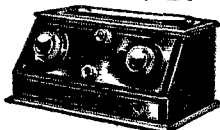

CROSLLEY RADIO

Write Dept. 18 for Booklet
THE CROSLLEY RADIO CORP.
CINCINNATI, OHIO
Prices slightly higher west of the Rockies.
Dealers sell Crosley Radios from \$9.75 to \$75, and the Mustcone Loudspeaker at \$14.75

Short-Wave Apparatus

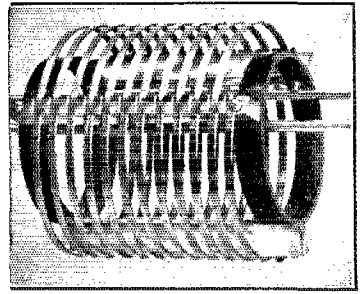
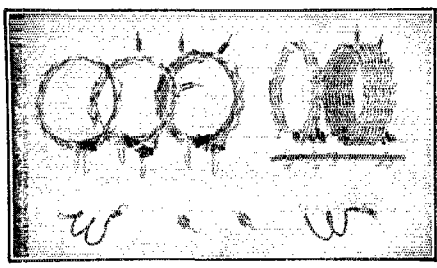

The Very Best in Receiving and Transmitting Inductances

RECEIVING

Basket-wound with heavy triple-cotton-covered paraffined wire.

Electrically efficient and mechanically rugged.

Each coil rigidly secured to Radion strip on which nickeled bronze plugs are mounted.

Adapted to any circuit. Complete set of five coils and mounting strip has wave-length range of 12 to 120 meters with 100 µfd. condenser. Price, complete set, \$4.50.

TRANSMITTING

Unquestionably the finest short-wave transmitting inductance on the market.

Flatwise-wound nickel-plated copper strip on moulded glass separators.

Made in two sizes; type L, 5 inches diameter, for 40-, 80- and 150- meter bands and type S, 2 3/4" diameter, for 20-meter band and lower.

Price, single unit with three clips, \$5.50; double unit (pri. and sec.) with glass coupling rods and six clips, \$11.00.

Calibration—Each coil of each wavemeter is separately calibrated. This means that each instrument is accurate. A wavemeter that is not accurate is a very useless piece of apparatus.

Calibration Curve—Three curves drawn in different colors give the readings for the three coils. The chart is neatly covered with a transparent material and bound with black tape. This makes it dirt-proof.

The wavelength ranges of the coils are:

- Coil No. 1—
Black Curve,
20 to 80 meters.
- Coil No. 2—
Red Curve,
74 to 200 meters.
- Coil No. 3—
Green Curve,
200 to 550 meters.

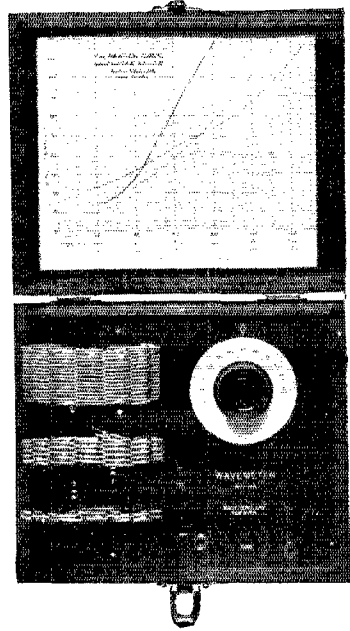

The REL Type "A" Wavemeter will be found satisfactory for all general purposes. It has a range of 20 to 550 meters with an accuracy within 1%. The design of the inductance and capacity is such that the high frequency resistance is as low as possible, so that the losses in the wavemeter circuit are small. By thus keeping these losses small the Wavemeter is more sensitive, the sharper its tuning to resonance and the lower its decrement.

The Coils are of "basket weave" design with heavy brown tripple cotton covered paraffined wire. Each coil is specially treated after winding and then permanently mounted on an insulating strip which holds the mounting plugs. The coils are easily interchangeable by means of the REL Plug-In Method.

Type "A" Wavemeter With Neon Tube Indicator
Price Complete With Calibration Curve \$22.00

Radio Engineering Laboratories

27 Thames St., New York, N. Y.

SANGAMO

Mica Condensers in intermediate sizes



IMPROVE
TONE
RANGE
AND
VOLUME

IT is accuracy, not luck, that makes one receiver sweeter and more powerful than another that is almost its twin. Especially condenser accuracy, for the closer you come to absolute accuracy at these critical parts, the more wonderful your receiver will be. The cost of accurate condensers is small—the effect is immense.

Now you can get Sangamo Mica Condensers in capacities in between the usual stock sizes so you can build with greater accuracy than ever before. They are guaranteed to be accurate, and they always stay accurate, being solidly molded in bakelite. Neither heat, cold, moisture, pressure nor acid fumes will affect their capacity, because bakelite seals the delicate parts against all outside influences.

Capacities in microfarads and prices

0.00004	0.001	} 50c.
0.00005	0.0012	
0.00006	0.0015	
0.00007	0.00175	
0.00008	0.002	
0.0001	0.0025	} 40c.
0.00012	0.003	
0.00015	0.0035	
0.000175	0.004	
0.0002	0.005	
0.00025	0.006	} 70c.
0.0003	0.007	
0.00035	0.0075	
0.0004	0.008	
0.0005	0.01	
0.0006	0.012	} 85c.
0.0007	0.015	
0.0008	0.015	
		} 90c.
		} 95c.
		} \$1.00
		} 1.15
		} 1.20
		} 1.25

With Resistor clips, 10c. extra

Also Sangamo By-Pass Condensers

1/10 mfd. 80c.	1/2 mfd. 90c.
1/4 mfd. 80c.	1 mfd. \$1.25

Sangamo Electric Company
Springfield, Illinois

RADIO DIVISION, 50 Church Street, New York

SALES OFFICES—PRINCIPAL CITIES

For Canada—Sangamo Electric Co. of Canada, Ltd., Toronto.
For Europe—British Sangamo Co., Ponders End, Middlesex, Eng
For Far East—Ashida Engineering Co., Osaka, Japan

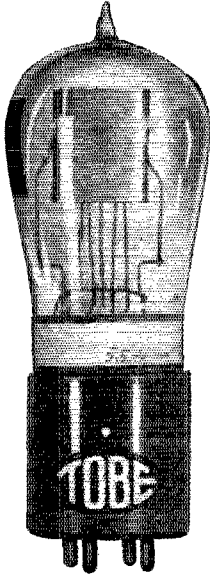

This is the new
**TOBE MS IV — 8
Watt Transmitting
Tube.**

OPERATING DATA
Filament volts—6.
Filament current—2
amps.
Maximum plate volts—
300.
Plate current—40 M.A.

1. This tube is characterized by extreme hardness.
2. Careful and rugged internal construction.
3. Bakelite base.

Unexcelled for technical precision and durability.

Price—\$6.00
At your dealers, or send check or money order to

The Tobe - Mueller transmitting tubes were used in the tests at Mass. Inst. of Tech. described in this issue.

Tobe Deutschmann Co.
Cornhill, Boston, Mass.
*We sell transmitting-condensers, too.
Send for literature.*

V.T. 14 Transmitting Tubes

Rated at 5 Watts

(MFD BY GENERAL ELECTRIC CO.)
NEW, IN ORIGINAL CARTONS

Filament voltage 7½ Volts.
Filament current 1½ amps.
Normal Plate voltage 350 Volts.
Plate current 40 milli-amps.

Also Used as Power Amplifying Tube
STANDARD BASE

PRICE ONLY \$1.50 EA

American Sales Co.,
21 Warren St., N. Y. C.

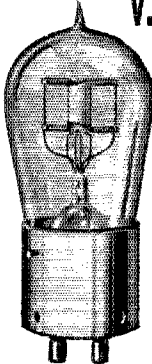

Laboratory Product

CRESCENT LAVITE RESISTANCES

For Distortionless Amplification.

TRANSMITTING GRID LEAKS

Use Crescent Lavite resistances, noiseless, compact, non-inductive. Each unit will dissipate 4 watts, parallel for higher wattage. 5000 Ohm grid leak as specified by JOHN M. CLAYTON \$2.50 each.

Dual Resistance for DeForest "H" Tube \$3.50

Dual resistance consists of two units mounted on bakelite and connected in parallel.
Please specify if your "H" tube requires 60,000 ohms or 20,000 ohms.
All amateur apparatus in stock. Let us drill and engrave your panels.

CRESCENT RADIO SUPPLY CO. 1 Liberty St., Jamaica, N. Y.

Startling

Two New Products by "General Instrument"

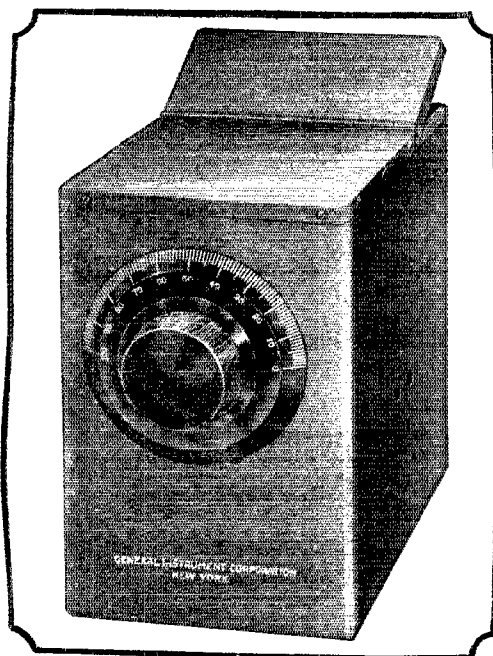

G. I. SHIELDED UNITS

Are single stage T. R. F. Amplifiers which can be used interchangeably as detector or amplifier—increasing the selectivity and sensitivity of any set.

Can Be Used —

As complete sets using from 1 to 8 tubes

To replace old tuning units

To add R. F. Amplification to any set.

G. I. Shielded Units cover the entire Broadcast band with absolute stability and increase amplification.

Each unit a complete receiver in itself —with dial, UX socket and S.F.L. condenser in a mahogany crystallined aluminum "can".

G. I. VARIABLE AUDIO TRANSFORMER

For the first time—a transformer that really matches the characteristics of the tube.
For use in any set—in detector circuit and any or all stages of amplification. Easily adjustable—merely turn the knob until reception is clearest and sharpest. No squeals, no howls; just perfect reproduction.

Write for complete literature on all G. I. Products

**General Instrument
Corporation**

Manufacturers of Laboratory Equipment

477 Broadway

New York City

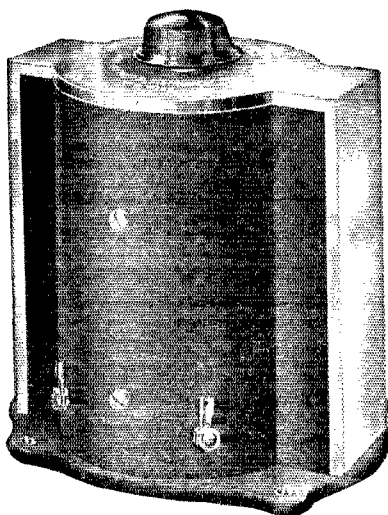

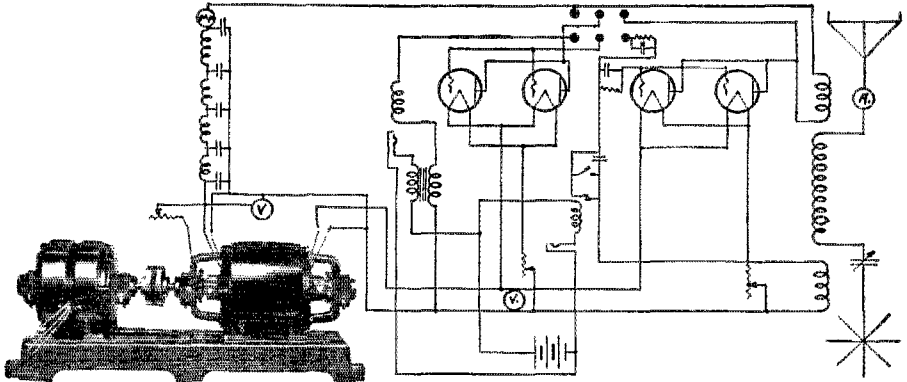

Item 37 2 unit four bearing set, delivering 1000 volts, 600 watts for plate and 12 volts, 300 watts for filament. The "ESCO" Set is shown here furnishing Power Supply for 4—50 watters in a phone or telegraph set. This is the Item used by CB8 in pioneer achievement of the first two way amateur wireless communication between North and South America.

ELECTRIC SPECIALTY COMPANY

Manufacturers of Motors, Generators, Motor-Generator Sets, Dynamotors and Rotary Converters for all radio purposes. Have you got your copy of Bulletin 237B and ESCO Filter facts? If not write for them.

TRADE "ESCO" MARK

225 South Street

Stamford, Conn., U. S. A.

"ESCO" Engineers will help you solve that Generator problem

Hoyt Switchboard Meters

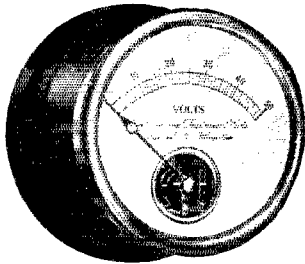

HOYT has made Precision Switchboard Meters since 1904, in all sizes, from 3" to 8" case diameter, both for A.C. and D.C. They all have hand-calibrated scales and are recommended for all transmitting station and amateur uses.

A new catalogue on HOYT Switchboard Meters is ready for distribution and will be gladly sent you free on your request.

BURTON-ROGERS CO.
26 Brighton Ave. Boston, Mass.
National Distributors

CARTER

"HI-OHM" Universal Volume Control
For All Circuits



(PAT. PEND.)

500,000
OHMS

HALF SIZE

\$2

A non-inductive, variable, wire wound resistance $1\frac{3}{4}$ " dia. Projects $\frac{3}{8}$ " back of panel. The contact arm slides on protecting wires covering the special moisture proof resistance element, eliminating wear and assuring long life and unvarying electrical characteristics.

"HI-POT" same size with third terminal, \$2.25. Write for illustrated folder of full description and circuit diagrams.

MEMBER
R.M.A.

Any dealer can supply

In Canada — Carter Radio Co., Limited, Toronto



For Experimenters who prefer Impedance Coupled Amplification

Type 369
Coupling
Impedance

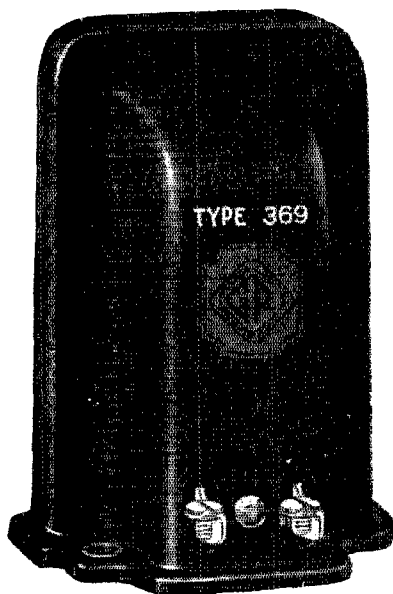

Price
\$5.00



The General Radio Company has endeavored to make it possible for the experimenter to obtain its products with a minimum of effort. A careful selection of distributors and dealers has been made. They are best fitted to serve you. If, however, you are unable to obtain our products in your particular locality they will be delivered to you, postpaid, direct from the factory upon receipt of list price.

In search for a perfect amplifier experimenters are now giving much attention to coupling impedances.

While transformer coupled amplification produces more amplification per stage than any other method under some conditions slightly better quality may be obtained by the use of impedances and resistances.

By using chokes of sufficiently high inductance, a quality of reproduction may be obtained equivalent to that produced by resistances.

The use of chokes has the added advantage of requiring considerable less plate voltage thus reducing operating costs of the set, and also giving greater amplification per stage.

A three stage amplifier using three General Radio Type 369 coupling impedances will give a combination of generous volume with exceptional purity of tone.

Write for our circular showing wiring diagram for a 3 Stage Impedance Coupled Amplifier and our latest parts catalog 924-A.

GENERAL RADIO CO., Cambridge, Mass.

GENERAL RADIO

INSTRUMENTS

Behind the Panels of Better Built Sets

BUY YOU SAW IT IN QST—IT IDENTIFIES YOU AND HELPS QST

American Transformer Company

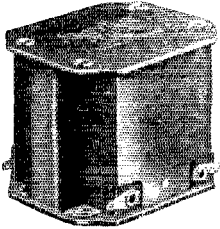

*AmerTran
DeLuxe*

A reputation for fine transformers a quarter-century old! Today this standard is more apparent than ever—for Radio recognizes AmerTran products as dependable leaders.

The new AmerTran DeLuxe Audio Transformer actually puts the development of the "audio side" ahead of existing acoustical devices. Faithful amplification with natural quality over the entire audible range is consistently obtained. This Audio Transformer sets a new standard of audio amplification.

As the receiving set of the future will be power operated, the American Transformer Company is now offering two units of the finest type—especially adapted to the use of the new 7½ volt power tubes in the last audio stage. These are the AmerTran Power Transformer and the AmerChoke. The Power Transformer also has filament supply windings for the power tube in the last stage and for the rectifying tube, and supplies sufficient plate current, after rectification, for the operation of the set.

Write today for interesting free booklet—"Improving the Audio Amplifier"—and price list.

AmerTran Products Are Sold Only at
Authorized AmerTran Dealers

AMERICAN TRANSFORMER CO.
178 Emmet Street Newark, N. J.

**Transformer Builders for
Over Twenty-Five Years**

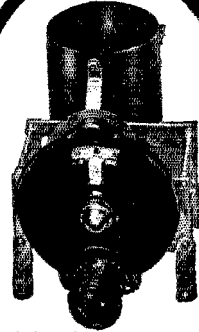

BD-1B Includes the NATIONAL Equicyclo (straight line wave length) Condenser and the genuine BROWNING-DRAKE Inductance Coil with the new Type B Dial. Price \$10.25

THE NEW NATIONAL Tuning Units

Comprising the genuine
BROWNING-DRAKE SPACE WOUND
TRANSFORMER

and the
NATIONAL Velvet Vernier
Dials and Condensers
Are now in the hands of your dealer. Their
beauty and efficiency will greatly surprise
you. See them at your dealer's.

Send for Bulletin 105 R. B.

NATIONAL COMPANY, Inc.
W. A. READY, President
110 Brookline St., Cambridge, Mass.

BD-2B
Includes the NATIONAL Equicyclo (straight
line wave length) Condenser and the genuine
BROWNING-DRAKE Transformer with the
new Type B Dial. Price \$13.75

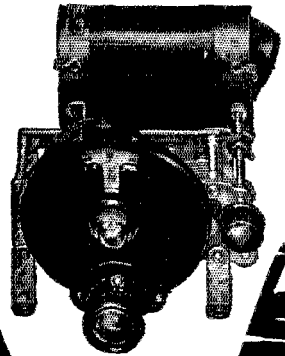

GUARANTEED - TELEPHONE CONDENSERS

½—MF 25c,	7/10—MF 30c,	1—MF 35c
1½—MF 40c,	2—MF 50c,	4—MF \$1.00

Telephone induction coils 35c

Postage extra.

BUCKEYE TELEPHONE AND SUPPLY CO.
Columbus, Ohio.



This is Mr. William H. Priess, President of the Priess Radio Corporation, with one of the batteries he uses in his new "Priess Straight Nine" circuits, which employ six stages of radio frequency amplification, with a detector tube and two stages of audio frequency amplification. Mr. Priess is sponsor of radio frequency amplification and the reflex principle in America and the latter owes its name to him.

PRIESS RADIO CORPORATION
693 Broadway 67-9 New York, N. Y.

Mr. G. Charter Harrison, March 29, 1926
French Battery Company,
Madison, Wisconsin
Dear Mr. Harrison:

I have been using RAY-O-VAC "B" Batteries for the past two years, and have found them very satisfactory in receiver circuits. The batteries have a low initial resistance and a consistent long life. They also have a very small battery noise.

You will appreciate, of course, the importance of this last-mentioned factor, especially in the detector tube circuit. I have found many cases in my experience where noises have been ascribed to static, whereas the noises have been merely due to noisy batteries. This destruction of reception quality caused by battery noises can be cured by utilizing batteries such as the RAY-O-VAC.

Very truly yours,

PRIESS RADIO CORPORATION

William H. Priess
President.

WHP:MN

"Bill" Priess approves these batteries

. . . because of their "low internal resistance and consistent long life" . . .

FEW *hams*, anxious as they may be to pick up and amplify weak DX signals, ever put radio batteries to as severe tests as they have received in the laboratories of the Priess Radio Corporation.

When you get to working with both radio and audio frequency in the same tube, as "Bill" Priess does, you are asking a lot of your batteries. The slightest battery noise, the slightest multiplication of battery internal resistance, spoils the whole works.

So there is no wonder that Mr. Priess employs Ray-O-Vac batteries in his experimental work. No other batteries have such low internal resistance or such staying power under trying conditions.

Give your apparatus the same chance to work at its best, as Bill Priess gives his. Install Ray-O-Vac batteries and increase the range of your set for both transmission and reception. Ray-O-Vac batteries cost no more than ordinary batteries.

Your regular radio dealer can furnish you with Ray-O-Vac batteries. Ask for them by name. If you have any trouble getting them, write us for the name and address of a nearby dealer who can supply you.

FRENCH BATTERY COMPANY
Madison, Wisconsin

Also makers of Ray-O-Lite Flashlight Batteries and Ray-O-Lite Flashlight Cases

Ray-O-Vac "B" batteries in all standard sizes, both flat and upright.

Ray-O-Vac "A" batteries recuperate during rest periods, lasting longer and giving excellent reception.

Ray-O-Vac 4½ volt "C" batteries with 3 variable terminals give voltage adjustments of 1½, 3 and 4½ volts.



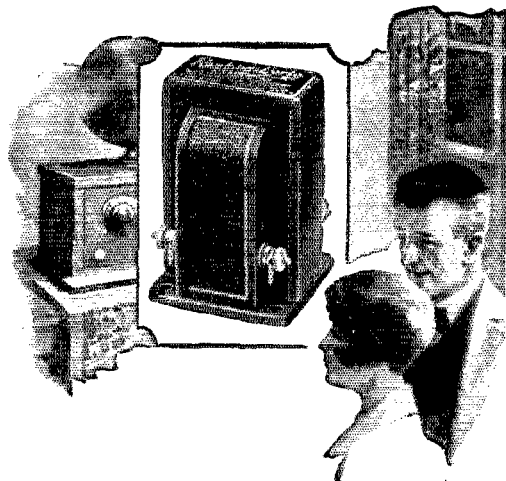

Build that Set so as to *Deserve* Rauland-Lyrics

Gone is the day of the jerry-built radio. Whether you build for use or for profit—one set or a hundred thousand—skimping on quality does not pay.

For the radio frequency stages, choose any good circuit and any type of coils you like—opinions differ. But, having chosen your circuit, be fair to it—let it show what it really can do—give it the benefit of Rauland-Lyrics.

Rauland-Lyric
AN
ALL-AMERICAN
TRADE MARK
TRANSFORMER

FOR THE MUSIC LOVER

The Choice of Noted Music Critics

Rauland-Lyric is a laboratory-grade audio transformer designed especially for music lovers. The price is nine dollars. Descriptive circular with amplification curve will be mailed on request. All-American Radio Corp., 4205 Belmont Ave., Chicago, U. S. A.

Member **RRMA** Owning and Operating Station **WGNR-266 Meters**
ALL-AMERICAN

Radio Built for Years to Come

74

SAY YOU SAW IT IN QST—IT IDENTIFIES YOU AND HELPS QST

PYREX

Reg. U. S. Pat. Off.

1 BD Plainfield, Vermont, went on the air for the first time March 29th and on April 4th from 6:00 to 6:30 A. M. worked 6BIL California and was reported R.5. The input power was not over 25 Watts.

1 BD uses Pyrex amateur type insulators.

The MacMillan Arctic Expedition of 1925 used Pyrex and the Byrd Arctic Expedition of 1926 is using Pyrex.

The Coast Guard Ice Patrol, the Navy, the Air Mail Service, the Lighthouse Service all use Pyrex Insulators.

PYREX GIVES RESULTS

CORNING GLASS WORKS

Industrial and Equipment Division

Corning

New York

THREE "E" STRAIGHT LINE RHEOSTAT

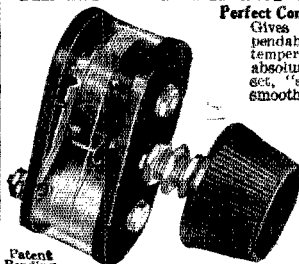

Perfect Control of Filament Temperature Gives you a fine, smooth, dependable variation of filament temperature. Runs smoothly, is absolutely NOISELESS, and once set, "stays put". Controls volume smoothly, and without distortion, over the entire range. Equally efficient for short and long wave sets. By all means secure this precision instrument at once. Ask your dealer or order direct. Price \$2.50. Postpaid.

Patent Pending

Illus. 3/8 Size 6-15-30 Ohms

ELECTRICAL ENGINEERS EQUIPMENT CO.
Radio Division
708 W. Madison St., Dept. 7 Chicago, Ill.
Information on Request



AEROVOX

"Built Better"

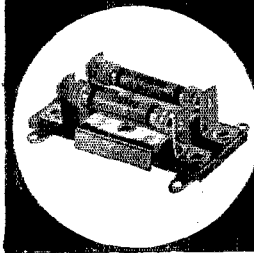

RESISTOFORMERS

Tested and approved by A.I.T., Yale Radio News, Popular Radio, and Popular Science. Used by over 200 of America's leading set manufacturers.

AEROVOX WIRELESS CORP.
429-441-493 Broome St., New York

Branch Offices:
St. Louis, Mo. Southgate Trust Building
Cincinnati, O. 404 Eastern Avenue 40-42
Chicago, Ill. 317 W. Dearborn Boulevard
Boston, Mass. 92 Central Street
Los Angeles, Cal. 324 N. Sun Pedro St.



NO Radio Unit is any better than its Coil! Every Engineer and Manufacturer realizes this. While it is true of all Electrical Apparatus it is more true of Radio.

The performance of Battery Eliminators, Audio Transformers, Loud Speakers, and all other Radio Units is in exact ratio to the efficiency of their windings. *It's the coil that does the work!*

The great DUDLO Plants at Fort Wayne, Indiana, have specialized on fine Magnet Wire and Windings for many years, and DUDLO is today the

chief source of supply to manufacturers in the Radio Industry.

DUDLO Engineers and Manufacturing Facilities provide you with the widest experience and knowledge and the finest methods of production. The DUDLO plants, the largest of their kind in the world, and equipped with miles of special machinery and an immense organization of trained specialists, produce better coils and windings for your product than any other source of supply—and do it more efficiently from your standpoint.

It is probable that you already are using DUDLO Coils and Magnet Wire. If not, we will promptly make up samples and quote on your requirements. No obligation—it is part of DUDLO Service. Correspondence invited.

DUDLO

MAGNET WIRE AND WINDINGS

DUDLO MANUFACTURING CORPORATION

Eastern Office
Office and Warehouse
NEWARK, N. J.

MAIN WORKS AND GENERAL OFFICES
FT. WAYNE, INDIANA

Chicago Office
160 N. La Salle St.
CHICAGO, ILL.

SAY YOU SAW IT IN QST—IT IDENTIFIES YOU AND HELPS QST

DON'T MISS IT, FELLOWS—EVERYBODY'S COMING!

The First Annual ATLANTIC DIVISION A. R. R. L. CONVENTION

**HOTEL LAFAYETTE
BUFFALO, N. Y.**



**JUNE 24, 25, 26,
1926**

**Technical Talks---Contests
Government Exams---Real
Short-Wave Dope**

**Special Illumination of
Niagara Falls
Banquet---Stunts---Fun**

SEND IN YOUR RESERVATION TO

**The Radio Association of Western N. Y.
598 Masten Street, Buffalo, N. Y.**



Bring Your Set Up-to-Date

Dongan, with several other manufacturers, has gone through the experimental stages and now offers B-Power Units (Transformers and Chokes) for Raytheon and other type Eliminators that were found without question to furnish the most satisfactory known source of B-Power. You can build your own Eliminator according to simple diagram at slight expense.

Ask your dealer or send money-order to factory direct.

TRANSFORMERS

Manufactured in 25, 40, 50 and 60 cycles.
No. 599. Full Wave for Raytheon Tubes.
No. 537. Full Wave for R.C.A. UX-213 Tubes.
No. 538. Half Wave for R.C.A. UX-216-B Tubes.
No. 561. For R.C.A. UX-216 Tubes.
No. 1572. For New 80 Milli-Amp Raytheon

Milli-Amp Raytheon for trickle chargers.

CHOKES

No. 514. 20 Henry
No. 505. 30 Henry
No. 539. 50 Henry
\$5.00 List

Raytheon Tubes
\$6.00 List

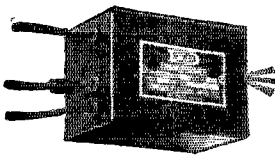

Tubes. \$7.00 List. Special Transformers for trickle chargers.

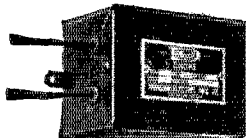

**Dongan Electric Manufacturing Co.
2999-3001 Franklin St., Detroit, Mich.**

TRANSFORMERS of MERIT for FIFTEEN YEARS

RADIO OPERATORS WANTED

Radio Operators are needed on board ships sailing for Europe, The Orient, Africa, South America, etc. THE EASTERN RADIO INSTITUTE can train you quickly and thoroughly because:

**MODERN and EFFICIENT METHODS
THOROUGH yet Simple INSTRUCTION
New and UP-TO-DATE APPARATUS
THIRTEEN Years a RADIO SCHOOL**

The OLDEST, LARGEST, and MOST SUCCESSFUL school in New England. RECOMMENDED BY THE A. R. R. L.

Day or Evening Classes Start Every Monday.
Write for Illustrated Prospectus

**EASTERN RADIO INSTITUTE
899 BOYLSTON STREET
BOSTON, MASS.**

ACME

~for amplification

LEARN THE CODE

with **SIGNAL**

a **High Pitch Buzzer and Key Set**



Build complete with key, true tone adjustable high pitch buzzer and code plate. Write us today.
Signal Electric Mfg. Co., Menominee, Mich.

KRUSE SAYS:

"If we had an audio amplifier that amplified one pitch only, and did *not* amplify the line leaks and static and off-tune signals, we would be able to use one stage to better advantage and often could use two stages, bringing in signals that cannot be read with one stage. In other words, we would be able to make the signal stand out from the noisy back ground. The best known example (of this peaked audio amplifier) is the OLD General Electric Transformer sold by the Radio Corporation as the UV-712. This had a 9/1 ratio; in other words, there was not a great deal of primary. It was meant to amplify 500-cycle spark signals (1000-cycle tone) and it did that in beautiful shape because resonance occurred in the neighborhood of 1000 cycles, but not sharply enough to result in ringing or "dragging".

**WE HAVE THOUSANDS OF
RCA UV-712 (9/1 ratio) TO SELL AT ONLY \$1.60**

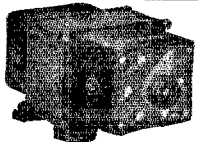
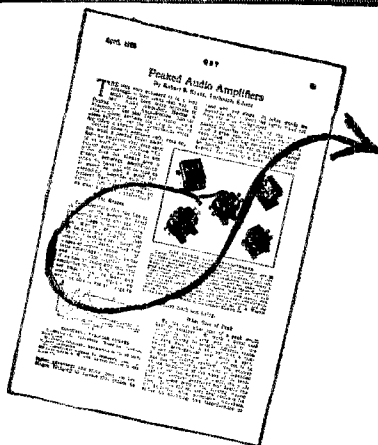

RCA UP-1016 POWER TRANSFORMER. Has plate, filament, and rectifying tube windings. Plate winding up to 3000 volts. List, \$38.50. SPECIAL, \$11.50.

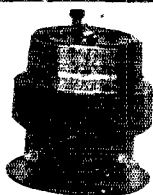

RCA UP-1656 FILAMENT TRANSFORMER. Output, 75-watts. List, \$15.00. Our Price, \$5.50.

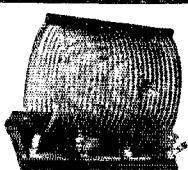

RCA UL-1008 OSCILLATION TRANSFORMER. Can be easily converted for shortwave transmission. List, \$11.00. Our Price, \$7.50.



**GENUINE RCA
201 TUBES.**

Ideal for low-wave transmitters. Draws 1 ampere. SPECIAL, 95c.

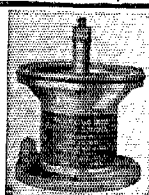

RCA UC-1803 FARADON CONDENSER .000025 mfd. 10,000 volt breakdown. List, \$5.00. Special, 95c.

BLUEBIRD (Gem) 202 TYPE 5-watt TRANSMITTING TUBE. \$3.25.

TELEGRAPH KEYS. Solid silver contacts. Well made. Remarkable bargain at 49c.

"Q" RECTIFYING TUBES.
1. **FULL-WAVE,** with bakelite UX base. Will give output of 65 milliamperes. Can be used in any rectifying transmitting circuit as well as most "B" eliminators. \$1.25.
2. **HALF-WAVE.** Will pass 65 milliamperes. Suitable for any low-power transmitting circuits. Maximum working force, 500 volts. Double filament and double plate construction insures long life and smooth operation. 95c.

CARDWELL CONDENSERS. Genuine Allen B. Cardwell .0005 Condenser, \$1.50. King-Cardwell Dual, 15-15 plates, \$1.95. 11-11 plates, \$1.50. King-Cardwell 11-plate, \$1.25. King-Cardwell 41-plate. Easily made into a transmitting condenser by double spacing, \$1.25.

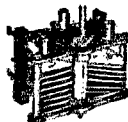

PHILLIPS TUBES. Imported; manufactured in Holland. Be ahead of the times! UV-200 type, drawing ¼ ampere; ideal detector tube for that short-wave set. \$1.95. UV-199 type, drawing .06 ampere, and with a filament to operate on 1 dry cell. \$1.95. 201-A type, drawing 1/10 ampere, \$1.95. WD-11, WD-12, 201-A, and 199 types, all at \$1.95.

ROLLER-SMITH AMMETER. Large size, 0-1. Panel mounting; ultra-sensitive. SPECIAL, \$4.75.

RCA MAGNETIC MODULATOR. UT-1367, 3½ to 5 amperes. Requires No Adjustment; Ideal for Radio-iron Telephone Operation. For I.C.W. Transmission, and C.W. Transmission with Modulator. List \$17.00. SPECIAL, \$9.50.

RCA R.F. TRANSFORMER. UV-1714. Range, 200 to 500 meters and 500 to 5000 meters. List, \$6.50. OUR PRICE, 75c.

RCA INTERMEDIATE WAVE TRANSFORMER, UV-1716. Range 5000 to 25,000 meters. List, \$8.50. OUR PRICE, \$1.10.

BRANDES PHONES. List, \$5.00. OUR PRICE, \$2.25.

CUTLER-HAMMER PLAIN 4-Ohm RHEOSTATS, for the control of 202's. List, \$1.25. Our Price, 20c.

SIGNAL CORPS SETS, made by Western Electric. Use the dispersion method developed by General Squires. Suitable for transmission over a distance of about 10 miles. Uses no antenna; only 2 wires on or in the ground. A real portable. Complete with key and transmitting buzzer, \$5.95.

3000-OHM HEADSET, made by Western Electric for Colin B. Kennedy Co. List, \$8.00. SPECIAL, \$1.95.

PORCELAIN SOCKETS, 10c.
MUSETTE LOUDSPEAKER (Frost). Moulded bakelite bell. List, \$12.50. OUR PRICE \$3.95.

COMPLETE LINE OF BROADCAST MATERIAL FOR THE HAM DEALER.



RCA WESTINGHOUSE 20-watt VACUUM TUBE TRANSMITTER, MODEL TF. Designed for radio telephony and continuous wave telegraphy, a switch on the front of the panel permitting the use of either at will. Employs a simple but effective circuit, easily converted for the short waves. SPECIALLY PRICED AT \$75.00.

MOTOR GENERATOR. Westinghouse Make. MODEL ME. 100 watts, 500 volts D.C., 110 volts, 60 cycle, single phase motor, complete. \$42.50.



RADIO SURPLUS CORPORATION 11-19 STUART ST. BOSTON, MASS.

Radio Operated Automobile

Builders and operators of America's First Radio-Operated Automobile

"THE AMERICAN WONDER TOUR"
Francis P. Houdina Co.
1477 BROADWAY
New York

Address Reply to:
Apr. 30th, 1926
Greenville, S. C.
General Delivery

J. E. Albright & Co.,
825 Broadway
New York City
Attention Mr. La HIR

Dear Sir:

This is to advise that two VIBROPLEX are used by STATION 2YAX, the portable radio transmitter used to control "America's First Radio Operated Automobile."

These instruments have been in use for some time, and have proven very satisfactory. Our operators are well pleased with the results, because it is much easier and quicker to handle this radio operated of the old type keys. We also find these instruments constructed of best materials which enables them to withstand the various weather conditions to which they are subjected.

It is with pleasure that we thank you for the opportunity of using an instrument of this kind, because we are always ready to give any manufacturer of products of this kind a letter of approval, not because of a policy that is bound to give satisfaction. Workmanship, high grade materials, and accuracy.

We wish to thank you again for your attention and wish to "boost" the VIBROPLEX thruout the balance of our continental tour, with your approval.

We beg to remain
Respectfully
FRANCIS P. HOUDINA CO.
F. P. HOUDINA, Pres.

Reg. Trade Marks
Vibroplex
Bug
Lightning Bug

Use The Improved Martin
VIBROPLEX
The World's Greatest Sending Device

For Continental,
Morse or
Navy
Codes

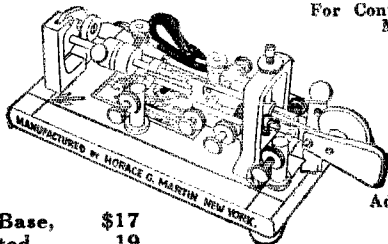

Japanned Base, \$17
Nickel-Plated, 19

Adjustable
To Any
Desired
Speed

Over 100,000 Morse and Wireless operators use the Vibroplex because it is **EASIER, QUICKER** and **MORE ACCURATE** than the old key

It transmits with amazing ease **CLEAR, CLEAN-CUT** signals at any desired speed. Saves the arm. Prevents cramp, and enables anyone to send with the skill of an expert.

Special Radio Model

Equipped with Large Specially Constructed \$25 Contact Points. Requires no relay

Every amateur and licensed operator should know how to send with a Vibroplex. **Easy to learn.** Sent anywhere on receipt of price. Money order or registered mail. **ORDER YOURS NOW!**

THE VIBROPLEX CO., Inc., 825 Broadway, New York

EAGLE



All That's Best in Radio

Eagle Owners have the satisfaction of knowing they have the best Radio Receiver made, regardless of cost.

Ask Your Dealer



EAGLE RADIO COMPANY

16 Boyden Place Newark, N. J.

FROST-RADIO

Here is the new **FROST-RADIO**
Metal Frame Rheostat **List 50c**

Not only new and radically different, but infinitely better! Sturdy one piece nickel plated frame insures precision operation and smooth, non-wearing action. As

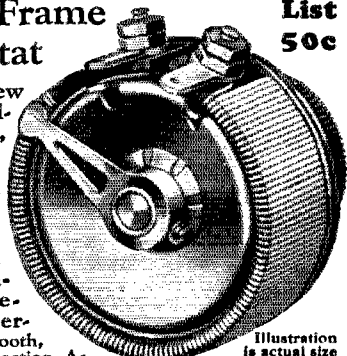
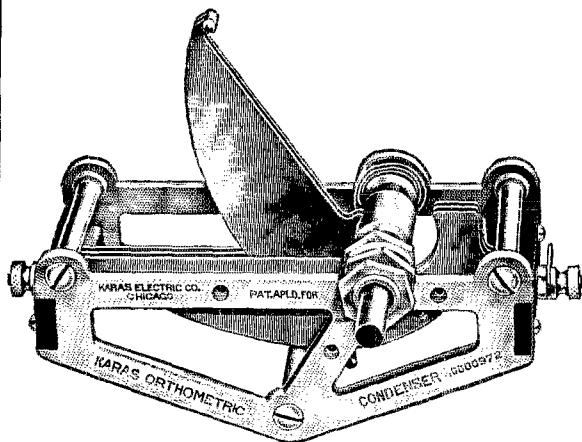

Illustration is actual size

frame cannot warp or bend, shaft alignment is permanent. Bakelite pointer knob; tinned soldering lugs; 2, 4, 6, 10, 15, 20, 25, 30 and 35 ohm types 50c. 200-400 ohm potentiometer, 65c. A remarkable achievement. Ask your dealer about the new **FROST-RADIO** Bakelite Rheostat.

HERBERT H. FROST, Inc.
314-324 WEST SUPERIOR ST., CHICAGO, ILL.
New York City Cleveland Kansas City
Los Angeles

Play Safe With Karas



Karas Orthometric Short Wave Condensers		
5 plate0001	\$6.50
7 plate00014	\$6.50
11 plate00025	\$6.50
Karas Orthometric Broadcast Condensers		
17 plate00035	\$6.75
23 plate0005	\$7.00

Harmonik the Favorite—Why

The Harmonik was the *original* audio transformer with a sufficiently large primary and core to pass the entire range of musical frequencies. With the introduction of Karas Harmonik, radio listeners heard perfect reproduction for the first time. That larger primary and larger cross section core give tone quality and freedom from lost notes. It is this principle of design, evolved by Karas, that other makers of better grade transformers are trying to incorporate.

"High voltage amplification per stage" may be something you know little about, but its presence means volume *plus*. This higher amplification per stage without distortion, is one of the exclusive features that makes the Harmonik the most popular transformer in the country.

Now that we have power tubes for the last stage of audio frequency amplification, with characteristics such that this output stage can handle *all* the energy impressed on it by one preceding tube and two Harmoniks, you can obtain full, round volume *every time*. Low notes and high notes, vital overtones and rich harmonics at all frequencies, pass through such a system without that slighting of some and over-emphasizing of others, which so long gave to Radio reproduction that "canned" effect.

Order Through Dealer or, Direct on This Coupon

Karas Condensers in the 23, 17 and 11 plate sizes are sold by good Radio Parts Dealers in most cities. The 7 and 5 plate sizes are not so widely stocked by dealers. Orders will be filled direct, or may be placed through your dealer and his jobber. If you prefer to order direct, use this coupon. Send no money. Just pay the postman the price plus a few cents postage.

KARAS ELECTRIC CO.
Manufacturing Plant: N. Rockwell St.
Offices: 1070 Association Building
Chicago, Ill.

When you undertake the construction of a multi-tube receiver (such as is necessary today), you are investing quite a sum of money in parts. Also many hours of drilling, assembling and wiring—and your reputation as a set builder.

It's a temptation to save a little on certain items—too often condensers. But—can you tell by looking at a condenser whether it is efficient, whether it will lose much of the picked up energy in leakage and absorption? Hardly!

Lieutenant Schnell of the A.R.R.L. has tested many condensers—and he uses Karas Orthometrics. Milton B. Sleeper of Radio Engineering has tested them—and he recommends Karas. Scores of other well-known leaders in Radio, with facilities for tests, are enthusiastic about Karas Orthometrics.

Because every Karas condenser is as electrically and mechanically perfect as such equipment can be today, you *know* there will be minimum possible losses when Orthometrics are used. The higher cost of a Karas condenser is "the price of perfection"—made necessary by quality materials, finest possible workmanship and most rigid inspection.

The Orthometric condenser has an exceptional minimum to maximum capacity range. It turns smoothly and evenly throughout that range. The skeletonized end plates are far from the stator plates. The active plates themselves are made entirely of brass. And with the proper coil, an Orthometric gives an absolutely equal 10 kilocycle separation of broadcast channels between 200 and 550 meters.

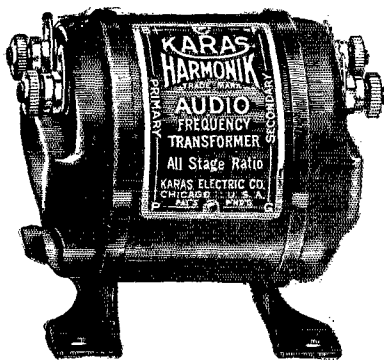

Karas Harmonik Transformer \$7.00

Karas Electric Co., 1070 Association Bldg., Chicago.

Please send me.....Karas Harmonik Transformers and
.....Karas Orthometric Condensers,
sizes as checked below. I will pay the postman the
price plus postage upon delivery. It is understood
that I have the privilege of returning these condensers
and transformers for full refund any time within 30
days if they do not prove entirely satisfactory.

..5 plate; ..7 plate; ..11 plate; ..17 plate; ..23 plate.

Name

Address

If you send cash with order, we'll ship condensers and transformers postpaid.

Gross Short-Wave Plug-in Coils

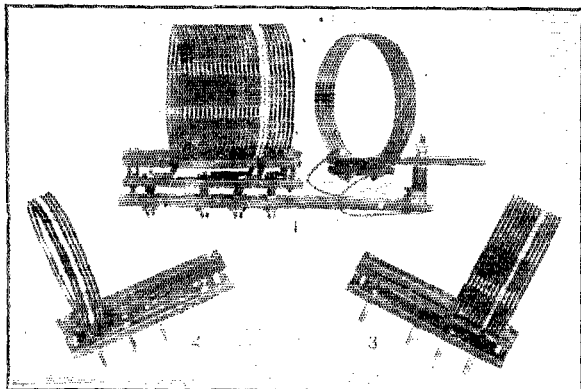

General Radio Jacks and Plugs used. Most efficient plug in arrangement on the market.

Can be handled freely without fear of injuring coils, also making possible permanent calibration of set.

Minimum amount of dielectric insures lower losses resulting in stronger signals and sharper tuning.

Without question the most rugged receiving coil on the market.

Spaced winding insuring minimum distributed capacity.

Price for 80 Meter Band complete with Base (58 to 115 meters) \$3.50.

Price for 40 Meter Band (30 to 60 meters) \$3.50. Complete with Base.

Separate coils only for 20, 40, or 80 meters \$3.00.

GROSS WAVEMETER

Built into neat cabinet. Range 20 to 200 meters. Low Loss inductances and condensers insure a low resistance wavemeter. Accurate calibration checked against crystals. Can be used with both receiving and transmitting sets.

PRICE WITH FLASH LAMP \$18.75

The original short wave Pancake inductance Transmitting 20, 40 or 80 meters \$6.00. Quartz Crystals \$6.75.

PRICE WITH GALVANOMETER \$33.75

Transmitters—anything from a peanut tube to a 1000 watt installation. Send stamp for circulars describing complete line of short wave transmitting and receiving apparatus manufactured. Hook-up and list of parts for efficient S. W. receiver for stamp.

J. GROSS & CO.

907 Fox Street, Bronx, N. Y. City

Laboratory, 30 Park Place

SUPERUNIT SET TESTER

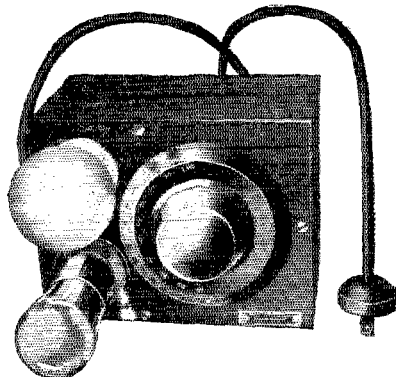

An A. C. driver with the dial calibrated in meters. Wavelength range 175 to 575. Indispensable for radio service men and experimenters.

Ideal for neutralizing.

Sold By Dealers Everywhere

PRICE \$10.00

HANSCOM RADIO DEVICES

Woonsocket, R. I., U. S. A.

TYPE **SM**
220

AUDIO TRANSFORMER

This new SM 220 Audio Transformer gives more perfect reproduction than resistance, impedance or other transformer audio amplifiers. No loud speaker on the market will reproduce the low notes it delivers. Guarantees greater amplification and less distortion than any other ever manufactured. Try out a pair—you'll find them the greatest \$12 worth of radio equipment you ever purchased. If they're not just twice as good as any audio transformer you've ever used—return them and get your money back.

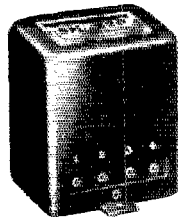

LIST PRICE \$6 each

SEE

Handle S-M Parts at your Dealers. Find out for yourself exactly why they are selected by experts and engineers.

SILVER-MARSHALL, Inc.

858 W. Jackson Blvd., Chicago

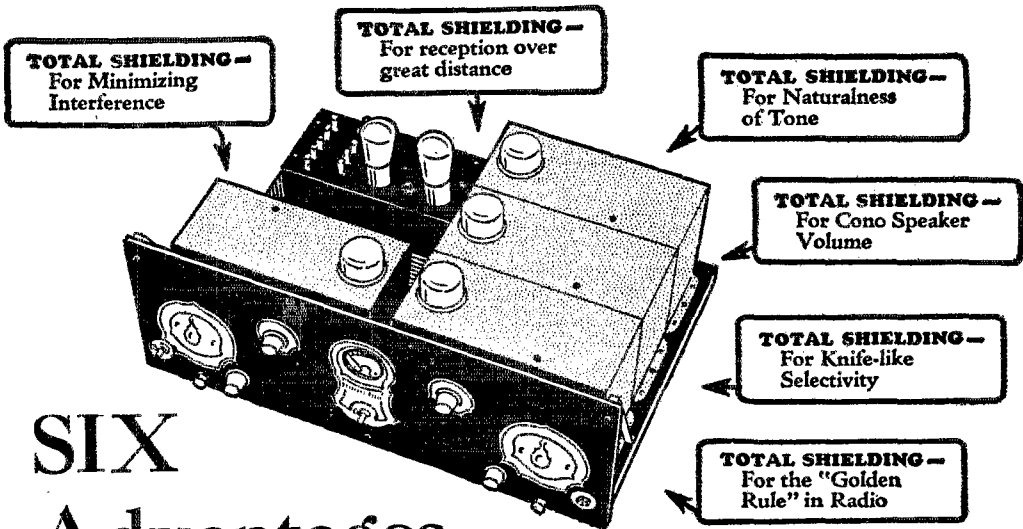

SIX Advantages of TOTAL SHIELDING

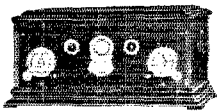

No. 601 Receiver. treasure chest type. 6-tube; totally shielded; dual control; operates horn or cone type Loud Speaker; Equipped with voltmeter; Solid Mahogany, \$210 without accessories.



"A Stromberg-Carlson never disturbs your neighbor's receiver"

Tone quality, volume, range, selectivity, and non-radiation—all these desirable features are perfected in the Stromberg-Carlson Receiver by the total shielding of the radio frequency circuits.

Total shielding permits employing three stages of radio frequency amplification without interstage coupling instead of two stages,—the limit in an unshielded receiver. This third stage adds not only 8 times more amplification to the detector but also approximately 50% more selectivity.

Total shielding, further, prevents any signal entering the receiver except through the antenna, and permits total neutralization of each radio frequency amplification stage independent of the other stages. This perfect neutralization means non-radiation.

Stromberg-Carlson Telephone Mfg. Co.
Rochester, N. Y.

Stromberg-Carlson

Makers of voice transmission and voice reception apparatus for more than thirty years

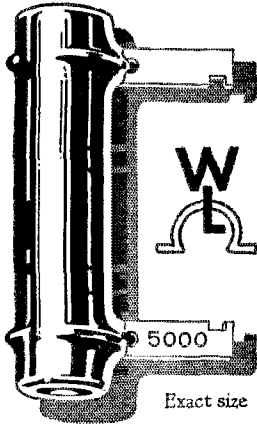

Ward Leonard VITROHM Resistor Unit Kit

Wire wound. No carbon or graphite. Vitreous enameled. Hard to break but easy to use. Soldering lugs. Values assorted to give all desired resistances for *B* eliminators or radio experimental work. Eight resistors in kit.

- 1 Resistor 750 Ohms
 - 3 Resistors 1500 Ohms each
 - 1 Resistor 3000 Ohms
 - 1 Resistor 3500 Ohms
 - 2 Resistors 5000 Ohms each
- Total 21,750 Ohms

Sold by

R. H. McMann & Co., Inc., 122 Chambers Street
Morison Electrical Supply Co., 15 East 40th Street
NEW YORK

20th Century Radio Co., 102 Flatbush Avenue
BROOKLYN

7131-7

QST Oscillating Crystals

Let us grind your quartz crystals to your specified frequency. We grind them accurate to one-tenth of one Per-cent, and all crystals guaranteed.

We are specialists in this kind of work, and can give prompt deliveries.

If you do not have the quartz plate for us to grind, we will purchase one for you upon request. We will be glad to quote you on your requirements.

Scientific Radio Service
Box 86, Dept. A, Mount Rainier, Maryland

for Dependable, Efficient! DX RECEPTION!

The A. R. S. Co.

Short Wave Receiver

A notable achievement in short wave receiver design. Absolutely LOW-LOSS THROUGHOUT. Designed and built EXPRESSLY for EFFICIENT, DEPENDABLE reception on the high frequencies.

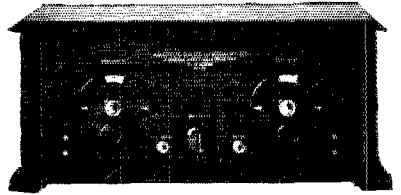

Component parts are of highest quality. Include HAMMARLUND S.L.F. Condensers—Benjamin shock absorbing sockets—MARCO Vernier dials—AERO or R.E.L. plug in coils. Solid Mahogany Cabinet.

Price (Complete in cabinet less accessories)

\$38.

R.E.L. COILS

Receiver with Aero Plug-in Coils (as above) \$48.50

The A. R. S. Co.

No Loss Inductance

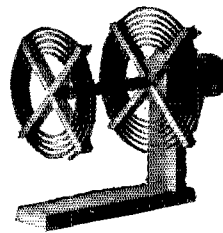

Wound with heavy brass on specially treated KILN dried maple. Highest Insulating Qualities. Adjustable Coupling. Maximum Energy Transfer. Q.S.T. RECOMMENDS IT

Special Price

20 and 40 meter size \$4.95

80 meter size \$5.45

Cardwell Receiving Condensers Rebuilt for Transmitting Purposes

Ideal for primary or antenna and counterpoise series. 2,000 Volt Flashover Test Capacity .0002 MFD.

Special Price

\$3.95

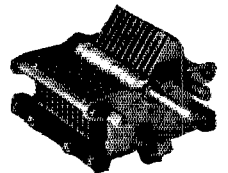

See Our Ham-Ad for Summer DX Specials

AMATEUR RADIO SPECIALTY CO.
77 CORTLAND STREET, NEW YORK

Noted Entirely
To The Amateur

Send Stamp for
Latest Bulletin

For the Musical Epicure

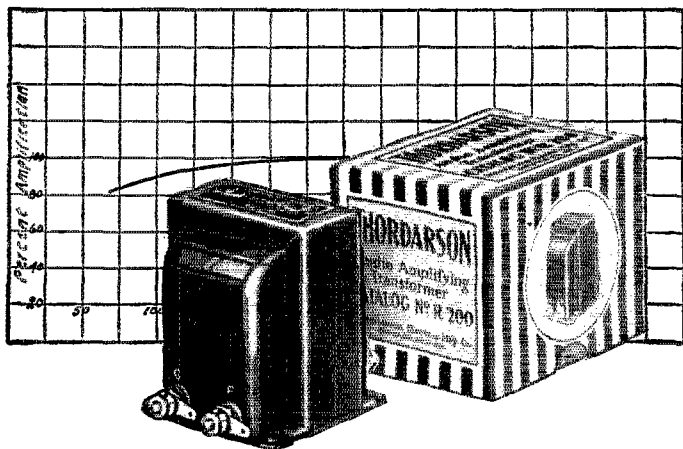

R-200

Price, \$8.00

WHEREVER tone quality, timbre, and perfect reproduction are paramount, Thor-darson amplifying transformers predominate.

The better receiving sets of today are musical instruments of the highest order. More than fifty of these leading set makers specify Thor-darson transformers as standard equipment.

The R-200 is used in sets costing up to \$2500.00. A superlative transformer giving good bass note reproduction. Ideal for use with cone type speakers.

THORDARSON

ELECTRIC MFG. CO.

Transformer Specialists Since 1895

World's Oldest and Largest Exclusive Transformer Makers
CHICAGO, U. S. A.

Radiohms and Potentiometers

Centralab non-inductive, variable resistances are controls of graphite type that insure smooth, noiseless tuning and permanent service. A single turn of the knob gives stepless variation of resistance from zero to maximum. Centralab Radiohms have two terminals, and can be furnished with maximum resistances of 2,000, 25,000, 50,000, 100,000 or 200,000 ohms. Centralab Potentiometers have three terminals, and are furnished in resistances of 400, 2,000 and 500,000 ohms. There is a type adapted to every radio circuit for control of oscillation or volume.

Write for literature describing these and other Centralab super-quality controls.

Central Radio Laboratories
20 Keefe Ave., Milwaukee, Wis.

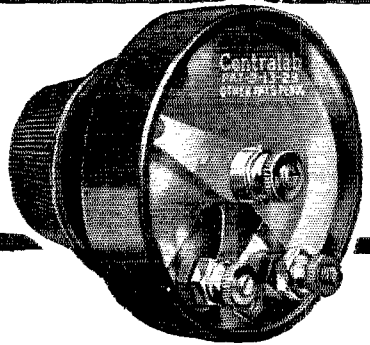

Centralab

To Our Readers Who Are Not A. R. R. L. Members

Wouldn't you like to become a member of the American Radio Relay League? We need you in this big organization of radio amateurs, the only amateur association that does things. From your reading of *QST* you have gained a knowledge of the nature of the League and what it does, and you have read its purposes as set forth on page 6 of every issue. We would like to have you become a full-fledged member and add your strength to ours in the things we are undertaking for Amateur Radio, and incidentally you will have the membership edition of *QST* delivered at your door each month. A convenient application form is printed below—clip it out and mail it today.

.....1926

American Radio Relay League,
Hartford, Conn., U. S. A.

Being genuinely interested in Amateur Radio, I hereby apply for membership in the American Radio Relay League, and enclose \$2.50 (\$3 in foreign countries) in payment of one year's dues. This entitles me to receive *QST* for the same period. Please begin my subscription with theissue. Mail my Certificate of Membership and send *QST* to the following name and address.

.....
.....
.....

Station call, if any

Grade Operator's license, if any

Radio Clubs of which a member

Do you know a friend who is also interested in Amateur Radio, whose name you might give us so we may write him about the League?

..... Thanks!

A BETTER AND DIFFERENT PLUG-IN COIL

Note its advantages listed below—and try and do without it!

1. Positive contact is secured through General Radio plugs and jacks.

2. With 3 Coils, continuous, gapless range is secured from 140 to 16 meters. One of the 20-40-80 meters amateur bands is located in the middle of the tuning range of each of the 3 coils. (For this a SFL Condenser, 140 mmfd. max. cap. is essential.)

3. Operation of regeneration condenser has no effect on the tuning; the 2 controls are completely independent.

4. Antenna coupling is adjustable; by a primary coil

and not through a condenser. Secondary coils are specially constructed so that setting of primary coil does not need to be changed when secondaries are exchanged.

5. Coils are space-wound solenoids on skeleton frames.

6. Both tickler and antenna coil are at filament end of the secondary.

7. These coils cover the 3 U. S. Amateur Bands, all European Amateur Bands, Short-Wave Broadcast, U. S. Naval and Commercial Short-Wave Stations, etc.

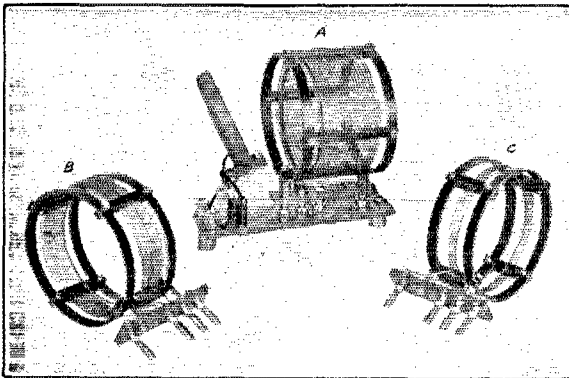

The Kit Illustrated Covering 15 to 133 Meters Complete **\$12.50**

Coil No. 4, 125-250 M
Price \$4.00

Coil No. 5, 235-550 M
Price \$4.00

These coils are essential to the most efficient operation of your station. Order your TODAY.

AERO PRODUCTS INCORPORATED, Dept. 16, 1768-1772 Wilson Ave., Chicago, Ill.

ROBISON'S MANUAL OF

RADIO TELEGRAPHY and TELEPHONY

6th EDITION

This book, written for the U. S. Navy, first appeared in 1907, the author being Lieutenant (now Admiral in command of the U. S. Fleet) S. S. Robison, U. S. Navy. This edition has been revised and brought up to date by Commander S. C. Hooper, U. S. Navy, Radio Officer of the U. S. Fleet during the past year. A review of this book appeared in the December issue of QST, in which it was stated this is perhaps

“The Best Radio Book That Ever Came To This Desk”

The review was as follows:

“The famous ‘manual’ has, in its 6th edition, risen to entirely new heights. This last edition ranks with the very best of all published radio matter and adds to its usefulness the excellent printing and binding that has marked the earlier issues.

Never have we seen a book that so well followed out the plan of starting with simple theory but always keeping in mind that the reader was interested in the application of the theory, and cared nothing about the theory itself. Therefore the text progresses rapidly to the actual apparatus and discusses the modern types clearly, rapidly and usefully.

This book is so universal that it deserves unusual treatment and shall have it—here are the chapter headings in full.

- 1—General Theory
- 2—Elementary theory of electricity
- 3—A.C. Theory
- 4—A.C. Theory applied to radio
- 5—Damped oscillations

- 6—Wave propagation
 - 7—Radio Instruments
 - 8—Radio Transmission
 - 9—Radio Reception
 - 10—Theory of vacuum tubes
 - 11—Vacuum-tube transmitters
- Part 2—Practical application of apparatus and measurements
- 1—Practical application of apparatus
 - 2—Radio measurements
- Part 3—Useful Information
- 1—Tables and formulas
 - 2—Mathematics (Arithmetic, Algebra, Geometry, trigonometry)
 - 3—Radio Laws
 - 4—Miscellaneous
- Part 4—Index

That is a tremendous territory to cover in a single volume, and it takes almost 900 pages to do the job. However, the job is done and the result is a book that is not only worth \$8 which it costs but is perhaps the best radio book that ever came to this desk.”

PRICE, \$8.00 POSTPAID

Send checks or money orders to Secretary-Treasurer, U. S. NAVAL INSTITUTE, ANNAPOLIS, MARYLAND, U. S. A.

Special Offer:

Send \$2.00 additional and the “Storage Battery Manual, Including Principles of Storage Battery and Design, 1920,” by Lieut.-Comdr. L. C. Dunn, U. S. Navy, will be sent postpaid. This book of 391 pages recently sold for \$7.00.

The **SC** **SILVER COCKADAY**
"All Wave Receiver"

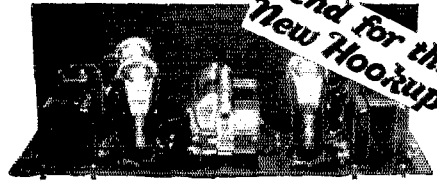

**Send for this
New Hookup**

THE NEW 4-TUBE RECEIVER
 Sponsored by Popular Radio, endorsed and described by Radio publications and Newspapers from coast to coast. Perfected Single Control—Unlimited wavelength range—Volume equal to 6-tube receivers—Quality unsurpassed and hair-line selectivity. Easily assembled by even a beginner with just a screw driver and pliers.

REPRESENTED MANUFACTURERS:
 Belden Mfg. Co.—S-C Wiring Harness.
 Central Radio Laboratories—Centralab Resistances.
 Polymet Mfg. Corporation—Fixed Condensers, Leak and Pester & Co.—Leak Clips.
 Pester & Co.—Drilled and Processed Front Panel and Drilled Sub-Panel.
 Silver-Marshall, Inc.—Variable Condensers, Coil Sockets, Coils, Tube Sockets, Vernier Dial, Mounting Brackets.
 Thordarson Elec. Mfg. Co.—R200 Power Transformers.
 Yaxley Mfg. Co.—Rheostat, Jacks, Switch.
Send for S-C Building Instructions today or see your dealer
S-C MERCHANDISING CO.
 288 S. Peoria St. Chicago

Faradon

**MODEL T All-Metal-Mica Condensers
For Receiving Sets**

Also *Faradon* For

BY-PASS, FILTER, BLOCKING
and
Interference elimination applications

Complete data and quotations furnished promptly upon receipt of advice as to requirements.

19 Years Specialization in the Radio Field

Wireless Specialty Apparatus Co.
 JAMAICA PLAIN, BOSTON, MASS., U. S. A.
 ELECTROSTATIC CONDENSERS FOR ALL PURPOSES

A. R. R. L. Members -- What about your friends?

You must have a friend or two who ought to be members of our A.R.R.L., but aren't. Will you give us their names, so that we may write to them and tell them about the League and bring them in with the rest of us? The A.R.R.L. needs every eligible radio enthusiast within its ranks, and you will be doing your part to help bring this about by recommending some friends to us. Many thanks,

American Radio Relay League,1926
 Hartford, Conn.

I wish to propose

Mr. of

Mr. of
 Street & No. Place State

for membership in the A.R.R.L. I believe they would make good members. Please tell them the story.

.....

Deforest

20 Watt

Transmitting Tubes

<i>Fil. Volts</i>	.	.	.	10.
<i>Fil. Amps</i>	.	.	.	2.35
<i>Plate Volts</i>	.	.	.	750-1000
<i>Plate Current</i>	.	.	.	40-50MA

Price \$12.00 Parcel Post Prepaid

RADIOPHONE SALES CO.

216 West 58th St.

New York City, N. Y.

Exclusive Sales Rights—Deforest Specialists

WESTON 506 Voltmeter and Universal Bi Polar Switch

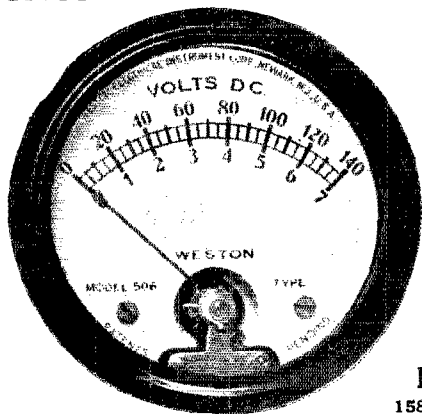

GIVE economy and positive Set control. A twist of the switch . . . quick check on all voltage conditions on the double scale (140/7 volts) voltmeter. Adaptable to all makes and models of receiving sets. Made by the Weston Craftsmen of Quality Radio Instruments, and makers of the leading models of measurement device in every field of electrical work. Its use insures operation of tubes at proper filament voltages and economical use of batteries. For further information request circular.

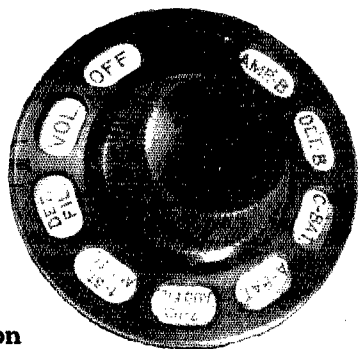

**Weston Electrical
Instrument Corporation**

158 Weston Avenue Newark, N. J.

STANDARD THE WORLD OVER.

WESTON

Pioneers since 1888

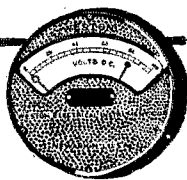
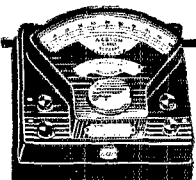

**SEE
THAT
SCREW**

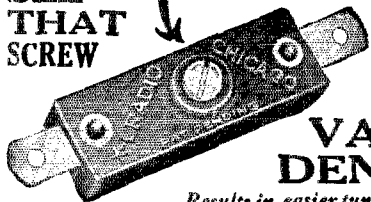

*A screw-driver
adjusts an X-L
in crowded
places.*

**X-L
VARIO
DENSER**

*Results in easier tuning, more di-
ance, volume and clarity—greater stability Indorsed
y leading radio authorities.*

Model "N"
A slight turn obtains correct tube oscillation on all tuned
radio frequency circuits. Neutrodyne, Roberts two tube,
Browning-Drake, McMurdo Silver's Knockout, etc., capacity
range 1.8 to 20 micro-micro farads. Price **\$1.00**

Model "G"
with grid clips obtains the proper grid capacity on
Cokaday circuits, filter and inter-
mediate frequency tuning in heterodyne and
positive grid bias in all sets. Capacity range
.00018 to .00055 and .0003 to .001 micro
farads. Price \$1.50.

X-L Push Post
Push it down with your thumb, insert wire,
remove pressure and wire is firmly held.
Releases instantly.
Price 15c.



X-L RADIO LABORATORIES
242S Lincoln Avenue N. Chicago, Ill.



**What Size Grid and Plate
Blocking Condensers?**

You have always used .002 mfd. for blocking con-
densers but who knows that it is the best size
for short waves? The builders of KFUH believe
.000036 mfd. better for their tuned grid 'n plate
circuit. Our UC 1015 condenser gives eleven
different capacities between .0002 mfd. and .001
mfd. so you can select the best size for your set.
Why not try them?

Price \$1.25 postpaid

General Electric Gridleaks



Brand new enameled porcelain
G. E. Gridleaks in 5000 ohm
and 10,000 ohm sizes for all
tubes.

PRICES, 5000 ohm \$1.25, 10-
000 ohm \$1.75, Postpaid.

Utility Radio Co., 30 Leslie St., East Orange, N. J.

**TOAZ
DUBBELUGS**

May now be had in highest quality
tinned stock in nominal lengths of
1, 2, 3, 4, 5 and 6 inches, correspond-
ing to 3/4, 1 1/8, 2 3/8, 3 1/8, 5 and 6 1/2
between holes.

Let's You Build Without Solder

**Price \$7.50 Per M
Nominal Inches
SPECIAL PACKAGE**

Nominal 125 Inches Any Assortment

\$1.00 Net

**Toaz Engineering and Sales Co.,
11703 Robertson Ave., Cleveland, Ohio.**

ARE YOU BUILDING A NEW SET?

If so—you will need instruments. Tell us your story and
we will recommend the best instrument to use.

Ask for Circulars
JEWELL ELECTRICAL INSTRUMENT CO.
1650 Walnut St. - Chicago
"26 Years Making Good Instruments"

RARE GAS AND HIGH VACUUM PRODUCTS
Neon, Helium, Argon, etc.

We specialize in construction and development
of all types of special thermionic valves, Neon
glow lamps, Neon arc lamps, Mercury arc lamps,
hot cathode and gas filled rectifiers, tubes utilizing
the alkali and alkaline earth metals, and photo
sensitive apparatus.

Also, high vacuum pumps, manifolds, etc., made of lead,
lime glass or quartz glass. Special high frequency ap-
paratus for electronic bombardment.

Flashlamps



1. Neon flash lamps for oscillographs, wavemeters, etc.
Price \$3.50.
2. We are the makers of Hyro—the really safe high
voltage indicator.
3. Newest developments in photoelectric cells. Price \$15.
Complete equipment for high vacuum work installed.

RADIO ELECTRICAL WORKS
Research Division, 23 Union Sq., New York, N.Y.

GENUINE

Kenotron Rectifying Tubes

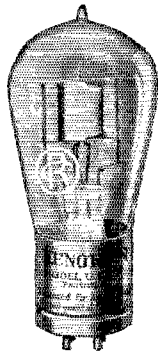
Model UV-216

THESE Tubes are the GENUINE R.C.A. Kenotron Rectifying tubes.
Filament voltage 7 1/2 volts and will safely stand A.C. input of 750 volts. Four
of these tubes will run a 50 watt.

These Rectifying tubes will pass plenty of current and voltage for your
TRANSMITTER and also are very efficient for use in "B" ELIMINATORS.

STANDARD BASE, EVERY TUBE BRAND NEW AND PACKED IN ORIGINAL CARTONS.

List price \$7.50 ea.—**Extra Special \$1.85 ea.**

AMERICAN SALES CO., 21 Warren Street, N. Y. C.

HAM-ADS

NOTICE

Effective with the July, 1926 issue of *QST* the policy of the "Ham Ad" Department will be altered to conform more nearly to what it was originally intended that this department should be. It will be conducted strictly as a service to the members of the American Radio Relay League, and advertisements will be accepted under the following conditions.

(1) "Ham Ad" advertising will be accepted only from members of the American Radio Relay League.

(2) The signature of the advertiser must be the name of the individual member or his officially assigned call.

(3) Only one advertisement from an individual can be accepted for any issue of *QST*, and the advertisement must not exceed 100 words.

(4) Advertising shall be of a nature of interest to radio amateurs or experimenters in their pursuance of the art.

(5) No display of any character will be accepted, nor can any typographical arrangement, such as all capital letters, be used which would tend to make one advertisement stand out from the others.

(6) Contracts for "Ham Ad" advertising which are now in force, and which have until later than July, 1926, to run, will be completed in accordance with the understanding under which they were made, but cannot be renewed.

(7) No new contracts will be made for "Ham Ad" advertising after March 20, 1926.

(8) The "Ham Ad" rate will be 7c per word, and remittance for full amount must accompany copy.

(9) Closing date remains as heretofore; the 25th of second month preceding date of publication.

(10) This notice will be published in the May and June, 1926 issues of *QST*.

HAVE SOME GENERAL RADIO COIL MOUNTING ACCESSORIES. THEY ARE ADAPTABLE TO ANY TYPE OF COIL, SEND YOUR QRA TO THE ONLY HAM STORE IN THE FIFTH DISTRICT. FORT WORTH RADIO SUPPLY CO. FORT WORTH, TEXAS.

REAL BARGAINS:—New and perfect UP-1016. 750 watt Power Transformers, 3000v with midtap; Filament winding 10v with midtap, \$10.00; UP-1656. Filament Transformers 75 watt, 7.5v with midtap, \$4.00; UP-1658 UV-712 Audio Transformers 9/1, \$2.00; UC-1831 4000v Variable Transmitting Condensers, \$1.50; UC-1803 Antenna Coupling Condensers, \$1.50; Genuine Holtzer-Cabot No. 4 Headphones, 2200 ohms, double pole, high grade, \$3.00; Genuine Cardwell Type 123-B Variable Condensers .0005 \$2.50; Signal R-48 Telegraph Keys \$2.25; Jewell Meters for immediate delivery, send for catalog. UC-490 Filter Condensers 1750v, 1mfid, \$2.25; UC-1014 Grid Condensers, \$2.25; 1000v Mica Condensers, .001 mfd. Bakelite mounted, 25c. Bakelite Navy Key Knobs, 25c. Cutler-Hammer Variable Grid Leaks, 35c. AMRAD No. 2796 Lightning Switches mounted on 5" porcelain posts, \$1.50. Day-Fan Balanced Vernier Condensers, 7 or 18 plates may be used, Bakelite ends, \$1.50—F-F Battery Chargers 6 amps, 110v AC 60 cyc. \$9.00. Send for discount sheet and keep in touch with bargains. 25% deposit on C. O. D. orders. All items under 4 Lbs. postpaid. STATE RADIO CO., 236 Columbia Road, Dorchester, Mass.

EVERYTHING IN RECEIVING apparatus. 25% discount to "hams". Over 2 pounds data, catalog, etc.—prepaid—25c. Kladag Laboratories, Kent, Ohio.

EXCHANGE—What NEW RECEIVING parts do you want? Can use perfect, latest model RECEIVING parts, in new condition, in exchange. No sets. RADIO EXCHANGE, KENT, OHIO.

NEW Western Electric Power Amplifier, complete with horn and tubes, \$55.00. Box 1450, Springfield, Mass.

PERMANENT PLATE POWER. A LIFE-TIME STEEL ALKALINE EDISON B BATTERY. (THE SML KIND). ELECTRICALLY WELDED FOR ABSOLUTE QUIET. 54 VOLT \$8.25, 100 VOLT \$15.00. IN FUMED OAK POLISHED CABINET. REAL EDISON SOLUTION. THAT BIG SET NEEDS A POWER HOUSE. HERE 'TIS—2000 MILLIAMP HOUR. 195 VOLT \$24.00. SAMPLE CELL 30c. GIANT SUPERCCELLS 4000 MILLIAMP HOUR 40c CELL, SAMPLE 50c. 3 RUNS YOUR 199. PEPPY ELEMENTS—WELDED PAIRS 7½c. SEPARATORS ½c, ¾ x 6" TUBES 3c, 1" —4c. BATTERY OR RECTIFIER SHOCKPROOF JARS 1" x 6" —4c, 1½ x 6½" —5c. PURE SOFT .032 NICKEL 1c, .034 (HEAVY) 1½c ft. REAL EDISON ELECTROLYTE (THAT'S NO LYE) LITHIUM COMPOUND \$1.25 MAKES 5 lbs. COLLOID B CHARGER \$2.00 SMALL, \$3.00 LARGE. FOR A PERMANENTLY PERFECT AERIAL No. 12 SOLID COPPER ENAMELED 75c—100 ft. MINIMUM RESISTANCE—MAXIMUM RECEP-TION. INSULATORS—PYREX BOWL LEADIN \$1.50, IMPREGNATED OAK STRAIN 20—\$1.00. WRITE IN, GANG. RADIO 8ML.

FRANK M. J. MURPHY,
4837 ROCKWOOD RD.,
CLEVELAND, OHIO.

NEW GENERATORS, rated at 275 volts 120 watts will give 500 volts \$8. UC1831 variable 4000 volt condensers \$1.50. Bakelite 3 coil honycomb, geared mountings \$1.50. Western Electric microphones \$1. VT2s \$4. VT1s \$3. Used generators, 30 volt direct current input, output 300 volts \$8. 500 cycle 200 watt \$10. ½ KW \$15. SEND STAMP for list. R. Wood, 38 Way Ave., Corona, New York.

EDGEWISE wound copper ribbon, the only really satisfactory antenna inductance; 3¼" outside diameter 10c turn; 4¼" 15c turn; 5¼" 15c turn; 6¼" 17c turn; 7¼" 20c turn, prepaid any number turns in one piece; Geo. Schulz, Calumet, Michigan.

MUELLER 150-WATT INPUT POWER TUBES \$15.00 socket FREE. CURTIS-GRIFFITH, FORT WORTH.

HEADQUARTERS FOR HAM STUFF: ASK FOR OUR CATALOGUE A-2. WE SPECIALIZE IN AMATEUR TRANSMITTING AND RECEIVING APPARATUS. NO. 12 "DYNEX" SOLID COPPER ENAMELED AERIAL WIRE, 1c FT. NO. 10 (FOR HEAVY DUTY), 1½c FT. NO. 14, ¾c FT. PYREX GLASS TRANSMITTING IN-

TELEGRAPHY—Morse and Wireless—taught at home in half usual time and at trifling cost. Omnigraph Automatic Transmitter will send on Sounder or Buzzer unlimited messages, any speed, just as expert operator would. Adopted by U. S. Govt. and used by leading Universities, Colleges, Technical and Telegraph Schools throughout U. S. Catalog free. Omnigraph Mfg. Co., 1318 Hudson St., New York.

HAMS. A PENNY FOR YOUR THOUGHTS, IS A TRITE EXPRESSION, "BUT" TWO PENNIES ON A POSTAL CARD ASKING FOR PRICE LIST OF TRANSMITTING PARTS, WILL PROVE TO BE A MONEY SAVER. FOR INSTANCE, PLUG IN COILS ARE QUITE TROUBLESOME TO BUILD, UNLESS YOU SAY YOU SAW IT IN *QST*—IT IDENTIFIES YOU AND HELPS *QST*

SULATORS, 12", \$1.50; 7 1/4", \$1.50. RECEIVING SIZE 45c. PYREX LEAD-IN BOWLS, \$1.50. WE ALSO CARRY THE PYREX STAND-OFF INSULATORS. FLERON LEAD-IN INSULATORS, \$1.10. BARKELEW LIGHTNING SWITCHES, \$2.50. WARD-LEONARD 5000 OHM GRID LEAKS, \$2.00. ALLEN-BRADLEY RADIOSTAT, \$6.50. TYPE E-210, \$4.00. RADIOLEAK (VARIABLE TRANSMITTING GRID LEAK), \$5.00. ACME 2 MFD. 2000 VOLT CONDENSERS, \$6.50. 2 MFD 750 VOLT CONDENSERS, \$2.50. FEDERAL 1 MFD. 1000 VOLT, \$2.00. RCA, UC-490, 1 MFD. 1750 VOLTS, \$2.50. FEDERAL MICHROPHONES, DESK TYPE, \$6.50. HAND TYPE, \$7.00. NATIONAL AND CARDWELL TRANSMITTING CONDENSERS IN STOCK. ALL SIZES ACME CHOKES AND TRANSFORMERS. A FULL LINE OF JEWELL METERS. THORDARSON 80 WATT FILAMENT TRANSFORMER, \$7.00. 150 WATT, \$10.00. 300 WATT \$15.00. THORDARSON PLATE TRANSFORMERS, 100 WATT, \$13.00. 450 WATT, \$18.00. 900 WATT, \$30.00. LEAD AND ALUMINUM, 90c SQ. FT. "DYNEX" KEM ELEMENTS. 1" x 4" 6c EACH. 1" x 6" 7c. 1 1/4" x 6" 8c. BREMER-TULLEY PLUG-IN HAM TUNER, \$8.00. BRADLEYSTATS, \$1.85. GAROD-PYREX SOCKETS, \$1.50. PYREX SOCKETS FOR UX TUBES, 70c. NATIONAL, KARAS, GENERAL RADIO AND CARDWELL CONDENSERS FOR THAT SHORT WAVE TUNER. NATIONAL VELVET VERNIER DIALS, \$2.50. NO. 16 COTENAMEL, 75c LB. THE NEW CITIZENS RADIO CALL BOOK (HAM EDITION), 75c. "EVERYTHING FOR THE HAM" IS OUR MOTTO. "DYNEX FOR DX" OUR TRADEMARK. WE SHIP C.O.D. IF DESIRED. WE ARE THE "EIGHT THAT PAYS THE FREIGHT" EAST OF THE ROCKIES. NICHOLSON ELECTRIC CO. (OPERATING 8BIN), 1407 FIRST NORTH ST., SYRACUSE, N. Y.

ONE KW DEFOREST Transmitter CW-1CW phone. Complete with tubes, 2KW motor generator, etc. R. B. Ladd, 323 N.E. 34th St., Miami, Florida.

Five new Western Electric 50 watters \$28 each. Western Electric power amplifier, speaker and 216A tubes \$95, cost \$181. Like new. 100 volt Exide "B" batteries \$20. WANTED Esco motor generator about 750 watts, reasonable. Brown, 192 South Goodman Street, Rochester, New York.

INDUCTANCES—40,80 meter transmitting. Spiral wound heavy brass ribbon. Mounted on solid oak. Variable coupling, 40 meter, \$4.90; 80 meter, \$5.25; postpaid east of Mississippi. Send for photo. H. Kaltwasser, 735 E. 166 St., New York City.

SELL lot of transmitting and receiving sets and parts. List for stamp. Tanner, 217 East Mulberry, Springfield, Ohio.

TEE DEE (Edison element) "B" batteries are everlasting. Completely assembled; beautiful cabinet, panel and switches. 45 volt \$10, 90 \$20, 135 \$30. Write for information. Discounts to dealers.

RADIO ELECTRIC CO., WEST WINFIELD, N. Y.

FOR SALE: One UL1008 at \$7.00, UP1368 transformer \$15.00, UP 1626 filter reactor \$7.50, Robbins and Myers 200 watt 500 volt DC generator \$25.00, 1/2 HP heavy duty Wagner motor \$30, and following Jewell meters: TC RF Amp. 0-25 7.00, 0-500 DC volt \$8.00, 0-300 Milliamp. \$3.50, 0-10 AC volt \$4.50, and Roller Smith 0-150 AC volt \$3.00. John B. Gray, 3rd, Wilson, N. C.

??? What do you need ??? To amateurs and experimenters, we offer at reduced prices (prepaid) a full line of transmitting and receiving equipment. Write now for descriptive literature and ask for special Ham prices. M. B. S. Sales Co., Dept. H.2, 27 School St., Boston, Mass.

FOR AN EXCELLENT NOTE AND MAXIMUM DX. General Electric 24/1500 volt .233 ampere dynamotors \$45. Slightly used \$25. IDEAL FOR BATTERY SUPPLY. \$3.00 additional for belt or battery drive. Pulleys and endless leather belt for any speed motor. Excellent results. Crocker-Wheeler 24/1500 volt 450 watt \$45.00, GE 12/350 volt \$18. Shaft for motor drive \$2.00. Holtzer-Cabot 12/500 volt \$18.00. Navy Keys \$2.00. Crocker-Wheeler 500 cycle motor generators. 1500 volt meters \$15.00. Special genuine Cardwell .0005 mfd condensers \$2.00. Cut down for lower capacity. Henry Kienzle, 501 East 84th St., New York City.

DOUBLE spaced transmitting variable condensers completely assembled with 3 1/2" Bakelite Dials, hard rubber end plates, nickel plated brass parts, aluminum plates, calibrated spacers, 13 plates \$3.00, 17 plates \$3.50, 23 plates \$4.00—can be immersed in oil for extra high voltages. Prepaid cash with order—satisfaction or money back. Geo. Schulz, Calumet, Michigan.

WRITE for list of bargains in used equipment. Want high voltage generator. R. Lewis, Princeton, Illinois.

BARGAINS. Synchronous motor, \$10; UV 211 tube, new, \$25; UV 204 tube, used, \$40; UV 203A tube, new, \$25; 500 volt S tubes, two, \$6 each; 0-1 Roller Smith hot-wire ammeter, \$3; 0-1 GE thermoammeter, \$5; UP1653 forty henry choke, \$6. UL1003 oscillation transformer \$7; 0-250 GE milliammeter, \$4; 0-5 GE thermoammeter, \$5; RCA 5 watt sockets, 75c each; UP1653 10 volt 150 watt filament transformer, \$5; 200 watt 500 cycle motor generator with 80 volt dc motor, \$15; 110 volt AC chopper motor, \$5; Western Electric 7A Cabinet power loud-speaker less tubes, \$25; Deforest hand microphone, \$2; Bruno shortwave coupler, \$2; Bremer Tully short wave coupler, \$2.50; Stromberg Carlson loudspeaker, \$3; Ward Leonard 5000 ohm gridleak, \$1.65; Bakelite panels 14 x 18 x 1/4, \$1.50. W. M. Derrick, 80 Leslie Street, East Orange, N. J.

Building a B eliminator? Best make full wave transformer, tapped primary and secondary \$4.95. Chokes fine job fully mounted \$3.95. Block of condensers, 2, 2, 8 and 1 Mfd \$6.25. 1 and 1 in series 95c. Salvaged 2 Mfd Condensers 75c net. UP 1016 transformer \$12.95. Write us for anything hard to get.

WRAP—THE RADIO CLUB INC., La Porte, Ind.

FOR SALE—1/2 KW Navy Holtzer-Cabot 500 cycle motor generator—perfect condition—complete with spares, 1 Crocker-Wheeler 24 to 1500 volt DC 450 watt—6500 RPM dynamotor—never used—\$30. 1 Acme 300 watt power transformer—perfect—\$10. All kinds of transmitting and receiving apparatus accumulated at 1BV and 1FB since 1917—am moving—all inquiries QSLd. Cumming, 33 Marlboro St., Boston, Mass.

CURRI-CO 5-WATT DX BATTERIES \$3.15 postpaid. (Dealers wanted.) CURTIS-GRIFFITH, FORT WORTH.

AN SUX cartoon for your DX cards \$1. No two alike. Don Hoffman, 34 Kirkwood, Akron, Ohio.

MOTOR BARGAINS, 1/4 horsepower 110 volts \$8.00. 5 watt transmitting tubes \$1.00. Receiving tubes \$.60. 6 volt batteries \$2.75. 824 North Fifth, Philadelphia, Pennsylvania.

SELL 50 WATT EQUIPMENT (NEW). Send for prices. 1PF.

GENERAL ELECTRIC motor new 1/4 h.p. 3450 RPM 32v. A bargain \$19.75. Snare Drum with complete set of traps. Cost new last year \$65. Sacrifice \$35. Ship C.O.D. Arthur Dunlap, Bowertson, Ohio.

Bids wanted on all or part ONE THOUSAND VOLTS three or four ampere hour separate STORAGE CELLS. Must be willing ship for approval before payment to arrive Seattle not later August. Reference Colonel Hartman, Signal Corps, Arcade Building, Seattle. Address Paul Estle, Bethel, Alaska.

500 cycle alternators for plate excitation and other army air service equipment. Radio Service Shop, San Antonio, Tex.

SUPER using J. K. Long Wave Air Core Transformers and standard parts. Eight tube set which cuts down interference, selectivity tone rich and clear. Long range on loop entirely new principle in heterodyne reception. Ask for literature blue prints 50 cents. We can furnish all parts to hams at special discount. Davisco, 30-B Euclid Arcade, Cleveland, O.

SILICON Transformer Steel cut to order .014", 10 lbs. 25 cents, 5 lbs. 30 cents, less than 5 lbs. 35 cents per lb., 4 cubic inches to the lb. .007" for radio frequency transformers, 50c cubic inch, postage extra. At least 1/4 cash with order—balance C. O. D. Geo. Schulz, Calumet, Michigan.

Special motor generator bargains. New motor generator sets at less than secondhand prices. We have in stock

a few New Westinghouse double commutator 750 V. 200 W. D. C. generators direct connected to 110 V. 60 cycle A. C. motors \$45.00 each. Field rheostat extra \$4.50 each. 25% with order, balance C. O. D. express inspection allowed. Subject to prior sale. QUEEN CITY ELECTRIC CO., 1734 GRAND AV., CHICAGO, ILL.

100 WATT power transformers 350 each side, complete. Room for filament winding, \$7.50. 9CES Frank Greben, 1927 S. Peoria St., Chicago, Illinois.

SAMPLE REPORTS.

9BNT CRESTON, IOWA. THOUGHT WAS STUNG AGAIN BUT DECIDED TO STUDY AND FIND OUT. AT THIS TIME MY SPEED LIMIT WAS EIGHT PER. AND AFTER 3 EVENINGS WITH SHORTKUT COULD DO 15 AND CAN NOW DO 20 EASILY.

4QY FORT MYERS, FLA. WAS LICENSED AND LITTLE BOOKLET LOOKED LIKE STUCK AGAIN BUT TRIED IT AND DOUBLED RECEIVING SPEED IN FIVE HOURS—HI. PUT SHORTKUT INTO EVERY HAMS DEN.

9CMW HICKMAN, KY. WHEN GOT RIGHT SLANT ON YOUR PAN RAISED MY RECEIVING SPEED FROM 15 TO 25 IN 3 EVENINGS.

Reports from 200 Hams and Quarter Coupon 25 cents. Reports from all Dist. Other information on request. SHORTKUT with Appendix and Better Key Work \$3.50 to US-CAN. Elsewhere \$4; Reg. Mail: None COD: Send PO Order.

DODGE RADIO SHORTKUT, MAMARONECK, N.Y.
Trade Mark BKUMA YRLSBUG Registered.

AMATEUR RADIO EQUIPMENT THAT IS GUARANTEED WILL WORK! ENSALL RADIO LAB., EQUIPMENT WILL WORK. FROM THE SMALLEST TO THE LARGEST JOB IN THE RADIO LINE WE WOULD BE PLEASED TO QUOTE ON THE PARTS ARE THE COMPLETE WORK. WE BUILD TO ORDER SPECIAL EQUIPMENT FOR AMATEUR OR BROADCAST STATIONS. INDUCTANCES, WAVEMETERS, RECEIVERS, TRANSFORMERS, ALL TYPES OF CHOKE COILS, etc., PRICES ON REQUEST. WE SUPPLY GENERAL RADIO EQUIPMENT, THORDARSON, ACME, NATIONAL, PYREX, ESCO, JEWEL, WESTON, GENERAL INDUSTRIES, AND ALL OTHER WELL KNOWN AMATEUR EQUIPMENT. THE "ENSALL RADIO" SPEECH AMPLIFIER WILL PUT A KICK ON THAT PHONE OUTFIT. THE SHORT WAVE RECEIVER WE BUILD HAS A WAVELENGTH RANGE FROM 5 TO 200 METERS. WE REWIRE SUPER-HETERODYNE RECEIVERS AND GUARANTEE THEM. REWIRE AND BUILD ANY TYPE TRANSMITTER. DISCOUNTS TO DEALERS ON ANY RECEIVERS WE BUILD TO ORDER. ALSO ON A NUMBER OF THE PARTS WE CARRY. IF IT'S RADIO JUST DROP US A LINE. QUOTATIONS GLADLY GIVEN ON ANY EQUIPMENT OR PARTS. FOR THE BEST IN AMATEUR RADIO, GET QSO. THOS. ENSALL (ENSALL RADIO LAB.), 1208 GRANDVIEW AVE., WARREN, OHIO. (Designers of High Grade Amateur and Broadcast Radio Equipment).

IVORY RADIO PANEL, makes most beautiful set of all, cut any size 3c square inch 3/16" thick. Also dials and knobs. Guaranteed satisfactory. Write for FREE sample. Will ship prepaid or C.O.D. Ivorylite Radio Panel Co., 3222 Ave. F, Fort Worth, Texas.

MOTOR-GENERATOR—Esco. 1/2 h.p. three phase—220 volt motor; 1000 volt D.C. generator for one-third cost. 1015 Milam Place, Austin, Texas.

"ESCO MG For Sale—1000 volt, 200 watt, motor 110 a.c., 60 cycles, four bearing unit, new and slightly used, A.N.1 condition. Price \$95. 9EP Lexington, Ky."

HAMS: Get our Samples and Prices on Printed Call Cards made to order as YOU want them. 9APY HINDS & EDGARTON, 19 S. Wells St., Chicago, Ill.

NO BUNK. New tubes UV203s \$21.00. UV203A's \$29.00. "S" tubes \$7.50. Can you get these cheaper elsewhere, QM? If so, please let me know. P. Running, 706 So. Third Ave., Maywood, Illinois.

THE CRICKET is better than a Bug or Beetle. It hops faster, goes farther, sings better. Listen for 5EH or write.

UNMOUNTED CHOKES—50H-60-MA \$1.75. 30H-50MA \$1.50. 20H-30 MA \$1.25. Transformers—420v from 110 SAY YOU SAW IT IN QST—IT IDENTIFIES YOU AND HELPS QST

with 6v filament winding, center tap on filament and secondary windings, 70MA for UX213 tube \$3.75. Unmounted 280v from 110-60 MA no taps \$1.75. 190v from 110-6v filament, no taps for 201A "B" eliminator, \$1.75. Audio 3-1 or 5-1 ratio .90. Write for details and list of "B2" eliminator parts and "B" supply for transmitters. Radio Parts Sales Co., Box 24, Orange, N. J.

DEFOREST "H" tube. Never used. Fifteen bucks. 6CUW, Bisbee, Arizona.

RADIOMEN—Send for our radio catalog 25% discount to hams. Radio Specialty Shop, 525 Park Avenue, Kent, Ohio.

PRIVATE—FOR HAMS ONLY. Better QSL cards. Send for samples and see for yourself. 6APK.

FOR SALE CHEAP, two used 250 watt DeForest 2-Q-15 tubes. WCAJ.

PURE ALUMINUM and lead rectifier elements, holes drilled with brass screws and nuts per pair 1/16", 1 x 4, 13c, 1 x 6, 15c, 1 1/4 x 6, 17c, 1 1/2 x 6, 19c, single elements half price. Sheet aluminum 1/16", \$1.00, 1/8", \$1.90. Lead \$1.00 square foot all prepaid. GEO. SCHULZ, Calumet, Michigan.

LISTEN to 5EH. Sounds like an Omnigraph. It isn't. It's the Cricket Key. No bum fists. No "glass arms"!

ESCO 500 volt 100 watt motor-generator. 120 volt DC drive. Practically new, \$20. 9UH, Milwaukee.

HAVE UP-1016 power transformer 1500 v each side, mid-tap and two "S" tubes. Want MG. Let's QSO. Roger Hill, East Liverpool, Ohio.

SELL 480 volts Willard 3000 milliamp. plate supply \$100. Deliver free one hundred miles. Transmitter DeForest H tube, three meters National transmitting condensers, filament transformer. Make offer. Receiving parts. What do you need? Sacrifice everything. A. P. Southworth, Wakefield, Mass.

IVORY RADIO PANEL is a pure white grained Ivory, the most beautiful radio panel of today. Any size 3/16" thick, sent anywhere prepaid or C.O.D. Also dials and knobs. Write for FREE sample. Ivorylite Radio Panel Company, Dept. Q, 3222 Ave. F., Fort Worth, Texas.

750-WATT TRANSFORMERS 1500 each side. For DEFOREST "H-TUBES" \$15.00. 90-VOLT "B-BATTERY" ELIMINATOR \$18.00. CURTIS-GRIFFITH, FORT WORTH.

Tobe Deutschmann ideal transmitting condensers. — 1 — .5 — 1 — 2 mfd. 1000 and 2000 volts (tested). Just the right condensers for plate supply filters. New 8-watt tubes, max. pl. volts 800. All parts required for receiving sets and power amplifiers, including chokes, transformers, filter condensers, fixed and variable resistances, and sockets. Get your blueprints giving full construction details of the plate supply units, both for the Raytheon and Thermionic types. Write now for descriptive literature and special Ham prices. Everything sent prepaid. M.B.S. Sales Co., Dept. H.2, 27 School St., Boston, Mass.

SELL: Westinghouse Motor-generator, 1000 volts, 250 milliamperes. Motor: 110 volts, 60 cycles. GUARANTEED! Just from factory. BID. Also other parts. C. Fingar, Hudson, N. Y.

OMNIGRAPHS. TRANSMITTING TUBES BOUGHT. SOLD. RYAN RADIO COMPANY, HANNIBAL, MISSOURI.

FOR SALE—20 watt transmitter complete. Tubes, Rectifier, Filter, Transformers, Meters. All in one cabinet \$65.00. Edwin Carlson, Waterman, Illinois.

CERTAINLY! We have all the parts you need for that Raytheon eliminator. Also have few full wave eliminators using two 201A tubes. Bargain while they last \$9.95. WRAF, THE RADIO CLUB INC., LaPorte, Ind.

Have you received your copy of the new HAMALOG, the Original Ham Catalog, yet? If not, ask for it and we will be glad to send you a free copy. This catalog contains the most complete stock of Amateur transmitting and receiving equipment in the country, some good circuit diagrams and dope on transmitters, receivers, rectifiers, chokes, transformers, B-eliminators, information on getting started in this great game of Amateur transmitting, and on operating Radiotrons at short waves. You can't afford

to be without it. Belongs on your table with QST and Ballantine. A card or letter brings it at once, FREE. Ballantine's "Radio Telephony for Amateurs" \$2.00. Citizen's Call Books, Amateur Section, 75c. broadcast, 50c. Edgewise wound copper strip, 4" inside diameter, 10c per turn, 6", 12c. Beldenmetal antenna wire, No. 14, 65c per 100'; No. 12, \$1.00 per 100', postage prepaid to any point, up to 25% of value. UC-1014 Condensers, .002 mfd., \$2.50; UC-490, 1 mfd., 1750 volts, \$2.50. Grid leaks: Ward-Leonard, 5000 ohms, \$2.00; 4000 ohms, 95c; 2500 ohms, 80c. Radioleak, variable, \$5.00. These are just some examples. Also have National condensers, Acme chokes, transformers, and condensers, Thordarson transformers, Pyrex insulators, etc. Discounts to dealers, use your letterhead. E. F. JOHNSON COMPANY, 9ALD, WASECA, MINNESOTA.

TRANSMITTER, receiver, miscellaneous parts for sale. Amos Sorenson, 9CXP, Waseca, Minnesota.

AGENTS WANTED to sell a perfected "B" Battery Eliminator using Radio Corporation Rectron tube, and Trickle Charger using General Electric Tungar bulb at very low prices permitted by eliminating the jobber and dealer. Agents make \$20 to \$50 weekly in spare time. For further information communicate with Peerless Radio Corporation, Newton Lower Falls, Mass.

AMATEURS! DEALERS! Write today for details of UNITROLA EXCLUSIVE DEALER FRANCHISE for the sale of six tube, one control UNITROLA at \$80.00. RADIO ELECTRIC CO., West Winfield, N.Y.

DO YOU WANT TO MEMORIZE THE WIRELESS TELEGRAPH CODE? THE CORYDON SNYDER CODE METHOD IS EASIEST, QUICKEST, PATENTED. Send 25c coin for complete method to Corydon Snyder, 1423 Elm Dale Avenue, Chicago, Illinois.

\$2.00 each. Send and Receive, nine Terminal Cann Switches in case (British) Type SES 42. We have \$10,000 worth of United States Government Department Radio Transmitting Receiving Sets and Parts. Get our new and latest reduced price list. Send stamp for list. Mail orders answered all over the world. WELLS CURIOSITY SHOP, 20 South 2nd St., Philadelphia, Pa.

TRANSFORMERS—CHOKES—Built to your specifications. Write for estimate. O.K. Battery Service, Carthage, Illinois.

THORDARSON 650-VOLT POWER-FILAMENT TRANSFORMERS for 5-WATERS \$6.90. CURTIS-GRIFFITH, FORT WORTH.

Fifty Watt Broadcasting Station, with key equipment, three fifty watt tubes, thousand volt ESCO, etc. Used less than 200 hours. Specifications on request. Price \$250.00, WBBD, Reading, Pa.

BRASS ribbon for pancake Helices for 20-40-80 meters; $\frac{3}{8}$ " wide, .064" thick, 6c foot, 50 foot lots, 7c foot for less. Prepaid to 5th zone. Geo. Schulz, Calumet, Michigan.

GENERATORS—350w 500v O.K. \$12.50. 200w 500v Re-wind \$5.00. 0-10 radiation meter new \$7.50, $\frac{1}{2}$ KW cycle generator \$15.00. Amplifier and 2 tubes \$5.00. 6LC.

ENGRAVER-BRANCH TOOL COMPANY'S, TWO SETS OF MASTERS—COST \$150, SELL \$120. SILVER-MARSHALL SUPERHETERODYNE \$30. STANDARD RADIO LABORATORIES, 1083 AILEEN STREET, OAKLAND, CALIFORNIA.

THE LATEST. The Cricket Key. Pie for old hams. Beginners perfect list in one tenth time. Call or write 5EH.

NEW TYPE EDISON ELEMENT STORAGE "B" BATTERIES ENTIRELY ENCLOSED IN STEEL CASES. REMOVABLE LID. NO HUM OR OTHER NOISES TO HINDER RECEPTION. COMPLETE IN EVERY DETAIL. 100 VOLT TYPE "A" \$12.50. 140 VOLT \$17.00. 100 VOLT TYPE 5-G. 3000 MILLIAMPERE HEAVY DUTY \$19.50. WELDED TYPE "A" ELEMENTS 5c PER PAIR. WELDED 3-G. 6c. HEAVY DUTY TYPE 5-G WELDED ELEMENTS 9c. $\frac{3}{4}$ " x 6" TUBES, 3c. 1 x 6", 4c. NO. 20 PURE NICKEL WIRE, 1c PER FT. NO. 18, 1 $\frac{1}{2}$ c. SEPARATORS, 1/3c. SHEETS $\frac{3}{4}$ " x 5 $\frac{1}{2}$ ", 6c. SEND FOR FULL PRICE LIST AND OTHER INFORMATION. J. ZIED, 904 N. 5th ST., PHILA., PA.

For Sale—One complete broadcasting station former! KFLB Signal Electric. This set includes two 60 foot steel towers, complete antenna and counterpoise system, motor generator, four 5 watt tubes, three microphones, Thermo Coupled 0-10 Amp meter, three stage Magnavox amplifier The present wattage of this set is 25 watts but can be easily increased. Signal Electric Mfg. Co., Menominee Michigan.

New $\frac{1}{4}$ Horse 220 V. 60 cycle 3450 Speed motors \$5.50 110 V. \$9.50, $\frac{1}{2}$ H. P. 220 V. 3450 RPM \$17.50, $\frac{3}{4}$ H. P. 110 V. 3450 RPM \$18.50. Motor Generator Bargains Robins & Myers 110 V. Generator 350 V. 100 W. \$30.00 Esco 220 V. 60 cycle 3 phase 1750; Generator 400 V. 100 W. \$25.00. 110 V. A C 260 V. D.C. \$25.00. 220 V. Direct Current Generator 1500 V. 500 W. \$75.00. All above machines are ring oiled. Also many others, including several 3000 and 4000 V. machines. Write us for prices on anything in motors, generators and motor generators, stating kind of current, voltage, etc. Queen City Electric Co., 1734 Grand Av., Chicago, Ill.

ARE you building a B-Eliminator? Then you will want to use the new Tube "B" Block which assembles in one single compact unit, one 8; two 2; and two 1 mfd. Tube filter condensers. We carry all parts required for your B-Eliminator. Everything sent prepaid. Special prices for members of A.R.E.L. on many items. Write now for descriptive literature. M. B. S. Sales Co., Dept. H.2, 27 School Street, Boston, Mass.

OJOI QUE ESCRIBIMOS ESPANOL. THORDARSON POWER TRANSFORMERS 650 each side \$9.95. SPECIAL POWER-FILAMENT 250-WATT TRANSFORMERS 350-650 each side \$10.50. ALUMINUM square foot 85c; LEAD square foot 85c. JEWELL 0-15 AC VOLT METERS \$7.50, 0-600 MILLIAMMETERS \$7.50. 5-PLATE CONDENSERS 49c. "HAM-LIST" 4c. SERVICE—THAT'S US. CURTIS-GRIFFITH, 1109 Eighth Avenue, Fort Worth, Texas.

THREE Electrad rectifier jars. 1 jar takes place of 2 ordinary jars with $\frac{1}{2}$ " x $\frac{3}{4}$ " aluminum 99.7% pure, 75c each, plus postage on 2 lbs. 60c each dozen lots plus postage on 15 lbs. Geo. Schulz, Calumet, Michigan.

10 DAY free trial short wave receiver, made of the best parts. Write us for this offer and our other time payment offers. HUDSON RADIO COMPANY, 1416 WYTHE PLACE, NEW YORK CITY.

DON'T spend all your money on one item. We can supply you with the same thing at half the money. Write us for our time payment plan for amateurs. HUDSON RADIO COMPANY, 1416 WYTHE PLACE, NEW YORK CITY.

DO YOU NEED SOMETHING AND HAVEN'T GOT THE MONEY? WE SELL ALL TRANSMITTING PARTS ON TIME PAYMENT. A special offer is made to those who want to buy for cash. Write us before buying anything. Our list contains over 300 items. HUDSON RADIO COMPANY, 1416 WYTHE PLACE, NEW YORK CITY.

BEAT THIS! BRAND NEW, LATEST TYPE RCA UX 210 \$6.95; UV 203A \$32.50. PYREX $7\frac{1}{2}$ inch \$1.29. 12 $\frac{1}{2}$ inch \$2.95, 3 inch standoff \$2.39. 7 inch \$2.49. No. 12 enameled wire 100 ft. roll \$75. Pflon 8 inch porcelain glazed insulators \$4.5. Cardwell .0005 condensers \$1.25. .001 \$1.95. Double spaced 21 plate transmitting condenser withstand 3000 volt flashover \$3.95. Aero short-wave coils \$10.50. Bremer Tully shortwave outfit \$7.25. Allen Bradley radiostats large \$6.25, small \$3.85. Send for bargain list on Acme transformers and chokes, Thordarson transformers, Jewell meters, R.E.L. transmitting inductances, Hammarlund transmitting and receiving inductances, Bunnell cootie and heavy duty keys, Tobie Deutschmann filter condensers and many others. It pays to deal with AMATEUR RADIO SPECIALTY COMPANY, 77 Cortlandt St., N. Y. C.

THREE THOUSAND foreign calls, including complete British and Canadian lists. The International Amateur Call Book. Every ham needs one. Fifty cents to The International Call Book Co., Drawer 205, Station "A" Hartford, Connecticut, brings you one.

Jewell Meters, 25% discount, Acme transmitting and receiving apparatus, National transmitting and receiving condensers with type A and B velvet vernier dials Genuine Nathaniel Baldwin phones and speakers. Philco A and B batteries and battery eliminators. Tobie Deutschmann 2000 volt condensers. 12 and 14 enameled wire Magnet wire, Bakelite panels, rods and tubing, all sizes

Vietreen Super Heterodyne Kits are the last word in supers. Some RCA apparatus left. Bulb type chargers, special. Rectigon bulbs. Also Hydrometers, Keys, Buzzers, Omnigraphs, Celatsite Wire, insulators, amperites, German litz wire, Yaxley and Centralab products. Be sure to get the new National Type B velvet vernier dial. Ward Leonard and Lavite Transmitting Grid Leaks. Double your DX with the new Donie detector tube. Radio Engineering Laboratories short wave transmitting inductances, wave meters and receiving coils. Aero Products, Inc., short wave receiving coils. Cardwell Condensers. Allen-Bradley and General Radio products. Mueller and Telefunken transmitting tubes, sizes from 8 to 250 watt, F B for short waves, plate lead from top of tube. Western Electric, Kellogg and Federal Mikes. Highest quality 120 A. H. storage A batteries \$11.00. No catalogs issued. They are obsolete after 30 days. Tell us what you want and we will send manufacturer's latest descriptive and illustrative literature with list prices and discounts. We allow discounts to A. R. R. L. members and dealers only. Give your call letters. Write us when you need anything. We carry it in stock. Roy C. Stage, Wholesale Radio, Montgomery & Burt Sts., Syracuse, N. Y.

THERMO Galvanometers (5) model 425 Weston 1-115 M A cost \$18.50. As good as new for \$9.00 each while they last. F. B., 1220 Longacre Bldg., New York City.

WAVEMETERS, 10 to 100 meters, two coils, individually calibrated. Accuracy guaranteed within one percent. Excellent construction and handy size, with flash lamp, \$12.50 Postpaid. **SHORT WAVE COILS**, set of four celluloid supported space-wound plug-in coils with mounting for that new receiver, 18 to 250 meters, \$4.00. We build real amateur equipment and carry the supplies you need. Send for list. Seattle Radio Laboratory, 3335 33rd Ave., South, Seattle, Washington.

Q R A SECTION

50c straight, with copy in following form only: CALL—NAME—ADDRESS. Any other form takes regular HAM-AD rates.

1BV—L. G. Cumming, 83 Marlboro St., Boston, Massachusetts.

1CIO—Philip T. Brown, 15 Bramhall St., Portland, Maine.

1CKM—C. D. Moir, Box 121, Shrewsbury, Mass.

1FB—L. G. Cumming, Prout's Neck, Maine.

1GJ—H. D. Holt, 78 Glenville Ave., Allston, Mass.

1RD—J. Raymond Decker, 212 Winslow Road, Waban, Mass.

1ZA—C. E. Jeffrey, Jr., 725 Commonwealth Ave., Newton Center, Massachusetts.

2ATM—John B. Trevor, Jr., 11 East 91st St., New York City.

2ATX—E. Dillmeier, Jr., 8408 114th St., Richmond Hill, Long Island, N. Y.

2AVP—Ex 2AHI, Maurice Grayle Suffern, 607 West Beach Street, Long Beach, L. I., N. Y.

2AWN—E. Dillmeier, Jr., 125 S. Clinton Ave., Bayshore, Long Island, N. Y.

2AXS—Paul R. Leonard, 8 Worrall Ave., Poughkeepsie, N. Y.

2CHK—Harold Sachs, 161 West 75th Street, New York City.

2MK—E. F. Reynolds, Central Valley, Orange Co., New York.

2PX—F. V. Broady, 35 Wagner Ave., Schenectady, N. Y.

2QB—John M. Avery, 181 South 29th St., Flushing, N. Y.

2AIR—Fernand Causse, Box 81, Lester, Penna.

2AKD—Roger Causse, Box 81, Lester, Penna.

2CZ—Clarence L. Durham, Box 550 Hendersonville, N. C.

2GO—R. Painter, 736 Lillian Ave., S. W., Atlanta, Georgia.

2AQ—H. H. Green, 6119 Bryan Parkway, Dallas, Texas.

SAY YOU SAW IT IN QST—IT IDENTIFIES YOU AND HELPS QST

6ASS—Garland Swain, Rivera, California.

6ALU—J. A. Carnes, M.D., 311 Plum St., Massillon, Ohio.

6BEM—Rob-Roy Phillips, Box 231, Hornell, New York.

6CWT—Quentin D. Bellas, 402 Armstrong Ave., Apollo, Pennsylvania.

6DOY—H. C. Morrison, 333 Rohrer St., Greensburg, Pennsylvania.

6DSQ—C. A. Gillilan, Box 83, Carbondale, Ohio.

6ADZ—Henry M. Licht, 514 Powell St., Streator, Illinois.

6ARA—Robert Henry, Butler, Missouri.

6AVM—Leslie E. Jaecke, Junction City, Kansas, R. 1.

6BCQ—Ben Plunkett, Butler, Missouri.

6BGL—L. C. Campbell, Miller, So. Dakota.

6BUB—J. J. Pickhardt, 10th and Clay Sts., Jasper, Indiana.

6CDF—Heber King, Butler, Missouri.

6C0R—Howard Lowen, 210 So. Chautauqua, Wichita, Kansas.

6CRX—Harry A. Douglas (& Geo. Waddell), West Liberty, Illinois.

6CVY—Walter Henry, Jr., Butler, Missouri.

6CWZ—John McNav, Butler, Missouri.

6DCG—Roland B. Cooper, 326 Nicholas St., Vincennes, Indiana.

6EAI—Lyle F. White, 523 S. Washington Ave., Kankakee, Illinois.

6EBY—C. C. Rhodes, Butler, Missouri.

BZ6QA (ex 7AA)—A. A. Santos, Box 53, Maranhao, Brazil, S. A.

The following stations belong to members of the A.R.R.L. Headquarters gang. Mail for them should be addressed care A.R.R.L., Hartford, Conn.

1MK Headquarters	1ES A. A. Hebert
1AL H. P. Westman	1KP F. Cheyney Beekley
1BAO R. S. Kruse	1MO Dorothy E. Menk
1BDI F. E. Handy	1OA R. S. Kruse
1BHW K. B. Warner	1SZ C. C. Rodimon
1DQ John M. Clayton	1XAQ R. S. Kruse

A PIONEER RADIO SCHOOL With a Record of Successful Graduates

This school was started back in the days of the ten inch spark coil. Radio has advanced and so have we. Completely equipped with Spark-Arc-Vacuum Tube Transmitters, and Automatic Code Machines. Send for Booklet, "Opportunities in Radio."

Y. M. C. A. RADIO INSTITUTE
159 East 86th Street, New York, N. Y.

**HERCULES
AERIAL MAST**

We pay freight

20 Ft. \$10. 40 Ft. \$25. 60 Ft. \$45.

All Steel Construction
Complete with guy-wires etc.

Mail the Coupon

S.W. HULL CO. Dept. D 2048 East 79th St. Cleveland, Ohio
Please send free the full details about this "HERCULES" Aerial Mast.

NAME _____ STREET _____ CITY _____

\$\$\$\$\$\$\$\$\$\$\$\$\$\$\$\$

Prize contest

\$25
for five
words

First Prize:
Magnavox R3 or
M3 Loud Speaker;
value \$25.00.

Second Prize:
Set of 5 Magnavox
Tubes; value
\$12.50.

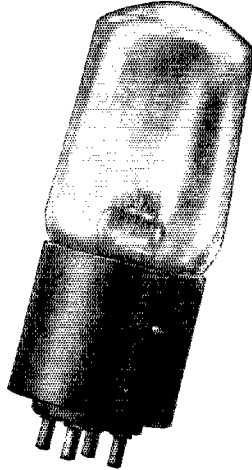

WE want a slogan to sum up the superiorities of the new Magnavox non-microphonic tubes. Perhaps you have used these tubes and have found some unusual feature. If so, put it in words and you may win a prize. If you don't know the Magnavox Tube, borrow one from a friend, read the following, ask the Magnavox dealer or write to us for full information.

The Magnavox Tube is ideal for short wave reception as its internal capacity is only 4.5 MMF. It oscillates freely on low wave lengths without unbasing. Its amplification constant is very high, with low impedance. It is equally dependable for detecting or amplifying. It is backed by 15 years of radio manufacturing experience.

Rules of Contest:

1. Slogan must be non-technical —easy for laymen to grasp.
2. Must not be more than three to five words.
3. Contest closes June 15th. Announcement of winners will be made in QST, August issue.
4. The Magnavox Company will be sole judges.

Start right now to win one of these prizes.
Address entries "Magnavox Contest."

THE MAGNAVOX COMPANY
OAKLAND, CALIFORNIA

24D10 In the Radio Business Since 1911 ©1926

\$\$\$\$\$\$\$\$\$\$\$\$\$\$\$\$

—FOR YOUR CONVENIENCE—

QST'S INDEX OF ADVERTISERS IN THIS ISSUE

Acme Apparatus Company	Page 76
Advance Electric Company	65
Aero Products, Inc.	85
Aerovox Wireless Corp.	74
All American Radio Corporation	82
Amateur Radio Specialty Company	65
American Radio Engineers	68, 88
American Sales Company	72
American Transformer Company	84
A.R.R.L. Application Blank	86
A.R.R.L. Recommendation Blank	
Bremer Tully Mfg. Company	66
Buckeye Telephone & Supply Co.	72
Burgess Battery Company	4th cover
Burton-Rozens Company	79
Cardwell, Allen D., Mfg. Co.	1
Carter Radio Company	70
Central Radio Laboratories	84
Corning Glass Works	74
Crescent Radio Supply Co.	68
Frostey Radio Corporation	66
Cunningham, E. T., Inc.	2nd cover
Deutschmann Co., Tope	68
Dongan Electric Mfg. Co.	76
Dubilier Condenser & Radio Corp.	96
Dudlo Mfg. Company	73
Eagle Radio Company	78
Eastern Radio Institute	76
East Side Y. M. C. A.	93
Electrical Engineers Equipment Co.	74
Electric Specialty Co.	79
French Battery Company	79
Frost, Inc., H. H.	78
General Instrument Corp.	69
General Radio Company	70
Grebe Company, A. H.	7
Gross & Co., J.	60
Hanscom Radio Devices	80
Hughes Electric Co., Benj..	65
Hull & Co., S. W.,	93
Jewell Electrical Instrument Co.	88
Karas Electric Company	79
Magnovox Company	94
Mario Electric Co.	96
National Carbon Company	95
National Company	72
Pacent Electric Company	2
QST Premium Offer	3rd cover
Radio Association of Western New York	76
Radio Electrical Works	88
Radio Engineering Laboratories	67
Radiohphone Sales Company	57
Radio Surplus Company	77
Sangamo Electric Company	68
Scientific Radio Service	82
S-C Merchandising Company	86
Signal Electric Mfg. Company	76
Silver Marshall, Inc.	80
Stromberg Carlson Telephone Mfg. Co.	81
Thordarson Electric Mfg. Co.	83
Toaz Engineering & Sales Co.	88
U. S. Naval Institute	85
Utility Radio Company	88
Vibroplex Company	78
Ward Leonard Electric Co.	82
Weston Electrical Instrument Corp.	87
Wireless Specialty Apparatus Co.	86
W-L Radio Laboratories	88

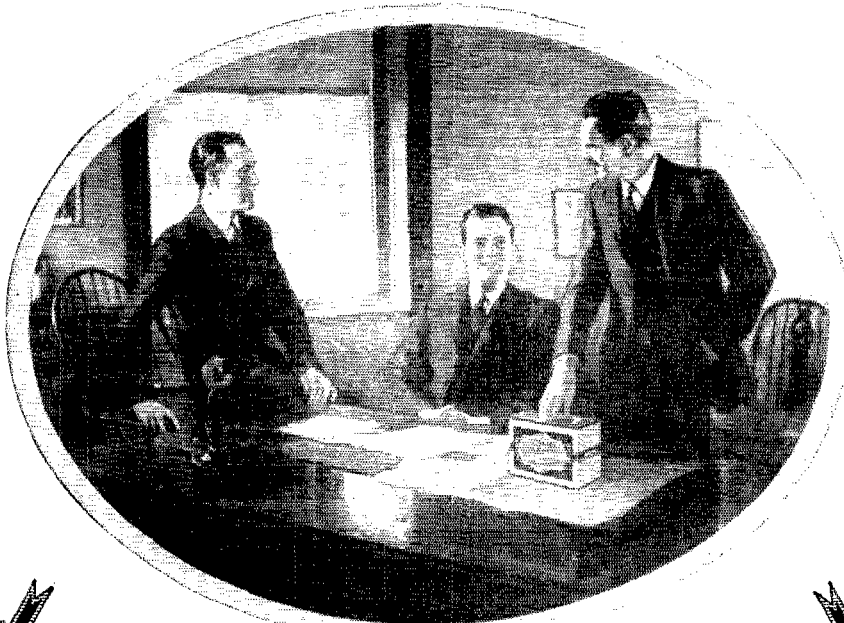

*“I’ve just had a lesson in
radio economy, and, believe me,
it’s illuminating”*

“I WENT into my radio dealer’s this noon for a couple of ‘B’ batteries and said, ‘Tom, give me a pair of Eveready 45-volt ‘B’ Batteries, No. 772’s.’

“‘How many tubes in your set, Jim?’ he asked.

“‘Five,’ I answered.

“‘Then what you want is a pair of Heavy Duty Evereadys—the Layerbilt No. 486’s.’

“‘Why?’ I asked.

“‘Because the Eveready 772’s are meant for one to three tubes. With average use of two hours a day, and used with a “C” battery*, they should last a year or longer. But on a five-tube set, with average use and with a “C” battery, they will only last about four months. Anyone with a four or five tube set should buy a pair of Eveready Layerbilts No. 486. Used two hours a day and with a “C” battery they should last eight months or longer.’

“‘Yes, but the 772’s cost only \$3.75 each,’ I said, ‘and the Layerbilt \$5.50.’

“‘Well, figure it out,’ said Tom. ‘Two sets of 772’s should last you about eight

months, and will cost you \$15.00. One set of Eveready Layerbilts should last about eight months, and will cost you only \$11.00.’”

The simple rules for this satisfaction and economy are:

On 1 to 3 tubes—Use Eveready No. 772.

On 4 or more tubes—Use the Heavy Duty “B” Batteries, either No. 770, or the even longer-lived Eveready Layerbilt No. 486.

On all but single tube sets—Use a “C” battery.

When following these rules, the No. 772, on 1 to 3 tube sets, will last for a year or more; and the Heavy Duties, on sets of 4 or more tubes, for eight months or longer.

* NOTE—A “C” battery greatly increases the life of your “B” batteries and gives a quality of reception unobtainable without it. Radio sets may easily be changed by any competent radio service man to permit the use of a “C” Battery.

Manufactured and guaranteed by
NATIONAL CARBON Co., Inc.
New York San Francisco
Canadian National Carbon Co.,
Limited, Toronto, Ontario



LAYER—No. 486,
for 4, 5 or more
tubes. \$5.50.



RIGHT—Ever-
eady Dry Cell
Radio “A” Bat-
ttery, 1½ volts.

EVEREADY

Radio Batteries

—they last longer

Tuesday night means Eveready Hour
—8 P. M., Eastern Standard Time,
through the following stations:

- | | |
|------------------|--------------------|
| WEAF—New York | WSAI—Cincinnati |
| WJAR—Providence | WTAM—Cleveland |
| WEEB—Boston | WWJ—Detroit |
| WTAQ—Worcester | WGN—Chicago |
| WPT—Philadelphia | WOO—Davenport |
| WOR—Buffalo | WCCO { Minneapolis |
| WOAB—Pittsburgh | WCCO { St. Paul |
| | 8SD—St. Louis |

in radio little micadons make a big difference/



MICADON 640
An improved design making possible a wider range of capacities.

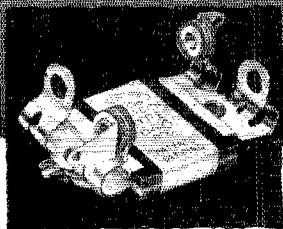

MICADON 640A
Compactly made for use in resistance coupled amplifiers.



MICADON 601
The standard fixed condenser of radio

THERE doesn't seem to be much to a Micadon when you look at it. The infinite care that is given to every detail in the manufacture of Dubilier Micadons is your assurance that they will always do their job.

Micadons are a small item in the cost of any radio set. But the difference between clear and poor reception, and the change from noise to natural tones may often depend upon their use.

Send 10c for our booklet which shows fourteen ways in which you can improve your set by simple application of fixed condensers.

4377 Bronx Blvd., New York

Dubilier

CONDENSER AND RADIO CORPORATION

Here's Your Wavemeter!

And it won't cost you a cent



THE LEAGUE needs 5000 new members and QST needs 5000 new subscribers. We believe that there are at least 500 loyal members



The Wavemeter:

An accurate instrument, well made and designed to be convenient and easy to handle.

It is equipped with a handle which makes it possible to hold it in one hand while you twist the dial with the other hand.

Coil mounted on G-R plugs so that additional coils may be used to cover various ranges.

Wavelength range, with coil supplied, is approximately 35 to 90 meters thus covering the 40-and 80-meter bands.

Each meter is individually hand-calibrated so only in this way can accuracy be assured. Chart furnished with each meter, from which you can easily draw your own curve.

Mounted in a genuine mahogany box, with a carrying handle.

Coil wound on the standard Baker type of G-R plug, with an accuracy of calibration within 1%.

The construction is standard, with a carrying handle.

Meta-plate mounted and made by the inventor, making it possible to use the same plate for all frequencies.

Attenuator mounted in a standard type of G-R plug, making it possible to use the same plate for all frequencies.

willing to put a little effort into doing a big service for their League—and at the same time they can profit by an extraordinary offer we are able to make for the next two months.

The C-W Laboratory has just started production on their new Type A Wavemeter. It was designed to sell for between ten and fifteen dollars. We have made an arrangement with them by which we are able to make an offer which seems too good to be true.

If you are a member of the American Radio Relay League, we will send you without cost a C-W Laboratory Type A Wavemeter in return for your helping the League by securing ten new member-subscribers.

How to get it:

In your own neighborhood, there are at least a dozen people who are getting interested in short-wave work.

Every one should be a subscriber to QST and a member of the League.

Show them QST and tell them what they can learn from it and how much the League is doing for short-wave work.

Show them that their two fifty cannot be better spent than for a subscription to QST.

Send in their names and retail prices as you find them and send your name along with each one, mentioning that you are working for the wavemeter.

With the tenth one you send in, tell us to ship the wavemeter.

Please be sure to give us your full name and address—not just your call.

After you've sold your first ten, go out and sell ten more. Then sell the other wavemeter to some rich fellow.

Remember that the subscription to QST (A. R. R. L.) does not count. Refunds don't count. Only new subscriptions count in this offer.

This offer expires Jan. 31, 1926.

All right, gang—send 'em in!

Address

QST, Circulation Department, 1711 Park St., Hartford, Conn.

ASK ANY RADIO ENGINEER

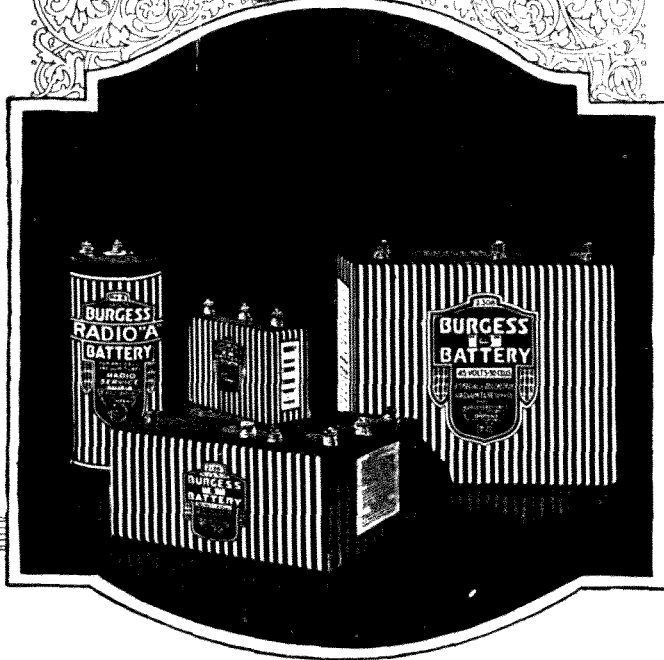

Contributors to your radio entertainment

UERY probably hidden away in the cabinet of your receiving set, the batteries you use are nevertheless surrendering their power unseen and unheard.

And to be able to contribute their energy and to add to the complete efficiency of your receiving equipment, those batteries must combine every desirable factor and formula known in the electro-chemical field.

Such Batteries are Burgess—products of the Burgess Laboratories—products which have been used by practically every famous explorer the majority of amateurs and the leading radio engineers.

That's why when you use Burgess Radio 'A,' 'B' and 'C' Batteries you are using batteries which assure the utmost dependability, longer life and complete satisfaction.

BURGESS BATTERY COMPANY

GENERAL SALES OFFICE: CHICAGO

Canadian Factories and Offices: Niagara Falls and Winnipeg

BURGESS RADIO BATTERIES

The Communications Department

F. E. Handy, Communications Manager
1711 Park St., Hartford, Conn.

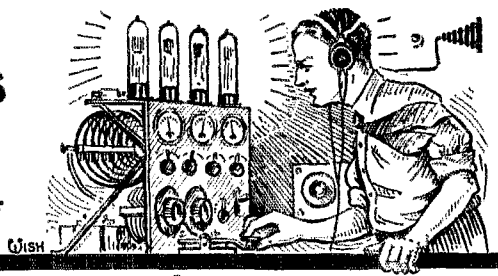

Notice!

ALL A.R.R.L. members of the Northwestern, Dakota, Hudson, and Maritime Divisions!

The Sectionalizing of territory in the Divisions named is indicated as follows:

Northwestern Division (five sections): Washington, Oregon, Montana, Idaho, and Alaska.

Dakota Division (four sections). North Dakota, South Dakota, Northern Minnesota (including all counties north of the Minnesota River and north and east of that part of the Mississippi River between the mouths of the Minnesota and St. Croix rivers), Southern Minnesota (including all counties south of the Minnesota River and south of that section of the Mississippi River between the mouths of the Minnesota and St. Croix rivers and in addition the county of Hennepin).

Hudson Division (three sections): Northern New Jersey (all of New Jersey within the Second Federal Inspection District), New York City and all of Long Island, Eastern New York (all of New York state within the Second Federal Inspection District excepting Long Island and New York City).

Maritime Division (four sections): Province of New Brunswick, Prince Edward Island, Nova Scotia, and the Dominion of New Foundland.

Nominating petitions are hereby solicited. Five or more A.R.R.L. members in good standing have the privilege of nominating any League members in their Section as candidate for Section Communications Manager. The election will take place in July and August on ballots which will be mailed from League Headquarters.

A form for nomination was shown on page 45 of April 1926 *QST*. Such petitions must be filed at A. R. R. L. Headquarters, Hartford, Conn. by noon of the 15th day of July, 1926. There is no limit to the number of petitions that may be filed but no member shall sign more than one such petition. April *QST* fully explains the change in organization will continue in force until the As previously announced, the present organizations will continue in force until the Section Communications Managers have been elected. Members are urged to take the initiative and file nominating petitions immediately.

—F. E. Handy, Communications Manager.

Further Notes on Checking Messages by Cable Count

CORRECT your May *QST* at the top of the second column, page 40, to read, "IMK counts as three words in the signature or text of a message."

The name of a state that has two parts is *always* counted as *one* in the address. It is usually counted as two in the text but may count as either one or two depending entirely on how it is written and transmitted. Example: If written, "NEW YORK" in the text, it is counted as two words. If written, "NEWYORK" it is counted as but one word.

It is customary at shore stations handling General Public Service Messages to omit the count of the name of a state in the check when it is included in parenthesis in the address. If New Jersey is transmitted with a parenthesis (K.K. ---) before and after it, it indicates that the word has not been counted in the check.

In code messages, no word containing more than ten characters is accepted.

When messages are written in plain language, code, and cipher, the passages in plain language and code are counted as code ten letter count) and the passages in cipher take the five letter count.

When messages are written in plain language and cipher, the passages in plain language take the fifteen letter count and the passages in cipher take the five letter count.

When messages are written in plain language and code, the entire message takes the ten letter count.

When the letters "ch" come together in the forming of a dictionary word, they are counted as one letter. In artificial words the combination is counted as two letters.

Don't forget that in checking messages using Cable Count, the words in address, text, and signature are counted.

C. O. S. of WFK-8LA + F. E. H.

The Atlantic Coast QSR Line By "MP" of 8DXH

IT will be of great interest to the traffic men of the A.R.R.L. to learn of the existence of a complete "sure fire" relay system covering the entire Atlantic Coast. It includes, at present, no less than twenty-nine traffic moving stations. Its completeness can be seen at a glance at the accompanying map.

This "sure fire" net has been, with some modifications, in actual nightly operation for a half year's time. Included in it are some of the biggest and fastest Official Relay Stations of the East. No message, when once started in the net, ever gets stale. Delivery is guaranteed for any city within the net.

Maine and foreign traffic is routed to IATJ who ties the Atlantic Coast Line and the Maine Message Pusher's Club* net together. Traffic for Canada is routed via 8EU and 8GI. Far West messages go via 8CNX. 8DXH clears all New York State traffic including a great deal of that to New York City. The "hub" of the system, 8BWT, clears all south bound messages via 4JR and 4MV.

The amount of traffic handled can be judged by noting the brass pounders included, some of whom are runners up for the Traffic Trophy—namely 8EU, 8DXH and IATJ.

There is room for real traffic stations and schedules are needed in several places yet. A number of the members of the Atlantic Coast Line traffic system are lining up nets of stations in their states to efficiently dispose of the North-South state traffic which is handled over the trunk route. More dope

* See "A New Idea"—page V, Communications Dept., May 1926 *QST*, Vol. X, No. 5.

is available from either 3BWT or 8DHX for anyone wishing to join the system.

It seems to the writer that a system for Trans-Continental Relaying and for work along the West Coast can be developed along similar lines and be

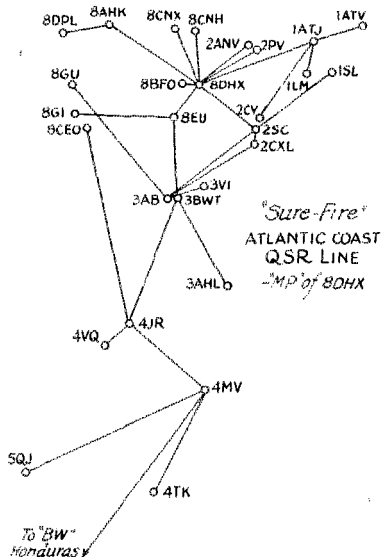

of great value to the A.R.R.L. Then "Chuck" of 8CNX wouldn't be jammed every night with a score of west coast messages. Hi!

What say, gang? Shall we have a Trans-Continental route to join to the present Atlantic Coast net? Stations and operators who can keep schedules, who want real traffic and plenty of it, who know how to handle a key efficiently are needed. If you are one such, join the chain without delay! QST will follow the progress of the work and give credit where it belongs. A.R.R.L. men everywhere are behind the idea.

Army-Amateur Notes

2ND CORPS AREA—Radio Nets have been organized for the New Jersey National Guard, 77th, 78th and 98th Divisions, Organized Reserves. These nets are functioning, but not complete. From time to time additional amateurs will be assigned. The work in this Area is progressing very satisfactorily. The only trouble encountered to date is the lack of coordination between each amateur and the officer of the unit to which he must report for traffic. The officers of various military units have not had opportunity to become familiar with the plan, or versed in Army traffic handling, but progress in these matters is being made. It is suggested that all Army amateurs be well versed in this plan and the possibilities for handling that traffic and offer suggestions or advice to their units when called upon.

The National Guard net for Delaware has not been organized, lacking amateurs in the proper localities. 6 amateurs are needed for Wilmington, 2 for Delaware City and 2 for Laurel.

The organization of the National Guard of New York State is held up pending information from that organization. The following amateurs have been appointed and certificates mailed: 3jw 2evf 8agd 2aoc 2ks 8an 2wr 8vx 2oqz 3btg 2ne 2erp 2zb 2dx 2adt 2ll 2ka 2aho 2ava 3zi 2at 3xan 8aut 8bpm 8kw 8dsi 2er 2aob 2kr 2als 8ql 2awf 8hr 2pu 2auu.

3RD CORPS AREA—Tests were conducted throughout April with the amateurs of the Third Corps Area taking part in the Army-Amateur plan. Signal Corps Station 8sn at Fort Howard, Md., is the station designated for the purpose.

Each amateur has been assigned a time and wavelength on which to call 8sn. Tests have been arranged in mornings, afternoons, and late at nights. 8sn transmits on 8945 Kc's at all times so that stations worked have no difficulty due to a shifting wavelength. The amateurs are all enthusiastic and cooperate to the fullest extent possible.

At the conclusion of the tests, the stations needed

will be designated, and certificates will be issued by the Signal Officer, 3rd Corps Area. When the Net begins functioning, only those amateurs who have demonstrated their ability to Signal Corps officials will be found operating stations therein. These tests are open to other amateurs within Pennsylvania, Maryland, Virginia and the District of Columbia, who may wish to affiliate with the Signal Corps. Upon application, the Signal Officer, Hq, Third Corps Area, Baltimore, Md., will be glad to arrange tests.

5TH CORPS AREA—The Net has been on a regular schedule for two months, working every Saturday at 2:00 pm, Eastern Standard Time, on 40 meters. Traffic has been handled in a prompt and satisfactory manner. The 83rd, 84th and 100th Divisions, Organized Reserves, are rapidly filling up their Divisional Nets. Certificates have been mailed to the following stations: 8amd 8egh 8av 8gz 8byi 9cac 9dhj 9abp 9ebw 9aqf 9dpl 9evr 9eji 9adk.

6TH CORPS AREA—Considerable progress has been made this month. The Corps net is nearly completed. The Organized Reserve net is being built up as fast as reliable stations are made available. More amateur stations are needed in Michigan at Marquette, Sault Ste. Marie, Escanaba, Muskegon, Grand Rapids, Lansing, Jackson and Flint; in Wisconsin at Stanley, Wausau, Oconto, Madison, Sparta and Janesville; in Illinois at Rockford, Sterling, LaSalle, Pontiac, East St. Louis, Ottawa, Aurora, Joliet, Peoria, Springfield, Bloomington, Urbana, Taylorville and Centralia. Interested stations able to handle traffic in the Army Amateur Net in the above towns should write Signal Officer, Sixth Corps Area, 1819 West Pershing Road, Chicago, Illinois, for particulars. Those chosen will receive a certificate authorizing them to handle army traffic. Messages are now being handled over that much of the Net already organized and those doing the work find it interesting and instructive.

7TH CORPS AREA—The Governor's net in Minnesota having been completed, a test was conducted by the Signal Officer, on April 10. A message originating at Omaha addressed to the Commanding Officers of National Guard organizations at Dawson (9efd), Luverne (9bnf); Kenneth (9egc); Crookston (9dkr); New Ulm (9bkk); St. Cloud (9cof); Rochester (9cos); Redwood Falls (9sf); Ortonville (9dvw); Mankato (9btz); Stillwater (9elc) was filed with Mr. Diehl, Assistant to the Manager, Midwest Division, A.R.R.L. at the Corps Headquarters control station, Omaha, Nebraska, Saturday, April 10, 10:35 AM. This test message was sent by Mr. Diehl to the Governor's control station 9bay, St. Paul, and promptly relayed by Mr. McCord to destination on Sunday, April 11 at 3:00 PM. While replies from addressees were not received with expected promptness, the test was highly satisfactory insofar as the net itself is concerned. The test demonstrated that the Minnesota net is thoroughly organized, and that traffic can be handled with speed and accuracy.

8TH CORPS AREA—The Governor's net in Texas is shown by the diagram. It operates on 40 meters between 6:30 and 7:30 pm, daily except Sunday. Sixty-four operators have been issued certificates of appointment and assigned various National Guard Units in 29 cities and towns. Test messages have been exchanged between net control station 5ain (Fort Sam Houston) and practically all stations in the net. The enthusiasm is all that could be asked.

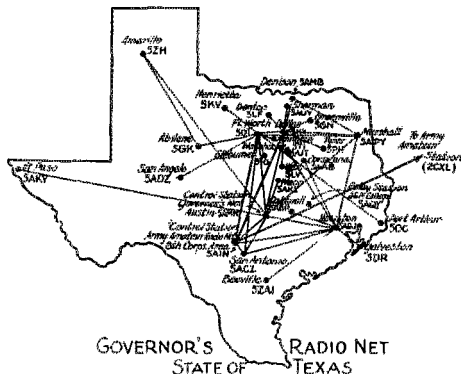

When three broadcasts were sent recently, over 80% of the appointed stations reported.

A similar net in Oklahoma is now in the process of organization. It is expected to become operative

May 1st after which nets in Colorado, Arizona and New Mexico will be organized.

WTH CORPS AREA—A number of assignments of amateur stations were made by the A.R.R.L. representative during the month. Certificates will be issued during April. Considerable difficulty is being experienced in securing stations at some points where important National Guard units are located. As an example, it has been found that there are no licensed amateur stations at Cheyenne, Wyoming, and the whole state of Wyoming is practically without a station.

Army-Amateur Notes follow the progress of this important amateur work from month to month. The general plan was given on page 22 of October 1925 QST. Appointment certificates are being issued to the amateurs selected just as fast as the applications and information from Army units can be put together. Stations that offer their services must first be designated to serve specific National Guard or Organized Reserve units.

Some interesting things have been planned for the work of the coming season. You will want to get a chance to take part in it. Better send in your application today, OM. Get lined up while the opportunity still holds good and there are some blank positions to be filled.

A.R.R.L. Representatives in the Army-Amateur Communication system have been appointed for each Corps Area. Applications from amateurs residing in the different Corps Areas are referred to the proper Representative. If you do not know in what Corps Area you are located, write A.R.R.L. Headquarters and we will see that your letter is forwarded correctly. If you do know in which of the nine Corps Areas you are located, you can send your application to your Corps Area representative:

Corps Area	Call	Name	Address
First	1ZWP	P. K. Baldwin	899 Boylston St., Boston, Mass.
Second	2PF	David Talley	2222 Avenue O., Brooklyn, N. Y.
Third	3WF	Chas. A. Miller	405 N. Curley St., E. Baltimore, Md.
Fourth	4IO	J. Morris	58 Frederica St., Atlanta, Ga.
Fifth	8BY	H. C. Storck	698 Carpenter St., Columbus, Ohio
Sixth	9AAW	W. E. Schweitzer	4264 Hazel Ave., Chicago, Ill.
(Acting)	9AFF	W. W. Bingham	2424 West Munroe St. Chicago, Ill.)
Seventh	9DXY	P. H. Quinby	Box 184A, Rt. 6, Omaha, Nebr.
Eighth	5ZAE	L. D. Wall	316 Callaghan Ave., San Antonio, Tex.
Ninth	cZD	A. H. Babcock	65 Market St., San Francisco, Calif.

OFFICIAL BROADCASTING STATIONS

Changes and Additions

Call	Local Standard Time			Days of Trans- mission	Days of week
	7.00 pm	10.30 pm	12.30 pm		
6A1H	40-30	—	—	Tues.	Thurs. Sat
6ANO	40	40	—	Mon.	Wed. Fri.
6BUC	—	40.25	—	Fri.	—
6NX****	—	—	—	Mon. Wed.	Fri.
8BSU*****	39	—	—	Mon. Fri.	—
9DZR	30	—	—	Fri. Sat.	—
WJBA	—	206.8	—	Mon.	(voice)
c1BZ**	—	—	—	Sat.	—
c1DD	52.5	—	—	Sat.	—
c1EI	52.5	—	—	Sat.	—
c8AR***	—	—	—	Sat.	—

* 7.30 pm 52.5 meters.

** 52.5 meters 12 pm.

*** 46 meters, 6:30 pm.

**** 6 pm, 39 meters.

***** 9 pm, 39 meters, same days.

Traffic Briefs

THE Chicago Daily News—C.R.T.A. message service is rounding out nicely. The traffic committee hold weekly meetings. A lot of work is being done on message organization. The problem of better relaying is also receiving proper attention. The arranging of schedules and strict use of A.R.R.L.

standard practice helps in this. The traffic committee has undertaken to give a special message service to six hotels and hospitals in the Chicago district. Thanks is due to the Chicago Daily News for preparing two kinds of message blanks for collecting and delivering the radio messages.

The membership of the Maine Message Pushers Club is now as follows: 1KL, 1ATV, 1AUF, 1AQL, 1UU, 1BFZ, 1BTQ, 1AWQ, 1AYJ, 1ADI, 1AAV, 1SO, 1CSY, 1BNL, 1CIB, 1BUB, 1AII and 1BIG. 8AHK is going ahead with the organization of a message-pushing network in Western New York. 1KY intends to form a club of traffic handlers in Eastern Massachusetts. Look at the Maine fellows who rated the Brass Pounders' League this month? Then start something with your local gang.

5WK has the right idea. His QSL card tells the usual things about transmitter and receiver and in addition it is a get-acquainted card. It tells a lot about himself. 1ATV uses some stationery printed along similar lines. If your cards don't seem to bring replies it may be that they lack a personal friendly touch. When you make up some new ones for the printer bear 5WK's suggestion in mind.

Mr. Leon C. Grove writes from Nenana, Alaska, that he keeps a daily schedule with 6HJ. He requests that all traffic for interior Alaska be routed through 6HJ. 7GZ and 7SM have been in regular touch with the Wilkins Arctic Expedition ever since the start from Nenana. 7GZ assisted materially in maintaining contact with KPZH. 7SM (Mr. Grove) handled a bunch of messages during April.

c3CK has a bunch of schedules with Canadian stations on 52.51 meters. He reports that during a big storm the last of March, several Canadian stations were kept busy handling the emergency traffic that resulted as the result of the storm. Official messages were handled for the Marconi Company and also for the Ontario Hydroelectric Company, c8EC sent a lot of press to Ottawa and Port Arthur and was in constant touch with Toronto. Besides this there were many messages for private individuals transmitted. Everyone made good use of our A.R.R.L. service.

KFUH and 6HV bat them out in fine style. 200 word messages are not uncommon. All the San Jose boys can hold up their end with the key. Listen to 'em!

5AKT suggests using mimeographed government postal cards for temporary or portable stations. He says this procedure cuts down excessive printing rates on small lots.

6SV, the Santa Clara County Radio Association, has just concluded a five day test at Mt. Hamilton, Lick Observatory. The results were wonderful. One of the features of the tests was just an ordinary thing to the amateurs concerned but made a great impression on the Director of the Lick Observatory. A 75-word technical message directed to "Observatorio Astronomico, Santiago, Chile," was given to ch2LD and promptly delivered. We guess the observatories all over the world could make good use of amateur radio, if they got in touch with their local "hams."

NKF still has a transmitter right on 8010 Kc's—(slightly below 37.5 meters)—marking the lower edge of the amateur 40-meter band. 8DAJ operates squarely on the upper edge of the same band. FW on 7139 Kc's is also near the upper edge of the band. Any of these stations can be logged on the receiver and used in checking the wavemeter. There is no excuse for operating off-wave and amateurs who find their licenses suspended or revoked by the Department of Commerce have only themselves to blame.

9ZA casually mentions working KFUH and z1AO. Yes, it was two-way break-in, at 30 words per minute! That's real sport!

SZG, 8PL, 9ZA, 3ZO and 3AUV have worked five-way break-in many times. All are right on zero-beat talking in order. There are no unnecessary calls, no signs necessary during the conversation, and perfect contact. 9ZA gets on about 5:30, says, "dah-h-h, ge 9za." 8GX comes back with, "ge FJ hr Windy" and they're off! What think of

that, you chaps who say its necessary to call thirty times to raise 'em?

After trying to handle messages with some "punk" who repeated each word four times after calling you fifty times and giving you r9, it is a pleasure to work or even listen to a snappy, efficient operator.

IAAV writes in to point out the value of brevity to the traffic-handler. He is one of the MMPC operators who believes in cutting down on unnecessary transmission. "R K" or "87 R" is all that is necessary to acknowledge a message when there is no QRM. Sending speed is of secondary consideration to good operating form and accuracy. A sizeable amount of traffic can be handled in a very short time if the man at the sending end is brief and the receiving "op" has his wits about him.

Try to make your operating snappy and brief, OMs. Don't get a "bug" thinking that will solve the problem wholly. Study the way it is done, practice with a buzzer or audio oscillator a bit, and then try the standard abbreviated procedures on the air.

In the Fifth Corps Area the Army-Amateur Stations are using AA in a similar way to that in which PRR has been used for railroad emergency work. If you hear a "CQ AA" it is simply the general call for Army-Amateur work.

ZADH always listens for at least 5 minutes following a general CQ. Every other good station should follow the same policy (we were surprised on logging a number that didn't). There is no excuse for calling a foreign station just because one happens to be heard while listening for answers to a CQ. A suitable time for stations to call you should be occupied with an earnest hunt for signals all over the dial. Let's try to cultivate the same courtesy shown by our foreign amateur friends. We shall be richly repaid.

Club Activities

CONNECTICUT—The Grid and Plate Association of Stamford, held their first annual banquet and get-together April 17. The ADM and many amateurs from neighboring cities attended. The affair was most successful and the enthusiasm shown bespeaks a bright future for the club. 1BM, 1IV, 1BGC, 1CTI, 1BWM, 1ABN, 1BGQ, 1BEZ, 1AXN, 1AJJO, 1CJJ, and 1VY were among those present. 1BEZ was toast-master. ADM Nichols was the principal speaker.

ILLINOIS—The LaGrange Radio Club had a ham-fest Sunday, April 11. The guests were 9DD5, 9BNQ, 9ELR, 9ELF, 9BZH, 9KC, 9GE, 9QD and 9APY. 8BEH from Holland, Michigan was present. 9CYS, 9CWL, 9DLB and 9AVZ were among the stations visited.

The Chicago Radio Traffic Association was favored with a talk on club organization by Mr. Pease, 9KC, at the last meeting.

A general meeting of amateurs of Chicago and its outlying districts was held at 9BWM, Joliet, Illinois on May 9. The formation of a state traffic-handling net was discussed and we hope to include a further report on the action taken in these columns.

MANITOBA—At the April 13 meeting of the Winnipeg Radio Traffic Association plans for the second annual Prairie Division Convention were made. 4DE spoke on the construction of power transformers. The usual buzzer practice ended the meeting. On April 27th, there was one of the biggest gatherings of Winnipeg amateurs held. A good time was had by every amateur attending the WRTA banquet. All live hams are urged to get in touch with Secretary Paterson, c4DY, and to attend the meetings.

MASSACHUSETTS—The first meeting of the Radio Club of Melrose was held May 4. The 10 watt station of the Melrose National Guard will be used by club members. Lieut. Talbot and Lieut. Brown of the National Guard gave fine talks at this meeting. Meetings are held in City Hall the first Monday in each month. Mr. Cutting, 1APK, is President, Mr. Graham, 1ARS, is Secretary-Treasurer and Mr. G. Shaw 1IN, is Vice-President. 1FF was temporary chairman. All amateurs and professional radio men of the vicinity are invited to join. The dues are low and the initiation FB.

NEBRASKA—The local club at Omaha are taking steps to boost traffic work in the state. Division Manager Quinby is chairman of the traffic committee. The amount of traffic originated locally is being increased by placing numerous message blanks and

mail-boxes with explanatory placards in conspicuous places about town at the disposal of the public.

NEW JERSEY—The Amateur Radio Association of Essex County have over 30 licensed "ops" as members. The club has four message boxes in various hotels in Newark and have two alternate collectors every other night so each operator gets his share of traffic. 2KA, 2ZB, and 2KS are Army-Amateur stations. All the operators follow ARRL standard practice in respect to Communications Department matters. The youngest operator in this live club is 14 years old, the oldest 57.

The Eclipse Radio Club organized about one year ago, has progressed well. The Club Headquarters were obtained through 8SU (now 2QD). A "shack" was purchased ten miles from its present site and brought to Orange where the rebuilding and refinishing was carried out by club members. A few months ago, the first anniversary dinner was held and Treasurer A. A. Hebert of ARRL Headquarters gave a very enlightening talk that was enjoyed by all.

OHIO—The Ashtabula Radio Club are busy with the usual activities. They are trying to locate some illegal transmitters in the city and bring them to Justice.

The Cleveland Amateur Radio Association had an interesting talk by Mr. Hebert of A.R.R.L. Headquarters who stopped off on his way to the Kalamazoo Convention.

8DDQ, the station of the Norwalk Amateur Radio Association, continues to operate with a slight falling off in message handling due to the warmer weather.

The Findlay Radio Club have started the erection of a Club House where the club station will be located next winter (8FT).

The Mahoning Valley Amateur Radio Club of McKinley Heights has just completed a new club station. A 80 watt MO-PA set with 1000 volt B-battery supply will be used. The station is half way between the two cities on the Youngstown-Warren Road.

PENNSYLVANIA—The regular monthly meeting of the Lehigh Valley ORS Club was held in the shack of 8CTZ, Palmerton, Pa. April 12. There was nearly 100% attendance from Dist. No. 2, Pennsylvania. Routine business was handled and better operating practice was discussed.

The Amateur Transmitters' Association of Western Pennsylvania had a fine turnout at their hamfest March 12. We are reproducing the excellent prospectus that the Association distributed before the meeting was held. It is a good example for any club and the folks who got it up are to be congratulated. There were talks by A.D.M. Wiggan, MacAulay, Young, and Buzzard. Then Coleman spent the rest of the evening with a talk on Hertz antennae and quartz crystals. With the good feed and raw-chew, the meeting was a tremendous success from every standpoint.

Radio Bugs!

The 40-watt wedding QRM cutting, key clickers, low funds that sit up into the wee small hours of the morning, calling Amateur and that popular guy CQ. You have with the sweet sweet-tweeters and the rough detritus, there's a message that you'll like and take a bit. Turn the page—read on.



Alert that it only shows will be easy. No real hamster is capable without one, and the one will be real. Owing and after the coming week of there will be plenty of opportunity to discuss your own problems with each other and we will come glad attention to help you to solve them.



When you can't talk any more you'll have no home. Now you'll be a good operator.

The Amateur Transmitters' Association of Western Pennsylvania is having a hamfest on Saturday evening March 12 in the Franklin Park Building, 10th Street and Wood St. Pittsburgh second floor and we extend to you our warmest invitation to attend.



John Coleman, an old time ham, 8BFT, is in the spot of the report and will be making progress with the Westinghouse Company. The ham fest will be held at the Lehigh Valley Amateur Radio Club and Central Control. The Lehigh Valley Amateur Radio Club will be in the spot to meet with each other and we will be glad to answer all questions.



Enough interest! The meeting of March 12 is the first of our annual club hamfest. It has been made an open meeting to show you fellows what we've got and what we are doing. Meetings will be held every month and the Association will be the work in bringing the amateurs together and in this day of rapid change in a necessary



There will be no hamfest made at the meeting to persuade you to join the Association. The Club will look us over if the attraction

Having such excellent food that before realization is second he will get you to know about any questions that you be posing.



In addition to the excellent feature 9B, 9BZ, 9BZC, and the New Amateurs group will provide entertainment in a light-hearted way. You will remember that 8BFT, has the honor of this delightful hamfest. The 8BFT, that was present at a hamfest in New York City, a few years ago. Whatever your club will be good.



We have to offer ourselves you that you need no help, it will be essential to do so at the meeting. But we will not say any great word.



Come yourself and see the good thing to all our friends. It is a pleasure to have you here in P.C.A. The only request is no interest in favor.

THE AMATEUR TRANSMITTERS' ASSOCIATION of Western Pennsylvania

A number of Vigilance Committees are clearing up interference cases in the Pittsburgh area. The Pittsburgh Chronical-Telegraph and A. D. M. Wiggins are responsible for the good work that is being done.

VIRGINIA—The Richmond Short Wave Club was organized formally April 24. The early work will be on 40 meters 3BMN, 3CEL, 3NG, 3AJR, 3AEV, 3AIK, WBBL and a dozen other "ops" were present. Mr. Gordon Hammond was elected President and Mr. R. N. Eubank, Sec'y-Treas. The club meets twice each month at the Y. M. C. A. and interesting meetings are planned for the coming season.

WISCONSIN—The Milwaukee Radio Amateurs' Club have a new stunt that is useful in boosting attendance. Every member who arrives on time is given a chance at a raffle. The prizes are receiving tubes donated by the operating staff of 9DTK. The Club has taken a firm stand against untruthful radio advertising and reports have it that results are shown already in Milwaukee. Professor Wood of the U. of W. Extension Division gave an interesting talk. Mr. Burton F. Miller, chief operator of 9XM-9DW at the University also spoke on crystal control and short wave radiophones.

TRAFFIC SUMMARY BY STATES

DURING March-April, there was a slight increase in the total amount of traffic handled, probably due to the increasing number of traffic networks in different parts of the country. Delivery figures remain about the same as before.

The percentage of all the Official Relay Stations under each officer and the percent of TOTAL messages handled by each section are included in the summary of this month's work. By comparing each column showing these percentage figures the standing of each section is shown on a message-handling and reporting basis. If the percentage shown opposite your name under "%ORS" is greater than shown under "% MSGS" it means that some of the following things need to be done: (1) Dead O. R. S. need to be cancelled. More live stations need to be appointed. (2) Message lanes need to be formed covering your territory. More schedules may help. Perhaps the fellows need to be urged to originate more messages. (3) Maybe the messages are being handled all right after all but the reports are not coming in as they should—which means that some letters need to be written.

The different Assistant Division Managers are listed below. Are you doing your part to keep your State and Division a leader? How will you stand next month?

If every station owner who reads these words will see that every message he handles is delivered or passed along promptly and report his good work, we will be able to show 100% delivery in the National scheme of things in a short time!

The problem of message RELAYING and DELIVERY must get some serious attention if our general service is to be one of which we are proud. The reports show that messages going over regularly scheduled routes get through with the desired speed and 100% accuracy. The figures show that there is plenty of traffic to be handled. More individual responsibility regarding prompt relaying and delivery will bring the results we want.

Messages received should always be delivered immediately (a) by telephone, (b) in person, or (c) by mail if no other means of effecting delivery are available.

Never accept messages which cannot be handled or delivered without informing the chap filing the message of the circumstances.

Keep the hook clear by handling traffic on schedule daily.

ATLANTIC DIVISION					
State or Division	ADM	% ORS	Orig	Rel. D	Total
D. of C.	A. B. Goodall	.46	123	59	201 306
Md.	G. L. Detschmann	.871	.71	10	24 71 104
So. N. J.	H. W. Densham	1.39	—	—	— — —
W. N. Y.	C. S. Taylor	3.65	4.32	207	144 653 1072
East. Pa.	J. P. Rau	3.5	4.23	114	85 461 1074
West. Pa.	P. E. Wiggins	3.9	3.76	127	160 651 937
Del.	H. H. Layton	.174	—	—	— — —
					13.8 9.05 617 459 2037 3493
CENTRAL DIVISION					
Mich.	P. D. Pallain	3.00	5.27	35	37 51 131
Ohio	W. E. Schweltzer	5.74	4.82	137	90 441 731
Ill.	W. E. Schweltzer	4.87	7.36	500	342 996 1824
Wis.	C. N. Crapo	2.66	5.76	429	288 714 1431
Ind.	D. J. Angus	2.54	3.20	77	52 366 818
Ky.	J. C. Anderson	.93	—	—	— — —
					19.8 21.66 1168 799 2568 4935

DAKOTA DIVISION						
Minn.	C. L. Barker	4.5	5.20	306	229	756 1293
So. Dak.	M. J. Junkins	1.45	1.24	36	24	272 332
No. Dak.	G. R. Moir	.093	.20	13	7	33 59
					6.9 6.64 354 260 1063 1677	
DELTA DIVISION						
Miss.	J. W. Gullett	.297	.137	18	—	16 34
Ark.	L. M. Hunter	.25	.137	3	—	26 34
Tenn.	L. K. Rush	.058	1.72	19	4	19 43
La.	C. A. Freitag	.347	1.39	2	6	29 37
					1.24 .58 47 10 91 148	
HUDSON DIVISION						
N. N. J.	A. G. Weston, Jr.	2.3	1.90	166	104	211 471
N. Y. G.	F. H. Marston	2.5	3.1	373	194	347 1003
E. N. Y.	H. N. Ammenheuser	2.4	6.1	321	124	836 1281
					7.7 11.1 860 422 1394 2760	
MIDWEST DIVISION						
Iowa	D. E. Watske	1.74	1.806	64	34	88 200
Kans.	C. M. Lewis	1.16	.685	38	32	90 170
Mo.	L. B. Leizure	2.02	2.46	63	34	746 845
Nebr.	H. A. Neilson	1.16	2.68	114	67	258 455
					6.1 6.63 289 167 1192 1670	
NEW ENGLAND DIVISION						
Maine	S. B. Coleman	1.56	4.97	362	227	700 1238
N. H.	C. P. Sawyer	.87	—	—	—	— — —
Vt.	C. T. Kerr	.69	7.0	61	25	84 176
E. Mass.	Miss Hannah	2.04	2.98	205	155	480 740
W. Mass	C. J. Green	2.03	1.29	81	39	191 320
Conn.	H. E. Nichols	1.22	.98	72	26	142 240
R. I.	D. B. Fancher	1.16	.56	18	12	113 141
					9.64 17.86 797 484 1710 2855	
NORTHWESTERN DIVISION						
Mont.	A. E. Wilson	.58	2.69	—	—	— 67
Wash.	Otto Johnson	1.74	2.06	—	—	— 506
Ore.	A. C. Dixon	1.1	.372	—	—	— 92
Idaho	K. S. Norquest	.46	.407	—	—	— 101
Alaska	Leo H. Machin	.12	—	—	—	— — —
					4.00 3.10 — — — 768	
PACIFIC DIVISION						
No. Sect.	P. W. Dann	2.72	2.31	66	58	188 326
So. Sect.	L. E. Smith	3.87	3.30	605	404	1301 2310
Hawaiian	K. A. Cantin	.58	2.18	446	70	27 543
					12.17 12.79 1117 532 1516 3179	
ROANOKE DIVISION						
West Va.	C. S. Hoffman	1.9	2.13	171	152	207 530
Va.	J. F. Wohlford	1.6	1.13	32	53	208 231
No. Car.	R. S. Morris	1.02	1.08	53	52	154 269
					4.5 4.34 266 257 569 1030	
ROCKY MOUNTAIN DIVISION						
Colo.	C. R. Schwann	1.45	2.20	199	62	297 549
Utah	Art Johnson	.63	.94	28	10	197 235
Wyo.	N. R. Hood	.18	—	—	—	— — —
					2.26 3.14 227 72 494 734	
SOUTHEASTERN DIVISION						
So. Car.	A. Dupre	.23	—	—	—	— — —
Ala.	H. S. Brownell	1.85	.920	19	23	177 229
Fla.	B. J. Grosnan	1.45	1.10	77	82	111 275
Ga.	J. J. Morris	.81	—	—	—	— — —
Porto Rico	Luis Rexact	.058	.23	—	—	— 58
					4.4 2.25 86 105 288 562	
WEST GULF DIVISION						
Okla.	K. M. Ehret	1.16	.563	28	23	88 140
So. Tex.	E. A. Sahn	.87	.145	6	5	25 36
No. Tex.	W. B. Forrest, Jr.	.87	—	—	—	— — —
					2.90 .708 34 28 113 176	
PRAIRIE DIVISION						
Man.	F. E. Rutland	.42	.408	40	29	33 102
Sask.	F. L. Maynard	.56	.208	14	21	18 58
					.98 .61 54 50 51 165	
ONTARIO DIVISION						
No. Ont.	Wm. Sulton	—	.254	—	—	— 58
East Ont.	E. A. Harrison	—	.634	—	—	— 157
So. Ont.	J. A. Vavre	—	.174	—	—	— 43
Cent. Ont.	A. R. Williams	—	1.12	—	—	— 278
					2.3 2.16 — — — 536	
VAN-ALTA DIVISION						
Mgr.	A. H. Asmussen	.93	.328	25	15	44 84
MARITIME DIVISION						
Mgr.	W. C. Borrett	.70	.320	26	8	24 58
QUEBEC DIVISION						
Mgr.	J. V. Argie	.46	—	—	—	— — —
TOTAL FOR COUNTRY						
Originated	5977	Delivered	3501	Relayed	1162	Total 24920

BRASS POUNDERS' LEAGUE

Call	Orig.	Del.	Rel.	Total
8EU	21	30	462	513
8DHX	75	34	260	369
6BJX	102	107	146	355
pi-CW	121	43	162	326
8GI	15	63	238	316
6BUC	273	16	3	292
8AYP	120	111	52	283
9CDV	58	18	184	260
9DTK	87	42	127	256
8XE	31	18	206	255
1BIG	36	29	182	247
1AVJ	46	22	164	232
1ATV	149	23	45	217
8CNX	75	8	123	211
8DBM	26	38	142	205
8GZ-ZG	15	36	154	205
8BBG	26	33	142	201
4JR	10	34	136	180
1KL	28	29	119	176
1LM	4	1	170	175
9XM	47	22	146	175
6BQ	20	9	146	175
9IX	54	21	96	171
2AJE	30	13	128	171
2CY	100	62	4	166
2NZ	44	5	6	156
9DOL	35	19	98	152
9PU	7	10	134	151
9DMJ	—	—	150	150
6ANO	25	3	121	149
1AMZ	49	76	24	149
2APT	56	1	91	148
2FK	59	21	68	148
6RV	12	2	129	143
9DKS	58	56	25	139
6CUW	15	5	115	135
9DKA	33	34	68	135
9FAM	14	19	97	130
9CPM	2	—	126	123
6AJM	48	33	40	121
9CAA	28	13	78	119
9DXY	25	18	80	118
9LJ	6	4	106	116
9XI	15	13	82	110
6BDS	52	—	57	109
1JL	44	25	39	108
9DPJ	11	14	82	107
1AAV	16	19	72	107
9RR	14	8	84	106
2ZT	11	68	27	106
9DWN	4	3	98	105
9NV	37	24	38	101
9AAE	32	15	54	101
3ZO	—	2	99	101
1JL	44	25	31	100
9ZK	—	—	100	100

TBB would have been listed in the Brass Pounders' League if the number of messages originated delivered, relayed and total had been turned in to Headquarters. Watch this, OMs! 8EU has been on the job right along. This month he succeeded in pulling up into first place and rates the starred rectangle. 8DHX is in second place while 6BJX still holds his own in third place. piCW handled more messages than last month and managed to pull up a bit so that it isn't so far to the top.

 E. L. Maneval—8EU
 1470 W. Fourth St.,
 Williamsport, Pa.
 Orig., 21; Del'd., 30; Rel'y'd., 462; Total 513.

DIVISIONAL REPORTS

ATLANTIC DIVISION

MARYLAND—8PS, operated by Midshipmen Fen-ton and Knight, is on 37 meters and is reported from the west coast as the loudest east coast station. 3BUR is QRW from studies at the N. A. 3WA's 50 has gone west and he is carrying on with

a liver. 3ACW is getting out FB on 40 and 80. 3PH has been putting strong 38 meter sigs across the pond with a 50. 3AOJ is perking again with a five watter. 3QI has shot his big jugs and is going strong with a single 50. 3SF has been QSO N. Z. and Australia. 3BMO has had trouble getting down on 40 but is FB now. 3RF is breaking records with one UX210. 3ALT has blown his H tube and is going with a UX210. 3VI has dropped from 80 to 40. 3AIB is QSO west coast on 40. 3HP is FB on 80. 3AHA is putting pure DC sigs into all parts of the globe. 3CGC and 3GT put out snappy sigs on 40. 3IG is QRW studies. 3MF has sold out and says he is through with transmitting. 3AA is coming back into the game. 3ARK reports not much DX.

Traffic: 3ACW 32, 3WA 13, 3PS 27, 3AIB 22, 3HG 11.
 EASTERN PENNA.—Dist. 1—3VT is now working with a 301A.

Dist. 2—3BNU was off last month waiting for a new 50 watter. 3BLP is QSO west coast E7 on 80 meters using crystal control. 3TS is slowly getting a station going on short waves. 3CTZ is now working on 40 and 80 meters with a 5 watter and doing fine work. 3BLC is working on 40 meters and stepping out fine. 3EK is going strong after a period of idleness. Easton has several new stations and should help to increase traffic totals. 3CDN and 3MQ are QRW with school work and find little time for traffic. 3TP is doing fine DX. 3CJN is the ether buster of Allentown. 3UE and 3AFW are working the short waves consistently. 3AVL is still knocking 'em dead and wins the fur lined stove pipe for DX shooting. 3LK is pounding out great on 40 meters. 3BUV is very QRW with land wire work. 3AUV has a new 500 cycle motor generator. 3BQ expects to be on 40 meters soon. 3BVA did some excellent DX work while home from college at Easter. 3NP reports QRN is showing its effect in his vicinity. 3ZO keeps schedules daily with 8ZG, 9ZA, 8PL and 3AUV. 8EU's traffic hit a high point in the face of a flat 50 watter. 8CCQ added some DX countries to his 5ers large list. 3AVK is flat due to moving and a popped H tube. 8CGZ QSO'd A on a new MG. 8CMO is a new one and busted his Ken. rect. and is now on slop jars. 8BFE is flat due to a gang of tubes leaving and a busted inductance. 8BSZ built a new amitter and a ham receiver for a BCL. Handled code stuff from Brazil to Asia. 8CDB-8AHO busts out with the low power bug—a 201A and 90V B batts. 8AFR guards his antenna and CP from BCLs with a shot gun. 8CFT is fussing with 40 yet. 8BR just got his rect. fixed up. 8DQG gets out when the BC fone set is not taking all the colleges DC.

8RWI sends in a good report. 8AJF is sick. 8BLM has the low power-wave fever. 8BFC is getting out FB. 8BFN pounds through on 80. 8BWI is going on 80. 8AOL worked G on 40. W-B hams are requested to cooperate and get reports, etc., to B. Warner, 14 Grant St., Wilkes-Barre. 3BIT is going FB on both 40 and 80 meters. 3AJR, 3COR and 3DTL are all pounding away on 40 and 80. 3COR says he has a hi-loss low powdered rig stepping out FB. 3BQ moved to 597 N. James St., Hazelton, where room is now at his disposal for an NSS and if he needs it. 8BRT has a wicked 100 watt rig. 3RQ didn't get his 100 watt set in shape due to punk tubes. We understand our old friend S. Ballentine has an X license at White Haven. DON'T FORGET TO VOTE!

Traffic: 3VT 1, 3AEN 2, 3ZM 5, 3PY 3, 3BLC 5, 3RUV 4, 3BLP 20, 3CDN 2, 3LK 17, 3CJN 7, 3UE 12, 3AVM 4, 3AUV 43, 3BQP 6, 3BVA 44, 3NP 5, 3ZO 101, 8EU 513, 8CCQ 16, 8CGZ 25, 8CMO 6, 8WH 4, 8BIT 14, 8BCQ 9, 8BWI 9, 8AFR 1, 8AHO 16, 8BSZ 54, 8CFT 16, 8CQZ 4, 8BQ 30, 3LW 6, 3AY 12, 3HD 13, 3JN 12, 3AY 12, 3ABH 18, 3FS 5.

WESTERN PENNA.—Dist 5—8AXD is now working on both 40 and 80 meters. 8BOY is getting out very well using a 201-A. 8CMP is experimenting with the ultra short waves. 8XE has been doing good work on the PRR tests.

Dist. 6—8DOQ has been having trouble on 80 meters. 8CCI is still building the big transmitter which will have a 50 watt master oscillator, crystal control. 8BES has forsaken the 50 watter. 8BAA is now operating at 8BES. 8AKI is testing with 3SN for Signal Corps Army Amateur Net.

Dist. 7—8DRB is on the air again with a 50 watter. 8ABW has been doing excellent test work on 40 and 80 meters. 8CUH has dropped down to 40 meters. 8AUD is now using two 50 watters on 80 and 176 meters. 8BYI has handled some traffic with the West Coast working both ways.

Dist. 8—8BRC has been working schedules with 8GI, 8GU, 8CEO and 8BUN. 8BDJ has been quite

active. SGU and 8BVK have been experimenting with loop transmitters.

Dist. 9—8GI is still the undisputed leader at this end of the state when it comes to handling traffic. 8BRB is living up to his reputation of the past and is trying hard to turn in a higher traffic total than 8GI. 8CEO was third best in the way of traffic. 8BBL is on the job handling his share of traffic. 8CRK has just given his entire outfit an overhauling and is on the air again. 8DNO blew the old fiver and installed a UX210. 8AGO and 8CHF have added French 8ZO to their list of stations worked. 8DKS has been inactive due to sickness but reports a new ham station, 8HM. 8BY is looking for some "S" tubes. 8AYH reports that he has perfected a new rapid wave change outfit. 8BJV is back on the air again. 8ARC is a newcomer and has done well with traffic and the PRR tests in the central region. 8OW and 8DIO have been grinding quartz crystals for the last few months. 8BT is heard often on the air. 8BHJ is rebuilding his station. 8CLV and 8BEJ are installing a shortwave transmitter and receiver for the Pittsburgh Unit of the U.S.N.R.F. 8AKU is using one 250 wattor on 40 meters. 8AGO has handled a very large amount of PRR traffic this month. 8VE is knocking out some good DX as well as handling a large amount of traffic. 8JO, 8BIT, 8CTK are heard often. 8 Cosgrove has high hopes that he will be on the air soon if the RI will donate him a license. 8PX is on the short waves. 8AKJ is working with 8PX on their new s/w station. 8HK and 8VX are heard often at the CM's station. 8X-8CFH is taking out a new license and will be back on the air soon on 40. 8ZD is on the air again experimenting with B battery plate supply and a 5 wattor. 8ZAE has been working foreign stations consistently on low power.

Traffic: 8AXD 2, 8XE 255, 8DOO 12, 8CUH 23, 8BRC 21, 8BDJ 42, 8GI 316, 8BRB 51, 8CEO 37, 8BRL 15, 8CRK 8, 8DNO 6, 8DKS 6, 8BY 4, 8AYH 3, 8VE 48, 8CLV 11, 8AGO 70.

WESTERN NEW YORK.—With the coming Convention to be held at Buffalo, June 24 to 26, the gang have been very busy getting things in shape for the grand reception. E. B. Duvall will be the guest of 8PJ. Remember its the FIRST ATLANTIC DIVISION CONVENTION and SPECIAL RATES HAVE BEEN SECURED FOR THE VISITORS. AND ITS A.R.R.L. to the core. 8KW has been appointed an Army station and have been doing fine work on 40. 8BLP has been handling traffic and attending school at same time. 8ARG and 8AFO are operating separate stations now. 8DSI handled traffic. 8DPL is traffic chief of Radio association of Western New York and desires a new title for his office. 8ADE has moved out into the wilderness where he can pound brass without disturbing the neighbors. Cats. 8BCL will be on this summer with a 250 wattor. 8BKS came home from college but the gang couldn't find him. 8RV is still on the air after schedules. 8FP, another checking station with a real wave meter, is doing fine work with foreigners. 8UL still has the traffic sizzling through his station in great style. 8QB is still working hard on the PRR tests. 8AYB has traffic as usual. John Eichmann, the Superhet expert in Buffalo, has fallen for ham radio at last and just received the call 8AOM. 8PJ now works both 40 and 80 meter bands and has a transmitter and receiver for both bands. 8DAJ is the Crystal control station in Niagara Falls. 8DAJ will check any wave meter or station on request. 8BSF is on again with a 250 wattor. 8CTK is off the air. 8HJ is also working PRR tests. 8DFK is working Europeans since rebuilding transmitter. 8VW still sticks to 80 and 175 meters. 8DRJ, 8AKS and 8BQK are dividing honors for their work on 40. 8DKN is a new one in Iilon, N. Y. 8CHN is handling schedules on 76. 8APU operates 2SZ occasionally. 8AVJ and 8DA have DX records and not much traffic. 8DHX seems to be the star station for schedules. 8CNT is a new ham in Fredonia. 8AXA is another new station. 8DME is having trouble with antenna. 8ZU is married. 8ADM has trouble with power line interference. 8CVJ is a new station in Auburn, N. Y. 8AHC will be on again this month. 8ABG is a new star in Ithica. 8CBS was heard in England on 10 watts. 8DBC is working hard on checking up BCL modulation troubles. 8DBQ is having trouble with the BCLs. 8CNX does all the handling of traffic in two weeks of month. 8AXA gets to Italy easily. 8BIN is experimenting with self rectification and has some H tubes. 8CTL is experimenting. 8ABX is back after a long vacation. 8BHM is now in Hornell and will be on soon. 8PK is attending R.P.I. 8NT works 7s, 6s and ch's. 8UL handles messages with N.V.E.

at Guantanamo Bay, Cuba. 8DPL has joined the USNRF. 8CAN is also in USNRF pounding out well. 8DHX gets PBL credit this month. 7CNX as close second. 8DBC has been on the 80 meter band for the past seven months.

Traffic: 8NT 13, 8BCZ 4, 8HJ 8, 8DFK 7, 8BSF 6, 8DPL 13, 8ADE 4, 8QB 6, 8CNT 26, 8FJ 15, 8ABX 2, 8AXA 7, 8CTL 19, 8BIN 60, 8DME 32, 8CFZ 12, 8BFG 4, 8CVJ 12, 8ADM 11, 8ZU 40, 8CNH 35, 8AIL 4, 8DKN 16, 8BQK 40, 8AKS 26, 8DRJ 21, 8DA 2, 8DHX 369, 8DX 2, 8UL 55, 8CNX 211, 8AVJ 4.

DISTRICT OF COLUMBIA—The most encouraging observation made this month is with respect to new stations and new operators. There have been several such cases where the operator has not yet a station license but has received the operator's license and has been experimenting with transmitting equipment. Here's hoping this will keep up. 8BWT and 8JO report the installation of phone sets on 180 meters. 8BWT blew his 14th 50 wattor this month. The 180 meter transmitter at 8BWT is in addition to the two regular ones on 40 and 80 meters. 8ASO handles practically all of the messages coming through his station by phone.

Traffic: 8BWT 226, 8AB 34, 8ASO 24, 8ACM 13, 8JO 2, 8BKT 7.

CENTRAL DIVISION C. E. Darr, Manager

OHIO—Dist. 1—8DND has rebuilt his transmitter, using a UX210. 8EQ has been unable to keep schedules on account of sickness. 8BIQ blew a tube so is off the air temporarily. 8BSA-8BEY is still using portable and still handles messages. 8DCB has started up again. 8AOE is now using 5 watts and reports better work than with his 50. 8BQI had too much noise lately so no report. The Findlay Radio Club is building a new shack and will be ready for business in about two weeks.

Dist. 2—8DDQ has two schedules daily. 8AGS is operating at Valpariso, Ind., under the call 9HEF. He is using the Hertz antenna scheme and says it is FB. 8WE finally got his stuff going but is still having trouble with it. 8BKQ is being held up on account of no crystal for his outfit. Expects to be going soon if new crystal is a good one. 8ZE has been sick for a month but is back on again. 8RY is still in Kentucky but expects to be back at the old location very soon. 8BCE worked A, BZ, Z and PR this month.

Dist. 3—Old man QRN has been on a rampage most of the past month giving some of the boys cold feet. 8DAE reports a slight decrease in activity due to the QRN and school activities. 8RJ finally came down on 40 meters and seems to be stepping out FB. 8AZU, 8BF, 8DAE as well as several others are doing very good DX. 8ADA deserves much credit for sticking through to the finish on the PRR tests. The Cleveland boys were mighty happy to have Mr. Hebert of HQ as guest at one of their club meetings. 8AGY has been sick.

School has kept 8BNH from being on the air but 8BPL and 8BTH have been vibrating the head phones of amateurs in many foreign lands.

8BKM has been playing sailor on one of the lake boats and as a consequence has a smaller traffic total than usual. The Warren and Youngstown gang have been busy getting their 50-wattor crystal control xmitter installed in their club house. 8DCH has been doing consistent work with 7.5 watts. 8DEX is mourning the loss of a 50 wattor. 8DFQ says he is getting out better lately.

Dist. 5—8DEM put up a tin mast but it blew down. 8DSY changed back to 80 meters. 8GZ takes traffic honors in this district again. 8PL is off the air for a short time. 8CBP is QRW school. 8CRI is modest, never says much, but the DS knows he does good work. Welcome back, 8BBH. 8BAU was too QRW with the Charlestown and YLs to report. 8BYN is now using a Hertz antenna, his cage having blown down.

Traffic: 8AOE 14, 8BSW 51, 8BSC 17, 8CVS 3, 8BSA 5, 8ANX 8, 8DND 2, 8BN 9, 8DDQ 29, 8AGS 15, 8WE 8, 8BKQ 4, 8DIA 98, 8BPL 44, 8BKM 40, 8DAE 31, 8BOP 27, 8DRX 25, 8RJ 12, 8ADA 12, 8AVH 10, 8AOK 9, 8AZU 9, 8KC 2, 8ACY 42, 8BYN 108, 8DEM 15, 8DSY 20, 8GZ 205, 8PL 12, 8CBP 7, 8CRI 24.

WISCONSIN—Dist 1—8DTK says it appears that 40 meters is fading out as summer approaches and 80 is getting better. 8DOL now has a commercial ticket. 8BKR is QRW Badger A.R.R.L. News and school. 8RH says traffic moving is better on 40 now.

9BWO was QSO an Aussie and 2 Hu's. 9BSS is still doing good work on 80 meters. 9CDT is trying to get set for work on 40 meters. 9CIB will have a crystal set going soon. 9AFZ is again experimenting with antennas. 9ATO says not much traffic floating around these days. 9NY received a card from 95AX on 40 meter transmission. 9CKU did good work on 40 meters until his fiver went west. 9ELD will soon be on the Lakes again. 9UH is off until Sept. 9EHM's transmitter is being rebuilt. 9BTK is operating on both 40 and 80 meters. 9BEK is attending the U. of W. and only operates when he comes in from Madison.

Dist. 2—9XH-EK is on every Mon. Wed. and Fri. night from 8 to 12 pm. 9CM is KRW school. 9DZV's antenna tower came down in a storm so he will not be on for some time. 9BIB has trouble getting his crystal set to work. 9EGW is using a DeForest H tube. 9COI has an entirely new station now. 9EAN reports not much luck on 40 meters. 9EAR is working break-in with fair success. 9DLA is working on 40, 80 and 175 meters.

Dist. 3—9DKA is going to install a 17 tube antenna to prevent swinking. 9ANE compliments 9DKA for his reliability as an ORS. 9GGL seems to be the only active station in Sheboygan. 9BVA has his station in good working order. 9AZY makes his first report. 9CXX sent in his report on the stationery of the Plymouth Radio Club. 9EMD is rebuilding for a 50 watt station. 9AEN is looking forward to vacation when he can be at the key.

Dist. 4—9AZN is on the 40 band. 9CAV reports from Alma Center. 9DCX is building a permanent shack for operating. 9EIL has a new job operating a broadcasting station at Eau Claire.

Dist. 5—9ELI is the only station reporting. 9DPR has joined the ranks of the benedictes.

Traffic: 9DTK 256, 9DOL 152, 9BKR 50, 9RH 26, 9BWO 24, 9BSS 22, 9CDT 10, 9CIB 7, 9AFZ 5, 9ATO 5, 9NY 5, 9CKU 1, 9ELD 1, 9BTK 75, 9VD 9, 9XH-EK 82, 9OM 25, 9BIB 2, 9EGW 12, 9COI 2, 9EAN 12, 9EAR 18, 9DKS 139, 9XM 175, 9DLD 8, 9ELI 67, 9AZN 28, 9CAV 2, 9DKA 135, 9ANE 50, 9GGL 17, 9BVA 6, 9AZY 4, 9CXX 4, 9EMD 2.

INDIANA—Dist. 1—9AAI must be still QRW on Superhets. 9AVB is unable to be on evenings as he is busy carrying the morning papers. 9ECI handled some nice traffic. 9BKJ kept the Detroit gang busy with messages concerning illness of a relative. 9DPJ and 9QR were heard in England. 9II was installed at the radio show and stirred up quite some excitement. 9DDA works fone on 175 meters. 9EG is still saving his money for that 204A. 9EJT has sold out and is going to sea. 9EJU works fone on 177 meters with fine results. A BCL in Muncie has a five tube low-wave receiver that brings in the foreign hams on a loud-speaker. 9BRG is with us again. 9CAP has a new fivver and going after the YLs strong. 9DRS is giving 40 meters a try again. 9BUQ is working 40 with a new M. G. plate supply. 9CXG is still at radio school.

Dist. 2—9DEJ is keeping a regular schedule with 8CEP. 9DXI is working on 40 and 80 but is having QRM from power leaks. 9BK reports too much business for radio. 9CUB is married and on the air as usual. 9BMT, the gang's youngest squirt, is going good on 80 with a 5. 9BVV and 9BVX are new men on 80. 9DQV is starting up with a 7 1/2 watter. 9AIL is forever through with YLs and is coming back on the air. 9EBF is still on. 9BO is using 7 1/2 watter and B battery plate supply successfully. 9OG is using high power but complains of no messages. 9CCL is off on account of YLs day and night. 9AMI blew his ancient fiver. 9BBJ found the trouble in his set. Blown blocking condensers, blown grid leak, and blown milliammeter, otherwise his set is FB. 9BYI reports traffic good on 40 and 80. 9ABP is on the army radio route with 7 1/2 watts. 9AEB is rebuilding. 9CEM is on all the time with his new set. 9BUZ is fairly successful with low power on 20 meters. 9XE is broadcasting so no traffic. 9BSK worked AXU, a whaler 6000 miles on 21 meters. 9AHE is using a 5 watter and working the 6s. 9CP is doing some unusually good work on 20 meters. 9EBW just installed a 50 watter. 9DYT is trying out a Hertz antenna. 9DDZ's set perks ok on 80 meters.

Dist. 3—9BSC has worked all continents except Africa. 9EBW has a 50 watter on DC and getting out FB. 9NG is using all of his power (5) worked 6TS at noon. 9BEP is getting out fine on 40. 9DIE lived up to his call—he sold his set and got married. 9AHM is going strong as usual. 9BSC is building a 250 watt crystal controlled set so plug your ears.

Dist. 4—9CNC uses two 201As and B batteries on 40 and 80 meters. 9BQZ is using a 201A and 550

RAC, operating on 175 meters. 9DPI uses 3 201As in DH circuit, 250 volts dc on plate. 9BNP uses an H tube with 1100 on dc. 9AIP is just starting up. 9BCM is going good for a beginner.

Dist. 5—9CMQ is acting as DS for Dist. 5. 9CSC is on 37.5 meters regularly. 9CMJ has had transmitter trouble. 9CMQ has been handling a lot of traffic for his dad relating to the auto business he is in. 9BME is going strong on 40 meters.

Traffic: 9DPJ 107, 9ECI 47, 9AFY 31, 9BKJ 29, 9AAI 26, 9BUQ 17, 9CXG 14, 9DRS 13, 9AVB 8, 9EGZ 5, 9BRG 4, 9EJU 1, 9DHI 11, 9DXI 4, 9BK 6, 9CP 17, 9ASX 10, 9BVV 1, 9BVX 1, 9BMT 1, 9DQV 1, 9AEB 18, 9BYI 22, 9ABP 2, 9CEM 3, 9BSK 15, 9AHE 5, 9ABI 42, 9ASN 20, 9DYT 6, 9EBW 23, 9BSC 37, 9CNC 3, 9BTP 35, 9BME 30, 9AGU 12, 9ADK 16, 9ASJ 10, 9CBJ 3, 9APG 1, 9ACR 2, 9DSC 12, 9CYQ 14, 9EJ 25, 9DOM 5, 9CLO 11, 9BVZ 4, 9DUC 4, 9ADN 83, 9CSC 60, 9CMQ 30, 9CMJ 12.

ILLINOIS—Dist. 1—9BHT on 38 meters, worked IBAZ. Mr. Shalkhauser, Physics Instructor of Bradley Poly. at Peoria, Ill., is experimenting with a 210 local oscillator for use in calibrating Peoria wave-meters.

Dist. 3—9ELF is back on 150 meters to chew the rag and make friends. 9BRX has a new set, using a sync and No filter. 9ELR says one tube works better than two. The Radio Inspector has been holding First Grade licenses in this district. Most passed OK. 9ARM is the new Village Board Trustee.

Dist. 3—9AHJ rebuilt his transmitter and has a new B-T receiver. 12-200 meters. 9CSW is again getting the fever and will be on soon. 9ATT is quitting the game for about a year. 9AHJ reports high watters the best of all.

Dist. 5—9ALW has transmitter trouble. 9EHQ works sixes easily with 10 watts when on. 9CEC is rebuilding. 9CDG is remodelling into a low power transmitter. 9DQR is listening to G. E. Co's tests.

Dist. 7—9ALE is now QRV for 40 meter schedules. 9NV is building a 250 watt 83 meter fone set. 9AXF got his commercial ticket. There is a new aerial at 9AAW. 9AHD says his old 5 watter beats his new H. 9BNA moved to 179 N. Harvery, Oak Park, Ill. 9DLG is now on 80. 9GE is still at school but traffes with two A tubes. 9IX threatens to put in 500 watts. 9CEJ and 9FJ have been recommended for ORS. 9ALG had to come from Texas to handle traffic in Chicago. 9CIA put up a Hertz for 40 and 80 bands. 9EFF has higher power. 9CSL junked the panel for breadboard. 9APY has a new set on 40 besides the regular on 80 and 150. 9BAA and 9DXG collect messages at school. Chicago delivered over 200 messages this month. 9QD is on 40 often to avoid QRM. 9AOA uses a Hertz on 40. 9PU is experimenting with antennas. 9DPL is out for an ORS. 9DDS is on 40. 9NK is about to enter the fifth ham stage. 9CSB worked both coasts, daylight and was reported in Australia. 9DLG is off the air for a month. 9KB lost his quiet hours. 9BFF is back on the air on 80 both fone and CW. The ops at WMAQ have a station under the call 9IM. 9BVP has a dandy card. 9ZA uses a Hertz on 40 and reports FB. 9BWS is going down to 20 meters soon.

Traffic: 9IX 171, 9PU 151, 9NV 101, 9AAE 101, 9RVP 82, 9CXC 81, 9CEJ 79, 9ALG 76, 9DDE 75, 9RK 64, 9CSB 61, 9FJ 60, 9BNA 55, 9AIZ 47, 9APY 44, 9AAW 38, 9QD 37, 9DOX 36, 9DYD 35, 9DWH 32, 9EHQ 30, 9ALK 30, 9CNB 28, 9AXF 27, 9DLG 21, 9DPL 20, 9AFF 19, 9BBQ 18, 9DYL 18, 9DAF 14, 9CG 14, 9EJY 13, 9CSL 12, 9ALJ 11, 9BHT 11, 9DQR 10, 9DXG 10, 9AAJ 9, 9AHJ 9, 9CWC 9, 9ELR 8, 9AGQ 7, 9ALE 7, 9BRX 6, 9DDS 6, 9AOA 4, 9GE 4, 9CIA 3, 9AJM 2, 9ALW 2, 9RIZ 2, 9NK 2, 9RQ 2, 9DCG 1, 9MR 1, 9AHJ 1, 9BWS 1.

MICHIGAN—Traffic: 8CEP 55, 8EFP 5, 8QN 4, 8CM 40, 8ACU 3, 8ZH 5, 8ZZ 19.

DAKOTA DIVISION D. C. Wallace, Mgr.

SOUTH DAKOTA—Dist. 1—9CKT is the President of Madison's largest graduating class and finds himself extremely busy. 9ALN continues to pound out DX. 9AJP is a new station at Sioux Falls and is going with a 201A. 9DIY is still busy.

Dist. 2—9BRF had the roof burnt off over the station but the fify and all other tubes came thru OK. 9DID is building a IUV-199 transmitter for experimental purposes. Will have the big crystal controlled as soon as he can get a crystal ground. The R. I. dropped in on the Huron gang and as a consequence we are short two good stations for the time being. 9DWN got his station on the air during the spring vacation and handled a nice bunch of

traffic by the means of schedules. 9CJS has again completely rebuilt. 9NM wishes the gang to know that schedules cannot be kept on account of the work at this time of the year. 9BKE is getting an H tube and expects the school and YL QRM to let us somewhat. 9BDW worked KEGK. 9DZT's kenotrons went bad and he is using AC on 40.

Traffic: 9DIY 2, 9ALN 23, 9CKT 16, 9CJS 16, 9DWN 106, 9DGR 62, 9BDW 11, 9BBF 14, 9NM 23, 9DZI 61.

NORTH DAKOTA—9CCT is making a loud noise on 38 meters. 9BJV is a new ORS and has been doing good work on 40 and 80 meters. 9BQD has rebuilt his set for 80 meters 10-watt fone and CW. 9DM is going some after being stranded for power for some time. 9CZG is back on the air again. 9DIG says he cannot be on the air much from now on. 9CRB has been doing exceptional work on 178 meters. 9DKG is still QSO both coasts with 15 watts master oscillator on 80 meters. 9EFN is having trouble burning up his neighbor's radio frequency tubes with his stray currents.

Traffic: 9CCT 35, 9DM 6, 9BJV 3, 9DIG 4, 9EFN 4. **MINNESOTA**—Dist. 1—9EGU has been off the air most of the time during the past month rebuilding. 9EGE will not be with us for a time. 9ADW works the west coast regularly and does fairly well with traffic. 9DKR works good DX. 9AOG just returned from a trip to California and is itching to get back on the air again. 9ADS reports hearing a Britisher at 4:30 pm. 9CKI and 9KV are the only active stations in Duluth. 9KV worked 3 more Zedders. 9BJD had to tear his set down on account of the landlord. 9ADF is in the hospital. 9BMB, 9BPW, 9DFD and 9ADF are inactive.

Dist. 2—9GZ is an old timer back on the air again at Wheaton. 9EHO has received quite a lot of material towards rebuilding his station which was destroyed by fire. 9COS is having trouble with his H tube. 9SF has been appointed an Army station. 9DDB will be off the air until fall. 9AIR has moved his radio installation to a shack where he can be by himself. 9EFD handled several important Army messages. 9DBW has trouble with his rectifier. 9DJW keeps daily schedule with 9BBT. 9BBV is experimenting with antennae and filter systems with good success. 9BNF keeps regular schedules and continues to work DX besides. 9EBC works on 80 meters. 9BIY suffers from a bad power leak so was unable to do much work. 9CPO is still off the air but expects to be back soon, as it is hard to keep from it. 9CAJ is back on the job again after his West Coast trip. 9BOI is rebuilding his set with changeable coils for 20, 80 and 178 meters c. w. and fone. 9BKK was off the air for three weeks on account of sickness. 9BTZ hears everything with his 500 foot antenna.

Dist. 3—9XI worked Africa, Japan and Tasmania. 9BVH continues to work foreigners. 9APE joined the 109 Aero Squadron and is going to make some tests with 9BMK as he is in the Radio Division. 9CUM keeps schedules with 9ANE on Saturdays. 9ASW has great luck with his new H tube. 9ABK lost 8 miles of filter condenser and his DC. 9ELJ uses a 201A with 90 volts battery. 9DHP is a new ORS using a UX-210. 9DGE has reports from 19 countries. 9ZT took 18 sheets of press from foreigners. He keeps weekly schedule with NAJ and worked 7 districts in one day on 20 meters. 9DAW is on with 5 watter. 9CFM is handling big traffic. 9DWO is at a new location now with Zeppelin antenna and a 50 watter. 9BNK is back on the air again with UX210.

Traffic: 9CKI 32, 9KV 37, 9EGU 6, 9ADW 12, 9DKR 6, 9EGF 16, 9CWT 45, 9BMR 28, 9CDV 260, 9SF 3, 9BBV 5, 9DWB 31, 9BIY 16, 9AIR 12, 9COS 1, 9DJW 20, 9EBC 19, 9EFD 9, 9XI 110, 9CFM 128, 9BNK 64, 9ZT 106, 9DGE 81, 9DHP 8, 9ECC 68, 9ELJ 12, 9IG 40, 9ABK 28, 9BMX 5, 9DYZ 2, 9BAY 57, 9ASW 10, 9BVH 4, 9CUM 6, 9GH 4, 9BTZ 6.

DELTA DIVISION B. F. Painter, Mgr.

THE Director hopes that the four sections of this Division have each nominated their best man for the position of SCM. The new things after electing your SCM is for each one to get behind him and do all possible to help him in his work. To do this, it is necessary that each one of you write to him every month telling him what you have been doing, hope to do and what the rest of the gang are doing.

LOUISIANA—5EN is having trouble with his transmitter and is not getting out as well as usual. 5KC states that he is using a 201A tube with an indoor antenna and a tin roof for counterpoise. The

Delgado Trades School, 5YF, just got on the air. 5UK is still working his 50 watt set. 5AEN continues to kick out and has worked Australia with his 5 watter. 5APA is a new kid doing good DX work. 5SQ is building a new ACCW set. 5IC is busy with his oil wells. 5WY worked all districts again on 40 meters but is rather busy. 5ANC and 5AGJ are on 80 meters. 5AKI now has a 20-600 meter model C-7 superhet on loop the same as 5ML. 5AKI and 5ML have installed 35 foot gutters and are doing fine DX on 40 and 80 meters.

Traffic: 5ML 7, 5EN 6, 5KC 18, 5UK 6. **MISSISSIPPI**—This state reports a very great deal of QRM from County and State field meets and High school plays. 5QZ is always to be depended on for a report. 5AKP's transmitter is on the blink again for no apparent reason.

Traffic: 5AGS 18, 5AKP 15, 5QZ 6. **ARKANSAS AND TENNESSEE**—5WK reports that he has moved to Monette, Arkansas. 4HL and 4JJ visited 5AX and 5MI last month. 5AJ has started sending in reports again. 4DA advises that he is on the air on 40 meters. 4MM converted into a 250 watt master oscillator, crystal controlled.

Traffic: 4AJ 27, 4HL 9, 4FP 7, 5WK 9, 5ACY 25.

HUDSON DIVISION E. M. Glasser, Mgr.

2 PF has taken over the Army-Amateur work in the Second Corps Area acting as A.R.R.L. representative. The DM had to resign from this position because of heavy college and outside work taking up all his available time. Appointments are being made as rapidly as the army is asking for them.

ORS are again urged to report on time or their appointments will be cancelled. The Division was well represented at the New England Division Convention. 2 CYX, 2APV, 2NZ, 2BNL, 2PF, 2GP, 2BW and 2APF attended. 2 BW won the liar's contest. (2PF wasn't there on time).

NEW YORK CITY—Brooklyn—2WC and 2CLA are crystal controlled transmitters. 2JB manages to pound brass after operating WNYC all evening. 2NO is another op at WNYC. 2QH and 2CV are coming back on the air strong soon. 2CRB is moving from Brooklyn for the summer. 2PF is too busy with the Convention to be on the air. 2BO is active on 40. 2UD is busy with crystals and YLs. 2BRB is QRW building transmitters and college work.

Queens—2AVB is doing some fine traffic work. Bronx—2ALL is experimenting with antennas. 2APV is still doing great work on 40. 2BBX will be on the air soon with a 50 watter using the KFUH circuit. 2CVL was back from college during Easter week. 2CYX is on the road again and will make his yearly visit to the 3rd, 9th, 4th and 5th districts.

Manhattan—2PK reports the gang have to study and cut the wireless work. 2AMJ is sure running in hard luck. Manhattan Electric Supply Co. has decided to cut down the office force and Frank has lost his job. 2KR reports that he is building a 150 watt set for a radio store. Ed Wilbur was up to the New England Convention and had a great time. 2LD is still on the job, using a MG set. 2EV is now rebuilding all his receivers. 2ALS hasn't done much. There is a good looking YL taking his time. 2CZR has at last worked Europe and his sigs were PB. 2CHK is still keeping schedules with e2BE. 2HJ has started up again amidst the experimenting in the college laboratories. 2BRB and 2AOF are at the key.

Richmond—2AKK is going strong on 40 and 80. 2CEP is op on board KVF. 2AYH is a new station using a fiveer. 2ACZ is handling a lot of traffic with his 10 watter. 2AYW is a new station in Totentville. 2CZN hopes to be going strong soon. 2AKR, 2ARK, 2CLF and 2AFV have schedules with KVF. 2ATQ is getting sick of low power and expects to QRO soon. 2AFV has a new UX210 on 40, 80 and 180 meters.

Traffic: 2ALL 64, 2APY 23, 2BBX 84, 2CVL 44, 2CYX 61, 2NZ 155, 2PK 148, 2CHK 12, 2AMJ 19, 2KR 6, 2BNL 2, 2LD 6, 2LM 14, 2EV 6, 2ALS 17, 2CZR 58, 2APJ 11, 2AKK 89, 2AYH 1, 2ATQ 3, 2AKR 30, 2CEP 31, 2CZN 16, 2AFV 31, 2ACZ 94, 2AVB 33.

EASTERN NEW YORK—Dist. 1—2AV is doing good DX now. 2AUL is recommended for an ORS. 2AWQ is also recommended for ORS. 2AWX is a new station. 2AJE heads the traffic this month. 2BPB has been experimenting with Lecher wires. 2AIZ blew all his tubes so has not been on the air. 2KX does not get on much.

Dist. 3—2SZ is now on the air with a new fifty watt set. 2CYH is stepping out in good style. 2CDH

is still doing good work in spite of being busy with his baby chicks. 2AGM worked Hawaii and Brazil. 2CTH is doing the same good DX as usual.

Dist. 4—2AKH is on again. 2CYM is on some but is QRW. 2MK is reaching out as well as ever. 2BSE is on again on 80 meters and his new QW helped him put up the antenna and counterpoise. 2AIL, who has been sick for a long time, expects to have a receiver and a low power transmitter going soon. 2AOX is QRW school. 2COV is working out of town so is not able to be on the air much. 2AGQ is still stepping out as well as ever.

2CTF has rebuilt the transmitter. 2AJQ is using a.c. on 40. 2ANN is also using a.c. on 40 with a Hertz antenna and has worked NZ, Morocco and Tegucigalpa in Central America with 165 watts input. 2AG has gotten his crystal controlled transmitter working on 80 meters. 2DD changed to the old Armstrong circuit and likes it better than the Hartley for ease of adjustment. 2ADH has an 82 meter crystal and intends to get on with it soon. His 600 cycle note sounds too good on 40 to leave that band yet. 2ALC is back on 80 with his generator and a five watt. 2ASE is getting out well on 40 and handles a batch of messages. The Youkers Radio Club has three more new operators under way and points with pride to eight graduates who have gotten licenses. 2CIL is operating YHZ bound for Naples, Italy, and is listening for the gang on the way across. 2BOW has joined the club and will send in reports in the future. 2CNS is QSRing his traffic direct instead of relaying to distant points on 40. 2AAZ is on 80 again with a D.C. note with less than two mikes of filter. 2BQB went to the first district convention in Providence and hasn't been on much due to school qrm.

2AIU and 2CYH should report to the DS, whose QRA is Box 118, Youkers, N. Y. 2LA is rebuilding his transmitter a la 2BHY. 2APT wants an appointment as Army-Amateur net station. He has two separate xmitters for 40 and 80. 2AML intends to report regularly and wants an ORS appointment. 2AXP is on 40 meters for a change with a five and is doing good work. 2KV still hammers away on 40 and 80 when he gets a chance.

Traffic: 2AV 67, 2AUL 18, 2AJF 171, 2AWX 10, 2AWQ 17, 2EX 7, 2SZ 9, 2AGM 18, 2CTH 21, 2CDH 7, 2CYH 11, 2ANV 11, 2AOI 23, 2AKH 29, 2CYM 4, 2AGQ 15, 2APT 148, 2ASE 36, 2AAZ 25, 2AML 23, 2BQB 11, 2AAN 10, 2CNS 8, 2LA 7, 2CTF 6, 2AJQ 5, 2DD 5, 2ADH 5.

NORTHERN NEW JERSEY—We all offer our deepest sympathy to 2CJX, who had the misfortune of losing his father. 2ADU will operate 8CHG this summer. 2CTQ is going strong on the higher waves. 2WR, 2CQZ, 2KS and 2AOC are handling Army traffic. 2ABZ is rebuilding. 2GV has installed his transmitter in the cellar. 2AHK had a slight brush with the BCL, which resulted in an inspection by the RI, who gave the station his entire OK. 2CY handled the largest amount of traffic. 2BQQ is moving. 2EB reports handling very important traffic with 6DCF and 6HVC. 2BAW complains of too many R9 reports followed by a QRM report. 2ALM is a new ORS. 2EY is busy. 2CXY is offering his entire station for sale as he desires to buy a car. 2BZJ is QRW college. 2BUY is QSO Australia, Brazil and all Europe. 2BGI is experimenting on 20 meters. 2CGK was QSO BzIAC on 20 meters. 2FC has trouble working across the pond. 2ARS is at sea as first opr on a coast wise steamer. 2LD lost a 50 which was QSO every continent. 2AMB burned out his MG and is now using a five. 2DX is building a 20 watt fone for 80 meters. 2CP is helping 2JG get on the air with a tube set. 2CQZ is still going strong with his sync on all waves.

Traffic: 2WR 8, 2CYV 1, 2CTQ 44, 2LD 15, 2ALM 16, 2BAW 27, 2ZB 28, 2AHK 43, 2BQQ 2, 2CY 166, 2GDR 7, 2BGI 10, 2FC 1, 2BUY 18, 2CGK 2, 2AMB 14, 2CP 34, 2DX 32, 2CQZ 8.

MIDWEST DIVISION P. H. Quinby, Mgr.

NEBRASKA—Dist. 1—9BFG is maintaining schedules with 8AOS, GUO, 9AQB, 9AJW, 9ADW, 9ABL, 9AED, 9RK and 9EAM. 9DUH has improved his QSB considerably. 9DUO reports his transmitter completely rebuilt again. 9BYG reports no activity for himself on account of operating at 9DR. 9AIJ is on with various sets equipped with tubes from 201As up to 203s. 9CGS surprises us by getting on the air again. 9EW reports working Honolulu with his 210. 9BGK and 9CJT have been quite consistent. 9DXY is very QRW. 9DRY, 9AL

and 9AWS are on. 9BNU and 9DPS report little activity. 9EBL has not been heard as regular as usual. There will soon be two new stations in Alliance.

Dist. 2—9BQR applies for ORS. 9BOQ reports being sick. 9DI has light traffic report but says it will increase as soon as school is out. 9EAK has his regular DX. Short wave set installed at KFAB in charge of 9ANF, 9CIN and 9JK. 9AKS reports he had a scrap with the YL so is back to radio.

Traffic: 9BFG 201, 9DUH 26, 9DUO 1, 9DR 40, 9AIJ 7, 9CGS 4, 9CJT 11, 9DI 6, 9EBL 36, 9DPS 3, 9BNU 2, 9DXY 118.

MISSOURI—Dist. 1—9DMJ says he hasn't much time for hamming and then turns in the 2nd largest total. 9ZK put in an emergency set with B battery supply. 9BEQ and 9BHI are building crystal sets. 9DLB is building BCL sets. 9AOT is QRV for traffic. 9DXN is QRX as for some time past. The active gang from St. Louis plan a ham excursion to K. C. Apr. 30-May 1st, returning on the 2d. It is hoped this will result in definite plans looking toward a joint Missouri and Kansas A.R.R.L. Convention some time this year.

Dist. 2—9AJW reports 4 hams now QRV in Joplin. 9AQB visited the gang in Wichita, Kansas. 9EAO is on 170. 9AYK says he is going to quit ham radio for no good reason. 9DNJ has had sickness in the family but is coming on 40 and 170 soon. 9CDF is using fone on 171. 9CYK reports double barrel QRM—BCL sets and YLs. 9DX is QRW school. 9DAE says he's on when he can wake up. 9BUE is on 176 and kept schedules with 5ES daily. 9BSE and 9CXU applied for ORS. 9ARA handled a few messages. 9CVY worked Wisconsin on fone with a 210 on 80 meters. Some more hams are reported starting in Pleasant Hill. 9BQS received an ORS. 9DKG kept schedules with 9BSE. 9RT is reported coming back on the air. 9LJ handled a good score of messages. 9AYW is another St. Joe station handling traffic. 9DRW had some traffic. Arc light QRM is still making operation after night miserable according to 9DRW. 9DVF reports quite a few messages on 38 m.

Dist. 3—9BSH is not operating. 9BDS and 9BSH have made several trips to 9DWK and boiled several owls. 9EEH has been out of town. 9BDS is married and will soon have more time for ham radio. 9BOB was heard operating at 9CZ1 but no amount of calling could get his attention.

Dist. 4—9RR and 9ZD handled the bulk of reported traffic in K. C. 9ADR lost a 50 watt tube. 9TJ blew up and sold out. 9ACX still working on 40 but all DX. 9RR tried to keep several schedules but they were not uniformly successful due to various kinds of QRM.

Traffic: 9BEQ 32, 9AOT 6, 9BHI 8, 9DMJ 150, 9ZK 100, 9CYK 3, 9CDF 3, 9AYK 18, 9AQB 45, 9AJW 84, 9BUE 8, 9BSE 1, 9ARA 8, 9DKG 23, 9LJ 116, 9AYW 4, 9DVF 25, 9CRM 6, 9ZD 8, 9BND 70, 9CZW 15, 9EEZ 43, 9FF 11, 9RR 106.

KANSAS—9CJT was sick last month. 9DBH still pounds out the DX. 9ACQ has moved to Kansas City and will be on the air soon. 9CVL has good success with his H tube. 9BYI is on 178 and has several schedules. 9DPU is on 40 and keeps 8 schedules. 9RY is on again on 40. 9CV, using an H tube, worked France. 9CET is putting in a 250. 9AET is alternate for 9DPU in Army-Amateur work. 9CKV is a new ORS. 9BLB is on 80 and handled some traffic. 9DHW worked NZ, Australia and Hu. 9BGX is going strong on 40. 9BRD says that all the Newton hams are on 80 meters. 9DRD worked several As and Zs. 9DNG can't get his sink to work right. He and 9CCS attended the Midwest Convention at Ames. 9CCS put up a Hertz antenna and likes it the best yet.

Traffic: 9BRD 3, 9BGX 22, 9DHW 4, 9BLB 13, 9CKV 40, 9DPU 16, 9BYI 10, 9DBH 62.

IOWA—A good share of the ORS of the state turned out for the Midwest Division Convention at Ames. 9EFS reports he handled traffic from HuGAFF with transmitter on 40 meters. 9DAU reports his wave is 36.5 meters. 9BZE's best DX is 6PW. 9CWG kept schedules with 9DMO. 9CGY has finally managed to get his transmitter to the 80-meter band and wishes schedules. 9DOA reports his QRH is 35 meters. 9DJA reports his QRH as 38 and using the self rect. Hartley. 9HK is using 5 watts. 9BCD is back on 80 meters. 9AXD reports best DX on 100 watts this month as Porto Rico. 9CS reports his wave on 40 meters. 9CS is also helping the RCA by making observations of the signals sent out by 2XK, etc. 9ADX is a new station in Clinton.

9BCD reports that he couldn't make the convention at Ames on account of an empty pocket book. 9CZC has been trying to get down to 40 meters but no luck. 9AED has several good schedules working now. 9BDH has been QSO KFUF, Porto Rico and Canal Zone. 9DMS is now operating with the call 9DIZ the ham set of KOIL. 9LC have their remote controlled transmitter in operation and will be on in full force.

Traffic: 9DOA 88, 9DJA 2, 9CGY 22, 9CGW 1, 9RZE 7, 9DAU 37, 9EFS 24, 9HK 5, 9BDH 28, 9AED 14, 9CZC 69, 9DMS 6.

NEW ENGLAND DIVISION T. F. Cushing, Mgr.

MAINE—The following appointments have been made: 1BIV, 1AQL, 1ABO, 1GO, 1BFZ, 1ADI, 1AWB. Cancellations: 1ZB, 1CPN.

If you doubt the efficiency of Maine's traffic organization, just take a look at the totals this month. No small amount of the credit goes to the Maine Message Pushers Club, organized by 1BIG and named by 1AUF.

Dist. 2—1BNL was QSO his first foreigner, f8JF this month. 1ASR says his bedroom is so full of haywire that he can't retire. Four hams from Portland attended the convention and every one of them copped a prize. 1ADI received his ORS certificate this month.

Dist. 3—1AQL and 1BFZ received ORS certificates. 1ACK intends to spend the summer with Westinghouse at Pittsburgh. 1UL has a whole new outfit on 40 and is QSO everywhere. 1UU has been getting in some good DX on 40 for the past month. 1AXU is going good on 100 watts with pure DC note. 1EB attended the Convention representing the Queen City Radio Club.

Dist. 5—1BGS is on 80 with a phone set for experimental work. 1AUC says its hard to get traffic around Bar Harbor at this time of year.

Dist. 6—1ATV is now rebuilding both transmitter and receiver. 1BIG and 1KL attended the convention and had a wonderful time. There were ten Maine hams there and they had a whole table to themselves at the banquet. 1IB is QRW the General Electric Co. and doesn't get home often enough to pound brass.

Traffic: 1AAV 107, 1AQL 22, 1ATV 217, 1AYJ 232, 1BFZ 35, 1BIG 247, 1BKK 37, 1BNL 55, 1BUB 43, 1KL 176, 1UU 48, 1OR 19.

VERMONT, 1AJG, ADM—Dist. 1—Things improved in this district. 1YD was high traffic station. FB, gang 1 1BBJ is hitting on all fours and QSO 65 and 78. 1BEB is back on 40 and reports no great DX. 1BD is on the air now and QSO'd the west coast on 37 meters daylight with a VT2 and 25 watts plate input. His outfit is shown in the photo. 1BDX handled a lot of traffic. The northern part of the state is coming along FB. 4 new non-ORS were heard and if they report to 1BDX a few times, they can earn an ORS.

Dist. 2—1FN hopes to be on soon with a new H tube. 1CQM at RPI, won a scholarship for a three year course, PG. 1AC is QSO anywhere and the cards are rolling in FB. 1APU is working out of the state somewhere this month. 1BIQ has gone to sleep.

Traffic: 1YD 73, 1BBJ 17, 1BEB 20, 1BDX 20, 1AC 20, 1AJG 12.

RHODE ISLAND—Quite a number of the boys in the Providence Division didn't report this month but we will forgive them this time as the Convention got them all excited and a little thing like reporting was forgotten. All the boys say that they had a great time and are all set for another.

The ADM was very sorry that he could not be there as he should have been, but he had to stay away to carry on his job.

Dist. 1—1PB is changing his QRA so is off the air just now. 1AFO has a fone on 80. 1AMV has opened up in Cranston. 1AID says she has been QSO with the Flu. 1AWE is using a UV203A with an H and UX210's for spares. 1BCC is running along FB. 1ALD says he has been QRW with his work so didn't get on much. 1DP and 1AHE are still tied up with BCL work. 1ABP reports DX getting better all the time. 1BIE is using a long antenna with a ball at the far end. 1AEI says he will be on more often now.

Dist. 2—1AAP, 1CDS and 1QV all attended the Convention. 1CDS, who always was lucky, won the 2d door prize. 1AAP is building a couple of transmitters, one for 40 and the other a fone for 80. 1QV

is using a couple of UV210s and stepping out FB. Not much doing at 1BVB due to "bread and butter" job QRW.

NEWPORT—1BQD installed a UX210 and works everything. He and his YL took in the Convention and had a bang-up good time.

Traffic: 1BQD 32, 1AEI 2, 1BIE 7, 1ABP 7, 1BCC 23, 1ALD 1, 1AWE 8, 1AID 17, 1AFO 22, 1PB 3, 1BVB 18, 1CDS 1.

CONNECTICUT—We have passed through a wonderful period when we realize that distance has been

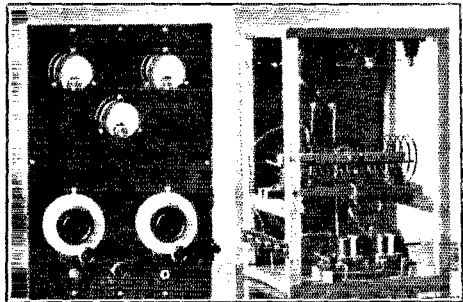

conquered by the amateur who has persevered and brought his station up to efficiency and the future must, of necessity, bring him even greater success.

1ADW says power leaks put him out of business so he hopes to form a radio club to put the leak out of operation. 1CKP doesn't find traffic very heavy so makes up for it with DX. 1BHM worked Chile and has been in contact with Europe twenty-one times during the month. 1BGC didn't like his borax rectifier so made a good one and communicated with Belgium to prove it. 1ZL experimented with a Hertz antenna during the month but still likes his old flat-top as much as ever. 1MY believes his transmitter can behave best "down where the corn and 'taters grow" so put in his cornfield and uses remote control. 1CTI reports hearing KEGK and is working hard to get on 40 meters. 1IV attended the Convention and from his description it must have been about the best yet. 1AOS hopes to be on the air while he is at home for a short vacation, but is working hard at present to get his M. A. degree. 1AVX has received an Army Station appointment and is experimenting with phone on 80 meters. 1AOX is tubeless but not dead, although he reports one of his feet went on a strike. 1SZ has been having tube trouble. 1VY reports DX as very good.

Traffic: 1ZL 2, 1CKP 9, 1ADW 37, 1BHM 24, 1BGC 11, 1HJ 14, 1MY 21, 1CTI 3, 1IV 26, 1SZ 16, 1VY 29, 1AXN 46, 1BLF 2.

EASTERN MASSACHUSETTS—Dist. 1—1BZQ is changing his QRA. 1LM is the star traffic station this month. 1NV is building a 60 foot lattice work tower. 1ACJ is going on 40 meters. 1BKK has spent most of the month getting his transmitter tuned to 40 meters. 1CJR hooked up with KEGK and handled some traffic with them. 1JL has been doing some good DX. 1AEO has been QRW with school and YLs.

Dist. 2—1AHL is experimenting now and getting ready for better DX. 1NT's transmitter raises the fs but his receiver won't detect them. 1UV can blow fuses in the local YMCA when he can't work DX. 1ACT's transmitter seems to be in a slump and doesn't like to work in the early morning. 1BHM is back with us once more and has his transmitter going on 40 meters. 1OU is rebuilding again. 1YC still continues to handle plenty of traffic. 1AXA has a crystal control set perking on exactly 39 meters. 1AVY is still pounding out. 1SL was heard in Germany on 79 meters. 1ABA, with his peanut tube outfit, is still getting out. 1ALP shortened the leads of his rectifier and worked Europe the same day. 1BAT has been so QRW school that he hasn't had time to be on. 1HVL is getting out FB as usual. 1EF says his sigs are only heard round Boston. 1RR still has time to push the key and work DX. 1GA worked A-3BD in the PM on the 40 meter band. 1ALA worked Europe nine nights in succession. 1AHX has a new 203A getting out FB. 1AWB has joined the Army forces. 1ADM get on most week ends now.

Traffic: 1ACJ 6, 1AEO 18, 1BKK 7, 1BZQ 31, 1CEA 8, 1CIT 2, 1CJR 40, 1JL 108, 1KY 66, 1LM 175, 1NV 28, 1WD 18, 1BMS 66, 1AVY 14, 1AXA 8,

1YC 88, 10U 6, 1BBM 2, 1AWB 27, 1AHL 1, 1INT 10, 1ACT 20, 1AIR 6, 1RF 5, 1BVL 6, 1BAT 1, 1ALP 10, 1ABA 12, 1SL 23, 1RR 1, 1GA 19, 1ADM 8.

WESTERN MASSACHUSETTS—Dist. 3—1ARE is dusting off the old ether buster for summer activities with some of the expeditions. 1AMZ has daily schedules with stations in all directions. 1AAE has installed 6HM's circuit and is knocking holes in the ether. The skating rink in 1CLN's shack is disappearing and he will soon be on again. 1AMS has installed a 50 watter and is working DX stations at will.

Dist. 4—Springfield is turning BCL. The Radio Assn. has invited BCLs to learn the code. 1BLU has moved to Boston. 1AWW reports QRW from work but manages to keep the dust off the key.

Dist. 5—1AOF has been ill. 1BOM has joined the ranks of the married men. Poor thing.

Dist. 7—Worcester County is quite alive although only a few stations are continuously active. We have three new ORSs in the stations. 1BIV, 1GR, 1AJK. 1DB is on 80 meters every night. The BCLs like 1ASU's antenna wire very well and remove it from his stick frequently. 1AQM is quite busy and finds little time for radio. 1AAL is running two transmitters, one on 40 meters and the other on 80 meters. 1ANP and 1ANE are new stations in Worcester. 1AKZ is still cutting holes in the ether. 1BDP worked Australia. 1ABY is using fone on 170 meters and is working 1500 miles. 1BBF, 1AJM, 1BAL are all on.

Traffic: 1AWW 8, 1APL 6, 1EO 20, 1AMZ 149, 1AAE 57, 1AJK 1, 1AAL 6, 1XZ 1, 1DB 7, 1AKZ 48, 1ASU 19.

NORTHWESTERN DIVISION Everett Kick, Mgr.

7EK was QSO with South African O-A6N some 11,000 miles, which is believed to be the first communication from this district.

WASHINGTON—7FD, ADM—Spring evidently turns a young man's thoughts to something other than radio from reports for last month. 7BB leads the Division for traffic. 7AFO works As and Zs on schedules. 7DF, 7GB, 7TG, 7UO and 7AW report good traffic work. 7ABF and 7BY have shipped out as commercial ops. 7TT and 7AD, ex7AAX are going up north to pound brass at canneries. 7AD will be on the air soon. 7OY shot his third H tube. 7AIM, 7RL, 7UL and 7WQ are increasing power. 7GE is on with a 250. 7AIB, using an H tube on 80, reports good DX. 7NH works As and Zs on a 7½ watter. 7DC is refreshing his rectifier. 7UQ and 7OT are rebuilding. 7AG, 7NL and 7HO are on. 7PK and 7TX are new Seattle stations. 7DU gets out well with two 201A tubes. 7BO also does well. 7CS works As and Zs with a 210. 7VV is on occasionally. 7AAB is a new Everett station. 7GY and 7PZ have consolidated and are now 7VK. 7VL gets out using his counterpoise as antenna. 7OB is a new Spokane station on 40 and 80. 7AF will be back with us soon. 7TJ is a new station at Opportunity.

Traffic: 7BB 148, 7EK 97, 7AFO 62, 7GE 53, 7UO 30, 7DF 27, 7GB 25, 7TG 16, 7AW 15, 7ABF 10, 7NH 8, 7RL 6, 7BO 6, 7OY 5.

OREGON—7IT, ADM—Traffic took quite a slump this month. 7UJ will be on steady soon. 7AY, on account of poor health, is at the Open Air Sanatorium at Portland. 7AA added Chile, Tasmania and Alaska to his DX. 7SY is getting out real well. 7HB and 7OZ use KFUH circuit with H tubes. 7OK says if his H tube doesn't show some pep, he's going to use it as a detector tube. 7AKH is on occasionally. 7EO rebuilt both transmitter and receiver. 7AEK handles a lot of QTC with HU. 7PP is still off but when he comes back, it will be to handle traffic. 7LQ is rebuilding. 7FE has a new plotron. 7ND pushes out a tremendous AC sig. 7KY has a UX210 to replace his 5er. 7MF sent in a fine report for 7ACM who has been ill with smallpox. 7QJ is a new station reaching out well. 7NZ is having trouble with his transmitter. 7LS and 7MF set up a 50 using AC for plate supply at their High School. 7RW is contemplating a low power transmitter.

Traffic: 7AEK 41, 7OK 21, 7SY 16, 7AJQ 8, 7EO 5, 7IT 1.

IDAHO—ex7OB, ADM—7YA has seedules every day handling air mail traffic. 7PS was going fine with a new 50 watter when he blew his plate transformer. 7ST is starting up with a 4d coil on a 201A. 7BT is the chief op at 7YA so doesn't pound brass at home. 7PJ has gone back to Alaska. 7GW reports ND for too much sunshine. 7JF is using a

Hertz antenna with extra good results. 7ZN is on some when he can't see to play tennis.

Traffic: 7YA 60, 7JF 41.

MONTANA—7NT, ADM—The ADM is making a business as well as pleasure trip through the East and reports having a wonderful time. 7PU is the top-notch this month for breaking the old gag that DX couldn't be worked from Montana. 7ACI is inactive on account of deceased bottles. 7DD has a lo-loss transmitter in construction. 7ZU still reports heavy school QRM. 7AGE will be going as soon as he gets a new aerial working. 7FL is studying hard for he is expecting to graduate. 7BI would like a schedule with someone to send to him for code practice. 7JX uses a UX210 on 88 meters.

Traffic: 7PU 48, 7JX 20, 7DD 3, 7BI 1.

PACIFIC DIVISION

P. W. Dann, Manager Northern Section

THIS is the last report that the present Asst. Communications Manager for the Northern Section, Pacific Division, will forward to Headquarters, as my appointment expires April 30. I wish to take this opportunity of expressing my thanks and appreciation to ALL of you who have made the Northern Section what it is today. If you give my successor the same undivided support that you have given me in the past two years, the N. S. will be one of the largest in the Pacific Division.

Probably the most interesting achievement last month was the five day tests at Mt. Hamilton, conducted by the Santa Clara County Amateur Radio Assn. A message for the Chilean Observatory was delivered half an hour after receipt at experimental station 6SV. The answer to this was received by 6CKV last week. 6APS, 6CKV, 6AMM, 6BON, 6NX and 6OI are on the job every day. 6NX spent most of the month checking waves of amateurs and sending out cards to those below the band. 6BON is bothered by bad power leaks. 6CKV is handling traffic with Chile for the Lick Observatory. 6AMM has schedules every morning. 6OI put in a 250-watter and worked O-18R in Rhodesia, South Africa. 6BMW worked Chilean 8IJ and NQY in China. 6APS is another Meissner man and putting a terrific signal into Australia and NZ. 6CEJ just got a Commercial ticket and is back home pounding again. 6ALW is one ham that hasn't let Super DX get the best of him. 6AIH is QRW school. 6CLP is second highest traffic man. 6BVY has schedules with 7AY, this being a Naval Reservist and Army Relay Station. 6CIS has moved his set to Yosemite for the summer. 6CUL has changed from a fifty to a five watter.

Dist. 6—Adams advises things are slow around Eureka, as 6SA is off the air on account of remodeling his set. 6BWR is also remodeling and is going to use copper tube inductances. 6BAF received the belated replacement on his 50-watter and of course is pleased.

Dist. 7—Nevada—6UO, the only one reporting from Nevada, says there is very little activity, as the gang up there seem to have lost interest since the contemplated change in organization was announced.

Traffic: 6UO 33, 6CJD 3, 6CIS 14, 6CCY 3, 6BVY 23, 6CLP 52, 6ADB 3, 6NX 9, 6BON 12, 6CKV 15, 6AMM 80, 6OI 17, 6BMW 21, 6APS 30, 6ALW 4, 6AIH 2.

Southern Section

L. E. Smith, Manager

This month the gang held the biggest of any of the A.R.R.L. banquets yet held in the Section. Mr. Babcock journeyed down from Oakland to speak to us. The coming change in the traffic department was discussed and explained so that all might understand. A good time was enjoyed by all.

Dist. 1—6HU reports working RAM at Paete, Tahiti. 6AXU and 6AOY are new stations in Santa Ana. 6AOY is a 250-watter installed by 6APP. 6CGO and 6OP. 6FC says that U. S. mail is the only traffic route into Los Angeles. 6CHS has just returned from an op job on a tanker. 6AJM worked 38WW at Kobe, Japan, with a 7.5 watter. 6BQ keeps schedules with several p. 1. and u. stations. 6SB reaches England regularly. 6ZH is now one of the ops at a new 1000-watt B C station. 6OP, 6CNK, 6CGC, 6BAS all threaten to get on the air soon.

Dist. 2—QRN is getting so heavy on 80 meters that most of the stations are being forced to drop to 40. 6AEs set doesn't suit him. 6AFG is QSO hu often. 6BBV works 'em all from his new QRA and is putting in a 500-cycle MG. 6BCS has a portable set on Santa

Rosa Island. 8BHI is a new ORS on 40 meters. 6BJD keeps schedules with uu and pi. 6BJX is going to take a portable set on his vacation and try to keep his schedule with pi on 10 watts input. 6CAH filters his sync and gets pure DC. 6CND is an op at KSMR now. 6CTO reports trying a Hertz antenna. 6DAH is on with a 7.5 watter. 6IH is suffering from a soft 50. 6UT says he can't work



Miss Flora Turner 6BXA

YLs and radio at the same time. pi-1CW is going strong with a flock of schedules. 6CGK is reported to have a mysterious schedule with a certain WI at sea. 6CAE has been QSO all continents but Europe, with his 50. 6AJI is getting better after getting rid of a big stick and a flock of guy wires. 6RN worked pi and Japan. 6ML is now 6BXD. As a result of his training, his YL now has a license and will soon be on the air. 6BLS has a message at the local American Legion post. 6CQA has finished his new transmitter and is doing good work. 6AHP is taking traffic from pi. 6BUR can't keep on the air and be SM and go to college at the same time. 6BUW is experimenting as usual. 6CSS has fallen for the YLs but promises a comeback. 6CIX has a new Chevy and we suppose will turn sheik now.

Dist. 3—6BAV is the new DS. 6BVM is handling traffic on 80. 6KB, 6AJJ and 6HAV are on every am. Some new ORS are promised soon.

Traffic: 6AE 12, 6AFG 61, 6BRV 37, 6BRS 10, 6BGC 20, 6BGV 3, 6BHI 20, 6BJD 82, 6BJX 355, 6CAH 11, 6CSW 84, 6CTN 75, 6DAH 6, 6IH 2, 6RF 40, 6UT 4, 6BC 23, 6DAA 18, pi-1CW 326, 6CGK 11, 6CAE 27, 6US 10, 6BVO 16, 6ANI 27, 6RN 40, 6ML 97, 6BBQ 50, 6BLS 109, 6CMQ 68, 6BTM 30, 6AKW 3, 6CQA 10, 6AHP 38, 6CSS 2, 6BUR 18, 6BQ 175, 6AJM 121, 6SB 9, 6BAS 5, 6CGC 3, 6NW 9, 6HU 8, 6APP 5, 6EC 8, 6BVM 7.

ARIZONA—The ADM, 6ANO, is now busy on a cattle ranch but 6AMW is keeping the set on the air. 6CUW is still knocking 'em over, having now worked So. Africa. 6CBJ says he can hear 'em from all over the world using his 300-foot receiving antenna. 6YB works everything possible. 6ARX gets out well. 6DCQ is a new station. 6RS is still doing his stuff with the traffic. 6AMW, 6BTV, 6AMZ, 6PZ and 6GS will be on soon.

Traffic: 6ANO 149, 6CUW 135, 6CAP 40, 6YB 8, 6CBJ 28.

Hawaiian Section K. A. Cantin, Manager

Due to an epidemic of BCLitis local amateurs are being accused of causing considerable interference to the broadcasting fans. The matter is being handled by an interference Committee but it is hard to convince the BCL that the amateurs are willing to cooperate and eliminate interference—providing they are causing it.

Message delivery from Hawaii to the mainland is very disappointing due to the lack of delivery. Please, fellows, make an effort to relay or deliver messages from the Hawaiian Islands.

6BUC broke all local records for traffic handling, and is voluntarily observing the quiet hours. 6AFF had trouble with his 250 watt tube. Established contact with pi-CD8 and 1ER. 6CLJ with a power input of 88.5 watts worked South Africa O-ASB. 6CFN is working with 800 watts input—contact was established with G-5LK. This is the first time that local stations have communicated with England. 6BDL, another new station in our ranks, has established communication with pi-3AA and 2AMG.

6CST using 500-cycle is putting out an excellent signal. 6TQ confines his work to the 6th district. Australia and NZ. 6CFQ, with a ten watter, is going after the Australian and New Zealand stations. 6ASR is about QRV to test his new 500-watt CW and phone set. 6ASE left for a trip around the world. On reaching Calif., the first lap of his trip, the sign of all the amateur sets made him homesick. He is back in Honolulu again. 6OA, 6CMH and 6DBL are on the air occasionally. Capt. Adams and 6DCF working at FX1 have been experimenting with phone on the low waves. Using phone, contact and communication was carried on with KFUH, who was somewhere near New Zealand. Contact was also established with NKF.

Traffic: 6HUC 292, 6AFF 87, 6CLJ 42, 6CFN 37, 6BDL 36, 6TQ 22, 6CST 14, 6CFQ 13, pi-3aa 125.

ROANOKE DIVISION W. T. Gravelly, Mgr.

WEST VIRGINIA—8ALG got R-9 report from New Zealand. 8AUL worked f8ZO and f8BX several times. SCDV is handling nine-tenths of the messages and getting them through too. 8BSU is experimenting with 8AKZ. 8BSK is coming on again on 40. 8DOH is a new station in Wheeling. 8BJG worked TRU and 7OK, using one UX-210 with 4 watts input. 8BXP, 8AWV and 8CYR are very active. 8ALG is contemplating big tubes now. 8AMD says he has a 2 ampere YL! The Huntington Transmitting Amateurs Club claim the call 8BFW. 8AMD is experimenting with crystal sets. 8SV has schedules with 8GZ. 8IT is operating on a steamer on the Lakes for the summer. 8SP and his pardner 8CSR are going good. 8CSR and 8ACZ are new ops. 8CSR is visiting Wheeling. 8ZW will probably be on the air soon. 8ZW is in Florida overhauling a BC station.

Traffic: 8SP 14, 8AUL 17, 8CDV 37, 8BSU 8, 8DOH 2, 8BJG 21, 8BXP 3, 8CBR 68, 8AMD 13, 8SV 51, 8AYP 238, 8DRR 32.

NORTH CAROLINA—Dist. 1—4RF has been appointed an Army Amateur Station.

Dist. 2—4TS has been experimenting with BCL sets. 4MI has had the "fu" for a month. 4GW lost his ORS for not reporting.

Dist. 3—We are very sorry to lose one of our best stations 4TJ, now operating at WDBO. 4BX has been experimenting with antennas. Both operators at 4AC gave 4JR the once over. 4JR continues to handle a lot of traffic on schedules.

Dist. 4—4RW has QRM from school work. 4WE has a new 70 foot cage and a new power supply. 4NT has a 201-A.

Traffic: 4TS 11, 4MI 67, 4BX 19, 4JR 180, 4WE 4.

VIRGINIA—Dist. 1—3MK is keeping schedules with 3CO. 3CKA now operates on 80 and 40. 3QF worked KEGK. 3AHL is using a five watter till his "H" tube arrives. 3SB has dissolved partnership with 3AHL. 3TI is still working as usual.

Dist. 2—3BMN is coming back on the air with a bang. 3ATB is just back from Miami. 3AUI is QRW with shop work. 3NO is working hard to get the xmitter going. An active radio club is now operating in Richmond. Seems there is some life in Richmond and we have a report that a flock of the old timers are coming back. 3MO and 3TJ will be back on the air shortly. 3AJR hasn't pounded the key since he came back from the hospital. 3AEV worked 7GV using one fiver. 3AIK is erecting a sixty foot mast.

Dist. 3—3IW on again using remote control and break-in. 3KG has been logging quite a few foreign stations. 3AAI is on the air at present. 3BGS is working on 39 meters. 3RX has schedules with 4TG every Sunday afternoon.

Dist. 4—3CKL has made a trip to Washington but no report as to whether he got in jail or not. 3BZ suggests the Division adopt a standard wave for division communication. 3CA was QSO 4DA for the first time in three or four years. 3BDZ is hitting the high spots.

Traffic: 3CKA 13, 3CKL 57, 3RX 2, 3IW 6, 3BGS 12, 3MK 48, 3QF 74, 3AHL 6, 3TI 6, 3CA 0.

ROCKY MOUNTAIN DIVISION N. R. Hood, Mgr.

COLORADO—9QL has been working hard. 9CAW reports he is getting through to NZ and Australia regularly now. 9WO shot 3 S tubes and what was once a perfectly good high voltage transformer. 9CAA reports that things have improved as to QSR west on 80 meters which is his normal wave. 9CDW

works out good now with his 7½ watter. 9EAM is still hitting high with the traffic. 9AJQ discovered it isn't always the YL who walks home. No, you got him wrong. He took the YL home but when he decided to go himself, the cars had quit running out where he lives and he walked 4 miles, in a snow storm to get home. 9DQG is busy running a broadcasting station. 9OO gets his report in just as this is being written.

Dist. 1—9DVL is rebuilding. 9DEU reports that he kept his family in touch with the condition of a relative in Los Angeles during a serious illness. 9AOL is rebuilding.

Dist. 2—The D.S. reports that the gang are not reporting regularly. 9CHD says that the thrill a 5 watter got out of its first weeks working DX must have affected its heart, as it died very suddenly. 9DZY will probably leave the state in the near future. A couple new stations are expected on the air soon. 9DUI learned along with a couple of other Denver hams that it costs money to ride in a taxi.

Traffic: 9ADI 60, 9DFH 8, 9CDE 49, 9CHD 1, 9EAE 10, 9EAM 30, 9WO 15, 9CAW 7, 9QL 2, 9OO 58, 9CAA 119.

UTAH—6CVA is a very active station. 6FM reports moving his transmitter to a new radio shack and is building an additional phone set. 6BTX keeps schedules with 9CAA and 6AJP twice a week. 6BUH and 6ZT have been too busy with other work to handle any traffic. 6CRS's transmitter is doing good work on 42.3 meters. 6RV heads the list for traffic handling this month.

Traffic: 6BTX 71, 6CRS 8, 6FM 7, 6RM 6, 6RV 143.

SOUTHEASTERN DIVISION A. D. Trum, Mgr.

PORTO Rican hams are doing splendid work with foreigners. Florida hams are coming back with stamina and vigor never heard of before. Georgia is the home of wide-awake DX hounds. South Carolina is doing its share. Alabama hams are the cat's whiskers. Alabama lost one of her best amateurs in 5AC who went aboard ship for a while.

PORTO RICO—Atmosphere conditions in the present month have not been of the best and our gang is having difficulty at steady communication with Europe and the Mainland. 4KT has done the best work handling most of the U. S. Traffic. 4SA has done most of the South American and European message handling. 4JE, 4BJ and 4UR have all been doing their bit to boost our traffic total.

Traffic: 4KT 18, 4SA 16, 4JE 10, 4UR 9, 4BJ 3, 4RL 2.

GEORGIA—Georgia Tech Radio Club is going strong and is now an ORS. 4AV has 6 good ops ready for traffic all the time. 4AAD works France, England, and Australia regular. 4AAE is piling up a long list of DX on a 7.5er. 4CC, portable of 4RM worked c8GG on a 201-A with 2 watts input. 4FC is now with the Power Co. and has a 250 on 20 meters there. 4GO is the fone and low power station of 4AAE. 4HW is still expounding theory for "Dad" Wills at the Power Co. 4HO has been sick but is back at the key again. 4KV is now on fone on 80 with FB signs. 4MC, portable of 4AAD, is making a good record. 4KW is bursting holes in the ether with a 5er. 4OA is heard occasionally but is about out of the game. 4PX is a new station. 4RM is about the same as usual. 4SI is the most consistent station in town doing good DX. 4XJ is the new station of the Ga. Ry & Power Co.

FLORIDA—Our new ADM is just getting acquainted with the boys and says he is going after good operating, fine traffic handling and rag chewing. He is going to make Florida the best state in the S. E. Div. 4DM did fine work this month. 4BL has been on 40 most all the time. 4QY just made himself a new B-T receiver. The following are on regular: 4DD, 4WB, 4BL, 4DF and 4UA. On account of the change in ADMs in the past few months, quite a few good reports failed to get in. All stations in Florida are requested to send in their reports to Mr. Grogan of 4QY. 4OB is working fine. 4TV is still with us when he has time.

Traffic: 4OB 79, 4TV 1, 4DM 79, 4BL 82, 4QY 34.
ALABAMA—The ADM has been exceedingly busy with business this month. 5ARJ is QRW with school. 5QP blew a perfectly good plate supply due to misplacement of some of the wires. 5AIW works out on fone FB. 5ACM seems to have lost interest. 5GP will open a set of his own at Auburn this summer. 5AWF is rebuilding. 5AX is the most consistent station in Birmingham. You can hear 5VV calling

and chewing the rag most any time. 5AMH and 5UP are heard once in a while. 5AC was on the air more than any other Mobile ham this month. 5AC offered a prize to the station handling the most traffic this month. 5DL won it. 5DL shot his H-tube and was only on one week this month. 5LC shot his plate transformer and reports ND. 5QF is still on with his fiver. 5QF also handled a message this month. 5QK was not on much on account of his OM having to sleep in his room and can't stand the clicking of a relay. 5AC-QF has erected a portable set on 40 meters under the auspices of the AJAX Athletic Club. 5AAD heard 11GW. 5AR has been pretty busy lately and hasn't had time to do his stuff. The boys in Montgomery have just finished fixing up a club set at 5NL's house. 5ADA is working on all bands. 5AJP is heard often working 40 meters but says that 80 is the best working band. 5ATP was laid up two weeks with the mumps. 5DI and 5WI are pounding the brass at 5YB.

Traffic: 5AC 18, 5AAD 4, 5ADA 50, 5AJP 20, 5ATP 20, 5AX 51, 5AWF 10, 5DL 21, 5QF 1, 5QK 10, 5VV 14.

WEST GULF DIVISION F. M. Corlett, Manager

NORTHERN TEXAS—The report for this section was lost!

SOUTHERN TEXAS—Activity has not been so great this last month. Traffic figures seem to decline. 5MS reports that he has handled no traffic due to building a new shack. 5HS and 5VL visited the ADM Sunday. 5HS has borrowed a chemical rectifier and is back on the air. The RI paid San Antonio a visit recently and complimented the Bexar County Radio Assn. for their good work. 5ZAI has rebuilt his set using a tuned plate and grid. 5APM has also been moving his shack.

Traffic: 5EW 2, 5ZAI 30, 5HS 4.
OKLAHOMA—Springtime, fancies, the old fishing hole and numerous other diversions have crept in and reports were somewhat lax this month.

Dist. 1—5AGN reports very bad QRM from school. 5APG worked As and Zs three times with his new UX210. 5AAV works consistently with the far east. 5APG and 5AAV have been working on a group of photographs of Oklahoma City stations and hope to have them in QST soon. 5ARQ, 5ASW and 5AVT are bent on putting Newkirk on the map. 5ANL, 5VH, 5ADO, 5ASK, 5DQ and 5ATO recently passed amateur first grade examination with an average of 85%. 5APC is now QRV at Ponca City. 5ADO-AML is very QRW with school. 5ABO is on frequently now. 5ATK is off the Yis for life and is getting the old wreck back on the air more frequently. 5SW spent most of his time trying to run down a "hot check" 5VM gave him. 5ATO is a fireman and sometimes has to QRT right in the middle of a message to put out a fire.

Dist. 2—5GJ has been doing his stuff with a 5er while waiting for the big Esco M. G. to arrive.

Dist. 3—5JU appears to be the only station operating.

Dist. 4—5ED-5AVF is busy trying to get his station perking decent. 5AJM reports traffic dull but plenty QRM from YL. 5AGO has been doing some good work. Rumors are flying thick and fast that 5VM has gone to Old Mexico. Before the present ADM fades out of the picture, let's have at least one more keen report for next month.

Traffic: 5APG 12, 5SW 20, 5AGN 6, 5ADO 2, 5ANL 31, 5ATO 23, 5ABO 16, 5JU 15, 5ED 5, 5AJM 10.

CANADA

MARITIME DIVISION W. C. Borrett, Manager

ARRANGEMENTS are being made in the Division to reorganize on the Section System with each Section Manager reporting direct to the CGM. It is hoped that with this system that each section will show more pep and try to beat other sections out in the matter of members and traffic or communications activity. 1ED put over a nice bit of work by means of a schedule with a Boston amateur reporting the result of the Boston Marathon Race in which his fellow townsman distinguished himself by winning the race. 1CX and 1DM are the two other CB stations working mostly on schedule. 1BZ of PEI is on with a strong signal on 40 meters. 1AI the

DC gent has three schedules with USA hams and complains of lack of 52 meter signals. All NB stations are on the air but little traffic. 1DD has QSO'd two more Europeans on 52 and has schedules with c8WM, who with B-battery 200 volts works 1s, 2s, 3s, 5s and 4s in USA. 8AR reports working England 47 days out of 100 and has heard all kinds of strange ones. The Maritime Convention was held in St. John and a report will appear in the editorial space of QST. This traffic report may seem small but until we can get more members we cannot get more space. Listen for 1DD at 7pm Saturday and Sunday on 55 meters for weekly QST. 1AK stands out this month working Denmark, France, Portugal Italy and New Zealand, in one week.

Traffic: 1DD, 9, 1AI 8, 8AR 4, 1CX 3, 1ED 3, 1AK 31.

ONTARIO DIVISION

W. Y. Sloan, Manager

GLISTENING INSULATORS ANGER NEIGHBORS WHO MAKE HAM REMOVE OFFENDING SPARKLERS. AMATEURS ASSIST DURING SLEET EMERGENCY. INDOOR AERIAL AT 3FC WORKS HAWAII TWO-WAY. ANOTHER ROTAB INITIATION TO BE HELD. 9AL WORKS BYRD ARCTIC EXPEDITION.

CENTRAL ONTARIO—3WG writes that he cannot get out any more as he is so surrounded with BCL serials which seem to have a shielding effect. We had great hopes when 3DS came on the air again, but he has neither been able to write or work the set lately on account of scarlet fever. The activity in Toronto certainly saves the situation for the district. 9AL again takes the lead in communication with Arctic boats by working the Byrd Expedition, KEGK. His contact with f8RFB marks the first communication of the year from here with France. It has been extremely difficult to work Europe until recently this season, the Aussies being heard much more frequently than the European amateurs. 3EL stepped out with the messages and further distinguished himself by his emergency work during the recent sleet storm. 3CK is a typical Toronto station—low power, Hertz, 52.5 meters and the odd bit of traffic. 3MV is our star station for the month, having worked England, Porto Rico, Mexico and Newfoundland. He is candidate for ROTAB membership. The Toronto stations did great work during the sleet storm that brought down practically all the telegraph wires. 3FC lost his aerial but rigged an indoor one and proceeded to work California, Hawaii and Australia with it. 3FC works consistently with c1AR on 20 meters. 3BR, 3AJ, 3BL, 3BY, 3AZ, 9AG and 9BJ are other locals that are heard pounding away early and often.

NORTHERN ONTARIO—3GG has arrived down on the short waves at last. 3HP has had to take down his antenna system, because the neighbors who are all ardent BCLs, objected to the reflection of the sunshine from his plate glass insulators. 3NI has lost his second op but it took the Aurora to interfere with the regular schedule with 3FC. NI kept the hocky fans posted during the playing of the final game of the amateur championship of the world which was played at Toronto. G5AX reports 3NI R6 on the 20-meter band at 19.00 GMT.

EASTERN ONTARIO—3XL has secured his ticket and is all set to sail the briny. 3DO has an H-tube perking and in addition to leading the Eastern Division in traffic, has worked some foreign stations. 3MP is also working DX with an H-tube. BCLs are on the track of 3KT whom they blame for poor reception. Suggest they page Mr. A. Borealis who has been active on super power. 3XM is suffering an attack of YLitis. 3JL sounded the last post over another flyer.

SOUTHERN ONTARIO—3ADY is contemplating taking the drop to 40. 3ABG is reaching out fine on his 50. 3ACO is selling out. Who is she, OM? 3DH leads the traffic hounds again. 3DU has a real tuner and can now say "Nil Hr" in ten languages. 3FU has a liver on 40, and a fifty on 80. 3GX is ex 3UJ of British Guiana fame. New live-wire ham club in London. 3GY banging away on 20 and 40. 3IA QRW but coming back on low power. 3MF thinks a diet of 4400 would agree with the fifty better than the 2200 he is now feeding it. 3TB is also selling out. 3VW says 40 meters is not up to the label on the bottle. Lost strayed or stolen—none other than old 3XL. 3ZD is QRW school work. 3ZB lost his bottle. 20 meters proved too much for it. c1BV is now with the St. Catharines gang. A real ham from a real ham town—Halifax.

Traffic: 3BEL 60, 3FC 53, 3CK 35, 3MV 22, 9AL 23, 3BY 21, 3BR 19, 9BJ 21, 3BL 9, 9AG 8, 3AZ 6, 3AJI, 3NI 58, 3DO 73, 3JL 44, 3AFP 23, 3KT 11, 9CC 6, 3DH 21, 3ABC 11, 3KA 6, 3ZB 2, 3FU 1, 3KP 1, 3ZD 1.

QUEBEC DIVISION

Alex Reid, Manager

THE Old Ham fever seems to be spreading, there will be four new notes on the air shortly. Spring seems to have dulled the old game somewhat, but 2CG, 2AL, 2AX, 2CB, 2HV and 2BE are still working hard for traffic and DX. 2CG has a schedule with 2ZAC Wednesday and Saturday nights and carries on tests on various wavelengths. 2BE worked a BZ and Z station. The Westend Gang have formed a new club and are collecting funds for the erection of an up-to-date shack, where technical meetings and Ham-fests will be held. During the recent storm in Ontario when all wires between Montreal and Toronto were down for some days, 2CG and 2BE pushed through some real traffic and handled information for the Press. 2CB and 2AX have been carrying on some fine experiments with a portable transmitter and receiver and have interested the Gang to such an extent that we understand most of the boys who own drivers will equip them with portable sets this summer. 2CN is going out of the game and is selling his valuable equipment. 2BG is moving so we will miss old Tommy's flat for at least a month. The DM would like to have applications for ORS certificates and applications for two OBS stations.

PRAIRIE DIVISION

F. E. Rutland Manager

SASKATCHEWAN—Some fellows in this district can't seem to learn to write or else have paralysis. 4AL is putting 350 volts into a Myers dry-cell tube and is QSO Toronto and the 1st U. S. district. 4AC is also putting a fine signal in the air and was QSO Toronto every night for a week. These two stations are working schedule on 160 meters and invite others. 4FA is working FB on 80 meters with 4AQ. Both of them with 201A's and 200 volts on plates. 4AQ is working 1000 and 1500 miles consistently. He worked 12 stations in one night. He thinks he is using too much power and is changing to a 199 tube. 4FA got a QSL card from g6CJ and his hat no longer fits his head. "Dad" Maynard of 4CB has worked c1AR and c1EJ and is trying 20 meters. 4AV is married. 4AO is on occasionally on 52.51 meters and is gradually getting his 250 bottle in shape. 4HH is on consistently with 250 watts. 4BF is going strong but finds 600 volts rather meagre for his H-tube but gets R5 on 20 meters in Los Angeles.

Traffic: 4HH 15, 4BF 8, 4AQ 11, 4AC 11, 4CB 8. MANITOBA—The gang are showing much more pep but still a lack of stations working on 52.51 meters. Several stations failed to report this month, and are warned that two such failures mean a cancellation of their ORS certificates. 4DE has been experimenting with various types of antennae and has little traffic to report. 4DY has a regular schedule with c3NI. 4EA's traffic total is small. An old-timer 4DT, has opened up again and is on 40 meters and works consistent DX. 4DF has at last got his 10 wattor to perk with a good note on 40 meters. 4AW is working with a UX210 and S tubes and is looking for some schedules. 4BT hands in a nice traffic total. He is minus a tube but will be QRV when he gets a UX210 delivered. 4AD has opened up with 10 watts. 4DU is using AC supply while getting a rectifier lined up. 4EH has rebuilt his set and has erected a new antennae. 4DW works on four wavelengths with very good results. He handled a third word message from the Mayor of Chatham. 4DY will carry on with the OBS while 4DE rebuilds.

Traffic: 4DE 6, 4DY 26, 4EA 8, 4AW 4, 4DW 14, 4DF 2, 4BT 42.

VANALTA DIVISION

A. H. Asmussen, Manager

THE DS for Vancouver district complains of inconsistent operation of the stations in his district but 5CT manages to keep schedules and therefore has the best traffic report in the Vancouver district. 5GF reports 52 meters FB. 5AS threatens to go back to 80. 5GO is stepping out FB, having landed on the third harmonic and should be the next appli-

cant for WAC honors. We hope to have two more stations reporting next month—old 5HG and a newcomer. 5HK having been laid up with a bum arm, is again going strong on 40. 5AW is stepping out FB with 201-A's. 4CL reports being QRW getting the family PHORD in resonance. 4AH is going strong and sends in a fair message total. 4AK paid the DM a visit and expects to get out better soon. We have a new comer at Medicine Hat that should be stepping out by the time this gets into print. 4AF tops the division in traffic handled working on both 40 and 80. 4AL's traffic suffered due to the loss of a stick. The OW at 4DQ keeps the OM busy charging batts and hands in a fine message total. 4GT got his WAC certificate but hasn't been on much due to OIL. 4IO managed to run up a better traffic total this month and keeps a schedule with the coast twice a week. 4CC and 4CG are moving a little traffic on 40 meters. 4AG finds time to do a little operating on the key and the mill. The AREA gang have novel QSL cards—have you received one?

Traffic: 4AF 25, 4AH 4, 4AL 6, 4DQ 10, 4GT 4, 4IO 12, 5GF 5, 5GO 8, 5CT 10

Late Reports

5DW is on 20 meters. 5OT will be on about June 1. 8AOR is on 80 meters. 8BQA worked GOC several times. 8BYN is experimenting with filter and keying systems. 3BO is inactive. 1BEH, 3KY, 9ALK and 1AER are QRW. 1EF hopes to have a spark coil cw set soon. 3ACY has been sick. 9HP was heard in Mauritis Islands. 9BHM is on again.

Traffic: 5DW 6, 8BQA 19, 8BYN 44, 8KY 10, 1BDH 4, 1EF 2, 1AUC 7, 1AER 8, 9HP 1, 9OX 1, 9ALK 80, 9BHM 5.

Late Traffic Briefs

On May 4, 6XBR, the portable station of Warner Brothers Motion Picture Studios (March QST, p. 81) started from Hollywood for a tour of the United States. A wavelength in the 40 meter band will be used for amateur contact. Orders and reports will be sent regularly via amateur radio. All amateurs are requested to keep an ear open for 6XBR and 6KY (the base station.) A daily message is sent to 6KY at 9:30 P. S. T. after establishing contact. A \$500 award will be made the amateur turning in the most complete and correct copy daily. Second prizes of \$200 and \$100 are worth trying for. Further prizes will be given for the best story of the trip and for reporting the signals from the greatest distance. The Section Manager of the Southern Section of the Pacific Division and two League members picked by him will serve on the committee of eight in awarding the prizes. Reports by letter or card should go to Radio Dept., Warner Bros. Studios, Hollywood, Cal.

During the tour of 6XBR, a monthly program, conducted by the Southern Section gang of the A.R.R.L. will be put on at KFWB. The first program, May 3, was a great success. There was plenty of talent and lots of the necessary pep to put it across! A. R. R. L. songs and stunts were balanced with interesting talks about the amateur, his traffic work, his DX, his apparatus, and his position as a radio technician. FB, everybody!

Midwest Division Convention

ROUNDLY one hundred hams from at least six states assembled at the Campus of Iowa State College at Ames for the annual Midwest Convention and Radio Short Course, on Friday, April 16th. In the afternoon 9DNG, Fergus McKeever, of Lawrence, Kansas, started the ball rolling with his talk on International Communication. Upon the conclusion of this, Mr. Porter H. Quinby, Midwest Division Director-Manager, took the stand and told all about the general condition of the A.R.R.L., the significance of our worthy organization, and the recent changes made by the last Director's meeting. Our DM and Director is an enthusiastic and sincere supporter of the League and deserves a great

deal of credit for the sacrifices he has made and is making in this regard. Next Mr. E. W. Phillips, 9BGK, of Omaha, told us about filters, their construction and usage. The manner in which he presented his subject made it easily understandable to all present, even the young squirts.

The banquet was pulled at the Cranford Banquet Hall over in "Campus Town." There was not a single empty chair at this festivity. Between courses elections were held on the "most popular ham," "best brasspounder," etc. 9CCS copped the former distinction, while Fred Schnell and Quinby tied for the latter. A tie would not do, so two pieces of pie, exactly alike, were obtained, the contestants blind folded, and set to work. Quinby finished a little over a mouthful ahead of Schnell. After the dinner moving pictures were shown of Trans-Oceanic and Marine Radio. The prizes were then awarded. Some very fine pieces of ham and BCL apparatus were given away by courtesy of the manufacturers, all of whom are consistent advertisers in QST. 9BSL snaffed first, with 9DEX, 9CCS and 9BOS coming along as 2nd, 3rd and 4th. Many other prizes were given, their number prohibiting mention. C. T. Norton, of 9CL and the Campus Radio Club, was an able toastmaster. It kept him busy, too.

Saturday's functions commenced with Fred Schnell's very interesting description of his trip with the Navy. The writer takes liberty to represent the whole Midwest gang in thanking Fred for coming to Ames and lending us his spirit in Amateur Radio. It is hoped that the ideals and spirit shown by him will incorporate themselves in all those who were present, to champion and perpetuate our A.R.R.L.

Arthur Collins, 9CXX, of Cedar Rapids, the next speaker, described a transmitting and receiving circuit, each using two tubes, the transmitting circuit generating equally both halves of the R.F. cycle, and the receiver rectifying both halves of the R.F. cycle.

The afternoon was spent on the subject of brasspounding. Schnell and Quinby gave very good talks, assisted by others.

Thanks are due the Campus Radio Club and the Alpha Sigma Delta frat for the splendid program arranged. All meetings were presided over by Mr. Don E. Watts, ADM of Iowa, who handled the program in a very creditable manner.

—Louis R. Huber 9DOA-9AEJ

