

QST

Devoted entirely to **AMATEUR
RADIO**

Published by the
**AMERICAN
RADIO RELAY
LEAGUE**



The "hundred footer"

20¢

APRIL 1924

Hyde E. DARR 8ZZ

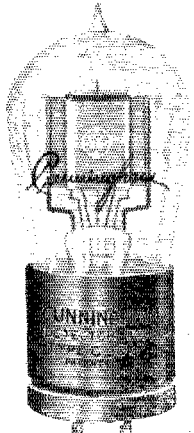

C-300—6 Volts Gas Content Detector \$5.00

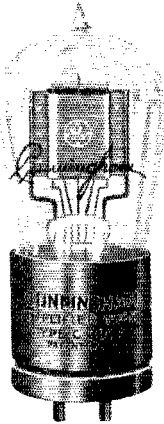

C-301A — 6 volts $\frac{1}{2}$ amp. amplifier \$5.00



C-12—Similar to C-11 with standard base \$5.00



C-11 — 1.1 Volt amp. Dry Battery Det. and Amp. Special Base \$5.00

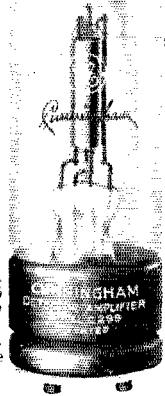

C-299 — 3 Volts. .06 Amp. Dry Battery Det. and Amp. \$5.00

The complete line of Cunningham RADIO TUBES

FOR EVERY TYPE OF RECEIVING SET

WHATEVER type of receiving set or circuit you are using—one or more of these five Cunningham receiving tubes will be ideal for obtaining maximum distance reception with perfect reproduction of both voice and music.

Three of the five tubes are designed to use dry batteries for filament lighting. C-299, the latest development in Radio Tubes, is compact in design and highly efficient in operation as a radio frequency amplifier, a detector and as an audio-frequency amplifier. When used for the latter purpose, the output of two stages is sufficient for the operation of a small loud speaker.

The most remarkable feature of this tube is the new patented filament used which draws only .06 amperes at 3 volts.

C-11 is a dry battery tube with a special base for use in sets having special sockets. It is a good detector and audio-frequency amplifier. The filament is lighted from a single dry battery and draws .25 amperes.

C-12 is identical to C-11 in operating characteristics, but is mounted on a standard base to permit the use of a dry battery tube in sets equipped with standard sockets without the aid of special adaptors.

Whenever storage battery supply is available for filament lighting, the C-300 will be the best tube to use as a detector because it is the most sensitive for the reception of distant and weak signals.

Under the same condition, C-301A will be the best tube for amplification at other ratios of audio frequency, because it gives greater gain per stage than any other tube on the amateur market. The new patented filament used, similar to that in C-299 draws only .25 amperes at 6 volts, reducing the necessity of frequent storage battery charging.

Patent Notices Cunningham tubes are covered by patents dated 2-28-28 and others issued and pending. Licensed for amateur, experimental and entertainment use in radio communication. Any other use will be an infringement.

The care and operation of each model of Receiving Tube is fully explained in our new 50-page "Radio Tube Users Book". Copies may be obtained by sending ten cents to our San Francisco office.

H. J. Cunningham Inc.

Home Office 182 Second St. 154 West Lake Street
San Francisco, Calif. Chicago, Illinois
30 Church Street
New York City, N. Y.

Here — the new Radiolas!

*New Triumphs of Radio Invention—
New Performance Records*

"There's a Radiola for every tune"

\$35 to \$425

	† Model	Price	Approximate Range	Type of Antenna	Degree of Selectivity
	Radiola III With two WD-11 Radiotrons* and head telephones	\$35	Up to 1500 miles with headphones. Local stations on Loudspeaker.	Outdoor or indoor antenna.	Improved selectivity. Minimum radiation.
	Radiola Balanced Amplifier To be used with Radiola III. With two WD-11 Radiotrons.*	\$30	Gives Loudspeaker operation with Radiola III up to 1500 miles under favorable conditions.	Outdoor or indoor antenna.	
	Radiola III-A with four WD-11 Radiotrons,* head telephones and Radiola Loudspeaker.	\$100	Loudspeaker operation up to 1500 miles under favorable conditions.	Outdoor or indoor antenna.	Improved selectivity. Minimum radiation.
	Same without Loudspeaker.	\$65			
	Radiola Regenoflex with four WD-11 Radiotrons,* and Radiola Loudspeaker.	\$206	Loudspeaker operation up to 2000 miles under favorable conditions.	Outdoor or indoor antenna.	Extraordinary selectivity. Non-radiating.
	Same without Radiotrons or Loudspeaker.	\$150			
	Radiola X with four WD-11 Radiotrons.* Loud speaker built-in.	\$245	Loudspeaker operation up to 2000 miles under favorable conditions.	Outdoor or indoor antenna.	Extraordinary selectivity. Non radiating.
	Radiola Super-Heterodyne with six UV-199 Radiotrons* and Radiola Loudspeaker.	\$286	Loudspeaker operation up to 2000 miles with internal loop. With external loop up to 3000 miles under favorable conditions.	No antenna. (Concealed small loop built into set.)	Super-selectivity. Non-radiating.
	Same without Radiotrons or Loudspeaker.	\$220			
	Radiola Super-VIII with six UV-199 Radiotrons.* Loudspeaker built-in.	\$425	Loudspeaker operation up to 3000 miles under favorable conditions.	No antenna. (Concealed large loop built into set.)	Super-selectivity. Non radiating.

† All Radiolas sold without batteries.

* Only dry batteries used.

Radio Corporation of America

Sales Offices: 233 Broadway, New York

10 So. La Salle St., Chicago, Ill. 433 California St., San Francisco, Cal.

Send this coupon for an illustrated booklet that tells the story completely, with detailed description of every set.

RADIO CORP. OF AMERICA
Dept. 294 (Address office nearest you)
Please send me your new free Radio Booklet.

Name _____
Street _____
City _____ State _____

Radiola

REG. U. S. PAT. OFF.

Get distance that everyone can enjoy



LET the whole family hear the announcer's "This is station ZYX, The Voice From 'Way off Yonder!" They can—by adding BALLANTINE Radio Frequency to your present outfit. Providing, of course, that you have a loud speaker. The voice or music will be clear and strong. And you'll find it easier to separate the various stations. Furthermore, squealing and distortions may be entirely eliminated.

Any standard set

One or more BALLANTINE units may be hooked in between any standard receiver and its audio amplifier—as shown above. Easy changes in wiring adapt it to regenerative, non-regenerative and even crystal sets. Besides, to

reflex circuits the BALLANTINE brings the advantage of tuning each stage. Notable results have been obtained in the One-, Two-, and Three-Tube Reflexes as described in *Radio Broadcast*.

All wavelengths

Pure tones at maximum volume for the number of tubes employed are assured by the *continuously variable* feature of the BALLANTINE transformer. For, by turning only one knob, this instrument tunes sharply throughout the range of 200 to 600 meters. Pigtail connections and full shieldings prevent stray noises. Theory and details of construction will be furnished to those interested in our 25-page booklet, *Radio Frequency Amplification*.

A special service

Every user of BALLANTINE VARIOTRANSFORMERS is entitled to the experience and advice of the engineering staff of the Boonton Rubber Mfg. Co. Try the instrument first. Then, if there's anything you don't understand, write, giving full details of your complete outfit.

Complete radio frequency amplifier unit with socket \$15.00 and rheostat.
Transformer only for \$9.60 panel or base

At dealers or postpaid

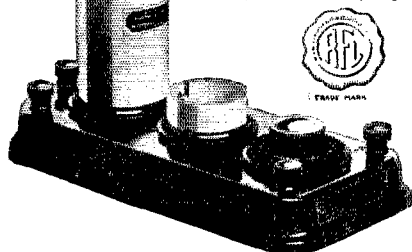

BOONTON RUBBER MFG. CO.
Pioneers in Bakelite Moulding

124 Fanny Road, Boonton, N. J.

THE TRAFFIC DEPARTMENT, A.R.R.L.

ATLANTIC DIVISION

Manager	C. H. Stewart	St. David's, Pa.
A.D.M. D. of C.	A. B. Goodall	Washington
A.D.M. Maryland	G. L. Deichmann, Jr.	1824 Ingleside Ter., Baltimore
A.D.M. No. N. J.	A. G. Webster	Irvington
A.D.M. So. N. J.	H. W. Densham	440 Washington St., Collingswood
A.D.M. East. N. Y.	E. M. Glaser	845 E. 13th St., Brooklyn
A.D.M. West. N. Y.	S. Woodworth	425 Brownell St., Syracuse
A.D.M. East Penna.	J. F. Rau	2085 E. Kingston St., Philadelphia
A.D.M. West. Penna.	P. E. Wiggin	5106 Liberty Ave., Pittsburgh
A.D.M. Delaware	H. H. Layton	305 Washington St., Wilmington

CENTRAL DIVISION

Manager	R. H. G. Mathews	332 S. Mich. Ave., Chicago, Ill.
A.D.M. Michigan	C. E. Darr	137 Hill Ave., Highland Pk., Detroit
A.D.M. Ohio	C. E. Nichols	739 Weadock Ave., Lima
A.D.M. Illinois	N. C. Smith	1036 N. Dearborn St., Chicago
A.D.M. Wisconsin	C. N. Crapo	1175-2nd St., Milwaukee
A.D.M. No. Indiana	M. W. Hutchinson	1222 Washtenaw Ave., Ann Arbor
A.D.M. So. Indiana	D. J. Angus	Rm. 66, Y. M. C. A., Indianapolis
A.D.M. Kentucky	J. C. Anderson	Glengarry Farm, Lexington

DAKOTA DIVISION

Manager	N. H. Jensen	Box 394, Sioux Falls, S. D.
A.D.M. Minnesota	D. C. Wallace	54 Penn Ave. N., Minneapolis
A.D.M. So. Dakota	Orville Wheelon	300 E. Capital Ave., Pierre
A.D.M. No. Dakota	Bert Wick	1025-3rd St., Devils Lake

DELTA DIVISION

Manager	W. W. Rodgers	1106 Union Ave., Memphis, Tenn.
A.D.M. Louisiana	V. L. Rosse	Box 415, Maquenne
A.D.M. Mississippi	W. L. Kennon	University Post Office, Mississippi
A.D.M. Tennessee	W. C. Hutcheson	Wind Rock, Little Rock
A.D.M. Arkansas	Dr. L. M. Hunter	207 1/2 Main St., Little Rock

EAST GULF DIVISION

Manager	H. L. Reid	76 E. 12th St. Apt. 6, Atlanta, Ga.
A.D.M. So. Carolina	C. E. Wells	1309 Buncombe St., Greenville, Va.
A.D.M. Alabama	V. C. McIlvaine	106 W. 3rd St., Sheffield
A.D.M. Florida	C. P. Clark	c/o Western Union Tel. Co., Jacksonville
A.D.M. Georgia	C. B. Transou	309 Greenwood Ave., Atlanta
A.D.M. Porto Rico	Luis Rexach	Box 319, San Juan

MIDWEST DIVISION

Manager	P. H. Quinby	Box 134-A, Rt. 6, Omaha, Nebr.
A.D.M. Iowa	D. E. Watts	116 Highland Ave., Ames
A.D.M. Kansas	Clifford Peters	Tonganoxie

NEW ENGLAND DIVISION

Manager	I. Vermilya	Mattapoisett, Mass.
A.D.M. Rhode Island	D. B. Fancher	86 Franklin St., Westerly
A.D.M. New Hampshire	R. H. Stevens	118 Brook St., Manchester
A.D.M. Vermont	W. W. Hall	3915 Union St., Burlington
A.D.M. Maine	L. Hilton	20 Wood St., Lewiston
A.D.M. West. Mass.	A. S. McLean	585 Armory St., Springfield
A.D.M. East. Mass.	B. H. Chase	39 Chester Ave., Winthrop
A.D.M. Connecticut	D. C. S. Comstock	1622 Main St., E. Hartford

NORTHWESTERN DIVISION

Manager	Glenn E. West	Polytechnic, Mont.
A.D.M. Montana	H. E. Cutting	Box 517, Bozeman
A.D.M. Washington	Everett Kick	3802 Hoyt Ave., Everett
A.D.M. Idaho	LaVerne Martin	422-14th Ave. S., Nampa
A.D.M. Oregon	P. R. Hoppe	1633 Willamette St., Eugene

PACIFIC DIVISION

Manager	J. V. Wise	Walnut Grove, Calif.
A.D.M. Arizona	H. L. Gooding	Box 175, Douglas
A.D.M. Nevada	G. M. Lewis	211 West St., Reno
A.D.M. So. Calif.	M. E. McCreeery	628 W. 49th St., Los Angeles
A.D.M. Central Calif.	B. R. Coles	16 Ellenwood Ave., Los Gatos
A.D.M. No. Calif.	E. C. Garrette	Coluso
A.D.M. Hawaii	K. A. Cantin	1593 Piikoi St., Honolulu, T. H.

ROANOKE DIVISION

Manager	W. T. Gravely	854 Main St., Danville, Va.
A.D.M. West. Va.	J. L. Bock	Main St., Farmington
A.D.M. Virginia	J. F. Wohlford	118 Cambridge Ave., Roanoke
A.D.M. No. Carolina	T. M. Simpson	Peoples Nat'l Bank Bldg., Winston-Salem

ROCKY MOUNTAIN DIVISION

Manager	N. R. Hood	1022 S. Ash St., Casper, Wyo.
A.D.M. Utah	H. C. Wilson	c/o Deseret News, Salt Lake City
A.D.M. Colorado	P. M. Segal	604 Interstate Trust Bldg., Denver
A.D.M. Wyoming	P. N. Mitchell	Box 575, Greybull

WEST GULF DIVISION

Manager	F. M. Corlett	2515 Catherine St., Dallas, Texas
A.D.M. New Mexico	Louis Falconi	Box 421, Roswell
A.A.D.M. Oklahoma	C. E. Whartenby	211 News Bldg., Enid
A.D.M. So. Texas	E. A. Sahn	Box 569, New Braunfels

MARITIME DIVISION

Manager	W. C. Borrett	14 Sinclair St., Dartmouth, N. S.
A.D.M. P. E. I.	W. Hyndman	Charlottetown

ONTARIO DIVISION

Manager	C. H. Langford	258 Cheapside St., London, Ont.
A.D.M. Central Ont.	Wm. Choat	241 Roberts St., Toronto

QUEBEC DIVISION

Manager	J. V. Argyle	493 Decarie Blvd, Montreal
----------------	--------------	----------------------------

WINNIPEG DIVISION

Manager	J. E. Brickett	260 Athabaska St., E., Moose Jaw, Sask.
A.D.M. Saskatchewan	F. L. Maynard	Box 339, Morse
A.D.M. Manitoba	E. Nicholson	397 Burnell St., Winnipeg

VANCOUVER DIVISION

Manager	A. J. Ober	Cor. Main & Minerva Sts., Vulcan, Alberta
----------------	------------	---

The GREBE "13"

A Real Receiver for Relay Men



"It is not easy to find a man who after three years of learning has not reached happiness."

—Confucius

The relay man attains happiness in far less time when he owns a Grebe "13".

Doctor Wu

Wavelength Range: 80-300M

Licensed under
Armstrong U. S.
Pat. No. 1,118,149

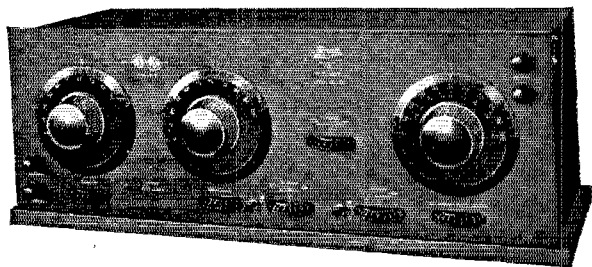

COMBINING Regeneration and Tuned R.F. this Instrument affords sharper tuning, greater range and quieter operation. And, each detail of Grebe craftsmanship assures trustworthy performance.

You will find the Grebe '13' in the stations of seasoned DX men who have established worth-while records.

Ask your dealer or write us.

A. H. GREBE & CO., Inc.

76 Van Wyck Blvd., Richmond Hill, N. Y.

Western Branch: 451 East 3rd Street, Los Angeles, Cal.

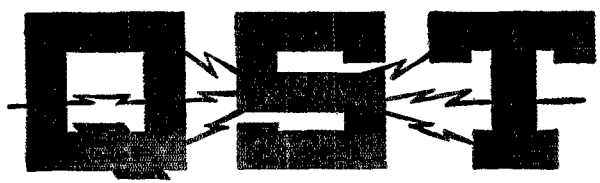

The Official Organ of the A.R.R.L.

VOLUME VII

APRIL, 1924

No. 9

Editorials		7
Notice to Our Newsstand Readers		8
Something New in Radio Frequency Amplifiers	<i>M. B. Sleeper</i>	8
Loose-Coupled Transmitting Circuits	<i>Maurice G. Goldberg</i>	11
The Amateur Scores Again		14
Phase Multipliers and Mercury Arc Rectifiers	<i>C. P. Sweeney</i>	16
Third District Convention		19
Amateur Wavemeters—Part Two	<i>S. Kruse</i>	20
Are We Losing Contact With WNP?		23
The Story of the Royal Order of the Wouff Hong	<i>F. D. Fallain</i>	23
Radio Transmitting Circuits	<i>A. W. Parkes</i>	26
Your Antenna Tower—A Real Problem	<i>S. Kruse</i>	29
Information Service Notice		31
Seeing What Your Tubes Are Doing	<i>H. J. Nolte</i>	32
Northwest Convention Notice		34
Should Regeneration Be Eliminated?	<i>William W. Harper</i>	35
WWV Schedules		38
A Low-Loss Antenna Insulator	<i>E. J. Atkinson</i>	39
Amateur Radio Stations—1AJP, 9EKY, 2AGB		40
International Amateur Radio		43
The Amateur Builder		46
With the Affiliated Clubs		50
Book Reviews	<i>S. Kruse</i>	50
“Strays”		52
Radio Communications by the Amateurs		55
HAM-ADS		105
QST's Directory of Advertisers		111

Q S T is published monthly by The American Radio Relay League, Inc., at Hartford, Conn. Kenneth B. Warner (Secretary, A.R.R.L.), Editor and Business Manager
 S. Kruse, Technical Editor; H. F. Mason, Department Editor
 F. C. Beekley, Assistant Editor

Edwin C. Adams, Advertising Manager.

Subscription price in United States, Possessions, and Canada, \$2.00 per year.
 Foreign, \$2.50. Single Copies, 20 cents.

Entered as second-class matter May 29, 1919, at the post office at Hartford, Connecticut, under the act of March 3, 1879. Acceptance for mailing at special rate of postage provided for in section 1103, Act of October 3, 1917, authorized September 8, 1922.

Copyrighted, 1923, by the American Radio Relay League, Inc.,
 Title registered at United States Patent Office.

THE AMERICAN RADIO RELAY LEAGUE, Inc.
 HARTFORD, CONN.

THE AMERICAN RADIO RELAY LEAGUE

The American Radio Relay League, Inc., is a national non-commercial association of radio amateurs, bonded for the more effective relaying of friendly messages between their stations, for legislative protection, for orderly operating, and for the practical improvement of short-wave two-way radio telegraphic communication.

It is an incorporated association without capital stock, chartered under the laws of Connecticut. Its affairs are governed by a board of Directors, elected every two years by the general membership. The officers are elected or appointed by the Directors. The League is non-commercial and no one commercially engaged in the manufacture, sale or rental of radio apparatus is eligible to membership on its Board.

"Of, by and for the amateur," it numbers within its ranks practically every worth-while amateur in America and has a history of glorious achievement as the standard bearer in amateur affairs.

Inquiries regarding membership are solicited. Ownership of a transmitting station, while very desirable, is not a prerequisite to membership; a bona-fide interest in amateur radio is the only essential. Correspondence should be addressed to the Secretary.

OFFICERS

President
HIRAM PERCY MAXIM
Hartford, Conn.

Vice President
CHAS. H. STEWART
St. David's, Pa.

Traffic Manager
F. H. SCHNELL
1045 Main St.
Hartford, Conn.

Canadian General Manager
A. H. K. RUSSELL
234 Westmount Drive
Toronto, Ont.

Treasurer
A. A. HEBERT
Hartford, Conn.

Secretary
K. B. WARNER
Hartford, Conn.

DIRECTORS

H. M. ANTHONY
Muncie, Ind.

H. A. BEALE, JR.
Parkesburg, Pa.

A. H. BABCOCK
Berkeley, Calif.

V. F. CAMP
Brightwaters, L. I.

F. M. CORLETT
Dallas, Tex.

C. E. DARR
Detroit, Mich.

A. A. HERBERT
East Hartford, Conn.

S. KRUSE
Silver Lane, Conn.

H. P. MAXIM
Hartford, Conn.

A. H. K. RUSSELL
Toronto, Ont.

F. H. SCHNELL
West Hartford, Conn.

C. A. SERVICE, JR.
Glastonbury, Conn.

C. H. STEWART
St. David's, Pa.

K. B. WARNER
West Hartford, Conn.

K. W. WEINGARTEN
Tacoma, Wash.

M. B. WEST
Lima, Ohio

G. L. BIDWELL
Washington, D. C.

ADVISORY TECHNICAL COMMITTEE

STUART BALLANTINE
WM. C. BALLARD, Jr.
HEROY M. E. CLAUSING
FRANK CONRAD
LEO C. YOUNG

MINTON CRONKHITE
J. H. DELLINGER
C. L. FARRAND
PAUL F. GODLEY
F. C. BLAKE
MELVILLE EASTHAM

L. A. HAZELTINE
C. D. TUSKA
R. H. G. MATHEWS
GERALD M. BEST
S. KRUSE
D. G. McCAA

Address General Correspondence to Executive Headquarters, Hartford, Conn.

EDITORIALS

de AMERICAN RADIO RELAY LEAGUE



The April Elections

DURING the first week in April ballots are being mailed from A.R.R.L. Headquarters to every member of the League residing in the United States and Canada, the U. S. members to elect a Director to represent the division in which they live and the Canadians to elect the A.R.R.L. Canadian General Manager.

There now devolves upon every one of us A.R.R.L. members not only an opportunity but serious duty. Our new constitution gives us a greater measure of democracy than we have ever had before, and we must use it in this first election held thereunder for the choice of a new A.R.R.L. Board. The system of government we have adopted is helpful to A.R.R.L. only if it reflects the wishes of the majority of its members. In voting for the members of our new Board, then, we are not only exercising a privilege but fulfilling a solemn duty, worthy of our most serious forethought.

A.R.R.L. has a glorious history of achievement and progress. It has done much to advance short-wave radio. It stands for the best in Amateur Radio, a power for good always. It provides the opportunity for co-operation, so essential in our lives as radio amateurs. It represents and protects us in our relations with the rest of the world, where, unaided, we would fall.

A.R.R.L. must carry on. Much depends upon the new Board. Altho the new directors will be elected as the representatives of certain areas, they are the governing power of the League in all its matters. Every League member therefore should give deep consideration to the choice of the director from his territory, to the end that the men put into office will have been selected not only because they can represent their territory but because they are endowed also with vision, wisdom, fairness, and ability as leaders, so that in all things they will act for the greatest good of our A.R.R.L.

B.C.L. Amateurs

WE amateurs, who love amateur radio for its own sweet sake, can find much encouragement and hopefulness in the fact that there is only an insignificant percentage of the millions of people listening to broadcasts who do not

get bitten by the mysterious little bug and straightaway graduate from the viewpoint of regarding radio purely as they do their phonograph. The overwhelming majority of the B.C. fans have become amateurs in their own game, much closer to us telegraphing amateurs than it ever appeared they would be, and except that their interest lies in reception only and in telephony instead of telegraphy, they are becoming of much the same breed as ourselves. They are circuit hounds, tireless experimenters; their aim is greater DX and they compare their records even as you and we. We admire an article appearing in a recent issue of the Southern California Radio Association Bulletin so much that we want to reproduce it here, with its welcome to B.C.L.'s, as an example of what we think the amateur's attitude should be everywhere:

"The Broadcast Listener is usually one of two types: he is either one who takes radio for granted and who is not at all interested in what makes the wheels go 'round or he is of the experimenter type, exceedingly curious to learn the whys and wherefores of radio.

"The designation 'amateur' is from the French, and means 'lover' or 'admirer.' Radio amateurs are just that—they love radio: they enjoy unraveling its mysteries; they enthuse over circuits, diagrams, theories and practice; they get a thrill from tinkering with radio—not in a haphazard way—but with a definite scientific object in view. They are for Better Radio, the most fascinating and absorbing study that is available to all!

"A part of radio's thrill is the glory of 'working' a fellow amateur. One may putter around with a few odds and ends and emerge with a capable radio transmitting set—a set capable of reaching far, far away. This thrill needs to be experienced just once, to be understood and appreciated. It's a g-r-a-n-d 'n' glorious feeling!

"The ranks of amateur radio are open to all BCL's who are real, dyed-in-the-wool amateurs; who love the mysteries of radio and would appreciate good fellowship and sound technical advice and help. If you are of this type, and have not yet become a 'ham' (as the amateur prefers to call himself) this association welcomes you to its ranks.

"Our members are always glad to cooperate with the BCL in every respect. We who love radio are only too glad to

be of help to those who are looking for the ultimate in radio, and our hand is extended to this end!"

Make that be your policy too, O.M.—we want the fellows of this type in Amateur Radio.

NOTICE TO OUR NEWSSTAND READERS

As announced in our last issue, the Traffic Department Report and the "Calls

Heard" Department have been eliminated from the newsstand edition of *QST* because our non-member readers in general are not particularly interested in them. This results in a saving in expense which makes possible the publication of a larger and better *QST*.

These two departments are included in the edition supplied to members of the A.R.R.L. If you are interested in them, it is proof positive that you ought to be a member of the League. May we not direct you to the handy application blank appearing on page 88 of this issue?

Something New in Radio Frequency Amplifiers

By M. B. Sleeper*

The simplest way of doing a thing always deserves respectful consideration. It is often very much worth while to sacrifice something to gain simplicity. Mr. Sleeper here presents a tuned radio-frequency amplifier which does not oscillate under the ordinary conditions of broadcast reception, altho no unusual circuit is employed.

The transmitting amateur will find the article interesting reading, partly because he too may soon be using non-oscillating receivers, still more because his family is certainly interested in phone reception.

—Technical Editor.

LAST year I designed a variometer with the idea of making it in such a way that the change of inductance from minimum to maximum would be very great, while the distributed capacity and the resistance at radio frequencies would be exceedingly low. The variometer turned out even better than my

ly hit upon a design which was both economical in the matter of molds and did away with a lot of trouble and worry. It did *not* provide a variocoupler, to be sure, but something better, a *fixed* coupler.

Figure 1 shows the variometer and also the fixed coupler. The latter is simply the variometer stator frame with a special winding. Altho you cannot see this in the illustration, the winding is broken so that a small part is brought out to two binding posts as a primary for the fixed coupler, while the balance serves as the secondary coil.

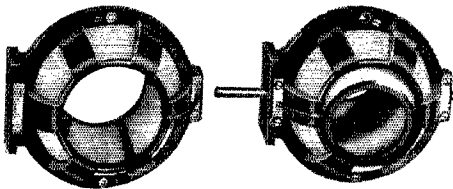

Fig. 1. Sleeper Variometer and Fixed Coupler.

expectations, and I felt well pleased with myself, both because the variometer was good electrically, and because, in simplifying the mechanical design, I avoided the well-known wet-blanket of radio—patent infringement.

However, I was soon informed that an unusually good variometer was not so good unless it had an equally good variocoupler to go with it. The molds for Bakelite parts are expensive, unbelievably expensive in fact, so there is a very definite economical advantage in using the same parts for both variometer and variocoupler. I final-

Why a Fixed Coupler Is Satisfactory

Perhaps you are in the habit of using a vario-coupler because you think the variable coupling is necessary. If you stop to think you will realize that, however much you turn the coupling-control knob, you finally leave it at just a few degrees on the scale. Really, you don't need to vary it at all if it is kept fairly loose. Also, in ordinary amateur and broadcast reception, it is the custom to do very little tuning in the antenna or primary circuit. The fixed coupler, then, provided the twin for the variometer in the form of an inexpensive instrument which replaced the vario-coupler and at the same time did away with primary switches, soldered taps and coupling variations. I felt better after that.

Another Use for the Fixed Coupler

About that time David Grimes, I.D., (I.D. stands for Inverse Duplex) appeared on

* M. B. Sleeper, Inc., Technical Publisher.

the scene. I thought I was something of an experimenter but I.D. can think of more things to do without stopping than I can if I sit up the night before planning them. When he suggested that the fixed coupler be used as a tuned radio-frequency amplifying transformer, I dropped everything to see what could be done in that direction. At the same time he rushed to Penmar-davem's to make out a patent application,

the tuning condenser, making the signals weaker, the tuning broader, and the B-battery consumption much greater (which can be said also of the practice of putting an actual resistance across the tuned circuit, or in series with it.) In the present circuit however, the *negative* voltage from the C-battery saves the B-battery.

Perhaps you don't understand why it won't oscillate. I might claim that it won't because there is nothing to make it, but that wouldn't be quite fair. To make the circuit oscillate, a fairly large inductance must be put into the plate circuit of the tube, either by putting it directly in as the primary of the r.f. transformer, or (what is exactly equivalent) by putting it into the secondary circuit and using a low ratio of transformations. The design of these couplers is such that the inductance in the plate circuit is not sufficient to cause oscillation. That's a very simple reason. (See "Appendix for Amateurs" for details.)

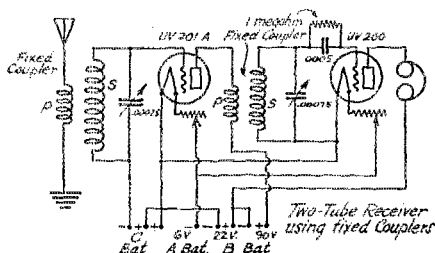

FIG. 2

Circuits

and, by the time I found out how they worked, he had reached the Q.E.D. of his claims thereon. Which was as it should have been, for it was his idea. For my part I am glad enough that I can pass the story along to other Experimenters.

As an R.F. Amplifying Transformer

The simplest application of the fixed coupler to radio frequency amplification is illustrated in Fig. 2. Here is a 2-tube set with one step of radio amplification and an audion detector. A fixed coupler is used as the input tuner, just as a vario-coupler might be connected. The secondary is tuned from 200-600 meters by a .00025 microfarad variable condenser. The plate circuit of the first tube is connected thru the primary winding of another fixed coupler, with the secondary tuned by another .00025 condenser and connected to a detector tube, preferably a UV-200 or C-300.

First off, you will say that there is nothing new about this circuit. But there is, as it has been constructed here, for it has all the advantages of tuned radio frequency, yet it does not oscillate. (This is correct within limits only—see the "Appendix for Amateurs"—Tech. Ed.) To be sure, ordinary tuned radio-frequency circuits can be prevented from oscillating by using a potentiometer to put a *positive* charge on the grid but the effect of this is as if a resistance were connected across

The arrangement can be substituted for a radio frequency transformer in plain radio-frequency circuits, reflex, or inverse-duplex circuits. Fig. 3 shows a 5-tube set, giving two stages of r.f. amplification. If you are clever at putting things together you can arrange the three condensers to be controlled by a single knob. Verniers, either separate or in the form of an extra plate, are needed on the second and third condensers to get a perfect adjustment. A loop may be connected to the first condenser in place of the first fixed-coupler.

Figures 4, 5 and 6 show one of the best sets I have ever used, a one-step reflex

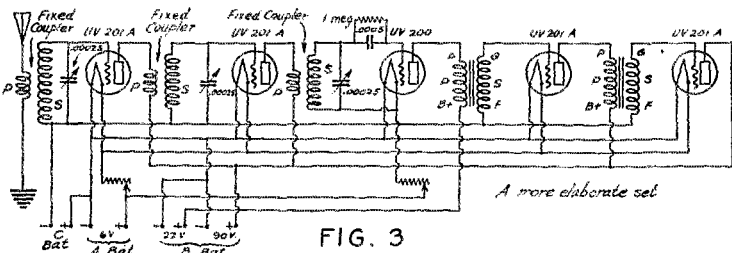

FIG. 3

A more elaborate set

receiver with an audion detector. You will see that two fixed couplers are used, one between the antenna and the first tube as an input tuner and another as a tuned radio-frequency transformer. Both tuning condensers have a maximum capacity of .00025 microfarad.

An exceedingly interesting circuit is shown in Fig. 7. This diagram (shown by permission of the Sleeper Radio Corporation licensee for the Grimes Inverse Duplex Inventions), is a Grimes Inverse Duplex Set. When used on an antenna within a mile of WEAf the tuning is so

sharp that WEA F, operating on 495 meters, could not be heard when the controls were set on WDP, 502 meters. Great range is also possible when a loop is substituted for the first fixed coupler, but tuning then becomes so sharp that recep-

tion largely becomes a matter of luck in striking the right combination for the three dials. In place of the tapped loop shown (and usual with Grimes sets) an antenna may be used, and the secondary of the first fixed-coupler tapped to permit adjustment of the voltage applied to the grid of the first tube. This is necessary on strong signals to prevent overloading the tube.

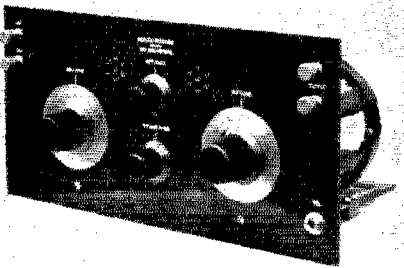

Fig. 4. Two-tube Reflex Receiver.

The C-Battery and the Choice of Tubes

Either UV-199 (C-299) or UV-201-A (C-301-A) tubes may be used thruout, altho 201-A's (C-301-A's), with a UV-200 (C-300) detector, give the best results. The C-battery is very important, where shown in these diagrams, for the current drawn from the B-batteries is heavy at the best. With UV-199 (C-299) tubes the

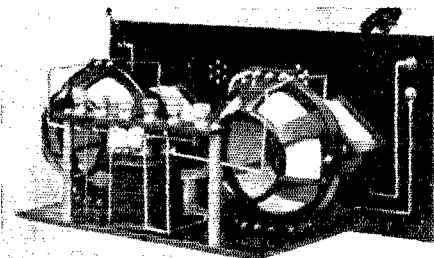

Fig. 5. Construction of 2-tube Reflex Set.

saving effected by the low filament current consumption is small compared to the increase in B-battery cost, unless the C-battery is employed. 1½ to 4½ volts are required. Since the life of the C-battery is practically its shelf life, its use is many

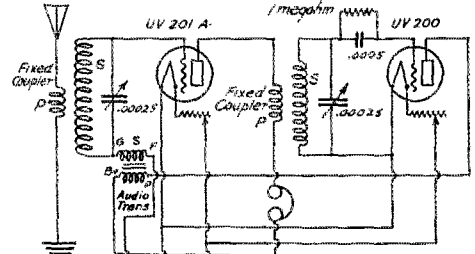

FIG 6 Circuit of Set shown in Figs. 4 & 5
C-Bat. A-Bat. B. Bat.

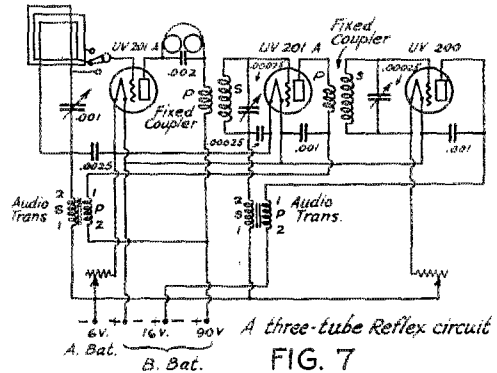

FIG. 7

At a slight sacrifice in results UV-199 (C-299) tubes can be used thruout.

AN APPENDIX FOR AMATEURS

By the Technical Editor

When reading hastily, it is so easy to misunderstand Mr. Sleeper's claims, that an explanation seems strictly necessary.

There is nothing unique about the circuits shown; that claim is not made. The originality lies in the proportioning of the fixed couplers in such a fashion that the tendency to oscillate is not troublesome as long as ordinary receiving antennas are used. This may be explained as follows.

The tendency to oscillate arises from the fact that a fairly high inductive load is placed in the plate circuits of most r.f. amplifiers, especially those of the tuned variety. If this inductive load is kept low enough the tendency to oscillate will not be troublesome as long as the antenna resistance is fairly high. Now the inductance in the plate circuit of such a set as here described can be cut down by using few primary turns and a step-up ratio in the fixed couplers. This is what Mr. Sleeper has done.

With a low resistance amateur antenna-

and-counterpoise this device does not usually suffice and oscillations cannot be fully prevented unless resistance is introduced (as in the Grebe CR-12 and CR-13) or some other device used as described in "Anti-Regenerative Amplification", (*QST* for January, page 12). This is a pretty safe statement—in fact it is so safe that the Technical Editor is authorized to say that a prominent laboratorian makes the following offer: \$100, cash in hand, for even a single-stage r.f. amplifier, having a tuned transformer giving a *non-regenerative* amplification of 3 or more per stage, which he cannot cause to oscillate in the course of ordinary reception, when connected to the low resistance antenna at his laboratory. Amplifiers in which the grid-plate capacity is balanced (Rice, Hazeltine, etc.) are of course barred.

"Rolling Your Own"

At the last moment we have a letter from Mr. Sleeper in which he gives the following constructional information for those who wish to try it first with home-made equipment. A fixed coupler equivalent to the one pictured (except in looks) can be made by winding on a 3-inch tube 45 turns of #22 S.S.C. wire, then leaving a space of $\frac{1}{8}$ inch or $\frac{3}{16}$ inch and winding 6 turns of the same wire. The small winding is the primary and the end of it nearest to the secondary goes to the B-battery, the other end to the plate.

The long winding is the secondary; the end farthest from the primary goes to the grid. A one-wire antenna 20 feet high and 100-300 feet long is recommended.

For amateur work both windings may be reduced about one half.

Loose-Coupled Transmitting Circuits

By Maurice G. Goldberg, 9ZG ex-9APW

"We amateurs are a fairly considerate lot and most of us pay some attention to the QRM our transmitters cause the other fellow in the same neighborhood. Some of us put in good filter systems; some put in loose-coupled transmitters; and a few of us try to combine the two into the ideal amateur transmitters. Having discoursed somewhat on filter systems in QST with good effect! it is the writer's intention to invite a more pronounced interest in loose-coupled circuits for transmitters in order to reduce interference and swinging signals and to increase the efficiency of many transmitters."

THE loose-coupled transmitter has many advantages over nine tenths of the circuits used in our amateur stations. It is far superior to all direct-coupled sets in that it reduces key thumps which are prevalent with all direct-coupled sets using any of the common methods of keying (which is more than enough cause for throwing out all of our present circuits.—Tech. Ed.) The loose-coupled transmitter will work very near the fundamental of the antenna without any need for series condensers. (Neither is there any need for care about the location of the antenna nodal point as there is with direct-coupled sets.—Tech. Ed.) Finally, the loose-coupled set emits a steadier wave as the tuned primary has a stabilizing effect and prevents swinging².

Drawbacks

The only drawback to the use of a loose-coupled transmitting transmitter is the necessity of using a good variable condenser.

1.—Mr. Goldberg was first to make experiments on amateur filters and to give the results to the rest of us—see *QST* for April, 1923, page 14. This was the start of the movement for good plate supplies which has called forth Prof. Dellenbaugh's classic article and the Reinartz Modulator scope.

2.—Swinging is a change in wavelength, back and forth. This is not the same thing as fading which is a change in the strength of the signal.

3.—See the article on antenna series condensers in last issue: these condensers can also be used in tuning the primary circuit of a loose-coupled set.

ser to tune the primary circuit³. If any amount of power is being used this condenser will have to be immersed in Transil or castor oil, as the current in the primary circuit may be anything from 10 to 100 amperes. (We can't agree with this—the current is generally within 50% of the antenna current. At 8AQO-8XH, with 3 UV-204 tubes the primary current is about 10 amperes altho 2 kilowatts are being put into the antenna.—Tech. Ed.) The size of the wire in the primary will have to be larger than ordinarily used in direct-coupled circuits. Number 12 copper wire might carry the current in a direct-coupled set but will get hot enough to fry eggs when used in the primary circuit of a loose-coupled set.

The Set at 9ZG-9APW

In Fig. 1 is shown the circuit in use at station 9ZG-9APW with the values of capacity and inductance shown. It will be noticed that the variable condenser shunts only a part of the plate inductance, the best number of turns being found by noticing the combination that will give the highest reading on the antenna ammeter when adjusted in the fashion explained later in this article.

At the writer's station the "reversed-feedback" circuit of Fig. 1 is used because it has been found best suited for the peculiar conditions of this location. No

grid-tuning condenser was found necessary, which is fortunate as that would make two tuning adjustments in the primary circuit. Four turns of No. 26 wire have been found to work best as a grid coil. Such small wire can only be used

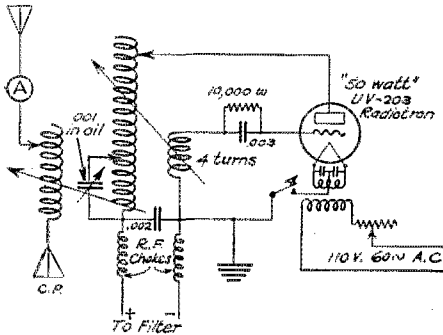

FIG 1 LOOSE-COUPLED "REVERSED FEED-BACK" CIRCUIT USED AT 9ZG-9APW

where the grid-tuning condenser can be eliminated. At a wavelength of 220 meters the primary tuning condenser works best (at this station) when placed across 11 turns of the plate inductance. At this wavelength 8 turns are used in the antenna circuit between the antenna and the counterpoise clips. The primary tuning condenser is set at 35 on a 100 division scale; the maximum capacity being .001 before immersing in oil, probably .004 at present. For shorter waves fewer turns should be used in both inductances and the primary tuning condenser adjusted for the wavelength desired.

Tuning

To shift the wavelength it is only necessary to change the position of the antenna clip on the secondary coil by a few turns and then turn the primary tuning condenser until highest antenna current is obtained with good "pickup". It will be found that in moving the primary condenser (with the key down) it is possible to make an adjustment giving .3 to .5 ampere more antenna current than can be "picked up" when the key is operated. In other words it is possible to raise the antenna current to perhaps 5 amperes by holding the key down and adjusting the primary condenser but the set will not oscillate promptly on this adjustment and may fail to work at times, the result being that the tubes heat badly. To avoid this condition the primary circuit is worked at a slightly lower wavelength. This best adjustment is found by holding the key down and gradually bringing the primary condenser up toward the resonance point. As the resonance point is approached the

antenna current rises. The best operating position is the one giving the highest possible antenna current without giving unsteady operation. Working too close to the resonance point will result in unsteady operation and working too far from it will reduce the antenna current. Adjust the primary condenser to a point that seems to give prompt pickup each time the key is depressed. This adjustment will be, as already stated, a little below the resonance peak. The peak itself can be detected by a terrific "Bang!" in the receiver as the primary condenser is swung thru the resonance point. Place the receiving set at a considerable distance from the sending set and listen carefully while sending the alphabet clear thru, noting carefully if any of the letters "miss out." (It may sound unreasonable but a set of this sort will at times work perfectly on some letters and miss others regularly. —Tech. Ed.) If one hears every letter it is a fair certainty that the best operating point has been found. If, however, one or more letters miss out the best point has not been found and the condenser should be set a trifle lower and the operation repeated until every letter sent can be copied in the phones. This had beter be checked by sending to a local station until one has become used to the circuit.

One must not be deceived by the slight drop in antenna current when this adjustment is made. As stated before the reduction from the maximum will be from .3 to .5 ampere but of what use is a large antenna current unless the signals can be read? Besides, even after this adjustment is made a good loose coupled set will still produce a higher antenna current than can be gotten with most direct-coupled

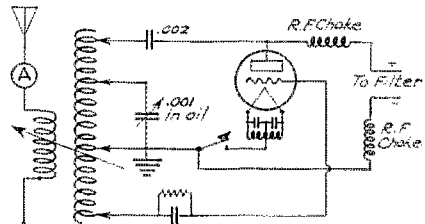

LOOSE-COUPLED HARTLEY CIRCUIT FIG. 2

sets. At the writer's station it is possible with one 50-watt tube to get an antenna current of an ampere when only 1/2 turn of inductance is used in the antenna circuit. With one turn the current is 2.1 amperes. Thus we are able to work effectively near the antenna fundamental without using series condensers.

Circuits

The Meissner Circuit, being inherently

loose-coupled, is not shown. The ordinary loose-coupled circuits with tuned primaries (Hartley and Colpitts) have an advantage over the Meissner in that they are somewhat more stable because of the steadying effect of the tuned primary. The Meissner circuit is affected by everything that happens in the antenna circuit; if the antenna falls down in a storm or is grounded accidentally the tubes will at once stop oscillation and draw a very heavy overload. The same effect takes place to some extent when the insulators are wet by a rain. In the loose-coupled circuits with tuned primaries, changes in the antenna system do no harm since the tubes draw an appreciable load only when the primary circuit is tuned to the antenna or nearly so. A large change in the antenna constants (wavelength or resistance) will remove the load from the oscillating tubes. The same dangers that have been mentioned as applying to the Meissner circuit usually hold true also for direct-

is because no adjustment of the plate turns was made. Had this adjustment been made as it is under normal operation, the maximum value of antenna current for all couplings would be very close to the same.

The Helix

In order to determine the best type of inductance for use in the antenna cir-

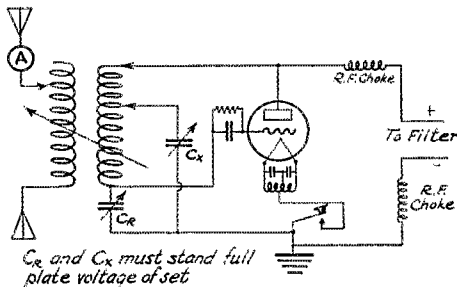

LOOSE-COUPLED COLPITTS CIRCUIT
FIG. 3

coupled sets, especially if the antenna comes down on the counterpoise. (Anyone who has had to work a tube set during a heavy rain will know how true this is. We had a horrible time with our Hartley circuit at 1XAQ on the evening the "Shenandoah" was adrift.—Tech. Ed.)

Coupling

Figure 4 shows three resonance curves drawn from data obtained at 9ZG-9APW with various distances between the nearest edges of the primary and secondary inductances. It will be noticed that at the closer couplings there is quite a region thru which the primary circuit will not operate steadily, shown by the dotted portions of the curves. If the coupling is made loose enough (4 inches in this case) the circuits can be in exact tune without disturbing the oscillator's persistence in the least. With this coupling the tuning is also much sharper. The curves are not quite correct in one way as they show less current for the looser couplings. This

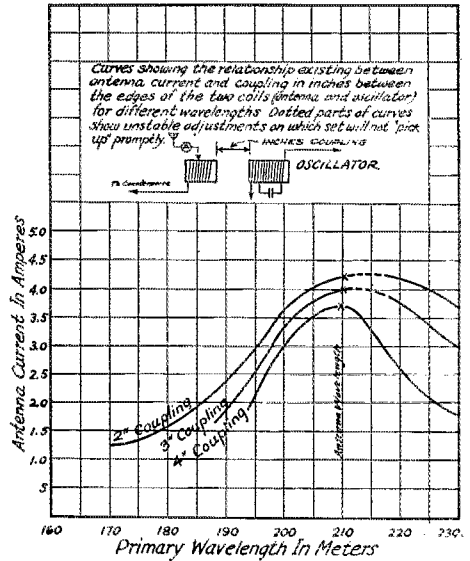

FIG. 4

circuit, 9 turns of No. 26 wire were wound very close together on a four-inch form and with coupling of 2 inches and the tube running on 1200 volts, 3.3 amps was obtainable in the aerial circuit at the optimum operating adjustment. Needless to say the wire got burning hot, so 9 turns of No. 11 D.C.C. wire were wound on the same form after removing the No. 26 wire. To the writer's surprise the antenna current was 3.2 amperes, .1 less than in the case of No. 26 wire. A Radiocorp inductance was next tried, and with 8 turns in for the same wavelength, 3.2 amperes was obtained. To be absolutely certain of results the No. 26 wire was wound on the same form again, and when inserted in the circuit the meter again read 3.3 amperes, showing that for some reason the No. 26 wire was better than the larger wire of smaller resistance. This could be due to one of two things; either the increase of resistance in the antenna circuit meant the possibility of operating closer to the resonance point, or the compactness of the inductance was doing the trick. To determine just which one of those theories was correct a pancake in-

has the disadvantage of requiring (in all stages except that immediately preceding the detector) an extra isolation condenser and grid biasing resistance, and the voltage cannot be stepped up as with the transformer.

Several years ago it occurred to me that all the advantages of the variometer method

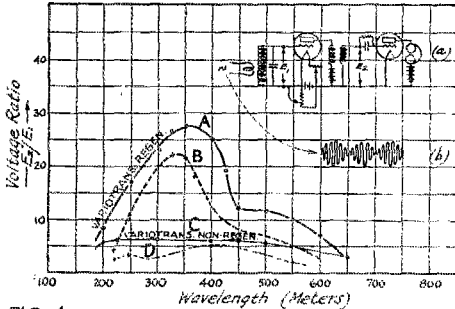

FIG. 4 COMPARISON OF REGENERATIVE AND NON-REGENERATIVE AMPLIFICATION CURVES

A—Tunable transformer regenerative.
 B—Fixed transformer regenerative.
 C—Tunable transformer non-regenerative.
 D—Fixed transformer non-regenerative.
 Note.—Tunable transformer used was a Ballantine variotransformer.
 The fixed transformer was an unusually good one.
 The oscillator supplied sine-wave-modulated r.f.

could be retained, its disadvantages eliminated and the amplification considerably improved by replacing the variometer by a transformer whose primary, secondary and mutual inductances could be simultaneously and continuously varied over the range of wavelengths to be received. I called this device a *variotransformer*, and a witty friend supplied the abbreviation "BVT" to shorten a word which was unfortunately long. The separate windings of the BVT eliminate the isolation condenser and grid resistance which are necessary with the variometer; furthermore by providing a turn-ratio greater than unity the voltage may be stepped up. The device tunes in exactly the same way as the variometer, by means of a single knob.

Use of Iron in Radio Frequency Transformers

The effective permeability of iron at short wavelengths is small out of all proportion to the heavy hysteresis and faucalt current losses. We have thoroughly studied iron cores of many types, in the form of thin steel sheets down to .001" thickness, in the form of small particles (oxidized particles, iron precipitated by hydrogen, rumbled with high resistance materials, etc.) molded under large pressure with an insulating binder, and ended up with a special core which was moulded of extremely thin "magnetic-oxide" sheets (.0002" thickness). Even the losses in this core

were too great for use at such wavelengths (600 meters) although we expect to make some use of the material in long-wave radio transformers such as are used in a super-heterodyne intermediate-frequency amplifier. The idea of using iron at short waves was immediately abandoned.

Coupling

Sometimes loose coupling is used between the windings of a radio transformer having a fixed primary and a tuned secondary. This broadens the range of wavelengths over which the device will amplify. (Within reasonable limits this range then depends on the tuning-range of the secondary. There is an incidental advantage in loose coupling; if the primary turns are kept down the tendency to oscillate is decreased without using any means of compensating for feedbacks.—Tech. Ed.) However, loose coupling lowers the height of the resonance peak.

When an adjustable primary is used and the amplifier is properly compensated for feedbacks there is no purpose in using loose coupling and in such devices as the Ballantine variotransformer the coupling is made as close as possible by winding the primary and the secondary coils together.

Turn Ratio

The best turn-ratio depends, among other things, upon the plate resistance of the tube and the amount of the capacitatively-reacting feed-back from the next tube. For ordinary tubes of resistances ranging from 10,000 to 30,000 ohms a turn-ratio of 1 to 2 is about right. The sharpness of the resonance curve increases with the turn-ratio, the effect being much the same as that of increasing the capacity across the primary winding.

This is illustrated by Fig. 2. The curves represent the non-regenerative amplification of one stage with a UV-201 (C-301) tube. As previously defined this is the pure repeater action of one stage into a tube detector (UV-200 or C-300) and excludes the effects of regeneration. The higher turn-ratio (2.1/1) gives more amplification but is harder to adjust on account of the greater selectivity. The ratio 1.2/1 represents a good compromise. In the case of a "Variotransformer" this ratio gives a pretty uniform amplification of about 6 times, over the entire range of wavelength adjustment.

It seems a trifle unreasonable to present broad curves like those of Fig. 2 with the statement that one of them was obtained from a sharp-tuning transformer and the other one from a moderately sharp one. The explanation for this is given in Fig. 3 which shows how Fig. 2A was obtained.

The operation of a tuned r.f. transformer cannot be represented by a single curve, since each setting of the transformer gives a different curve. The final curve for the

such a condition, gave most of their assistance to the broadcasting of press for the news associations, leaving the amateurs to handle the point-to-point work.

Chicago naturally was a center of activity. 9AAW, selected by the Chicago Radio Traffic Assn. to handle emergency work, immediately adopted a 24-hour schedule disregarding quiet hours with full permission of the Radio Supervisor. Don Wallace, 9ZT-9XAX, Minneapolis, acted as a radio Paul Revere in his territory, calling amateur minute-men into action, and continuous watch was kept in the Twin Cities. 9BQQ, Minneapolis, did exceptional work, sticking with his set with only three hours sleep in as many nights. 8ZD-8VE, Pittsburgh, handled an emergency message from the manager of telegraphs and signals of the Pennsylvania Railroad in the Pittsburgh region to a similar P.R.R. official in Chicago, inquiring the extent of the storm damage and the prospects for re-establishment of wire service. This message was relayed to 9AAW in Chicago via 8FU in Defiance, Ohio, the answer returning the same route. 9BRS in Des Moines handled a message from a disabled Air Mail plane at Ft. Des Moines to its base at Iowa City, and then turned around and copied 1500 words of press from 9AAW and gave it to 6BDI, thereby giving California its first news on the arrangements for the Wilson funeral. Early in the storm officials in the Twin Cities perceived their inability to repair the damage with supplies in hand and a rush order for emergency equipment was given to 9ZT-9XAX to get thru to Ohio. He tied up immediately with 1XAM in Connecticut, who put the message on the Western Union wire in a part of the country where the wire service was OK. A rush reply to that message came back to Minneapolis via amateur radio—on 200 meters to 9BLY.

It was about this time that the disaster occurred at the Milford Mines near Crosby, Minn. 9BQQ, Minneapolis, put out a 300-word bulletin on the subject for the United Press and got direct acknowledgements for it from Chicago, Atlanta, Boston, Pittsburgh and San Francisco. In about four hours elapsed time the 300-word message to the U. P. office in New York was relayed there by 9BQQ-???-9BMX-9BRK-3QT-2BOY, the latter making the delivery.

9AAW maintained a continuous watch for four days, a number of local amateurs helping to man the station and other local stations co-operating 100%. The first night seventeen stations were cleared with storm traffic. 9ATO, Milwaukee, had Chicago traffic for the railroads, which went via 9AAW. At the request of the roads a check-up was made on the trains stalled in snowdrifts in Wisconsin, 9ZY, LaCrosse,

handling the business in his territory. Red Cross messages relative to relief at Crosby, and railroad traffic for the C.M. & St. P. road were handled with Minneapolis via 9BQQ.

Hundreds of urgent private messages were handled. 9CCM in Dana, Ill., summoned medical aid for his town from Streator, and directed a nurse on a case in Streator for a doctor isolated in Longpoint, Ill. 9DLO handled the Streator end. He lives on a farm three miles from town and delivered those messages by flivver during a blizzard! The wife of a North Dakota man had just had a serious operation in a Chicago hospital; he could not learn the outcome. Amateur radio got it for him—from 9XN in Chicago via 9AIC, Streator. 9DVL in Naperville, Ill., copied train orders for the C. B. & Q. R. R. in his city, and several amateurs in Davenport gave valuable help to their local railroad people, who had no information on the condition of their trains.

Among other stations which did splendid work in addition to those already mentioned are 9CD-9XBA, 9ZA, 9BGT, 9BZI, 9CA, 9ED, 9DOZ, 9DHZ, 9DQ, 9ARM, 9YY, 9CSJ, 9BSP. Many of these stations worked under the handicap of ice-grounded antennas. 9ED is due particular commendation: he threw together a simple transmitter using three receiving amplifier tubes for power, building the set for this storm work right in the midst of the emergency. It worked, too, putting fine signals down to 9CA Dwight and connecting that territory with Chicago.

From the above it may be seen that many stations did fine work. There were many failures, however, and we are in no position to put ourselves on the back as far as the net result is concerned. Not enough stations were on the job, and too many continued selfishly in their own work instead of QRXing or aiding in the relief work. Whenever there is a big storm every amateur ought to realize that communities somewhere are suffering, and that that is his opportunity to serve. When these emergencies come, every amateur ought to get on the job as quickly as possible and help in every way he can, even if it is only to QRX and watch for cases to arise where he may be needed. We handled only one message for the Pennsylvania Railroad in this storm—all the others were lost or stalled. The railroads are good enough to compliment us on our cooperation but we must admit we didn't do anything very much worth while for them—this time. The few stations that did good work are much to be commended—they demonstrated to Uncle Sam that the American amateur *can* eliminate isolation. Their good work should prove an incentive to the rest of us to step out and do our stuff next time!

—K.B.W.

versed" feed-back. Several schemes are available. Mr. Tuska has already explained the advantages of the reversed tickler-coil method. He used this method in connection with a capacitatively tuned coupling; it is not so successful with an inductance tuned coupling. Effective methods in this case are those shown in Hull's article (Fig. 5a and 5b), and in the present Fig. 5. For control of regeneration (rather than complete compensation) the condenser C. is made variable.

In Fig. 5a the coupling between the antenna and secondary coils should be close, but care should be taken to keep down the distributed capacity between the lower part of the coils if they are wound in the same direction, and between the upper parts if they are wound in opposite directions. This is very important in the case of Fig. 5b, in which the coils are wound in opposite directions. I have shown in these diagrams only one stage of r.f. amplification. Additional stages may be added, of course, and if regeneration in later stages should happen to be troublesome, the simplest remedy is a grid-potentiometer commonly controlling the extra tubes. Additional regenera-

tion in the detector circuit is less effective than might be supposed (perhaps 20% increase) and hardly worth the extra adjustment. For c.w. work the autodyne oscillation should not take place in the tuned circuit, at least in a multistage amplifier, because succeeding tubes may become overloaded. *It will probably be better to let the circuit immediately preceding the detector oscillate, or to provide a local oscillator coupled to this point of the circuit, thus heterodyning the amplified signals.* This also reduces or prevents the radiation of a "carrier-wave" by the receiver.

According to the measurements depicted above a single stage of r.f. amplification with variotransformer coupling and proper regeneration should give with square-law detection a telephone signal amplification of from 100 to 1000 times. Hull and Snow have actually measured amplification of 100 times at 400 meters, and there was some doubt here of the failure of the square-law detection so that with weak signals the 1000 mark might have been reached. At any rate the value and economy of tuned r.f. amplification is not all on paper.

How Antennaz Work

By John L. Reinartz, 1QP

Our idea of a really good radio amateur is John L. Reinartz.

Reinartz isn't connected with a commercial station, a factory, a laboratory, or a university, yet his name is internationally known and his articles have been reprinted in a dozen countries. Here's the explanation: Reinartz never believes that a job is done until he has had a try, and he never admits that there isn't something in an amateur station that will do the work.

For instance—all of us had dropped the Tesla Coil as an old-fashioned toy. Then when we wanted to find out how our filters worked we began to have dreams of \$2000 oscillographs. But Reinartz resurrected the Tesla coil, put a bit of wire on it, and gave us the 10¢ "Modulascope".

Lately most of us have admitted that we don't know anything about antennaz at short waves. John admitted it, too, but he immediately got out the Tesla Coil again and—but that's his story and we will let him tell it.

—Tech. Ed.

IF you will follow these experiments with me you will find that they provide most interesting recreation and also a means of conveying to you, as they did to me, the need for properly proportioned circuits for transmission. It is not difficult or expensive to make the Tesla Coil and repeat these experiments, and a single "5-watt" tube will drive it. Be sure to try the things I will tell you about.

A look at Figure 1 will show the regular arrangement of apparatus used with my Tesla Coil. A simpler arrangement could be used but it is convenient to use the regular set at 1QP and simply shift the clips A and B to the Tesla primary. These clips ordinarily go to the antenna and counterpoise leads. When the set is running the current passing thru the Tesla primary induces a voltage in the Tesla secondary. Because the secondary has many turns this

voltage will be quite high, especially when the primary is tuned to the natural wave of the secondary coil.

Obtain a Westinghouse "Spark C Pencil" or an Airco "Ignition Gauge". The little vacuum tube is a very good indicator for high voltages. When it is held near a wire or coil that is at high voltage the tube glows; we can get a rough idea of the voltage by seeing how near to the wire we must get before the tube will light up.

If you are ready we will proceed with the experiment.

Place a sheet of paper right back of the Tesla Coil, press the key of the tube set and adjust the variable condensers. If things are working right the upper end of the secondary coil will show a slight corona (or brush) discharge. Now hold the little vacuum tube as shown in Figure 2, putting it just close enough to the top turn of the

two positive electrodes, one connected to each end of the secondary of a center-tapped transformer. The pool of mercury is the positive D.C. terminal, while the negative D.C. connection is taken from the center-tap of the transformer. This is the ordinary center-tap connection used with electrolytic rectifiers.

Now if this valve is tilted the starting arc strikes as before. The main arc then

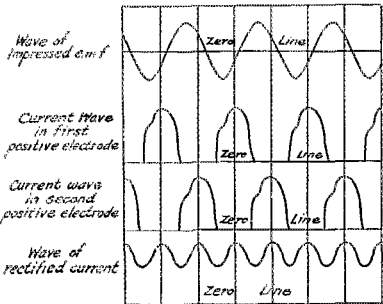

TYPICAL WAVE FORM OF SINGLE-PHASE RECTIFIERS

FIG. 4

strikes, going to the particular upper electrode that happens to be negative at that moment. The starting switch is then opened as before.

As the polarity of the transformer secondary reverses the arc shifts back and forth between the upper two electrodes. This happens 120 times per second, consequently the valve looks as if two arcs (or a forked arc) were going all the time. See Fig 3.

Figure 4 shows how the irregular currents of the two upper electrodes combine to make a fairly smooth output current, a considerable part of which is direct current, the rest being mainly 120 cycle A. C. It will be seen from this figure that the current thru each of the upper electrodes lasts more than half of each cycle. This effect is due to the fact that the transformer has a fairly high reactance, which causes it to act as a smoothing choke. This prevents the current from going to zero and prevents the arc from going out at each half-cycle. Increasing this reactance will naturally make the wave form smoother and more effectively prevent the current through the valve from reaching zero at any time.

"Keep-alive" Load

If the D. C. line is opened the arc of course will go out and cannot be struck without going thru the business of using the kick-coil or the starting switch again. This is not good, so it is necessary to keep the D. C. line l aded at all

times, at least enough to keep the arc going.

Feeding Vacuum Tubes.

When supplying vacuum tubes the power taken from the valve may not be enough to keep the arc going but this

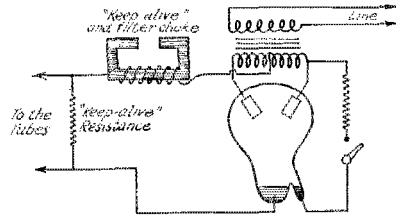

FIG. 5

can be corrected by using the proper size of "keep-alive" load as mentioned above.

The complete circuit for vacuum-tube plate supply then is the one shown in Fig 5.

Such a rectifier may be gotten together for about \$10.00—and some diplomacy. First get on the good side of one of the men with the local light plant, some one in the testing department. From find out when he has on hand a small pole-transformer or manhole-transformer that has nothing wrong with its windings but showed [on test] a core loss too high to allow keeping it on the line at times of light loads. Then go up to the company and buy that transformer. A transformer of 1 k. w. rating is large enough and such discarded transformers are usually sold for \$1.00 per kilowatt; give the company a dollar and cart the transformer home in the Ford. (One

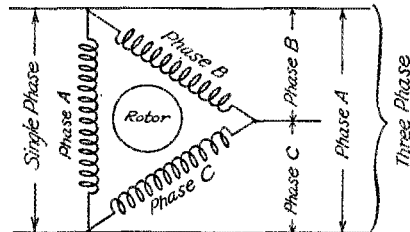

FIG. 6

winding of this transformer must, of course, be suited for the voltage of your house supply line.—Tech. Ed.)

The next, and hardest, thing is to get hold of the mercury arc tube. Here you have to use some diplomacy and talk the company into selling one of the small mercury arc tubes they use for supply-

started with a 300 meter wave in Fig. 4 the wave is now 150. Tuning down to the 2nd harmonic (one half wavelength) will

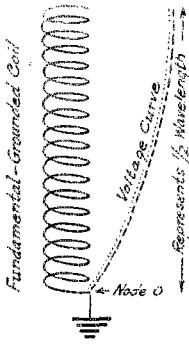

FIG. 4

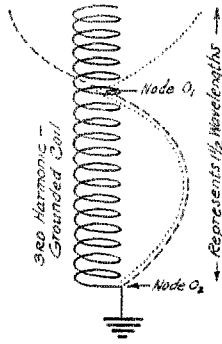

FIG. 5

give us two voltage nodes; pass this by and tune down to the third harmonic (one third wavelength) which has three voltage nodes, one in the center of the coil and

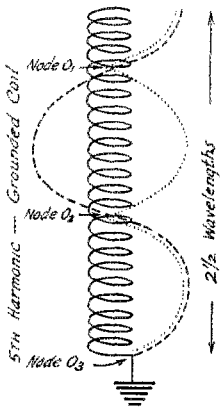

FIG. 6

one near each end of the coil. This is the wave we are going to study. The voltage curve is shown in Fig. 9.

The Antenna With Counterpoise

As in our other experiments we will assume that the part of the coil above the node O_1 is the antenna and the part below the node O_2 is the counterpoise. As before, this leaves too many turns in the helix (the part between O_1 and O_2) and we will shunt a variable condenser across the inductance so that the number of turns can be made small. In Fig. 10 this has been done and the tube set has been connected to the helix so that the filament tap comes at

the node O_2 , and there is zero voltage at both the antenna and counterpoise lead-in insulators, thus reducing the losses at these points. At the same time we have taken care of the need for a nodal point at the filament clip.

The whole system is again working at the antenna fundamental, and of course

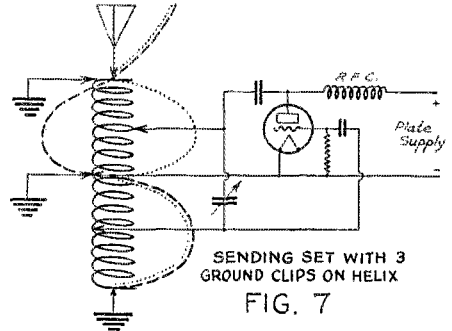

FIG. 7

the part of the system inside the station is also working at that wavelength. It might be well to say this in another way. If the antenna-and-counterpoise system works at 200 meters when their leads are connected directly together, then the thing for us to do is to set the antenna and counterpoise clips at the end of the helix, set the condenser clips about half way in toward the center and then turn the condenser until the helix system oscillates at

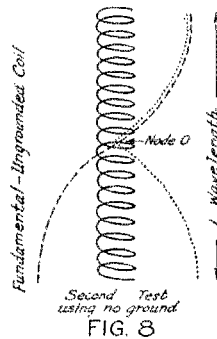

FIG. 8

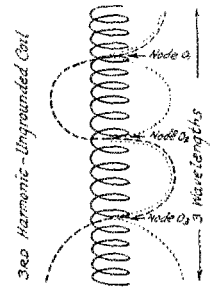

FIG. 9

200 meters. This is much the same thing as in Fig. 7.

Series Condensers

In order that we may be able to work on any wavelength within the amateur band (and below it if we have an X license), the next step is to insert two series condensers, one in the antenna lead, and another in the counterpoise lead. We will

If we take the three transformers just described and bring out center-taps we can connect the secondaries as shown in Fig. 8. This connection is called "three-phase dametircal" and is very evidently equal to a six-phases upply. It would be desirable to have a rectifier tube with 6 positive electrodes for rectifying such a supply as shown in Fig. 8, but a pair of three-phase valves may be used.

The ripple from such rectifier will not be over 15% and this can be smoothed out easily.

A very fine plate supply may be obtained by modifying this last system a trifle. If we separate the two valves of the secondaries of the transformers used in the three-phase and six-phase rectifiers we will have 6 secondaries. These can then be connected as shown in Fig 9 to form two separate three-phase Y systems. Each of these can of course be rectified separately, giving the same sort of output as would have been obtained with the circuit of Fig. 7. However, the ripples of the two systems may be made to cancel each other by the scheme of connections shown in Fig. 9. The choke must be quite large and the windings at either side of the center-tap should be exactly alike and closely coupled. A rectifier of this kind can be used for telephony with-

the Hotel Adelphia, Philadelphia. The entire roof of the hotel has been reserved by Dave Provan, genial proprietor of the hostlery. Dave never does things by halves, quarters or three-quarters; therefore he has given consent for the installation of a complete amateur sending and receiving station to which has been issued the call "3DRC" (Third District Radio Convention).

And that isn't all—there will be a real radio show of commercial and amateur apparatus plus pictures of Third District stations. W. Bradley Martin is building a special wavemeter for a set-calibration test and "Daddy" Cadmus will be on hand with the official wavemeter and will hold license examinations.

There will be speakers from various fields of radio engineering, but their names will not be stated now as the managers intend to promise only what they can make good on, which is a Dutch way of saying that the men whose names appear on the program will speak unless death or accident prevents them.

Special sessions will be held for the general public and at these the activities of the radio amateur will be explained.

There will be a visit to Central High School, known to Philadelphians as "The Birthplace of Radio", and the tour will include many other places around Philadelphia. (Take it from us, gang, that Philadelphia puts on some nice tours.)

The banquet on Friday will of necessity be limited to real qualified *amateurs*. Send reservations to the manager of the convention, Thomas Appleby, 708 Harrison Bldg., Philadelphia. The main banquet speeches will be broadcast by WOO, John Wanamaker's station.

The last feature of the convention will be the first R.O.W.H. initiation to be held in the Third District. The novices will be led into the Order of the Wouff Hong by Charles H. Stewart, Atlantic Division Manager, and Thomas Appleby, who entered the realm at Chicago and Atlanta respectively.

There will be a receiving contest—and prizes, of course.

Thomas Appleby is in complete charge of the convention as the District President. Mr. Horace A. Beale, jr., is convalescing in Florida from a long illness. The other officers are Paul C. Peterson, vice president, John D. Reister, secretary-treasurer. The committeemen are Chas. Van Housen, Publicity; C. H. Stewart, Banquet Broadcasting; Joseph M. Nassau, Amateur Exhibits; F. Richardson, Technical Director; James F. Rau, Music; W. Bradley Martin, Contests and Prizes; Prof. Lloyd M. Knoll, Station 3DRC. The convention directors are Messrs. Peterson, Nassau, Richardson, Knoll, Van Housen, Appleby, and Fred Mergenthaler.

FIG. 9A

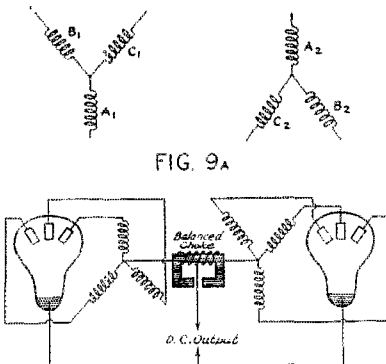

FIG. 9B

out other filter. Such a system is used with kenotrons at WGY and was described recently in the Proceedings I.R.E. —(Tech. Ed.)

Third District Convention

April 24, 25 and 26!

Paste those dates in your Easter bonnets and make up your minds to attend the 5th Annual Convention of the Third Radio District, the which is to be held at

Amateur Wavemeters

Part Two

By S. Kruse, Technical Editor

HAVING made a wavemeter as described in the February issue we are ready to calibrate it and start using it.¹

Calibration

By "calibration" is meant the job of finding out what wavelengths are shown by different readings of the condenser

for an amateur to do well. It is better to use a wavemeter chart as in Fig. 1b or 1c.

Standards

Before any wavelengths can be put down on a chart or a dial one has to know them and that calls for some sort of a standard. The best standard right now is most certainly the "Standard Frequency" transmissions from WWV, Bureau of Standards at Washington. The schedules have been printed regularly in *QST* and many amateur wavemeters have been calibrated accurately. The ways of doing this were explained in *QST* at the following places: July, 1923,* page 28, "How to Use the Signals," and September, 1923,* page 20, "How to Use the Signals." The titles are the same but the two items are different.

The service of WWV may possibly be extended to other stations as we are informed by the daily papers that some arrangements along this line have been made with the Cutting & Washington station WLAG at Minneapolis.

Not everyone can hear WWV well enough to use that stations' signals. *It is NOT a good idea to use other stations except those listed in the monthly Radio Service Bulletin.* Ordinary radio stations are not particularly careful about being on their correct waves.

Some amateur stations can give you correct wavelength—but take this sort of evidence *mightily cautiously*—we know of only two in the whole country that are able to do a really first-rate job.

Commercial Calibration

Strictly speaking we ought to compare with a standard wavemeter if we can't hear WWV. Now there are not very many standard wavemeters and generally the people that have them are too busy to take on jobs of calibrating. The Bureau of Standards does such work² but they are usually very far behind and considerable delay must be looked for. The work done is, of course, excellent. Lately also the Washington Radio Laboratories (you will find their ad. in *QST*) have begun doing wavemeter work.

If you send a meter to either of the above laboratories be sure that it is packed in a very large box with at least 4 inches

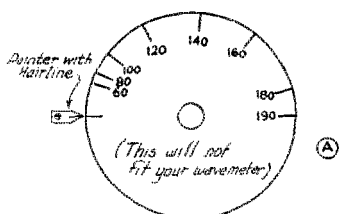

DIRECT READING DIAL

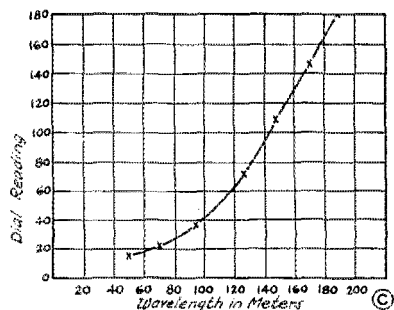
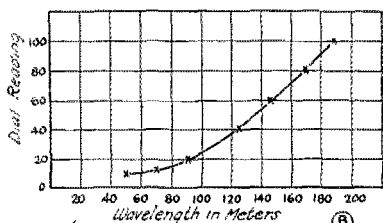

FIG. 1 SAMPLES OF WAVEMETER DIAL AND CURVES
(Will not fit your wavemeter.)

scale. These wavelengths may be marked directly on the scale of the condenser as in Fig. 1a, which makes a "direct-reading wavemeter." This is usually hard

¹—More information on short-wave wavemeters can be gotten from the Bureau of Standards Letter Circular, LC 78. This can be gotten from the Radio Section, Bureau of Standards, Washington, D. C. *Can be obtained from the *QST* Circulation Dept. at the regular price.

²—No good amateur ought to be without this monthly sheet. It can be gotten from the Superintendent of Documents, Government Printing Office, Washington, D.C., at 25¢ per year. A surprising amount of information is given.

³—Rates may be obtained by writing them for the rate sheet on radio measurements.

of excelsior all around it. Also make sure that the dial or pointer is absolutely solid on the shaft and finally tie or otherwise fasten the condenser so it cannot "flop" around and damage itself.

Standard Wavemeters

If you cannot use WWV's signals and cannot ship your meter to a laboratory, then get hold of the best wavemeter you can locate and use it for a standard. There are not many good wavemeters in amateur stations and you will have to do some looking. If you can get hold of a General Radio Precision, Kolster, or any one of several good Navy wavemeters, you are in luck. They will be better than you really have need for. If you can't get hold of such a meter it is a good idea to look at the nameplate; if it came from a good firm the meter is probably O.K. for amateur work.

Calibrating Against a Wavemeter

The best method of calibrating a new wavemeter is by use of a standard wavemeter and a small oscillator. This method was pretty well explained in the article "A Short-wave Oscillator" in *QST* for May, 1923,* page 47. It may seem like a good bit of work to build an oscillator just for the sake of getting a wavemeter calibrated, but the oscillator is good for many other things, as explained by Mr. White.

Other methods of calibrating are so much poorer that they will not be described at all; everyone can rig up an oscillator these days. If you haven't a Western Electric "E" tube as described by Mr. White, use a Radiotron 5-watt tube or even a UV-201A or C-301A.

The Indicator

Sometimes it is a good idea to equip a wavemeter with a crystal detector—but we can't remember when. Leave the crystal off; it always get out of order and isn't of much use on C.W. If you *must* use a crystal be sure to connect it as described last month—not in the usual amateur fashion.

The little lamp is about the best for all-around work. Sometimes good service can be gotten from a little vacuum tube connected *across* the wavemeter condenser. A very good tube for the work can be gotten from a Westinghouse "Spark C" pencil or from an "Airco Ignition Gauge." These are the same affairs Mr. Reinartz referred to in his article on antennas last month.

Making the Wavelength Chart

It isn't necessary to describe the way of marking wavelengths on a dial; that's easy enough. Usually such dials do not read at all closely and a *chart is much better*. In laying out a chart it is a great advantage to use "cross-section paper." If you cannot get this, rule up a sheet of paper

about 8" x 10" and do a very careful job of it. The size of the squares depends on the wavelength range but $\frac{1}{4}$ " ones are handy.

Put down each wavelength reading as you get it and work along the curve. Perhaps something like the curve of Fig. 2 will happen. This shows that the points x_1 and x_2 are off and ought to be re-run. *These mistakes would not show on a dial or other scale.*

Using the Wavemeter on the Sending Set

In measuring the wavelength of a sending set it is very important to use loose coupling between the wavemeter and the sending set. If you do not, you are likely to burn out the lamp (or thermo-galvanometer) in the wavemeter and in addition are very likely to get wrong wavelength readings. Start out with the wavemeter a yard or so from the helix and work forward gradually until you get an indication when turning the condenser *very slowly*. When the coupling is loose you will get a dull red glow from the lamp at the very best setting—if the lamp lights brightly you are much too near the set.

A low power set will sometimes fail to light the wavemeter lamp. Another stunt may then be used; bring the wavemeter rather close to the top of the helix and hold down the key while slowly turning the wavemeter condenser. When you run into the working wave the plate current of the set will go *up* and the antenna current will go *down*. Sometimes the resonance point can be spotted by the changing hum of the plate transformer. This stunt can also be used with large sets by putting them on low power, not over one ampere in the antenna at 200 meters and not over .2 at 100 meters.

The last scheme is handy but not accurate if there is no plate-current meter. A good emergency scheme that is surprisingly accurate is to start the buzzer on the wavemeter and then watch the contacts while the wavemeter is held over the helix. Turn the wavemeter condenser until you strike the resonance point, which will be shown by a sputtering spark at the buzzer contacts. Then take the wavemeter away from the helix, working the condenser back and forth as you go, until you find the distance at which it is *just possible* to get fire at the contacts *over a hairline distance on the dial*. The cutoff is extremely sharp and the indications surprisingly good. With one of our wavemeters at 1XAQ we can always get readings within $\frac{1}{2}$ of a division on a 100-division dial.

Using the Wavemeter With Receiving Sets

In last month's *QST* we accidentally omitted the number of turns in the secondary coil of the 1BGF tuner in the article "Low-loss Tuners." That should not

What Is a Good Condenser?

A good condenser must be used. If the condenser has high resistance the antenna efficiency will be lower and the tuning will not be sharp. The best condenser of all would be a thing insulated with air entirely, but how would one hold the plates in place? Any one can see that some solid material must be used. Now solid material always causes some losses; therefore we must build the condenser in such a fashion as to keep the solid material out of the

badly. Good glass condensers are made, in the form of copper-plated leyden jars, by the Stahl Rectifier Co. These jars were described briefly on page 65 of the November issue; their capacity is .00019 microfarads. These jars are low priced and extremely hard to puncture—the antenna current probably will never harm them.

When it comes to variable series condensers the proper one to choose depends on the antenna current. Sets using two or three "5-watt" tubes will usually operate perfectly with a good .0005 microfarad variable receiving condenser. The best condensers for this work are those with a fair amount of spacing and with rubber or thin *molded bakelite* ends. Condensers insulated with "moulded mud" are not good, neither are those with most of the sheet insulating-materials, especially fibre. Generally condensers with insulation in the form of a bushing around the shaft (or around the bolts) will not work well in the antenna.

For larger powers there is only one condenser on the market, as far as I know: the Allen D. Cardwell type 147B. This condenser stands up well with powers as high as four 50-watt tubes or a single

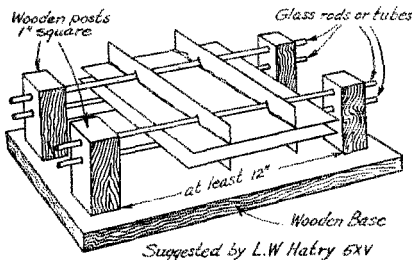
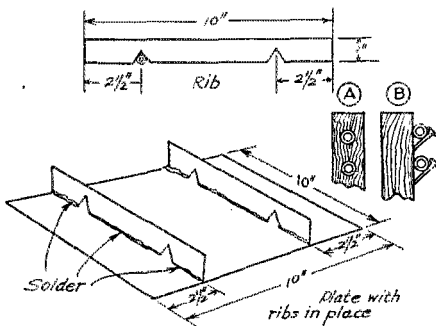

AN EXCELLENT \$1.92 LOW-LOSS FIXED CONDENSER

FIG 1

space between the plates, and to make all leakage paths as long and narrow as possible.

There is not space to go into detailed descriptions on this point, it will become clearer on looking at the descriptions of the following condensers.

Factory-Built Condensers

We have just said that an air condenser will give the lowest losses. That does not mean that all condensers with solid dielectrics are bad. They may be quite good if the best mica or quartz or pyrex glass sheets are used. For small sets mica series condensers with taps at .0002, .0003 and .0005 microfarads are made by the Dubilier Condenser Co. and also by the Radio Corporation of America. These condensers are quite satisfactory at antenna currents below 2 amperes; above that they heat rather

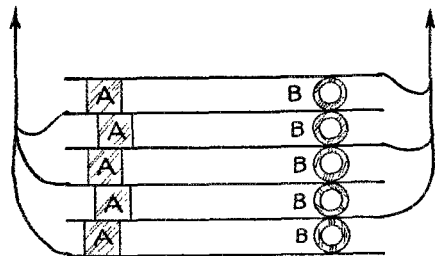

A-A-A Narrowest possible strips of glass as spacers
Glass Tubing may be used as at B-B-B.

CHEAP METAL AND GLASS FIXED CONDENSER Suggested by Brown, Darne & Basima 3BWT.

FIG. 2

UV-204. Keying surges jump across at times but the antenna current does not, and no harm at all is done.

Home-Made Condensers

In Fig. 1 is shown a condenser suggested by L. W. Hatry of 5XV. As there are only two plates they must be large to get the required capacity; in fact the design calls for plates 10 inches square. These should be cut from a good heavy sheet of tin on the square shears, *not* by hand, as it is necessary to have the plates flat. It is not possible to cut them with a pair of tinsnips without bending them more or less.

Are We Losing Contact With WNP?

Help! What is the matter with you fellows and your super-hets? What have you done toward establishing contact with WNP? The report for the month of February is the worst since Jack Barnsley hooked up with Mix last September. Only three slim reports were received for the entire month. Awful! Mix must have thousands of words of press and many messages on his hook and it is up to us to get busy and clear them for him. For the benefit of those who do not know it, WNP uses 500-cycle plate supply and works on about 180 or 220 meters.

There may be some reasons for lack of communication during the month of February. It is possible that the daylight period has had some effect on communication. Mix may have been off on a hunting trip and again it may be that his equipment has been out of order, but we doubt the latter. Until we again establish contact, no one can say just why there has been this falling off of that good contact we enjoyed during the preceding months when quite a number of stations were in nightly communication with WNP. Get busy, gang, and let us investigate this at once. Listen for WNP every night you can and send your reports to A.R.R.L. promptly.

About Christmas time, British 5NN heard WNP. On January 16th, Canadian 9BP sent 6 messages to WNP and 4 more on January 24, but was able to receive only 2 from Mix. On January 22, 8JY heard WNP as did 9AHT on January 26th. Canadian 4FV reports WNP on February 1, and 6CJQ heard WNP on February 16th. On February 19th, 9DKB sent 3 messages but was unable to receive any from WNP.

That is the extent of the contact with WNP for February and we want to see a concerted effort by those fellows who have been successful, to devote as much time as possible on WNP.

—F. H. S.

The Story of the Royal Order of the Wouff Hong

By F. D. Fallain, 8ZH-8AND, Supreme Secretary

Starting originally as a bit of "horse-play" at a state convention, the Royal Order of the Wouff Hong has become a fine and permanent part of A.R.R.L. life. No amateur can attend a conclave of the K.O.W.H. and not be made a better amateur and a more loyal member of our A.R.R.L. In the following article Supreme Secretary Fallain tells of the origin and early history of the order, and how a group of typical American amateurs at Flint, Michigan, made their mark in the annals of Amateur Radio.—Editor.

BACK in January 1922 the Flint gang was rounding into shape for the 2nd Michigan Annual A.R.R.L. Convention and, as in the case of all good conventions there was a heap of work and swearing to be done. And the convention was just four days off.

On one particular night the usual arguments were being hashed over; posters were not all out and, hang it all, the advance

registrations were not coming in as planned. In general the night was cloudy and the silvery lining had not appeared. However, it looked as if there would be a convention if the committee members did not kill each other.

As usual the gang was gathered in the offices housing 8AND-8ZH, soaking in the heat and gassing freely. Some bright individual came into the argument and sug-

no explanation. If the rig is tilted slightly there is no need for the rubber and the condenser action will be smoother.

The capacity obtained may be found from the second column of the table above, the capacity going down as the movable plate is slanted further away from the fixed plate.

Another Home-Made Variable Condenser

When two plates do not give enough capacity the idea of Fig. 4 can not be used. For such occasions the three-plate condenser of Fig. 5 will do excellent work, even if it is a blood-brother to the old "come-and-go" condensers that used to have tin plates and wooden insulation! If the same size of plate is used the capacity of such a condenser may be found from the last column of Table B just given above. Here the capacity is cut down by sliding the central plate out.

Some General Rules

All of the home-made condensers are rather "big for their size." To keep down bad capacities leave 6" between the condensers and any other part of the set. To prevent heavy induction losses keep the condensers at least a foot from the helix.

In making any of the glass-plate condensers be sure to stick to the number of plates given. More than that will put glass into the field and the losses will go up very fast. Stick the tinfoil on with beeswax or paraffin, not with glue or shellac or anything that contains water, alcohol,

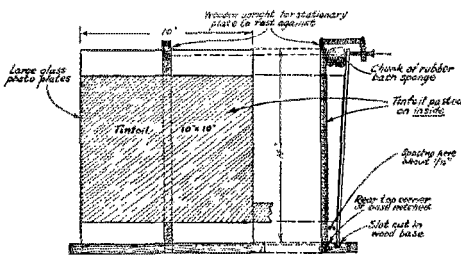

VARIABLE CONDENSER Suggested by F.C. Beckley I.A.E.L. FIG. 4

ether, turpentine or the like. Wide margins have been shown on all of the glass plates. Do not cut down these margins; in moist weather there will be leakage, even if you do not see anything happening.

If you can get hold of it use thin copper foil or aluminum foil instead of tinfoil; these materials do not tear so easily. No matter what you use it is possible to solder light flexible leads to the sheet after it is on the glass if care is taken to drip the solder on when it is just hot enough to "take". Everything must be perfectly clean first, tho, and a bit of Nokorode will help; wash it off afterward with gasoline or alcohol.

Current-Rating of Condensers

If the wavelength is known it is possible to give a current-rating for fixed condensers. This current rating is good for that particular wavelength only. For a variable condenser one cannot give a current rating unless the wavelength and the setting of the condenser is known.

Current ratings do not mean much in the case of air condensers: the only important thing is the voltage rating; that is, the

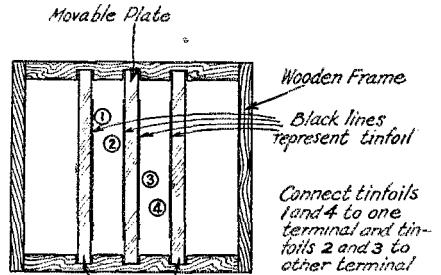

FIG. 5
FIXED OR VARIABLE CONDENSER GIVING HIGHER CAPACITY

voltage needed to spark thru the air space. This can be calculated as follows:

$$\text{Peak Voltage} = \frac{\text{Current in Amperes (1.41)}}{2\pi (\text{Frequency}) (\text{Capacity in Farads})}$$

Other formulas that amount to the same thing are

$$\text{Peak Voltage} = \frac{(\text{Amperes}) (\text{Wavelength})}{1340 (\text{Capacity Microfarads})}$$

$$.00075 (\text{Amperes}) (\text{Wavelength})$$

Capacity in Microfarads

Spacing of Air Condensers

With most amateur sending sets the flashovers that take place in the antenna condensers are not caused by the antenna current at all, but by the keying surges—the things your neighbor hears on 400-meters (or anywhere else). Cut these out and there will be little trouble along this line.

It is hard to say just what will be the flashover voltage with a certain spacing, because it depends on the sharpness of the edges of the plates, also the moisture of the air. The following are safe values.

Flashover Voltages for Air Condensers.

Conservative Values from Practice

Spacing of Plates inches	Voltage (peak)	Current that produces this (peak) voltage	
		at .0002 mfd. and 200 meters	at .00005 mfd. and 100 meters.
1/4	15,000	21.	10.5
1/8	8,000	10.7	5.35
1/10	7,000	9.4	4.70
1/16	5,000	6.7	3.35

Table C

R.O.W.H. was not in shape for the Second National A.R.R.L. Convention and said convention was but ten days away. A meeting was called and the gang gathered at the offices of 8ZH again for conference. Much dignified information was forthcoming and finally Cowing made a rough outline and wrote it up with Lathrop butting in and Fallain pounding the station mill. Outline was right, it could just be seen thru the smoke. Another meeting was called next night and the plot thickened with suggestions and advice from the gang—we were out in full force again. Brother Lathrop took the outline and a bunch of hours off with a cord of pencils, and wrote a ritual and presented the results at the next night's meeting. Again suggestions and the station mill, together with well-timed cussing, produced a typewritten copy. Fallain started the part of I.K.L.A. and had to finish it. The rest of the gang had their pet suggestions incorporated into the ritual and finally it was accepted as a finished job. Copies were made and we were ready for rehearsals. The whole cast had but three rehearsals; then Fallain went to Chicago as advance agent and the rest of the bunch had two or three more and came on to Chicago Friday night.

The stage was set but no time for a dress rehearsal. Lathrop checked the wardrobe trunks at Flint but they did not get on the train the gang came on, and it looked as tho \$1200.00 worth of robes were coming too late. It was but two hours before the initiation, and no trunks in sight yet. Lathrop called upon all the gods. Then Brother Wright, the mystery man at Chicago, gathered in a truck and driver, the traffic laws were broken and the necks of the two men bent in going 'way down town and back, but they made it in no time and came back with the trunks which had just arrived at Chicago. The sigh of relief sounded like a Kansas cyclone. In due time the initiation was put on and the delegates liked it immensely and voted it a big success. The first National Conclave was a thing of the past! Make-up and wigs were removed and the gang sat down and waited for Nora.

At the close of the Night of Mystery at Chicago we were informed that A.R.R.L. would like the initiation within the circle of the A.R.R.L. and we were requested to draft By-Laws and Rules and Regulations. Upon our return to Flint we had as many as three meetings per week at the homes of the various fellows. Twice our proposals were sent to Hartford for suggestions. In October we received a letter from K. B. Warner, Secretary of the A.R.R.L., stating that at a Board meeting of the A.R.R.L. held during the week of

Oct. 7th he had presented the matter of official recognition of the R.O.W.H. and he was directed to say that official A.R.R.L. endorsement was extended to the R.O.W.H. and that the Board accepted the offer of the Supreme Council (at Flint) to make the order a part of the A.R.R.L. affairs in connection with the A.R.R.L. conventions.

During meetings held to draft rules and regulations officers of the Supreme Council of the R.O.W.H. were elected. The members of the Supreme Council are Guy R. Cowing, Gordon Bell, Harry Phelps, Thos. Lathrop, Burton Wallrath, Frank Fallain, Silver King, and Chas. Tiedeman.

The officers as elected are as follows:

Guy R. Cowing—Supreme Master of Ceremonies.

Frank D. Fallain—Supreme Secretary.

Gordon Bell—Supreme Treasurer.

The present Supreme Council comprises the original cast of the first conclave of the R.O.W.H. Columbus, Ohio, was the second city to put on the R.O.W.H. The first conclave with the new ritual was at the Second National Convention at Chicago. The second city to get the new ritual was Atlanta, Ga., in December, 1923. It will be put on by the original cast at the 3rd Michigan A.R.R.L. affair in Detroit about March 1, 1924. Now from far off Seattle, Wash., comes the request for the "dope."

* * * * *

In conclusion the Supreme Council wishes you all to know they will do all possible to help any convention get this initiation across. We shall be glad to answer any and all inquiries concerning the initiation—provided, of course, that we are not asked to divulge any of the secrets. You are asked to send a self-addressed and stamped envelope.

Conclaves are held only at a state, Division, district or national A.R.R.L. Convention, and are under the control of the Supreme Council. Applications for a conclave should be addressed by the Convention Chairman to the Supreme Secretary, F. D. Fallain, 321 First Ave., Flint, Mich., and must be filed at least two months prior to the convention. The application should designate the person who will act as Master of Ceremonies and who will be responsible both to the convention chairman and to the Supreme Council for all matters pertaining to the R.O.W.H. at the convention. The convention chairman should also notify A.R.R.L. Headquarters at Hartford, Conn., that application has been filed, as a conclave will be authorized by the Supreme Council only upon the sanction of A.R.R.L. Headquarters.

The Supreme Council has prepared detailed rules and regulations, copies of the ritual, and certain paraphernalia, which will then become available to the conven-

top one is the speech amplifier with its associates. Next come three 250-watters, reputed to be doing the work of four, and a few other mysterious but necessary parts. The third shelf contains several immense antenna inductances, and the bottom shelf

ning little lighthouses, equipped with aerials after the fashion of BCK's first one. The idea seems to be to make the tubes in one lighthouse squeal intermittently, then the other takes up the wail, and a ship operator, approaching, tries to get as

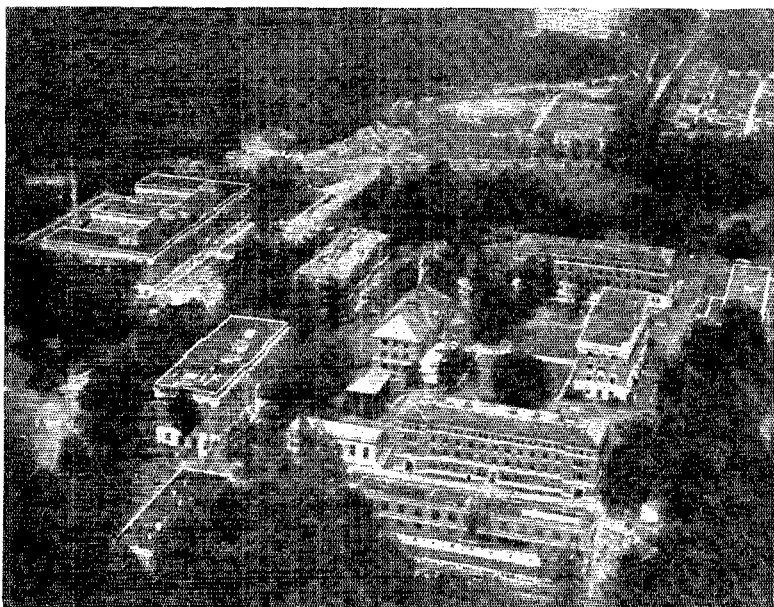

Airplane View of the Bustands.
The Radio Lab. is located at the extreme right center.

holds two mammoth condensers and a row of B batteries, with more on the floor beneath. The walls of the rack are covered with meters and switches. On a table nearby stands a formidable looking receiver, while the rest of the room is littered with receivers and wavemeters, tubes and condensers, apparently ad infinitum. Everytime the young man smiled we felt our interest in WWV mount, whereas our curiosity regarding the rest of the Laboratory dwindled to nothing. We must have asked the same questions a number of times, lacking new ones. It may have been mere chance, of course, or perhaps our guide had ulterior motives, but we were unceremoniously bundled out of the room after only the fourth explanation of the transmitter, and were forced to inspect the other rooms. They all looked pretty much alike to us—all strewn with radio apparatus of every description, and apparently all in use for one test or another. One room contains dozens and dozens of tubes of every kind. They let you look at them from behind a railing.

In the lobby is a model of the dashing waves breaking high on a stern and rock-bound coast which is guarded by two cun-far away as possible from the racket, and

so steers clear of the treacherous rocks. We can't blame him. It seems like a pretty good idea. Our guide all this time was Miss Elizabeth M. Zandonini, "OW of DC". How that girl manages to keep all that information in one head is a mystery to us. We'd have to carry a few spares, with a little card index showing which facts were filed in which head.

Coming out from that atmosphere, heavy with profundities, into the bright sunshine, brought back our buoyant spirits with a rush. We leaped lightly onto a little hillock by the road, preparatory to racing down the path, but it turned out to be a cinder pile, and we sank in up to our knees, getting our shoes full of cinders and our head full of blasphemies, and blessed if we'd swap BCK for the whole Bureau.

Concerning the 1BGF Tuner

We don't know how it happened but the number of secondary turns was omitted from the description of the tuner on page 9 of the February issue. The correct values are 24 turns for amateur work and 40 for broadcasts. The excitement displayed about that omission certainly indicates a tremendous interest in low-loss tuners.

with amateurs because it is very easy to set up "spurious" or "parasitic" oscillations when working at low wave lengths, due to the combined effect of inductive and capacitive coupling which cause out-of-phase effects. However, the circuit is extremely flexible because it requires very little change of coupling over a wide range of wavelengths, hence it is popular in the laboratory as a source of high frequency current. It is convenient as an external heterodyne, for hunting down harmonics, or as a source of power when measuring antenna resistance, using the method described by Mr. Albert F. Murray in the May 1923 issue of QST.*

The Hartley Circuit

In the Hartley circuit of Fig. 2 we couple the plate to the grid by means of the voltage drop across the reactance of the helix turns. The Hartley circuit may generate short-wave "parasitics" but they are easily stopped by placing a very small choke coil in the grid circuit, right at the grid binding post. At 3YO this happened, and the "parasitic" wave was found clear at the lower end of the wavemeter scale, where it was located on 50 meters! As soon as the grid choke was inserted, the wavelength returned to normal and no further difficulty was experienced. The grid choke was made by winding 20 turns of ordinary bell wire on a pencil. Morecroft (Principles of Radio Communication, page 502) explains that this also occurs when the natural frequency of the grid circuit is near that of the main oscillatory circuit. The tube may then oscillate at the frequency of the grid circuit instead of the proper frequency. (And it may at times jump from one to the other.—Tech. Ed.)

The Colpitts Circuit

In the Colpitts circuit of Fig. 4 the voltage drop across the condenser C is used for the grid excitation. For this reason we call this a "capacity coupled" grid circuit. The Technical Editor has pointed out that as we tune the antenna with the condenser C we also change the value of the grid coupling, since the voltage across the condenser changes with its setting. This disadvantage can be readily appreciated. Another great disadvantage of the circuit is that (especially with large tubes) it is difficult to obtain a variable condenser that will stand the plate voltage and at the same time have low losses. Of course it is possible to leave the condenser alone and change the wavelength by varying the antenna clip on the helix but this too changes the grid excitation because the voltage across the condenser changes, not only with the antenna current, but also with the frequency (wavelength).

*Can be obtained from the QST Circulation Dept. at the regular price.

Methods of Feeding the Plate Power Series Feed

In the Meissner circuit of Fig. 1a we have an example of series power feed. This means that the D.C. and the radio frequency A.C. components of the plate current flow thru the same paths in the plate circuit (first going thru the plate coil together and then going to the source

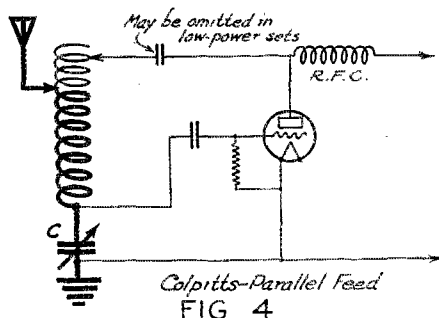

of plate power, where the A.C. may be passed around the generator or transformer by a condenser, and finally back to the filament together). In consulting Professor J. H. Morecroft on this subject he says: "I can say that practically all of the ordinary circuits are capable of being adjusted to give equally efficient operation of a tube, but those in which alternating or pulsating currents flow in the fewest circuits are best."

Parallel Feed (Shunt Feed)

In Figs. 1b, 2, 3, 4 and 5 parallel feed may be observed. Note that always with parallel feed there must be a high frequency choke coil (R.F.C. in the figures) to keep the radio frequency away from the plate-power supply, and a blocking (stopping) condenser, to keep the plate power out of the plate coil.

Telling Shunt from Series Feed

The use of parallel (shunt) power feed, as compared with series feed, may always be determined in any circuit by observing whether the power lead to the plate also carries the oscillating current. If it does we say we have series feed; if it carries the plate power only and the oscillatory current is led off another way we say we have parallel (shunt) feed.

A bypass condenser around the source of plate power is *always* needed for series feed, otherwise the oscillatory current will not go thru or else would damage the power source. With parallel feed it sometimes happens that some of the radio frequency gets by the choke. In this case also the power-source (generator or transformer) must be protected by a by-pass condenser.

"Unscrambling" Amateur Circuits

In comparing the Hartley circuit of Fig. 2 and the so-called "sure fire" circuit of Fig. 3 we find that the only difference between them is that the "sure fire" has a tuned grid circuit—in other words it is a "Hartley with a tuned grid". When working with a high resistance antenna the transmitter often refuses to oscillate until the grid circuit is tuned. However, this same thing can be accomplished by using the proper values of plate stopping con-

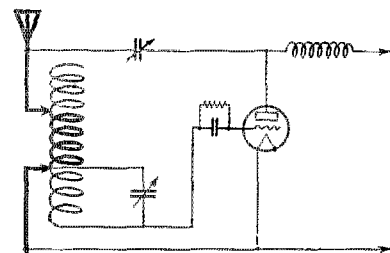

"Old Reinartz" (Oct. 1922 QST) (Improved Reinartz has inductive feedback as well as capacitive.) Also this is a Reinartz receiving tuner notice that, with the exception of the "untuned" antenna system, it is the Hartley with tuned grid.

FIG. 5

denser and radio frequency choke as shown by Mr. Prince of the General Electric Co. in the June, 1923 issue of the Proceedings, I.R.E. The exact values for any set cannot be given as they depend on the antenna capacity, also the grid and plate inductances and resistances. A variometer used as an R.F. choke would give the variation necessary. For anyone interested in a presentation of the voltage vectors as used in determining the size coil and stopping condenser to be used, Mr. Prince's article will be extremely valuable. The entire object is to get the grid voltage 180 degrees out of phase with the plate voltage, i.e., to make the grid voltage maximum in one direction at the moment when the plate voltage is maximum in the other direction.

If this adjustment of the R.F. choke is made the tuning condenser of the "Hartley with tuned grid" may be done away with. After this change, the only difference between this and the common Hartley is the extra grid coil being used. By using part of the helix instead we accomplish the same thing, and have the basic Hartley. Fundamentally both are the same—both have parallel power feed, but the Hartley uses two parts less. (The Hartley circuit is being used by many amateurs with series feed but it is not suited to this use.—Tech. Ed.)

The "sure fire", "1DH", "reversed feedback" sending circuits and Reinartz receiving circuits are all essentially the same. In the Reinartz circuit a detuned aerial system is used for receiving, while in all the others

the antenna is tuned to the working wave and used for transmitting. Fig. 5 is the "Old Reinartz" tuner as it appeared in October, 1922, QST. This has purposely not been drawn the conventional way but so as to show that the "Hartley with tuned grid" and the "Reinartz" are one and the same, used for different purposes. It is very interesting to draw circuits out side by side in this fashion with the parts in the same relative position. The likenesses of circuits may then be easily observed. Many "new" wonders will disappear if you analyze them this way.

In this discussion the term "reversed feedback" has been used as by the amateur, not as by Ballantine, who applies it to an arrangement in which there is no inductive coupling between the helix and the grid coil.

Master Oscillators

While the master-oscillator is always one of the three standard circuits, still we cannot classify the complete master-oscillator-with-power-amplifier under our self-oscillatory circuit headings. It is here mentioned for the purpose of stating that the output of the amplifier tubes will not differ greatly from that obtained with self-excitation. At 3YO a 5-watt tube was made to furnish grid excitation for two 250-watt tubes in a self-rectifying arrangement. The output after a little tinkering, was about the same as with self-excitation but with the advantage that the wave does not shift as the antenna swings in the wind. (This is a combination that the amateur had better not attempt. Usually it is quite impossible to get reliable performance unless the master oscillator tubes represent at least $\frac{1}{4}$ and better $\frac{1}{2}$ the power rating of the amplifier. There is much sad experience back of this advice!—Tech. Ed.)

The question of Master Oscillators brings up that of harmonics. At 3YO, with self-excitation the strength of the 2nd, 3rd and 4th harmonics was measured with a wavemeter. The deflections on the scale of the wavemeter galvanometer were 1, 28 and 3 respectively. With the master oscillator, and about the same antenna input, the deflections were 1, 3 and 3. The fundamental is here considered as the first harmonic.

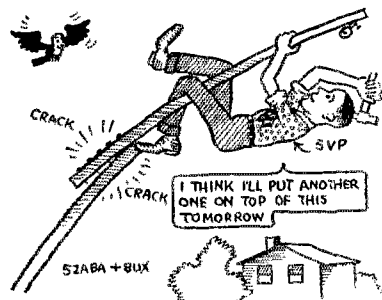

Your Antenna Tower---A Real Problem

By S. Kruse, Technical Editor

WHAT sort of mast or tower shall I erect?" It is the commonest question of our members, yet we can never answer it fully. It seems worth while to explain *why* there is no good answer—to point out a few of the problems that every station-owner must solve for himself, and that are generally overlooked.

Why We Know Nothing

Antennas have been carried on masts and towers for more than 25 years, yet little enough is known about them. What theory there is concerns itself mainly with imaginary antennas that are located in the center of a large flat plain, without a house, tree, wire or river within a great distance. Does that fit an amateur antenna that springs from a 25x30 back yard and terminates on a pole set between two giant maple trees? Hardly! Neither does commercial experience have any value to us, for we work our antennas at, or even below, the fundamental (natural) wavelength and it is quite easy for a long guy wire or a steel pole to fall into resonance and mysteriously do away with large amounts of energy—a thing our commercial brethren have no experience with.

It becomes clear that we will have to do our own thinking—help from the outside has not arrived.

Towers

There is always with us the man that swears by the self-supporting wooden tower and presents strong claims for it. He says that there will be no induced currents running around in a wooden tower, that it will not, by its presence, particularly lower the effective height of the antenna and that we can work on any wavelength without worrying about resonance humps or re-radiated energy from the tower. Also the tower does not cost much. These are strong arguments and must be considered—but first let us hear from the man with the steel tower.

The steel tower's claims are that the induced-current loss in a steel tower does not amount to much, the currents are perhaps large but the resistances are very low and so are the losses. Whatever the loss may be, the steel-tower man is sure that they are lower than those caused by putting a large mass of wet wood into the field of the antenna and making a poor condenser of that antenna. Neither does the steel-tower man worry especially about the effect of the tower in lowering the effective height

—that can be regained by making the tower a bit higher—it will still be safe. As advantages for the metal tower one can claim that it is lightning-proof, permanent, handsome, and the strongest of all amateur antenna supports.

Which shall it be? Certainly the steel tower costs more—especially if one has to move it; probably also the effect of bringing the antenna close to it will be much worse than with the wooden tower; also we will have to stay off waves near the

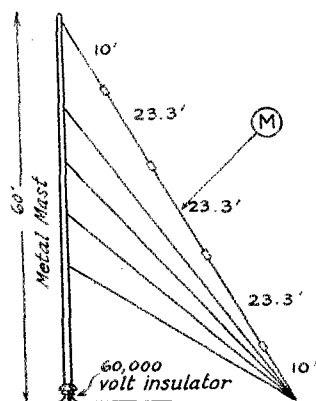

FIG. 1 MAST AT 9LQ

natural wave of the tower. But where there is room and money and a free choice of wavelengths the steel tower would seem to have the best of it; in other respect the wooden one leads.

Self-Supporting Masts

For the present the guy-less mast can be considered as a very narrow tower and all the arguments of the previous paragraphs applied without much change, except that such an affair is less rigid and more handsome.

Guyed Masts

When the guyed mast is considered, numberless questions appear at once. It is no longer possible to settle out-of-hand the business of choosing wood or metal for the structure, for the electrical effects are now caused mainly by something *entirely different*—the guy wires. The effect of these guy wires is to make the whole affair have electrical properties somewhat like those of a lubberly steel tower with a base as wide as the spread of the guy wires. Such a monstrosity would cause the average

veloped by the Corning Glass Co., of Corning, N. Y. Pyrex is a particularly good glass for such work as water does not

gather on it in a continuous film as it does on ordinary glass—the surface is such as to make the water draw apart and form drops.

The Second Saskatchewan Convention

Reported by c4AL

This report of the Second Saskatchewan Convention reached us just too late to make our January issue and was inadvertently omitted from our February number. It is so splendid and inspiring a report, that we are sure it is much better late than never; we are only sorry that it is late.—Editor.

THE morning of November 12th saw Regina hams meeting trains and receiving amateurs from all parts of the province. The incoming amateurs were also greeted by pouring rain which rather knocked the visiting hams with autos on the head. The morning session of the convention was spent in visiting amateur sets in the city and general discussions. Towards noon many amateurs arrived from other outlying points in spite of the bad weather. The real ham spirit could not be downed; some came as far as they could by car and finished their journey by train.

The afternoon session was attended by about forty amateurs, including one Y.L. in the person of Miss Bowen-Smith of 4AJ. The meeting opened with a short speech from G. F. Muirhead, President of the Regina Radio Club, who called on 4HH for a talk. 4HH's first subject was that of the C.R.R.L. He outlined to us the plan of the A.R.R.L. for Canadian publicity and explained that they had offered us a substantial section in QST solely for Canadian affairs. This would be ample for our work. The organ for the C.R.R.L. is "The Radio Bug." Mr. Brickett explained that with the amateurs of Canada in their present financial condition, it would be utterly impossible to finance an organ of their own.

"The A.R.R.L. educated us into relay work and we cannot and will not leave them. The C.R.R.L. has not asked to affiliate with them. The so-called C.R.R.L. has no policies, no constitution, and we do not know what they are or what they are doing. The amateur has nearly always started any radio magazine that has been published but after the publishers have made as much as they desire out of them the amateur has generally been left in the lurch."

The next speaker was Mr. Maynard, who spoke very highly of Mr. A. H. K. Russell, our A.R.R.L. Canadian General Manager, with whom he has had a great deal of correspondence. He says Mr. Russell is a lawyer, an ex-service man, and carries a good deal of weight in Canadian matters, and we can rest assured that the

Canadian amateur will get a square deal.

In regard to the forming of a C.R.R.L. Mr. Maynard thinks that the Winnipeg hams are sincere in regard to such a thing. But at the same time he is of the opinion that the originators started the thing with the idea of making money. He is very much in favor of sticking with the A.R.R.L. who are always willing and ready to help. In his remarks he stated that he had never in all his

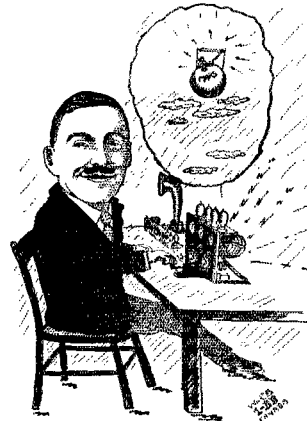

9-AL Toronto
Canadian Manager ARRL

life met in Canada or U.S.A. a better bunch of chaps than the members of the A.R.R.L., who were always willing to help and a real pleasure to meet. At this time Mr. Maynard gave an invitation to every B.C.L. present to come and join us. In respect to transmitting out of hours, etc., Mr. Maynard stated that for months he had listened in and had not heard any amateur in Canada or elsewhere transmitting on an illegal wave or interfering with broadcast concerts. He also expressed the willingness of all hams present to help Listener's-In in any way they could or to clear up any misunderstandings that may arise.

The next speaker was Mr. G. Muirhead who advised us that he had been

Base Insulation

When a steel mast or tower is used one naturally wonders if losses in the structure cannot be lowered by insulating it from the ground. Again there is not a very general answer. At pre-war 9LQ (see Fig. 1) and 9DM the results were neutral; the mast could be insulated or grounded to a large buried wire net without any particular

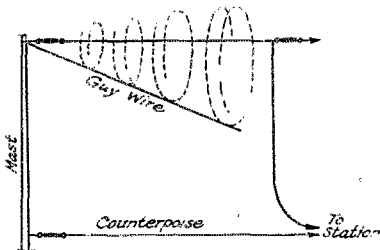

(A) HORIZONTAL GUY WIRE CUTTING THRU MAGNETIC FIELD

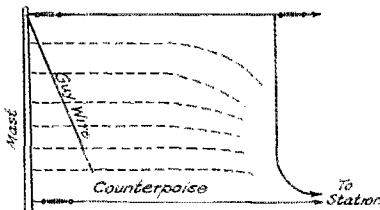

(B) VERTICAL GUY WIRE CUTTING THRU EQUAL-POTENTIAL PLANES

FIG. 3 HOW VOLTAGES ARE INDUCED

effect on the signal strength at 9NH (600 miles), 9EP (40 miles), 5ED (450 miles), or 6DM (1300 miles). However, a slight retuning of the antenna circuit was required. When a *poor* ground connection (a water pipe) was used things became entirely different, the antenna current dropped about 10%, signals failed at all points beyond 200 miles, and the antenna tuning was very broad. In the government tests at the opening of NAA the results seemed to favor grounding the towers, altho they had been built with the idea of always using the insulators. Ballantine suggests that the best method is to insulate the tower or mast and then connect it to the regular station ground, merely to prevent an accidental (and always poor) ground. This seems to check with the tests above.

How High?

Finally there is our old argument as to the proper height of the antenna supports. If there were no chance of resonance with the mast, nor any guy wires to occupy extra

space, one would naturally suppose that the highest mast would be the best, as long as the antenna did not become too long for the station's wavelength. But it is quite possible that too tall a metal mast may get into trouble with a short wave or that the extra height will call for a compromise-vertical antenna which runs much too close to the top guy wires. Still, the space and wealth that most of us have available does not ordinarily get us into this difficulty and the owner of the usual "T" or "inverted L" antenna has small cause to fear that his mast is too high!!

**Information Service,
American Radio Relay
League**

After April 5th, 1924, the Information Service will be resumed under the following rules:

1—Before writing, search your files of QST. You will probably find the answer there.

2—Do not ask for comparisons between advertised products.

3—Be reasonable in the number of questions you ask, also do not ask questions that require large amounts of work; give the other members a chance.

4—Put questions in the following form:

A—A *standard business size* (not freak correspondence size) stamped, self-addressed envelope must be enclosed. A stamp alone *will not do*.

B—Write with typewriter or ink on one side of sheet only. Pencil letters will not be answered.

C—Make diagrams on separate sheet and fasten all sheets together. Label diagrams carefully.

D—Number each paragraph and put only one question in a paragraph.

E—Keep a copy of your letter and your diagrams so we can refer you to them.

F—Put your name and address on each sheet, and do a complete job of it. *A radio call is not a signature; neither is it an address. We can not spend time digging your address out of the callbook.*

G—Address all question to Information Service, American Radio Relay League, 1045 Main Street, Hartford, Connecticut.

5—Letters not observing the rules will not be answered.

Transatlantic Tests Report

THIRTY-SEVEN different European amateur stations were received with codes verified in the Fourth A.R.R.L. Transatlantic Tests of 1923-1924.

Five other Europeans, not entered in the tests, were received without codes, making a total of 42. That is excellent, and proof conclusive of the wonderful progress the Europeans have made since the tests a year ago, when but two stations were received with certainty.

An even hundred American amateurs,

Tests (stations counted but once per night). He won by a very narrow margin over Sheldon S. Heap, 1BDT, Atlantic, Mass., with 1BCF a hot third.

The Ott Radio Co., Lacrosse, Wisc., kindly donated one of their WC5 short-wave radio-frequency-equipped tuners as a prize, but it was entered "too late to classify" in the list previously published. The judges consequently awarded it to 1BDT as an additional "consolation" prize.

PRIZE WINNERS IN THE TRANSATLANTIC TESTS

Grand Prize: Greatest Total Station Miles—R. B. Bourne, 1ANA, Chatham, Mass.

Group A: Greatest Mileage for Any Single Reception

1st:	Norman S. Hurley, 5AC, Mobile, Alabama.....	4750 miles
2d:	William Moore, 9DES, Caney, Kansas.....	4710 miles
3d:	L. W. & T. E. Bryant, 4BL, Lakeland, Florida.....	4540 miles
4th:	Quentin Swigart, 9COL, Galesburg, Ills.....	4310 miles
5th:	Fred Marco, 9CD, Chicago.....	4200 miles

Group B: Greatest French Mileage for Any Single Night

1st:	Sheldon S. Heap, 1BDT, Atlantic, Mass.
2d:	Wm. Coates Borrett, c1DD, Dartmouth, N. S.
3d:	Lafayette College Radio Club, 3YO, Easton, Pa.
4th:	Ed Scattergood, 3II, Cynwyd, Penna.
5th:	M. H. Hammerly, 2BIS, Bronxville, N. Y.

Group C: Greatest British Mileage for Any Single Night

1st:	J. L. Fenderson, c1AF, Jacquet River, N. B., Can.
2d:	Bronx Radio Club, Bronx, N. Y.
3d:	Robt. H. Sproul, 1GG, So. Hamilton, Mass.
4th:	Richard S. Briggs, 1BVL, Dorchester, Mass.
5th:	J. Van Riper, 2AJF, Passaic, N. J.

Group D: Greatest Total French Mileage

1st:	Levi G. Cushing, 1BCF, So. Duxbury, Mass.
2d:	A. W. Greig, c1BQ, Halifax, Nova Scotia.
3d:	R. W. Woodward, Hartford, Conn.
4th:	Bernard J. Kroger, 3APV, Washington, D. C.
5th:	Geo. H. Pinney, 1CKP, So. Manchester, Conn.

Group E: Greatest Total British Mileage

1st:	A. A. Learned, Providence, R. I.
2d:	A. R. Tabbut, Bar Harbor, Maine.
3d:	Boardman H. Chace, 1BDU, Winthrop, Mass.
4th:	Chester W. Sprague, 1AUC, Bar Harbor, Maine.
5th:	Harold G. Riley, 1AUR, Livermore Falls, Maine.

many of them in Canada, reported European sigs. Many, to our knowledge, did not report; but few of the stations that have worked Europe seemed to think it worth while to report the calls heard during the Tests. The total probably would have run two hundred or so.

R. B. Bourne, 1ANA, Chatham, Mass., wins the \$1,100 Grebe transmitter offered by Messrs. A. H. Grebe & Co. as a grand prize to the amateur copying the greatest number of station-miles during the entire

In making the awards of prizes the judges counted only those receptions in which a code word was copied and submitted for verification. This confines the official reception record to the Europeans formally entered in the tests and eliminates the splendid transmission of nPCII, who altho sending a code, was not entered and apparently made up his own code groups, with no way for verification. Another unusual feature was introduced into the judging by the rule that contestants

Comparing Plate Temperatures

Results obtained by judging the plate temperatures with the eye without some standard would be extremely inaccurate. To insure accurate plate temperature comparisons, the principle of *matching the brightness of a lamp filament against that of the plate* is used. This principle is incorporated in standard optical pyrometers which may be obtained on the market. An improvised optical pyrometer, however, gives nearly as good results.

A sketch of a readily constructed optical pyrometer is shown in Figure 2. A 10-watt 115-volt Mazda lamp is mounted either in a box or on a block of wood. Sighting tubes which may be of any material such as brass or paper tubing are supported so that a portion of the filament may be seen through the tubes against the area whose brightness is to be matched—in this instance the Radiotron plate. A single sighting tube between the eye and the filament may be used providing a cardboard shield with a hole to sight through is placed near the plate. Either the shields or the second tube helps to prevent the entrance of light from other portions of the plate into the sighting tube. If a more carefully designed instrument is desired, it is possible to prevent the entrance of all confusing light reflections by inserting stops in the form of washers with proper sized holes at definite points along the inside of the tubes.

The filament lighting source may be a 22½ volt or a 45 volt "B" battery. The current need only be of the order of 40 milliamperes and if the filament is lighted for only short periods, there is but slight danger of running down the battery.

For adjusting the temperature of the filament, when matching its brightness against that of the anode, a rheostat of from 250 to 500 ohms is required. A lower resistance rheostat is practical if the battery used is equipped with intermediate voltage taps.

A D.C. milliammeter, to read values of filament current for varying filament temperatures of the 10-watt lamp, completes the pyrometer. The instrument for measuring this current need not be accurate as its indications are only relative and do not enter into the calculations of output. *A voltmeter may be used to measure voltage across the pyrometer filament instead of current through it.*

Figure 3 shows instrument constructed for portable use. Here, however, the lamp is especially designed for lighting from dry cells. The sighting tubes contain stops and slits for varying the area of heated zone to be observed. Figure 1 shows an observation being made.

Because of the short filament length, small low-voltage lamps, such as used for

flashlights or on automobiles are not satisfactory for pyrometer use.

Procedure for Making Output Measurement

The procedure is best illustrated by taking a practical example. In this case the grid leak loss is assumed to be negligible and will be omitted. The output to be

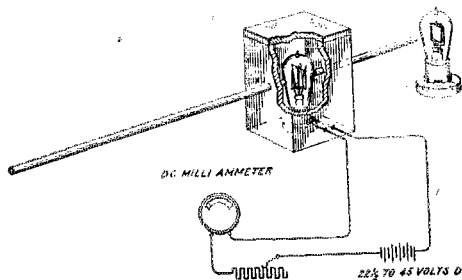

Figure 2—Construction of a home-made pyrometer for measuring power lost in transmitting tubes.

measured is that of a UV-206, 1 K.W. Radiotron operating in a Hartley circuit with a dummy antenna and a resistance load.

The pyrometer is set up so that the middle area of the plate is visible through the sighting tube. The set is adjusted and the condition of oscillation at which output measurement is to be made is obtained. The tube is allowed to operate until the temperature of the anode is constant. While the plate voltage and current are maintained constant the filament of the pyrometer is matched against the brightness of the anode. To make this color match it is best to bring the temperature of the lamp filament above that of the anode and then slowly decrease it until the filament just fades out against the heated anode background. Values of plate voltage, plate current, and pyrometer filament current are recorded.

Now the tube is disconnected from the oscillating circuit, leaving the plate connected to the high voltage source and the grid connected *directly to the filament*. The plate voltage is slowly increased until the plate appears as near as possible to the temperature it was during oscillation. A color match is made with the pyrometer to observe if the pyrometer filament current is the same as the recorded value. If these values are not the same, plate voltage is adjusted again until a color match gives a value of pyrometer current the same as the value recorded when the tube

3—Don't make the mistake of thinking that your plate voltage is shown by your transformer name plate—there is a drop in the rectifier, also the line voltage may be off. Use a voltmeter or "fake" one as explained QST for October, p. 18.

tor had a bet with Mr. W. W. Burnham that at least twelve Europeans would be heard during the Tests. Mr. Burnham has radioed us via g5NN and u2AGB:

CONGRATULATIONS AM SENDING CLOCK AT ONCE I WANTED THE GREEN SUSPENDERS BADLY BUT BRITISH HAMS HOPE TO GIVE YOUR GANG SOCKS SOON.

Further Reports

The analysis of the Test reports is a formidable job; work is progressing on it but no further details are available at this writing. If any particularly interesting features become evident as the analysis proceeds, further reports will be made in QST.
—K.B.W.

Cornering That Buzzing Interference

By Perry O. Briggs, 1BGF*

Radio amateurs often can be helpful in locating radio interference caused by power lines. This should be done in co-operation with the power company, not only because the work goes faster that way, but also because they will best know how to cure any line troubles that may be found.—Editor.

FELLOW hams. A new chapter in radio reception has been opened: the hunting down and eliminating of interference caused by, or at least blamed on street lighting equipment. The proverbial job of "finding a needle in a haystack" is a cinch compared to tracing and eliminating the microscopic

broadcast programs. In desperation the electric light company appealed to the radio club for assistance. A request for data on this bothersome "buzz" was published in the local papers by Mr. J. F. Furey, now President of the Radio Club of Hartford and Chairman of the Club's Interference Committee. The request was not

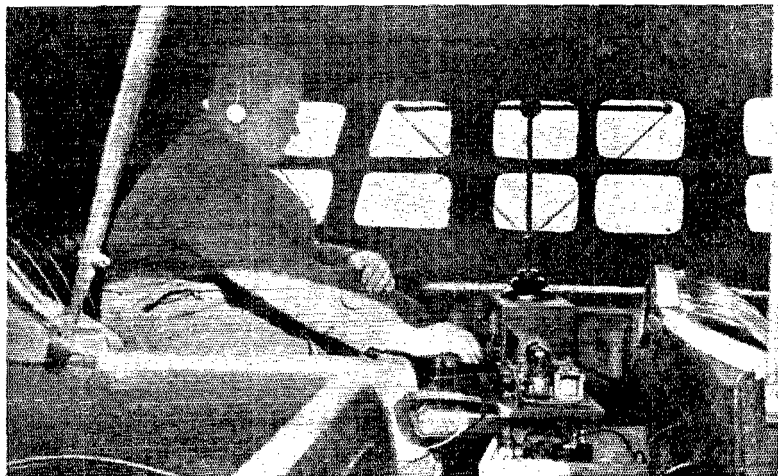

The Set That Did The Work

causes of radio frequency oscillations emanating from street-light wiring.

Let me now relate what has happened in Hartford the past few weeks. Since last March the Hartford Electric Light Company and local amateurs owning transmitting sets have been goaded to exasperation by "hot" letters received from broadcast listeners in the southern part of the city giving them the "razz" and blaming them for starting and maintaining a terrific "buzz" just the minute it became dark and when they wished to receive

met with any great enthusiasm; neither amateurs nor others responded at all well. However, several amateurs, especially Messrs. Furey, Schnell and Warner, tried by means of loops and radio frequency amplifiers to get a bearing on the "buzz" demon, but without avail for it was equally loud at all points. The task was abandoned for several days until the writer devised a systematic method of procedure.

A map of the city of Hartford was tacked on a board and twenty-five pins with numbered paper flags glued to them were stuck in the map at various points

*Interference Committee, Radio Club of Hartford.

Should Regeneration Be Eliminated?

By William W. Harper, Experimental Section, A.R.R.L.

It is generally agreed that all tuned radio-frequency amplifiers are regenerative unless something is done to make them non-regenerative. Some makers aim at purely non-regenerative amplifiers, others merely limit regeneration so that oscillation will not take place. Mr. Harper prefers the second sort of amplifier and limits regeneration by reducing the inductance in the plate circuits of his tubes, an idea that is used in Mr. M. B. Sleeper's amplifier, described in this issue of QST.

Some true amplification must be given up in doing this, whatever the gain due to regeneration may be. One accordingly thinks of restoring the plate circuit to its usual state and then preventing oscillation by one of the schemes described by Dr. L. M. Hull in the January issue of QST. By under-compensating regeneration can then be allowed to creep in.

The eventual r.f. amplifier probably will use one of the two plans and in addition put the tuning of all the stages under control of one knob. This would leave only two tuning controls, the other one being on the input tuner.—Tech. Ed.

WITHIN recent years much attention has been directed to the subject of radio frequency amplification at short wave lengths and consequently many articles have been presented describing certain improvements in this phase of the art.

It is well known that probably the most important factor in the development of radio frequency amplification at the lower wave lengths has been the electro-static capacity between the grid and plate elements of the vacuum tube.

This unavoidable property is known to give rise to regenerative action within the vacuum tube circuits and has been explained in detail by other writers. It is also true that this property may result in sustained oscillations if care is not taken to limit the reaction.

A review of the existing conditions in this field has recently been given by Hull¹, wherein the nature of regeneration has been discussed and a resume presented concerning the various means of control and elimination.

In all literature which has been presented in recent years it is quite obvious that internal tube capacity as well as its effect has been defined as a menace to high frequency amplification. As a result, the work which has been done has had for its objective the *complete elimination* of this effect. (It is to be understood that it is physically impossible to eliminate the electrical capacity between the grid and plate of the vacuum tube, though it is electrically possible to eliminate or render negligible the effect of this capacity.)

Is Regeneration Really Harmful?

An analysis of the entire situation seems to indicate that many experimenters, having found suitable means for limiting the

reaction so as to avoid sustained oscillations, have gone further by attempting to apply methods which serve to annihilate completely the reaction or regenerative amplification. At this time the writer is not in a position to discuss the logic in this trend of the development. At least

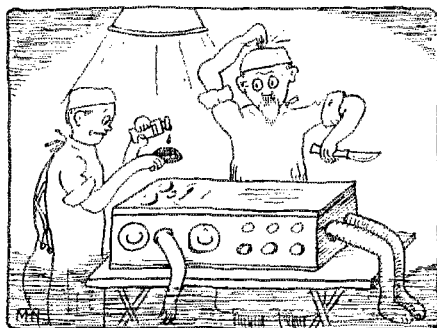

SHALL WE REMOVE
ALL OF THE FEEDBACK?

it has not been clearly stated why we should eliminate completely the seemingly *useful* regenerative amplification which develops as a result of the coupling capacities. If we may expect greater voltage amplification after having eliminated the regeneration phenomenon, surely very little data has been given to show the superiority and feasibility of such a scheme over those which involve the use of reaction currents. Furthermore, it is not too clear that the receivers on the market which claim absolute neutralization of the tube capacities are actually so arranged that this can be accomplished. It seems the neutralization only goes so far as to prevent the creation of sustained oscillations, or, in other words, the degree of regeneration amplification is definitely *limited*. Then it becomes logical to assume

¹—"Anti-Regenerative Amplification" By L. M. Hull, QST, January, 1924.

that probably the success of these receivers resides in the small amount of reaction which remains by virtue of the incomplete neutralization.

We are all well acquainted with the fact that regenerative amplification gives rise to intensified signals and it is not entirely undesirable until locally sustained oscillations are produced. If we then eliminate the slightest trace of regenerative action as well as the local oscillations it is reasonable to say that we will have a noticeable loss in the effectiveness and

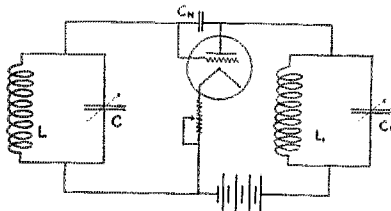

FIG. 1

responsiveness of the receiver. To the writer's knowledge it has not been clearly shown how we may compensate for this loss.

A. Review

It may be advisable to review again the cause of regeneration in tuned radio frequency amplification in order to gain a better understanding of the data to be given later in this article.

A fundamental circuit is shown in Fig. 1. When the tuned circuits LC and L_1C_1 are resonant or approximately resonant the reaction currents through C_n will be of sufficient value to give rise to sustained oscillations. This assumes that the grid return is so connected that oscillations are possible—that is, the grid return is connected to the negative filament battery. By substituting a small inductance, L_2 , in the place of L_1C_1 , we will have a circuit as shown in Figure 2. In this instance, if the inductance L_2 is small the reaction currents passing through C_n are so limited that oscillations can not be sustained.

Now, if we bring the circuit L_2C_1 into inductive relation with L_2 , as shown in Figure 3 (instead of putting it directly in the circuit as in Fig. 1) we will find it possible again to produce oscillations, providing the input circuit LC and the output circuit L_2C_1 are in approximate resonance. A useful explanation for this condition resides in the fact that anything closely coupled to a circuit acts partially as if it were in the circuit. The nature and extent of this effect depend on (A) the closeness of the coupling and (B) the ratio of turns in the two coils. In this case we are concerned with the ratio of turns of the coils L and L_2 ,

also the closeness of the coupling between them. Of course it will be clear that we may reduce the amount of this reinduced energy from the circuit L_2C_1 by removing this circuit from L_2 , or by making L_2 small enough that the potentials created by L_2C_1 will be definitely limited. It is accordingly possible so to arrange the coefficient of coupling and the ratio of transformation in these transformers that maximum reaction currents may be realized through C_n without producing undesirable oscillations. This condition may be so utilized that no oscillations can be generated regardless of the sharpness of resonance of the tuned circuits or the frequency settings and at the same time a very responsive circuit is realized.

How to Build the Tuner

In Figure 4 a circuit is given of a complete receiver using this principle. The fixed-tune antenna circuit and the detector tube circuit have merely been added to the circuit of Figure 3. The design of the coupling transformers is, of course important, since the stability of the entire system hinges on this factor. The size of the secondaries, L and L_2 , depends upon the wave length range to be covered. For the broadcasting frequencies the writer has found 75-turn honey-comb coils useful. Any low loss inductance having a value of approximately 3 millihenry is satisfactory. The condensers used should have a capacity of approximately 250.

This ratio of inductance to capacity makes the tuning somewhat easier than would be the case if a smaller ratio were used. In this part of the circuit it is well worth the effort to abide by what has been suggested in *QST* as to avoiding losses in the inductance and capacity. An inductance should be used which has a minimum distributed capacity² as well as a minimum ohmic resistance, and it always pays to buy a condenser having low losses and rugged mechanical design.³ Losses in this part of the circuit not only cause the signal energy to be dissipated but the sharpness of resonance and selectivity will also be impaired. The primaries of the coupling transformers are dependant upon several factors and for the layman the number of turns to be used is best determined by experiment. For the broadcast frequen-

2—See "Radio Frequency Amplifiers" by Stuart Ballantine in this issue.

3—This is correct, but must not be misinterpreted. Distributed capacity, in the amounts found in receiving coils of ordinary types, does not do much to weaken signals, and practically nothing at all to increase the losses. What it does do is to narrow down the tuning range. It acts as a fixed condenser across the variable one; naturally such a combination does not cover as wide a frequency band as if all of the capacity were in the variable condenser.—Tech. Ed.

4—See various past *QST* articles and communications as to the difference between a good and bad condenser.

cies about twenty or twenty-five turns are satisfactory and may be wound on wood spools or cardboard tubing which will fit snugly into the secondary coils. The number of turns mentioned above for the primaries is based on a separation of approximately five inches from center to center of the coils,⁵ with their axes parallel and with a negative coefficient of electromagnetic coupling between the tuned secondaries.

The greater part of the experimental work done on this type of amplification has been carried out on broadcasting frequencies. A receiver has been constructed, however, which uses coupling transformers having 5-turn primaries and 25-turn secondaries with 250 μ f condensers and the 100-meter DX has been received with great effectiveness. The arrangement for this

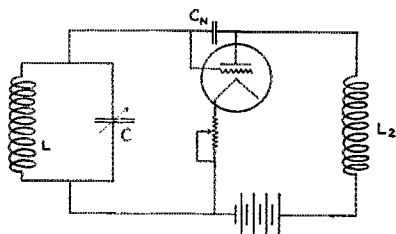

FIG. 2

work consists of one radio, detector, and one external heterodyne. We have not found it necessary to employ any radio frequency amplification on this set. The principle has been further extended for use in super-heterodyne work and at this time the writer is obtaining very consistent results on a small loop using one detector, one external heterodyne oscillator, one stage of self-balanced radio frequency amplification (5000 meters), second detector, and one audio frequency amplifier. It has also been applied successfully to receivers designed for intermediate frequency reception and in all instances seems to function according to theory and gives remarkable responsiveness. A very efficient set has also been evolved using this principle in connection with the inverse duplex method of reflex. In this receiver all the original difficulties, including the use of the potentiometer resistance, have been eliminated. It will not function satisfactorily, however, on a loop antenna, for various reasons, but gives unusual results on a small antenna used as a collector. The exact circuit arrangement for this set is shown in Figure 5. *It does not seem logical to the writer to attempt to apply this set to short wave communication.*

5—That is, the center of one pair of coils is supposed to be 5 inches from the center of the coils connected to the next tube.

Unfortunately the application of this principle to the design of a receiver to meet any certain requirement is a rather involved procedure. The difficulties to be met come under two classifications: First, the presence of parasitic capacities due to

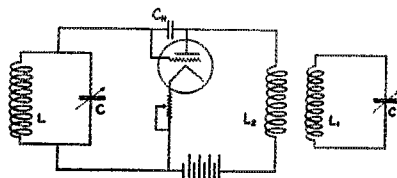

FIG. 3

electrostatic couplings external to the tube; and, secondly, the presence of electromagnetic couplings between the tuned transformers. Both of these factors have considerable influence upon the design of the transformers, or more definitely, upon the number of turns to be used on the primaries. In both cases the conditions are dependent entirely on the physical arrangement. If the coupling capacities external to the tubes are large the number of turns on the primary will have to be reduced accordingly in order to prevent locally sustained oscillations by reason of the excessive reaction currents through these parasitic capacities. On the other hand if the transformers are placed together with a negative coefficient of coupling⁶ between the tuned secondaries the entire set will be "dead" and unresponsive. A positive electromagnetic relation may result in great responsiveness or even vigorous oscillation. In the case of negative coupling we are forced to recognize the effect of the reversed feed-back which is

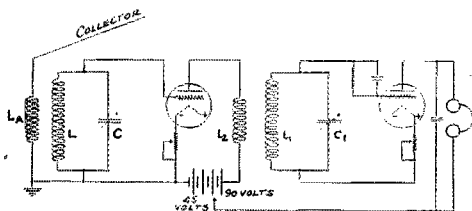

FIG. 4

now in commercial use and has been thoroughly described in other articles.⁷ In the second instance where a positive magnetic relation exists we have a condition

6—Meaning that the coils are placed in the same "attitude" so that the magnetic fields tend to "buck". If one of them were turned end-for-end the magnetic fields would aid and troublesome feed-back would be in action at once.

7—The Superdyne Receiver, by C. D. Tuska, QST for November, 1923.

identical to that described as feed-back regeneration.

Conclusion

It seems that more information is needed as to the relations between regenerative and anti-regenerative receivers. It is claimed that remarkable results are obtained when all traces of reaction are eliminated, but the reasons for this have not been clearly stated. At any rate the

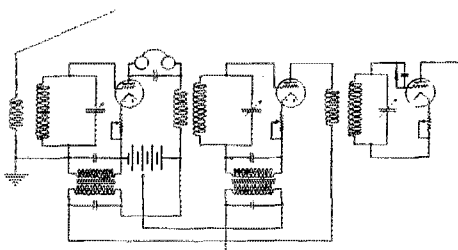

FIG. 5

writer has been able to demonstrate the effectiveness of regenerative non-oscillating receivers and has observed thus far that they compare very favorably in all respects with the so-called anti-regenerative apparatus. It should be mentioned that it has been possible to obtain reasonable loud speaker volume on all the average broadcasting stations by using only one radio amplifier, detector, and one audio amplifier, using UV-199 tubes. Removing the radio frequency amplifier and adopting tuned plate or feed-back regeneration, results in a very noticeable loss and a great reduction in signal intensity, which is not in agreement with the data given by Budlong³ in a recent article. More quantitative data as to the comparative responsiveness and selectivity of regenerative and anti-regenerative receivers will be of great interest and will clear up the question of whether or not we should strive completely to eliminate all traces of regenerative action.

³—"Tuned Radio Frequency Amplification" By A. L. Budlong, QST, December, 1923.

WWV Schedules

Every day there are fewer amateurs who do not know their sending wavelengths with exactness. The reason is the continuation of the "Standard Frequency Transmissions" from station WWV, at the Bureau of Standards at Washington, D. C.

The service costs nothing, and it continues to grow more popular especially and particularly with the members of A.R.R.L.

The next schedules are given below; they can be heard and used at most points

east of the Mississippi River and at many beyond.

The signals are of use in testing receiving sets, checking wave meters and adjusting transmitters. The accuracy is better than 3-10 of 1%. This is much better than the accuracy of any wave meter the average amateur will ever own.

Information on using the signals was given in the February, 1923, issue of the Radio Service Bulletin, also in the following places in QST—July, 1923, page 28, "U.S. Will Send Standard Waves for A.R.R.L."; May, 1923, page 47, "Laboratory Oscillators." More detailed information can be found in the Beureau of Standards Circular No. 92 which may be obtained on application from the Bureau of Standards, Washington, D. C.

All transmission is by "straight" unmodulated continuous-wave telegraphy. A complete frequency transmission consists of a general call (i.e., "QST de WWV"), a standard frequency dash, and announcements. The call continues for two minutes, including the statement of the frequency, (not wave lengths) being used. The standard-frequency dash is broken occasionally by the signature "WWV" and continues for about 4 minutes. The "announcement" is on the same wave length as the test that has just been sent and gives the exact frequency of the signal, measured while that signal was being sent. The next frequency is then announced and a 4 minute interval follows while adjustments are made.

Schedule of Frequencies in Kilocycles

(Approximate wave lengths in meters in parentheses)

Eastern Std. Time	April 4	April 21
11:00 to 11:05 P.M.	166.5 (1800)	500 (600)
11:12 to 11:20 P.M.	205 (1463)	600 (500)
11:24 to 11:32 P.M.	260 (1153)	700 (428)
11:36 to 11:44 P.M.	315 (952)	833 (360)
11:48 to 11:56 P.M.	375 (800)	900 (333)
12:00 to 12:08 A.M.	425 (705)	1000 (300)
12:12 to 12:20 A.M.	500 (600)	1200 (250)
12:24 to 12:32 A.M.	570 (526)	1400 (214)

Error: In the article "Amateur Wave-meters", page 22, February issue, reference was made to the September, 1922, QST. This should have read September, 1921. As a matter of fact our supply of this issue is now exhausted.

A Low-Loss Antenna Insulator

By E. J. Atkinson*

ONE of the most important items in connection with the efficient operation of short wave continuous wave transmitters lies in losses involved in the radiating system. This particular item is given perhaps the least amount of thought and intensive

on the gas stove. Bring the mould up to a dull red heat and maintain this temperature until the work has been com-

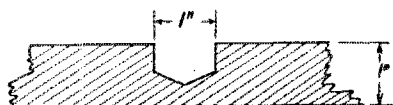

FIG. 1

study of any one unit making up the transmitter itself.

The losses in moulded insulators can be reduced by properly designed flux shields which will so distribute the flux over a large area as to prevent high losses at any point. This principle is used by commercial radio companies, even on the lower frequencies encountered in transoceanic work where flux concentration is not as harmful as in the high frequencies encountered in amateur work.

The best materials for antenna insulators are quartz, glass and porcelain. Any type of "moulded mud" insulator is unsatisfactory. Quartz insulators are very good but neither cheap nor easy to obtain.

Various tests on porcelain insulators have been described in past issues of QST and porcelain will not be discussed here.

Very satisfactory antenna insulators can be made from the ordinary glass towel bars, which can be purchased for about 25¢ each. The rods should be carefully selected, taking only those that are clear and free from bubbles, strain checks and crooks. The rods should be of equal length and thickness.

After choosing a number of rods get a piece of soft steel or cast iron and drill a hole in the center as shown in Fig. 1. The block can be of any piece of scrap steel or cast iron and of any dimensions, except it should be at least one inch thick. This piece of steel will provide the mould used in forming the ends of the glass rods. To prevent checking of the heated rod when same comes in contact with the mould, place the mould

*Transformer Engineering Dept., General Electric Co.

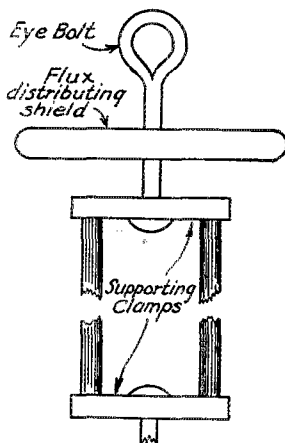
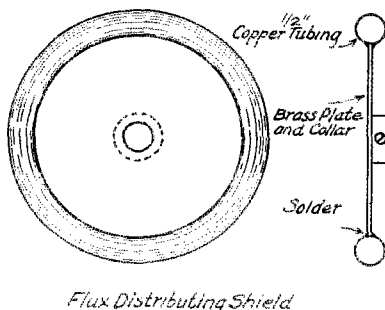

FIG. 3

pleted. Take one of the glass rods and hold about two inches of one end in the flame of another burner, keeping the glass as completely in the flame as possible. The upper part of the flame is hottest. The rod should be very carefully rotated so



Flux Distributing Shield

FIG. 4

as to obtain an even rise in temperature of the glass. In about fifteen minutes, a yellow flame will begin to rise from the end of the rod. This is the burning of the glass and the rotation of the rod should be speeded up a little to prevent the end of the rod from bending from its own weight as the glass is pretty soft

(Concluded on page 54)

tube as each has separate rheostat control. The other two switches break the 110-volt 60-cycle A.C. lines to the filaments and motor-generator set. Power to the station is supplied direct to the operating room by a three wire 110-220 volt line capable of standing a 200 ampere load, so there is "power to burn."

A traffic record was also established in the handling of 2855 relay messages between February 15th and March 15th of last year. On the call, 8ZD, only D.C.C.W. is employed, while phone, chopper, I.C.W. or A.C.C.W. may be used on 8VE.

"If it can be QSR'd it will be" is the motto of this station.



To the left of the transmitter is the send-receive switch which starts and stops the motor generator set, closes the filament circuits and transfers the antenna and counterpoise from receiver to transmitter.

The receiving apparatus consists of a Westinghouse RC set that has been altered to cover the wave length band between 85 and 275 meters. To the left of the RC set is an old C.R.L. Paragon with detector and two-stage amplifier. Baldwin and Western Electric phones are used when headphones are desired while a Callophone (loud speaker) may be used at times on strong signals.

On the other side of the room is equipment arranged in regular ham style for rapid changes in circuit. A 500-watt experimental tube is used at times in this set-up. A good wavemeter and other experimental apparatus are also in the station and come in handy.

The antenna consists of two 6-wire cages 6 inches in diameter and spaced about 10 feet apart. It is 70 feet high and 65 feet long and is used in conjunction with a 10-wire fan counterpoise. The antenna and counterpoise lead-ins are brought through holes in the window panes directly above the change-over switch.

The transmitter first described, using one 50-watt tube with pure D.C. plate supply, was used at 8ZD last winter and worked every state with the exception of two, and was heard in every district, Canada, Panama, Porto Rico, and in England.

Book Review

By S. Kruse, Technical Editor

"Henley's 222 Radio Circuit Diagrams", by John E. Anderson, M. A.; Arthur C. C. Mills; Elmer H. Lewis, Radio Instructor, East Side Y. M. C. A., New York City. The Norman W. Henley Publishing Co., New York. \$1.00.

The "circuit hound", whether receiver or sender, will revel in this book. The 222 circuit diagrams are cleanly drawn, nicely labeled, and *up to date*. More than that, the book is logically arranged, it begins at the beginning and explains the first steps briefly but clearly, then goes ahead to the next thing. To this is added a "list of symbols", a code chart, some general information on tubes and coils, and three excellent little chapters that explain the "Art of Reading Diagrams", the care of batteries, and the conversion of wavelengths to frequencies. At other points in the book there are treated: tuning, the requirements of the fire underwriters, and the construction of loops and antennas. Taken all together it is an excellent little book and one well worth having.

"The Outline of Radio", by John V. L. Hogan, Consulting Radio Engineer, Fellow and Past President I.R.E., Member A.I.E.E. Little, Brown & Co., Boston. \$2.00 net.

It is a real pleasure to review this book, because one can say pleasant things about it. No better introduction can be given than by quoting from the preface of the book itself: "If you are weary of radio publications, take heart. Beneath the froth of writing that has been stirred up to meet (but hardly to satisfy) the wants of radio users, there exists a substantial literature of the art and science. . . . A large part of the material recently published has already been forgotten, for it was neither accurate nor readable. However, the fact remains that radio is accomplishing great

(Concluded on page 47)

counterpoise is limited in length by the position of the house to which it is attached but it is the best that could be put up under the circumstances.

The transmitter consists of two UV-203 tubes in a conventional shunt-feed Hartley circuit. Plate current is furnished by an Esco 1750-volt 600-watt motor-generator. The normal plate input is 615 watts and the antenna current is 6.6 amperes on 150 meters. On a test the current on 115 meters was 4 amperes and 3.5 amperes on 100 meters with the tubes running cool.

Two receivers are used on the amateur waves; a Grebe "13" and a tuner constructed in accordance with Mr. Hassel's article in the December 1923 QST. Exceptionally good results have been had in logging West Coast and European amateurs. A Grebe CR-9 and a W. E. power amplifier furnish entertainment for the family.

As for transmitting results, here are a few of the better ones. The 195-meter wave was logged in England twelve times during August, 1923; in France, Hamburg, Panama, Cuba, Porto Rico, WNP; in New Zealand six times since last April; in Mexico; in the Gulf of Mexico at 2 p.m. E.S.T., and in England at 9 a.m. G.M.T. Every district has been worked in one night. 1AJP was the first station in the first district to be heard in New Zealand. In the Transatlantic tests of 1922 1AJP was heard in England, France, and Holland and over the greater part of the U.S.A.

Mr. Nathaniel Bishop is the owner and operator and the station is located at 31 Park Place, Bridgeport, Conn. Mr. Bishop says he has tried to obtain the kind of results that should be expected with the apparatus used. In this he has more than succeeded.

9EKY, St. Louis, Mo.

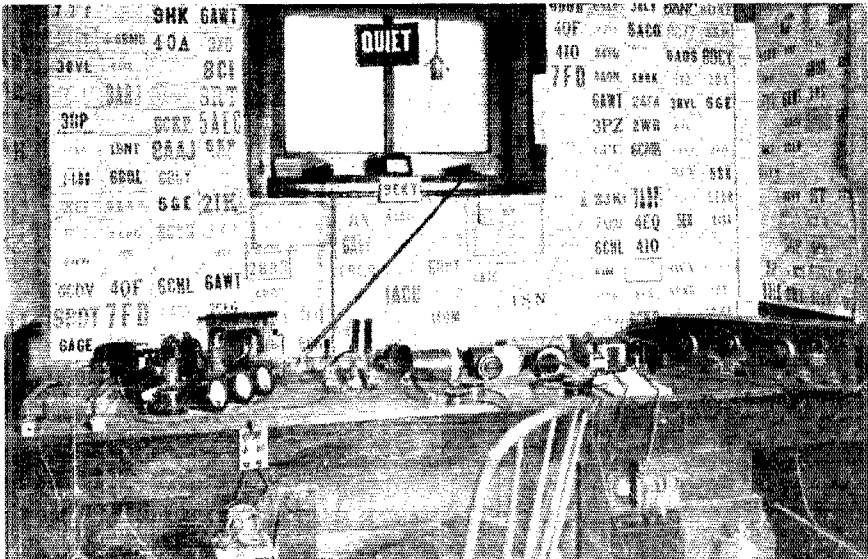

For a consistent amateur station, few can beat 9EKY, located near the center of the country, relay traffic is handled to the tune of 200 messages per month on an average by this station. Numerous DK records have been established. New Zealand 1AA reports about a dozen Yanks louder than 9EKY but few if any more consistently QRK! With two 50-watt tubes in the transmitter 9EKY's signals have been heard by ships in the Atlantic and Pacific Oceans besides which the station

has been heard by amateurs in Hawaii, Alaska, Porto Rico, New Zealand, Australia, every state and Canadian province and aboard WNP. Stations in every state except Delaware have been worked and 6CEU in Hawaii has also exchanged signals with 9EKY. Three operators, Ken, ER and WR (brothers), keep the station on the air almost nightly, assisted by a bunch of neighborly hams.

9EKY is an A.R.R.L. Official Relay Station and an Official Broadcasting Station

The equipment is situated in a basement room at 5809 DeGiverville Ave., St. Louis, Mo., and the license is in the name of Richard K. Rohan. Mr. Rohan is a member of the R.O.W.H., the Radio Transmitter's Society of St. Louis, and a member of the Traffic Committee of the latter organization.

The first transmitter was installed at 9EKY in February of 1923 and used one 5-watt tube. Gradually it was added to until, a few months later the present set which uses two 50-watters was installed, and constant work was done through the summer of 1923. Referring to the photograph the filament transformer is on the extreme left. The Emerson 400-watt motor-generator that supplies 1,000 volts to the plates of the tubes sits on a door mat under the table. Next to the transformer are the two UV-203 tubes and meters for indicating the values of plate current, filament voltage, and antenna current. The transmitter employs the reversed feedback circuit with series plate supply. The normal plate current is around 250 milliamperes making the plate input about 250 watts. The normal antenna current is 4.5 amperes and the operating wave 197 meters.

The present receiving set, seen in the center of the photo, consists mostly of loose coils and condensers connected in a manner suggested by Mr. D. C. Wallace, 9ZT, at the Chicago convention. This was a forerunner of the lowloss tuners described in recent issues of QST. A Grebe CR-8 receiver is also used at times.

The records made at this station would lead one to believe that it has a wonderful antenna system. This is not the case, however, for the back-yard at 9EKY is not very large. A counterpoise of 45 wires 39 feet long on 22 foot spreaders and suspended at a height of nine feet between the rear of the house and the back fence forms one side of the radiating system. An inverted L antenna with a four wire flat-top 36 feet long with the wires spaced 6½ feet apart and 65 feet high is suspended above the counterpoise. The far end of the antenna is supported by a 65-foot telegraph pole as there was not sufficient room for a guyed mast. The lead-in drops right down to the radio room and for the last few feet is made of ¼ inch copper rod. Pieces of gauge glass are used for entering insulators.

2AGB, Summit, N. J.

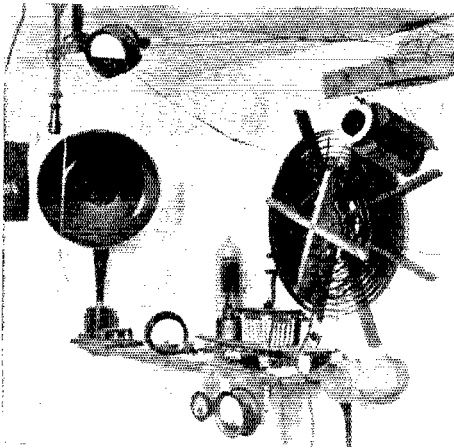

So far as is known 2AGB is the only station to work amateur stations in every district of the U. S., Canada, and England; and Holland, France, and Italy besides. Most of this work has been done within the past few months. Last April a transmitter using two W. E. 250-watt tubes was installed and a little later a super-heterodyne receiver replaced the Paragon RA-10. By the middle of October, after a synchro-

nous rectifier had been obtained, stations in every U. S. and Canadian district had been worked, and numerous reports from English amateurs were being received. Soon the tubes began to go west, all except a lone 50-watter, so the station was shut down for a time on Nov. 10th.

One Saturday afternoon, D. A. Griffin,

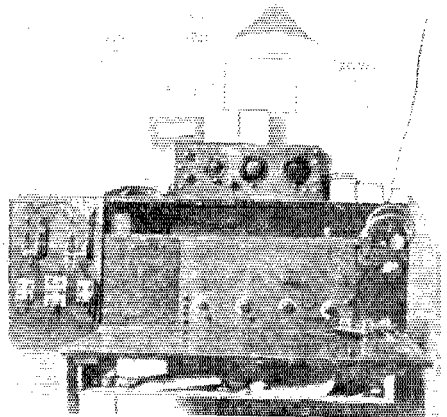

one of the operators, read how French SAB had been successful in working American stations on 100 meters. He im-

(Continued on page 54)



A Trophy for Your Station!

A genuine Australian boomerang, suitably engraved, as significant of two-way communication, to the American or Canadian amateur who is first to definitely establish two-way radio communication on amateur wave lengths between New Zealand, or the continent of Australia, and North America!

In special recognition of and as a lasting trophy to the amateur accomplishing this praiseworthy feat, the A.R.R.L. makes the above offer.

The contest is open to all. The trophy is one that will cause the chest of any amateur to swell with pride. Definitely establishing two-way communication will consist in an amateur submitting logs and evidence sufficient to prove to the satisfaction of A.R.R.L. Headquarters that two-way communication was really established. Forward your complete logs on this work to F. H. Schnell, Traffic Mgr., A.R.R.L., 1045 Main St., Hartford, Conn., and he will do the rest.

Progress on the Pacific Side

Events within the past month show that Australia and North America will be linked by amateur radio soon. Australian and New Zealand amateurs hear our signals regularly and we are beginning to hear theirs. The reception of Australian 3BD by two different American amateurs has been accomplished. Frank Creswell of Los Angeles, and Y. Ito, of Moneta, California, are the lucky ones. Reception was exceedingly spotty and this can hardly be considered more than a freak but it shows that Australasian signals are coming over our way and if we will listen for them we will hear them. In addition, 9AVG of Eureka, Kansas, reports the reception of a C.W. station signing 4AA and using the New Zealand interval (z). 1CMP at Bridgewater, Mass. reports New Zealand 4AA heard on the morning of March 2nd.

A station signing 4AA has also been heard by Rev. Chapman at Anvik, Alaska. Is this our old friend F. D. Bell, New Zealand 4AA, whose signals we are hearing? We certainly hope so, but the latter reception has not been confirmed so it cannot be claimed as an actual fact just yet.

Several series of special tests have been taking place between the Hawaiian amateurs and those in Australia and New Zealand. Hawaiian stations are quite regularly heard in Australia and New Zealand, and Australian 2CM has been heard in the Hawaiian Islands, but we have no record of two-way communication having been established yet. Perhaps another series of tests beginning February 25th will accomplish this.

In the Philippines Fred Elser, whose call is 1ZA, is doing his best with two 50-watt tubes to connect with the U. S. He recently heard 6ZW and as far as he knows this is the only American amateur to have been heard in the Philippine Islands. NPO's arc mush utterly ruins all chances of doing any DX reception on short waves, so we cannot expect any startling lists of calls heard from him for some time, he says. He believes that the splendid receiving that is being done by the New Zealanders and Australians is due to less commercial interference, less interference from long wave arc stations, a cooler climate and less static. Given equal conditions in the Philippines he could copy U.S. amateurs every night, he says. The Philippines and New Zealand are about equally distant from the center of the U.S.

Nothing further has been heard from Mr. Hiroshi Ando, JFWA at Tokyo. Much of his equipment was lost in the great quake and he is doubtless having difficulty in getting his station back on the air. We expect to hear from him soon.

In the meantime Capt. Baldwin, attache of the American Legation at Peking, is copying scores of American amateurs, some as far inland as Indiana. The ones along the coast are received very well.

Amateur Radio in Western Samoa

Through the courtesy of the American Vice Consul at Apia, Samoa, acting through

the State Department, a very interesting report on radio conditions in Samoa has been received. Though too long to publish in its entirety it is of interest to American amateurs who expect to communicate with the Samoan Islands by radio before long.

"Western Samoa, administered by New Zealand under a mandate issued by the

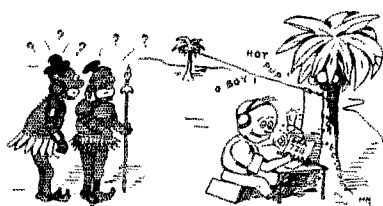

AMERICAN HAMS HEARD IN SAMOA!

League of Nations, is created a radio district of New Zealand and is subject to New Zealand regulations governing radio. Licenses are issued for one year to persons of any nationality upon payment of the proper fee. Spark transmitters are prohibited. Wave lengths from 150 to 180 meters, depending upon the type of transmission, may be used. Wave lengths from 171 to 180 are permitted for straight C.W. telegraph.

"Until recently there has been little interest in amateur radio, probably due to the many restrictions which were in force prior to January, 1923, but the regular reception of programs from New Zealand and American broadcast stations is stimulating interest in radio. There are five licensed receivers in operation at the present time.

"The lack of electric current in Western Samoa is a serious handicap in the growth of amateur radio. The short life of dry batteries in the tropical climate prohibits their use. Battery charging plants with power units had to be installed. One used a small gasoline engine to drive a generator salvaged from a motor boat. Another erected a small windmill and harnessed it to a motor car generator. Another used a small Pelton wheel to drive a six volt generator. These three cases indicate the difficulties in the way of developing power for the operation of transmitters.

"Amateur stations working in the United States are heard nearly every night in Western Samoa. Most of these stations are in California, but many stations from other parts of the United States have been heard. Unfortunately no record of these stations has been kept by the Apia station. Static would interfere to some extent with regular amateur service between Apia and the United States. C.W. signals originating in the United States on 200 meters are strong enough to be read by an experienced

operator through all but the very worst atmospheric electrical disturbances.

"The distance records established by broadcast fans of this territory prove that the islands are favorably situated for reception. Three of the receiving sets that are now there have been equally successful in bringing in broadcasting stations which are usually considered beyond the range of the standard receiver. Kansas City, Chicago, Portland, San Francisco, Los Angeles and Calgary are received regularly during the American winter by four of the Apia fans. Receiving WJAZ on a single circuit receiver with two stages of audio on air line distance of 6,555 miles with at least 1500 miles of the distance over land is a record appreciated by the most inveterate distance fiend."

Irish Broadcasting Hits Snag

Amateur transmission in Ireland is as yet not permitted and even broadcasting is just getting started. The Radio Association of Ireland is quite a growing organization, however, and an organization that is made up of persons interested in all classes of radio. It was planned to organize Irish broadcasting on the English plan of forming a combine of the various radio manufacturers for the purpose of maintaining the broadcast stations. There was such a storm of protest at this, because of its amounting to granting a monopoly to these companies, that the plans are held up until some agreement can be arrived at. It will be quite some time before Irish amateurs will be allowed the privilege of having transmitters evidently but we do hope that they will be able to get on the air soon.

Stations Lining up for Pan-American Tests

The time for the Pan-American tests is drawing near. Have you signified your intention of taking part by dropping a postcard to the Traffic Manager, telling the power and wave-length you will use and to what extent you are familiar with the Spanish or Portuguese language? If you have not done so yet, better hurry, OM, as the time is getting short.

May 19th to 31st, inclusive, are the dates for the tests. Page 41 of the March, 1924, QST gives the complete story to date.

Cuban amateurs are already keeping one ear open for signals that might be coming from South America. Cuban 8DW-8GT, 2BY, and 2WW are all on the air and are being regularly heard in the U. S.

Stations scattered throughout South America are getting in readiness for the tests. A ship operator in the Straits of Magellan has copied scores of U. S. amateurs. This makes us feel that the tests are sure to succeed and that by the latter part of May we will all be having a merry

time trying to understand each other's signals.

Listen For Australia

Don't forget that a2CDM, aboard the S. S. "Tahiti", will be testing on approximately 220 meters with Australian 2CM every night from March 11th to April 8th, Sydney time, during a voyage from Sydney to San Francisco. 2CM, Sydney, will have a 10-watt set on 240 meters and a 100-watt set on 200 of perhaps a lower wave such as 160, and will be testing to 2CDM from 2 to 3 A.M. and from 3:30 to 4:30 A.M., Pacific Standard time, March 10th to April 7th. Keep an ear out!

Who is JUPU?

As recently chronicled in QST, u7HG worked JUPU who gave his QRA as Tokyo, but no details except that the operator was an American. Now on March 3d 8BBH, New Straitsville, Ohio, heard JUPU call a six and, a few minuts later, 7CO;

1XAR (1BDT) used phone for about an hour working a London ham recently. Not so bad.

Brand New Amateurs

Danish 7EC is on the air, and with A.C. note, 1 amp. in the aerial (wavelength unknown to us), has worked g5KO, g5CS and g2WJ during January. Italian 1MT continues good European work, altho not yet reported in America. Swiss XY, in Geneva, is on the air and has worked g5DN. Luxemburg 1JW was heard in Liverpool on Jan. 27th. They're coming, fellows, all around the world!

More Success

Many more amateurs have succeeded in working transatlantic. New foreigners include Dutch PCTT, g2WJ and f8CT, while iACD has had more luck recently too. Among the American stations to get in recently are 1BDI-1XAH, 1BDT-1XAR, 1AF-1XJ, 1XAK, 1BSD, 1ALJ, 3BG, 3OT,

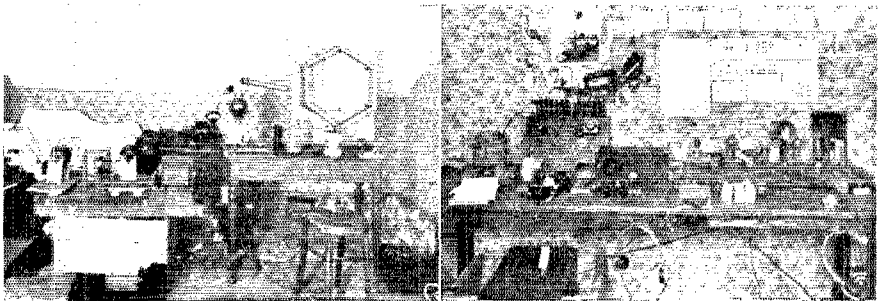

BRITISH 2SH, HIGHGATE, LONDON. Frederick L. Hogg's station, second Britisher to work America, a set untidy in appearance but performing excellently nevertheless, as attested by working a dozen or so Americans. Left-hand view is of the transmitter: extreme left, two Mullard rectifier valves delivering 60-cycle current at 3000 volts, unfiltered, to Mullard 250-C tube in center; Colpitts oscillator circuit, 300 watts input, 3 amps in aerial at 115 meters. Aerial 4-wire L, 70' flattop 45' and 30' high, small counterpoise, system badly screened by trees. Note key on stool in foreground of photo. 2SH has been kidded for his bum fist; doubtless due to a jolly British custom of sending by sitting on the key. Hi! Right-hand view: the receiver, on which 150 American amateurs have been logged, as far west as 5ZA. Commonly used with 1 stage tuned-plate r.f. and detector.

tone pure D.C., wavelength about 190, good fist, reasonably loud. If JUPU is a shipboard set, it may be near the west coast at this writing. Can anybody enlighten us?

Amateur Phone Communication

While working 1BDI recently, g2KF carried on his end of the conversation with phone. Not the first time phone has been heard across, but our first record of its use in actual work. 1BDI says his voice and comments seemed great stuff, modulation perfect, and fine punch. g2KF has done excellent work, tying up with 19 American stations up to Feb. 18th. 2OD has done about as well, and so have 2SH and 2NM. F.B. Getting back to phone,

3YO, 4BZ, 4XE, 8AOL, 8XBH, 8XAP.

1XAM has worked PCII with a plate input of 30 watts, signals reported QSA all over room on loud-speaker, using various wavelengths down to 75 meters. 1BSD, Providence, worked PCII on the night of Feb. 15th using one UV-202 with an input of 80 m.a. at 800 volts, 64 watts, wavelength 150 meters, which was somewhat above the antenna fundamental.

Foreign amateurs who do not yet understand the American method of rating tube transmitters should re-read the article "How I Operate UV-202 Radiotrons" in the February issue, by Mr. H. H. Tilley. This is a good example of an American "30-watt set"!

THE AMATEUR BUILDER

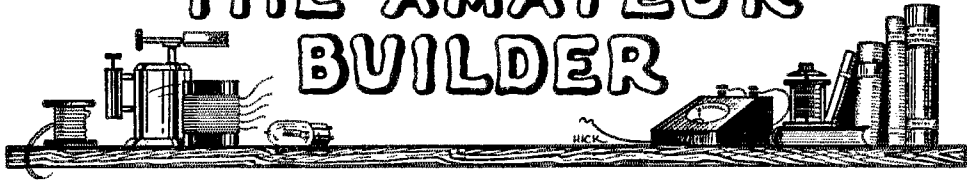

BUILD YOUR OWN BATTERY CHARGER

By H. F. Mason, Department Editor

THE battery charger is an important item in every station, for the reliability of that station and consistency of operation depend a great deal on having the storage battery always charged and ready for immediate use. Home made battery chargers are usually smelly, grimy, and hot affairs that are more effective in running up the light bill than they are in charging the storage battery. It is possible, however, to build rectifiers that do their work effectively and may be left turned on for hours without requiring the least attention. The charger described in this article is of the latter type. With reliable and tried information as to the constructional details one of these chargers can be built by almost anyone.

The purpose of a battery charger such as we are describing is to enable you to charge a storage battery from your regular house-lighting circuit. A low-voltage direct current is needed for charging the battery, and this is obtained by stepping down the house lighting power by means of a transformer and then rectifying it. Rectifying the current consists of changing the alternating current to direct current by passing it through a one-way valve: a device that permits the passing of current in one direction but not in the reverse direction. A pulsating direct current results

and this is used to charge the storage battery.

It is well known that, in the three-electrode vacuum tubes used in our radio sets, the current flows from the plate to filament but not in the reverse direction. This is the principle used in the thermionic battery charger. The charging tube looks greatly different from a vacuum tube used in radio, however, for the grid has been

dispensed with and various other changes made so the tube will handle heavy current. In its practical form a rectifier tube for battery charging has a heavy tungsten filament and a graphite plate. The elements are enclosed in a round glass bulb filled with argon, an inert gas. The bulbs are made in two sizes. The first charges a six-volt battery at about two amperes and costs about \$4.00; the latter at about five amperes and costs \$8.00. The smaller tube is mounted on a standard Edison screw base while

the larger fits a Mogul socket such as is used for extra-large electric lights. The construction is similar in both tubes, for the filament connections come out through the Edison base while the plate connection is brought out at the top of the tube. When in normal operation there is a blue haze between the plate and filament in addition to the light from the filament and the plate will become just barely a dull red.

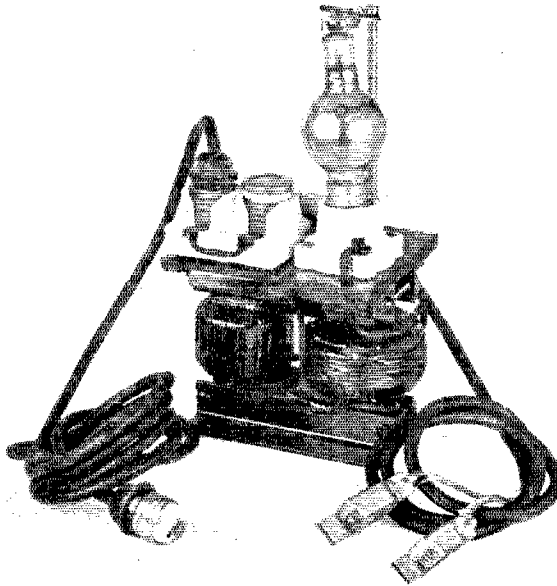

Below is given data for the construction of a two-ampere charger and also for a five-ampere outfit. Detailed instructions for winding the coils, assembling the core, and so forth are not given, however, as those things will be covered in an article next month on general transformer construction. If the reader has not had much experience in building transformers and is doubtful as to the procedure it would be best for him to wait until next month before starting to build the charging outfit here described.

A Two Ampere Charger

The constructional details of a two-ampere charger are shown in Fig. 1 and Fig. 2 is a diagram of the connections. A photo of the complete outfit appears on page 46. The transformer is at the bottom and the sockets for making connection to the battery, line, and rectifier bulb are mounted on a horizontal panel above. This method of mounting is only a suggestion, for the builder can arrange the parts any way he desires as long as the size of the core and transformer windings are not altered.

The transformer has three windings; a primary winding, a charging winding which is part of the primary, and a filament-heating winding. The primary winding is connected to the 110-volt 60-cycle source of supply. The filament-heating winding heats the filament of the charging tube which consumes about 4 amperes at 2 volts in the case of the two-ampere tube. The charging winding furnishes the current that is run through the rectifier and then the battery. A two-ampere fuse is connected in the 110-volt line.

The transformer core is 1 1/4 inches square in cross section and has a window two inches square. For its construction enough pieces of transformer iron 1 1/4 by 3 1/4 inches and about No. 28 gauge to make a stack 4 3/4 inches high will be required. Ordinary black sheet iron (stovepipe iron) may be used if regular transformer iron is not obtainable, practically the only difference being that the core will heat slightly when ordinary iron is used and a little more current will be drawn from the line.

The main primary winding consists of 500 turns of No. 20 D.C.C. wire. The charging or secondary wind, which also serves as a part of the primary, as explained above, consists of 70 turns of No. 14 D.C.C. wire. The filament-heating winding is made of eleven turns of No. 14 D.C.C. wire, doubled so as to carry the current without heating. The two wires composing the filament winding should be wound side by side in two even layers and should not be twisted before wind. A tap is brought out at the center of the winding, of 5 1/2 turns.

The primary and charging windings are wound one at a time on a wooden form 1 1/2

inches square, two layers of thin fibre or fish paper 1 3/8 inches wide being placed tightly over the form before the winding is started. The windings are wound in

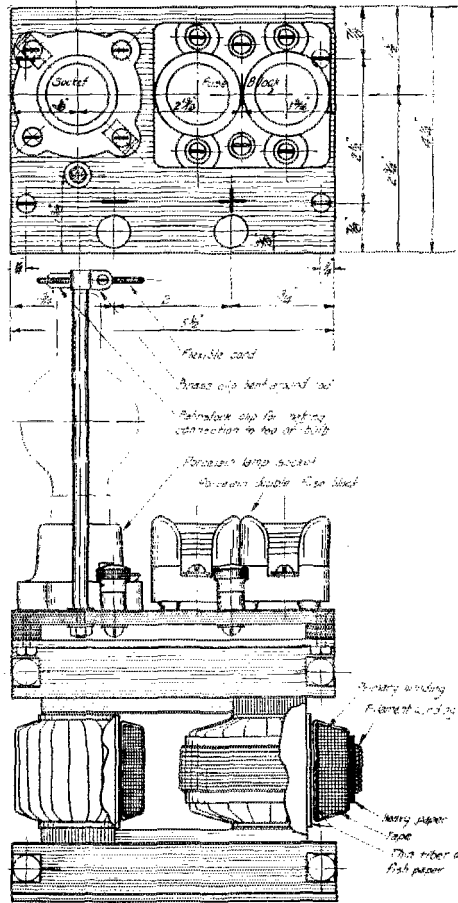

Fig. 1

even layers, shellacing each layer as the winding proceeds. When through, the windings are removed from the form and taped. Three layers of thin fibre or fish paper are then glued to the outside of the primary winding and the filament winding is wound on. More information as to exactly how to go about winding coils for transformers will be given in the article on transformers next month.

When the windings have been placed on the core, the core is clamped together by pieces of one inch by 1/2 inch angle iron 5 1/2 inches long with one-quarter inch bolts 1 1/4 inches long. If you are unable to get the pieces of angle iron at your local hardware store or junk yard, four pieces of

hardwood one inch square and $5\frac{1}{2}$ inches long will suffice.

The completed transformer can then be made to appear very business-like by giving it a coat of black asphaltum paint or good insulating paint. A panel of bakelite or similar material measuring $3\frac{1}{2}$ by $5\frac{1}{2}$ and $\frac{1}{4}$ inch thick is used for a terminal board and on it are mounted three porcelain-base sockets, two of these sockets being in the form of a double fuse block.

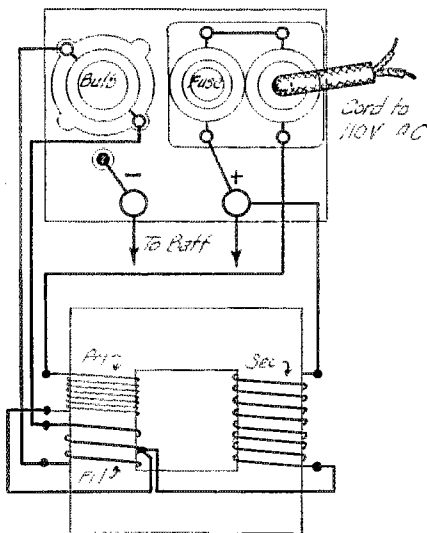

Fig. 2

The exact location of these parts is given by the dimensions in Fig. 1 in the top view of the rectifier. A length of $\frac{1}{4}$ -inch brass rod is also secured to this panel near the rectifier bulb socket. This rod is $6\frac{1}{2}$ inches long and its lower end is threaded with an 8-32 thread for a distance of $\frac{1}{2}$ inch where it passes through the panel. At the upper end a small brass clip is fastened to it and to the clip is fastened a short length of flexible lead. The other end of this lead is soldered to a Fahnestock clip for making connection to the plate terminal on the bulb. Two binding posts, as terminals to be connected to the storage battery, are also fastened to the panel in the location shown in Fig. 1.

The terminal panel is secured to the transformer by four 8-32 flat-head screws passing through the horizontal flange of the top pieces of angle iron. Strips of $\frac{1}{4}$ -inch bakelite hold the panel away from the transformer so leads can be run under the panel. When making the connections it is essential that the main primary winding and the charging secondary winding be connected in series, with the current

traveling through the coils in the direction indicated in Fig. 2. Make all of the leads out of wire at least as heavy as the winding to which they connect. Extra holes should be drilled in the panel for the wires to run through and all wiring run underneath the panel. A piece of fish paper placed beneath the panel next the core will keep the wires from touching the core.

When the connections are finished and the top panel permanently fastened in place, all wiring and ironwork should be given another coat of black insulating paint. The rectifier is then completed by adding the cords, plugs, and battery clips necessary for making the external connections.

A Five Ampere Charger

For those who wish to charge a storage battery quicker than can be done with the two-ampere charger, data on one that will charge a six-volt battery at about five amperes or a twelve-volt battery at about three amperes is here given. This charger can be mounted after the fashion of the two-ampere outfit as shown in Fig. 1, or it may be mounted in the simpler fashion shown in Fig. 3. We are indebted to Mr. E. J. Krusel, 9EO, for the data on this charger, as he has built one that is in successful operation.

The five-ampere charger is quite similar to the two ampere charger and a diagram of its connections is shown in Fig. 3. You will note that the charging winding is, in this case, entirely separated from the primary winding. An ammeter, which may be of the automobile type, is used to indicate the charging current as well as the current on discharge. A snap switch for turning the rectifier on and off and binding posts for external connections, together with the ammeter, are mounted on the front panel. The placing of the windings on the core of the transformer is the same as for the two-ampere charger; the primary is wound on one leg of the core with the filament heating winding over it, while the secondary winding is on the opposite leg. A 5-ampere fuse should be placed in the 110-volt line, though not shown in the drawing or diagram.

The core is built up from pieces of soft black iron or transformer iron of about No. 28 gauge, each piece measuring $1\frac{1}{8}$ by $4\frac{1}{8}$ inches. A stack of these pieces $5\frac{3}{4}$ inches high will be required for the complete core. The core, when assembled in the usual fashion, will be $1\frac{1}{8}$ inches square in cross section and will have a window $2\frac{3}{4}$ inches square.

For the primary winding 550 turns of No. 18 D.C.C. wire will be required. The secondary winding consists of 135 turns of No. 14, or preferably No. 12, D.C.C. wire. This winding is tapped at the 100th, 105th, and 135th turn to provide for a variation in

(Continued on page 49)

(Continued from page 48)

the charging current. The filament heating winding in the case of the five-ampere tube must carry about 8 amperes and if it is tapped in the center, which is advisable, it must also carry the charging current, making a total current of 13 amperes. Two No. 10 or No. 12 D.C.C. or enamelled wires in parallel may be used for this winding. Ten turns of this double wire will be required with a tap brought off at the center of the winding. Be careful when bringing off this tap or in making other connections in this filament circuit to see that the connection is sturdy enough to carry the current without heating.

The windings are wound and taped, then assembled on the core, in much the same fashion as for the two-ampere charger. In the top view in Fig. 3 part of the windings are shown cut away to better illustrate this construction. The transformer is mounted by setting it on two blocks of wood $1\frac{1}{2}$ inches square and 5 $\frac{1}{2}$ inches long and clamping it down to the wooden base by two strips of sheet iron. The Mogul socket for the rectifier tube is mounted directly behind the transformer.

The general arrangement of the panel is shown in Fig. 3. It is a piece of bakelite or ebony asbestos-board 8 by 9 inches and $\frac{1}{4}$ inch thick. Three wood screws hold it to the wooden base. After everything is mounted on the panel the wiring should be done as shown in the diagram. The transformer and base should then be painted.

Operation

Through some slip in the construction, trouble may be had in getting either one of these rectifiers to working properly. When charging a battery there will be a blue haze around the filament in the tube and the transformer will hum slightly. If the filament lights but no current goes through into the battery, try turning the 110-volt current on and off rapidly several times in succession. If still it does not start charging it will be necessary to put a few more turns (about ten) on the charging winding.

Perhaps the rectifier will go the limit in the other direction and charge at an excessive rate, and the plate of the rectifier tube will become very red. In this case a few turns should be removed from the charging winding to lower the voltage, as when in normal operating condition the plate should never exceed a very dull red. Aside from this it would be well to check the filament voltage with an A.C. voltmeter. It should be between 2 and 2.25 volts. If one of the transformer coils gets very hot there is liable to be a shorted turn in the coil, in which case the coil should be re-wound.

On the five ampere charger posts marked "6", "7", and "12" are provided. A six volt battery can be charged by connecting it between the terminal marked "negative" and the 6-volt post. If a greater charging rate is desired the positive terminal of the battery should be connected to the post

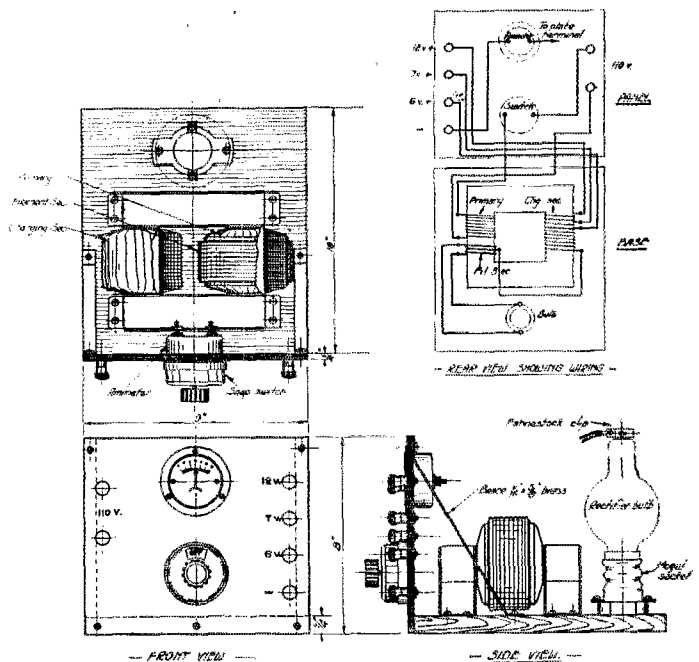

Fig. 3

marked "7" on the charger for a few hours. Two six-volt batteries may be charged in series at about three amperes by connecting their proper terminals between the posts marked "negative" and "12". If, when charging, the ammeter reads on the discharge side of its scale, reverse the connections on the back of the ammeter.



Amateur Radio Club of Seattle Presents a Method to Keep the Air as it Should Be

IN days of old when the spark was heard on the air in the Northwest, Seattle was among those cities bothered by her own QRM. Now Seattle is a sparkless city, a condition brot about in no small way by the following methods. The club was trying to find some way to remedy the QRM, generally caused by some ham holding down his key to see the sparks fly or playing with the coupling of the O.T.—in fact, it had reached the place where traffic handling was out of the question. Then Mr. J. G. Nordahl, 71B, made what he called the Rubber Contact Cooty Key and presented it to the first ham reported causing undue QRM. Upon being presented with the key, said ham got somewhat frilled and began looking for some other unlucky guy to hand it to. Each fellow on getting the key is obliged to engrave his call on it; in this way we can keep track of the number that have had it. One ham has his call on it three times—the record so far.

Since spark left town and C.W. took its place, the use for the key has almost died out, but it still goes its rounds, keeping the Seattle amateurs on the straight and narrow path. The last fellow to get it was 7UU; it was awarded to him for telling a yarn about lightning striking antennas, which, altho true, still sounded haywire. No more such yarns will be told in club.

Another trophy we have is the oilcloth diaphragms. They help a fellow when he is compelled to listen to his own sigs in the next block on a two-step. It is a convincing argument to QRT during certain hours.

Before presenting either of these tokens a mock trial is held to determine if the accused is guilty. This trial is carried on in the regular form of a court, with the club acting as jury. The verdict is nearly always "guilty." Various other forms of punishment are given also, but by the combined methods the gang lives up to the laws as set down by the club, for if they are

disobeyed the consequences are not pleasant to think of. As a result the air in Seattle is as near perfect as any place, and if the harmonics of the broadcasts could be eliminated we would be content.

Our rubber-contact cooty key was made as follows. The kid brother's Meccano is robbed of a base plate and two right-angles. Next procure a short length of steel strap to use for the vibrator; fasten it to the two right-angles, and then fasten the angles to the base. Next get two rubber blocks and fasten one on each side of the strap. The key is completed then and is guaranteed not to pass juice, so it is perfectly safe in the hands of the offenders and serves to remind them of their offense. This system works here; maybe it will help to solve like problems in other sections of the country.

The Seattle Amateur Radio Club extends its good wishes to the other clubs of the world.

—I.V.I.

Book Review

By S. Kruse, Technical Editor

"Experimental Radio", by R. R. Ramsey, Ph. D., Professor of Physics, Indiana University. The University Book Store, Bloomington, Ind. \$1.60.

All experimenters!! Here's your book at last! Strictly a laboratory manual, this book will help you a good deal in getting the hang of radio laboratory work. There are 50 radio experiments and 12 others that help in understanding radio work. There is a plentiful supply of references to standard texts, and when these fail the theory of the experiment is given directly and completely. No amateur can help getting a tremendous amount of good from working his way thru this book. He will learn to do his own thinking, and he will learn to use the apparatus he has to find out the answers to such questions as "How big ought my antenna to be?"; "Is my ground connection good?"; "What is the capacity of this condenser?"; "How can I make the cheapest receiving set?"

"Wireless Course in Twenty Lessons," by S. Gernsback, A. Lescarbourea and H. W. Secor. Published by the Experimenters Publishing Co., New York. Price \$2.00 in limp cover with gold stamping.

In the 12th edition the "Wireless Course" has become so unified that the authors would have been well justified in dropping the old form of division into lessons; the "course" has become a book.

Like all the previous editions the book makes in-

interesting reading, and its form is very greatly improved by a complete re-writing and an extension to additional subjects. Both amateur and broadcast-fans will find here interesting accounts of radio matters that are entirely new to them. We find ourselves especially appreciating the historical chapter. It is a rare radio author these days who can discuss the various "super" and "ultra" circuits of the moment and still keep in mind the fact that radio is an old art. The authors of the "Wireless Course" have kept this general vision and have tied the entire book together very skillfully by references to the beginnings of the various pieces of modern apparatus.

It is a pleasant book, a readable book, and an interesting book. We only regret that it is necessary to bring up objections to Lesson 5 which gives the wholly incorrect impression that the modern amateur sending set uses spark equipment and—what is much worse—that these spark sets employ fixed gaps and electrolytic interrupters.

"Radio Simplified", by Lewis F. Kendall, Jr., Instructor, and Robert P. Koehler, Director, of the Y.M.C.A. Radio School, Philadelphia. The John C. Winston Co., Chicago, Philadelphia and Toronto. Price 1.00.

When beginning to read "Radio Simplified" we were at once struck by the large amount of good common sense shown in the chapter on "Erecting the Aerial". There isn't a bit of romance or nonsense in that chapter; we wish the installation men of all radio stores could be compelled to read it.

The same keynote runs thru the whole book; the reader is told in simple and straightforward language how he may build most of the modern receiving devices and the telling is done without introducing a single wild theory, but with ample detail so that even the most inexperienced should be able to follow.

Distinctly "Radio Simplified" is one of the better class of radio books that is beginning to replace the low-grade publications that filled the market two years ago.

We find but one express need for improvement; the chapter on spark sending sets should by all means have been omitted to allow expansion of the one on tube transmitters, a subject that is given rather scanty attention.

"Acoustics and the Telephone", by G. B. Crouse, Chief Engineer, The Connecticut Instrument Co., Inc., Stamford, Conn. No charge.

This little pamphlet relates to the "C. I. C." headset and explains the scientific reasons for its unusual construction. The effects of correct magnetic airgap and non-resonant diaphragms are especially mentioned.

"Mast and Aerial Construction for Amateurs", by F. J. Ainsley, Associate Institute Civil Engineers. Published by The Wireless Press, Ltd., 1 Henrietta St., Strand, London. Price in England 1/6, American price not known.

Even in a month of good books "Mast and Aerial Construction for Amateurs" stands out as an excellent piece of work. No matter what your interest in radio may be you will still find some very interesting reading in this clearly-written and well-printed booklet. The masts described are small, from the American standpoint, but the methods of construction are so well set forth that it is perfectly easy to expand the author's 35 footers into the 70 footers we are accustomed to thinking of. By all means order a copy.

"Constructional Data on the Superdyne Receiver", by Boyd Phelps, Research Engineer, The C. D. Tuska Co. Published by the C. D. Tuska Co., Hartford. 50¢.

This booklet is intended to supplement the article which appeared in the November issue of QST under

the title of "The Superdyne Receiver". A later type of set is described in the booklet and constructional details are given. In view of the good account this set has given of itself there should be quite a demand for the booklet, which is clearly written and well printed.

"Fundamentals of Radio", by James L. Thomas, A.B. D. Van Nostrand, New York, \$1.50.

An interesting book for the man who wishes to learn something of radio but does not wish to make a business of it. The book assumes an intelligent reader; one who will want to understand the "why" of things in the different types of sending and receiving sets. The author uses a bit of mathematics, he uses the language of the radioman, but he does these things so neatly and so clearly that the beginner will follow without the least difficulty. Distinctly, this is one of the good popular radio books.

"I.C.S. Radio Operator's Handbook", Compiled by Harry F. Dart, B.S.E.E. and edited by Francis H. Dane, Principal of the School of Electrical Engineering, International Correspondence Schools, Scranton, Pa. Price not indicated in copy received for review.

To those who know and cherish the publications of the International Correspondence Schools it is only necessary to say that "Radio Operator's Handbook" is up to the I.C.S. standard. No further recommendation is needed.

The book is of convenient pocket size and contains 400 pages of concise to-the-point diagrams with characteristic brief and clear explanations. In addition there are about 100 pages of formulas and tables with the units given for every one of them. (How we do wish all textbook writers would learn that trick!)

The last 50 pages are given to a call-list, common and unfortunate habit of present-day radio books which seem not to appreciate the fact that such lists are hopelessly obsolete in six months and had better be left to the callbooks proper.

"Theory and Operation of Reflex Circuits", by Edwin S. Watkins. Published by The Wireless Shop, Los Angeles, 25¢.

Because it is strictly necessary, the author starts by diving into deep water; he insists that the reader will never understand the reflex until he understands the actions of condensers and chokes in separating high and low frequency currents. It is good that someone has had the courage to do this. Various circuits are then described, leading up to a reflex neutrodyne. The illustrations are good—and the author does not make any wild claims.

"British Standard List of Terms and Definitions Used in Radio Communication". Published by Crosby, Lockwood & Son, 7 Stationer's Hall Court, Ludgate, London. E.C.4. Price in England 1/ plus 1/2d postage; American price not given.

Perhaps the most prominent feature of this booklet, to the American eye, is the fact that there is strong need for international standardization of terms. The British list swarms with terms that sound strange to us; some of these strangers are better than our own terms, others are worse. Certainly something should be done to secure agreement between "radiation height" and "effective height", between "dead space" and "zero beat", and between "reaction" and "feedback".

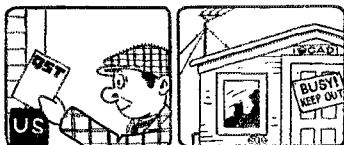

Strays

Flash—9ZT Wins 1923 Hoover Cup

The A.R.R.L. Board of Directors at a meeting just as we go to press, awarded the Hoover Cup for 1923 to Don C. Wallace, Station 9ZT, Minneapolis, Minn. See next *QST* for details and a description of the winning station.

Puzzle (to be answered by law violators). If the best amateur waves are ten meters above the law, how can we account for this?—

- Lowest power spark to cover 500 miles used 135 meters
 - Lowest powered station to work WNP used 190 meters
 - Loudest signal from Chicago to east coast used 80 meters
 - Steadiest Texas signal heard in New England used 125 meters
 - Best amateur Transatlantic signal to date used 100 meters
 - Poorest fist heard in Hartford used 210 meters
 - Rottenest CQ hound on record used 213 meters
- Names of all but the last two on request—the last pair don't know any better and are not to be held responsible.

It is a good stunt to take your filament voltmeter apart and put a rather heavy line with red ink at the normal scale reading. This can be regarded as a danger mark and will help to keep the operators of your station from overloading the filaments.

Suggestion for Radio Party

Players sit in semicircle before a 1DH transmitter using 2 to 4 fifty-watters. 2200 volts A.C. is supplied the plates and the key is held down. All players are told to keep their eyes on the antenna ammeter and watch for a pleasant surprise while the operator connects a 2 microfarad condenser across the antenna and counterpoise terminals. The object of the game is to guess where the ear splitting crash came from. The booby prize goes to the operator.

What has become of the ham who calls three times and signs three times? We haven't heard him in the longest time!

When you send that card or letter to an amateur in a foreign country be sure there is enough postage on it. Don't expect it to go half way around the world for one or two cents. Consult your postmaster regarding the proper postage first as it varies with the country the letter is addressed to.

Many of your questions regarding the super-heterodyne set can be answered by digging the April, 1923, issue out of your file of old *QST*'s and rereading the article called "Building a Super-Heterodyne and Making it Work", by O. A. Kimball, which appeared on page 19 of that issue.

A New Broadcast Set

The Bristol Co., of Waterbury, Conn., have brought out a new B.C.L. set, licensed under the Grimes Inverse Duplex amplification patents, which is unusual in many of

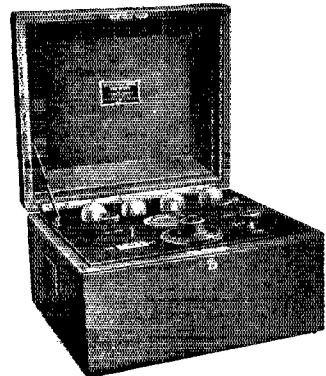

its constructional points. As shown by our cut, the equipment is mounted on a horizontal panel in a mahogany case with hinged lid, all connections to the set except phones being made thru a panel board mounted at the back of the case. Ten plugs with 4-ft. cords are part of the equipment. The first two tubes are r.f. amplifiers, the third a detector, and then the first two tubes are

used again in inverse order as reflexed audio amplifiers, the final tube being a power amplifier in the well known and really excellent Bristol circuit. The combination makes an unusual set; in fact, it was the good results Grimes experienced with the Bristol power amplifier which first brought the two interests together in relations which resulted in the Bristol Co. purchasing the remaining ten licenses under the Grimes system.

The set has but one control, a vernier-equipped tuning knob. A voltmeter, showing the voltage at which the amplifier tubes are operating, is a valuable and rarely-seen part of the set.

The Mercury Radio Products Co. of Little Falls, N. J., are also licensees under the Grimes Inverse Duplex patents and manufacture sets employing that circuit.

A. L. Budlong of Washington, D. C., author of recent *QST* articles on receivers, and secretary of the A.R.R.L. Railroad Emergency Service Committee, has joined our headquarters staff to take charge of the preparation of material for our newspaper syndicate service thru the Publicity Department. Bud, LQ, and Beek have formed a Triple Alliance at Silver Lane, Conn., and will be on the air soon with various sets and a variety of calls.

It was a set using four 50-watt tubes at Camp Alfred Vail, 2CXL, that was heard in Holland; not the "Constant Frequency Set With a Record" described on page 19 of the January *QST*. Mr. Rives went on the air February 1st for a month with the little master-oscillator set, however, and locked up the 50-watters.

This "Question and Answers" business will be the death of us yet. Here's just one of them that has us guessing; "Dear Eddy; Can you tell me the function of a heterogeneropliothermodynatron when used in conjunction with a hot dog radio frequency super differential oxyliferous thermionic dynamic ohm eliminator of the 500-volt E.M.F. type?"—Any suggestions as to a possible solution?

Approximately 200 messages were filed at the A.R.R.L. booth at the Radio Show recently in conjunction with the Twin City Auto Exposition at Minneapolis, for transmission to various parts of the U.S. Two men were at the booth during the show to explain the aims and objects of the League and to accept message traffic. Don. C. Wallace, 9ZT, was a member of the general show committee and was largely responsible for the success of the radio booth.

The Southern California Radio Assn. had an interesting booth at the American Radio

Exposition Co.'s show in Los Angeles in February, with ham sets on exhibit and the gang keeping open house and answering questions from prospective amateurs. Sold a bunch of *QST*'s, too, and signed up some members for A.R.R.L., for which many thanks, fellows.

Tests with Australia and South Africa

K. P. Frederick, editor of *Radio Journal*, sends complete schedule for tests with Australia, New Zealand, and South Africa. In all cases, the American and Canadian amateurs are to use wave-lengths between 100 and 200 meters for transmission—those with special calls using the waves below 150 meters. Australia and New Zealand amateurs will use 200 to 300 meters.

It is very important that careful slow sending be used that amateurs in those countries may recognize calls and not guess at them. The idea isn't to call three hundred times and sign once, but to call a few times and sign oftener—they don't want to hear what you are calling, but they want to hear your call. Stations in the tests are to send a brief sentence of a few words, changing each night but keeping a complete record of each transmission for verification later. Refer to December *QST* and use the proper interval in every case. During the tests there will be no code words, but you are to call "Australia and New Zealand" in one test and "South Africa" in the other.

The schedules for the first half of March didn't arrive in time for March *QST* when we were to listen for the Australian and New Zealand amateurs from March 15th to 31st.

Americans and Canadians transmit:

April 2, 4, 6, 8, 10, 12, 14 from Midnight to 3:00 A.M., P.S.T.

April 1, 3, 5, 7, 9, 11, 13, from 3:00 A.M. to 6:00 A.M., P.S.T.

Attempts at two-way communication will be held from April 15 to 30 as per the following schedule:

American and Canadians transmit first and third 15 minutes of every hour; Australians and New Zealanders transmit second and fourth 15 minutes of every hour.

April 16, 18, 20, 22, 24, 26, 28, 30 from Midnight to 3:00 A.M., P.S.T.

April 15, 17, 19, 21, 23, 25, 27, 29 from 3:00 A.M. to 6:00 A.M., P.S.T.

South Africa Tests

Amateurs in South Africa will listen for all amateurs to transmit from 5:30 P.M. to 8:00 P.M. standard time. Thus, no matter what time zone you come under, you are to transmit from 5:30 P.M. to 8:00 P.M. which means that amateurs in South Africa will be listening from 12:30 A.M. to 6:00 A.M., South African time. The

(Concluded on page 58)

A LOW LOSS ANTENNA INSULATOR

(Concluded from page 39)

by this time. Now, transfer the rod quickly from the flame to the mould, placing the heated end of the glass rod in the drilled hole. By careful manipulation of the rod, the heated end can be formed into a very neat head as shown in Fig. 2. This will require a little practice. Now the very

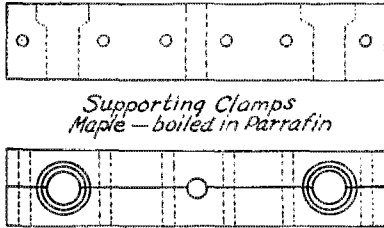

Supporting Clamps
Maple — boiled in Paraffin

FIG. 5

important part follows. Return the piece to the flame and cool very slowly by turning down the gas by degrees. If allowed to cool too rapidly, it will very likely strain and crack. This annealing process should cover a period of from 20 to 30 minutes at least.

Construction of the finished insulator will be left to each individual operator, but there are a few important items to take into consideration when preparing it for installing into the antenna system. Metal collars placed below the heads of the rods are not as satisfactory from a viewpoint of dielectric losses as the method in use at 1CEK which is shown in Fig. 3 and in Figs. 4 and 5. This method has several advantages. The support bars leave a clearance of about $\frac{1}{8}$ " between the glass and the bars to allow for expansion and contraction of the glass. Two glass rods are used to give greater strength.

Flux shields should be provided to distribute the flux and prevent losses from corona which is sure to occur where metal

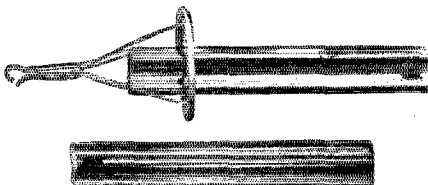

Fig. 6
10" Ohio Brass Co. Porcelain Insulator with and without Corona Shield.

collars are used in direct contact with the glass.

The writer has endeavored to present this article in such a manner as to allay the fear of attempting construction of this type of insulator. The use of same in

your radiating system will make a very pleasing increase in your DX.

AMATEUR RADIO STATIONS

(Continued from page 42)

mediately went home, pulled some wire out of the tuning unit of the superheterodyne and that night heard 8AB 15 feet from the phones. The next afternoon the old 55-wave with a hole in its grid and plate was resurrected and made to put one ampere into the antenna on short waves. French 8AB was worked that night. A.W.E. 250-wattter replaced the 50-watt tube and progress on short waves was then rapid. It was not long before stations in England and Holland were communicated with almost nightly. The latest record was made when ACD in Italy was worked and complete messages received.

From the above, 2AGB was one of the pioneers in two-way Transatlantic work on short waves. The transmitter used for this work consisted of one 250-watt tube connected in the familiar three-coil Meissner circuit, except that the grid and plate coils are really sections of the same coil. Two pancake coils are used; one for the antenna circuit and one for the grid and plate circuits. The antenna series condenser controls the wave length and no other changes are necessary when shifting waves. This circuit does have the disadvantage, however, that the swinging of the antenna is liable to cause the wave to vary somewhat. Plate current is supplied by a Westinghouse 110-2200 volt pole transformer working through a home made synchronous rectifier. No filter is used. An antenna current of 6 amperes on 180 meters is obtained and from 3 to 4 amperes on wave lengths around 100 meters, depending on the plate voltage used. This same transmitter, changed over to the conven-



The Crew at 2AGB

tional Hartley circuit, is used on 180 meters for general amateur work.

The antenna at this station consists of a six-wire cage three feet in diameter hung between an 80-foot mast at the far end and a 50-foot tree at the lead-in end. The cage is 65 feet long. The counterpoise is made of three cages of varying lengths,

(Concluded on page 58)

Radio Communications by the Amateurs

The Publishers of QST assume no responsibility for statements made herein by correspondents



Long Wave Reception on Tape Recorder

Daytona Beach, Fla.

Editor, QST:

In the January, 1924, number of QST you inquire about "the fellows who used to be interested in the reception of Long-Wave foreign stations." Well, here is one of them! Why don't you run a "Long-Wave Department" in QST for us? I enclose some samples of long-wave reception as received and recorded on my radio relay and tape recording machine. I hooked up this machine as per the specifications of Dr. Dunmore, of the Bureau of Standards at Washington, D. C. My radio receiving set is a simple three-coil regenerative set. I use a 300-foot antenna for all reception from amateurs to station LY in France! (the latter using some 23,000 meters.) My reception seems to be about as good on all wave-lengths as any of the other elaborate and special sets I have read of. It is simply a matter of pulling out the large honeycomb coils, substituting my Groves single layer coils, and then adjusting the condensers, to tune in the amateurs and broadcasting stations, etc. Nothing could be simpler! As I have found amateur-sending usually very poor in style as well as usually uninteresting with its inevitable "CQ-ing," I have listened in mostly on the broadcasting and long-wave stations. The samples of tape that I am sending you were all of long-wave stations in this country. It is simply a matter of amplification in order to record the foreign stations on the tape, I understand. I have not retouched the tape in the slightest, so you see it just as it come in on my set. This Dunmore Relay and tape recorder is a wonderful thing for showing up one's "style" in transmitting! As long as the long-wave stations are transmitting automatically, the record on the tape comes in well, and is good to look at; but when the operator breaks in to transmit by hand, very often it is difficult to translate the dots and dashes quickly, if at all! I wish all transmitting amateurs could see the stuff they might record on the tape! (Their "CQ's" even would not look as beautiful as they think!)

My Dunmore Relay is not in cabinet form, but is spread all over my table. I

use usually only two steps of audio amplification to work the relay, although it will work on one step sometimes, just depending on the intensity of the received signals. I once succeeded in getting my set to record a few letters from station UFT in France, also NBA in Panama. Have succeeded in recording most of the long-wave stations in this country from WQL to old NAA.

In closing let me again mention that I owe many thanks to one of your contributors, Mr. A. L. Groves of Brooke, Va., for the information he originally gave me as to the use of honeycomb coils, and especially as to the use of his own single-layer coils for the short waves. He used to be a splendid long-wave man himself, but seems to have given up most of his time lately to the short and even shorter waves!

—Henry I. Middleton.

Modulating the Low Power Phone Set

Palo Alto, Calif.

Editor, QST:

The attached hookup is the result of a line in the December QST regarding the use of the plate to filament resistance of a modulator tube as the grid leak of the oscillator tube. The set in question uses two 5-watt tubes with about 800 volts D.C. on the plates, supplied by a rectifier-filter system. The normal antenna current is 3.2 amperes and I have reports from all districts, 37 states, and New Zealand.

The first trouble in getting this modulation system to working was in keeping the r.f. current in the oscillator grid circuit out of the modulator tube. Two chokes were finally used on the grid side, L_1 and L_2 , in series, and one on the filament side. One was a 500-turn honeycomb coil and the other a home-made choke of 350 turns of No. 25 D.C. wire wound on a tube and coated with a very little shellac. (This was the best choke). The only modulation transformer that would work well was a Ford coil, and even then it was necessary to switch the terminals around until the best arrangement was found.

Now for the operation of the set. As soon as the filament of the modulator is heated the whole set will squeal and con-

tinue to do so, increasing in pitch, until the tube is heated to about its full brilliancy. The oscillator plate current will steadily increase also during this process. This is the same effect as was described in the article "I.C.W. Without Mechanical Motion," by 9BXQ in the October issue of QST on page 20. The point for best modulation is where the filament rheostat is turned up until this squeal just stops.

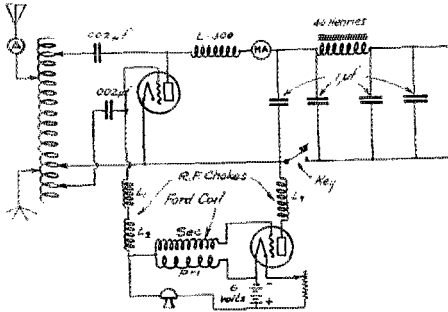

At this point, the oscillator plate current was about three-fourths normal. If the microphone is now whistled into, the plate current will drop to about half of its former value with proportional drop in antenna power. With the phone the antenna current was about 2.6 amperes. Different tubes as modulators were tried but the best seemed to be a C-301 or a C-302. A bias of about 35 volts negative on the modulator was found to reduce the plate current to zero. If we could get a range of 0-35 volts on voice modulation, modulation would be 100%.

Now as to results. I have only operated the set one day but I have never had so many local calls. Everyone has pronounced the modulation perfect, and two fellows called to ask what I was using. One said that I was louder at 35 miles than most of the local phones, and so on. It certainly was different than my former attempts at phone. With increased voltage on the oscillator plate, to raise the plate current (This can also be done by putting a positive bias on the modulator—Dept. Ed.) it will be possible to maintain the same antenna current as when using C.W. and have the wave nearly fully modulated. I am lucky in having two storage batteries so that the separate one needed for the modulator tube filament is no drawback. If a UV-199 tube will pass the grid leak current, there is no reason why one could not be used with an Everready "3" filament battery, although I have not tried this.

—N. R. Morgan, 6BM.

P.S. POSITION OF KEY: I have found the position of the key as shown in the

diagram to be the best yet when using the "Brute Force Filter." There is a 1 μ f condenser on either side, so that there is no sharp break in either circuit, and there is also a total of 1/2 μ f across the key contacts; just enough to kill the spark.

Isn't He Right?

1261 Jefferson Ave.,
Ogden, Utah.

Editor, QST:

Just a few lines of suggestion that may go toward making more reliable the handling of traffic on the 200-meter wave length.

I have noticed lately a great deal of jamming on these wavelengths and have noticed that almost invariably the majority of the stations in sending their messages are repeating each word twice, and I know that in the majority of the cases that this is not necessary. It seems to be a great habit that the CW operators have adopted, regardless of the necessity, to repeat each word. I know I have been working stations and have told them that they were QSA and not to repeat, and they would come back with the same OK OK OM OM Hr Hr Nr Nr.

Now instead of making better operators of the average ham, it is a decided step backward to repeat. An operator loses confidence in his receiving ability. He is used to hearing the regular repeat all the time, and as soon as some one jumps him at a fair speed and no repeat he comes back "nd om pse QTA. QSZ." If the operator at the receiving end will learn to concentrate, learn to rely upon his own ability to receive a msg with no repeat, and if all stations will refrain from sending each word twice and only do so when asked by the receiving station out of absolute necessity, traffic will be handled faster, we will have a great number of better operators, and there will be far less congestion of traffic on the 200 meter wave.

I would like very much to see something done in regards to this matter, and I think you will say that I am right. It is only a suggestion and I would be very much pleased to receive your views on the matter and also the views of other operators.

—W. C. Garner, 6ZAM.

Rotten Rectifiers

Chester, Pa.

Editor, QST:

Well, Eddy, I don't know which is more stubborn, a woman, an electrolytic rectifier, or maybe a mule. I thought as how it would be fine to have D.C. on the plates of my tubes so I could use fone sometimes, maybe. Then the BCL's that have delerium tremens every time they see a light in my radio shack would know it was me inter-

fering instead of having to just guess who it was.

Well, anyhow, Ed I got me some of the wife's cooking utensils that the man she bought 'em from said was pure aluminum. I didn't doubt it because they cost enough to be almost anything.

Well, Ed, after I had just about kilt myself from eating home-made jelly to get the glasses, I finally got the thing fixed. Actually, Ed, that thing raised my radiation on my maybe-more-than-likely-not hot wire meter exactly six tenths of an amp. It sounded fine in my receiver too. The first guy what I calls gets me and sez "QSA vy QSB AC note". Well, Ed, I knew rite away that he had a punk receiver so I shut down for a while.

Well, Ed, things was going fine after while when the darn cat walks in and just conversationally-like sez "Meow!" You won't believe it, Ed, but that thing ain't worked since.

Well, then I went back to the hardware store and told the man if that stuff he sold me was supposed to be aluminum to give me some sheet pig iron. Anyhow Ed, I got another rectifier built and used distilled water this time after putting the fire out a couple of times when I was distilling it. This one worked fine until the solution got shy and interrupted me in the act of saying what I thought about liquids in general; which was an act of Providence. So then I had to rebuild the thing again and again. The third one went fine until my neice took the meassels and immediately the rectifier begins to work considerable less than none at all.

Nr 4 was OK until I put a filter on and then it got shy and balked on me. I turns off the juice and started to extract said filter. I swear, Ed, I turned the juice off but that darn contraption give me an awful jump. When I woke up and got my bearings again I started for a mop and then some new glasses for nr. 5. After a while, when they got me to come down out of the tree where I had went to look for squirrels I decided to make a good rectifier or bust.

Six days I labored and the seventh I prayed. Next day I connected it up and pushed the key. It was about six p.m. at nite Ed, and the lights were lit. That is, before I pushed the key they were. After they got the new meter put in I found that my plate transformer was shot.

—E. E. Miles, 3ADQ.

P.S. Had fine time last Saturday shooting the jelly glasses off the back fence.

What About It, Fellows?

919 42nd St.,
Des Moines, Iowa.

Editor, QST:

The first thing I have to say is a few

words about this thing of not answering cards and letters. Perhaps you do not care about receiving reports on your signals, but it's a sure thing that the other fellow does, if he goes to the trouble of writing and mailing you a card. He does not care whether you have an expensive printed card, or a plain postal with only "tnx for card, U fb hr" scribbled on it, a card's a card, and it helps to make the pile bigger! It's mighty disheartening, especially to the fellow with low power, to finally raise a distant station and then have him fail to QSL your card. What will happen to our famous A.R.R.L. spirit if we give up this practice of writing to fellow hams and getting a little closer acquainted? Would

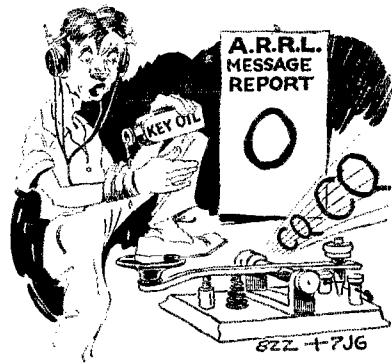

we still have the same spirit and love for the game if *no one* sent cards? There is not an amateur in the country that is too busy to answer every report that he receives. Don't be selfish. Be a good sport. Start answering those cards *today*.

The next topic is about keys. There is not more than one out of every hundred hams that can operate a cootie or bug so that it really sounds good. Then why, oh why, do half of the fellows in the country persist in using them, when they could send so much better with a good old straight key? The average amateur does not send over fifteen words per minute, and this slow pace surely doesn't demand a speed key. Let's do away with the fancy keys and develop some real fists that are a pleasure to read.

Next I want to say a few words about the epidemic of ham fones that is running across the country. Of all the disgusting things, this takes the cake. They talk about the sparks and the synk rectifiers being broad, but they're just naturally out of it when compared to the squeaks and groans emitted by an amateur fone. What's the use of this thing anyway? It's NG for DX, useless for handling traffic, in fact, all that it does is gum up the air for everybody. If the fellows are so crazy about

Coto

"Built First to Last"

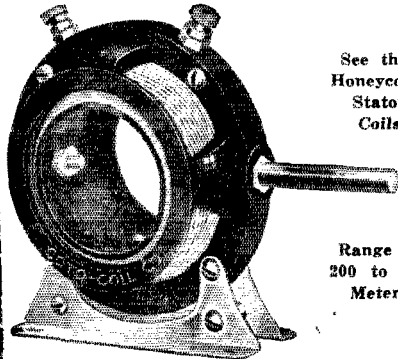

See those
Honeycomb
Stator
Coils

Range is
200 to 600
Meters

Every User More than Pleased!

Nation wide welcome by radio enthusiasts has proved that there is just one mistake you can make while buying this remarkable variometer. You can allow the dealer to switch you to one he wants to sell rather than let you have the popular Coto that is hard to get. Don't let him. Pound the counter if you must. **INSIST!**

Moulded Variometer Type 8000. \$5.

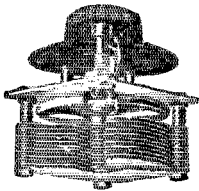

The Silver Plated Air Condenser

Copper plates soldered firmly in place and **SILVER PLATED**. Losses of antenna energy are very low because of improved design and best rubber insulation. .001 Mfd. \$6. .0005 Mfd. \$5. .00025 Mfd. \$4.50.

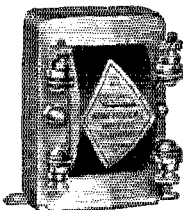

Where Loud Speaker Tones are Rich—

look for a really fine 5 to 1 turn ratio **Audio Amplifying Transformer**. Coto type 4000 has stood every test of wide use and can be depended upon for amplification that it's a treat to hear. \$5.

COTO COIL CO., 87 WILLARD AVE., PROVIDENCE, R. I.

Los Angeles, 329 Union League Bldg.

Minneapolis, Geo. F. Darling.

705 Plymouth Bldg.

Atlanta, C. P. Atkinson.

Atlanta Trust Co. Bldg.

Canada, Perkins Electric Co., Ltd.

Montreal Toronto Winnipeg

fone, why don't they get a broadcast license and get up on the broadcast wave lengths where they belong? They would get a lot more cards from the BCL's, and this is evidently their reason for using it.

Let's be amateurs, and keep in our field, the advancement of radio telegraph on short wavelengths.

"Long live the ham."

J. Mack Swiggert, 9CLQ,
C.C. for Des Moines.

A Bouquet

Upper Montclair, N. J.

Editor, *QST*:

First, foremost, and most important, I wish to make myself a delayed Xmas present of a ten years subscription to *QST*; for which I take great pleasure in handing you my check for \$20.00. There is no radio publication that is so humanly and helpfully and reliably up-to-the-minute-all-the-time as *QST*. I am a retired lawyer who has been actively delving into the mysteries of radio, as a hobby, for a little over two years, and every number of *QST* since August, 1921, has brought me an added sense of appreciation of the splendid work you are doing. More power to you!

—A. Leonard Brougham.

STRAYS

(Concluded from page 53)

dates for the South African Tests are April 14 to May 12, inclusive.

The A.R.R.L. is behind these tests and we urge every amateur to dust the cobwebs off his transmitter and get busy. We want to see two-way communication established with Australia and New Zealand—don't forget that a genuine Australian boomer goes to the first ham who does it—and we want to see a flock of calls logged in South Africa.

—F.H.S.

AMATEUR RADIO STATIONS

(Concluded from page 54)

each having three wires and suspended 8 inches above the ground.

2AGB has four operators. In the photo, from left to right they are; D. A. Griffin "DA", Wallace Lander "WAL", John Tiffany "DC", and John Dodman "JO". Mr. Griffin and Mr. Dodman are the owners of the station, Mr. Tiffany is the Chief Op. and "sleepless wonder" who deserves most of the credit for the DX records made at the station, and Mr. Lander is the Technical Advisor. The station is located at 24 Oak Ridge Ave., Summit, New Jersey.

Readers should note that amateurs may no longer use wave lengths under 150 meters without an experimental license or a special permit from their Supervisor of Radio.—Dept. Ed.

Here is the Man—Here is the Receiver

The amazing story of continued communication with the MacMillan Expedition, on the Steamer Bowdoin—frozen in somewhere near the North Pole—and with other distant points is here told by Mr. Len Weeks, Radio 9DKB, Minot, N. D.

December 30, 1923.

"I submit the following account of the use of the Ace Type 3B and the Ace Type V radio receivers for DX work, especially with WNP.

"Using the Ace Type 3B or Type V have heard the schooner "Bowdoin" radio WNP a total of seventeen times during November and December. On thirteen of these occasions communication was established. Thirty-four messages totaling several thousand words were received from the Bowdoin, including a 1500 word press dispatch, taken in 3 hours and 30 minutes. Twenty-two messages were sent to MacMillan and members of the crew. The greatest length of time between communication was nine days, of which four were spent away from the station. Signals were unusually readable and often uncomfortably loud on two steps.

"During the month of December Canadian 9BP, Jack Barnsley, has been on a vacation. During this time my station has been the main, but not the only, link between the North Greenland expedition and the United States. Most of the credit for this is due to the fine control of regeneration and ease of adjustment on the Ace sets. Having a



wave length range that completely covers the amateur band, it was easy to quickly shift wave length in order to avoid interference.

"In addition to the above reception, 7AHB in Alaska and 6CEU in Hawaii have been copied several times. Of course stations on both the east and west coast are heard every night. It is nothing unusual to copy stations from every district in a night's work. I have discarded a higher priced three circuit set for I honestly believe that the ACE

sets give greater receiving range both in miles and kilocycles."

January 5, 1924.

"Last night my second operator, Homer Stenerson, a man comparatively inexperienced in amateur work, successfully established communication with WNP, giving him a message and getting an acknowledgment. Many people seem to think that the results are due to expert manipulation. This is not the case, for on several occasions I have had other amateurs listening for WNP while I took a much needed sleep. Nearly always they were able to pick him up and hold him till I got on the job."

The above communications are merely samples of the continued proofs, voluntarily sent us of the superiority of Crosley Instruments.

We believe that for bringing in distant stations they cannot be equaled. And the prices are Remarkably Low.

The ACE TYPE V—\$16.00

The ACE TYPE 3-B—\$42.00

Write for Complete Catalog

THE CROSLY RADIO CORPORATION

Powel Crosley, Jr., President

Formerly

The Precision Equipment Company and Crosley Manufacturing Company

318 ALFRED STREET

CINCINNATI, OHIO

The Ace Receivers mentioned above are now known as Crosley Receivers

The background of the advertisement features a stylized illustration of two radio towers on either side, with a city skyline visible at the bottom. The towers are connected by a network of lines, possibly representing power or signal paths. The city skyline includes various buildings and a ship in the water.

CITIZENS RADIO CALL BOOK

A Complete
Radio Cyclopaedia

**NEW ISSUE
NOW READY**

A complete revised list of all Telephone Broadcasting Stations showing Call letters, wave lengths, kilocycles, class, schedules, time these schedules are based on and station slogan. Also listed by states in case you miss the call letters.

All American, Canadian, English, French, and Australian Amateur and experimental stations with complete American Radio Relay League Directory. Also Canadian Broadcasting Stations. Complete list of Commercial ship and land Stations of the United States. High Power Land stations of every country in the world. "How to build the new Regenerative Super Heterodyne," by Lawrence M. Cockaday. Also suggestions for the beginners.

Graphic illustrations of all the latest hookups with construction and operating data shown in such a way that anyone can build their favorite set.

Maps, log sheets, blank recording map, distance chart, kilocycle-meter-table, Continental code and other items too numerous to mention.

**ALL FOR
ONLY . . . 50c**

Add parcel postage as follows. West of Denver to Salt Lake City, 17c. West of Salt Lake City, 24c. All other American points, 15c. Canada and foreign countries, 25c.

If you are interested in a monthly service, send us \$1.50 and we will mail you each month a list of all the changes in Amateur and Broadcasting Stations until the new issue comes out next October.

Make sure that you will get the next issue promptly by mailing us \$1.25 for one year's subscription. This includes parcel postage. Dealers write for our guaranteed plan of sale.

CITIZEN'S RADIO SERVICE BUREAU
508 South Dearborn Street CHICAGO, ILL.
Department B

"THE AIR IS FULL OF THINGS YOU SHOULDN'T MISS"



Eveready "B" Battery No. 766. 22½ volts. Six Fahnestock Spring Clip Terminals, giving variable voltage from 16½ to 22½ volts, in 1½-volt steps. Length, 6¾ ins.; width, 4¾ ins.; height, 3 3/16 ins. Weight, 5 lbs.

WE THINK that No. 766 is the handsomest battery ever made. But that is a matter of opinion. It is a matter of engineering record, however, that this great standard "B" Battery has proved itself as perfect in performance as we are convinced it is super-fine in appearance.

The 45-volt Eveready No. 767 contains the same large powerful cells as the No. 766. For maximum "B" Battery economy, therefore, buy the 22½ volt Eveready No. 766 or the 45-volt Eveready No. 767, as you prefer.

NATIONAL CARBON COMPANY, INC.

Headquarters for Radio Battery Information

New York

San Francisco

Canadian National Carbon Co., Limited
Factory and Offices: Toronto, Ontario

If you have any radio battery problem, write to G. C. Furness, Manager, Radio Division, National Carbon Company, Inc., 224 Thompson Ave., Long Island City, N. Y. Informative and money-saving booklets on "A," "B" and "C" Batteries sent free on request.

EVEREADY
Radio Batteries
- they last longer

The
Supreme
Insulation

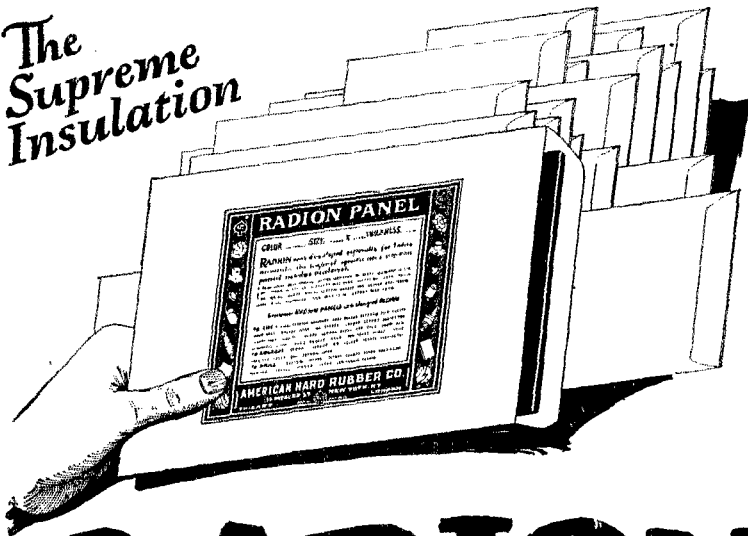

RADION Panels

Absolutely guarantee you the lowest phase angle difference, the lowest dielectric constant, the highest resistivity, and supreme moisture, gas and acid repelling properties.

Eighteen stock sizes in black and mahoganite.

6 x 7	9 x 14	7 x 24	7 x 18
6 x 21	12 x 21	10 x 12	7 x 48
7 x 12	6 x 10 1/2	14 x 18	12 x 14
7 x 21	7 x 9	6 x 14	20 x 24
	7 x 14	7 x 10	

These leading manufacturers of CONDENSERS adopted
RADION ENDS

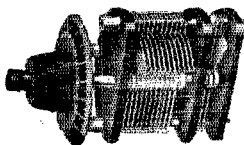

Amsco Products, Inc.
Commercial Screw Machine
Prod. Co.
Elgin Tool Works Inc.
Freed Eiseman Radio Corp.
General Radio Co.
Heath Radio & Elec. Mfg. Co.

Jewett Mfg. Corp.

Pacent Electric Co.

Superior Instrument Co.

because RADION is the best possible insulation against current losses in high frequency reception.

AMERICAN HARD RUBBER COMPANY
11 MERCER STREET, NEW YORK,

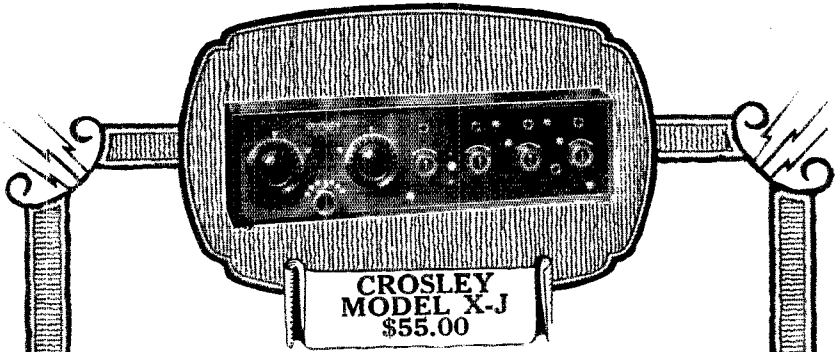

The Famous Crosley Model X-J A Long Distance Receiver

Probably the greatest single feature of this Crosley Model X-J receiver is its remarkable selectivity. It will not only tune through powerful local broadcasting stations and bring in distant stations clearly with great volume. It is the most popular receiver in America to-day, we believe.

A four tube radio frequency set combining one stage of Tuned Radio Frequency Amplification, a Detector and two stages of Audio Frequency Amplification. A jack to plug in on three tubes for head phones, the four tubes being otherwise connected for loud speaker.

CROSLY TYPE 3-B.....\$42.00

This three tube regenerative receiver licensed under Armstrong U. S. Patent No. 1,113,149 combines the Crosley Type V, single tube receiver, and the Crosley two stage amplifier. In the hands of amateurs and professionals alike it has consistently out-performed sets costing a great deal more. A person hearing a broadcasting station may turn off the set by throwing switch and come back later without re-tuning.

CROSLY MODEL VI.....\$24.00

A two tube medium range receiver of exceptional merit. Consists of one stage of tuned radio frequency amplification and detector. The one stage of tuned radio frequency amplification not only amplifies the signal before it reaches the detector, enabling the detector to work more efficiently, but it also eliminates interference to a wonderful degree.

Crosley instruments are sold by best dealers everywhere. Write for complete catalog of Crosley receivers and parts.

The Crosley Radio Corporation

Powel Crosley, Jr., President

Formerly

The Precision Equipment Company and
Crosley Manufacturing Company

418 Alfred Street, Cincinnati, Ohio.

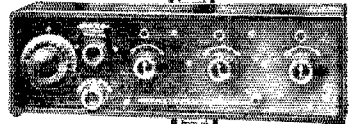

CROSLY
Type 3-B

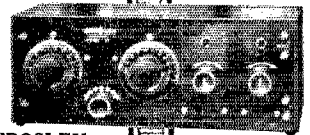

CROSLY
Model VI

CROSLY

Better - Cost Less
Radio Products

TRADE

“ E S C O ”

MARK

Generators — Motors — Dynamotors — Motor-Generators
Stand Supreme in Wireless Field

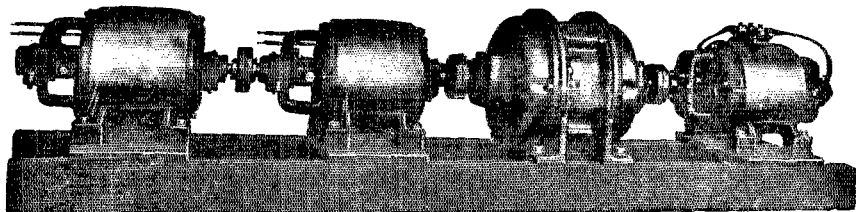

This Special 4 Unit Set made for Wis. Dept. of Markets—the largest Broadcasting Station in existence. A 10 H.P. Motor—two 1000 V., 2000 W. Generators to operate in series, producing 2000V. and 4000 W. and one 12 V. 2000 W. Filament current Generator.

SEND FOR BULLETIN 237A listing over 200 combinations. We design and develop Special Apparatus for Special Purposes.

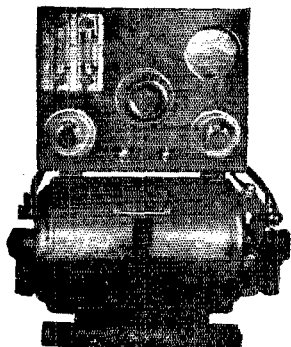

BATTERY CHARGER
 Many Sizes with or without panels

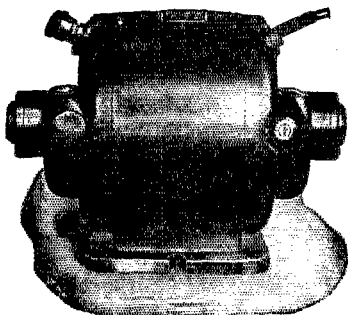

DYNAMOTOR
 Sizes to fit all requirements.

SOLD BY PRINCIPAL DEALERS EVERYWHERE

ELECTRIC SPECIALTY COMPANY

225 South Street,

Stamford, Conn., U.S.A.

Pioneers in developing High Voltage Apparatus

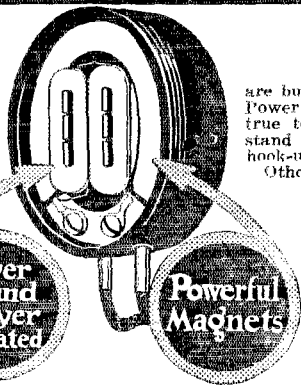

Layer
Wound
2 Layer
Insulated

Powerful
Magnets

Stromberg-Carlson

RADIO HEAD SETS

are built to give lasting service and satisfaction. They are equipped with Powerful Magnets which are necessary for sensitivity, sound volume and true tonal quality; also Layer Wound and Layer Insulated Coils which stand up under the high plate voltages now prevalent for loud speaker hook-ups.

Other distinguishing features of Stromberg-Carlson Radio Head Sets are—

The receivers are balanced as to volume—both ears get the message.

The ear caps cover the ears—excluding outside noises.

The adjustment rod telescopes and fits comfortably on any head.

Send for booklet 1029Q.S.T. which tells more about these superior headsets.

Sold by dealers everywhere
STROMBERG-CARLSON
TELEPHONE MFG. CO.

1060 University Avenue, Rochester, N. Y.

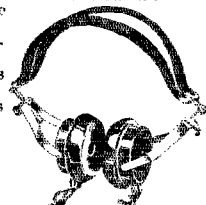

K & C TUNED R. F. TRANSFORMERS

THESE EFFICIENT UNITS GAINING REMARKABLE SUCCESS

These Radio Frequency Transformers are the result of considerable research work by our Radio Engineers, and are remarkably flexible and efficient units. The wave length of the transformer is controlled by the position of the rotor and can be set for any given wave length between 150 and 600 meters. This range covers all broadcasting and permits of maximum efficiency of the transformer. Previous efforts along the line of radio frequency amplification have been confined to the use of a Radio Frequency Transformer working efficiently only at one or two wave lengths. The K & C Radio Frequency Transformer can be accurately tuned to any wave length between the limits mentioned above.

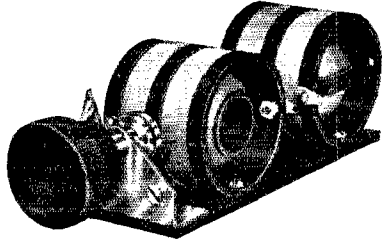

Specifications

Insulated shaft and disc type coupling.
Each stage of amplification adjustable.
Pig-tail connections to rotating secondaries.
Constructed of high grade bakelite
Arranged for both panel and base mounting.

Continuously Variable Radio Frequency Amplifying Transformer

Two Stage.....\$10.00 ..Single Stage.....\$5.50
Range 150-600 meters

Send 25c for blueprint giving details of highly efficient Radio Audio Frequency Circuit.



K C YOUR GUARANTEE

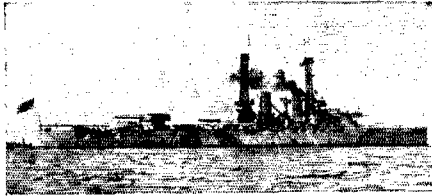

The same skilled engineers and mechanics that have been building our radio equipment for the U. S. Navy and Merchant Marine for the past ten years build the finest radio sets for your home.

ALL NAVY
RADIO MEN
KNOW
KILBOURNE &
CLARK

ASK THEM!

KILBOURNE & CLARK MANUFACTURING CO.
Head Office and Works, Seattle, Washington

BRANCH OFFICES:

Chicago, 453 National Bank Bldg., Phone Randolph 3480; San Francisco, 591 Mission St., Phone Sutter 40; Los Angeles, 1103 W. 10th St., Phone 552-63; Portland, Ore., 305 Larrabee St., Phone, East 6156.

New York Representatives: Steelman, Inc., 24 Murray St., Phone Barclay 7941-2.

K & C MOULDED MIDGETS

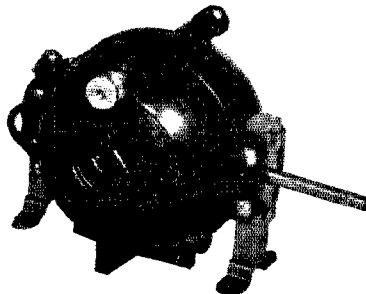
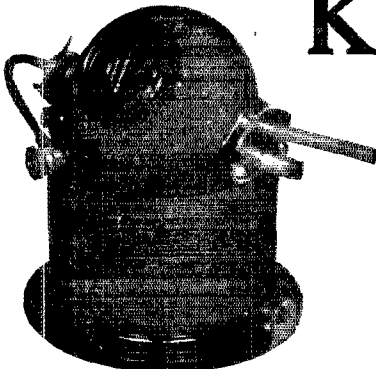

Moulded in high-grade Bakelite. Double-covered, green silk windings. Flexible braid connections to rotors. Windings designed for minimum capacity. Wavelength 100-700 meters with .0005 mfd. cond.

VARIOCOUPLER
Prim. Induct. .327 M. H. **\$5.50**
Sec. Induct. .227 M. H.
Dimensions 4" high x 3 1/2" x 4 1/4"

VARIOMETER **\$6.**
Max. Inductance .556 M. H.
Dimensions 8" high x 3" x 4 1/4"

To Our Readers Who Are Not A.R.R.L. Members

Wouldn't you like to become a member of the American Radio Relay League? We need you in this big organization of radio amateurs, the only national amateur association that does things. From your reading of *QST* you have gained a knowledge of the nature of the League and what it does, and you have read of its purposes as set forth on page 6 of every issue. We would like to have you become a full-fledged member and add your strength to ours in the things we are undertaking for Amateur Radio, and incidentally you will have the membership edition of *QST* delivered at your door each month. A convenient application form is printed below—clip it out and mail it today.

.....1924

American Radio Relay League,
Hartford, Conn.

Being genuinely interested in Amateur Radio, I hereby apply for membership in the American Radio Relay League, and enclose \$2 in payment for one year's dues. This entitles me to receive *QST* for the same period. Please begin my subscription with the.....issue. Mail my Certificate of Membership and send *QST* to the following name and address.

.....
.....
.....

Station call, if any.....

Grade operator's license, if any.....

Radio Clubs of which a member.....

Do you know a friend who is also interested in Amateur Radio, whose name you might give us so we may write to him too about the League?.....

.....Thanks.

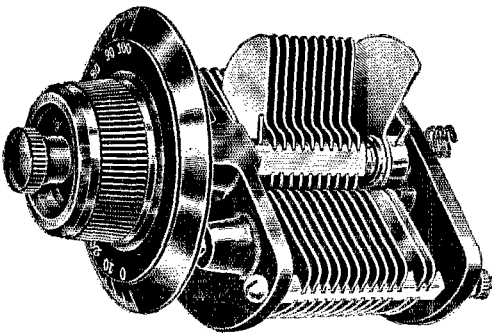

SEXTON CONDENSERS Double Knob Vernier

Most Compact Vernier Condenser Built. Furnished with 3 inch Black Bakelite Dial. Separate Button for Vernier Control. Ball Thrust Bearing Insures Perfect Action.

Also Made in Balanced Types with Half-Capacity Switch

Write for literature and name of nearest distributor.

The Hartford Instrument Co.
308 Pearl St., Hartford, Conn.

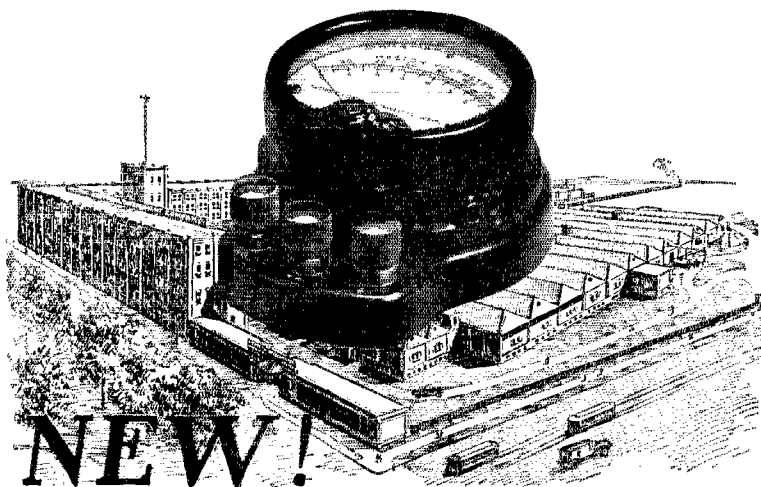

Best
Quality
throughout
just like the
larger high grade
Weston
Instruments

NEW! DOUBLE Range Portable VOLTMETER

An indispensable instrument. Especially designed for accurately measuring filament, plate and grid voltages. Ranges 150 and 7½ volts. May be mounted on panel if desired. This high resistance instrument will constantly indicate the condition of your batteries, eliminate noise, lengthen the life of your tubes and accelerate exact tuning. The voltmeter you need.

This and other radio instruments described in booklet "J". You need this booklet to assist you in testing out transmitting and receiving sets. Sent free on request.

WESTON ELECTRICAL INSTRUMENT CO., 158 Weston Ave., Newark, N. J.
Branch Offices in All Principal Cities

Electrical
Indicating
Instrument
Authorities
Since 1888

WESTON

STANDARD - The World Over

WE REPAIR THE FOLLOWING

RADIO TUBES

and Guarantee Them

WD-11	\$3.00	DV-6A	\$3.00
WD-12	3.00	UV-199	3.00
UV-200	2.75	C-299	3.00
UV-201	3.00	UV-201A	3.00
C-300	2.75	C-301A	3.00
C-301	3.00	Marconi	3.00
DV-6	3.00	Moorhead	3.00
DV-1	3.00	6 v. Plain Detector	2.75
DV-2	3.00	6 v. Plain Amplifier	3.00

Mail Orders solicited and promptly attended to.
Dealers and Agents write for Special Discount

H. & H. RADIO CO.

P. O. BOX 22-W

CLINTON HILL STA.,

NEWARK, N. J.

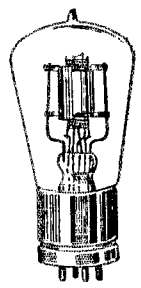

KELLOGG RADIO PARTS

Easy { **to Mount**
to Wire
to Solder
to Tune

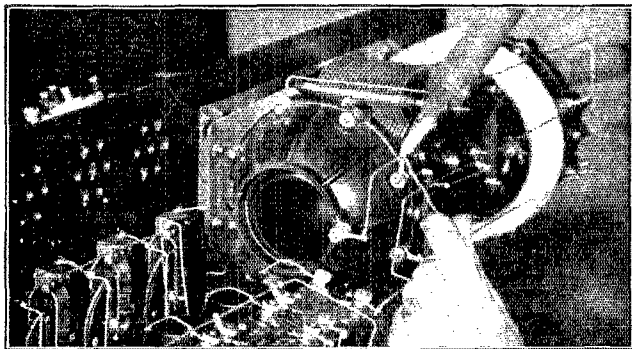

No Fussing or Re-drilling—Just Mount and Solder

They furnish every convenience for quick efficient assembly. And when connected—"O Boy!"

Did you ever hear such volume and still so clear and distinct!

That is the satisfaction of using Kellogg radio equipment—it puts the 'Ray' in Radio.

Join the group of "Happy Radio Fans." They are strong believers in quality, and Kellogg apparatus.



USE—is the test



KELLOGG SWITCHBOARD & SUPPLY COMPANY

1066 West Adams Street, Chicago

CHELSEA

SHORT WAVE WORK

makes that better insulation necessary that CHELSEA PARTS give you.

Chelsea dials of genuine bakelite will not discolor or warp out of shape and always run true. Sizes $2\frac{3}{8}$, $3\frac{1}{4}$ and 4 inch.

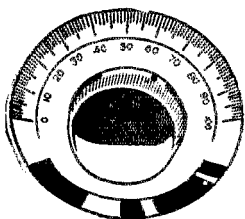

#44 four inch dial \$0.50

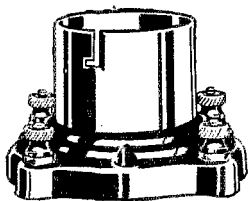

#60 Price \$0.75

CHELSEA OFFERS A COMPLETE LINE

- Variometer with vernier \$8.00
 - Variocoupler with Binding Posts \$8.00
 - Variable condensers with vernier \$4 to \$5, without vernier \$3 to \$4
 - Amplifying transformer \$4.50
- At your dealers or write direct

CHELSEA RADIO COMPANY
175 SPRUCE ST., CHELSEA, MASS.

Save 25 to 50%

on your

Radio Panels

By Insisting Upon Getting Panels Bearing This Name and Trade-mark:



ELECTRASOTE
REG. U.S. PAT OFF

TRADE

MARK

Electrasote, the new panel material introduced by THE PANTASOTE COMPANY, INC., has highly desirable radio-electric properties—greater volume and surface resistivity than any other panel, therefore less surface-leakage and power-loss in the set.

Electrasote Radio Panels are a distinctly *quality* product, beautifully finished; each panel in an individual envelope.

Remember—a good panel deserves proper handling. To get the best results use a new, *sharp* drill with *slight* pressure.

All Standard Sizes at good Radio Dealers

JOBBERS AND DEALERS:

Write for our interesting proposition.

M. M. FLERON & SON, INC.

Exclusive Sales Agents for Electrasote Radio Panels

Trenton, New Jersey

A Freed-Eisemann **KNOCK DOWN** **NEUTRODYNE RECEIVER**

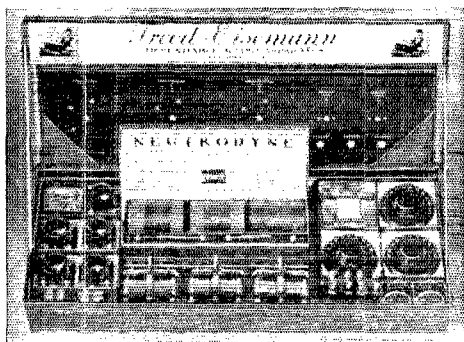

Unassembled Model KD-50
Freed-Eisemann Neutrodyne Receiver.

NOW the opportunity is presented to obtain a complete set of parts, recommended by the manufacturer, to work with each other in building your Neutrodyne set. An illustrated 32-page book on how to build the Neutrodyne with full-sized diagrams and templates included.

Complete
With full instructions

\$80

Dealers Write for Name of
Nearest Distributor.



Front View KD-50
Neutrodyne Being Assembled

NEUTRODYNE has taken the country by storm. It is the remarkable distance getting, powerful, non-oscillating and non-whistling receiver.

A 32-page book answers every question. The panel is accurately drilled. A baseboard is furnished; in fact, everything down to the very last screw and nut, including all necessary parts excepting the cabinet.

Besides the book there is furnished schematic blueprints and template for drilling the baseboard, also full-size pictorial perspective wiring diagram, so that it will hardly be possible for the amateur with ordinary care and skill to make an error.

Remember that here are licensed parts—not a collection of apparatus trusting to luck that they will assemble properly. Each part is designed and fitted to work with each other part in this particular set. The instructions are so complete and the parts so accurately matched that you will be grateful for the manner in which we have eliminated guess work in the amateur construction of this receiver.

For sale by dealers of the better class throughout the country, for amateurs and experimental building. Builders are cautioned against attempting to build a Neutrodyne Set with parts which are not recommended and designed by the manufacturer to work with each other.



32-page illustrated book of instructions on "How to Build the Neutrodyne" with full size pictorial wiring diagram and full size panel and baseboard templates, \$1. At your Radio Dealers.

Freed-Eisemann Radio Corporation

SPERRY BUILDING, MANHATTAN BRIDGE PLAZA, BROOKLYN, N. Y.

This Variable Leak easiest to install

No trick at all to put a DURHAM Variable on most any detector tube. For, most people use grid condensers supplied with spring clips. Snap out the old fixed leak. Pop in a DURHAM Variable—and tune in the Big Improvement. Try it!

Kill that howler

Third stage audio is the new noise now-a-days—and mostly noise, unless you by-pass the second secondary. A variable high resistance, with or without condenser, clears things up nicely. DURHAMS Type 100 do it! Also fine across B batteries.

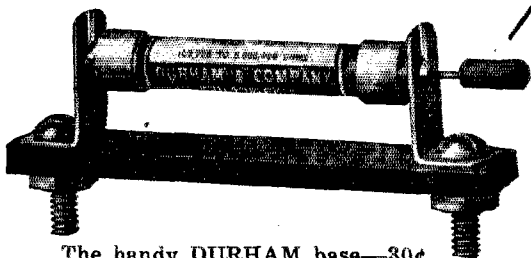

The handy DURHAM base—30¢

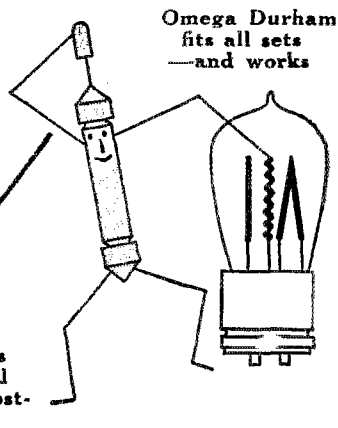

At dealers
or by mail
Add 5¢ postage

Durham Variables—75c

No. 100—1,000 ohms to 0.1 megohms
No. 101—0.1 megohm to 2 megohms
No. 201A—2 megohms to 10 megohms

Manufactured by

DURHAM & CO., Inc.

1936 Market St., Philadelphia

Dealers—The 40,000 or more readers of QST do real salesmen's work for you. Their recommendations carry weight. And they sure do boost DURHAMS.

The New

METALECTRIC SOLDERING IRON

Operates on any electric current with the simplicity and efficiency of a writing instrument.

Accepted as the logical solution to radio soldering problems by leading amateurs and manufacturers.

Ample heat capacity
Handle always comfortably cool
Renewable tips



An indestructible all-metal quality instrument with a worth-while guarantee.

If your dealer cannot supply you, order direct or write for descriptive circular. We will ship in exchange for remittance or by P.P. C.O.D.

Post Electric Co., Mrs. (Section Five) 38 E. 42nd STREET NEW YORK

Tested and Listed as Standard by Underwriter's Laboratories

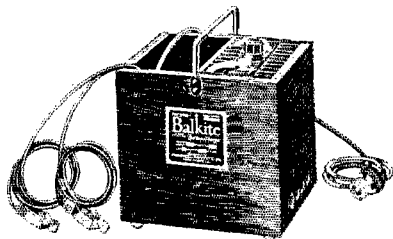

FANSTEEL Balkite PATENTS APPLIED FOR Battery Charger

NOISELESS and INDESTRUCTIBLE

A new battery charger for Radio "A" (6 volt) batteries. Entirely noiseless. Has no moving parts, requires no attention or adjustment, and cannot get out of order. No bulbs to break. Simple and unfailing in action. Can be used while the radio set is in operation. A positive economical charger for home use. Can also be used to charge "B" and automobile batteries. If your dealer can't supply you, sent direct on receipt of price. Money back guarantee.

Price \$19.50 (\$20 West)
of Rockies

Dept. Q4 Fansteel Products Co., Inc.
North Chicago, Illinois



"Products of
Proven Merit"

Amplification— Undistorted

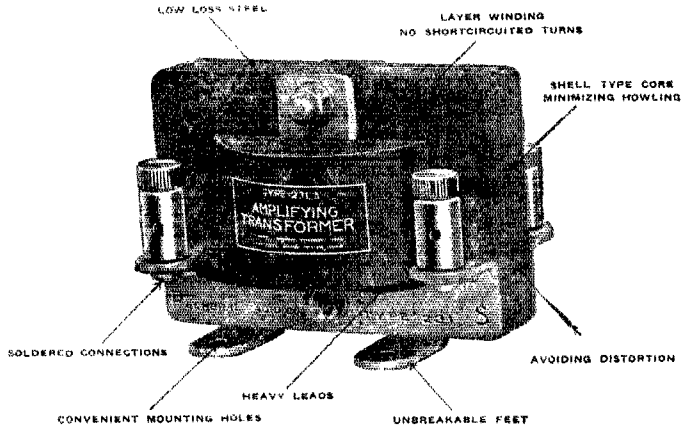

Type 231-A Audio F.A. Transformer

The efficiency of a broadcast receiver is often destroyed by poor amplification—due to inferior transformers.

In buying transformers be sure to look well into the electrical and mechanical features, as well as appearance and price.

The features which have gained the GENERAL RADIO CO. Type 231-A Transformer its enviable position as a leader among Transformers are:

Low loss steel used in its core construction.

Layer winding prevents short circuiting of turns.

Air gaps in core avoid distortion.

Unbreakable feet with convenient mounting holes, make installation easier.

Soldered connections eliminate losses from poor contacts.

Not only has this Transformer a high amplification factor but the amplification is nearly uniform throughout the entire audio range—making it **best for all stages**.

Turns Ratio 3.7 to 1. Impedance Ratio 10 to 1.

Carried in stock by all good radio dealers

Write **TODAY** for Instructive Folder—"Quality Amplification" and Bulletin 917Q

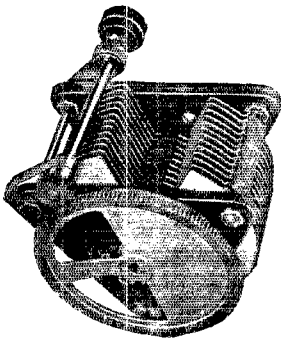

Type 247-H Condenser
Price \$5.00

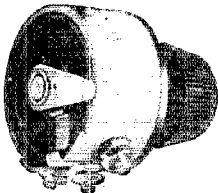

Type 301 Rheostat
Price \$1.25

GENERAL RADIO CO.

Manufacturers of
ELECTRICAL AND RADIO LABORATORY APPARATUS
MASSACHUSETTS AVE AND WINDSOR ST.

CAMBRIDGE,

MASSACHUSETTS

SIGNAL Radio Products

Originality of design. Electrically correct. Quality materials. Expert workmanship. All at a price which can't be beat. Is it any wonder the big majority buy Signal Radio Products.

Rheostats

	Vernier	Plain
6 ohms	\$1.30	\$1.00
15 ohms	1.30	1.00
25 ohms	1.30	1.00
40 ohms	1.30	1.00
400 ohms	Potentiometer	1.80

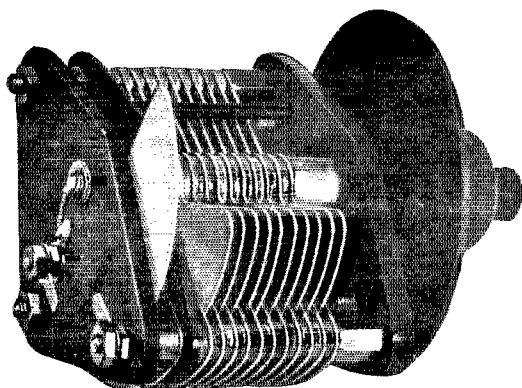
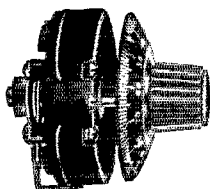

Vernier Variable Condensers

R 131—43 plate	\$4.50
R 132—21 "	4.20
R 133—11 "	3.90

Prices on Plain Condensers on request.

SIGNAL Electric Mfg. Co.

Factory and General Offices
1915 Broadway,
Menominee, Michigan

Boston, Chicago, Cleveland, Minneapolis, Montreal, New York, Pittsburgh,
St. Louis, San Francisco, Toronto, Philadelphia, Los Angeles
You'll find our local address in your Telephone Directory

THE TRIPLE-DUTY BATTERY CHARGER

The type A-B-F-F charger economically charges 2, 4 or 6 volt Radio "A" Battery, 6 volt auto Battery, and from 20 to 120 volts of "B" battery. Easy to operate. Fool-proof and simple. Built for safety and service. Charges a battery for about a nickel. The pioneer charger—a success for over ten years.

Type A-B-F-F Charger price \$20, West of the Rockies \$22; type G for "A" battery or auto battery charging \$16, west of the Rockies \$16; "B" battery charging attachment \$2.50 extra.

Write for New Bulletin containing data on battery maintenance, station calls, and wiring diagrams for basement installation of batteries. We will send nearest dealers name.

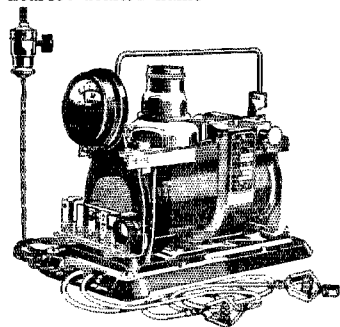

**The
France
Mfg. Co.,**

10431
Berea Rd.,
Cleveland, Ohio



Greater Volume

A Celoron Radio Panel helps you get the best results from your instruments. Its high dielectric strength gives your set greater volume. Celoron, a bakelite product, is approved by the U. S. Navy and Signal Corps, and used by leading radio set manufacturers.

Celoron panels comes in nine standard sizes, in black, mahogany or oak. Other sizes cut to order. Ask your dealer.

DIAMOND STATE FIBRE COMPANY
Bridgeport, Pennsylvania
Branches in Principal Cities
Toronto, Canada London, England

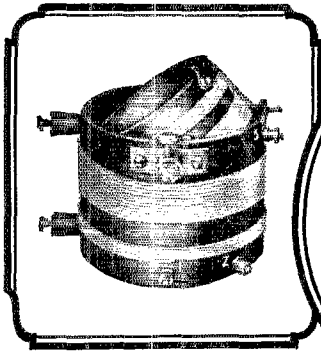

R-90—Oscillator Coupler, complete, with mounting brackets, bank wound inductances and adjustable coupling coil with locking device. It covers a band of wave lengths from 150 to 800 meters and generates the maximum amount of current . . . \$5.00

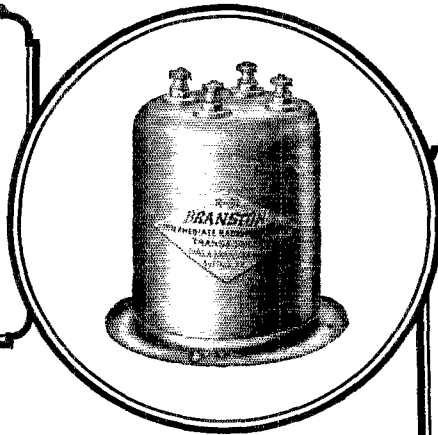

R-91—Intermediate Radio Frequency Transformer. Very sharply tuned and completely shielded \$6.50

R-92—Special Transfer Coupler for Last Stage of Intermediate Frequency. Very sharply tuned and completely shielded. . . . \$7.50

R-93—Specially Designed Coupler for Using Antenna. . . . \$4.50

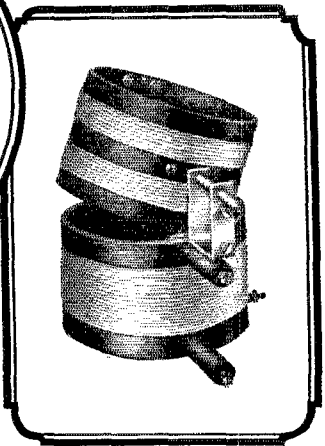

AT LAST! Intermediate Radio Frequency Transformers

YOU can construct a Super Heterodyne Receiver with the assurance that you will possess the "last word" in Radio Reception. You can log each station and later single it out again with the same dial setting. List your stations in phone book style. Musical reception of crystal clarity, loud speaker volume and minimum interference.

The Branston Special Transformer is not an adaption, it was specially designed for this specific purpose. Rigorous tests prove it greatly superior to anything available prior to this announcement.

Our publication "SUPER HETERODYNE CONSTRUCTION," makes it possible for the amateur to construct a complete and efficient Super Heterodyne Receiver.

PROMPT DELIVERY AT YOUR DEALER'S OR WRITE FOR DETAILED INFORMATION

CHAS. A. BRANSTON, Inc.

823 Main Street, Buffalo, N. Y.

MANUFACTURERS OF
Branston Violet Ray High
Frequency Generators

In Canada Chas. A. Branston, Ltd. Toronto, Ont.



Add Miles and Smiles with Branston Standard Radio Parts

OFFICIAL REPORT

ELECTRICAL TESTING LABORATORIES

80th Street and East End Avenue
New York City

proves the high efficiency and remarkably low phase angle loss of less than 1 minute and a voltage breakdown test of 8,000 volts on the

"FRESHMAN SELECTIVE" Variable Condenser

It is the only variable condenser the plates of which vary in area—an engineering feat never accomplished before—making it most efficient for fine adjustment and selective tuning.

For Transmission or Reception.

No Leakage
Absolutely Quiet

No Plate Vibration
Cannot Short Circuit

Chas. Freshman Co. Inc.
Radio Condenser Products

106 Seventh Avenue,

New York

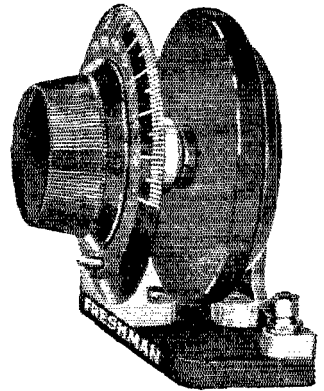

All Molded Parts and Dial
of the finest Bakelite

.0003 MF (Equiv. to 17 pl.) } \$5 ea.
.0005 MF (Equiv. to 23 pl.) }
.001 MF (Equiv. to 43 pl.) }

With 3" dial

With 4" dial 50¢ extra

At your dealer's, otherwise send purchase price and you will be supplied postpaid.

Ask your dealer or write direct for free diagrams of Neutrodyne, Reflex, Heterodyne and other popular circuit.

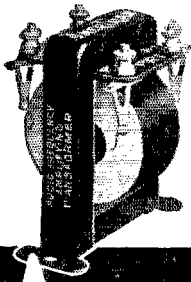

STANDARD
of
EXCELLENCE
for audio amplification
With all tubes
In all stages

AMERTRAN

TRADE MARK REG. U.S. PAT. OFF.

Improve your set with an AmerTran

When a band or orchestra is broadcasting, do you hear all the instruments in their balanced harmony?

Can you distinguish one speaker from another through his articulation and the tone of his voice?

If you have not used an AmerTran, perfect reproduction is as yet unknown to you. Type AF-6; turn ratio 5:1. Price \$7. At your Dealer's; or, sent carriage charges collect.

American Transformer Co.

Designers and builders of radio transformers for over 22 years.

176 Emmet Street, Newark, N. J.

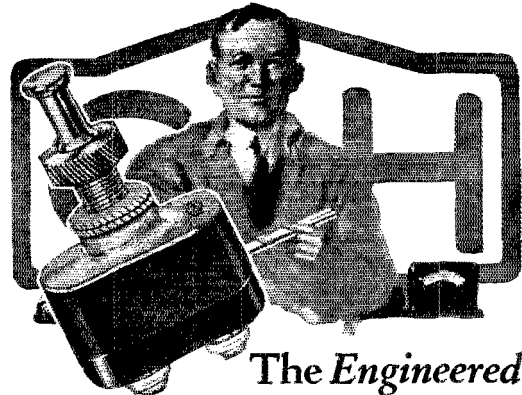

The Engineered Switch for Your Radio Panel

Within the dustproof fibre case of the radio switch by Cutler-Hammer, master builders of all control apparatus, is a mechanism that you can safely insert in your most delicate circuit without introducing microphonic noises. Its floating contactor is independent of the button—touching it or jarring the table will not produce noise in your phones. Sold by radio dealers everywhere. Insist on the genuine in the orange and blue box—the C-H trademark is your assurance of satisfaction.

THE CUTLER-HAMMER MFG. CO.

Member Radio Section, Associated Mfrs. of Electrical Supplies
MILWAUKEE, WISCONSIN

RADIO SWITCH

Introducing — A new Broadcast Receiver

Type RF-2, a receiving set of surpassing excellence is offered to the radio public.

Radio frequency amplification at its best is employed—a transformer-coupled tuned radio frequency circuit, with two stages of audio frequency amplification.

There are but two controls and tuning is extremely simple. Extraordinary sensitivity is combined with a high order of selectivity. Broadcast programs from far distant points are received with marked clarity and volume.

The assembly of instruments is encased in solid mahogany.

SEE IT! HEAR IT! COMPARE IT!

Ask your dealer

EISEMANN MAGNETO CORP.

William N. Shaw, President

— Thirty-Third Street, Brooklyn, N. Y.

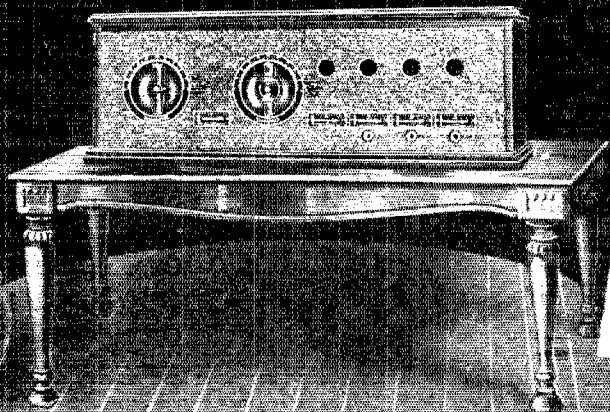

Type RF-2
PRICE
\$110.00

EISEMANN

HOMMEL SERVICE MAKES MORE PROFITS

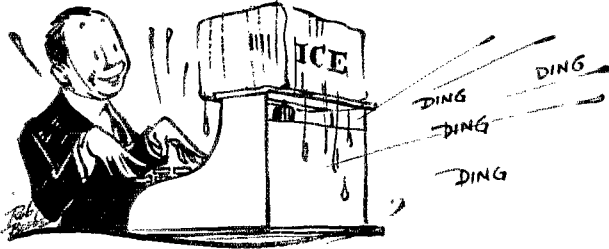

This company has been wholesale distributors of high grade electrical equipment for over 16 years and have built up an enviable reputation for dependability and service. The same principles responsible for their success in the electrical field have been applied to their activities in the radio field.

They wholesale exclusively,—they never compete with their dealers by retailing;—their discounts are fair and liberal;—they represent only the leading manufacturers of radio equipment;—they carry complete stocks of radio supplies insuring prompt deliveries and a dependable source of supply for the dealers. Dealers who align themselves with HOMMEL service enjoy a steady repeat business,—with satisfied customers—and that means more and better profits.

Let us send you complete facts—Encyclopedia No. 246T sent on request.

AMATEURS—Tell us what you are interested in—send us the name of your dealer and we will see that you are supplied promptly.

LUDWIG HOMMEL & CO

530-534 FERNANDO ST. — ZZZ — PITTSBURGH, PENNA

30 STATIONS IN ONE HOUR!

—heard with one Myers Tube (name and address furnished on request). The remarkable results being obtained are due to the elimination of socket with bunched leads. MYERS TUBES (practically unbreakable) add 50% to the efficiency of any set by reducing interference.



Half Size

See that you get the New Improved Myers Tubes. Others are not guaranteed. Insist on Myers—otherwise send price and be supplied postpaid. Two types: Dry Battery and Universal (for storage battery). Write for free circuit diagrams.

\$5 each, complete with mounting clips; no sockets or other equipment necessary.

F. B. Myers Co. Ltd.
Radio Vacuum Tubes

240 Craig St. W.
MONTREAL, CANADA



C. N. CRAPO, 9VD

The logical man for Central Division A.R.R.L. Director

He Deserves Your Vote

Proposed and Endorsed
by

**THE MILWAUKEE RADIO
AMATEURS' CLUB, INC.**

"RIGHT IN THE CENTER OF THINGS"

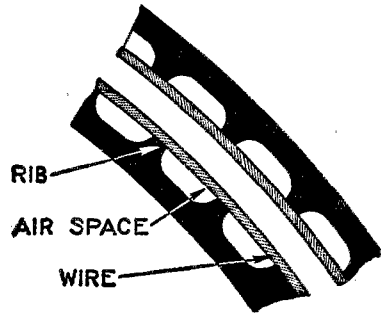
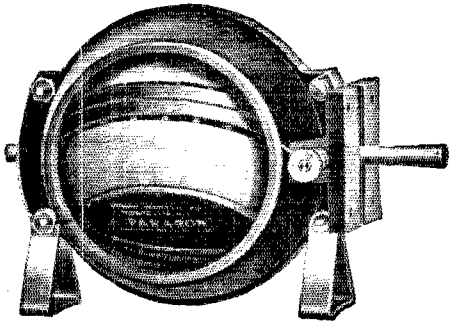

The Paragon Variometer No. 60

reduces dielectric losses to the minimum. It is the first variometer to combine coils surrounded by air with the mechanical strength necessary in such an instrument. It has no equal in the radio field.

Both stator and rotor forms are of polished black, moulded Condensite, each having 24 narrow raised ribs upon which windings are supported, thus practically surrounding them with air. This design, the result of eight years' experience, meets the rigid electrical requirements of Paragon Receivers and fulfills the high mechanical standards of Paragon parts. Price \$5.00.

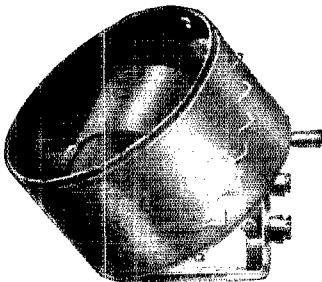

Paragon Variocoupler No. 65

The ultimate in Variocouplers. Coils of double-silk covered wire wound on moulded, black Condensite tubes with highly polished finish. Only multiple turn taps are brought out in the primary. Single turn taps and switch for same are unnecessary. Is simple to operate and insures better reception. Price \$3.50.

Write for Illustrated Catalog of Paragon Radio Parts

ADAMS-MORGAN CO., 4 Alvin Avenue, Upper Montclair, N. J.

PARAGON

Reg. U. S. Pat. Off.

RADIO PRODUCTS



PATTERN No. 95

RADIO TEST SET

- ¶ This radio test set has been designed to meet the demands coming to us from serious experimenters, manufacturers and dealers in radio equipment and supplies, for a complete radio testing outfit.
- ¶ While the various ranges of readings permit making practically every test necessary in connection with radio receiving sets, it has been particularly designed for the taking of characteristic curves on vacuum tubes, the only extra equipment required being the batteries.
- ¶ The several instruments, any of which may be used independently, include a 0-1.2 filament ammeter, a 0-6 filament voltmeter, a 0-120 plate voltmeter, a 0-10 plate milliammeter, and a 10-0-10 grid voltmeter.

Complete With Instructions

Price, \$75.00

Send for Circular

ORDER FROM DEALER

**JEWELL ELECTRICAL
INSTRUMENT CO.**
1650 WALNUT ST.
CHICAGO

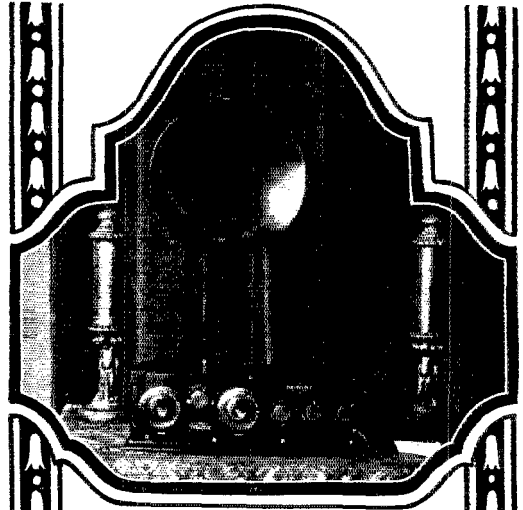

WL
Radiodyne
CL

"The Voice of the Nation"

No Loops—No Aerial

The air is your theatre, college, church and newspaper if you own a Radiodyne. New York, Cuba, San Francisco and Honolulu can be picked up clear and distinct without interference from nearby stations.

The RADIODYNE is ready for operation by simply grounding to a water pipe or radiator, and throwing a few feet of wire on the floor. Uses any standard tubes—dry cell or storage battery. Extremely selective. Simple to operate—**Only two controls**—You can tune in on any program you select—any wavelength from 200 to 700 meters.

For use in apartments, boats, automobiles, railroad trains, etc., the RADIODYNE is enjoyable where other receiving sets would not be practical.

Price \$150.00

Write for illustrated folder which describes the RADIODYNE in detail. Every radio fan will be interested in this new type (antennaless) receiving set.

Just drop us a line and we will see that your inquiry gets prompt attention

Western Coil & Electrical Company
305 5th St., Racine, Wisconsin

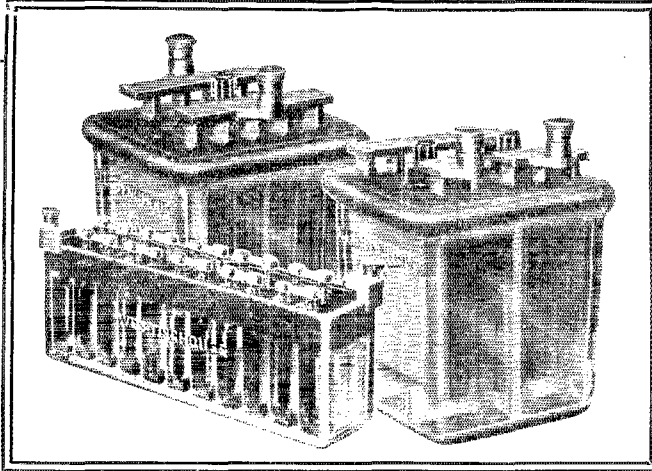

MAIL COUPON
for interesting facts
about batteries

WHEN Westinghouse places an article on the market you can depend on it for highest efficiency. Westinghouse Radio Batteries are made with the most careful consideration of every factor that enters radio broadcast transmission and reception. Built for full-powered and even-powered current delivery; for long sustained voltage; for ample capacity; for utmost quiet; for long life; for economy. Nothing but the very best is good enough in the construction or equipment of an instrument so sensitive as a radio set. Don't be satisfied with anything less than Westinghouse Radio Batteries.

Westinghouse **CRYSTAL CASE** Radio Batteries have one-piece clear glass cases. Solid glass cell partitions and high glass plate rests. Thoroughly insulated against current leakage. They hold their charge long. Last indefinitely and can be easily recharged innumerable times. "A" Batteries in 2, 4 and 6 volt sizes. "B" Batteries in 22-volt units. Regular type 22-MG-2; quadruple capacity 22-LG-2. "C" Batteries in 6-volt units.

WESTINGHOUSE UNION BATTERY CO.
Swissvale, Pa.

WESTINGHOUSE

RADIO "A," "B" and "C" BATTERIES

Westinghouse Union Battery Co.
Swissvale, Pa.
Send me Westinghouse Radio Battery
Folder A-3-D.

.....
.....
.....

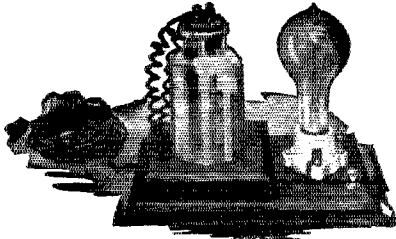

Mounted Charger

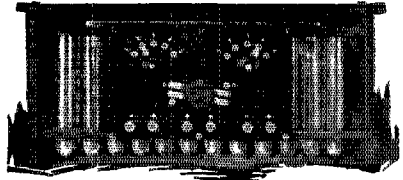

100 Volt Panel Type

"I've found KIC-O "B" batteries the most satisfactory."

A prominent New York engineer said the above. KIC-O batteries make good with professionals and novices. Alkaline type; won't sulphate or buckle. Life unlimited. Not harmed by short-circuiting, over-charging, idleness. Panel switches give single cell variations. Recharge from any 110-volt A.C. line with small home rectifier. Charge lasts 3 to 6 months in detector plate circuit.

GUARANTEE

Your money back on any KIC-O Battery if not satisfied within 30 days. Write for full information on "A" and "B" Batteries.

Unmounted Rectifier.....\$1.00
 Mounted Rectifier..... 2.50

KIMLEY ELECTRIC COMPANY, Inc.
 2666 Main Street, Buffalo, N. Y.

K I C - O Storage "B" Batteries—
 long service, low cost

Volts	Price Plain	With Panels
22	\$5.50	
32	7.25	\$11.75
48	9.50	14.00
68	12.50	17.00
100	17.50	22.50
145	23.50	28.50

ARE YOU A 1923 MAN ?

IF YOU ARE—GET OUT OF THE RUT

Radio has improved with leaps and bounds since last year—to be a 1923 man is to be satisfied with last year's results—Broadcasting and CW will accomplish wonderful results this Fall and Winter and for you to share in these coming successes—both receiving and transmitting—you need a good set, made from the latest and most improved parts.

ROSE RADIO HAS IT ! !

(and I don't mean maybe)

ROSE RADIO AND ELECTRICAL SUPPLIES

129 CAMP STREET,

NEW ORLEANS, LA.

AMATEUR LICENSE

Why not go up for an amateur license? Demonstrate your ability as a first class experimenter. Stand head and shoulders over the crowd by qualifying for an amateur license.

Our short course teaches you to read the code, draw diagrams and understand the theory and practice of Radio.

Special course for amateurs.
 Send for further information.

Y.M.C.A. RADIO SCHOOL

152 E. 86th St. New York City
 Tel. Lenox 6051

**FROST-RADIO
 Catalog and
 Instruction Book**

THIS new booklet on the care and operation of **FROST-FONES** and **FROST-RADIO** is now ready. Contains 36 pages of valuable information on radio apparatus. Your copy mailed free on request.

Address Dept. 11F62

Herbert H. Frost, Inc.
 154 West Lake Street
 CHICAGO, ILLINOIS



FREE!

A post card from you will bring this 40-page catalog.



You shall be Sole Judge

A Most Unusual Offer

TEST N & K Phones on your radio set alongside *any other phones made*. If the N & K Phones do not reproduce both high and low tones more perfectly, if they do not give a clearer, more mellow tone, if they do not fit more comfortably on the head, send them back to the store within three days, and your money will be promptly refunded. No obligation whatsoever will be incurred. *You shall be the sole judge.* The N & K Head Set, Model D, 4000 ohms, is the imported head set that the radio "fans" are all talking about. Larger diaphragms. Nickeled brass sound chamber. Leather covered bands. \$8.50 at leading stores. Ask for descriptive folder.

THE GOLDSCHMIDT CORP., 15 WILLIAM STREET, DEPT. Q4 NEW YORK

Any of the stores listed below or any other store displaying this advertisement will send you an N & K Head Set to make this trial.

- Arhol, Mass. M. Steiner & Sons Co.
- Atlanta Hochschild, Kohn & Co.
- Baltimore Little Joe Winesapfeld Co.
- Bangor, Me. Joel Gutman & Co.
- Boston Jones Electric Radio Co.
- Bridgeport M. Steiner & Sons Co.
- Brooklyn A. P. Merchant Co.
- Chicago United Cigar Store
- Cleveland Iver Johnson Sporting Goods Co.
- Colorado Springs M. Steiner & Sons Co.
- Detroit Abraham & Straus
- Des Moines Frieserick Loewer & Co.
- Detroit H. Lesser & Co.
- East Orange, N. J. Kautzman Co., Inc.
- Elmire The Anderson Piano Co.
- Elmire Parks & Fisher Stores Co.
- Full River Younger Brothers
- Fitchburg J. L. Hudson Co.
- Harrisburg Crowley, Miller Co.
- Hartford Detroit Electric Co.
- Houston United Cigar Store
- Indianapolis Barker, Ross & Clinton Co.
- Jamaica, L. I. M. Steiner & Sons Co.
- Johnstown M. Steiner & Sons Co.
- Kansas City Pomeroy's Inc.
- Los Angeles Sage, Allen & Co.
- Lowell W. C. Munn Co.
- Memphis Alamo Sales Corp.
- Minneapolis Babert Electric Co.
- Newark, N. J. Royal Eastern Electric Supply Co.
- New Haven United Cigar Store
- New Orleans Penn Traffic Co.
- New York City The Schmeier Co.
- Long Island City Western Radio Corp.
- Los Angeles J. W. Jenkins Sons
- Lowell Royal Eastern Electric Supply Co.
- Memphis Hamberger's
- Minneapolis M. Steiner & Sons Co.
- Newark, N. J. Bon Marche D. G. Co.
- New Haven Rev. Brock Mercantile Co.
- New Orleans J. Goldsmith & Sons
- Philadelphia Gimbel Brothers
- Pittsburgh E. S. Donaldson Co.
- Pittsburgh L. Hamberger & Co.
- Pittsburgh Edward Malley Co.
- Pittsburgh M. Steiner & Sons Co.
- Pittsburgh D. H. Holmes Co.
- Pittsburgh Davaga (11 stores)
- Pittsburgh Gimbel Brothers
- Pittsburgh John Wansmaker
- Pittsburgh Harber & Huesgen Co.
- Pittsburgh United Cigar Stores (10 stores)
- Pittsburgh David Killoch Co.
- Pittsburgh Royal Eastern Elec. Supply Co.
- Pittsburgh J. L. Lewis, Inc.
- Pittsburgh Hanes-Zener Co.
- Pittsburgh Haynes-Griffin Radio Service, Inc.
- Pittsburgh J. W. Jenkins Sons
- Pittsburgh Music Co.
- Pittsburgh Oakford Music Co.
- Pittsburgh Richard M. Silas
- Pittsburgh Davidson Radio Co.
- Pittsburgh M. Steiner & Sons Co.
- Pittsburgh Block & Kuhl Co.
- Pittsburgh Gimbel Brothers
- Pittsburgh John Wansmaker
- Pittsburgh Lit Brothers
- Pittsburgh N. Snellenburg & Co.
- Pittsburgh Boggs & Buhl
- Pittsburgh Kaufman & Barr Co.
- Pittsburgh Ludwig Hommel & Co.
- Pittsburgh Holden & Stone Co.
- Pittsburgh M. Steiner & Sons Co.
- Pittsburgh Davidson Bros. Co.
- Pittsburgh Radio Exchange Co.
- Pittsburgh M. Steiner & Sons Co.
- Pittsburgh E. Amous & Barr Co.
- Pittsburgh Van-Ash Radio Co.
- Pittsburgh Pioneer Electric Co.
- Pittsburgh Alexander Grant's Sons
- Pittsburgh J. W. Jenkins Sons
- Pittsburgh Music Co.
- Pittsburgh Woodward & Lothrop
- Pittsburgh M. Steiner & Sons Co.
- Pittsburgh M. Steiner & Sons Co.

Dealers: We authorize you to refund the price of any N & K Head Set returned under the conditions named in this ad. We will exchange or replace any sets that come back to you.

When you buy Federal Radio Parts

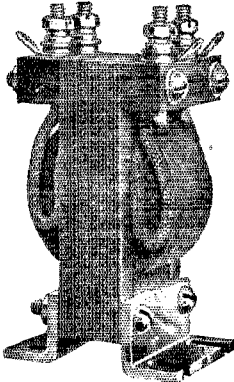

The now famous No. 65 Audio Frequency Transformer is but one of over 130 radio parts designed, manufactured and guaranteed by Federal.

\$7.00

Federal Telephone and Telegraph Company

Factory: Buffalo, N. Y.

Boston New York
Bridgeburg, Canada

Philadelphia

Chicago

San Francisco

Pittsburgh
London, England

you are purchasing

the perfected result of over a quarter century of research and experimentation,

an iron-clad performance guarantee of an organization which has reached leadership through its willingness and ability to fulfil both the letter and the *spirit* of its obligations,

the satisfaction that the part or set is built for *permanency* of performance as well as for today's gripping thrills.

Thus the 130 radio parts, designed, manufactured and guaranteed by Federal offer every possible advantage and safeguard to those who want the joys of home assembly.

NA-ALD

De Luxe Socket



De Luxe Contact

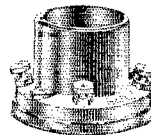

Na-ald DeLuxe No. 400

The laminated phosphor bronze contacts of the Na-ald De Luxe Socket press firmly on both the ends and sides of tube prongs, keeping the surface clean and insuring clear reception.

Moulded of genuine Bakelite this socket expresses the very highest quality in appearance and workmanship.

ALDEN MANUFACTURING CO.
Largest Makers of Radio Sockets and Dials in the world.

Springfield, Mass.
Dept.M 52 Willow St.



TRADE MARK

AUDIOPHONE

REG. U. S. PAT. OFFICE

LOUD SPEAKER

A REAL REPRODUCER
OF THE ORIGINAL BROADCASTING

It is easy to listen to the reproductions made by the Audiophone because they are so perfect. The speech, the songs, and instrumental music are not blurred or disguised by mechanical distortions. You will get all the fine shadings and every inflection. In fact, the very personality of the artist seems to be present as you listen.

Senior Audiophone Price \$32.50

Baby Audiophone Price 12.50

Juior Audiophone Price 22.50

Write for copy of Bulletin AX-3012

THE BRISTOL COMPANY
WATERBURY, CONN.

TELEGRAPH INSTRUMENTS

DANDY MORSE
LEARNER'S OUTFIT

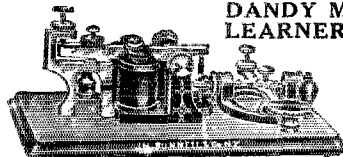

One dry cell is all that is required to operate this instrument. Made by the best Telegraph Instrument Makers in the World. Other types carried in stock. Send stamp for Telegraph Manual No. 43Q.

Instrument only \$5.00

With dry battery 5.50

Special Price to Dealers

Send stamp for new and complete No. 29 General catalogue, just off the press.
J. H. BUNNELL & CO. 32 Park Place, N. Y.

Don't annoy your neighbor

*How to avoid interfering
with the broadcast listener*

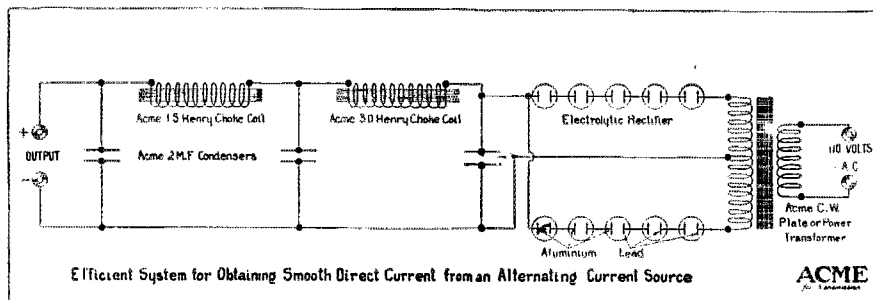

*Follow this diagram and you can make an
efficient filter for your set*

IN most cases where a complaint has been entered by a broadcast listener against an amateur using a straight C.W. transmitter, it has been found that the trouble has been due to an inefficient filter system. This interference is caused by a sixty cycle or motor-generator commutator frequency modulating the output.

The Acme Apparatus Company has always been interested in the amateur and offers this filter as a solution to the adverse criticism directed against him.

We do not say that the other filters will not work, but we have found the one shown above to be economically efficient.

The connection for an electrolytic rectifier is also shown. It is essential that the rectifier have sufficient jars, (1 per 75 volts) be properly formed, and be kept clean at all times. Use pure materials.

If tube rectifiers are used the same diagram may be used, substituting one rectifying tube for each series of jars. Acme Apparatus Co., Cambridge, Mass.

Send to Dept. 37 for Bulletin T on transmitting apparatus

Specifications of Acme Choke Coils

Henries	Current	Type	Prices	Henries	Current	Type	Prices
1½	.150	Single	\$4.00	6	.200	Single	\$14.00
1½	.150	Double	6.00	6	.600	Single	18.00
1½	.500	Single	6.00	30	.150	Single	18.00
1½	.500	Double	8.00	30	.300	Single	25.00
6	.150	Single	10.00	30	.600	Single	33.00

ACME

for transmission



Highest acoustical efficiency at moderate price

MMURDOCK Radio Phones represent the highest acoustical efficiency. For 20 years they have been the choice of research radio engineers and discriminating amateurs. Powerful magnets build up volume signals—and sensitive, perfectly adjusted diaphragms turn these into clear, natural tones, with all the vital beauty of the original voice and music.

Built, not assembled

MMURDOCKS are made in a single unit, of superior moulded insulation. Each part is fitted by one process into its proper place—and they are moulded together. This assures firmness, strength and durability. The parts can't get out of adjustment.

Why pay more?

QUANTITY manufacture has standardized the price at what a high grade 'phone should sell for. Get a Murdock today and test it out. They are fully guaranteed.

SEND FOR FREE BOOKLET

"The Ears of Radio". Tells the importance of headphones to efficient radio reception.

WM. J. MURDOCK COMPANY
343 Washington Ave. Chelsea, Mass.
Branch Offices: Chicago and San Francisco
Murdock Multiple Plug Jacks, for one to four 'phones—\$1.

Standard
Since
1904

GIVE YOUR SET A BETTER CHANCE
TO MAKE GOOD

MARCO
RADIO
PRODUCTS

Use
the MAR-CO

MARCO
RADIO
PRODUCTS

DOUBLE STA-PUT PHONE PLUG

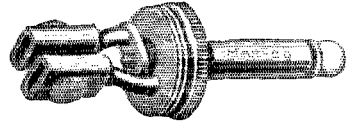

Most recent among Mar-Co improved radio devices, the Double Sta-Put Plug is unequalled for convenience and efficiency.

Oval binding posts permit use of one or two headsets, regardless of differences in size of terminal tips. Instant connection or disconnection, without tools. Has protecting sleeve (not shown in cut).

Price (in U. S. A.)50c
Try one today!

For more detailed information about this and other

MAR-CO PLUGS
Write for Folders
Address Dept. R-8

MARTIN-COPELAND CO.
PROVIDENCE, R. I., U.S.A.
ESTABLISHED 1880.

RADIO TUBE EXCHANGE

We Repair All Standard Makes of Tubes, Including

W.D. 11 or 12
U.V. 199 or C299
C. 11 or 12
U.V. 201A or C. 301A
D.V. 1 or D.V. 2
U.V. 200 or 201
C. 300 or 301

\$2.50



All tubes guaranteed to do the work.
RADIO TUBE EXCHANGE, 200 B'way, N. Y.
All Mail Orders Given Prompt Attention.
Orders Sent Parcel Post C. O. D.

CATALOG L-25-148 PAGES FREE

Latest Reflex Neurodyne and Super-Heterodyne Circuits. 40 Diagrams, latest Hook-ups. Largest Complete Stock.



SPECIAL American Reflex
Crystal, 35c ea. Hot as Hot, Every Spot. Hear stations clearly.
GUARANTEED ONE YEAR
Jobbers and Dealers write for Quantity Discounts.

AMERICAN RADIO MFG. CO.
WHOLESALE DISTRIBUTORS
Dept. T 6 WEST 14TH ST. KANSAS CITY, MO.

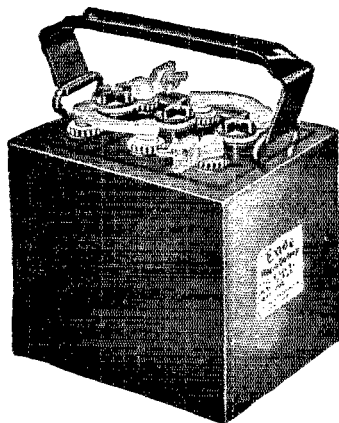

“A” Battery for
six-volt tubes

When is a battery *cheap*?

A BATTERY that allows your soloist to be accompanied by a noise like a thunderstorm is never a cheap battery; because it's certain that you will be dissatisfied and soon supplant it with a good battery.

Obviously, a battery that does not last long is not a cheap battery.

The battery that is really cheap is the one that gives perfect service and gives it a long time; one that does not have to be recharged too frequently—a silent, long-lasting battery, steady and dependable.

Because they give such good service and such long service, you will find Exide Radio Batteries cheap in the true sense of the word. They may cost you more than some to start with, but long life and freedom from repairs make the last cost low. And the added enjoyment you get from your set, through clarity and lack of needless bother, will be priceless.

In replacing a worn-out battery or when buying a new set, be good to yourself and get an Exide.

Complete line of Exides for radio

There is a complete line of Exide Radio Batteries—batteries that give uniform filament current over a long period of discharge.

Apart from the 12-cell “B” battery there are three “A” batteries for whatever type tube you use. The Exide for 6-volt tubes

gives full-powered, ungrudging service. It has extra-heavy plates and requires only occasional recharging. It comes in four sizes, of 25, 50, 100 and 150 ampere hours capacity.

The Exides for low-voltage tubes are midgets in size but giants in power. The 2-volt battery weighs only five pounds, has a single cell, and will heat the filament of WD-11 or other quarter-ampere tube for approximately 96 hours. The 4-volt “A” battery has 2 cells and will light the filament of UV-199 tube for 200 hours.

The dominant battery

On sea and on land the Exide plays an important role in the industrial life of the nation. In marine radio, Exide Batteries provide an indispensable store of emergency current. A majority of all government and commercial radio plants are equipped with Exides.

Exide Radio Batteries are sold by radio dealers and Exide Service Stations everywhere. Ask your dealer for booklets describing in detail the complete line of Exide Radio Batteries. Or write direct to us.

Exide

RADIO BATTERIES

THE ELECTRIC STORAGE BATTERY COMPANY, PHILADELPHIA

In Canada, Exide Batteries of Canada, Limited, 133-157 Dufferin Street, Toronto

To Our Readers Who Are Not A.R.R.L. Members

Wouldn't you like to become a member of the American Radio Relay League? We need you in this big organization of radio amateurs, the only national amateur association that does things. From your reading of *QST* you have gained a knowledge of the nature of the League and what it does, and you have read of its purposes as set forth on page 6 of every issue. We would like to have you become a full-fledged member and add your strength to ours in the things we are undertaking for Amateur Radio, and incidentally you will have the membership edition of *QST* delivered at your door each month. A convenient application form is printed below—clip it out and mail it today.

.....1924

American Radio Relay League,
Hartford, Conn.

Being genuinely interested in Amateur Radio, I hereby apply for membership in the American Radio Relay League, and enclose \$2 in payment for one year's dues. This entitles me to receive *QST* for the same period. Please begin my subscription with the.....issue. Mail my Certificate of Membership and send *QST* to the following name and address.

.....
.....
.....

Station call, if any.....

Grade operator's license, if any.....

Radio Clubs of which a member.....

Do you know a friend who is also interested in Amateur Radio, whose name you might give us so we may write to him too about the League?.....

.....Thanks.

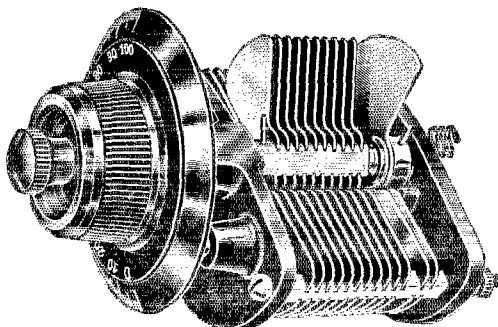

SEXTON CONDENSERS Double Knob Vernier

Most Compact Vernier Condenser Built. Furnished with 3 inch Black Bakelite Dial. Separate Button for Vernier Control. Ball Thrust Bearing Insures Perfect Action.

Also Made in Balanced Types with Half-Capacity Switch

Write for literature and name of nearest distributor.

The Hartford Instrument Co.
308 Pearl St., Hartford, Conn.

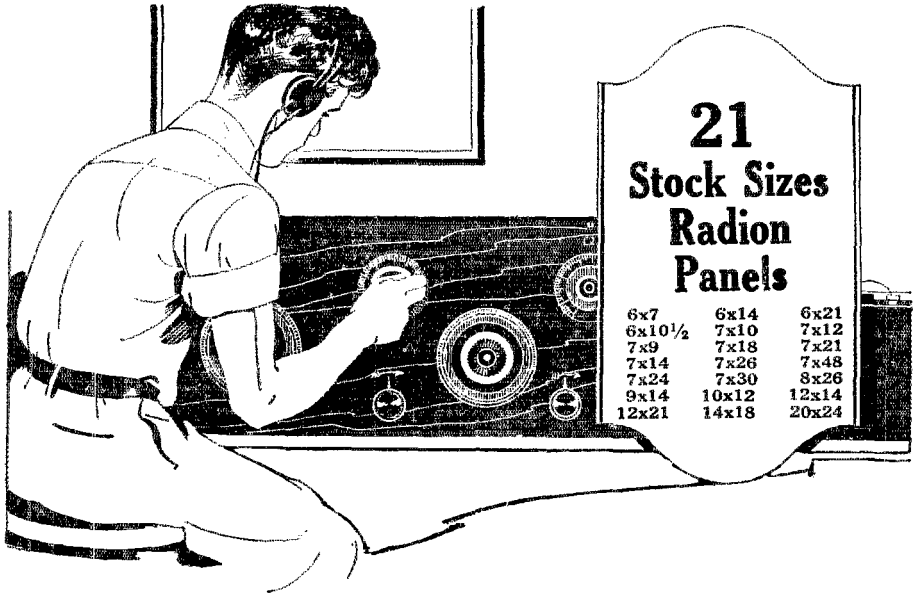

**21
Stock Sizes
Radion
Panels**

6x7	6x14	6x21
6x10½	7x10	7x12
7x9	7x18	7x21
7x14	7x26	7x48
7x24	7x30	8x26
9x14	10x12	12x14
12x21	14x18	20x24

***Eliminate Short Circuits
and Distortion***

Any panel material which will absorb moisture is apt to cause short circuits and distortion. Radion Panels are impervious to moisture. They eliminate most of the leaks of radio frequency currents where other materials fail.

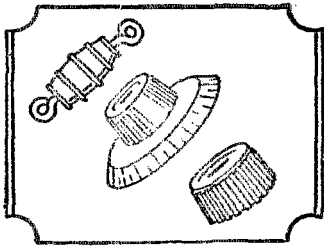

Your dealer carries a stock of Mahoganite or Black Radion Panels, Dials and Knobs. Experienced amateurs and professionals, too, demand genuine RADION. Try it and you will notice the difference.



Look for this stamp on every genuine RADION Panel. Beware of substitutes and imitations.

RADION
The Supreme Insulation
PANELS

AMERICAN HARD RUBBER CO., 11 Mercer St., N. Y.

As You Gaze at the Stars

The gentle calm of a bright starry night fills us with mystery. Little did we dream a while back that today, far and wide in the unknown, thousands of voices, hurried by electrical energy, are rushing at unheard of speed through space to all points of the compass.

A person here, a group there—in fact, in a million or more homes people are anxiously tuning in on their radios, groping in the air, hoping to catch the sound of a far away station. Scarcely a sound, a slight turn, a faint noise, another adjustment and then clear and clearer comes voices, a quartet is singing; so clear and distinct comes the soft gentle melody that the listeners close their eyes, the singers seem to be in the very room with them.

If you desire clearer reception, greater volume and the elimination of howling and distortions, install Jefferson transformers in your set.

There's a Jefferson Transformer for every circuit.

Write for amplification data and interesting descriptive literature.

Jefferson Electric Mfg. Co.
425 So. Green St. Chicago, Ill.

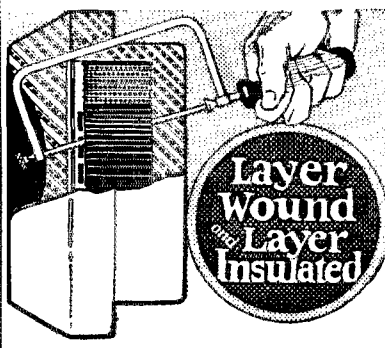
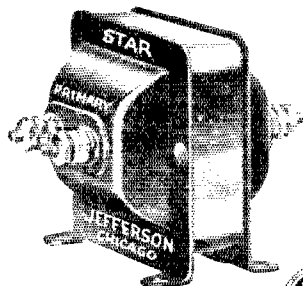

A cross-section cut through a receiver of the Stromberg-Carlson Radio Head Set reveals the layer wound and layer insulated coils. Stromberg-Carlson coils are wound a layer at a time with a wrapping of tough insulating material between layers, and are used exclusively in

Stromberg-Carlson

Radio Head Sets

This high grade coil construction combined with powerful magnets ensures permanent sensitivity, fine tonal quality, and enables these Head Sets to stand up under the high plate voltages now prevalent. Our 80 years' experience is your warrant of quality and service. Send for booklet 1029 QST, which tells more about these superior Head Sets.

Sold by dealers everywhere
Stromberg-Carlson
Telephone Mfg. Co.

1060 University Ave. Rochester, N. Y.

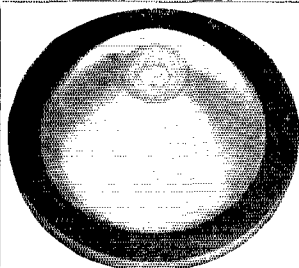

PYREX
LEAD-IN
INSULATOR

\$3.75
Complete

Prepaid to anywhere in U. S.
P. F. BECHBERGER & CO.
NORWALK, OHIO



When phonographs were first made they were square boxes without ornamentation. Likewise the first dials, turned out in a laboratory,—had hard straight lines for shape. Beauty is a later development. Na-ald dials have soft, graceful lines which makes them very pleasing to the eye. They lead in both beauty and quality. They have the right grip for delicate, exact tuning.

ALDEN MANUFACTURING CO.
Largest makers of Radio
Sockets and Dials in the world
Springfield, Mass
Dept. M 52 Willow St.

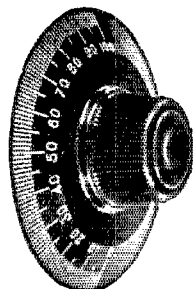

3 inch
No. 3003—4
35c, 3 for \$1.00



Super-service

Wide-awake radio fans prepare for clear reception of all programs by keeping the storage battery full-powered with the Tungar. For super-service the Tungar is used to recharge both radio and auto batteries. The result is longer battery life and more "pep"—plus convenience.

In homes with electricity Tungar recharges the run-down radio or auto battery overnight at a saving. Sold by Electrical, Auto-accessory and Radio dealers.



Tungar is one of the many scientific achievements contributed by the G-E Research Laboratories toward the wonderful development of electricity in America.

Tungar Battery Charger operates on Alternating Current. Prices, east of the Rockies (60 cycle Outfits)—2 ampere complete, \$18.00; 5 ampere complete, \$28.00. Special attachment for charging 12 or 24 cell "B" Storage Battery \$4.00. Special attachment for charging 2 or 4 volt "A" Storage Battery \$1.25. Both attachments fit either Tungar.



Tungar

REG. U.S. PAT. OFF.

BATTERY CHARGER

Tungar—a registered trade mark—is found only on the genuine. Look for it on the name plate.

Merchandise Department
General Electric Company
Bridgeport, Connecticut

GENERAL ELECTRIC

48E-0

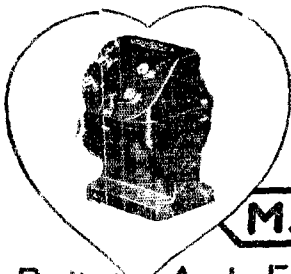

Radio & Audio Frequency TRANSFORMERS

"The Heart of a Good Receiver"

EQUAL to the widest range of reception requirements. *Marle Transformers* amplify the weakest broadcasting over frequencies all the way up to 3500 cycles without variation. Perfect tone quality. Utter absence of howling or distortion. To get the most out of radio—use *Marle Transformers*.

Specially adapted to the latest circuits, the SUPERDYNE, SUPER-HETERODYNE, FOUR-CIRCUIT TUNER, NEUTRODYNE, INVERSE DUPLEX and any circuit that makes high requirements of a transformer.

Type A9
Shelltype
Ratio 5 to 1
Audio F.
\$8.00

Type A4
Ratio 3½ to 1
Audio F.
\$3.75

Type A6
Ratio 5 to 1
Audio F.
\$4.25

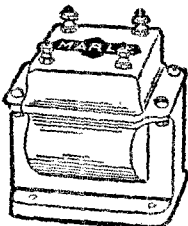

Audio F
Type A7
Ratio 3½ to 1
\$4.50

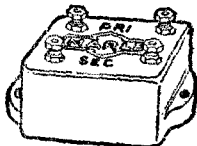

Radio F
Types
R1 and R2
\$4.00

MARLE
Engineering
Company
Orange,
New Jersey

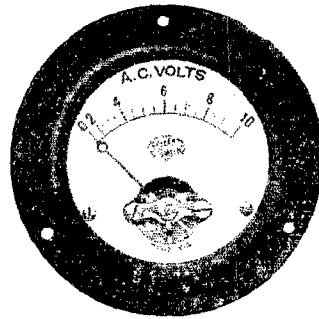

YOU
A.
R.
R.
L.
FELLOWS

know that it doesn't pay to buy cheap stuff. Roller-Smith 3½" Ammeters, Voltmeters and antenna Ammeters are not cheap, neither are they expensive. The prices are *right* and so are the instruments.

Send for Bulletin No. AG-10, pick out what you need and ask us to quote you. We'll treat you right—we're radio fans ourselves.

ROLLER-SMITH COMPANY

16 Park Place,

NEW YORK

Offices in principal cities in U.S. and Canada

RUSONITE

RADIO CRYSTAL

Entire Surface Sensitive
The Recognized Standard Crystal Rectifier

Used all Over The World

Hundreds of Thousands of Satisfied Users. Rusonite Has Revolutionized Crystal Radio Reception.

"THE PERFECT SYNTHETIC CRYSTAL"

Guaranteed, Price mounted 50c
RUSONITE CATWHISKER 14K. GOLD
Supersensitive; will not oxidize, Price 25c

Order from your dealer or direct from

Rusonite Products Corporation
15 Park Row, New York, N. Y.



RADIO "B" BATTERIES
At Factory Prices

Greatest radio "B" battery on market. Full number voltage taps; **QUALITY GUARANTEED; LOWEST PRICES;** brings in concerts **LOUDER AND STRONGER;** will work on any tube or loud speaker. Order by number **TODAY** with check, money order or pay postman C. O. D.
No. 222B 22½ volt variable, regularly \$2.25.. \$1.52
No. 222A 22½ volt variable, regularly 3.00.. 1.85
No. 245A 45 volt, 5 taps, regularly 5.50.. 3.25

AYRES BATTERY CORPORATION. Cincinnati, Oh io

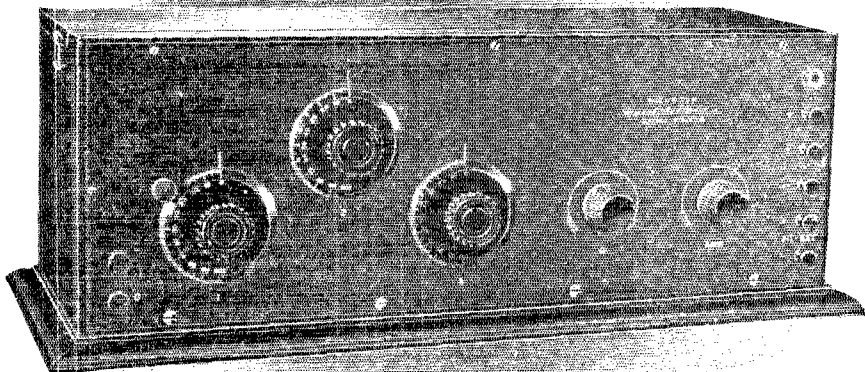

TUNE IN ON THE SHORT WAVE TRANSATLANTIC MESSAGES

If you are having trouble getting the short wave trans-atlantic signals you should have a WC-5-SW receiving set. It is the most practical set for low-wave specialists. Built by short wave experts the WC-5-SW eliminates the trouble which transmitting amateurs are having with ordinary receiving sets. If you are interested in getting better low wave results it will be to your advantage to investigate the WC-5-SW. Enthusiastic operators from all parts of the country write us praising its efficiency.

WC-5-SW

Built especially for Transmitting Amateurs

The WC-5-SW is a 4 tube set. One stage of tuned Radio Frequency amplification is employed ahead of the detector to make it super-sensitive. Two stages of audio frequency are used to bring up the signal strength. Uses any type of tubes. Gives perfect control of audibility. Detector rectifies only. Uses antenna compensating condenser. Only two control adjustments. Pure negative biasing on all tubes. thus marked saving on B Battery cur-

rent. Tuned Radio Frequency sharpest known and most selective principle ever adopted. Plate potential non-critical. Mono-block tube socket. No grid plate leads on audio amplifiers. Audio amplification absolutely necessary when using low efficiency receiving antenna, i.e., underground or indoor. Mahogany cabinet, piano rub finish. Rabbited-in panel, Split lid cover. The price is only \$85.00.

Write for complete description and illustrated folder on this practical set for low wave specialists. All transmitting amateurs will be interested in this literature.

OTT RADIO, Inc.

224 Main Street

La Crosse, Wis.

OTT

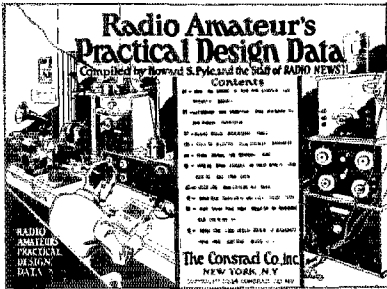

Get Acquainted with your station

Don't be one of those irresponsible fellows who merely hook-up a set and trust to luck that it is going to work efficiently. Make sure that you are familiar with the values of your apparatus by intelligent measurement of each individual part, circuit, etc.

Radio Amateur's Practical Design Data

This new Conrad Packet has been especially compiled by Howard S. Pyle (U. S. Asst. Radio Inspector) and the staff of RADIO NEWS to give the amateur the most valuable data that will enable him to understand the design of his apparatus i.e.: Measurement of Capacity (Substitution method). Measurement of Inductance of a coil or circuit (Two methods). Measurement of Distributed capacity of an inductance. Measurement of Fundamental wavelengths of Antenna (Three methods). Measurement of Wavelength of distant transmitting station. Calibration of a receiving set. Measurement of Effective Antenna capacity. Measurement of Antenna inductance and efficiency capacity. Measurement of Antenna resistance. Proper Filtration of the D. C. Plate supply. Hartley circuit employing full wave self rectification. Navy standard regenerative receiving circuit. Five Watt C. W. transmitter with synchronously rectified A. C. Plate Supply source. The Reinartz tuner. A 15 Watt C. W. Transmitter. A Spark coil low power transmitter. Wavelengths of inductance coils. Table giving oscillation constant and frequency, for Wavelengths between 200 and 20,000 meters. (L. C. in Microhenries and Microfarads). Table giving oscillation constant and frequency, for Wavelengths between 200 and 20,000 meters. (L. C. in Centimeters and Microfarads). Antenna Characteristics.

All contained in a heavy manila envelope printed in two colors, size 9 x 12 inches. **50c Prepaid**

FOR SALE AT ALL RELIABLE RADIO DEALERS OR DIRECT FROM US.

The Conrad Co., Inc., 233-Q-Fulton St., New York City

NATIONAL PERFECT VERNIER CONDENSER TYPE DX

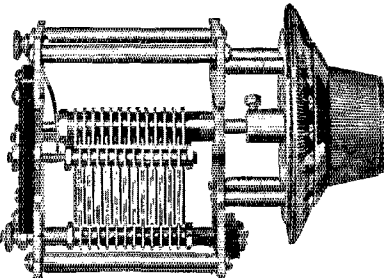

The National Type DX Condenser is a thoroughly tested unit, designed especially for radio circuits where initial signal impulses are a minimum.

It has a very high efficiency, a minimum phase angle and a high ratio of maximum to minimum capacity.

The action of the vernier is positive yet operates with a "Touch" of velvet smoothness. It is of material assistance in obtaining sharp tuning.

As Summer approaches signal strength becomes weak. Do not waste it in inferior apparatus.

Sizes: .001 Mf .0005 Mf .00035 Mf .00025 Mf
Prices: 7.00 6.00 5.75 5.50

Guaranteed for one year against defects in material and workmanship.

THE NATIONAL COMPANY, INC.
Engineers & Manufacturers Established 1914
Cambridge, Mass.

NESCO

Complete line Radio Corporation Products, and popular parts for amateurs.

Mail orders given special attention.

Complete consultation at your service for the asking.

In emergency telegraph or call 3ZW, W. A. Parks.

National Electrical Supply Co.
1330 New York Avenue, Washington, D. C.

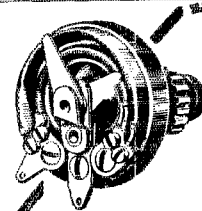

Entirely New Principle

Premier
MICROSTAT
Trade Mark
Super-Vernier
Rheostat

\$3.00 Two windings in parallel—one 6 ohms and worth infinite control. Absolutely noiseless. Handles any tube. Cap. 3 amp. Bakelite molded. Silver etched dial. The finest detector tube rheostat made—bar none. LET US PROVE IT. Fully guaranteed. Ask your dealer. Get our Free Bulletin No. 92.

Premier Electric Company

3811 Ravenswood Ave., Chicago



THE name Magnavox on a Radio Reproducer stands for the most careful workmanship, highest quality of material and also for a fundamental operating principle utterly distinct from that of ordinary "loud speakers."



The base of the new model Magnavox Reproducer R3, showing tone control

Important features now offered in Magnavox Radio—the Reproducer Supreme

THE Magnavox electro-dynamic principle obviates the need of any mechanical adjustment to regulate the air-gap or change the position of moving parts. This famous principle of operation permits the use of an electrical tone control.

This control directly affects the character of the electrical circuit which creates the sound, controlling the sensitivity of the instrument and also its volume of reproduction.

Moreover, this electrical control produces a great saving of current

(already reduced in the new R3 and R2 to a maximum of .6 amperes) for, by its action, the current value can be reduced to a minimum of .1 amperes.

The new Magnavox electro-dynamic Radio Reproducers R3 and R2, in fact, are equipped with the first true sound controlling device ever designed. See them at your dealers and write us for catalog.

THE MAGNAVOX COMPANY
OAKLAND, CALIF.

New York Office: 370 Seventh Ave.
Perkins Electric Limited, Toronto,
Montreal, Winnipeg, *Canadian Distributors*

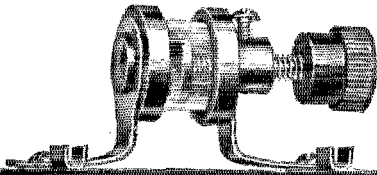

Areal balancing condenser

THE newly perfected Shamrock Balancing Condenser practically eliminates body capacity. This and other exclusive features—makes this coupon a little wizard of efficiency. It permits one to balance a set with ease and precision. Makes your work the equal of factory experts.



The Shamrock Kit \$20

CONTAINS two of the above balancing condensers—and three Shamrock air core transformers mounted on U.S. Tool condensers. Another exclusive Shamrock feature. Inspect this kit at your dealer's today. If he hasn't it in stock, send us the coupon below.

SHAMROCK MANUFACTURING CO.
314 W. Market St., Newark, N. J.

Send no money

Shamrock Mfg. Co.,
314 W. Market St., Newark, N. J.
Free—Our guarantee of money refunded if the kit is not satisfactory, gives you a free trial over a reasonable period of time.

Gentlemen: Send me prepaid one Shamrock Kit, upon receipt of which I will pay postman \$20.

Name.....

Address.....

Dealer's Name.....

Shamrock—for Selective Tuning



IMPROVED AND PRACTICAL SUPER-HETERODYNE

"The Rolls Royce of Radio"

The improvement worked out by our Chief Radio Engineer and his staff has definitely established the superiority of our Super-Heterodyne because:

1. It is easy to control.
2. It has only two dials for tuning (which can be calibrated).
3. It employs a tuned intermediate wave amplifier—so
4. It is more selective and more sensitive than other S.H. sets.
5. No potentiometer is used, thereby eliminating a very critical control. Moreover
6. Balancing of tubes is entirely unnecessary, and
7. Filament control is not at all critical.
8. Regeneration and oscillation on intermediate wave amplifier is controlled by a small feed back condenser that can be permanently set at most sensitive point.
9. Tuned plate system at the first tube gives additional Short Wave Radio Frequency Amplification.
10. Any regenerative or Radio Frequency tuner may be used with the oscillator and intermediate wave amplifier.

A complete description of this improved circuit appeared in the New York Evening Mail Radio Magazine of January 19, 1924. A copy of this editorial will be sent FREE on request.

All parts for this
8 Tube Set

\$75

Every part needed is included and
Each part is absolutely guaranteed.

The Famous 8-Tube Set

\$150

built in a beautiful piano finish solid mahogany cabinet. Unconditionally guaranteed for one year.....

When ordering by Mail Include Postage with Order

Atlantic & Pacific Radio Co.

223 W. 34th St.

New York City

Guaranteed Head-Sets

"RED-HEADS" are *guaranteed* radiophones. You run no risk when you buy them. Money back if, after 7 days' trial, you're not satisfied that they're the *best* receivers on the market at the price. Why not act *right now* and get a pair? It'll mean getting the *maximum* from broadcasting from the day you put them into use.

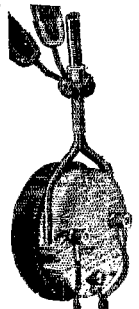

**RED-HEAD
RADIO
RECEIVERS**

NOW READY

The new '24 Model F
Per Pair
\$6.50 Complete

The new "Red-Head" Jr.
Per Pair
\$5.00 Complete

"Red-Heads" sent prepaid on receipt of price if you are unable to get them at your dealer's.

The NEWMAN-STERN COMPANY
Dept. Q 5 Newman-Stern Bldg. Cleveland

NOT CLAIMS — JUST FACTS!

THORDARSON Super Transformers

AUDIO
FREQUENCY

3½ to 1 RATIO.....\$4.00

6 to 1 RATIO..... 4.50

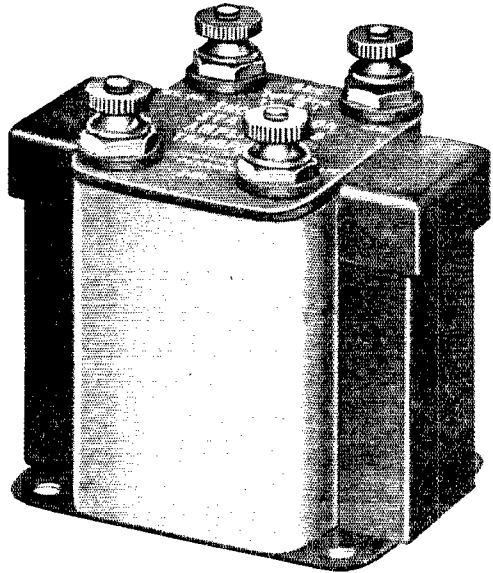

Every manufacturer claims that his product is the "best" in the world. But the quality of scientific apparatus is not a matter of claims and opinions, but of facts.

**CUTTING & WASHINGTON
KENNEDY
ZENITH**

are the names that rank supreme in the receiving set world. The superiority of their apparatus does not depend on opinion, but is the result of careful construction and scientific selection of parts. All three use the Thordarson Super Audio Frequency Amplifying Transformer, for, after exhaustive tests, it was found to be the most in keeping with the high quality of their sets.

AMATEURS READ THIS

McMillan, preparing for his North Pole expedition, sought the most efficient and durable radio equipment obtainable. His engineers specified Thordarson transmission equipment because Thordarson can be relied upon for serviceable distant transmission.

When selecting your apparatus bear in mind the choice of these experts.

THORDARSON

ELECTRIC MFG. CO.

CHICAGO — ILLINOIS

We Thank You, Mr. Cockaday, For This Compliment !!

HOW TO BUILD AN AMATEUR TRANSMITTER

**By Laurence M. Cockaday, R. E.*
Cost of Parts: about \$150.00

Transmitting Range: about 25 miles

HERE ARE THE ITEMS YOU WILL NEED—

- A—inductance coil;
 - B—antenna fixed condenser, .0015 mfd. (Any standard make of high-voltage mica condenser can be used in place of the home-made one);
 - C—grid condenser, .0008 mfd. (Not critical, a .0005 mfd. can be used);
 - D—Ward Leonard resistance, 7,000 ohms;
 - E and F—filament rheostats (resistance values to suit tubes used);
 - G—honeycomb coil, size L200, used as a radio-frequency choke;
 - H and I—vacuum tubes, either VT-2 tubes or UV-202 tubes can be used;
 - J—Acme double-coil iron-core choke, 1½ henries, 150-milliamperes carrying capacity;
 - K—Federal paper condenser, No. 58-B, 2 mfd.;
 - L—General Radio hot-wire ammeter, scale reading from 0 to 2.5 amperes (for mounting on front of panel);
 - M—Century buzzer (H-F);
 - N—single-circuit jack (well insulated type);
 - O—single-turn modulating loop wrapped tightly around inductance coil A;
 - P—composition panel; two switch levers; eight binding posts; twenty switch points and four switch stops; cabinet;
- ESCO 350-VOLT MOTOR GENERATOR;**
DPDT starting switch, 25-ampere carrying capacity;
 connection wire, solder, etc.

TRADE " E S C O " MARK
FOR QUALITY

ELECTRIC SPECIALTY CO.

225 SOUTH STREET,

STAMFORD, CONN., U.S.A.

Pioneers in Developing High Voltage Wireless Apparatus

* Reprint by permission of "POPULAR RADIO"— March, 1924 Issue.

JUST OUT

—the type
 R-100



ALL-AMERICAN

**LONG WAVE
 RADIO FREQUENCY TRANSFORMER
 4,000 to 10,000 Meters
 (75 to 30 K.C.)**

Suitable for all long wave radio frequency circuits such as Reflex, Heterodyne, Ultradyne, etc. Designed by the same engineers who created the celebrated All-American Audio, Radio and Power Amplifying Transformers. Placed on the market only after long and thorough tests. Again All-Americans lead.

RAULAND MFG. CO.
 2650 Coyne St., Chicago

Windings of American Audio Frequency Transformers — properly treated and impregnated. Housed in a handsome nickel-plated shell of same physical design as All-American. Shielded to prevent interference or reaction.

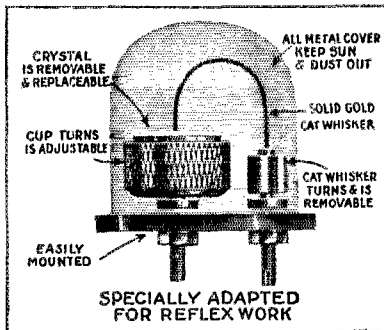
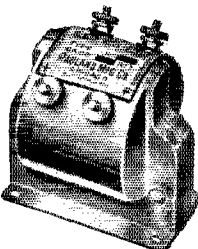

**THE "LINCOLN" ENCLOSED
 FIXED ADJUSTABLE DETECTOR**

New. Wonderful. Fans wildly enthusiastic. Kills your reflex troubles. Brings in distant stations loud and clear. Price only \$2.00. Absolutely guaranteed for one year. Ask your dealer or write—today. Jobbers and dealers: wire or write. Mention this ad. Address dept. K:

LINCOLN MFG. CO.
 Los Angeles, Cal.

RADIO MASTS

Fabricated steel masts, the self-supporting kind. The most beautiful masts to be found. The best job for supporting antenna properly. Each mast equipped with cable and mast-head pulley. No guys, no platforms, no necessity for climbing up. Patents pending. Write for prices and describe your antenna.

WHITTLESEY ENGINEERING CO.
 Cleveland, Ohio.

CARDWELL CONDENSERS

Code Number	Capacity	Number of Plates	List Prices
141-B	.00025	11	\$4.25
152-B	.00035	17	4.75
123-B	.0005	21	5.00
137-B	.001	41	6.00
*147-B	.00043	43	15.00

*Double spaced, (8000 volt minimum breakdown), Transmitting Condenser.

CARDWELL Audio Transformers

124-B Audio Frequency Transformer, First Stage (ratio approx. 9 to 1) \$5.00

139-B Audio Frequency Transformers, Second Stage (ratio approx. 4.8 to 1) \$5.00

Order through your local Dealer

THE ALLEN D. CARDWELL MFG. CORPORATION

81 Prospect Street, Brooklyn, N. Y.

ATTENTION AMATEURS!!

Radio Corporation of America Transmitting Material
at Greatly Reduced Prices.

SERIAL NUMBER	ARTICLE	LIST	OUR PRICE
UP 1016	Power transformer 750 Watts	\$38.50	\$25.00
UP 1368	Power transformer 325 Watts	25.00	17.00
UP 1626	Filter Reactor 160 Mills	11.50	8.00
UP 1627	Filter Reactor 300 Mills	15.75	11.00
UP 415	Plate Circuit Reactor	5.75	2.00
FX 1638	Chopper Wheel	7.25	4.00
UT 1643	Magnetic Modulator	9.50	6.50
UT 1357	Magnetic Modulator	12.00	9.00
UT 1367	Magnetic Modulator	17.00	14.00
PT 537	Filament Rheostat (for large transmitting tubes)	10.00	6.50
UC 1831	Transmitting Condenser	9.00	5.00
UM 530	0-2.5 Radiation Meter	6.50	2.90
UM 533	0 - 5 Radiation Meter	6.50	2.90
81	RCA Mesco Key	3.00	2.00
UC 1846	Antenna Series Condenser (tested for 10,000 volts)	10.00	6.00
UC 487	Faradon Condenser (750 volts .5 MF)		1.00
UC 489	Faradon Condenser (1750 volts .5 MF)		1.25
PR 535	Rheostat 33 OHM	3.00	1.60
PR 539	Rheostat 6 OHM	3.00	1.60
PR 536	Potentiometer 200 OHM	2.00	1.50
	RCA Marconi 18" Micarta Insulators		.40
	Westinghouse TYPE SA Lightning Switch		2.25
	Western Electric 50 Watt Tubes		28.00
	Western Electric 250 Watt TYPE I Tubes		110.00
	Kenotrons No. 217		20.00

A large quantity of CW and 500 cycle transmitting material on hand at very low prices. We also expect a lot of 0-500 0-250 Milliameters and 0-1500, 0-1000 Voltmeters.

TROY RADIO CO., INC.,

1258 St. John's Place,

Brooklyn, New York City.

Telephone Decatur 6139 J

—and when it comes to selecting condensers, there is no need for deliberation. Of course, the choice is



Vernier Variable Condensers.

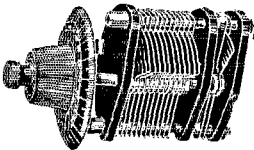

Satisfy the most exacting—accurately spaced, permanently adjusted, afford a high maximum to low minimum ratio. There is absolutely no iron used in any bearing or other part of the condenser.

Ask your dealer or write for complete literature

AMSCO PRODUCTS, Inc.

Broome and Lafayette Sts.,

New York City

"RADIO CALL PINS"

1AW	1RRM	1PCN	1CIT	17E	2AX
2CFB					3ATB
3BA					3BCK
3BJD					3BVA
3VO					3ZO
4GL					4MA
5ALI					5VU
6AFZ					6BBN
6SN					6UG
8AA					8AVN
8DFI					8EU
8FM					8YY
8ZZ					9AAW
9AVZ					9BSG
9CD					9CGA
9DCR					9DPV
9ZG					are but
Can.					a few
3AEB					that
4DY					wear
tc. etc.					them

(Twice actual size)

Put Your Call In Gold On A 50 Watt "Bottle"
\$2.00 Pins FB
M.O. or R. C. BALLARD, 9FZ or money
Check back
1202c W. Oregon St., Urbana, Ill.

Power Vacuum Tubes

Your Repair Work Solicited

GRAY AND DOANE

Box 563,

Orange, Texas

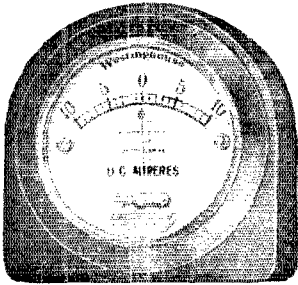

TYPE PI

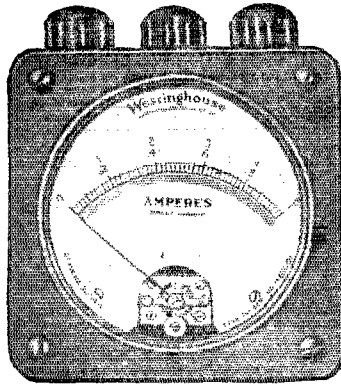

TYPE PX-3

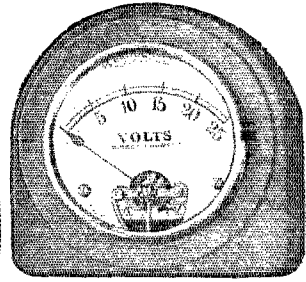

TYPE PX-2

Handy Instruments for Everyday Use

Do you dig things out for yourself? Are you a man who likes to charge your own battery, know how your radio set operates—one who enjoys experimenting a little with electricity?

How would you like to have a meter to enable you to charge your battery correctly—an instrument that will save you money on your radio tubes, and is just the thing for amateur experimenting? How would you like to have **one** instrument that can do all this?

You have your choice of a PI, PX-2, or a PX-3 instrument. You can put them in your pocket.

PX-2 and PX3 instruments operate on the same principle as the larger and higher priced instruments and are extremely accurate. Shocks and vibrations have no injurious effects. The cases are of acid-resisting composition, making them particularly desirable for battery testing.

PX-3 has an external zero adjuster, two ranges of readings and other refinements. It is larger than the PX-2 and, because of its larger dial and mirror scale, can be read with greater ease and accuracy. Both PX-2 and PX-3 can be furnished for radio high-frequency work.

Where high accuracy is not required, the PI instrument has a wide range of applications. It operates on a much simpler principle and is very rugged. The zero-center scale arrangement makes this instrument especially suitable as a polarity indicator.

Westinghouse Electric & Manufacturing Company

Newark Works

Newark, New Jersey



Westinghouse



STA-RITE RADIO BATTERIES SAVE YOU 60%

And Guarantee You in Writing 2 Years of Better Battery Performance
STA-RITE RADIO BATTERIES are made especially for Radio and the big saving is made possible by coming direct to you instead of thru distributors dealers etc. Boxes are made of oak finished in mahogany and the plates very thick and will give a steady discharge over a long period. No premiums, just good honest battery value.

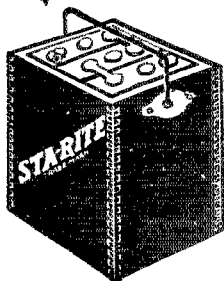

TRY TO BEAT THESE PRICES

2 Volt for W. D. 11 and 12	\$4.00	6 Volt 60 Ampr. . .	\$ 7.50
4 Volt for U. V. 199 Tubes	7.00	6 Volt 80 "	8.50
RADIO B. STORAGE Glass Jars, Heavy Plates— Case of 12 Cells 24 V. .	4.90	6 Volt 100 "	10.00
		6 Volt 120 "	12.10
		6 Volt 150 "	14.00
		6 Volt 200 "	17.00

Get Yours Today — NOW — Send No Money

The batteries are fully guaranteed in writing and shipped subject to examination on the day your order is received. You pay on delivery or deduct 5 per cent if full cash accompanies order. You may deduct 10 per cent if two or more are ordered at one time.

STA-RITE BATTERY CO.

"DEPT. 13"

LOUISVILLE, K_Y.

NEUTRODYNE

5 TUBE KNOCK-DOWN NEUTRODYNE SET

with blue print, drilled and engraved panel. Every part needed to build this set is included as follows:

3 Neutro-Coils, silk wire wound on all genuine Bakelite tubes,
 3 Variable Condensers, high grade capacity .000375; 6
\$25.95
 Mounting Brackets—Neutral-izing Condensers (sets of parts WITH ORDER with glass Dielectric), 5 Bakelite Sockets, One 20 ohm Rheostat, One 6 ohm Rheostat, Two shielded Audio Transformers, 3 Dials, 3 Mica Fixed Condensers (capacities .006, .001, .00025), 1 Tubular Grid Leak and Mounting, 9 Binding Posts, Lugs, 9 lengths Bus Bar, 2 lengths Spaxhetti, 1 Panel (drilled and neatly engraved), Blue Print (large, with complete and simple diagrams), 1 Copper Sheet, 1 Print for Placing parts.

We guarantee these parts to be the best quality money can buy, irrespective of price.

READ THE FOLLOWING NEWS ITEM FROM "FINANCE and COMMERCE"

At last, however, the price objection has been overcome. Naturally it was one of the oldest of radio firms, one of the substantial units in the radio world, that brought this about.

The Atlantic & Pacific Radio Company set its technical department to work upon this problem of producing a neutrodyne set to be sold at a moderate cost. The radio world, as a result, has just welcomed the announcement by the Atlantic & Pacific radio stores of complete parts for a neutrodyne set, the "Set of Heart's Desire" at the incredibly low price of \$25.95.

Atlantic & Pacific Radio Co.

223 W. 34 St.

New York City

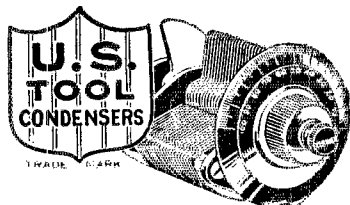

Accurate
Compact

Durable
Always Reliable

End Plate of Celoron

Low Dielectric Losses
100% Guaranteed

USE Vernier Cap. .00057 Mfd. (24 Plate)

or
Plain Cap. .00055 Mfd. (23 Plate)

For Superheterodyne Superdyne Inverse
Duplex New Four Circuit Tuner.

Condensers of Recommended Capacity for other known Circuits are also carried in stock by leading radio retailers.

Write for Booklet

U. S. TOOL COMPANY, INC.

112 Mechanic St.,

Newark, N. J.

RADIO PANELS

Cut exactly to size and a guaranteed 12 hour shipment. $\frac{1}{8}$ " thick .0112c per square inch. $\frac{1}{16}$ " thick .0112c. Made of the highest grade black fibre. This material possess electrical strength of 200 volts per mil, is inexpensive, unbreakable, easy to work and takes a fine finish. We pay postage.

RADIO INSTRUMENT & PANEL CO., 564 W. Monroe St., Chicago, Ill.

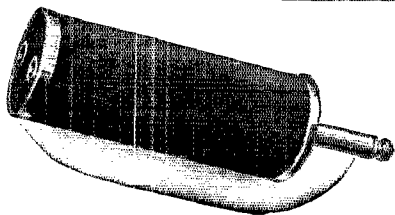

Pat. Appl'd for

VOLT-X
TRADE MARK
tone FILTER

An Old Principle—With A New Application!

Would You Like To—

1. Lengthen the life of your headset or loud speaker?
2. **KNOW** that your head set or loud speaker is always properly connected?
3. Use your headset as a loud speaker without injuring it?
4. Remove the inherent rattle from your loud speaker?
5. Improve the articulation of your headset or loud speaker?
6. Use less current from your B Battery?
7. Insure your headset and loud speaker against injury from excessive B Battery voltage?

ALL OF THE ABOVE ARE POSSIBLE WITH THE VOLT-X FILTER. Leading Engineers have approved it; some of the most expensive receiving sets and loud speakers include the principle; every set should have a Volt-X Tone Filter. Price \$2.50

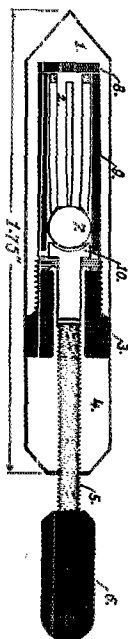

Ball Bearing—Variable Grid Leak

Range— $\frac{1}{2}$ —to 15 megohms

Once Set—it "stays put"

Operation smooth—Resistance unit cannot wear or tear

1. Metal Case
2. Compressor
3. Insulating Bushing
4. Metal Cap
5. Compression screw
6. Screw Cap
7. Steel ball
8. Insulating thrust plate
9. Resistance unit (tubular)
10. Ball follower.

Price \$1.00

Sold—Through The Jobbers—By

BURTON-ROGERS CO.

26 Brighton Ave.

Boston, Mass.

Distributors for
HOYT—Radio Peep-Hole Meters
"B" Battery and Dry Cell Testers
Switchboard Meters

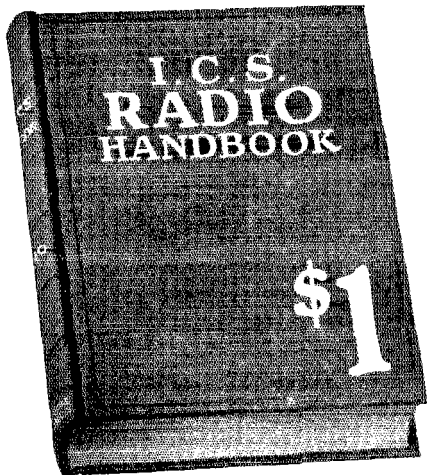

A practical,
authoritative book on
RADIO

514 pages. Price only \$1
Compiled by HARRY F. DART, E.E.
Formerly with the Western Electric Co.,
and U. S. Army Instructor of Radio
Technically edited by F. H. DOANE

EVERY member of the American Radio Relay League should have a copy of this I. C. S. Radio Handbook. Price only \$1. Written, compiled and edited by practical radio experts of national reputation. A handy reference book that will help you improve your sending and receiving apparatus. Explains the operation of dozens of circuits. Filled with interesting experiments. Note this list of contents:

Static strays, dynamic electricity, electron theory, electrical measuring devices, magnetism, circuit effects and co-efficients, condensers, coupling, transformers, aerial systems, wave-length formulae, direction finding, batteries of all types, generators and motors, radio devices, detectors and transmitters, relays, phones and microphones, filters, commercial receiving sets, formulae, symbols and definitions, regulations, etc.

Send the coupon to-day with \$1 and get this 514-page I. C. S. Radio Handbook. Money back if not satisfied.

TEAR OUT HERE

INTERNATIONAL CORRESPONDENCE SCHOOLS
Box 6132-B, Scranton, Penna.

I enclose One Dollar. Please send me—post-paid—the 514-page I. C. S. Radio Handbook. It is understood that if I am not entirely satisfied I may return this book within five days and you will refund my money.

Name.....

Address.....

HEATH'S Radiant Condensers

A condenser short circuited will create no end of trouble. Better to think of the plates first and buy a Heath Radiant Condenser, with the PERMANENTLY F-L-A-T Plates. Write for Interesting Booklet and Name of Nearest Dealer.

MICROMETER VERNIER

LIST PRICES
Vernier Type

A 11 including 2 3/4" dial and knob.

18 Plate, \$5.00; 25 Plate, \$5.50; 45 Plate, \$6.50.

Plain Type

Mfd. Cap.

11 Plate approx. 0.00025—\$2.30

17 Plate approx. 0.00035—\$2.55

23 Plate approx. 0.0005—\$2.90

43 Plate approx. 0.001—\$3.30

Genuine Condensite Dials 65 cts. Extra.

Jobbers and Dealers: Write Immediately for Proposition.

HEATH RADIO & ELEC. MFG. CO.
207 First St., Newark, N. J.

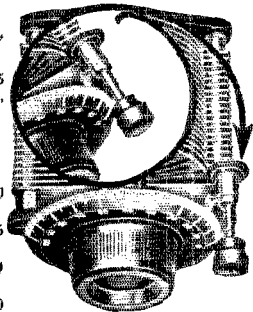

"WARRANTED"
Audio Transformer

MTD. \$2.00 UNMTD. \$1.45

10 Days Money Back Guarantee
Dealers Write

C. C. ENDLY

22 Sturges Ave.
MANSFIELD, O.

2650 MILES

ON ONE TUBE, Broadcasting from Atlantic Coast, Mexico, Canada, Cuba and Hawaii, heard in California, by users of the CROSS COUNTRY CIRCUIT. Atlantic Coast users hear California, Range due to simplicity of set and operation by one tuning control. Easy and cheap to build by any novice. Dry cell tubes may be used. Complete understandable instruction, full size panel layout, assembly photo, etc. Postpaid, 25 cents; stamps accepted.

Box Q-117 VESCO RADIO SHOP Oakland, Calif.

HUNDREDS OF RADIO FANS

Are saving money by buying their radio supplies from us.

Send stamps for large radio catalog.
24 HOUR SHIPMENT

THE CUT RATE RADIO CO.

P. O. Box 472

Newark, N. J.

Genuine
Western Electric VT-2 Tubes
\$7.45

Send 10¢ for copy of new 48 page

RADIO CATALOG

CHICAGO SALVAGE STOCK STORE
509 S. State St., Dept. Q-6 Chicago, Ill.

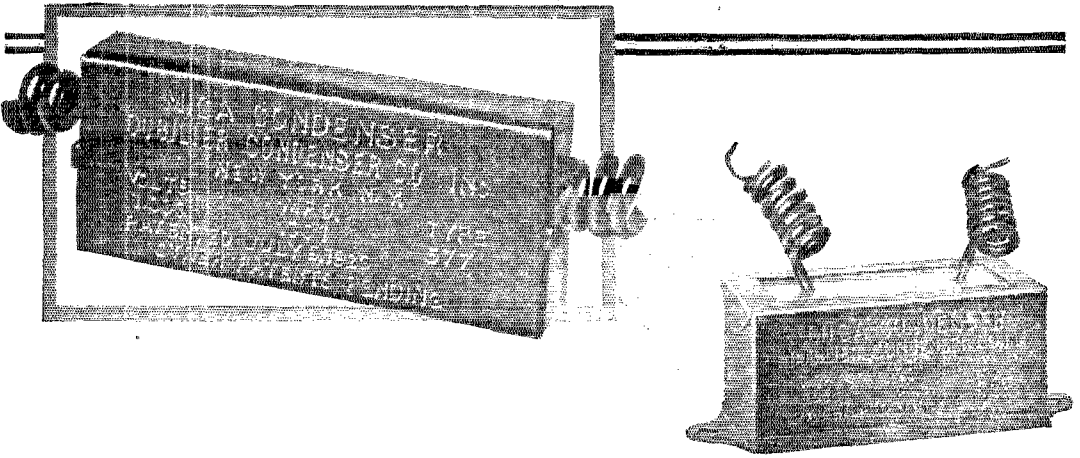

Dubilier Condensers

Standard for Radio Transmitters

Type 577 and 580 condensers are recognized as standard equipment for Low Power Tube transmitters, and Precision instruments because of their accurate, permanent capacity and low loss.

Capacity in mfd.	Voltage	Capacity in mfd.	Voltage
.00025	1000	.001	5000
.0005	1000	.002	5000
.001	1000	.005	2500
.002	1000	.01	2500
.005	1000	.02	2500
.0075	1000	.0003 } These 3 capac-	5000
.01	1000	.0004 } ities combined in	
		.0005 } one condenser	

Complete information will be supplied on request.

DUBILIER CONDENSER AND RADIO CORP.

42-50 WEST FOURTH STREET, NEW YORK

DUBILIER DEVICES

HAM-ADS

Six cents per word per insertion in advance. Name and address must be counted. Each initial counts as one word. Copy must be received by the 1st of month for succeeding month's issue. NOTE NEW CLOSING DATE.

A "B" BATTERY WITH A CONSCIENCE—BUILT OF FULL—O—PEP EDISON ELEMENTS TO LAST YOU A LIFE TIME. 54 VOLTS, 42 CELLS \$8.50, 100 VOLTS, 78 CELLS \$15.00, 130 VOLTS, 102 CELLS \$19.00, 150 VOLTS, 117 CELLS \$22.00. COVERED CABINET OF FUMED OAK ASSEMBLED, LARGEST EDISON ELEMENTS WIRED WITH PURE SOLID NICKEL, NON—FLOATING PERFORATED HARD RUBBER SEPARATORS & BANDS, GENUINE EDISON ELECTROLYTE (THAT'S NO LYE), WHITE SEALING OIL, TEST TUBES FELT PACKED, CRATED FOR SAFE SHIPMENT. CELLS ALONE 15c EACH. WILLARD COLLOID RECTIFIER \$2.00 JUMBO COLLOID \$3.00. TUNGAR HIVOLTAGE CHARGERS & PARTS. INSTRUCTION SHEET 50c. ANNEALED GLASS TEST TUBES INDIVIDUALLY WRAPPED, $\frac{3}{4}$ x 6" 3c, 1" 4c, 1 $\frac{1}{2}$ " x 7" 7c (FLAT BOTTOMED) 99% PUREST SOFT DRAWN SOLID (NOT PLATED IRON) NO. 20 NICKEL WIRE FOR CONNECTORS 1 $\frac{1}{2}$ c FOOT PREPAID, PERFORATED HARD RUBBER SEPARATORS $\frac{1}{2}$ c. GENUINE EDISON ELECTROLYTE (THAT'S NO LYE) 5lb. CAN \$1.50. PURE POTASH 80c lb. TYPE A EDISON ELEMENTS 6c (SPECIALLY TREATED TO MAKE DRILLING EASY), DRILLED 7c, WIRED WITH SOLID PURE NICKEL 10c PAIR TYPE G ELEMENTS 4c PAIR, 2 POSITIVES 1 NEGATIVE 5c, 3 POSITIVES 2 NEGATIVES 8c, SAME IN HIGH CAPACITY UNIT DRILLED AND CUT READY TO WIRE 10c, ALL PARTS AND SOLUTION FOR HIGH CAPACITY CELL 17c, SAME WITH ELEMENTS DRILLED AND CUT READY TO WIRE 19c, WIRED AND ASSEMBLED 24c. A CELL. GREAT FOR TRANSMITTERS, POWER AMPLIFIERS, SUPERS, FOR 250 WATTS AND SUPERS—A SUPER CELL OF 6 A ELEMENTS IN 1 $\frac{1}{2}$ " x 7" FLAT BOTTOMED GLASS CONTAINER, SOLUTION AND ALL PARTS READY TO WIRE 30c, WIRED 35c, 3000 MILLIAMP HOUR CAPACITY, SAMPLES A & G CELLS 25c, SUPERCCELL 35c. FRANK MURPHY, RADIO 8ML, 4837 ROCKWOOD ROAD, CLEVELAND, OHIO.

A BRIGHT AND SHINY AERIAL, GLISTENING IN THE SUN, NOT ONLY ATTRACTS THE EYE, BUT THE SIGNALS AS WELL, PROVIDES A CLEAR TRACK FOR YOUR SIGS, BOTH COMING AND GOING. NO. 12 SOLID COPPER ENAMELED AERIAL WIRE STAYS NEW DOES NOT BECOME BIRTLE WITH AGE. LOWEST HIFREQUENCY RESISTANCE OF ANY AERIAL WIRE SOLD, EASY TO HANDLE, DOES NOT WRAP AROUND YOUR NECK, 1c FOOT PREPAID TO YOUR STATION, DON'T LET EM FOOL YOU—NOTHING JUST AS GOOD AS GENUINE OHIO BRASS CO. PORCELAIN ANTENNA INSULATORS, 5" 75c, 10" (GLAZED ALL OVER) \$1.50 PREPAID STAND 3000 lbs. PULL. CORONA BUSHINGS WHEN REQUESTED. CORONA SHIELDS \$1.00 ATTACHED. SNAPPY SHIPMENT ON OBs & WIRE. SILICON STEEL TRANSFORMER PUNCHING 25c lb. (NO CUTTING TO ORDER). EVERYTHING FOR THE TRANSMITTER. RADIO 8ML, 4837 ROCKWOOD, CLEVELAND, O.

RUBBER STAMP with large call letters 50c; Radiogram and Relay Radiogram blanks 25c per hundred, Stock Post Card 60c hundred. Send us your orders. Carolina Printing & Stamp Co., Wilmington, North Carolina.

WHILE THEY LAST: A few 50 watt power transformers left, \$7.00. For 5 watt tubes, 375 volts each side of center tap. Filament winding 10 volts with center tap. Send money order. If not satisfactory, may return within ten days and receive money back. Fair enough! C. C. Endly, 22 Sturges Ave., Mansfield, Ohio.

NAVY TYPE CW 936 transmitter and receiver complete. Includes receiving and transmitting cabinets, power amplifier, loud speaker, two generators and switchboard, remote control box, 5 VT1 and 3 VT 2 and phone transmitter. \$150 without batteries. \$225 with Edison Storage Batteries and Tungar charger. S. Miller, 303 Fourth Avenue, New York.

EMPIRE CLOTH FOR INSULATING THAT NEW TRANSFORMER. ONE SQUARE YARD \$2.00 HALF \$1.00. QUARTER 60c. FOURTH EDITION CITIZENS RADIO CALL BOOK JUST OFF THE PRESS, WRITE FOR YOUR COPY, PRICE 50c PLUS POSTAGE ONE POUND. ARE YOU USING HEISING IN YOUR PHONE SET? WELL YOU NEED A REAL HE CONSTANT CURRENT CHOKE, GET AN ACME DOUBLE COIL 1 $\frac{1}{2}$ HENRY 500 MILLI \$8.00 MAGNET WIRE No. 10 DCC 55c LB. No. 12 DCC 60c LB. No. 15 DCC 85c LB. AS MUCH OR AS LITTLE AS YOU WANT. EQUIP YOURSELF WITH THE "BEST" ANTENNA. PUT UP SOME No. 12 SOLID COPPER ENAMELED SELLS FOR 1c PER FOOT, AND HAVE DONE WITH THE HIGH RESISTANCE RADIATION SYSTEM. ENAMELED WIRE AND OHIO BRASS INSULATORS WILL PUT YOU IN A CLASS BY YOURSELF. OBS. SELL 5" AT 75c AND 10" AT 1.50. ALUMINUM????????? HECK YES, LOTS OF IT. SAYS SAJT. BY USING YOUR CHEMICALLY PURE ALUMINUM AND SHEET LEAD, MY NOTE ON CW SOUNDS LIKE B BATTERY PLATE SUPPLY. ALUMINUM SELLS FOR 90c PER SQUARE FOOT SHEET LEAD 30c PER LB. 2 $\frac{1}{2}$ LBS. TO SQUARE FOOT. GIVE US A TRIAL ORDER, WE GIVE REAL SERVICE. THE ONLY HAM STORE IN THE FIFTH DISTRICT, FORT WORTH RADIO SUPPLY CO., 104 EAST 10TH ST., FORT WORTH, TEXAS.

MAGNAVOX R3 or M1. Latest nationally advertised reproducers. List \$35.00 Introductory \$25.00 The factory sealed carton is your guarantee. Radio Central, Dept. Q, Abilene, Kansas.

\$12.EACH takes Ohio or Wagner 110 volt sixty cycle eighteen hundred R.P.M. motors built in $\frac{1}{4}$ H.P. frames. Can be used as power motors. Type G. Edison elements per pair 3 $\frac{1}{2}$ c. Highest quality 1 $\frac{1}{2}$ " x 6" test tubes \$3.00 gross. Perforated hard rubber separators 1 $\frac{1}{2}$ c. No. 20 99% pure nickel wire \$1.50 per hundred feet. 25% off on 4 new Acme $\frac{1}{2}$ and $\frac{3}{4}$ K.W. Plate transformers. Kimley Electric Company, Inc., 2685 Main St., Buffalo, N. Y.

RADIO GENERATORS—500 Volt 100 Watt \$28.50 each Battery Chargers \$12.50. High Speed Motors. Motor-Generator Sets, all sizes. Motor Specialties Co., Crafton, Penna.

SELL: Grebe RORN, forty dollars; CR3 and RORD Amplifier, hundred dollars; R3 Magnavox, twenty dollars. A. W. Hynds, Seward, N. Y.

WANTED: All A.R.R.L. members to know that we have a complete stock of radio parts and give mail orders special attention. Write phone or wire. Hard-soc Mfg. Co., Radio Division, K.F.J.L., Ottumwa, Iowa.

FIFTY ASSORTED FLAT HEAD solid brass machine screws, nuts, washers, copper lugs, 50c. Eight initial binding posts, set 60c Twelve nickleed binding posts 50c. All three items \$1.50. RADIO LIST for stamp. All prepaid. Stamps accepted. Kladag Radio Laboratories, Kent, Ohio.

FOR SALE: Grebe CR3, 3 circuit long wave tuner and RORD, 100 Watt transmitter with transformers and rectifier. Write for quotations. 8YAK, Yankton, So. Dak.

CALLS HEARD POSTAL CARDS (for DX letters). Send \$1.00 with your name, address and call letters for 100 (\$1.75 for 250) printed report postal cards with large red call letters. Complete form for description of your station, etc. State if member of A.R.R.L. Cards also printed to order—prices on application. Twenty-four hour service. Samples of our complete line of cards, radio stationery, etc., on request. Printed by 9AVO, member A.R.R.L. Radio Print Shop, Box 582, Kokomo, Indiana.

SELL—Kennedy type 220 Receiver and type 525 Two Stage Amplifier \$125.00 f.o.b. Middletown, Conn. Cecil Wm. Kieft.

WESTINGHOUSE RC—Absolutely new and guaranteed in perfect condition \$85.00 Edith Larson, LeRoy, Minn.

WANTED: Loud speaker and storage battery or radio receiver in exchange for \$80.00 equity in La Salle Industrial Management Efficiency Course. 506 Austin Ave., Abingdon, Ill.

QSL CARDS 500 POSTAL SIZE PRINTED IN BLACK INK WITH LARGE RED CALL LETTERS \$4.00; 500 GOVERNMENT POSTALS \$8.50. NOT OVER TEN LINES CASH WITH ORDER. BY A.R.R.L. MEMBER. CURTIS, 1109A EIGHTH AVENUE, FORT WORTH, TEXAS.

HAM BARGAINS ONLY, from 3BOV! CW & Fone Transmitter, reaches 1000 Miles using One 5 Watter. Set with Tube, \$20; Rotary (6V) Spark Gap with Motor, speed as $\frac{1}{2}$ horse \$5; Large Wound CW Inductance \$3; 2 New VT2 Tubes \$6 each; Battery Charging MG Outfit \$20; Radio MG Set \$25; 2 Filter Condensers 1 MF \$1 each; Key \$.50; 3-1 $\frac{1}{2}$ V, Mercury Tubes, \$3.25 each New; Brandes 50,000 Ohm Navy Headset \$5; Detector & 2 Step Amplifier—inclosed \$20; Ultra Audion Tube Set \$7; Varicoupler Mounted \$3; Chelsea Dust Proof 43 Plate Condenser \$3; 3 DX Radio Frequency Transformers for HAM Meters, with Base \$4 each or 3 for \$10; 3 Amsco Compensating Condensers \$2 each or 3 for \$5.00. 1" Radio Spark Coil \$2. Minor Apparatus also including Tait & Kent Dials; Honeycombs with Mtgs; Switches; Rotors; Stators; etc. at Great Savings. S. Strobel; 3923 N. 6 St., Phila, Pa.

GREBE OUTFIT NEW, Cr 3—\$40.00. Rorn tuned radio frequency \$40.00; Rord detector, two audio with tubes \$60.00. Osborne Conrad, Stillwater, Minn.

FOR SALE—4EL's complete transmitter. Two fifty watt tubes plus sockets, \$38; Plate transformer, 500 watt 3000 volts, variable, \$20; Filament transformer, 300 watt \$10; Jewell ammeter, \$3; Voltmeter, milliammeter, both \$8; 7 1Mfd., 1750 volts condensers, \$1.50 each; home-made (50 Henry) choke, \$6. L. Hahne, 8 West 43 Street, Savannah, Ga.

WANTED: Grebe RORK amplifier. Ernest Thornhill, Muncie, Indiana.

SELL: 900 cycle 200 Watt generator, transformer, and two .004 mica condensers, \$25. Andert, 2017 Market St., San Diego, Cal.

BUY TRANSMITTER: CW and Phone. Must be in A1 condition and worth the money. R. B. Hannah, Lorenzo, Tex.

LARGE SIZE: Edison Elements, 3 $\frac{1}{2}$ c pair, Drilled 1 $\frac{1}{2}$ c pair, Original Separators included. John Evans, Springfield, Mo., Route 7, Box 841.

FOR SALE: Fifty Watt, Panel Mounted Transmitter. Write 9BUJ.

U.S.N. COMBINATION RECEIVER TRANSMITTER: Cutting and Washington boat set in brass bound trunk. Cost Government \$800. Ideal for experimenters. Price \$95. M. Applegate, 1010 Bergen St., Brooklyn, N. Y.

FOR SALE— $\frac{1}{2}$ KW. 500 cycle Generator \$60, 1 HP motor \$30. 2CUL.

UV216 KENOTRONS—New \$6, Used \$4. 5AND.

MASTER RADIO CODE in 15 minutes. Ten word speed 3 hours. Our students made these world records. Previous Failures who tried all known methods have thanked us for License. To hesitate kills speed. To master Code our way kills hesitation; gives speed. Code instructions that instruct only \$2.00. Information free. Dodge Radio Shortcut, Dept. SC, Mamaroneck, N. Y.

WONDERFUL BARGAINS IN RADIO APPARATUS. We are closing our resident radio school and are disposing of its entire apparatus at these amazing reductions: One \$80 Grebe Type C.R.S., 150-100 Meter Receiver, now only, \$40; One \$25 N.R.I. Single Circuit Receiver, for \$12.50; One \$22.50 DeForest P.500 Audion Panel for \$15; One \$17.50 DeForest P. 401 Audion Panel for \$11; Four \$2.50-100 Amp. Lightning Ground Switches for \$1.50 each; Seventy-five \$1.25—300 turn unmounted Honeycomb Coils for 75c each; three \$3.50 Murdock Double pole Double Throw Antenna Switches for \$2. each; Six \$1.10 5000 ohm Transmitting Grid Leaks for 50 cents each; Four \$2.50 Essex Meter Double Slide Tuning Coils for \$1 each; One \$270, 20 Watt DeForest Tube Transmitter for \$75; One \$350, 500 Volt D.C. Motor Generator (110 Volt D.C. Motor) for \$100; One \$1.50 5", 100 Turn Varicoupler for \$1; One \$750, 600 Meter Marconi Ship Transmitter for \$100; One \$350 Independent $\frac{1}{2}$ kw Ship Panel for \$35; one \$285 Crocker-Wheeler $\frac{1}{2}$ K.W. Motor Generator—110 V-DC to

260 Volt AC, 500 Cycles for \$85; One \$85 Magnavox Loud Speaker for \$30; One \$150 Magnavox 3 Tube Power Amplifier for \$60; One \$25 Navy Type 150-750 Meters Wave Meter for \$8.50; One \$5 Marconi Aerial Changeover Switch for \$1.25; One \$4 Murdock Oscillation Transformer for \$2. Send money order or check with order. We pay parcel post charges, but material shipped express, charges paid by purchasers upon receipt. Mail your order NOW! Address National Radio Institute, Washington, D. C.

SELL—At once. Complete 50 watt transmitter. Use 1DH ckt. C.R.A.C. All quality Apparatus. Heard 2600 mi. All U. S. Districts worked, three Canadian. Write for description. Address 9ER, Lincoln, Illinois.

JUST RECEIVED 400 Transmitting Receiving Tubes from government, same cost \$75.00 will sell \$2.50, also 1000 Storage Batteries A.-B. \$2.00. Transmitting sets cost \$150.—\$25.00. \$24 North Fifth, Philadelphia, Pa.

SELL: 500 Volt, 125 Watt Motor Generator, Excellent condition, \$40.00. Three Circuit Receiver and one step with tubes, \$25.00. Carlton Fider, Box 303, Ft. Lauderdale, Fla.

SOMETHING NEW—Available to A.R.R.L. members only. We have just what you are waiting for. Beautiful Black and Yellow felt Pennant (6 x 24) for your Radio room, your station call letters at top and large embroidered League Emblem below, Price \$1.35 postpaid. Send all orders direct to Eric Robinson, Jefferson Road, Webster Groves, Missouri.

FOR SALE—High voltage generator, Shelton, Dictograph Loud Speaker, Iresco tuners. Other apparatus. Write. 9BCX.

BARGAINS. Brandes phones, \$4.85; Acme audio transformers, \$3.98; Eria reflex transformers, \$4.15; Paragon Variometers, \$4.65; Workrite Variocouplers and Variometers, \$2.95; all prepaid. Merrimack Radio Co., Box 746, Lowell, Mass.

FOR SALE: G. E. quarter kilowatt tube, used little, \$60. Henderson Lynn, 16 Oakland Ave., Uniontown, Pa.

BEST OFFER takes 4-DeForest Singer 50 Watt tubes Have never been used. The Radio Shop, Bradford, Pennsylvania.

FOR SALE: 2-stage amplifier, Fisher Vario-Coupler, USL 80 AH "A" Bat., For prices, etc., write Ernest Thornhill, Muncie, Indiana.

ENTIRE STATION OF 8WC must be sold; am going to the navy. One UP1016 750 Watt filament and plate supply transformer, \$25.00; One UC1803 transmitting condenser, \$3.00; One UP415 Plate Reactor, \$4.00; One UP414 Microphone Transformer, \$5.00; Two UC489 Filter Condensers, \$1.00; One UP1718 Grid Leak, \$1.00; One Ammeter 0-5 Amp. RCA, \$ 5.00; One New Kenotron, \$5.00; One UV202 New, \$5.00; One UC487 Filter Coundenser, \$1.00; One Western Electric Microphone \$3.00. Above Apparatus all RCA and was used very little for it was never set up. All guaranteed. Alban A. Michel, 116 Benson St., Reading, Ohio.

9VD WILL MAKE A REAL DIRECTOR FOR THE CENTRAL DIVISION.

FOR SALE. Complete 15 Watt phone transmitter. Escro motor generator and three WE tubes, sixty dollars. Radio, Box 36, Binghamton, N. Y.

MAKE \$120 WEEKLY IN SPARE TIME. Sell what the public wants—long distance radio receiving sets. Two sales weekly pays \$120 profit. No big investment, no canvassing. Sharpe of Colorado made \$955 in one month. Representatives wanted at once. This plan is sweeping the country—write today before your county is gone. OZARKA, 853 Washington Blvd., Chicago.

SELL: C. W. parts cheap. Write for List. Kraus-Steffen, 1611 North Eighth Street, Sheboygan, Wis.

OMNIGRAPH WANTED—Must be in good shape. Robt. G. Starrett, Sheldon, Iowa.

FOR SALE OR TRADE—3 WD-12 Brand new Radiotrons, \$14.00. Want Filament Voltmeter and Aerial Ammeter. Thermo preferred, write what you have. Fay Allarding, Lake Odessa, Mich. R1.

ONE NEW mounted Acme 200 watt plate transformer, \$12; One new mounted Acme 75 watt Filament transformer, \$8; One Faradon UC-1831 Variable Transmitting Condenser, \$3. 3KO Paul Kern, 1030 N. 10th St., Reading, Penna.

GREBE CR 13 and RORK—Perfect condition, \$95.00; RC large iron core choke UP 1654, \$12.00; General Radio Antenna Meter 1-7, \$5.00. Richard A. Donnelly, 2CPD, Brielle, N. J.

METER BARGAINS—Brand New Jewells for panel mounting, 1-0-3 Thermo-ammeter, \$8.00; 1-0-15AC Voltmeter, \$5.00; 1-0-2000 DC Voltmeter, \$20.00; 1-0-500 Milli-Ammeter \$5.00; 1-1100 volt center tapped plate transformer filament winding, 250 watt, \$10.00; 1-Jefferson Stepdown trans. any voltage up to 30, \$5.00; 2-New 5 Watt Tubes, \$4.00 each; 3-New 25 volt Exide "B" Batteries, \$8.00 Each. Cash with all orders. Money refunded if orders sold out. Prepaid anywhere U. S. or Canada. WINNINGHAM, 222 North Mission, WENATCHEE, WASHINGTON, 7ZI.

SELL—Grebe CR3A 150 to 375 meter relay receiver, \$25.00. 8BMV-419 North Euclid Ave., Pittsburgh, Penna.

FOR SALE—Factory condition. One Grebe CR8 Receiver, one Rork amplifier, one Rork radio frequency input with coils. KFO has been heard from New Jersey with this set. \$115.00. Chas. E. Jacquart, South River, N. J.

WANTED—Motor Generator, 500 volts about 200 watts Motor 110 volts, 60 cycles. Lester Landt, 1513 Belmont, Chicago. Radio 9ASK.

MUST SELL: Three circuit regenerative, Kellogg variometers, coupler, Detector, two stage amplifier. Perfect condition. 150-600 meters, \$90; Single circuit Regenerative, CR-9 circuit, Bank wound 150-3100 meters, Detector, two stage amplifier. Fine condition, \$90. Brand new Magnavox two stage power amplifier due to lack of power this used but twice, \$50. G. E. ER753 crystal receiver 150-700 meter, \$12. Joseph Schindler, 116 Rebecca Avenue, Scranton, Penna.

30 HENRY CHOKES, Capacity .75 amperes, \$15. R.C.A., UL1008, Inductances, \$7.50. 3PZ.

D.T.W. SUPER PHONES for real DX. Adjustable pole pieces, adjustable leather covered headband. The most perfect fitting receiver in the world. Wear them all night and get some real DX. Price \$5.00; Parcel Post prepaid. Tilley Radio Corp., 311 Woolworth Bldg., Providence, R. I. Order by mail or thru IGV.

A BARGAIN—Western Electric Loud Speaker with power amplifier and new 1C8 volt B Battery. Just like new. Cost \$176. First \$100 buys it. Hennessee & Reese, Melbourne, Iowa.

15 PERCENT DISCOUNT on standard apparatus. New 50 watt radiotrons, \$20; G.E. motor generator, 650 volts, \$30; Magnavox two stage amplifier with tubes, \$40; plate glass insulators one foot long, 75¢; lead-in Panes, 2 1/2 sq. in.; Acme R.F. transformers, R-2, \$3.75. All apparatus guaranteed. SDDA, Box 902, Canton, N. Y.

WANTED IMMEDIATELY—Parts for 100 watt transmitter. Louis Bruchiss, 2164 Lincoln Ave., Chicago, Ill.

SELL TRADE—Radio Apparatus Co's Undamped Receiver, \$25.00 720 cycle hundred watt Motor-Alternator. \$30.00 Want Milliammeter. Russell Huckstep, Lebanon, Indiana.

SET OF HAWKIN'S Guides, Five Dollars. Albert Presley, Vaughan, Miss.

NEW 200W 500V EMERSON motor-generator; new Acme 1 k.w. transformer; Acme 500v 200w plate transformer. Filament winding; Paragon 10w phone, new; \$161 Western Electric loud speaker; DeForest D-7A reflex receiver. Best offers, prefer cash. Verner Hicks, Marion, Ill.

IVORY RADIO PANEL—White pyralin ivory makes the most beautiful set of all. Guaranteed satisfactory. Any size 1/8 inch thick. Three cents per square inch. Sample sent. E. P. Haltom, 614 Main Dept. T, Fort Worth, Texas.

SELL-DUBILIER .007 21,000 volt condenser, \$12. Acme 1KW transformer, \$10. Write 2WZ.

SELL—Colt .45 calibre Army Automatic, \$25; Luger .30 Calibre Automatic, \$30; Perfect Condition. 8AQO.

100 METER coil and complete data for Reinartz Circuit. Postpaid \$1.50. Superior Coil Co., Harwichport, Mass.

SELL—1/2 KW 500 cycle alternators, \$70; 1/4 KW Ditto, \$25; GE 150V 400W Generators, \$35; RCA 750W Transformer, \$22.50; 5000V 1KW Transformer, \$27; 4WE Peanut Tubes, \$-; UV204A's, \$135; UV203As, \$32.50; UV206s, \$125; UV203s, \$23; C O D Quarter Cash. Edward Page, Baldwinville, N. Y. 8AQO.

FOR SALE—One Murad T-11 R. F. Transformer, \$4.00. Also one FILKOSTAT, \$1.50. U.B.C., 1001 Woodrow St., Columbia, S. C.

WANTED—Portable Typewriter. Sell: Amrad short Wave Tuner with Grid Load Coil, \$25; 50 watt Tube, \$12; 5 watt Tubes, \$5; 32-350 V Dynamos, \$15; DC-AC Rotary Converter, \$15; Natrometer, \$15; Omnigraph, \$10; Weston, 0-10 Ammeter, \$4; 10 Amp. Rheostat, \$3; DeForest Condenser, \$4, 2CYU. F. Mann, Sea View Hospital, Staten Island, N. Y.

REINARTZ and one step in Cabinet. Guaranteed, \$20. Roland Place, 350 Sprague St., Fall River, Mass.

PULMOTOR SERVICE FOR EDISON Bs. Do the cells choke up with salt crystals? Have the connecting wires turned green and rusted off at the joints? Does it hold a charge like a sieve? It wasn't made at radio 8ML. Just needs a shot of A-N-D-R-A-L-I-N. Write quick. Radio 8ML, 4337 Rockwood Road, Cleveland, Ohio.

LAST CALL! My brand new "Advance" Clark Rect. for \$25. Never used. 8BQB.

RUN A RADIO TUBE Exchange—We start you. Save your customers 25% and you make 25%. We sell—at 50% off. Tube and Batteries are the only renewals, several times per year for every set. A Radio tube Exchange makes \$100 to \$300 per week clear profit. Our Catalogue and book of instruction cost us 50¢ to produce. It is full of information, business hints, ads, etc. We will send our book at cost and deduct the amount if you go in to this best paying branch of radio. Radio Tube Exchange, 453 Washington St., Boston, Mass.

SELL—Five watt rectified AC CW transmitter. Sixty five dollars. Archie Schultz, Clarkston, Nebr.

FOR SALE—Transformer U.P. 1368—1100 volts, centre tap, \$15.00; Filter Choke U. P. 1653, \$10.00; 5 watt Kenotrons used 3 hours, \$5.00. 2CPV, 58 East 94th, N. Y. C.

WANTED—United Wireless Coffin, two Dubilier 25,000 volt .018 or .01 Condensers. Write 2WZ.

HAMS—GET our prices and samples on Printed Call Cards, Envelopes, Letterheads and Radiograms. HINDS & EDGARTON, Radio Printers, 19 S. Wells St., Chicago, Ill.

FOR SALE—1 KW "Sinc" Spark Transmitter used by I-CIB and myself, Type R Thordarson Transformer. Will sell or swap for CW. What have you, OM? All cards answered. I-LY, Yarmouthville, Me.

FOR SALE—Edison 6 1/2 volt, 225 amp. Battery fully charged, \$40; No. 2 Jr. Omnigraph, \$15; DeForest 43 plate vernier condenser, cost \$16, sell \$10; Magnavox Type Loud Speaker, \$20; everything perfect condition. Lowrey, 326 High St., Watertown, N. Y.

PARAGON RA 10 with Radio Electric Detector and two step. Forty dollars, or trade for Western Electric non power Loud Speaker, E. W. Lamparter, South Sixteenth, Independence, Kansas.

LITZ WIRE green silk two cents per foot. Postpaid. Superior Coil Co., Harwichport, Mass.

SAVE MONEY on your radio apparatus. Our profit-sharing gives you all nationally advertised radio apparatus at a price that must interest you. Transmitting and receiving apparatus, meters, wire, batteries, tubes and all standard makes of complete sets. Prompt replies to all inquiries. Brand new, no seconds. We pay transportation. Jack Ross, Clayton, New York. DA DIT DA.

SELL—One Omnigraph with twelve dials. New and used parts. Write Albert Krug, Gardner, Illinois.

SILVER NICKEL—Nickel plated iron—only another way of spelling T-r-o-u-b-l-e. For a lifetime B wire your Edison elements with 99% purest solid (not plated iron) No. 20 soft drawn nickel wire. 1½¢ foot prepaid. Who told a lie? Then why use it in your Edison B? Genuine Edison Electrolyte \$1.50 5 lb. can. Radio 8ML, 4837 Rockwood Rd., Cleveland, O.

TELEGRAPHY—Morse and Wireless—taught at home in half usual time and at trifling cost. Omnigraph Automatic Transmitter will send, on Sounder or Buzzer, unlimited messages, any speed, just as expert operator would. Adopted by U. S. Govt. and used by leading Universities, Colleges, Technical and Telegraph Schools throughout U.S. Catalog free. Omnigraph Mfg. Co., 16M Hudson St., New York.

HAMS WHO DESIRE SPEED—a moment's attention. Brother Ham whose limit was 15 words doubled his speed in One Evening. Send your Call and ask for the facts as told by himself. Dodge Radio Shortkut, Dept. SC, Mamaroneck, N. Y.

BARGAINS—For that Storage B battery—Largest size Edison A battery Elements only 4¢ per pair. \$29.50 Edison A-6, 225 amp. hour cells for only \$15.00 each. Everything in first class condition. We carry a complete line of radio supplies; write us your needs. Triumph Electric Co., Inc., Sheffield, Ala.

FOR SALE—One Acme Modulation transformer, \$25.00; One R.C.A. Radio Frequency transformer, U.V. 1714, \$15.00; Four 5 watters @ \$5.00, never been used; One 2 stage amplifier, \$25.00; One Thordarson C. W. Filament transformer 8 volt secondary. 8BBF.

SELL—Brand new French tube 50 watts output, \$15.00; reason higher power, Reinartz tuner, \$10.00; 1/5 H.P. Induction motor, \$12.00. 2CUZ.

EDGEWISE WOUND Copper Ribbon ¼ inch wide 6 inch diameter 15¢ turn, any number turns one piece. Remler Giblin Coils mounted 25-75-100-150-200-300-400-500-600-750-1000 turns, half price. Genuine Silicon Transformer steel, cut to order, 25 cents pound, 10 lb. and over, 4 cubic inches to lb. Postage extra. Geo. Schultz, Calumet, Mich.

TWO NEW TYPE S tubes in original sealed cartons, \$8.00; Two Mershon Condensers, never used, \$6.00. A. E. Alger, Lorain, Ohio.

BARGAINS—Acme 75 Watt CW Transformers, \$10.00 only few left. Wroklrite Neutroformers, \$5.00 set VAN BLARICOM, Helena, Mont.

SELL—Few new W.E. 50 watters, \$27. each. Signal Corps 30 to 350 volts D.C. dynamotor, \$12.00; W.E. Peanut tubes, \$4.75. 2BYJ.

EVENTUALLY you will own a Neutrodyne, why not now? Fada 4 tube, \$80; Freed-Eisemann 5 tube, \$97.50. Tully Battery Co., Tully, N. Y.

200 WATT PLATE Transformer. Voltages 750, 1000, 1200, either side of center, \$11. Roller Smith Milliammeter 0-100 \$5.25. Other Stuff. 2 CNH.

FIVE HUNDRED CYCLE, one kilowatt, motor generator for sale. Complete with voltmeter, frequency meter and transformer. Kenneth W. Clark, Winchester, Ind.

FREE DIRECTIONS for constructing home built Radio with two thousand mile receiving range. Send self-addressed stamped envelope. Maitland Roach, 2905 Columbia Ave., Philadelphia, Pa.

FOREIGN COMMERCIAL STATIONS. Copy the Transatlantic Press. Set of three 1250 and 1500 Giblin Remler Coils, special \$7.50, postpaid while they last. PHILADELPHIA WIRELESS SALES CORP. 1533 Pine St., Phila.

ONE DEFOREST OT-3 Midget Transformer, Price \$100.00, Our Price, \$35.00; Four Weston Thermo. Ammeters, Range 1.5 amps., Price \$17.50 each, our Price, \$13.00; One Weston Thermo-Galvanometer, Range 115 Milliamps, Price \$18.50, Our Price \$13.50. Cash with order. H. B. Shontz Co., Inc., 161 West 64th St., New York City.

FOR SALE—80-330 meter receiver det.; 1 step complete with 80 amp. storage; 2 "B" batteries; 2 C301-a

tubes and 1 pair fones. Also 5 watt CW 1CW fone transmitter complete with RCA helix; 16 jar rectifiers Federal condensers and microphone. Receiver \$60, Transmitter \$40. 8DBT, 41 Prospect St., Ashtabula, Ohio.

FOR SALE—Navy Receiving Sets CN240, \$50.00; Navy Transmitting Sets CN100, \$125.00. Detailed information on request. Milton Cone, Box 1558, Richmond, Va.

CHEMICAL RECTIFIERS everything to build them Lead, Aluminum, Soluton, Test Tubes, and Racks. Write for particulars. Dell Richardson, Round Lake, Ill. 9EB1.

A NEW METHOD of making and calibrating a wavemeter at home, makes it easy. No calculations or guesses. Send 10¢ for instructions. R. M. Moore, North Fourth Ave., Tucson, Ariz.

V.T.1—now made in Canada and known as 203B, with improved 5000 hour filament. Finest detector in the world. Ask any old timer. Postpaid \$9.50. Western Electric "N" tubes \$4.25; Myers with mounting clips, either type \$3.75; Genuine Marconi V.24s \$7.50. Cash with order. Reliance Garage, Canora, Sask. (Can.4CE.)

GREBE CR9 practically new, \$75.00. Harry W. Thomson, 1909 3rd Ave., North, Seattle, Wash.

FOR SALE—Autoplex receiver, \$20.00. 1-Long wave loose coupler, tapped primary and secondary \$5.00. C. A. Moore, 248 S. Balch St., Akron, Ohio.

FOR SALE—1 Acme Detector and 2 Step, \$25.00; 1 complete set of DeForest parts for Honeycomb regenerative Set including 13 Coils, \$45.00 W. E. Van Vallenburg, 1005 So. 17th St., Fort Dodge, Ia.

WRITE FOR prices on the parts you need for that new set. Hoosier Radio Supply Co., 816 Johnson, Gary, Ind.

FOR SALE—Esco motorgenerator 1500 volts 600 watts with field rheostat for panel mounting brand new, never used, \$200. Ten watt C.W. and fone set all complete in cabinet and panel mounted antenna ammeter, 0 to 5 plate milliammeter, 0 to 250 Jewell meters; set can be used with any D. C. source plate supply, \$75. Kennedy receiver 281 @ \$95; Power transformer U. P. 1016 @ \$25; Magnetic modulator 1367 @ \$10; Omnigraph @ \$18; 3 tube sockets for 50 watters @ \$1.75 each; rheostat P.T. 537 @ \$5.00; Grid Chopper PX 1368 @ \$4.50. No trades considered must have cash. Every article guaranteed A No. 1 condition. 8BCA.

ATTENTION!! New tubes, any make 5 watters, \$6.95; Detectors, Amplifiers, \$4.35. Other apparatus 15% off list. E. M. Darter, 3015 Boulevard Place, Indianapolis, Indiana.

SEVERAL 50 WATTERS \$13 each; 1-250 watter, \$42; Radio Corporation tubes, excellent condition. B. Vail, 1761 State St., Schenectady, N. Y.

FOR SALE—250 Watt 500 Volt ESCO Motor-generator \$70.00; Grebe CR5 \$45.00. Both in A1 condition. L. S. Hutton, 125 E. Market St., Warren, Ohio.

HAM RECEIVER—100-300 meters, two-step audio with two tubes, \$38.00. Write 9COV.

FOR SALE—Grebe CR6, Sixty dollars; 4 W.E. type E 5 watters, perfect, five dollars. 8BTO.

SCHNELL USED Cardwell condensers in the set with which he worked French 8AB. There's a reason. Cardwell transmitting condensers, 3000 volt, .00045 Mf. maximum capacity, 43 plate, now obtainable from us. Price \$15.00. Cardwell receiving condensers; 11 plate, .00025 mfd., \$4.25; 17 plate, .00035 mfd., \$4.75; 21 plate, .0005 mfd., \$5.00; 41 plate, .001 mfd., \$6.00. ALSO General Radio type 247 W wavemeter and filter, \$10.00. Write for quotations on other instruments. Herbert Isaacson, 515-80th St., Brooklyn, N. Y.

SEVERAL 50 WATTERS \$13 each. 1-250 watter \$42. Radio Corporation tubes, excellent condition. B. Vail, 1761 State St., Schenectady, N. Y.

PORCELAIN INSULATORS—(QST No. 6) only 90¢. Why pay more? Lorain Radio Supply Co., Lorain, Ohio.

ALWAYS MENTION QST WHEN WRITING TO ADVERTISERS

REINARTZ ONE TUBE. Heard west coast regularly, \$12; 2 CNH.

WESTERN ELECTRIC 10A. loud speaking outfit cost \$161, sell \$105; complete. Grebe CR5 and 2-step cost \$125, sell \$75. Also lot of receiving parts. Jacob G. Harden, Greenwood, Ind.

UNUSUAL BARGAINS—Navy 5 watt fone sets. Original cases. Complete with dynamotor, transmitter for fone, cw, low, two microphones, keys, tubes, etc. Very compact and operates on 12 volt battery, \$75. General Electric 350 volt .143 ampere dynamotors for 12 volts \$18, with filter. Excellent condition. Following brand new. General Electric 1500 volt dynamotors .233 ampere for 24 volt supply \$45; Holtzer-Cabot 500 volt .07 ampere for 12 volts; \$22. Any of above adapted for belt drive \$3. additional. $\frac{1}{4}$ Crocker-Wheeler new self excited 500 cycle generators \$22.50 $\frac{1}{2}$ KW used \$20, with motors \$65.00. Flame proof lvs with blinker light \$1.50 UV 203A tubes \$30. Henry Kienzie, 501 East 84th Street, New York.

WANTED—Large Size Omnigraph, State model, price and condition. C. L. Jaren, Barrett, Minn.

Q R A SECTION

50c straight, with copy in following form only: CALL—NAME ADDRESS. Any other form takes regular HAM-AD rates.

Canadian 1DU—Chas. & Jos. S. MacDonald, Box 458, Bathurst, N. B., Can.

1AQB—E. L. Johnson, 23 Owen St., Hartford, Conn.

1XAR-1BDT—Sheldon S. Heap, 132 Atlantic St., Atlantic, Mass.

1ZD es 1CAK—John M. Wells, 40 Main Street, Southbridge, Mass.

2ALZ—William C. Poole, Qtrs. Post Surgeon, Mitchell Field, Hempstead, Long Island, N. Y.

2CM—Cornelius C. Vermeule, Jr., 63 Harrison St., East Orange, N. J.

Can. 3GV—A. G. Simmons, 92 James St., Ottawa, Ont.

Canadian 3GG—M. J. Caveney, Lat. 48, Long. 81 near TIMMINS, Northern Ontario, Canada.

3SJ—Arthur Bennet Cochrane, 317 Main Street, Crisfield, Maryland.

4HV—Herman E. Kennedy, Cumnock, North Carolina.

4KW—W. Mulford Marsh, 1654 College St., Jacksonville, Florida.

5AKX—Durward J. Tucker, Wolfe City, Texas.

SBS—Frank G. Atwater, 406 West Main St., Houston, Texas.

SUP—G. C. Coleman, 605 S. 66th St., Birmingham, Ala.

6AAJ—1356 Vancouver Ave., Burlingame, Cal.

6ANQ—Harold Whitney, Route A, Box 406, Hemet, Calif.

6DO—Norman A. Woodford, 440 Tenth Street, Richmond, Calif.

6UR—Herbert C. Colburn, 448 Dowling Blvd., San Leandro, Calif.

8AEJ—C. W. Morgan, 908 W. Bridge St., Grand Rapids, Mich.

8DNL—Kenneth McConnery, Lisbon, Ohio.

3CFM—John H. Botbyl, 514 Monroe St., Grand Haven, Mich.

SDNQ—Frank F. Babb, 1307 S. Fountain Ave., Springfield, Ohio.

9AAQ—O. P. Stufflebeam, 1419 Logan Ave., Marinette, Wisconsin.

9BHY—Leonard P. Megginson, 28 Orchard Ave., Webster Groves, Mo.

9BUV—Joe Somers, 1804 Vermont Ave., Connersville, Indiana.

9BZJ—Jos. L. Fjelde, Madison, Minnesota.

9CSI—Martin L. Monson, Grafton, North Dakota.

9CVM—Power 2 Watts, Reassigned to Jerome Kitterman, Batavia, Iowa.

9DLX—Chester C. Jones, 1130 Tennessee Street, Lawrence, Kansas.

9DZQ—John Saxton, 4644 Maryland Ave., St. Louis, Mo.

YOUR OWN Name, Address AND STATION ON CALL CARDS STATIONERY OR RADIOGRAMS

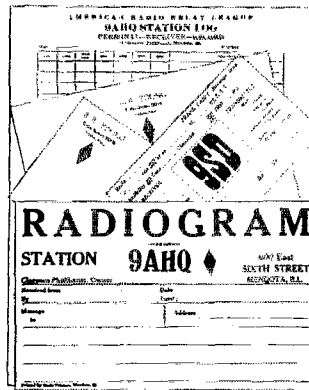

Be individual. Be up-to-date. Enjoy these neat and stylish conveniences made especially for YOU. Good quality materials — highest class workmanship. Very low prices.

MONEY REFUNDED
If Not Thoroughly satisfied.

A.R.R.L. Emblem Used Where Requested by Member.

Special! Special! Call Cards:

Red Call, black printing. High quality, neat typography. Latest design. 100 only \$1.75; 200

\$2.75; 500-\$3.60. PREPAID. Government post cards 1c extra per card. Blue, green or brown call 25c extra. These save time and bring many replies.

RADIOGRAMS:
Printed in black on good quality sanary colored bond paper. The kind all amateurs enjoy receiving. They give your messages personality. Get these now. 100 only \$1.75; 200-\$2.75; 300-\$3.60. PREPAID. Glued in pads 25c per hundred extra. These are all the rage.

LETTERHEADS and ENVELOPES:
Good quality clear white smooth surface bond paper—exact kind we use on our own business and personal stationery. Black printing. Neatly arranged to please and be appropriate for amateurs. You will be more than pleased. Letterheads 5 1/2 x 5 1/2. Envelopes 6 1/2" long. 100 of each only \$2.25; 200 of each only \$3.25; 300 of each only \$4.25 PREPAID. Double lengths 8 1/2 x 11 for 25c per hundred extra. Individual radio stationery gives you prestige and makes you envied by your friends. You can't afford to be without your own stationery at these low prices.

LOGS (a Personal Receiver Record):
All amateurs say these Logs are not only a luxurious convenience but a necessity. They can't get along without them. Ideal to save or to mail to your friends. Each sheet contains your name, address and station. Separate columns for the call, time received, remarks and other desired information. Printed on good quality bond paper. 100 only \$1.75; 200-\$2.75; 300-\$3.60 PREPAID. Glued in pads 25c per hundred extra. Once you use these you will never be without them. Send order with check or money order today—NOW

RADIO PRINTERS, Dept. 14, Mendota, Ill.

—FOR YOUR CONVENIENCE—

QST'S INDEX OF ADVERTISERS IN THIS ISSUE

Acme Apparatus Co., The.....	85	International Correspondence Schools.....	104
Adams-Morgan Co., The.....	79	Jefferson Elec. Mfg. Co.....	90
Alden Mfg. Co., The.....	84, 90	Jewell Elect. Instrument Co.....	80
Allen-Bradley Co., The.....	66, 112	Kellogg Switchboard & Supply Co.....	69
American Hard Rubber Co.....	89	Kilbourne & Clark Mfg. Co.....	65
American Radio Mfg. Co.....	86	Kimley Electric Co.....	82
American Radio & Research Corp.....	4th Cover	Lincoln Mfg. Co.....	98
American Transformer Co., The.....	76	Magnavox Co., Inc.....	95
Amsco Products, Inc.....	100	Marie Engineering Co.....	92
A.R.R.L. Application Blank.....	88	Martin-Copeland Co.....	86
Atlantic & Pacific Radio Co.....	96, 102	Milwaukee Radio Club, Inc.....	78
Ayres Battery Corp.....	82	Murdock, William J.....	86
Bakelite Corporation.....	64	Myers Co., Ltd., E. B.....	78
Ballard, R. C.....	100	National Co., The.....	94
Bechberger & Co., P. F.....	90	National Carbon Co., Inc.....	60, 61
Boonton Rubber Co.....	2	National Elec. Supply Co.....	94
Branston & Co., Chas. A.....	75	Newman-Stern Co., The.....	96
Bristol Co., The.....	84	Ott Radio, Inc.....	98
Bunnell & Co., J. H.....	84	Post Electric Co.....	72
Burgess Battery Co.....	59	Premier Elec. Co.....	94
Burton-Rogers Co.....	103	Radio Corp. of America.....	1
Cardwell Mfg. Corp., The Allen D.....	99	Radio Instrument & Panel Co.....	102
Chelsea Radio Co.....	70	Radio Printers.....	110
Chicago Salvage Stock Store.....	104	Radio Tube Exchange.....	86
Connecticut Telephone & Electric Co.....	3rd Cover	Rauland Mfg. Co.....	98
Conrad Co., The.....	94	Roller-Smith Co.....	92
Coto-Coil Company.....	58	Rose Radio & Elec. Supplies.....	82
Crosley Mfg. Co.....	62, 68	Rusonite Products Corp.....	92
Cunningham, E. T., Inc.....	2nd Cover	Shamrock Mfg. Co.....	96
Cutler-Hammer Mfg. Co.....	76	Signal Elec. Mfg. Co.....	74
CutRate Radio Co., The.....	104	Sta-Rite Battery Co.....	102
Diamond State Fibre Co.....	74	Stromberg-Carlson Telephone Mfg. Co.....	90
Dubilier Condenser & Radio Corp.....	105	Thordarson Elec. Mfg. Co.....	97
Durham & Co.....	72	Troy Radio Co.....	100
Eisemann Magneto Corp.....	77	U. S. Tool Co.....	102
Electric Specialty Co.....	98	Vesco Radio Shop.....	104
Electric Storage Battery Co., The.....	87	Western Coil & Electrical Co.....	80
Endly, C. C.....	104	Westinghouse Elec. & Mfg. Co.....	101
Fansteel Products Co., Inc.....	72	Westinghouse Union Battery Co.....	31
Federal Tel. & Tel. Co.....	84	Weston Electrical Instrument Co.....	68
Fleron & Son, Inc., M. M.....	70	Whittlesey Engineering Corp.....	98
France Mfg. Co., The.....	74	Y.M.C.A. Radio School.....	82
Freed-Eisemann Radio Corp.....	71	Zenith Radio Corp.....	67
Freshman Co., Inc., Charles.....	76		
Frost, Hebert H.....	82		
General Electric Co.....	91		
General Radio Co.....	73		
Goldschmidt Corp., Th.....	53		
Gray & Doane.....	100		
Grebe & Co., A. H.....	4		
HAM ADS.....	106 to 110		
H & H Radio Co.....	68		
Hommel Co., Ludwig.....	78		
Hartford Instrument Co., The.....	88		
Heath Radio & Elec. Mfg. Co.....	104		

ALWAYS MENTION QST WHEN WRITING TO ADVERTISERS

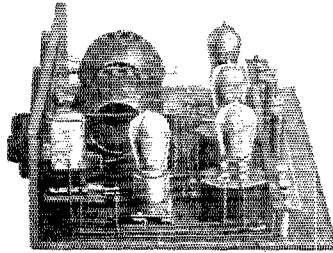
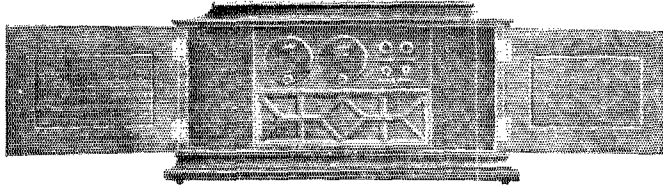

Amrad Radio Unit, removed from Console Cabinet, to show Bradleystat and Bradleyleak mounted in front of detector tube

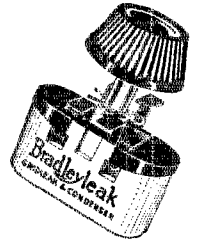
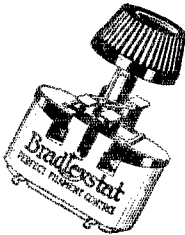

Amrad Adopts Both Bradleystat and Bradleyleak!

The Amrad Jewel—Italian Renaissance Period Art Model
Is Now Equipped With Ultra-Fine Tuning Control

ALL of the more expensive Amrad receiving sets, including the beautiful Jewel Console models, are now equipped with Bradleystats and Bradleyleaks! The noisy wire rheostats have given way to the noiseless Bradleystat. The old type of grid leak is replaced by the stepless Bradleyleak. The perfect filament control of the Bradleystat means greater range and louder reception. The stepless grid leak adjustment of the Bradleyleak, from $\frac{1}{4}$ to 10 megohms, means higher tube efficiency.

The Console models, with self-contained loud speaker, battery compartment, and highly perfected tuner, are made more selective with the ultra-fine filament and grid control, so essential for long range reception.

YOUR radio receiving set will afford new possibilities and new thrills if equipped with Bradleystats and Bradleyleaks. Many radio dealers replace the wire rheostats of ready-built sets with Bradleystats, and they invariably recommend them to set builders who seek the best in radio.

The Bradleyleak has the endorsement of Amrad, Flewelling, Kennedy, Crosley, Clarkson, Cockaday, and other radio engineers. It is pronounced "the perfect grid leak" by all users.

Get the benefit of the graphite disc design by avoiding all substitutes. Carbon or metallic powder was abandoned, years ago, as impractical and unreliable. Insist that your dealer supply you with the genuine Bradleystat and Bradleyleak.

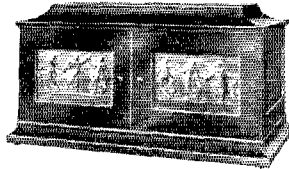

Send for the latest bulletins
on closer tuning and perfect
grid leak control

Allen-Bradley Co.
Electric Controlling Apparatus

277 Greenfield
Ave.



Milwaukee,
Wis.

There is no substitute for
the scientifically-treated
graphite discs

THE ALLEN-BRADLEY CO. HAS BUILT GRAPHITE DISC RHEOSTATS FOR OVER TWENTY YEARS

Triple Range

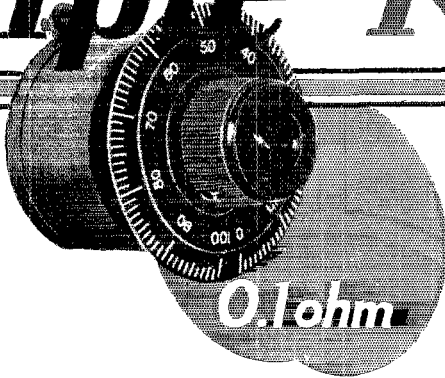

**Low
Loss**

The True Measure of Efficiency

0.1 ohm is the resistance of the
**CONNECTICUT
D-10**

Triple Range Variable Condenser

at a capacity of 330 micro-microfarads on a wave length of 215 meters.

This is a statement that means something.

Those who know that the losses of a condenser are in direct proportion to its resistance—

Those who have learned that measurements taken at radio frequency are much more valuable than those taken at audio frequency—

Those who can see the importance of judging the efficiency of a condenser for amateur and broadcast work on results obtained at a frequency in the immediate vicinity of that at which it is to be used—

Will see in the above the real reason why this condenser should be used by all who wish to obtain the greatest degree of signal strength and sensitivity from their receiving equipment.

Three Condensers in One

These three ranges of capacity enable it to take the place of the ordinary eleven, twenty-three and forty-three plate instruments.

The chart tells the story—

The range indicated by Curve B—from .000075 to .000275 mfd.—approximately that of an eleven plate condenser, is secured by wiring into the circuit from posts G and B.

The range indicated by Curve A—from .0001 to .0006 mfd.—approximately that of a twenty-three plate condenser, is secured by wiring into the circuit from posts G and A.

The range indicated by Curve AB—from .00015 to .00085—approximately that of a forty-three plate condenser is secured by bussing A and B and wiring into the circuit from G and B.

**FEATURES: Vernier Scale—Complete Shielding—Compact size
And all the convenience that goes with One-hole Mounting**

PRICE \$4.50

Complete with dial, index stud, spacing washers and buss bar.

Send for Bulletin A-104 describing this unique instrument, with information and diagrams illustrating its special applications.

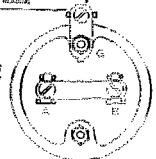
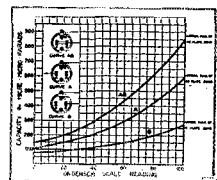

AMRAD

"S" TUBE RECTIFIER -- What Takes Place In The Tube

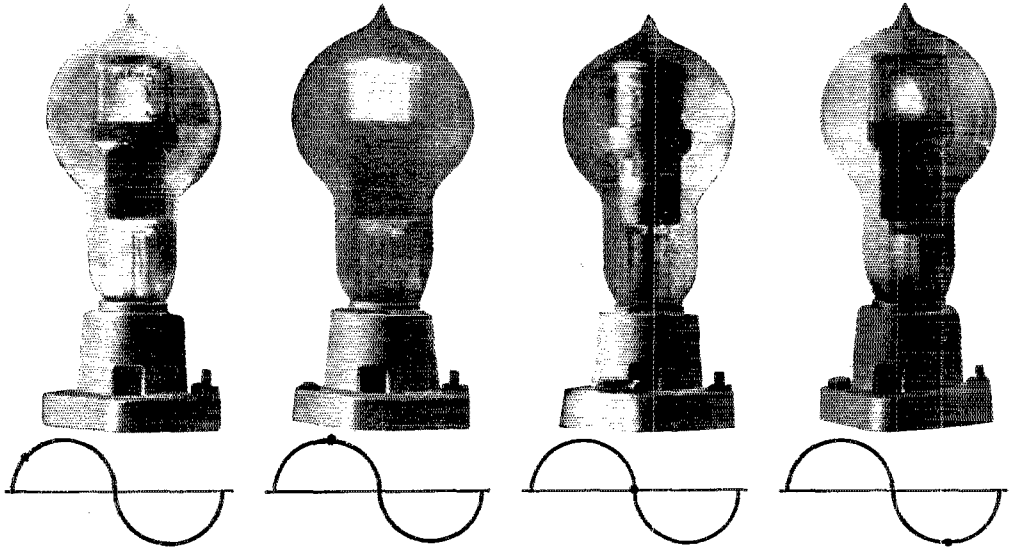

FIG. 1.

TUBE JUST BEGINNING
TO CONDUCT
FORWARD DIRECTION

FIG. 2.

TUBE IN FULL
CONDUCTION
FORWARD DIRECTION

FIG. 3.

TUBE AT 0 POTENTIAL
NO CONDUCTION
EITHER DIRECTION

FIG. 4.

TUBE AT REVERSE
POTENTIAL SHOWING
LEAKAGE CURRENT

The above Laboratory photos show what actually takes place inside the rectifying "S" Tube. The small spot on the sine curve below each view shows the point on the AC wave at which the photo was taken.

The glow in Fig 4, although apparently quite bright, is due to the negligibly small reverse current—which is less than 3 milli-amperes irrespective of the voltage and value of the forward current.

The "S" Tube used was the standard AMRAD No. 4000, excepting only that a specially constructed cathode of gauze was utilized to permit photographs being taken. A small amount of neon was added to the helium within the tube to give a brilliant red glow. A panchromatic film, sensitive to red light, was used to record the discharge image, and a specially designed shutter running at synchronous speed with the AC supply, served to catch the discharge at the desired points of the cycle.

IDEAL FOR AMATEURS

"S" Tubes find ready application in radio transmitting circuits, in charging Storage "B" Batteries, and wherever DC is desired under conditions requiring dependable performance. The "S" Tube has no filament to burn out.

Write for descriptive Bulletin J-2

AMERICAN RADIO AND RESEARCH CORPORATION
205 College Ave., Medford Hillside, Mass.
AMRAD Dealers in Principal Cities and Towns

The Traffic Department

F. H. Schnell, Traffic Manager
1045 Main St., Hartford, Conn.

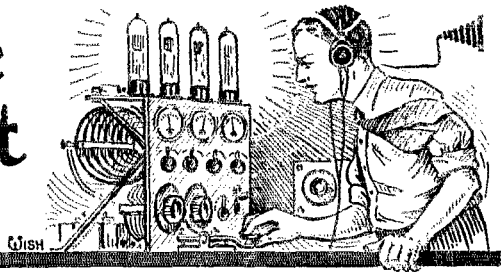

The activity reports of the many men of the Traffic Department have reached such volume that it is going to be necessary to confine reports more toward traffic routes and messages handled. A good example of how the traffic routes will be shown is given on page VI of March *QST*, where the routes of Iowa are clearly defined.

We must eliminate this mention of so-and-so is now using "a ten watt" set when really what is meant is two five watt tubes. The small town gossip must be cut out and we are to get down to organization during the coming months.

Each state will have a general resume of conditions throughout with the traffic routes when possible. Space in *QST* is fearfully limited and there isn't one half enough pages to cover everything in detail—hence general reports will be the thing. Your individual reports will continue as in the past to your D.M. but a concise report will be made up for *QST*. Watch this, fellows, and lend a hand toward bringing this about as quickly as possible. A good idea of the activity of a station can be gained from the individual traffic figures which will appear in the usual manner. We want nothing but the snappy news of general interest to all in the future.

TRAFFIC REPORTS FROM A.R.R.L. OFFICIAL RELAY STATIONS

ATLANTIC DIVISION: 8LQ, 387, 8APT, 30; 3MF, 28; 3PH, 25; 3WF, 94; 8DQ, 14; 3HG, 57; 3SE, 30; 3EH, 12; 3RWJ, 60; 2CGK, 7; 3BBL, 30; 3HS, 180; 3RSB, 18; 3RWT, 9; 3PZ, 49; 2BRB, 114; 2CHY, 53; 9CJR, 10; 2PF, 4; 2BO, 35; 2CPQ, 127; 2WZ, 73; 2CLA, 47; 2ABN, 22; 2DL, 11; 2CDE, 10; 2WC, 6; 2CLW, 2; 2CWO, 3; 2WZ, 8; 2RKG, 1; 2CRQ, 218; 2CYX, 96; 2CNO, 72; 2PZ, 31; 2CVX, 18; 2CWR, 7; 2EE, 6; 2KR, 55; 2CSL, 79; 2DI, 18; 20HK, 26; 2XNA, 38; 2KX-2AB, 72; 2ACS, 64; 8AVJ, 59; 8APU, 12; 2AWE, 37; 2TS, 84; 2ADJ, 12; 2CAJ, 10; 2AGC, 2; 2BQU, 40; 2ONH, 33; 2CTN, 28; 2BCK, 16; 2BNC, 4; 2AVE, 4; 2GSX, 3; 2CXB, 20.

ATLANTIC DIVISION: 8CDI, 138; 8ROY, 53; 8AKI, 80; 8DY, 28; 8AOX, 116; 8RED, 10; 8FX, 25; 8AGO, 60; 8DGE, 12; 8AIG, 58; 8DIP, 8; 8BGZ, 12; 8AEY, 6; 8CTE, 7; 8ADS, 58; 8CCK, 138; 8BYI, 87; 8QC, 46; 8CMN, 62; 8AVU, 7; 8YV, 10; 8ALF, 31; 8BJV, 92; 8ABS, 208; 8BDU, 6; 8RKY, 34; 8AAF, 11; 8BBP, 23; 8DBL, 77; 8WR, 3; 8BRM, 6; 8BJA, 16.

ATLANTIC DIVISION: 8AEN, 14; 8BOB, 22; 3ZS, 6; 8GC, 21; 8CJN, 58; 8BAQ, 13; 8EN, 2; 8RNU, 26; 8TS, 17; 8LK, 24; 8AVM, 53; 8YO, 117; 3ZO, 254; 3CHG, 44; 3AVU, 16; 3ACY, 21; 3CCX, 26; 3BBV, 10; 8BQ, 21; 8CDG, 42; 8BJL, 2.

CENTRAL DIVISION: 9CZL, 406; 9BRY, 292; 9CTF, 268; 9AAW, 267; 9AWQ, 201; 9DAY, 141; 9MC, 141; 9AIC, 134; 9EFQ, 124; 9TW, 117; 9AHQ, 116; 9CMC, 106; 9BUO, 104; 9ATT, 102; 9BUK, 99; 9AWU, 86; 9US, 84; 9BUH, 81; 9DHL, 81; 9LZ,

79; 9BHH, 77; 9DQU, 74; 9DVL, 72; 9AP, 72; 9AHH, 71; 9CA, 70; 9CSK, 68; 9BDN, 65; 9BYX, 64; 9ELB, 62; 9DKH, 62; 9CBS, 61; 9EAC-9AKA, 51; 9AMZ, 54; 9DGA, 51; 9DBP, 50; 9DYN, 50; 9COL, 48; 9CMN, 48; 9AMZ, 42; 9CXT, 28; 9ARM, 36; 9CRX, 34; 9BDA, 32; 9AD, 31; 9DLO, 30; 9CLJ, 29; 9CTT, 28; 9CXH, 27; 9EHQ, 27; 9BGC, 26; 9AQD, 25; 9AZJ, 23; 9DHQ, 23; 9CSW, 22; 9HTZ, 22; 9CD, 21; 9CFD, 21; 9CLX, 21; 9DWS, 20; 9DHC, 20; 9BFX, 20; 9BEG, 19; 9AX, 17; 9DVW, 17; 9DRC, 16; 9VK, 14; 9FBH, 14; 9ABB, 10; 9DWX, 10; 9BJT, 10; 9BZQ, 10; 9ALW, 10; 9DWB, 7; 9BTA, 4; 9BRE, 3; 9BWA, 2; 9AKU, 2; 9KD, 1; 8BYN, 636; 8GZ, 209; 8CHEY, 186; 8QK, 178; 8AK, 148; 8CKV, 131; 8EKN, 112; 8AGP, 108; 8DKM, 95; 8CXU, 92; 8WG, 90; 8CCT, 83; 8CWP, 74; 8BND, 70; 8DL, 69; 8BDM, 67; 8RN, 66; 8PL, 62; 8BCE, 51; 8CVD, 50; 8CRC, 49; 8CYZ, 48; 8BX, 40; 8BHO, 36; 8CNL, 33; 8COJ, 32; 8AAJ, 31; 8FU, 29; 8AA, 27; 8AJD, 23; 8AL, 22; 8BNZ, 18; 8CSK, 17; 8DDQ, 17; 8CIE, 16; 8BCF, 16; 8CZT, 15; 8BGH, 12; 8CMU, 11; 8RY, 8; 8TJ, 8; 8EF, 5; 8CQS, 47; 8CVM, 6; 8YV, 5; 8VX, 4; 8GD, 4; 8AVN, 4; 8BX, 4; 8CSL, 2; 8TJ, 10; 9BRK, 240; 9EAD, 51; 9AEP, 36; 9CYQ, 19; 9EID, 15; 9ES, 13; 9EJL, 11; 9BVZ, 9; 9BJR, 8; 9BOW, 7; 9UR, 4; 9AQJ, 2; 9AFY, 90; 9BJZ-9BER, 6; 9AZK, 56; 9CUL, 53; 9DYT, 48; 9DLW, 40; 9BON, 38; 9CIS, 29; 9YB, 27; 9ECL, 20; 9CP, 13; 9QR, 5; 9DHJ, 10; 9DCY, 200; 8YN, 132; 8DDT, 101; 8CED, 97; 8CPY, 92; 8CWX, 91; 8AZG, 80; 8BNC, 75; 8CZZ, 69; 8EHQ, 66; 8AJ, 52; 8MX, 51; 8AII, 50; 8CFQ, 47; 8ZZ, 46; 9CE, 44; 8CPT, 42; 8ZH, 37; 8ZF, 34; 8BDR, 33; 8BBO, 20; 8CYS, 17; 9BGO, 13; 8BQ, 12; 8DGC, 7; 8DAT, 5; 8AMS, 2.

DAKOTA DIVISION: 9COF, 24; 9MB, 28; 9BNF, 126; 9DSW, 87; 9DAW, 102; 9CEH, 108; 9DYR, 60; 9BFI, 250; 9ZT, 109; 9DGE, 52; 9COC, 2; 9BTL, 2; 9DGV, 33; 9DQH, 50; 9BLY, 75; 9CJV, 53; 9BIS, 60; 9BQ, 35; 9ZG, 14; 9CO, 108; 9AJA, 27; 9AXX, 35; 9AGB, 30; 9RQY, 14; 9ASN, 20; 9BMX, 58; 9BPN, 233; 9DOE, 253; 9EGU, 208; 9CDV, 182; 9BMR, 98; 9AND, 94; 9EGF, 70; 9RAV, 61; 9CMS, 39; 9BG, 150; 9CKT, 26; 9BOF, 138; 9BCG, 28; 9AGL, 44; 9BRI, 5; 9ADZ, 25; 9AEJ, 74; 9AMP, 103; 9CSI, 184; 9DLL, 96; 9DNX, 29; 9EBT, 95; 9UH, 2; 9DKB, 100; 9AFM, 11; 9ACK, 97; 9DLE, 5.

DELTA DIVISION: 5AAT, 30; 5DAW, 20; 5AAC, 48; 5DQ, 19; 5AIR, 44; 5YE, 2; 5KR, 112; 5AGV, 30; 5AKP, 27; 5AGS, 27; 5ALV, 34; 5PV, 59.

EAST GULF DIVISION: 4KU, 10; 4IO, 12; 4ME, 6; 4GZ, 20; 4QF, 15; 4AY, 25; 4HW, 2; 4LG, 8; 4PZ, 110; 5AOM, 132; 5AC, 75; 5AFS, 42; 5JN, 12; 5ADS, 50; 5AMH, 75; 5ML, 23; 5WS, 12; 5VV, 50; 5ZAS, 15; 5AJB, 35; 3OI, 125; 4EZ, 105; 4IZ, 72; 4OH, 70; 4SB, 48; 4FS, 47; 4BR, 45; 4II, 42; 4HN, 30; 4BA, 27; 4PU, 18; 4HZ, 15; 4HL, 10; 4JZ, 10; 4SD, 6; 4DP, 7; 4BN, 5; 4LR, 4; 4PB, 4; 4JE, 43; 4JA, 6; 4OI, 9; 4SH, 60; 4IT, 50; 4RR, 48; 4ZA, 3; 4EQ, 85; 4IK, 2; 4GO, 5; 4BZ, 109; 4RL, 10; 4HS, 35; 4IO, 19; 4HS, 12; 4BL, 129; 4CH, 19.

MIDWEST DIVISION: 8EKY, 80; 9DRX, 10; 9COW, 55; 9DWE, 32; 9CZM, 20; 9PW, 21; 9HLG, 25; 9DXN, 20; 9YM, 20; 9AAU, 57; 9DZO, 32; 9CKS, 60; 9DAE, 2; 9ACX, 37; 9AHZ, 66; 9AVN, 30; 9AYL, 87; 9BDZ, 16; 9BKO, 25; 9BSI, 41; 9CDO, 1; 9COL, 22; 9CXO, 8; 9IB, 16; 9DJB, 10; 9EDJ, 8; 9ELZ, 16; 9PM, 123; 9SS, 21; 9ST, 94; 9DOJ, 20; 9BXJ, 20; 9BSX, 67; 9CKB, 20; 9AXD, 17; 9HK, 25; 9FK, 27; 9DJA, 32; 9CHN, 48; 9DSL, 25; 9BXC, 168; 9CS, 92; 9AKE, 88; 9DXU, 62; 9AOU, 56; 9AHH, 46; 9DKY, 47; 9AGY, 55; 9AMI, 90; 9ASI, 27; 9ELQ, 2; 9CZO, 115; 9ACH, 76; 9DIP, 138; 9CLQ, 100; 9DAI, 130; 9DBK, 15; 9AYE, 5; 9ATN, 32; 9BWC, 61; 9BGH, 264; 9CTD, 30; 9CWF, 152.

NEW ENGLAND DIVISION: 1AH, 127; 1AWY, 50; 1AML, 32; 1CKP, 22; 1AVJ, 57; 1XAM, 9; 1APC, 60; 1FH, 23; 1CDE, 68; 1AKD, 10; 1BIY, 32; 1FD, 27; 1BJ, 21; 1AJT, 216; 1IV, 29; 1AJP, 36; 1ZL, 30; 1BGC, 14; 1BM, 4; 1MY, 116; 1ABC, 10; 1GV, 23; 1OW, 12; 1CAB, 40; 1AWE, 73; 1AID, 10; 1IL, 350; 1ANX, 107; 1AAP, 4; 1BVB, 218; 1BQD, 94; 1ACO, 23; 1ALL, 21; 1ALK, 8; 1AFP, 48; 1APM, 35; 1AUC, 36; 1AUR, 75; 1BDL, 130; 1BHR, 70; 1BJS, 23; 1BNL, 32; 1BQL, 52; 1BUB, 132; 1CDO, 31; 1CKQ, 4; 1CNP, 5; 1CQN, 11; 1CRU, 70; 1CPT, 135; 1EF, 25; 1IT, 11; 1KX, 59; 1BDH, 33; 1SK, 141; 1OV, 29; 1CJR, 109; 1CIT, 37; 1AGS, 106; 1BRM, 20; 1KK, 23; 1AAC, 65; 1COO, 9; 1AF, 156; 1BFA, 12; 1ALL, 8; 1BDU, 31; 1SE, 53; 1AHL, 31; 1NT, 40; 1ARL, 65; 1CPN, 90; 1JV, 82; 1BSZ, 81; 1BOM, 62; 1BIP, 54; 1AWW, 50; 1AGT, 50; 1BCU, 50; 1CAK, 33; 1ASU, 32; 1HL, 23; 1VU, 27; 1LC, 27; 1GY, 27; 1BKQ, 26; 1AQM, 26; 1YK, 26; 1PY, 24; 1CCP, 18; 1ABF, 18; 1XZ, 18; 1AKZ, 15; 1BB, 14; 1BSJ, 12; 1AJK, 12; 1BLU, 7; 1BLX, 7; 1EO, C; 1AAL, 5; 1CBH, 4; 1AJJ, 4; 1AOU, 3; 1JQ, 15.

NORTHWESTERN DIVISION: 7GO, 381; 7CO, 344; 7GE-ZX, 112; 7ZU, 181; 7ACL, 101; 7AF, 101; 7BJ, 100; 7LY, 100; 7ABB, 98; 7VM, 90; 7LH, 30; 7ZL, 97; 7WP, 76; 7AB, 75; 7AB, 10; 7CA, 9; 7DU, 26; 7FD, 26; 7IH, 41; 7OY, 59; 7ABF, 50; 7ADP, 1; 7AEL, 18; 7AIF-DC, 52; 7WS, 32; 7NO, 30; 7ER, 20; 7SZ, 32; 7ADJ, 31; 7MP, 17; 7NT, 43; 7ZF, 31; 7EL, 28; 7AGF, 6; 7ET, 3; 7SK, 4; 7AKK, 6; 7AHO, 8; 7AHz, 10; 7GQ, 14; 7WQ, 15; 7SN, 17; 7AHK, 17; 7PP, 25; 7JF, 26; 7TT, 32; 7ADM, 55; 7ABY, 56; 7EL, 65; 7QT, 31; 7JF, 26; 7IO, 17; 7FT, 55; 7OB, 20; 7LN, 8.

PACIFIC DIVISION: 6ZH, 56; 6BNY, 14; 6ALF, 8; 6BQR, 6; 6CHV, 111; 6AFG, 134; 6JX, 11; 6BRO, 2; 6BKO, 15; 6CBB, 45; 6BWE, 65; 6BWD, 20; 6BVZ, 6; 6BEG, 4; 6ADG, 1; 6CMU, 25; 6BJR, 12; 6BPZ, 10; 6AQD, 10; 6MG, 35; 6PL, 385; 6LG, 71.

ROANOKE DIVISION: 3BMN, 82; 4KC, 81; 4GW, 72; 4ML, 47; 8AUE, 46; 8ATC, 31; 3CKL, 30; 8AMD, 26; 4MV, 25; 8ATP, 20; 8DBK, 19; 8AIP, 16; 8CXM, 15; 8CA, 3; 4PC, 7; 4CM, 6; 8BBM, 6; 3ATB, 5; 8CQH, 3; 4GH, 2.

ROCKY MOUNTAIN DIVISION: 9AMB, 97; 9BUN, 57; 9CAA, 257; 9EEA, 20; 9QL, 50; 9APP, 185; 9CJY, 140; 9BVO, 16; 9DTE, 79; 9DFH, 34; 9CLD, 47; 9EAE, 51; 9CDE, 18; 9CWT, 13; 7ZD, 53; 7ZO, 35; 7NR, 8.

WEST GULF DIVISION: 5NN, 25; 5XV, 18; 5VY-5ZG, 6; 5NK, 62; 5ZX, 4; 5JT, 7; 5ALR, 7; 5ZU, 5; 5YK, 56; 5ADI, 8; 5MT, 55; 5ADB, 80; 5HY, 40; 5JL, 46; 5AIC, 80; 5AJJ, 39; 5CT, 39; 5LR, 414; 5QL, 34; 5AHT, 73; 5AMB, 25; 5AHC, 4; 5AL, 8; 5FX, 46; 5ALL, 10; 5UD, 12; 5NW, 104; 5DW, 7; 5NY, 42; 5ALJ, 41; 5SD, 34; 5QT, 5; 5CV, 79; 5KX, 39; 5ADH, 54; 5AMW, 40; 5AET, 5; 5AGH, 60; 5QY, 118; 5ABV, 39; 5PH, 30; 5AAF, 20; 5ADV-5TO, 217; 5FC, 259; 5UY, 16; 5AJT, 37; 5AFH, 34; 5UO, 100; 5AIJ, 76; 5ZH, 18; 5ANC, 110; 5CE, 75; 5ZM, 4; 5ZAV-5NG, 90; 5QL, 124; 5AJB, 62; 5XT, 50; 5SG, 26; 5ED, 7; 5GA, 21; 5BM, 15; 5AAW, 19; 5GJ, 74; 5XBF, 6; 5TW, 7; 5FU, 24; 5AHD, 54; 5VM, 50; 5ZA, 176; 5ADO, 57 BX, 33.

CANADIAN SECTION

MARITIME DIVISION: 1AR, 1; 1DQ, 1; 1DD, 9; 1BQ, 35; 1EF, 5; 1BV, 6; 9BL, 18.

VANCOUVER DIVISION: 5AS, 21; 5AK, 19; 5CT, 16; 4CL, 8; 4AB, 15; 4CW, 8.

Cancellations and Corrections in and Additions to Traffic Department, Directory Printed in October, 1923, January and March, 1924

Cancellations

Atlantic Division, Northern Section—E. A. —F. B. Ostman, 130 Broad St., Ridgewood, N. J.
 EASTERN NEW YORK: A.D.M.—Dr. E. A. Cyr-lax, 219 E. 71st St., New York City.
 NORTHERN NEW JERSEY: A.D.M.—R. S. Johnson, White St., Red Bank, N. J.
 KENTUCKY: A.D.M.—J. A. Kolb, 1101 Broadway, Louisville, Ky.
 OHIO—Dist. No. 4: C.M. NORWOOD—R. M. Blair, 3980 Ivanhoe Ave. C.M. DAYTON—E. P. Getter, R.D. No. 8.
 TENNESSEE—Dist. No. 3: C.M. KNOXVILLE—S. E. Adcock, 2000 Washington Ave., Knoxville.

Midwest Division—D.M.—G. S. Turner, South-western Bell Tel. Co. Rm. 611, Tel. Bldg., Kansas City, Mo.

NEBRASKA: A.D.M.—J. G. O'Rourke, 3064 South 32nd St., Omaha, Nebr.

MISSOURI: A.D.M.—Dr. C. L. Klenk, 429 Metro-politan Bldg., St. Louis, Dist. No. 1: O.R.S.—9AON.

VERMONT: A.D.M.—R. P. Slayton, Converse Hall, Burlington, Vt.

WASHINGTON: A.D.M.—K. W. Weingarten, 3219-24th St., Tacoma, Wash. Dist. No. 7: D.S.—F. A. Mueller, Jr., 319 N. Emerson St., Wenatchee, Dist. No. 4: D.S.—Walter Hemrich, Box 511, Aber-deen, Wash.

OKLAHOMA—Dist. No. 1: C.M. OKLAHOMA CITY—Tom McMain, 427 Nelson St., Oklahoma City, O.R.S.—5ZAT, 5ZT, 5KE, Dist. No. 4: D.S.—D. H. Boyette, 111-7th St., Lawton, Okla. O.R.S.—5DS, 5TJ.

NORTHERN TEXAS: A.D.M.—R. L. Clinkscapes, c/o F. A. Hardy Co., Amarillo, Texas, Dist. No. 1: D.S.—Dale Hales, 2826 Anderson St., Greeville, Texas. O.R.S.—5LB, 5TU, 5ZC, 5IX, 5TC, 5SF, 5AER, 5KO, 5IS, Dist. No. 3: O.R.S.—5LL, 5ZASA, Dist. No. 4: 5RW, 5NS.

SOUTHERN TEXAS: O.R.S.—5IM, 5AE, 5JM, 5XB, Dist. No. 7: O.R.S.—5TM, 5KP, 5GR, 5ZAI, Dist. No. 8: D.S.—L. D. Wall, 216 Pereira St., San Antonio, Texas. O.R.S.—5ZAE, 5RR, 5AEW, 5GE, 5KG, 5SS, Dist. No. 9: 5ZAD, 5JZ.

Additions

Atlantic Division: Northern Section: E.A. R. S. Johnson, Box 93, Red Bank, N. J.

EASTERN NEW YORK: A.D.M.—E. M. Glaser, 845 E. 13th St., Brooklyn, N. Y. Dist. No. 2: C.M. BROOKLYN—W. A. Schudt, 227 Clermont Ave.

NORTHERN N. J.: A.D.M.—A. G. Webster, Irvington, N. J.

DISTRICT OF COLUMBIA: A.D.M.—A. B. Good-all, 1824 Ingleside Terrace, Washington, D. C.

SOUTHERN N. J.: Dist. No. 8: O.R.S.—3ACQ, KENTUCKY: A.D.M.—J. C. Anderson, Glengarry Farm, Lexington.

MICHIGAN—Dist. No. 3: C.M. KALAMAZOO—H. L. Prange, 1003 Short St., Kalamazoo, Mich. C.M. GRAND RAPIDS—H. A. Westveer, 84 Nagold St., Grand Rapids, Mich.

WISCONSIN—Dist. No. 2: C.M. MADISON—H. O. Brickson, 502 Oakridge Ave., Madison, C.M. KENOSHA—L. S. Hillegas-Baird, 479 Prairie Ave., Kenosha.

OHIO—Dist. No. 2: O.R.S.—8CTD, Dist. No. 3: C.M. JEFFERSONVILLE—Earl Ogden, 1518 Spring St. O.R.S.—8DCE, Dist. No. 4: C.M. DAYTON—R. Baird, 34 W. First St. C.M. CINCINNATI—Carl P. Goetz, 1128 Atwood Ave. O.R.S.—8COJ.

ILLINOIS—Dist. No. 2: O.R.S.—9DLO, Dist. No. 5: O.R.S.—9KKS, 9EBQ.

SO. DAKOTA—Dist. No. 1: O.R.S.—9DKQ, 9YAM, 9BCQ, 9EG, 9CKT, Dist. No. 2: O.R.S.—9DEC.

NO. DAKOTA—Dist. No. 1: O.R.S.—9GK.

MINNESOTA—Dist. No. 3: O.R.S.—9APE, 9AWV.

TENNESSEE—Dist. No. 3: C.M. KNOXVILLE—J. E. Ross, 1620 East Fifth Ave., Knoxville.

GEORGIA—Dist. No. 1: O.R.S.—4KU.

FLORIDA—Dist. No. 1: O.R.S.—4IU, Dist. No. 2: O.R.S.—4SU, Dist. No. 3: O.R.S.—4JZ, 4PB.

VERMONT: A.D.M.—W. W. Hall, 2915 Union St., Burlington.

WASHINGTON: A.D.M.—Everett Kick, 3803 Hoyt Ave., Everett, Dist. No. 7: D.S.—J. C. Mc-Chure, Leavenworth, Wash.

MONTANA—Dist. No. 2: O.R.S.—7II, 7IT.

OKLAHOMA—Dist. No. 1: C.M. ENID—Wyane Easley, 223 South 3rd St. Dist. No. 2: C.M. TULSA—E. Austin, 1239 S. St. Louis Ave. Dist. No. 3: D.S.—E. A. Ford, Box 602, Ada, Okla., Dist. No. 4: D.S.—W. G. Green, 705 Monnet Ave., Norman, Okla.

ATLANTIC DIVISION

C. H. Stewart, Mgr.

Considerable pickup in business is noted with Glaser at the helm of Eastern New York, Bronx stations reporting were 2CNO, 2CYX, 2EZ, 2EE, 2CVX, and 2CWR. 2CWR is now C.M. of entire Bronx and this will correct the impression that appeared last month about the lone stations not being active etc. Brooklyn is well represented by 2CHY, 2CJR, 2PF, 2BO, 2WZ, 2ABN, 2CPD, 2DL, 2WC, 2CWO, 2CLA, 2CLW, and 2BEG. 2CHY is the new C.M. of Brooklyn. Other changes will be made as required to bring about a high standard of efficiency in this section.

Manhattan stations reporting are 2KR, 2CSL, 2DI,

2XNA, and 2CHK. 2TS is resigning as C.M. and a new man will be appointed to fill the vacancy. Reports were received from 2ADJ, 2CAJ, 2AGC, 2CEV, 2CZN, and 2CEP. Queens stations reporting are 2CNH, 2CTN, 2BCK, 2BNC, 2AVE, and 2CSX. 2CXB is the only reporting station from Long Island.

2AWF is the only active station in Albany at present.

Dist. No. 3. 2CPA and 2CWJ have been closed down. 2AGS, 2APU, and 2AVJ had good reports but 2GK leads in traffic. What's the matter with 2XQ, 2CGJ, 2ADM, 2CKN, 2MX, 2BXW, 2AOL, 2DDG, and 2BQH?

There was no report from Western New York and there is going to be a new A.D.M. unless 2AWP snaps out of his slumber pronto! District of Columbia: Reports were received from 2HS, 2BSB, 2BWT, and 2PZ. Traffic has fallen off due to the experimentation going on in this section. 2JJ is lost from us for a while as is 2SU. Every station is observing the quiet hours and wave-length law rigidly. No other reports were received.

MARYLAND—2APT is operating under the call 2ZD. 2LG surely is doing good DX. 2WF, 2AJD, 2PH, 2DQ, and 2FK are doing their usual good work. 2MF has been completely rebuilt. 2TE uses French tubes and gets out FB, as is 2TF on his 50 watter. The ten watters are 2BMO, 2AEK, 2CDU, 2UZ, 2BCK, 2CHR, and 2GL, all of which are doing excellent work. 2CJC is increasing to a 100 watter and will have a new antenna. 2CJW is using a 30 watter. 2LL gets out well on a five. 2SS is back with us again. 2SF will open up with C.W. and this will be the passing of the last DX spark. 2BU and 2AM are seldom on. Delaware: Practically every station is inactive due to some cause or another. There is nothing further to say.

EASTERN PENNSYLVANIA—Dist. No. 1: 2B0B has changed over to a master oscillator. 2AEN is confined to his home with chicken-pox, whooping cough and hives. 2GC is stepping out to the west coast.

Dist. No. 2: 2YO worked several British stations and is getting out FB. Tube trouble reduced total at 2BNU. 2LK and 2AXM are reaching out in fine shape.

Dist. No. 4: 2CHG is heard in all districts using a 10-watter. 2ZO has a schedule with 2ZZ and portable station 2OI in Sarasota, Fla.

Dist. No. 5: 2ACY is the only station reporting. The district is well represented but fail to report. (Step out fellows and boost the district!) Harris-

regulars are heard at intervals doing their stuff in good shape. 2VE has been tearing things loose with the 250 watter and a sink rectifier. By the time this appears in print, the old station of 2ZD, 2VE, 2XW will be a matter of history. The combination of events including MO's plans to move, and medical school for WX, makes a disbandment necessary. Mr. Wiggin will take his old call 2ZD

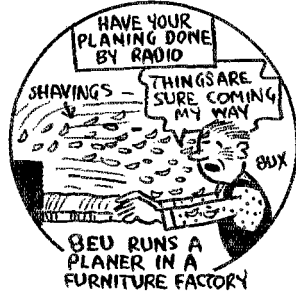

with him, while Westervelt will keep his call, 2VE, at the present location.

2BR1 is rebuilding two 250-watters. 2AYW is a new station. 2CFB has been busy with school. 2BED blew out his motor generator and has been straight A.C. 2PX received cards from every district. 2AGO has been doing early morning operating.

Dist. No. 10: 2ADS is reaching out in good shape. 2CBH is on once in a while. 2BHA is using fone exclusively. 2BYI is reaching out a little better. 2CCK is reaching out FB with a 20-watter. 2BRB is having tuff luck getting his set to perc. 2XBI-2BJV is handling traffic on a wave-length of 176 meters. Schedule for traffic west has been arranged with 2CJC. 2ABS is back on the air and is handling traffic in his usual reliable manner. 2BKY guarantees quick delivery of traffic coming his way. 2BDU finds that lower wave-lengths are giving best results and stations will find this station on 180 meters for traffic. 2AAF has been getting out in great fashion on low wave and reports good results but little traffic moving his way. 2DBL is handling his portion of traffic in a very creditable manner. 2BBP has succeeded in getting a pure D.C. note and is getting out into the wilderness in good shape. 2BRM has been unable to work except on Saturday and Sunday nights. 2BJA is beginning to get into his old stride.

CENTRAL DIVISION R. H. G. Mathews, Mgr.

OHIO—Dist. No. 1: 2AVN is back on spark. 2AA has been connecting up with 2AWL. 2BCF has QRM from YLs. 2GD is running short of 5-watters. 2GCI, on a 20-watter is knocking off 6's often. 2ZY-2OA has trouble with his chem-rectifiers freezing.

Dist. No. 2: 2BNH has a good msg. total. Dist. No. 3: 2BDM complains of no traffic. 2BXW worked 4AF on fone with a 50-watter in daylight. 2RY is handling lots of traffic at 2ZE-2YAL.

Dist. No. 4: Two stations report from Cincinnati, 2COJ and 2ZAB, the latter handling 445 messages. (FB.) 2CWR blew his tubes but will be on soon. 2CNL is still going on top notch speed. 2CVD, 2RV for traffic at noon and 3:30-5:00 P.M. He was reported by 4AQ in New Zealand and using only two 5-watters. 2BOG with a 50-watter is reaching out in good shape. 2CZX is only on at weekends on account of school. 2DC is still having trouble with that generator. 2CVM is handling traffic.

Dist. No. 5: 2GZ shot all his tubes, but peeled off 209 msgs. 2GWP's 100-watter does not perk quite right. 2TJ is using C.W. and spark. 2BL blew himself and got a Crebe 13. 2BYN handled 636 msgs. 2AV, 2CRC, 2EF report nothing startling. 2BVX is planning putting up a conical cage antenna in an effort to increase his range. 2JU moved his station back to his home.

SOUTHERN INDIANA—Dist. No. 3: 2BRK is handling most of the traffic in the southern part of the state. 2ES has a 50-watter and is reported QSA in all districts. 2CGS blossomed out at Terre Haute. 2BVZ is getting out FB. 2ARP has increased to a 20 watter. 2VC has a 10-watter going



burg is always on the job. 2CCX and 2BBV carry the work through in fine shape.

Dist. No. 6: 2BIR is rushing the completion of a 50 watt set. 2XN is supplanting the 2KW spark for a 50 watt tube set.

Philadelphia: A large amount of traffic is passing through here and not being reported. The A.D.M. is really ashamed to write up a report when Phila. has such a poor showing for the size of the city. Nothing to report as usual.

Dist. No. 7: 2GDI is reaching out fine with his 5-watter. 2BOY tried to put up a 50 ft. pole but the darned thing busted. HL

WESTERN PENNSYLVANIA—Dist. No. 8: 2AOX got his call back and is operating. 2AKI rebuilt his transmitter and installed a counterpoise and is working a daylight schedule with 2CCK.

Dist. No. 9: O.R.S. certificates have been received for 2JV, 2VN and 2GDC. 2ASB was one of the most successful in receiving European amateurs. 2RZC has taken back his sink rectifier and is busting up the ether again as per usual. 2VN, 2CKM, 2VQ, 2GEO, 2CUV, 2ONW, 2BW, 2LJ and the other

good. 8CZS is threatening to quit business. 9UR's traffic has fallen off due to fooling with short wave stuff and forgetting the old combination when he wanted to get back in the 190 meter game. 9BP's wife left town for two weeks and he spent all of the time he wasn't cooking out in the barn with the mufflers clamped on his ears. He was rewarded with a sheaf of one and fives.

Dist. No. 5: 9BBL has a 10-watt set under construction. 9EIL handled 15 messages.

KENTUCKY—J. C. Anderson, Glengarry Farm, Lexington, has been appointed A.D.M.

Dist. No. 2: 9ASE has worked several 6s, and 7s, also Can. 5GO. 9CTU handles quite a bit of

is in operation again. 9DHU, with his 1/4 k.w. spark is back on the job again. 9YB is the only active station. 9DJL moved his 5-watter to the Phi Sigma fraternity House. 9CHV is changing to straight C.W. on a 5-watter.

MICHIGAN—Dist. No. 1: 8DGO is starting to reach out OK. 8AMS is in operation on north route. 8DAT is on the air regularly. 8DBO is trying out the "S" tubes. 8AH worked Alaska twice in January. 8CWK worked 4JE on a 10-watter.

Dist. No. 2: 8CED is out of commission due to that "\$30.00 feeling." 8CFQ and 8BNC handled traffic between their cities when telephone lines were down in the recent storm. 6JJ is experimenting with D.C. on his 1/4 k.w. tube. 8DCY is pounding brass with 200 mgs this month. 8DDT hands in 101 mgs and is blowing big holes in the ether on low power. 8CPY will be going strong again with new aerial and a 200-watter. 8CZZ still climbs in DX records and handled 69 mgs. 8CPD reports 42 mgs and plenty of DX. 8AZG handed in 80 mgs. 8BGO hands in 13 mgs. 8BGO is a real ham with A.R.E.L. spirit 100%. 8DGC hands in 7 mgs. (That's better, none, O.M.) 8ZAG blew all tubes and is waiting for some new 50's. 8CP has sold out. 8CGM is laid up with appendicitis. 8AYJ, 8ACO, 8AEB, 8DKF, 8BFW, 8CQS are all working again.

Dist. No. 3: Only station reporting is 9CE.

ILLINOIS—Dist. No. 1: Sleet storms took down so many aeriels that the district is very low in msg. total. 9BIZ has been experimenting with coupled circuits and reports better results than with single tuned ckts and also that he does better with D.C. than R.A.C. 9DAY works all districts but 6th on tone.

Dist. No. 4: 9CTF blew six 5-watter during the storm work. 9AHQ is going good as usual. 9AMK is on with a 500 cycle 1CW using a quarter k.w. tube. 9AHO is off because of plate transformer

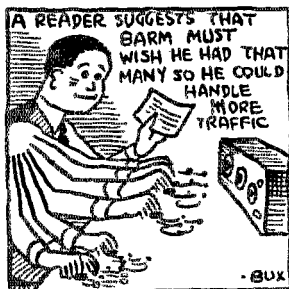

traffic on a five-watter. 9EI is doing consistent work with a 30-watter. 9CAP will be on the air again as soon as he makes some minor repairs.

WISCONSIN—Dist. No. 1: 9ATO did well handling traffic for the railroad during the storm. He operates on schedule with 4FZ, 9EHB and 9BQJ. 9CVI did some railroad work. 9DTK doesn't pile up a heavy msg. total, but they are honest-to-goodness messages. 9LR's 5-watter went west—B.C.L.s may rejoice! 9ELV lost an aerial and 9KKR lost a mast, same at 9BFY and 9OKS. 9CGB says 161 meters is the berries for DX. 9CKW says 110 is better.

Dist. No. 2: D. S. W. Kelley of Madison has resigned as C.M., and H. O. Brickson, 9DKS has been appointed. L. S. Baird has been appointed C.M. of Kenosha. Masts are down at 9CHE, 9EGW, 9CWZ and 9AZA. (Tuff luck, fellows!) 9DWP wants to pound brass on 1KW spark but is afraid of the B.C.L.s.

Dist. No. 3: 9BMU and 9AJX were the heroes at Sheboygan locating lost boats, lost trains, etc. 9AEU and 9BUJ are doing good work on spark. 9BQG and 9BCH buried a fiver. 9BCH handled traffic with every district.

Dist. No. 4: 9ZY did creditable work during the storm keeping operators on day and night and handling traffic for the Northwestern R.R. to Chicago. 9PJ also assisted. 9AZN has daylight schedule with Superior. 9CLF, 9ALI and 9EIL are going strong. 9EEM and 9BSO are new O.R.S.

Dist. No. 5: 9GD and 9CYG handle most of the traffic.

NORTHERN INDIANA—Dist. No. 1: 9UB is rebuilding and will use four 50-watter with battery plate supply. 9DCE is using a 100-watter. 9CNV is rebuilding his set again. 9AMJ is working on

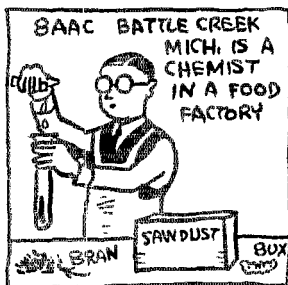

and tube trouble. 9BTA blew his afties and is going back to fivers for a while. 9DRU and 9DRJ are not very active. 9CXH was wrecked by the recent storm. So was the big pole at 9BJTs. 9DXL has been on fairly consistently working every district, but 6 and 7. 9AIC is QSO with the west coast. 9DLO has been appointed O.R.S. 9DVL is QSO Chicago. 9BRX is doing good daylight work having worked 8CAA in Denver on fone at that time and also works all districts at night, as well as being heard by Cuba and WNP. 9ARM had his aerial damaged by the storm. 9DYN lost a tower but is working out a master osc. set on the remains of the antenna. 9CA lost the vertical cone and big tower but is putting up an enameled wire of the same dimensions with the pole one foot higher, which puts him up to 101 feet.

Dist. No. 3: 9AWQ heads the msg. column with the largest total although 9MC is not far behind. 9EFQ has the sinking \$8.00 feeling twice this month but will be on soon. 9TW changes from Meissner to D.H. and is getting better results. 9CMN sends in his 13th consecutive report. He and 9CMN are the only active stations in Granite City. 9ATT has his set perking fine and comes in with a good report. 9AHK will have two ops. 9BYX has a new C.P. and a new receiver perking FB. 9EAC and 9AKA have joined forces for a 50-watt bottle. 9CMN, the old reliable, struck hard luck and turns in 43 mgs. 9CRX blew a Kenotron. 9CSW is a new comer.

Dist. No. 4: 9AP is back in the amateur ranks and does lots of DX. 9CLJ blew a fiver and is now waiting for the arrival of a 50. 9COX is doing the biz with 106 real mgs. this month on



fone. 9BGF is doing very good work on 150-meters. 9CLN is frozen in for the rest of the winter. 9AZX pushed over to British ZOP and 2KF. 9CUI handled a nice bunch.

Dist. No. 2: 9DYT reports 48 messages. 9BON

spark. 9DWS, using S tubes and 3 fivers gets better DX. 9DCR is installing S tubes for work on 176 meters. 9DHz is working the spark consistently. 9DKH has S tubes and does fine work on 3 fivers. 9AQA has come back and is remodelling his receiver for low waves. 9BGC continues to do good work on 176 meters. 9DOG put up a new C/P and is doing well considering his location. 9BCB is going again with A.C. on two-fivers. 9ASD built a 2 ckt receiver and heard French 8AB and British 25H right off the bat. 9DQU was heard in New Zealand and France.

Dist. No. 6: 9AKU is trying to get a 100-watter to reach the far edges. 9EBH says DX is good but traffic not coming his way. 9EHQ blew a bottle. 9BUO dumped his car over but comes through with the best report of the month.

Dist. No. 7: E. W. Kimbark has just been appointed C.M. of Evanston. 9AMZ is owned in partnership by E. W. Kimbark and H. B. Smith of 9APK and with 50 watts wk'd. 4JE and all districts with the exception of the 8th. 9BRE with 50 watts worked all districts but the sixth. 9BP burned out a few fifties. Page was surprised to listen in and hear a spark coil working 9EDZ and signing 9BP. "Ahh" he thought. "U must have an echo." 9EDZ found the QRA and 9EDZ and 9PB visited see QRA. The spark coil has not been on since. The fellow did not think that he was doing anything wrong. 9DBF has a new 60-ft. mast like 9AMZ's. He worked three sixes in one night with a 100-watter. 9EEG worked 6BCL and was heard by three sixes. 9ED helped in train dispatching all day February 5th. He burned out all his 5-watters, and used all three receiving tubes all different in parallel rest of the day. Has worked all American district but 6 and 7, and Can. 3rd with these reg. tubes. 9EDG has been on with C.W. as is 9ASA. 9AER has C.W. and fone. 9DHQ is a 50-watter. He burned out his plate transformer. 9VK has a new 200-watter. 9CLX is working 6a on one 50-watter. 9DIL and 9REF are still using spark. 9AVL and 9COW are new stations working good DX. 9CVS is radiating 11 amps on four-50-watters. 9AOL and 9GL are both on the air now. Traffic in Chicago has been very slow. 9AAW leads the list. 9ELB has been spending most of his time getting a 100-watter working 9BEF helped 38 along. 8CD has been exploring the lower waves under his new call 9XBA. 9CFD has been spending most of his time hunting up 5-watters, of which he uses two as long as they last. 9COT received a report from British 22S reporting his 5 (?) watter. 9AZJ put 23 msgs. through. 9BEF ran up a total of 20 msgs with his 5-watter. 9DWX has been having a lot of fun with his two new fifties, and handled only 10 msgs. 9LZ did fine work during the storm for the C. & N. Y. RY. 9US is back on the air.

DAKOTA DIVISION N. H. Jensen, Mgr.

MINNESOTA—Dist. No. 1: A total of 1113 messages were handled. 9DOE heads the list with 253. Traffic is moving in great shape and increasing every month. 9DXT is a commercial operator and will do some fine work for his end of the range. Routes to Canada and to the west are being kept open. The jumps are now only about 100 miles between stations and in the most difficult steps the stations are only about 50 miles apart.

Dist. No. 2: 9DSW continues as the most consistent station, although not high in traffic handled. Rubber stamp messages are all being QSK'd and short calling rules are being observed. Stations doing good work are 9CAJ, 9BNF, 9CEH, 9DYR, 9DSW, 9EGG, 9CMT, 9DDP. Other stations in the district outside of the SMRA who are doing good work are 8COF, and 9MB. The latter station does daylight work at 6:40 A.M. and from 4 to 5:30 P.M.

Dist. No. 3: Stations which did good storm work are 9BLY, 9APE, 9BMX, 9ZT, 9RFT and 9AUA. These stations and any others taking part in this important work deserve commendation. 9CVV burned up his plate transformer. 9DPX is on the air with a greater punch. 9DEV is having trouble trying to get his rectified juice filtered. 9ZG has been heard in France with less than 45 watts input. 9DGW is now 9HM. 9XAX has worked 14 districts and France on 115 meters.

NORTH DAKOTA—Dist. No. 1: Nearly every man in the district put his shoulder to the wheel this month with the result that a total of 558 messages were handled, the largest this season. This large number is due in part to the good work of 9AMP and 9CSI. 9EBT has been having his troubles

with filaments, resorting to the use of fuses which blew as fast as replaced. The key has been forsaken for phone by 9AAU. 9UH felt the call of the ether too keenly and reconsidered allowing the station to remain idle until summer. The broken pole was repaired and with the assistance of 9ZT, on a visit in Fargo, the rectifier was put in shape and operations begun. A daylight route is being engineered by 9AEJ and has proved a worth-while means of getting traffic through.

Dist. No. 2: L. H. Weeks is moving back to Fargo. 8DKB did some wonderful work while located at Minot. 9ACK continues to do good work. 9AFM and 9DLE report some traffic.

SOUTH DAKOTA—Dist. No. 1: 9BG is doing consistent work and deserves a lot of credit. 9CKT is doing good work, but his message total has suffered due to school work. 9BOF is QSO both coasts. 9DKG continues to do the most consistent work. 9BCG with a 5-watter has worked distances of 1100 miles. 9EHC will be combined with 9BCC. 9AYD has installed a generator. 9DIY is a new station. 9BNH continues to do consistent work.

Dist. No. 2: 9AGL did good work during the month. 9AHT-9TM is doing well on a wave-length of 150 meters and is getting very good results with one 5 watt tube. 9BRI blew his 50 and is getting along with a five temporarily. 9CGA is getting five amps into the antenna on a 50-watter.

DELTA DIVISION W. W. Rodgers, Mgr.

MISSISSIPPI—Meridian: 5AGS reports 27 messages and has nothing else to say. 5AKP used a 5-watter and works into the Eighth and Ninth districts easily on a bum aerial. "Christmas Card" 5AGV complains that fellows have no traffic for him. Opening routes through Mobile, New Orleans and Meridian. (Slip him your messages, fellows—D.M.) 5KR gets them off the hook every night—kills one of 'em. 5AFV used 400 volts "B" batteries and gets out all over the map. 5AIR is "going sum" and got away with 44 messages. 5YE has been out of commission most of the month.

TENNESSEE—Memphis: 5ALV works both coasts. 5PV has dropped to a very low wave and gets all over the country. 5MB-XAT reports that following a visit from the Inspector things have been quiet.

ARKANSAS—5DQ modestly reports 19 messages and blames his low number to his sharp wave. 5ADW had to QRT for exams. 5AAC handled 43 his first month.

LOUISIANA—Baton Rouge: 5AAT wasn't on much. AAT is going to be a commercial until next winter, so we will miss his fist until then.

GET THIS MEN: The new O.R.S. certificates are being distributed. Only the worthy stations can get these appointments. If you have a good station, and this does necessarily mean a powerful one, write us for an application blank—maybe you can land one of these swell certificates for your station.

EAST GULF DIVISION H. L. Reid, Mgr.

GEORGIA—4JD and 5DT have taken hold of LaGrange to put it on the map. 4DT opened up with a 10-watter and 4JD with a five. 4LG started up on a five-watter. 4AY has blown a couple of 5-watters, but this did not stop him as he put in an amplifying tube and worked a "one". 4FZ is using a 15-watter in the set he won at the Atlanta Convention. A good route to Florida is through this station. 4RW is going good. 4BZ has busted loose and has communicated with six English stations and French 8AB. 4QF lost one of his fifties.

SOUTH CAROLINA—4JX is trying to find some means of rectifying the juice and in the meantime the station is silent. Spartanburg has three stations. 4SH, 4IT and 4RR.

PORTO RICO—Porto Rico and Cuba have been connected via amateur radio. Communication was definitely established early this month between Cuban 8DW located at Santiago and 4OI at San Juan. This will afford Portorican amateurs an opportunity to talk to foreign countries in their native language. 4JE, with 150-watter is handling most of the traffic with the mainland. A new transmitter has been put up at 4BJ.

FLORIDA—4XE, owned by Mr. Cooper and 4IU is using one 50-watter on 90 and 150 meters, and has been QSO Europe. 4FS dropped to 150 meters and worked 7AF, 7HG, 6BUY, 6CMR, and Canadian 5GO.

District No. 1: 4KW reaches out consistently and has been reported many times QSA in Cuba. 4EK

has a 70-foot antenna and is one of our main traffic stations. 3BA has worked Cuba. 4PK is QSO Porto Rico and Cuba. 4FS built a new short wave tuner and copies French 8AB and Dutch PCN nightly on a small indoor antenna. 4LS has increased to a 10-watter and does daylight DX. 4DU is a new 20-watter with storage battery plate supply. 4EZ keeps daily daylight schedules with 4BL and 4IL. 4HZ handled 15 mssg. 4SB is QSO with Porto Rico 4JE and 4OI. 5PI is back with a 5-watter. 5OH is doing splendid work with a 10-watter. 4SD is on with a 5-watter. 4QT started up with a 5-watter.

Dist. No. 2: 4RL keeps a daylight schedule with Jax and handled 120 messages. 4LZ lowered his wave and comes through much louder. HI-4RO is doing splendid DX and handled 42 mssg. the first month. 4PQ, 4JZ, 4PB, 4LR, and 4BN are doing good work. 4JY will be back on the air soon. 3OI, 3ZO's portable station, and a station at Sarasota knocks them cold with a pair of 250-watters and handled 126.

Dist. No. 3: 4IH puts his station to practical use and reports direct to A.D.M. by radio.

Dist. No. 4: 4HN is QSO Pacific coast. 4GH works Jax regularly on spark, and 4DP keeps a schedule with 4EZ of Jax.

ALABAMA—225 messages were handled by seven stations. 5AMH leads with 75. 5VV is making the fellows with small power sit up and take notice and is in second place for the month with 50 mssg handled. 5ADS is pushing VV for the second place in the line and steps up this month to share the honors with a total of 50 mssg. 5ADS boasts a 20-watter. 5KQ has just been opened up by A.D.M. McIlvaine and his partner Breedlove. Although in operation only one month, it has worked every district but the sixth and handled 53 messages. 5ABT will be off the air until he can accumulate some tubes. 5AJB handled 35 mssg. 5AOM has 182 messages to his credit. 5AC handled 75. 5AFS and 5JN scored 42 and 12. Mobile is QSO Havana.

MIDWEST DIVISION Porter H. Quinby, Mgr.

Porter H. Quinby, 9DXV, becomes the manager of the Midwest Division succeeding G. S. Turner, resigned. The Midwest will be kept right up on top if Quinby has anything to say about it and all that is needed is the whole support of the many individual stations throughout the division. Keep 'er on top, boys!

IOWA—9CS is working the east coast on spark. 9BSX is proving to be a promising C.W. station. Stations reporting this month are 9BXJ, 9BSX, 9CKB, 9AXD, 9HE, 9FK, 9CS, 9DJA, 9DSL, 9BXC, 9CHN. 9BGH reports the routes working in fine shape. 9DAL, 9DBK, 9AYE and 9BRS are on duty. 9DBK hears foreign stations with one tube. 9CLQ's masts blew down in the recent storm. C.M. 9AMI reports 9ELQ, 9AST, 9DKY and 9AMI on in Mason City. 9AOU has sold his 50 WE. 9DXU has a 100-watter now. 9AKE is using a 50 watter and gets out good. 9BDI and 9DXU have been out of

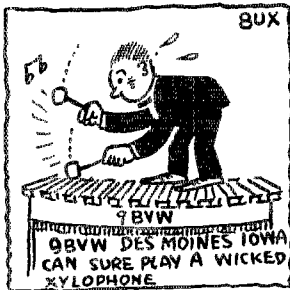

commission on account of sickness. 9DKY has been reported in New Zealand twice when using a 5-watter. Also 9AE of Boone was heard the same place. 9CTD was heard in England when using a 10-watter.

MISSOURI—9CTG and 9DRW are the only stations handling traffic. 9DLT is erecting new masts. 9LJ is doing remarkable work using 110 volts on the plate of a lone 5-watter. 9EX is out of commission. 9YM lost a mast and will move the station to a new location. 9CRM reports 86 mssg on spark. 9BZH gave up the commercial operating and stands watch at 9BZH all night, every night. 9CHJ

is again operating and getting out well on a 10-watter. 9BUL has a daylight schedule with 9COP. 9EKP is operating daily and working good DX. 9DZO works good DX on a 5-watter C.W. and 50 watt fone & I.C.W. 9CYK reports 60 mssg from 9CKS operated by 9CYK. 9DUX also operates at 9CKS. 9BLW reports 40 mssg. 9BLW, using a 15-watter, works 4s in daylight.

KANSAS—The gang certainly brought home the bacon this month. Listen! 1626 messages, and all on C.W.—ALL OF 'EM! And what a great spark state this once was, but gone are the days. 9DLM pushed through 35 on two Sundays. 9CKM lost a 50-watter. 9BVN swy a 5-watter breathed its last. 9DHE is back with quite a shack. 9CFI got in bad



with the B.C.L.'s and they tried to shut him up from 9 P.M. until 12:30 A.M. The Dept. of Navigation explained to them in such a way that their hearts softened and all is OK. 9CZW has been heard in 8 countries. 9CCV continues to work all of them as usual. 9BEZ, and his freak set works everything. He uses iodine in his rect. solution. 9CCZ survives a 50 and two 5s. And to make it worse his mast bit the dust. An 80 footer is going up. 9AVM is heard at intervals. 9RKM is coming up with a 10-watter soon. 9BEP does himself credit with a 5-watter. 9IW is heard from. 9AIM continues to lead the way in DX. 9EFU executed a 5-watter and now turns to 50. 9AVG works from 1XAQ to 6XAD with ease. 9AYP uses 1600 volts on an innocent 5-watter and a late bulletin report is very hopeful. 9CCS pounds away and sets the rest of us an example. 9CZW gets the April fool candy this month with 9BVN so close he had better look to his laurels. 9OAD heard WNP. 9AOG blew a 30 berry fire bottle and succeeded in bringing back to life a dead one. 9CGM will soon be on with a bang. 8BVV sent in a dandy report. (FB, GM.)

NEW ENGLAND DIVISION I. Vermilya, Mgr.

NEW HAMPSHIRE—1GL wins the bet this month and walks off with a total of 205. This is about the largest total a New Hampshire station ever reported. The A.D.M. reports as follows: 1BNK, 82; 1AVL, 73; 1ARV, 14; 1ATJ, 57; 1YE did some wonderful work and rapped out 130. (That's FB). 1CSS, 35; and 1BJF, 58. 1BTF busted the air to pieces handling 180.

VERMONT—R. P. Slayton has packed his bag and gone to Florida to college. So Wm M. Hall has been appointed to take the job of A.D.M. 1ARY handled 42 messages. 1CQM gets 1.2 ams out of a 5-watter. 1AJG has been elected C.M. by the Poultry Exec. Radio Council. 1AOZ sent 4 using a receiving set as a transmitter. 1AEY is experimenting with new hook-ups. 1AJG is now on a 50-watter.

MAINE—1ALI is grinding his nose on the grindstone of knowledge. 1ALK has been on only two nights. 1APP is never heard after dark. 1AUR and 1AUC were heard in England. 1BDH with 1CRU has been hearing the other in the vicinity of Searsport. 1XAH-1BDI works Europe like locals. 1BQL blew his last 5-watter and is using a receiving tube for transmitting. 1BRQ will be off the air for some time. 1CIB's ambition is to own a spark coil C.W. 1CRU is using A.C.C.W. on low waves and is QSA in the 9th. 1CTP is changing to a lone 50-watter. 1EF is just starting up. 1FR has a new station. 1KX has worked 1650 miles and is QSA everywhere except in Maine. 1VF will be going soon.

CONNECTICUT—Dist. No. 1: 1BM says reports come in on time. 1PA and 1AVW have been

awarded special licenses. 1PA is now 1ZT and 1AVW is 1ZL. 1AGH took exam for special license but didn't make it. 1LV is keeping up his good reputation and is experimenting with antennae. 1AJP is still with us.

Dist. No. 3: 1AV4 and 1BIY are hard workers and are getting reports in on time. 1FH is doing good work. 1EDE has his mast up again and going good. 1AKD is increasing his power to a 20-watter. 1AH works 7s with a 5 watter. 1AMI is dividing his time with "her" now. (Watch your step young man!) 1AVI works 9s FB. 1CKP raised his antenna current one amp by putting a condenser across high voltage. Good dope. Try it! 1XAM is working Dutch PCII consistently and is being heard in England, France and the west coast regularly. It takes Reinartz to do it! 1APC has come to the conclusion that American tubes work best in his transmitter.

Dist. No. 3: 1XW is heard every night on 112 meters and works England, France and Holland consistently, also 6s and 7s. 1MY hasn't been on much this month due to other business. 100 has received cards from England.

Dist. No. 8: 1AJT reports business good. 1FD is one of the regulars and has one of the finest, if not the finest station in New England. 1BIJ handled his first two messages and promises to be a real ratiocier. 1CTX is one of the D.S.'s and we hope he gets on the air again as we need a real station in New London.

RHODE ISLAND—Well, another month has rolled by and finds us getting nearer to the time of the year when a fellow don't care to stay in and pound brass. This month finds a pick-up in the Westerly section and a drop-off in other sections. For some reason or other the fellows up around Providence seem to be losing interest. I don't know the cause of this but perhaps it is for the reason that I mentioned to you in the last report. We have started a clean up in this state as you will see in the following report.

Dist. No. 1: 1GV has a 500 watt tube and is getting out in fine shape. 1OW and 1AWE are in with him. 1ABC is not on much. 1CAB doesn't raise many but he does move traffic. 1AWV continues his good work. 1BCC has opened up. Rhode Island has a real YL station. This station is situated in Providence and is under the call 1AID. This ought to make a few of you fellows snap out of it. Just think this YL handed in a msg report. The following stations have been notified that their QRS certificates have been cancelled for failure to report: 1OJ, 1BSD, 1ARR, 1AQU and 1BES.

Dist. No. 2: 1ANX got going again with a 50-watter and is handling the traffic. 1AAP is doing exceptionally good work with his two fives. 1AAP shuts down at 7:45 and doesn't open up again until 10:45. 1BVB was out for a week and a half this month without any mast to hold up one end of the aerial.

Dist. No. 3: 1BQD reports nothing doing down there this month. The R.C.L.s are hot on his trail and every time NAF or any of the naval vessels start up or even a power line leak they all say "There is that Mathewson guy on again!" 1BQD has installed a 50-watter.

WESTERN MASSACHUSETTS—Dist. No. 5: 1AWW seems to think that 205 meters is OK for transmission. 1CI has been turned over to the Radio Inspector; sending during quiet hours. 1CGQ was logged for sending on 205 meters. The Springfield Radio Assn. has promised great things to us; now we ask them to come across. 1IL worked 6BU for an hour with three 5-watters.

Dist. No. 6: 1BSZ reports traffic going through Greenfield OK via 1BOM and 1CCP.

Dist. No. 7: Worcester seems to be the most active point in Western Mass. Worcester County Radio Assn. is again on the climb as there is a real need for a live organization and the hams have turned toward the old club.

EASTERN MASSACHUSETTS—1COC is putting in a W.E. 50-watter. 1AAC, using but one lone 5-watter, has worked 5AAC and 5NY in Texas, and is QSO the 9s nightly. 1CBJ got going but some experimenting to do. 1AGS turned in a very good traffic report. 1CIT is on 175 and working the 5s every night. 1CJR blew a 5-watter. 1OV is getting out in fine shape for his 5-watter. 1SK has been heard by 6BCL. 1BFA is about ready to quit the game. 1CPI is getting out all over the place.

Dist. No. 2: 1AJA has worked PCII and PCTT. 1BDD-1XAR is working the Europeans every night and is also handling a bunch of traffic. 1BBM is hearing PCII all over the lot. 1SE has been heard but very little in the past month as his OW has

been sick. 1AHL received a card from England so he feels happy. 1NT is increasing to a 10-watter. 1AHE is going to get on with a 10-watter. 1AUL is working 9s every night and 5s as well.

NORTHWESTERN DIVISION Glenn E. West, Mgr.

Our message total looks mighty punk when compared with that of a year ago. Many of our best relay stations complain that there are no messages in the air. Everybody says "NIL in OM".

The Traffic Department is the backbone of the League. Message handling is bread and meat to and took a 250 word msg. from Mix. 7AIB the saturated with A.R.R.L. traffic.

WASHINGTON: Cum Al Ye Hams! To the 7th District Convention to be held in Seattle April 11th and 12th. Don't forget.

Dist. No. 2: 7DJ worked WNP using a 5-watter and took a 250 word msg from Mix. 7AIB he other 5-watter moved to a new GRA. 7MT is off for repairs. 7FN opened up on a 5-watter and worked Alaska the first night. 7ABB has dropped off considerable but gets an occasional OK on the 1X sent to Mix every Monday night. Stations handling traffic are 7CA, 7DU, 7ED, 7H, 7OY, 7VM, 7ABF, 7ADP, and 7AEL. 7FD and 7DU are heard with a great wallon.

Dist. No. 3: 7WS had the experience of beerless bottles but replaced them. The combined station 7DC-7AIF has broken up as 7AIF is going to Y.M.C.A. Radio School.

Dist. No. 4: Mr. C. Maginn, Jr. has been appointed new D.S. 7SC has resigned. 7ADR reaches out fine using 50-100 watter. 7NN lost his antenna in a recent wind storm. 7SH, 7SF are QSA throughout the country. 7LH takes the honors of the most messages and works lots of DX. 7NO comes 2nd and has worked 2200 miles.

Dist. No. 5: 7GP takes the cancelled postage stamp for handling the most messages in the state. His number this month being 381.

Dist. No. 6: 7BJ and 7LY lead for traffic handled and DX. 7AAV is in deep mourning over his 5-watter. 7AJY is active. 7GR is working 9's and 5's from the start. 7BJ is using the Meissner circuit with some 30 DX stations worked during the month. 7VN is using higher plate voltage with hopes of greater DX.

Dist. No. 7: C. J. McClure, 7NE, is the newly appointed D.S. The activities are nil at present but there's hopes of 7NE coming on with 5 watters, including his cement mixer.

Dist. No. 9: 7RY and 7QC are getting out. 7GE-7ZX is handling traffic in all directions.

Dist. No. 10: 7AF handled the most msgs and is working great DX. 7WA coming second. Others reporting are 7EB, 7ER, 7GI, and 7SZ. 7FO is getting out FB working 2s and 8s.

OREGON—The past month has been exceedingly full of activity and the messages have increased. The DX craze has given away to real ham radio again.

Dist. No. 1: 7GQ is doing good work on a 10-watter. 7IW is pounding brass most of the time, but has been having rectifier trouble. 7SY has worked a number of sixes with his 115 volt battery fone. 7SQ is on the air quite consistently with a 5-watter. 7AHZ and 7FH have put in a 50-watter. 7ET is using a 5-watter.

Dist. No. 2: 7HA is on the air every night. 7QT has worked 7MN in daylight. 7ZE and 7QU are both working consistently using 10 and 15 watters, respectively.

Dist. No. 3: 7ALD, 7SN and 7AKH are holding the air down this month. 7SN, after losing his antenna got it up again and now his counterpoise is down. 7AIX is a new station using a 10-watter.

Dist. No. 4: 7EL, 7TT and 7ADM are handling most of the traffic. 7ADS has succeeded in hooking up with WNP.

Dist. No. 7: 7GU is on with a 5-watter. 7JY uses a 5-watter and is doing good work. 67FR and 7ACM are combining their bottles and also getting them in oil. 7QD can be heard any night as he has a second op. The D.S. has been working out good and gets many reports from eastern stations hearing his signals.

Dist. No. 9: 7ABY used too much plate voltage and burned out \$16.00 worth of perfectly good 5-watters. 7AJJ and 7JE are pounding brass most of the time.

MONTANA—Dist. No. 1: 7AGF has some of the new 3 tubes coming. 7WP reports QSRing a batch of messages right into the territory they were intended for.

Dist. No. 2: TACI has been rebuilding. 7NT is doing good work on one UV202 with 35.4 watts on plate—had QSLs from 3APV, 5FU and 3CEL. 7EL using a 5-watter with spark coil supply is working all over the country. 7TD is handling traffic in great style. 7MP was relieved of his tonsils. 7ZF-KBB has been playing with the short waves and his message total went up the creek. 7ZL-XBC-JD, the A.D.M.'S station, has also been down around the 100 meter line and finds it the ideal place to do business. Traffic was handled with Atlantic Coast stations on about 120 meters that could not hear the 160 meter or higher waves. To do this the most outrageous array of junk was used that ever was assembled under one canvas. Three UV202s with 500 volts MG filtered through 50 H and 8 miles and current of 160 mills was put on the plates, 7.4 A.C. on plates and .6 amps in the antenna whose fundamental was 176, and say, the way the eastern hams snatched the sigs and came back was surprising.

Dist. No. 4: 7AJD is going good but night work somewhat interferes with the message handling. (Well as long as it isn't drug store beauty, it's all right. Hey 7BT) 7ZU has been on the air nearly every night handling traffic and working all kinds of DX. Stations from every district are logged nightly. A two foot loop brings 'em all in and QRN is nil. The short waves have been tried by 7ZU but it takes too long to raise 'em down there so he has QSY'd back to 220 meters where he has a powerful kick.

IDAHO—Dist. No. 1: 7JF has been doing very good work on A.C. C.W. 7JF has handled several messages.

Dist. No. 2: 7ET leads in messages handled and 7OB comes next. 7OT has his transmitter fixed so he can work on any wave from about 120 to 200. 7IO and 7LN are rebuilding their sets. 7OH and 7FT also have built short wave tuners. 7YA has been teaching the B.C.I.s the code via station KFAU. 7GW is on with a 5-watter, and has opened a new route for traffic going east.

PACIFIC DIVISION

J. V. Wise, Mgr.

Southern California is the only section of the state represented this month and a very fine report is filed by McCreery.

Dist. No. 1: 6AWQ is a 100 watter reaching out for the Grey Castle Radio Club. 6CGC is back with us after a lay-off of a couple of weeks. 6CDV uses spark and C.W., alternating and trying to find out which is better. 6BFB is knocking wicked holes in the ether. 6BAS-6XBI is a new comer with a kick in San Diego. 6BNY is now C.W. and has junked his spark. 6BOQ, 6BKK, and 6CIA are doing good work. 6GT has dumped his spark for C.W.

Dist. No. 1A 6XAD-6ZW has been having a hard time of it trying to work WNP as sigs from the Bowdoin have been punk for the month. To give a list of the stations worked by 6XAD would be

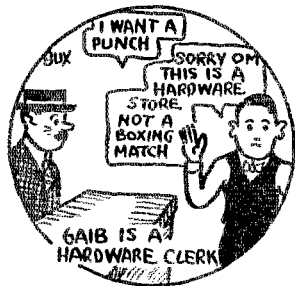

out of the question in this limited space—so let us say that it looks like a call book. Hi.

Dist. No. 2. A good many of the stations are recovering from the storm which wrecked things around these parts. 6MH is on the air but little and does good work when he is on. 6BEG has a new mast and uses remote control. 6CBB has a new 100 watter perking. 6BKO is back with a good wallop. 6CMU doesn't seem to be able to get his 50 watter perking. 6CMS fell short on work this month. 6BDW increased to a 10 watter and improved his DX. 6AFP isn't getting quite as well in his new QRA. 6BVG was on for a

while after he got off his ship. 6ALG-6ZBB is rebuilding a 100 watter. 6LJ is getting out FB with his 500 cycle outfit. He had the misfortune to have a fire and lost quite a lot of his junk. 6BWD burned out some generator coils which accounts for his absence from the air for a time. 6BRO finally got his fiver working ok. 6ADG got his rectifier going and is doing good DX. 6BIC is getting out the same as ever. 6BWE is pushing 6.4 amps into the antenna with three 5-watters. 6AQD worked Mexican BX and blew two 5-watters. 6BJR is QSO the east coast. 6BQY and 6BQC say that they are off of radio. 6PL succeeded in getting two messages to New Zealand. 6BPZ has been working good DX. 6BRF repaired his antenna and is going strong. 6EA and 6EB are raising a real mast. 6CFY continues to burn up the air as per usual. 6CHV has started to reach out in fine shape. 6EN surprises the gang by coming on the air once in a while. 6ALF is increasing power to a 50-watter, and is sticking up a new antenna. 6PT is back with a 50-watter, and sink rectifier. 6TF is a new station reaching out FB. 6BJW and 6CFM have installed a rectifier and their wave is considerably sharper around town. 6BTS has gone to sea. 6CIX is rebuilding. 6BBW seems to have trouble picking up traffic, but reaches out FB. 6CHZ is still reaching out in the same old way. 6BUR handled a bunch of traffic but doesn't get much DX.

ROANOKE DIVISION

W. T. Gravelly, Mgr.

WEST VIRGINIA—8CHO is overhauling his transmitter. 8SP and 8AUE did some good work handling storm messages between Pittsburgh and Fairmont, while wires were down. 8AMD is working on 100 meters using four 5-watters. His set is located on top of a seven story building, and he is in touch with the west coast. (FB) 8CHQ says everyone is QRU. The A.D.M. says it looks like school and "Wimmen." 8DKB is a new comer in the game. 8AJP is back from school and working on RF now. 8CXM is rebuilding. 8BAG blew his transformer. (Rotten luck!)

NORTH CAROLINA—4MV, with rockcrusher is going strong. (Come on with CW, OM!) Asheville has eleven active stations with 4KC, 4MI, and 4GW leading the gang. 4SF has his station lined up in good shape, and has been reported from all districts. 4FQ has a 100-watter; 4JR has a 15-watter, and both of them are doing good work. 4BT leads in west coast work. 4EA is back again. 4NT was married and eloped to California. Hi. (Congrats, OM.) 4AB with 15-watter works sixes and sevens. (FB, OM.)

VIRGINIA—3BCH recently lost his wife. (Sympathies, OM.) 3ATB with a 150-watter is doing good work, with 3SG helping out. 3SG threatens to open up again. 3ABS has the quitting game now. (Look what happened to 3SG, OM!) 3CKN has joined the Navy to pound brass for uncle Sam. 3BMN used a 10-watter until it blew up then stuck in a 50 and did some good work.

Dist. No. 5 sends in a report. One operator at 3TW at school, another building crystal sets and the other has no "ambish." 3CKL is reaching out in fine shape and can handle traffic to the south. 3DT can handle traffic now since they have a good bunch of operators in the club. 3KZ los his mast, antenna and counterpoise, in a recent sleet storm. The 60-foot mast fell in a space of 20 feet and did considerable damage to the residence. 3AEV also lost some of his junk.

ROCKY MOUNTAIN DIVISION

N. R. Hood, Mgr.

COLORADO—Denver:
9CAA, C.W., 287 Msgs.
Denver, Colo.

9CAA just saved the D.M. the expense of getting a rubber stamp made for 9AMB for the box seat. 9APF follows second with 185 messages, and 9CJY third. 9AZG had its first operator Hansen down to Denver to have his appendix removed and the Father of 9AYO did the job. Ham cooperation, eh? 9AMB's 50-watt tube took a deep breath and is no more. 5 watts now for a time. 9QL, 9BUN, 9EEA, all have been on and moved traffic the past month.

Dist. No. 1: 9EVO and 9DTE are the only reporting stations from this district and we are glad to see those stations keep the northern part of Colorado open to traffic.

Dist. No. 2: 9EAE leads in this district with 51 msg's. 9CLD is second and 9DFH third. 9UDE, the

station of the D.S. is not in regular operation due to fact that he earns his bread and butter by doing much traveling, but he has put this traveling to good advantage by personally visiting all his men. 9CHT, a new station has been on the past month.

WYOMING—The same stations are still doing work in Wyoming, 7ZD-7LU being the most consistent. A new 7ZV will soon come into being. 7ZO has not been on regular due to other duties. 7NR has opened in Buffalo which gives good QSO north.

WEST GULF DIVISION F. M. Corlett, Mgr.

Twenty-one of the O.R.S. failed to report this month. Fifteen of them have permitted this habit to grow on them and as a result the following O.R.S. appointments are hereby cancelled. 5NS, 5ES, 5AE, 5KP, 5XE, 5IS, 5IM, 5JM, 5ZADA, 5TM, 5JZ, 5SS, 5ZAT, 5KO, and 5AER. The last named being cancelled due to station closed for an indefinite period.

NORTHERN TEXAS—R. L. Clinkscales finds it necessary to resign as A.D.M. due to business responsibilities and in appreciation of his work well done his resignation is accepted.

Dist. No. 1: 5LR has led the division in the number of messages four consecutive months. 5AJJ handled 39 on A.C.C.W. 5AIC on one lonely 5 watt lamp works 6CEU in Hawaii, also every district. 5JL is going fine again. 5HY passed 40 along. 5CT has junked the spark, two, so called, 5 watt bottles doing the trick now. 5AGT reports 73. 5QI had a generator burn out. 5YW is QSO both coasts, working on 198 meters. 5ALI handled 10. 5UD handled 12, 5FX, 46, and changing to a four tube affair. 5NY handled 42. 5NW is QSO all districts and Canada. 5AHC is percolating again. 5AMB handled 25. 5AL reports 8.

Dist. No. 2: 5SD, working on 170 meters, handled 34. 5CV says traffic moving fine. 70 passed along here. 5QV handled 10. 5AGH moved 60. 5UY has been QRW. 5AFH reports traffic falling off. 5ADH lost 4 tubes. 5QY has a new 85 foot mast, rectifier, and an 80-250 M. tuner, on from 3 to 5:30 A.M. 5ARW blew one bottle and is doing better work with the one left. 5PS's antenna is down for repairs, a new 98 foot mast going up. 5QT handled 5: 5KX, 29 and 5AJT 67. 5AJT has a new 50' mast. 5FC will be a 100 watter. 5FA is out of commission. 5ADV-5TO works Ft. Dodge, Iowa in daylight. 5AET reports 5. 5ALJ is rebuilding transmitter, putting up 60', and 68' masts, new CP 'n everything.

Dist. No. 3: Traffic is picking up and moving in fine shape.

Dist. No. 5: 5AIJ is on the air most every evening and morning for east and west traffic. 5ZH is holding down the relays here.

SOUTHERN TEXAS—5ZX operates daily from 6 to 8 P. M. 5NN passed along 25 of 'em. 5XW works Fort Arthur, Ont. on 100 meters. 5ZG is remodeling.

Dist. No. 7: 5ZU QRW building a set for 5EN who is in Bozoto, Columbia, S.A. where he will establish an A.R.K.L. relay and attempt two-way communication with U.S. 5ALE on only five days handled 7. 5YK passed 56. 5JT just 7.

Dist. No. 8: 5VO under going repairs. 5MT received 14 and sent 41, no "tnx for erd" type either, they average 40 words per message and total some 2,200 words. On a basis of 10 words per message, the total for this station would be 220 messages instead of 55. All day light work and real traffic. 5AKZ is on from 6 to 8 each night except Sunday and will be on from 10:30 until "off" on Friday nights. 5JC had a flock of tubes go west. 5ADI is working on 150 meters now.

Dist. No. 9: 5ADB is moving traffic in fine shape. **OKLAHOMA**—Dist. No. 1: 5CE lost a mast in a storm. 5ANC sent 54 and received 56, total 110. 5ZAV-5NG is a 100-watter now. 5QL leads with 124. 5AJB moved 62. 5XT batted out 50 in three nights with his "bug" just to let the gang know how it is done.

Dist. No. 2: 5RM is rebuilding. 5AJQ lost a couple of tubes and a lonely 5 is doing the drag now. 5FD is a new station located at 2626 Okla Ave. 5SG handled 26. 5GA is not on much. 5XBF has been all piled up with "Ink Slingers" and only got 6 across this time. 5AAW passed along 19 on two 5 watt bottles. 5GJ is down on 150 meters.

Dist. No. 3: 5AMZ wants traffic. 5TW moved 7 messages for his first month.

Dist. No. 4: 5VM is trying some 100 meter stuff. 5AHD is rebuilding his antenna and the wind-warped 110' stick. He had to cut off 30' of it.

NEW MEXICO—5ADO handled 57. QRN seems

to be starting up for the "summer." 5ZA moved 176.

MEXICO—BX is dismantled and shut down on account of the revolution.

MARITIME DIVISION

W. C. Borrett, Mgr.

"Ray for our gang! Transatlantics gave the Maritime Division the chance to show 'em we are on the map.

We are all set now to have the dinner in Halifax on April 5 to talk over future plans and have a general get together. His Worship Mayor Murphy of Halifax has given us his word that he will be there and will make a presentation of a silver cup at the dinner to the amateur who has qualified for it. The rules and qualifications for winning the cup are being made up now and will be given out at the dinner. The cup will be put up for competition annually and will correspond to the Hoover Cup which the U.S.A. amateurs compete for annually. Other prominent people who will likely attend are the Radio Inspector, the A.D.M.s for P.E.I. and N.B. and it is hoped at least two or three other amateurs from P.E.I. and N.B. Traffic is moving along nicely through the division.

IAF is right on the job and with IDU is working hard to keep up connection with Montreal and Nova Scotia. IEI is trying hard to induce his set to send out a few dots with the dashes and with IDN is QSA in Halifax. IBZ had the misfortune to lose his tube. 9AK paid a visit to Halifax and has arranged schedules with the gang. IDQ hooked up with g2OD, his second British station, for a short period. IDD satisfied his hopes by working g2NM for ninety minutes.

IBQ continues to be the star of this division maintaining constant communication with the European stations consistently, despite a dead period when reception on any wave was well nigh impossible. Both he and 9BL are doing some low power work with 4 to 5 watts, which make the big inputs look foolish. IBV is breaking in gradually. IEB with a lone 202 is pushing things through in fine style. Our old standby IDT has a YL and is seldom heard in the air except at unexpected hours. IDJ appeared on the air this month with raw A.C. IAQ turned up on voice with a 201-A and was heard all over the country. IDE is a second op at almost all of the new stations in town, as he has not yet got his own outfit up. IAI and IAU are very busy men, but some day they promise to displace a chunk of ether.

CANADIAN SECTION

A. H. K. Russell, Can. Gen. Mgr.

ONTARIO DIVISION

C. H. Langford, Mgr.

Short wave transmission is gaining steadily. There is a point to be watched, namely, that 125 meters is the lowest wave a "3" can use. The late supply must be unmodulated D.C.

NORTHERN ONTARIO—3WS handled 151 messages and worked 7 districts and 2 Canadian Provinces in one night. 3AEB is doing good work on 150 meters with a fiver. 3AAZ uses a 5-watter and straight A.C. (Change it, OM, this is 1924.) 3NI moved 46 messages.

WESTERN ONTARIO—3IR reports 15 messages and war with the B.C.Ls. Sarnia is well represented by 3AD who put through 74 messages. 3MN-9AR is doing good work on 175 meters and reports 32 messages. 3AEO is using 200 volts "Bs" on fone and C.W., and handled 8 messages. 3XI handled 20. 3IF handled 20 messages. 3YV handled 22; 3LM, 1; 3GN, 2; 3DB, 10.

EASTERN ONTARIO—9CC and 3HE are QSO on 130 meters 3NF is getting out fine on one lonely 5-watter, as is 3AEL. Practically every op in Kitchener is hearing European hams. 3DS is working on a 50-watter with his real tuner all ready to go. 3YH on a 10-watter is getting out on 125 meters. 3ADU is using a fiver with success. 3BQ has worked British 2OD and 6BCL on 125 meters. He has been reported QRK by Canadian IBQ using an input of 1.5 watts.

QUEBEC DIVISION

J. V. Argyle, Mgr.

Traffic has not been very heavy but it has been in great distance covered and in percentage of delivery.

(Concluded on page XVI)

Calls Heard



When preparing a list for QST, it is essential to observe the following rules:

1. List the calls neatly on a separate sheet of paper with a line of space between lines; do not embody them in a letter.
2. Arrange the calls as they will appear in QST: across the page, numerically by districts, alphabetically in each district, Canadian and foreign calls listed separately, state whether spark or C.W., and give period of time covered by the list.
3. Forms close on the fifth of the month preceding the date of issue of QST. Make your lists cover the period from the first of one month to the first of the next if possible, but don't let your list come in late.
4. List only calls over 500 miles distant.

HEARD DURING FEBRUARY unless otherwise specified

W. R. Burne, 2KW, "Springfield" Thorold Grove, Sale, Cheshire, Eng.
 1adj, (1aja), (1aj), 1apc, 1brd, (1cmp), 1csw, 1er, 1iv, 1jv, (1ke), 1ty, (1xah), 1xam, 1xag, 1xar, 1xra, 1xw, 1xm, 2agb, 2by, 2cei, 2cxd, 2xab, 2xac, 2xay, 2zko, 3auv, 3bwk, 4bz, 4iu, 4st, 4ww, 4xe, 5ek, 5hw, 5zav, 5zav, 5zaf, 5zoi, 5zwa, 5zf, 5zap, 5zxb, 5zk, 5al, 5mc.
 Canadian: 1ba, 2bg, 2bn, 3bp, 3bd, 9al.
 French: (8ab), (8ct), (8cz), (8da), (8du), (8dy).
 Dutch: (pci), (ony), (oba), (37x).
 Luxembourg: 1jw. Italian: 1mt. Belgian: (p2).
 Danish: (7zm), 7ec.

G. Marcuse, ZNM, Coombe Dingle, Queens Park, Caterham, Surrey, England
 1aja, auk, 1cmp, 1bw, 1bfc, 1xar, 1xag, 1xak, 2ul, (3au), 3ot, (3oy), 9bl, 9zt.
 Can: (1bq), (1dd), (2bn).

Geo. Rogers, "Dunavon," Chesterfield Rd., Ashford, Middlesex, England
 1aja, 1auk, 1cmp, 1bw, 1bfc, 1xar, 1xag, 1xak, 1xb, 1xm, 1xw, 1xj, 2xt (sometime in 1923), 3vw, 3yo, 3bwj, 4xe, 8zap.
 Pse QST. All cards answered.

F. L. Hogg, 2SH, Highgate, London, N. C. England, (Jan. 17—Feb. 18)
 1aja, 1aj, 1aur, 1bfc, (1bdi), 1bdt, 1cc, 1cmp, (1xar), 1xam, (1xj), (1xw), (2agb), 2azy, 2by, 2bvz, 3dau, 3gr, 3mb, 3oe, 3te, 3um, 3yo, 4by, 4bz, 4er, 4ft, 4je, 5abt, 5aol, 5bep, 5bnh, 5cm, 5zbb, (9axz).
 Can: (1bq), (2bn), 2bq, 3bq, (9al).
 All cards answered. If you can't get an "X" work on 150. We watch there.

M. L. Perusquia 1B, P. O. Box 524, Mexico City, Mex.
 1akl, 1an, 1yb, 2ca, 2cl, 2cc, 2kf, 2ts, 2wb, 3ab, 3adb, 3atb, 3ig, 3sf, 4ai, 4by, 4es, 4eu, 4dv, 4er, 4fz, 4gz, 4hs, 4hu, 4id, 4ik, 4in, 4iu, 4iz, 4oa, 4ob, 4pb, 4pt, 4px, 4af, 5aac, 5aat, 5ae, 5adu, 5aes, 5aic, 5aiu, 5ajj, 5alj, 5aly, 5aly, 5amj, 5amk, 5amu, 5amw, 5ana phone, 5be, 5ek, 5cu, 5ef, 5ft, 5hd, 5ie, 5ig, 5il, 5ke, 5la, 5lr, 5ml, 5nk, 5ok, 5ot, 5ov, 5po, 5pv, 5pw, 5ql, 5qv, 5rb, 5rs, 5sd, 5to, 5ta, 5ua, 5uc, 5uf, 5ur, 5xau QRA?, 5kb, 5xd, 5yw, 5za, 5zav, 5zf, 5zg, 5zu, 5zx, 5acn, 5aoc, 5apt, 5auu, 5ax,

5bda, 5bm, 5cau, 5cnd, 5cm, 5dn, 5du, 5v, 5w, 5xa, 5xab, 5aac, 5ad, 5ac, 5ac, 5aim, 5aiu, 5ami, 5aou, 5aou, 5qa, 5ap, 5apf, 5arr, 5aro, 5au, 5aui, 5auq, 5awp, 5bed, 5bhi, 5bmu, 5bqq, 5brk, 5brs, 5bry, 5bul, 5bvy, 5bz, 5ccm, 5ccu, 5cdy, 5cel, 5cfl, 5ega, 5ejc, 5etr, 5ev, 5ey, 5eyw, 5ezm, 5y QSA, 5day, 5dhr, 5eak, 5ecy, 5ehj, 5eky, 5elb, 5ell, 5ely, 5eq, 5ek, 5uk, 5zax QRA?, 9zt.
 On 3 ft. loop, no R.F.—Feb. 2nd—4ez, 5amw, 5jc, 5j, 5ir, 5nr, 5rb, 5rh, 5sd, 5za, 5aau, Cuban 2by.

H. T. Mapes "BX" Guanajuato, Gto, Mexico.
 On a 3 ft. loop from Feb. 14th to Feb. 20th: 1aw, 1ary, 1bsz, 1yb, 2gr, 2act, 2hqb, 3xz, 3ab, 4ba, 4es, 4er, 4ft, 4hn, 4k, 4oa, 4of, 5adb, 5amb, 5amo, 5aim, 5aix, 5ahr, 5aiu, 5air, 5ou, 5ov, 5oa, 5er, 5ek, 5fc, 5fv, 5gi, 5hz, 5il, 5kh, 5lr, 5ml, 5na, 5oh, 5ol, 5ov, 5sq, 5ti, 5ua, 5vm, 5va, 5xau, 5yw, 5zax, 5acm, 5aol, 5adh, 5agd, 5awt, 5abe, 5abb, 5arf, 5acu, 5awo, 5brf, 5but, 5cms, 5eni, 5el, 5obb, 5egw, 5emu, 5mh, 5od, 5ms, 5eb, 5dd, 5li, 5pl, 5to, 5abb, 5alc, 5atx, 5aix, 5aen, 5acy, 5amb, 5amm, 5bpc, 5bk, 5bz, 5ccf, 5eno, 5czy, 5cud, 5eku, 5ed, 5qw, 5rv, 5yq, 5ou, 5av, 5aul, 5auu, 5ael, 5aku, 5aim, 5ahz, 5agc, 5brk, 5blg, 5bhi, 5brs, 5bhd, 5bin, 5boz, 5bz, 5brk, 5bds, 5beu, 5ely, 5elq, 5evt, 5ezw, 5eic, 5ega, 5evi, 5ezm, 5evo, 5ean, 5ell, 5egn, 5epe, 5etr, 5evc, 5emk, 5dhw, 5dxc, 5dxu, 5doo, 5dmc, 5edb, 5eeb, 5eak, 5es, 5hw, 5ih, 5ir, 5re, 5ss, 5yz, also 5gz, 5udo, 5bvg, pd, kiz, kpo, "BX" is closed down at present due to QRM fm Revolution.

Juan E. Chibas, SGT, G. Portuondo Baja 12, Santiago, de Cuba, Feb. 6th to Feb. 25th.
 1aur, 1asi, 1asu, 1avj, 1aw, 1bg, 1gv, 1mi, 1sw, 2afp, 2bfp, 2bqh, 2bum, 2buq, 2zgb, 2coa, 2kf, 2wr, 3adb, 3aen, 3ar, 3bmn, 3btk, 3caf, 3eel, 3ij, 3ig, 3mf, 3ol, 4ba, 4dp, 4er, 4ft, 4hn, 4iu, 4iz, 4je, 4mi, 4oi, 4pk, 4sh, 5ac, 5aht, 5kr, 5rg, 5sz, 5ua, 5yw, 5akj, 5atc, 5bks, 5bvy, 5axm, 5dkb, 5fm, 5rv, 9aau, 9aj, 9ahz, 9aor, 9anf, 9az, 9bhy, 9br, 9brx, 9bsi, 9caa, 9ccn, 9evo, 9duh, 9dxc, 9eac, 9edo, 9eky, 9fl, 9ur, 9vm, 9wc.
 Spark: u4ch.
 Can.: 2be, 3uf.
 Cuban: 2ww, 5ev.

T. W. Higgs, 45 Howard Rd., Westbury Park, Bristol, England, Jan. 10th to Feb. 18th.
 1aja, 1aj, 1aur*, (1bfc), 1bdi, (1bdt), 1bes, 1boq, 1bwj, (1cmp), 1eru, 1iv, (1xak), 1xam, (1xar), 1xm, (2agb), 2boh, 2bce, 2cei, 2xab, 3bji, 3ot, 3vw, 4bz, 4eh, 4zz*, 5fv, 5aaf, 5aol, 5atp, 5zap*, 5zxb*, 5zk, 5zv, 9eb, 9zt.
 Canadians: (1bq), (2bg), 2bn, 3ds, 9al.
 *Cannot trace QRAs. Cards waiting here at Bristol.

G. Ferroux, 8BV, 96 Blvd., Montparnasse, Paris
 1aja, 1aj, 1auk, 1bdi, 1cmp, 1tk, 1wa, 1wk, 1xam, 1xar, 3bg, 3pl, 4tu, 5bxh, kdka, nkf.
 Can.: 2bg, 9bl.
 Receiver: single valve.

Ahbe LeBoy, Neuvy-en-Beauce par Janville (E et L) France, Jan. to Feb.
 100 to 125 meters: lawr, 1cmp, 1xj, 1xw, 1xar, 2agb, 4bz, 5aol, kdka.
 All good, received on simple coupler as described in QST, February 1924, page 8, but with one stage of audio-frequency, no aerial, no frame, no ground. Primary 4 turns, secondary 16 turns, tickler 25 turns. Variable condenser (0.0005) on grid.

Ex 9BZZ at Sea between San Diego and Balboa, Jan. 2, 800 miles out: 5ado, 6fm, 8bda, 8cgr, 9aim, Jan. 3rd: 4ft, 4hs, 4ws, 5ajd, 6amw, 5jc, 5jf, 5if, 5lg, 5um, 5za, 5zu, 6adh, 6arf, 6aol, 6aup, 6aru, 6bce, 6bgd, 6bjj, 6br, 6brf, 6buo, 6buy, 6bve, 6cao, 6eel, 6eek, 6edg, 6efm, 6ekp, 6che,

6cmr, 6cmt, 6cng, 6cng, 6nb, 6rn, 6ru, 6tu, 6vf, 6zah, 6zbl, 6zp, 7aw, 8djp, 8do, 8aap, 9dhr, 9vm, Jan. 5th: 5lr, 6bce, 6bic, 6bku, 6bns, 6car, 6cau, 6nx, Jan. 6th: 5agt, 6aie, 6at, 6if, 6jg, 6rh, 6vm, 6xau, 6zak, 6akz, 6blw, 6cbb, 6chv, 6ckr, 6cng, 6la, 6xad, 7fd, 8cdm, 8cwn, 8wx, 8yv, 8aer, 9bal, 9cto, 9byc, 9ccs, 9cnyf, 9dqu, 9dsw, 9mc, 9vm, Jan. 27th, 1 day out, enroute Colon to Culebra Islands: 5htw, 5lr, 4je, 4pk, Jan. 28, 2½ days out: 1xz, 2bpf, 4ba, 4hn, 4iv, 4iz, 5abc, 5bc, 5hr, 5vj, 5atr, 5ij, 5ve, 9aau, 9ahj, 9ahz, 9brx, 9buf, 9hyc, 9ccv, 9dbf, 9dou, 9dwk, 9egb, 9mc, Jan. 29th, 3½ days out: 9efi, 9vw, Jan. 30th, 4½ days out: 4fn, 4hu, 4iu, 4oa, 4ht, 5on, 5vw, 8yv, 9bed, Jan. 31st, 100 miles south Culebra Islands: 4ba, 4oa, 4pk, 5afq, 8bda, 9hvk, 9yv.

Canadian 2FU, Montreal, Que.

5eb, 5ft, 5gu, 5hs, 5ku, 5lj, 4mi, 4sh, 5gj, 5ku, 5lr, 5tj, 5vm, 5yw, 5za, 5zb, 5auu, 5ajq, 6lv, 6cjb, 7co, 7lu, 8ta.

Canadian 3JE, Toronto, Ont.

1ef, 1fn, 1gv, 1il, 1vc, 1xw, 1zk, 1zx, 1abl, 1abc, 1aex, 1aas, 1ajh, 1alg, 1all, 1anu, (1alw), (1aoo), 1aul, 1aur, 1awe, 1bn, 1bdi, 1bef, 1bhh, 1bhn, (1bis), 1buq, (1bkg), 1brl, 1bt, 1cab, 1ccx, 1cea, 1emp, (1cjc), 1cww, (1cmx), (1cpi), (1ctp), 1cxn, 1xak, 1xam, 1zp, 3bc, 3hh, 3me, 3mb, 3ot, (3oe), (3qv), 3tr, 3yo, (3vp), 3zs, 3aek, (3avy), 3als, 3aou, 3akr, 3aur, 3beg, 3bdi, 3bhw, 3bip, 3bnu, 3ccc, 3eas 3ehz, 3cnd, 3cfn, 3ckj, 3aa, 3ab, 3bu, 3dv, 3eb, 3ec, 4fe, 4ft, 4fg, 4gz, 4hs, 4io, 4jr, 4my, 4pk, 4rr, 4ek, (5bx), 5fv, (5ka), 5ke, 5na, 5nh, 5ul, (5ts), 5ka, 5yw, (5aae), (5aa), 5aww, 5abf, 5ads, 5afh, 5aic, 5ajj, 5aja, (5aau), (5xau), 5zav, 6ct, 6hh, 6nx, 6zt, 6arl, (6bul), 6buv, 6chg, 6cwg, 6cmr, 7co, 7hg, 9ap, (9co), (9cd), 9ry, (9one), 9eq, 9er, 9fm, 9hm, 9jw, 9lb, 9lz, 9ry, 9ta, 9ta, (9ve), 9wn, (9yy), 9zy, 9abl, 9abp, 9ao, 9aee, (9aem), 9aep, 9ae, 9ajp, 9aly, 9ahs, 9ami, 9amk, 9aou, 9api, (9ape), 9aqc, (9aqz), (9arq), 9asn, 9ar, 9asw, 9atu, 9ato, 9avs, 9axx, (9azj), 9ayx, 9bab, 9bcx, (9baa), 9bdj, 9bed, 9bfb, (9bge), (9bex), 9bhg, 9bjn, 9blj, 9bmm, 9bpc, 9bze, 9bvt, 9bjq, 9bst, 9bvm, 9bwd, 9bxj, (9bhz), 9bze, (9cna), 9caj, 9cem, 9cdc, 9ccc, 9cfr, (9cch), 9cfr, (9cgb), (9cgl), 9cgn, 9ccm, 9chr, (9cho), 9che, 9cic, 9ckm, 9cms, 9cmo, (9caw), 9csc, 9ctr, (9ctt), 9cve, (9evj), 9cvt, 9eui, 9ewf, (9exi), 9eyb, (9euc), (9dap), 9daq, 9dfq, 9dfg, 9dd, 9dkb, 9dmj, 9dvg, 9dul, (9dtt), (9dym), (9eal), 9eak, 9efh, 9egw, (9ehy), 9eib, 9eky, (9ell), (9exa), (9yau), Canadian: 1ba, 2bg, 2bn, 3ad, 3kp, 3ms, 3nf, 3ud, 3wg, 3xi, 3aac, 4cn.

Canadian 9BL, Halifax, N. S.

(1brl), (1dq), (2acd), 2aed, 2azb, 2al, 2ami, 2amo, 2aur, (2awf), 2axf, (2ayv), 2azy, 2bbv, 2bis, 2hkl, 2bpl, 2bq, 2bw, 2brb, 2bum, 2buq, (2byv), 2hyw, 2cc, 2ccc, 2ccz, 2cjk, 2ck, 2cla, 2cal, 2cty, 2cu, 2cud, 2cxe, 2cys, 2cyl, (2pkl), 2ku, 2me, 2mu, 2tp, 2ts, 2tw, 2za, 2aa, 3adb, 3adv, 3akl, 3aou, (3aqf), 3aqr, 3ath, 3aun, (3auv), 3bay, 3bb (3ben), 3bco, 3bdi, 3be, (3bei), (3bjy), 3blr, (3bla), 3boc, 3buc, 3bvn, 3bwj, (3ccs), 3cnd, 3cex, 3chv, 3cfn, 3ck, 3ekj, 3esh, 3de, (3fx), 3iw, 3ll, 3mb, 3me, 3mj, 3oe, 3oj, 3ot, 3tf, 3ud, (3xw), 3xi, (3yg), 3yo, 3yv, (3zl), 4by, (4bz), 4dv, (4eb), 4eq, 4er, 4fs, 4ft, 4gz, 4hs, 4io, 4iu, 4mb, 4rr, (4xe), 5aa, 5aic, 5aiu, 5dq, (5dw), 5ph, 5xrv, 5yw, 5aaf, 5abm, 5acm, 5ada, 5aid, 5aig, 5al, 5alf, 5alg, 5alm, 5amr, (5aol), 5aor, 5apt, 5aru, (5atp), 5ay, 5ayt, 5bcp, 5bcr, 5bgd, 5bjy, 5bkd, 5bks, 5boe, 5bpa, (5bpn), 5ba, 5bas, 5bxi, 5cci, 5cic, 5cng, 5coi, 5cep, 5ceg, 5erv, 5etp, 5eus, 5eck, 5cxm, 5czz, 5daw, 5dbl, 5deb, 5df, 5dgo, 5dgr, 5dhv, 5dka, 5dkb, 5ds, 5er (5fm), 5gu, 5hd, 5xap, 5xb, 5xce, 5xkd, 5xk, 5xm, 5za, (5zk), 5zn, 9aft, 9aim, 9aou, 9apd, 9agb, 9ato, 9avs, 9axx, 9azx, 9bed, 9bgy, 9bob, 9bri, (9buj), 9cd, (9ccc), 9chg, 9ckv, 9ckw, 9ctr, 9der, 9dfq, 9dhg, 9dqe, 9dpr, 9dvg, 9efh, 9eky, 9elz, 9eq, 9er, 9fm, 9lz, 9nu, 9yz, 9zy, Canadian: 2an, (2az), 2be, (2bg), (2bn), 2bt, 2eg, 2kg, (2adn), 3be, (3ba), 3kq, (3nf), 3ot, (3xn), 3yh, 3vv, 9al, European: 19ab, 18bf, (18ct), 22kf, g2nm, (g2od), (g2sh), (g2sz), g5nn, peii.

SCH, Prince Rupert, B. C.

5ahr, 5ain, 5ajb, 5ajj, 5amu, 5na, 5sc, 5tj, 6aao, 6acu, 6adh, 6ao, 6arf, 6aau, 6bcl, 6bgl, 6bq, 6cao, 6cay, 6cbb, 6cbl, 6cbl, 6ede, 6edg, 6edk, 6egg, 6cgv, 6cib, 6cmn, 6dd, 6fn, (6ip), 6kw, 6aa, 6atc, 9aal, 9aed, 9amp, 9amq, 9aou, 9ap, 9awf, 9awv, 9aza, 9bez, 9brs, 9bvk, 9cl, 9cva, 9ezn, 9dl, 9dkq, 9dsw, 9dxn, 9dxu, 9dyr, 9eeb, 9elb, 9er, 9ss, 9zy.

1BIS, Claremont, N. H.

4db, (4fg), 4gy, 5aao, (5ads), 5aiu, 5aly, 5anc, 5go, 5ol, 5sd, 5za, 6aao, 6ajh, 6atr, 6bue, 6bai, 6cmu, 6ip, 6lv, 6tv, 6wp, 6zah, 7af, 7co, 7ij, 7kl, 7lu, 9aau, 9agb, 9ait, 9amb, 9amu, 9asn, 9apt, 9aqg, 9ava, 9avs, 9ayl, 9bad, 9ban, 9bed, 9bgh, 9bhi, 9bu, 9bmx, 9bsl, 9bun, 9bwe, 9bxa, 9cau, 9ccj, 9ccs, (9ccw), 9edo, 9efi, 9ec, 9eld, 9ely, 9er, 9evo, 9evs, 9evb, 9czm, 9afh, 9dfq, 9dli, 9dpx, 9eae, 9eak, (9efh), 9ek, 9eq, Porto Rico: 1je, Canada: 4as, Cuba: 2vw.

1GG So. Hamilton, Mass.

4je, 5abd, 5alj, 5nw, 5ov, 5ql, 5vy, 5zh, 5za, 5uk, 5zd, 5za, 6aja, 6alv, 6arl, 6atz, 6avj, 6bbe, 6bdi, 6bh, 6bkz, 6cgv, 6cjb, 6cuj, 6cmu, 6fp, 6jx, 6nd, 6no, 6zbf, 6zh, 6zj, 7ads, 7ald, 7ajt, 7co, 7fq, 7ih, 7lu, 7ta, 7wp, 7zl, 7zu, 9afh, 9avs, 9azg, 9bkt, 9bun, 9bxa, 9can, 9eka, 9cve, 9df, 9eae, Can.: 4hh, 4io, Cuban: 2vw.

2ACS and 2ADM, Schenectady, N. Y.

4ab, 4ba, 4bl, 4by, 4co, 4db, 4eb, 4ft, 4hn, 4hs, 4io, (4jr), (4lp), 4mi, 4mr, (4on), 4og, 4ol, 4pk, 4py, 4qw, 4ru, 4f, 4sh, 5am, 5en, 5ek, 5el, 5fv, 5gf, 5gg, 5go, 5hl, 5hn, 5ht, 5il, 5kz, 5lv, 5aw, 5oo, 5ov, 5qh, 5ul, 5vr, 5rr, 5vc, 5ix, 5tj, 5it, 5uo, 5vv, 5xa, 5xt, 5xy, 5za, 5zc, 5aac, 5aaw, 5abf, 5abn, 5als, 5am, 5air, (5au), 5aju, 5ajx, 5aku, 5aly, 5anc, 5amh, 5aau, 5xav, 5zav, 5zax, 6bh, 6by, 6fr, 6gr, 6gt, 6jd, 6ka, 6lv, 6mo, 6og, 6pl, 6aw, 6rm, 6tk, 6uo, 6za, 6zw, 6zx, 6zy, 6ad, 6ao, 6aw, 6awd, 6awq, 6bbe, 6bcl, 6bic, 6bub, 6btw, 6cbb, 6cub, 6cgv, 6cmr, 6crr, (6xad), 6bah, 7ap, 7co, 7lu, 7mz, 7on, 7or, 7se, 7sc, 7td, 7ta, 7u, 7z, 7w, 7ab, 7acc, 7ajr, 7co, 7dr, 7er, 7gr, 7cs, 9hw, 9in, 9mm, 9nu (9oy), 9pf, (9rc), 9ta, 9vc, (9vm), 9we, 9yy, 9zt, 9ad, 9aar, 9afi, 9afy, 9ahz, 9ahz, (9aic), 9ako, 9ajv, 9aiw, 9akv, 9amb, 9am, 9amu, 9amz, 9ao, 9aot, 9apd, 9aps, 9arp, 9arv, 9ash, 9asr, 9atn, 9aue, 9avn, 9awd, 9awr, (9ayl), 9azg, 9ak, 9eat, 9ban, 9bav, 9bhv, 9bby, 9bc, 9ed, 9bgh, 9bck, 9bhd, (9bhh), 9bhv, 9bib, 9bii, 9bs, 9biz, 9bf, 9bjp, 9bom, 9boz, (9brk), 9brs, 9brx, 9bth, (9btrn), 9bun, 9bwo, 9bve, 9byf, 9byo, 9caa, 9ccj, 9ccm, (9ccn), (9cdo), 9cgu, 9cic, (9cjm), 9cpe, 9cph, (9csm), 9ctv, 9cui, 9cvo, 9cvs, 9cvd, 9cvg, 9cvm, 9cvt, 9cza, (9day), (9dbf), 9dcp, 9dew, 9dfh, 9dfn, 9dgh, 9dhr, 9dkp, 9dl, 9do, 9dmk, 9dml, 8doe, 8dre, 8du, 9drs, 9dr, 9dte, 9dwa, 9dwk, 9dwx, 9dxk, 9dyv, 9dzo, 9aac, 9aag, 9aar, (9adb), 9edo, 9eeg, (9ehi), (9ekf), 9eld, 9ell, 9elv, Will QSL on request. Wud appreciate all reports on our sigs.

2CYH, Troy, N. Y.

4af, 4ai, 4akl, 4ba, 4by, 4bz, 4ca, 4cy, 4qb, 4dd, 4du, 4dv, 4eb, 4er, 4fs, 4go, 4hk, 4hn, 4hr, 4ia, 4ik, 4jr, 4ms, 4gz, 4rh, 4sl, 4th, 4uv, 4va, 4wt, 5aa, 5aac, 5abd, 5abl, 5abn, 5ac, 5ads, 5adv, 5afh, 5agh, 5ags, 5ajj, 5aik, 5aiu, 5amh, 5anh, 5anu, 5av, 5be, 5bv, 5ekn, 5dq, 5db, 5hw, 5it, 5ib, 5lu, 5nh, 5pc, 5pv, 5zc, 5rb, 5sd, 5ts, 5ui, 5vc, 5vv, 5wa, 5wy, 5zax, 5zn, 6aja, 6ajh, 6ak, 6bd, 6cmr, 6dd, 6du, 6ep, 6fm, 6fp, 6gr, 6gw, 6jm, 6pe, 6pr, 6sg, 6ul, 6zal, 7afe, 7co, 7cn, 7dd, 7fd, 7fq, 7hr, 7kt, 7lf, 7lu, 7tc, 7xd, 7yb.

3HS, Washington, D. C.

(5aac), 5abc, 5abf, 5abn, 5adv, 5af, 5agh, 5agv, 5ajb, (5ajq), 5ajt, 5av, 5amh, (5dm), 5eh, (5gg), 5go, 5ht, 5hy, (5ib), 5il, 5lj, 5mz, 5ud, 5vy, 5z, (5rh), (5to), (5ts), 5uk, 5vm, (5zav), 6aao, 6adt, 6ahp, 6alk, 6dlq, 6aoh, 6aoc, 6arf, (6aru), 6ati, (6atz), 6aau, 6avr, 6bcl, 6bde, 6bez, (6bh), 6bih, 6blq, 6bnt, 6bnu, 6bqk, 6brf, 6bui, 6bui, 6cgv, 6cbg, 6cgv, 6cej, 6cgd, 6cgr, 6cgs, 6cwg, 6cid, 6cie, 6cmr, 6cni, 6fp, 6gr, (6gt), 6hc, 6fi, 6jk, 6lv, 6nc, 6of, 6qj, 6rn, 6tv, 6vd, 6xad, 6zh, 6zx, 7ael, (7af), 7ahv, 7ake, (7akk), 7bj, 7co, 7el, 7fd, 7fq, 7go, 7gr, (7if), 7iw, 7od, 7ou, 7to, 7td, 7wd, 7zr, 7zu, (9aaw), 9afi, 9agb, 9agl, 9ahm, (9aju), 9amb, 9any, 9aoc, (9aog), 9apd, 9apf, 9asl, (9atr), (9aua), (9axs), 9ayl, 9ayp, (9ayx), (8azx), 9baq, (9bzc), 9bhi, 9bhx, (9bie), (9bkr), (9bil), (9bop), 9bqg, (9bre), (9bvn), 9bvv, 9bwe, (9caa), (9ccj), 9ccm, (9ccv), 9ccw, 9ccc, 9cgn, (9cvi), (9cvo), 9cvg, 9cvg, 9dap, (9dap), 9dar, 9dip, 9dkb, 9dp, (9ds), 9dt, 9duj, (9dyt), 9eak, 9eam, (9ecb), (9edb), 9efh, (9efj), (9efu), 9egt, 9ehq, (9eht), 9ehy, (9eib), 9ekt, 9la, 9ov, 9pw, 9sd, 9tm, (9yy), Canadian: 4cl, 4co, 9bl, British: 2nm, 2od, 2sz, 5nn, Dutch: pa9, pcii, French: 8ab, 8hq.

9baf, 9bop, 9boz, 9bpt, 9bgr, 9baj, 9bqa, 9bri, 9brk, 9brs, 9bsi, 9bsp, 9bth, 9bhm, 9bto, 9btt, (9bwc).
 9bxa, 9bxx, 9bzi, 9ca, 9caa, 9caem, 9cev, 9cea, 9cep, 9ceh, 9cfl, 9cfx, 9ca, 9ega, 9egn, 9che, 9chp, 9cip, 9cjc, 9cju, 9cjl, 9ckj, 9ckm, 9clg, 9clj, 9clz, 9cms, 9co, 9cpe, 9cpeo, 9ckr, 9cl, 9csl, 9ctg, 9ctr, 9cuc, (9cuv), 9cwl, (9cxz), 9czg, 9czm, 9dap, 9daw, 9day, 9dbf, 9dbw, 9dce, 9des, 9det, 9dcw, 9dgi, 9dha, 9djb, (9dkb), 9dji, 9dpp, 9dpx, 9ddq, 9dro, 9dsl, 9dsw, 9dte, 9dts, 9dtd, 9dum, 9dun, 9dwn, 9dws, 9dxx, 9dyr, 9dyz, 9ebi, 9ebt, 9edb, 9eea, 9eg, 9eep, 9efh, 9ehj, 9enn, 9ea, 9ekt, 9eab, 9ell, 9eq, 9er, 9fm, 9g, 9hm, 9hn, 9hs, 9hw, 9ia, 9iz, 9mc, (9oy), 9qe, 9qr, 9rc, 9ss, 9uh, 9vm, 9vk, 9vy, 9xab, 9xam, 9xax, 9xba, 9xi, (9xw).

1xu (voice), 1xz, 1yb, 1yk, 1abn, 2aj, 2ale, 2ana, 2ats, 2auy, 2ay, 2ayc, 2be, 2bbk, 2bbx, 2bip, 2blu, 2bse, 2bz, 2cel, 2ced, 2cecx, 2ceg, 2cjr, 2cjj, 2cjk, 2clt, 2cor, 2cpz, 2cvj, 2cqp, 2cta, 2gk, 2kl, 2ks, 2nl, 2om, 2rb, 2abw, 2acy, 2ad, 2ajs, 2bu, 2bu, 2cel, 2ce, 2cg voice, 2ia, 2iz, 2fc, 2fo, 2fk, 2fn, 2sc, 2cf, 2crp, 2jx, 2lg, 2nc, 2nf, 2pz, 2pl, 2pi, 2pf, 2pk, 2sl, 2xm, 2yg, 2zo, 2ai, 2bg, 2bs, 2cg, 2es, 2ft, 2io, 2pk, 2iu, 2je, 2me, 2mi, 2og, 2ov, 2qw, 2qx, 2sb, 2sc, 2sh, 2auc, 2ac, 2ail, 2alo, 2aiu, 2aln, 2amf, 2amh, 2ek, 2fv, 2gg, 2gn, 2kg, 2kr, 2mb, 2pl, 2qh, 2qu, 2qs, 2sk, 2ay, 2ta, 2uk, 2un, 2xab, 2ye, voice, 2za, 2zav, 2sc, voice, 2aaz, 2alite, 2aao, 2aev, 2bbw, 2bex, 2bdc, 2bcj, 2bm, 2dne, 2cgv, 2co, 2ff, 2gr, 2fq, 2emu, 2lv, 2nb, 2qh, 2tu, 2uw, 2zat, 2zh, 2aim, 2eo, 2eu, 2fd, 2fg, 2ta, 2tu, 2ry, 2aau, 2aci, 2ack, 2aed, 2ael, 2aem, 2aen, 2aia, 2amu, 2ami, 2aom, 2ape, 2apf, 2arp, 2asr, 2axd, 2ayp, 2azg, 2bg, 2bhg, 2bkk, 2bhy, 2bis, 2bhi, 2bkr, 2bpf, 2bqn, 2bqx, 2bqy, 2bsi, 2bsp, 2bsk, voice, 2bvm, 2byp, 2bzi, 2bzh, 2bcd, voice, 2ccs, 2ccw, 2ede, 2edu, 2eeh, 2efi, 2ega, 2ecl, 2elq, 2elc, 2ela, 2elf, 2eon, 2epy, 2emk, 2erk, 2edg, 2eur, 2evg, 2eyg, 2eyp, 2daw, 2ded, 2dep, 2dev, 2dvg, 2dvl, 2doh, 2doo, 2dr, 2drx, 2dxu, 2dyl, 2dyu, 2dwn, 2eak, 2edb, 2eck, 2eky, 2elj, 2hm, 2mb, 2um, 2uv, 2at. The following day-lites: (9crw), 2dwn, 2dwr.

7ALI, Mt. Vernon, Wash.
 1ajx, 1yb, 2bq, 2lc, 2rk, 2ak, 2az, 3lg, 4al, 4gu, 4gz, 4my, 5ado, 5agl, 5aid, 5ahr, 5aic, 5ajj, 5ajq, 5ak, 5amb, 5anc, 5be, 5bx, 5ev, 5ef, 5fe, 5ff, 5gi, 5gm, 5hk, 5jg, 5it, 5jw, 5kc, 5ip, 5ml, 5nw, 5ny, 5pw, 5ql, 5qg, 5so, 5rg, 5rh, 5rw, 5sp, 5xab, 5xd, 5yw, 5xav, 5xaw, 5xv, 5az, 5bc, 5gc, 5gg, 5ag, 5ak, 5aj, 5ajd, 5ajh, 5alv, 5alw, 5aoh, 5arf, 5aru, 5atz, 5auu, 5awe, 5awg, 5bbc, 5bbw, 5bin, 5biu, 5bkk, 5blq, 5blz, 5bm, 5bnf, 5bnu, 5bon, 5bou, 5bpf, 5bq, 5bri, 5buf, 5buh, 5ui, 5nu, 5ocay, 5ocbb, 5oci, 5chw, 5cc, 5ccu, 5ekd, 5egg, 5chw, 5cis, 5cib, 5civ, 5ckz, 5dd, 5do, 5fm, 5hs, 5kf, 5kw, 5lg, 5lj, 5nx, 5ol, 5pl, 5pu, 5qb, 5vc, 5xz, 5zar, 5zbo, 5zbs, 5zbu, 5abx, 5acc, 5acy, 5aig, 5anm, 5app, 5apt, 5bau, 5bcp, 5bda, 5bdr, 5bjy, 5bk, 5bmb, 5bhn, 5bsi, 5btt, 5bvt, 5bwc, 5bwo, 5bwj, 5bze, 5com, 5epk, 5ese, 5cto, 5ewk, 5ewp, 5ewu, 5ezy, 5dae, 5dat, 5ddc, 5dp, 5er, 5fm, 5iy, 5mz, 5nb, 5oc, 5pl, 5rv, 5sv, 5xy, 5wo, 5yd, 5yn, 5z, 5aaw, 5ac, 5aci, 5ack, 5ac, 5aif, 5aib, 5agl, 5ahz, 5aic, 5aim, 5alc, 5amb, 5amf, 5amp, 5amz, 5any, 5aog, 5aou, 5ap, 5aru, 5asn, 5at, 5att, 5av, 5avs, 5awv, 5axs, 5axx, 5ayi, 5bal, 5bbg, 5bzd, 5bez, 5bfb, 5bfs, 5bjj, 5bix, 5bly, 5bmx, 5bnu, 5bp, 5bpy, 5baj, 5bba, 5bbr, 5bbs, 5bvn, 5bvc, 5bxc, 5bxm, 5bvd, 5bzd, 5bzi, 5caa, 5caj, 5cec, 5cec, 5cee, 5ceg, 5che, 5cim, 5cka, 5clj, 5cms, 5cpe, 5osi, 5cvs, 5cuv, 5cwi, 5cwx, 5czm, 5daw, 5dbf, 5dc, 5djb, 5dli, 5dmw, 5dsw, 5dum, 5dun, 5dxu, 5dyr, 5eak, 5ebh, 5era, 5eh, 5eky, 5elb, 5er, 5fe, 5fb, 5mc, 5or, 5pf, 5ql, 5rh, 5st, 5rs.

9AQO-9AHK, Lincoln, Neb.
 1aac, 1agj, (1all), 1ana, 1apc, 1asl, 1ati, 1aur, (1avj), 1ayt, 1bq, 1baw, 1bbc, 1bcf, 1bc, 1bes, 1bge, 1bik, 1bix, 1bko, 1bom, 1bsd, 1bsz, 1bvb, 1bwj, 1cdo, 1cgg, 1aw, 1ela, 1emp, 1cpi, 1cpn, 1cp, 1er, 1es, 1ez, 1fd, 1fh, 1fz, 1i, 1iv, 1my, 1sw, 1xj, 1xw, 1xah, 2aw, 2ana, 2awf, 2ayp, 2azy, 2be, 2bj, 2br, 2bt, 2baw, 2bpl, 2bq, (2brb), 2bse, 2bwp, 2ccx, 2egd, 2ela, 2eyw, 2ezr, 2kc, 2kg, 2ok, 2om, 2pd, 2rk, 2ur, 2wc, 2wr, 2xi, 2xna, 2aj, 2ade, 2aen, 2afz, 2agr, 2ath, 2ats, 2au, 2av, 2avp, 2bel, 2bo, 2bw, 2bdi, 2bji, (2bdo), 2bhu, 2bot, 2bss, 2bui, 2bwj, 2bwo, 2cc, 2cj, 2cx, 2ck, 2cev, 2ccx, 2ckj, 2hh, 2hk, 2ir, 2lg, 2me, 2mk, 2ml, 2mo, 2mu, 2ph, 2qv, 2sb, 2sm, 2tr, 2vy, 2wv, 2xi, 2yh, 2ys, 2zb, (2yo), 4aa, 4ai, 4aj, 4av, 4ay, 4ek, (4bz), 4ch, 4cn, 4cp, 4cs, 4db, 4dv, 4ea, 4eb, 4el, 4er, 4fh, 4fg, 4fs, 4fv, 4gz, 4hh, 4hn, 4hs, 4iq, 4ku, 4kv, 4ll, 4lj, 4bn, 4mi, 4mv, 4na, 4oa, 4ow, 4of, 4rh, 4rr, 4sc, 4sh, 4sw, 4zob????RA, fives too numerous to list, Gabx, 6age, 6agl, 6agk, 6ahp, 6aja, 6ajf, 6ajp, 6akw, 6anb, 6aos, 6arb, 6awx, 6bh, 6bm, 6bcl, 6bic, (6bjj), 6bka, 6bkb, 6blw, 6bnk, 6bpm, 6bga, 6bqb, 6bq, 6bur, 6buy, 6bvz, 6byh, 6brv, 6cg, 6ebi, 6ebo, 6cho, 6cwb, 6cdj, 6cgv, 6cjb, 6ckp, 6cmr, 6cnl, 6ce, 6fy, (6gt), 6gu, 6h, 6nb, 6nx, 6pe, 6pl, 6qj, (6tv), 6zh, 6zo, 6zt, 6zu, 6zar, 7bj, 7hw, (7co), 7ih, 7ij, 7ur, 7nt, 7ob, 7ps, 7qc, 7td, 7zd, 7zu, 7afn, 7jt.

SCPM, Wilbur A. Stetzer, Frankfort, Mich.
 1aac, 1aad, 1abc, 1aez, 1af, 1aif, 1agh, 1agk, 1aju, 1ajx, 1ajj, (1arf), 1arp, 1ary, 1atj, (1aur), 1avf, 1avm, 1ayt, (1bbh), 1bes, (1bod), 1btt, 1bvb, 1bwj, 1cex, 1eit, (1eje), 1cfr, 1emp, 1emx, 1epi, 1ean, 1ere, 1tp, 1td, 1fn, 1fs, 1hx, 1il, 1iv, 1ke, 1my, 1pp, 1va, 1xam, 1xz, 1yb, (1bcr), 2abn, (2apy), 2az, 2axf, 2azy, (2bbn), 2bck, 2bpl, 2bq, 2bd, 2bse, (2btw), 2bu, 2bwm, 2bvw, 2bz, 2byv, 2ccx, 2cee, 2eel, 2enh), 2com, 2cna, 2cpe, 2cqi, 2cu, 2cd, 2ctn, 2cur, 2cuw, 2cwi, (2cxg), 2cyx, (2in), 2ku, 2nc, 2wr, 2zq, 2ab, 2abw, 2acy, 2ad, 2ad, 2aek, (2aen), 2afl, 2ahp, (2aid), 2akl, 2aky, 2ale, 2apb, (2apv), 2as, 2atb, 2auv, 2bbs, (2bdi), 2bdr, 2be, 2bge, 2bhm, 2bkl, (2bpl), 2bin, 2bmn, 2bms, 2bpl, 2bpd, 2buv, 2wah, 2zap, (2ecu), 2edn, 2egs, 2azy, 2and, 2ahr, (2ac), 2ail, 2air, 2aiu, 2ajb, 2aji, 2as, 2iw, 2ic, 2me, 2oc, 2og, 2rz, 2su, 2tf, 2tj, (2tr), 2va, 2wn, 2yp, (2af), 2al, 2ba, 2bq, 2bz, 2cb, 2cd, 2dv, 2el, 2er, 2fg, 2af, 2fg, 2fv, 2gv, 2hs, 2it, 2jk, 2jl, 2ll, (2imi), 2mv, 2na, 2oa, (2pd), 2qf, 2aw, 2br, 2ads, 2ae, 2aal, 2abb, 2abh, 2abn, (2ac), 2acr, 2adh, 2ads, 2ae, (2afq), 2aef, 2ago, 2ago, 2aes, 2agv, 2ahr, (2aic), 2aj, 2air, 2aja, 2ajb, 2ajj, 2ak, 2ak, 2akp, 2alv, 2am, 2ami, 2amf, 2amv, 2an, 2ap, 2bx, 2ce, 2ca, 2ev, 2dh, 2di, 2dm, 2du, 2ev, (2fu), 2iv, 2wa, 2vj, 2kz, 2ep, 2fr, 2in, 2ir, (2je), 2mi, 2mi, 2na, 2ny, 2ay, 2od, 2ov, (2pf), 2ph, 2py, 2uy, 2ud, 2oi, 2ol, (2ag), 2gw, 2ga, 2az, 2br, 2rd, 2rh, 2sd, 2sk, (2ar), 2sz, 2tj, 2tq, 2ta, 2uk, 2uv, 2uv, 2vv, 2xa, 2xap, 2yg, 2za, 2zav, 2aze, 2abp, 2ahz, 2akz, 2am, 2ams, 2aol, 2aqq, 2avv, 2beg, 2bic, 2bjj, 2bsz, 2buh, 2buo, 2bur, 2bvd, 2bgh, 2cgr, 2cgv, 2ckp, 2cnh, 2co, 2cmh, 2ni, 2pl, 2xad, 2yb, 2zd, 2ab, 2adr, 2bj, 2co, 2hg, 2iu, 2mp, 2nr, 2sf, 2zu, 2ack, 2afm, 2afy, 2agf, 2amb, 2amp, 2apf, 2ase, 2azg, 2bjk, 2bkl, 2bpf, 2bri, 2bxq, (2ca), 2cyl, 2ckz, 2cwo, 2ctu, 2dlf, 2dli, 2dun, 2awe, 2dwn, 2eez, 2uz, 2tm, 2yu.

9AQO-9AHK
 Can.: 1bq, 1ef, 2ei, 3ad, 3aao, 3ada, 3ex, (3ni), 3rg, 3tb, 3wc, (3ws), (3yv), (3xi), 3zt, 4eb, (4co), (4fz), 5go, (9bj).
 British: 2nm, 2ah.
 French: 2ab.
 Dutch: 2pci.
 Mexican: 6x.

Harold Marks, Alexandria, Nebraska.
 1aa, 1agg, 1akh, 1all, 1anr, 1ary, 1ati, 1avi, 1avx, 1aw, 1awg, 1awy, 1axn, 1ayt, 1bea, 1bez, 1bge, 1bja, 1bom, 1bqe, 1bez, 1btr, 1bvb, 1bwj, 1cde, 1ced, 1cez, 1ci, 1ciz, 1ckq, 1cre, 1cpr, 1er, 1fd, 1hk, 1iv, 1my, 1rq, 1se, 1uj, 1yb, 1yk, 2adc, 2add, 2aed, 2agb, 2anm, 2ayp, 2az, 2yb, 2bnn, 2bbx, 2bfc, 2bms, 2bq, 2bq, 2bqu, 2brb, 2btw, 2bwp, 2cee, 2ele, 2egb, 2enk, 2epd, 2epn, 2ez, 2evj, 2exx, 2exy, 2di, 2kf, 2kr, 2le, 2aao, 2ada, 2afu, 2aky, 2alx, 2arp, 2ath, 2auv, 2ava, 2avy, 2bv, 2bnn, 2bdo, 2bel, 2bhw, 2bpl, 2bq, 2bss, 2btl, 2buv, 2bwt, 2bcl, 2cdg, 2cdg, 2cej, 2cel, 2chg, 2cjm, 2ckl, 2cm, 2gg, 2ij, 2lg, 2me, 2mf, 2oi, 2qv, 2wt, 2ab, 2al, 2ba, 2bu, 2co, 2dp, 2dv, 2er, 2fg, 2ft, 2gz, 2zh, 2hn, 2it, 2iu, 2jz, 2jr, 2iz, 2il, 2mi, 2nv, 2og, 2oh, 2pk, 2qw, 2rr, 2ru, 2rz, 2sh, 2st, 2sh, 2ves too many, 2aao, 2aap, 2abk, 2acv, 2acz, 2age, 2aja, 2ajd, 2ajh, 2ak, 2akr, 2akz, 2ao, 2ape, 2aqf, 2arf, 2auu, 2avm, 2awq, 2awx, 2bcl, 2bel, 2bfb, 2bhz, 2biq, 2bjj, 2bm, 2bq, 2brf, 2bum, 2bwp, 2cbe, 2cbw, 2cdg, 2cfs, 2ega, 2egd, 2egz, 2ev, 2evw, 2end, 2eib, 2cjb, 2civ, 2cka, 2cmu, 2cnl, 2dd, 2eb, 2eu, 2ff, 2fm, 2fp, 2gg, 2gis, 2iv, 2mh, 2nb, 2nx, 2od, 2oz, 2pe, 2pl, 2qj, 2rn, 2ux, 2vd, 2vk, 2zan, 2zat, 2zbt, 2zhh, 2abb, 2aci, 2adr, 2ads, 2af, 2agd, 2agi, 2ahs, 2ajd, 2co, 2dc, 2em, 2fn, 2ge, 2gw, 2hw, 2iy, 2jh, 2ju, 2mp, 2nr, 2nt, 2ob, 2om, 2ot, 2uc, 2ud, 2rd, 2ry, 2sh, 2sy, 2ta, 2va, 2w, 2wp, 2xaf, 2ights and 2ines too many.
 Porto Rico: 4je.
 Can.: 2bn, 3ex, 3mn, 3ms, 3nf, 3ox, 3pz, 3rg, 3vv, 3yh, 3yv, 4ab, 4fn, 4fz.

SAMS, Tawas City, Mich.
 1ahl, 1ajg, 1all, 1ama, 1anr, 1atc, 1atj, 1avi, 1aw, 1axn, 1bez, 1bge, 1bgu, 1bom, 1cab, 1eep, 1, 1ekp, 1epi, 1eal, 1emp, 1cwe, 1ke, 1il, 1lm, 1qm, 1uj,

My Biggest Thrill!

By George S. Turner, Former Manager
Midwest Division, A.R.R.L.

MOST of you fellows who were on the air in those days will remember what January 17th and 18th, 1921 are famous for. On those nights our A.R.R.L. made radio history by relaying a message from Hartford, Connecticut, to Los Angeles, California, and getting an answer back in **SIX AND ONE-HALF MINUTES**. Considering the wonderful co-operation necessary and the fact that all participants were using *sparks*, it was truly a remarkable performance.

Down here in Missouri it was cloudy and cold, an ideal night for honest-to-goodness long distance work. As this was the last night of the "Trans-Cons", I was at the set early. However, it turned out that my anticipation was not half equal to the realization.

It seemed as if in the early evening, every ham in seventeen states was on the air. I never *heard* such QRM. Those of you who remember those old spark days will know what I mean when I say the air was full of screeches, moans and sputterings; figuratively speaking, it was a "Tower o' Babel" a-la-radio. I could not help but have grave forebodings for the outcome if this continued. However, this was the last night and I was on to see it finished.

Along about midnight the youngsters started to get sleepy and soon the air had cleared up considerably. With the clearing of the air my spirits rose again. Even tho there were a large number of the gang on, they were of the old school and could be depended upon to co-operate to a man. Everyone was asking for information. Everyone's mind was on the Trans-Con. As the time slowly passed the excitement increased and it was a big relief when I heard word pass down the line, from east to west, that the first message would start as soon as the route was lined up and the air clear.

I was using a Paragon tuner with a detector and one stage of amplification practically all winter with excellent results and tonight, being an exception inasmuch as conditions were good and most of the gang QRXing, I started along about midnight to hear all districts. Old 1AW back at Hartford of course was handling things back east. The Clanders over in Ohio were trying to get in on things but it seems they were not needed as Matty up at Chi was easily working 1AW direct. The St. Louis gang and 9HT up at Omaha were bidding for a place on the route along with 9LR down at Anthony, Kansas. It seems, if I remember correctly, there was a possible two-way route open to the coast via Denver and Salt

Lake City or via our old stand-by 5ZA at Roswell, N. M., who was QSO to the coast. There was no doubt that the messages would get thru; what was worrying me was would there be too many fingers in the pie? Here is where the old A.R.R.L. spirit took a hand. Those stations altho as good as any on the air *voluntarily took it upon themselves to QRX!* Soon all was quiet except for 1AW, 9ZN, 9LR, 5ZA and 6JD. This was about 1:45 A.M. on the 18th.

The Relay Starts

At last 9ZN got in touch with 1AW and told him all was QRV to the west and to GA. I do not need to repeat here the results of the first message as the story of how it was relayed to 6ZK via 6JD, 5ZA, 9ZN from 1AW can be read first hand in detail in the March, 1921, issue of QST. However, the elapsed time of only 26 minutes from the time it was started until an answer was received back at 1AW seems in itself to foretell what was to follow. The second message was a failure due to the fact that it was no longer possible to get thru to 6ZK. However, this did not "queer" the game for immediately after 1AW was advised regarding the failure of number two he started another message west, this time to 6JD at Los Angeles. The message read, "6JD—What time did you start message—Maxim." I was receiving very QRK at this time but 1AW's sigs were QRZ. However, his steady smooth sending enabled me to copy him almost perfectly. Matty had no trouble getting him for he immediately QSR'd to 5ZA at a wicked rate. That old growling spark of 9ZN together with Matty's nervous speedy sending still rings in my ears. Falconi at 5ZA had no trouble getting 9ZN and shot the message to 6JD direct. 6JD was QRZ here, but I heard his QSL and copied his answer in full. Back over the old route it went, 6JD to 5ZA to 9ZN to 1AW. The prettiest little QSR job ever pulled off. No breaks and no bones. Every man on his toes and fighting against time. Man, it made one's blood tingle to twist those dials; tuning in first Los Angeles then Roswell, following thru to Chi and back again to Hartford. I heard some of the keenest sending I ever listened to and did some of the best DX I ever expect to do in following each of those fellows from Connecticut to California and back again in **SIX AND ONE-HALF MINUTES**. A thrill? Well, I felt like waking up the family to tell them the good news or like dancing a Spanish fandango. That I believe I can proudly say was **MY BIGGEST THRILL**.

"It Works"

What Puts Joy Into the T.E.'s Heart

Mr. S. Kruse,
Technical Editor, *QST*,
Hartford, Conn.,
Dear Editor:

I tell you, for a while I felt pretty rotten. Here I had been reading in *QST* about stations using five watts being heard all over the map, and I with my enormous ten-watt set couldn't be heard across town. Was I not using just twice as much power as a five-watt station, and should I not, therefore, have gotten out twice as far? If not, why not? Of course I understood that with five watts I'd be heard all over the world anyhow and with the ten watts I'd be heard just twice as loud and ah—well you know.

So in a very short while I had my set all ready. The transformer delivered 1500 volts on full power and 750 on half power. The rectifier was a twelve-jar. You see I had read about a fifty-watt station using 42 jars so I reasoned 42 jars for fifty watts, 4.2 for five watts and 8.4 for ten watts, but just to be on the safe side and maybe put a few extra watts into those tubes I decided on 12 jars. When connected to the transformer they all sparked nicely, *which showed that they were working!* The circuit was called "reverse feedback."

I turned on the transformer and pressed the key. **LOOK OUT EVERYBODY! GRAB YOUR PHONES! HERE IT COMES!** But no. Something seemed to be wrong. I wasn't radiating a thing. That was strange.

Well, I twisted the condenser and I shoved the coil in and out and I put water in the rectifier (which was using it at the rate of about a pint an hour) and I changed the taps on the inductance, and I shoved the filaments up till they were so bright you couldn't look at them. But all to no avail. The ammeter stuck right to the 0. Then I became suspicious of the ammeter and I put in a small flash-light bulb instead. The bulb just barely glowed a dull red. I started to fool around with the set and found that as I increased the turns on the antenna inductance the antenna current increased. Hah! That was the trouble, so I increased the turns until I got the current to where I burned out the bulb and had to put back the ammeter. The meter just barely moved and I kept right on increasing the turns until I had forty and the antenna current was .5 amperes. There it stopped because I had no more turns left on the inductance. I called on several local experts for advice and they told me several things to do which *didn't* help and one even went so far as to tell me that it takes a while for a set to settle down before it works, that is a set never works right the first time!! But evidently mine had already settled that it wasn't going

to work. All the twisting and shoving, changing and fooling, irrigation and irritation, cussing and discussing, didn't make that ammeter budge past .5, and then is when I wrote *QST*.

I tell you, Mr. Kruse, it is trifling with a man to print the wonderful results of stations using five watts and then have him come to the realization that it isn't as simple as it looks.

But when I got your letter I sort of felt ashamed of myself, for didn't you tell me just what to do to make it work so that I could talk to stations ten-thousand miles away and get cards from all over the world. So I started right out to make the changes you suggested, and with that completed decided to take a look at the wavelength. The radiation had been increased so that it was now about .7. After about ten minutes searching I found the wavelength, and ye Gods! it was 350 meters! I knew right then and there that something was wrong and proceeded to take off a few turns on the inductance, but each time I took off two or three turns the antenna meter seemed more and more determined to rest and by the time I had gotten the set down to 285, the meter had given up entirely, and there I was back where I had started. I did a little more pondering and came to the conclusion that that wasn't the right way for a set to act.

I had changed everything except the grid coil and so now I changed the direction of that, and OH BOY! ain't it a grand glorious feeling? The wave was anything from 120 to 300 and the radiation was about 1.8 all the way.

I was sitting on top of the world then and right away called some DX station, but he didn't answer. Then I called another, and another, and another and still no answer. By that time I was desperate and so sent out a CQ, but even that failed. The next night it was the same thing and the next and the next and by that time I wasn't quite so happy. A few nights later, however, I did succeed in raising a station in Omaha and the hopes rose within me, but when I got his card and he reported me 'vy qrz om' the hopes took a slump.

I moped and I pondered but I couldn't reason it out, for hadn't *QST* been publishing reports of stations using a lone five-watt tube being heard off some coast anywhere from one to two-hundred thousand miles away? And not only that, but I even surmised that some of those fellows who live on ranches far from any power were domesticating the firefly with the intention of using them for plate voltage.

But all that didn't help me any, to the contrary it made me think of that song,

"Somebody's Wrong." And the more I thought the worse I felt, and the worse I felt the more I thought, till at last I got desperate and went into a radio store and with just the slightest tremble in my voice I said to the clerk, "Give me a five-watt tube."

Well, I hooked it along with its other two playmates and put on six more rectifier jars, and right away, bingo! the radiation went up 1. After the necessary introductions the tube finally became accustomed to its surroundings and began to settle down to the serious work for which it had been acquired, and by the time it had become fully habituated the current was 2.6 on 195 meters.

With that current the hope rose within me again, only this time it was so weak as to be scarcely noticeable, for radiation and meter readings now meant two entirely different things to me. It was all well and enough for that meter to say that I was putting out enough power to knock the ears off a Chinaman listening in at Hong Kong, and another thing to get some fellow in the next state even to know that I was operating a radio set.

With those thoughts in mind I turned to my receiver and before long I heard dah-dit-dah-dit dah-dah-dit-dah, and I answered him. But no reply. Then I answered another, but ditto as above. After answering two or three more with no luck I decided to try my fist at CQ.

It was with rather an indifferent air that I turned dials after that long-drawn, heart rending plea for *someone* to answer me, and I did it more out of curiosity than hope, for to have anyone hear me—WHAT WAS THAT? 'Somewhere a voice is calling' and, joys of joys, it was calling me.

I don't know how to describe it but I don't believe there was ever a sound made which gave anyone more joy than the sweet melody of my call coming over the ether, and with it the realization that at last, at last, *I had been heard!* No, I know no sweeter sound was ever made. At last he signed and it was a "6" and he was in Los Angeles and he said, "vy qsa hr om, been copying u all evening."

Now, dear editor, I love QST and I wish that there would be as many editions of it each month as you can buy (German marks (see money quotations) for 20¢). And I love every fellow who wears the diamond shaped pin, in fact I love every amateur, and loving them so I would not doubt for a second that all these reports about stations being heard in the South Sea Islands on an onion are true. Nor would I doubt that a five-watt tube when connected to an antenna and a source of power forms a means of reliable communication between stations from one to two-hundred thousand miles apart, but just between you and me, I'm going to buy another tube in a few days, and when some more shekels come rolling home, I'm going to put in a fifty-watter or maybe two or three or more.

Well, I'm not so despondent and blue now.

Thanking you for your help in getting my station to work, I remain,

Yours respectfully,

—Arnold C. Grossman, 9AVS.

MORAL: If you will ask for help and then work like the devil, you can make a go of your station—but it takes industry on your part as well as the information we can give you.—Ed.

(Concluded from page IX)

The new O.R.S. have not yet reached their stride. At present 2BE, 2BG, 2BN, and 2CG are holding new O.R.S. certificates. 2DN, 2EL, 2AN and 2BV are getting out well, and low wave work with Europe is common now.

WINNIPEG DIVISION

J. E. Bricket, Mgr.

4CO is the A.D.M. of Manitoba. Winnipeg has a new D.S. in 4EA. 4CN has two fifties but no time. 4AS is back again. Hi! 4AD will render a selection or two on 10 watts this month. 4CO lost his spark and in doubt if all the noises he hears are cheers or tears. (Hi!) 4CR will need one of those bologna meters if he radiates any more. 4FZ hits the distant spots on a fiver and wastes no time about it. 4GH and 4BT have combined their machinery to make more noise in someone's fones. 4DK sold out. D.S. says he got spring-fever. 4DY is moved to Portage la Prairie on business, but just see if that stops him! 4BI will be on by now. That's another step west. 4BP junked the spark for C.W. No holding back 4AW except when he blows his transformer (plate) but his C.W. (not transformer) raises awful smoke. 4BK's 10-watter gets real DX and handles traffic FR; 10 msgs. Gosh, what a punch. 4EA has on 5 watts (?) Gets into all districts, but complains about QSO in Western Canada.

SASKATCHEWAN—4AJ and 4PV continue to hold Regina and up. 4AJ has had hard luck with aerial coming down. 4FV reports trouble with his mast. 4BR is experimenting with rectifying his sink rectifier. 9BK and 4CB always in trouble, but going when can get time and can get things to work. They have a "haywire" set covering 95 to 225 meters reception here now.

Regina and Morse both have trouble in moving traffic into Moose Jaw.

SAO has been ordered by the doctor to keep away from radio and late hours. 4HH worked WNP and is getting out well on his 50-watter. 4ER gets out fairly good on his 10-watter. 4BB is still "girling." 4IW has started splitting the air with a 5-watter, and now holds 4FR's honored position being the B.C.L.'s victim of complaints. Hi! 4GH is going very strong on spark and C.W. and is moving traffic nicely. 4AA is shoving sigs over the country F.R. Prince Albert is coming to the front with 4FC operating consistently and 4GR chasing him strong.

VANCOUVER DIVISION

A. J. Ober, Mgr.

ALBERTA—4DQ will be on 125 meters, and 4CW between 100-150 meters. 4IO is sure going to step when he gets a few more turns of wire on the 'Fields.' 4IC was a visitor over the week-end at the D.M.'s Static Shack. 4AB is the most active station in Alberta. 4DQ is in the act of putting some pep into his batteries, and will be going soon.

EDMONTON—4CL is getting down to 125 meters and reports WNP regularly. He worked 6CEU.

VANCOUVER—5AH is rebuilding for short waves. 5AK is heard occasionally. Chilliwick: 5AS is the only station on the air. Kelowna: 5BW is on with a 100-watter, but so far has been unsuccessful in his attempts to work amateur stations.

VANCOUVER ISLAND—5CT is working on 150 meters. He is the only station doing any traffic work on the island and hands in a nice report every month. 5HK has M.G. trouble and can't get any pep with spark coil C.W. 5BL, with a 5-watter, is QSA at 5CT.