

# QST

Published by  
*The American Radio Relay League*

Devoted exclusively to

June **AMATEUR RADIO** 1923

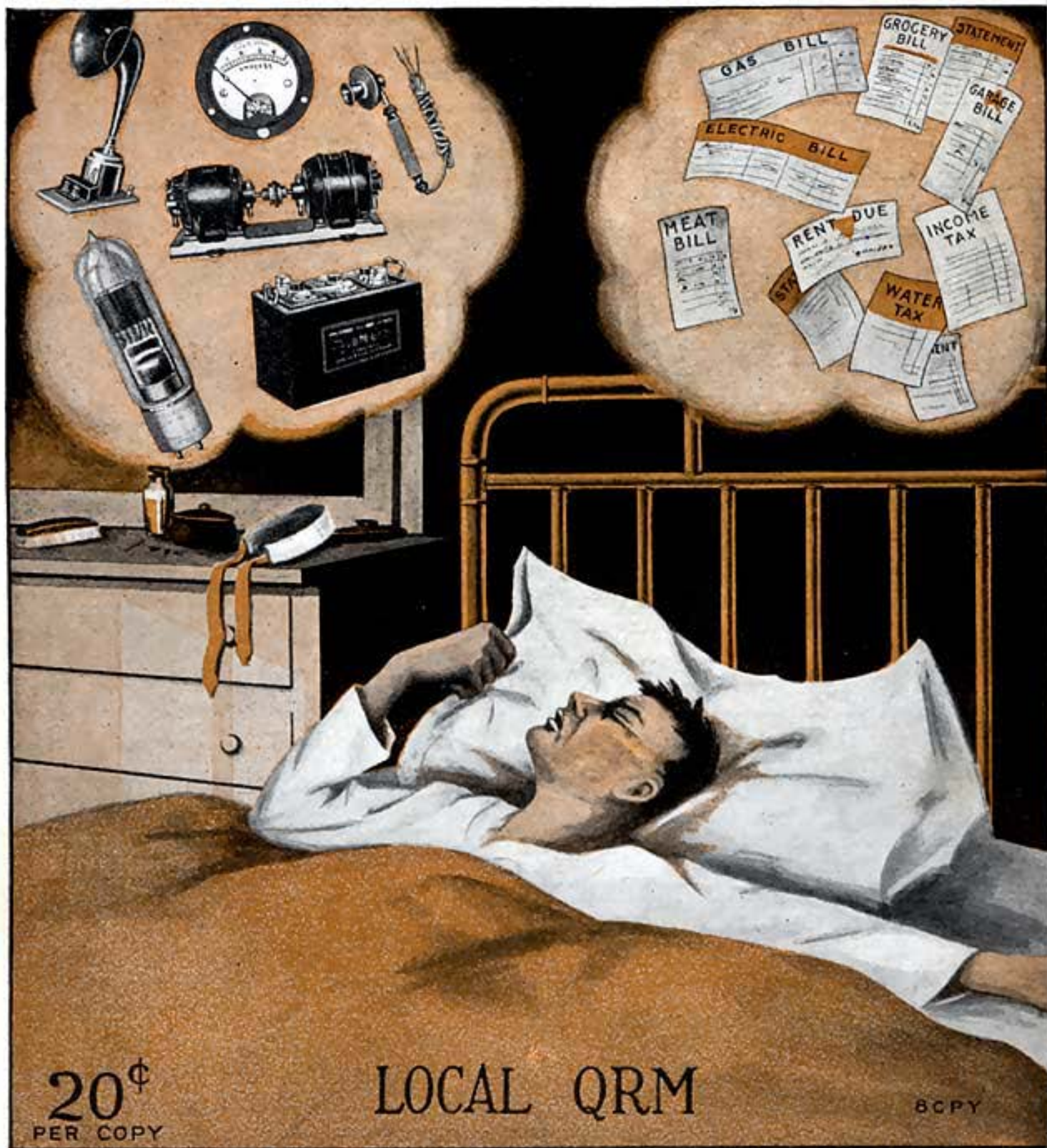

20¢  
PER COPY

LOCAL QRM

BCPY

*Filament Current  
.06 amp. Mutual  
Conductance 337  
Micromhos at 40  
volts plate and 0  
grid potential.*



Cut shows actual size of tube  
3 inches high

*Type  
C-299  
Price  
\$6.50*

**ANNOUNCING THE NEW**

*Cunningham*

### **Dry Battery Detector and Amplifier Tube**

Designed by the engineers of the General Electric Company's great research laboratories, this new dry battery tube, type C-299, is by far the most economical vacuum tube ever placed on the market for amateur, experimental and entertainment use.

It has been designed for use as a Detector and Amplifier of both radio and audio-frequency currents. The filament is lighted from three 1½ volt dry batteries in series, and the filament current is only .06 of an Amp. This is less than one fourth of the current of any previous type of dry battery tube. This feature makes it possible to use four of these tubes in parallel, with only one set of three dry batteries.

The C-299 has practically the same operating characteristics as the previous Cunningham Amplifier, type C-301. Due to the low distributive capacity of the elements it is an excellent radio-frequency amplifier. When used as an audio-frequency amplifier the output from two steps is sufficient for the operation of a small loud speaker.

Bulletin No. 2-Q describes this new tube in full and gives the necessary data regarding rheostats, battery voltages, transformers, etc. A free copy will be sent to you by return mail, upon receipt of your request at either of the addresses given below. Complete instruction sheet for its care and operation is packed with each of these New Cunningham Dry Battery Tubes, type C-299.

248 First Street  
San Francisco, Cal.

*J. Cunningham*

154 W. Lake St.  
Chicago, Illinois

"Allow the ear to hear  
what it likes,  
the eye to see  
what it likes."

KUAN-YI-WU.

The  
**Grebe Receiver**

delights both  
ear and eye.  
For the ear enjoys  
the eye good music,  
beautiful  
craftsmanship.

Doctor Mu.

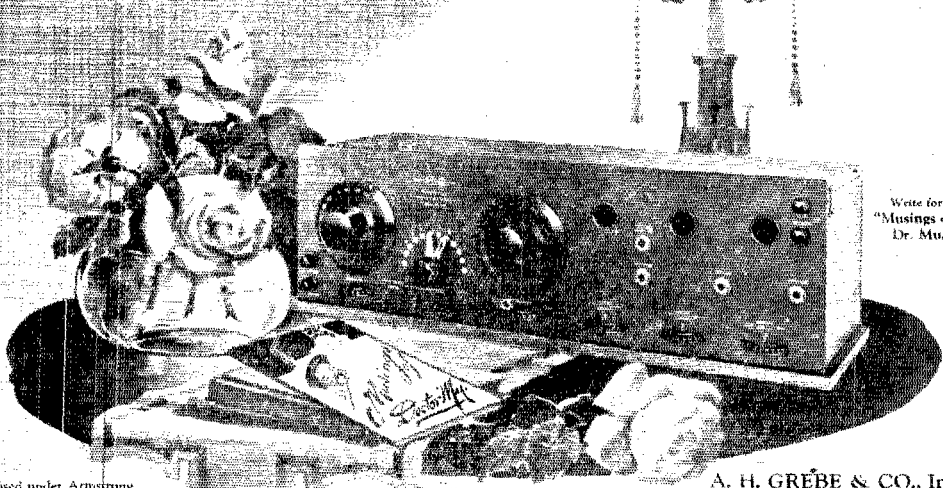
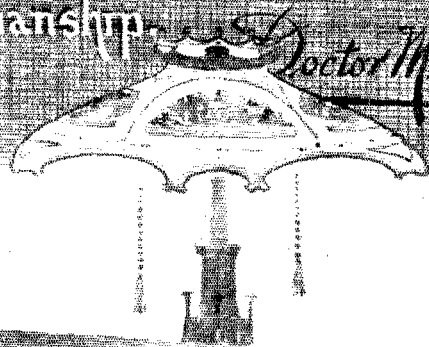

Write for  
"Musings of  
Dr. Mu."

Licensed under Armstrong  
U. S. Pat. No. 1113149

A. H. GREBE & CO., Inc.  
Richmond Hill, N. Y.

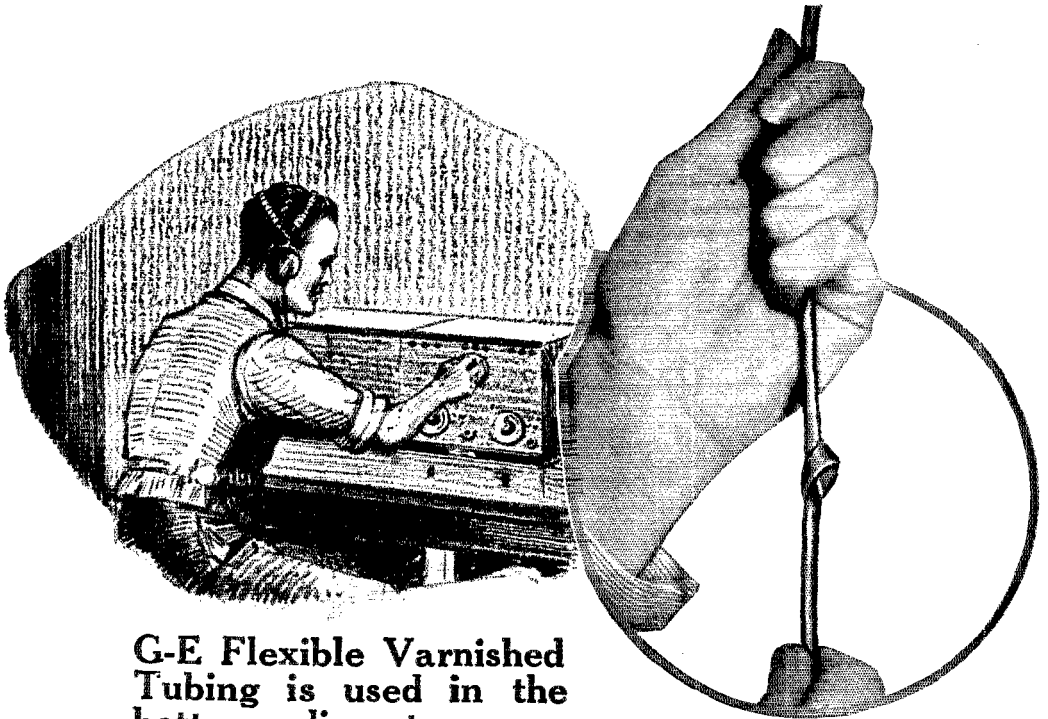

## **G-E Flexible Varnished Tubing is used in the better radio sets**

The flexible varnished tubing (or "spaghetti") used in high grade professionally built radio equipment is now available for the use of those who are building or reassembling their own sets.

This tubing is of high mechanical and dielectric strength and is so flexible that it will not crack even when tied into a knot. Furthermore, it retains this flexibility indefinitely.

Ask for "G-E" when you buy tubing—you will get assured quality. G-E flexible varnished tubing is finished in red, green, yellow and black and sold in two-foot lengths.



General Electric Company  
Merchandise Dept., Bridgeport, Conn.

# **Insulations**

**Use them when you build—demand them for repairs**

# DIRECTORY (Incomplete) OF THE PERSONNEL OF THE OPERATING DEPARTMENT, A.R.R.L.

## ATLANTIC DIVISION

<p><b>Manager</b> A.D.M. Dist. of Colo. A.D.M. Maryland A.D.M. So. N. J. A.D.M. No. N. J. A.D.M. East. N. Y. A.D.M. West N. Y. A.D.M. West. Penna. A.D.M. East. Penna.</p>	<p>C. H. Stewart H. J. Wadsworth G. L. Deichman, Jr. R. S. Johnson H. W. Densham Dr. E. A. Cyriax S. Woodworth James F. Rau P. E. Wiggin</p>	<p>70 V St. N. W. Park Hgts. &amp; Bancroft A  219 E. 71st St. 425 Brownell St. 2085 E. Kingston St. 5106 Liberty Ave.</p>	<p>St. Davids, Pa. Washington ve. Baltimore Ret. Bank Collingswood New York City Syracuse Philadelphia Pittsburgh, Penna.</p>
--	--	--	---

## CENTRAL DIVISION

<p><b>Manager</b> A.D.M. Michigan A.D.M. Ohio A.D.M. Illinois A.D.M. Wisconsin A.D.M. So. Indiana A.D.M. Indiana A.D.M. Kentucky</p>	<p>R. H. G. Mathews C. E. Darr Mrs. C. Candler N. C. Smith B. A. Ott M. W. Hutchinson J. E. Hall J. A. Kolb</p>	<p>332 S. Michigan Ave. 137 Hill Ave. 106 S. Ash St. 51 E. Stinary St. c/o Seigel &amp; Kohihaus c/o Seymour Elec. Co. 1101 E. Broadway</p>	<p>Chicago, Ill. Detroit St. Mary's Hoopston La Crosse Middlebury Seymour Louisville</p>
--	---	---	--

## DAKOTA DIVISION

<p><b>Manager</b> A.D.M. Minnesota A.D.M. So. Dakota A.D.M. No. Dakota</p>	<p>N. H. Jensen Don C. Wallace E. W. Freeman Bert Wick</p>	<p>Box 894 54 N. Penn Ave.  835 Broadway</p>	<p>Siuox Falls, S. D. Minneapolis Elk Point Fargo</p>
--	--	--	---

## DELTA DIVISION

<p><b>Manager</b> A.D.M. Louisiana A.D.M. Mississippi A.D.M. Tennessee</p>	<p>J. M. Clayton F. L. Pullen University of Mississippi W. C. Hutcheson</p>	<p>1301 Welch St.  (W. L. Kennon)</p>	<p>Little Rock, Ark. Houma University, Miss. Wind Rock</p>
--	---	---	--

## EAST GULF DIVISION

<p><b>Manager</b> A.D.M. So. Carolina A.D.M. Alabama A.D.M. Georgia A.D.M. Florida</p>	<p>R. W. Cochran W. C. Etheredge V. C. Melvaine W. B. Pope C. F. Clark</p>	<p>Box 113 36 E. Georgia St. Box 12 197 Dearing St. c/o Western Union Tel. Co.</p>	<p>Palmetto, Ga. Woodruff Auburn Atlanta Jacksonville</p>
--	--	--	---

## MIDWEST DIVISION

<p><b>Manager</b> A.D.M. Missouri A.D.M. Nebraska A.D.M. Iowa A.D.M. Kansas</p>	<p>G. S. Turner Dr. C. R. Klenk J. G. O'Rourke D. E. Watts C. Himoe</p>	<p>Room 611 Telephone Bldg., 420 Metropolitan Bldg. 6406 Maple St. 502 N. 4th St. 739 Ohio St.</p>	<p>Kansas City, Mo. St. Louis Omaha Clear Lake, Ia. Lawrence</p>
---	---	--	--

## NEW ENGLAND DIVISION

<p><b>Manager</b> A.D.M. Connecticut A.D.M. Rhode Island A.D.M. Vermont A.D.M. Maine A.D.M. New Hampshire A.D.M. West. Mass. A.D.M. East. Mass.</p>	<p>I. Vermilya J. L. Reinartz D. B. Fancher R. P. Slayton F. H. Pierce H. R. McLane A. S. McLean P. F. Robinson</p>	<p>23 N. Water St. 271 Hartford Rd. 86 Franklin St.  Jordan High School 288 Main St. 149 Hollis Ave.</p>	<p>New Bedford, Mass. So. Manchester Westerly Burlington Lewiston Laconia Springfield Braintree</p>
---	---	--	---

## NORTHWESTERN DIVISION

<p><b>Manager</b> A.D.M. Montana A.D.M. Washington A.D.M. Idaho A.D.M. Oregon</p>	<p>B. B. Bliss Jr. H. E. Cutting K. W. Weingarten LaVerne Martin P. R. Hoppe</p>	<p>417 Bannock St. Box 517 3219 North 24th St. 423-14th Ave. 1633 Willamotte St.</p>	<p>Boise, Idaho Bozeman Tacoma South Nampa Eugene</p>
---	--	--	---

## PACIFIC DIVISION

<p><b>Manager</b> A.D.M. Arizona A.D.M. Nevada A.D.M. California</p>	<p>J. V. Wise H. L. Gooding E. Anderson E. C. Garrett</p>	<p>Bisbee Highway Box 175 1420-26th St.</p>	<p>Walnut Grove, Calif. Douglas Sacramento, Calif. Colusa</p>
--	---	---	---

## ROANOKE DIVISION

<p><b>Manager</b> A.D.M. West. Va. A.D.M. Virginia A.D.M. No. Carolina A.D.M. Porto Rico</p>	<p>W. T. Cravely A. G. Heck J. F. Wohlford T. M. Simpson Luis Rexach</p>	<p>854 Main St. 410 Fairview 118 Cambridge Ave. Peoples Nat. Bank Box 319</p>	<p>Danville, Va. Manington Roanoke Winston San Juan</p>
--	--	---	---

## ROCKY MOUNTAIN DIVISION

<p><b>Manager</b> A.D.M. Utah A.D.M. Colorado A.D.M. Wyoming</p>	<p>N. R. Hood H. C. Wilson J. L. Turre P. N. Mitchell</p>	<p>1022 S. Ash St. c/o The Desert News 706-18th St.</p>	<p>Casper, Wyo. Salt Lake City Denver Greybull</p>
--	---	---	--

## WEST GULF DIVISION

<p><b>Manager</b> A.D.M. New Mexico A.D.M. Oklahoma A.D.M. No. Texas A.D.M. So. Texas</p>	<p>F. M. Corlett Louis Falconi M. L. Prescott R. L. Clinkscales A. P. Daniel</p>	<p>1101 E. 8th St. Box 421 426 Eufala St. 3913 Hamilton St. 2504 Bagby St.</p>	<p>Dallas, Texas Roswell Norman Dallas Houston</p>
---	--	--	--

## HAWAIIAN DIVISION

<p><b>Acting Manager</b></p>	<p>K. A. Cantin</p>	<p>1593 Piikoi St.</p>	<p>Honolulu, T.H.</p>
------------------------------	---------------------	------------------------	-----------------------

## MARITIME DIVISION

<p><b>Manager</b></p>	<p>K. S. Rogers</p>	<p>19 Upper Prince St.</p>	<p>Charlottetown, P.E.I.</p>
-----------------------	---------------------	----------------------------	------------------------------

## ONTARIO DIVISION

<p><b>Manager</b></p>	<p>A. H. K. Russell</p>	<p>11 Pinewood Ave.</p>	<p>Toronto, Ont.</p>
-----------------------	-------------------------	-------------------------	----------------------

## QUEBEC DIVISION

<p><b>Manager</b></p>	<p>A. J. Lorimer</p>	<p>Buzzell-Lorimer Co.</p>	<p>Cowansville, Que.</p>
-----------------------	----------------------	----------------------------	--------------------------

## VANCOUVER DIVISION

<p><b>Manager</b></p>	<p>J. T. North</p>	<p>2017-15th Ave. W.</p>	<p>Vancouver, B. C.</p>
-----------------------	--------------------	--------------------------	-------------------------

## WINNIPEG DIVISION

<p><b>Manager</b> A.D.M. Saskatchewan A.D.M. Manitoba</p>	<p>P. Socolofsky J. F. Maynard Vincent Thomas</p>	<p>Rm. 214, C. R. R. Bldg. 33 Roseworn St.</p>	<p>Loreburn, Sask. Morse St. Vital</p>
---	---	--	--



## The City's Music In Vacation Times

Thousands of summer resorts are going to keep in touch with the world by radio. Thousands more will wish that they had thought of it.

The Jones *Symphony* Receiver, detector and three stage, is particularly fitted for this service.

Because: **FIRST**, it is positively in a class by itself in the durability of its construction and assembly.

**SECOND**, its simplicity of operation.

**THIRD**, its reliability.

We sell with the Jones *Symphony* Receiver, for this purpose, a stout traveling case. All you need to do is to disconnect your leads, put the *Symphony* in the case, turn the lock, put the case in your car with a couple of "B" batteries and you are all fixed. Use your automobile battery. If that isn't convenient, use "peanut tubes" with adapters. If you want the best, we suggest using regular tubes with a six-volt battery. You can rent one at any town.

But in any case include a Jones Receiver in your summer outing plans. The *Symphony* will repay you many, many times over.

Summer radio has been handicapped by absurd stories of noises. The quality of our *Symphony* receiver, and more efficient broadcasting stations have eliminated many defects heretofore assumed to be caused by static. On most summer nights, especially in dry weather, the receiving is as good as at any other time in the year.

The use of the *Symphony* under many and varied conditions proves it to be one of the most efficient long distance receivers on the market. Every part of the *Symphony* is built and inspected by the Kellogg Switchboard & Supply Company, for twenty-five years manufacturers of highest grade telephone equipment.

Ask your dealer —If he has not a *Symphony* in stock, or complete information, wire us immediately. Get your order in at once to avoid delay.

**JONES RADIO COMPANY**

LYTTON BUILDING, CHICAGO

The *Symphony* is manufactured under U. S. Patent No. 1,113,156, Acoustical Receiver of the Circuit

# QST

## The Official Organ of the A.R.R.L.

VOLUME VI

JUNE, 1923

No. 11

The Reinartz Modulascope	S. Kruse	7
Arctic Explorer to Communicate with Amateurs	J. K. Bolles	9
Radio Filters	Melville Eastham	11
The Third District Convention	M. Adaire Garmhausen	13
Official European Report on the Transatlantic		15
Signal Report Cards		17
Corrections		18
Notes on the Neutrodyne	G. L. Bidwell	19
The Second Ohio A.R.R.L. Convention		20
"DX"—A Poem		22
Capacity Coupling to Operate the Antenna at its Fundamental	V. D. & E. B. Landon	22
Hoover QSR's Cup to 20M		24
Re-winding a Direct-Current Motor for Use as a Plate Generator	C. C. Brown	25
Why Filament Transformer "Go West" and How to Stop Them		27
Back Copies of QST		28
A New Method of Controlling Regeneration: The Four Circuit Tuner	L. M. Cockaday	29
Why Kilocycles?	Dr. A. N. Goldsmith	32
Concerning Amateur Interference with Broadcast Reception		33
Editorials		35
Operating Department		37
International Amateur Radio		50
With the Affiliated Clubs		53
Amateur Radio Stations		55
Junior Operator		59
Strays		63
New Apparatus		65
Calls Heard		67
Antenna Resistance		69
Radio Communications by the Amateurs		70
Classified Advertisements		123
Index to Advertisers		127

QST is published monthly by The American Radio Relay League, Inc., at Hartford, Conn. Kenneth B. Warner (Secretary, A.R.R.L.), Editor and Business Manager. S. Kruse, Technical Editor; H. F. Mason, Department Editor. W. B. Cowles, Assistant Editor.

Edwin C. Adams, Advertising Manager.

Subscription price in United States, Possessions, and Canada, \$2.00 per year. Foreign, \$2.50. Single Copies, 20 cents.

Entered as second-class matter May 29, 1919, at the post office at Hartford, Connecticut, under the Act of March 3, 1879. Acceptance for mailing at special rate of postage provided for in Section 1103, Act of October 3, 1917, authorized September 8, 1922.

Copyright, 1923, by the American Radio Relay League, Inc.  
Title registered at United States Patent Office.

THE AMERICAN RADIO RELAY LEAGUE, Inc.  
HARTFORD, CONN.

# THE AMERICAN RADIO RELAY LEAGUE

The American Radio Relay League, Inc., is a national non-commercial association of radio amateurs, bonded for the more effective relaying of friendly messages between their stations, for legislative protection, for orderly operating, and for the practical improvement of short-wave two-way radiotelegraphic communication.

It is an incorporated association without capital stock, chartered under the laws of Connecticut. Its affairs are governed by a board of seventeen Directors, elected every two years by the general membership. The officers, in turn, are elected by the Directors from their number. The League is non-commercial and no one commercially engaged in the manufacture, sale or rental of radio apparatus is eligible to membership on its Board.

"Of, by and for the amateur," it numbers within its ranks practically every worth-while amateur in America and has a history of glorious achievement as the standard bearer in amateur affairs.

Inquiries regarding membership are solicited. Ownership of a transmitting station, while very desirable, is not a prerequisite to membership; a bona-fide interest in amateur radio is the only essential. Correspondence should be addressed to the Secretary.

## OFFICERS

### *Traffic Manager*

F. H. SCHNELL  
1045 Main St.  
Hartford, Conn.

### *Canadian General Manager*

W. C. C. DUNCAN  
196 Ellsworth Ave.  
Toronto, Ontario

### *Treasurer*

A. A. HEBERT  
Nutley, N. J.

### *Secretary*

K. B. WARNER  
Hartford, Conn.

*President*  
HIRAM PERCY MAXIM  
Hartford, Conn.

*Vice President*  
CHAS. H. STEWART  
St. David's, Pa.

## DIRECTORS

H. M. ANTHONY  
Muncie, Ind.

H. A. REALE, JR.  
Parkesburg, Pa.

A. H. BABCOCK  
Berkeley, Calif.

V. F. CAMP  
Brightwaters, L. I.

F. M. CORLETT  
Dallas, Tex.

C. E. DARR  
Detroit, Mich.

W. C. C. DUNCAN  
Toronto, Ontario

A. A. HEBERT  
Nutley, N. J.

S. M. MATHES  
Bremerton, Wash.

S. KRUSE  
Hartford, Conn.

H. P. MAXIM  
Hartford, Conn.

F. H. SCHNELL  
Hartford, Conn.

C. A. SERVICE, JR.  
Hartford, Conn.

C. H. STEWART  
St. David's, Pa.

K. B. WARNER  
Hartford, Conn.

M. B. WEST  
Chicago, Ill.

## ADVISORY TECHNICAL COMMITTEE

C. S. BALLANTINE  
WM. G. BALLARD, Jr.  
LEROY M. F. CLAUSING  
FRANK CONRAD  
LEO C. YOUNG

MINTON CRONKHITE  
J. H. DELLINGER  
C. L. FARRAND  
PAUL F. GODLEY  
F. G. BLAKE  
MELVILLE EASTHAM

L. A. HAZELTINE  
C. D. TUSKA  
R. H. G. MATHEWS  
GERALD M. BEST  
S. KRUSE  
D. G. McCAA

Address General Correspondence to Executive Headquarters, Hartford, Conn.



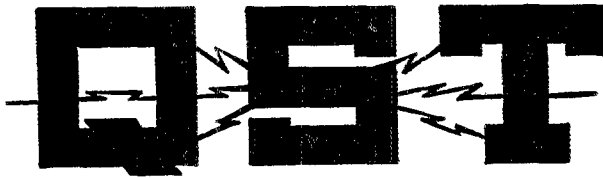

A Magazine Devoted Exclusively to the Radio Amateur

## The Reinartz Modulascope

By S. Kruse, Technical Editor.

**W**OULD you believe that in ten minutes you can build, from a pickle bottle and some scrap wire, a device that will show you—even let you photograph—the sort of output you are getting from your tube set? Would it not be fine to have a device that would actually let you SEE the sixty cycle “bumps” in the antenna current when you are using “raw A.C.” on the plate; that would let you SEE for yourself if that collection of condensers and chokes is really filtering? That is what the “Modulascope” does.

The idea for the Modulascope was suggested by an accident. Mr. John L. Reinartz of 1QP was operating a small Tesla coil driven by a 50-watt tube when it happened that the top turn of the secondary came loose. Immediately the free end began to brush violently and squirm around exactly like a fire hose when the nozzle-man lets go. Immediately there occurred the thought, “If this loose wire acts like a hose under water pressure, why is it not possible to make a little motor that will run like a ‘whirligig’ lawn sprinkler?” Within ten minutes this had been tried and as soon as the little wire spinner was

balanced it began to run at high speed, painting a ring of blue fire around itself. While the thing was still running Mr. Reinartz attempted to change the speed by adjusting the grid condenser and found that at a certain adjustment the spinner would run synchronously and the blue ring of fire would break up into patches. Here was a discovery—*this thing could be used to show if the output of the tube was real C.W.* It is perfectly simple too;

build a ten cent Tesla coil, equip it with a little wire spinner, get the thing going and see if you can make the brush discharge break up into patches—if you can your tube set is *not* a C.W. set, but if the most careful adjustment does not break the ring up, then it is pretty fair. Of course this has to be done carefully, the condensers have to be adjusted very slowly while the blue ring is sharply watched. If you cannot make the ring break up into patches and

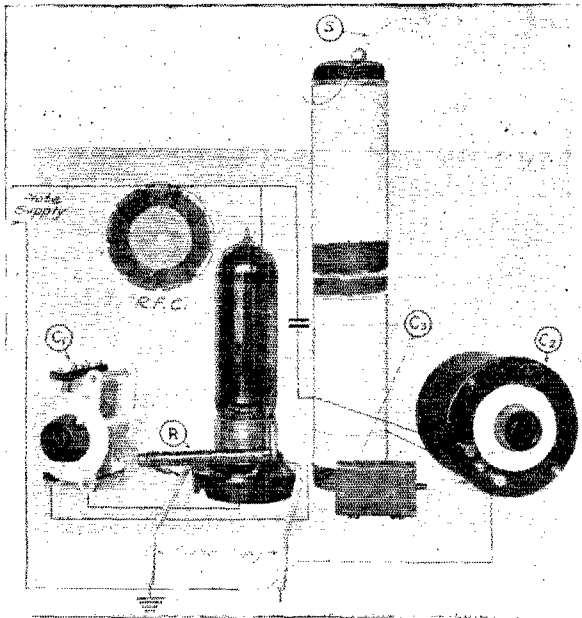

cannot even make it seem to turn, you have a C.W. set.

### What the Modulascope Will

We ran a number of experiments and took pictures of the blue ring around the

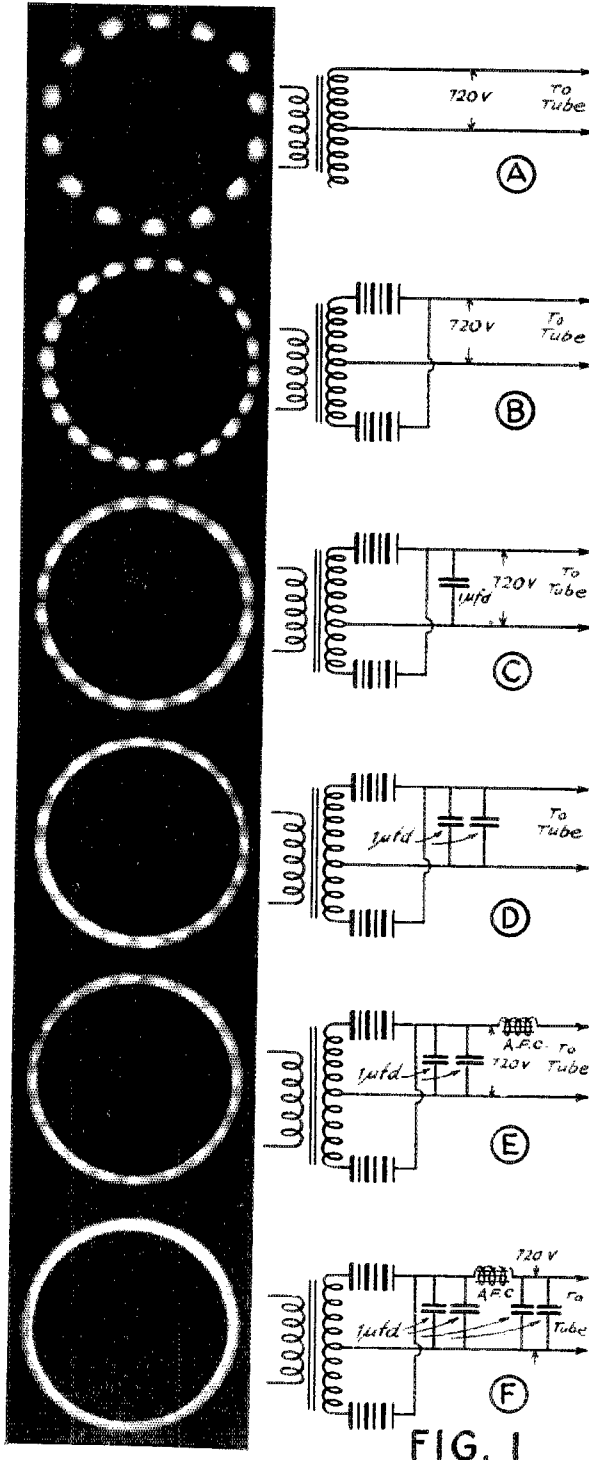

spinning wire. This was done with an ordinary vest-pocket kodak and the pictures were developed in the ordinary way. Fig. 1A shows the tube running on "raw 60 cycle" plate supply at 720 volts. This is certainly *not* C.W.

The next step was to hook in a rectifier raising the transformer voltage to make up for the loss in the rectifier so as to keep the plate voltage the same. B shows that this is not as terrible as the raw A.C. but it is bad enough.

A condenser (1 microfarad) made the improvement shown in C and a second one made a slight additional improvement as at D. Two more did not help.

Next a choke was put in. This choke was a big surprise—it made things *much worse*. Several things were then tried as chokes. A small 110-220 transformer was no good at all; neither was an ordinary amplifying transformer core with a substitute winding of #24 wire. A big one-kilowatt 2200-volt transformer was an absolute failure; and a make-and-break spark coil from a motorcycle was *worse* than nothing. Finally the secondary of a Thordarson  $\frac{1}{2}$ -kilowatt spark transformer was tried. This was better—it made the change shown in E.

The output of the tube was now pretty fair, but just as a final touch we put the other two condensers on the output side of the "filter" and got the smooth ring shown in F. This sounded very smooth in the receiving set too.

In the photographs there is not much difference between E and F. There was a *big* difference when looking at the spinner, tho. When working with the E connection it was possible to make the blue ring seem to turn either with or against the clock by adjusting the grid-series and the plate-tuning condensers. But F was so smooth that this could not be done—no matter whether the spinner was running synchronously or at other speeds the ring still seemed to stand still. This was pretty near to being C.W.

**Construction of the Set**

The winding of the Tesla coil (Fig. 2) is 360 turns of No. 25 D. C. wire wound on a glass tube 2½" in diameter and 12" long. At 1QP the "glass tube" was two

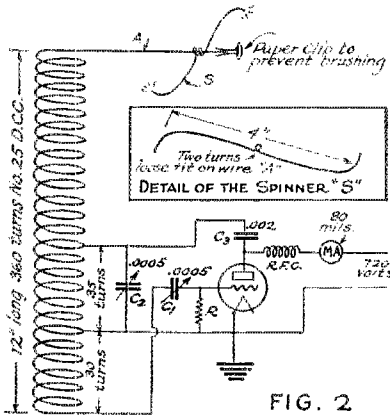

FIG. 2

pickle bottles, each 6" long. The winding was put on without any "dope" and held in place by tape at the ends of the

tubes. This coil operates at about 160 meters so that wave by the variable condenser C<sub>1</sub>. This condenser and the grid-series condenser C<sub>2</sub> must be *good* variable condensers. The plate stopping condenser C<sub>3</sub> can be of any size if it is big enough and is able to stand the plate voltage. A glass or mica fixed condenser of about .002 microfarads is best. The radio choke can be a spider web coil or a single layer coil but must be kept away from the Tesla coil—a foot, at least. The grid leak should either be inductive (spools of fine wire or spark coil secondaries) or else one may use an ordinary grid leak with a radio choke in series. This grid choke is not absolutely necessary but helps a lot.

The "spinner" is made of a 4½"-length of No. 26 or 28 pure copper wire bent into the shape shown in Fig. 2. The two turns at the center are a free but not "wobbly" fit on the wire A. It is important to have the two arms of the spinner *exactly* alike.

**Now You Are All Ready**—a 7¢ Tesla coil and an evening's pleasant amusement and you have gained a lot of information as to your sending set and just how much QRM it really does make.

## Arctic Explorer to Communicate with Amateurs

By J. K. Bolles, A.R.R.L. Publicity Manager

### WIRELESS NORTH POLE—NEXT!

WNP will be the most popular of all amateur calls next winter, and if you are among the "ops" fortunate to hear it, address your card to Donald B. MacMillan, North Pole. Altho it may not reach its destination thru the usual channel—the U. S. Post Office Department—you may be convinced of one thing, that you have heard direct from a little party of seven in the polar regions.

You fellows with an itch for distance, who have been landing ½ kilowatt signals in France, England, and on the China coast, may no longer overlook land to the North and South. Members of the MacMillan expedition, leaving the Maine coast about June 15 are to be accompanied by an A.R.R.L. operator and will be the first party bound for the north to keep in touch with civilization by radio.

**A** FEW months ago when a lot of us were pulling coat collars over our ears and warming our hands on the old spark gap, one of the A.R.R.L. radio clubs presented a mock trial involving an amateur and a broadcast listener. In the course of the proceedings, the counsel for the prosecution declared that his client had a remarkable receiving set with which he could hear the wind whistle around the North Pole! Naturally there were some sceptics in the audience, but they are now in a different frame of mind. Donald B. MacMillan, who time after time has braved the polar regions in

the interest of science, on a visit to Hartford recently, told Hiram Percy Maxim and other A.R.R.L. officers that next winter he will carry on two-way communication with amateurs within about 700 miles of the pole itself.

In the past, members of every expedition into the Arctic were confronted with a condition more terrifying than six months of darkness, more awe-inspiring than miles of floating ice, more difficult to contend with than a temperature of 60 degrees below zero; namely, loneliness and the thought of being cut off from the rest of the world. Ever since the first dash for the pole men

have overcome hardship of every description only to break down finally in the face of something they could not see or feel. The loneliness of the Arctic has been their greatest handicap. In view of these facts the little cabin of MacMillan's vessel, the "Bowdoin," will be a direct contrast to what such cabins have been before. Imagine,

These are some of the advantages, but it must be remembered there are many disadvantages and the chap who goes must be prepared for months of real hardship.

Dr. MacMillan spent several days in Hartford and was formally introduced to the A.R.R.L. fellowship by Mr. Maxim. When he learned that it was a great net-



Dr. MacMillan at 1AW

if you can, a little group of seven men inside an 80-foot schooner completely surrounded by ice. Where in the past they would have had only their own company for a six months winter, they can now communicate directly with their friends at home and be entertained thru hours of darkness by broadcast music.

The radio equipment on board the "Bowdoin" will be a real ham transmitter, hence it will be impossible to hear the wind whistle, the Eskimo talk, or the seal bark, but fellows, we can hear a m a t e u r messages direct from the Arctic Circle.

By this time most of you know that the A. R. R. L. Board of Direction has agreed to provide an expert operator for the polar party and that a questionnaire has been sent out stating his qualifications. We might add here that CQ are unknown letters in the Eskimo language, and that the Department of Commerce does not give a hoot if a chap sits on his key till the sun rises and you know how long that takes up there?



Dr. MacMillan and Mr. Maxim

work spread over the whole of North America, he was all the more anxious to introduce a ham to the north-land where the only interference is caused by icebergs cracking a couple of hundred feet in the air. Of course we do not know who the amateur operator is going to be yet, but we do know that he is not going to forget his A. R. R. L. friends and that for weeks he will stick by his transmitter telling of the adventures and hardships of himself and companions in the North. Dr. MacMillan has definitely agreed to send a news story of about 500 words once a week, if conditions permit. These stories of an arctic winter will be received by the A. R. R. L. and relayed for distribution in daily newspapers all over the country. In addition Dr. MacMillan will send a list of calls heard, so you fellows will

know from week to week what stations have been heard in the vicinity of the pole.

The explorer has brought back from each expedition some contribution to science and

(Concluded on page 79)

## Radio Filters

By Melville Eastham\*

**R**ADIO filters are most useful in decreasing interference when a single circuit tuner is used, because the inductively-coupled tuner is fairly satisfactory by itself. However, there are many cases where a filter will more than justify itself on a very selective set. Comparatively little has been done by experimenters with filters, apparently, and it seems to the writer to be a particularly fruitful field for investigation. I am, therefore, describing some of those I have worked with.

A simple form of filter is a series capacity-inductance circuit, connected across the receiving set (see Fig. 1), and tuned to the interfering signal. We will call this a "Type A" filter. Interfering signals are, to quite an extent, shunted thru this circuit, but it is not very selective, so it will not be useful on waves of nearly the same length. It is quite a help where a nearby broadcasting station is strong enough to make a detector insensitive, or where a spark station on a materially longer or shorter wave length bothers. For use on interfering waves of 150 to 250 m., the variable condenser should be about 500 m.m.f., and the coil about 1 M.H., which will be obtained by winding about 22 turns of No. 28 D.C.C. wire on a tube 3" in diameter. For 300 to 500 m., the coil should have about 40 turns of the same wire.

The filter shown in Fig. 2 (Type B), consists of one or two turns of heavy wire shunted by a mica condenser. It is tuned to the interfering station, and when in resonance, a local current flows around it, setting up a potential across its terminals almost equal to and opposing that due to the incoming wave, so very little current of that frequency flows into the receiving set. It will only work successfully on a C.W. station, so it may be used to receive a spark station thru a much stronger tube station on the same wave length. This arrangement has been used quite extensively by the British Navy, and called a rejector circuit. They usually use a single copper turn about 10" in diameter, having

a cross-section of about  $\frac{1}{2}$ " x 1". A sliding contact, revolving about the center of the turn, varies the inductance from a minimum to a full turn. A mica condenser of about 1/10 m.f. (usually adjustable in steps), is connected by very short and heavy leads to one end of the turn, and to the moving contact. This outfit works very well for cutting out a C.W. station, but is rather difficult to build, as great care must be used to keep the losses low, due to the comparatively large current that flows in it.

It is of no use in cutting out a spark signal. The mica condenser and single turn

may be replaced by a condenser of 500 or 1000 m.m.f. and a coil of 35 to 50 turns on a 3" tube, and very fair results obtained, tho the interfering wave must be quite a little different in wave length, as the tuning is not extremely sharp. It is sometimes called an "anti-resonant circuit." It may be connected across a receiving set, as shown in Fig. 3 (Type C) and is then called an "acceptor," and acts as a by-pass for all interfering waves, but allows the frequency for which it is tuned to get into the receiving set.

It is most useful in receiving C.W. thru strong spark interference.

The filter shown in Fig. 4 (Type S) operates in the same way that Type B does, but it has several advantages. Instead of putting the filter directly in the aerial circuit, it is inductively coupled to several turns, which are wound directly over the filter coil, and these turns are in series with the antenna circuit. *This is the best thing I have used to cut out a nearby broadcasting station, or a C.W. transmitter;* but, like Type B, it will not stop spark stations. It should be understood that this type will cut out the one C.W. station to which it is tuned, and allow normal receiving on wave lengths differing by about 1% from the interfering signal. It will not satisfactorily eliminate a spark station. The tuning is extremely sharp; to get the best results, the losses in the coil must be low, and the condenser should be one having a low resistance at high frequencies.

### Do You Have Interference?

What will you give for a magical instrument that stands beside your tuner and gives you the power to *destroy* interfering stations instantly by the mere turn of a dial?

That is, in effect, what these coupled radio filters will do for you.—Tech. Ed.

\*President, General Radio Co., Cambridge, Mass.

Fig. 5 (Type P) shows this coupled type as an "acceptor," and it operates about the same as Type C, but is simpler and sharper in tuning. It is very satisfactory in cutting down interference from C.W. or spark sets, as well as are light noises, or A.C. hum. It is rather more difficult to adjust than the "S" filter because it usually makes necessary the readjustment of the receiving set, but when one learns to handle it correctly, it is even more useful than Type S.

QRM from a beginner, using a Ford coil, with a spark gap in the antenna, may cause quite a little trouble, but a Type P filter will usually eliminate him entirely.

be about forty turns of No. 28 D.C.C. wire, which will make it about 1" long. Over this coil is wound about 3 or 4 turns of heavy writing paper, for insulation between the two coils. The outer coil should have 8 turns of No. 24 or 26 D.C.C., tapped at 3 and 5 turns. The inside, or secondary, coil is connected to the variable condenser, and the outer coil may be connected in series with or parallel to the receiving set. For the "P" type, 3 or 5 turns should be used; for the "S" type, 5 or 8 turns.

Fig. 7 shows a filter of this kind, but wound on a 3" square tube so that a switch may be mounted directly on the coil for changing the turns or cutting the filter out

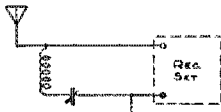

Fig 1  
TYPE A FILTER

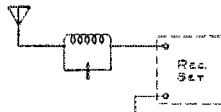

Fig 2  
TYPE B FILTER

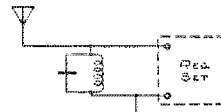

Fig 3  
TYPE C FILTER

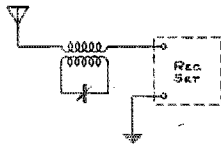

Fig 4  
TYPE S FILTER

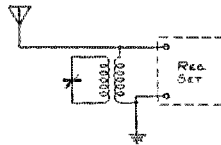

Fig 5  
TYPE P FILTER

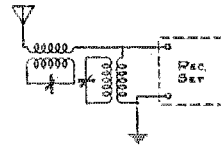

Fig 6

If your aerial is very small, it will help to put a coil of about 20 or 30 turns in series with it, to increase its natural period. This will bring a point of lower voltage across the receiving set, and the filter will absorb less energy from the desired signal. Working an aerial just at its natural, however, means that the receiving set has almost no voltage at its terminals (through the capacity and inductance separately have), and the filter will not be very selective, though it will help with waves of materially higher or lower frequency.

Several of the "S" filters may be used in series, each for eliminating a single C.W. station, and they may also be used when a "P" type is in operation. I have used three filters, with a real gain. When 1XE is working, I set one "S" filter on his wave length, and forget him, though he is only one mile from me and seriously interferes on a single circuit regenerative tuner working at 360 meters.

The filters I have used have been wound on insulating tubes about 3" in diameter, and, to cover a range of 150 to 500 meters with a 500 m.m.f. condenser, there should

of circuit. The filter coil has 36 turns of No. 28 D.C.C., and the small binding posts on the coil can be connected to 3, 5, or 8 turns, short-circuited, or open-circuited. The off position in the "S" filter is with the posts short-circuited; in the "P" filter

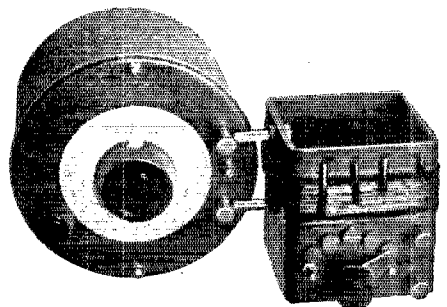

Fig.7—Filter or Wave Trap. May be used as either Type S or Type P.

with them open-circuited. Note that the same filter may be used as a Type S or a Type P.—Tech. Ed) The coil is supported

by two brass rods which are held by the binding posts on the condenser, and also connect the filter coil to the condenser. The range of this instrument is 150 to 500 meters, and a scale on the dial of the condenser reads directly in wave length, so

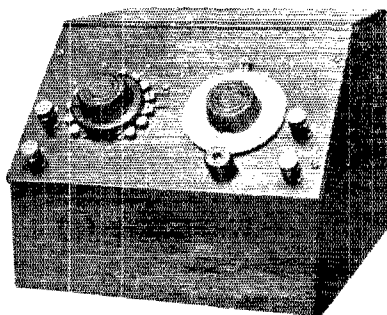

Fig. 8—Filter equipped with special switch for shifting from Type P to Type S or cutting instrument out of circuit

that it may be used for measuring the wave length of an incoming signal, as well as for setting for a known signal. The purpose of the primary switch is to vary the coupling of the secondary circuit to the antenna system. In the case of the Type S filter a very narrow band will be "blanked out" if only a few primary turns are used

and a somewhat wider band if more primary turns are used.

A more elaborate filter is shown in Fig. 8, the principal difference being in the switching scheme, as it allows the filter to be cut out of circuit completely, in

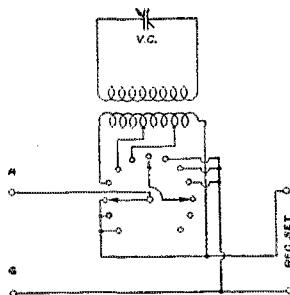

FIG 9  
WIRING DIAGRAM  
305 FILTER  
(SHOWN IN FIGURE 8)

parallel with 3 or 5 turns or in series with 5 or 8 turns. The coil data is the same as the round one described above having 40 secondary turns. The switching scheme is shown in Fig. 9, and it will be noticed that a special double-blade switch is necessary, but the extra bother is well justified if one lives in a neighborhood with several transmitting sets.

## The Third District Convention

By M. Adaire Garmhausen, YL and Sole Proprietor of 3BCK

**A**WAY back in August, 1922, it seemed like a magnificent idea. "We will have the convention in April instead of in February as heretofore. Always we have had bad weather but if we wait 'til April it will be spring and trees will be budding, flowers blooming, birds singing. Skies will be blue with little white fleecy clouds floating hither and yon—the warm glow of the glorious sun will make us all glad to be alive."

April was indeed glorious! Trees budded, flowers bloomed and birds sang as per schedule. The warm sun of April 12th made us glad to be alive. Tomorrow the Fourth Annual Convention of the Third Radio District was to open; all was well.

Friday morning the 13th it poured pitch-forks. There was never a rainstorm that took itself so seriously, that was so thoroughly in earnest. We paddled into the Hotel Emerson and promptly forgot that there

was such a thing as weather. A whirl of greetings caught us up and spun us around until we were breathless and dizzy. There

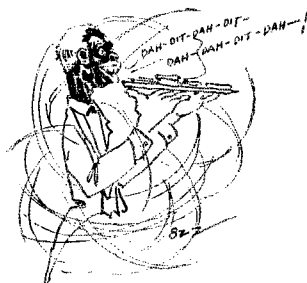

...falling waiters who had got tangled up in serpentine.

was space on the programs for autographs and we signed 432,987 dotted lines. Eventually we found ourselves in possession of

a nice new pen of unknown origin. No matter how many times we lent it out this pen came back each trip. It is really a nice pen and we have learned to fill it and everything.

At this period it is our privilege to present to the fraternity another YL—Miss Elizabeth Zandonini, Radio 3CDQ, of Washington, D. C. She is a Radio Aide at the Bureau of Standards and you ought to hear her tell about the British tubes and the kilocycles and things. We hung around and tried to look intelligent while the boys elbowed each other for a chance to have a word with her. After 3CDQ moved toward the lecture room it was surprising how quickly the place filled up. Our local mayor opened the convention and told what a top-notch city Baltimore is, while we glowed and patronized the visitors. The convention president, Mr. Bateman of 3APT, also spoke and then we went out to collect more fountain pens.

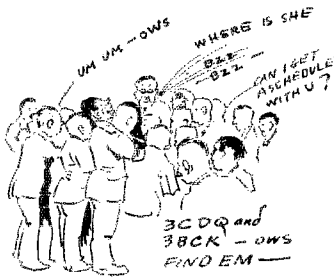

When we returned they were collecting an audience for the technical talks. If there is anything noisier than a Ford auto horn with dry batteries and a key, we hope never to meet it. This awful device had been introduced early in the morning and by now had multiplied to six but the six did not make a bit more clamour than one—they couldn't. The chairman splintered the gavel and yelled himself blue in the face—but they broke out every time a speaker stopped for breath. First on the program was Mr. S. Kruse, technical editor of *QST* who gave us an insight into the daily life and habits of the North American Antenna Insulator. Next was Mr. Bunker who told us how to make a tube set mote. Mr. Edwin L. Powell's talk was nailed for *QST* before he stepped off the platform. There is something about Mr. Powell's talks that keeps his audiences discussing them for months. The climax of our career will have arrived when we are able to argue with him about one of them.

Followed the code-speed contest and now we know who has the hardest radio huck in America. After working like anything to make the convention a suc-

cess, planning the speed contest and wearing out a 50-watt tube telling the gang about it, Mr. George Deichmann of 3HG was taken sick and couldn't be present. 3GZ, the speed demon of this neck of the woods, ran the contest but we cannot tell who won because we do not know, which is ample reason.

That evening came the convention's big surprise. We were signally honored by having as a guest *Mr. Stuart Ballantine* of "Radio Telephony for Amateurs" fame. The majority had formed the same mental picture of him as we had—a tall, thin, talkative person with white whiskers and a superior air—the professor type. We could not have been farther off. When he was revealed the gang blinked and blank and blunk but no trace of the be-whiskered professor could they find. And superior—gosh!! He does not think his book is any great shakes and does not realize that he is a hero to the lesser lights. The main comment of the evening was "I can't get over Ballantine. He's the biggest surprise I ever had."

The evening was clear—there was not another drop of rain left in the clouds. In the morning we could have wept for what Ballantine called "the general cussedness of Nature." Snow!!! Great big soggy flakes of it. We sloshed down to the hotel and wished everybody Merry Christmas. But our spirits were high as we held up traffic while 400 hams got into a street car with a total capacity of 31. Next to the steamer "Stony Creek" lay a giant freighter and the owners of the auto-horn transmitters tried to raise the operator. They should have raised George Washington and Columbus but they only succeeded in raising the devil. It was a little cool for a boat ride—the "Stony Creek" is one of these open-work craft used for summer excursions. But when we hit the bay our real troubles began. Ol' Chesapeake was in no gentle mood and the passengers were soon divided into two classes, those that wished they had not come and those that wished they had never been born. At the place where we froze to the deck Walter Bradley Martin, the Philadelphia Live-Wire, was doing some snappy wrestling. He got so warm that he removed his overcoat, which we promptly appropriated. After two hours of this we heard a mighty shout and saw Annapolis floating up to the side of the boat.

The Navy or somebody had kindly provided 40-foot life boats to take us up the river to NSS. We took one look at these boats and fled toward the nice, warm, W.B.&A. interurban station. Two hundred brave souls stuck to the boats and came back with stopped watches and tales of powerful magnets and jumping sparks.



The day's trials had had their effect and a noisier, more reckless banquet crowd would be hard to find. The auto horns were going strong as were the crickets, toy horns, flutes and the orchestra. Bedlam was a deaf-and-dumb home by comparison. There were rolls of serpentine at each plate and it didn't take ten minutes to have the room buried in it. The floor was knee deep with it and the proceedings were punctuated by the crash of falling waiters who had got tangled up. It was rumored that there were two "sixes" present. We even had a seven and 5KM from clear down Texas way; in fact we had every district. The headquarters delegation was larger than at *any* previous convention, President Maxim, K. B. Warner with his T-A headgear, C. A. Service, F. H. Schnell, S. Kruse, and Howard Mason, *QST's* latest acquisition. Mr. Mason, ex-7BK, gave a delightful talk which we personally wish could be reproduced in *QST*, so that we could enjoy it all over again. It is always a pleasure to have a speaker, especially a newcomer, talk sense instead of silver-tongued oratory. The stunt committee dug up 4,000 years of buried history and gave an Egyptian entertainment with a wicked Oriental dance and real incense. They gave us the cutest little sheik hats to wear, too.

We tried to sneak into the house at

a quarter of two but it didn't work; mother was awake and waiting. That is the disadvantage of having a convention in your home town. We do not know what happened on Sunday. Everybody claims to have slept all day.

Post-convention whispers have it that the Washington, D. C., gang came over on a chartered car on the W.B.&A.; also that

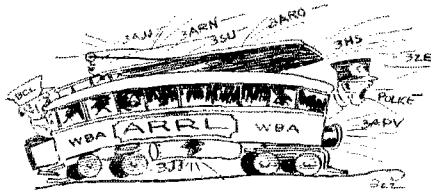

the car had to be scrapped after the trip. What tickles us is that someone tried to walk on the backs of the seats just when the car hit a curve. He woke up half way out of the window while the tinkling glass made gentle music.

Next year the convention will be at Philadelphia and Mr. Beate will be President. We are glad it isn't going to be here. Just the same we never fail to murmur as we flop into the hay after the banquet—"God bless the guy that invented conventions."

## Official European Report on the Transatlantics

**A** REPORT on the Transatlantic test of December, 1922, must be preceded by a rather apologetic explanation. Their news value has of course quite disappeared and most of the stations that made the tests have been dismantled or else so changed that they are almost unrecognizable.

These reports are therefore presented mainly as a matter of closing the books on the T-A tests and for the purpose of correcting some errors in the original reports, as well as listing some additional calls not reported before.

### English and Dutch Report

We first quote from the English and Dutch report of Mr. Philip R. Coursey, chairman of the T-A Committee of the Radio Society of Great Britain:

"Many listeners complained of the very careless sending of some of the stations. For instance 1AGK often sent his call as 1AKG and was in fact accidentally reported in this manner on one occasion. 2UD

sometimes sent his call as D2U, the spacing being very bad, while 8AQO, who produced extremely powerful signals here, practically always sent his code word as PQPPG instead of FQPPG. The regularity with which these and similar errors were reported shows that they did not arise from careless reception. Apparently 1BET sent his proper call only once or twice during the whole duration of the tests, since he was always reported as sending "Test test de UWXXI UWXXI" etc. UWXXI was his code combination. Many stations also repeated their code words over and over again for prolonged periods before giving their call signs and omitted all spaces between the successive repetitions of the code word. Thus listeners on this side had no idea where the code word began or ended.

"This style of transmission caused unnecessary delay....and many more stations would have been logged if *every* transmitter had kept rigidly to the transmission scheme."

(Some of our stations are doing this sort of thing today—if you hear one of them, go after him and tell him what an ass he is making of himself.)

The following table includes the calls of all U.S. and Canadian amateur stations heard in England and Holland during the tests. Some of them were heard calling or working other stations, some were heard in the free-for-all periods, and some were heard sending their code combinations. The list is as nearly correct as it could be made.

First District: 1AC, 1ACN, 1AD, 1ADL, 1AHZ, 1AJ, 1AJI, 1AJP, 1AJU, 1AJW, 1AK, 1AL, 1AN, 1ANA, 1ARQ, 1ARY, 1ASF, 1AT, 1ATV, 1AWL, 1AWP, 1AXE, 1AZW, 1BAS, 1BB, 1BCF, 1BCG, 1BCS, 1BDG, 1BDI, 1BDS, 1BDT, 1BEP, 1BES, 1BET, 1BFR, 1BFT, 1BGF, 1BGY, 1BH, 1BHR, 1BI, 1BK, 1BKA, 1BKQ, 1BN, 1BNA, 1BNT, 1BPG, 1BPH, 1BRQ, 1BRY, 1BSZ, 1BW, 1BWJ, 1BX, 1BY, 1CBR, 1CCA, 1CDA, 1CDI, 1CDJ, 1CDK, 1CDO, 1CDR, 1CES, 1CF, 1CIV, 1CJA, 1CJF, 1CJH, 1CKD, 1CKG, 1CKP, 1CKR, 1CLA, 1CMK, 1CN, 1CNF, 1CNI, 1CNJ, 1CQX, 1CW, 1CYM, 1DD, 1FB, 1FD, 1GER, 1GV, 1HT, 1II, 1IL, 1IT, 1JR, 1KDI, 1KW, 1LAU, 1LL, 1MIE, 1MK, 1MO, 1MV, 1MY, 1ON, 1OR, 1OW, 1PG, 1PM, 1RA, 1RD, 1SD, 1SPW, 1TM, 1TMS, 1TOK, 1TT, 1UN, 1VI, 1WN, 1XK, 1XM, 1XN, 1XNT, 1XR, 1XU, 1XW, 1XY, 1YK, 1ZA, 1ZE, 1ZN, 1ZT, 1ZUK.

Second District: 2AB, 2ACK, 2ACT, 2AF, 2AFB, 2AFP, 2AFX, 2AG, 2AHO, 2AJ, 2AMD, 2AON, 2APD, 2ARF, 2ARS, 2ATS, 2AU, 2AUM, 2AW, 2AWA, 2AWF, 2AWL, 2AWP, 2AWZ, 2AYV, 2BAO, 2BAS, 2BBB, 2BDA, 2BDT, 2BG, 2BGA, 2BGO, 2BL, 2BLF, 2BLP, 2BM, 2BMC, 2BML, 2BNN, 2BNZ, 2BQH, 2BQM, 2BQN, 2BQT, 2BQU, 2BRB, 2BRP, 2BT, 2BYS, 2BYW, 2CAR, 2CBW, 2CBX, 2CDO, 2CF, 2CGT, 2CHH, 2CIM, 2CIN, 2CJH, 2CJN, 2CJW, 2CK, 2CKD, 2CKK, 2CKN, 2CKR, 2CKS, 2CMK, 2CMZ, 2CP, 2CPD, 2CQ, 2CQZ, 2CRB, 2CSL, 2DMA, 2DZ, 2EI, 2EL\*, 2FP, 2FU, 2FW, 2GI, 2GJ, 2GK, 2GM, 2GR, 2GS, 2GU, 2HJ, 2HW, 2IG, 2IS, 2KB, 2KF, 2KG, 2KL, 2KP, 2KQ, 2KRQ, 2KS, 2KW, 2KZ, 2LO, 2LY, 2MF, 2MN, 2MU, 2MV, 2NM, 2NN, 2NZ, 2OAO, 2OYM, 2PQ, 2PR, 2PY, 2QU, 2QV, 2QYX, 2QZ, 2RC, 2RO, 2RP, 2RW, 2RY, 2SG, 2SH, 2SP, 2TK, 2TSU, 2UD, 2UE, 2US, 2VX, 2XAD, 2XAM, 2XAO, 2XAP\*, 2XL, 2XM, 2XMO, 2XRB, 2XRO, 2YK, 2ZA, 2ZK\*, 2ZL, 2ZM, 2ZS, 2ZW, 2ZY.

Third District: 3ADT, 3AFB, 3AP, 3AQP, 3AQR, 3AUU, 3AYY, 3BES, 3BF, 3BFU, 3BG, 3BGJ, 3BGT, 3BHM, 3BIJ, 3BLF, 3BLZ, 3BMT, 3BNU, 3BOB, 3BS, 3BVC, 3CC, 3CG, 3CYN, 3DM, 3EU, 3FS, 3GE, 3GG, 3HG, 3HQ, 3JJ, 3KD, 3KFU, 3LK, 3MO, 3MX, 3MY, 3NH, 3OD, 3OE,

3OL, 3OT, 3QO, 3RP, 3SG, 3TJ, 3UFD, 3XA, 3XBK, 3XL, 3XM, 3XR, 3YG, 3YO, 3ZW, 3ZY, 3ZZ.

Fourth District: 4AA, 4BF, 4BX, 4BY, 4EA, 4EB, 4FB, 4FN, 4ID, 4KM, 4KS, 4OI, 4ZS, 4ZW.

Fifth District: 5AAM, 5AGI, 5BV, 5DH, 5DQ, 5DWP, 5EK, 5FV, 5GBZ, 5HS, 5JL, 5KK, 5MA, 5MX, 5MK, 5US, 5WD, 5WW, 5XA, 5XB, 5XK, 5XR, 5ZA, 5ZB.

Sixth District: 6CBL, 6ZZ.

Seventh District: 7BXV, 7OE, 7BO, 7WZR, 7ZV.

Eighth District: 8AA, 8ADG, 8AIW, 8AJM, 8ANP, 8AP, 8AQO, 8AR, 8ASC, 8ASV, 8ATF, 8ATU, 8AV, 8AW, 8AWP, 8AWZ, 8AXC, 8AXE, 8AXK, 8AYO, 8AZD, 8AZQ, 8BBT, 8BCS, 8BDE, 8BFM, 8BJC, 8BK, 8BKF, 8BLC, 8BNJ, 8BPL, 8BSS, 8BTI, 8BTV, 8BUM, 8BVL, 8BX, 8BXF, 8BXH, 8BYH, 8BZY, 8CDD, 8CJH, 8CMK, 8CNE, 8CPK, 8DB, 8DET, 8DKX, 8FQ, 8FU, 8GM, 8GQ, 8HJ, 8IB, 8J CZ, 8KG, 8KM, 8OW, 8QT, 8SB, 8SP, 8SPM, 8TT, 8UE, 8UF, 8UY, 8VK, 8XA, 8XAE, 8XAN, 8XC, 8XE, 8YB, 8YD, 8ZAF, 8ZV, 8ZW, 8ZZ, 8ZY.

Ninth District: 9AGT, 9AN, 9AMT, 9ASW, 9AUL, 9AX, 9BDF, 9BDS, 9BET, 9BP, 9BRY, 9BZ, 9CBX, 9CD, 9CG, 9CM, 9CR, 9CX, 9CXP, 9DYN, 9EP, 9FM, 9GM, 9II, 9IM, 9KM, 9UU, 9XAC, 9XB, 9XE, 9ZN.

Canadian: 3CO, 9AL.

Note—\* indicates "heard also on fone."

Number of nights on which individual transmission were heard from the best stations listed:

Nine nights: 2EL, 2ZK.

Eight nights: 2AWL.

Seven nights: 2AWF, 3ZW, 8AQO.

Six nights: 1XM, 1YK, 1ZE, 2BQU, 2GK, 3XM.

Five nights: 2LO, 3AUU, 3BG, 3ZZ, 8ATU, 8AWP.

Four nights: 1AJP, 1ASF, 1BDI, 1BGF, 1GV, 2BML, 2NZ, 2XAP, 3BGT, 4BY, 8UE.

Three nights: 1BCG, 1BEP, 1BET, 1CMK, 1CNF, 1FB, 2AHO, 2CQZ, 2GR, 2UD, 2ZL, 3AFB, 3BLF, 3BXH, 3SP, 8YD, 9AL (Canada).

Two nights: 1AGK, 1AZW, 1BCF, 1BKQ, 3CC, 3CG, 3NH, 3YO, 4EB, 5XK, 8BK, 8IB, 8XE, 9ZN.

Correction—British 2FZ was NOT the station that was widely reported by American listeners. British 2FZ was not in operation during the tests. Neither was the offender our American 2FZ. Evidently someone was kidding us, or possessed an unusually wicked fist.

#### An Additional Dutch Report

From the Dutch magazine "Radio Nieuws" for February we take the following.

At Delft, K. C. van Rijn received the following with one stage radio amplification and detector: 8ML, 1BRQ, 2LO, 2CKR, 2AWL, 8AGO, 1CNF, 3AUU, 1BET, 2EL, 2XA, 9EMK, 1AU, 1ASF, 9WE, 1BQR, 1XM, 1AJP, 1BEP, 2XAO, 2BQH, 2XAO, 2GK, 2EBX, 2AWF, 4BY, 8UE, 3ADT, 8JB, 1CDO, 8SP, 3BNU, 2CJN, 9EC, 2UB, 2BRB, 1CDO with a complete message, 1BEP, 1EDO, 4KK, 3BFU, 1FB, 2HJ, 2GK, 2AWL.

At Dordrecht, L. F. Doormans copied on a loop with two stages radio frequency amplification, detector, and two stages audio. He heard tests from 1BCG and 1AN.

**Final French Report**

The final French report from Dr. Pierre Corret of the *Comite Francais des Essais Transatlantiques* does not contain a summary like that given in the British report. It is assumed that the report of the February number of QST is correct except in the particular instances given below.

Referring to the February issue of QST—1BEP was the station heard on Dec. 20. The station was reported as 1BFP for the reason that an error had happened in the A.R.R.L. offices and 1BFP had been set down as owning the code combination which actually belonged to 1BEP.

On December 12 the mysterious "1NMK" was 1YK (poor spacing?) and this station was reported by Dr. Corret and later verified.

On December 18 5ZA was heard sending his code combination, badly spaced so that

it became MLKRM instead of the correct form KRMLM.

On December 12, 8AQO was heard making the same mistake in his code that was reported by the English—evidently someone at Cazenovia was very sleepy.

Referring to the mysterious "zero" station mentioned on Page 19, Dr. Corret explains that both OMK and OBS has been located, the former in Amsterdam and the latter at another point in Holland.

**Equipment Used By the French Receiving Stations**

Type of Receiving Set	No. of Stations Using It	No. of Calls Heard
Superheterodyne	2	158
1 stage tuned radio	7	153
No amplification ahead of the detector	8	102
Air-core transformer-coupled radio	4	59
Several stages tuned radio	3	9

The antennas were of all possible types, and the tuners included all the familiar-American types as well as some not known to us.

**Final Report on Stations Heard**

26 French and 2 Swiss listeners heard 246 American calls, all on C.W. except 2RP and 1BCF which were spark.

**French Sending Stations**

23 French sending stations enrolled, 10 actually sent, and of these only one was heard; namely, 8AB.

**Signal Report Cards**

**T**O pick the best from the flood of cards that resulted from the "Stray" in December QST is practically impossible. Every ham seems to have a different idea regarding what a good card should include and how it should be arranged. Consequently, when all these ideas are worked out, a batch of equally good cards result. Even so, those of 1CKP and 8CMH are good examples so they win the message blanks, five pads each. May their traffic run high next month!

When over 225 cards "rolled in" as applicants for first place it makes us wonder who invented this signal report card idea anyway. Honestly, where the system originated, it is hard to say, unless it was just a natural outgrowth of the desire of the radio amateur to get into closer touch with those with whom he carries on radio communication, to make friends and to exchange ideas. These cards, which mean life itself to a Boiled Owl, and food for one who burns midnight oil, are one of the most interesting phases of the amateur game.

A good card utilizes the comparatively small space available to best advantage. Neatness and clear wording are essential, as the card is a direct reflection of the station behind it. A well balanced, clean cut, report card instantly gives the impressions of one of those good all-around efficient stations, where attention is paid to details.

A few cards are of especial interest. 7ZV has one that does not tell much about the station nor the equipment used, but say! it surely does show the personality of the owners of this station. His card should at least be worth two pads of blanks. Unfortunately the weird and wonderful color schemes on some of the cards do not lend to reproduction in the pages of QST. 4OI, 4JY, 6BRG, and 8AFN use this method of making theirs attractive.

9DJB deviates from the beaten path by fixing his cards up like a combination street car transfer and gas-meter dial, then proceeds to put over the desired information with a ticket punch. 1ZE, 5MN, 6AWM, 7SC, 8VY, 8DAT, 9AUL and 9BJT have

evidently tried to see which could put their call in the largest and gaudiest letters on a post card. 2BRC and 8HS have a hard

have their cards printed at a print shop, there are other ways in which the job may be done. The simplest and most inexpensive method is to cut the letters (reversed) about one or two inches high out of a piece of gasket rubber with a wet penknife. These can then be glued to a piece of wood, and used as an ordinary rubber stamp. Members of radio clubs can get together and have cards printed in quantity, then each member can make a stamp bearing his own call as described above, to be put on individually. 2BRC fixes his card with india ink on an old photographic film which has had the emulsion cleaned off. Then he uses this as a negative and prints on sensitized post cards. 6BLV has his cards printed on the "double" post cards, which may be purchased at any post office; in this way an answer to his card is practically assured.

It is hard to leave the subject of report cards without saying a word about those who do not answer cards received. Why on earth don't you fellows get a card printed especially for answering these cards, and carrying on general correspondence? 9EDA is a typical example of this kind of a card.

The friendly spirit of co-operation and good fellowship which is both portrayed and encouraged by our signal report card system is typical of an A.R.R.L. man. Many a life-long friendship has been formed in this manner; just by having one's signals reported on a post card. An incredible thing for the average person to grasp, but something that the radio amateur knows is one of the things that makes the good old game interesting. 73's, OM. QSL by card.

—H.F.M.

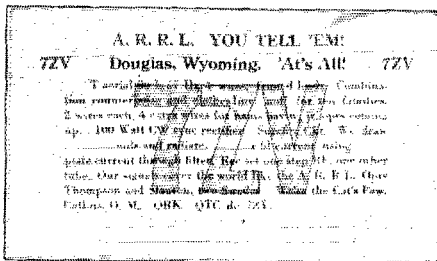
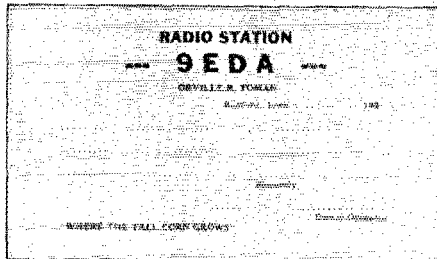
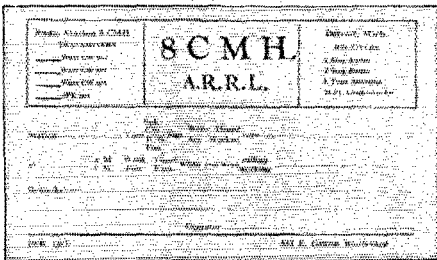
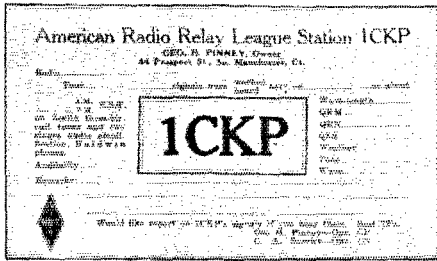

time telling the gang just where their particular small town is located, so they include a map of their state on the card with a big arrow pointing to the location of their station.

While the large majority of the fellows

### Corrections

The following errors in the May (Antenna) number have been called to our attention.

Page 27, second column, second paragraph. The sentence "No. 1 held up wonderfully but is a little short" is incorrect. The insulator referred to is No. 16, the 10¢ Woolworth-store wonder.

Page 27, second sentence below Fig. 2. The dye used was not eosin but rodamine. Either one would be satisfactory and both give a brilliant pink stain.

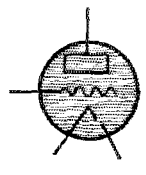
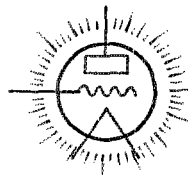

ADD THESE TO YOUR LIST OF STANDARD SYMBOLS

# Notes on the Neutrodyne

A Talk by Harold Wheeler Before the Washington, (D. C.) Radio Club  
Reported by G. L. Bidwell

(Mr. Wheeler was a co-worker with Prof. L. A. Hazeltine in developing the so-called "Neutrodyne," a device to keep radio-frequency amplifiers from oscillating.—Tech. Ed.)

THE first attempt at a device for neutralizing the undesirable capacity feedbacks that make a radio amplifier howl was based on a magnetic feedback but this was abandoned as too critical; too tricky, in other words. This is not the same thing as a sharp tuning device, which may be a good thing.

The second attempt at preventing the effects of capacity feedback can be understood from Fig. 1. The number of turns from A to C and the size of the condenser D are so adjusted that the feedback thru D just cancels the feedback thru the tube capacity, which is represented by the dotted condenser E. In the first set the turns from A to C were made equal to the turns from A to B and then the condenser D had to be equal to the tube capacity.

The neutralizing coil can be put inside the plate coil and the whole thing arranged as in Fig. 2. The neutralizing coil has now become the secondary of a radio transformer and feeds the next tube of the amplifier.

It was soon found that it was possible to use a step-up ratio in these radio transformers. For 360 to 400 meter waves the plate coil was wound with 15 turns on a 3" tube, with a 60-turn grid (secondary) coil fitting closely inside. This inside coil is shunted by a 13-plate (.0003 microfarad) variable condenser. For 200 meter-work the plate coil should have 10-12 turns and the secondary (grid) coil should have 40 turns. With these step-up radio transformers the neutralizing condenser D (called a "neutrodon") should have a capacity equal to the tube capacity divided by the ratio of transformation—that is, the ratio of secondary to primary turns.

As the primary turns are reduced the set becomes more selective. The thickness of the tubes and their difference in diameter should be chosen so that there is about  $\frac{1}{8}$ " between the windings, but this is not strictly necessary. Some good transformers were made in which the plate coil was wound right on the grid coil with only a layer of paper between. It is best to wind the primary to cover half the secondary and to put it at the filament end of the secondary as shown at Fig.

3. The windings are in the same direction. If the coils are wound in opposite directions they must be connected as in Fig. 4 but this is not as good. The number of secondary turns may be adjusted for the wave length but the primary can not be changed very much.

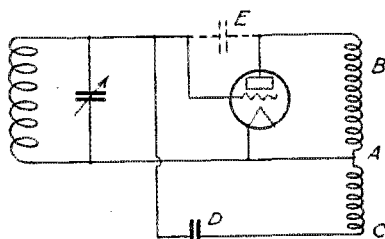

FIG. 1

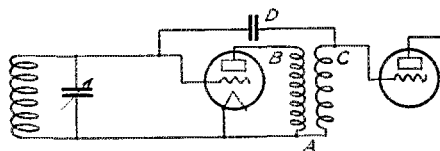

FIG. 2

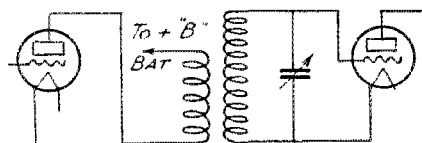

FIG. 3

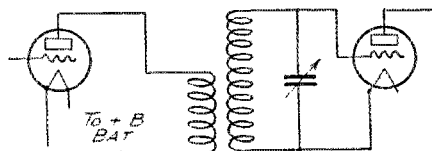

FIG. 4

## Different Kinds of Neutrodyne

The neutrodyne works best on an antenna but may be used on a loop. One step of neutrodyne radio amplification plus a non-regenerative detector will give louder signals than the ordinary regenerative (but not oscillating) detector. Over

two steps of radio amplification become hard to control at short waves, even tho they are neutrodyned. With this sort of a receiver the detector may be made to oscillate by tuning the plate and so receive amateur C.W. signals. A tickler may be used feeding back to the detector, grid, or to the antenna, but this second scheme is not good, as strong oscillations occur. A separate heterodyne is better in every way.

The neutrodyne does not reflex very well. Very large by-pass condensers must be used and all parts of the set widely separated.

The best set for 150-220 meter work is a super-heterodyne with the radio amplifier built to operate at 1000 to 3000 meters and stabilized by being neutrodyned. A good arrangement would be a detector,

2 steps of neutrodyned radio amplification, a second detector, and 2 steps audio. A separate heterodyne will be needed, of course. Such a set will receive almost anything on an indoor antenna. The long wave radio transformers (called "neutroformers") are made with a 20 to 40 turn primary wound on one end of a 4" x 4" tube and a 200-turn secondary wound over the primary and extending to the other end of the tube. When this is once adjusted only two controls are needed.

#### Neutrodyne Condensers

The neutralizing condensers may be of the tubular type described by Prof. Hazeltine or be made of two square plates 1" x 1" that can be moved to or from each other. The leads *must* be well separated. The capacity is from 1 to 5 micro-microfarads.

## The Second Ohio A.R.R.L. Convention At Columbus, April 6-7-8

**F**OR ten years "The Ohio Punch" has ruined headsets all over the western half of the world. Now we have seen the gang that does it and understand perfectly.

From early in the morning of Friday, April 6th, 'til way beyond midnight of the 7th the Columbus Hotel was a joyful QRM factory. At the door a mob of grinning blue-badged hams grabbed the newcomer, banged him on the back, pumped his hands up and down and shoved him into a registration room as full of "eights" as a sardine can is of fish. By 10 A.M. the blackboard had 7 layers of calls on it and the halls were full of guys joyously disagreeing on every doggone thing in amateur radio. They never even stopped at noon but waved their sandwiches around and went right on wrangling.

The relayer's meeting in the afternoon busted away from Matty, of 9ZN, about eleven times and had to be hollered into submission. Then Mrs. Candler ("CC," 8NH, 8ER, 8ZL, and general good scout) got reports from all the traffic men in Ohio and passed them roses or cabbages according to their deserts. Someone started a whole herd of contests and passed a bale of the papers to Matty, Schnell, and Kruse who did Chinese Math. and Peruvian Guesswork to pick the winners.

That night the halls of the hotel were filled with shoeless hams filing into the gloom of the assembly room where amid queer sounds and strange lights they were initiated into the Royal Order of Wouff Hong. None came out before 2:30 A.M.

Saturday A.M. a lot of the gang slept

thru the trip, but the rest went to see the stations and came home raving about the herd of captive  $\frac{1}{4}$  K.W. tubes at Signal Corps Station WVZ.

The convention photographer had an awful time at noon trying to get a decent picture of a gang that insisted on yelling "When do we eat?"

The technical meeting came when everyone was filled up with the good food of the Columbus cafeterias and the audience

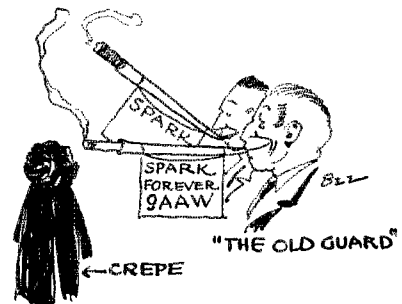

stayed clear thru—a most unusual thing. Prof. F. C. Blake of Ohio State U. told about the electrical theory that we all ought to know and don't. Matty told how to make the loose-coupler retrieve lost signals. R. C. Curtis talked about some tuned radio amplifiers which he had tamed. Kruse of the QST staff went after antennas and sending sets. The windup was a talk by C. H. Whysall on the ways of operating a set that is where you aint—remote control.

That's all—all but the banquet. That night the ammeter went clean off the scale and the antenna spurted blue fire for 4 hours. Even the exhibits were forgotten. Part of the time it was a banquet and part of the time it was a near-riot. They dragged in a receiving set with a panel 5 feet square and let Matty try tuning it.

and the gang forgot to eat. Then there were speeches and Matty razed the sparks until friend Schweitzer of 9AAW felt so lonesome that he called a meeting of the G.A.S.—Grand Army of the Spark. The delegates joined him at once—traveling in straight lines across the tables and the ol' spark once more proved its ability to out-



He finally licked the thing but not until it gave an imitation of a fight between a jazz band and a circus calliope. A 9-years-old dancing girl appeared from somewhere

yell a big gang of C.W. hounds. The contest winners were announced and had to rise and look pretty. When the racket died down a bit Toastmaster Breeze awarded a liar's cup to a Columbus broadcast station for their regular announcement that they were improving their modulation. Just then some fiend discovered the idea of passing around the menus to be signed. In the next half hour Darr of 8ZZ drew 186 cartoons, Mrs. Candler signed 211 menus and the Chicago delegation is believed to have taken the honors by signing every book in the place; when the gang discovered who "VD" was they pretty nearly mobbed that table.

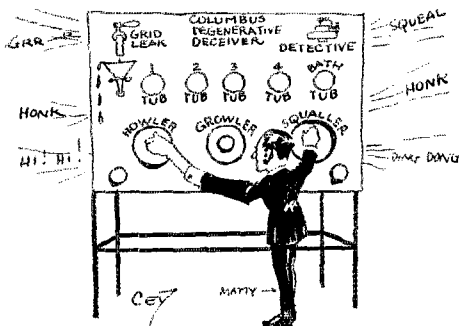

Matty Tuning the Columbus Degenerative Deceiver

At this point things begin to get hazy and darned if we remember how the show wound up but we awoke at—oh never mind; it was a great convention.

## “DX”

### — A Pome —

To our wireless aristocracy, “Knights of the Midnight Key,”  
 To you who crowd the voltage on the plate,  
 To all the many members of Boiled Owl’s fraternity.  
 These verses I sincerely dedicate.

Oh! It’s nice to handle traffic with the stations close around  
 And always get a “Nr 1 OK”  
 But there’s nothing else in radio that brings such joy profound  
 As to hear a distant station’s “QSA.”

Though we figure out capacities and constants to a “T,”  
 Our radiation never is enough  
 To satisfy our craving; but can anyone forsee  
 The finish to this super-distance . . . . .

Now I am no old-timer, but I well recall the day  
 When to hear an eight was hailed as something grand.  
 “I worked a fellow in Detroit,” your friend would proudly say,  
 And with honest pride you’d see his chest expand.

How is it now? Where are the men who used to get a thrill  
 When some one in the next state heard their call?  
 Just ask one of those same old boys, and chances are he will  
 Reply, “I don’t work local stuff at all.”

“I’ll get your messages to France, I clear with England too,  
 I’m QSO Hawaii after eight,  
 But to waste my time on local work will never, never do,  
 My good friend, you are sadly out of date.”

But there always is a limit to the length that we can go,  
 And this globe is getting smaller every day.  
 And the time is fast approaching when the farthest lands will know  
 The sound of signals from the U.S.A.

When there’s no more world to conquer it is very plain to see  
 That the amateur will have to turn to stars,  
 And I predict that someday we will read in *QST*  
 Of “The First Trans-Planetary Test with Mars.”

—W.S.C.

## Capacity Coupling to Operate the Antenna at its Fundamental

By V. D. & E. B. Landon, 8VN

**A**S emphasized by Mr. Boyd Phelps in his article “Antenna Resistance Measurement” in January, 1923, *QST*, the best operating wave length of an antenna is not the adjustment where the antenna current is greatest but the point at which the radiation resistance is the greatest *percentage* of the total antenna resistance. Working the antenna at its fundamental wave length causes the radiation resistance to be high and elim-

inates inductances and condensers with their accompanying losses. The best way of doing this, is by utilizing static coupling as described herein.

There is nothing new about static coupling as illustrated in Figure 1. The innovation lies in the use of the inductance of a straight section of the antenna as in Figure 2 and 3, thus eliminating the necessity of a loading inductance. Mr. Frank Conrad of 8XK and Ass’t. Chief



Eng'r. of the Westinghouse Elec. & Mfg. Co. is the originator of this circuit. So far as we know 8VN was the first station to use this circuit at amateur wave lengths, altho its use is spreading rapidly at present.

The theory of operation is quite simple. As shown in Figure 4 the antenna system consists of antenna and counterpoise directly connected by a vertical conductor. A local oscillator in the radio room is tuned

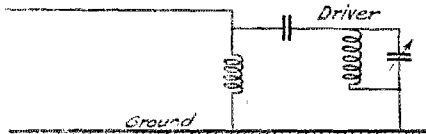

FIG. 1 Ordinary capacity coupling between antenna and a driver circuit.

to the wave length of the antenna system and is coupled to it by means of a small condenser. When the local oscillator is brought into resonance with the antenna circuit a high frequency current builds up in the antenna to a maximum limited by the power of the oscillator.

If the coupling wire is connected to the ground potential point of the antenna, which is usually near the station end of the counterpoise or a few feet up the vertical lead, no results will be obtained. For a 200-meter antenna ten or twenty feet on either side of the ground potential point is about right, but this is not at all critical.

The circuit used in the local oscillator is immaterial.

The plate-current meter is valuable as an indicator of resonance between the two

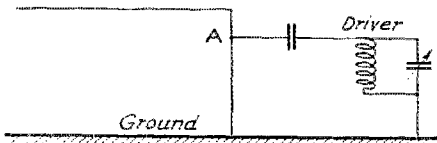

FIG. 2 Same as Fig. 1 but no helix used in antenna; inductance of straight wire between point A and ground is sufficient.

circuits. It will be noticed that as the local circuit is brought into resonance with the antenna circuit the plate current rises gradually to a peak value. When resonance is passed, however, the current drops with a snap to a low value. As resonance is approached from this side the current again gradually rises to a peak and then snaps to a low value when resonance is passed. It will be found that highest radiation occurs when the shunt tuning condenser is set to a slightly lower value than that which results in the highest plate current, i.e., just below the resonance click. If too large a value of coupling condenser

is used the set will stop oscillating when the two circuits are in resonance. For this reason the coupling should be kept small in preliminary tryouts. When the resonance point is found, however, the coupling condenser should be set to as large a capacity as possible without stopping oscillation. Increasing the inductance and decreasing the shunt capacity of the local circuit will increase the tendency to oscillate and allow the coupling condenser to be still farther advanced, thus increasing the load on the tubes. If this process is carried too far, however, the coupling condenser will begin to act as a series antenna condenser and the two circuits will oscillate as one, and at a wave length al-

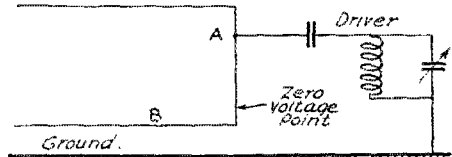

FIG. 3 Same as Fig. 2 but using a counterpoise. There is a point where the antenna has zero voltage to ground. The coupling wire may be attached either above this point, (A) or else below it, (B). A ground wire can be put on at the zero voltage point but is not necessary.

most double that desired. This effect is never troublesome, tho, as a slight decrease in coupling condenser restores the set to a normal condition.

The advantages of this circuit are:

1. By eliminating condensers and inductances from the antenna system, losses are reduced to a minimum.
2. The antenna system itself does not enter the shack. The lead-in of the ordinary antenna system wastes energy in absorption.
3. Swinging signals caused by the antenna, counterpoise or down-lead swaying in the wind are practically eliminated because the frequency is determined by that of the driver circuit, which is only slightly affected by changes in the antenna capacity.
4. Being a coupled circuit, no keying click and practically no harmonics will be transmitted except for the almost negligible radiation from the driver circuit. Amateur harmonics are beginning to be troublesome as the short wave lengths are beginning to become popular. Amateur receiving conditions would be greatly improved if this circuit were adopted by broadcasting and arc stations.
5. The radiation resistance varies directly with the antenna height and inversely with the frequency. Hence on the very short wave lengths where a vertical radiator is practical, a longer and therefore higher

radiator can be used, which is an obvious advantage.

The apparent disadvantages of this circuit are easily overcome.

1. It is necessary to have the antenna ammeter outside on the mast but the operator soon becomes accustomed to this and will be able to make a close approximation of the antenna current by watching the action of the plate current meter.

2. It is often desirable to be able to change from one wave length to another. This has been arranged for at 8VN by the insertion of a loading coil in the vertical

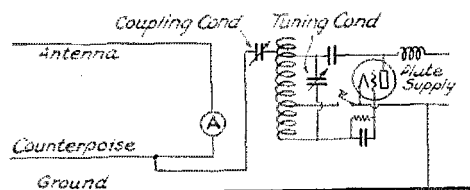

FIG. 4 A PRACTICAL EXAMPLE.  
Antenna - 120' long, 45' high, 2 wires  
Fundamental wave 190 meters  
Counterpoise - 120' long, 2 wires  
Helix - 40 turns, 6" diameter  
Variable Condensers - .0005 or .00025 microfarads

lead, which raises the wave length. This coil may be thrown in or shorted out of the circuit by means of a locking relay operated from the operating room. Of course the wave length of the driver must be changed also but a QSY may be accomplished in about fifteen seconds if the settings are marked. If a decrease from the fundamental is desired a series condenser may be substituted for the loading coil and operated in the same manner.

3. The antenna must be considerably longer than those ordinarily used to operate on the same wave length. A long one wire antenna may be used with very good results. Such an antenna is much more easily erected than a multi-wire type. When 8VN first tried this circuit a single wire antenna system was used and the results were practically equal to those obtained later with a two wire system on 10-ft. spreaders.

If the fundamental of your antenna is between 150 and 200 meters you will find that such a low wave length makes an excellent working wave, as there is little interference below 200 meters. Static is also considerably less. As previously explained an inductance may be inserted in the vertical lead to raise the wave length to above 200 meters. The longer wave can be used for calling.

Unfortunately we have no dazzling records as testimonials of this circuit having only had a short time in which to test it out. Our results have been consistent and quite good, however. A month and a half of actual operation with two 5-watt tubes has brot in 125 cards from stations up to 1150 miles and all districts except 6 and 7. Not much to brag of these days but our present make-shift receiver has failed to bring in any station farther than our best worked record, with the exception of two sixes. We would be very glad to hear how the circuit works out in the hands of other amateurs. We will try to answer by mail any requests for further information. A stamped and addressed envelope will insure a reply.

We will greatly appreciate a card from any distant station especially from the 6th or 7th district as we have determined to stay in the 5-watt class until a 6 or 7 is heard from.

## Hoover QSR's Cup to 20M

IN our April issue we reported that a committee of our Board of Direction had awarded the 1922 Hoover Cup to Station 20M. The cup has now been forwarded to 20M with the following letter from Secretary Hoover:

Department of Commerce  
Office of the Secretary  
Washington

April 20, 1923.

Dear Mr. Ostman:

The Board of Direction of the American Radio Relay League by unanimous vote have decided that you are entitled to the Department of Commerce Cup for 1922 in recognition of the notable efficiency of your radio station and your activity in amateur radio work.

*It gives me very great pleasure therefore to present you with the cup herewith. I also desire to express my hearty congratulations on the success of your work.*

Yours faithfully,  
Herbert Hoover,  
Secretary of Commerce.

Mr. Frederick B. Ostman,  
80 Broad Street,  
Ridgewood, N. J.

The cup is identical with the one awarded for 1921 to Falconi of 5ZA. Of solid silver, it stands 10 inches high with a bowl diameter of 6½ inches and an overall width across the handles of 9½ inches. On the

face is engraved the following inscription:

DEPARTMENT OF COMMERCE CUP  
DONATED BY  
HERBERT HOOVER  
TO BE AWARDED TO THE OWNER  
OF THE  
BEST ALL-AROUND AMATEUR RADIO STATION  
IN OPERATION DURING 1922  
THE MAJOR PORTION OF WHICH  
HAS BEEN DESIGNED AND CONSTRUCTED BY  
THE  
AMATEUR HIMSELF

On the reverse side is engraved:

AWARDED TO  
FREDERICK B. OSTMAN  
STATION 20M  
RIDGEWOOD, NEW JERSEY

We want again to point out that the contest for the annual Hoover Cup is open to every U.S. licensed amateur transmitter. It remains the highest honor that amateur radio can bestow and is worth working hard for. The conditions of the award, which is made by the Board of Direction of the American Radio Relay League, are set forth on page 27 of our January issue.

## Re-winding a Direct-Current Motor for Use as a Plate Generator

By C. C. Brown, 6KU

THE cost of high voltage generators keeps many amateurs from owning motor-generator sets to supply the high voltage for the plate circuits of their C.W. sets. It sometimes happens that a person in these circumstances can get a D.C. motor with a suitable commutator (one with many segments) cheaply enough to justify rewinding it as a plate generator. While a motor which has been re-wound by an amateur will not as a rule give very good efficiency when operating as a generator, this is not serious in small sets. The main things are that it can be done *economically* and that it will work *reliably*.

The idea is not limited to the machines I happened to use nor to the voltages at which I worked them, but it is easiest to tell a clear story when talking about a particular job.

A  $\frac{3}{4}$  h.p. 1700 r.p.m. 220 volt D.C. Fort Wayne motor was on hand and I decided to re-wind this as a 500 volt generator. First there was purchased a  $\frac{1}{4}$  h.p. 3400 r.p.m. induction motor. Then there was cast and planed a heavy iron base on which the two machines were mounted with the shafts in alignment and connected by an insulating coupling. The set was then operated and the voltage was found to be about  $\frac{13}{20}$  of what was required. It was evident that the number of turns in the new armature coils and the new field coils would have to be  $\frac{20}{13}$  of the number on the old coils.

The motor was then stripped and the size of the wire, number of turns and exact arrangement carefully noted and recorded.

The field coils were stripped from the frame, and the size of wire and number of turns carefully noticed and recorded. Knowing that the coils had to have  $\frac{20}{13}$  as many turns as the old coils it was found

that 10,000 turns were needed in each coil. As the wire had to have  $\frac{13}{20}$  as great an area as the old wire it turned out that No. 34 enameled would have to be used.

The field coils were wound in a three-piece wooden spool held together by a threaded  $\frac{1}{4}$  inch rod and two hex nuts. When winding a coil the rod was held in the chuck of a breast drill (Figure 1)

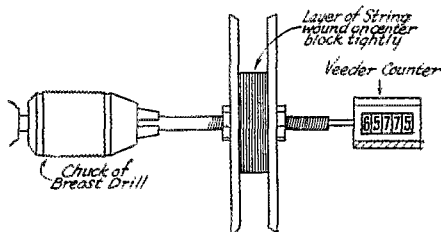

FIG. 1 WINDING THE FIELD COILS

which in turn was held in a vise. The free end of the rod was drilled to take the shaft of a Veeder counter.

When ready to begin, a layer of string was wound evenly into the spool. The end of the wire was started into the spool, which was then rapidly rotated by the breast drill until the counter showed that the required 10,000 turns had been wound. The time required was short. The sides of the form were then carefully taken off and the string pulled out from between the coil and the center of the coil form, allowing the center to drop out. The corners of the coil were secured with strong linen thread to keep the coil from bulging when the tape was put on. Short lengths of stranded wire were then soldered to the coils to make connections between them and

the brushes, after which they were taped with two layers of cotton tape and boiled in paraffin. They were placed on the field poles while hot. If the coils were left until they had cooled, it would have been impossible to shape them to the field poles. When cool, the coils were very rigid.

The armature was next on the program. All of the wedges were removed from the slots, and the coils taken out. The type of winding and connections were carefully noted. Each coil was comprised of 104 turns, with a tap at the 52nd turn. These mid-taps were connected to alternate commutator segments. The armature was lap-wound, 16 slots, 32 commutator segments. It is very important, for one not having the experience of an armature winder, to note all the details. In my case I wrote everything down, so I would not lose track of how the connections were made. This was my first attempt at armature winding, so I was taking no chances at making a mistake. A good way to do it is to draw a diagram such as in Fig. 2. The commutator connections were also noted.

After all the wire and old insulation were removed the slots were re-lined with thin Peerless paper. The edges of the paper were allowed to extend above the slot and folded back to make it easier to lay the wire therein. Then the armature was placed in the vise with the commutator away from me, and the first coil started from left to right in slots 1 and 7. At the 80th turn a loop was pulled out and twisted; then the winding was continued to

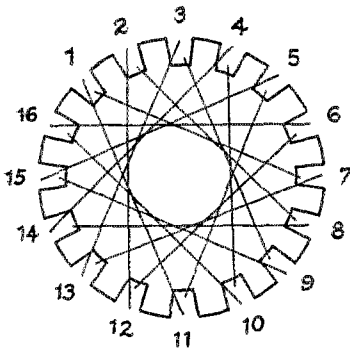

FIG. 2 METHOD OF RECORDING ARMATURE WINDING

160 turns and another loop brought out, twisted, and then twisted with the center tap for identification. The center-tap was marked with ink (this was cotton-covered wire). If all of these precautions are not taken trouble will be absolutely certain to happen. The second coil was then started in slots 2 and 8, and so on. After the first coil it was necessary to begin placing in-

isulation between coils where they laid on each other, both inside the slot and at the ends of the armature. First a strip of thin Peerless paper was placed in the slot and on top of the first coil, then a strip of Empire cloth was folded into the slot in the same fashion as the original strip of Peerless paper. Outside of the slots the coils were separated by Empire tape.

After all the coils were wound, the paper and cloth were trimmed down and the taps run thru the slots in small cotton

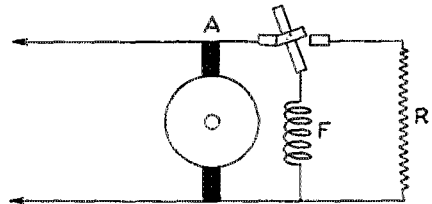

FIG. 3 FIELD DISCHARGE RESISTANCE

sleeving to the commutator. It was necessary first to press down the wire in the slot, using a fibre strip (armature winders call it a "doodlehopper"—Ed.) Then the center tap of the first coil was put in to slot 7, after which the final tap of the same coil and then the original wedges were forced into the slot. The finished armature was given a good coat of insulating varnish and baked for three days, great care being taken to prevent scorching of the varnish and the cotton.

The commutator was connected up next. The proper soldering flux is resin—no acid or soldering paste may be used. Since both the taps and the commutator were marked there was no chance of a mistake and the job became simple, altho tedious. After all taps were soldered the armature was placed in a lathe and the superfluous solder turned off. The taps were then bound down with a layer of heavy linen thread, the whole thing given another coat of varnish, and allowed to dry.

The generator was then ready for test. The set was assembled and started up but the generator failed to generate. The field terminals were reversed but it still failed to build up. The trouble was that the frame had lost its residual magnetism. 120 volts D.C. was then put on the generator and the motor started again. This time it built up slowly to 600 volts. If there had been no D.C. line handy the same thing could have been done by connecting 50 or 100 volts of B battery across the generator terminals for an instant while the machine was running.

When the set was connected the voltage was 600 with the key up, and 550 with the key down and the tubes drawing 200 milliamperes. The voltage was perfectly steady, the operation as satisfactory as that of a factory-wound machine, and no trouble has

appeared after a year's running. The commutator ripple is not bothersome except locally and cannot be detected at distances over a mile. This of course assumes that the commutator and brushes are being kept clean.

Now it is quite a job to rewind a machine and before beginning it is well to find out if re-winding is really needed. It must be remembered that the voltage of a shunt machine is directly proportional to the speed. By increasing the speed we gain the same result as by putting more turns on the armature and the field. If the machine at its original speed and with the original winding gives half the needed voltage we will have to double the speed or else double the number of turns in all windings.

It is quite easy to make speed changed if the set is coupled with pulleys and a belt. With direct coupling the thing is hard to do but on the other hand direct coupling gives less trouble and makes a neater set. As a rule also it is hardly practical to get the desired voltage with increased speed alone unless the machine was originally made for 500 volts.

The method of getting at the number of turns required has been stated. The size of wire is found as follows. Say that the old coil has 50 turns of No. 20 D.C.C. and that we need 5 times as many turns. The wire will have to have  $\frac{1}{5}$  the area of No.

20. The cross-sectional area of wire is measured in circular mils, which is the area of a  $\frac{1}{1000}$ -inch circle. By looking in any ordinary wire table we find that No. 20 has an area of 1,022 circular mils. One fifth of this is 204.4. The wire that has an area nearest to this is No. 27. It is possible, however that a size or so smaller may have to be used if the original wire was very tightly packed into the space. This is all right because the original machine was probably to run steadily while as a radio generator it will be loaded only part of the time and we can stand a little extra heating.

Never under any circumstances should the field of the generator be opened abruptly while the machine is running, as the inductive kick is almost certain to puncture the insulation of the field winding sooner or later. It may not happen the first few times but it *will* happen. If the operator insists on breaking the field circuit a field discharge resistance must be provided to "soak up" the inductive kick without harm to the field. This device is connected as shown in Figure 3. It is absolutely necessary to build the field switch so that the contact blade touches both contacts at once when in the center position. The resistance should be about equal to the field resistance, which can be measured or found roughly by referring to the wire table and the amount of wire used.

## Why Filament Transformers "Go West" and How to Stop Them

**B**ECAUSE it is simple and cheap the so-called "reversed feedback" is a popular circuit for tube transmitters. It is a good circuit. But why the gang should prefer to use the particular brand of reversed feedback known as the "Stanley" or "1DH" circuit is a mystery. Mr. O. A. Pearson, of our old friends the Thordarson Electric Mfg. Co., calls attention to the fact that the very best thing this circuit does is to burn out filament-lighting transformers.

The Stanley circuit was originated for a very low powered set, and was introduced to use by Whittier of 1DH when we all used low plate voltages and operated the filament on batteries. For such sets the circuit is OK. But for sets using over 500 volts on the plate it is not OK if the filaments are operated on A.C.

### Why the 1DH Circuit Burns Out Transformers

Looking at Figure 1 we see that with the 1DH circuit the entire grid circuit and the entire filament circuit are at high voltage above ground. This high voltage comes on the secondary of the filament transfor-

mer too, and is sure sooner or later to arc to the grounded 110-volt primary of the transformer.

This is not the fault of the transformer maker for he did not know that his product would be abused by putting 700 to 5000 volts between the windings—there is nothing to explain or excuse such a performance.

### What to do about it

In any tube set using A.C. filament supply and a plate voltage over 500 there should be a permanent ground on the center-tap of the filament transformer. If your circuit does not permit this, throw out the circuit or lay in a supply of filament transformers—you'll need 'em.

### Some Circuits that are OK

Looking at Figure 2 we see the circuit of Figure 1 with one small (but important) change; the ground has been moved to the other side of the feed condenser, C. The parts of the set that were "hot" before are "cold" now; while the helix, plate, and antenna are at high voltage. This circuit

does not blow up filament transformers but it does put high voltage on the antenna and if your neighbor touches it he will blow the fuses on his self-control. Also C now carries the antenna current and if that happens to be 7 amperes the price of C will be many \$\$\$\$.

Let's try again. In Figure 3 the feed condenser has been shifted to the plate lead. This takes the plate voltage off the

ter efficiency by using a tuned choke—a "wave trap." This sounds attractive, as do most of the inventions of the devil. If you insist on philandering with the thing, it can be made from a coil having 20 turns of No. 14 D.C.C. wound on a 3" tube. This is put in the plate supply lead and shunted by a .001 variable condenser. When this choke is exactly in tune it works a little bit better than the untuned one; as

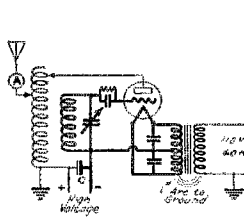

FIG 1 "STANLEY" TYPE OF REVERSED FEEDBACK.

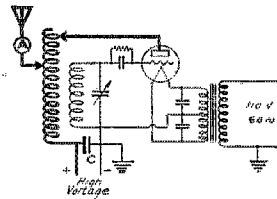

FIG 2 NORMAL REVERSED FEEDBACK.

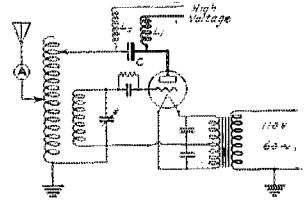

FIG 3 REVERSED FEEDBACK WITH SERIES FEED IN PLATE LEAD

antenna (without putting it back on the filament circuit) and is generally a fair sort of circuit. Of course, like all tube circuits, it is not perfect—two radio chokes  $L_1$  and  $L_2$  are needed to discourage the antenna current from straying off via the high-voltage supply (and incidentally burning that out). The fewer radio chokes the better, so we try once again. In Figure 4 everything has been left as in Figure 3 except that the low-voltage side of the plate supply has been taken off the plate lead and run to the ground. Now only one radio choke is needed and not a thing but the plate is "hot." The transformers, the operator, and the neighbors-that-come-to-lean-against-the-lightning-switch will all live longer.

**The Radio choke  $L_1$ — $L_2$**

Now for a pleasant surprise. The more you cheap-John the making of that radio choke the better it will be.

If you take a 4-inch pasteboard tube and wind on it (without any varnish at all) some 250 turns of D.C.C. wire just big enough to carry the plate current without getting hot, it will work beautifully. If you are entirely unable to be happy without doing something further to the coil, dry it well in a "slow oven" and put on a coat of Squibb's flexible collodion or a very light coat of insulating varnish. But don't pretty it up with shellac or silk-covered wire, banked or honey-comb windings. In particular, don't use large wire and heavy insulating tubing—stick to your little old No. 34 to No. 28 D.C.C. and the familiar Dutch Cleanser box or No. 6 dry battery case. It is not even necessary to take off the colored wrapper.

**Tuned Chokes**

Theoretically it is possible to secure bet-

soon as it gets 1/9 of a meter off-tune the tube abruptly quits oscillating and the plate melts, which is annoying. So it is best to keep a plain ordinary choke in the

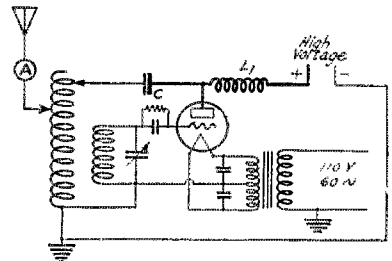

FIG. 4 REVERSED FEEDBACK WITH SHUNT FEED.

circuit and add the tuned choke in series by way of giving "lagniappe." This leaves one free to make some other adjustment with a little peace of mind.

S.K.

**Back Copies of QST**

In answer to numerous inquiries from readers of the Antenna Number we print below a list of the back copies of QST that are available thru the Circulation Department at the usual price of 20c.

- 1916: October.
- 1917: May, June, July, August.
- 1918: None.
- 1919: June.
- 1920: April, May, June.
- 1921: March, April, May, June, July, August, September.
- 1922: April, May, June, July, August, September, October, November, December.
- 1923: January, February, March, April.

## A New Method of Controlling Regeneration; The Four Circuit Tuner

By L. M. Cockaday, Technical Editor of "Popular Radio"

**W**HAT is regeneration? There are a number of different methods whereby regeneration may be realized, but let us dig into their theory before investigating these methods.

If an old time amateur were asked by a novice to state what regeneration was he would probably reply that it consisted of "feeding back" the radio frequency component of the plate circuit to the grid

er signal. This is exactly what is accomplished by regeneration. When a passing radio wave induces an impulse in the grid circuit there is a change in the plate current. This circuit operates at much larger voltages and currents than the grid circuit, hence the change in the plate current represents much more energy than the original grid impulse. If part of this plate energy is fed back to the grid circuit (by any one of several methods) the re-

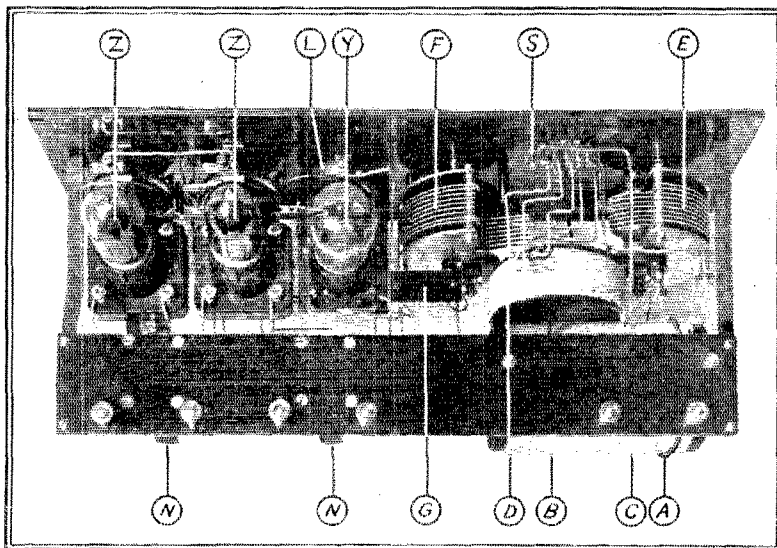

circuit, causing a greater variation of the grid voltage and thereby a louder signal. The novice would gulp a few times and go away with the words "feed back" fixed in his mind. Still later when a newer radio recruit asked him the same question he would reply that a regenerative set is one that has a tickler which shoots the signal around thru the tube a few times and makes it stronger each time. That is a very fair answer.

**A more exact explanation of regeneration.** In receiving sets the oscillating energy in the grid circuit is that which was induced in the antenna by a passing radio wave. This energy is very small and is still further reduced by the resistance of the tuning circuits. If there were only some way to do away with, or neutralize, the "positive resistance" of these circuits we would be able to obtain a much strong-

er signal. This is exactly what is accomplished by regeneration. When a passing radio wave induces an impulse in the grid circuit there is a change in the plate current. This circuit operates at much larger voltages and currents than the grid circuit, hence the change in the plate current represents much more energy than the original grid impulse. If part of this plate energy is fed back to the grid circuit (by any one of several methods) the re-

er signal. This is exactly what is accomplished by regeneration. When a passing radio wave induces an impulse in the grid circuit there is a change in the plate current. This circuit operates at much larger voltages and currents than the grid circuit, hence the change in the plate current represents much more energy than the original grid impulse. If part of this plate energy is fed back to the grid circuit (by any one of several methods) the re-

**Methods of regeneration.** Regenerative circuits are sometimes classified under two general headings, those accom-

plishing regeneration by inductive feedback, and those accomplishing regeneration by capacitive feedback.

Under the first heading come the "single circuit" and inductively coupled regenerators of Fig. 1. These sets have a plate inductance  $L_3$  which is inductively

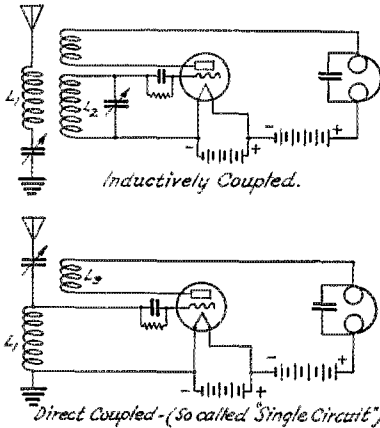

FIG. 1 REGENERATIVE TUNERS WITH INDUCTIVE OR "TICKLER" FEEDBACK

coupled to the grid inductance, the regeneration being varied by changing the position of  $L_3$  with respect to the grid coil. In these circuits (and their ten thousand variations—Ed.) the plate circuit is only roughly tuned, if it is tuned at all.

Under the second heading we have circuits which feed back through the tube

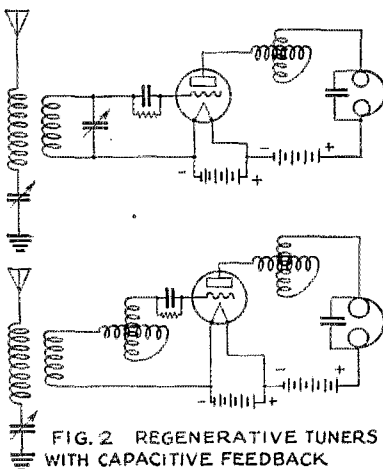

FIG. 2 REGENERATIVE TUNERS WITH CAPACITIVE FEEDBACK

itself, making use of the internal capacity between the grid and the plate. In this class belong the original Armstrong tuned plate circuit. Here regeneration is controlled by tuning the plate circuit more or

less closely to the working wave by means of the coil in the plate circuit. A direct descendant of this circuit is the very popular variometer-tuned circuit shown in various form in Figure 2. Here the plate tuning is carried out by adjustment of the plate variometer. Still another circuit of the capacity-feed-back type is the ultraudion shown in Fig. 3. Here regeneration is usually controlled by means of a variable grid condenser or a vernier filament rheostat.

Some years ago it occurred to the writer that the old ultraudion was one of the simplest of the oscillating audion circuits and needed only some device for controlling its regeneration. The difficulty lay in the very thing that made the circuit

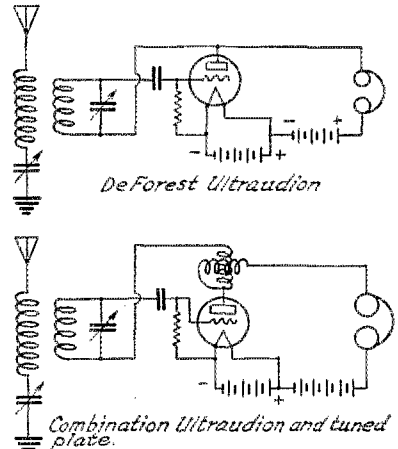

FIG. 3 ULTRAUDION TYPE OF CAPACITIVE FEEDBACK.

simple, the fact that the plate circuit was not tuned. Everything could be repeated into it equally well and then fed back to the grid, causing the circuit to oscillate. The stronger the incoming signal, the stronger the feedback. If the circuit was adjusted for a weak signal then a strong one or a burst of static, would at once cause it to break into oscillation. Of course for C.W. reception this was great; the circuit would oscillate over the entire wave length range and had only one control; but for voice or spark it was lacking because of its extreme instability. Still the simplicity of the circuit was so striking that we started out to see if it could not be controlled in some simple way. This was finally accomplished by a scheme which absorbed energy from the grid circuit. This absorption can be adjusted to increase the resistance of the grid circuit so that the tube will just stop oscillating. After this adjustment has been made, the device automatically accommodates itself to the strength of the signal.



If a weak signal comes in, only a small amount of energy is taken out of the grid circuit by the absorption circuit but a strong signal causes greater absorption so that the same condition holds true; the circuit does not oscillate but stays at the critical regenerative condition where there is maximum response. Not only that, but it is found that if the set is properly proportioned the stabilizer can be set and then left alone, regardless of tuning changes; in other words it is independent of the wave length. The stabilizer or absorption circuit consists of a fixed inductance coupled rather closely to the grid inductance and shunted by a variable condenser. When the capacity of the variable condenser is increased this "fourth circuit," or absorption circuit, extracts more energy from the grid circuit takes less energy from the grid circuit.

The circuit is shown in Fig. 4 and the completed tuner on page 29. The parts are labeled in the same manner in both figures. The tuner shown has a range of 150-530 meters.

#### List of Parts

A—Primary winding, one turn of heavy copper wire wound directly over the secondary, one quarter inch from the outer end. (Note that this gives very loose coupling to the antenna, and that the device accordingly is able to TUNE, unlike most of the popular receiving sets sold today. —Tech. Ed.)

B—Secondary winding, 65 turns No. 18 S. C. C. wire on one end of the tube which is  $3\frac{1}{4}$ " in diameter and  $5\frac{1}{8}$ " long.

C—Fourth circuit or absorption winding wound on the other end of the same tube as B. This coil has 34 turns of No. 18 S. C. C. wire.

D—Antenna loading and tuning coil. Can have different forms but here consists of 43 turns of No. 18 S. C. C. double-bank-wound on a tube  $1\frac{1}{8}$ " long and  $3\frac{1}{4}$ " in diameter. Tapped at start, at 3, 7, 13, 21, 31, & 43 turns.

[The position of this coil (D) is somewhat makeshift. Suggest that those who construct one of these tuners place the loading coil at least six inches away from and at right angles to the A.B.C. coil form. —Ed.]

E & F—Variable condensers, capacity .00035 microfarad maximum.

G—Fixed mica condenser .00025 microfarad.

I—Grid leak, 1-2 megohms.

L—Vernier rheostat of detector tube filament. (Carbon compression type suggested.)

N—Audio frequency amplifying transformers.

S—Primary (antenna) tuning switch.

V—Grid-leak mounting clip.

Y—Detector tube.

Z—Amplifier tube.

The reason for naming this the "four circuit tuner" is as follows: The coil A (one turn) plus the antenna load coil D are connected in series to antenna and ground, forming the antenna or *first circuit*. The coil B plus its condenser and the path thru the tube from grid to filament form the grid or *second circuit*. The third circuit is the *plate circuit* which is untuned. The *fourth circuit* is the absorption circuit and consists of the coil C and its variable condenser.

In tuning the set the antenna switch is set for the correct wave length (for the antenna used), the condenser E in the stabilizer (absorption) circuit set at about half scale and the rheostat of the detector

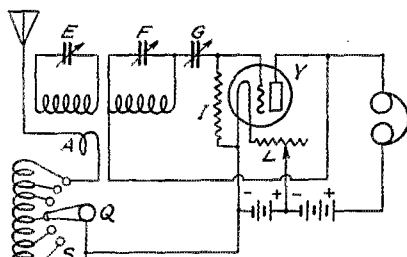

FIG. 4 THE FOUR-CIRCUIT TUNER (Audio Amplifier Omitted)

tube adjusted so that the tube just fails to oscillate. The signal is then tuned in on the grid-tuning condenser F. Then to increase the signal to maximum regeneration the condenser E is rotated two or three degrees toward the lower part of the scale and the signal retuned on the condenser F. This process should be continued until the signal is strong enough or until the detector starts to oscillate. Spark or voice signals should be tuned in with E set at a high value and C.W. signals with E at a low value (between  $\frac{1}{2}$  and  $\frac{1}{4}$  of the scale). Amateur signals will tune between zero and 20 on the condenser F and broadcasting stations will tune from 20 to 60. The wave length range of the set is from 150 to 530 meters. (These settings refer to a 180-degree dial. —Ed.)

The claim made for this set is that it is exceptionally sensitive to weak signals without being unstable and that it reduces interference to almost zero. When the operator learns how to tune it properly interference from even nearby stations can be cut out, provided the interfering station is not *exactly* on the same wave length as the more distant station.

(This great selectivity would seem not to be a property of the circuit but due to the very loose coupling used; any decent secondary circuit is very selective if it is

very loosely coupled to the antenna. It is possible however, that the Cockaday circuit permits adjustment of the detector tube a high degree of sensitivity so that full advantage can be taken of the beautiful selectivity obtained by the

use of extreme loose coupling. In any case we hope that this tuner will encourage the makers of the popular "simple tuner for simple folks" to try producing something that can be thought of as a tuner without a mental apology.—Tech. Ed.)

## Why Kilocycle?

By Dr. A. N. Goldsmith\*

LONG ago a choice was made between wave length and frequency in describing radio waves. It is interesting to speculate how it came about that wave length swept the field; it seems much more natural to use frequency since this is the common practice in ordinary alternating current engineering. No one ever thinks of referring to lighting a building on 5,000,000 meter waves tho, to be sure, such waves are propagated thru the circuits of an ordinary 60-cycle system. Probably the early experiments of Hertz had some influence on the original decision. Hertz worked with waves a few meters in length so that their length was a very convenient quantity to use in specifying them. Furthermore in the study of light, which is but another form of electromagnetic waves, it was found that the wave lengths were small and comprehensible quantities while the frequencies were enormous quantities and practically impossible of comprehension. It was therefore natural to use wave

For I.C.W. (interrupted continuous wave) telegraphy—a frequency band containing a number of cycles equal to twice the audio frequency note (assuming a pure note is used).

For telephony, with speech only—a frequency band about 4,400 cycles wide.

For telephony, with high grade music—

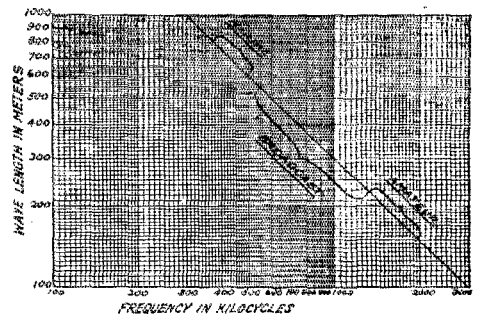

FIG. 2

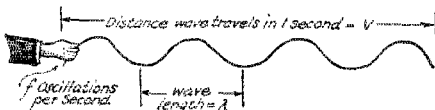

FIG. 1

lengths in describing the radio waves, the "big brothers of the light waves."

But it was a sad mistake from the modern viewpoint to use wave lengths in place of frequency. To make this clear, it is only necessary to consider what a modern continuous wave transmitter requires in the way of "space for transmission." This is sometimes called the "width of a communication channel." If one desires to transmit (using both side bands), one needs the following amounts of frequency space, at the very minimum, (and in practice something more):

For C.W. telegraphy—a frequency band containing a number of cycles equal to half the transmitting speed in words per minute, (assuming suitably rounded dots and dashes).

a frequency band approximately 15,000 cycles wide.

There is no getting away from these figures in ordinary transmission. They represent the number of cycles which must be employed. Generally more than this will be required and space must be left between the bands allotted to various stations.

One of the interesting consequences of all this is that it is seen to be improper to speak of assigning a "wave length" to a station. A station's transmission does not occupy a "wave length" but a band of waves or frequencies. The frequency at the center of this band is called the "carrier frequency" and is important in all future discussions of the subject. Given the carrier frequency it is possible to tell, from the above table (if we speak in frequencies), just what space the station will occupy.

Thus, suppose an experimenter is transmitting on 200 meters, with C.W. telegraphy at a speed of 20 words per minute. His carrier frequency is found to be 1,500 kilocycles, and he occupies a band only 10 cycles wide! So that he should cause very little interference.

\*Secretary, Institute of Radio Engineers.

As another example, suppose he is transmitting on 190 meters I.C.W. with a tone of 1,000 cycles. His carrier frequency is 1,580 kilocycles, and the width of his band is 2,000 cycles, or 2 kilocycles. That is, he occupies from 1,579 to 1,581 kilocycles.

Spark stations occupy no sharply defined band of frequencies. They just extend out indefinitely to both sides of their carrier frequency, becoming weaker and weaker as one goes farther from the carrier frequency but never disappearing. That is why spark stations must be eliminated. A well-behaved modern station must have a definite address. It must occupy a certain numbered residence of reasonable width on the "Street of Carrier Frequencies," and it may not invade every one else's home to some extent. And that is exactly what the spark station unfortunately does.

It is of course obvious that there will be a conventional and sentimental objection to getting in line with progress and talking of kilocycles. But think how simple it is. Instead of 200 meters, use 1,500 kilocycles. Instead of 150 meters, think of 2,000 kilocycles. And remember that the *band of frequency* which any station occupies is *always the same* for a given sort of transmission whereas, the band of wave lengths which it occupies depends entirely on its wave length, even for a given sort of transmission. Thus, a speech radio telephone station occupies 4,400 cycles at all frequencies. But it may occupy 1 meter of wave length (at a wave length of 261 meters), or it may occupy 1,000 meters (at a wave length of 8,250 meters). Clearly the wave length is not the right way to express the characteristics of a radio wave in these times.

#### The Relation of Wavelength to Frequency

For every kind of wave-motion there

is the general relation:—Velocity of the wave = (Wave length) multiplied by (Frequency of the oscillating source).

Each oscillation of the source (sending set) sends out one wave and this wave has moved forward by its own length (which is one wave length) by the time that the next wave is sent out. (See Fig. 1). If the source oscillates  $f$  times in a second and each wave is  $\lambda$  meters long, it is evident that at the end of the second the first wave must have moved forward  $f$  times  $\lambda$  meters in order to make room for the following waves. Another way of saying this is that the speed of movement, or the velocity of the wave, must have been  $\lambda f$ . If we call the velocity  $V$  and write the statement as a mathematical equation we have—

$$V = \lambda f$$

All radio waves have a velocity  $V$  of 300,000,000 meters per second. It is therefore very easy to get the frequency from the wave length; one needs only divide 300,000,000 by the wave length to get the frequency or to divide 300,000,000 by the frequency to get the wave length.

In Figure 2 is shown the relation between wave length and frequency drawn in such a way that it is possible to find either quantity from the other. To find the frequency corresponding to a wave length of 176 meters, one runs across from the 176 meter point on the left hand wave length scale until one strikes the oblique straight line, then down to the horizontal axis. One finds that the frequency is 1,700 kilocycles per second. A kilocycle is 1,000 cycles. The frequency in kilocycles of a radio wave is three hundred thousand divided by the wave length in meters. Thus, a 300 meter wave corresponds to a frequency of 1,000 kilocycles, or 1,000,000 cycles per second.

## Concerning Amateur Interference with Broadcast Reception

THE following is excerpted from the paper "A Preliminary Statistical Study of the Range of Radiotelephone Broadcasting Stations," by C. M. Jansky, Radio Engineer, Bureau of Standards, and member of the A.R.R.L. Advisory Technical Committee. The paper as a whole is not reproduced here as it related mainly to the problem of covering a specified territory by radio telephonic broadcasts.

"It was decided to take observations on only two transmitting stations, the University of Minnesota telephone and telegraph broadcasting station, WLB, at Min-

neapolis, Minn., and the Westinghouse E. & M. Co. station, KDKA, at East Pittsburgh, Pa. At that time KDKA was using a 360-meter wave length and WLB a 485-meter wave length . . . . The names of approximately 60 receiving-station operators willing to assist located within a radius of 400 miles of Pittsburgh, were secured from the American Radio Relay League for the Bureau of Standards. The names of 70 possible recorders were secured from the files of the University of Minnesota and the University of Wisconsin."

The test method is then explained, as is the log sheet used by the observers and the method of analyzing the returns with the aid of a Bureau of Census card-punching machine. The phase of these results that seem of especial interest to us are here mentioned as they second our long-standing experience.

“ . . . it will be seen that observations taken in the 100-150-mile zone show a greater degree of reliability than those taken nearer the transmitting station . . . it will be seen that the observations taken on Station WLB show the same peculiarity. However, here it is the observations taken in the 150-200-mile zone that show the greatest reliability . . . The conclusion that the reliability of signals from a given station first decreases and then rises as we increase the . . . distance . . . seems justifiable. The fact that this rise occurs at a greater distance on the 485-meter station than on the 360-meter station would seem to indicate that this peculiarity is also a function of the wave length used. The experience of experimental and amateur stations seems to verify the above conclusions altho, to the writer's knowledge, this is the first instance in which statistical data . . . has been secured . . . The increased reliability at greater distances may

gust and September on KDKA by observers selected by the American Radio Relay League are being continued by the Bureau on a larger scale with the help of additional observers selected by the Bu-

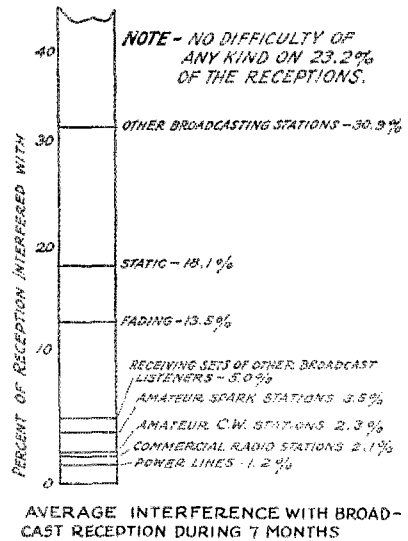

RELATIVE MAGNITUDE OF OBSTACLES TO RECEPTION OF RADIOPHONE BROADCASTS

Results expressed in percent of total observations in the month.

	Aug.	Sept.	Oct.	Nov.	Dec.	Jan.	Feb.	Averages
No Obstacle	10.4	11.3	13.4	25.8	32.2	34.2	35.3	23.2
Interference by Other								
Broadcast Stations	30.6	32.0	34.9	38.2	22.2	25.3	33.6	30.9
Static	37.4	38.2	11.4	9.0	12.7	12.3	5.5	18.1
Fading	9.4	10.5	18.5	9.8	15.3	15.8	15.3	13.5
Interference from Oscillating Receiving Sets	5.1	4.6	16.8	2.5	2.8	2.3	0.6	5.0
Amateur Spark	0.5	1.7	0.8	7.3	7.2	3.8	3.5	3.5
Amateur C.W.	0.5	0.0	2.5	3.3	2.6	2.6	3.9	2.3
Commercial Stns.	2.4	1.3	1.7	3.0	3.3	2.2	1.3	2.1
Power Lines	3.7	.4	0.0	1.1	1.0	1.5	1.0	1.2
No. of Observations	372	238	232	1174	986	889	307	

be a result of the more extensive use of receiving apparatus using electron tubes.” (This seems doubtful; we have the same experience on the amateur waves where all of us receive with tubes.—Tech. Ed.)

“It is of interest to note the relative magnitude of the various obstacles [to reception] due to human agencies . . . A study of the variations of these magnitudes with the season of the year should give much valuable information. The conditions resulting after new radio regulations become effective could be the subject of a similar study.

“The preliminary tests conducted in Au-

reau, assisted by the Westinghouse Electric & Mfg. Co. . . . The Bureau would be pleased to hear from persons seriously interested in these range tests who would be willing to assist by taking observations at regular times, in case their services could be advantageously used.”

Since the receipt of the report from which we have quoted there has come to us from the Bureau of Standards a further tabular summary of the tests insofar as they relate to interference with broadcast reception. This summary is given in the table above. The figure presents the same information in graphic form.

# EDITORIALS

## de AMERICAN RADIO RELAY LEAGUE



### Amateur Regulations

**A**T the time of the First National Radio Telephony Conference called by Secretary of Commerce Hoover a year ago there was considerable talk among the amateurs of subdividing the band assigned to amateur work into smaller bands for the different kinds of transmitters. It was felt that this would do a great deal to reduce intra-amateur interference, and the Conference recommended to the Department that it be done. At the second conference held this past March the subject of wavelength allocation was gone over anew, and as our readers know the band from 150 to 200 meters was assigned for general amateur work. The Conference then started to consider subdividing this band as had the first conference, but contented itself by recommending that the amateur spark be confined between 176 meters (1300 k.c.) and 200 meters, agreeing that further subdivision should be left for consideration between the Department and the amateur.

Subsequently, our A.R.R.L. officials conferred with the Department and were told that if we amateurs would say what we wanted they would try their best to give it to us. A special meeting of our Board of Direction was immediately called and in the meantime our Directors commenced a canvass of their respective territories to find out what we fellows actually wanted. Many plans were considered and many ideas secured, and when finally our Board came together it had representative opinions from our members all over the country, not only on subdivision but on numerous other matters of amateur regulation now pending.

It was immediately apparent that our membership frowned upon any elaborate plan of subdivision as hopeless of application, however splendid an interference-reducer it looked on paper. The country was united, however, in favoring some form of division which would protect our increasingly-valuable short waves from undue interference and which would more or less confine the QRM-producing types of transmitters to certain waves. Finally a solution was hit upon—to ask for a relatively broad band for all the modulated forms of sending sets and to let straight C.W. work any-

where it wished. The band from 176 to 200 meters, recommended by the Conference for amateur sparks, was chosen as the proposed modulated band, in which not only sparks but I.C.W., A.C.C.W., unfiltered "C.W.," and phones would operate. This of course represents almost no change from the existing operation of amateur stations and would amount simply to a regulation barring modulated types of senders from going below 176 meters. As the chief idea is to conserve our shortest waves, which are constantly increasing in amateur estimation, this would seem to work out beautifully. The Conference, too, had recommended an extension of the amateur band to 220 meters for pure C.W. sets (under special license), and so the net result would be a band from 150 to 220 meters for C.W. sets, with the "modulated types" staying in an intermediate band between 176 and 200 meters. A recommendation to this effect has been conveyed to the Department, and at this writing we are awaiting their consideration.

Amateur ranks were thrown into consternation and dismay in early April when word got around that the Department was recalling amateur licenses to endorse them with the provision that no transmitting could be done between the hours of 7:30 P.M. and 10:30 P.M. local standard time. Had our old friends gone back on us? Who put that thing over, the gang wanted to know, after the Hoover Conference had considered the matter and yet had declined to make any such recommendation? Our A.R.R.L. got busy at once, and here is what we found, fellows. The Department knew all about our voluntary quiet hours but they figured that there were some amateurs not members of the League and perhaps a few of our own members who would not agree to "play the game" with us, and since the rest of us were already in favor of quiet hours as our contribution to co-operation, why not avoid hard feelings in amateur ranks and make things uniform by making quiet hours compulsory? The Department was still our friend and was trying to help! But we had to point out the big difference between voluntary and enforced QRXing, and as a result the new regulation was held up on all but new licenses until our Board could consider it. Again the Board had representative amateur opinions from

all over the country for its guidance, and at its meeting reiterated its declaration in favor of our A.R.R.L. voluntary quiet period but unanimously objected to the compulsory QRX hours. A regulation with the force of law prohibiting our transmission between certain hours would prevent our assisting in the rather numerous emergencies such as storms, floods, wrecks, etc., where we have had opportunities to serve our communities, and besides, prohibition is bad business and never as effective as the nearly-perfect co-operation which we amateurs have learned to give to our voluntary team-work. We have communicated this idea to our friends the Department, but at the last minute we can wait before going to press we have not learned the result. As good Americans we of course will abide by their decision, but we hope it will be to recall the order for compulsory quiet.

The law of 1912 stipulates that the waves above 200 meters may be used only by special-license stations, and that such licenses may be issued only to applicants of considerable experience and ability. It is desired to extend the effective amateur band to 220 meters, with that privilege granted to all who can qualify instead of a relatively few 375-meter "specials" as heretofore, but it can be done only under the conditions specified in the law. As there are several thousand of use who can expect to qualify for the use of the waves up to 220 meters, why not have an "Extra First Grade Amateur Operator's License" to qualify us for the possession of a special station license to meet the new condition? The Department said the idea was OK, and so our Board rounded up opinion on that too, and the result was a recommendation to Commerce that the idea be adopted, with two years amateur experience under license and a code speed of twenty words a minute as the chief requirements. Like the other matters mentioned, this one is still pending at this writing.

Things are in a state of flux at the moment. The old 375-meter specials are no more or are being recalled, with 200 meters as a maximum limit for sparks and I.C.W., and 220 for C.W. Quiet hours may or may not be required of us by endorsement on our licenses. Maybe we get subdivision, maybe we get some shorter waves we don't know now, but we'll know before our next issue.

### Dern the Amateur

**H**APPILY the day is rapidly passing when the public believes that the amateur is the one and only source of all poor broadcast reception, from ordinary garden varieties of interference to such things as auroras, dirty contacts, static,

and sulphated batteries. The crisis in our young lives when the slogan of the general radio public was "Damn the Amateur" has passed with the coming of a better understanding, the realization of what the helping hand of the amateur means, but more particularly as the dope got about that after all it wasn't the confounded amateur but something else that caused most of the trouble. But even tho the day of our "doomnation" has passed along into history along with lots of other funny things, it is very interesting to consider the results of a careful survey of the interference business made by no less competent an authority than the Bureau of Standards, with the help of several hundred listeners, as set forth in a paper by Prof. Cyril M. Jansky, Jr., reviewed elsewhere in this issue.

The observations extended from last summer until March of this year, and thousands of data sheets were gathered and analyzed. The first thing that strikes one upon looking at the results is the fact that only about 23% of the time can one hope to get a desired station without interference. It bears out what we have said frequently—that interference is the rule in radio rather than the exception. But the most startling thing in the report is the fact that during 68% of the time broadcast reception is interfered with by something inherent in the system itself, such as fading and static, or other broadcast stations, or howling receivers; and only 9% of the time is reception bothered by some form of man-made interference exterior to the fabric of broadcasting itself. That reports begins to absolve somebody, for it shows that of all the broadcast programs listened to, about 91% were received perfectly excepting for interference that originated within the broadcast system or else was of natural origin!

Interference of some sort was experienced something over three-quarters of the time, and of this, roughly eighty-eight percent was in the system itself or from natural causes, with but 12% from other man-operated devices.

Twelve percent of the total, and interfering with 9% of the observations! And this 9% includes all the "funny noises," the commercial spark sets, the ships, the government stations, and the amateurs, with us amateurs responsible for but a small fraction of this 9%. And a considerable portion of this time was before our voluntary quiet hours came into any wide adoption! Who said we interfered? Why, it's obvious from this report, certified by our own government, that because we know how to co-operate, the trouble we amateurs cause our neighbors is *entirely negligible!*

We hate to say it, but "we told you so!"

# The Operating Department

F. H. SCHNELL, Traffic Manager  
1045 Main St., Hartford, Conn.

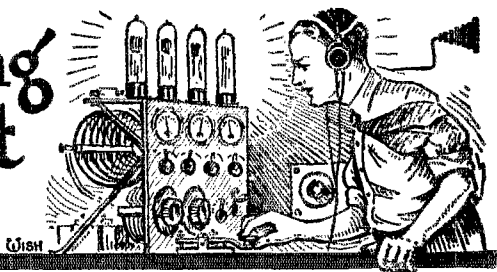

Just as we expected—when the least bit of QRN started up, the spark traffic goes to the dogs while the C.W. traffic rides right thru and brings in a greater total!

Some one suggested that the ante for the Brass Pounders League be raised to at least 400 messages for a station to "stay." Accordingly, the suggestion was accepted. Now, how many stations are going to hold their position thru the summer months? How many are going to abolish the "rubber stamp" message traffic and "stay" in the box? It's going to take a lot of grit to do both and still be with the top-notchers, but once a man gets there under the above conditions, he is entitled to everything we can give him. What station is going to cop the record of being in the box the greatest number of times during the year? What station will have the greatest number of messages at the end of the year? You must remember that the operation of a station and its observance of all rules and regulations is an important factor deciding the winner of the Hoover Cup. We could name several dozens of stations which have a chance of winning this Hoover Cup if they entered in due form, but its up to the individual to have his say—we've had ours. The men of the Operating Department should bear in mind this annual honor and make a concerted effort to file entries. We want to see at least two hundred in the 1923 contest!

How long is the Atlantic Division going to have the station taking individual honors? Seems like several months have gone by since some other division has been seen in the box. Well, let's see!

## TRAFFIC REPORTS FROM ALL A.R.R.L. OFFICIAL RELAY STATIONS

EAST GULF DIVISION—C.W.: 4YA, 150; 4DG, 83; 4CY, 78; 4LE, 71; 4DO, 64; 4KU, 45; 4EQ, 45; 4JL, 45; 4DF, 44; 4MB, 40; 4HS, 34; 4EH, 25; 4BL, 21; 4BG, 20; 4ME, 15; 4DN, 12; 4GM, 10; 5XA, 135; 5ABT, 40; 5CP, 23; 5ZAEA, 12; 5XAE, 10; 4FD, 30; 4RY, 15; 4EL, 214; 4MR, 86; 4EB, 406; 4OD, 4; 4JD, 4; 4BQ, 191; 4LV, 384; 4FB, 506; 4FG, 50; 4GP, 10; 4FS, 114; 4NU, 19; 4HZ, 15; 4AQ, 14; 4AR, 50; 4XJ, 76; 4IZ, 35; 4OZ, 11; 4OR, 25; 4PF, 12; 4LH, 3; 4IW, 11; 4JZ, 64; 4JY, 12; 5CP, 26; 5UP, 15; 5ADS, 5; 5FU, 1; 5AGJ, 110. SPARK: 4FD, 148; 4HS, 130; 4DF, 25; 5XA, 173; 4BC, 30; 4JU, 5; 4MZ, 10.

MIDWEST DIVISION—C.W.: Missouri: 9BLG, 344; 9EIS, 20; 9EQ, 40; 9AQB, 72; 9AAL, 11; 9DXN, 214; 9ARG, 10; 9EKF, 170; 9PW, 104; 9CVO, 335; 9AAU, 53; 9DCW, 126; 9ATX, 42; 9AON, 255; 9BIE, 100; 9CJC, 152; 9DWK, 123; 9BDS, 357; 9DZY, 95; 9CUF, 11; 9CAO, 302; 9AFH, 10; 9CHJ, 27; 9BZH, 21; 9CKS, 706; 9DPY, 38; 9BOZ, 14; 9DAE, 210; 9SS, 100; 9ACX, 50; 9AHZ, 203; 9AYL, 354; 9BDZ, 108; 9BJC, 463; 9BKK, 66; 9BKO, 36; 9CXO, 45; 9DJB, 211; 9DXX, 212;

## Message Traffic Report By Divisions

A P R I L

Division	C.W.		SPARK		TOTAL	
	Stns.	Msgs.	Stns.	Msgs.	Stns.	Msgs.
Atlantic	253	36498	24	1734	277	38232
Central	278	45672	44	3773	322	49445
Dakota	79	11537	11	718	90	12255
East Gulf	53	3340	7	521	60	3861
Midwest	129	21720	20	2545	149	24265
New England	135	19236	6	260	141	19496
Northwestern	56	5854	2	75	58	5929
Ontario	41	2987	2	53	43	3040
Pacific	35	3094	5	436	40	3530
Roanoke	42	7292	2	349	44	7641
Rocky Mountain	25	3661	3	513	28	4174
Vancouver	9	1025	1	25	10	1050
West Gulf	63	10154	4	320	67	10474
Winnipeg	9	693	—	—	9	693
Total	1207	172763	131	11322	1338	184085

C.W. Messages, 172,763—94%

Spark Messages, 11,322—6%

H. A. Beale, Jr., (8ZO)  
Parkesburg, Pa.  
Atlantic Division  
1,762 messages.

9CYG, 94; 9CTG, 316; 9ANO, 120; 9DLT, 116; 9DRW, 80; 9EFB, 309; 9BWR, 87. Iowa: 9AHH, 308; 9BGH, 1010; 9ATN, 419; 9DXC, 321; 9BSG, 329; 9BCF, 118; 9UL, 188; 9BDR, 85; 9CLQ, 95; 9BIF, 40; 9CSY, 42; 9DAL, 26; 9RPV, 123; 9BAL, 146; 9BXC, 123; 9BVL, 133; 9EDB, 82; 9CWF, 116; 9CTD, 74; 9CNR, 20; 9BYC, 85; 9FK, 321; 9CHN, 351; 9DKY, 287; 9AML, 136; 9DOF, 300; 9DJM, 178; 9BXJ, 114; 9BIK, 284; 9DJA, 68; 9EER, 92; 9ARZ, 90; 9AMU, 130;

9BZL, 168; 9DFT, 12; 9ASI, 7; 9CGY, 110; 9DTF, 48; 9BCD, 10; 9DMH, 71; 9HK, 135; 9BCR, 296; 9BGT, 62. Kansas: 9CAC, 332; 9DUG, 205; 9AOG, 355; 9ABV, 101; 9EHT, 318; 9CKM, 139; 9ANQ, 45; 9CVT, 8; 9ECZ, 65; 9DPD, 40; 9CCS, 522; 9BZZ, 526; 9CYV, 26; 9CJE, 319; 9DTA, 340; 9AOD, 173; 9CFI, 338; 9CCV, 232; 9NR, 49; 9AEY, 56. Nebraska: 9CMK, 248; 9AQK, 24; 9JK, 110; 9DXY, 75; 9CPB, 138; 9ASO, 103;

1CPV, 84; 1CK, 94; 1CQJ, 113; 1IX, 17; 1ASU, 22; 1BES, 51; 1BNT, 324; 1BBM, 21; 1BDU, 66; 1ZE, 101; 1AWB, 118; 1AIR, 83; 1CBJ, 12; 1CAK, 1AOK, 225; 1OV, 17; 1AOJ, 31; 1BFA, 49; 10: 1FD, 42; 1CPI, 456; 1AWE, 125; 1AQU, 40; 1ABC, 2; 1AWO, 1; 1AXR, 50; 1BGD, 170; 1GV, 178; 1IL, 456; 1OW, 100; 1AIU, 98; 1BHK, 105; 1BQD, 216; 1BVB, 307; 1CBP, 354; 1AQM, 219; 1BKQ, 91; 1YK, 404; 1BVH, 145; 1BOQ, 338; 1BFA, 24; 1CJR, 306; 1AAC, 117; 1CR, 39; 1RR, 239; 1TV, 88; 1CJD, 161; 1CQJ, 168; 1MC, 1090; 1GL, 314; 1IX, 36; 1BNK, 25; 1FD, 42; 1CPS, 25; 1CR, 21; 1AYU, 4; 1AVW, 72; 1CTX, 5; 1AW, 72; 1EX, 35; 1AVK, 12; 1AVJ, 50; 1FY, 168; 1TL, 107; 1TS, 317; 1AYZ, 200; 1AJP, 200; 1AYQ, 185; 1CAC, 100; 1BM, 5; 1AVQ, 108; 1CBS, 211; 1CKP, 58; 1BYM, 8; 1HN, 89; 1BIY, 178; 1WC, 222; 1CQZ, 47; 1AKP, 223; 1QP, 40; 1VK, 172; 1KV, 192; 1UJ, 87; 1CGV, 111; 1BAG, 41; 1MY, 536; 1IV, 126; 1PA, 86; 1CJZ, 426; 1BYN, 400; 1JN, 345; 1KC, 338; 1AWW, 312; 1IL, 260; 1CPN, 237; 1VC, 187; 1BVR, 137; 1ARF, 126. SPARK: 1ARY, 17; 1CSS, 18; 1CM, 29; 1AEQ, 40; 1CM, 51; 1CIB, 105; 1CMK, 99; 1BKQ, 91; 1CGQ, 81; 1AKL, 42; 1BHO, 42; 1BSJ, 39; 1CTT, 32; 1AOJ, 31; 1AUG, 21; 1BSZ, 11; 1BDI, 155; 1CNP, 6; 1BQL, 150; 1CKQ, 28; 1BRQ, 351; 1ALL, 177; 1CTP, 63; 1BHJ, 35; 1CRU, 191; 1BID, 5; 1AZZ, 7; 1AYM, 3; 1IT, 29; 1CNL, 465; 1SK, 39; 1SN, 334; 1CSS, 32

**BRASS POUNDERS' LEAGUE**

Call	Msgs.	Call	Msgs.
3ZO	1762	9AVZ	523
3BMN	1336	9CCS	522
9DQU	1284	9BIL	513
5KP	1119	4FB	506
1MC	1090	8ALF	506
9MC	1021	9CGA	489
9BGH	1010	9AZA	489
8L	998	3WF	485
8BNH	974	8QC	485
8BLU	912	8BYN	467
3HS	902	*2BMR	465
8AAF	883	1CNI	465
3APR	856	9BJC	463
8SM	838	9BRI	462
9DWF	834	1CPI	456
5XAJ	806	1II	456
9CTF	800	*8EB	456
9DSW	783	7ABB	454
8VY	763	8UR	450
9BXT	729	3SU	445
8AVD	726	5TM	439
8CEI	718	8BQA	438
9CKS	706	*9AOJ	438
9VM	692	*6APL	436
9OX	672	9AWQ	432
9CFK	659	8CWP	429
8CEJ	641	1CJZ	426
8BDJ	634	3ADP	423
8CQX	621	8YN	423
9BKP	611	6ZH	421
8CYT	610	8AIZ	420
9BRK	608	9ATN	419
9DWN	608	3AJG	419
8BXA	605	8BOZ	417
9ASF	671	9CMN	417
2AGB	567	8CF	415
5SK	550	8ANB	409
5XADA	540	3BRF	408
8QK	538	4EB	406
1MY	536	8BJV	404
3BLF	532	1YK	404
9BZZ	526	8FT	404
9BYX	524	3AAO	401
		1BYN	400

(\* ) Spark

9EHW, 42; 9ANF, 100; 9AEC, 96; 9DTU, 21; 9DQE, 20; 9BDU, 151; 9AYS, 48; 9AHV, 339; 9AVC, 523; 9BXT, 729; 9BWM, 116; 9BYO, 150; 9CKL, 223; 9DPE, 185. SPARK: Missouri: 9EFC, 205; 9AOJ, 138; 9BMN, 363; 9AUK, 31; 9DNY, 226; 9AWT, 9; 9BCJ, 45; 9BZH, 33; 9DAE, 567; 9CXM, 5; 9RR, 84. Iowa: 9BXT, 175; 9BRS, 42; 9BEL, 17; 9CS, 12. Kansas: 9DUG, 36; 9ATA, 30; 9BHL, 32. Nebraska: 9DNC, 94; 9APN, 21.

NEW ENGLAND DIVISION—C.W.: 1CPI, 273; 1FY, 168; 1JV, 326; 1TL, 107; 1CJH, 33; 1AIQ, 29; 1ARY, 52; 1BHM, 14; 1CPO, 149; 1ATJ, 27;

NORTHWESTERN DIVISION—C.W.: 7ABB, 454; 7CF, 379; 7ZN, 357; 7ZF, 324; 7WM, 319; 7TQ, 307; 7PE, 304; 7ZU, 221; 7MX, 210; 7LN, 164; 7AGK, 150; 7JG, 145; 7ADP, 128; 7LR, 112; 7DU, 110; 7JS, 102; 7HS, 80; 7DC, 80; 7ZL, 79; 7AIF, 77; 7KS, 62; 7ACZ, 62; 7VE, 60; 7BA, 58; 7EQ, 54; 7OE, 53; 7AM, 52; 7OO, 30; 7AGL, 23; 7AFH, 27; 7AFN, 26; 7ADR, 24; 7SF, 19; 7OZ, 18; 7ADQ, 17; 7IO, 14; 7CG, 14; 7AK, 14; 7GE, 14; 7IY, 12; 7NG, 11; 7AHL, 6; 7ER, 48; 7QW, 39; 7WX, 114. SPARK: 7AIO, 50; 7WD, 25.

PACIFIC DIVISION—C.W.: California: 6ZH, 421; 6EC, 219; 6AHU, 46; 6AAG, 40; 6BOB, 38; 6AQP, 24; 6AHP, 20; 6ALK, 18; 6IV, 16; 6BWP, 11; 6BK, 5; 6BJY, 5; 6ASN, 20; 6JN, 160; 6HP, 58; 6BFL, 128; 6AOR, 27; 6ACM, 217; 6BPL, 75; 6LV, 311; 6BRU, 82; 6TU, 29; 6LU, 100; 6QM, 20; 6CC, 222; 6ABK, 46; 6TC, 20; 6BUA, 100; 6AME, 5; 6AWT, 95; 6PH, 158; 6AOL, 223; 6BIQ, 135. Nevada: 6BIP, 77; 6ZO, 16; 6SPARK: California: 6BJU, 6; 6ASN, 28; 6AQU, 53; 6AOR, 207; 6TU, 23. Nevada: 6RR, 19.

ROANOKE DIVISION—C.W.: 3BMN, 1386; 3APR, 855; 3BLF, 532; 3AJG, 419; 3GA, 330; 3CEL, 327; 3TT, 305; 3BUV, 303; 3ATS, 180; 3IW, 155; 3XAL-3BJ, 143; 3MO, 137; 3ASP, 75; 3ALB, 56; 3ZZ, 48; 3CBZ, 44; 3BHL, 37; 3ACV, 35; 3SK, 26; 3AOT, 21; 3BZ, 21; 3HU, 13; 3BY, 11; 3ZAA, 6; 3SG, 3; 3AOW, 1; 4IU, 232; 4FA, 117; 4MV, 40; 4NV, 17; 4BX, 100; 4FT, 300; 4EP, 68; 4MF, 36; 4OI, 104; 4AUV, 275; 4AUB, 312; 4BQG, 21; 4AMD, 40; 4BPU, 86; 4SP, 112; 4BDA, 92. SPARK: 4BDA, 235; 4TH, 114.

ROCKY MOUNTAIN DIVISION—C.W.: Utah: 6BUH, 3; 6CBU, 55; 6ZA, 10; 6TZ, 75; 6ZV, 26; 6ZO, 34; 6AFW, 136; 6DB, 38; 6ZO, 60; 6CJ, radio; 9BJL, 371; 9CAA, 331; 9BXM, 320; 9BUN, 308; 9AYU, 290; 9DTM, 270; 9AM, 178; 9AJU, 175; 9CJY, 161; 9EEA, 140; 9DTE, 101; 9BTO, 9BXA, 12. SPARK: Utah: 6BUH, 41; 6APL, 436; 6BKE, 33.

WEST GULF DIVISION—C.W.: New Mexico: 5ZA, 247; 5ADO, 76. Oklahoma: 5ZM, 39; 5KE, 80; 5ZAV, 250; 5AJB, 9; 5DN, 25; 5GA, 110; 5SG, 26; 5BM, 101; 5SR, 75; 5GJ, 32; 5VM, 65; 5AAH, 75. Texas: 5AHC, 20; 5AL, 20; 5AQ, 134; 5KK, 306; 5DL, 156; 5QI, 82; 5MN, 24; 5BE, 387; 5SK, 559; 5AHT, 205; 5FX, 176; 5FA, 67; 5ADY, 12; 5FG, 24; 5LL, 329; 5UN, 12; 5FO, 10; 5CY, 60; 5ZADA, 65; 5OK, 322; 5XAJ, 506; 5NS, 45; 5ZH, 161; 5JL, 114; 5NN, 161; 5ZX, 6; 5NK, 218; 5KADA, 389; 5VY, 102; 5KB, 261; 5XV, 172; 5OC, 3; 5KP, 1119; 5TM, 489; 5GR, 22; 5JT, 71; 5RN, 148; 5PD, 108; 5TK, 108; 5SS, 105; 5ZAE, 155; 5MT, 133; 5ZAK, 194; 5VO, 153; 5JF, 2; 5ADI, 1; 5DE, 9; 5JZ, 101; 5ADB, 207. SPARK: 5AJT, 115; 5KT, 102; 5KX, 28; 5KA, 75.

DAKOTA DIVISION—C.W.: Minnesota: 9BAF,





32. Western New York; 8AAW, 40; 8BM, 52; 8AKD, 360; 8CHY, 30; 8TC, 101; 8BUM, 106. Pennsylvania; 8BIP, 21; 8CI, 60; 8EW, 136. District of Columbia; 8ASO, 10. Pennsylvania; FONE; 8MB, 48.

ATLANTIC DIVISION  
C. H. Stewart, Mgr.

SUMMARY OF TRAFFIC BY STATES

State	C.W. Msgs.	Spk. Msgs.	Total Msgs.
Northern New Jersey	7859	746	8605
Southern New Jersey	464	49	513
Eastern New York	3411	53	3464
Western New York	5849	679	6528

Traffic is moving without delay throughout the northern section. Good reports were received from all districts. A slight increase in traffic figures was due to warmer weather and the immediate cessation of QSL card messages, etc. The northern section is making an effort to discontinue all unnecessary messages.

Appointing of O.R.S.'s throughout this section continues, and by next fall the northern section of the Atlantic Division will have the most complete traffic organization of any division in the country—providing such fellows as are now in charge can continue with the necessary duties.

**SOUTHERN SECTION:** Some difficulty is experienced in working Baltimore out of Wilmington. Daylight operation between these points is satisfactory, but during the evenings it is impossible to do any real work.

8BBS is pushing stuff through direct to the Canal Zone and deserves credit. 8AFB has had a little trouble or no time to work his set due to school work. 8BLV will be converted from spark to C.W.

Wadsworth of the District of Columbia reports that the number of stations reporting are fewer, but very good work has been done. 8HS takes the lead with 902 messages. "Thanks for the card" messages are dropping off rapidly and they are lining up for real business relaying. 8BWT was in on 100-meter test and was reported on the west coast. QRN is setting in but the regulars expect to stick through it all summer. The total for the D. of C. is 2014 messages which is the highest yet attained.

Mr. Deichmann makes a short report, and owing to sickness and the convention, little has been done in his office. However, the message report for Maryland seems to ride higher than usual, even though the convention kept the gang quite busy. Considering the advent of QRN, Baltimore stations are doing commendable work. 8TE has been breaking the local records by reaching Spokane, Washington on 20 watts. 8MF is doing excellent work on 10 watts, as is 8BCK. 8XX, a new experimental station operated by Wm. E. Lehr, has recently installed 20 watts, temporarily.

The total for Maryland is 1402 messages. The total for eastern Pennsylvania district being 7896, and the western Pennsylvania district being 7398, makes a total of 15294—the grand total for the southern section being 18779.

**EASTERN PENNSYLVANIA:** Dist. No. 1. A marked increase in traffic was shown throughout the entire district with new stations reporting, 8HH breaks out with an initial report of 415, and 8AEN with 169. 8GC, 8AWH, 8AKR, 8ZM, 8ZS, 8BLU, and 8BTL helped to turn in a good total for this district.

Dist. No. 2. Message traffic has taken a tremendous drop since December, each month shows a decrease in totals. Tube trouble has been reported as the main cause. 8JG will assume the duty of city manager of Bethlehem.

Dist. No. 3. 8ATA blew a few 5-watters but since the installation of a new rectifier does better DX work. Glad to hear 8BIQ is much better.

Dist. No. 4. 8ZO continues to bat out a high average. He has taken a schedule with 8JJ and 8ZZ. 8AUV is having hard luck with tubes, only blew 3 last month, the two 5-watters left are working 1500 miles. 8MB handled 48 of his total via radiophone. New tubes at 8LP are giving better service. 8BJ is record man. 8BDI turns in an initial report.

Dist. No. 5. 8CCU is back on the air pushing things through between 4:30 and 6:15 A.M. 8BRF is one of the big leaguers. 8AAO is coming on with a new transmitter. 8AAY is establishing a schedule with 8CU and 8AWT. 8BGG was heard in Hawaii by 8ZY on 5 watts. (The 5 watts has been verified by local stations.)

Dist. No. 6. D.S. reports activities very much "dead and buried" and claims malicious QRM from B.C.L. using Ford spark coil when he opens up after quiet hours. The D.S. caught the B.C.L. in the act of using the coil and not a licensed station. (Why not have him arrested—D.M.)

**PHILADELPHIA:** Dist. No. 1. 8KD and 8BUT are the only stations on the job.

Dist. No. 3. Many stations have improved their C.W. sets, and increased traffic was the result.

Dist. No. 4. But few stations reported. 8HD is breaking in C.W. operator.

Dist. No. 5. There are still a great number of those foolish messages such as have been referred to during the past few months in these columns. However, the different operators are beginning to cut out the "QSL card messages" and get right down to real business. All stations in the district are making an earnest effort to QSR all messages as nearly direct as possible. In the past there has been a tendency to pass messages around in circles without any definite routing and since this is not at all real amateur relay, the ninth Pennsylvania is setting a precedent by handling all messages as nearly perfect as possible. All stations are reporting the number of messages that are relayed direct to the point of destination. The D.S. has also suggested to the different station operators that they secure messages from city officials and other well-known men of the community addressed to officials in other sections of the country. Messages of this nature would be more or less official and would really mean something if delivered promptly and directly. In order to assure prompt and direct delivery, each station is supposed to keep a check on the routing and delivery of messages by means of a service message to the first relay point.

8AGO handling 316 messages was one of the best stations in Pittsburgh this month. This station, although not reported in the first reports of the Transatlantic Tests, has received word from Sologe, France stating that 8AGO has been received five different times very QSA on detector and 1-stage audio no radio frequency. 8CKO is now using 20-watts C.W., while the 100-watt transmitter is being rebuilt. Considerable trouble is being experienced on account of QRM from the arc light lines. 8PX has turned in his first traffic report with 10 messages and remarks that as soon as a new antenna system is completed he will be able to report regularly with greater traffic. 8AAF takes the record this month for most messages handled and he certainly deserves it. 8LH reports that his antenna rope parted during a recent storm and on this account, his traffic report is low. 8CJY is still helping along with the rest of the Pittsburgh group. 8ASB is on the air strong again. 8SF has not been very active lately on account of moving to a new location. 8RP is still handling messages for 8AGY. The operator has considerable school work and can only operate three nights per week. 8AGY will be on the air again soon with a new C.W. set. 8ALF has succeeded in working 6XAD consistently and during the last period was able to maintain communication for 30 minutes without fading. DX has been reported more regularly during the last 30 days than at any other time. 8CEJ, with a report of 641, says that QRN is so bad that it has been almost impossible to do good DX work during the last few weeks. 8BRM says that he tried hard to hit the 300 mark but just couldn't do it this time. Crichton also reports that he is just about sick of handling "Thanks for card" messages and hopes that some real official messages will start coming through soon. 8FM reports traffic moving smoothly with no changes in apparatus or any happenings of great importance. 8CQX has a good report this month with 821 messages, but also reports that his station will be out of the running for the next two months on account of thorough overhauling. 8DGE has reported no traffic this month, the station being under construction. 8CEI, with

718 messages, has set a new record for his own station. 4HRL reports that the C.W. was the only set used during last month. 2BUT reports no change in station but has handled 231 messages. 8CLK is still out of commission on account of burnt out tubes. SAIG reports no happenings out of the ordinary. 8VN has both masts back up again, and the Landon brothers are at it strong with three 5-watters. 8BDU handled 165. Special tests are being run every Sunday from 8 to 9 A.M. and from 1 to 2:30 P.M. at a wave length of 150 to 160 meters. 8GVX handled 48 during the past period. 8EW, who is one of the last of the spark operators, is ready for C.W. The antenna fell down Friday the 13th; this has started reconstruction of 8EW. 8CI has been working 1/2 K.W. spark but has decided that one 50-watter will do much better work, so here's another spark set that will go to the scrap pile. 8UT is another new station reporting for the first time. 8CFB reports that his station is entirely dismantled. 8VQ has been operated by only one operator for the past 30 days, but has handled 277 messages. 8OW, his chief experimental station for the 9th Penna., has improved 100% in message traffic handling with a report of 10. The Connelville section is still holding up its reputation with 8ALT and 8BJV. At 8BJV two sets are being used, 20-watts straight C.W. and 50-watts A.C.C.W. Best results so far have been reported using the 20-watt set. Stations 8WR and 8BGV have been off the air on account of extensive work. 8ZD is taking a little time off to reconstruct a complete station, since having made a record last month. In the past it has been almost impossible to do any experimenting at all with the equipment in the small shack; so now a real station is being laid out where plenty of room will be had for trying out different kinds of circuits and equipment.

During the Third District Convention at Baltimore, the 9th Penna. District was well represented by 8BJV, 8WR, 8SE, 8ALT and the two operators from 8XD.

Dist. No. 11. The only report received for the month was from 8AXD. 8CON has been out of operation for the past month and it will be thirty days more before his station will be ready for traffic. Several B.C.L.'s in Warren, Pa. are learning the code and rapidly becoming real amateurs. They promise to be on the air soon with regular relay equipment and this will help out the district wonderfully. 8BLT is installing a 50-watt C.W. set.

Of 300 messages handled at 8AIO, 231 were of the "rubber stamp" type and 69 of more importance. No more "rubber stamp" messages will be accepted, only those having an important text will be QSL'd for and QSR'd. (F.B., OM, like to hear you talk that way—T.M.)

#### CENTRAL DIVISION R. H. G. Mathews, Mgr.

Contrary to expectations, traffic in the Central Division has held up through April, the total being approximately the same as last month. For the first time Ohio does not lead the division in traffic, but has been passed by Illinois. It will be interesting to watch the battle next month.

NORTHERN INDIANA: Dist. No. 1. 9DFB is doing good work. He is using 150 watts and doing most work in the afternoons and on Sundays. 9CBA has installed a new 100-watt set and is doing exceptionally good work. 9EHI is working consistently. 9AVO will be on again with I.C.W. within a short time.

Dist. No. 2. At South Bend the active stations are 9CUE, 9FP, 9AFP, and 9AKD. 9RBI will be off the air until he can put in 50 watts. 9FP says the same and is going to put in 100 watts. 9BOP had a little trouble on Friday the thirteenth and consequently is putting up a new pole. 9CP is "rarin' to go; he is all set with a new generator and two good 50-watters.

Muncie Radio Association: 9AZE like the rest has given up the spark and gone for C.W.—10 watts A.C., which has been reported in Los Angeles. 9BEC, down, likewise his aerial for the summer. Will be on next winter with 50-watts C.W. and fone. 9BAK also lost his aerial recently.

SOUTHERN INDIANA: With QRM coming on, activity seems to be on the increase instead of decrease.

Dist. No. 3. D. S. Butler was on about half of the month, but has generator trouble now. 9ARR and 9PIS are both doing good work. 9BRK is still high man by a big margin.

Dist. No. 4. Dudley Andrews, 9AED, has been appointed C.M. of Indianapolis. Indianapolis is coming to the front, over 600 messages being reported through there this month. 9BJR, 9UR, 9BGW, 9BVZ, and 9EAD handled the bulk of traffic. 9YJ is doing a fine lot of daylight work on the 10-watt set. 9YJ is starting a move toward handling a better class of messages. 9AQJ is the only active station at Terre Haute.

Dist. No. 5. C.M. Druly of Richmond has things coming along OK there. 9APM handled the bulk of messages in this district. 9AMO burned out some tubes so is a little behind with his total. 9EJT, 9EJU, 9DDA, are all new comers, stepping out on C.W. 9BJY and 9DDA were reported in Seattle on 20 watts. 9CBA works them all with his 100 watts. 9CTB is doing good work on 5 watts. 9DCB will soon be on with 50 watts. 9BQR HOT DOG! 3 amps. on one V.T. 2!

LaFayette: We are observing 7 to 10:30 quiet hours; most of our stations do not interfere at other hours. We have had a couple of new stations springing up; viz., 9AYD and 9DLE, and they certainly have been responsible for much QRM in the start. Have 9AYD straightened out with Kenotron rectifier and filter. Am trying to teach the listeners that there are other kinds of sets besides the single circuit.

WISCONSIN: The entire state is running along smoothly in traffic activities and seems well organized for summer work, with the exception of district No. 5. The A.D.M. regrets exceedingly that it was necessary for him to accept the resignation of E. J. Krusel as superintendent of that district due to his moving from Superior. The new superintendent has not yet been appointed and things have not been running as they should have been this last month. The B.C.L.'s seem to have the Superior gang buffaloed. E. C. Mass, together with the men in his district, No. 2., certainly deserve a lot of credit for the amount of traffic they are handling. They turned in a total of 1365 messages this month with 9AZA leading them with 489 to his credit. He is again the winner of the Wisconsin Cup by a majority of 162 over his nearest competitor, 9ATO of district No. 1, who had 327. Another "300" Brass Pounder was 9CHK of district No. 2 with 305 messages.

Dist. No. 1. Milwaukee is holding its own very nicely.

Dist. No. 2. Mr. Mass's report was so lengthy and complete that the A.D.M. is going to condense it and give the calls of the boys who are doing the real work in this district: namely, 9AZA, 9CHK, 9EEY, 9CWP, 9EGW, 9EAR, 9EGH, 9XM, and 9CCF. Madison has now four good stations, and all traffic dispatched in that direction will be ably taken care of.

Dist. No. 3. The superintendent has his district well in hand, and he states that heavy traffic reports are continuing to come in regardless of QRM and many bad DX nights. Outside of Sheboygan, the B.C.L.'s are good sports and accept the 50/60 principle of the gang. 9CZY is still putting 'em over in great style with the same 5-watt bottle he started with.

Dist. No. 4. Traffic in this district fell a little this past month, but the A.D.M. thinks it is mostly due to cutting down the "TNX fr crd" msg's, not being handled in this district anymore. The new stations in this district are 9EIL, 9BLF, and 9DFA. 9ZY, 9CWR, and 9LN are combining equipment and putting it under one roof which will be a 20'x20' cottage built on the State Normal School Grounds. The cottage is practically finished at this writing, and when completed its equipment will consist of one 500-watt master oscillator transmitter, one 200-watt, and one 35-watt. Two one hundred-foot windmill towers are being erected. The station will be put in active service sometime in July or August if all goes well.

KENTUCKY: Burnt out tubes and new install-

ations kept some of our total boosters from performing; viz.: 9AWF, 9AMH, 9APS, QRN also helped lower our total—watts from 90X, 9CON, a newcomer, reports handling 91 on a single 5-watt. 9YC will be out shortly on a new 100-watt set. 9APS has sold his 100-watt and has a new 250-watt ether wrecker on the way. 9AAS is still at work on his speedster, hence his 250 does not perk very often. Something is wrong with 9ASE's total. (How cum OM, so small?)

ILLINOIS: Dist. No. 1. The D.S. is consistently increasing his force of O.R.S. and from the impressive message total this month, it seems that his efforts are bearing fruit. 9EJ was reported on both coasts during the low wave tests recently.

Dist. No. 2. 9APB, home for Easter vacation, handled messages on quench as also 9CFL on with 5-watts D.C.C.W. and fone. 9DXL mourns a 5 but keeps some extras so the traffic keeps on. 9BJT sold his flivver and is tinkering with a 250-watt outfit. 9CCN is doing most of the work for Lockport and Joliet. 9FW was on but he failed to report. 9BTA is on a vacation in Chi. (How can anyone have a vacation in Chicago—D.S.) 9UU says "Too much QRM" but hands in a fair total. 9EIM blew a 5-watt at the end of the month so his total is for 15 days. 9SA; home for Easter and sounded fine to hear the old boy again. 9DYN expects to be making hay while the sun shines but can't rig up a windmill to drive the generator. The old spark at 9ARM still booms at noon and evenings and turns in a good report. The kind neighbors who stored their A batts. with 9DDY are beginning to call for them so 9DDY is off the air 'til he gets power for the dynamotor. 9EBN sez he has been blowing his brains out on a saxophone so the report is slim. 9GI is expecting a new generator to augment his message total. 9CTF leads the district this month with 800 via C.W.—all on a 10-watt set. 9AHQ had trouble with the power company using his rock crusher so is back on C.W. 9CXH is keeping a 5-watt hot. 9BRX has been recommended for an O.R.S. appointment. 9CA is working and does not get much time to punch the key. He has been heard in every district and 5 Provinces of Canada. The trial has not come off yet so 9CA continues to broadcast bedtime stories for the BCL at 10:30 every night.

Dist. No. 3. HEN'S district with 17 O.R.S. turns in a 365 message per station report. Looks as if the 300 mark is too easily obtained and they want to raise the ante. 9MC leads with 1016 but will be off the air rebuilding the 100-watt set. 9BYX almost choked to death when one of his 5-watters rolled off the table and the other burned out. He gets out on an amplifier now. 9AWO tried for three days to be sure his burned out 5 watt had gone west; could not sleep; finally sold his (?) pet chickens and is now back on the ether. 9CMN says the BCL's are cutting down aeralis, but he works all districts but the sixth and seventh on a 5-watt. 9DPV says practice makes perfect. He has blown 6 of the small bottles this year. 9CDU is changing from 15 watts to 100. If he gets out with that the way he did on 15, lookout for 9DCU. 9CMC with a 5 watt tube does 860 miles regularly. 9CLZ is figuring on 20 watts but has QRM from school, 9BYX, baseball, and finances. 9EAC sez 300 or bust next month. 9CKP is doing his darndest to put his burg on the map. 9EFQ turns in the best report ever received from Taylorville. 9CXT is intent on putting Lincoln on the radio map. 9CIE had trouble with BCL's and had to take his set down. 9TV has installed C.W. and turns in his first report. 9CTK is held back on account of BCL's, QRM, and the landlord.

Dist. No. 4. All stations working except 9UK. A route has been formed taking traffic for the south from district No. 2, to 9DCR, 9DQU, 9EFW, and 9CZL. A branch off at 9DQU-9DWF to district No. 3, takes care of St. Louis and southwest bound traffic. It is working F.B. too. 9DQU installed 100 watts to replace the 20. 9BIL handled 234 in one day but failed to hold the pace. 9BHX is rebuilding. 9BIT lost his antenna but hustled out and put a new one up which works better. 9CZL achieved his 300 goal. 9EFW does all his

work in the day time and gets out on a fever. 9BXD has spark QRM and work to hold him down.

Dist. No. 5. 9DG reports a peculiar type of interference resembling a heavy spark discharge effecting the territory east of him for miles but not audible at 20 miles west. 9BLO sold his 15-watt set but plans to be on by June with a 100-watt whistle. 9DLE is beating his own records with a 5-watt. 9DBN is back on the air for the first time since the war; 9BDA is getting started and has hopes. 9CED is another fever who works DX; reports from Canal Zone being the latest.

Dist. No. 6. Traffic routes to Chicago are being formed. 9AQD is in the Rockford gang now.

OHIO: Ohio has fallen off somewhat this month in number of messages handled. This is due to two things; a number of aeralis were destroyed by high winds, and power tubes have been expiring for a lot of stations. Some of our best stations were prevented from working nearly all month because of demolished aeralis. 8GZ was operating only 5 days this month. A wind storm took both masts. He is in the air again with two new masts. 8IJ is again Ohio's star station.

Dist. No. 1. 8BIU handled all his messages on 5-watt tubes during daylight hours. 8AZA is aching to get into the air with his new 50-watt tubes. 8BZQ is changing to 10 watts self rectified C.W. 8QK is temporarily out of the air while his station is being moved to another location. 8AA has not yet succeeded in erecting his transmitting aerial which was leveled in a storm.

Dist. No. 2. 8BMF is putting in 50-watts A.C. C.W., 10-watts C.W. and 10-watts phone. 9BPB operates a 5-watt when college work does not QRM too much. 8BZD burned out two 5-watt tubes but worked 6CBZ, 6CGW, and 6ZH on 10-watts. 8BHY handles his traffic on a U.V. 201, and does fine work with it. 8BXX uses 5 watts in daytime and 50 at night. Traffic is often handled with the west coast. He worked 7ABB with one 5-watt radiotron.

Dist. No. 3. 8BWA has had his trouble by having two aeralis smashed within three weeks. 8TT is having fine success in converting the BCL and Boy Scouts into regular hams. He has another new station going, call 8DCN, and has four others ready for their examinations. 8PD, 8BVR, and 8CYU furnish the sad news of the death of three 50-watters each. 8AWX has come back into the amateur world from "Broadcastom." He is trying to stir the Niles, Warren, and Youngstown bunch into action again. Cleveland is coming to the front more and more under the management of Mr. Domizi.

Dist. No. 4. 8UC was so disgusted when his 50-watt tube expired that he is putting in 500-watts. 8EB is raising his antenna which puts him out of the air for a little while. 8DAG is increasing his traffic every month.

Dist. No. 5. Heavy clouds causing the loss of several aeralis has cut down the report somewhat for this district. 8BYN, 8UR, and 8CPW go better than 400 each. 8BEK mentions that he worked 6BLB, GEO, and 6ZZ with one 5-watt tube. 8BKO has been working 9DYN with 5 watts on an indoor aerial.

Dist. No. 6. 8ABE, 8BKN, 8CXW, and 8CRC are the only stations that report regularly. All these are doing their bit in helping line up the districts and get the operators newly interested. 8ABE has not been on the air this month due to loss of aerial. He is also changing from A.C.C.W. to a motor generator set. 8CRC has a good start in putting Canton on the map.

(The following is a special report received from K. A. Duerk, 8ZY, former D.S. of district No. 1. Duerk has moved to Los Angeles and we hope to hear from him soon with a good 6th district station—D.M.) 8BZQ of Van Wert advises that there are now four good stations in Van Wert, in addition to 8CIE a spark coil station, which does good work. 8CQS and 8CAI are new stations with 50 watts each. 8MQ is a fair spark station. 8BZQ is a 5 watt C.W. with DX of 32 states and heard on the west coast.

The D.S. turned over his regular amateur station license, call 8PU, to ex-8BVX of Holgate. 8AA keeps Lima on the radio map with some very fine

work out of several five-watt tubes, consistently working good DX.

8FU, the Allen station, of Defiance (former 8BEP on spark) now have two large C.W. sets in operation. One set consists of two 50-watt tubes on 1400 volts D.C. The other set is two 250-watt-tubes on 2000 volts D.C. motor generator plate supply on both sets. They have been consistently heard on the Pacific coast, and reported from 6ZY in Hawaii and have worked 6ZZ and 7ZV.

MICHIGAN: Dist. No. 1. SCBA is a new man but coming along quite well and getting out F.B. He will be ready for traffic work in a few months. SAHO, the other Flint station, is doing good work and is likewise a new one; a good station and a good operator, he is reliable and will take much traffic. It is now possible for 8AND and SAHO to work tricks and handle traffic in and out of Flint. Another new station is 8BDO.

Sorry to report the closing of 8CF. He has done the best work so far. He claims to be going to Greenville, Ohio; however, may turn his equipment over to another Ann Arbor station. 8CF has always helped in every way possible and is truly a loss to the district. It is through him (Chas. H. Katzenberger) that Ann Arbor has done so much and with the aid of 8BXA have turned in the highest reports to date.

Dist. No. 4. 9DRR is working New England most every night now and Brainerd, Minn. in daylight. 9OL is on schedule from 10 P.M. to 12 P.M. every night. 9BOH has installed a new counter-poise ground and is putting in a new filter circuit. 9AMQ is started and when Jelk starts he's lively. His 10-watt C.W. is developing a strong kick. 9CE came through with a big report although his station was closed from March 6th to 28th. 9CWI was off most of the month installing a new antenna and ground system. A 60-foot pipe was raised with some excitement when one of the joints broke when the pole was nearly up. It's up for good; so next month ought to sound good from 9CWI. 9CGE sez "I'll break through or bust!" and has installed a 1 k.w. spark in place of his half k.w.

#### DAKOTA DIVISION N. H. Jensen, Mgr.

More than 12,000 messages handled this month fellows! Doesn't it make you feel good to see the old division club the way it has been the past few months? In looking over the reports it is noted that the increase in total messages is due to the greater amount of traffic handled by each station, and not due to a greater number of stations reporting. 9DSW gets the derby this time with 783 messages.

MINNESOTA: Dist. No. 1. The traffic honors go to 9BAF. 9BAV burned out two of his three 5-watt tubes, but with the remaining 5-watt-tube he managed to handle more traffic than ever. 9ZC has been out of commission part of the month due to his aerial blowing down. 9CDV was home for Easter and did a little relay work. 9CMJ has been moving and has not been on much for that reason. 9ABB with 50 watts did all his relay work in the daytime. 9BAU has finally ditched the spark and put in 10-watts C.W. As a result, the daylight route between Duluth and Chisholm has finally been put into operation. In Eveleth, 9EGF, appears to have handled all the traffic. 9DCG has been out of commission on account of burning out his tube. 9CZR, another new station, is the first to spring up at Hibbing. C.M. Hayes of Duluth reports that stations in that city handled more than 600 messages. 9ADF has been on the sick list. 9DUQ swung a snappy fist to the tune of over 300 messages.

Dist. No. 2. Superintendent Skifter has reason to feel proud of his district. With an organization such as the S.M.R.A., some wonderful progress can be made. The association paper, the "Southern Minnesotan," published at Luverne by a peppy bunch of hams, is a real help toward the organization and this month contains 14 pages of real live news. (Congrats N.R.—D.M.) 9DSW leads the entire division with 783 messages. 9BKP is doing very good work, having two operators—one in the daytime and one at night. 9AJV is coming to the front. 9QF continues to reach both coasts.

He has been reported in Panama, Alaska, and Porto Rico. Also by two ships at sea.

Dist. No. 3. This is the new district made up of Hennepin and Ramsey counties, with 9APW as Superintendent. 9ASK is off the air until next fall. He has sold his set to 9BPY who is attending school and who will be on the air in St. Paul in June. 9CIP has invested in a synchronous rec-

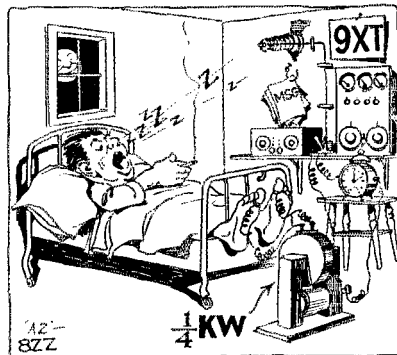

*The night-op at 9XT needs a 1/4 KW Lizzie to put him on the job on time! Hi Hi!*

tifier. 9BKJ with 10 watts heads the traffic list in St. Paul. In Minneapolis, 21 stations reported this month as against 17 last month. 9BTT with 50 watts has worked 7DH and 8ZA and to the Atlantic Coast in daytime. 9BTL with 10 watts outclasses many other local stations using much higher power. He has handled traffic with 3 Canadian and all American districts. 9ZT, 9DAW, and 9OY are all doing good work. The Minneapolis gang welcome 9EBG, 9CXP, 9CMM, and 9AMF as new traffic stations reporting this month.

NORTH DAKOTA: A.D.M. Bert Wick reports business on the increase in his state. 9AHC has been busting the ether with a 5-watt and knocked down a total of 350 messages. He works all directions and all stations within 500 miles. Practically all of his work is in the daytime. 9ABU has been experimenting in rebuilding his transmitter and sends in a good report. Fargo now has four stations on the air and all of them are doing good work. Traffic is moving in fine shape through Aneta. 9DLF and 9DLI are on the job regularly.

A.D.M. Bert Wick has been keeping the North Dakota hams posted on what is going on in the amateur line the past six months by sending out a "sheet" each month in the form of a letter under the name of the "North Dakota Bottle." This was sent to all amateurs and proved of great value. Recently Mr. Wick was elected assistant editor of "Kick Backs," the official division paper. The publishing of the "Bottle" will be discontinued, now. All state news will appear in "Kick Backs" in the future. Rumors which have not been denied are to the effect that this efficient A.D.M. will take unto himself a YL for keeps next June. (Here's congrats., OM.)

SOUTH DAKOTA: Dist. No. 1. 9CXV keeps the traffic moving through Yankton and reports that 9ALN will be going soon with 100 watts. 9DKQ continues to do good work at Sioux Falls, and 9BDH turns in a good report of both spark and C.W. Apparently the old spark set is about to be ditched. 9BOF sticks to the spark with good results.

Dist. No. 2. This has been the best month for South Dakota in its A.R.R.L. history and 9DWN deserves a lot of credit for the competition he offered. This station uses from 5 to 15 watts depending on how many tubes went west the night before. 9ASF has been stepping out with 5 watts, working both coasts. He now has 50 watts and if his results are in proportion to the 5 watts, the Chinese will have to quit wearing galena ear-rings. 9CGA and 9AVZ continue to do good work. 9BRI

is getting good results from one 50 and two 5-watt tubes in parallel. The new superintendent in South Dakota are: 9BOF for dist. No. 1, and 9BRI for Dist. No. 2.

### EAST GULF DIVISION

B. W. Cochran, Mgr.

We report the appointment of C. F. Clark, Jacksonville, Fla. as assistant division manager for Florida, and G. W. Etheredge, Woodruff, S. C. as assistant division manager for South Carolina.

GEORGIA: QRN has been more continuous and heavy during this April than any ever experienced with the consequent falling off in traffic.

Atlanta: As usual, the largest part of the traffic in the state is handled by Atlanta with 4HS leading and followed closely by 4YA, 4DG, 4CY and 4LE. 4DC is handling traffic like a veteran. 4KU expects to remodel his lead-in and with 100 watts should be fixed for summer work. 4DF is using both spark and C.W. but most of his work this month was on C.W. 4JL, 4EQ, and 4MB turn in nice message reports. 4BG reports trouble with his tubes. We are losing 4FJ and 4CG, two good stations who have sold their sets. 4HW has also quit the game. (Not for long we hope.) 4BG shot several tubes but decided that a 50-wattner run below rating would probably be safe and he is now on regularly. Several are trying out their fones handling traffic with fair results. 4BI, 4EH, and 4ME have had some measure of success in this line. 4DN and 4GM are heard regularly on their low power sets. 4NA is a new comer but is doing some good work. Through the efforts of the Atlanta Radio Club a quiet period is strictly maintained in the city so that harmony prevails with the BCL's.

Athens: The premier traffic shooter of the division this month is 4FB, who made an enviable record with his rock chusher, but suddenly switched to C.W. 10 watts, and immediately commenced to break records in traffic handling for this territory. 4FG has had tube trouble and has decided that summer work needs straight C.W. so is getting a M.C. Another fone artist is 4AG who has succeeded in filtering rectified A.C. into a good imitation of real D.C. 4GP opened up this month and put a few through.

Rome: Due to changes which proved disastrous, 4BQ was off the air for a time with eleven amperes that 500-watt set is QSA most anywhere. We now have a sure fire route from BHL in Chattanooga into Atlanta by way of 4BQ, 4DB, 4AI, and 4HA are new stations that are reaching out nicely. 4IV has been doing some phenomenal work on one 5-wattner and has worked Canada and every district but the seventh with a DX record of 2500 miles overland. 4GN and 4ED, both excellent stations, who for years have served as relay points for Florida traffic are practically being forced from the game. With the quiet period extending until 10:00 P.M. and their power being shut off a little later they have no chance to work. 4MJ, 4DT, and 4JD are heard occasionally. 4OD is reaching out in great style and is handling some traffic. 4BK and 4BW have handled some work and should serve as a good link from Atlanta to Savannah. Savannah: 4BY reports his aerial down and he is using a temporary one with but fair success. 4EL handled practically all the Savannah work. 4GE is closed; he is now a ship operator.

FLORIDA: Summer static is here full blast, but our message report is the largest we have ever turned in due to the large number of stations reporting. 4FS is doing consistent work through the QRN and believes he can keep it up all summer. 4HZ is back again on C.W. after a period of absence due to set trouble. 4MT and 4CI at St. Augustine are doing good work.

Dist. No. 2. This district is leading the state. Superintendent Hall is getting his men lined up for traffic handling, with good results. 4XK and 4JZ, both with 100 watts handle the bulk of the traffic, with 4AR and 4IZ close at their heels. 4JZ has been copied in Belgium. 4IZ is changing from 10 to 50 watts. 4AQ, 4OB, 4JY, 4OZ, 4IW, 4LH, 4PF, and 4NU are all doing good work on C.W. 4MZ, 4BL and 4JU handle traffic with Florida stations on spark. 4GA, Orlando, although blind,

is a real Ham and is pounding mean brass, but is handicapped in handling messages.

Dist. No. 3. 4BC is consistent on spark and continues to be the only dependable station in the district. 4DL steps out fine with 100 watts, but has turned his station into a B.C. station and does but little traffic handling.

Dist. No. 4. 4DP has been appointed C.M. of Miami. He has a 100-wattner about completed and should do the trick nicely. 4IC, 4AT, and 4XP, all on C.W., are reaching out.

ALABAMA: A great deal of interest is being taken by the men of this state with the result that they have moved a lot of traffic and more stations are reporting than ever before. (Keep up the good work—D.M.)

Dist. No. 1. 5ZAS sold their set to 5AGJ who has been doing excellent work with it, and he has handled the largest part of the Birmingham traffic. 5MI, ex-5ZAS, has about completed a 50-watt set and will soon be on the air again. We have lost 5ADE; he having moved to a town without power. 5UP is using both spark and C.W. 5CP is on the air regularly and has a good range with his 10-wattner. 5ADS and 5FU are reaching out nicely and handling traffic. At Anniston, 5VV is handling most of the work but 5WB and 5BP are heard now and then.

Dist. No. 2. The only active station is 5ABT who has done quite a lot of work this month. 5ES has quit the game.

Dist. No. 3. With bad QRN in the southern part of the state we have reports from only two stations, 5ZAEA and 5XAE both being on the air consistently, and doing considerable work.

Dist. No. 4. 5XA is the only active station, but they have handled a lot of traffic using both spark and C.W. They get in the Brass Pounders League this month.

South Carolina: The A.D.M. has written every station in the state trying to get a reliable route into Charleston and also the southern part of the state.

4JK continues to handle the largest amount of traffic, but 4EG on spark is a good second. 4LA and 4PV are getting into the DX class and doing fine work. 4FQ has opened up with 10 watts and is reaching out in good style. 4JK has replaced the old 10-watt set with one of 50 watts and should increase his range considerably.

### HAWAIIAN DIVISION

K. A. Cantin 6TQ  
Acting Mgr.

To date the Hawaiian Division has been up to resume communication with the mainland where 6ZAC left off owing the fact we have been unable to make ourselves heard. Coast stations are QSA here. (See Calls Heard) Would suggest "lay off" sending some night and listen for the following C.W. stations of the Hawaiian Division: 6ASR, 6CCL, 6CCR, 6CEU, and 6TQ.

### MIDWEST DIVISION

G. S. Turner, Mgr.

In order not to take up any more of our valuable space than is necessary I am going to make my message to you all this month very brief.

To the men of the ol' Midwest—

I am very well pleased with the excellent co-operation shown. The results accomplished are very gratifying indeed. I THANK YOU ONE AND ALL and my only request is that you keep up the good work.

KANSAS: SPECIAL MENTION TO 9CCS with 522 and to 9BZZ with 626.

Our old friend QRN is back with us again but he just can't seem to stop these C.W. sigs. 9BZZ and 9CCS were the star stations, each passing the 500-mark. We have a new A.R.E.L. booster in G. L. Garrington, 9XP, of El Dorado, who has been appointed to the office of assistant publicity manager for Kansas. He and the A.D.M. are putting out a paper, "The Kansas Amateur Bulletin" which is sent semi-monthly to O.R.S. and A.R.E.L. officers of Kansas. The idea is to stimulate interest in relay work particularly during the summer months. (F.B., Kansas,—D.M.) After handling the most messages in the state, 9BZZ says he has dismantled

again and 9CAC now has his set. 9CPV is clearing traffic with an amplifier tube and "4D" coil plate supply. Not a single message was reported by 9DSD this month. If rumor is right, a little bobbed haired vamp has got him. What you got to say for yourself O.M.? Also, no reports from 9BHN, 9DHB, 9AQE, 9EFA, or 9PS this time. ("Smatter fellows?")

The following stations were appointed O.R.S.: 9CJE, 9CZW, 9AOD, and 9EHT. 9CWC, I. J. Simms, 850 Faulkner Ave., Wichita is the new city manager for Wichita. (Now let's put the old town on the map—D.M.)

NEBRASKA: 9BXT IS STAR THIS MONTH WITH 729.

Due to the A.D.M. being out of town on business this month, the report was handled by the C.M. of Omaha, Mr. P. H. Quinby. (F.B. O'Rourke—D.M.)

Mr. Chansky reports 9CMK handling 248 messages, also 9AQK, a rather new station in the locality, handled some traffic. 9ASO is now an O.R.S. and reports that he is busily engaged in the construction of a C.W. set to supplant his old spark. 9ALK is stepping out with his new 20-watt C.W. set. 9YU has been very sick and not able to operate. We sure miss old YU. 9AVC and 9BXT got jealous and are competing for highest honors—Hi. 9BXT says he can't be on so much as in the winter as his duties won't permit. 9AHV is an O.R.S. 9DTU blew 2 fivers and 9AEC blew three. (Competition eh?—D.M.)

Quinby reports Omaha traffic going through as usual—even QRN storms not hindering 'em. (They're using loops now—D.M.) Here's news; at 9DXY lately on a loop using one tube, all districts were copied.

IOWA: AN IOWA STATION BEATS MISSOURI—9BGH HANDLES 1010.

Message traffic has taken another jump, going over 4000 to nearly 7400.

The new O.R.S. that have been appointed are 9AHH, 9AOU, 9BCF, 9UL, 9DAH, 9CLQ, 9BRS, 9BIF, 9BZI, 9BSZ, 9ATN, 9AMU, 9BIK, 9CKP, 9EDB, 9BFG, 9DKY, 9AMI, 9DXC, 9BGI, 9DOF, 9BVL, and 9CHN. 9UL has been appointed C.M. of Fort Dodge, 9AHH of Eagle Grove, and 9AMI of Mason City, and 9IF of Des Moines. Supts. Vailey and Decker report everything going nicely and are to be commended on this month's report. 9CLQ blew a 50-watter while trying to put an important message through when the telegraph lines were down. 9AMI and 9DKY have been using 5 watts but have changed back to their usual sets. 9BKI's aerial blew down in a storm but he will be going strong again soon. 9BZI not on this month due to sickness in his family.

The state has been divided into counties instead of dividing by a line running north and south. Every one note that the A.R.R.L. month is from the 18th to the 18th and your report must be sent to the D.S. on the 18th of the same month in order for him to get his report in on time.

MISSOURI: 9CKS WINS FIRST HONORS WITH 706 FOR APRIL.

OM static and the fine balmy weather seems to have put a crimp in traffic during the last month. Many of the best stations have slumped and others have not turned in a report.

Eastern section: This section of the state known as district No. 1 did not hold its own as expected. They seem to feel that the west section is entitled to the honors this time.

COLUMBIA: 9AOC and 9EFC did good work. CAPE GIRARDEAU is still actively represented by 9BDS.

JACKSON: 9WK seems to be the only live fellow in this town. He has replaced his antenna and promises big doing for next report.

MAPLEWOOD: This hot bed of spark transmitters is active as usual but the sparks are gradually being replaced with C.W. 9AWT is trying to sell the old rock crusher. 9CUF is on the C.W. and getting out fine. We are rather surprised that his new OW has consented to this as we understood that C.U.F. was through for at least a year. We understand 9CWC and 9DZY have their sparks FOR SALE. F.B.—both are using C.W.

CLAYTON: 9AON is on the job as usual. 9DXV is still using his crusher.

PINE LAWN: 9ALK is now using C.W. He

is still the only amateur in this neck of the woods. WARRENTON: 9DNY is doing F.B. with his spark and keeping this town on the map.

MOKANE: 9BIP, at once a very active transmitter, has been appointed official observer. Let's hear from you OM, and what has become of your transmitter?

ST. LOUIS: 9BLG is the observer in St. Louis. He is quite active and handling "oodles" of traffic. We regret that his message totals for the last two reports were accredited to 9BIG. We hope, however, that 9BIG will wake up and get busy with the code and report traffic handled shortly.

Western Section Dist. No. 2.

ST. JOSEPH: 9CTG is putting 9 volts on the filament and 800 on the plates of his 5-watters. A little hard on the tubes but he cares nothing for expense. He's getting out. 9ANO has second honors this report; 9DLT third. 9DLT has a new 65-ft. aerial using three 5-watters and 600 volts D.C. on the plates. He has been reported QSA on both coasts and has worked Canadian 3GN. 9DRW is using C.W. and junked his spark.—F.R. 9EX has been inactive. 9N<sup>3</sup> is also showing signs of life.

JOPLIN: The C.M. reports little activity due QRN. 9CHJ is handling most of the traffic. 9BYP is building a new set.

WEBB CITY: 9BZH reports both spark and C.W. F.B. 9CXM is using a spark. A new 50-watt set is waiting for a license.

ROCKPORT: 9CAO is going great. 9AFH is also helping to put this town on the map.

MARYVILLE: 9CKS has been appointed O.R.S. He is doing good work and has handled a raft of messages; daylight, at that.

HOPKINS: 9EAO has written that his set is out of commission due to the local power plant having burned down.

TARKIO: 9DPY and 9CRR are not doing very much. A little pep fellows.

WARRENSBURG: 9DAE is going great. He has daylight schedules with 9AYL and 9PWR. He reports that he has another set operating under the call of 9DZO.

SEDALIA: As usual this city is being taken care of by 9BMN and 9BWR. 9BWR has recently written the A.D.M. asking where the O.R.S. certificates come from. (Ask 9RR, O.M. He might tell you that to get an O.R.S. certificate you must work for it.)

KANSAS CITY: 9FM has been appointed an observing station. The K.C. ordinance against amateur transmission seems to have died a natural death. The A.D.M. is rather disappointed with the results for this month especially the eastern side. Cannot understand why some of the fellows sent in no reports; especially the new official stations. Wake up fellows! We granted you these certificates because we believed you merited them. We surely expect better results by next report. So you fellows, especially the officers, are urged to get in touch with the O.R.S. in your sections.

## NEW ENGLAND DIVISION

I. Vermilya, Mgr.

The most notable, outstanding feature of this month's report is the doings of 1AJP. The facts are as follows: On March 31st a new 1750, 600W. motor generator was installed. By 6 P.M. two 50-watters were putting 7.3 amps. into the antenna. 4BX was worked as a starter. From 10 P.M. to 4:22 A.M. the following were worked: 1ZA, 2CDB, 3CEO, 4XJ, 5ABH, 6ZZ. (took four messages), 7ZP. (took 1 message), 8AIP, 9AHQ, and 9DHR. 1AJP has been reported by 7PN, 7AS, 6VD, also in Mexico, Cuba, Panama, Porto Rico, Holland, France, and England.

MAINE: Maine's total was 1815, which is not very bad for Maine. No report has been received from district No. 4 yet. This includes 1CDO, 1AOC, 1APT, and 1BJS; all are good relay stations. New stations in Maine this month are as follows: 1CNP, 1AZZ, and 1AYM. 1BDI still continues to be ahead at 2SZ London and 8AB France. The new operator at 1BDI is George Barney. He signs "BA."

NEW HAMPSHIRE: The report this time for

New Hampshire covers two month's activities as last month's report for this state was delayed in the U.S. mails.

From February 15th to March 15th this state handled 755 messages and from March 15th to April 15th they handled 1633 messages.

IMC seems to be stepping on the gas. This last month he handled 1090 messages which greatly helps swell the total; incidentally, he earns a seat in the Brass Pounder's League.

VERMONT: The report from Vermont is very small this month and we are beginning to entertain fears that this state needs a convention or something to smooth out the ruts and bumps. Come on, Vermont, let's not let New Hampshire run away from you. IARY and ICPO are the leaders here, but not quite enough so to put them in the B.P.L.

MASSACHUSETTS: As per usual, this state continues to be the leader. Of course size counts, but nevertheless there is considerable activity here just the same. We miss a few of the big brass pounders and are wondering why 1PM and 1BKQ suddenly dropped out of sight. 1CPN claims 3000 miles DX work. 1BNT shows some good steady operating. 1AIR, "Slim Crocker," who is holding down the Island of Nantucket so it won't blow away, has increased his power to 20 watts and is burning up the salt air out his way. 1CBJ has a big sign on his report card, "No Rubber Stamp Messages." "Atta Boy;" he proudly reports handling 12 messages. These 12 are worth 25 R.S. kind, no doubt. He is on from 3 A.M. to 6:30 A.M. 1AOK reports working 4FA, 1000 miles on 10 watts, and 5KC, 1425 miles on 15 watts. 1AOJ is interested in short wave, and heard the following below 150 meters: 2AGD, 2CCD, 2ZE, 4FT, 8IB, 8KK, 8ZW, and 9ECE. 1BKQ has been testing with short waves and is down to 140 meters. 1YK handled 404 messages. The following stations handled over 300, thus entitling them to the coveted Brass Pounder's League. 1CJR, 1CNI, 1SN, 1BYN, 1JV, 1KC, 1AWW and 1CNI has worked Cuba and Nebraska.

CONNECTICUT: Reinart's territory continues to uphold its reputation and for real team work and close cooperation, this is a hard state to equal. 1BOQ was heard in the Canal Zone and Frisco. ITS seems to be coming back into the game. 1MY hit about his usual average. 1CJZ handled 426 messages. ITS is up to his old tricks. On March 1st he connected up with 5ZAS in Birmingham, and put over a Mexican Relay. Station "JH" in Mexico City was worked. An answer was received in four minutes. 1QP promises something new for the Radio World. 1AWB seems to have gotten lost in some Connecticut convention. Has any one seen him?

RHODE ISLAND: Rhode Island may be small but there's "lotsa" pep and ginger contained therein. 1BES handled 51 messages and although this is no record breaker, still his DX is to be highly complimented. 1II still hangs out with the Brass Pounders and this time with 456 messages. 1BVB just made it with 307. 1CBP got away with 354. 1CSW sort of slipped this month and let Woonsocket plug along for herself. Watch the O.R.S. certificate, ol' timer! 1AWE with 5 watts has worked every district except the 6th and 7th. 1AWU has had hard luck. He blew five 5-watters in five days. Better get a filament meter, ol' man. He continued operation on 2 U.V. 201's and handled 40 messages on these. 1AXR is a new station and in one week handled 50 messages. 1GV rakes them in from all districts, even the 6th and 7th. We call this good. Its better than some of the bigger bottles ever did. 1OW comes along like a regular feller that he has always been, and sends in a total of 100. 1BQD seems to be making out the "berries" as city manager of Newport. He turned in an excellent report for this month. 1BHK and 1AIU are both doing excellent work. 1BQD is going to move and expects to increase his power, and put up two 50-ft. masts. Nothing from 1ALZ this month. Watch that certificate ol' top! A coal wagon backed into 1CBP's couterpoise and upset the whole works. 1BVB lost one of his masts during a heavy wind storm. 1AHT is still recuperating from his honeymoon. A 500-watt C.W. station with two, steel, 100-foot masts is being built in Westerly. Now, you gang

of Rhode Island Brass Pounders, here's a good long report and we hope you will like it.

#### NORTHWESTERN DIVISION

B. B. Bliss, Mgr.

Thank you all for the numerous letters of congratulation. The Northwest is going to lead. It may take time but with your solid backing we are going to lead. Remember that I am your representative, not your dictator. If you have even the smallest idea for the betterment of our division send it in and you will get due credit in this section if the idea is practical. Who will have the first good idea? "Daylight routes for Sundays?" How's that for a starter? Get your brains to work. Let's all forget to grouch and get the brotherhood spirit. Remember ALL FOR NORTHWEST.

The kicks are now in order. Only one this month and that is all O.R.S. send in your report to your D.S. and not to the A.D.M. or D.M. (This does not apply to Oregon at present.)

The following appointments have been made: L. L. Martin, 7LN, 423-14th Ave., South Nampa, Idaho, assistant division manager for Idaho; P. R. Hoppe, 7IW, 1633 Willamette St., Eugene, Ore., assistant division manager for Oregon. (Come on Idaho and Oregon, you know these boys.)

WASHINGTON: Dist. No. 4. 7GP reports that things are steadily improving.

Dist. No. 6. 7AGI is getting out in good shape. The D.S. says that poor cooperation is being given him by the stations in his district.

Dist. No. 7. Things in this district have been right on the move this month. In Everett, four stations are on the job, and are doing an immense business in the way of handling traffic. 7AFH is remodeling, but will be on with more power soon. Seattle reports that it will soon be sparkless. A number of licenses have been suspended until they get down to 200.

Dist. No. 8. Superintendent Tate reports that things are pepping up in great shape and more traffic is being handled. 7AIO and 7WD are working sparks; and 7JS, C.W. All stations are using break-in systems.

Dist. No. 13. The hams have had considerable school QRM so the traffic report is not as great as would be expected. 7HE will soon be back.

No reports from the following districts: 1, 2, 3, 5, 9, 10, 11, and 12. However, some stations reporting direct are: 7BA reports that 7WX, 7WM, 7AFO, and 7AIM also 7BA are all doing good DX in Tacoma. 7HI in Auburn is doing good work on C.W. Spokane has at last come to life with five C.W.'s on the air, 7SZ with 5 watts, 7AF with 5 watts, 7EB with 10 watts, 7WA with 10 watts; 7ADO has the DX record of the city, and 7ABM the last named is fooling with fone. (Better stick in a key, OM.)

Oregon: 7HA has a 5-watt fone and C.W. 7MU and 7BH are too busy with other things to work their sets much. 7AGP of Silverton is installing 100 watts. 7AGE of Salem will soon break in with 100. 7GT is high man in Corvallis. In Portland 7VE, 7VF, 7ACK, 7TT, and 7TO are doing good work, all on C.W. In Eugene the new A.D.M. will soon have his C.W. perking in place of his spark. 7LR, our publicity manager, reports that he is installing 100 watts and making improvements on his aerial; and hopes to break all records. 7NA has sold out and we miss his consistent sigs. 7TQ has handled 307 the past month on 50. 7EM and 7VO will soon be going. Great things may be expected from Oregon in the future under the able guidance of their new A.D.M.

IDAHO: The women of Moscow are very grateful to 7JF for keeping them supplied with stacking darners. At last a use for burnt out tubes has been found. He has burnt out 18 tubes in the last two months. Also his mast blew down. (Quite a blow;—T.M.) 7CG does good work when he can find time to pound brass. 7IO is getting in deep and moves traffic with ease. Mrs. 7IO is learning the code in the hope of assisting IO in making the station famous. We welcome Idaho's first OWI 7ABH, a new station in Twin Falls and 7MB in Burley have been heard on the air and we are glad to see some action from that section of the



state. Boise is well represented with 7HJ, 7ZN, and 7PJ who are doing exceptionally good work on 10 watts, and 7YA when he can stop broadcasting long enough.

**MONTANA:** This state has shown better work during the past month than at this time last year by a considerable margin. The contrast is one that is interesting. Last year with seven stations operating (all spark) 145 messages were handled while this month with five stations reporting (all C.W.) 854 were hung up. So we are making progress. The box seat this month goes to 7ZF of Butte with a total of 824. He has a short range set of ten watts and 100 watts for reaching out. 7ZU has a second operator and may be expected to hang up quite a record. 7AGF of Troy has found an outlet east through 7ZF and so will now accept traffic east. 7HS on 5-watts A.C.C.W. has a schedule with 7DH at 7:00 P.M. 7ZL, the station of the A.D.M., is using 10-watts D.C.C.W. He has not been on very regular because of sickness and business. He is contemplating building a 100-watt to combat QRN.

### ONTARIO DIVISION

A. H. K. Russell, Mgr.

The big event of the past month has been the successful Trans-Canadian Relay. Toronto stations as well as those in Niagara Falls and Kingston took part in helping the good work along, but the star part in the Ontario Division was that played by 3NI, who held his end up during the whole three nights, and without whose aid the relay would have been very badly handicapped, though not entirely blocked. So great has been his success that a separate division has been created for Northern Ontario with 3NI as district manager, and if he makes as great success of his district as he does of his station the southern districts will have to look to their laurels.

In Northern Ontario only 3BG and 3NI as yet are reported active, the latter reporting having worked all American districts and Canadian 4HE, 4FN, 4SP, and 5GO. 3NI reports in future 'til fall he will be on only one of every three nights, but we can no doubt count on him for a good traffic report nevertheless. This month he is our only 300 hitter!

In the western district 3BV has been temporarily out of "75%" due to a mast being down, but will be on the air again right away. 3KN has been appointed Government Radio Inspector for London. 3DH is now operating under special license, 9BW, but will likely not be on a great deal 'til fall.

In central Ontario the interest is keeping up in fine style. With new stations coming to the fore in the shape of 3SI and 3ZS who are now the pace for the district. 3GK lent very valuable aid in the Trans-Canadian tests, working 1BQ in Halifax, while at the same time 9AL was working 9BX in Saskatchewan. (A pretty good advertisement for C.W. Hi.) Gowan has been appointed Radio Inspector for Fitchener. 3BQ is doing wonderful work, as is 3XX.

In the Eastern district 3HE and 3IL are the only stations really working hard. The latter has, we are informed, shut down for awhile, but 3HE is still on the job. The greatest difficulty is experienced in working between Toronto and Kingston. 3MP in Cornwall says he will be on the air soon to help out.

### PACIFIC DIVISION

J. V. Wise, Mgr.

There seems to be some misunderstanding about reports. For the benefit of all Operating Department men, let us clear up some little points. Official Relay Stations report to their district superintendent or city managers, who, in turn report to their assistant division managers. Assistant division managers report to the division manager. This is the routing all reports should follow as various operating department officers are desirous of keeping in touch with their local activities. Applications for appointment as official relay station should be made to the district superintendent

or city manager who will make proper recommendations for issuance of certificate.

**California:** The report this month is not encouraging. 6ZH and 6HP were the only reporting superintendents. 6EC, with 20 watts has worked 3JJ and is reported on the east coast. 6AHF, ex-6ANH is doing good DX with 50 watts, having been reported in New Zealand. Only one or two sparks remain in district No. 1.

District No. 6. Traffic is moving with rapidity to the north, east, and south. 6JN has been bothered with high voltage QRM. 6ALV and 6ALU, on C.W., are always consistent, and 6BFL is a comer. The sparks are represented by 6AQU, 6AOA, and 6BOS.

District No. 4. 6AMK is junking the spark for 100-watts of C.W. 6UW uses a sink rectifier on his 50-watt and is getting out. 6ATC has just completed a new aerial and receiving set. 6ANR and 6BZ, using 5 watts, work sixes and sevens quite consistently. 6VX has not been heard for some time. The old familiar spark at 6TU has passed into history, having been replaced by C.W. 6BON is now using 10 watts and is reaching out F.B. 6NX is a good relay point for eastbound traffic. 6AGJ has opened up with 100 watts. 6HC does good work with his spark.

**NEVADA:** 6AJR is still out on account of repairs to his antenna. 6ZO is going pretty steady with his 100 watts. 6BIP is going strong and handled the major part of traffic. 6GR has been able to do very little as he has only been able to work south into California.

**ARIZON:** 6BKA is a new station with D.C.C.W. and fone. He is located at Sacaton Diversion Dam, near Florence, Ariz. 6CAR, Phoenix is on the air with spark. 6BSQ is another good Arizona station located at Nogales. 6OD receives most of the west coast traffic from 6ZZ. He sure is a wizard, taking twenty to thirty at a clip and he never fails to say OK for the whole bunch. 6ZZ gets considerable traffic from 9BXT, 9CGA, 5ADB, 6UP, 6OD, etc.

The division manager wishes to say that he has been confined in a hospital for some time and spent many days at home with an illness that kept him from his A.R.R.L. work.

### ROANOKE DIVISION

W. T. Gravely, Mgr.

Fellows, look at this, 3BMN with 1336 messages and Summer static on the firing line. Isn't it a fine indication of what we may expect from the division in the hot days to follow? And look at 3APR with 865 messages.

C.W. 1335  
R. J. Carr, 3BMN  
Petersburg, Va.

**Porto Rico:** Traffic with the mainland has been going on in spite of QRN. If plans materialize there will be a half dozen stations in full swing next season, with power enough to reach the mainland. A station is being erected by the Porto Rico Radio Club which will be used for traffic with amateurs around San Juan.

**WEST VIRGINIA:** 8AMD failed to get his report in on time and fired a telegram to the manager reporting his traffic. The A.D.M. attributes the few reports to "spring fever" but we didn't know that West Virginia suffered so much from this malady. Kiser and Jones of SSP attended the 3rd District Convention at Baltimore. 8AUE is to blossom with a 100-watt M.G. set. Morris and Stealey attended the convention at Columbus, Ohio, and reports a fine trip.

**VIRGINIA:** Dist. No. 1. Our old friend 3ZZ has resigned as D.S. on account of bad health, and is returning to his old home at Youngstown, Ohio, after a rest at Catawba. 3BNE is still working on indoor antenna and gets out over short distances. 3BVC is losing a flock of tubes. 3ATS is a very consistent operator.

Dist. No. 2. 3TJ seems to be engineering this one in great shape and all of his scouts are handling traffic.

Dist. No. 3. 3MO has an antenna now and has discarded the clothesline. 3CEL is developing rapidly. 3AJG got back safely from the convention.

Dist. No. 4. 3BLF has closed up shop and has gone on the road. 3ZP has gone back to the old location and will use two or more operators.

Dist. No. 5. 3IW handles all kinds of traffic. 3BUY is moving to new location. 3SK is getting out with 100 watts and is adding new equipment.

Dist. No. 6. 3BBL is overhauling, but keeps on the air. 3CRZ, 3ALB, 3HU, 3YV, and 3BFE are new stations and breaking in fine.

Dist. No. 7. 3ZAA and 3ASP are on the air. 3YK seems to have dropped off. 3ZK has sold out and gone to the west coast.

Dist. No. 8. 3APR works all the time as his traffic report shows. Most of it is done in the day, and if there is smoother operation in the country, we don't know it. 3AEV and 3BZ attended the Baltimore Convention. 3CA was there too.

**NORTH CAROLINA:** 4FT and 4BX both attended the Baltimore Convention and they are a pair of enthusiastic operators. 4LJ with 5 watts does splendid work, and is always hungry for traffic. 4NV and 4FA are doing fine with phones.

Will you fellows who are operating in North Carolina, please show your A.E.R.L. colors by placing your shoulders to the wheel, and by doing your part? There is no excuse for your neglect when others are carrying more than their load.

In summarizing the operation for the past month, Virginia shows up with more than 5000 messages alone, which goes to show what real development can accomplish. It means organization. Now fellows, let's show that Hartford bunch that we can put across 7500 or more messages during July, when static is at its worst, and when other divisions are sleeping. Are you on?

#### ROCKY MOUNTAIN DIVISION N. R. Hood, Mgr.

SPARK 436  
Young University  
6AFL

Provo, Utah.  
C.W.  
Dr. Van Slyck, 7DH.  
Hyatville, Wyo.

**COLORADO:** Colorado again takes the lead for the month and with a grand total of 2384 messages. This total was handled by Denver stations which certainly is a feather in the hats of the Denver amateurs. 9BJI takes honors in Colorado for the most messages of any station with a total of 371 messages. A schedule with 9CKI is maintained at this station. 9CAA used 10 watts and blew both tubes and then reverted to 5 watts and is going just as good with one bottle. 9EXM blew a 50-watt and is on with 10 watts and seems to get as good results with this power. 9BUN is getting good results with an RCA set and is forever away from the trouble of burnt up generators which seemed to be his lot. 9AYU was home from Colorado University for seven nights and put through 296 messages in that time. If we only had him on for a solid month. 9DTM has two 50-watters on each side of the cycle now, and gets seven hot amps. 9AMP says this was his hard luck month—short the generator and a 50-watt tube. New QRA, 4026 E. 14th Ave. Denver, Colo. 9CJY reports a five-watt to the haven of rest of such animals. Denver sure has a "blowing" gang down there. 9EEA, a new comer in relay circles is owned by a Denver lawyer. 9DTE says he has been down with nine kinds of grief. Wata-matter OM, another tube gone up in smoke. He is a charter member to the 5-watt brotherhood that does so well. 9BTO is plugging away in regular fashion. 9FV is using 10 watts, not 5 as in last report. 9BXQ tried to climb a seventy-foot stick but ND. You know the rest of the story. 9AVU an ex-oid timer who quit for awhile is now back in the game and in it to his neck. Welcome again, OM. 9BXA had some antenna trouble but now has a new pole erected. 9DHI reports school QRM with the traffic handling. 9EKH also had generator trouble but is now in full blast.

New appointments in Colorado: Philip Laskowitz, division publicity manager; M. O. Davis, 805 Carson St., La Junta, assistant div. publicity manager and district superintendent for southern Colorado. Our observers are now working full blast and KLZ

will broadcast their reports each week so that the novice may learn from what source his interference comes.

**WYOMING:** Another ill 'ol 5-watter takes the higher-power boys for a fall and lands 278 messages and sets in the box seat for it. 7DH is one of the wonder five-watters of the division; F.B. OM, and hope she keeps up for some time yet. 7LU has been off for the past month due to some changes being made. 7AFW continues to bang them through on 10 watts. Old Man 7ZV is still on the job but had QRN for the past month throughout the state has put a crimp in message work. 7ZO has been off for the past month due to rebuilding from aerial to ground. This state is now functioning under the new 7th District Executive Council and its rulings.

**UTAH:** Brigham Young University again takes honors for Utah and the division. A spark station with seven operators on duty and puts 436 messages through. Good work men. 6BOE was out of the state for the past month so no report. 6BLH has just installed a new C.W. and counterpoise and says he will take honors next month. 6BUH now has both C.W. and spark with most traffic this month on the rock crusher. 6RM has been moving and has some shiny new towers on the apartment and will be on full blast soon. Oh, for more landlords like this! 6ZA tied up with school work but got some messages through in order to keep in fit and help the gang along. 6ZT put through 75 in 8 evenings. A new 100-watt will be in operation here soon. 6BKE erected a new 70-foot mast which blew down on him just as he was finishing up. This is the fourth mast to blow down this winter and structural steel masts are going up now which he swears will stay put. F.B. Utah.

H. C. Wilson, Salt Lake City, appointed assistant division publicity manager for Utah.

#### VANCOUVER DIVISION J. T. North, Mgr.

The second Trans-Canadian test showed that we can at least relay across the continent without depending on the northern American stations. Stations in this division which took an active part in the test are: 5CT, 9BP, 5CN, and 5GO. Interference in the Vancouver district was reduced to a minimum, and everyone cooperated to his utmost.

**VANCOUVER:** 5CN and 5GO are handling traffic in fine shape and both hit the 300 mark this month. 5AK, 5EJ, 5AH, 5HD, and 5EB are all doing their share. 5AC has been appointed City Radio Inspector.

**VANCOUVER ISLAND:** 5CT is a lonely man and we certainly wish we could get some more good stations in this district. Reeves did very good work in the Trans-Canadians and sent in a still bigger message report.

**PRINCE RUPERT:** 9BP is routing considerable traffic to the east, being easily QSO with 4FN. This district also needs a little padding. (Come on 5CX we need you.—D.M.) 9BP did very good work in the Trans-Canadians.

**ALBERTA:** 4DO sends in a good report of his own work, but says his men were late with theirs. He wants his reports in not later than the tenth.

#### WEST GULF DIVISION F. M. Corlett, Mgr.

With the constant increase of QRN we rather expected a very noticeable decrease in messages handled but instead we have an increase of a little better than 4,000 messages over last month's total. An additional 14 stations reported this month making a total of 67 stations against 53 reporting last month helped to swell the total. This report covers the period from March 15th to April 20th. The operating month of this division is now from the 20th to the 20th of each month.

**NEW MEXICO:** An additional station reported from New Mexico and we see some friendly rivalry between old 5ZA and 5ADO the new relay station reporting. 5ADO is Arden R. Boelner, 508 N. Mo., Ave., Roswell. Both stations report QRN very heavy but traffic is still moving.

**OKLAHOMA:** Enid and Oklahoma City stations seem to have done all the relay work in district

No. 1. 5LB the O.R.S. and 5MP, 5TO and 5AAO at Edmond are temporarily out of the relay game. 5KE, 5ZAV, 5AJR, and 5DN took care of traffic for and via Oklahoma City.

Dist. No. 2. With C. M. Selby, 5BM, DS in charge with five stations reporting moved 675 of the citizen messages along their way through 5RS and 5GJ of Sand Springs, 5BM of Muskogee, and 5GA and 5SG of Tulsa.

Dist. No. 3. Wayne J. Cargille, 5KE, D.S. sends in the largest report from his district that we have had in a long time and it appears that he did all the work himself, handling 80 messages.

Dist. No. 4. Only two stations reporting traffic handled which 5AAH, who is on the air for traffic regular from 6:00 A.M. until 7:30 A.M. and from 5:00 to 7:00 P.M. 5VM is the proud owner of a 1000-volt motor-generator and we surmise that ere long the wee five-watter will be replaced with fifties and all the other fixings added. 5ZG, your A.D.M. for Oklahoma is completely rearranging everything and will be off the air for awhile. Summing up the Oklahoma section, 5ZAV of Oklahoma City after having just "gobs" of generator troubles finally got the upper hand of things and then gave the old set a thrill by working every district in one night.

**NORTHERN TEXAS:** Dist. No. 1. This district has a new D.S., Dale Hales, 5ACQ, 2326 Anderson St., Greenville, Texas. You A.R.R.L. relay stations in Denison, McKinney, Forney, Terrell, Whitewright, Greenville, Commerce, Mt. Vernon, and Texarkana keep in close touch with him and take up with him all relay matters including applications for official relay station appointments. Stations in Dallas and Tarrant counties are under the direct supervision of the respective city managers of Dallas and Fort Worth. April QST, due to misprint, gave 5AAF as being in Texarkana, Texas instead of Arkansas, the call letters should have been 5AER. Julian S. Fried, 411 State St., Texarkana and he is still in TEXAS. 5AHC is now O.R.S. Fort Worth stations: 5SK, leading the bunch with 550 messages to his credit; and 5BE second with 387; 5DI, 5QL, 5MN, 5AHT, and 5PX following right along close moved 1560 messages, while 5TL of Arlington which also comes under the Fort Worth C.M. added 152 more. (Fort Worth's report last month got lost somewhere between the "Stock Yard City" and the A.D.M.'s office and to this day has not been found; a duplicate, however, is indeed worthy of mention at this time for it shows that Fort Worth stations handled 2,468 messages between February 15th and March 15th with 5TC leading the "stampede" with 1290. (Using 50 watts he worked 44 states and 6 foreign countries—D.M.) Only two Dallas stations report this time, 5KK with 306 and 5JL with 114 making a total of 420. 5AL with 20 and 4ACQ with 134, both of Greenville, complete the activities of District No. 1.

Dist. No. 2. While minus a D.S., just now this district is not idle. 6 stations reported 338 messages. 5AJT tops the list with 115. 5KT was next in line with 102. The rest were passed along by 5KK, 5ADV and 5FC have a daylight route working every day at noon and want some help on a Dallas-Galveston route via their stations.

Dist. No. 3. This district is certainly coming to the front under the leadership of D.S. J. E. Martin, 5UO, Wichita Falls, 6 stations, 5LL, 5UN, 5UO, 5CY, 5ZADA, and 5OK moved a total of 798. 5AHP is a new 20-watt C.W. and fone. 5EL had to give up his call on account of a mistake in assignment and is now known as 5LL. 5UO has been out of commission on account of antenna troubles.

Dist. No. 4. D.S. C. B. Baxter, 5XAJ, pushes most of his traffic along in the early morning hours. 5NS has been bothered with QRM from school work. 5ZAK has a couple of 50-watters going 50-50 on fone and 100-watts on telegraph—fone has been heard in 30 states and telegraph in Panama on tests.

Dist. No. 5. Texas Panhandle with the D.S. doing all the work handled. 161. 5ZH is the fellow with fierce QRN who uses a loop and expects to work right on through the summer. He copied 12 straight from 9DTA on a loop. 6ZZ, 9DTA,

5HZ, 9AOD, 9ZT, and 9DKX are his best relays, so pass your traffic to him for those points.

**SOUTHERN TEXAS:** Most every station reports severe static.

Dist. No. 6. This district in spite of static reports a total of 1453 handled by 8 stations. 5XAD, although at times QRN was so bad he could not read NKB 85 miles away, managed to move 540 messages. He is using 1000-watts D.C. C.W. Only one Galveston station reports, 5VY totaled 102, and started out by working 1XM and 7SC and all on one 5-watt tube, yet he is contemplating a 100-watter. (?) Relay activity on the Island is picking up right along and so is QRN. (What did 5ADY, 5ACP, and 5IM the other A.R.R.L. stations on the Island do in the relay game?—D.M.) In Houston, only three stations reporting. 5NK is first with 218, and 5NN second with 161. 5ZK is on in the day time only and mostly on Sundays 5XB dropped off quite a bit due the operating staff being on a tour. 5OC just got on the air, been trying to make her go and had a bad tube. (Hear lots of this lately what kind of tubes are they turning out?) 5XV had all his "lamps" out at once. He worked all districts except the 7th in a 100-minute test. It is a shame to spoil this report by announcing that 5CA of Houston is contemplating opening up with a fine installation—featuring SPARK!! An auxiliary set of straight C.W. is included (?)

Dist. No. 7. 5KP tops the list for the whole division with a report of 1119 messages handled. 5TM is second with 439 messages. 5GR is ready for traffic Wednesday and Friday mornings and all day Sunday—shoot it to him. 5JT has been off the air for a few days, blown 50-watter. He is QSR to "BX" and "JF" in Mexico. 5RA is coming up with 50-watts of C.W. 5PD and 4RN are holding down the State Capitol relay point, Austin, and both went over the 100 mark.

Dist. No. 8. Under D.S. L. D. Wall this district continues to come to the front. A route is open to Old Mexico via 5MT, and 5VO of San Antonio and 5JF of San Angelo. "AX" is J. M. Velasco, Apartado Postal Num. 867, Mexico City, D. F. Mexico. "BX" is Harold T. Mapes, Apartado 21, Guanajuato, Gto., Mexico. Both are A.R.R.L. stations. (It looks very much like we are in need of an A.D.M. for the Mexican section. We have about 20 A.R.R.L. members in Mexico and two real relay stations. Applications for the appointment are in order.—D.M.) 5ZAK, 2nd F. A. Brigade, while only on 21 nights, tops the list with 194 messages. 5ZAF is next with 155. 5MT, 5VO, 5KG, 5SS, and 5JF totaled 850 messages for the district. 5JF worked "BX" about a month ago and secured his QRA and states that he was easily QRK and he also worked "AX" April 21 and reports him moderately QSA, and worked with ease. 5ADI was not very active in relay work this last month. 5AFI has a C.W. set coming up. 5BO will have a 250-watter going about the time this report appears in print, and "OM nose" how the West Texas biz will dance along.

Dist. No. 9. District No. 9, under D.S. E. E. McCracken "RM" when he is working for a living and 5ADB when he is "hobbying" pushed 207 citizen radios on their way out El Paso and 5JZ and 5DE helped swell the total for the district to 317. 5JZ is working his station over. 5DE will be on regular after May 1st. Come on El Paso, I am betting on you.

#### WINNIPEG DIVISION

P. Socolofsky, Mgr.

Well, well, here we are for the first time in the history of the League with a total of 700 messages for this division! Kii Yii Rip!

WINNIPEG: 4CN and 4CO are both 50-watt stations and are sure putting out the dope. 4DK is to have a credit mark for sending a most beautiful and beloved bottle west. 4DY and 4AX, both 5-watters, are to be congratulated on the work they are doing. The weather in the city during the attempt of the first Canadian Trans-Canadians was just plain ROTTEN. It seemed a regular pocket and stations were unable to punch out. 4DK work-

(Concluded on page 62)



# INTERNATIONAL Amateur Radio

## 5WS, London, England

5WS was the station of the Radio Society of Great Britain, the station that has been heard many times on this side of the Atlantic, and rose to prominence during the trans-Atlantic tests of last winter. The station has no polished table tops or shining panels but was built within a few days by a few enthusiastic English amateurs, who were put upon their own resources and were backed by a special permit from

for the station, not even a location. After a number of attempts at finding a suitable location permission was eventually obtained to use a 200-foot brick chimney for supporting the antenna and to utilize a nearby hut to house the apparatus. This hut was near the base of the chimney, so it was possible to erect an almost vertical antenna. The Society did not have the necessary apparatus for the tests, so a number of manufacturers were approached and they generously responded and loaned the Society the apparatus for the purpose. The time available for putting up the station was very limited and the station was eventually built and put into operation in the space of two or three days.

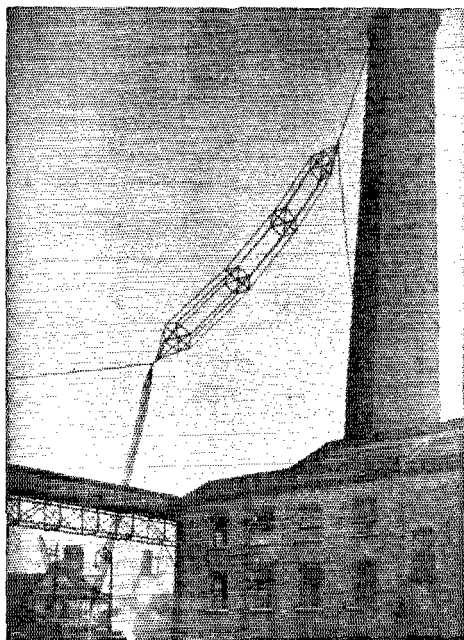

Fig. 1

the British Post Office which granted them the privilege of using one kilowatt of power, for the specific purpose of reaching America. Imagine yourself under similar circumstances—would you go about it in the same manner that these English amateurs did?

There was nothing to use as a nucleus

The upper part of the antenna, which is shown in Fig. 1, was made up of a six wire cage, the length of which was approximately 94 feet. The spreaders were of bamboo and made the cage six feet six inches in diameter. The upper ends of the six wires were all brought together and attached to three porcelain insulators connected in series. The lower end of the upper cage was tied off with three more insulators and the same six antenna wires were carried right through to the down-leads which were arranged in the form of a cage twelve inches in diameter. Ground connection was made to the coal conveyor which may be seen in the left hand side of Fig. 1. Six wires were also taken down to a water main which passes underneath the station, and in addition a copper strip was run down to the river and connected to brass plates sunk in the mud of the river bed. Altogether there were three earth connections and best results in actual transmissions were obtained when all three were connected in parallel.

Power was obtained at 230 volts, 50 cycles. This drove a 3 h.p. induction motor which was belted to a rotary converter, such as is used for ship's wireless sets. Belted in this manner the output of the converter was 100 volts at 350 cycles from the A.C. end and 100 volts D.C. from the motor end of the machine. The alternating current output of this machine was used

to feed two step-up transformers, the secondary current of which was rectified with two tube rectifiers, filtered, and then applied to the plates of the oscillator tubes.

Fig. 3. shows the connections. The D.C. output of the converter was used to excite the alternator field, as well as for battery charging.

The two transformers were manufactured for 350 cycles and 100 volts input and 6,600 volts output, the output being controllable, of course, by the generator field rheostat. The primaries were connected in parallel and the secondaries in series in order that full wave rectification circuit could be used. Filaments of both rectifier and oscillator tubes were eventually heated thru a step-down transformer from the 50 cycle station supply. Trouble was experienced at first in heating the rectifier filaments because the filament transformer had to stand the full high voltage. After getting thru half of the test by heating the filaments from a twenty-volt storage battery mounted on a special insulated platform, a filament transformer was obtained that had sufficient insulation to permit its use in this circuit.

After experimenting with three different circuits, the oscillating circuit finally used was the coupled Hartley, shown in Fig. 3. Two T4A valves of the Marconi-Osram Valve Company were connected in parallel for the oscillators. Each of these was capable of dissipating about 450 watts on its plate, so that by limiting the input to one kilowatt, nothing serious happened to the tubes if they stopped oscillating. The plates just began to show red when the tubes

condenser of .0005 mfd. was used. The final antenna current was  $4\frac{1}{2}$  amperes. Approximate measurements showed the effective antenna resistance to be around 30



Fig. 2

ohms, which gave something of the order of 700 watts in the antenna. Transmission was effected by keying the supply to the plate transformers. The change in the

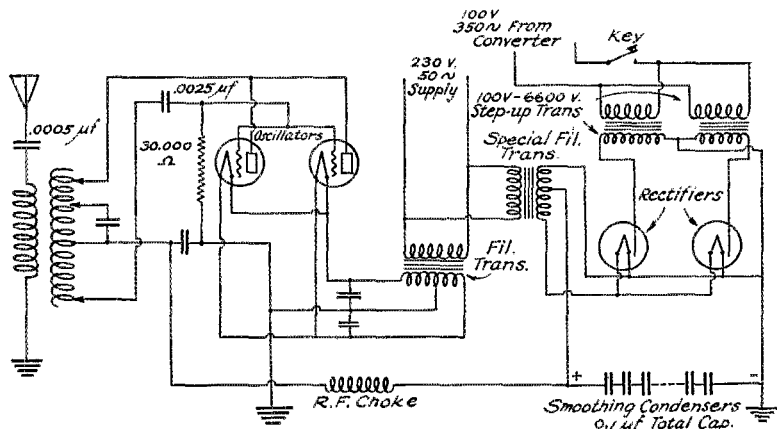

FIG. 3 FINAL TRANSMITTING CIRCUIT AT ENGLISH SHS

were not oscillating, and under normal operating conditions the plates were quite cold.

Since the fundamental of the antenna was fully 200 meters, an antenna series

smoothing condensers seemed to be sucked out rapidly, and as these condensers were fed at 350 cycles, the signals were not noticeably blurred by this method of keying. The inductances were mounted just to the

right of the set and are not shown in Fig. 2. They were wound with  $\frac{1}{8}$ " by one inch copper strip, which showed considerable improvement over the  $\frac{3}{8}$ " by  $\frac{1}{8}$ " strip that was tried first.

This station transmitted on ten nights at a different time period each night and its signals were heard on four nights out of the ten by ten different American amateur stations. The station was really a rush job all of the way thru, put together with the idea of getting something to work rather than something nice to look at. Since the tests, the apparatus has been moved to a new location and is operating under the call 5AT. Although the new antenna is not nearly as good, French 8AB reports stronger signals than those of 5WS.

#### Mexico and Cuba Heard From

The thought that Pan-American amateur radio will soon be a reality has been given an added impetus by the good word that both the Cuban and Mexican governments are now issuing licenses for amateur transmitting stations and already the signals of these stations have been heard and worked by amateurs in the United States.

In Cuba, the first to "get through" is the station of Frank H. Jones, located at Tuinucu, Cuba. Tuinucu is near the center of Cuba, two hundred miles east of Havana, and is the home of the largest and most modern sugar mills in Cuba. Quoting from Mr. Jones' letter, "For our sugar crop which will close in about a month we will have made about eighty five million pounds of sugar. Oh, you sweet toothed U.S.A.!!"

Getting back to amateur radio, a presidential decree has been issued in Cuba, pending the passage of a law to cover the use of radio. Up to the present time there has been no law or regulation covering the construction or operation of radio stations in Cuba. Under the decree, non-governmental radio stations are divided into five classes, to each of which is assigned a wave length and maximum power. No licenses of any of these will be issued for commercial purposes. The classification is as follows:

Class	Wave length (meters)	Maximum power (kilowatts)
*A—Amateurs	200	$\frac{1}{2}$
B—Educational institutions, experimenters	225-275	$\frac{1}{2}$
C—Colleges	300-360	$\frac{1}{2}$
D—State institutions only	400	$\frac{1}{2}$ to 1
E—Meteorological stations only	485	$\frac{1}{2}$ to 1

\*All receiving sets are rated Class A, regardless of type or size.

This decree went into effect March 16, 1923, and after that date no station may be operated unless the proper permit has been obtained from the Cuban Director of Communications. The permits are for a term of one year in the case of Classes A, B, and C, and for five years in the other two classes. Applicants must pass an elementary examination, but it is not believed that this requirement will in any way hamper the issuance of licenses. Transmitting stations of any class are made subject to the regulations of the International Radio Convention signed in London in 1912. Only apparatus capable of transmitting a pure continuous wave may be used.

Mr. Jones' station is licensed under both Classes B and C listed above. For amateur work, under the Class B license, the call 6XJ has been assigned with a wave length of 275 meters. Fifty or one hundred watts of C.W. is available and 6XJ has been heard by many stations in the United States within the last few weeks. Broadcasting with a fifty-watt fone set, the call under Class C license is 6KW. The broadcasts from this station are also heard regularly throughout the States.

In Mexico a different situation exists. About a year and a half ago, licenses were granted a few amateurs for transmitting stations by the Secretary of Communications. The maximum wave length permitted was 200 meters, which was later increased to 250 meters on the condition that no interference be caused the government stations. These licenses were issued for a definite period of time.

Some interference was caused the government station XDA by some badly tuned sets and the government stopped the issuance of licenses, even for reception, and cancelled many of those already granted. The use of receiving sets since that time has evidently not been restricted as the BCL's in Mexico City are very numerous. A great deal of enjoyment is obtained in receiving transmitting licenses and under the influence of new enthusiasm, aroused by learning of the great DX work that is being done by the amateurs in this country and in Europe, these Mexican amateurs are on the air again to partake of the laurels. Altho having "two-letter" calls, the Mexican amateurs are not "owtlaws," the initial calls being assigned by the government.

Station JH, mentioned in these columns of QST for April, 1923, is operated by J. R. Herran, a former Baltimore amateur of the spark coil era. The following excerpts from one of his letters tells of the work that he is doing:

"Up until lately, JH was a 100-watt set with A.C. on the plates, putting about

(Concluded on page 62)



The A.R.R.L. takes pleasure in announcing the affiliation of the following societies as of Feb. 17th, 1923: San Francisco Radio Club; Newburgh Radio Club; Princeton University Radio Club; Santa Cruz Oscillators School; Radio Technical Association; Y.M.C.A. Radio Club, Winston, Salem, N. C.; Springfield High School Radio Club; San Jose Radio Club; Amateur Radio Club of Seattle; Luverne High School Radio Club; Eugene Radio Club; Radio Association of Greater Norwalk; and Norwood Radio Club.

The following societies were affiliated as of April 27, 1923: Allentown Radio Club; Ashtabula Radio Club; Chicago Radio Traffic Association; Calgary Radio Club; Chicago Suburban Radio Club; Galt Radio Club; Huntington Radio Association; Junction City Radio Club; Muncie Radio Association; Plymouth Radio Club; Ridgefield Park Radio Club; South Philadelphia Radio Club; Texarkana Radio Club; Triode Club; Van Wert Radio Club; Whittier High School Radio Club; Woodland Radio Club; Young University Radio Club; and Heights Radio Club.

Names of officers and addresses of the above clubs can be had from A.R.R.L. Headquarters.

#### San Francisco Radio Club

Celebration in honor of its affiliation with the A.R.R.L. took place on April 19th in the form of a banquet given by the S. F.R.C. Colonel J. F. Dillon, U. S. Supervisors of Radio told of the new wave length allocations; A. H. Babcock, A.R.R.L. Director, spoke on A.R.R.L. activity; S. J. Fass, President, gave an address on better co-operation. J. W. Macbride, Secretary, and S. J. Keller, Treasurer, also made short addresses.

#### Springfield, (Mass.) Radio Ass'n

The third annual banquet of the S. R. A. was held April 3rd. The recently completed C.W. transmitter was officially put on the air with the call 1BWY. The election of officers took place with the result that H. R. Gurney was elected pres.; S. A. Burnett, vice-pres.; W. B. Lambe, secy.; C. W. Sias, treas. The club went on record in favor of the quiet hours and their enforcement.

#### Dallas Radio Club

A reorganization of the D. R. C. took place March 13th. A Board of Directors consisting of the following men was elected: F. M. Corlett, W. Stark, B. S. Shields, F. Glitch, A. G. Daniels, B. Dosterschill, T. F. Smith, Jr., and W. Bywaters. F. M. Corlett was elected president and W. Stark secy.-treas. The club has eighty members in good standing and is making a drive for eight hundred new members. The D. R. C. is starting out with the idea of building its own club house.

#### A.R.O.C. of Bremerton, Wash.

Realizing that it is the duty of the amateur to acquaint the community with what he is doing and to further the interest of those already interested in the radio art, the Amateur Radio Operators' Club of Bremerton, Washington, recently put a window

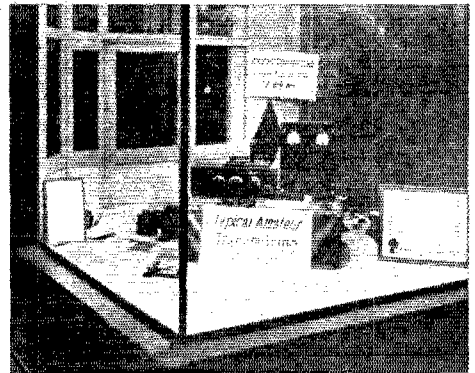

display in Bremerton's leading radio store that attracted much attention. As can be seen in the picture, the window shows a typical amateur station which radiates the co-operative spirit of the club's members.

Every licensed amateur in the town is an active member of the Bremerton club and is also a member of the A.R.R.L. This amateur radio club is held in the highest esteem by the people of the community, including the broadcast listeners. The school authorities, realizing the good influence of the radio club, have provided a place to hold meetings and a separate room in the new high school for the club's central station.

This station has been fully equipped by the members and regular watches are now being kept. Thus is the central station a community proposition thru which considerable traffic is handled for the people of Bremerton. In addition, this live club is conducting a class in the continental code and radio instruction two nights a week and many persons are being ushered into the amateur game. Upon completion of the club's course in amateur radio, the prospective amateur obtains a license and becomes a member of the club.

Verily, the Bremerton club is F. B.

**Radio Association of Western New York  
Establishes a Wave Length Service**  
By Benedict V. K. French,  
Research Dept. Federal Tel. & Tel. Co.  
Pres. R. A. W. N. Y.

The Radio Association of Western New York, affiliated with the A.R.R.L. has established a service of great value, not only to

length is sent by mail. A card index of all stations measured is kept and the wave length of the stations is checked periodically and entered on this card. The Association does not wish the radio fraternity to consider this service a policing of the air in any way, but merely an aid to those who wish to have their transmitters legally tuned. In the future it is hoped to expand the service to the calibration of wave meters and receiving sets, by sending continuous wave signals on various carefully determined wave lengths.

The measurement is done by the click method. The wavemeter is placed in close proximity to the secondary of Federal DX Type 58 receiving set consisting of a two circuit tuner, one stage radio, detector, and two stages audio. After the station has been tuned in, the antenna is disconnected and the wavemeter coupled to the secondary of the set, which is adjusted so as to

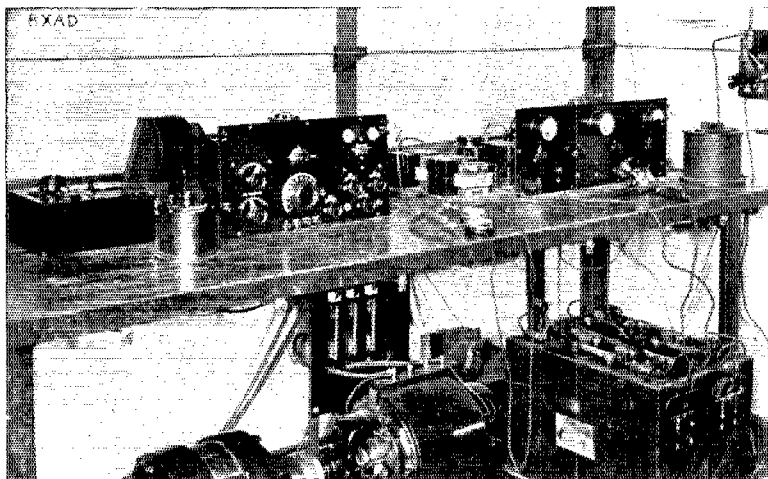

its members, but to the radio fraternity at large. This service is being furnished thru the courtesy and co-operation of the Federal Telephone & Telegraph Company, which has placed at the disposal of the Association the necessary apparatus and the use of its experimental station 8XAD. Operation and maintenance of the station is entirely in the hands of the members of the association, the writer and C. H. Fraser, Club Engineer, being directly in charge.

The nature of the work at present is measuring and logging the wave length of transmitting stations. Stations that request a check of their wave length are answered by radio and after the check has been made a printed form signed by the operator giving the date, time, and wave

oscillate very feebly. Resonance is then indicated by a click.

The transmitter at 8XAD is of the oscillator-amplifier type. This type of set is ideally suited to the needs of the station due to its extreme flexibility of wave length adjustment and the steadiness of its radiated wave. The normal wave used when checking wave lengths is 250 meters. Modulated telegraphy and phone can easily be accomplished in the master oscillator and the use of phone for local work assists very much in rapidly handling the service.

The regular checking times of the station are Monday, Wednesday, and Friday from 5:30 to 6:30 P.M. Eastern Daylight Saving Time. The operators will be glad to give a wave length check of any station which requests it.



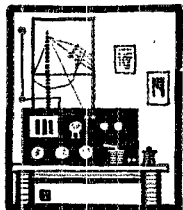

# Amateur Radio Stations



## 20M, Ridgewood, New Jersey

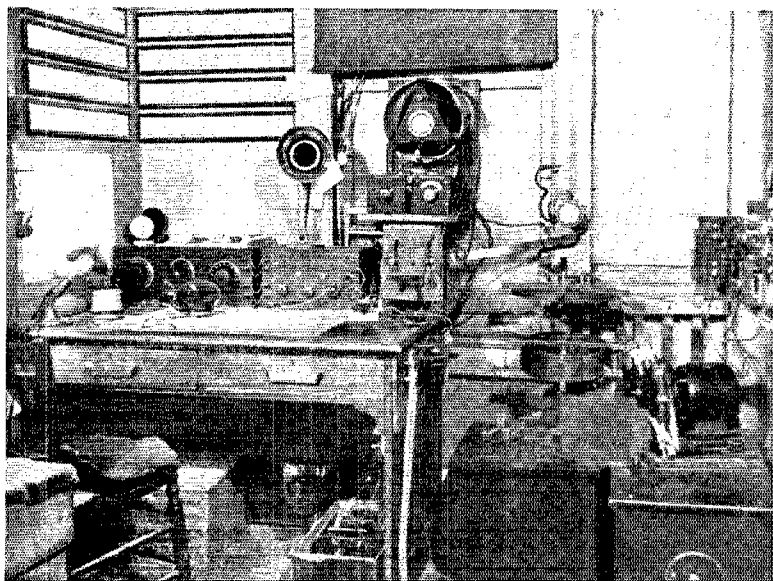

There is a certain appeal to the amateur in station 20M. One is impressed with that air of reliability and capability that typifies those stations whose calls are widely known. As winner of the Hoover Cup,\* presented annually by the Department of Commerce to America's Best All-Around Home-Made Amateur Radio Station, station 20M has had lasting fame bestowed upon it and it is with the greatest of pleasure that we present this month a description of the station.

The station is located at 180 Broad Street, Ridgewood, New Jersey, and has been in operation since amateur transmission was resumed at the end of the World War. It is licensed in the name of Frederick B. Ostman and is owned jointly by the licensee, his brother Walter Ostman, and Prescott Smith. A number of licensed operators in town have "sined on" at the station and personal sines are used to

distinguish the operators. The complete staff of operators is as follows: F. B. Ostman, Chief Opr., (SF), Walter Ostman (SW), Prescott Smith (SM), Louis Clark (SL), Kenneth Hiler (Ken) and E. Hopper (SA).

A great part of the success of the station is due to the orderly operating procedure that is maintained by these men. The usual theory that it is necessary to get away off in the wilderness somewhere in order to put up a really good station and do DX work has been dispelled by the fact that 20M is situated in the center of that part of the country where the users of the ether are most numerous. It has taken some mighty careful work to the part of the personnel to keep the station free from all criticism arising from others interested in radio in the vicinity. F. B. Ostman is the traffic supervisor for the Executive Council of the Second Radio District and is an officer of the Ridgewood Radio Club.

\*See page 25, April 1923 QST.

He has always kept right up to date and co-operated with other radio interests and endeavored to uphold a standard of operation at 20M that would be beyond all reproach. What this means can best be gained from the following rules, which are posted in the station at all times for the guidance of the operator on watch.

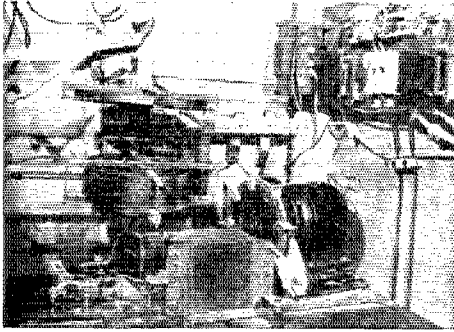

### Instructions for Operators Radio Station 20M

The large number of operators and the time given over to station operation is very large as compared with most other stations and the powerful spark set is heard sometime in each day or night. Due to this almost continuous operation it is very necessary that special attention be paid to the way the station is operated.

**Clean out sending** is desired at all times. This includes the perfect forming of the code characters, elimination of *unnecessary* abbreviations and double breaks, accuracy of transmission, etc. Sending very fast and stumbling over letters will not be tolerated. If an operator is qualified to send 20 to 25 words per minutes accurately and the receiving operator is able to receive that speed, all right; but it is desired to maintain an even speed of transmission of between 15 and 20 words per minute. This is the normal speed that the best amateur stations work on. In this way it is hoped to help set a good example to stations hearing our signals.

Eliminate as much as possible general conversation on the spark set unless the power is reduced to a minimum.

Use the C.W. transmitter for distant work when possible, raising the DX station by calling and making preliminary arrangements on spark.

Use the C.W. transmitter for local work. This is to keep local QRM and jamming in town and thru-out Northern New Jersey at a minimum.

It is desired to increase generally and show the advantages of the A.R.R.L. Operators are requested to help stimulate interest in the A.R.R.L. (Note: See A.R.R.L. Operating Department instructions attached).

Stricter adherence to the Second District Executive Radio Council's traffic Rules and Regulations is necessary. All infractions of these rules should be logged with full data, etc. (Note: See Traffic Supervisor's instruction attached).

Infractions of rules by all stations should be logged. A list of all stations *heard and worked* should be kept, to be logged in the daily log book together with other happenings of interest. These should be in the general order that has been followed thruout in the log.

A general outline of "petty instructions" has not been given here due to the fact that it is believed operators at this station are well qualified along radio lines to know the "do's and don't's" in operating.

On occasions when there are two or more strong spark stations working at the same time in this vicinity, it will be well to work transmissions in

turns, which can be decided by mutual agreement at that time.

If, when working a DX message, it cannot be cleared in three separate transmissions, sending station will advise QSU and try again later, unless only one or two words are required to complete said message in which case one or two more transmissions are allowable. Long efforts to work DX stations that are exceedingly weak should not be tried, unless to rush important messages by long jumps, or if no other stations in the vicinity are working or standing by.

Operators are requested to handle the apparatus with such care as they would their own.

A neat, orderly operating desk is to be preserved at all times.

Messages are to be written out *clearly*, printing the name, address and signature.

On leaving the operating room, all power switches must be opened, transfer switch must be in off position and heavy lightning switch grounded. This rule must be particularly adhered to during the summer months when electrical storms arise so quickly.

Operators will make it a point to listen in before transmitting and use the Morse letter C before transmitting if local station are working or listening in.

**Be Brief.**

This is a relay station; please eliminate all unnecessary conversation.

Operators are requested to furnish stations requesting readings of wave length and sharpness with the same at such times when relay work is not being carried on.

No abusive offensive or profane language will be tolerated over the air.

(Signed) F. B. Ostman	SF
Prescott Smith	SM
Walter Ostman	SW
L. Clark	SL
H. Rouctere	HV
John Eddy	JE

Turning to a description of the station, the operating room measures eight by ten feet and is located in the rear part of the house in a separately boarded off section of the laundry, three feet above the ground. A long workbench in the adjacent room is convenient when apparatus is being built or repairs are in progress. The operating room itself contains all of the transmitting apparatus except the motor-generator for the C.W. set. In one corner of the room is a cabinet in which are kept spare parts, magazines, and files. On top of this are filed books on radio, catalogs, and back copies of *QST* and the *Modulator*. Maps of different states are pasted on the window shades. Ordinarily a map of Northern New Jersey is in view, but by pulling window shades further down, other maps may be referred to. On the walls are maps showing stations thruout the country with routings for traffic marked. Framed pictures of amateur stations, cartoons on radio by "2AW's Porter" and the Executive Council and Club Members complete the interior decoration.

On the operating table is the receiving equipment which consists of a variometer set and a detector and two stage amplifier, and the transmitting keys. The antenna send-receive switch located just above the keys within easy reach. A C.W. transmitter employing two five-watt tubes is located on a shelf just above the send-receive switch. The various control switches are mounted along the edge of

the table and the batteries for the receiver are underneath the table. To the right of the operating table is the spark transmitter, and above it on the wall are mounted the power switches and protective fuses for the various sets. Now that a general idea of station 2OM has been formed, let us describe the station in detail, beginning with

#### The Radiating System

The antenna at 2OM is a slanting flat top of the inverted L type. The six wires

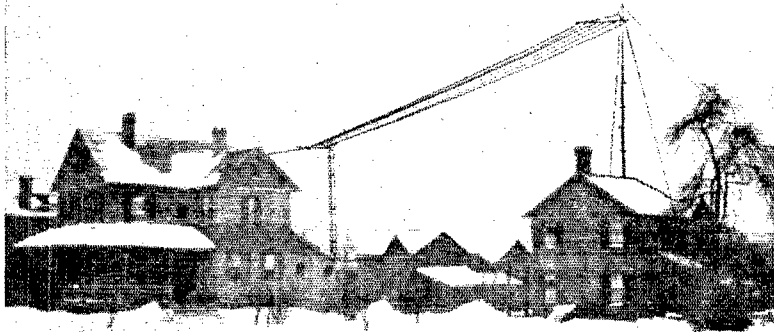

are spaced three feet on fifteen foot spreaders. The flat top is 75 feet long and 35 and 80 feet high at the house and far ends respectively. The spreader at the far end is of 1" iron pipe using a rope bridle and large electrose insulators. The lead-in is taken from the low end of the antenna and is a ten inch cage run directly to an electrose deck insulator in the wall of the radio room. A heavy lightning switch is installed to take care of static charges on the antenna.

The ground system consists of all of the water pipes in the vicinity connected with heavy soldered jumpers, a well and a cistern in which large plates have been sunk, strips of roofing tin one by thirty feet buried under the antenna, and heavy copper strips connecting to the nearby wire fences.

The counterpoise is of a delta shape, two wires 150 feet long and 60 feet apart at the far end, where another wire connects them together. The counterpoise is eight feet high.

#### The Spark Transmitter

Power supply is obtained from a separate service of 60 cycle A.C. at 110 volts. This is furnished from a 3 kw. pole transformer feeding through a 15 ampere meter. No. 8 rubber covered leads run from the meter to the switchboard shown to the right of the spark set in the picture. All other power wiring is in BX cable with the sheath grounded. Suitable protective devices are installed in the transformer primary and rotary gap circuits.

The transformer is a 1 kw. United Wireless "coffin" with a 20,000 volt secondary. Power is varied by means of the taps on the primary of the transformer and a large home-made choke coil, also tapped, which is connected in series with it.

The condensers in use are two .014 mfd. 25,000 volt Dubilliers in series, giving .007 capacity, and a large home-made ¼ inch glass plate condenser immersed in transformer oil. This latter condenser consists of 20 plates 12 by 14 inches, covered on

each side with tinfoil 10 by 12 inches. Each plate fits into a separate compartment in a rack and all connections to the plates are made thru phosphor bronze springs. The maximum capacity of this oil condenser is approximately .009 mfd., but this value can be varied by an arrangement of taps brought out thru bakelite bushings and connected with heavy brass clip jumpers. This oil immersed condenser is connected in parallel with the Dubilliers and the total capacity of the combination is from .014 to .016 mfd. No trouble has ever been experienced with this condenser from broken down plates and the efficiency seems quite high.

The primary of the oscillation transformer is of three inch brass ribbon, clamped between ½ inch bakelite strips. One complete turn is used for 200 meters. The secondary consists of ten turns of one inch brass ribbon mounted in a somewhat similar manner, as shown in the picture. The normal distance between the primary and secondary is six inches.

The rotary spark gap is a Grebe 8-point "sink" which runs at 1800 r.p.m. and gives a 120-cycle note.

Heavy copper leads can be seen behind the spark gap coming up from the various ground leads to clip on to the O. T. secondary. The antenna ammeter is a Weston 0-6 thermo-couple meter in series with the antenna lead. This lead is of two-inch brass ribbon supported on wall insulators. These insulators are nothing more or less than old telephone receiver cases. The

cap is fastened to the wall with a few screws and the shell is screwed back in place and the lead attached to the top. Thus an insulator that is simple, yet hard to beat, is formed.

The input of the spark transmitter, less that used by the rotary gap, is 930 watts on full power. The gap draws 287.7 watts when running. The antenna current varies between 6½ and 7½ amperes on full power. That this transmitter is efficient can best be judged from the results obtained, which equal those of any other spark station in this section of the country.

Several different C.W. sets have been used at 20M during the past year. The spark set is still the main standby at this station, and although a good C.W. set will no doubt be forthcoming in the near future, those used to date have been more or less of an experimental nature as they were not permanent.

The third C.W. transmitter was used at this station was one using one 250-watt DeForest Singer tube in a "1DH sure-fire" circuit with A.C. on the plate. An old Thor spark transformer was re-wound to give various desirable plate voltages and an Acme 150-watt C.W. transformer was re-wound to give the proper voltage for the filament. This set was only in use a short time and only 1.5 amperes were obtained in the antenna with it

**Control and Switching Arrangements**

Two knife switches along the right hand side of the desk control the power and rotary gap of the spark transmitter. Behind these is a D.P.D.T. switch which when thrown one way will start the motor-generator and light the filaments for the C.W. transmitter and when thrown the other way, will light the filaments and supply A.C. to the plates of the tubes. A system of clips is provided for changing

C.W. & PLATE VARIOMETERS-ANTI CAPACITY SWITCHES TO LEFT, COILS PARALLEL-WAVE LENGTH RANGE: 148 TO 235 METERS UP RIGHT SERIES " " " " 180 TO 350 TO RIGHT " " " " 425 TO 1400 \* CONDENSER SHUNT ON GRID SEC. COUPLER & PLATE VARIOMETERS

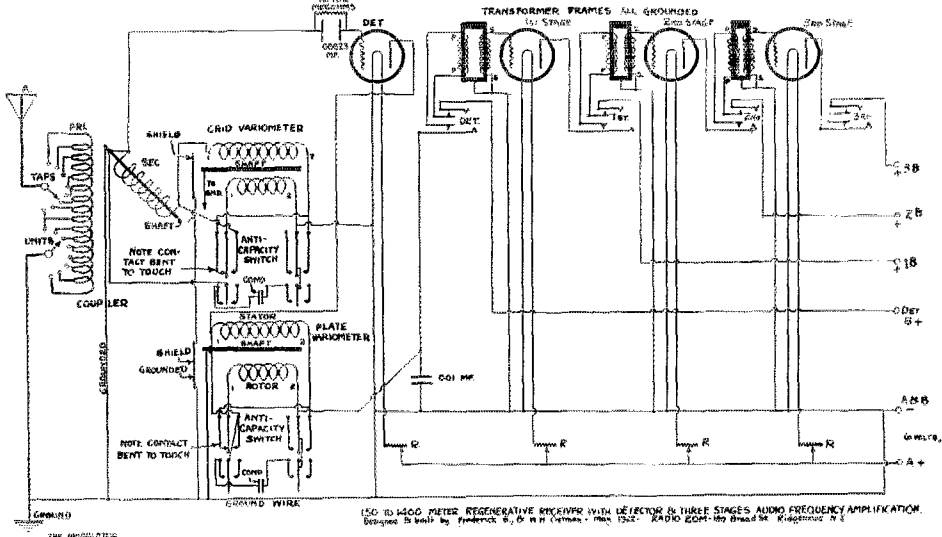

**C.W. Equipment**

The first C.W. transmitter in operation at 20M was built in November, 1921, and was in use during the early part of 1922. It used two five-watt tubes in a full wave self-rectified Hartley circuit. This is the transmitter shown in the station picture, just above the send-receive switch.

The transmitter used during the summer of 1922 was a set employing four five-watt tubes in a Hartley circuit. A 500 volt motor-generator, located just outside the radio room, furnished the plate supply. This set was arranged panel type and was complete with switches for using either C.W., buzzer, or phone.

the antenna, counterpoise, and ground leads from spark to C.W. or vice versa.

The send-receive switch that is mounted just above the transmitting keys switches the antenna circuit to either transmitting or receiving. The ground remains connected directly at all times. This switch also breaks the B battery current to prevent the receiving set from operating when power is connected to the spark set.

**Receiving Equipment**

The receiver used during the early part of 1922 and shown in the picture of the station is a regenerative receiver of the variometer type with a detector and two

(Concluded on page 78)

# The Junior Operator



## On Being An Amateur

The First of a Series of Articles of Helpfulness and Practical Value to Those Just Entering the Amateur Radio Game.

By H. F. Mason, Department Editor.

**T**HERE are thousands of people who, thru the medium of the broadcast, have become intensely interested in radio. Because of their great enthusiasm rapid progress has been made and these people are now able to receive the broadcasted programs from coast to coast. If you are one of those who have reached this stage, you are most likely possessed of a desire to stick to the radio game and go after greater laurels. It is our intent and earnest desire that you have a transmitter,—as well as a receiver—that you should learn the code, join the ranks of the amateur, and go after greater DX, greater distance. The object, then, of this series of articles is to extend the helping hand of amateur radio and good fellowship to all who would grasp it.

Many persons believe that the radio bug bites but once, and that in the course of time the victim regains his normal condition. Indications are, however, that the bug bites twice. Even if you have been interested in radio for some time, it is, in reality, a bad sign when you unconsciously try to make out the dots and dashes that come down your antenna and wonder what station is sending them; then again, perhaps, commence to wonder whether it would be very hard for you to learn the code; and lastly, when your mind wanders to visions of being able to communicate with a friend down the street or even in the next town without the aid of wires. You chance upon a copy of *QST* and become greatly interested therein—then truly you have been bitten by the radio bug the second time and are doomed to wear phones on your head for the rest of your life.

Within the last few years amateur radio has grown to such a vast extent that it is impossible for one to learn all of the tricks of the trade in the space of a few days. No longer can you be the dominant radio man in your town if you accidentally discover how to connect a spark coil straight on to the antenna and transmit miscellaneous sig-

nals into the ether. To become an amateur now means far more than this. It means that you must have a good all-around knowledge of the radio art and know how to apply it. A radio amateur is a wide-awake sort of a person who has cultivated the trait of being observant of everything that goes on around him, as far as radio is concerned, especially of those things that he can modify and apply through his own ingenuity to his own apparatus at home. He knows the latest circuits and also if they are good or not. He knows the latest DX records and is an individual who looks at the radio art from a most practical standpoint. He must of course also—and it comes second nature to him—combine a sensible amount of theory with the practical information that he has in his brain.

To one just entering the amateur field there is the big question of just how to proceed. Of course there are books on amateur radio, but a book is helpful only to aid the mind, and the mind of an amateur radio-man does not usually turn to books but rather to experimentation and the working out of problems for himself. Nevertheless, from time to time in the course of these articles, reference will be made to books and magazine articles when such information will materially aid those who pursue the following course.

It is only a case of becoming genuinely interested in amateur radio; then if you are of sound mind and possess the customary amount of gray matter you will within six months or so be one of the "gang."

From the very beginning, amateur radio may be spoken of as a game. As an amusement or diversion it differs from all others because of its very vastness and the unlimited opportunities placed before the players to excel. Amateur radio is a pleasant blending of recreation, learning, scientific research, and emulation that is surpassed in no other way. Every game must have some objective or goal; something to work and strive for. In amateur radio there are two that are as guiding stars, leading the

amateur onward. These two things are "DX" and *service*.

Truly they go hand in hand, but for the purpose of analysis, let us consider them as separate. "DX" is an abbreviation used in radio work meaning "distance." It is the constant aim of the amateur to cover distance; to annihilate miles, so to speak. Why? Because therein lies the chance for competition, and the greater the competition between the players the more exciting a game becomes. It is this desire to excel, by having the signals from your own station reach out just a little farther than those of the other fellow, that has gathered into the radio game people young and old, from all walks of life.

In order to be able to design and build a set for either transmitting or receiving over very long distances, you should have a clear understanding of the function of each piece of apparatus in the set and must know what is taking place in the various circuits. Being able to cover distance means, therefore, that your apparatus must be well designed; so in accordance with the latest and most advanced practice of the art—which is continually changing—it is necessary that your station work better than the other fellow's. Of course, accidents do happen, such as when a person has a streak of luck in getting something to work when he didn't expect it to, but it is far better to be on the safe side by acquiring at the outset a knowledge of the elementary principles involved.

In order to cover distance, one must know the operating side of the game. The "etiquette of the air" as it is sometimes called is a practical necessity to the telegraphing amateur. In order that you may take your key in hand, go on the air where dozens of other stations are working, do greater DX, and establish more reliable communication than the other fellow with a more powerful set requires a degree of operating ability and skill that should not be underestimated. The mere knowledge of the code is only a prerequisite. The rest can only be learned by actually getting on the air and working other stations. Here, again, your powers of observation will be brought into play, and you will profit by the examples set by others.

An amateur must not only be a good operator but should be a good co-operator as well. If you listen in any evening on 200 meters you will hear many stations working. There are at present over 21,000 of these stations in the United States, licensed to transmit on the same wavelength, 200 meters. Can you imagine the chaos that would result if there were not some understanding and some co-operation between the owners of these numerous stations? Again the rules of the road come into play, and you are placed upon

your honor as an amateur to conduct your station in a proper manner.

To perform a service is the other goal in the radio game. This is one of the main reasons why amateur radio continues to expand and grow. The amateurs of the country are performing a service, and are a necessity. The service that is most evident is that performed when an amateur accepts a message and transmits it via his station to a friend or relative in a far distant city. Then, too, if conditions are right, if perchance the luck of the amateur as a player in this great game is good, an answer will come back the same night. There is no question as to the service given the community when it has a station that accepts these messages from the people and transmits them without charge to their destination. Did you ever stop to consider that this is about the only way in the world that one can convey a bit of information to a distant friend without cost to the sender?

But think of the amateur radio relay in a broader sense than the handling of personal messages. Remember the possibilities of radio as a means of communication. It has been shown, time after time, that amateur radio has risen to the occasion and rendered its service when other methods of communication have failed. In times of floods, storms, and other communication-destroying influences, amateur radio has proven its worth too many times to mention here. Would you believe it that many of the leading railroads keep on file the names and addresses of capable amateur radio men along their lines—for just this purpose? There is coming to be a greater responsibility placed on your shoulders when you sign the application for a license to operate an amateur station. The government also realizes the value of the radio amateur to the country in time of a national emergency. So the amateur must justify himself by adhering to high ideals in radio both as regards his operation and his technical knowledge. Now this does not mean that you should take on a long face and put it into a bunch of books; rather the opposite; you should learn to be observant and store away in your mind, for future use, all things in radio that attract your attention.

Inasmuch as there is such a great number interested in amateur radio as their hobby, it is only natural that they find some means of co-operating in the exchange of experiences, ideas, and so forth. It was not long after amateur radio came into being therefore, that the first radio club was formed. The idea grew until today every town or city of any size has its radio club in one form or another.

The radio club is a definite unit in the organization of the amateurs of the country and for that reason it is very desirable that you, as a potential amateur, join your local radio club. Of course radio clubs differ in their make-up, but even so the participation in the activities of a radio club will assist you greatly in becoming a good amateur.

Let us learn more of the organization of a typical amateur radio club. The spirit of competition and friendly rivalry between the amateurs of a city is usually so great that the club needs to be a piece of democracy itself in order to exist. In a good club every one of the members takes an active interest in the club's affairs and is interested in making it a bigger and better society. Besides the customary officers of any association, it is usual to assign the various activities of the club, with their responsibilities, to committees, and a large part of the success of a club depends upon the proper performance of these committees in their respective duties. Chief among the committees is the "interference committee" otherwise known as the "traffic committee." The object of this committee is to further co-operation as regards actual use of apparatus in carrying on radio communication. In order that every one may get equal and maximum enjoyment out of the use of his radio set it is necessary that the individual subordinate his own pleasure to a certain extent for the benefit of the whole. These concessions take the form of a set of co-operative rules, adopted by mutual consent of the membership. It is the responsibility and duty of the radio club, through its set of traffic rules, to uphold and maintain high standards of operation and co-operation between the amateurs of the town. The report of the traffic committee consists of a general summary of conditions on the air since the past meeting. Any interference or violation of the club's rules is brought to the attention of the club and steps are taken to run down and do away with anything detrimental to the best interests of amateur radio in the shortest possible time.

Another important committee is the one that plans the meetings and promotes the general welfare of the club, thus making it a pleasing adjunct to the radio set at home. The work of this committee, often referred to as the "program committee," includes the making of arrangements for not only the regular meeting, but also banquets, mast-raising parties, auctions of apparatus, raffles, theater parties, and in general anything that would tend to liven up and add "pep" to the club. Following the business meeting it is usual for one of the members to address the club

on some subject relating to the practical operation of amateur apparatus. This acts only as a trigger, however, for the volley of discussion which follows.

A radio club is limited in that its scope includes only one town or city. It is frequent that conditions arise that make it necessary for all of the amateurs in a section of the country to get together and concentrate their united efforts towards accomplishing a result that will be beneficial to all.

So, then, amateur operators have co-operated in a larger way than in the club. In different parts of the country they have met and organized what is known as "district councils." These councils extend co-operation between the amateurs in a certain section of the country. A big convention is held once a year by each council, and every member who can possibly obtain the means, attends the convention. There is a great spirit of friendship and brotherly feeling in an amateur that causes him to have a strong desire to meet the other fellow who he hears and talks with over the air; to see what he looks like, and—to use amateur parlance—to "chew the fat" with him. The delegates who form the governing body of the council are chosen by the amateurs themselves and the secret of success of the council lies in the fact that everyone is satisfied, because he, himself, helped to perfect and knit the organization together. Therefore he will be unable to pick any flaws in the organization of the council or its work and must accordingly be a booster. Each amateur must be a definite part of the organization and not a misfit. In these days of radio chaos there is need more than ever for a strong amateur organization. You should, therefore, put your shoulder to the wheel early in the game, get the spirit of the thing, and be a booster.

As the crowning glory to amateur co-operation there is the national organization of amateurs, the American Radio Relay League. Through this large co-operative body of amateurs there has been accomplished for the country at large, what the radio club accomplishes for the single town. The affairs and policies of the League are governed by a Board of Direction consisting of seventeen men elected by the amateurs. All of the way through it is truly an amateur organization. An important part of the League's organization is the "Operating Department," so called because the men who make up this department of the League are those amateurs in all parts of the country who are actively engaged in the operation of amateur stations. These men are the voice of the League in their vicinity and have helped to perfect the great network of relay routes that we have today. The spirit of emulation between

the operators of the stations is very keen and each amateur tries as hard as he can to excel in the number of citizen radio messages handled at his station each month.

From time to time special relays and tests are held which try the skill and ability of the amateur and his station. Summarizing, the Operating Department is composed of the amateurs who are really getting a maximum amount of enjoyment out of the radio game. They play the game of amateur radio for the same reason that you play chess, tennis, or golf; i.e., for the love of the game; and for the fun and benefit it will bring to them.

Now that you have an idea of what being an amateur means, let us extend you a hearty welcome into the amateur game and help you in every way possible to become a "dyed-in-the-wool ham."

## Better Buzzer I.C.W.

By H. F. Mason, Department Editor

**H**ERE'S a good simple method of buzzer modulation for a low powered C.W. set that is an improvement upon previous absorption modulation methods.

The diagram shows the apparatus and its connections. An inductance is connected across the contacts of the buzzer with a .002 mica phone condenser in series to prevent shorting of the buzzer contacts.

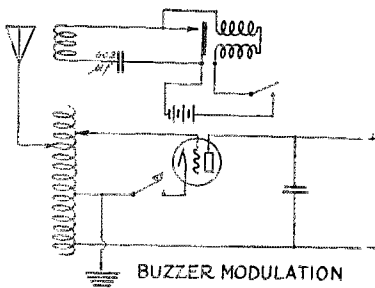

This inductance has about four turns of wire and may be wound in any manner suitable. If the transmitter uses the reversed feedback or 1DH circuit this coil is placed inside of the grid coil or the four turns of wire may be wound directly on top of the grid coil. If the Hartley or Colpitts circuit is used, the coil should be placed inside of or near the main inductance.

In order to change from C.W. to I.C.W., it is only necessary to put the modulating coil in the proper position and close the switch in the buzzer circuit. This starts the buzzer, which operates continuously; the transmitter is keyed in the usual way, the same as if C.W. were being trans-

mitted. What happens is that the action of the buzzer causes small pulses of current in the inductance and condenser connected across its contacts. When the key is closed and the transmitter is put into operation, these pulses immediately break up the C.W., and a steady and pleasing I.C.W. note results.

The good thing about this arrangement is that nothing will reach the receiving operator unless the transmitting key is depressed. There is no back or spacing note, as there is in many buzzer modulated sets, to interfere with the reception of the buzzer note, even if the receiving set is in an oscillating condition. If a self-rectified set, or a set using a rectifier but no filter, is modulated in the above manner, the transmitted note will sound very much like a rotary gap set depending of course upon the pitch of the buzzer.

The credit for this particular arrangement of absorption modulation goes to 3BJY of West Philadelphia who finds it is the "whale's raincoat" for calling and collecting local traffic.

## THE OPERATING DEPARTMENT

(Concluded from page 49)

ed 9BX on the last night of the tests. Other stations heard very QRZ were 9AL, 4BV, and 8NI. SASKATCHEWAN: Gosh, it was only about three months ago that 4BV and 4HH had the air all to themselves, and popular RUMOR stated that it was absolutely impossible to QSR east to Regina from Saskatchewan. (Look us over now, gang!) Along comes 9BX ex-4CB with those two fifties, then 4FV and 4AJ open up in Regina. Next thing we hear is 4AO claiming a space in the air with his ten watts. Guess we will have to wait until he gets through juggling with his rectifier and then he'll show them. 4AL, 4ER, 4DN, and 4CG are all 5-watters. 4GG has much trouble to keep the old air drum propped up. 4IH is patiently waiting for the generator which will put another good D.C. station in operation. 4BB is still razzing away with  $\frac{1}{2}$  K.W. rotary spark—has a fine counterpoise too. A.D.M. J. E. Maynard introduces himself via 50-watts signing 4FN Saskatoon. By gum, he's sure got some smoke!

Well gang, about QSR east through Saskatoon to Winnipeg. N.D. 4BV pushed a hole through to 3NI at Fort William and then 9RX shows us how it is done. 4CN, 4CO, also 4DK register west. (F.B.) 4DY worked 4HH on a 5 so that's that spook chased down.

## INTERNATIONAL AMATEUR NEWS

(Continued from page 52)

four amperes into the antenna, but as we had a schedule with 4YD and wanted to work 4OI we tried to increase power and then things began to happen. The radiation went over five amperes which gave a sad end to our five ampere thermoammeter. Next one bottle gave away, punctured in the seal. Then went the bypass condensers, then still another bottle—punctured too. Even so, we agreed that the pleasure in working the above

(Concluded on page 66)



# Strays

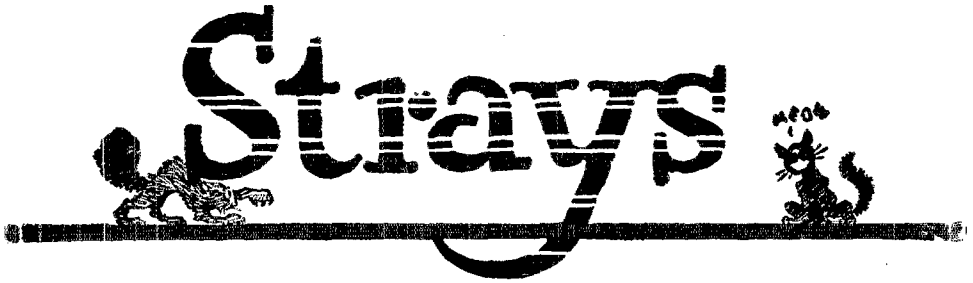

Someone has started the wild theory that every time another tube is added to a sending set the antenna current should rise about one-third. This is bunk. If the efficiency remains the same, and there is no change in wave or input voltages, the antenna *power* (watts) will be increased in proportion to the number of tubes.

The antenna *current* is increased in proportion to the *square root* of the number of tubes. Here is the simple rule that applies: The antenna current to be expected is equal to the old antenna current times the square root of the new number of tubes, divided by the square root of the old number of tubes. If you have a good ammeter, figure this out. If it does not follow in your case, either the plate or filament voltage is pulled down or the set needs readjustment.

Whenever the BCL next door raises HX about the guy that is supposed to be holding down the key of a punk spark set it is time to raid all the single cct. tuners around the neighborhood and see who it is that is using a vibrating battery charger to charge his filament batt. while it is still connected to the receiver. This is Reason 5,678,953 why we think the antique single circuit ought to be in Gehenna.

Now they are gonna can the wave length and get to talking about the frequency we are working on—it isn't 200 meters any more, it is one and one half million cycles or else 1500 kilocycles. Now we wonder how that is going to be distorted by the boob that at present insists on speaking of "broad wave lengths."

Can anyone think of a good reason for calling CQ 30 times and then signing 30 times? For Pete's sake why not throw in a sign at intervals instead of saving them all for the finish. Remember sigs fade usually just after you finish the CQ's and start to sign. Mix 'em up.

3HU tells us the story of the darkey who entered a radio store and "desired very much to get a Venus condenser of a certain captivity." Howzat?

Outright purchase of the entire business, good will and patents of the DeForest Radio Telephone and Telegraph Co. has been announced by President E. H. Jewett of the Jewett Radio and Phonograph Co., of Detroit, Mich. As a result of the purchase, Mr. Jewett and his associates are in possession of 181 radio patents, among which are the basic right to the three electrode tubes and all other tube manufacture as conducted by virtue of license under the DeForest patents. The purchase also includes the extensive new plant of the DeForest Company at Jersey City, N. J. Dr. DeForest will continue his activity with the company as consulting engineer and a large share of his attention will be devoted to the perfection of equipment by means of which the human voice may be synchronized and reproduced in conjunction with moving pictures; thereby adding a widened range of interest to the hitherto "silent drama."

What kind of results are you getting with "S" tubes? Those that use them do not seem to have much to say. Come on, fellers, let us have the dope.

Everyone who uses separate plate and filament transformers watches his filament voltage drop as he presses the key and wishes he were hooked on to a 100 K.V.A. transformer. Such mental anguish is unnecessary. Simply put ten or fifteen turns of lampcord around the plate transformer core and put them in series with the filament transformer primary. With right polarity and correct number of turns, the filament voltage will be absolutely constant. Where the line voltage regulation is bad, this will materially lengthen the life of the tubes and increase the antenna current—9BHD.

Some A-1 Dope on Simple Receivers for the fellow that wants to break into the receiving game. If he wants to make his own set and wants to do it right without spending 6½ fortunes in the process, there is respectfully offered the suggestion that he lay off the radio funny-papers that come with the Sunday paper and spend a few cents for some honest-to-goodness

information regarding apparatus that will WORK. Incidentally, our whole gang is likely to learn something from this. Here's how: Send thirty cents (not in stamps) to the Supt. of Documents, Govt. Printing Office, Washington, D. C., and ask him to send you the following Bureau of Standards pamphlets:

Circular 121, "Construction and Operation of a Two-Circuit Receiver."

Circular 133 or Letter Circular 48, "Description and Operation of an Electron tube Detector Unit."

Letter Circular 49, "Description and Operation of an Audio Amplifier."

Letter Circular 78, "Design of a Short-Wave Wavemeter."

We have had several requests from persons who desire to rig up some sort of a wired wireless system that can easily be installed between houses so that our Junior Ops. can practice code without busting up radio in the vicinity—something that will utilize the receiving equipment that they already have. Will someone kindly step forward?

British 2SH has heard 1ZV and 1ZZB during the past month. The cards are at QST headquarters. Will the persons signing the above calls please speak up?

The cost of fuse plug maintenance is a story of the dark ages now. Remove dead fuse and insert case knife. If it fuses, repeat the insertion; the knife is good clear up to the handle.

Hark you northern birds. Do cold nights freeze your tubes? Eliminate your rectifier troubles by adding a little alcohol to the acid solution or by placing lighted candles between the rectifier jars to keep them from freezing.

6ZZ must have a menagerie around his sunny Arizona home. After throwing the Corona at the cat (See pg. 18, June, 1922, QST) he now tells us that the tail of his yellow dog did not stop the "synk" rectifier from running the other night.

Canadian 3NI doesn't like the stunt American hams have of putting two cent stamps on their post cards going to Canada. One cent is all that's necessary, fellows. If eight hundred stations heard 3NI that would be the price of a good tube saved.

Pre-war double filament audiotrons are getting scarcer'n good lick. A friend whispered to us on the QT the other day that 8ANB still has six of them. Of course they're under double lock and key, though.

Every cloud has a silver lining. So has the mess of gurgles and squeaks on

200 meters. The following stations according to 9BOH are to be complimented on their exceptionally good C.W. notes: 5ZX, 8ER, 8BRT, 3HU, 9CJC, 9BKP, 9BXT.

Major Lawrence Mott, of 6XAD fame, announces that he is now 6ZW in addition to 6XAD.

Say gang, name some candidates for "Who's Who" and "Amateur Radio Stations" and we'll go get 'em. Hw?

Down deep amongst the flood of letters regarding the Grimes Inverse Duplex set, the following just caught our eye: "Dear QST: I hooked up the Grimes reflex and was very surprised at the results obtained though I haven't put up my antenna or loop yet."

"—and just think, kiddies, Uncle Wiggly was going to have a *Wireless Radio set!*"

There's the WD-11, the WR-21, the WD-12, the WT-501, the VT-24, the Q tube, also some DP-1s, and they're all "peanut tubes" and Oh, gosh! what's the use of differentiating?

Our Publicity Department, in putting over the fact that "Ain't it grand to be an amateur" would appreciate hearing the experience of amateurs on "Friendships I have Formed by Radio" We feel that this would make an excellent story and look to you for help.

If we can't get those DX cards in one way, we'll get them in another. 8CPY will give a printing plate to print cards with call letters like his own to the first ten cards received from over 1000 miles from Kalamazoo, Michigan, reporting 8CPY's signals on 100-watt fone and to the first five who report his C.W. over 1500 miles distant. Reports must be complete and check with log.

Hey!! you fellows that are exploring 100 meters. Remember that the amplification obtainable with a super-regen set varies *inversely as the square of the wavelength*—four times the amplification on 100 meters as on 200.

All right, you math. sharks—break out the slipstick. If the log of 100 is 2 and the log of 1000 is 3, what is the log of an amateur?

2BBB tells us that no one will answer his CQ's because they are afraid of being stung by the B's—Clank!!

2AGB handled over 500 messages one month *without a single CQ*. That's the way to show 'em up. OM.

## NEW APPARATUS

This department is conducted for the purpose of accordng free publicity to advertisers. It stands on its own bottom. Its purpose is to give QST readers accurate information on new products. Apparatus described here must be sufficiently interesting to give its description and interest to our readers. The contents of this department will be selected each month from the most interesting material at hand.

### THE JEWELL WAVE METER

The Jewell Electrical Instrument Co. of Chicago has placed a wavemeter on the market at a very reasonable figure that has many good features. It is enclosed in a walnut case about six inches square, with a hard rubber panel carrying a lamp socket, two binding posts and a condenser scale. The variable element is an air condenser of superior design, working in connection with a fixed pancake coil to which is loosely coupled a single turn containing the lamp or other resonance indica-

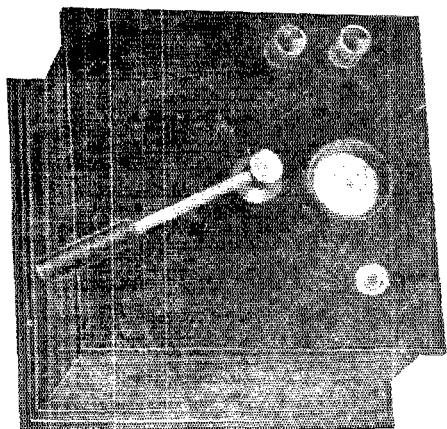

tor. The lamp is surprisingly sensitive and will give a good indication when the coupling is twelve inches to the oscillation inductance of a 5-watt C.W. set. A plug and cord is furnished with each instrument to connect a current squared galvanometer in place of the lamp when such an arrangement is desired for higher sensitivity or for decrement measurements. The two binding posts on the panel are connected to the two ends of the main inductance coil and permit the attaching of a buzzer and battery to the meter for generating damped oscillations.

These wavemeters are calibrated on a C.W. driver against an accurate standard, and the scale of each meter is hand calibrated and hand drawn after being directly compared with the standard at a number of points. In this way, the calibration of each meter conforms to the par-

ticular characteristics of each instrument and a very good accuracy is obtained. Each one of these instruments is calibrated to be exact, but a guarantee that the error is less than one is given to cover unusual conditions such as bad shocks in shipping that may disturb the calibration. The wave length range of the Jewell wavemeter is from 150 to 625 meters.

### THE CARDWELL CONDENSER

A variable condenser is one of those pieces of radio equipment that will continue to be made and sold as long as radio sets are built. The average purchaser does not realize the great difference electrically between a really good condenser and the many inferior makes on the market today. To him a variable condenser is a condenser and that is all that is necessary.

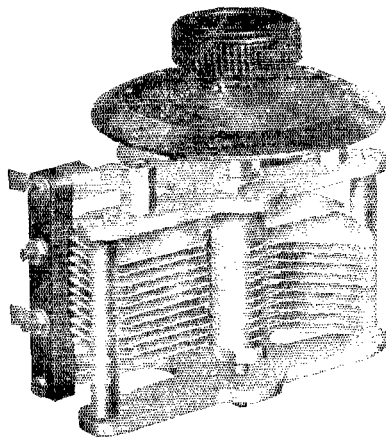

Air is a good dielectric, therefore, it is used in variable condensers as far as possible. Nevertheless, in order to be constructed at all, the two sets of plates must be supported and insulated from each other by means of some solid dielectric. Aside from the capacity between the plates of the condenser there exists a fixed capacity through the solid dielectric. In order to insure that the condensers have a very low minimum capacity—and this greatly increases the range of usefulness—the value of this unvarying capacity

through the dielectric must be kept as low as possible. Furthermore, the less this capacity is, the smaller will be the proportion of the total current through the condenser that becomes absorbed and wasted by the dielectric. These losses are very pronounced on very short waves.

With the above, and all other more generally recognized points of condenser design, in mind the Allen D. Cardwell Mfg. Corp'n. of Brooklyn, New York has placed on the market some variable condensers of very superior design and workmanship. Both electrically and mechanically they are excellent. The power losses in the dielectric are kept small by using hard rubber insulation and locating it where the electric field intensity is not great and by using pieces of such size and shape that the capacity thru it is small. The total area of contact between the fixed plates and the dielectric mounting strip is less than one fourth of a square inch. This is made possible by a new design in which the stationary plates are insulated from the aluminum end frames. If the end frames, movable plates, and metal dial are used they are all at the same potential, which is an advantage as the condenser can be directly mounted on a metal panel without any special insulating bushings. Mechanically, the Cardwell condenser is a fine piece of work. The end frames and plates of heavy aluminum are exceptionally rigid, insuring a permanent alignment of the plates.

For 100 meter work the Cardwell condenser is among the very few that work at all, and on 360 meters, on actual test signal strength was nearly doubled by substituting a Cardwell condenser for the one previously used.

#### THE CITIZENS' RADIO CALL BOOK

The May, 1923, issue of the Citizens' Radio Call Book which is published semi-annually by the Citizens' Radio Service Bureau at Chicago has recently made its appearance in the radio stores. The size of this edition has been greatly increased over that of previous issues and it now contains 176 pages of information. The list of calls have been revised and many corrections have been made. The book not only contains complete lists of the amateur and broadcasting stations in the United States and in Canada, but also includes a list of the naval stations, foreign time and press schedules, high power transoceanic schedules, and other material of value to both the amateur and commercial operator. Advertisements of the foremost radio manufacturers appear throughout the book. Of course the book would not be complete without an A.R.R.L. section, so four of its pages are devoted to a directory of our A.R.R.L. including

the operating department. A map of the country showing the A.R.R.L. divisions and a letter of introduction to the prospective amateur is also printed. The last eight pages are devoted to a good collection of practical hookups and radio formulas. Considering the wealth of information contained within its covers, the Citizens' Radio Call Book should be on the table of every radio station.

#### INTERNATIONAL AMATEUR STATIONS

(Concluded from page 62)

stations was worth the two or three hundred pesos that it cost us. We now have a single fifty-watt tube with from 4 to 4½ amperes in the antenna and are able to work 5EN, 5KC, 5XAJ, 5ZAK, and 5XAD. The antenna is a flat top of four wires of the inverted-L type thirty feet above the roof. It is 60 feet long, and a chicken-wire counterpoise fifteen feet below the antenna is used. By September of this year we will have a 500-watt set and a big T antenna.

"We are trying to locate stations in Central and South America and would be glad if you could help to put us in touch with somebody down that way, OM. Will be glad to be appointed official relay station. Please let us have two subscriptions to QST and two membership certificates. Please address mail to: Ramirez y Herran Ave Rep. Argentina No. 95 Mexico City, Mexico.

"We are on every night after eleven P.M. C.S.T. on a 250 meter wave exactly, according to XDA's wavemeter, and are QRV for traffic for this city, we can also relay to Guanajuato, Gto., Mexico."

J. R. Herran "JH"

Station AX is also located in Mexico City and is a 10-20-watt fone or straight C.W. set, working on about 220 meters. This station has been reported heard by many amateurs in the southern part of the United States. Mail for AX should be addressed to Joe M. Velasco, Apartado Postal Num. 867, Mexico D. F. Mr. Velasco is very anxious to co-operate with American amateurs and wishes it to become known that Mexican amateurs are very much on the job and are anxious to form a route to South America. He especially urges that American amateurs remember that all two letter calls are not "outlaw" stations, as AX, BX, CX, DB and CM are all endeavoring to co-operate with other amateurs to the fullest extent.

BX is the station of Harold T. Mapes, pre-war 3AUC, who now operates a twenty-watt set at Guanajuato, Gto. Mexico. He has worked fifth and sixth district U. S. stations and has been logged by 6ZY of Honolulu. An excellent description of his station has just been received and it will appear in an early issue of QST.

# Calls Heard



The attractive cover that adorns QST this month is the generous contribution of Jas. A. Wilson, SCPY. "Local QRM" is a particularly fitting subject, and as interpreted by SCPY strikes a vulnerable spot—the amateur's pocketbook. Again we compliment you, OM, on the fine piece of work and the interest you have taken to make QST better.

9BIK, 9BKP, 9BK, 9BXT, 9BSG, 9BP, 9BZZ, 9BLY, 9BRK, 9BGS, 9BJU, 9BEY, 9BKM, 9BKK, 9BSQ, 9BXM, 9BX, 9CNA, 9CNY, 9CPU, 9CR, 9CDE, 9CMK, 9CGK, 9CNS, 9CUC, 9CFY, 9CKM, 9CWC, 9CCV, 9CBA, 9CCU, 9CTG, 9GVO, 9CFU, 9CPA, 9CJE, 9DQU, 9DKQ, 9DGE, 9DWK, 9DSM, 9DQM, 9DKY, 9DFB, 9DGV, 9DBL, 9DZ, 9DTM, 9DSD, 9DFD, 9DZY, 9DWF, 9DFQ, 9DVJ, 9DUG, 9EBT, 9EHJ, 9GK, 9GN, 9HK, 9IG, 9IY, 9IR, 9LN, 9PN, 9PW, 9PI, 9RE, 9RC, 9UU, 9VE, 9XAQ, 9XAC, 9YAJ, 9YM, 9ZAA, 9ZT, 9ZN.

All the above stations are over 600 miles distant Spk. Stas. 4GN, 5AGH, 5AG, 5ACQ, 5FZ, 5FL, 5HZ, 5JN, 5JD, 5KK, 5RB, 5RA, 5TG, 5TP, 5UD, 5UG, 5XAJ, 5XA, 5KAC, 5YG, 5UK, 5QS, 5ZAI, 9AQE, 9ASO, 9ATT, 9BMN. Mexican Stas. CX, JH, AX, DB, CM.

Would appreciate a QSL if anyone hears my call "BX" over 1500 miles.

### French 8AB—Nice, France

Dec. 10 to Mar. 20, 1923.

C.W.: 1ARY, 1BCG, 1BDL, 1BEF, 1BGF, 1XM, 1YK, 2BQH, 2KL, 2XQ, 3EX, 8AQO, 8AW, 8BSY, 8CYH, 8DA, 8MZ, WUBA.  
SPARK: 2FP.

### J. B. Stout, Hanscom, Alaska.

C.W.: 3CFU, 4CN, 5ZE, 6AW, 6AQO, 6AOC, 6AWT, 6AVN, 6AVP, 6BNT, 6BON, 6BVG, 6BRF, 6CU, 6CO, 6CGW, 6IF, 6GK, 6XAK, 7ACA, 7AEA, 7AGF, 7BA, 7BV, 7BJ, 7CS, 7CH, 7ZU, 7NE, 7ABB, 8BOA, 9ABU, Can. 9BP.

### 2ASE at Sea, West of Honolulu.

All C.W. and over 4000 miles. Log kept in E.S. Time. Feb. 18th 1936 miles W. of Honolulu at 3 A.M.: 4:05 A.M. 6BJQ calling 9APW, QSA but QRN bad. 4:16 6BJQ calling 7SC.

Feb. 19th 2194 miles W. of Honolulu at 4 A.M.: 2:59 A.M. 6BOE calling 4CN saying QRZ-QSZ. 9BED calling 9BXM "did u deliver message? 6XK calling 6XA. 6BOE calling 4CN. 9(?) calling 2AN QSA but QRN broke call. 4CN calling CQ-long call. 6AJF calling 9BPT. 7SC calling 8A(?) QRN vy bad now.

Feb. 20th 2452 W. of Honolulu at 5 A.M.: 2:53 A.M. 7SC vy QSA. 3:08 7SC again—static coming up bad.

Feb. 22nd 2975 W. of Honolulu at 5 A.M.: 3:48 A.M. 6AWT calling CQ QSA. 3:50 6TI saying "let it" last 2 wds. 3:52 7SC calling CQ, QRZ now. 3:58 6AWT calling CQ, vy QSA. 4:01 7SC calling CQ. 4:03 6TI calling 8CYU. 4:07 6TI calling CQ. Put 6TI on Magnavox this time and heard him all over shack. 4:12 6TI calling CQ again (thot CQ was out of date). 4:15 NPN harmonics drowning out everything on 200.

Feb. 23rd 3245 W. of Honolulu at 6 A.M.: 4:58 A.M. 8BYO calling 6ZY very QSA. 5:10 9(?) in very faintly. 5:30 off to copy NPN press.

Feb. 24th 3511 W. of Honolulu at 6:30 A.M.: 5:25 A.M. 6TI calling CQ. 5:27 some 5 station in. sending too fast to read thru QRN. 5:30 Off to grab press

Signals were received on Reinartz tuner with one or two steps, on ship's antenna with 410 meter natural wave length. Hundreds of other stations heard but couldn't copy their calls thru QRN. Will make further tests in Kobe, Japan upon arrival. 73's.

### Can. 2TA, Tillsonburg, Ontario.

C.W.: 1ABB, 1ABF, 1ABY, 1ACB, 1AIQ, 1AKW, 1AOK, 1ALL, 1ASF, 1AYZ, 1BEP, 1BIE, (1BRQ), 1BTU, 1CMP, 1CNI, one, 1CPO, 1EZ, 1GV, 1IL, 1KC, 1MC, 1WC, 1YK, 2AGD, 2AIF, (2AJF), (2ANM), 2ATS, 2AWF, (2ANF), 2AQL, 2AYB, 2AYD, 2AYV, 2BNL, 2BRB, 2BRM, 2BYC, 2BZV,

## HEARD DURING APRIL Unless Otherwise Specified

### "BX" Ex 6XXA

Harold T. Mapes, Guanajuato, Gto., Mexico  
1AZW, 1CKP, 1AJP, 2UD, 2FP, 2AXO, 3YO, 3VO, 3DH, 4AB, 4BI, 4EB, 4FG, 4FS, 4GG, 4HW, 4KM, 4AA, 4AFO, 4ADP, 4AIB, 4AHD, 4AIV, 4AHT, 4YD, (5ADO), 5AE, 5AEG, 5ADE, (5ACP), 5AAS, 5ABY, 5ABE, 5AHH, 5AJC, 5AKI, 5AIU, 5AEH, 5AFQ, 5ADR, 5AHR, (5ATT), 5AGJ, (5ABH), (5BE), 5BM, 5CK, 5CL, 5CO, 5CV, 5DI, 5DA, 5DQ, 5EN, 5EK, (5FT), 5PV, 5FA, 5FC, 5FO, 5GL, 5GAM, (5GR), 5GEN, 5GN, 5GT, 5GA, 5GG, (5HZ), 5HH, 5HO, 5IX, 5IR, 5IA, 5IQ, 5JB, 5JAL, (5JL), (5JT), 5JZ, 5JS, 5JM, (5JF), 5KC, (5KP), 5KE, 5KG, 5KW, (5KN), 5LA, (5MT), 5ME, 5MY, 5MO, 5MX, (5NN), (5NK), 5NS, 5NO, 5NZ, 5OK, (5OV), 5OI, 5OK, 5OF, (5PO), 5PV, 5PX, 5PN, 5PK, 5PF, 5PD, 5PZ, (5QI), 5QY, 5QA, (5RH), (5RN), 5RE, 5RR, (5SF), (5SS), 5SM, 5SZ, 5SK, 5TK, (5TJ), 5TC, 5TA, (5TM), 5UI, 5UO, 5UK, 5UG, 5UN, 5VM, (5VY), (5VA), (5VO), 5WZ, 5XVH, 5XA, (5XAJ), 5XD, 5XX, 5XY, (5XAD), (5XV), (5XB), 5XAB, 5ZAV, 5ZAA, (5ZAK), 5ZAT, 5ZB, 5ZU, (5ZA), 5ZO, 5ZAG, 5ZAS, 5ZAE, 5ZS, 5ZG, 5ZAK, 5ZAP, 5ZH, 5ZB, 5AK, 6ANH, 6AGP, 6ABX, 6AVD, 6AMZ, 6AJF, 6ARB, 6APW, 6AEQ, 6AW, 6AH, 6AKI, 6ALU, 6AWX, 6AOF, 6AWT, 6AO, 6AHQ, 6ACM, 6AQP, 6AVN, 6AHU, 6AVR, 6ALK, 6BKO, 6BOE, 6BUN, 6BRF, 6BJQ, 6BVW, 6BRB, 6BUM, 6BVQ, 6BOD, 6BPZ, 6BIQ, 6BV, 6BEQ, (6BSQ), 6BIC, 6BJR, 6BJY, 6BJJ, 6BM, 6BAW, 6BVF, 6BVG, 6BUA, 6BIK, 6BEO, 6BUO, 6BKA, 6BWP, 6CU, 6CC, 6CBL, 6CGW, 6CAJ, 6EK, 6EN, 6FH, 6FF, 6FT, 6GC, 6EA, 6EB, 6GX, 6HV, 6IF, 6IV, 6KA, 6LV, 6NN, 6NY, 6OL, 6OH, 6RM, 6RR, 6SF, 6SU, 6TI, 6TW, 6WH, 6XAD, 6KK, 6XA, 6XWI, 6XBA, 6ZH, (6ZZ), 6ZX, 6ZA, 6ZF, 6ZO, 6ZB, 6ZN, 6ZAO, 7AD, 7AW, 7BJ, 7LR, 7SC, 7TQ, 7ZU, 7ZY, AD7, 8ABA, 8AZF, 8AB, 8ABC, 8AZQ, 8AZD, 8ATU, 8AMM, 8FT, 8AQ, 8AQO, 8BYO, 8ARD, 8BK, 8BSY, 8BLC, 8BXH, 8CID, 8CUR, 8CZC, 8DAG, 8PD, 8QK, 8SP, 8UE, 8XE, 8YD, 8ZN, 8ZY, 8ZW, 8ZZ, 9AAV, 9AOU, 9ABU, 9AUL, 9AYU, 9APW, 9AON, 9ABV, 9APS, 9AVZ, 9AIX, 9AJH, 9AIG, 9AFK, 9ANQ, 9ANF, 9AMI, 9AWM, 9AAP, 9AUA, 9AET, 9AOG, 9AEX, 9AWN, 9AVL, 9AQR, 9AWS, 9ALG, 9AHL, 9ATN, 9ARJ, 9AVU, 9BM, 9BDS, 9BED, 9BBF, 9BJI, 9BJ, 9BZI, 9BXQ,



# Antenna Resistance

The following is quoted from a letter just received from Mr. A. F. Murray, author of the article "How to Measure Antenna Resistance and Capacity" which appeared on page 18 of the May, 1923, issue of QST.

"There are some corrections that I had to make in this article and I should like to get them in the next issue, of course, but at the same time I should like to wait as long as I could because people will write me telling me what luck they have had with the scheme of antenna resistance measurements I have suggested and from these troubles I can find more mistakes than I can find at the present time. The present ones are as follows:

1. Your draftsman omitted from Figure 3 the numeral subscripts on ammeter "A." The text gives this as "A."

2. I neglected to state in Appendix II, Resistance Variation Method, that the resistance of a thermo-galvanometer should be subtracted from the measured resistance of the antenna. Also, in talking about this method, I should say that in testing for reaction the antenna circuit should be suddenly opened, or, as I do say, "if Switch S should be suddenly opened," about 100 ohms should be inserted in R.

3. In stations where there is very little room, the required distance of ten feet between antenna and driver cannot be conveniently arranged and I have attempted to measure, since writing the article, the resistance of an antenna in an amateur's house, where the distance was only four feet.

"The resulting electrostatic coupling between driver and antenna was such as to give a 20° deflection when there was no magnetic coupling whatever between the two. In a case like this, I suggest the scheme used at the Bureau of Standards, that is, enclosing the whole driver in a box made of metal screening, this screening being grounded."

## ARTIC EXPLORER TO COMMUNICATE WITH AMATEURS

(Continued from page 10)

On this occasion he plans to make some observations of the Aurora Borealis for the terrestrial magnetism laboratory of The Carnegie Institution at Washington, D.C. Of all natural phenomena, the aurora, which is hollow in shape and builds up in a wall around the magnetic north pole, is one of the most mystifying. No one knows what the aurora is or what causes it. Dr. MacMillan proposes to find out and take motion pictures of it with two cameras connected by ten miles of telephone wire. He

(Concluded on page 73)

### 3CCU, Emigsville, Penna.

C.W.: 1AF, 1AP, 1AW, 1QP, (1ABB), (1AJT), (1AKL), 1AQ, (1AQM), (1ARP), (1AUG), (1BAN), 1BLD, 1BOQ, (1BRQ), 1BTR, (1CJR), (1CIT), (1CNI), (1CQP), 2BG, 2EL, 2FN, (2RY), (2ADD), (2AGB), 2AXF, 2BMS, (2BQB), 2BRG, 2BTE, 2BUS, (2CBW), 2CFB, (2CGS), (2CJV), 2CLJ, (2CQI), (2CVJ), All three's worked daylight, (3AB), (3FQ), (3HS), (3MO), (3PZ), (3RE), (3TF), (3ZO), (3AJJ), (3AAO), (3AAY), (3ACN), (3AGB), (3APR), (3ARP), (3ASP), (3ATB), (3BBV), (3BDI), (3BHM), (3BGG), (3BNG), (3BRF), (3BRL), (3BVA), (3CBL), (3CBM), (3COX), (3CDN), (3CEQ), 4EP, (4FB), 4HW, 4KC, 4DL, (4HL), 5CG, 5RT, (5ABG), 5AGJ, 6JD, 6BVG, 7ZU, 8CK, 8EO, (8UP), (8AAF), 8AFI, (8AFL), 8ALF, (8ANV), (8APW), 8ARF, (8ASB), (8AZO), (8BAH), (8BCU), (8BDV), 8BHP, (8BIB), (8BNH), 8BNO, (8BOA), (8BRC), 8BRT, 8BTR, 8BUT, (8BWK), (8BYN), 8CBQ, 8CEL, (8CHV), 8CJZ, 8CKO, 8CKU, 8CNC, 8COO, (8CTN), 8CTY, 8CUV, 8CYT, 8DAA, 8XAM, (8XAN), (9DK), 9PQ, 9QR, 9UU, 9AHH, 9AKD, 9AMK, 9AMH, (9ATO), 9BHM, 9BIE, 9BWF, 9CCK, (9CEH), 9CGU, 9DFB, 9DHR. Canadian: 3CO, (3IN), (3TA), (3XN).  
Spark: (1RR), (3ACY), (3API), 9DHZ,

### 5AKZ, Alamogard, New Mex.

C.W.: 4AJ, 5AA, 5AAG, 5AAJ, 5AAO, 5AAR, 5AAS, 5ACO, 5ADO, 5AEC, 5AFQ, 5AG, 5AID, 5AIR, 5AII, 5AKI, 5AKY, 5AO, 5BC, 5CC, 5CO, 5CV, 5CY, 5DV, 5FK, 5EN, 5FW, 5FT, 5GA, 5GG, 5GJ, 5GR, 5GT, 5GZ, 5HG, 5JG, 5JL, 5JS, 5KC, 5KE, (5LG), 5LZ, 5ME, 5MG, 5MK, 5NJ, 5NK, 5NN, 5PD, 5PQ, 5PX, 5QL, 5QW, 5RA, 5RM, 5RR, 5RY, 5SA, 5SG, 5SM, 5SR, 5SS, 5UL, 5VM, 5VO, 5WA, 5WN, 5XA, 5XAJ, 5XD, 5XJ, 5ZA, 5ZAD, 5ZADA, 5ZAJ, 5ZAT, 5ZH, 5ZM, 5ZV, 6ATQ, 6AUJ, 6BA, 6BBC, 6BC, 6BEG, 6BIC, 6BJO, 6BU, 6BUO, 6BVG, 6CBI, 6EC, 6EO, 6KA, 6KV, 6TA, 6XAD, 6ZL, 6ZZ, 7AFW, 7DH, 7FT, 7IO, 7TB, 7ZO, 8AAF, 8AII, 8AQO, 8ARD, 8ASC, 8ATX, 8GA, 8LH, 8XAD, 8YN, 9AAJ, 9AAK, 9AAP, 9AAV, 9AAW, 9ABC, 9ABM, 9ABK, 9AEV, 9ALK, 9AOC, 9APS, 9APV, 9ASI, 9AUK, 9AUL, 9AUW, 9AVQ, 9AV, 9AXD, 9BAJ, 9BAK, 9BDZ, 9BEB, 9BGV, 9BJJ, 9BK, 9BKK, 9BKM, 9BND, 9BST, 9BUW, 9BVQ, 9BVV, 9BWE, 9BWW, 9BXX, 9BZX, 9BZZ, 9CAA, 9CAO, 9CBD, 9CCA, 9CCS, 9CCV, 9CCZ, 9CEI, 9CFK, 9CFY, 9CGU, 9CKI, 9CKM, 9CMA, 9CMK, 9COW, 9CRR, 9CRY, 9CVA, 9CVO, 9CWF, 9CXB, 9CZA, 9DAT, 9DAW, 9DBA, 9DEQ, 9DGE, 9DJB, 9DJL, 9DJT, 9DKT, 9DKX, 9DKY, 9DMU, 9DPD, 9DPN, 9DRI, 9DRW, 9DSR, 9DSW, 9DTR, 9DTS, 9DIB, 9DYA, 9DVB, 9DVJ, 9DWN, 9DWR, 9EAO, 9EON, 9ECZ, 9EEK, 9EHV, 9EKP, 9EKK, 9ESE, 9EST, 9FV, 9KX, 9SJ, 9VM, 9YB, 9ZAF, 9ZN.  
PHONE: 5XAJ, 5ZAK, 9AUW, 9CXB, 9EHV.

### 8AUU, Canton, Ohio.

C.W.: 1ABF, 1ASJ, 1ATJ, 1ARB, 1AYZ, 1AGB, 1BLK, 1ABY, 1ABZ, 1ABE, 1AQM, 1APD, 1AP, 1BKQ, 1BUW, 1BR, 1BOQ, 1BY, 1MCR, 1BRQ, 1BHD, 1BHR, 1BVR, 1BTR, 1GAC, 1CAZ, 1CGR, 1CQI, 1CMP, 1CPO, 1CNI, 1CHE, 1CIV, 1CIV, 1CVI, 1CMI, 1DL, 1EZ, 1GS, 1LL, 1JC, 1KC, 1MC, 1QP, 1SM, 1WC, 1XY, 1ZY, 2AB, 2AQ, 2ASJ, 2AUZ, 2ASK, 2AER, 2AGD, 2AEP, 2ALK, 2AXF, 2AY, 2AYV, 2AJA, 2AIF, 2AFJ, 2AMF, 2ADS, 2AZ, 2AF, 2AM, 2BGS, 2BMS, 2BUT, 2BHZ, 2BRE, 2BQD, 2BFE, 2BTW, 2BT, 2BBD, 2BBE, 2BNT, 2BUS, 2BFC, 2CGL, 2CWP, 2CKL, 2CCD, 2CIZ, 2CPA, 2CPI, 2CRB, 2CXE, 2CQI, 2CFB, 2CDB, 2CBW, 2EL, 2ES, 2GC, 2L, 2KP, 2MO, 2OM, 2PZ, 2RD, 2RM, 2SF, 2WN, 2WR, 2ZK, 2ZV, 3AAO, 3ABW, 3ACQ, 3ADN, 3APR, 3AHP, 3AJJ, 3AKR, 3ANF, 3ANO, 3APJ, 3AKR, 3AUV, 3BAR, 3BEL, 3BU, 3BGE, 3BGU, 3BKX, 3BLP, 3BLU, 3BLZ, 3BMN, 3BMO, 3BOB, 3BOD, 3BPE, 3BSS, 3BTL, 3BUY, 3BVA, 3BVL, 3BWB, 3BWT, 3BJ, 3BQ, 3BZ, 3CAN, 3CBZ, 3BEL, 3CEZ, 3CCD, 3CA, 3CE, 3CM, 3CW, 3CV, 3DH, 3FP, 3FQ, 3FS, 3GL, 3GZ, 3HJ, 3HS, 3IH, 3IL, 3IZ, 3JC, 3JK, 3JL, 3JY, 3LK, 3LR, 3MB, 3MF, 3MO, 3NB, 3OH, 3OV, 3PI, 3RF, 3RK, 3RV, 3SU, 3TR, 3WF, 3WX, 3XAL, 3XU, 3XX, 3YO, 3YT, 3ZAN, 3ZP, 3ZZ, 4AG, 4AL, 4AL, 4BK, 4BX,

(Continued on page 74)

# Radio Communications by the Amateurs

The Publishers of QST assume no responsibility for statements made herein by correspondents



## From R. C. A.

(The following letter was received in answer to an inquiry as to procedure when the exchange of defective vacuum tubes was not going ahead in a satisfactory manner.—Tech. Ed.)

New York City  
Mr. S. Kruse, Technical Editor,  
The American Radio Relay League,  
Hartford, Connecticut.  
Dear Mr. Kruse:

Referring to your favor of the 19th inst. directed to the attention of Mr. Gawler, I am pleased to have this opportunity to express to the members of the American Radio Relay League our policy with reference to adjustments on RCA products which may develop a defect due to the manufacturing process.

In an endeavor to perpetuate the high quality of our radio devices, they undergo a most rigid inspection at the factories. Our interest, however, extends beyond this into the homes of our customers, as we value their complete satisfaction. Although we believe our apparatus to incorporate the best engineering skill, material and workmanship known to the art, it is obvious, due to the intricate and delicate construction of such devices as vacuum tubes, that in spite of these extreme precautions a defective tube may develop now and then.

The Radio Corporation has established the policy (and it has fully advised its distribution channels to that effect) that defective material be returned by the consumer to the dealer or the distributor from whom it was purchased—this for the reason that the dealer is nearer to the buying public than the manufacturing company, and also the necessity of establishing an orderly routine. Our adjustments on defective material are made through the distributor; but if the distributor or dealer is unable to determine whether an apparently defective device is the result of manufacture or ill-use, they are then requested to return it to our warehouses for a decision or for replacement as the case may be. Cases have been brought to our attention where our policies were not carried out, whereupon the necessary action was taken. It may

be said, however, that the great majority of radio dealers stand ready to give the public fair and equitable consideration, and this is in accordance with our wishes.

In the case of a vacuum tube, there is some reason for discussion as to whether or not the tube became inoperative through ill-use or was actually the fault of the manufacturer; but our own records indicate that in the majority of cases the customer is given the benefit of the doubt.

If this satisfaction has not been extended to the customer, we would be glad to have the matter brought to our attention, as we have an earnest desire to see that service is rendered to the public. In many cases where a dealer has failed to adjust the customer's claim, we have taken care of the customer direct from our own warehouses. We have done our utmost, however, to inform dealers as to our policies with respect to replacements of defective vacuum tubes, and the majority of them are now handling such matters in the approved way.

Appreciating as we do the contributions of the American Radio Relay League to the popularization of radio, we are desirous of extending to them every possible business courtesy. We would, therefore, appreciate their bringing to our attention any cases where a defective vacuum tube or other equipment was not given consideration through our sales channels.

The A.R.R.L. may be assured that we stand ready to grant the same service and satisfaction to its members as to the public at large.

E. E. Bucher,  
Manager Sales Department,  
Radio Corp'n of America.

## The Variable Condenser

(Originally presented as a paper at the Technical meeting of the Fourth Annual Convention of the Third Radio District at Baltimore, Md., April 13th and 14th.—Ed.)  
Washington, D. C.

Editor, QST:

This paper is an eleventh hour preparation prompted by the very interesting let-



ter of Mr. Ben. B. Skeete's beginning on page 2 of the April issue of QST. Mr. Skeete asks a myriad of questions on that most important unit, the variable condenser; the answers to which, if generally known and heeded, will undoubtedly increase the efficiency of the average amateur station and ultimately sound the death knell for a multitude of atrocities now being marketed to the unsuspecting.

Before replying specifically to Mr. Skeete's queries, a general discussion of the desirable characteristics of condensers should be in order. Roughly, a good condenser of the variable type should be of rugged construction, well finished mechanically, and have low electrical losses. In the case of power circuits, the dielectric strength or the voltage to which the condenser can be charged, is also quite important.

A large percentage of the variable condensers now on the market are subject to strong criticism of their mechanical qualifications so much so that this point requires some notice. Probably the most common and flagrant defect is that of poorly fitted bearings which allow side play of the shaft, causing it to roll slightly before rotating, when a torque is applied to the knob. Indeed, a large percentage of the units offered for sale have only roughly drilled holes in the insulating end plates to serve as bearings for the shaft. Even tho the fit may be neat when new it will soon wear loose in service. It is impossible to accurately tune a receiver circuit of sharply resonant characteristics when trouble of this nature is present in the condensers. Hence, in making your selection, it is well to see that the design includes well fitted, or self centering conical or spring bearings, *of dissimilar metal from that of the shaft which rotates in them.* Other items of poor mechanical finish that produce trouble in operation are end play in the shafts, loosely assembled rotary or stationary plates, lack of means to prevent rotation of the movable plates with respect to the spindle, and careless spacing of the plates.

Undoubtedly the most important point in variable condenser design should be low power loss, yet it must be conceded that it has received the least attention by the majority of manufacturers. Losses in condensers are due to three causes: namely, *leakage, series resistance, and dielectric absorption.*

*Leakage* is due to low insulation resistance which allows the condenser to discharge by ordinary conduction thru the dielectric, and its effect on the power factor of the condenser is inversely proportional to frequency. Hence this defect is seldom found in variable condensers of sufficient magnitude to be series at radio frequencies. Nevertheless no self-respecting amateur should ever invest in a condenser having

a paper dielectric, or plain fibre insulation, —not even for a 'phone bypass capacity.

*Series resistance*, within a condenser or in the leads thereto, affects the power factor just oppositely from that of leakage; that is, it is directly proportional to frequency and therefore most alarming at amateur wavelengths. Series resistance is present to a greater or less extent in many of the condensers on the market today, caused mainly by poor contact to the rotating plates; but also sometimes found in leads from the terminal post to either set of plates, poor contact between the separating washers and plates, and even in the material of the plates themselves. Purchasers will therefore do well by selecting condensers which are already equipped with, or are capable of being provided with soldered flexible connections to the rotary members. Condensers designed for assembly by sliding the plates into grooves in the supporting columns should not be considered.

*Dielectric absorption* is probably best defined by its name. Its effect is equivalent to that of resistance both in series and in parallel with the condenser; but it is most conveniently represented in terms of series resistance, when it is generally called equivalent resistance. Unlike condensers having leakage or series resistance, the power factor of an absorbing condenser is practically a constant for all frequencies. Hence, since power factor,  $\phi = \omega CR$ , the equivalent resistance is inversely proportional to the frequency. The phase difference of pure dry air dielectric is zero: whereas all solid insulators are imperfect, and raise the power factor of a condenser to a greater or less degree. But even air condensers must have some solid dielectric to support and insulate the two sets of plates. The equivalent resistance and resultant power factor of the variable air condenser is therefore determined by the quality of the solid dielectric and the ratio of the capacity thru this solid dielectric to that thru the air. Bakelite, Formica, and all classes of fibre have been found to have a high dielectric loss; whereas porcelain, quartz, and hard rubber can be considered as good, the latter probably being the most practical for commercial use in low priced condensers. That few manufacturers have heeded these laws is evidenced by the number of specimens having bakelite or fiber insulation; the most horrible examples being those employing only thin washers as the bearings for insulation between the rotors and fixed plate members. Condensers having hard rubber insulation so designed that its area of contact with the two plate members is small, and the points of contact widely separated and located where the field intensity is low, will have a minimum power loss due to dielectric absorption.

Returning now to the queries voiced by

Mr. Skeete: "The Murdock and Chelsea condensers are the die cast type of plate mounting. Why? Does the die casting of condensers introduce any losses or reduce any losses? Is it more efficient than a condenser using washers for separators?" Mr. Skeete evidently means moulded, as die cast condensers are those having both their entire rotary and stationary plate systems cast in complete units, as developed by Seibt in Germany. Moulded condensers are cheaper to build than the washer type; for, after an accurate mould has been made, no special care is required in their assembly. If the alloy used for the moulded columns has a negative coefficient of expansion, causing the material to grip the plates under considerable pressure when cooled, this process is contributory to the reduction of series resistance in the completed condenser. However, from the number of specimens of one make of moulded condensers having loose plates observed by the writer, it is doubtful if such material was used. In the washer type of condensers, the separators should be machined, not punched, and be of harder metal than the plates, so that when tightened up the sharp edges will bite in for a good electrical contact. The present Navy specifications for variable air condensers call for moulded columns, since they cost less to manufacture, and permit of greater accuracy with closer spacing of the plates.

Quoting again from Mr. Skeete: "Next let us compare insulation. The Clapp-Eastham and DeForest vernier use a bakelite bushing to insulate the rotary from the stationary plates. The Chelsea and Murdock use end plates of bakelite or moulded composition to separate the plates. The Illinois uses small squares of bakelite to insulate the plates. The Coto-Coil condenser uses three bakelite washers for insulating the plates and three for support and insulation. On considering these various methods we are confronted with the problem of deciding which of these various methods of insulation offers the highest efficiency. What are the losses caused by poor distribution of insulating material? What material has the best insulating qualities? What is considered the ideal method of insulating plates?" It is believed that all of these questions were fully covered under the heading of dielectric absorption. The writer hastens to correct Mr. Skeete's impression of the Coto-Coil condenser, however. The insulation between the rotor and fixed plates of this make of condenser not only consists of *two* hard rubber dielectric paths in *series*, but a close examination of the interior arrangement of these bushings will disclose an earnest effort to reduce their areas of contact to a minimum. As a result, the Coto-Coil condenser probably has a lower power factor than any other

popular priced unit on the market today. If I am not mistaken, hard rubber is also used on both the Clapp-Eastham and the Illinois condenser. Apparently Mr. Skeete has failed to differentiate in this most important case. There should be no difficulty in identification, as hard rubber is quite the softer and has a strong characteristic odor. While still on this subject, it may be of interest to note that the mounted type of Chelsea condensers, which have electrose insulation, have lower losses than their unmounted types, which employ moulded bakelite.

Again quoting, "Considering the plates, some are made of brass, others of aluminum (which seems to be in the majority), and one concern has a variable condenser on the market, the plates of which seem to be made of zinc. What metal is considered the most efficient? Why?" Electrically, copper would make the best condenser plate, but mechanically it is unfitted. Rolled aluminum has the advantage of hardness, low specific resistance, and light weight. Its chief drawback is its tendency to oxidize, thus increasing the resistance at the point of contact with the separating washers. The writer has noted instances in tightly compressed condensers where an open circuit existed between a separating washer and the adjacent aluminum plate. Altho of greater weight and slightly higher specific resistance, brass is particularly well suited for the plates since it produces a rugged unit, and permits of soldered connections at all plate and separator joints. Zinc should not be used for variable condenser plates on account of its relatively high specific resistance and the resultant series resistance loss therefrom.

Again from Mr. Skeete's letter: "A question of importance in designing receiving apparatus, where more than one variable condenser is used, is, what is the maximum distance of separation of the variable condensers to give the greatest efficiency? In what position should a variable be mounted in regard to the inductance? How should the plates of the variable condenser be connected to the inductance to reduce the capacity effect? How far do the electrostatic lines of force extend beyond the edges of the plates? What is the effect of these lines of force on apparatus in the set?" The writer has made no tests to determine the optimum separation between condensers in a receiving set, nor the extent of the surrounding electrostatic field. Any ill effects of this nature, however, could be minimized by the addition of enclosing shields. In this connection it should be kept in mind that all wires in the set of different potential gradient form small condensers in themselves; and, unless properly spaced, may cause more capacitive coupling than the field about the condensers. The condensers, as well as all other metal-

lic surfaces, should be sufficiently spaced from the inductances to minimize losses from eddy currents induced by the magnetic field about the inductance. Tests indicate that two inches spacing between the surface of an inductance and any metallic body in any direction from the inductance is sufficient for the purpose. In any oscillating circuit, one side of the condenser is at high potential, and the other is at low, or ground. The body of the operator is essentially at ground potential, hence when the hand approaches a high potential part of the circuit an increase in capacity results which is the equivalent of advancing the condenser setting. To minimize this condition, condensers should always be wired with the stationary plates to the high potential side. In an open antenna circuit, with series tuning capacity, the condenser should be placed between the inductance and the ground, with the rotary plates to ground. In the secondary or grid circuit, connect the stationary plates to the grid side and the rotor to the filament side of the inductance. Similarly, in the plate circuit, the stationary plates should connect to the plate, and the rotor to the B battery. In the case of single circuit receivers, it is not well to place the series antenna condenser between the inductance and ground, because of the narrow wave length range obtainable by reason of the antenna capacity to ground through the filament battery being considerably above that of the zero condenser setting. The condenser should then be placed between the antenna and the grid side of the inductance, with the rotary plates connected to the antenna. Some capacity effect will result, but it can be further reduced by using a metal dial, insulated from the rotary member, and grounded thru a brush contact. Condensers having one more rotary plate than stationary will be less affected by body capacity when properly connected in the circuit. Condensers so designed that the panel mounting screws are in electrical contact with the stationary plate assembly are objectionable in this connection, a shielded dial connected as above being the best remedy. Dial shields in the grid and plate circuits of coupled receivers, however, should have their brush contacts connected to the filament battery rather than to ground.

Careful attention to the foregoing should enable prospective purchasers to segregate the good condensers from the bad by sight. The actual laboratory measurement of their losses constitutes a rather elaborate process which is best handled with an alternating current or radio frequency bridge, and produces results which are only relative at best.

Edwin L. Powell.

## ARTIC EXPLORER TO COMMUNICATE WITH AMATEURS

(Concluded from page 69)

has been inside of the aurora several times and in 1921 succeeded in copying time signals from Arlington thru it. But this was on long waves and it now remains for him to discover whether short waves will also penetrate it.

Incidentally the station call is WNP (Wireless North Pole). Altho the wave length has not been determined as yet, the license will cover the use of any wave and 200 to 300 meters will be available. The set which is being built by the Chicago Radio Laboratory, is to be a 100-watt, equipped with two 50-watt Western Electric Type G (211-A) tubes. It will have a 500-cycle plate supply from a ½ kilowatt Telefunken generator, motor-driven from the ship's 32 volt storage battery. The battery will be kept charged by a Delco light charging unit. While it is a simple matter to install a radio set on the little vessel, which is an 80 foot auxiliary type schooner with a 20-foot beam, it will be by no means an easy task to erect a suitable antenna when he reaches winter quarters. Anyone who has put up an aerial in his own dooryard can imagine the difficulty which will be encountered in the land of ice and snow. When the vessel is frozen in, it will be necessary to put up a portable mast, or run wires to the top of an ice cliff.

The final arrangements for two-way communication with the polar party from start to finish of the journey will be sent out thru the A.R.R.L. broadcast stations. They broadcast every Saturday and Sunday at midnight. Anyhow start about June 20th to listen for WNP.

## 20M, RIDGEWOOD, N. J.

(Continued from page 58)

stage audio frequency amplifier. This was later changed to employ one stage of radio frequency amplification as described by Paul Godley in December, 1922 QST on page 34. This equipment was home-made.

Since April, 1922, a different receiver than the one shown in the picture has been used. This later receiver is also of home-made construction and articles describing it have been published in several of the radio magazines. The set has been on exhibition at three different radio shows and has been awarded two first prizes and one third prize. It is a variometer set with detector and three stages of audio frequency amplification in one cabinet.

An interesting scheme for improving the wave length range of a receiver using variometers for grid and plate tuning has been made use of on this set. Referring to the picture and diagram, a four-circuit three-position anti-capacity switch is mounted on the rear of each variometer. When thrown to the left side, these switches connect the

rotor and stator coils of each variometer in parallel, giving a range of wave length from 140 to 295 meters with better control and signal strength than the usual method of series connection gives, with the added advantage that the full 180 degrees of rotation is available over amateur waves only. Thrown upright, these switches connect the windings of each variometer in series and a wave length range from 180 to 550 meters is obtained. When the switches are thrown to the right, they connect the variometer windings in series, and in addition they switch small condensers in parallel across them in such a way that a wave length range from 435 meters to 1400 meters results.

#### Station Performance

The excellent results at this station are due to the persistent work on the part of the operators; it has been their constant endeavor to get maximum efficiency out of the equipment at hand.

Local co-operative measures to minimize interference have been carried out and the station has never been reported for any infractions of the U. S. Radio Communication Laws. Station 2OM has been very faithful in observing such regulations, regardless of the many complaints made by persons unfamiliar with the code who believe that any strong station in the vicinity is 2OM.

A complete log is kept. An inspection of it reveals the work that has been done at this station. Communication has been carried on with 409 stations outside of the Second District and except for two months during the summer when the station was not in operation, an average of 347 messages were handled each month. During 1922, 2OM has worked stations in every state east of the Mississippi River and has either worked or been reported heard by stations in 41 states. Signals of either the spark or C.W. transmitters have been reported in Canada, Cuba, Porto Rico, Colon, and Cristobal, Canal Zone. The daylight record of the station was made on C.W. when traffic was handled for half an hour without interruption with 9DYN of Kempton, Illinois, at 2:30 in the afternoon. This is a distance of 800 miles. Using a 25-watt tube putting about five watts into the antenna, the C.W. signals of 2OM were heard by 7MF of Eugene, Oregon.

The DX reception done at 2OM is also interesting for the log shows that every district has been repeatedly logged, including the signals of 6ZAC at Hawaii.

In concluding this description of what has been adjudged America's Best Amateur Station, we must state that 2OM is essentially a spark station; a station of the old school that has continued to be, in these days of C.W., an A-1 station. As such, a memory of 2OM and its work will live in the minds of all good amateurs for many years to come.

## CALLS HEARD

(Continued from 69)

4CR, 4CY, 4DB, 4DG, 4DW, 4EB, 4EH, 4EP, 4EQ, 4FA, 4FD, 4GV, 4GW, 4HA, 4IR, 4JK, 4JL, 4JZ, 4KC, 4LJ, 4LP, 4ME, 4PY, 4QG, 4YA, 4YD, 5AEC, 5AJP, 5ABH, 5ACE, 5AGG, 5AAR, 5AGJ, 5AHT, 5BM, 5BW, 5CY, 5DA, 5DQ, 5EI, 5EK, 5FG, 5FV, 5GA, 5GG, 5GP, 5IC, 5JJ, 5LF, 5LH, 5MB, 5NR, 5NT, 5NV, 5NZ, 5OV, 5PJ, 5QI, 5RH, 5RJ, 5SL, 5UK, 5UW, 5XAD, 5XA, 5XK, 5XY, 5YE, 5ZAB, 5ZOV, 6AJF, 6BZ, 6CK, 7AK, 7DN, 7GS, 7FS, 7ZU, 7ZV, (eights too numerous) 9AAP, 9AAR, 9AAU, 9ABU, 9ACE, 9ACX, 9AHH, 9AHQ, 9AIX, 9AJP, 9AKD, 9AMG, 9AMI, 9AMO, 9AMS, 9AMT, 9AMU, 9APD, 9API, 9APM, 9APS, 9APW, 9AST, 9ATN, 9ATO, 9AUA, 9AUS, 9AVP, 9BAS, 9BAW, 9BAZ, 9BCF, 9BCH, 9BDB, 9BDN, 9BDS, 9BED, 9BEH, 9BIQ, 9BK, 9BMM, 9BOO, 9BQD, 9BQG, 9BRI, 9BRK, 9BRT, 9BRY, 9BSZ, 9BTA, 9BTL, 9BUO, 9BWE, 9BWF, 9BXB, 9BZN, 9BZY, 9CBA, 9CBZ, 9CCG, 9CED, 9CEH, 9CFB, 9CGK, 9CHK, 9CIC, 9CII, 9CIP, 9CJC, 9CJ, 9CLR, 9CLY, 9CNU, 9COO, 9CRK, 9CTE, 9CUC, 9CUI, 9CUG, 9CWI, 9CWP, 9CYT, 9CYW, 9DAE, 9DBN, 9DBE, 9DCB, 9DCW, 9DDT, 9DFB, 9DFQ, 9DGE, 9DGI, 9DGV, 9DHK, 9DHR, 9DIO, 9DIS, 9DJB, 9DJM, 9DJN, 9DKA, 9DMO, 9DMW, 9DRH, 9DRI, 9DSW, 9DUQ, 9DVP, 9DWE, 9DWM, 9DWN, 9DYU, 9DZX, 9EAD, 9EAR, 9EBI, 9ECI, 9EIL, 9EIL, 9EKF, 9EKY, 9EI, 9EP, 9ES, 9EW, 9FP, 9GJ, 9IL, 9KZ, 9LF, 9LZ, 9MO, 9OL, 9OT, 9OX, 9PF, 9RC, 9UC, 9UG, 9UI, 9UM, 9UR, 9VM, 9VZ, 9WC, 9XM, 9XT, 9YB.

Canadians: 2BG, 3CA, 3CO, 3GK, 3KO, 3NI, 3PG, 3QS, 3XM, 4HH, 5A7, 9BJ, 9BU, 9BV, 9BW, 9CD.

Dalite: 1BHD, 1BVH, 1CMP, 1CVJ, 1QP, 2AIF, 2BGL, 2CPA, 2CQJ, 2RM, 3AAO, 3ALV, 3APR, 3BET, 3MBN, 3BVL, 3BZ, 3CA, 3CM, 3FP, 3MO, 3TJ, 4AR, 4EB, 4FB, 4HA, 4IR, 4YA, 5LE, (eights too numerous) 9AKD, 9APM, 9DIS, 9DRI, 9ECL, 9UC, 9UM.

Spark: 3ABB, 3AIT, 3ANU, 3CXO, 9BOF, 9DHG, 9DHQ, 9DRG, 9DVG, 9DWF.

### 9ZT, D. C. Wallace, 54 Penn. Ave., N., Minneapolis, Minn.

C.W.: 1AW, (1WC), (1BQC), 1CKP, 1CMP, 1CNA, 2WR, 2AGB, 2AWL, 2BZV, 2CWO, 3AB, 3BQ, 3CX, 3GC, 3JJ, 3JL, 3ZO, 3BFU, 3BLL, 3BNU, 4CG, (4EB), 4PU, (5CY), (5DI), (5EK), (5LL), (5NY), (5NN), (5NV), (5PZ), (5XA), (5XY), (5ZA), (5ABH), 6BY, 6EA, 6EC, 6JD, 6MO, 6YU, 6ZH, 6ZW, (6ZZ), (6AAK), (6ACM), 6ADO, 6ALK, 6AQP, 6AZV, 6BNT, (6BQC), 6BQD, (6BRF), 6BUN, (6BVG), (6CAJ), 6XAD, 7IW, (7SC), 7SF, (7TG), (7ZF), 7ZO, (7ZU), (7ACM), 7ADP, 7AHC, (7AHI), (7AIY), (8FY), (8GP), (8QK), (8RV), (8ADA), (8APW), (8AZO), (8CBI), (8CBG), (8CJH), (8CMI), (8CPD), (8CUR).

Canadian: (2BN), 3CO, 3DS, 3KO, 3NB, 3NI, (3SI), 3TA, 3XM, 4CN, 4FN, 4HH, 4HX, 9BX, 9CD, (9DY).

### 9DZB, Chicago.

C.W.: (1ABF), (1AKL), 1BAS, 1BKQ, (1CMP?), 1GV, 1KC, 1YK, 2AGB, 2AYV, 2BMR, 2CCD, 2FP, 2ZS, 3AA, 3AAO, (3APR), 3BLE, 3BVA, 3CFQ, (3CX), (3FQ), 3GT, (3II), 3IZ, 3JL, (3NI Can.), 3SS, 3TA Can., 3TC, 3TR, 3XN Can., (3ZO), 3ZP, 4BI, 4CN Can., 4EB, 4EN, 4FT, 4FQ, 4GZ, 4LA, 4MB, 4NA, 5ACF, 5AGG, 5AGJ, 5AIX, 5AKY, 5AJB, 5BM, 5BW, 5CO, (5EK), (5HL), 5HZ, (5IQ), 5KE, 5KG, 5MA, 5MB, (5ML), 5MO, 5NK, 5OI, 5PV, 5UJ, 5XA, (5XB), (5XAD), 5ABA, 5ZAK, 5ZAT, (5ZAV), (5ZB), 6BGV, 6BGY, 6CBL, 6CGW, 6ZAO, 7ZU, 7ZV, 8ALF, (8AQV), (8APW), (8ATC), (8AXT), 8AZW, 8BCP, 8BDA, (8BGQ), 8BGT, 8BHO, (8BOG), 8BOY, (8BWK), 8CCV, 8CK, 8CJZ, 8CQX, (8CUR), (8CUU), (8CWP), 8CXW, 8CYU, (8CZN), (8DAK), 8ER, 8HN, 8LH, (8RJ), 8TE, 8TT, 8VL, 8XA, 8YV, 8ZV, 9AL Can., 9AJL, (9AMH), 9AMI, 9ANQ, (9AQD), 9APW, 9AUA, (9BAV), 9BDS, (9BIE), 9BK, 9BKJ, (9BRK), 9BTA, 9BTK, 9BX Can., 9BXY, 9BZL, (9CBA), 9CEH, 9CGA, (9CTG), (9DAW), 9DBF, (9DBL), 9DCV, (9DDZ), (9DGE), 9DGV, (9DGW), (9DKQ), 9DLF, 9DJR, 9DNB, (9DSS), 9DUQ, 9DZU, 9DZY, 9EBI, (9LH), (9QR), 9OX, (9VZ), 9XI, 9ZT.

7WM, Tacoma, Wash.

C.W.: 2XQ, 5HY, (6BU), 6CJ, 6CU, (6EC), 6GR, (6FH), 6JN, 6LK, (6LU), (6TU), (6UW), 6VK, 6VM, (6ZQ), 6ZO, (6AAT), 6AAM, 6ABN, 6ABX, (6ACM), 6AHU, 6AIV, 6ALU, (6AOT), 6APE, 6ATY, 6AUP, 6AVN, (6AVV), (6AWT), 6BAQ, 6BRE, 6BRR, (6BDS), (6BFL), 6BGE, (6BHK), (6BIP), 6BNT, 6BOE, (6BON), (6BOU), 6BQD, (6BQB), (6BPL), 6BPZ, 6BRF, 6BRI, (6BUA), 6BUN, (6BUY), (6BVG), 6CAN, 6CBD, 6CRG, 6CBI, 6CBU, 6CGG, 6CGD, 6CJB, 6CJJ, 6CHL, 6CRW, 6XBC, (7AK), (7BJ), (7EQ), (7GE), (7HF), 7HS, (7IO), (7IW), 7JE, 7JF, 7JS, 7JW, (7LN), 7LR, 7LU, 7NK, (7PF), (7PJ), 7QT, (7QW), (7RI), (7SC), (7SF), (7SN), (7TG), (7TQ), 7TO, 7TT, 7VF, (7WA), (7WE), (7WQ), 7ZF, 7ZL, (7ZN), (7ZR), 7ZU, (7ABB), 7ABS, (7ADG), 7ACT, (7AGF), 7AGU, 7AOL, 9ABU, 9AYU, 9BXM.

Canadian C.W.: 4CL, (4DQ), 4DY, (4FN), 5AC, 5AK, (5CT), (5CN)—in daylight (5EJ), (9BX) voice. All cards answered.

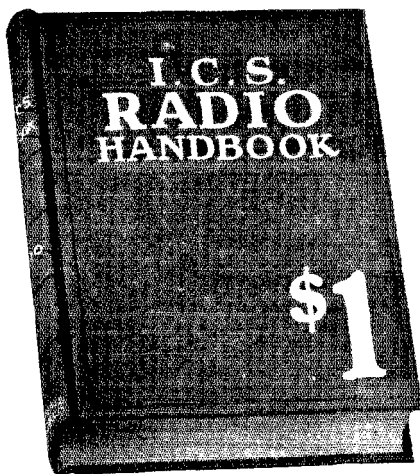

A practical,  
authoritative book on  
**RADIO**

62 pages. Price only \$1  
Compiled by HARRY F. DART, B.S., E.E.  
Formerly with the Western Electric Co., and  
U. S. Army Instructor of Radio  
Technically edited by F. H. DOANE

EVERY member of the American Radio Relay League should have a copy of this I. C. S. Radio Handbook. Price only \$1. Written, compiled and edited by practical radio experts of national reputation. A handy reference book that will help you improve your sending and receiving apparatus. Explains the operation of dozens of circuits. Filled with interesting experiments. Note this list of contents:

Static strays, dynamic electricity, electron theory, electrical measuring devices, magnetism, circuit effects and co-efficients, condensers, coupling, transformers, aerial systems, wave-length formulae, direction finding, batteries of all types, generators and motors, radio devices, detectors and transmitters, relays, phones and microphones, filters, commercial receiving sets, formulae, symbols and definitions, regulations, etc.

Send the coupon to-day with \$1 and get this 62-page I. C. S. Radio Handbook. Money back if not satisfied.

TEAR OUT HERE  
INTERNATIONAL CORRESPONDENCE SCHOOLS  
Box 6126-B, Scranton, Penna.

I enclose One Dollar. Please send me—post-paid—the 62-page I. C. S. Radio Handbook. It is understood that if I am not entirely satisfied I may return this book within five days and you will refund my money.

Name.....

Address.....

“— the ‘Viking Audio’  
has been found best  
for the Grimes Inverse  
Duplex.”—

Boud Phelps in March Q.S.T.

THE “VIKING AUDIO” AND THE GRIMES CIRCUIT—A COMBINATION THAT BRINGS IN DX ON HALF THE TUBES.

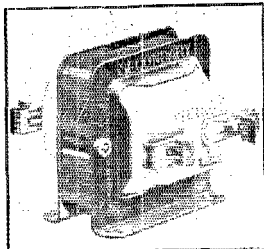

Shell type core;  
layer insulated  
windings; practical-  
ly distortionless;  
quadruple tested at the  
factory.

Send for your “Viking Audios” today  
**PRICE \$4.75**

(Dealers, write for special discount)

**VIKING RADIO CO.**

91 Seventh Ave., New York City

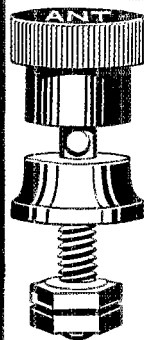

**“Read'em”  
Binding Posts**

With knobs that won't come off  
Anyone can “read ‘em.” All popular styles—Antenna, Ground, Phones, A and B Battery plus and minus—abbreviations of different names engraved on knobs. Ask your dealer for “Read ‘em”—the kind for real Radio fans. If your dealer does not have them—write direct.

The Marshall-Gerken Co.  
Manufacturers  
Dept. F. Toledo, Ohio

# MAKE OTHERS ENVY YOUR RADIO SET

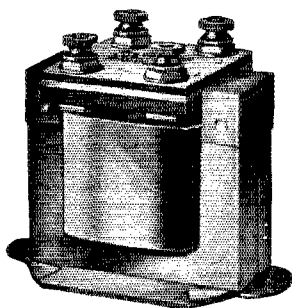

Price, mounted only  
6 to 1 ratio  
transformer \$5.00  
(With Red Label)  
3½ to 1 ratio  
transformer \$4.50  
(With Black Label)

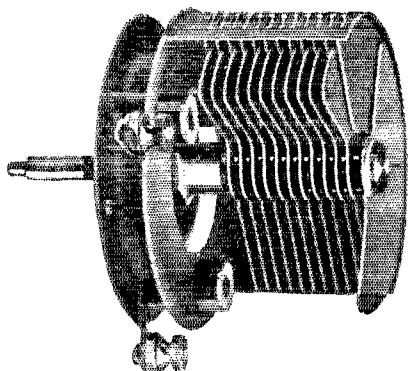

13 plate .00025 M.F. \$2.00  
with vernier, knob  
and dial..... 3.50  
23 plate .0005 M.F. 2.50  
with vernier, knob  
and dial..... 4.00  
43 plate .001 M.F. 3.00  
with vernier, knob  
and dial..... 4.50

**N**O radio set is better than the parts that go into it. All parts must be the best if the best results are to be obtained. There is no pleasure in receiving messages so jumbled up or indistinct that effort is required to understand them. You must have clearness.

Thordarson Radio Apparatus is manufactured with this thought in mind. Thordarson Radio Apparatus is made by a concern long in the electrical business; a concern that has been building quality goods for thirty years; a concern that never has and never will put their name on an inferior piece of merchandise.

Thordarson Transformers are made for those desiring high transforming ratio with high and constant amplification without distortion. The same high-grade workmanship and material are used in our radio transformers that are found in transformers made for central stations.

If your set is not giving you complete satisfaction—if you are having transformer troubles or condenser troubles—write us today for our folder which will give you full and complete technical information on Thordarson Radio Products.

**Thordarson Electric Mfg. Co.**  
500 WEST HURON STREET, CHICAGO, ILL.

# Burgess, the *Radio* Battery

*Specified by radio engineers — designed and built by wireless specialists—and recommended by leading manufacturers of radio equipment.*

Burgess Radio Batteries, the result of years of careful experiments are built under exacting manufacturing standards which must meet the requirements of strict laboratory formulae and tests — a supervision that insures their perfect operation.

For professional or amateur radio use, where noiselessness, long life, high capacity and uninterrupted, dependable service are essential, Burgess has no superior.

Burgess Batteries are built for both "A" and "B" circuits. The Burgess No. 6 is used and found most satisfactory on the "A" or filament circuits equipped with the new type one and one half volt vacuum tubes. The Burgess "B" Battery is everywhere recognized as the Standard of Quality in the wireless field.

## **BURGESS BATTERY COMPANY**

**Engineers — Dry Batteries — Manufacturers**

**FLASHLIGHT — RADIO — IGNITION — TELEPHONE**

General Sales Office: Harris Trust Bldg., Chicago

Laboratories and Works: Madison, Wisconsin

Branches:

New York Boston Washington St. Paul Kansas City New Orleans

In Canada: BURGESS BATTERIES, Ltd.  
Winnipeg, Toronto, Montreal

# BURGESS RADIO BATTERIES

"ASK ANY RADIO ENGINEER"



## Yes — why don't you?



### Does your set "sign-off" because your battery quits?

Are you reminded—when a good program is on—that your outfit is of no further use until you lug the battery down town and back?

Keep the battery at home, keep it full of pep and prolong its life with Tungar.

Tungar—the go-between from house-lighting circuit to storage battery—puts an end to unheard and half-heard programs.

Just connect Tungar—turn on the current and charge the battery while you sleep.

Tungar is *certain, clean, quiet*. No moving parts to get out of order. Inexpensive to operate. Good for your auto battery too—the same Tungar.

See Tungar at any good electrical shop, or write for literature. Address Section Q6.

Merchandise Department  
General Electric Company  
Bridgeport, Connecticut

*Tungar Battery Charger. Operates on Alternating Current.*  
2 Ampere Outfits—\$18.00  
5 Ampere Outfits—\$28.00  
(Prices east of the Rockies)  
Special attachment for charging 12 or 24 cell "B" Storage Battery—\$3.00—fits either size Tungar.

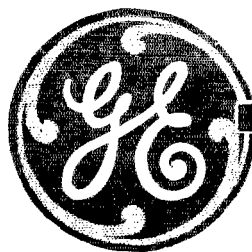
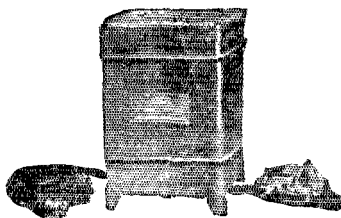

Charge 'em at Home, with

# Tungar

**BATTERY CHARGER**

A GENERAL ELECTRIC PRODUCT

33-A-97-C



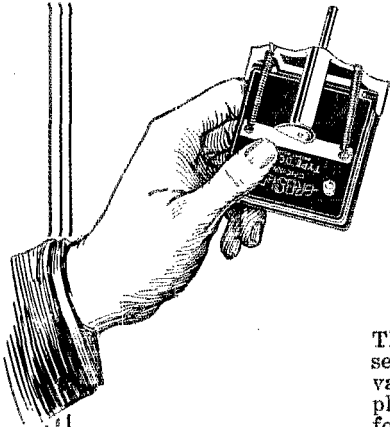

# Just one Reason why ~~CROSLEY~~ RADIO RECEIVERS are so much better

The heart of any receiver is the variable condenser. The superiority of the Crosley book-type variable condenser over the old type interlocking plate air condenser is now generally admitted for the following reasons:

1. Rugged construction that prevents damage.
2. Freedom from short circuits.
3. Permanent metallic contact with plates eliminates sliding contacts.
4. Minimum stray electrostatic field eliminates body effects when tuning.
5. Liberal leakage paths through condenser.
6. Grounded frame provides electrostatic shield.
7. Minimum high frequency resistance or energy loss.
8. Maximum variation in wave length with fixed coil.
9. Maximum mechanical and electrical efficiency.
10. Minimum cost.

We state positively that the substitution of a Crosley condenser for any other type of commercial receiving condenser in any receiving set or circuit will greatly increase the range, volume and simplicity of tuning.

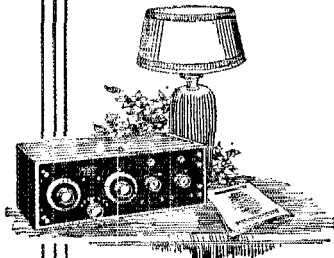

The justly famous Crosley Model VI, a two tube set incorporating one stage of tuned radio frequency amplification and detector, price \$28.

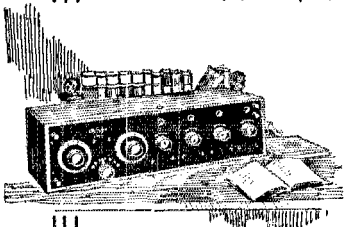

The standard Model X that has made history during the past year, and is now recognized as the most efficient set on the market, will be continued at the same price.....\$55.00, notwithstanding the advanced cost of materials. We announce a new Model X, to be designated as Model X-J, equipped with head phone jacks for detector and one stage of amplification, in addition to loud speaker binding posts. The instrument has been redesigned internally with new molded sockets, condensers having molded plates, rheostats in molded shells, new dials, price—\$65.00.

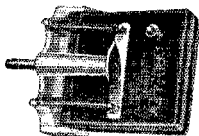

New Crosley type D Condenser has moulded plates. Price \$2.25

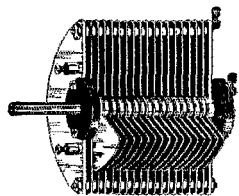

Old-fashioned multiple plate condenser which has been largely replaced by Crosley type D.

New York Office,  
C. B. Cooper, 1808 Tribune Bldg., 154 Nassau St.  
Boston Office, B. H. Smith, 929 Blue Hill Ave., Dorchester,  
Chicago Office,  
1811 Steger Bldg., 28 E. Jackson Blvd.,  
R. A. Stemm, Mgr.

Crosley receivers incorporating tuned radio frequency amplification reduce static and other interference to a wonderful degree, which greatly increases summer receiving range.

**CROSLEY MANUFACTURING COMPANY**  
618 ALFRED ST., CINCINNATI, O.

# ACE MODEL V

Formerly Called Crosley Model VC

## REGENERATIVE RECEIVER

# \$20

Licensed under Armstrong U. S. Patent  
No. 1,113,149

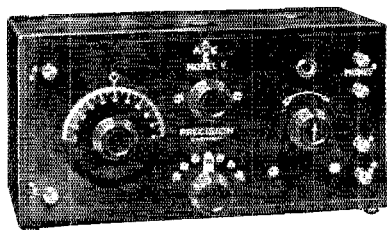

Efficiency and moderate price have caused an enormous demand for the Ace Model V Regenerative Receiver. It is a wonderful set and its popularity is increasing daily. Thousands have been sold and all are producing remarkable results. Everyone knows the set will bring in far-away stations clearly and loudly. Hundreds of satisfied customers have written to us lauding the Ace Model V. Read what a few say:

*"We have tested the Ace Model V with outside aerial, house wiring and bed spring and get excellent results on long distance reception. St. Louis, Kansas City, Fort Worth, Cincinnati, Omaha and many others come in fine. We consider the Ace Model V supreme.*

CLOVERDALE MOTORS CO.,  
Montgomery, Ala."

*"I consider the Ace Model V a little wonder. Last night I tuned in Portland, Oregon and Los Angeles, Calif. The set performs like a well-bred horse. I have operated many expensive sets, but they are not in it with the Ace Model V.*

R. H. RINES,  
St. Paul, Minn."

*"I am writing to tell you of a long distance record for the Ace Model V. The other night Mr. Blake D. Foster, who purchased the set from us, tuned Kamach, Hawaii, and held a concert from 10:45 to 11:45 P.M. He was using a lamp socket plug instead of an aerial. He told us the music was clear and the speaking distinct.*

HAROLD FINK,  
Evansville, Ind."

We do not claim everyone will be able to hear Hawaii, but the mere fact that certain owners have done so is evidence of the efficiency of the set.

For Sale by Good Dealers Everywhere

**THE PRECISION EQUIPMENT CO.**  
*Powel Crosley Jr. President*  
618 GILBERT AVE., CINCINNATI, O.

## ACE TWO STAGE AMPLIFIER

to match ACE MODEL V

# Only \$18

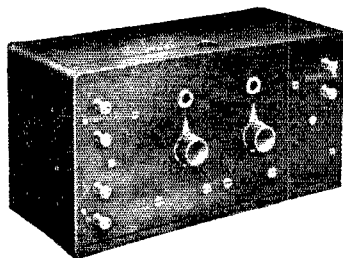

The Ace two stage audio frequency amplifier was designed to be added to Ace Model V Radio Receiver, illustrated and described on the foregoing page. However, it operates efficiently with any type of tuner and detector. Like in the Ace Model V, the simplicity appeals to everyone, especially to the man who knows but little about radio. Every part used in it has been tested carefully and thoroughly; it has been compared with parts made by other manufacturers, and has been found to produce far better results.

The transformers, with their ratio of nine to one, are naturally the most important units in the set. They are made with the greatest care and the very best material available. Special insulating paper is used in insulating the core laminations, something not found in any other transformers in the market. It is completely shielded, and incorporated in it are all the characteristics so essential and necessary in obtaining the maximum amplification from the modern vacuum tubes. These tubes, with their high amplification constant, operate most effectively at large fluctuations of the grid potential. The transformers used are designed to accomplish these results and tests have shown that the design is correct to insure maximum efficiency. And so it is with the rheostats and sockets. Each is carefully made with the one aim—to produce perfect results. It also must be remembered that either six volt or one and one-half volt tubes may be used.

Naturally use of an amplifier is necessary when the owner of a receiving set desires to add a loud speaker, and it will be found that there are few, if any, that will compare with the Ace. Eliminates howls and other extraneous noises. It amplifies desired signals and cuts out undesirable ones. It does not produce volume, it amplifies it. In fact, the Ace Amplifier increases the volume of the Ace Model V approximately one hundred times.

For Sale By Good Dealers Everywhere

## THE PRECISION EQUIPMENT CO.,

Powel Crosley, Jr., President

618 GILBERT AVE.,

CINCINNATI, O.

# Pleasant Evenings in Camp

## With a Crosley Portable

No matter how far into the wilds you go on your vacation, you can keep in intimate touch with the outside world and enjoy its pleasures in the evening.

Crosley Portable Radio Outfits have made this possible. Absolutely complete in their compact cases, they may be easily carried and quickly set up.

After a hard day's motoring, fishing or canoeing what a pleasure to get out the old pipe, sit before the camp fire and listen to music, plays and innumerable other interesting things. Get a Crosley Portable and take it with you on your vacation. It will afford you the least expensive pleasure you have ever enjoyed.

~~CROSLEY~~  
Better--Cost Less  
**RADIO**

**CROSLEY MANUFACTURING CO.**  
618 ALFRED ST.,

CINCINNATI, O.

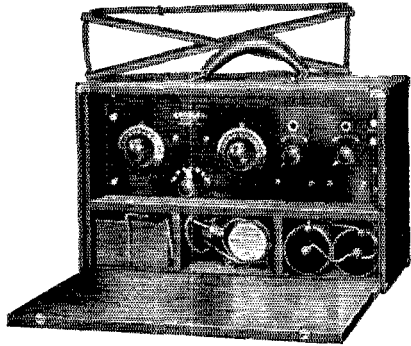

**Crosley Model VI Portable**

Consists of detector and one stage of tuned radio frequency amplification. Compact compartments are built into this set for batteries, phones, etc. Thousands of users have testified as to its satisfactory performance. Price without tubes, batteries or phones .....\$40.00

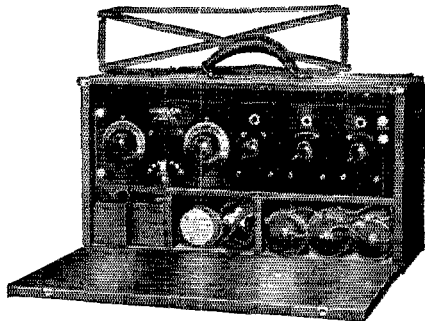

**Crosley Model VIII Portable**

Consists of one stage of tuned radio frequency amplification, detector and one stage of audio frequency amplification. This set has the same general construction as Model VI Portable, but performs even more efficiently. Price, without tubes, batteries or phones .....\$60.00

*Free Catalog on Request*

# Three Beautiful Cabinet Models

## The Last Word in Crosley Efficiency

### CROSLY MODEL XX

(Below)

This attractive model is our Model X built into a highly polished mahogany cabinet. A hinged lid, when raised allows the operator access to every part of the receiving apparatus. A sliding board under the receiving apparatus forms a desk for the operator when desired. The lower compartment is made to take care of the batteries and the middle compartment contains a loud speaker which makes it possible for music, speeches, etc. to be heard clearly by every one in the room. As a beautiful piece of furniture, this model is an addition to any room. Price without tubes, batteries or phones .....\$100.00

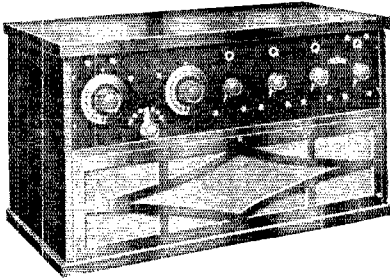

CROSLY MODEL XV  
(Above)

The receiving apparatus in this model is the same as that in our cabinet Model XX. The cabinet contains no place for the batteries, however, placed on a mahogany table or stand, it forms an attractive piece of furniture. Price without tubes, batteries or phones .....\$70.00

### CROSLY MODEL XXV

(Below)

We can conscientiously recommend this console model as the most beautiful and efficient model offered today. The receiving apparatus contains the same units as our model X though differently arranged. The cabinet, of mahogany, exceptionally well finished, is arranged to take the model R-3 Magnavox and also contains space for "A" battery, "B" battery and battery charger if desired. Guaranteed to bring in broadcasting stations 1000 miles or more distant so that they may be clearly heard all over the room. Price without tubes, batteries or phones .....\$150.00

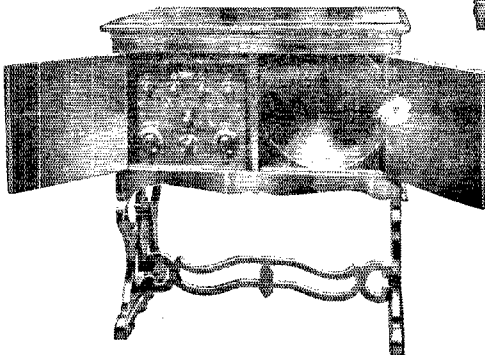
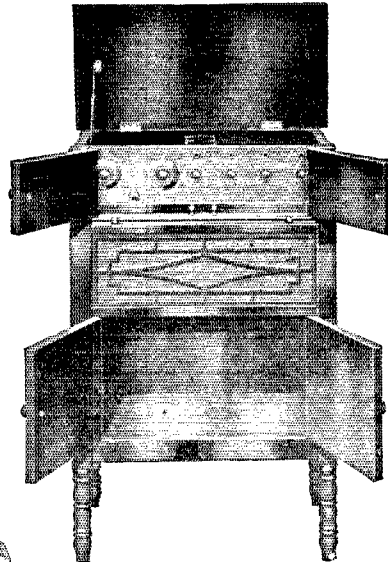

**CROSLY**  
Better---Cost Less  
**RADIO**

**CROSLY MANUFACTURING CO.**  
618 ALFRED ST., CINCINNATI, O.

# Crosley Radio Parts

## Popularity Proves Their Worth

The fact that innumerable favorable comments are received daily from people everywhere who have used Crosley parts with entire satisfaction leads us to believe that you too will find that they will fill your every requirement.

The Crosley V-T Socket has been pronounced by many radio engineers as the best socket on the market. Its popularity is based chiefly on its high quality, efficiency, service and practical unbreakability combined with its very low cost.

The Crosley Radio Frequency Amplifying Tuner consists of an inductance coil and a Crosley book type variable condenser. It can be tuned to any wave length between 200 and 600 meters. When used with non-regenerative sets it will increase the range many times.

The Crosley Sheltran is a completely shielded transformer. Embodied in it are all the characteristics so essential to obtain maximum amplification from the modern vacuum tubes used in radio work. Tests have proven the design to be correct to insure maximum efficiency.

*For Sale By Good Dealers Everywhere.*

**CROSLEY**  
BETTER · COST LESS  
**RADIO**

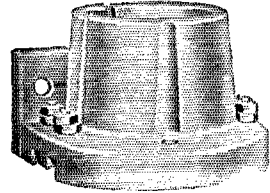

**CROSLEY V-T SOCKET**  
Made of porcelain for base  
or panel mounting.  
Price .....40¢

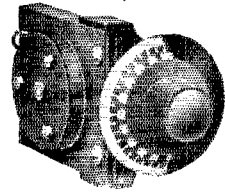

**CROSLEY AMPLIFYING  
TUNER**  
Price .....\$4.00

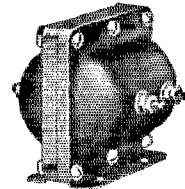

**CROSLEY SHELTRAN  
TRANSFORMER**  
Price .....\$4.00

**CROSLEY MANUFACTURING CO.**  
618 ALFRED ST., CINCINNATI, O.

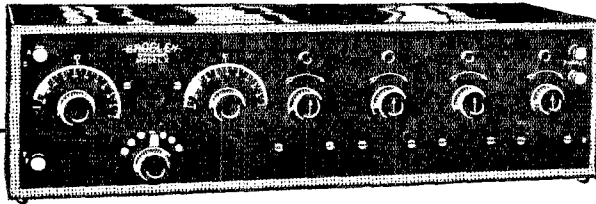

# CROSLEY

## Uses Formica for Panels and Insulation

CROSLEY radio sets are universally known and used. They are produced in a factory that is famous for its well developed production methods and factory systems.

Radio engineers for the Crosley Manufacturing Company, like those of nearly every other well known independent radio manufacturer, appreciate the superior qualities of Formica insulation for radio.

They use it in panels and for many other purposes in connection with their radio product, because it is good looking, because it works well with ordinary tools and because it has high di-electric strength and maintains it indefinitely, improving with age.

The Crosley Company is a large distributor of Formica panels and of radio parts of its manufacture in which Formica is used for insulation purposes.

*Formica dealers can supply you promptly with panels in all standard sizes. They can also supply special sizes when you want them.*

### THE FORMICA INSULATION COMPANY

4620 SPRING GROVE AVENUE,  
CINCINNATI, OHIO

#### SALES OFFICES

50 Church St., New York, N. Y.  
422 First Ave., Pittsburgh, Pa.  
1042 Granite Bldg., Rochester, N.Y.  
415 Ohio Bldg., Toledo, Ohio

1210 Arch St., Philadelphia, Pa.  
1819 Lyndale Ave., S. Minn., Minn.  
Sheldon Bldg., San Francisco, Calif.  
Whitney Central Bldg., New Orleans

414 Finance Bldg., Cleveland, Ohio  
9 S. Clinton St., Chicago, Ill.  
313 Title Bldg., Baltimore, Md.  
47 King St., Toronto, Ontario

# FORMICA

Made from Anhydrous Redmanol Resins  
SHEETS TUBES RODS

# GIBLIN-REMLER INDUCTANCE COILS

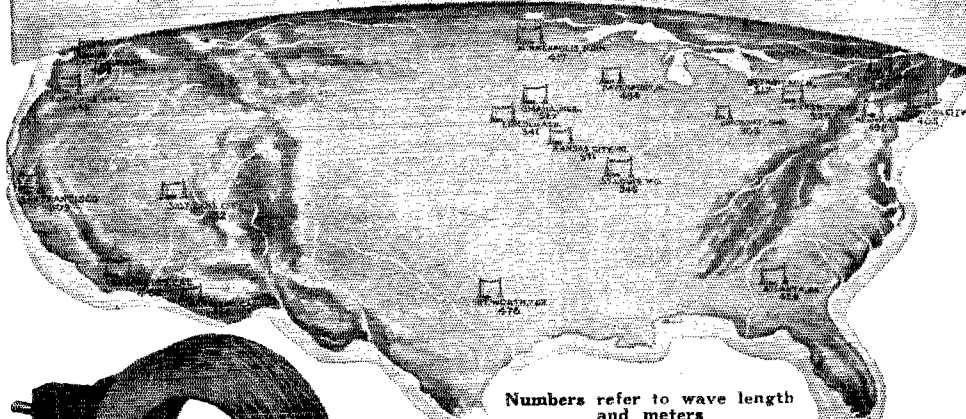

Numbers refer to wave length and meters

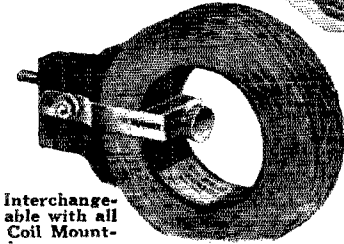

Interchangeable with all Coil Mountings.

—the basic and correct system for receiving over the entire range of broadcast wave lengths—228-546 METERS

Under the new assignments recently made by the U. S. Government, radio stations are now broadcasting on wave lengths ranging from 228 to 546 meters. It is, therefore, necessary that your receiving set operate efficiently over this entire range of wave lengths. For this purpose sets using Giblin-Remler Coils are ideal. As shown in the table when using condensers of .001 microfarads capacity a single set of coils may be selected that will satisfactorily cover this entire range.

In addition to this novel feature the Giblin-Remler coils, due to their special winding, have maximum inductance and minimum distributed capacity for a given number of turns. These two important electrical features insure maximum selectivity and greatest signal strength under any given condition.

The use of Giblin-Remler coils also insures greatest possible flexibility. By merely changing one or more of the coils your set may be made to cover any desired range of wave lengths.

Write for Bulletin Q giving complete information, table of constants and prices on Giblin-Remler coils.

Type and Number of Turns, Mounted	Price, Mounted	Type and Number of Turns, Unmounted	Price, Unmounted	Inductance in Milli-henrys at 1000 cycles Accuracy 1/2 %.	Natural Wave Length in Meters, Accuracy 1/2 %.	Distributed Capacity, in micro-micro-farads, Accuracy 1 %.	Wave Length Range in Meters using Condenser of .001 max. and .00004 mid. min.		High Frequency Resistance in Ohms at Wave Length shown.			
							Min.	Max.	200	500	1000	2000
RC 20M	1.50	RC 20U	.70	.030	39	14.3	63	334				
RC 25M	1.50	RC 25U	.70	.041	47	15.3	389		1.1			
RC 35M	1.50	RC 35U	.70	.083	67	25.4	350		1.5			
RC 50M	1.80	RC 50U	.80	.169	114	21.6	785		3.5			
RC 75M	1.65	RC 75U	.85	.377	163	19.3	1170		8.3	4.4		
RC 100M	1.70	RC 100U	.90	.666	217	19.3	1550		29.3	12.1	6.2	
									80.3	26.8	12.6	
RC 150M	1.75	RC 150U	.95	1.503	281	14.8	512	2320		1000		10000
RC 200M	1.80	RC 200U	1.00	2.68	374	14.7	690	3110	69.8	23.8	7.1	
RC 250M	1.80	RC 250U	1.10	4.20	424	12.1	860	3880		50.8	12.5	
RC 300M	2.00	RC 300U	1.20	6.11	494	11.2	1030	4680		87.5	19.9	
RC 400M	2.10	RC 400U	1.30	11.04	618	9.7	1380	6300	141	29.3	13.8	
RC 500M	2.30	RC 500U	1.50	17.50	747	9.0	1730	7900		54.6	22.3	
										93.1	34.9	
RC 600M	2.40	RC 600U	1.60	29.2	1024	10.1	2260	10250	2000	5000	10000	20000
RC 750M	2.65	RC 750U	1.85	39.0	1249	11.3	2660	11850		111	43.8	
RC1000M	3.40	RC1000U	2.50	71.6	1620	10.3	3570	16000			64	
RC1250M	3.80	RC1250U	2.90	108.0	1930	9.7	4380	19700			123	
RC1500M	4.40	RC1500U	3.50	159.8	2300	9.3	5300	23800				

These tests have been made by Robert F. Field of Cruft High Tension Electrical Laboratory, Harvard University, Cambridge, Mass.

## REMLER RADIO MANUFACTURING COMPANY

Factory and Home Office  
248 First Street, San Francisco, Cal.

Eastern Sales Office  
154 W. Lake Street, Chicago, Ill.



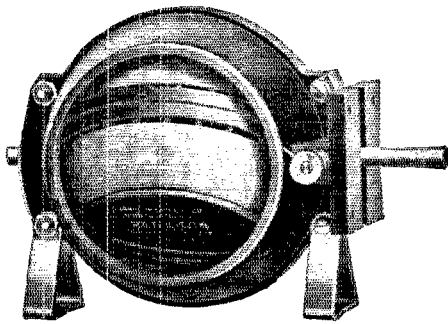

# New Paragon Variometer \$5.00

**T**HIS new Paragon variometer No. 60 has been designed to meet the very rigid electrical requirements and high mechanical standards of Paragon receiving equipment. The rotor and stator forms are molded of Bakelite—highly polished. The windings are supported, *on both stator and rotor forms, by twenty-four thin ribs* of the molded material in such a way that they are entirely surrounded with air excepting at points of contact. This method of construction results in an unusual mechanical strength and a decidedly superior electrical result. Ideal for use wherever a continuously variable inductance is needed.



**Paragon Stage Control Switch**  
Positive—noiseless—rapid—  
ideal  
No. 90, \$3.00

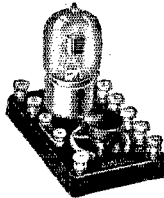

**Paragon V. T. Control**  
Attractive—compact—  
efficient  
No. 70, \$4.50



**Paragon Audio-Frequency  
Amplifier Transformer**  
No. 81, \$5.00

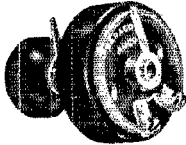

**Paragon Rheostats**  
Panel or Table  
Rugged—Dependable—  
smooth action  
No. 25—6 ohms for No. 200  
and No. 201 Tubes  
No. 26—16 ohms for No. 201 A,  
W D-11 and W D-12 Tubes  
No. 26 A—35 ohms for  
No. 199 Tubes  
\$1.50

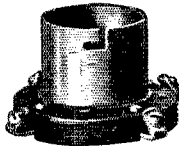

**Paragon V. T. Socket**  
Perfect contacts—heatproof—  
mirror finish—non-breakable  
Standard  
No. 30, \$1.00

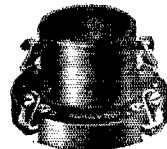

**New Paragon WD-11  
Tube Socket**  
Molded from Condensite—  
indestructible—mechanically  
and electrically perfect  
No. 34, 75c

An illustrated Catalog of Paragon Radio Products is yours for the asking.

**DEALERS**—The Adams - Morgan Company has an interesting proposition to make to reputable radio dealers who believe in quality merchandise. Details on request.

**ADAMS-MORGAN CO.** 4 Alvin Avenue, Upper Montclair, N. J.

# PARAGON

Reg. U. S. Pat. Off.

## RADIO PRODUCTS



# WHAT MAKES NOISE?

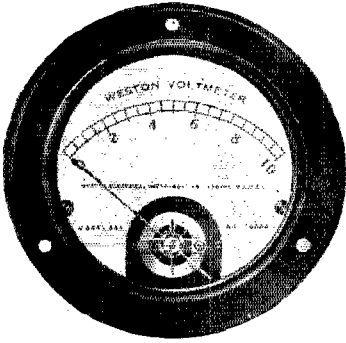

In the majority of cases it is the run down "B" battery and not static that causes the noise.

The "B" battery manufacturers recommend the discarding of 22½ volt batteries when they drop below 17 volts and 45 volt batteries when they reach 34 volts.

The Weston Voltmeter will tell you exactly the condition of your batteries.

An accurate instrument at a reasonable price.

Booklet 501-C gives complete information about Weston D.C. testing Instruments.

**WESTON ELECTRICAL INSTRUMENT CO.**

158 WESTON AVE.,

Branches in all principal Cities

NEWARK, N. J.

# WESTON



"THE SUN NEVER SETS ON THE WESTON"

"STANDARD" The World Over

**ELECTRICAL INSTRUMENTS**

*An Indicating Instrument for Every Individual Need and Industrial Purpose*

## "ILLINOIS" THE RELIABLE CONDENSER THAT IS MADE RIGHT AND STAYS RIGHT

Size	Panel	Cased
67 Plates...	\$7.00	\$8.50
43 Plates...	3.50	4.75
23 Plates...	2.75	4.00
13 Plates...	2.25	3.50

Vernier with single movable plate applied to 13, 23 or 43 sizes, \$2.00 extra. Send for Bulletin.

This list is inclusive of Fine Black, Moulded Dial. We also furnish the Condenser with smooth 3/8-in staff suitable for Dial at 15¢ off list.

Fully Assembled and Tested. IMMEDIATE SHIPMENT.

Money back if not satisfied. Just return within 10 days by insured Parcel Post.

Sent Prepaid on receipt of Price, Except; Pacific States, Alaska, Hawaii, Philippines and Canal Zone, add 10¢. Canada, add 25¢.

20% discount on orders of 6 or more; AMATEURS! Pool your orders and get benefit of discount.

**G. F. JOHNSON, 625 Black Avenue, SPRINGFIELD, ILL.**



*These two devices have revolutionized Radio:*  
**The Magnavox Reproducer and  
 the Magnavox Power Amplifier**

**T**HE efficiency of Magnavox Radio apparatus is best realized by comparison with other instruments constructed on less modern scientific principles. When operated in accordance with instructions, satisfactory results are assured.

Magnavox R3 Reproducer and 2 stage  
 Power Amplifier (as illustrated) \$90.00

R2 Magnavox Reproducer with 18-inch  
 horn: the utmost in amplifying power;  
 requires only .6 of an ampere for the  
 field . . . . . \$60.00

R3 Magnavox Reproducer with 14-inch  
 curvex horn: ideal for homes, offices,  
 etc. . . . . \$35.00

Model C Magnavox Power Amplifier  
*insures getting the largest possible power  
 input for your Magnavox Reproducer*  
 2 stage \$55.00  
 3 stage 75.00

*Magnavox Products can be had from good  
 dealers everywhere. Write for new booklet.*

**THE MAGNAVOX COMPANY**  
 Oakland, California  
 New York Office: 370 Seventh Avenue

**MAGNAVOX PRODUCTS**

*No Radio Receiving Set is complete without them*

6-T



# Mu-Rad R-F Amplifying Transformers

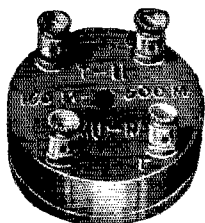

**200-600  
Meters  
Air Core**

## for Long Distance Work

**M**U-RAD Transformers were designed specifically for long distance reception. These very sensitive instruments are largely responsible for the astonishing performance of Mu-Rad Receivers. Use Mu-Rad Transformers in the set you are building and get the greatest possible amplification.

**Big Profits  
for the  
Dealer  
Who Handles  
Mu-Rad Products**

### Three Types

Type T-11 for the

first stage \$6.00

Type T-11A for

the second

stage \$6.50

Type T-11B for

the third stage

\$7.00

*Get Our Interesting Proposition*

**MU-RAD LABORATORIES, INC.**

304 FIFTH AVE. ASBURY PARK, NEW JERSEY

## The AMSCO LOUD SPEAKER

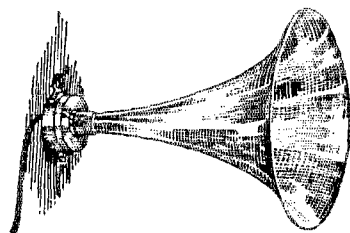

*is without a doubt the most scientifically accurate reproducing unit in existence—not the slightest trace of tone distortion being evident in the reception it affords. Tuning can be adjusted for either an unusually large volume of sound or meditative softness when desired.*

*The fact that the AmSCO Loud Speaker can be suspended from wall or ceiling, is a new and favorable innovation.*

Price, \$22.50

*A postcard will bring literature—illustrating and describing our entire line.*

**AMSCO PRODUCTS, Inc.,**

Successors to MORTIMER RADIO CORP.

ADVANCE METAL STAMPING CO.

Fairbanks Building

Broome & Lafayette Sts. New York City



**Send  
for these  
Bulletins**

No. AG-10. 3 1/2" ammeters, milli-ammeters, voltmeters, milli-voltmeters and thermal ammeters for all receiving and transmitting sets.

No. AG-20. 'Phones and Loud Speakers.

No. AG-810. Medium and large size ammeters, milli-ammeters, voltmeters, milli-voltmeters and current squared meters for all receiving and transmitting sets.

*Distributors write for attractive propositions.*

**ROLLER-SMITH COMPANY**  
16 Park Place, NEW YORK

*Offices in Principal Cities in U. S. and Canada*

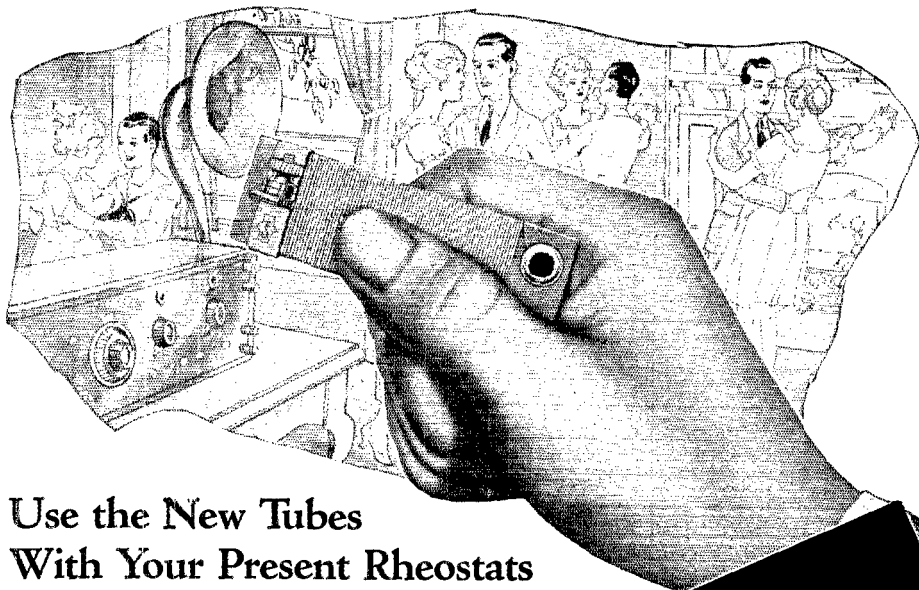

## Use the New Tubes With Your Present Rheostats

The resistance of each of your present rheostats (4 to 6 ohms) is too low to control the new quarter ampere tubes (UV 201A and C301A).

Cutler-Hammer engineers, however, have come to the assistance of the radio man once more and offer a small adjustable 25 ohm unit that can be attached to one of the posts of your present rheostat and with very little if any, wiring, and no loss of time, make it possible to use these new and better tubes for maximum results. It makes "junking" of your present rheostats unnecessary and saves the trouble and expense of redrilling your panel for new ones.

The C-H Radio Resistance Unit is arranged for use with all makes of rheostats and for panel mounting. This new unit increases the range of your 0-5 ohm rheostat to 0-30 ohms, the slider being adjustable over the entire range to care for changes in battery potential. After once set, this adjustment requires practically no attention and regulation of the tube is obtained entirely by turning the rheostat knob.

### THE CUTLER-HAMMER MFG. CO.

*Member Radio Section,  
Associated Manufacturers of Electrical Supplies*  
MILWAUKEE, WISCONSIN

*Carried by dealers everywhere. If yours has not been supplied, send 25c direct plus 10c for mailing*

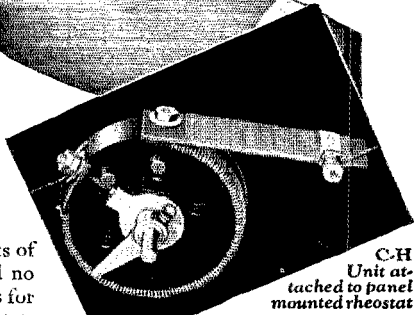
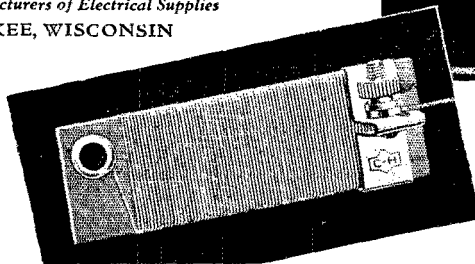

**C-H**  
Unit at-  
tached to panel  
mounted rheostat

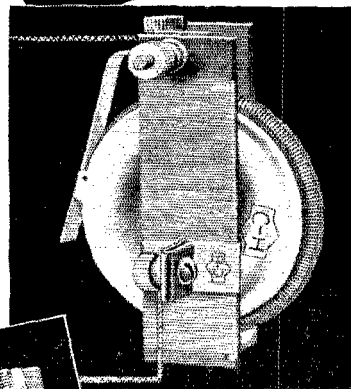

**C-H** Unit attached  
to standard C-H  
Rheostat

**C-H** Unit mounted on post  
fastened to panel; then wired  
in series with rheostat. Easy,  
neat, effective mounting



# RESISTANCE UNIT

FOR RADIO RHEOSTATS

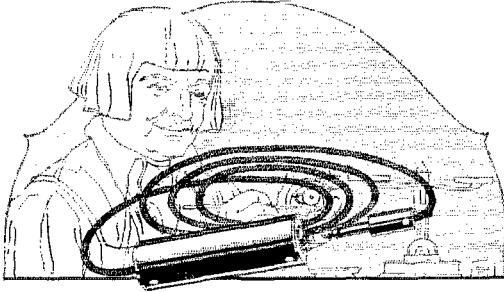

## The ideal loud speaker extension cord

**T**HIS handy Frost-Radio Extension Cord provides a slightly means of connecting your radio receiving set in one room with the loud speaker in another.

### Thousands in daily use

We have sold many thousands of these Extension Cords to enthusiastic users. The cord is furnished with a Frost-Radio Jack, in hard rubber housing, at one end, and a Frost-Radio Cord Tip Plug at the other. Sold in lengths and cord grades to suit every purse and purpose.



### Order today from your dealer

Your dealer probably stocks Frost-Radio. Go to him today and ask to see this handy Extension Cord. Order one today for your set, and inspect the other items of

## FROST-RADIO

The complete line of Frost-Radio includes Frost-Fones, Receiving Transformers, Tuning Coils, Microphones, Jac-Boxes, Plugs, Jacks, Multiphone Plugs and other popular items. Illustrated here is Frost-Radio Receiving Transformer No. 400. Price, \$8.50.

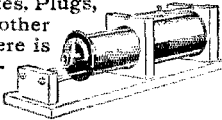

### Guaranteed by the name of the manufacturer



You will need several. Your dealer has them.

Frost-Radio Jacks are the best for your set. Five types, each the best for its purpose.



### Your dealer stocks Frost-Radio

Good dealers everywhere carry Frost-Radio in stock. Supply your needs today through your local dealer and save money. Every item guaranteed.

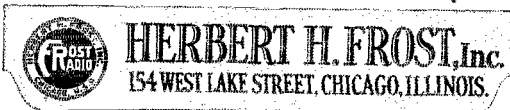

# ATWATER KENT

RECEIVING SETS AND PARTS

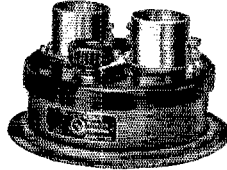

If you are now working with a one-tube set, the 2-stage amplifier shown here will give you the necessary volume of sound to make a

loud speaker possible.

It is a compact unit—transformers are sealed in the base so that no dampness can affect the working quality of the instrument. To demonstrate the damp-proof qualities, one of these instruments was soaked in a tub of water for several hours, then put into a circuit and tested for reception with perfect results.

*Send for an illustrated folder showing all parts and complete sets.*

ATWATER KENT MFG. COMPANY  
4945 Stenton Ave., Philadelphia

*a Chi-Rad Special!*



for W.D.11 tubes—

Standard Willard Storage batteries with well-known threaded rubber insulation. Specially adapted for W.D.11 tubes. Delivers 2 volts to one tube for 210 hours on a single charge. Rechargeable. Brand new, dry until ready to charge.

This is a special time and quantity limited offer. Orders will be filled in the order we receive them—get yours first by sending your order in now!

2-Volt Willard, Charged . . . \$7.50

2-Volt Willard, Dry . . . . . \$6.50

Chicago Radio Apparatus Co.  
415 S. Dearborn St., Chicago, Ill.

# Laminated Sheets, Rods, and Tubes

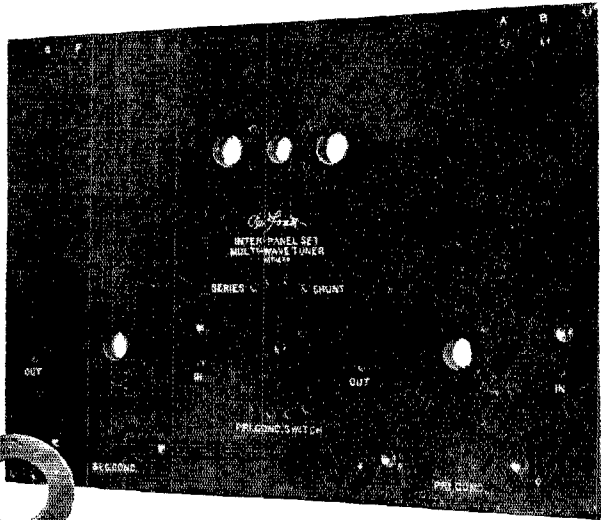
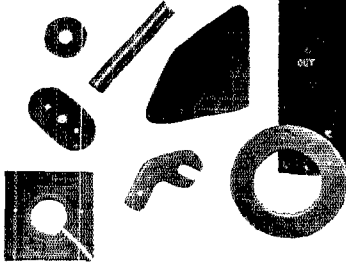
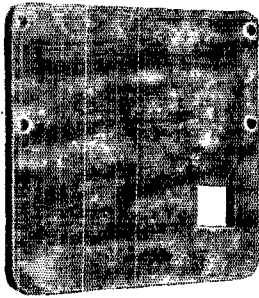

## Molded Parts

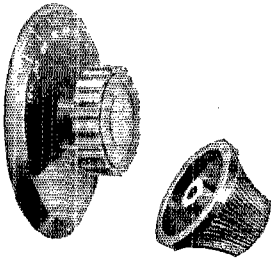

## Phenol Resin—

### *Radio's Standard Insulation*

The United States Navy, the Signal Corps and the leading Radio Manufacturers, without exception, have adopted

BAKELITE--CONDENSITE--or REDMANOL phenol resin insulating materials.

The reason for this unanimous endorsement by Radio authorities is easily understood, for phenol resin, in both laminated and molded form, is a standardized product of uniform quality. Time has no effect upon its high dielectric properties, it does not fade or change color and will not absorb moisture.

Our licensed fabricators are prepared to furnish radio parts molded from our products and also machined or engraved panels in large or small quantities at very reasonable prices. Names on request.

*Divisions of*  
**BAKELITE CORPORATION**

### **BAKELITE**

General Bakelite Co.  
8 West 40th St. New York

### **Condensite**

Condensite Co. of America  
Bloomfield, N. J.

### **REDMANOL**

Redmanol Chemical  
Products Co.  
636-678 West 22nd St.  
Chicago, Ill.

**BAKELITE CORPORATION**

*Address the Divisions*

# The Material of a Thousand Uses



## Federal Standard

**Head Sets Are Endorsed by Experts**



*Federal Standard Head Sets are made with 2200 Ohms and 3200 Ohms resistance.*

*Federal makes a complete line of Standard Radio apparatus—all reasonably priced. Write for latest catalog.*

**W**HEN you buy Federal Head Sets you obtain the lasting satisfaction that comes with Radio equipment universally endorsed by engineers and experts.

Twenty three years of experience in making communication apparatus. Federal

Standard Guaranteed Radio Equipment—the best of its kind.

Permanent magnets, counted field windings carefully insulated, specially treated steel, and precision machining, standard air-gaps; make all Federal Head Sets uniformly clear-toned and thoroughly dependable. And extra large ear pieces make them *comfortable*. Federal Standard Head Sets are the best you can buy.

*Ask your dealer for Federal Standard Head Sets. If out of stock he can get them from our nearest office. Accept no substitute.*

**Federal Tel. & Tel. Company**

**BUFFALO, N. Y.**

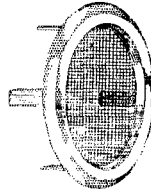

# Half-a-dozen

reasons for the ever increasing popularity of STEVENS Radio Panel Windows:

**CORRECT DESIGN.**

Improves the appearance of any set.

**STANDARD SIZE.**

Adaptable to any kind or size of panel.

**UNIT ASSEMBLY.**

Screens cannot loosen or drop out. Securely fastened without tools or effort.

**EASY INSTALLATION.**

Choice of Polished nickel or black enamel.

**PERFECT FINISH.**

Considering quality the price is low.

**MODERATE COST.**

Made for those that want the best

List Price 35 cents

If your dealer cannot supply you, send us his name and address and we will mail your order prepaid.

## STEVENS COMPANY

Manufacturers

434 60th St.,

Oakland, California

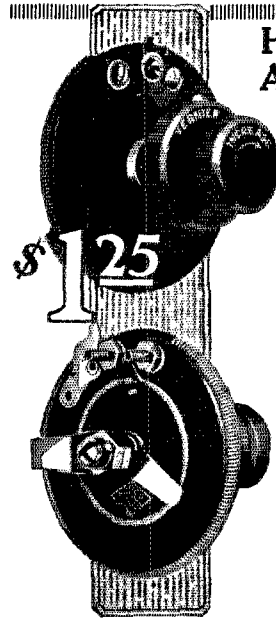

## Hair-Splitting Adjustment—

Smooth—

Positive

THAT fineness of control needed for tuning-in long distance. Control that makes the most of the "critical point" of your detector. Strongest, clearest signals—that's what you get with the

**BASCO**

## Vernier Rheostat

*Probe the Signal Out of Squalls!*  
Neat appearing. Smooth, positive operation. Only one panel hole needed for mounting. A small knob for coarse adjustment—larger knob for fine adjustment. (.015 of an ohm). Increases distant reception and tone clarity. See BASCO Complete Radio Line. If your dealer can't supply you, write us,



**Briggs & Stratton Co**

Milwaukee, Wisconsin



# Every Radio "Bug" OK's the Kellogg Variometer

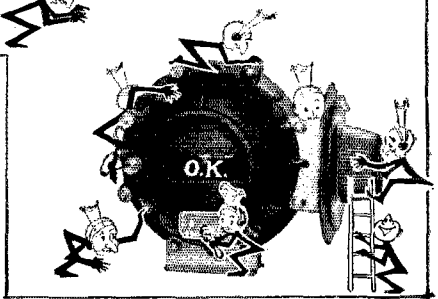

A product that stands up under the test of service of the widest range. The stator and rotor shells are of molded Bakelite, of extra strong rib design. A handsome brown in color.

The windings are of the highest grade insulated wire, terminating on binding posts securely molded in the Bakelite shell. The flexible wires used to bring the rotor leads to the outside of the variometer are of special construction with a heavy insulation.

Ample size bearings assure smooth, even movement with long life, a spring of proper tension takes up all play and prevents back lash. There are no sliding contacts, nothing to wear, nothing to "short," or produce noises.

High inductance and low distributed capacity.

Have your dealer show you other Kellogg radio parts—each in a class by itself. Get the most out of radio. Build it with Kellogg time-tested equipment. Use the following **KELLOGG** radio equipment for better results:

Variometers, \$8.00; Variocouplers, \$9.00; Tuner Coils, \$3.00; Head Sets, \$10.00; Microphones, \$8.90; Tube Sockets, \$.75; Plugs, \$1.00; Four Conductor Jacks, \$1.10; Two Conductor Jacks, \$.75; Six Conductor Jacks, \$1.25; Four Inch Dials, \$1.25; Forty Three Plate Variable Condenser with Five Plate Vernier-Four Inch Dials and Knobs, \$8.75; Twenty Three Plate Variable Condensers with Five Plate Vernier-Four Inch Dial and Knob, \$7.75; Eleven Plate Variable Condensers with Five Plate Vernier-Four Inch Dial and Knob, \$6.75; Miniature Condensers, \$.75; Rheostats, \$2.00; Air Choke Coils, \$1.00; Iron Core Choke Coils, \$1.35.

Kellogg Radio Apparatus proves the least expensive in the long run. Why experiment. Buy the best.

*All Kellogg Radio Parts are manufactured and guaranteed by*

## Kellogg Switchboard & Supply Company

CHICAGO, ILLINOIS

Columbus, Ohio

Kansas City, Mo.

San Francisco, Cal.

Portland, Ore.

*Kellogg Apparatus exclusively is used in building the Symphony Receiver*

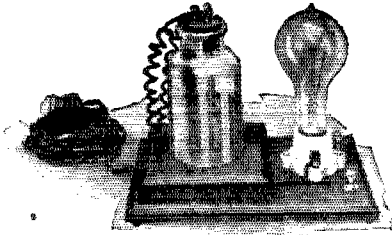

## Storage Batteries designed for **RADIO**

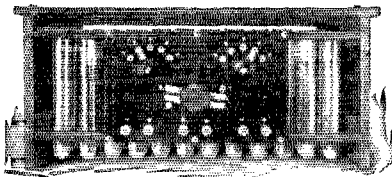

"B" Battery with Panel Control

KICO Storage "B" batteries are used by thousands of amateurs who understand radio and consequently buy nothing but the most efficient equipment.

### A FEW REASONS

1. Alkaline type.
2. They eliminate noises caused from "B's" that are rapidly deteriorating.
3. The switch control allows single cell variations from 12 volts up. (A critical plate adjustment is essential on your detector bulb for C.W. and Radiophone reception.)
4. Rechargeable from your 110 Volt A.C. line in connection with the rectifier supplied with each battery.
5. Will last from three to six months on a single charge while in the detector plate circuit.
6. NOT an experiment. All batteries sold with the privilege of receiving your money back if unsatisfied within a 30 day trial.
7. Neat, Efficient and Compact.
8. Unlimited life.

Prices without rectifier

	Plain	(With Panels)
16 cell 22 volt	\$5.59	
24 cell 32 volt	7.25	\$11.75
36 cell 48 volt	9.50	14.00
50 cell 68 volt	12.50	17.00
78 cell 100 volt	17.50	22.50
108 cell 145 volt	23.50	28.50
Unmounted rectifier	1.00	
Mounted rectifier	2.50	

F.O.B. Buffalo, N. Y.

Literature gladly furnished

**KIMLEY ELECTRIC CO., Inc.**  
1355 Fillmore Ave., Buffalo, N. Y.

## A Barrel O' Fun With Western Electric Microphone

Cord—Plug

Breast-Plate

Shoulder Straps

Transmitter

**\$1**

Sent prepaid  
on receipt of  
Money Order

These microphones were used by the army and navy for transmitters. Each one is thoroughly tested and was made to sell for \$7.50. Plug into your set and talk thru your speaker! Loads of fun!

# ROVA

**RADIO PRODUCTS CORPORATION**  
Dept. A. 167 West 18th St., N. Y. C.

## RADIO "BUGS" GET INTO BUSINESS FOR YOURSELF

Why not turn your hobby into money? You can easily make \$15.00 a day, or as much more as you like, by our wonderful plan of selling Radio direct to the millions of people just waiting for our better parts or sets. We furnish everything you need at lowest factory prices and tell you how to build a profitable business of your own. Knott products are up to the minute. Knott plans are unique and unbeatable. Radio is just beginning to come into its own. Are you? Want to make more money? Want to be your own boss? Write TODAY for FREE instructions How to Sell Real Radio.

**E. R. KNOTT MACHINE CO.**  
1-F Ellery St., S. Boston 27, Mass.

## MARLE TRANSFORMERS

Audio Frequency  
Radio Frequency

Superior Quality  
Reasonably Priced

Ask Your Dealer

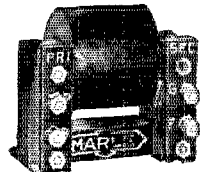

MANUFACTURED BY  
**MARLE ENGINEERING CO.**  
Orange, N. J.

### General Radio Type 300 Amplifier Unit—

Works equally well with crystal or tube detectors. Is a compact unit, wired ready for external connections. Two or more units may be used together to obtain multi-stage amplification.

#### Prices

Type 300-C Amplifier Unit for UV-199 Tubes, complete except for tube and batteries. **\$7.75**

Type 300-D Amplifier Unit, with standard socket for UV-201A. **\$8.25**

### Type 231-A Transformer

—Gives the maximum amplification possible without distortion. Like all instruments manufactured by The General Radio Company, the Type 231-A is guaranteed.

Price **\$5.00**

### General Radio Type 214 Rheostat—

A convenient, practical instrument, equally well adapted for experimental service or permanent installations. You'll never cause unpleasant noises in the phones when you rotate the contact arm of a Type 214 Rheostat.

#### Price

For the new UV201-A Tubes, 20 Ohms.  
For the newer UV199 Tubes, 50 Ohms.  
For the Standard Tube, 7 Ohms.

**\$2.25**

### Type 214 Potentiometer

To get your gas detector on that sensitive kink by fine adjustment of the plate potential, use this General Radio 400 Ohm Potentiometer to control regeneration in your radio frequency amplifier.

Price **\$3.00**

#### Amateurs—

Bring your problems to us. Our Engineering Staff is always at your disposal.



For more than eight years, among men who know and use Radio Apparatus of the better sort, the name—General Radio Company—has been accepted as a guarantee of all that goes to make up satisfaction and as synonymous with the advances in theory and practice which accompany all true Radio progress.

As an example—for the amateur who wants real Radio efficiency—there is no single piece of apparatus which more completely fills its niche than the General Radio Type 300-C Amplifying Unit—the Amplifying Unit which requires no storage battery.

If you are interested in Radio Apparatus in which price is subordinated to satisfaction, send for Bulletin 914Q. It is an educational pamphlet for the amateur who wants better equipment.

## GENERAL RADIO CO.

*Manufacturers of*

Radio and Electrical Laboratory Apparatus  
11 Windsor St., Cambridge, Massachusetts

5169

# BUILD YOUR OWN RADIO

The Radio Specialty Company—RASCO for short—specializes in small orders; in fact, 50% of our orders are less than one dollar. 24-hour service guaranteed.

This Company specializes in small parts for radio, selling only the highest class of materials. This Company is aware of the fact that very high prices prevail in radio now. By buying material from us you not only save anywhere from 50 to 75% on the cost of the instruments, but you have the fun and instruction of making them yourself.

Our quick 24-hour service means satisfied customers. We have no Complaint Department. Hundreds of letters such as the following, unsolicited, are in our files:

41 Rodney St., W. St. John, N.B.

Dear Sirs:  
Enclosed you will find one (1) dollar for which please send me 1 dozen binding posts No. 201 at \$1.00 per dozen and oblige.

Geo. B. Ingraham  
P.S. — Rasco Service is sure all it is cracked up to be. I have received three different orders from Rasco and I am still waiting for an order from another Company which was sent in before the first Rasco order.

Yours truly,  
G. B. I. 64 page catalog

Our prices are low and all goods are shipped prepaid. You deal with the oldest and only Company exclusively manufacturing the small parts in their own two big factories. Our big 64-page catalog, No. 7, containing over 300 illustrations will save you money. This catalog also contains

75 Diagrams of  
Vacuum Tube Hook-Ups

not to be found in any catalog, only found in expensive text books. This catalog sent only upon receipt of 15¢. Once you have tried the RASCO service you are a customer for life. 85% of our customers always come back.

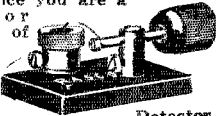

Detector 50¢

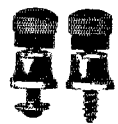

**Radio Specialty Co.**

98-100 PARK PLAGE, NEW YORK CITY

## RHAMSTINE\*

Victophone

For Your Phonograph  
or Horn

A New Loud Speaker

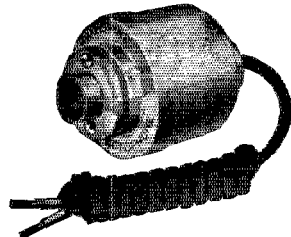

Price  
**7.50**

Complete with  
Cord

Remove the reproducer from your phonograph and put on the Rhamstine\* Victophone; adjust the pole regulator until the tone and volume are just right, and your needs are met for a perfect loud speaker.

Compare it with any other loud-speaker designed for the same purpose—in volume, in tone, in quality—it surpasses all—and the price is only \$7.50—backed by the Rhamstine\* name.

Dealers write for discounts.  
**J. THOS. RHAMSTINE\***  
2162 E. Larned St., Detroit, Mich.  
\*Maker of Radio Products

Don't just ask for  
a Head Set ~ Say:  
**DICTOGRAPH**  
Choice of experts  
Sold by all  
Responsible  
Dealers &  
Department  
~ Stores ~  
**DICTOGRAPH PRODUCTS CORP.**  
220 W. 42nd St., New York

**BUY TWO OR THREE DICTOGRAPH HEADSETS**  
and let the rest of the family enjoy the broadcasting.

**FIRST TO RECEIVE ACROSS THE SEA**  
A Tuska Radio Set at Station 1RU received the first British amateur code in trans-Atlantic tests. Finely built. Several models. Catalog 1-C on request.  
**THE C. D. TUSKA COMPANY**  
Hartford, Conn.



**TUSKA RADIO**

ALWAYS MENTION Q S T WHEN WRITING TO ADVERTISERS

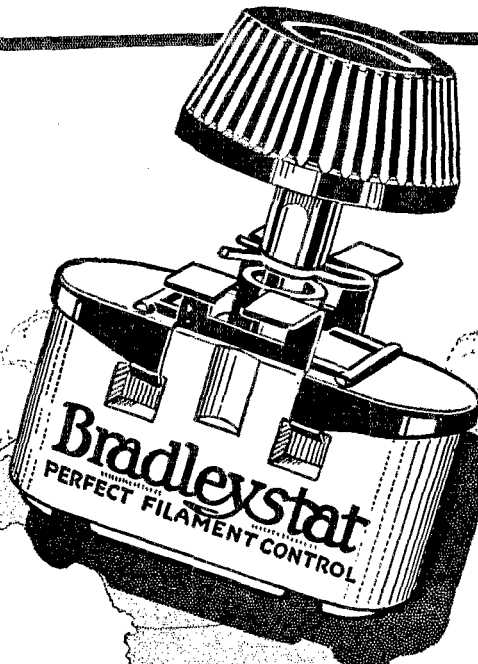

# Tune Sharper & Quicker with the Bradleystat



There is no question about the superiority of the Bradleystat. Its supremacy is becoming more manifest every day. Thousands of letters from delighted radio enthusiasts, amateurs and professional radio men prove, beyond a doubt, that the Bradleystat gives perfect filament control.

A letter just received from an Ohio radio dealer reads:

*"The Bradleystat has met with our entire approval. We have made it regular equipment on all Westinghouse RC sets sold by us and have installed many Bradleystats on Crosley and other receivers with perfect satisfaction."*

Why strangle your radio set with a poor filament rheostat? Try the Bradleystat, tonight, for better radio reception.



**The Checked Box**  
is easily recognized in radio shops by enthusiasts who are looking for the best equipment in radio. Complete instructions and drilling template are included.  
Retail Price, \$1.85  
Parcel Post 10c extra



### The Bradleyometer

is a perfect potentiometer in 200-ohm or 400-ohm sizes. 200-ohm, \$2.00; 400-ohm, \$3.00  
Parcel Post, 10c extra



**The Bradleyadapter**  
is a high-grade adapter for WD-11 tubes with silver-plated contacts. Price, \$1.00.

**Allen-Bradley Co.**

Electric Controlling Apparatus  
277 Greenfield Avenue, Milwaukee, Wis.

Manufacturers of graphite disc rheostats for over twenty years

# Bradleystat

REGISTERED U.S. PAT. OFF.

## PERFECT FILAMENT CONTROL

# This Is A Set That Operates RELIABLY

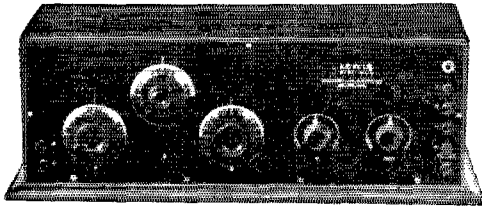

## The W. C. 5

You can depend on the W.C.-5 to operate without trouble or delay even under the most unfavorable conditions. It is the result of our 10 years experience in the manufacture of X-Ray and Radio-Frequency apparatus.

The W.C.-5 is a 4 tube set. One stage of tuned radio frequency amplification is employed ahead of the detector to make it supersensitive. Two powerful stages of audio frequency are used to bring up the volume of signal strength. Simplicity of construction and the elimination of unnecessary parts make this set easy to operate and effective for receiving from long distances without high or expensive antenna.

### 1,000 to 2,000 Miles on Loud Speaker

The W.C.-5 will receive signals from stations within a radius of from 1,000 to 2,000 miles. It tunes wonderfully sharp on all popular telephone broadcasting wave lengths. This set is so efficient on short waves that it has picked up many stations on their lower harmonics.

## Price \$80.00

Wave length 160 to 750 meters

Write us for complete description of the WC-5. See it at your dealers or at one of the distributors below:

Julius Andrae & Sons Co., Milwaukee, Wis.	Western Motor Supply, Minneapolis, Minn.
Morton Electric Co., St. Louis, Mo.	Funsten Electric Co., Kansas City, Mo.
International Electric Supply Co., 29 Broadway, New York City.	Continental Radio Co., 120 North Wells St., Chicago, Ill.

W. A. Roosevelt Co.,  
La Crosse, Wisconsin.

WESTERN COIL & ELECTRICAL CO.  
302-Fifth St., Racine, Wis.

Here is where you can get  
"Everything worth  
while in Radio"



The Radio Store of  
**PAUL FRANKLIN JOHNSON**  
560 E. Colorado St.  
Pasadena, California

## THE NEW R T-8

Radio Frequency Transformers are specially designed by the Radio Service LABORATORIES for maximum efficiency when used with any low current consumption tubes on the market.



For Audio Frequency the new RT-A2 will give you 100% Tone Quality and High Amplification without distortion. For best results on both tone and distance, use Radio Frequency RT-8 (for all stages) in the black case, retail price \$8.00, and Audio Frequency RT-A2 in brown case, retail price \$6.50. For sale at all reliable electrical or Radio Stores. If your dealer cannot supply you, order

direct. Order by type number, accept no substitute, and remember that all Radio Service Laboratories' Transformers are individually triple tested and unconditionally guaranteed.

Send ten cents for booklet on Radio Frequency with schematic diagrams—a most valuable and helpful publication for the radio amateur and expert.

**RASLA SALES CORPORATION**  
National Distributors  
DEPT. B, 10 E. 43rd ST., New York City

## CHARGE YOUR BATTERY.

(RADIO OR AUTO)  
at HOME for a NICKEL  
The **HOMCHARGER**  
POPULARLY PRICED—PAYS FOR ITSELF  
SEND FOR THE AUTOMATIC ELECTRICAL  
DEVICES CO.  
FREE BOOK, 127 W. THIRD ST., CHICAGO, ILL., U.S.A.

# \$1000.00 in prizes

*for the best results with Radio frequency.  
Read how you can enter this summer's contest*

FOR the fifty best articles setting forth how radio frequency has helped conquer summer static and other forms of interference (such as from spark transmitting stations and your neighbor's radiating receiving set) the Acme Apparatus Company will pay a total of one thousand dollars in cash and radio apparatus.

Each article submitted must narrate the personal experiences and experiments of the writer in securing distant stations, in avoiding interference and distortion, and in securing volume and clearness of reception. Wiring diagrams showing the hook-ups used to secure these results will add greatly to the value of the article. No article shall exceed five hundred words.

Radio and audio frequency transformers of any make or brand will be eligible. The contest starts June first and ends September thirtieth. In case of a tie, each tying contestant will receive the full amount of the prize. All articles must bear a postmark of not later than October first. Do not stay out of the contest for fear that you are not an "expert". A novice with natural mechanical or electrical ability may hit on a combination which will win the first prize—\$250.00 in cash. Send the coupon or apply to any radio dealer to secure the four page folder explaining complete details of contest, the judges, the prizes to be given, etc.

# ACME

*for  
amplification*

ACME APPARATUS COMPANY  
Cambridge, Mass.

Gentlemen:—Please send me full details of radio frequency contest.

Name \_\_\_\_\_

Street \_\_\_\_\_

City \_\_\_\_\_ State \_\_\_\_\_

# SOMETHING

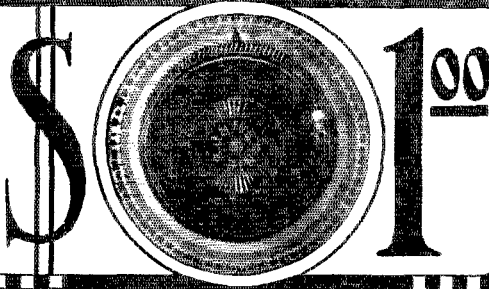

# NEW

## SELECTIVITY AT LAST!

The UNIVERNIER provides ultra-fine vernier adjustment for ordinary Variable Condensers, Variometers, Variocouplers, Potentiometers, Rheostats and Tickler Coils.

### EASY TO INSTALL

The UNIVERNIER takes the place of the ordinary knob, and is applied in a few minutes without disturbing the set.

### DISTINCTIVE

The UNIVERNIER will add to the appearance of any radio set. It is an instrument of precision and has that appearance. It consists of a well designed knob inside of which is a simple mechanism so arranged that the knob rotates nearly 12 times to one revolution of the shaft. By pressing lightly towards the panel, it functions as an ordinary knob, thus combining vernier and coarse adjustment in a single unit. DX results are surprising!

**THE UNIVERNIER... \$1.00**  
 360 degree finely graduated silver plated dial for use with UNIVERNIER 25¢ extra—  
 Complete, \$1 25

At your dealers or direct on receipt of the above amount.

#251 for 1/4 inch shaft  
 #188 for 3/8 inch shaft  
**DEALERS AND JOBBERS  
 WRITE FOR DISCOUNTS**

**WALBERT  
 MANUFACTURING CO**

929 Wrightwood Ave., Chicago, Ill.

# UNIVERNIER

## RADIO TRANSFORMERS

REAL MERIT is what you expect and what you receive when you use STANDARD Radio Transformers.

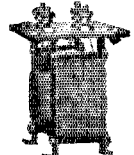

Type M

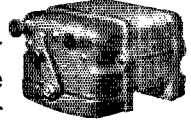

Type FL

PERFECTLY SHIELDED by virtue of the design MAXIMUM AMPLIFICATION by proper impedance.

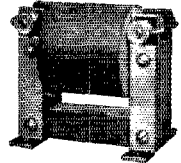

Type MR

Silicon steel cores, insulation test on coils 1500 volts. Bakelite Terminal Board.

Type M—Ratio 9 to 1.....\$5.00  
 Type MR—Ratio 4 to 1..... 4.50  
 Type FL—Filament Heating..... 3.00  
 Discount 10% for cash with order

Designed by *Pickard* engineers, a quality name in Radio.

**THE  
 STANDARD TRANSFORMER COMPANY  
 WARREN, OHIO.**

**"BUILD YOUR OWN"**  
 With "RASCO" Parts!  
 If you need small radio parts in a rush, "RASCO" will supply them cheaper, better and quicker than any one. Be sure to get our great 68-page catalog, over 500 different parts, 300 illustrations. This catalog contains 75 Vacuum Tube Hook-Ups, all values being shown. Due to great cost, catalog sent only upon receipt of 15c, stamps or coin.  
 Radio Specialty Co., Inc.  
 980 Park Place, New York

# NOVO

## "B" BATTERIES

WITH INSULATED BINDING POSTS & DETACHABLE WIRE CONNECTOR

**NOVO MFG CO.**

424 W 33rd ST NEW YORK - 531-80 DEARBORN ST CHICAGO.



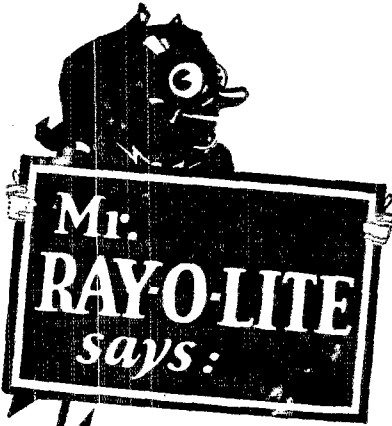

## No Acid to Ruin Rugs

Accidents will happen with a storage battery.

Equip your set with WD-11 or WD-12 Dry Battery Tubes and Ray-O-Vac "A" Dry Cells. Then you can set up anywhere in the house without a chance of hurting anything.

This combination gives the best possible reception, too, and costs less. When properly connected, Ray-O-Vac "A" Batteries give 200 hours service. They come in 1, 2, 4 and 6-cell units.

Everyone interested in radio should have the Ray-O-Vac Radio Trouble Finder and Broadcasting Station Directory. It's free. Send for it today.

FRENCH BATTERY & CARBON COMPANY  
Madison Wisconsin

Atlanta - Chicago - New York - Minneapolis - Kansas City  
Dallas - Denver

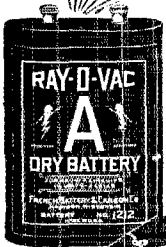

Use Ray-O-Vac "B" Batteries for sustained voltage, longer service and elimination of noise.



# RAY-O-VAC

*The Battery that Completes Radio*

Send for this

2nd Edition  
\$2.00 postpaid

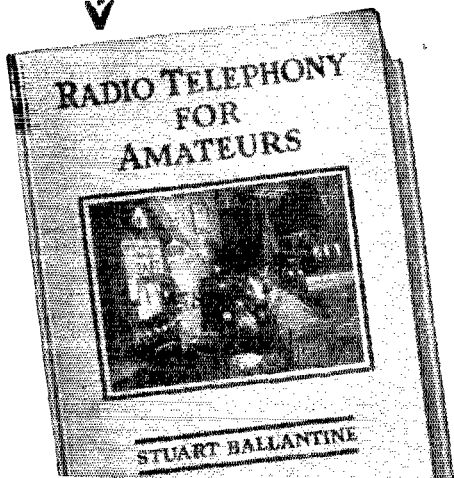

## Here's the book for real Radio Men

You fellows who really know radio need this book. The author, a fellow A. R. R. L. member, has filled its 290 pages and 153 illustrations chockful of practical information on new things to do and make.

Here are some of the high spots. Sections on MODULATION tell clearly how it is done. FILTER circuits are described. Drawings and data are given for making special transformers and complete sets, together with ways of reducing losses. Order your copy NOW.

David McKay Co., Philadelphia

### Fill in, Cut off and MAIL

David McKay Co.  
S. Washington Sq.  
Philadelphia

Radio Telephony  
for Amateurs  
Price \$2.00 postpaid

Gentlemen:

Please rush my copy of Radio Telephony for Amateurs for which I inclose \$2.00. Send AT ONCE to,

Yours truly,

Name .....

Address .....

City & State .....

KVQ—Pittsburgh, Pa.—RADIO BROADCASTING STATIONS—Washington, D. C.—WMU

## STANDARD RADIO ESSENTIALS

All orders with remittance promptly delivered Post or Express paid

Up-to-Date Stock of Dependable Radio Equipment and Parts

### IMMEDIATE DELIVERY ON ALL ITEMS LISTED



Stromberg-Carlson  
No. 2-A Headset, \$7.50

D-H, E Crystal Receiving Set-R-24 Jr.	\$20.00
Radiola Sr. Receiving Set	65.00
Radiola Sr. 2 stage Amplifier	68.00
Type RC Receiving Set	132.50
Radiola Grand—Type RG	325.00
Simplex Variometer	6.00
King Amplitone	9.00
Holtzer-Cabot 2000 ohm Head Set	8.00
Standard Horns—7" Bell	5.00
Standard Horns—5" Bell	3.50
R-K Horns	3.50

Enclose Certified Check or P.O. Money Order with orders.

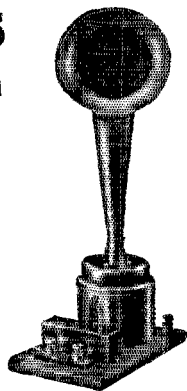

## DOUBLEDAY-HILL ELECTRIC CO.

WASHINGTON, D. C.—DEALERS WRITE FOR DISCOUNT—PITTSBURGH, PA.

### J. F. ARNOLD

Radio specialist since 1910

Sets built to order, rewired or repaired  
Your own material made into a set  
Baldwin Phones repaired, or made into  
Loud Speakers

Dependable work—Reasonable charges

Address 109 East 125th St., N. Y. C.

UP ONE FLIGHT

## \$200.00 in PRIZES

For brief letters describing your experiences with Radio. Send to FARM AND HOME, Springfield, Mass., for a free copy of our May issue in which complete details are given.

Trade

# “ESCO”

Mark

## “ROLL of HONOR”

*These (and many other) Institutions use “ESCO” Motor-Generators  
for Wireless Operation*

U. S. NAVAL ACADEMY  
 U. S. MILITARY ACADEMY  
 U. S. COAST ARTILLERY SCHOOL  
 U. S. ARMY AIR SERVICE  
 U. S. BUREAU OF STANDARDS  
 U. S. NAVY AIR SERVICE  
 U. S. NAVY YARD  
 U. S. DEPT. INTERIOR (*Alaska*)  
 U. S. LIGHTHOUSE SERVICE  
 CLARK UNIVERSITY  
 DENNISON UNIVERSITY  
 FORDHAM UNIVERSITY  
 JOHNS HOPKINS UNIVERSITY  
 JAMES MILLIKEN UNIVERSITY  
 LA. STATE UNIVERSITY  
 MARQUETTE UNIVERSITY  
 PURDUE UNIVERSITY  
 PRINCETON UNIVERSITY  
 QUEENS UNIVERSITY (*Canada*)  
 TULANE UNIVERSITY  
 UNIVERSITY OF FLA.  
 UNIVERSITY OF IOWA  
 UNIVERSITY OF MINN.  
 MAYO CLINIC, ROCHESTER, MINN.  
 UNIVERSITY OF MO.  
 UNIVERSITY OF SO. DAK.  
 CHICAGO RADIO LABORATORY  
 FORD TECHNICAL LABORATORY  
 GENERAL MOTORS RESEARCH LABY.  
 HAMMOND RESEARCH LABY.  
 JACKSON RADIO ENG. LABY.  
 MARITIME RADIO LABY.  
 (*St. Johns, N. B.*)  
 SIMPLEX RADIO LABY.  
 BD. OF EDUCATION, DETROIT  
 BD. OF EDUCATION, SAGINAW  
 BD. OF EDUCATION, TOLEDO  
 STATE BD. OF PUBLIC AFFAIRS  
 (*Okla.*)  
 CITY OF CHICAGO  
 CITY OF OAKLAND  
 WIS. DEPT. OF MARKETS  
 UNION STOCK YARDS, CHICAGO  
 IOWA SO. UTILITIES  
 BROADCASTING CORP. OF AM.  
 EXPERIMENTERS INF. SERVICE  
 Q. S. T. EXECUTIVE HQRS.  
 HENRY FORD

CHAS. P. STEINMETZ  
 MASS. INST. OF TECHNOLOGY  
 CAL. INST. OF TECHNOLOGY  
 ALA. POLYTECHNIC INSTITUTE  
 BILLINGS POLYTECHNIC INST.  
 ANTIOCH COLLEGE  
 CLEMSON COLLEGE  
 COLGATE COLLEGE  
 COLLEGE LAVAL (*Canada*)  
 COLLEGE ST. CROIX (*Canada*)  
 COLLEGE OF WOOSTER  
 CONN. AGRICULTURAL COLLEGE  
 DARTMOUTH COLLEGE  
 GROVE CITY (*Pa.*) COLLEGE  
 IOWA STATE TEACHERS COLLEGE  
 JAMESTOWN COLLEGE  
 LAFAYETTE COLLEGE  
 MARIETTA COLLEGE  
 OBERLIN COLLEGE  
 OHIO STATE COLLEGE  
 PENN STATE COLLEGE  
 S. E. MO. STATE TEACHERS COLLEGE  
 ST. OLAF COLLEGE  
 WESTERN UNION COLLEGE (*Iowa*)  
 DENVER SCHOOL OF MINES  
 RICE INSTITUTE OF TEXAS  
 WM. HOOD DUNWOODY INST.  
 COMMERCIAL RADIO INST.  
 FEDERAL INST. OF RADIO TELY.  
 CARNEGIE INSTITUTE OF WASH., D.C.  
 WESTERN RADIO INSTITUTE  
 ASBURY PK. RADIO SCHOOL  
 N. W. SCHOOL OF W. T.  
 PHILA. SCHOOL OF W. T.  
 CONTINUATION SCHOOL OF  
 WATERBURY  
 RIVERSIDE (*Cal.*) SCHOOL DIST.  
 SCHOOL DIST. OF READING  
 OAKMONT PUB. SCHOOLS  
 TILDEN TECH. HIGH SCHOOL  
 DOMINION OBSERVATORY (*Canada*)  
 CAN. DEPT. OF MARINES  
 CAN. DEPT. OF FISHERIES  
 HYDRO ELEC. COMM. OF CANADA  
 COLORADO STATE MILITIA  
 PAUL F. GODLEY  
 F. H. SCHNELL  
 A. H. GREBE

*Write for New Bulletin 237A*

**ELECTRIC SPECIALTY CO.** 225 SOUTH STREET  
STAMFORD, CONN., U.S.A.

Pioneers in Developing High Voltage Apparatus for C.W.  
Special Apparatus Developed for Special Purposes.  
Motors, Dynamotors, Generators, Motor-Generators.

# Cotogrip

"Built First to Last"

This little beauty was approved by our engineers only when convinced that they had produced the one socket that combines all the essential features of a good socket.

1. Positive Cotogrip Contacts.
2. Hard Rubber Insulation.
3. Rugged Construction.
4. Compact Design.
5. Concealed Mounting.

It is impossible to show the unique mechanical action of Cotogrip contacts in a photograph. It is different from any other socket you have ever seen. This socket will interest you in every way.

You ought to have one.  
Ask Your Dealer

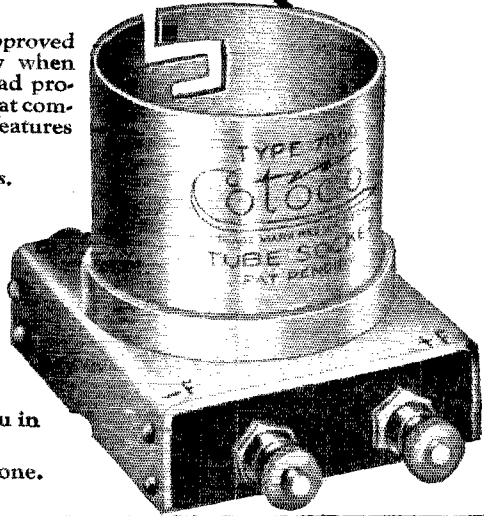

## COTO-COIL CO. PROVIDENCE

Pacific Coast Branch, 329 Union League Bldg., Los Angeles, Cal.

TRADE MARK  
*Wave Trap*  
PATENT APPLIED FOR

The Missing  
Link  
in RADIO

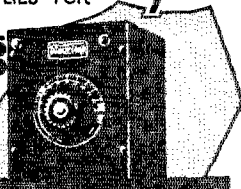

**Stops Interference!**

Get that elusive DX station thru heavy QRM. With the "WAVE TRAP" you can do it and greatly increase your range.

It is installed in a minute by changing only one connection and is indispensable on any receiving set, with any type of antenna. It is mounted on a Formica panel in a handsome mahogany finished cabinet 6x5x6, and is a high-grade instrument throughout.

**850** Ferbend Electric Co.  
23 E. SOUTH WATER ST.  
**CHICAGO**  
Circular on Request

## W.T.501 DETECTOR TUBE

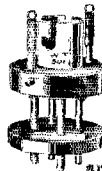

For tube sets, use our Special Adaptor, 75¢ extra. To convert crystal sets into tube sets, use Special Socket, 40¢ extra.

If not at your dealer's, send us his name and address with money order and we'll see that you are supplied. Include 10¢ extra for registration.

**\$2**

RADIO RESEARCH GUILD  
40 Clinton St.,  
Newark, N. J.



## DON'T

BUY YOUR RADIO EQUIPMENT  
UNTIL YOU HAVE SENT  
FOR OUR PRICE LIST

*It Will Pay You to Write*

**Cut Rate Radio Co.**

P. O. Box 472

Newark, N. J.

# HERE'S A PAIR OF WINNERS

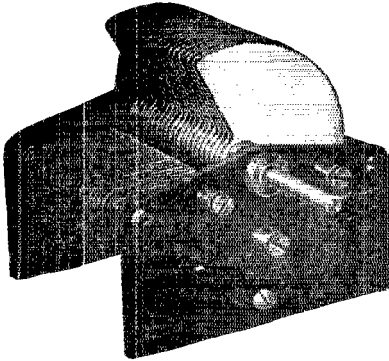

## THE WIMCO CONDENSER

Made to meet a demand for quality — highest efficiency, 3 plate, 23 plate and 43 plate sizes.

Very low resistance and very low zero capacity. The phase angle does not depart from  $90^\circ$  sufficiently far to be detectable. Highly recommended for the fine tuning necessary in amateur apparatus.



## THE CARCO COUPLER

Just the thing for the popular receiving set. Bakelite tube and rotor, silk covered wire, perfect contacts. Designed and developed by an amateur for the amateur.

Guaranteed to produce superior results. Range 150 to 700 meters. Not just "a coupler" but the real coupler—peer of all, the Carco.

**We invite Dealer and Jobber inquiries.**

**Send for literature and prices on the  
WIMCO SOCKET FOR WD-11 TUBES**

## THE WIRELESS MANUFACTURING CO.

CANTON, OHIO

**Manufacturers—Distributors**

## TELOS

### VARIO-TRANSFORMERS

When used in the

# ACMEDYNE

circuit give selectivity and amplification as shown by this curve taken from the MELCO SUPREME RECEIVER.

The base of the curve is magnified to permit comparison with two steps untuned R.F. No need for vario-couplers, tuning condensers or untuned R. F. transformers.

Write for **FREE** booklet by Lester L. Jones

*Formerly Expert Radio Aid U.S.N.*

**on TUNED RADIO AMPLIFICATION.**

**'DANZIGER-JONES Inc.**

143A Prince St., New York

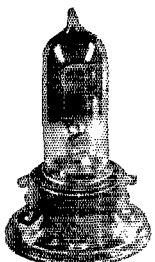

Na-ald Special Socket No. 499

### It's the contact that counts

The dual-wipe contact strips of the Na-ald DeLuxe socket avoid the troubles experienced with the socket of conventional design. Because of thorough cure and high dielectric properties this socket keeps plate to grid losses at a minimum (of particular importance in Flewelling Circuit or in Radio Frequency.)

**Price 75¢**

The Na-ald Special Socket No. 499 is a sturdy little socket for the G. E. No. 199 dry-cell tube. It has special slot construction, and is moulded of genuine Bakelite. The heat from soldering connections will not affect these sockets.

**Price 50¢**

Booklet with wiring design and instructions for Hazeltine's Neutrodyne circuit, together with other selected circuits, packed with each Na-ald product or sent in exchange for cover taken from any Na-ald carton.

**ALDEN MFG. CO.**  
Dept. M, 52 Willow St.,  
Springfield, Mass.

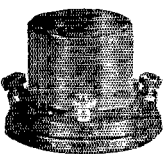

Na-ald DeLuxe Socket No. 400



## "EURACO" PRODUCTS

(Guaranteed)  
**Compact — Interchangeable**  
**Most Efficient — Accurate:**

60  
Cents  
per  
Unit

60  
Cents  
per  
Unit

**Mica Condensers — Grid Leaks Mountings:**

Interesting Proposition for Dealers  
**EUROPEAN RADIO CO.**  
1342 East 22nd St., Brooklyn, N. Y.

**SOUTHERN RADIO CORPORATION**  
Radio Engineers and Jobbers  
905 Realty Building, Charlotte, N. C.



THE SYMBOL OF SERVICE

# CONTINENTAL

*"New York's Leading Radio House"*

## Paragon *Input Amplifier Type 10-R*

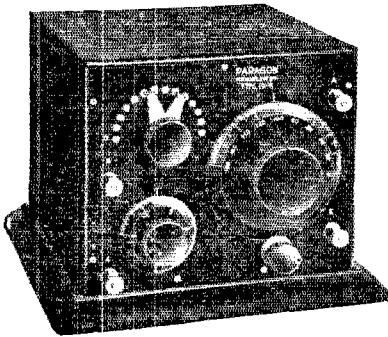

Price \$40.00

**R**ADIO frequency is fast becoming the leading factor in the radio world. Today there are no popular types of radio frequency amplifiers with which the public can work.

The Paragon Input Amplifier Type 10-R, a tuned radio frequency amplifier solves the problem of Radio Frequency Amplification for you. Signals are fed by the antenna into a tuned transformer, and in turn to the vacuum tube. Regeneration and effectiveness at any wave length can be had from 200 meters up to 1000. Every radio fan knows the meaning of Paragon.

Glad to write or show you all about it!

*"Modern Radio"—a two hundred and eight page catalog of Radio supplies, equipment and apparatus sent for twenty-five cents.*

**CONTINENTAL RADIO and ELECTRIC CORPN.**

6 AND 15 WARREN STREET

NEW YORK, U.S.A.

# FLEWELLING-KAUFMAN-REFLEX ULTRA REINARTZ-NEUTRODYNE

and other circuits are greatly improved by using  
**"MICON" Tested Mica Condensers**

Endorsed not only by experts, but by dealers, amateurs—in fact, every one interested in radio.

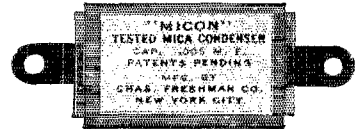

**Because** The design of "Micons" is such that constant equal pressure is exerted on the condenser plates over the entire area. "Micons" assure absolute noiselessness, clarity of tone, accuracy, constant fixed capacity. "Micons" are invaluable as a protection against damage to the filament and their consequential short life.

.006 Micon . . . \$1.00  
 .005 Micon . . . .75  
 .001 Micon . . . .40

Other "Micon" Sizes			
.00005 . . .	30c	.0025 . . . .	50c
.00025 . . .	35c	.003 . . . . .	50c
.00035 . . .	35c	.01 . . . . .	1.50
.0005 . . . .	35c	.015 . . . . .	2.00
.0015 . . . .	40c	.02 . . . . .	2.50
.002 . . . . .	40c	.025 . . . . .	3.00

AT YOUR DEALERS—otherwise send purchase price and you will be supplied postpaid.

## Chas. Freshman Co. Inc.

*Radio Condenser Products*

160 Seventh Ave., New York  
 Home of Freshman Variable Resistance Leaks

Ask for  
**FREE**  
 Diagram of  
 Kaufman  
 Circuit

Ask for  
**FREE**  
 Diagram of  
 Flewelling  
 Circuit

# BRACH VACUUM RADIO PROTECTOR

ASK YOUR  
 INSURANCE AGENT

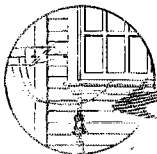

Approved By  
 National Board  
 Fire Underwriters

The Choice of the Foremost  
 Engineers for over 17 Years **\$3**

# SOLDERALL

The Only Convenient Metal Solder. **!!**  
 Every Electrical Connection  
 Needs **SOLDERALL**  
 For Perfect Reception



**SOLDERALL**  
 AT JOBBERS  
 AND DEALERS OR BY MAIL  
 25¢ A TUBE  
**L.S. BRACH MFG. CO.**  
 NEWARK, N. J.

GIVE YOUR EARS A TREAT!—USE

# RED-HEADS

3000  
 Ohms

With  
 Military  
 Head-  
 Band  
 and  
 Cord

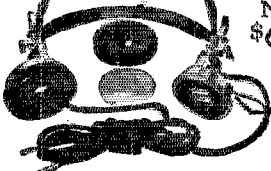

Now  
**\$6.50**

At your  
 dealers  
 or direct  
 on re-  
 ceipt of  
 price.

A Triumph in Radio, Receiver Design  
 The **Newman-Stern** Co. Newman-Stern Building  
 Cleveland, O.

Maximum



Efficiency

# Variable Condensers

Our trade mark tells the story. An absolutely reliable, high grade condenser—mechanically right, it produces the best results. At new, low prices—

- No. 201—3 plate Vernier Condenser . . . \$1.25
- No. 202—11 plate Vernier Condenser . . . 2.00
- No. 203—23 plate Vernier Condenser . . . 2.50
- No. 204—43 plate Vernier Condenser . . . 3.00

At your dealers or write direct to us  
**THE HIGGY-AVERY CO.**

1199 Franklin Ave., COLUMBUS, OHIO



# Send For Folder 4471-A

It tells an important story  
about Radio Instruments

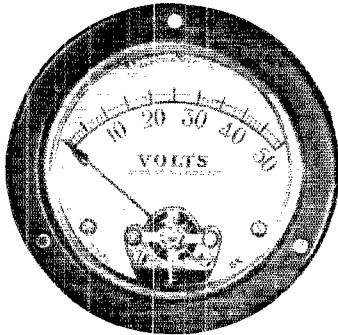

Type BX Voltmeter

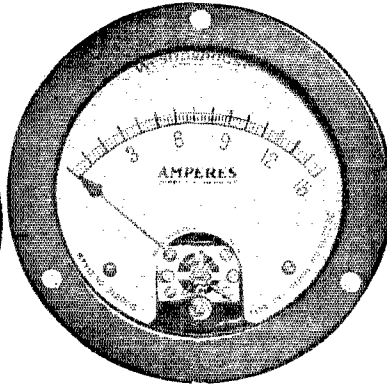

Type CX Ammeter

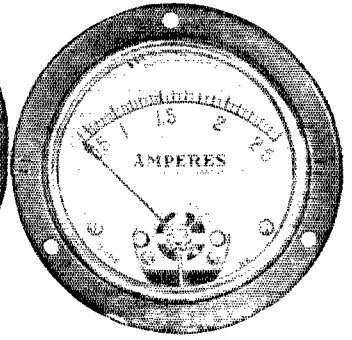

Type BX Radiation Ammeter



**Every Radio Receiving Set** should have its proper equipment of measuring instruments; an Ammeter for determining the filament current; a Voltmeter to tell the condition of the battery.

Westinghouse  
Electric & Manufacturing Co.  
Newark Works: Newark, N. J.

# Westinghouse



Trade Mark  
Reg.

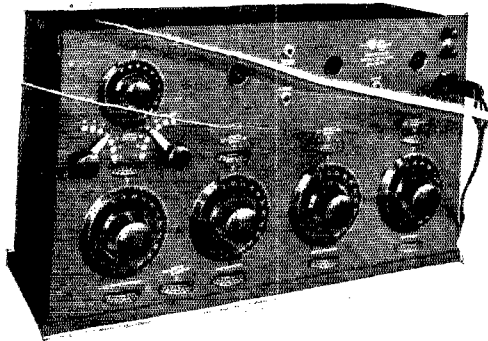

### THE NEW GREBE CR-6

A wonderful receiver for selectivity. Can be used with or without the Grebe Radio Frequency set. It increases the tone qualities of music and increases the range of C.W. reception. Booklet "T" sent on request.

## PHILADELPHIA WIRELESS SALES CORPORATION

*Affiliated with Philadelphia School of Wireless Telegraphy*

1533 PINE STREET,

PHILADELPHIA

**In Any or All Stages  
of audio frequency amplification**

### The AMERTRAN

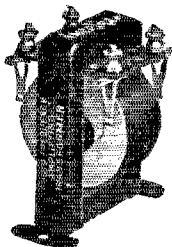

Price \$7  
Ask your electrical dealer, or sent carriage charges collect. (Wt. 1 lb.)

can and should be used. It is made in only one type and one ratio. Its flat-top amplification curve precludes the possibility of distortion on the part of the transformer when used in any or all stages. It will give the same clear-toned distortionless amplification with all tubes which are approximately alike in A.C. Impedance and Amplification Factor, such as

WD-11, UV-201-A,  
UV-199, C-299, C-301,  
C-301-A, UV-201

Its amplification in one stage is 38.6; two stages 1490.

### American Transformer Company

*Designers and builders of radio transformers for over 20 years.*

176 Emmet St., Newark, N. J.

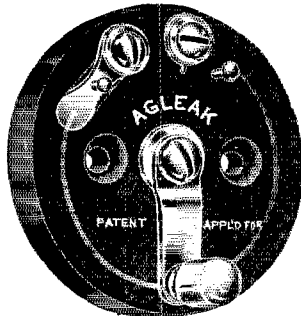

### Flewelling Circuit

A continuously variable grid leak over a wide range of resistance is the most essential and critical instrument required in this circuit.

The BUNNELL VARIABLE GRID LEAK with a range of  $\frac{1}{4}$  to 6 megohms fills the bill.

Furnished with or without japanned metal cover and screws for mounting.

Sample by mail. With Cover \$1.00; Without Cover 70¢  
Liberal discounts in quantities. Send stamp for catalog No. 45-Q  
32 Park Place J. H. BUNNELL & CO. New York City

## RUSONITE

CRYSTAL RECTIFIER

MULTIPOINT (Patent Pending)

A synthetic CRYSTAL DETECTOR, sensitive over its entire surface. Eliminates all detector troubles. Extraordinary clearness and volume. Endorsed by radio experts and press. Sold in Sealed Packages only. Join the ever increasing Rusonite fans.

Price, mounted **50c**  
Sensitiveness guaranteed  
RUSONITE PRODUCTS CORP.

14 Karat Gold Multiple **25c**  
Contact. Super-sensitive

Order from your dealer or direct from us.  
RUSONITE CATWHISKER

15 Park Row, N. Y.

Dept. "Q"

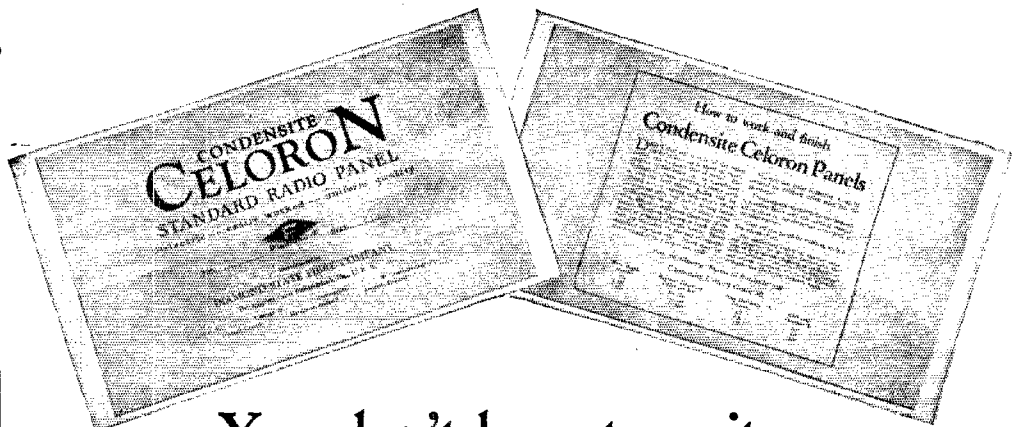

## You don't have to wait—

**Y**OU need a radio panel and you want it immediately. Your dealer turns to his shelf and hands you a Celoron Radio Panel, cut and ready to carry home. You won't have to wait or pay the extra cost for having your panel cut from sheet stock.

Each panel is a separate package, cut, trimmed, and wrapped in glassine paper. On every one are full instructions for working and finishing.

You can obtain from your dealer any of the following sizes:

- |                             |                            |
|-----------------------------|----------------------------|
| 1.—6 x 7 x $\frac{1}{8}$    | 4.—7 x 18 x $\frac{3}{16}$ |
| 2.—7 x 9 x $\frac{1}{8}$    | 5.—9 x 14 x $\frac{3}{16}$ |
| 3.—7 x 12 x $\frac{1}{8}$   | 6.—7 x 21 x $\frac{3}{16}$ |
| 7.—12 x 14 x $\frac{3}{16}$ |                            |

While we feature these standard sizes, Celoron comes in full-size

sheets, and we can supply special sizes if desired.

Condensite Celoron is a laminated phenolic condensation product used by many of the leading manufacturers of radio equipment. It is easily worked, machined, drilled, and tapped, and will engrave evenly without feathering.

Select the size you need for your set. Should your radio dealer not yet have them in stock, ask him to order for you.

### Send for free booklet

We have prepared an attractive booklet, "Tuning in on a New World," which gives lists of leading broadcasting stations in the United States and Canada, symbols used in reading radio diagrams, and several highly efficient radio hook-ups. This booklet will be sent to you free of charge upon your request. Write today.

To radio dealers: Write for special dealer price list showing standard assortments

## Diamond State Fibre Company

BRIDGEPORT

(near Philadelphia)

PENNSYLVANIA

BRANCH FACTORIES AND WAREHOUSES

BOSTON

CHICAGO

SAN FRANCISCO

Offices in Principal Cities

In Canada: Diamond State Fibre Company of Canada, Limited, 245 Carlaw Ave., Toronto

# CONDENSITE CELORON

## STANDARD RADIO PANEL

**THIS INSTRUMENT ACCURATELY  
MEASURES THE DISTANCE OF**

**D-X CALLS**

Science again has come to the aid of the radio fan. Here is a wonderful little instrument that tells you the exact range of your set and instantly indicates the distance of every call that comes in.

**Mc NEARY  
RADIO SCALOMETER  
& OFFICIAL RADIO MAP**

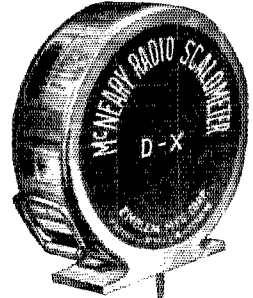

**\$1.00  
COMPLETE**

**WITH  
Radio Map**

Isn't it thrilling to hear a human voice hundreds of miles away? But how much more thrilling it is to know the exact distance the voice traveled in reaching you.

The McNeary Scalometer will tell you instantly. All you have to do is to place the Scalometer on the official radio map which comes with every scalometer. You look for the station—takes but a second—and there you have it—

printed in legible type; the exact distance in miles.

No more guess work necessary! Keep the McNeary Scalometer handy and you'll always have a valuable friend to tell you quickly—correctly the distance of every call you receive.

The McNeary Scalometer is a wonderful, precise instrument in a beautifully finished aluminum case. See it today!

See this SCALOMETER at any radio shop  
IF YOUR DEALER CANNOT SUPPLY YOU  
SEND ONE DOLLAR TO

**EMBLEM MANUFACTURING CORP.  
259 MIDDLE CITY BLDG., PHILADELPHIA, PA.**

Authoritative, up-to-the minute, showing broadcasting stations, time zones, radio districts, cities and towns of the United States and Canada.

**Broadcasting Directory**  
In handy booklet form with all broadcasting stations alphabetically arranged by call letters.

**PANEL SERVICE**

We offer to the amateur and dealer

**REAL PANEL SERVICE**

Our panels are cut to your order. Only genuine Condensite and Formica used.

1/8" per square inch \$0.02  
3/16" per square inch .02½  
1/4" per square inch .03

We also carry a complete line of radio essentials. Dealers will find it profitable to have our latest price list and discount sheet.

**PITTSBURGH RADIO  
AND  
APPLIANCE CO., Inc.**

"Pittsburgh's Radio Shop"

Desk B  
112 Diamond St., Pittsburgh, Pa.

**HYGRADE SPECIALS**

- 200 ft. 7 strand No. 22 Copper aerial wire. \$1.40
- Morse Eureka Test Clips, per dozen . . . . .50
- Nathaniel Baldwin Head Sets (Type C) . . . . .8.50
- No. 783 Eveready 22½ V. Variable B. Bat. 1.25
- No. 788 Eveready 22½ V. Variable B. Bat. 2.25
- No. 767 Eveready 45 V. Variable B. Bat. 4.25
- 2000 Ohm Murdock No. 56 Head Sets . . . . .3.95
- 3000 Ohm Murdock No. 56 Head Sets . . . . .4.49
- Federal or Brandes 2200 Ohm Head Sets. . . . .5.95
- Dictograph 3000 Ohm Head Sets . . . . .6.50
- Fada or Framingham Rheostats . . . . . .65
- Acme Amplifying Transformers (new type) 3.95
- Acme R. F. Transformers, Types R2- R3 R4 . . . . .3.95
- 6 Volt Marko Storage Batteries . . . . . 3.95

All orders must include Parcel Post charges.  
**HYGRADE ELECTRICAL NOVELTY  
COMPANY**  
41 West 125th Street New York, N. Y.

**Radio Operators! Radio Operators!  
Radio Operators!**

The shortage of Radio operators increases! During the past month we have been unable to find enough men for shipboard positions. More ships are in operation to all parts of the world and more Radio Operators are needed every month.

Join our SPECIAL SUMMER COURSE in Radio and prepare for an assured future with good pay and attractive opportunities for advancement.

Classes forming every Monday. Special Short Summer Course. Full particulars for the asking.

**EASTERN RADIO INSTITUTE**

899 Boylston Street, Boston  
Tel. Back Bay 5964

# The Receiver that Satisfies Telmaco Type B-R Receiver

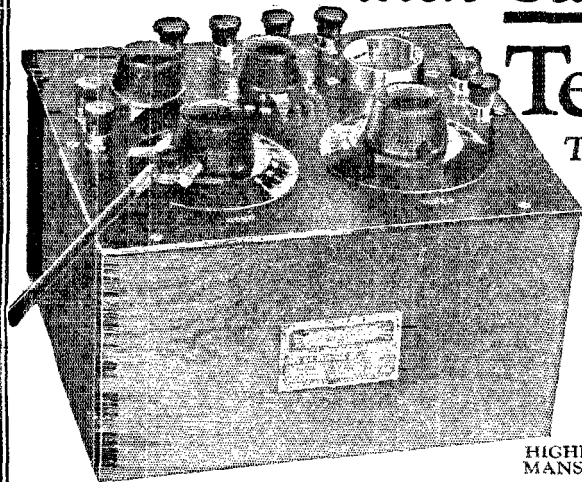

fully meets the requirements of the discriminating purchaser because of the following features:

**EFFICIENCY OF OPERATION:** Securing volume, distance (1500 miles with single tube is not unusual), selectivity. Broadcasting stations one-half mile distant are tuned out by a slight turn of condenser dial.

**EASE OF OPERATION** enabling the novice to secure satisfactory results.

**HIGHEST QUALITY OF WORKMANSHIP AND MATERIALS.**

**PRICE** within the reach of everybody.

Manufactured exclusively for us by the Tri-City Radio Electric Supply Co., licensed under Armstrong U. S. Patent No. 1113149, October 6th, 1914.

## Specifications:

**Panel**—Formica, grained and machine engraved. **Vario-Coupler**—Telmaco special silk wound with loading inductance. **Condenser**—Special 13-plate with Bakelite ends. **Rheostat**—Single knob control. **Socket**—Highly nickeled shell, Bakelite base. **Dials**—are polished, presenting pleasing contrast with dull panel. **Telmaco Adjustable Vernier Handle**—secures extremely fine tuning and entirely eliminates body capacity effects. **Workmanship**—manufactured according to Telmaco's rigid specifications. **This Guarantees Your Satisfaction.** Either 6 volt or 1½ volt tube may be used.

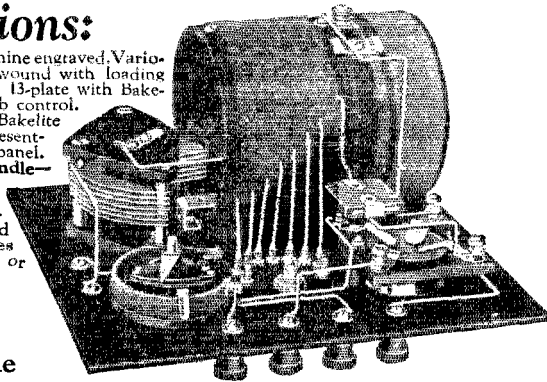

**Price \$25**

The ultimate in value

**TELMACO**

Quality Radio Exclusively

**Bona Fide Jobbers**

If our salesmen have not reached you with our proposition, write or wire for it today

**TELMACO Type B-A Two Stage  
A. F. Amplifier**

Matches the above in size and construction. The greatest Amplifier value on the market. Price \$20.00.

RADIO DIVISION

**TELEPHONE MAINTENANCE CO.**  
20 S. Wells Street, Dept. D. Chicago, Illinois

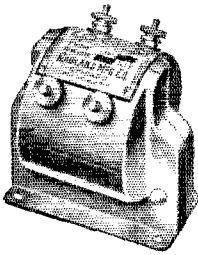

Your Dealer Probably Has  
**"All-American" Amplifying Transformers**

(RADIO and AUDIO Frequency)

If he has thus far missed these highly important aids to clear strong radio reception, tell him you'll buy "All-American" or nothing.



They cost no more; and your set is entitled to the best the art has produced. Our Radio Frequency Transformers should be used to amplify radio frequency impulses before they reach the detector tube and the Audio Frequency Transformers, to strengthen the detected signals. The combination of the two forms the ideal long-distance radio reception hookup for either headphone or loudspeaker reproduction.

**"ALL-AMERICAN" AMPLIFYING TRANSFORMERS**

R-10—Radio Frequency (150-550 meters) \$4.50  
 R-12—Audio Frequency (Ratio 3 to 1) . 4.50

R-13—Audio Frequency (Ratio 10 to 1) \$4.75  
 R-21—Audio Frequency (Ratio 5 to 1) 4.75

Ask your dealers first, before you write. If none of them can supply you, send orders to us with name and address of Dealer you wish to favor, and transformers will be sent you postpaid at the prices named. **FREE Hand Book of Radio Hookups** — 25 up-to-date diagrams of Successful Circuits. Send 2c stamp to cover postage.



**RAULAND MFG. Co.**  
 200 No. Jefferson St., Chicago, Ill.



Look for this label

Ask your Dealer

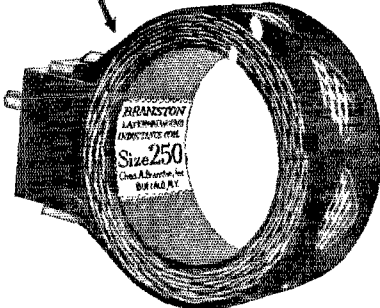

**IMPROVE YOUR PRESENT SET OR MAKE A NEW ONE BETTER by Using**

**BRANSTON Lateral Wound Honeycomb Inductance Coils**

(Licensed under DeForest Patents)

Ask your "Old Timer" Radio friend why sets using Honeycomb Coils are Best. Send 4¢ in stamps for Series 1 "Hook-Up" Circular showing five good Honeycomb coil hook-ups and Catalog of famous Branston Radio materials. Write today. Give us name of your Radio Dealer. If he can't supply you, let us know.

**CHAS. A. BRANSTON, INC.**  
 823 Main St., Buffalo, N. Y.  
 In Canada—Chas. A. Branston, Ltd.  
 Toronto, Ont.



**BRANSTON**  
 RADIO

**"REGAL" RHEOSTAT**

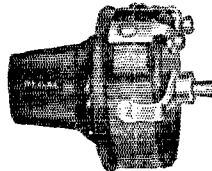

Has full exposed resistance wire giving fine sensitive adjustment. 6 Ohms resistance—2.2 Amperes. Better than a vernier rheostat..... **\$1.00**

**FOR FINE RESULTS USE REGAL RADIO PRODUCTS**

Vario-Coupler, Variometer, Potentiometer, Power Rheostats, Tube Sockets, Switch Levers, Condensers, Knobs, Dials, etc. Ask for our catalog No. 31.

**"REGAL" INDUCTANCE SWITCH**

A 15 point Inductance Switch complete in one unit. No more difficult soldering—no more drilling holes in panels for switch points. Biggest hit in radio..... **\$2.00**

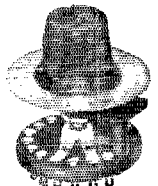

**The American Specialty Co.**  
 BRIDGEPORT, CONN.

**FOR SALE**

CW-936 Sub Chaser Telephone Transmitting and Receiving Set including:—Remote Control System, Power Amplifier, Loud Speakers, Tubes, Spare Microphone, etc. Can be tuned down to 200 meters.

**KLEIN'S**

**RADIO AND ELECTRIC SUPPLY CO.**  
 34 PARK PLACE AND  
 48 FULTON STREET **NEW YORK**

---

# WASTED EFFORT

---

---

The building of a radio set is absorbingly interesting.

The prime motive actuating men and boys of all ages in assembling their own receivers is the realization that only by so doing can a practical knowledge of radio telephony be acquired.

Thus, the different circuits and functions of the various parts are better understood.

Heretofore, much tedious labor has been involved in the undertaking. Laying out the panel and the drilling of from forty to eighty holes, as well as the mounting of tap-switches and soldering of primary leads, have all contributed to making the job a laborious one.

Eisemann units and panels eliminate more than half the labor ordinarily required.

All units are simply attached to aluminum panels with screws and nuts. All panels are completely drilled. Several sizes of panels are offered, with openings provided for any number of units that may be desired. The panel, itself, acts as a perfect body capacity shield. The variocoupler is complete—a tap-switch being carried inside the rotor.

Before starting to build a Receiving Set, it will be found worth while to examine Eisemann radio products.

*Descriptive literature on request.*

## EISEMANN MAGNETO CORPORATION

William N. Shaw, *President*  
BROOKLYN, N. Y.

DETROIT

CHICAGO

SAN FRANCISCO



# POSACO

# RADIO

## QUALITY AND EFFICIENCY

The "POSACO" condenser has made for itself an enviable reputation. It is a real instrument. The single knob controlled vernier is an absolute necessity for efficient tuning in radio frequency, super-regenerative and regenerative circuits. The regular variable is unexcelled for use in circuits which do not require a vernier adjustment.

MATERIALS used in the manufacture of these instruments are the finest obtainable.

WORKMANSHIP, the best. CONSTRUCTION and DESIGN, electrically and mechanically correct. Absolutely rigid. Minimum of dielectric loss.

Each instrument is tested before leaving our factory.

GUARANTEED to give satisfaction and to be free from any defect in materials or workmanship.

If your dealer or jobber cannot supply you, send us your order direct, together with his name and address.

*Circular sent free upon request.*

Manufactured by

**THE C. D. POTTER CO.**  
STAMFORD, CONN., U. S. A.

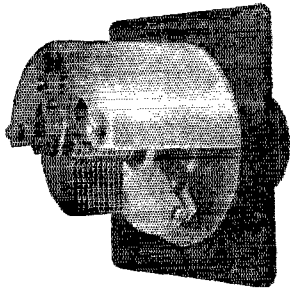

Patent applied for

AIDEN L. MCMURTRY, License

### VERNIER

(Single Knob Control)

B-1 Capacity .001045	Mfd.	\$7.50
B-2 " .000545	"	7.00
B-3 " .000295	"	6.50
D-2 Highest Grade 4" Dial		1.00

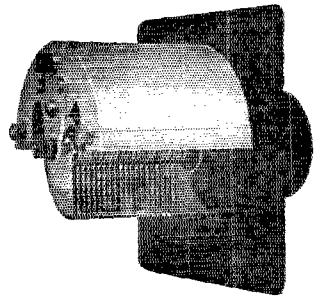

Patent applied for

### REGULAR

A-1 Capacity .001	Mfd.	\$4.50
A-2 " .0005	"	4.00
A-3 " .00025	"	3.50
A-4 " .000045	"	3.00

# POSACO

# RADIO

## Sterling

RADIO DEVICES

THE MORE YOU HAVE OF THEM THE BETTER YOUR OUTFIT

### STERLING

Portable Rectifiers    Filament Meters  
 Filament Rheostats  
 Audio and Radio Frequency Amplifying  
 Transformers  
 12 Point Rotary Switches  
 Pocket Voltmeters for Testing  
 "B" Batteries

### STERLING FILAMENT RHEOSTATS

Smooth running contact arm giving fine regulation of current. Attractive design

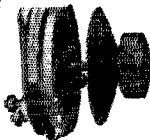

Adaptable to either panel or table mounting. List Price

**\$1.00**

Trade Discounts on application.

Write for bulletins

**THE STERLING MFG. COMPANY**

2345 Prospect Ave.

CLEVELAND, OHIO

Over 3 Million Sterling Devices in Use Today

### SILENT NILES

B  
A  
T  
T  
E  
R  
Y

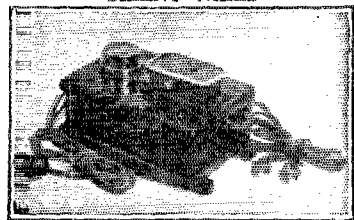

C  
H  
A  
R  
G  
E  
R

Pat. Pend.

### THE BATTERY CHARGER SUPREME

Keeps your battery in prime condition and your receiving set always in service by charging at home from electric light socket.

AN ASSET TO EVERY RADIO BATTERY OWNER—PAYS FOR ITSELF.

Price, \$17.50—\$19.50 West of Rockies

**RADIO PRODUCTS CORPORATION**

Manufacturers  
8928 Clarendon Ave.,

Distributors  
Detroit, Mich.

## ! LOOSE CONNECTION !

We sell an instrument that is guaranteed to do away with loose connections between filament and A battery.

**THE GARRICK RADIO LAB.**

91 Homestead Ave.

Beechwood Park, Delaware County,  
Penna.



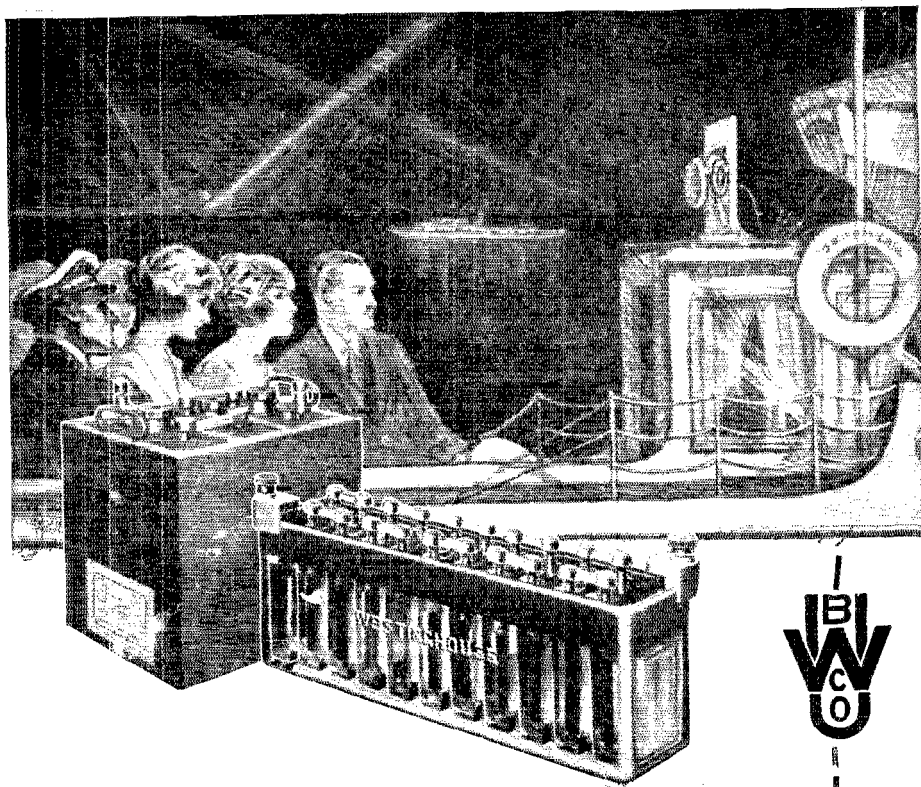

Many summer radio difficulties are often traceable to inefficient batteries rather than to static or instruments.

Westinghouse Radio Batteries, with their superior construction and engineering principles, give you that steady, noiseless, full-powered, even-discharging current so essential to real radio results. They last indefinitely and can be re-charged repeatedly. They are not only the most satisfactory, but the most economical in the long run. Sold by radio dealers and Westinghouse Battery Service Stations everywhere.

*Westinghouse "A" Batteries.* Slow discharge; long life; 4, 6, 8 volt sizes with 5, 9, and 13 plates per cell to meet various filament requirements. \$16.75 up.

*Westinghouse "B" Batteries.* The Westinghouse 22-MG-2 (22 volts) is a marvel for positive, quiet, full-powered service. Glass case; visible interior; sealed-in tops. \$8.00. Other styles, too.

WESTINGHOUSE UNION BATTERY CO.  
Swissvale, Pa.

# WESTINGHOUSE

## RADIO "A," "B" and "C"

### BATTERIES

# KEEP TO THE RIGHT

Quality Apparatus

We stock all makes and types of complete Radio sets and parts

Acme Apparatus Co.  
 Adams Morgan Co.  
 Andrea, F. A. D.  
 A. & P. Radio Supplies Co.  
 Baldwin, Nathaniel  
 Brach, L. S. Mfg. Co.  
 Brandes, C. Inc.  
 Bunnell, J. H.  
 Clapp-Eastham Co.  
 Corwin, A. H. & Co.  
 Cutler-Hammer Mfg. Co.  
 DeForest Radio T. & T. Co.  
 Dictograph Products Corporation  
 Dubilier Condenser Co.  
 Eby Mfg. Co.  
 Federal T. & T. Co.

Firth, John & Co.  
 Freed-Eisemann Co.  
 Frost, Herbert H.  
 General Radio Co.  
 Kennedy, Colin B.  
 Murdock, Wm. J. Co.  
 Radio Distributing Co.  
 Radio Corp. of America  
 Remler Mfg. Co.  
 Riley-Klotz Mfg. Co.  
 Sleeper Radio Co.  
 Ward Leonard Elec. Co.  
 Western Elec. Co.  
 Westinghouse Elec. Mfg. Co.  
 Weston Elec. Inst. Co.  
 Wireless Press, Inc.

Delivery same day order received

Pioneers in the Radio Field

Send 10¢ for Latest Catalog

## ROSE RADIO AND ELECTRICAL SUPPLIES

129 Camp Street,

New Orleans, La.



### Stromberg-Carlson Radio Head Sets

are preferred by ladies—the adjustment rod telescopes so it will not catch in hair or net.

There are other reasons why Stromberg-Carlson Head Sets are preferred not only by ladies but by all critical users—

The receivers are layer wound and layer insulated—to stand up under high plate voltages.

The ear caps cover the ears—excluding outside noises.

The receivers are balanced as to volume—both ears get the message.

*Ask Your Dealer*

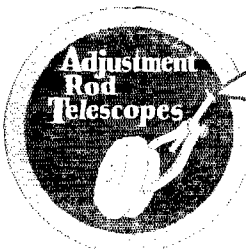

Stromberg-Carlson  
 Telephone Mfg. Co.  
 ROCHESTER, N. Y.

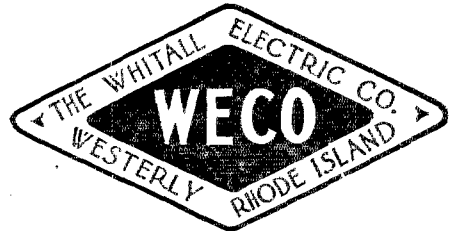

## BARGAINS

In All Makes of Radio Material—  
 Send for Our Special Summer  
 Bulletin No. 30.

We carry Radio Corporation, Federal, Magnavox, Acme, Frost, Chelsea, Electrose, Atwater-Kent, Cutler-Hammer and many other.

We are distributors for practically all the leading makers.

PROMPT AND EFFICIENT SERVICE  
 TRY US AND SEE

**Whitall Electric Company**  
 Westerly, Rhode Island

# Natural Re-PRODUCTION

THE artist's presence can almost be felt in the startlingly natural Re-PRODUCTIONS by the *Atlas Amplitone*. Not a sign of blast or distortion, for the Amplitone, itself, is a fine musical instrument.

Designed by musicians, acoustic experts and radio engineers in response to the demand for an improved loud speaker. Many important refinements that increase the pleasures of radio without adding to its cost. A fine musical instrument applied to radio reception.

Acknowledged supreme by highest musical and radio authorities.

## Atlas AMPLITONE LOUD SPEAKER

Complete with connecting cord and full instructions for connecting and adjusting.

**\$25<sup>00</sup>**

**Insist Upon the  
Atlas Amplitone**

Only the Atlas Amplitone can Re-PRODUCE. If your dealer has none, ask him to order for you.

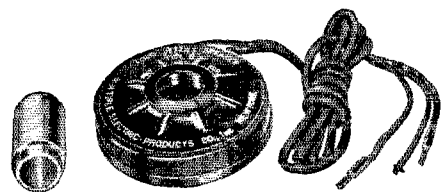

### Atlas Amplitone Unit

You can make your own loudspeaker, with this part of the *Atlas Amplitone* (without horn or base) and a horn or any phonograph, except the Bruns- **\$13<sup>50</sup>** wick. With phonograph attachment.....

Unit without attachment—\$12.50

WRITE for Illustrated Booklet

## Multiple Electric Products Co., Inc.

11 Orange Street

Radio Division

Newark, N. J.

# Getting DX through static

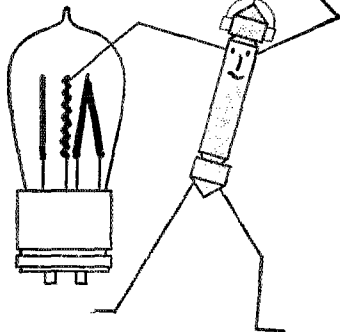

Manufactured by  
**DURHAM & CO., Philadelphia**

Largely a matter of  
close grid control

Sharp, clear DX tuning depends upon accurate control of the grid circuits. Little Omega Durham has an old friend of your working with him now—DUBILIER Micadons. With DURHAM plunger adjusted Variable High Resistance, these famous DUBILIER Micadon units will hold your tubes to a hair's breadth of efficiency. Then the static bugaboo shrinks to a minimum.

There's saving too, when you buy them together.  
Price, complete, only \$1.10

There's a combination for your tubes

**DURHAM**  
Variables

No. 101—to 5 megohms  
No. 201A—to 10 megohms



**DUBILIER**  
Micadons

.00025 mfd.  
.0005 mfd.

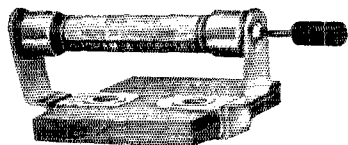

## F-F BATTERY CHARGER

All TYPES But "B"  
Charge AUTO  
Batteries  
Overnight  
Right In  
Your CAR

**\$15**

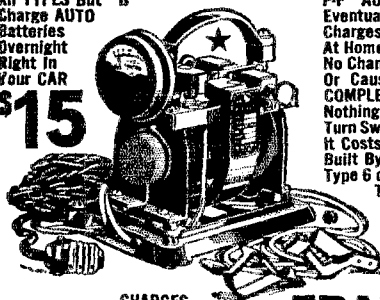

CHARGES  
RADIO & AUTO BATTERIES.

CHARGES RADIO "A" & "B" & AUTO STORAGE BATTERIES at HOME Overnight, for a Few Cents From Any 100 to 130 Volt 60 Cycle A. C. Lamp Socket. Eventually You Will Buy An F-F CHARGER & The Sooner You Buy One: The More You Save. A-B Charges All 6 Volt & up to 120 Volts of "B" & Loud Speaker Storage Batteries In Series Inductively At Home Overnight. Disconnecting & Multiple Connections Unnecessary. Charging Circuits Separate. No Chance For Grounds, or Short Circuits. Nothing To Stop Over, Be Filled, Burn Dirt, Need Attention Or Cause Trouble. Infusible Rectifying Brushes Maintain Constant Efficiency Uninterruptedly. COMPLETE PORTABLE AUTOMATIC. No Skill Required. AMMETER eliminates Guess Work. Nothing Like It Made. Lasts A Lifetime. Screw Plug In Lamp Socket; Snap CLIPS on Battery Terminals; Turn Switch & Battery Is Charged In Morning. Charged Batteries Mean Fewer Expensive Replacements. It Costs Less To Buy An F-F CHARGER Than To Be Without One. INSIST on The F-F CHARGER. Built By A Master Of The Art in 7 TYPES. Thousands Sold Make Possible These POPULAR PRICES: Type 6 charges 6 Volt Battery At 6 amperes \$15 Type 12 charges 12 Volt Battery At 5 amperes \$15 Type B charges Radio "B" Batteries Up to 120 Volts \$15 Type A-B is Combination Of 6 & B \$20 Type 166 charges 6 Volt Battery At 12 amperes \$20 Type 1612 charges 12 Volt At 7 amps \$20 Type 1626 is a Combination Of Types 166 & 1612 and Charges Both 6 & 12 Volt Batteries \$28 Types B & A-B are RADIO Specials. Types 166, 1612 & 1626 are For Heavy & Rapid Charging. SHIPPING WEIGHTS Complete with AMMETER & BATTERY CLIPS 11 to 15 lbs. PURCHASE from DEALER; Mail Check, or WRITE us to Ship TYPE desired C. O. D. ORDER Now, or WRITE Immediately for FREE Descriptive CHARGER Bulletins 31 & 31-A.

**FRANCE MFG. CO., Cleveland, Ohio.**

## Delicate Soldering

Both the manufacturers' and amateurs' problems on all fine work are readily solved by the instrument constructed for this particular purpose.

THE POST SOLDERING IRON

Platinum Heating Unit—Interchangeable Tips—Universal Current  
(Large & Small)

**\$6**

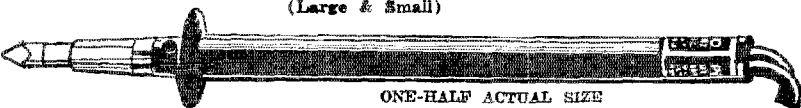

ONE-HALF ACTUAL SIZE

Awarded Certificate of Excellency, N. Y. Evening Mail Radio Institute.

From your Dealer, or write

POST ELECTRIC COMPANY

(Section Five)

30 E. 42nd St., New York

## CLASSIFIED ADVERTISEMENTS

Six cents per word per insertion, in advance. Name and address must be counted. Each initial counts as one word. Copy must be received by the 10th of month for succeeding month's issue.

**A WONDERFUL BOON TO CRYSTAL USERS.** Put the AJAX RECTIFIER in your crystal cup. No more hunting for the elusive spot. Your set is ALWAYS ready. Unaffected by static or rough handling. Ideal for portable sets. Sixty cents each, two for one dollar. We pay postage. Ajax Electric Company, Palmer St., Cambridge, Mass.

**PURE NICKEL WIRE FOR EDISON B BATTERY CONNECTORS.** 1 1/2 FOOT; PERFORATED HARD RUBBER SEPARATORS, HALF CENT. TEST TUBES, FIFTY CENTS DOZEN. COMPLETE HUNDRED VOLT BATTERY, RECTIFIER AND SOLUTION \$16. GENUINE EDISON SOLUTION IN 5LB. CANS, ENOUGH FOR 100 VOLTS \$1.50. TRANSMITTING BATTERIES & HIVOLTAGE TUNGAR CHARGER—CHEAPER THAN A MOTOR GENERATOR. WIRED ELEMENTS. RADIO 8ML, FRANK MURPHY, GRAND DIVISION & WARNER, CLEVELAND, OHIO.

**FOR SALE:** One G.E. 350 watt 1000 volt compound wound generator, 1725 RPM \$50.00; One G.E. 400 watt 700 volt shunt wound generator, 2700 RPM, with 2 pulleys and a belt, \$30.00; One 400 watt 500 volt motor generator, 110 volt 60 cycle motor double shaft extension, \$35.00; One G.E. 150 watt dynamometer, 750 volts generator, 24 volts motor, made by G.E. for Navy aircraft work. Light and rugged, \$30.00. George Bauer, 2133 Weisser Park Ave., Fort Wayne, Ind.

**FIRST TWELVE DOLLARS** received buys postpaid unused 75 watt Acme mounted power transformer. Edw. Borden, 310 Lees Ave., Collingswood, N. J.

**20 OR 100 Watt C.W.** \$60.00 less tubes. Alfred Beech, Sleepy Eye, Minn.

**FOR SALE:** A single tube honey-comb tuning, regenerative set. Head phones, tube and lightning arrester. Tested, \$35.00. Send Money Order. Kent Bummert, 1025 Zeisler Str., La Crosse, Wisconsin.

**FOR SALE:** Paragon 10 Watt C.W. and I.C.W. fono set, type 2, 5, u. Price \$40.00. Ra-di-co Motor Generator, 40 Watt, 350 Volts, \$40.00. 3DCY, Central High School, Kalamazoo, Michigan.

**LOOK IN** these columns for my special each month. This month's special N & K, Phones 6000 Ohms. Price \$8.00 a pair. Sent Parcel Post C.O.D. Send for list of other specials. D. E. Gilmore, 46 Thomas St., Newark, N. J.

**FOR SALE:** UV200 Radiotrons \$3.00 each; UV201 Radiotrons \$4.00 each, also 1 King Magnetic Battery Charger \$10.00. All this material guaranteed to be in A1 condition. Carlisle Benjamin, Clyde, N. Y.

**FOR SALE** at a bargain; Western Electric Loud Speaker complete with Power Amplifier and tubes. \$100.00. Trecco Receiver \$25.00. Grimes Loop Receiver \$50.00. Act quickly. C. H. Bills, Lenora, Kansas.

**FOR SALE:** 3 Circuit Penn. C. Regenerative Receiver, fine condition. First \$25.00 takes it. G. G. Collins, 601 Copley Road, Akron, Ohio.

**200-20,000 meter Receiver** including Radiotron \$35.00. Two step Amplifier \$22.00. Smith, 4416 Market, Philadelphia.

**A BARGAIN:** 100 watt C.W. transmitter with 6XAD DX including 2 perfectly good tubes, Weston thermocouple ammeter, and milli-ammeter, Jewell volt-meter, R.A.C. inductance, Acme filaments and plate transformers, Acme 3 henry choke and 5 1Mfd 1750 volt condensers mounted on Bakelite panel with variable condenser, 3 Federal switches and rheostat—already to use complete for \$150.00—a saving of over 20% on actual cost of parts. Also Reinartz tuner \$12. RCA UC1819 variable condenser \$6. 2 DeForest amplifying transformers \$3. Benwood inductance \$3. 4 WE VT1's @ \$4. Meyers tube \$3.50, sockets @ \$0.50. Clapp-Eastham BQ wavemeter \$22.50, brand new. General Radio 6-100 milliammeter \$7.50, Antenna \$1. RCA Potentiometer \$1.50, all guaranteed. J. R. Dean, 86 Vermont Street, Rochester, N. Y.

**BRAND NEW AMRAD** \$3500 2 audio, detector and one radio, list \$125.00, never been used \$80.00. Will send subject examination by express C.O.D. if you send \$5 to guarantee express. Original case and guaranteed by Citizens Radio Call Book, 416 S. Dearborn, Chicago.

**RUBBER STAMP** with large call letters 50¢; Radiogram and Relay Radiogram blanks 25¢ per hundred, Post Card 60¢ hundred. Send us your orders. Carolina Printing & Stamp Co., Wilmington, North Carolina.

**FOR SALE:** One Hall Relay and Recorder, \$35.00. One Kennedy Type 110 Receiver (175 to 25000 meters) with two stage amplifier Type 525, \$190.00. Assortment of Jewell and General Radio Meters, all ranges, 25% off list. One Hundred page Log Book, 40¢. 100 watt Thordarson Plate Transformers, \$18.00 each. These goods guaranteed in perfect condition. Commonwealth Appliance Company, 373 Robert Street, St. Paul, Minn.

**LOOK TWICE!** SELL—1 Marshall-Gerken and 4 Remler Variometers \$5.00 each; 1 Remler variocoupler \$4.00; 2 Boston Keys \$5.00 each; 1 Acme 200 watt 350-550 volt Power Transformer \$15.00; 1 Flush 0-3 Weston Antenna Ammeter \$14.00; 1 Five watt Kenotron tube \$5.00; 1 pair \$20.00 Type "E" Genuine Baldwin fones \$12.00 with plug; 3 Federal Radio Frequency Transformers Wave Length 175-300 \$5.50 each; 2 Fifty watt tube Sockets \$1.25 each. Above slightly used. Ed. Clark, 333 Princeton Place, Pittsburgh, Pa. QRK7 20 watts—8BQS.

**TWEET LOOP ARRANGEMENT**—No Radio Frequency. Good long-distance reception on detector only. Proportionately better with Audio Frequency Amplifiers. Both coasts have been worked from here on detector and two stages Audio Frequency. Description and diagram for One Dollar. T. J. M. Daly, Little Rock, Ark.

**FOR QUICK SALE:** New apparatus in original cartons. \$125 DeForest D-7a Reflex, \$100; 2 General Radio Amplifier units \$6 each; 2 pair \$10 Long Range Phones, \$6.75; Pair Manhattan 3000 ohm phones, \$5; \$12.50 Trinity Loud Speaker, \$9; 6 Socostats at \$1.75; Webster Radio Transformer or Murad \$3. Mawhinney Blue Prints \$1. D. V. Dawson, Elwood, Indiana.

**RADIO AGENTS** wanted in every city and town to sell standard radio apparatus on liberal commission basis. Stocking agencies also open. Delfelco, 19 Meeting Street, Pawtucket, Rhode Island.

**FOR SALE:** DeForest Multi wave tuner, detector and one step Audio \$75.00. F. J. Demarest, 811 Walnut St., Williamsport, Penn.

**SELL HONEYCOMB** receiver and Two step for \$65. Cost \$80. Beverly Dudley, 4909 Fletcher St., Chicago.

**CALL 2JC** has been assigned to Jack Dunham, pre-war 2ACV, 49 Overlook Circle, New Rochelle, N. Y. Using 10 watts A.C.C.W. All cards answered.

**FOR SALE:** 8CXW's 20 watt C.W. Set. Includes Eaco motor generator, tubes, four meters, etc., \$115. A card brings further particulars. Also other apparatus, write for list. K. R. English, Coshocton, Ohio.

**NEW SOCKETS,** plugs, three inch dials, 45 cents each. J. Francis, 414 Eddy Road, Cleveland.

**CLAPP-EASTHAM H.R.** receivers \$25.00, HZ amplifiers \$25.00. RADAK RZ \$65.00. All brand new. Dakota Radio Apparatus Co., Yankton, S. D.

**1-115 VOLT 10 AMP.** 1650 R.P.M. Robbins Meyer Generator like new \$45.00 with field rheostat. M. Liedeker, 61 Cornelison Ave., Jersey City, N. J.

**SPARK TRANSFORMER & CONDENSER WANTED.** 1 KW. Cash or trade anything you want. 9CZP.

**BATTERIES:** Edison Storage "B" Battery Elements, 5¢ per pair; 18 will make one 22.5 volt battery; Gilman's Battery Shop, Chelsea Sq., Chelsea, Mass.

**MULLARD BRITISH** 30 watt Output Oscillators, Plate 1,200 Volts, \$15.00; 250 Watt, \$96.00; 500 Watt, \$125.00. Also Receiving Tubes. Send for particulars to Kenneth Gold, United States Agent, 197 Beech St., Holyoke, Mass.

**CANADIAN 8BC, 3DS.** H. S. Gowan, Radio Inspector, Kitchener, Ontario.

FOR SALE: 9CBW's 5-watt C.W. transmitter and s.w. regenerative receiver. Going to school and must sell. Meters, bulbs, fones included. Will QSL all inquiries. Alban Gower, Tracy, Minn.

NOTICE: TUBE REPAIR business conducted by D. E. Gillmore, 46 Thomas St., Newark, N. J., taken over by the undersigned. The same high quality repair work. NEW prices in effect June 1st. Detectors or Amplifiers 200-201-300-301 E.R.-A.P. \$3.65 each. WD1-12-UV199-201A \$4.25 each. Returned PROMPTLY parcel post C.O.D. Radio Vacuum Tube Co., 55 Halsey St., Newark, N. J.

SELL: New 3 circuit tuner, detector, and 3 step complete with "A" and "B" batteries, Tungar, fones and brand new set UV201A's, \$125.00. New R-2 Magnavox \$60. William Dorival, Caledonia, Minn.

WANTED: General Radio Wave meter and two thousand volt motor generator set. I have for sale or trade, one Clapp-Eastham HR Tuner and HZ Amplifier, one Tresco Universal perfection receiver, cost \$150.00. One new Atwater Kent tuner, detector and three stage audio mounted receiver, value \$100.00. Baldwin small diaphragm receivers cost \$21.00. One pair Brown adjustable cost \$24.00. What have you? I also want Magnavox tone arm transmitter. E. Richard Hall, new call 3BLB, located at Avalon, N. J.

EDISON ELEMENTS for storage B batteries, six to ten cents per pair postpaid, depending entirely upon quantity ordered. I handle only strictly first grade, full capacity elements. A. J. Hanks, 608 Montgomery St., Jersey City, N. J.

DISTANCE—Greater than usual guaranteed on new circuit. Successful combination of regeneration and radio-frequency amplification. Sounds like one-step audio on regular birds. Circuit and instructions, 50¢. L. W. Hatry, Port Arthur, Texas.

FOR SALE: New Grebe CR8 sets \$58.50. Shipped promptly C.O.D. Ben Herr, Lebanon, Ind.

SEVENTEEN DOLLAR MODEL 425 Weston antennae ammeter five amp. scale, 10 dollars. One set (5) Marconi Victor Code Records, \$2.50. Federal and R.C.A. one mf. filter condenser \$1 each. R. R. Hill, 918 Academy St., Watertown, N. Y.

TUSKA INDUCTIONE nearly new with plate and grid coils cost \$12.50, sell \$6.25. 3CCX.

BARGAINS: Benwood 12 stud super gap \$10.00. New 1/4 HP 1750 RPM Motor \$15.00. Ellwood Hoepfner, Palmyra, New Jersey.

SMALL FUSE WIRE will protect your tubes. Connect between rheostat and socket. Quarter, half, one, two and three-ampere sizes, three feet for 50¢. Larger sizes for power tubes. 9CZP.

FOR SALE: 500V 200W Robbins & Myers M-G \$60. 500V 100W Westinghouse M-G \$70, both A1 condition. 2 new 5 watt tubes \$6 each. 5-5 watt tubes used very little \$5 each. 4-5 watt tubes, used, \$3 each. 1-UP 1626 RCA filter reactor \$7, 1-UP 1627 filter reactor \$10, 3 magnavox hand microphones less cords \$8 each. 12-UC 488-1Mfd. condensers \$1 each. 1-0-10-V AC Jewell voltmeter \$5, 1-0-10V DC Weston voltmeter \$5, Westinghouse type TF CW and fone transmitter—fair condition but needs rewiring \$50, or complete with M-G, microphone. Key and tubes \$125. Wilber Jameson, 1101 Third Street SW, Canton, Ohio.

TWO 50 WATTERS radiotron type UV203 for sale \$18 each. Used less than two hours. S. Jones, Box 220, Waterford, N. Y.

9BR REASSIGNED TO Beverly Dudley, 4909 Fletcher St., Chicago. Pse QSL.

CW AND RADIOPHONISTS: Our new converters will satisfy your need for a more economical and reliable plate supply. Output seven hundred to two thousand volts at 4 amperes D.C. No generator armatures to burn out. Synchronous motors and other parts sold separately. Write immediately. Kimley Equipment Mfg. Co., 290 Winslow Ave., Buffalo, N. Y. Attention L. W. Kimley.

BARGAINS: Grebe CR-5, intermediate wave receiver, with detector, \$40.00; Baldwin variometers and variocoupler in Grebe cabinet, very efficient short wave set, \$20.00; GF type AA-1400 det. 2-step in metal cabinet, \$22.50; Experimenters Information Service plans,

cabinets and some parts for receiver and det. 2-step similar to Paragon, cost \$65.00, never used, sell for \$30.00; King Am-pil-tone horn, \$4.50; Two WE 216-A power amplifier tubes, \$6.00 each; Three UV-200 tubes, \$2.75 each; N. Y. Coil Co. 23 plate variable condenser, unmounted, \$1.00. Apparatus guaranteed in good condition. Postpaid on receipt of price. Jack Dunham, 49 Overlook Circle, New Rochelle, N. Y. Radio 2JC.

TRADE Myers commercial X-Ray equipment for C.W. set or parts or W.E. power amplifier. Cash price 125 dollars. Kessler H. F. Labs., Maryville, Mo.

COMPLETE synchronous gap \$25. 1/4 H.P. motor \$10. R. Kinney, 1808 Middlehurst Road, Cleveland Heights, Ohio.

FOR SALE: 500 Volt Generator; 1/2 h.p. R & M Motor complete. Tesla outfit; Sinc Rectifier, Reinartz Tuner; DeForest Variable; Vernier Condenser; and many other items. Write for prices and list. J. Wm. Kidd, 404 Lafayette Street, Niles, Ohio.

FOR SALE: One Grebe CR-8 three circuit Receiver absolutely new and latest model \$60.00. One Vitalitone loud-speaker \$15.00. Also parts for small C.W. transmitter consisting of Acme 200 watt transformer, Acme Inductance with tickler coil, Jewell AC Voltmeter, Milliammeter, TC Ammeter, Filter Condensers, etc., write for prices. H. R. Lord, Cambridge Springs, Penna.

TWO NAVY TYPE C.W. 936 receiving and transmitting sets complete in original cases with 8 W.E. tubes each. 2 Generators, Loud speaker etc. \$150.00 each. M. Liedeker, 61 Cornelson Ave., Jersey City, N. J.

FOR SALE: 20 Watt C.W. Transmitter. Four Kenotron tubes for rectification and complete filtering system. Price, \$200 with power tubes. Radio 8AGC, Joseph Lathrop, 614 Atkinson Ave., Detroit, Mich.

BY REQUEST My W.D.11 Hook up that received Cuba and 15 DX stations in one night now available. Diagrams 50¢. Marchese P.O. Box 417, Brooklyn, N. Y.

SINGLE CIRCUIT broadcast receiver \$21.00; Rotary spark gap, \$5.00; UV200, \$4.00. Alban Michel, 116 Benson St., Reading, Ohio.

GREBE CR-9 costs \$130.00, sell for \$85. DeForest DV-7 Reflex, costs \$125.00, for \$80.00; New Genuine Western Electric V.T.II Power Tubes \$8.00 each. S. W. Mayer, Beechmont, New Rochelle, N. Y.

FOR SALE: Amrad three circuit regenerative receiver, detector, two stage amplifier, guaranteed new, complete with loading coils and tubes. \$100. Neal Miller, Webster Avenue, Bangor, Maine.

2AUR NOW Harry N. McMenimen Jr., Scotch Plains, N. J. Pse correct fr call book OM. Using low power. All cards answered.

FOR SALE: 1 Clapp-Eastham Radak, \$50.00; Guaranteed. Morrison's Garage, Cherryville, N. C. Ever Hr 4GV, QSL card to R. J. Morrison.

RADIO GENERATORS—500 Volt 100 Watt \$23.50. High Speed Motors—Federal Phones \$5.50—Battery Chargers \$12.50. Motor Specialties Co., Crafton, Pittsburg, Penna.

BARGAINS—Fifty watt Radiotron never used \$17.00. Honeycomb receiver with thirteen coils \$22.00. Quarter kilowatt Thordarson transformer \$3.00. Also have parts for C.W. set, condensers, keys, quenched and rotary gaps, tubes, etc. First money order for \$60.00 takes everything or will sell separately. D. Myer, 2614 East 74th Place, Chicago, Illinois.

CLEVELAND MOTORCYCLE—Sell cheap or swap. Want bicycle or Wireless apparatus. George Murphy, Salem, Ohio.

GREBE CR-8, like new. Sixty bucks. 9CZP.

8XH 8XAV 8XH Sell or trade transmitting and 500 cycle apparatus—want laboratory instruments. J. Edw. Page, Cazenovia, N. Y.

SACRIFICE: Grebe CR-9, fine for C.W. & Fone. Cost \$130.00. Sell \$100.00. Practically new. Guaranteed OK. Cash or one-third with order, balance COD. Broadcast stations heard in Calgary, Canada, Havana, Cuba, San Juan, Porto Rico, and from both coasts. Glenn Packwood, Chaffee, Missouri.

FOR SALE: Honeycomb regenerative tuner and detector 7x12 panel and cabinet with 4 Remler coils \$40.00; 2 step 7x9 panel and cabinet, General Radio Transformers \$22.00; 2 Acme R.F. Transformers \$3.75 each. C. Chandler Pidgeon, 1343 Clifton St., Washington, D. C.

SALE: 20 Watt fone & C.W. transmitter assembled on panel with power supply, all tubes, key, etc. Photo on request. \$100.00. 9CMV.

MAGNAVOX TYPE R3. Latest models in original sealed factory cartons. List \$35. Special introductory offer \$25. Express collect. Radio Central, West First St., Abilene, Kansas.

WANTED: Live amateur agents in every town to sell radio apparatus direct to users. Write immediately for exclusive territory and liberal discount schedule. No capital required. Radio Exchange, 511 Seventh St., Sioux City, Ia.

ENJOY RADIO THIS SUMMER with a SUPER REGENERATOR. Use the flivver method with a loop and reduce static interference. Hear the broadcasts on a horn through summer static with three tubes or less. Amateurs, carry on traffic unhindered with a "super." Super-regeneration, efficiency plus economy. Let us give you the real dope on the super and show you how to do it. Send 50 cents for complete treatise, formerly sold for ONE DOLLAR. Radio Consultation Bureau, P. O. Box 111, Plymouth, Mass.

WIRE YOUR SET WITH COPPER BRAID instead of solid wire. Has extremely low resistance at radio frequencies. Makes "cushion" contacts that never work loose. Never breaks, easy to work with, does not require soldering. Air dielectric has no distributed capacity. No 16 contains 96 No. 38 bare copper wires. Six feet for 25¢. Radio Panel Shop, Junction City, Kansas.

"2NZ" transmitter for sale. Heard in Europe, Hawaii, etc. If interested, send stamped envelope for details. Will sell reasonable. E. Raguse, Tottenville, S. L. N. Y.

FOR SALE: Two Tresco tuners, \$7.00 each, Variable Condensers, and other stuff. Louis Ratisseau, 3812 Ave "P", Galveston, Texas.

FOR SALE: 20 watt C.W. & Phone set including Motor-Generator, good record, also (1) 750 watt 3000 volt R.C. Transformer. Best offer takes. J. H. Rinehart, Box 215, West Fort Lee, New Jersey.

BARGAIN: Coupler, twin-variometer set in cabinet with detector. Formica panel, Bradleystat, Murdock phones, tube, complete \$20. Lawson Romjue, Macon, Mo.

FOR SALE: New Mullard 500 watter. Guaranteed perfect condition. 2000 Volts anode \$70. R. Russell, 814 Bath Ave., Niagara Falls, N. Y.

FOR SALE: Grebe CR9 receivers, brand new, \$105. each. R-2 Magnavox \$64.00; AC2C power amplifier, \$60.00. All new stock. Radio Service Co., Yankton, South Dakota.

COPPER BRAID has lower resistance at radio frequencies than solid wire, ribbon or tubing. Also many mechanical advantages. Ideal for C.W. inducances, loop aerials, OT's, lead-ins, pig-tails, etc. Twenty sizes. No. 16 for wiring sets, six feet for 25¢. 9CZP.

BUILD YOUR SETS with quality parts and get sure result. Radio Parts Co., Box 56, Dunellen, N. J.

FOR SALE: Slightly used Paragon RA Special, \$40.00, High grade detector and two step amplifier \$25. Amrad Electrolytic condenser and two "S" Tube rectifiers \$5.50 each, all for \$15.00, used about 25 hrs. One RCA 325 C.W. Transformer. Home-made C.W. transformer, filament and plate windings with center taps \$6.00. Radio SOC, C. Revere Smith, Port Arthur, Texas.

FLASH—50 watt Cunningham \$25. Slightly used. Socket \$1.50. 8QQ.

SELL 1/2 Kilowatt transmitter \$23. Ernest Schultz, 1311 Colburn St., Toledo, Ohio.

UNUSED Clapp-Eastham No. 64 Ammeter TEN DOLLARS; HALF KILOWATT SPARK CHEAP. Alva Smith, Caledonia, Minnesota.

FOR SALE: One 1000 volt Motor Generator 400 watt \$110.00; One 500 volt Motor Generator 200 watt \$65.00. Above almost new. One A.C. voltmeter 0-20 volts \$6.00; One Milliammeter 0-500 \$6.00; One R.C.A. Hotwire meter 0-5 amps, \$5.00; One Magnavox \$25.00; One Valley Battery Charger \$13.00; Three Tuska Receiving Sets Detector and Two stage amplifier \$30.00 each; One Aeriofa Sr. new complete \$50.00. J. L. Scroggin, Oak, Nebraska.

SELL: 2 Amrad S Tubes @ \$5.00, 2 Enclosed Federal Audio Transformers @ \$4.00, 2-1Mfd. Filter Condensers @ \$1.50. Write R. Slayton, Converse Hall, Burlington, Vt.

FOR SALE—\$24.00 Edison 22 volt storage B battery. I will furnish you with 30 famous chrome nickel plates, 15 containers, separators, wire, etc., nothing to buy extra. Complete with all instructions for assembling, charging, etc. Prepaid for \$3.15. All orders shipped same day received. H. B. Smith, Jr., 31 Washington Ave., Danbury, Conn.

EDISON STORAGE "B" BATTERY Elements, five to eight cents per pair, according to quantity. Nickel wire, 1 1/2 foot. All parts, excepting electrolyte and tube rack, for 45 volt battery, \$4.50. 6 volt, 75 Amp. Edison Battery, Type B4, \$15.00. A. R. Spartana, 615 N. Washington St., Baltimore, Md.

RBC moved to 12 Russell Ave., East Providence, R. I. Cards appreciated.

SELL 1 KW Type R Thordarson Transformer \$20., Hyrad rotary \$17.50, Thordarson O.T. \$4.00. Also 1/2 KW spk. set complete \$25. Carl Roszbach, 15 South McNab Ave., Gloversville, N. Y.

HONEYCOMB COIL Regenerative Receiver including Radiotron and coils \$38.00; two step amplifier \$22.00; Baldwin phones \$9.00; Loudspeaker \$10.00. All for \$75.00. Smith, 4416 Market, Philadelphia.

6FY's watt C.W. complete with used tube, \$60.00. DX 2200 miles. G. Thompson, 144 Sunset Blvd., Modesto, Cal.

EXCHANGE high grade radio equipment for good tenor banjo, camera, portable typewriter, or whatever you have. Will sell separately also. Albert Toth, 1628 First Avenue, New York City.

MOTOR-GENERATOR, for sale, 100 watt 365 volt, like new, only used about four hours, \$37.00. Also Hom-charger, \$13.00. Samuel Townsend, SWY. 79 Marvin Ave., Akron, Ohio.

FOR SALE: Thordarson 1/2 kilowatt Type T magnetic shunt transformer with glass plate condenser and kick-back preventer. \$15.00. 9EJY, 9323 Rhodes Avenue, Chicago.

FOR SALE: 1000 Watt 500 cycle generator with transformer and meters \$36.00. 25 General Radio Amplifying Transformers all new \$3.25 each. Write for list. 2CKL.

AUDIO FREQUENCY TRANSFORMERS \$1.50 each. L. Werts, 409 St. Julian St., Pekin, Ill.

DISCOUNT 20% on all radio apparatus to QST readers. Goods guaranteed. William Dorival, Caledonia, Minn.

SELL OR SWAP complete 1KW spark fifty dollars, want detector and amplifier or C.W. Willems, Monica, Ill.

A REAL BARGAIN: Regenerative Tuner and Detector. Complete with Radiotron and Brandes phones. Broadcast distance record 2000 miles. Perfect condition. Write for information. Price \$25.00. Adolph Will, Macon, Mo.

Edison "B" BATTERY UNITS one positive and one negative plate for 10¢. 18 sets will make a 24 volt battery. Wilkinsburg Wireless Shop, 711 Penn. Ave., Wilksburg, Pa.

FOR SALE: 50 watt tube CG1144. Practically same as UV203 \$15.00. Same but stands only 750 volts \$10.00. 2 RCA sockets for UV203 \$1.50 each. RCA UP 1718 gridleak \$1.00. Acme 500 watt plate transformer \$20., mounted. Jewell meters 0-5 thermo coupl. ammeter \$8.50, 0-15 A.C. voltmeter \$5., 0-300 milliammeter \$5. All type 64. Eaton Oscillator \$5. E. I. Winquist, 229 Garfield Ave., Jersey City, N. J.

EDISON STORAGE B BATTERY elements, 5 cents per pair. First grade elements only. J. Zied, 530 Callowhill St., Phila., Pa.

INVENTORS: Protect your invention through A. M. Wilson, Inc., Washington, D. C. Over 25 years of efficient, expert, confidential service. Skilled in Radio-Electrical, Chemical, and Mechanical fields. Our latest illustrated Patent Book, giving much necessary and very useful information which every inventor should know, will be sent free upon request. Prompt and careful attention. Highest references. Moderate fees. Send sketch or model for our careful opinion and preliminary advice. Write today to A. M. Wilson, Inc., (Radio 3ARH) 310-16 Victor Building, Washington, D. C.

FOR SALE: Two new Western Electric VT1's. \$6.00 each. 9KM.

FOR SALE: 110 volt electric soldering irons with cord and plug, \$3.75 each. Hollingsworth Electric Co., Box 126, Russiaville, Ind.

A REAL CHANCE—Clapp-Eastham HR Tuners, HZ Amplifiers, Mahogany cabinets, Regular Price \$40.00 Per Unit. While they last. \$20.00 Per Unit. The Buckeye Radio Service Co., 65 East Mill St., Akron, Ohio.

SEVENTY-FIVE DOLLARS for 100 watt transmitting apparatus used one month, cost \$140.00. Radio Corporation apparatus: 2 Fifty watters, UP1016 Transformer, UC1531 Variable Condenser, Two UL1655 Chokes, UL1008 Inductance, Two UC490 Condensers, UC489 Condenser, UP1718 Leak, UC1014 Condenser, Two UT541 Sockets, Grid Chokes. 6BRJ.

FOR SALE: 1KVA spark set. Frank Hollingsworth, Russiaville, Ind.

TUBES WANTED with burnt or broken filaments. Advise make and how many you have and I will quote on same. Eveland, Box 295, Newark, N. J.

A WONDERFUL BARGAIN: Federal Junior Crystal Receiving Sets complete with 2200 Ohm Federal Phones. \$25.00 Value. \$10.00. Without Phones \$5.00. An Ideal Set for Local Reception. The Buckeye Radio Service Co., 65 East Mill St., Akron, Ohio.

C.W. TRANSFORMERS for that new C.W. set \$10.00. Hollingsworth Electrical Co., Box 126, Russiaville, Ind.

FOR SALE: Western Electric Power Amplifier complete with high voltage battery and bulbs. Never used. Cost \$176.00 sell for \$125.00. Also complete parts for 15 watt C.W. set. George R. Caron, Danielson, Conn.

FOR SALE: Hemcharger \$10.00; A.P. Amplifiers \$3.00; UV. 201's \$3.00; 200's \$2.50; WD.11 \$3.00; 2 Variometers \$1.00; Cotocoll .005 on 6"x5" panel \$3.00; VT Detector Panel \$4.00; Chelsea .0005 and .001 Variable Condensers \$2.00 each; Clapp-Eastham Varocoupler \$2.00; Baldwin Phones \$3.00; Singles \$3.50; Murad T-11, T-11a, T-11b, all for \$2.00; Jewell Meters 0-500 volts \$6.00; 0-3 Amperes Thermocouple \$7.00; 0-5 Amperes \$3.50; 0-250 Milliampere \$3.50. All for \$20.00. C. Carlson, 5814 Stanton Avenue, Pittsburgh, Penna.

20 WATT C.W. & Fone Transmitter, \$100. L. F. Size, 31 Powder House Road, Medford, Mass.

FOR SALE: General Electric one stage Radio Detector and one stage Audio Amplifier, practically new and a bargain at \$25.00. Cost 75.00. W. A. French, Jr., Box 539, Wilmington, N. C.



FOR SALE: To A.R.R.L. members only. The genuine A.R.R.L. emblem, the sign of a real amateur. Heavy rolled gold and black enamel. Pin or button—say which. Get yours and wear it \$1 postpaid. A.R.R.L., Hartford, Conn.

# CHELSEA CONDENSERS

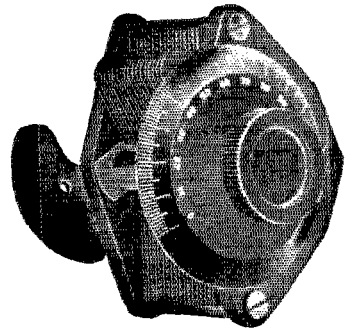

No. 3

## PRICES

No. 1	Table .001 mf.	\$5.00
No. 2	Table .0005 mf.	4.50
No. 3	Panel .001 mf. with dial	4.75
No. 3a	Panel .001 mf. without dial	4.35
No. 4	Panel .0005 mf. with dial	4.25
No. 4a	Panel .0005 mf. without dial	3.85
No. 5	Panel .00025 mf. with dial	3.75
No. 5a	Panel .00025 mf. without dial	3.35
No. 6	Panel vernier with dial	2.90
No. 6a	Panel vernier without dial	2.50
No. 7	Table .001 mf. with vernier	6.75
No. 8	Panel .001 mf. with vernier	6.50

Genuine Bakelite Construction  
The best and most complete  
line of condensers in existence.  
Write for our catalog No. 7.

**CHELSEA RADIO CO.**  
CHELSEA, MASS.  
156 FIFTH STREET

**HEAD SETS**  
\$3.20 in dozen lots

Compare them.  
Why Pay More?  
C. M. FRENCH MFG. CO.  
Seymour, Conn.

**WIS-WIN**  
RADIO SWITCHES

Be up to date—Use our concealed types single  
hole mounting  
Literature on request

**WILLIS SWITCH & INSTRUMENT CO.**  
8 Kingsbury St. Jamestown, N. Y.



—FOR YOUR CONVENIENCE

# QST'S INDEX OF ADVERTISERS IN THIS ISSUE

Acme Apparatus Co., The.....101	International Correspondence Schools.....75
Adams-Morgan Co., The.....87	
Alden Mfg. Co., The.....108	
Allen-Bradley Co., The.....99	
American Radio & Research Corp.....4th Cover	Johnson, G. F.....88
American Specialty Co., The.....116	Jones Radio Company.....1
American Transformer Co., The.....112	
Amso Products, Inc.....90	
Arnold, J. F.....104	
Atwater-Kent Mfg. Co.....92	
Automatic Electrical Devices Co.....100	
Bakelite Corporation.....98	
Brach Mfg. Co., L. S.....110	
Branston & Co., Chas. A.....116	
Briggs & Stratton Co.....94	
Bunnell & Co., J. H.....112	
Burgess Battery Co.....77	
Chelsea Radio Co.....126	
Chicago Radio Apparatus Co.....92	
Classified Advertisements.....123-124-125-126	
Connecticut Telephone & Electric Co.....3rd Cover	
Continental Radio & Electric Corp.....109	
Coto-Coil Company.....106	
Crosley Mfg. Co.....79-82-83-84	
Cunningham, E. T.....2nd Cover	
Gutler-Hammer Mfg. Co., The.....81	
Out-Rate Radio Co.....106	
Danziger-Jones, Inc.....108	
Diamond State Fibre Co.....118	
Dictograph Products Corp.....98	
Douglas-Hill Electric Co.....104	
Durham & Co.....122	
Eastern Radio Institute.....114	
Eisenmann Magneto Corp.....117	
Electric Specialty Co., Inc.....105	
Elwood Electric Co., Inc.....180	
Emblem Mfg. Co.....114	
European Radio Co.....108	
Farm & Home.....104	
Federal Telephone & Telegraph Co.....94	
Ferber Electric Co.....106	
Formica Insulation Co., The.....85	
France Mfg. Co., The.....122	
French Battery & Carbon Co.....103	
French Mfg. Co., E. M.....126	
Freshman Co., Inc., Charles.....110	
Frost, Herbert H.....92	
Garrick Radio Lab.....118	
General Electric Co.....2-78	
General Radio Co.....89	
Grebe & Co., A. H.....4	
Higgy-Avery Co., The.....110	
Hygrade Elec. Novelty Co.....114	
Kellogg Switchboard & Supply Co.....95	
Kennedy Co., Colin B., The.....128	
Kimley Electric Co.....96	
Klein's Radio & Electric Supply Co.....116	
Knott Machine Co., E. R.....96	
Magnavox Co., Inc., The.....97	
Marie Engineering Co.....96	
Marshall-Gerken Co., The.....75	
McKay Co., David.....104	
Mu-Rad Laboratories, Inc.....99	
Multiple Electric Products Co., Inc.....121	
Newman-Stern Co., The.....110	
Novo Mfg. Co.....102	
Philadelphia Wireless Sales Corp.....112	
Pittsburgh Radio & Appliance Co., Inc.....114	
Post Elec. Co.....122	
Potter Co., The G. D.....118	
Precision Equipment Co., The.....80-81	
Radio Research Guild.....106	
Radio Products Corp.....96	
Radio Products Corp. (Detroit).....118	
Radio Specialty Co.....98-102	
Radio Store of Paul F. Johnson.....100	
Rasla Sales Corporation.....100	
Rauland Mfg. Co.....116	
Remler Radio Mfg. Co.....86	
Rhamstine, J. Thos.....98	
Roller-Smith Co.....90	
Rose Radio & Elec. Supplies.....120	
Rusonite Products Corp.....112	
Southern Radio Corporation.....108	
Standard Transformer Co., The.....102	
Stevens Company.....94	
Sterling Mfg. Co., The.....118	
Stromberg-Carlson Telephone Mfg. Co.....120	
Telephone Maintenance Co.....115	
Thordarson Elec. Mfg. Co.....76	
Tuska Co., The C. D.....98	
Viking Radio Co.....75	
Walbert Mfg. Co.....102	
Westinghouse Union Battery Co.....119	
Western Coil & Electrical Co.....100	
Westinghouse Elec. & Mfg. Co.....111	
Weston Electrical Instrument Co.....88	
Whitall Electric Co.....120	
Willis Switch & Instrument Co.....126	
Wireless Mfg. Co.....107	

**ALWAYS MENTION QST WHEN WRITING TO ADVERTISERS**



# It's Ready—The Ideal Summer Set!

*Light, Compact, Portable—Just the Thing for Summer Outings and Home Use*

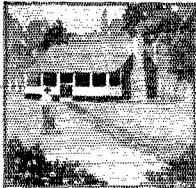

*Enjoy Radio concerts at your summer cottage.*



*A welcome addition to the camper's kit.*

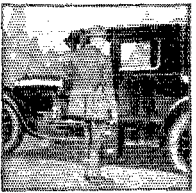

*Take it with you wherever you go.*

*All Kennedy Receiving Sets are regenerative—licensed under Armstrong U.S. Patent No. 1,113,149.*

Here is the ideal Summer Radio Set! Just the thing to take with you on your vacation—auto touring, boating, camping, or to your summer cottage. A handy, compact set, so easily transported from place to place that you can take it with you wherever you go—yet so exquisitely finished that you will be glad to have it in your home.

### Reduces Interference

This new set is the latest triumph of the Kennedy Engineering staff. It has all the beauty, refinement and perfection of detail that distinguishes the Kennedy line and makes it the "Royalty of Radio." It is simple to operate, yet highly selective, with unusual freedom from interference—the ideal summer set.

### No Storage Battery Needed

The Kennedy "Portable" is designed for use with any standard tube, including the dry-cell type. When dry-cell tube is used, the set is entirely self-contained, space being provided in the sturdy, beautiful oak cabinet for dry batteries and phones. Size 15x7½x7, weight 17 lbs. Complete, with tube, dry batteries and phones, \$75.00.

*See the nearest Kennedy dealer for demonstration, or write for descriptive literature on this and other Kennedy sets.*

THE COLIN B. KENNEDY COMPANY  
SAINT LOUIS SAN FRANCISCO

# K E N N E D Y

The Royalty  of Radio

# CONNECTICUT RADIO



## Built Like Its Big Brothers

Only in size does the Connecticut J-121 differ from the best of the big high power transformers you see in central stations.

The principle of its design, the quality of its materials, the character of its workmanship, and the surety of its performance are identical.

J-121 AF TRANSFORMER—\$5.00

With a ratio of 4.25 to 1, and its circuits properly proportioned to handle standard vacuum tubes, this transformer not only insures perfect balance between input and output but delivers maximum amplification without distortion.

Its shell type core is of the highest grade silicon steel laminations.

The windings which are thoroughly impregnated against moisture and perfectly insulated against leakage, are also protected against inductive interferences by drawn metal covers.

The terminals, mounted on blocks of CETEC, our own superior insulating material, are well separated and conveniently located.

*Bulletin A-12 illustrating and describing Connecticut Variable Condensers, one and two stage amplifiers, vacuum tube sockets, rheostats, head phones, jacks, plugs, and battery switches upon request.*

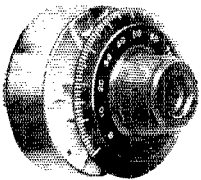

J-108  
PANEL TYPE  
VARIABLE  
CONDENSER  
\$5.00

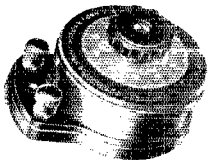

J-107  
PORTABLE TYPE  
VARIABLE  
CONDENSER  
\$6.00

RADIO DIVISION

# AMRAD

*The Recognized Symbol of Superior Performance*

New  
**BASKET-  
BALL**  
Variometer  
2607 (Less  
Knob and  
Dial)

**\$3.75**

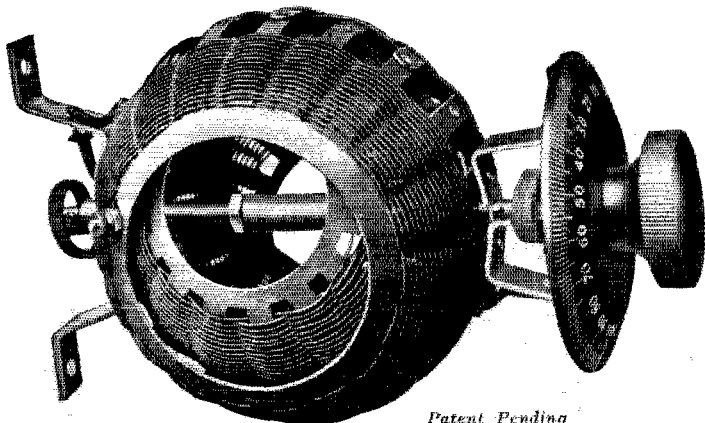

New  
**BASKET-  
BALL**  
Vario-Coupler  
2614  
(Less Knob  
and Dial)

**\$3.85**

*Patent Pending*

Use These New Basketballs  
for Greatest Efficiency

## "S" TUBE OWNERS

We want operating data from all "S" Tube owners for our Research Records. Many amateurs are getting excellent results from these Rectifiers.

If you are NOT an S Tube Owner, you should immediately investigate this new Rectifier which has NO FILAMENT to burn out.

AMRAD Basketball Variometers—used in every kind of circuit with unequalled success—assure the amateur who builds his own Set the greatest possible efficiency because

1. Dielectric losses are reduced to the barest minimum.
  2. Distributive capacity is practically eliminated.
- These two important fundamentals produce a Variometer giving you
3. Sharpest tuning
  4. Widest inductance variation (11 to 1)
  5. Ready application in any type of receiver.

**Price Only \$3.75**

Due to the recent development by us of special automatic machinery for Basketball production, we are able to sell these Variometers for LESS money than conventional types.

Order AMRAD Basketballs from your dealer. Insist on the best. Described in Bulletin C sent free on request. Complete catalog 10c.

AMERICAN RADIO AND RESEARCH CORPORATION

205 College Ave., Medford Hillside, Mass.  
New York District Office  
13 Park Row

Chicago District Office  
218 So. State St.