



OCTOBER

QST

A MAGAZINE DEVOTED EXCLUSIVELY TO THE WIRELESS AMATEUR.

PRICE

10 CENTS

HR HICK.

Klitzon . Rotary . Gap . Motor

Introductory Price

\$6.50

1-16 H. P. 2000 to 8000 R P M.

110-130 volts AC or DC

25 to 60 cycles

Shipping weight, 5 pounds

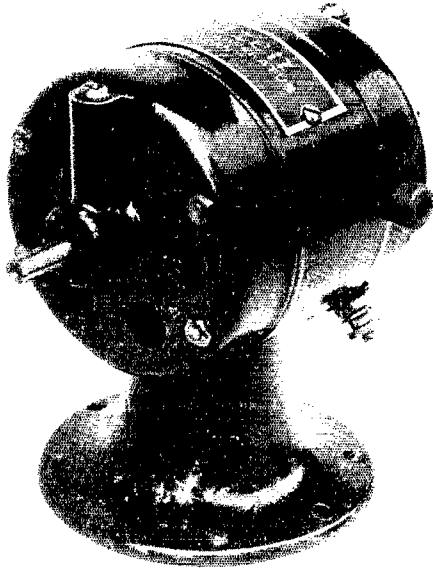

WATCH THIS SPACE FOR NAMES
OF DEALERS HANDLING THIS MOTOR

**Klitzon . Wireless
Apparatus . Company**

1123 Herrick Ave. - Racine, Wis.

Y. M. C. A. RADIO SCHOOL

YOU AMATEURS!

Have you ever thought of the possibilities of Wireless Telegraphy as a profession? Do you realize that competent operators are needed NOW for good positions, and that the DEMAND FAR EXCEEDS THE SUPPLY?

The Y. M. C. A. RADIO SCHOOL has graduated hundreds of competent operators. Many of these are filling important positions in all parts of the world. This school is completely equipped with all standard transmitting and receiving apparatus. Practice in code is given directly from Nauen, Honolulu, etc. Elementary and advanced courses in Electricity and Radio Engineering. Afternoon and evening classes for your convenience. Course requires 3 to 4 months day and evening instruction, or 6 months evening instruction only. Temporary employment for students.

Dormitory facilities and Y. M. C. A. privileges.

POSITIONS OPEN NOW FOR FIRST GRADE OPERATORS

CORRESPONDENCE COURSE, EMBRACING ALL DETAILS OF WIRELESS TELEGRAPHY, NOW IN PREPARATION. SEE OUR ADVERTISEMENT NEXT MONTH FOR FULL INFORMATION.

BOOKLET ON REQUEST

Y. M. C. A. RADIO SCHOOL

155 EAST 86TH STREET, NEW YORK, N. Y.

Always Mention "Q S T" When Writing to Advertisers

QST

Volume I

OCTOBER, 1916

No. XI

CONTENTS

- 279 Some Small Direct Current Sets *Bowden Washington*
284 High Note Versus Low
285 Rotten Construction *The Old Man*
287 February 22nd Relay Again
288 The Description of a Modern Experimental
Radio Telegraph and Telephone Station *A. H. Grebe*
292 What's the Answer ?
293 Liars *Chas. S. Wolfe*
294 A New Transformer
295 Monthly Report of Trunk Line Managers
300 Editorials
303 Who's Who in Wireless
304 New Turney Instruments
305 Radio Communications
309 Queries Department
312 Additional Membership to A. R. R. L.
313 Contest Scores
314 Subscription Contest—Prizes
319 For Sale and Exchange
322 New DeForest Instruments

Hiram Percy Maxim, President

Clarence D. Tuska, Manager and Editor

QST is published monthly by The QST Publishing Company, Incorporated at Hartford, Conn. Subscription price, \$1.00 per year. Single copies, 10 cents. Entered as second-class matter March 7, 1916, at the Post Office at Hartford, Conn., under the act of Congress of March 3, 1879. Copyright, 1916, by the QST Publishing Co., Inc. Title registration applied for at the United States Patent Office.

THE QST PUBLISHING COMPANY, INC.
HARTFORD, CONN.

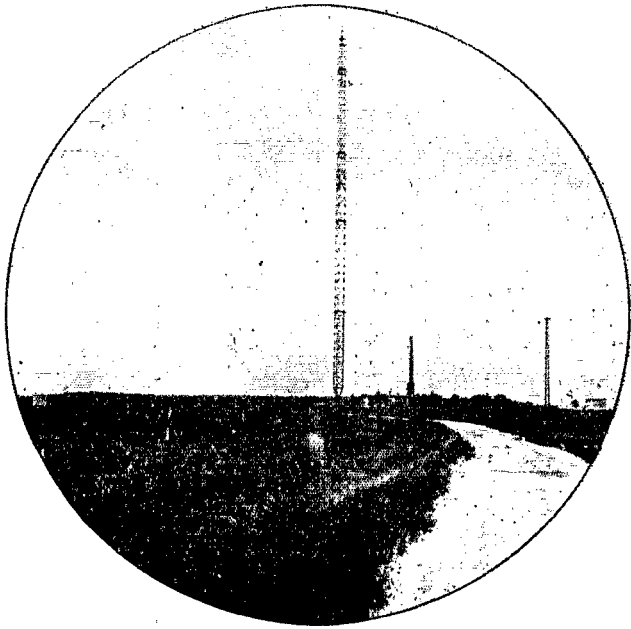

The Tuckerton Station

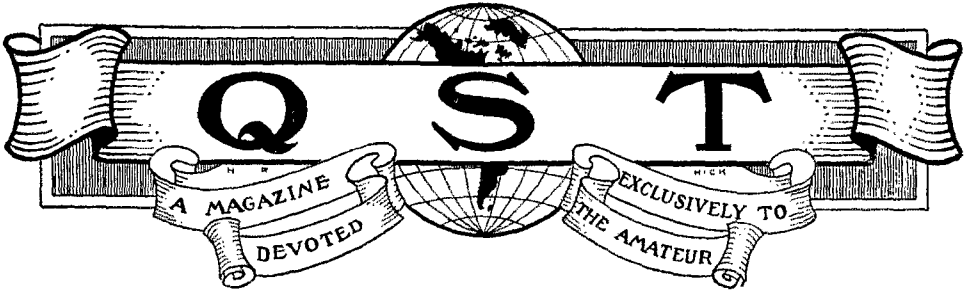

Some Small Direct Current Sets

By Bowden Washington
 (Radio Engineer, Cutting & Washington,
 Cambridge, Massachusetts.)

Reprinted from the Proceedings of the Institute of Radio Engineers
 with permission.

This article describes a commercial Chaffee gap, and the apparatus used with it. The use of direct current sets for amateurs is a development which is not far distant. If you have not kept up with the advancement, here is a fine opportunity to post yourself. EDITOR.

ALTHOUGH many radio engineers are undoubtedly familiar with the action of the Chaffee gap as used in the sets which are to be described, a short description of its behavior and characteristics may not be out of place.

This gap, originated by Dr. E. Leon Chaffee of Harvard University, consists of a copper anode and an aluminum cathode, in an atmosphere of moist hydrogen.† Figure 1 is a photograph of our standard gap; Figure 2 a section. We have found it extremely difficult to build a gap which is adjustable for gap length, and is also hydrogen-tight. All manner of threads and

†“A New Method of Impact Excitation of Undamped Oscillations, and Their Analysis by Means of Braun Tube Oscillographs,” by E. Leon Chaffee, “Proceedings of the American Academy of Arts and Sciences,” November, 1911.

stuffing boxes have been tried, without great success. The total adjustment required is very small, probably never being over 1-16 inch, so we have adopted the thin phosphor-bronze diafram shown in the section at “A.” This pushes in and out like the bottom of an oil-can, and we have found it very satisfactory. The periphery of this diafram is clamped against a soft rubber packing by a brass ring, held to the bakelite gap chamber by eight “10-32” machine screws. The base is a small composition casting. Cooling fins and the adjusting handle are shown.

The connections are as in Figure 3. When the direct current feed circuit is closed, the primary condenser, C1, is charged until a potential is reached which is sufficient to break down the gap, G. The condenser discharges thru the gap in a single loop, or half-cycle. The gap then goes out, and leaves the secondary circuit free to oscillate

at its own period. Meanwhile, the condenser, C1, is being recharged from the generator. When it has reached a poten-

undamped, oscillation will be maintained in the secondary.

The power and efficiency curves for changing feed current, Figure 4, taken from Dr. Chaffee's paper referred to above, may be of interest, and require no explanation. One gap is capable of efficiently handling about 200 watts input. We find that when two or three gaps are used, with the same primary condenser as with one, it is advisable to double or triple, as the case may be, both current and voltage, thereby keeping the I. C. F. the same, so that it may be roughly stated that the power increases with the square of the number of gaps. However, when powers of 1-2 kilowatt or larger are required, we use a later development of the Chaffee gap, which consists of a rapidly rotating alum-

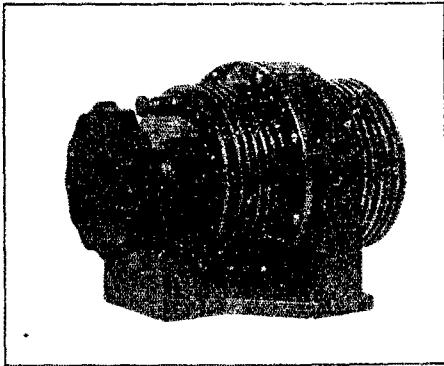

Figure 1

tial almost sufficient to break down the gap again, the e. m. f. induced in the primary circuit by the oscillating antenna is sufficient to "trigger off" the gap in the proper phase-relation to the antenna; which process continues indefinitely. The number of antenna oscillations which occur between gap discharges, called by Dr. Chaffee, the "Inverse Charge Frequency," and indicated hereafter by the abbreviation I. C. F., can be varied from two to almost any number, depending on the amplitude of

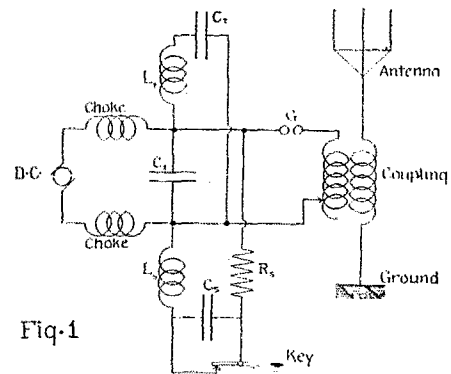

Fig-1

Figure 3

inum disc from which the spark passes to a stationary copper electrode, running in an atmosphere of hydro-carbon vapor; and used in conjunction with the Cabot high-voltage, direct current machine. We have shown with the Braun tube that the action of these gaps is identical, as is to be expected; but the efficiency of the rotary type is remarkably high, from 60 per cent. to 70 per cent.

There is no resonance between the primary and radiating circuits; and to obtain the best energy transfer it has been found advisable to tune the primary to a wavelength 1.5 to 2 times that of the secondary. However, the smaller the I. C. F., the more desirable it becomes to tune the two circuits to a ratio of 1.7 to 1. It will be seen that the efficiency from generator to antenna

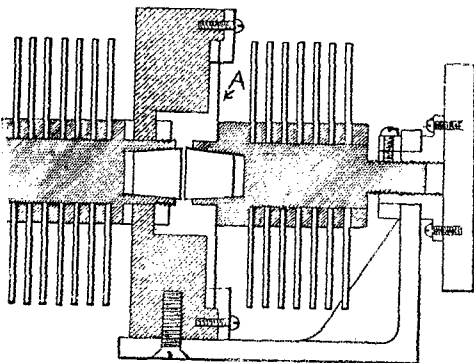

Figure 2

the feed current, the size of the primary condenser, the length of the gap, etc. It will be readily seen that with an antenna of normal resistance, and an I. C. F. of 2 to 6, a sustained, and in fact practically

of these sets is quite low, judged by modern standards; however, rather remarkable distances have been covered with small

a single-gap aeroplane set, which I will describe in detail later. The input was about 150 watts, and the antenna used consisted of two vertical or nearly vertical wires 130 feet long, spaced 4 feet apart, and having a natural period of 205 meters. The wave-length was 480 meters, and the radiation meter showed 1.5 amperes. This test was not pre-arranged in any way. The stations with which we obtained communication were simply called in the ordinary manner. Communication was established with Highland Light, a distance of about 51 miles and our signals were reported strong. We then worked with the S. S. Virginian, which reported 78 miles, signals good. Then we got the U. S. S. Gresham, presumably between 40 and 50 miles. We also worked several other stations at about these distances, with equal success.

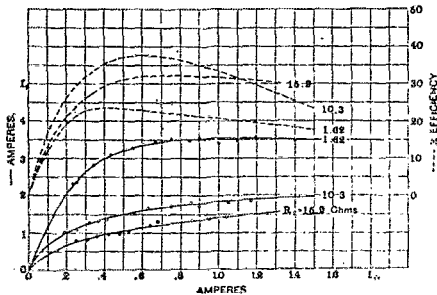

figure 4

powers, due probably to the radiation of a single wave, and to its maintained nature. Some tests were made not long ago with

One-sixth Kilowatt Aeroplane Set

Figure 5 shows a 1-6 kilowatt aeroplane set. The case is white pine, and is only a temporary arrangement, to be used until we secure something more suitable. On the

potential battery with switch, audion heating current rheostat, and audion heating current switch, all mounted as a removable unit. In front of the receiving set will be

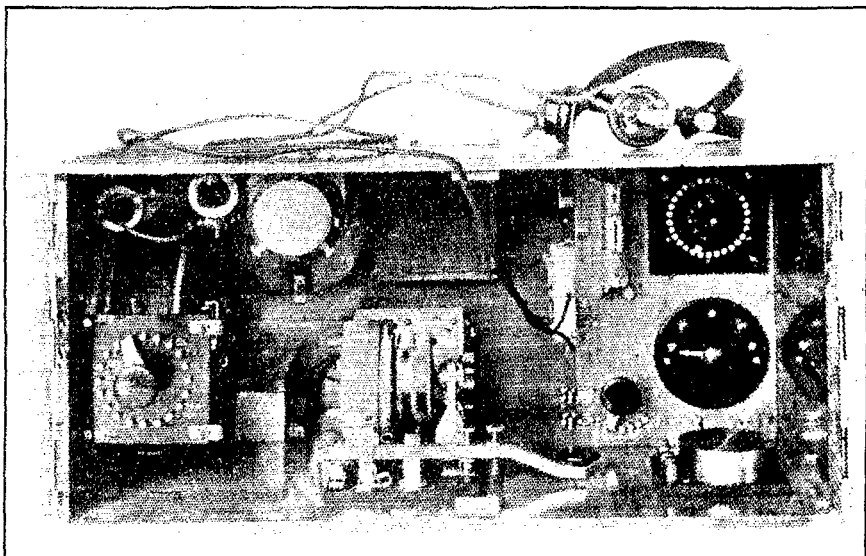

Figure 5

right will be seen the complete receiving set, consisting of the tuner, variable condenser, stoppage condenser, audion, audion

seen the chopper, which consists of a buzzer, the armature carrying an insulated contact which breaks up the sustained os-

cillations into audible groups.

The key, of the break-in type described above, is made largely of aluminum, and weighs 12 ounces. Details of the key are shown in Figure 6. Behind the key is the gap (Figure 7), embodying the same phosphor-bronze diafram used in the standard gaps, but constructed principally of aluminum castings, weighing complete 2.5 pounds. Behind the gap is a cast aluminum frame, holding two mica condensers (Figure 8), one of which is the primary condenser, the other the starting circuit condenser. The starting circuit inductance is seen behind the radiation meter, the starting circuit resistance in the upper left

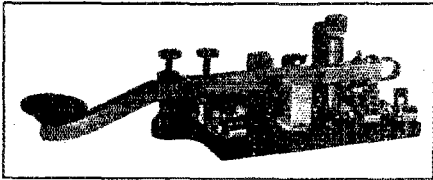

Figure 6

hand corner. To the left-hand side of the box is secured the coupling coil (Figure 9), wound with number 16 double-cotton-covered, shellacked wire* on well varnished wooden forms, and provided with switches

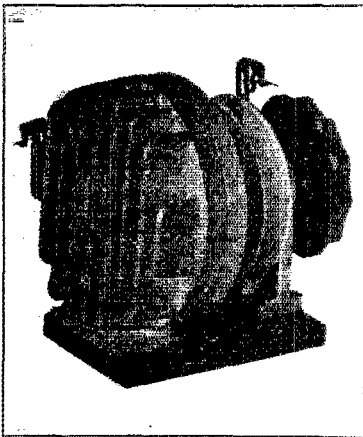

Figure 7

to vary both the primary and secondary inductance; which weighs 2 pounds, 6

*Diameter of number 16 wire = 0.051 inch = 0.129 cm.

ounces. The small iron-core choke coil is behind this. The small box above the condensers contains the audion heating bat-

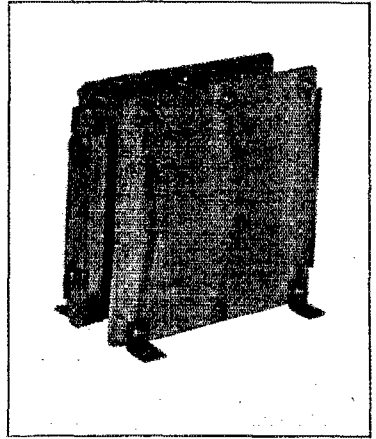

Figure 8

tery, which consists of one of the ordinary large 3-cell flashlight batteries. Spring binding posts are used almost altogether, as they would seem less likely to become loose from vibration. The box complete weighs 31.5 pounds.

The generator (Figure 10) accompanying this set is a small 3,300 R. P. M. direct current machine, giving 350 volts on no load, and 150 volts, and 1.2 amperes at its working point. It weighs 15 pounds. It is driven by the wind which operates a small aluminum air propeller mounted on the end of the generator shaft, and connected to the generator thru a centrifugal clutch. The clutch keeps the generator at its proper speed when the aeroplane speed is 50 miles per hour, or beyond. The entire generating unit weighs 20 pounds.

The antenna consists of 50 meters of number 16 phosphor-bronze wire, wound on a ball-bearing wooden reel, and is to be trailed behind. The engine, strut wires, etc., will be used as ground. The weight of the complete outfit is 55 pounds.

We have not as yet made any tests from a plane. The tests of a single-gap set referred to previously in this paper were made with this set. The inductance, capacity, and radiation resistance of the above

aeroplane antenna were calculated, the latter by Dr. G. W. Pierce and a similar artificial antenna was made up. The radiation current was from 1.5 to 2 amperes, or about the same as in the test referred to above.

The hydrogen for these sets is supplied compressed to a high pressure in steel tanks. Altho the hydrogen plays a neces-

one wave, adaptability for beat reception, and, in the rotary type, exceptionally high efficiency.

Since writing the above portion of the paper, I have discovered that alcohol vapor can be substituted for hydrogen in the stationary gaps with great success, if the alcohol is fed into the bottom of the gap

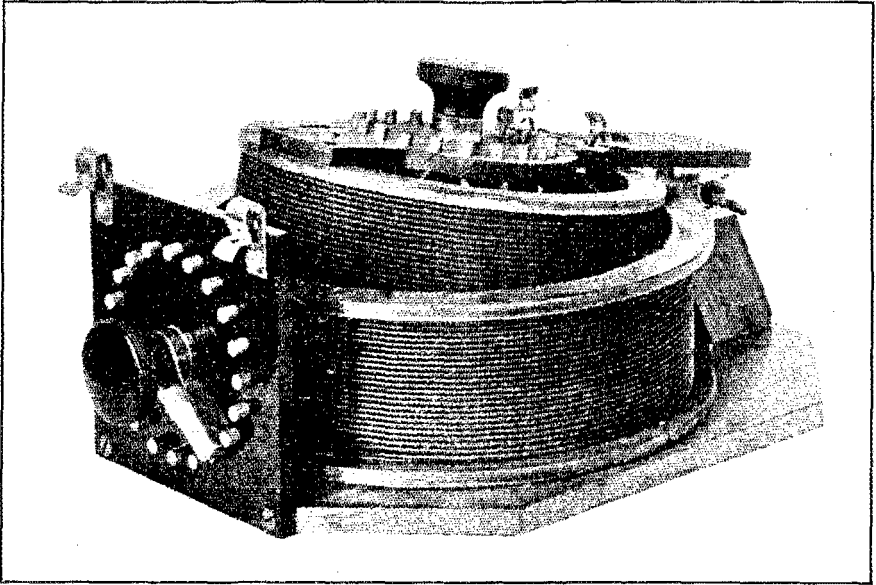

Figure 9

sary part in the action of the gap, it must go thru a complete chemical cycle of some sort, as it does not appear to be consumed; the writer having run a carefully sealed gap well over ten hours without renewal. The tanks are necessary only to supply gas lost thru any small leak that might develop.

The Chaffee Gap seems on the whole to have a wide range of commercial and laboratory applications. In the laboratory its use would include the production of sustained oscillations for the measurement of radio frequency inductance, resistance or capacity, and of dielectric and magnetic hysteresis at radio frequencies. It seems to be eminently fitted for short distance radio telephony, and its range can undoubtedly be increased when a suitable controlling device or transmitter is found. When used as a radio telegraph transmitter, it has the advantages of lightness, extremely low potentials, absolute quiet,

chamber thru a 1-4 inch round cotton wick from a small oil cup of the ordinary wick

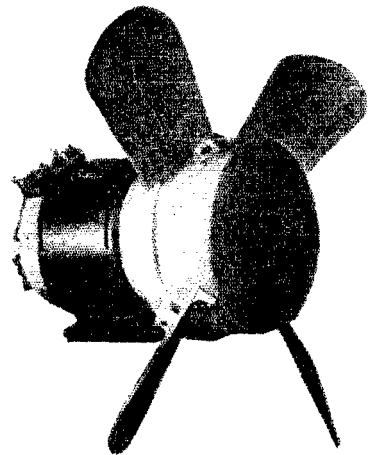

Figure 10

type. The carbon seems to distil off around

the wick, and form a light flaky soot—which can be cleaned out occasionally. The electrodes remain free from soot, which was not the case when alcohol was dropped in from above, and enough carbon did not collect in a twenty-hour continuous run (key down) to interfere with the operation of the gap. The gap sometimes starts with a slight explosion, but operates normally and without waiting. It uses about

2 c. c. of alcohol per hour. This, of course, adds considerably to the commercial value of the apparatus, as hydrogen is sometimes hard to obtain.

In conclusion, I wish to thank Professor George W. Pierce, whose kindness has enabled me to do a large part of the development work connected with these sets in the Cruft Laboratory of Harvard University.

High Tone Versus Low

With great interest and curiosity we have read the articles in QST favoring the low spark frequency for amateurs' use. In every article so far written, the proof was based entirely on the experimental results obtained by the authors of those articles. It is the purpose of this article to prove from solid facts that if the set is properly designed, the high pitched note will be the superior.

In the first place, it has been proven that the ear is more sensitive to pitches of higher frequency, i. e. 600 to 1000. Again Dr. Austin has carried on experiments which show that the telephone receiver will produce much more sound at a higher frequency than at a lower one even when the current is less. So that with respect to these, the higher pitches are the most efficient.

It, therefore, remains to be shown that the sending set can be designed so as to send out as much energy when the spark frequency is high as when low. The equation for the relation of the constants in the closed circuit is

$$Freq = \frac{KW \times 10^9}{(Sec. Volt)^2 \times C mfd}$$

Now the correct capacity for use on 200 metres wave length is 0.0086 Mfd. Substituting for the capacity this constant, and also for the voltage of the transformer, the frequency can be found. This should be doubled to obtain the spark frequency. It will be seen that by reducing the voltage, the frequency must be increased so that the equality still holds true. In this way, the sending set can be designed for a high pitched tone.

Now one more difficulty must be over-

come. The sending operator states that certain stations using crystal detectors hear him better on a low tone while he puts out more energy on a high tone. In this case, it is the fault of the receiving set. Usually on the average crystal receiving station, a condenser is shunted across the phones. In most cases this is much too large; in fact so large that the telephone circuit which includes that condenser is responsive best to lower tones. Therefore, the remedy would be to reduce that capacity. It has been noticed by one of us that the lower pitches are loudest, while the other receives the higher best. On observation it was noticed that the one of us who received the lower tones best had a much larger capacity in the phone circuit. The other condenser consisted only of two sheets of tin-foil six by one inch placed together with waxed paper so that it could be rolled up. If a condition such as stated above exists when the Audion is used as a detector, it is due to the fact the telephones are such as to be most sensitive when receiving on a lower tone. It is suggested that amateurs try reducing the capacity of the phone condenser if a crystal detector is used in order that these facts may be proven beyond doubt.

This article was not written to contradict any previous statement made by amateur operators but to show a way toward greater efficiency. It is hoped that operators using crystal detectors will change the condenser as stated in order that others who have been using the low tone may try using a higher pitch with increased efficiency.

Clinton R. Hanna,
Jas. M. Sommer.

Rotten Construction

By The Old Man

Here is another article by The Old Man. This time he has struck the truth pretty hard. It's "Rottener" than usual and just as funny. Read it and take it to heart if it hits you.

AFTER getting the phones adjusted and the old pipe going good tonight, I heard something come through on a short wave which sounded like a cross between a runaway tin peddler's wagon, and a Marconi rotary gap, and it seemed to be stuttering over my call. I tuned in a little better, and sure enough it was my call all right. The gap that sent it out certainly was bordering on a beastly state of intoxication, if it had not already reached that stage. It was up among the 500 cycle, down where it was hoarse, and ever now and again would blow off steam. It sounded like something I had heard before recently and I suspected somebody new was trying to get into the relay game.

I got enough of his msg. to guess that he wanted me to go over and look at his set. Any station which could emit a sound like his was worth looking over and so I went. I am just home from the ordeal. I probably saw more rotten construction to the square foot, than I ever saw before in my life, and believe me, Mr. Editor, I have seen some rotten construction in my time.

This young fellow wanted to get into the real relay game. He was a nice enough chap, and personally he seemed just the kind that is wanted. But he had not distinct ideas as to the necessity for having things right. He welcomed me at the front door and I was

escorted into a room in the attic where I found a marble topped washstand, which in happier days must have carried a washbowl, a big white washpitcher, and a soap dish, but which now carried a suspicious looking loose coupler in natural oak finish, a pretty fair old Arnold audion detector, a few switches and several badly tangled hanks of frazzled annunciator wire. Some day, somehow, someone had busted off one corner of the marble top at an angle of about 45 degrees.

This lent an untidy effect and also made a cavity in the top surface into which everything seemed to fall. Beside this disorganized washstand stood Mother's old card table, which evidently had been given to Son, because of one leg which had fallen off in by-gone days. To steady the table, a small nail keg, topped by a packing box, and a book of just the right thickness, had been used. This seemed fairly substantial, but again, lent an air of disorder.

On the floor was a brand new Packard 1-2 kw. transformer. It seemed like a gold ring resting in the ash barrel. It evidently had not been "installed",

but had simply been "put." Several badly tangled wires led to the terminals of this perfectly good transformer. Annunciator wire, I noticed, was used for the secondary. Where it ran to the gap and the condenser terminal, the young man had propped up a few porcelain insulators in order to stop

THIS ISSUE

WE believe the best lot of photographs are shown in this issue of QST which have yet appeared in any wireless magazine. Look them over and see if you don't agree.

When you show the October QST to your friends who have not yet subscribed, remark about the quality and ask them to look over the advertising. Notice the total absence of wireless trash.

Our Who's Who is getting us acquainted with each other. Watch coming issues. We have some good ones.

And our old friend The OM is here again.

her from jumping where no jumping was desired. It looked as though a breath of wind would upset the insulation of the whole high tension system.

On the three legged card table was a thing which stumped me for a few minutes. It looked like something to do with an insect trap. I found out later that it was the rotary gap I had been listening to. It was a fan motor which had a very high base and in the places where the guard around the fan had once been, this young man had ingeniously contrived a circular cobweb business which supported five adjustable screws, and a disk on the armature shaft revolved inside these screws. Lumps of something riveted to the disk, evidently with the teeth or a nut cracker, provided the sparking points. It had a differential effect, as the outside ring had five screws and the inside disk had four lumps. This was not so bad in theory, but Lord, such rotten construction!

The condenser caught my eye. It was made from 8x10 photograph plates, and the constructor had not bothered about getting the wrinkles out of the tinfoil, judging by what I saw. I should also judge that the contacts between the different sheets of foil had been left to a kind Providence. I was told that the condenser was not entirely reliable. I believed every word of it. If that condenser did not have a rotten disposition and if it did not jump and kick worse than any badly broken mule in the State of Texas, then I am not fit for a First Grade Commercial license. I know the bad disposition of condensers in general, and Mr. Editor, I say to you right here and now that I would rather be crucified head down than be compelled to work a radio station with a rotten condenser. And this young man was trying to get my influence to help him get into the big relay stuff.

The aerial switching was brilliantly provided for by a single throw single pole porcelain base affair, in combination with a dark colored object, which I suspected had once operated the ignition system of an automobile. The wiring of the whole set would certainly not pass inspection. It was not concealed wiring in any sense of the word. In fact, you had to watch your step and tread softly or you would disconnect,

ground, and short circuit every connection in the system. Rotten is not the word.

The lead-in came through the window and owing to the conveniently loose fit between the sash and the frame, you could shut the window down when it rained, and not disturb the lead-in. The ground wire was all you could lift. I estimated that there was not less than \$7.50 worth of copper in that ground. Son must have inherited this ground wire from some relative. It was the best thing in the station.

The owner of this wonderful agglomeration was a member of the American Radio Relay League; he reads QST, and he knew all about our mutual amateur organization. And yet, he did not have the mechanical or technical conscience rooted deep in him to tell him that he had botched his job to the very limit. He must have spent fully \$100 on his station, and worst of all, he did not have any appreciation of how rotten his construction was.

I will lay a bet right now that he hasn't a single soldered connection in his entire antenna, lead-in and ground. He probably intended to solder them later. Some of us always intend to fix a job later. It is so tempting to some folks to hook things together any old way just to try it. Somehow this kind never get into the real game.

I noticed he had a good Manhattan pancake oscillation transformer, and thinking perhaps he might get this tangle to work by sheer force of intellect, I felt him on a little theory. I knew he knew the code, and could receive twenty words easily. Considering his rotten construction, I was surprised to find that he was well informed. He had a wave length well over the legal two hundred, but I let this pass for the present. He knew that he had to have about half a dozen turns in the secondary of his oscillation transformer, and that he had to monkey around with the primary to determine the proper number of turns to get his condenser discharge oscillations in tune with his antenna. But the trouble was, you could not get a wave meter near enough to his outfit to make a test without stepping on something. Everything else was the same way. Nothing could be got in shape, no matter how fixed you were in your mind when you started, because something always broke down. This young chap

was all right regarding the essentials and yet he could not carry on any work with a town thirty miles away with his 1-2 kw. Packard transformer. His knowledge was first class, but his construction was rotten.

There is no use hurting another fellow's feelings unless you can do somebody some good. I decided that a few fatherly criticisms about frazzled annunciator wire in general, and balky condensers in particular, were as far as it would be any use for me to go. I got him to run his gap and touch his crazy key, just to see what kind of fireworks would result. He reached over back of the table, unhooked a wire off a nail, hooked it onto another nail, pulled the little single throw switch, which he called his aerial switch, held the black object down with one hand while he twisted it with the other, snapped a key socket and looked hard at the motor. Seeing him looking so hard at the motor, I also looked at it, and it came over me that he was watching to see if she would start. She did not indicate any intentions that way, so he reached over and gave her a push. This seemed to shake something loose, for she spit a little and gradually worked herself up to a speed which never quite seemed settled. It was up and down, and fully accounted for the thing I heard at my station and which some people call "tone". When she got up as high as she would go, he put his finger on a certain spot on his key, which by previous experience, he found would not give him a shock. Holding the key down to the table with his fingers care-

fully located on the correct spot, he began sending out Vs, meanwhile throwing a suspicious look on the condenser, which I had forgotten in the meantime. I was reminded of it immediately, for something let go somewhere over in its general direction, and for the moment I thought something downstairs had exploded. I know that I jumped a foot and that I had a terrible scare, because the boy and his friend had quite a laugh about it. The wires around the floor and under the table and up on the wall, would all get at it once in a while and it made quite a merry little celebration. After a while you got so you did not mind it. The Packard has quite a high voltage, you remember, and in a lot of crazy wiring, it is astonishing how much excitement one can work up.

After sending fifteen or twenty Vs; the motor contracted some kind of a disorder and must have got up to 8000 or 9000 r. p. m. before its owner could unhook the necessary wires and get hold of the key socket, find where the key was, and snap it off. I thought another calamity was coming and felt like edging over toward the door. The motor roared and trembled like a wild varmint, and why the lumps did not fly off the disk, and puncture some of us, I don't know. I went home after a while, and as I sit among my own old fashioned but orderly instruments and pen these lines, I wonder how many other amateur stations scattered up and down this country are not "getting there" because of rotten detail construction.

February 22nd Relay Again

The relay preparedness message sent out from Rock Island, Ill., on February 21, 1916, and addressed to the "Mayors of Towns and Governors of the U. S. A.", has been much talked and written of since. In a recent article which appeared in QST, credit for having relayed same to Washington with a consequent delivery to the President was accorded to 2SX. This was erroneous, and in all probability resulted from a misstatement in some newspaper from which data for aforesaid article was collected.

The Relay went through to the Capitol via 1ZL, Northampton, Mass. 8ZW was the station from whom it was received by Northampton, and verification was made from the signals of 8JX. The Washington amateur reported "Signals strong, easily readable, and no diminishing of signals throughout the message".

Nearly five hundred messages were handled at 1ZL from the beginning of December, 1915, to the middle of April, 1916, most of these originating at 1LE,

The Description of a Modern Experimental Radio Telegraph and Telephone Station*

By A. H. Grebe.

A description of one of the most distinguished amateur stations in the country is here given. It should be read with great care. How far we amateurs can go is suggested by this article. Mr. Grebe is to be complimented on the wonderful appearance of his set. Without a doubt it rivals many commercial equipments. See if some of his suggestions won't help you. EDITOR.

THE station which I am about to describe is located in Richmond Hill, Long Island, about ten miles distant from New York City. The QRM from the countless thousands of Greater New York Amateurs using various types of transmitters, tuned and untuned, on imaginary 200 meter wave lengths makes receiving extremely difficult when a super-sensitive receiver of the regenerative type is employed.

Many amateur radio experimenters obtain excellent results in receiving from distant stations by employing the well known Armstrong circuits. These excellent results are frequently obtained even with poorly constructed antennae and grounding systems, but very few succeed in transmitting over great distances owing to lack of data on the construction and erection of a sufficiently high support for the antennae. After describing the station it is my intention to touch more fully upon the antennae construction and I will endeavor to give a detailed description of the two types of mast which are proving entirely satisfactory at this station. For the present we will proceed with the station in general.

The antennae is supported by two masts as shown (Fig. 1.) These masts are located one hundred feet apart and the antennae proper runs almost due North and South. The higher mast is to the North and measures 93 feet while the shorter one is 83 feet in height. The antennae is of the "T" type composed of four parallel wires suspended between twelve foot spreaders. Leads are taken from the middle of each wire and dropped to a point just outside

of the entering insulator, where they are joined and brought to the lightning switch. Insulation is effected at the ends of the spreader bridals by means of series of porcelain egg insulators.

The importance of a good ground connection is not to be underestimated. This fact was clearly demonstrated by an actual experience at this station. There being no water pipe in the immediate vicinity, a ground connection was made through a series of ten boilers. These were buried at a depth of three feet and soldered together. This ground proved quite satisfactory until very recently when the extremely dry condition of the soil rendered it useless. The difficulty was soon overcome by stretching some four hundred square yards of galvanized wire netting on the surface of the ground directly beneath the antennae. Before the installation of this ground the antennae current radiation had dropped two amperes below normal but with the new ground it now increased two amperes above the former maximum.

Power is obtained from the street mains at 220V. 60 cycle, single phase A. C. This is controlled from a panel switchboard. A two horsepower Century induction motor is connected through a flexible coupling to a 500 cycle inductor type generator (Fig. 2.) which supplies current at 220V. to the primary of the radio transformer. A 350 volt D. C. generator is belted to a one horsepower motor and supplies current for the radio telephone equipment.

The quenched spark transmitter is very compact; (Fig. 3.) the condensers, gap and coupling inductance being mounted in a metal frame and the whole insulated from

*Presented before the Radio Club of

America, Sept. 15, 1916.

the operating table by means of hard rubber posts. There are ten spark-gap sections. Each section consisting of two copper plates with silver sparkling surfaces separated by a mica ring .01 inch in thickness and fitted with a radiating flange to dissipate the heat generated while transmitting.

Conductive coupling is employed. The open circuit loading inductance is of the spiral variometer type and may be adjusted while the transmitter is in operation. The close tuning essential in quenched spark transmitters is thus effected. All permanent connections are made with flat copper strip and movable connections with heavy Litzendraht.

The radiation of this outfit on 325 meters with a pure tone is 7 1-2 amperes and 9 to 10 amperes are attained with a slightly forced tone. The decrement being normally Q.1 A tone-tester is used when tuning the transmitter and is a great aid in obtaining a pure tone.

An auxiliary transmitter operating on storage cells is used for local communication. (Fig. 4.) This is of the panel type and is shown at the left of the figure. Similar circuits and tuning apparatus are used as in the power set with the exception of a specially designed induction coil which is used for charging the condensers in the primary oscillating circuit. The tone of the emitted spark is similar to that of a 120 cycle transmitter and a radiation of 1 1-4 amperes is obtained when a current of seven

amperes at twelve volts is fed into primary.

For the radio telephone, two types of persistent wave generators are available. The first is an arc generator of simple design which burns in alcohol vapor (Fig. 5.) This arc derives its power from the 350 volt D. C. generator. Adjustable paper condensers and coupled inductances make up the remainder of this arc transmitter. With it, speech has been successfully transmitted over a distance of twenty miles. The second means of generating

high frequency oscillations is by the use of a large vacuum tube which is shown in the figure (Fig. 6.) The filament is lighted by a 30 volt battery while the "B" voltage is obtained from a small 900 volt generator. The radio frequency current may be used for telegraphing or may be modulated into speech by connecting the secondary of a small telephone transformer into the grid circuit, the primary of which is connected in series with a battery and an ordinary microphone transmitter. Extended ex-

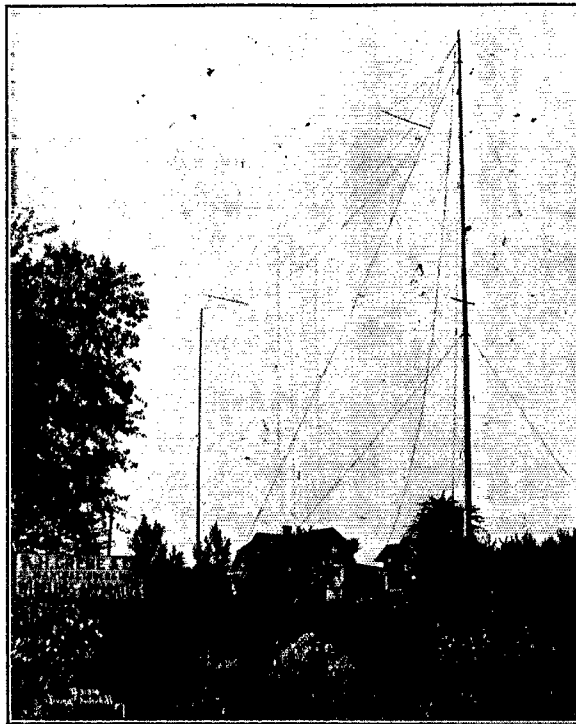

FIGURE 1

periments with this apparatus are still in progress and so far with satisfactory results.

The receiver employs an Armstrong circuit and is designed for a very wide range of wave lengths. (Fig. 7.) The various inductances and capacities for the reception of spark and continuous wave signals up to 3000 M. are contained in a single cabinet, the enclosed inductance coils for longer waves being mounted separately and connected into the circuit through bind-

ing posts on the top of the main cabinet. An additional box for the high voltage battery is seen between the loading coils

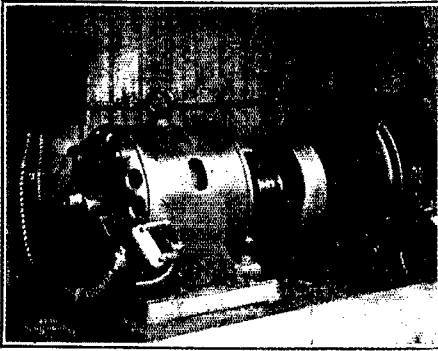

FIGURE 2

and is constructed with spring connections which allow defective cells to be removed

tuning in order to minimize the change of tone when continuous waves are being received. Transatlantic signals from Nauen and Eilvese are readable at all times when atmospheric conditions are not too strong. Numerous U. S. Naval, shore and inland stations are also received and include Darien, New Orleans, San Diego and many Atlantic coast stations. The Tropical Radio Telegraph stations at New Orleans and Swan Island in the Caribbean Sea are often received. At times when these stations have difficulty in communicating they repeat each letter ten to fifteen times in order to get their business through. During the long distance season scores of amateurs in the various states are communicated with. These include "8NH" in Ohio, "9NN" in Missouri, "9PC" in Indiana, "8ZW" in West Virginia, "1CM" in New Hampshire, "1ZL" in Massachusetts and "8YC" in Ithaca, N.



FIGURES 3 and 4

without unsoldering any wires. Extension knobs are provided on the condenser and inductance switch most frequently used for

Y. Operators have received signals from this station at other distant points, including ship stations up to distances of 1200

miles. A three step audio frequency amplifier can be seen just to the left of the receiver. This is used for experimental

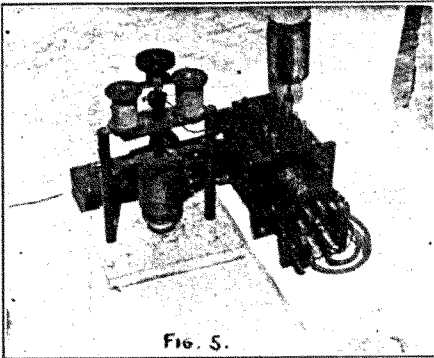

FIG. 5.

FIGURE 5

purposes only and may be connected to various recording devices.

An interesting feature of the equipment is the automatic transmitter which is used for test purposes in conjunction with the transmitting units. (Fig. 8). Currents up to 25 amperes can be broken and transmitted at 5 to 100 words per minute by regulating the speed of the perforated tape which passes through the contacting device. A system of polarized relays is controlled by contacts which are closed and broken by the moving tape. These relays faithfully reproduce the dots and dashes on a key which is connected into the transmitting circuit. The mechanism is quite delicate and requires considerable attention, but it is a pleasure to listen to the clear, clean-cut signals which it transmits. By using a dictaphone at the receiving station, many hundreds of words may be recorded in a few minutes and then reproduced for transcription at a moderate speed. The bulletins of this Radio Club; notices of meetings, etc., are sent broadcast with this machine and have been copied at a distance of seven hundred miles. These bulletins are first punched out on a paper tape, in the usual manner, and then transmitted at three different speeds, approximately twelve, eighteen and thirty words per minute.

Now I will endeavor to describe the construction of the masts employed at this station. The taller mast is 98 feet in length and consists of two spruce sections

spliced together 55 feet from the base. This mast is placed 5 feet in the ground and is supported by eight 5-16" stranded steel guys. Porcelain egg insulators are inserted at intervals of twenty five feet and are secured by flat two-bolt clamps. The top ends of the guy wires are bolted to forged mast bands; the lower ends terminating in X turnbuckles. These turnbuckles are secured to 5-8" guy rods which are embedded in concrete anchorages. These measure 18" in diameter by three feet deep and are considerably wider at the bottom. This mast was erected complete, including guy wires and halyard, by means of a gin-pole, 45 feet high which was placed 5 feet from the base of the mast. A trench was dug to guide the mast into position. Five men, with the aid of a triple block and fall, were able to raise the mast.

The shorter mast is 81 feet high, of much lighter construction, and was erected in two sections. The lower section is spruce, 50 feet in length and is 5 feet in the ground. The upper section is composed of two pieces of clear spruce, 3 1-2" square, spliced together and secured to the lower mast by means of two 10" lag screws. Nine No. 8

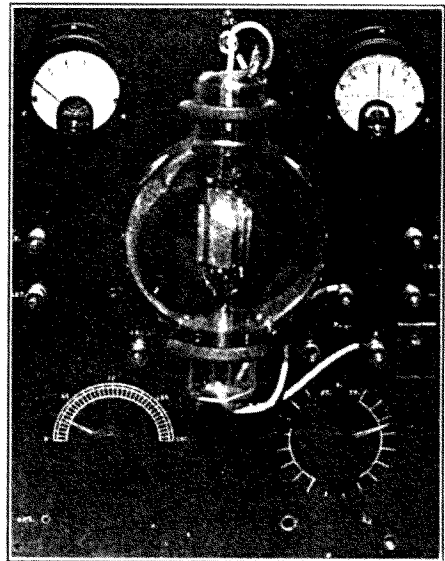

FIGURE 6

galvanized guy wires support this mast. Porcelain egg insulators are inserted at intervals of 25 feet. The lower section was

erected by means of shear legs and guyed in place. The base of the upper section was then butted to that of the lower and a rope,

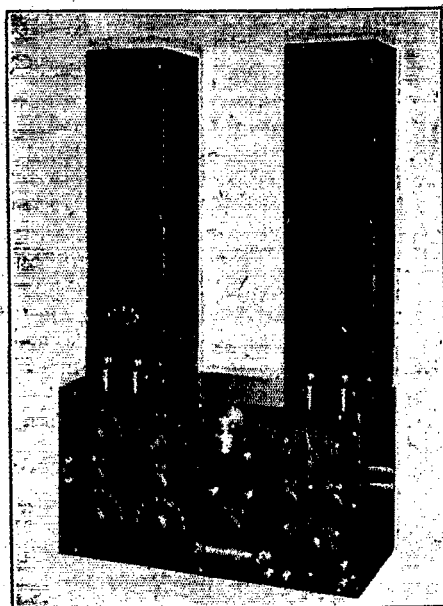

FIGURE 7

running through a pulley at the top of the first section was fastened to the middle of the second. The upper section was then raised as far as the rope would permit. The hoisting rope was then shifted from the middle to the bottom of the upper section

and the latter raised and secured in its permanent position. During the last stage of erection it was found necessary to balance the upper section by attaching a timber to the lower end to prevent it from becoming unbalanced. Two men were able to raise this top-mast while three gradually let out the guy wires.

The total cost of erecting these masts,

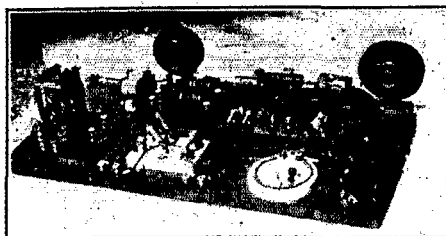

FIGURE 8

complete, was \$115, for the 93 foot mast and \$35 for the 83 foot mast. Although the larger mast will withstand much greater strains and is better in appearance, I would recommend the smaller one as being very efficient.

At this station we endeavor to keep right up to the minute both in transmitting and receiving apparatus and all new ideas which appear feasible are given a thorough test. In conclusion I wish to extend a cordial invitation to any one interested to visit this station.

What's the Answer?

"Doc" says this is for you to think about.

The Queries Department was not created to think for you, but to help you to think. The radio man's prime requisite is a thorough, up-to-the-minute, general knowledge of the fundamental laws which govern radio. If you have up-to-date text books, study them! If you have not, or if you do not study them, you are a back number—a nobody, as far as radio is concerned! Infrequently luck makes possible a good station. Luck never made a good radio man and never will. Study will make both,—anywhere! Think that over.

We are extremely sincere in the hope that this Department will aid you in increasing the efficiency of your apparatus,—especially your mental apparatus. That's what we're here for. But,—first, try to help yourself. You will gain most that way!

And while we are speaking of reference books, here is a list which every amateur should own in their order:

Manual of Wireless (radio) Telegraphy for the use of Naval Electricians, by Lieut. S. S. Robison.

Liars

By Charles S. Wolfe

Mr. Wolfe is becoming QST's star humorist. His article on "Interference" in the September QST made more than one of us roar with laughter. "Liars" is another article of the same style. Not one bit less funny. Read it and see.—
Editor.

I'M a trifle fogged on ancient history dope, and I don't believe I ever knew just who stood at the head of his class in electricity in old Rome. But as nearly as I can find out, an old gink named Ananias was the first chap to reduce lying to a science. Of course, long before Ananias' time lying had been practiced, but in a desultory fashion. I am told that Adam took a belt at it in the Garden of Eden. But Ananias simplified it to such an extent that it became one of the favorite sports of the people. The habit became quite general, at all times, and among all peoples. Ananias has had a large following.

Fishermen, for instance, and notably lawyers, have done interesting work along these lines. We find choice bits of ground and lofty lying scattered thru history and literature. With the advent of the daily paper, the professional liar came into his own, and this class has established a record, lying continuously and daily at the rate of five American passports per column.

When "Guggy" Marconi wormed the first grant out of the British Post Office folks, however, he laid the foundations on which has arisen one of the finest and most spectacular body of liars this old planet has ever seen. There has been some tall lying in ages past, but the Wireless liar is in a class by himself.

Two years ago I started the first leak in my father's roof, while sticking up my first twenty footers. In the past two years many a fine specimen of the genus liarus has sat beside me in my humble apparatus room and furnished startling exhibitions of skill and daring—vocally. On one occasion, at least, the climax of a yarn was so stunning that my audion bulb abruptly went out. (I may as well take a wallop at it myself once in a while.)

I suppose most of you have met the kind of fellow who listens nightly to Nauen thru the medium of a rain spout and a silicon rock. And no doubt many of you have listened to the chap who had to take down his set, because the neighbors complained of the hoarse roar of NAR, coming in at midnight, or thereabouts. I'm inclined

to believe that the fellow who heard the Republic's SOS is purely a product of the East, and I imagine you Western amateurs seldom have the pleasure of listening to this exceedingly interesting exhibit. Quite a few of you, doubtless, have sat crushed, while listening to a recital of how your friend, while working a one-inch coil in Philadelphia, was warned by San Francisco to stop interfering.

Startling was the tale, told by a commercial operator, of adventure in the Arctic Seas. He encountered intense cold, so intense, in fact, that all attempts to light a cigarette proved futile, for the flame froze on the match. This story is equalled only by the same fellow's experience in the Tropics. Here it was so very hot that he sustained painful burns when his hand came in contact with a piece of ice, which a sailor had carelessly left lying on the deck.

I believe, however, that few of you, if any, have met the chap who reads NAX by listening bare-eared at the points of his antennae switch. This one was really sprung on me, and in the presence of other witnesses, at that. The fellow actually had the nerve to tell a crowd of us that he got old NAX without apparatus of any kind, other than an aerial. What? Oh, yes, he got away with his life. There was a cop on the corner, and he would not have understood.

I have made a few experiments with wireless liars, and in hopes of interesting the boys in this particular line of research, I'll mention a couple of them. Following are the directions:

Take two good wireless liars, each of about two-hours-without-repetition capacity, and sic them onto each other. What a phenomenon now takes place! Notice the counter E. M. F. that each produces to the other's best lie. This experiment is fairly tame, but makes a good starter. A more complicated one follows:

Take a careful experimenter, a stickler for exact measurements, etc., one who is precise and staid in manner, and utterly devoid of a sense of humor. (Any good amateur club should have plenty of such lying

Continued on page 111

A New Transformer

THE Thordarson Electric Manufacturing Company of Chicago has just placed on the market a new type of wireless transformer for amateur use. These transformers are built in three sizes, $\frac{1}{2}$, $\frac{3}{4}$ and 1 Kw. The new design has the essential good features of the present wireless transformer manufactured by the above company. Mr. Thordarson brought out that design six years ago and it has proved to be the most successful amateur wireless transformer placed on the market.

The experience which this company has had in the wireless field is used to good advantage in the several new mechanical, electrical and magnetic features which

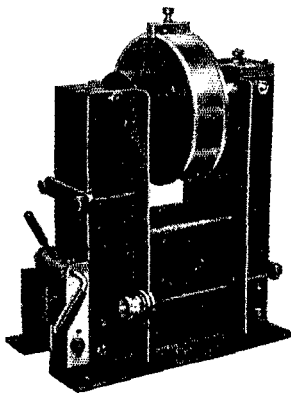

appear in the new type as improvements over the old. From a mechanical standpoint, the advantages are that all heavy and cumbersome castings have been eliminated and the structure is of formed sheet steel and brass. This eliminates the possibility of breakage and reduces the weight approximately 20 per cent. Reduction of the cross section of the frame-work naturally decreases the sectional area open to the eddy currents. This feature, therefore, improves the efficiency of the device. The magnetic circuit of this new transformer is similar to the old in that the external magnetic shunt is used. There is, however, one very important improvement that instead of varying the entire magnetic

shunt circuit by means of a spring and wing nut as heretofore the magnetic shunt circuit is rigidly and securely held in place, the only movable portion being a small "V" shaped laminated steel tongue which moved in and out of the shunted magnetic circuit varies the width of the air gap and thus gives any required regulation. The movement is accomplished by means of two geared wheels that engage either side of the tongue. On the same shaft is also placed an eccentric cam which readily locks the tongue in any position. The operation of the transformer throughout its range is practically noiseless. The movable tongue is graduated so that air gap can be readily adjusted for any current input desired.

The primary and secondary windings are disposed on opposite legs, the primary being on the upper one. This high tension coil is extremely well protected mechanically by a band of heavy metal which covers the outer surface. This band is so constructed as to eliminate corona effects, this in turn reducing the liability of flash over to a negligible quantity. The high tension coil is wound in layers with special insulated paper between, the edges of this paper being folded back, thus preventing the wire from slipping out of place, this construction being used and patented by Mr. Thordarson several years ago.

There are no high tension bushings or cable to this transformer, the metal shield of the secondary windings forming one terminal. Transformer is extremely neat in appearance. Its simplicity and rigidity of construction being readily recognized. One valuable feature of this transformer is that it is moisture proof. To demonstrate this fact one of these transformers was immersed in water. After being taken out the faces of high tension coil were dried with waste and transformer when tested under this condition indicated no insulation weakness.



**MONTHLY REPORT OF TRUNK LINES
"C" AND "D"**

A. A. Hebert, Manager

Our Editor sprung a surprise on your manager this month, by insisting that the report be in his hands not later than the 8th of the month. The result is that there is not much to say, as comments on the previous report are very seldom received before the 10th.

**MONTHLY REPORT OF TRUNK LINES
"C" AND "D"**

A. A. Hebert, Manager.

We are re-printing the routes of Lines C. and D. By comparing with the August issue, you will note several changes and additions. Several gaps have been bridged and more stations are needed to fill in the question marks.

LINE "C"

Boston, Mass. to Key West, Fla.

- BOSTON, MASS.
 - 1LE, Harvard University.
- READING, MASS.
 - 1SH, A. O. Parmelee.
- MANSFIELD, MASS.
 - 1IH, C. C. Fuller.
- FALL RIVER, MASS.
 - 1ZF, Harold C. Bowen.
- PROVIDENCE, R. I.
 - 1ZP, Ralph C. Watrous—1UQ, K. E. Barth.
- WESTERLY, R. I.
 - 1TL, Carl O. Flint.
- NEW LONDON, CONN.
 - 1DD, Paul Robillard.
- MIDDLETOWN, CONN.
 - 1WW, Philip A. Bailey.
- HARTFORD, CONN.
 - 1ZM, Hiram Percy Maxim—1ZT, C. D. Tuska.
- WATERBURY, CONN.
 - 1DJ, Geo. E. Cole.
 - 1WH, C. King Sam.

- ANSONIA, CONN.
 - 1VC, Joseph Zander.
- PORT CHESTER, N. Y.
 - 2ZP, John W. Hubbard—2AHN, L. H. Marshall.
- NEW ROCHELLE, N. Y.
 - 2ZK, Geo. C. Cannon.
- PORT WASHINGTON, L. I., N. Y.
 - 2FH, Jacob Weiss.
- YONKERS, N. Y.
 - 2IB, Walter Feeney — 2IK, Martin Jensen.
- NEW YORK, N. Y.
 - 2JD, Arthur R. Boeder.
- LEONIA, N. J.
 - 2ZE, Paul F. Godley.
- LAKEVIEW, N. J.
 - 2IM, L. L. Spangenberg.
- NUTLEY, N. J.
 - 2ZH, A. A. Hebert.
- NEWARK, N. J.
 - 2AQ, D. N. Corson—2AAZ, V. F. Pennell.
- ELIZABETH, N. J.
 - 2ES, Robert Campbell, Jr. — 2WG, Harry C. Lemkie.
- ROSELLE PARK, N. J.
 - 2OJ, Robert H. Horning.
- WESTFIELD, N. J.
 - 2MM, Chas. E. Apgar.
- NEW BRUNSWICK, N. J.
 - 2CG, F. K. Shield, Nelson Dunham.
 - 2ALI.
- TRENTON, N. J.
 - 3DH, Harry E. Stahl, Jr.—3DC, Donald M. Bergen.
- BURLINGTON, N. J.
 - 3OH, Lewis Levy.
- ABINGTON, PA.
 - 3AFA, Chas. W. Weber.
- BALA, PA.
 - 3QZ, Chas. A. Service, Jr.
- PHILADELPHIA, PA.
 - 3TQ, Edward C. Andrews—3XP, S. Delbert, Jr.—3JN, A. L. Frankenfield.
 - 3AEP, James F. Rau.
- ST. DAVID'S, PA.
 - 3ZS, Chas. H. Stewart.
- PENN'S GROVE, N. J.
 - 3FR, E. Craig Densten.
- WILMINGTON, DEL.
 - 3TN, Silas N. Venn—3FO, Dr. W. G. Hudson. 3NP, LaFrantz Jones.
- BALTIMORE, MD.
 - 3RD, R. G. A. Dimling—3ME, Chas. A. Lamdin. 3AK, Edward B. Duvall.
- ARLINGTON, MD.
 - 3QV, Robert S. Hall.
- LAUREL, MD.
 - 3KI, John S. Stanley.

- HYATTSVILLE, MD.
3XR, J. Harris Rogers—3IG, Harry H. Lyon.
- WASHINGTON, D. C.
3ZW, W. A. Parks — 3PR, E. Frank Ramsey.
?
?
- RICHMOND, VA.
3ZK, Frank S. Splatt—3ST, Ralph R. Chappell—3SM, A. Elmo Burnett.
- NEWPORT NEWS, VA.
3TY, Julian E. Krone.
- PORTSMOUTH, VA.
3SZ, L. C. Herndon — 3TV, Irving Blanford.
- SOUTH HILL, VA.
3KA, N. G. Smith.
- TOWNSVILLE, N. C.
4CV, James E. Smith.
- RALEIGH, N. C.
A. & M. College.
- WILMINGTON, N. C.
4AF, Arthur L. Humphrey—4BA, Marion C. Avant.
- SUMMERVILLE, S. C.
4BK, Mayrant Simons.
- CHARLESTON, S. C.
4CB, Wm. F. Allston—4YC, S. C. Military Academy.
- SAVANNAH, GA.
4XL, Manning White—4CG, J. A. Hussey.
- WAYCROSS, GA.
4CN, Robert L. Falks.
- JACKSONVILLE, FLA.
4AC, Elmer L. Rice—4AZ, Thos. R. Dunk.
- GAINESVILLE, FLA.
4AK, Chas. T. Whiting.
- TAMPA, FLA.
4AW, Patrick H. Wall—4CT, Victor G. McIlvaine.
- ST. PETERSBURG, FLA.
4CE, Albert L. Conn—4CU, Glenn L. Allen.
- MIAMI, FLA.
4BF, Seymour Dane — 4AQ, Wm. A. Marsh.
- COCOANUT GROVE, FLA.
4AU, Hugh M. Matheson.
- KEY BISCAYNE, FLA.
4BL, H. M. Matheson.
- KEY WEST, FLA.
4XA, Geo. W. Almour — 4AB, Isador Meltzer.
- Secondary Route Between Washington and Jacksonville, Fla.
- WASHINGTON, D. C.
3ZW, W. A. Parks.
- PROFFIT, VA.
3AHF, Clarence B. Lewis.
?
- MINERAL, VA.
3KC, Thomas F. Flynn.
- ROANOKE, VA.
3VF, E. R. Tompkins—3WE, John F. Wohlford.
- DANVILLE, VA.
3RO, W. T. Gravely.
- WINSTON-SALEM, N. C.
4CK, Chas. W. Clodfetter.
- GASTONIA, N. C.
4CA, Kenneth Babington.
- ATHENS, Ga.
4AA, Wilbur B. Pope.
- OXFORD, GA.
4CO, Geo. A. Howald.
- DECATUR, GA.
4CO, Geo. A. Howald.
- KIRKWOOD, GA.
4AL, Chas. E. Kruger.
- ATLANTA, GA.
4CL, F. F. Merriam—4AM, R. A. Devore — 4BY, Max A. Herzog — 4XG, Georgia School of Technology.
- COLUMBUS, GA.
4CC, R. A. Bowles—4CH, Stephen G.
- OCILLA, GA.
4AX, Clarence M. Gordon.
- WAYCROSS, GA.
4CN, Robt. L. Falks.
- JACKSONVILLE, FLA.
4AC, Elmer L. Rice—4AZ, Thos. R. Dunk.
- LINE "D"
Between New York City and New Orleans, La.
- NEW YORK CITY
2JD, Arthur R. Boeder.
- LEONIA, N. J.
2ZE, Paul F. Godley.
- LAKEVIEW, N. J.
2IM, L. L. Spangenberg.
- NUTLEY, N. J.
2ZH, A. A. Hebert.
- CHATHAM, N. J.
2ARF, J. J. Allen.
- MORRISTOWN, N. J.
3WN, John P. Gaty.
- CLINTON, N. J.
3UC, S. Van S. Howell—3AHW, Walter S. Leigh.
- BETHLEHEM, PA.
3SS, Emil B. Brany—3JK, Stanley E. Schnable.
- READING, PA.
3QD, Frederick J. Andersen.
- HARRISBURG, PA.
3PB, Daniel H. Zorger—3AGS, Alvin G. Michael—3KX, G. Webber Knight.

STATE COLLEGE, PA.
 8XE, Pennsylvania State College.
 ?
 ?
 PITTSBURGH, PA.
 8YI, University of Pittsburgh—8RN,
 Allen Altman—8AKA, R. C. Bender—
 8AEK, L. G. Young.
 WHEELING, W. VA.
 8ZW, John C. Stroebe, Jr.—8BF, Roy
 B. Jarvis.
 FAIRMONT, W. VA.
 8YP, Ezra L. Saunders.
 E. C. Jones, Jr.
 BARRACKVILLE, W. VA.
 O. Guy Heck.
 ATHENS, OHIO
 8YP, Ohio University.
 GALLIPOLIS, OHIO
 8AEY, Floyd D. Morrow.
 PORTSMOUTH, O.
 8SR, B. C. Locke.
 IRONTON, O.
 8UM, Paul D. Flehr—8ZG, Henry W.
 Campbell.
 HUNTINGTON, W. VA.
 8ANA, D. S. Johnston — NNC, Guy
 Chambers.
 ASHLAND, KY.
 9SW, Frank E. Gammon.
 LEXINGTON, KY.
 9YL, Otto Holstein.
 SOMERSET, KY.
 9UC, Harry L. Loveless.
 KNOXVILLE, TENN.
 MY, May Powell.
 CLEVELAND, TENN.
 5ZH, W. O. Horner.
 ?
 ?
 HUNTSVILLE, ALA.
 5BS, Robert M. McLain.
 BIRMINGHAM, ALA.
 5AM, Harold S. Brownell.
 BESSEMER, ALA.
 5CR, Geo. D. Cockran.
 AUBURN, ALA.
 5YA, Alabama Polytechnic Institute.
 MONTGOMERY, ALA.
 5ZI, Wm. H. Amerine.
 ?
 ?
 MOBILE, ALA.
 5ZM, Ben W. Martin.
 5CU, Daniel M. Booth.
 WOODVILLE, MISS.
 5CC, Wilkinson County Agricul-
 tural High School.
 FRANKLINTON, LA.
 5BB, P. E. Greenlaw.
 COVINGTON, LA.
 St. Paul's College.

NEW ORLEANS, LA.
 5AT, Frank M. Stone.
 Secondary Route, Between Pittsburgh and
 Lexington, Ky.
 PITTSBURGH, PA, 8YI, etc.
 STEUBENVILLE, OHIO.
 8LM, B. F. Collins—8ABD, Walter L.
 Myers.
 CANAL DOVER, OHIO.
 8ZX, Harry S. Weber.
 CAMBRIDGE, O.
 8CL, Roy W. Waller.
 NEWARK, O.
 8AGF, Carl G. Howard.
 COLUMBUS, O.
 8ER, Louis W. Elias—8YO, Ohio State
 University.
 SPRINGFIELD, O.
 8FH, Wm. Haynes—8ZM, Ross Mc-
 Gregor.
 DAYTON, O.
 8LT, Stanley Copp
 8LJ, Carl Linxweiler.
 WAYNESFIELD, O.
 8PI, James M. Day.
 HAMILTON, O.
 8ZU, Doran Bros. Elec. Co.
 CINCINNATI, O.
 8ZF, Henry M. Rubel, Jr.—8PO, J. M.
 Schaaf—8RY, Carl P. Goetz.
 NEWPORT, KY.
 9BN, John H. Flynn, Jr.
 COVINGTON, KY.
 9QJ, Kuper Hood, Jr.
 BELLEVUE, KY.
 9PZ, Thos. Tallentire.
 IRONTON, O.
 8UM, Paul D. Flehr—8ZG, Henry W.
 Campbell.
 LEXINGTON, KY.
 9YL, Otto Holstein.
 Brannon.

Since the last report several letters have been received from stations in the vicinity of Philadelphia, and it is now hoped that the unsatisfactory situation existing in the past will be so adjusted that relay of messages for western or southern points will not be delayed or just forgotten. Your manager is frank in stating that if no more enthusiasm is shown, another route will be arranged, eliminating Philadelphia on the main trunk.

A few days ago a letter from one of our good stations not very far from Philadelphia was received complaining of the

difficulty experienced in communicating with stations in the latter city. It seems that with all of the reputed good stations in Philadelphia, some schedule of working hours could be arranged among the members themselves, so that messages could be handled with the least inconvenience to every one. As a suggestion, relay could be carried on in the morning between 7 and 8 by those who are unable to work in the evening. This was done very successfully between your manager and 3AFA, Abington, Pa., for two Sundays in succession, the distance between the two stations being about 110 miles, and through QRM, QRN, but by QRZ, messages were cleared without trouble. Both stations used a regenerative receiving circuit, which is fully described in Mr. Godley's article in the August and September number of QST.

One of the troubles so far discovered for efficient receiving on short waves of say, 200 to 450 meters, which waves are in use at present, is due to poorly designed "tuning coils" and also to antennae being too long; that is, the natural period of the antennae being very much above that of the sending wave, making it almost impossible to tune in the incoming short wave.

Great interest is being shown by the southern members of both trunks, and from present appearance the eastern stations may have to fight for their laurels before the winter is over.

Mr. W. T. Gravely, 854 Main St., Danville, Va. (3RO) has kindly consented to assist us, and, for the present, see what can be done with the stations in Virginia and North Carolina. The definite appointments of District Superintendents has not been fully worked out yet, but more will be said in the near future.

In connection with Long Distance relay work the following arrangement, in so far as it goes, has been decided upon, and the stations named below, will be known as STAR Trunk Relay Stations:

BOSTON, MASS, 1LE
 (LEONIA, N. J., 2ZE)
 (YONKERS, N. Y., 2IB)
 (LAKEVIEW, N. J., 2IM)
 (NUTLEY, N. J., 2ZH)
 PORT WASHINGTON, N. Y., 2FH
 ABINGTON, PA., 3AFA

BALA, PA., 3QZ
 WASHINGTON, D. C., 3ZW
 LINE "D"
 (YONKERS, N. Y., 2IB)
 (LEONIA, N. J., 2ZE)
 (LAKEVIEW, N. J., 2IM)
 (NUTLEY, N. J., 2ZH)
 PORT WASHINGTON, N. Y., 2FH
 STATE COLLEGE, PA., 8XE
 PITTSBURGH, PA., 8YI
 WHEELING, W. VA., 8ZW
 ATHENS, O., 8YP

Stations in brackets are a few miles apart and will relieve each other in case of necessity.

These STAR Stations are able to work 100 miles and over, and will take care of the relaying of messages for points North and South or East and West which may be given them by the intermediate stations.

As fast as other STAR stations can be developed beyond the points mentioned above for the two trunks, their appointments will be published.

In principle a message from Newark, N. J., Bloomfield, N. J., or Montclair, N. J., for Washington, D. C., would be given to 2OJ, or 2WG who in turn would transmit to the nearest STAR STATION, 2ZE or 2ZH, and the latter station to Washington direct which should be done without any trouble in winter months or if QRN is bad to 3AFA, which can be worked daytime during the summer. QRM is prevented in this way, for the reason that the intermediate stations are working on a lower wave than the STAR stations—most Star stations, having a special license to work on 425 or 450 meters.

STAR STATIONS in the South or West on Lines "C" and "D" working with stations on the lines in question 100 miles or more should notify the manager promptly so that special notation can be made of the fact, and published for the information of the members.

To those members who have not been formally notified of their appointments by letter, but appear in the two trunk lines, the manager wishes to apologize and to say that it has been physically impossible to write to every one, and it would be appreciated if all of these would write, giving data as to their stations and the range

they have actually covered.

A. A. Hebert,
246 Highfield Lane,
Nutley, N. J.



REPORT OF ROUTES "B" AND "T"

H. C. and L. F. Seefred, Managers.

The Pacific Coast Trunk Lines have been lined up as follows and we hope soon to tell by actual practice where the strong and weak points lie.

TRUNK LINE F

- San Diego, Cal. 6SR and 6WF.
- Los Angeles, Cal. 6EA.
- Pomona, Cal. 6AAG (Branch Off.)
- Bakersfield, Cal., 6ZW.
- Fresno, Cal. (No official call yet.)
- Centerville, Cal. 6BJ.
- San Francisco, Cal. ?
- Richmond, Cal. 6BY.
- Berkeley, Cal. 6WL (Branch Off.)
- Acampo, Cal. 6NP (Branch Off.)
- Stockton, Cal. 6SH (Branch Off.)
- Ione, Cal. 6RJ.
- Reno, Nev. (No official call yet.)
- ? ?
- LaGrande, Ore. 7ZH.
- Portland, Ore. KDP.
- Seattle, Wash. 7NG.
- Van Couver, B. C. ?

TRUNK LINE B

- Reno, Nev. (No official call yet.)
- ? ?
- Salt Lake City, Utah 6ZV and 6SL.
- Pocatello, Idaho, 7SP (Branch Off.)
- Victor, Colo. KIW.
- Denver, Colo. KIX.
- Lincoln, Neb. 9AHR, 9XT, and 9RB.
- Topeka, Kans., 9QV and 9JW.
- Lawrence, Kans. 9XP and 9LQ.
- Kansas City, Mo. 9XK, 9LO, 9EP, 9MQ
- Cape Girardeau, Mo. 9NN.

We would be pleased to hear from anyone who can fill in the places marked (?).

Seefred Brothers, Trunk Line Mgrs.,
343 So. Fremont Ave.,
Los Angeles, Cal.

REPORT OF ROUTES "A" AND "E"

R. H. G. Mathews, Manager.

A letter of instructions has been sent to all Trunk Line stations giving detailed information as to the form, time of transmission, etc., of test messages. Operators of Trunk Line Stations who have not received these letters should communicate with the District Manager of Routes A and E immediately.

An extension has been added to Route A west; the line now reads:

- R. H. G. Mathews, Chicago, Ill. 9IK.
- F. W. Keeler, Superior, Wis. 9BD.
- University of North Dakota, Fargo, N. D. 9XN.

- A. C. Campbell, Lewiston, Mont. 7ZC.
- E. Dawes, Bozeman, Mont. 7ZD.
- O. M. Heacock, LaGrande, Ore. 7ZH.
- Lacey, Wash. 7YS.

Branch routes have been extended, according to the plan outlined in the September QST to the following cities:

BRANCH 1

- R. H. G. Mathews, Chicago, Ill. 9IK.
- H. C. Boardman, Kenosha, Wis. 9BK.
- C. Bates, Milwaukee, Wis. 9AOL.

BRANCH 2

- R. H. G. Mathews, Chicago, Ill. 9IK.
- R. Palmer, Lansing, Mich. 8ACD.
- , Saginaw, Mich. 8AAK.
- ?? Detroit, Mich.

BRANCH 3

- R. H. G. Mathews, Chicago, Ill. 9IK.
- L. J. Simms, Elgin, Ill. 9EY.

BRANCH 4

- Mrs. Chas. Candler, St. Marys, O. 8NH
- , Indianapolis, Ind. (9GU, 9JI.)

BRANCH 5

- R. H. G. Mathews, Chicago, Ill. 9IK.
- P. West, Gary, Ind. 9AAB.

Other routes will be added as the Trunk Line operators succeed in organizing them. A route book containing these lines will be compiled and mailed to all stations on Trunk Lines A and E, as soon as a sufficient number of branch lines are created.

R. H. G. Mathews, District Manager,
1316 Carmen Ave.,
Chicago, Ill.



NOMENCLATURE

We amateurs are committed to no commercial or patent interests, thank Heaven, and consequently we are strictly neutral when it comes to the various quarrels with which the radio world seems well stocked. One of the things which annoys us, is the noticeable efforts to confuse nomenclature. In the early development of any art, we always pass through a period of confusion as to the names of the new things. When it came to the names to put upon some of the new things in radiotelegraphy, it was finally decided to appoint a committee and have them standardize names for things. This committee after months of hard work, made its report which has been accepted by the radio world, at least as far as this country is concerned.

Among the names we find, one which runs as follows:—"AUDION: By DeForest Radio Telephone & Telegraph Co. The Audion is a relay, operating by electrostatic control of currents flowing across a gaseous medium. In its present commercial form, it consists of three electrodes in an evacuated bulb, one of these electrodes being a heated metal filament, the second a grid-like electrode, and the third a metal plate; an input circuit connected to the filament and the grid; and an output

circuit connected to the filament and the plate, including a local source of energy and telephone receiver."

In view of this we are at a total loss to understand why some distinguished gentlemen whom we will not mention insist upon calling an Audion bulb a "Vacuum Valve Detector," a "Three Element Vacuum Valve," etc., etc. They cannot seem to bring themselves to use the word "Audion." We neutrals look on with some doubt as to our respect for those gentlemen who seem to take a pride in this sort of thing. We cannot help asking ourselves what the real bed rock reason is for this attitude. It smells to us of petty jealousy. We wonder what anybody hopes to gain by never calling an Audion an Audion.

We amateurs know the Fleming valve, and we know the DeForest Audion. Thousands of us depend exclusively for our receiving work upon the latter, and when a detector has three electrodes in an evacuated bulb, we recognize it as an Audion, and we seem to have the Standardization Committee of the Institute of Radio Engineers back of us. Let us not forget this when we read the many technical articles presented to us.

TEST MESSAGES

When this issue reaches its readers, the regular Monday and Thursday night test messages will have been begun by the various Trunk Line Managers. Everybody

who wants to amount to anything in the amateur fraternity, should get into this test. For a while to come, there will be unavoidable hitches and this will offer opportunities

galore for many who are not on the official Trunk Line lists, because when a message becomes stalled, the outsider oftentimes can lend a hand and overcome the difficulty. The test messages on Monday and Thursday nights originate at the station of the Trunk Line Manager, and are supposed to go out to the end of his Trunk Line and be repeated back. If for any reason, the message stalls, it is to be reported back where the stalling occurred, and the Trunk Line Manager is expected to investigate, and find a means

of preventing its recurrence. Amateurs, whether in the League or not, are invited to aid the good cause on Monday and Thursday nights if they can. Of course, every amateur who really has any pep in his system, ought to be a member of The American Radio Relay League, and read QST, but whether you are members and readers or not, we welcome you and your aid in establishing a Trunk Line radio relay throughout the length and breadth of this great country of ours.

UNDAMPED WAVE TRANSMITTERS

How are we going to get started on this undamped wave business? If an ordinary spark station decides to install undamped wave apparatus, he shuts himself off from those stations with whom he has been working, but who still have the regular spark system. The only way would seem to be for a lot of us to jump in at the same time. In another column, we show the new DeForest $\frac{1}{4}$ k. w. undamped transmitting set. We understand that these sets can be obtained at a very reasonable price. One of them gives an operator an opportunity to master the sending part of the problem at one stroke. The receiving is not so difficult to provide for.

From the letters we receive from the amateurs in various parts of the country, it looks as though many were giving the question careful study and making up their minds. Probably in the next sixty days a

lot of these fellows will crystalize on something and the next thing we know there will be a goodly number of stations able to work on undamped waves. We suggest that all of those who are located at vital points on our Trunk Lines, give this careful consideration. We also suggest that all of those preparing to use the undamped wave, notify either Mr. Hebert at Nutley, N. J., Mr. Mathews, at Chicago, or Seefred Bros. at Los Angeles, depending upon whose Trunk Line they were on. We expect to have a station operating on undamped waves here at Headquarters in the near future. We hope it will be the means of overcoming some of our geographical handicap from which we have suspected we have suffered for a long time. There have been times when we believed Hartford, Conn. was insulated from the rest of the solar system.

OUR QST

A great many of our readers in their letters will write "our QST." In the whole history of wireless, can anyone recall of a publication which succeeded in making their readers feel so completely at home? This has been the result of our amateur experience and the fact that we Editors are the same as we readers. Really, the readers are the Editors. Another thing which succeeded in making this our magazine was that it is the magazine of the amateur, by the amateur, and for the amateur. We do not think we are getting too chesty

when we say that QST came, saw and conquered.

We only wish to offer just a little criticism about the readers who rather halfheartedly say "our QST"—we want them to say **our QST**. The only difference being that they are a trifle doubtful so they hook on the two safety gaps. When you write to the Editor, never do this. It's your magazine and don't hesitate about saying so to us as well as the other fellow. May it ever be our QST.

THE PUBLISHERS

If any one will take the trouble to read the fine print at the bottom of the Table of Contents page, and compare it with the corresponding fine print in previous issues of QST, he will find a change. This change is more important than the size of the type indicates. It records the incorporation of a Company to publish QST.

The object in having QST published by The QST Publishing Company, Inc. instead of by Mr. Hiram Percy Maxim and Mr. Clarence D. Tuska personally, is to protect the two latter gentlemen from lawsuits which might inadvertently come to pass, and possibly cost the latter gentlemen more money than they would care to invest. If

it should come to pass that we printed something which hurt the feelings of somebody, and the latter were to bring suit for libel, the two gentlemen named would be personally responsible. If, on the other hand, this little unpleasantness should arise, and QST was published by a Corporation, the Corporation would be the one to be sued, and incidentally, go bust if it did not have the price. We have thought it good business and good taste to have the Corporation attend to the busting business, rather than the two gentlemen mentioned. Hence, the advent of The QST Publishing Co., Inc.

BOOSTERS

Not so long ago, the Editor had a letter from one of our readers who was visiting in a rather large western town. In it, there were a number of amateurs who had NEVER HEARD OF QST! Just think what a terrible calamity it would have been if you had not heard of QST. These other fellows were in the same unfortunate fix. They had never heard of our magazine.

This should teach each one of us a little lesson. We can write it in two words. Why not learn it now? Always remember and always practice it—BOOST QST. If some kindly spirit among our fellow amateurs

had only boosted in _____, Ill., think how much good could have been done. Of course you will join our new club. Be a Booster. When you meet a new amateur, ask him if he reads QST. If you talk with a new station, give him a chance to answer the same question. If you are a member of a Club find out from all the members what they think of our magazine. Then if you want to advance even higher in our society of Boosters, become a FELLOW BOOSTER. The Fellows go further than Boosting, they pin a subscription blank to their patient. Start your Boosting today.

PLATTSBURG AMATEURS

During the Junior encampment at Plattsburg, N. Y. in July, there were thirty-five hundred members from all over the United States. This included many radio amateurs, but Uncle Sam had sent all his wireless sets to the Mexican border, so we wireless "bugs" were unable to get together.

One morning on the march, the command was given to halt and we were allowed to rest by the roadside. Without

thinking, I picked up a piece of grass, put it between my thumbs and began to blow CQ and sign off. I stopped and was very much surprised to hear five fellows of our Company (H, of the Fourteenth Regiment) come back at me with tones varying from a sick automobile coil to a five hundred cycle quenched. We soon got together and frequently spent our evenings discussing radio.

(Signed) L. S. SOMERS, JR., 3AFE.

WHO'S WHO IN AMATEUR WIRELESS

We shall publish each month two pictures of amateurs who have become known by call letters. This will draw us all closer together. We are often curious as to just what the other fellow looks like, and here's our chance to see.—Editor



ROY C. BURR, 8ZI

Who's Who this month is pleased to introduce you to Roy C. Burr of Cleveland, Ohio. He is operator of 8RD and 8ZI. Mr. Burr is twenty-four years old and holds a commercial operator's license. For the last five years, he has been interested in wireless, but his station is not at present in operation. It is a variable power as many of you know and will be located within a short time at Cleveland. Mr. Burr was one of the first appointments for American Radio Relay League station and many of us have heard of his communicating 900 miles using three quarter Kw.



EMMA CANDLER, 8NH

Mrs. Candler says, "Good morning, friends, pleased to meet you." The subject of this sketch needs no other introduction than to say she lives at St. Mary's, Ohio, and operates 8NH. Among her most intimate wireless friends she is known as "O W" She is responsible for this title herself. Having noticed in the beginning of her wireless career that no amateur can get along for any length of time without his "OM" she concluded to make a joke of it since none of them knew at that time who was on the other end of the line. One day a certain amateur used OM rather too frequently so she told him, by the way of explanation, that she happened to be OW. Mrs. Candler says she is awfully sorry that she could not see the other fellow's expression, but at any rate,

he answered "Hi, hi, that's one on me."

She has been operating since January, 1915 and is a member of the A. R. R. L. taking a very active part in relay work. Fourteen months after hearing her first wireless signal, she succeeded in passing the examination for a First Grade Commercial License, but was not quite speedy enough in copying from the omnigraph so had to be content with a Second Grade.* To those who want to know what the other

fellow looks like, she says, "Subscribe to QST."

*Many applicants for examination have had this same unfortunate experience. While they can copy even twenty-five words from their sets, they cannot receive more than fifteen or eighteen from the omnigraph. This effect noticed by so many must be one which is due somewhat to the machine and partly nervousness. The secret is: Borrow an omnigraph and practice before taking the test.—Editor.

New Turney Instruments

The latest development in radio head sets is shown in the accompanying illustration of Eugene T. Turney's new radio head sets. Mr. Turney has been willing



to get out of the well-worn rut. The new features add greatly to convenience and comfort. On the top of the head set is a small screw which gives instantaneous adjustment of the pressure. The head band can be adjusted while the receivers are in position on the head. There are no ball and socket joints and it is said that there are no parts in which the hair can be caught.

The adjustment for size is made by lining the bushings which hold the connecting rods by a felt cloth. The cloth will not wear and leaves the receiver in any position by simply pressing them in place. The back check is a radical departure consisting of a flexible canvas strap also

held by a friction adjustment. The receivers are wound to 3,000 ohms and weigh but nine ounces.

The Turney variable condenser also indicates a new step in condensers. As shown in the illustration, it consists of two semi-circular cones, one within the other. The inner cone is accurately mounted and can be raised or lowered by turning the upper rubber knob. This varies the air space between the cones and changes the capacity. The movable cone is turned by the handle connecting the lower knob. A pointer indicates, as shown, on a graduated scale.

Seven different capacities are gained by varying the position of the movable cone with respect to the fixed electrode. The

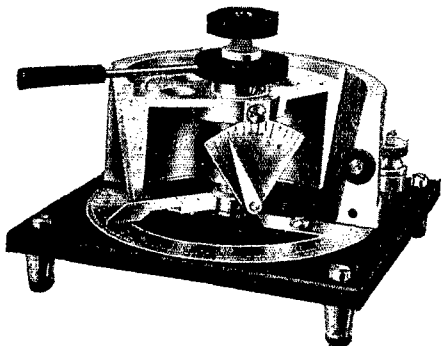

fan shaped scale indicates the several changes in capacity while the semi-circular indicator shows the variable capacity of each of the seven steps.

Radio Communications by the Amateurs

HAVE YOU EVER TRIED THIS?

Salt Lake City, Utah.

QST,

Hartford, Conn.

Dear Mr. Tuska:

Knowing that you yourself and QST are always interested in the welfare of our readers, I thought you and my other fellow amateurs might like to hear of some of my recent experiences.

Lieutenant Edwin Guthrie of the local Naval recruiting station called me up and informed me that in three days the Navy Safety First train would pull in. He also suggested that I was expected to be in direct communication with the Navy submarine set (NSF) which was installed on the train. You can imagine my dismay, because I had taken my panel transmitting outfit, as well as the receiving set, to pieces, just the day before. Some of the apparatus I had even sold. What was I to do? I was the only amateur in town having this special privilege, so I of course got busy right then. The newspapers came out to cover my glory ? ? !

That night I went downtown to purchase "a storage," photograph plates, tinfoil, oil, tin, "B" batteries, and everything else that a fully equipped five and ten cent store could supply. For the next few hours, I was kept out of mischief connecting apparatus and building a few spare instruments. When it came to the audion rheostat, I found I had sold it! ++ Dismay ++ Gloom ++ Idea !!! I ripped apart my old starting box, took out a coil, and thus made a "stat."

My next trouble was to make an oscillation transformer and a condenser. Which thing I did, after no less than six hours of "labor on the rock pile."—This is the life?

Well, finally I was ready for duty, but no amateur would recognize my set. In fact, reliable authorities believe it could be smuggled anywhere, without a Sherlock Holmes penetrating its disguise.

More hard luck. I started to communicate with the station—they got me like a steam engine. But I could not get them at all. So I kindly invented a whole lot of new cuss words and fables in slang. Once more the receiving connections were ripped apart. This was the fifth time, perhaps fourth, but no result in five hours. Up and down the tuner, from 50 to 200 meters. Still nothing doing. Then I tried the good old reliable, 600 meters. He was there.

"Then Heaven tries earth if it be in tune
And over softly her warm ear lays"

This is what I quoted to myself and then everything went well. For the benefit of those who would like to know something about the Navy sets, I will say it consists of the following: Close core, half Kw. transformer, condenser, quenched gap, with blower, oscillation transformers, loading inductance, switches, meters, etc. The receiving set: Mica diaphragm receivers, galena and silicon detectors, and two standard cabinets. It might interest the readers to know that I delivered an A. R. R. L. message from the Navy portable to Lieutenant Guthrie.

Yours sincerely,

(Sgd.) CEDRIC E. HART,
6SL

♦♦

MOTOR CAR SETS

Fullerton, Cal.

Mr. Clarence D. Tuska,
Hartford, Conn.

Dear Mr. Tuska:

I have been very much interested in the amateur wireless operators part of our

National Defense program. I was glad to see Mr. Felix's Communication on this article. His Communication covers the subject as we amateurs figure it out. I should like to add my opinion to his.

Our Editor also submitted some suggestions and the plan as a whole seems very feasible. It has already been narrowed down to the problem of a generator which could not readily be supplied by the amateur although he could supply all the rest of the equipment down to a suitable power supply.

For the sending equipment, the writer would recommend a large spark coil, together with suitable instruments to make up an efficient set and for the power he suggests that most of the modern automobiles have their own generating system which is a part of the car's equipment. This is used slowly for charging the storage batteries which in turn are used for the lights or starting the engine. The batteries can be kept charged continuously by carrying an extra set which can be on charge continually by keeping the motor running. When on storage, battery gets low from transmitting, it can be exchanged for the one on charge. This will give a pretty reliable source of current.

A spark coil can cover fifteen to twenty-five miles with an average antenna and the whole equipment would prove invaluable for National Defense. If we once start in the field, we shall have little trouble to maintain a number of equipments. Come on, let's get busy and experiment.

Respectfully,

6CR.

Editor's note: Mr. Potter has offered some valuable suggestions. Let us get together and have local radio clubs experiment, finding out what range they can cover and how efficiently. Someone in each club will have an automobile, and we can easily collect the rest of the apparatus. After the club has experimented, send in the data for publication and we can compare notes as to equipment, etc. Photographs will be exceptionally useful in helping out clubs who have not already attempted a portable transmitting outfit.

WORKING SOUTHERN AMATEURS DURING THE SUMMER

Mr. Godley, 2ZE, is an authority on long distance work. In one of his letters, he says: "It might be of interest to know that all summer long, I have been hearing Southern and Western amateurs. Atmospherics during the night, as a rule would make attempts to work these amateurs (assuming they were getting me) next to useless. During the morning hours, however, I am sure of distances from 250 to 300 miles easily possible. I have been able to read several amateurs at these distances without the slightest trouble. Last night, (August 17th) I listened to 8NH and 8AEZ calling each other. They did not get into communication due to static. The static was severe in this locality as well, but extreme loose coupling and the use of the regenerative audion accomplish wonders.

I have been able to establish satisfactory communication with Philadelphia and vicinity at night on only a few occasions, but in the daytime, barring extreme amateur interference, good communication is possible. This holds for both summer and winter conditions. The only Philadelphia stations with which it was possible to communicate use the same regenerative audion arrangement as is in use at 2ZE.

Yours very truly,

(Sgd) PAUL F. GODLEY.

♦♦

♦♦

THE A. R. R. L. IN CUBA

New York, N. Y.

Mr. C. D. Tuska,
American Radio Relay League,
Hartford, Conn.

My Dear Mr. Tuska:

I would like to call your attention to some work which one of the members of the Radio Relay League is undertaking for the benefit of the League and the amateurs in general. It is the first extension of the League to foreign countries—if this effort may be called such.

Mr. Amadee Saenz de Callahorra is erecting a half kilowatt station in Habana, Cuba. He had operated a station in this

city, and has done some high class receiving. In addition to receiving all the usual high power stations in Europe and America and the Pacific, he has operated low wave oscillating circuits. He has heard battleships communicating with stations on the Pacific coast in the daytime and has heard many notable amateur records. Of course, I have no details of this work, but it is of interest, as within a few weeks there will be a half kilowatt station in Habana in the hands of a competent and experienced operator, and when static clears up, perhaps some Ohio stations will be working Cuba!

Mr. Callahorra has been a pioneer in amateur work in Cuba, having operated a station in that country previous to his domicile in the United States, where he has resided for several years to complete his education. He has specialized in electrical engineering and his experience in this line should be of value in "hanging up" some new amateur records. He is expecting the co-operation of the Cuban authorities in the matter, and will in all probability be allowed to operate on a fairly high wave at certain hours.

For the present, atmospheric conditions are not favorable for communication but he writes that he will not wait for the "clear season" but will attempt transmission to southern stations of the Relay League. In this matter, he would value very highly any suggestion you have to make in this line, and particularly the names of high power amateurs in the southeast with good records. If you would care to write him in the matter, he would be appreciative, especially as his station should be in operation by September 15th, or sooner.

Most sincerely,
(Sgd.) EDGAR FELIX.



SOME PRAISE FOR QST

Franklinton, La.

American Radio Relay League,
Hartford, Conn.

Your, or rather our August issue of QST was such a good one that I cannot refrain from commenting on it. You note that I say our QST, well it is the only magazine that I have ever had that made anyone feel

that he was a part of it. It touches the wireless heart of us and makes us feel that we know each other. The fellow who wrote that "Rotten Stuff" has certainly been there, or else he could not tell the tale that is so true to us who have had the experience. Other articles are to be depended upon as we know they come from experimenters who have had the actual successful experiments. I do not see our states hear from very often, and I am very sorry that there are not more of us in the South who are taking the interest that you of the North are. However, there are a few of us down here making the fight and some day you will hear from us via Radio and know that we are on the map. You fellows at headquarters have a good nerve and determination and with continued co-operation, QST will be a live wire that we will be proud of. We think some very hard things about the Editors whenever QST seems to be a little late in coming out. Whenever we digest all that is in one issue, we are impatient for the next.

Yours very truly,

(Sgd.) P. E. GREENLAW.



OPERATING HOURS IN DALLAS, TEXAS

Mr. B. Emerson, 5DU, informs us that his operating hours have changed from 4:30 P. M. to 12 midnight. To call him before midnight would mean good energy wasted. However, his station will be open from 12:45 A. M. until there is nothing else doing.

The station of F. M. Corlett, 5ZC, will be open from dark to 11:15 or 11:30 P. M. at which time he has to close. This makes Dallas practically an all-night amateur city excepting a few minutes at midnight.

At present the indications are that 5ZC and 5DU will be the only two of the thirty-five of forty local stations which will be able to do any long distance transmitting. Mr. Emerson will be operating every Sunday evening besides the night hours as given above.

TELEPHONE INTERFERENCE

Scranton, Pa.

Editor of QST:

In my August QST, I noticed E. E. House, Battle Creek, Michigan, inquired about eliminating the noise in nearby telephone lines. I have had similar trouble and found that when operating the transmitting set, the telephone lightning arrester allowed a spark to occur between the telephone ground and line wires. In a few minutes, the lines would become grounded and put out all the phones in our neighborhood. The Telephone Company, after receiving complaints, informed me that I would have to dismantle my set, but I kept a good stiff upper lip, having made up my mind that it would take more than a phone company to put 8TY out of the field. They carried their investigations still further and finally decided to change their ground from the water pipe to the gas pipe. My set being grounded on the former. Although

the noise is not entirely eliminated, it is greatly reduced. I advise Mr. House to suggest this to the Company as it may be of some help.

I remain, extending my hearty wishes for QST's future success, respectfully,

(Sgd.) ROY C. EHRHARDT.

OBITUARY

Vincent St. James of Pittsfield, Mass., an A. R. R. L. member and wireless operator on the United States Torpedo Boat Destroyer Trippe was drowned in trying to save the life of Yoeman Plass. The burial was attended by representatives of the U. S. Army and Navy, as well as the National Guard and Spanish War Veterans. St. James was a brother of Robert St. James of Great Barrington, also an A. R. R. L. member.

Among the Radio Clubs**I. R. E. MEETING**

The first meeting of the Institute of Radio Engineers after the summer months was held Wednesday, September 6th, at 8:15 P. M. in the Engineering Society's Building, New York City. Two very interesting papers were presented by Mr. Leonard Fuller on "A Brief Technical Description of the New San Diego, Pearl Harbor, and Cabite High Power Naval Radio Stations" and "A Few Experiments with Ground Antennas." A paper containing much interesting and important data was also presented by Professor Charles A. Culver on "Notes on Radiation from Horizontal Antennas."

* *

ST. LOUIS RADIO ASSOCIATION

The St. Louis Radio Club started its 1916-17 season on August 10th, with its new quarters in the Engineers and Scientists Building. The club is given the use of the entire third floor, any member having the privilege of the quarters every night.

A different officer will be in charge each evening with a wireless policeman at the club set.

This club will have nearly every amateur in St. Louis as members. Schedules will be made out for operating hours in this part of the Country. Additions will be made to the present library and arrangements made for exchange of apparatus, as well as a code practicing class and a one Kw. set with damped and undamped receiving apparatus. The membership will be in the neighborhood of one hundred and the club would like to find out the ideas and practices of other associations through QST or by letter. Secretary Hadley Batterman, St. Louis Radio Association, Vandeventer and Olive Streets, St. Louis, Mo.

* *

NASSAU RADIO LEAGUE

On Friday evening, August 25 a meeting of radio amateurs of Freeport and Merrick was called by Thomas F. O'Brien and Sinclair Raynor at the headquarters, 8

Continued on Page 321

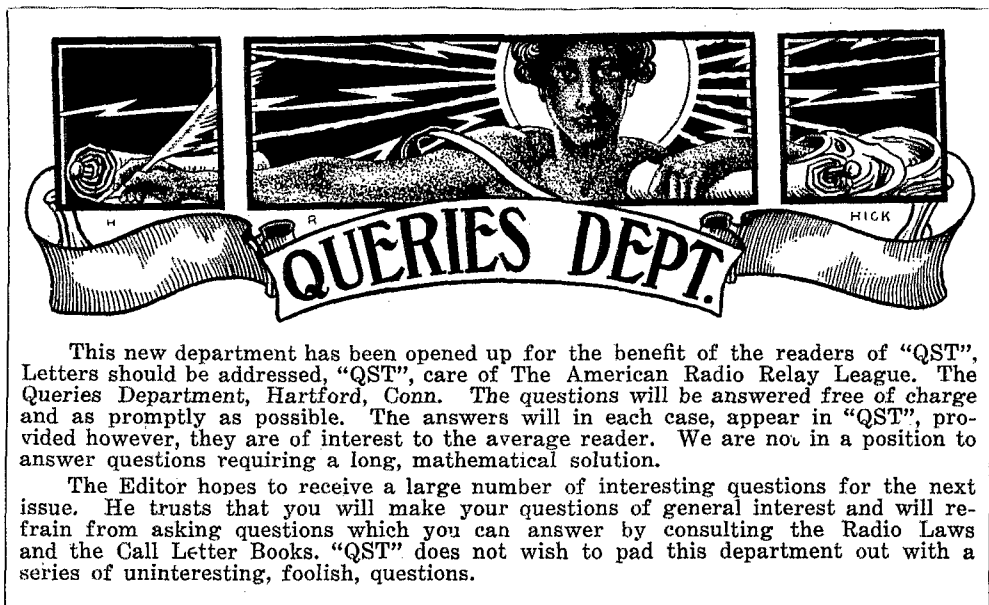

This new department has been opened up for the benefit of the readers of "QST". Letters should be addressed, "QST", care of The American Radio Relay League. The Queries Department, Hartford, Conn. The questions will be answered free of charge and as promptly as possible. The answers will in each case, appear in "QST", provided however, they are of interest to the average reader. We are not in a position to answer questions requiring a long, mathematical solution.

The Editor hopes to receive a large number of interesting questions for the next issue. He trusts that you will make your questions of general interest and will refrain from asking questions which you can answer by consulting the Radio Laws and the Call Letter Books. "QST" does not wish to pad this department out with a series of uninteresting, foolish, questions.

H. L. Hawke, Pa.

- 1—What do the first three figures in the Arlington weather report mean?

The first three figures are in the last three figures of the barometric pressure in inches. For example 998 indicates a barometric pressure of 29.98, or 001 a barometric pressure of 30.01 inches.

W. J. King, Louisiana.

- 1—Can a station be operated on 200 meters using an aerial of three wires 125 feet long, 90 feet high at one end and eighty feet high at the other end with a lead-in 95 feet long without using a series condenser, and if not what would be the wave length emitted using 8 turns in the open circuit.

You may approximate the fundamental wavelength of your antenna by multiplying the total length of your antenna from the apparatus to the end of the wire in meters by 4.7. It will be necessary to use a series condenser to operate on 200 meters.

- 2—Not knowing the electrical constants of your apparatus it is impossible to advise you concerning your second

question. We suggest you either purchase or construct a wavemeter for work of this sort.

Francis Blewer, N. Y.

- 1—Is the circuit given in the August issue of "QST" on page 200, Figure 17, suitable for the reception of 200 and 600 meter damped signals, and if so what amplification of signals would result?

Yes. Amplifications of from 40 to 50 times may easily be obtained.

- 2—What size should the coupler "M" be for those wave lengths?

The primary may consist of 50 turns 4" in diameter. The secondary may consist of 40 or 50 turns wound on a ball 3½" in diameter and so arranged the coupling is obtained by swinging the ball within the primary.

- 3—Would it not be preferable to use the circuit on page 192, Figure 3 in connection with a one-step amplifier rather than the one of Figure 17 without amplifier?

No. When the proper constants are obtained in Figure 17, the amplifications should excel those obtain-

able with the ordinary audion detector circuit of Figure 3, and a two-step amplifier.

- 4—How near can the natural wavelength of a coupler come to the received wavelength without any noticeable dead-end effect on 200 meters? Both above or below 200 meters?

If pains are taken to insure that the natural wavelength of the coils used is either 20% above or below the wavelength at which reception is being effected, no end-loss effects will occur.

John Cauffiel, Ohio.

- 1—Can electricity be created or destroyed?

Electricity can be generated and dissipated.

- 2—Which is best all around, a closed core or an open core transformer in regards to cost, range, efficiency, etc.

If properly designed the closed core transformer is better in all the respects you mention.

John J. Bueb, Conn.

- 1—Receiving transformers of the single layer type are preferable to those of the multilayer type for all ordinary work.

- 2—Your diagram Number 2, where you use the single loading coil is best.

Earl G. Simmons, Mass.

- 1—Are four sections of Murdock condenser sufficient capacity for a half kilowatt Blitzen transformer?

Yes. Use them in series multiple for 200 meters. Your sending range is probably about 25 miles.

W. J. King, La.

- 1—What is the latest and best way to incorporate an audion detector in a receiving set arranged so that either audion or mineral may be thrown into circuit?

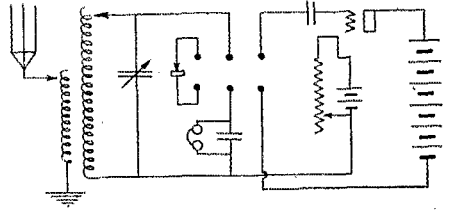

- 2—Does the relative position of the loose coupler, load coil, condensers, etc., have any effect upon the set through induction if they are mounted parallel to each other in a cabinet.

Yes. The inductances, leads, etc., of the different circuits should be kept well away from one another. See second paragraph, page 195, August "QST."

W. T. Gravely, Virginia.

- 1—What would be considered a good reading on a hot-wire ammeter for a half kilowatt transformer? (110 v. 4½ amps input meter in the ground lead.)

One and eight-tenths amperes would be considered good for an amateur installation.

- 2—If proper reading is not secured what would probably be the common causes?

Circuits out of resonance; secondary condenser leakage; poor ground connection.

- 3—Is there any way to stop the flickering of the lights in the house when the transmitter is being operated?

The flickering of the lights is due to the inability of supply lines to maintain the original voltage when a heavy intermittent load is thrown on them. The remedy is larger supply lines, or a larger step-down transformer in the supply lines.

- 4—What would prove an efficient choke coil for cutting down the speed of a rotary gap, and how constructed.

It is not practicable to attempt a reduction of speed if you have ref-

erence to an alternating current motor.

- 5—What size coupler is most efficient for 200 meter wave operation.

Primary: 4" dia. 40 turns, variable, variable condenser in series. Secondary: 3½" dia., 80 turns, 4 taps, shunted by variable condenser.

- 6—How far apart should the gaps of a rotary be set for best results.

They should be kept as close as possible, without touching.

- 7—What is the most efficient type of oscillation transformer?

The spiral type is probably the better.

George W. Mason, New York

- 1—Write to John K. Hewitt, Quail and Bradford Sts., Albany, New York.
- 2—Write to the DeForest Radio Telephone and Telegraph Co., 101 Park Ave., New York City.

William Foster, Ohio.

- 1—How may I connect a one-quarter and a one-half inch spark coil in series?

This would not be considered good practice. You may try connecting the primaries in series and the secondaries in multiple. One vibrator only should be used.

Paul J. McGee, Illinois.

- 1—Suggest you write the manufacturer of the transformer you have in mind.

F. S. White, Mass.

- 1—You do not state the input of your transformer. The capacity of the condenser which you describe is without doubt too great for 200 meter operation. It is however sufficient for your transformer. Immersion in oil, instead of parafine, and the placement of the plates in series multiple will aid in eliminating the sparking and brush discharge.
- 2—The rating of a transformer is usually based on the primary input.
- 3—The construction of a variable condenser for the transmitting circuit is

not practicable. An adjustable form of condenser meets all the requirements.

H. C. Seefred, California.

- 1—A disc 8" in diameter carrying 10 one-half inch copper studs evenly spaced will do nicely in use with a 1700 R. P. M. motor in conjunction with a Thordarson 1 Kw. transformer.
- 2—Two turns in the primary and five to eight turns in the secondary of your oscillation transformer will provide sufficient coupling for the proper transfer of energy to the antenna circuit. The spiral type of transformer is probably the better.
- 3—For 200 meter operation a capacity in excess of .005 MF should not be used, and even then the leads of the closed oscillatory circuit should be kept as short as possible.

Harry Weber, Ohio.

- 1—We have no data covering the transformers you mention. Any standard make transformer should suit your purpose, but we suggest you secure a closed core, magnetic leakage type. Write the Clapp-Eastham Company, Cambridge, Mass. and mention QST.
- 2—The average radiation using 1 Kw. on 450 meters, with a decrement of .2 or under is between 3 and 6 amperes depending upon the antenna and the frequency of the nonsynchronous type of gap you mention.

P. E. Greenlaw, Louisiana.

- 1—It is difficult to explain the apparent decrease in your radiation. Your ammeter may not be reliable, or your insulation may be leaky. Look everything over carefully and try again.

Malcolm Woodman, Paquaket, N. H.

- 1—Neither the hook-up on page 180 of the July issue or on page 211 of the August issue have especial merits. Substitution of a variometer for a condenser in the wing-circuit-to-ground connection of the former hook-up will

Additional Membership in A. R. R. L.

ARKANSAS			
Little Rock	J. S. McDonnell	3304 8th Ave.	5EA
CALIFORNIA			
Burbank	Gordon Farmer		6GF
Los Angeles	Seefred Bros.	343 So. Fremont Ave.	6EA
Redlands	Arthur Munzie	217 Tribune	6BV
San Diego	C. S. Lory	3839 7th St.	6LO
CONNECTICUT			
Windsor Locks	Herbert A. Holcomb	117 Spring St.	1ATY
FLORIDA			
Jacksonville	John C. Cooper, Jr.	326 Market St.	4EI
Tampa	V. C. McIlvaine	208 Verne St.	4CT
IDAHO			
Pocatello	Farrel Young	422 So. 2nd	7EY
ILLINOIS			
Winnetka	Kent T. Healy	849 Willow St.	9DY
LOUISIANA			
Franklinton	Paul E. Greenlaw		5BB
MAINE			
Bangor	George Curtis Barney	R. F. D. No. 7	1XK
MASSACHUSETTS			
Reading	Albert O. Parmelee	155 Main St.	1SH
MICHIGAN			
Grosse Pointe	David G. Carter	Rathbone Place	8WR
Lansing	Maurice H. Pancost	R. F. D. No. 6	8OT
Saginaw	Walter Pardridge	3039 S. Washington Av.	8CS
MINNESOTA			
Duluth	James Hayes	220 West 4th St.	9UV
Duluth	William D. Wagner	123 W. Fourth St.	9GO
MISSOURI			
Maplewood	B. R. Lydick	7362 Hazel Ave.	9GJ
Maplewood	E. N. Levander	7363 Maple Blvd.	9GJ
NEW JERSEY			
New Brunswick	Nelson Dunham	103 South First Ave.	2ALI
Town of Union	Richard Frank	408 Main St.	2AME
NORTH CAROLINA			
Winston Salem	William S. Rothrock	517 Ridge Ave.	4DI
OHIO			
Akron	Marion Hulderman	1050 Pitkin Ave.	MH
Canal Dover	Harry S. Weber	1113 No. Walnut St.	8ZX
Tippecanoe City	Raymond Smith	Box 194	8KL
PENNSYLVANIA			
Brookville	Clarence W. Wickes		8YW
Philadelphia	Percy Wyle Moor	6119 Ridge Ave.	3GG
Pittsburgh	Doubleday-Hill Electric Co.,	719 Liberty Ave.	
TEXAS			
Houston	James L. Autry, Jr.	5 Courtlandt Place	5ED
UTAH			
Salt Lake City	Clifton G. Guiver	170 First St.	YWM
Salt Lake City	Cedric E. Hart	718 Sixth Ave.	6SL
WISCONSIN			
Wauwatosa	Gilbert and Martin Hartmann, 210 State St.		9ADT

The Contest Scores

CONTEST SCORES

Large Gain in Number of Contestants

Contest Dept., Hartford, Conn., September 18th.—This morning's mail indicates a big jump in the number of QST subscription contest entries. The contest is progressing nicely and a large number of subscribers is predicted. It is still too early to prophesy much, but we do not hesitate in saying that the hard workers will win the prizes.

If you have not already entered and want to get a prize, send your name today. By steady work and plenty of "pep" you can come up to the leaders, but they will make you hustle to keep with them.

To the leaders, we would suggest: Don't let any grass grow under your feet. The latest entries will be pushing you hard in another week and you ought to store up a few credits for the rush. Your places aren't secure by any means. Get in the game and GET SUBSCRIPTIONS. KEEP AT IT IN YOUR SPARE TIME.

Let's all get together and make this first QST contest a great success. It means as much to you as to us. The prizes are first-class and worth a lot of hard work. START TODAY; MAKE UP YOUR MIND TO LAND EVERY POSSIBLE SUBSCRIBER.

Contest Manager.

CONTEST SCORES

Carl Linxweiler, Dayton, Ohio	84	Elmer Miller, Los Angeles, Calif.	0
H. R. Hick, Rocky Hill, Conn.	72	Herbert Fiedler, Chicago, Ill.	0
Gilbert L. Hartmann, Wauwatosa, Wis.	72	Gilbert R. Payson, Jr., Boston, Mass.	0
Charles Shanks, Maplewood, Mo.	64	S. Kruse, Lawrence, Kansas	0
Albert O. Parmelee, Reading, Mass.	54	Howard W. Eaton, Winter Hill, Mass.	0
Charles A. Service, Jr., Bala, Pa.	48	E. R. Schowalter, Haven, Kansas....	0
Hodge Alexander, Grove City, Pa.	45	George W. Bonson, Dubuque, Ia.....	0
Phil. H. Betts, Montclair, N. J.	27	Stephen H. Besley, Salt Lake City,	
C. R. Pardridge, Saginaw, Mich.	21	Utah	0
Maurice L. Muhleman, New York, N.		E. C. Wiendieck, Merrick, N. Y.	0
Y.	15	Herbert F. Corson, Newark, N. J.....	0
Harry B. Tyler, Old Orchard, Me.	12	Norman Chilton, Westfield, N. J.....	0
William S. Louchheim, Jenkintown,		John G. Schroll, Oak Park, Ill.	0
Pa.	12	R. N. Kingsbury, Ravenna, Ohio	0
Alvin C. Spencer, Magnolia, Ill.	12	John F. Teunisson, New Orleans, La.	0
John Nightingale, Paterson, N. J.	12	R. B. Parker, Hartford, Conn.	0
V. C. McIlvaine, Tampa, Fla.	12	Ferdinand F. Humphreys, New York,	
Paul J. McGee, Mattoon, Ill.	9	N. Y.	0
Robert Cushman, Brattleboro, Vt.	5	George W. Lillenthal, New York, N.	
Robert Hall, St. Paul, Minn.	4	Y.	0
Albert Bousquet, So. Braintree, Mass... ..	0	Robert B. Watt, Stapleton, N. Y.	0
Adolph Stein, Jenkintown, Pa.	0	Albert McKinley, Marion, Ohio	0
Valentine Harrington, Milton, Mass....	0	Earl Swain, Indianapolis, Ind.	0
William F. Justus, Columbus, Ohio....	0	G. F. Tompkins, New York, N. Y.	0
William A. Thompson, Roland Park,		Fred Coldevey, Cincinnati, Ohio	0
Md.	0	Arthur C. Young, Buffalo, N. Y.	0
Arthur Bragg, Evanston, Ill.	0	William Macke, New Orleans, La.	0
William Blum, Atlantic City, N. J.....	0	Ellis C. Pattee, Beaumont, Texas	0
Ralph E. Kepler, Dayton, Ohio	0	B. S. Coler Southern, Brooklyn, N. Y... ..	0
Harold H. Lewis, Lewiston, Idaho	0	Jay Stone Woodruff, Elmhurst, L. I.	0
Ashley Williams, Lincoln, Neb.	0	Elwood Squires, Berkeley, Calif.	0

Q S T SUBSCRIPTION CONTEST

Many of the most promising amateurs are held back for the want of money to buy first class apparatus. We have worked out a plan for helping these fellows. We have arranged for twenty different pieces of the latest wireless equipment and all of it is to be distributed among those amateurs who are willing to put in a little work for QST.

The one who sends in the most subscriptions to QST before November 18, 1916, receives the first prize, a \$25 DeForest Audion Detector of the latest type.

The one who sends in the second highest number of subscriptions to QST receives a second prize, a pair of Brandes Navy Telephones.

The third, fourth and so on up to the twentieth, receives apparatus as stated in the list below.

The conditions governing the contest are simple. They are:—

1. You must send in your name and address, and we will send you a quantity of subscription blanks. Your subscriptions must be made out on these blanks, and sent in to Contest Department, American Radio Relay League, Hartford, Conn.
2. Any one interested in wireless is eligible.
3. *To be entitled to any of the first five prizes one must send in a minimum of 20 yearly subscriptions or their equivalent. To be entitled to any of the last 15 prizes one must send in a minimum of 10 yearly subscriptions or their equivalent.*
4. Weekly reports must be sent in beginning August 12th. The score will be printed in QST each month, so you can see how you stand with the other fellows.
5. Part time subscriptions are counted proportionately. For example, a full year subscription counts 12. Six months subscription counts 6, a three months counts 3. If you buy copies and sell them, they also count as one each.

Remember, the most unexpected people are interested in amateur wireless, and will gladly subscribe if you ask them. Your family doctor, sometimes is crazy to know about the extent to which wireless is practiced. We know one ourselves. The grown-ups are the best kind of material, because not only are they interested themselves, but their children might be made to take an interest from reading QST, and moreover, the grown-ups always have the cash.

THE AMERICAN RADIO RELAY LEAGUE, INC.

Subscription Contest Department.

PRIZES

Any one of these may become yours, if you are willing to do a little work in your spare time. QST subscriptions may be secured for the asking. Try and see.

FIRST PRIZE. VALUE, \$25.00 DeForest Audion Detector. Type RJ8 Licensed for Amateur or Private Use Only

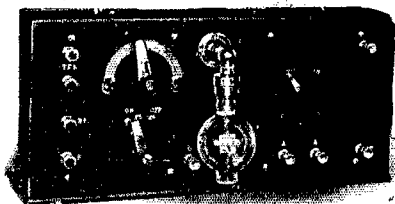

This NEW instrument excels every previous amateur type Audion Detector, thus placing it far above any other detector of any kind ever manufactured. It is provided with a POTENTIOMETER CONTROL for the "B" battery potential by means of a SPECIAL potentiometer designed especially for the Audion, thereby giving a closer regulation than ever before possible, resulting in greater efficiency and more service from the instrument and renewal bulbs.

The Type RJ8 Audion Detector has a hard rubber panel on which all the controls and potentiometer are mounted. The panel is set into a well finished oak cabinet measuring 13 $\frac{1}{4}$ inches long by 6 $\frac{1}{4}$ inches high by 3 inches deep. All of the metal parts are heavily nickel plated. The switch is of our well-known four-ply construction. It cuts the "B" BATTERY off from the potentiometer when the bulb is turned "off" preventing this battery from discharging slowly through the potentiometer. The rheostat for regulating the intensity of the filament is on the rear of the panel and controlled by the "OUT" and "IN" bulb. If the operator desires to incorporate this detector in a receiving cabinet, this can readily be done by removing the panel without disturbing any of the interior parts.

SECOND PRIZE. VALUE, \$14.00 Brandes Navy Type Receivers

This type possesses a peculiar, soft, clear tone—a great advantage for long distance reading. It possesses both extreme lightness and rigid construction. The case is made of hard drawn aluminum, through which the advantages of absolute permanency, lightness and handsome appearance are gained. The ear caps are of hard rubber and, instead of having one large hole in the center, are perforated by many small holes. This is done in order to protect the diaphragm from being damaged should the receivers be accidentally laid on some protruding object.

The wire used in the windings is of the best quality, pure enameled copper, .002 inch in diameter, covered with pure, uncolored silk. The receivers are wound to the fixed number of turns required for best results, giving an approximate resistance of 3,200 ohms to the set.

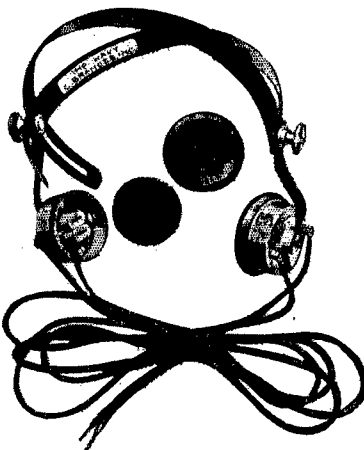

THIRD PRIZE. VALUE, \$14.00
DeForest Audion Detector Type RJ9

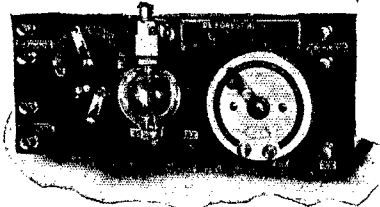

Licensed for Amateur or Private Use Only
 This NEW panel type instrument is the lowest priced Audion Detector. All the controls are mounted on the front of the mahogany panel, which measures 5 by 13 inches.

The control for the "B" battery is a POTENTIOMETER CONTROL giving very close regulation of the "B" battery potential. The switch controlling the filament brilliancy automatically cuts the "B" battery off from the potentiometer when the filament is turned off."

The Type RJ9 Audion Detector is provided with brackets so that it can be screwed to a table. If the operator desires to incorporate it in a receiving cabinet, this can be done readily without disturbing the wiring and parts. The metal parts of this detector are of lacquered brass.

FOURTH PRIZE. VALUE, \$10.00
A Rotary Quenched Gap

This gap is an instrument which will be a valuable addition to any station. It is a special piece of apparatus which was designed by the Technical Editor. Several were made and gave wonderful results. It is completely enclosed in a bronze casting; this eliminates the noisy spark and at the same time it is built for rapid quenching. It is similar to the gap described in the July QST. There are twelve fixed and twelve moving electrodes. Only needs a motor. The motor is not given with it.

FIFTH PRIZE. VALUE, \$10.00
Brandes Transatlantic, 2,800 ohms

These Brandes' would prove a nice addition to your set; either as an extra pair or as an improvement over your present phones. They are all that is claimed.

The receivers are a trifle larger than the Navy type. Are very sensitive and have the same soft, clear tone that facilitates the reading of long distance signals.

Transatlantic receivers are fitted with diaphragms .006 inch thick, tin plated. The caps are of hard rubber and shaped in such a manner that they fit very closely and feel quite comfortable to the ears. They are wound with silk insulated, pure copper wire .002 inch in diameter, to the required number of turns for the best results; the resistance being approximately 2,800 ohms to the set.



PRIZES 6 TO 15. VALUE, \$5.50 EACH
DeForest Tubular Audion Bulbs

These bulbs are so useful and popular that we are offering ten. This gives you plenty of chance to get one. Show a little pep; it's worth it.

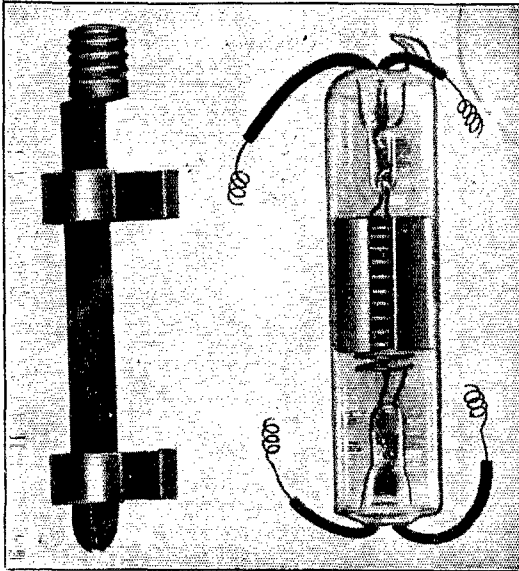

The Audion Detector is the most sensitive detector in existence. The Bulletin of the U. S. Bureau of Standards, Vol. 6, No. 4, Page 540, states that it is fully 50 per cent. more sensitive than any other known form of detector. It is the only reliable sensitive detector.

For the benefit of those amateurs who desire to experiment, and do not wish to buy complete Audion Detectors with the necessary accessories, and for those whose limited means will not permit the complete instruments to be purchased, we have brought out the Type T Tubular Audion Bulb.

Commencing March 15th, 1916, this type of Audion will be sold separately, without the other parts necessary for a complete Audion Detector. It is licensed for amateur use only and is NOT interchangeable with the regular round Audion Bulbs.

This type of Audion Bulb gives very loud response to signals. Every bulb passes two tests by our experts and is thoroughly up to our standard of sensitive qualities. It is finished in only one grade—the best.

The life of the Type T. Tubular Bulb is exceptionally long on account of the fact that the single straightline filament has no loops, and as there is no second filament, the Edison discharge to same is completely eliminated.

The plate or wing is in contact with the glass, preventing overheating. The filament is surrounded by a spiral grid.

This type of bulb is an excellent oscillator for the reception of continuous waves, being different in this respect than round Audion Detector Bulbs.

The grid is the spiral inside the tube and is connected to the green covered wire. The plate is connected to the red covered wire. The filament terminals are the white covered wires.

PRIZES 16, 17 AND 18. VALUE. \$5.50
Brandes Superior Phones

How often have you had visitors in your station and only one pair of telephones? It's inconvenient to say the least. You really should have an extra pair for your friends and this is the chance to get them.

Continued on following page



These receivers are without doubt among the best that can be bought on the market today for very little money. The case is made of aluminum, insuring rigid construction and lightness. All the interior parts are nickel plated and polished giving them a handsome appearance. The bobbins are wound with No. 40 pure copper enameled wire to the proper number of turns which register a resistance of one thousand ohms per receiver. The diaphragms are .006 thick, tin plated, and the receivers are fitted with hard rubber caps. None of the material is substituted by a cheaper grade such as, for instance in the cap and diaphragm which could be easily made of much less suitable materials and considerable money saved in the manufacture of these receivers. There is no question that these receivers are very substantially built and will do wonderful work for receivers sold at this price. In fact, we have reports from people who claim that they are better than receivers which cost as much as eight dollars per set.

PRIZES 19 AND 20. VALUE, \$3.50

Crystaloi Detector

Do you need a stand by detector? Here is a reliable one which is a prize well worth owning.

Start after it today!

The Crystaloi is a radical departure from any of the well-known types of detectors which depend on a metallic point in contact with an extremely minute portion of a sensitive mineral, which is subject to burn-outs, going dead, and the disadvantage of having to hunt around on the surface of the mineral for a sensitive point.

The principle of the Crystaloi is exactly opposite from that of any other detector, inasmuch as instead of a fine point of metal coming in contact with a minute portion of a sensitive mineral, the Crystaloi is constructed in such a way that a comparatively large surface of a very sensitive mineral is brought in contact with a great many points of a very light, finely divided alloy which becomes a conductor only when traversed by high-frequency oscillations. This arrangement renders the receiving apparatus remarkably free from static and other interferences, and is wonderfully sensitive.

It is only necessary to put the Crystaloi in circuit with a buzzer and while holding the key down, rotate the cylinder until the signals are loudest in the ear phones, at which time you are ready to receive anything that is in the air. The Crystaloi requires no battery or potentiometer and is ever ready to serve you under all conditions.

The Crystaloi is wonderfully sensitive, owing to the fact that the alloy is very light in weight and makes a very delicate contact.

Every Crystaloi detector is actually tested by putting it in service at our station and is guaranteed to do exactly what we claim for it or we will take it back and refund your money.



FOR SALE & EXCHANGE



WILL EXCHANGE—A new Murdock \$4.00 condenser .001 mfd. for a Blitzen unmounted condenser, for No. 366 Murdock. I want two condensers alike. I have for sale, \$15.00. Clapp-Eastham improved loose coupler in perfect condition. First \$9.00 takes it. W. J. King, Laurel Hill, La.

FOR SALE—Brandes phones, \$3.00; 12 ft. No. 7 brass wire, \$.45; two oscillation transformers, 1 Kw., \$2.00; one-half Kw., \$1.00; One-half Kw. gap, \$1.50; Navy type, 4,000 meter, \$12.00. Cedric E. Hart, 718 Sixth Ave., Salt Lake City, Utah.

FOR SALE—Complete rotary quenched spark transmitting set of one-half Kw. capacity; transformer, rotary quenched gap, variable speed motor, condenser, and oscillation transformer; also key. Complete, \$30.00. In perfect condition; a radiation of $4\frac{1}{2}$ amp. on 55 ft. antenna. R. S. Copp, 5 West Monument Ave, Dayton, Ohio.

FOR SALE OR EXCHANGE—1 audio motor, \$3.95; 1 pair 2000 ohm Holtzer-Cabbott phones, \$4.75; 1 pair \$7.50 Murdock 2000 ohm phones, \$4.95; 1 Tel-Radion, \$4.25, and one at \$1.79; a few new and burnt out audion bulbs, \$2.50 and \$6.45; 2 Electron Audio bulbs, new, \$.25; new Multo-Audi-Fone, \$13.95; $\frac{1}{2}$ Kw. mounted Packard, mounted; 1 K. W. Flexible transformer, new, \$21.00; 1 new set Hawkins' Guides, \$8.50; key; dynamo-motor Knapp; high speed motor and gap; Edelman's Experimental Wireless Stations, \$1.25; 2 copies Radio Stations of the World \$.24, each. Also have $\frac{1}{4}$ Kw. Blitzen, and \$15.00 Adams-Morgan Coupler, X-ray bulb, and Tesla coil. Want Mignon cabinet, Audio Tron cabinet, or

anything else in the radio line. Paul J. McGee, Mattoon, Ill.

FOR SALE OR EXCHANGE—One-quarter-inch spark coil in good condition; one silicon detector in excellent condition; one condenser. Will exchange 22 calibre rifle for galena detector stand in good condition. J. Richard Todd, Louisville, Ill.

FOR SALE OR EXCHANGE—Portable receiving set in leatherette carrying case, 7"x7"x16". Has gray fibre top and contains large variable condenser and variometer, two tuners, one having twenty silver plated taps, the other twelve. Telephone switch for tuning combinations of high, low, and standby waves. Buzzer test with pearl push buttons, six nickel plated binding posts with composition knobs for condenser and variometer shunts and aerial, ground, phones, and detector connections. Jove cat-whisker detector and pair Marconi Type 2000 ohm phones. Price \$20.00; without phones and detector, \$15.00. If interested send for photo and diagram. Want 1 K. W. transformer of reliable make—Blitzen preferred. Give full details and price in first letter. Duvall & Smith, 18 East Madison St., Baltimore, Md.

EXCHANGE— $\frac{1}{2}$ K. W. transformer coil in good condition and perfect working order for 3 tubular audions, oscilaudions, audiotrons, or pair of Brandes' transatlantics. Transformer coil good for 50 miles under ordinary conditions. The Washburn, 302 Orange Place, Plainfield, N. J.

WANTED— $\frac{1}{2}$ K. W. transmitter; Clapp-Eastham Hytone set; coupler. State age and condition, also lowest cash price. Os-

car Oehmer, 759 Franklin Ave., Brooklyn, N. Y.

FOR SALE—Chambers' loose coupler, new, \$3.50. John Miller, 33 Windsor Place, Brooklyn, N. Y.

FOR SALE OR EXCHANGE—High grade 4x5 Conley long focus plate camera, complete with tripod and three plate holders. Capable of doing highest class work. Cost a short time ago, \$20.00. Will sell for \$12.00 or exchange for a good second hand Multi-Audi-Fone, or Navy phones and variables. All communications answered. E. H. Hartnell, Salem, Wis.

WANTED—Amateurs to send their photos and 75c. I will make a cartoon of you operating your wireless set that will make a mule guffaw. Hang it in your station and give your friends a good laugh. Photo returned. Lloyd Manuel, 6 Nicol Terrace, Newport, R. I.

FOR SALE—Four sections of hollow wooden pole (same as used by U. S. Signal Corps) capable of being made into one mast, 26 feet, 8 inches long, complete with steel connecting tubes, top piece and guy plates. Purchased brand new from the inventor for \$15.00 and never been used. Will sell for \$8.00. Edwin L. Powell, 216 Spruce Ave., Takoma Park, Md.

FOR SALE OR EXCHANGE — Have a quantity of 5"x7" photograph plates which will sell for \$0.01 each. Also about twenty-five 8"x10" plates which will sell for \$0.02½ each or will exchange part or all for antenna switch or receiving apparatus. A. O. Parmelee, 155 Main St., Reading, Mass.

FOR SALE—Complete transmitting set. A1 condition. Packard ½ Kw. transformer—cost \$22.00 Rack copper plate condenser with bus-bar connections, oscillation transformer edgewise wound strip, bar type rotary fitted to Robbins-Myers motor, and heavy key. Hard rubber and fibre insulation throughout. Complete

\$38. Martin Jensen, 27 Grant Ave., Yonkers, N. Y.

FOR SALE—One Kw. Winger transformer, one sheet brass, glass plate, oil condenser, glass jar, oak frame, rubber terminals. One rotary gap, Barnes motor; one switch slate base, motor contacts; one heavy key, rubber base; one Helix, pancake type; one set Leyden jars, oak case. Chicago sale preferred. W. J. McGuffage, 5010 Vincennes Ave., Chicago, Ill.

FOR SALE—One Clapp-Eastham hot wire ammeter, 10 amps. practically new, \$8.50. O. G. Furman, 5528 Echo St., Los Angeles, Cal.

FOR SALE—Receiving set complete, including DeForest amplifier, PJ1, audion RJ5, improved Cheetham loose coupler, Murdock 2,000 ohm receivers. Murdock antenna switch, transmitting set—Packard ½ Kw. transformer, condenser, belt-driven rotary spark gap, oscillation transformer, practically brand new for \$50.00. If interested write for full description. Herbert L. Fowle, Reading, Mass.

I HAVE FOR EXCHANGE one RJ9 audion, one hinge type oscillation transformer, spark coil. Want Blitzen coupler or rotary spark gap. Also have a new three-quarter Kw. Thordarson for sale. Best offer over \$12.00 takes it. Will trade above transformer for a good Blitzen set. Want a few good detectors. George Trammell, Jr., 509 East First St., Rome, Ga.

FOR SALE OR EXCHANGE—Good 12,000 M. coupler Navy type, value \$10.00 Just the thing for WGG and WSL, etc. 2,500 M. double slide tuning coil, value \$1.25. Also have other instruments. What have you? Chester Ulsh, 451 Summit Street, Marion, Ohio.

WANTED—Would like to get a good ½ or 1 Kw. quenched gap. Will pay cash or else trade. Have a brand new "Halcum" rotary to exchange or for part payment on same. Would prefer a manu-

factured one. Cedric E. Hart, 718 Sixth Ave., Salt Lake City, Utah.

FOR SALE OR EXCHANGE—Panel receiving set, damped and undamped waves, Audion-Tron bulb, Holtzer Cabot head set, Mesco test buzzer, and two variable condensers. Maurice L. Muhleman, 622 West 137th St., New York, N. Y.

FOR SALE—Oscillating audion and amplifier with variometer and special hook-up. Also Murdock series condenser and other wireless apparatus. Arthur Haake, Bergen Co., Closter, N. J.

WANTED—Wave meter, amplifier coil, cash or exchange. H. B. Tyler, Box 622, Old Orchard, Me.

WANTED—Will buy or trade for a good typewriter. State wants or price in first letter. Cedric E. Hart, 718 Sixth Ave., Salt Lake City, Utah.

EXCHANGE—For an audion in good condition, a splendid half Kw. transformer worth \$20.00. Most popular make on the market. This is a chance for somebody as they are all advancing in price. Paul E. Nelson, 1012 So. 18th St., Fort Smith, Ark.

FOR SALE—As I am going away to college must sell my complete set of wireless apparatus. Every instrument in splendid condition. Transmitting set: Thordarson 1 Kw., kick-back preventer, 5 sections Murdock condenser, High-Tone Rotary, pancake style oscillation transformer, 15 amp. wireless key, antenna switch; cost over \$60.00, sell \$45.00. Receiving set: receiving transformer in polished quarter sawed oak cabinet, tunes to 4500 meters without loading coil, antenna wave length changing switch (for condenser), audion detector and amplifier, Brandes' Transatlantic phones, Multi-Audi-Fone variable condenser; cost over \$100.00, sell \$58.00. Also sell instruments separate. A. B. Church, Lamoni, Ia.

FOR SALE—Inch spark coil, \$4.00, gap, \$.50, key, \$.50, Tuner, \$2.00, relay, \$1.00, 75 ohm receiver \$.75. Albert E. Bousquet, So. Braintree, Mass.

FOR SALE—Mahogany cabinet receiving set, has Bakelite front, audion, variable, two couplers, phones and necessary equipment. Excellent receiver for both low and high waves. B. R. Lydick, Maplewood, Mo.

FOR SALE—\$15.00 Blitzen one-quarter Kw. transformer, price \$7.00; \$3.00 one-half Kw. antenna switch, price \$1.50. J. S. McDonnell, Jr., 3304 8th Ave., Little Rock, Ark.

Liars. Continued from page 293

around). Place him in the same room with the liars used in the foregoing experiment. **CAUTION!!** This experiment is somewhat dangerous. Just when the careful experimenter picks up the hammer, sieze his wrist.

Many other effects, quite as interesting and startling, can be obtained with liars, otherwise useless. These, however, are left to the originality and tact of the reader.

Among the Radio Clubs. Cont. from page 308

North Main Street, Freeport, L. I., N. Y.

The following officers were elected to hold office until September 1, 1917:

- President—Thomas F. O'Brien.
- Vice-President—Stephen Carpenter.
- Secretary—Holmes Swezey.
- Treasurer—John McCord.

The club affairs are in the hands of an executive committee, composed of the officers and three lay members, Clifton Weindek, Stanley Terry, and Wilbur Verity, with the President acting as chairman of the meetings.

- Chief Operator—Bertram T. Donnelly.
- 1st Ast. Operator—Sinclair Raynor.
- 2nd Ast. Operator—Herman Betz.

Business meetings are held the first Friday in each month. Code practice and lectures come the second, third and fourth Friday in each month.

The Tel-Radion Co., of New York presented the club with a Detector.

Correspondence requested. Address all communications to the Secretary, Club rooms and Wireless Station, 8 North Main St., Freeport, N. Y.

New DeForest Instruments

The accompanying illustration shows the new DeForest quarter Kw. Oscillation. The set is rather novel using a large audion bulb, the filament taking thirty volts while the high tension side requires 800 D. C. This voltage is obtained from a small

less telephony by the addition of a microphone transmitter, one or two dry batteries, and a telephone transformer.

The set is at present undergoing a test at the League Headquarters in Hartford and will be in operation on about a 600 meter wave. Any amateurs who hear 1ZM will please report giving data as to the strength of signals etc. An interesting feature about the equipment is that the rating is by watts put into the antenna and not primary input. This method should be

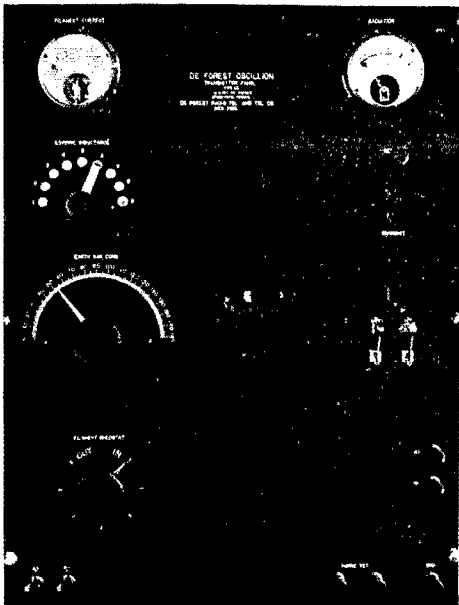
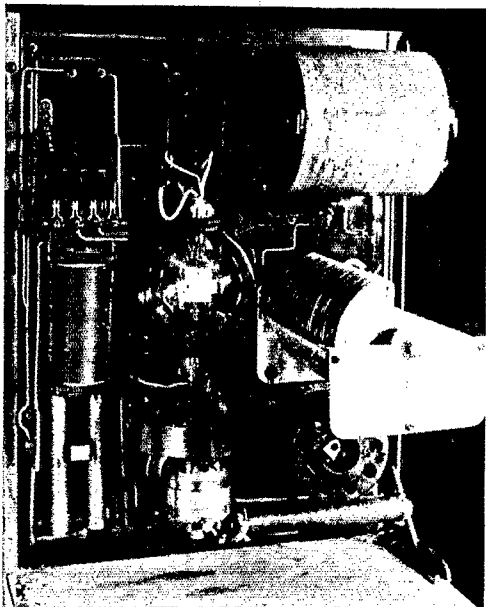

motor-generator. One meter gives the amperes used for illuminating the bulb and the other shows the antenna current. The resistance is controlled by the small knob on the lower left and can be used with up to 110 volts D. C. Above the rheostat control is the inductance and variable condenser. The antenna switch operates through a slot in the panel and just below this is a double pole, single throw switch, which operates a small fan for cooling the bulb. This set may also be used for wire-

used more generally as it means more than primary input. The DeForest Company are building these sets with the hope of introducing them to long distance relay work.

RADIO INSPECTOR GAWLER AT BORDER

Radio Inspector Gawler of the First District was a lieutenant of the Massachusetts Militia and is now with his Company on the Mexican Border. His two assistants were also members of the Militia and this

left the Radio office flat. The Department rushed a man from New York. We hope before long Mr. Gawler is back in the First District.

What's the Answer? Cont. from page 292

Wireless Telegraph Construction for Amateurs, by Alfred P. Morgan.

The Principles of Wireless Telegraphy, by Prof. Geo. W. Pierce.

Wireless Telegraphy and Telephony, a handbook of Formulae, Data and Information, by W. H. Eccles.

A textbook of Wireless Telegraphy, by Jonathan Zenneck. Translated by A. G. Seelig.

"Doc."

Queries Department. Cont. from page 311

be of no advantage. Suggest you try hook-ups shown in Figures 15 and 16, page 199 August issue.

Raymond Gerrard, Ky.

1—What kind of transmitting condenser shall I use with a one-half Kw. Thordarson transformer?

Use three Murdock sections, or you may construct a condenser by coating five 8"x10" photographic plates with sheets of tinfoil 6"x8" and immersing in oil.

2—What is the wavelength of my antenna: Single wire 150 feet in length, lead-in 80 feet, ground lead 6 feet? See answer to W. J. King above.

3—The night range of your set under the most favorable conditions might be several hundred miles depending on conditions. Your day range should be not less than 25 miles.

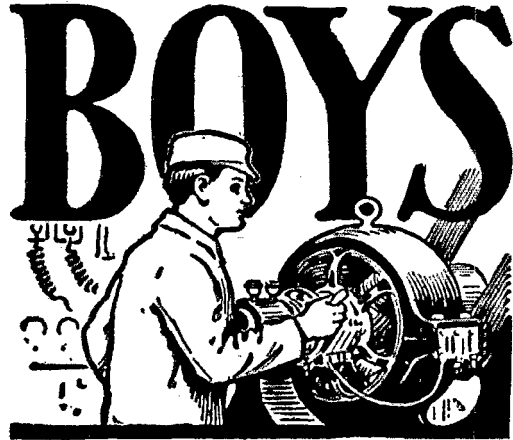

Big Money in Electricity

The electrical industries offer wonderful opportunities to boys with a liking for Electricity. The salaries paid to trained men are large, promotion comes rapidly and, best of all, the work is fascinating.

The discovery and development of new lines (such as wireless telegraphy and telephony), from time to time, promise attractive and paying fields to those who wish to specialize. The *will to do* and *Special Training* will bring success to you.

The International Correspondence Schools can help you to become an expert in electrical work, no matter what branch you like best. Thousands of young men have already won success through I. C. S. help. You can do as well as anybody, *if you try*. Everything is made so clear that you can learn in your spare time, regardless of where you live or what your work. No books to buy.

There's big money in Electricity. Get after it by marking and mailing the Coupon today. *Finding out costs you nothing.*



TEAR OUT HERE

INTERNATIONAL CORRESPONDENCE SCHOOLS
Box 6128, SCRANTON, PA.

Explain, without obligating me, how I can qualify for the position, or in the subject, before which I mark X.

<input type="checkbox"/> ELECTRICAL ENGINEER	<input type="checkbox"/> CHEMICAL ENGINEER
<input type="checkbox"/> Electrician	<input type="checkbox"/> SALESMANSHIP
<input type="checkbox"/> Electric Wiring	<input type="checkbox"/> ADVERTISING MAN
<input type="checkbox"/> Electric Lighting	<input type="checkbox"/> Window Trimmer
<input type="checkbox"/> Electric Car Running	<input type="checkbox"/> Show Card Writer
<input type="checkbox"/> Heavy Electric Traction	<input type="checkbox"/> Outdoor Sign Painter
<input type="checkbox"/> Electrical Draftsman	<input type="checkbox"/> RAILROADER
<input type="checkbox"/> Electric Machine Designer	<input type="checkbox"/> ILLUSTRATOR
<input type="checkbox"/> Telegraph Expert	<input type="checkbox"/> DESIGNER
<input type="checkbox"/> Practical Telephony	<input type="checkbox"/> BOOKKEEPER
<input type="checkbox"/> MECHANICAL ENGINEER	<input type="checkbox"/> Stenographer and Typist
<input type="checkbox"/> Mechanical Draftsman	<input type="checkbox"/> Cert. Public Accountant
<input type="checkbox"/> Machine Shop Practice	<input type="checkbox"/> Railway Accountant
<input type="checkbox"/> Gas Engineer	<input type="checkbox"/> Commercial Law
<input type="checkbox"/> CIVIL ENGINEER	<input type="checkbox"/> GOOD ENGLISH
<input type="checkbox"/> Surveying and Mapping	<input type="checkbox"/> Common School Subjects
<input type="checkbox"/> MINE FOREMAN OR ENGINEER	<input type="checkbox"/> CIVIL SERVICE
<input type="checkbox"/> Metallurgist or Prospector	<input type="checkbox"/> Railway Mail Clerk
<input type="checkbox"/> STATIONARY ENGINEER	<input type="checkbox"/> Textile Overseer or Supt.
<input type="checkbox"/> ARCHITECT	<input type="checkbox"/> AGRICULTURE
<input type="checkbox"/> Architectural Draftsman	<input type="checkbox"/> Spanish
<input type="checkbox"/> PLUMBING AND HEATING	<input type="checkbox"/> Navigator
<input type="checkbox"/> Sheet Metal Worker	<input type="checkbox"/> Foultry Raising
	<input type="checkbox"/> Automobiles
	<input type="checkbox"/> German
	<input type="checkbox"/> French
	<input type="checkbox"/> Italian

Name _____

Present Occupation _____

Street and No. _____

City _____ State _____

If name of Course you want is not in this list, write it below.

New Undamped Wave Coupler, No. 749

Special Introductory Price, \$18.00

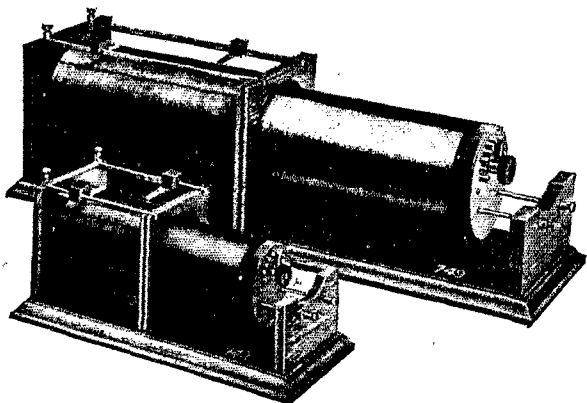

Our new Coupler No. 749 is 32 in. long, 9 in. wide and 10 in. high over all, and on the average sized antenna tunes up to 15,000 meters. This Coupler, used with the new CHAMBERS' SYSTEM OR CIRCUIT will bring in signals from domestic and foreign Aro Stations surprisingly loud and clear. Note the difference in size of our No. 748 and the new No. 749.

We claim to be the original inventors of a SYSTEM OR CIRCUIT, for the reception of the undamped waves without the use of Loading Coils or Oscillating Coils, as they are sometimes called; as with our system or circuit only two inductively coupled coils are necessary. Circuit supplied with each coupler.

This CHAMBERS' CIRCUIT saves you money. Think of it! No extra coils to pay for, and price of coupler only \$18.00.

Place order now so as to be in on the introductory price. Orders filled in rotation. Send for descriptive matter.

F. B. CHAMBERS & CO.

2046 Arch Street
Philadelphia, Pennsylvania

Announcing the DeForest Tubular Audion Bulb

"There is only one Audion—the De Forest"

The New Type T Tubular Audion Bulb gives very loud signals from powerful stations. It has a large cylindrical plate, a spiral grid and only one filament of tungsten. As this is a long straight-line filament, it has a long life. Edison effects are completely eliminated. The plate is in contact with the heavy glass tube, preventing overheating.

Sold Separately, \$5.50 each

The special adapter fits this type to the screw base receptacles of De Forest apparatus, and is furnished at 40 cents extra.

Send stamp for Bulletins D16 and B16

**The Wireless Mfg. Co.
Canton, Ohio**

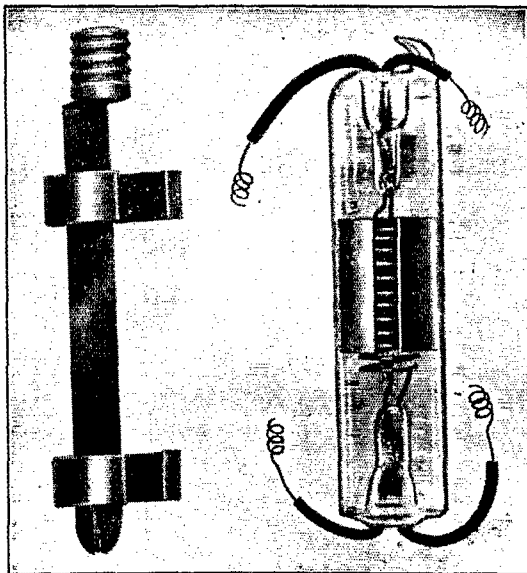

Always Mention "QST" When Writing to Advertisers

Feb. 22nd Relay Again. Cont. from p. 287

(Harvard Wireless Club), 2ZE (Leonia, N. J.), 9PC (Fort Wayne, Ind.), and 1CM (Laconia, N. H.) Greater distances were covered outside of the actual relay work, tests being made with 9LT and other amateurs in the West.

Not enough attention is paid by some members of the League to the preamble of a message. Some operators do not give the origin, date, or time filed, and sometimes not the check number. Simply;—hr.—nr.—1—To—M— etc. is not enough to properly file a message. The receiving operator must ask the sender for each item in the preamble. The reason for this may be due to absence of proper message forms or to lack of knowledge as to the proper method of making up a message. More expedient service would result were this point to be emphasized in club instructions.

(Sgd.) H. J. Murphy,

Florence, Mass.

Operator at 1ZL.

**RADIO CLUB OF AMERICA**

The Radio Club of America held its first meeting after the summer vacation on Friday evening, September 15, 1916, at 8:15 P. M., Columbia University, New York City.

Mr. Alfred H. Grebe presented a paper on "A Modern Experimental Radio Telegraph and Telephone Station". Mr. Grebe is well-known as one of the foremost experimenters in radio work and his station at Richmond Hill, Long Island is acknowledged to be as complete and well equipped as any of its kind in the United States. A detailed description of this station was given, together with considerable information as to construction costs and methods of improving the efficiency of the experimenter's station. The paper was plentifully illustrated by lantern slides. The paper appears elsewhere in QST.

The Board of Directors desires to announce that arrangement has been made

with The American Radio Relay League to publish each month in the QST magazine the paper presented at the previous meeting of The Radio Club of America. During the summer months articles contributed by members of the Club will be published, together with items of Club interest. Members of the Radio Club of America will receive a copy of the magazine each month.

**HAWKEYE RADIO ASSOCIATION NEWS**

The annual convention of the Hawkeye Radio Association, Iowa's state wireless organization, was held in the Masonic Hall at Des Moines, August 28th and 29th. Necessary changes in the constitution were made and plans for the season were discussed. The following officers were elected for the year 1916-17; President,—D. R. Lewis, Eldora, Ia.; Vice-president, and publicity manager,—H. K. Sels, Ames, Ia. Secretary-Treasurer,—J. W. Silcott, Brooklyn, Ia., Purchasing Agent,—A. B. Church, Lamoni, Ia. Relay Manager,—Ralph Batchelor, Ames, Ia.

The Association had a large wireless exhibit at the Iowa State Fair and Exposition and handled press for several newspapers. Through Mr. A. B. Church a very large display of modern transmitting and receiving apparatus was obtained from leading manufacturers. This made the exhibit a stopping place for many wireless enthusiasts. Undamped wave apparatus with a two step Multi-Audi-Fone made possible the reception of these signals considerable distance from the instruments. Thousands of people attended the exhibit.

**NOTE**

Mr. Clayton S. Hunt, R. R. No. 12, Urbana, Ill., has been appointed District Manager of the Central Radio Association for Illinois, in place of Mr. Lauron A. Kern, of Mattoon.

Has an Illustration of Your Station Appeared in QST ???

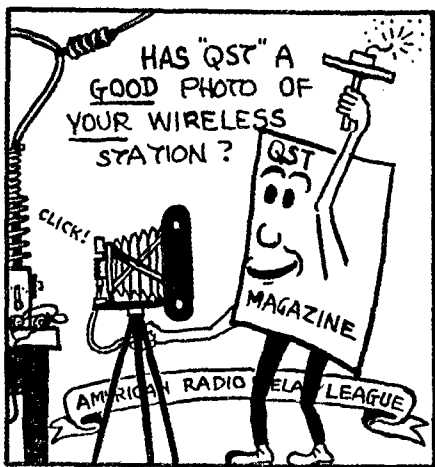

If it has, you are in luck. You can buy the half-tone and do what a great many amateurs have begun. The scheme is to print a photo on your stationery from the engraving. Then, when you write to a fellow-amateur, he can see just what your station looks like and all about it. It is a fine scheme and to help it we shall place on sale—for the owners—half-tons of stations which appear in QST.

These cost us from a minimum of \$1.25 up to \$2.50. We shall sell each one, regardless of size, for \$1.00. This gives you a chance to save some money and get in on a dandy idea. If your station has enjoyed the honor write today; just enclose a dollar, ask for your half-tone, and it will be sent post-paid by return mail.

ADDRESS: ILLUSTRATION DEPARTMENT

American Radio Relay League, Hartford, Connecticut

BRANDES RADIO HEADSETS

Superior Type, \$5.50



Made for Long Distance Reading

Send 4c in stamps for our new catalog "F"
of select wireless apparatus

C. BRANDES, Inc.

32 Union Square, Room 821
NEW YORK

We
Guarantee
First Grade
Commercial
Operators'
Licenses



The Largest,
Best Equip-
ped and ONLY
Practical
Radio School
in New
England

LEARN WIRELESS

"SEE THE WORLD AND GET PAID FOR
DOING IT."

ENDORSED BY GOVT. AND MARCONI OFFICIALS

Last year EVERY ONE of our graduates were placed in good positions; operating in all parts of the world, and still we are unable to fill the demand for them. We strongly urge you to join one of our Day or Evening classes if you wish to take advantage of the big demand for our Graduates. Send stamp for New Fall prospectus which contains detailed information and other useful data.

Eastern Radio Institute

899 E. Boylston St.

BOSTON - MASS.

Arnold Navy Type Loose Coupler Price, \$15.00

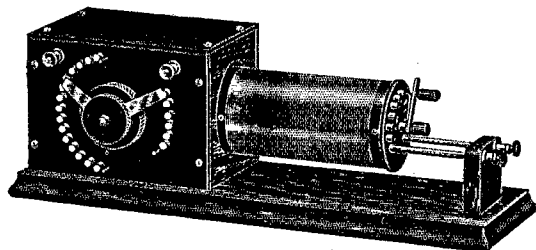

Perhaps you have noticed I specialize and this instrument is my specialty. One must excel when efforts are concentrated on a single instrument. These instruments are not and never were ground out in quantities and the personality of the maker lost. I make every instrument myself, test it and know just what enters into its construction.

With suitable inductance in conjunction with an Audion Detector, this instrument has proven very efficient for receiving undamped waves. This Hook-up will be furnished to prospective purchasers. I also carry the finest line of Switch Points, Rubber Knobs Cabinets and Accessories on the market.

PLEASE NOTE NEW ADDRESS

SEND 2c STAMP FOR BULLETIN No. 1

J. F. ARNOLD, 327 East 119th St., New York City

You don't know what Signals are until you have heard a Two Step M. A. F.

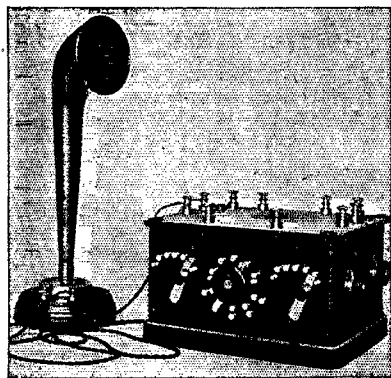

PRICE - \$75.00

SEND FOR NEW CIRCULAR

Multi-Audi-Fone	-	\$18.00
With Special Head Set	-	23.00
M. A. F. Detector Stand	-	4.25
M. A. F. Fixed Condenser		2.00
Pocket Wireless Receiving Set		5.74
Undamped Waver		45.00 and 100.00
Detector Fone		35.00

Multi - Audi - Fone

275 Morris Ave.

Elizabeth - N. J.

SWITCH POINTS and LATHE WORK for WIRELESS. Switch points made only of brass, highly polished, lacquered, and guaranteed to stay bright. Size 1-4 x 1-4 in, or smaller, \$.03 each. Prices for larger sizes on application. All switch points tapped for 4-36 machine screws which are furnished with the points.

Lathe work, bushings, loose coupler parts, rotary discs, etc. at moderate prices. WRITE FOR INFORMATION
EDW. M. SARGENT, 2235 Lake St. San Francisco

WANTED

Our QST needs helpers in every town. Become one of us. Write for "Agent's Proposition"

THE QST PUBLISHING CO., INC.
HARTFORD, CONN.

Always Mention "QST" When Writing to Advertisers

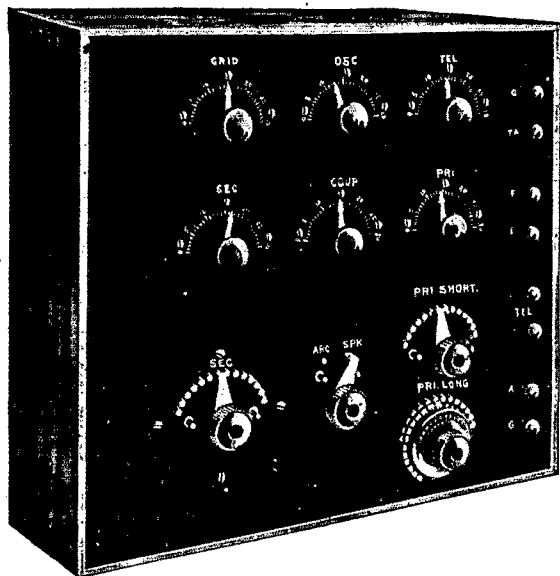

TYPE "ASA" RECEIVING SET

CLAPP-EASTHAM COMPANY
140 MAIN ST. - CAMBRIDGE, MASS.

Our New Catalog X

DISPLAYS IN ATTRACTIVE FORM MANY IMPROVEMENTS RECENTLY INCORPORATED IN A PRODUCT ALREADY REMARKABLE FOR ITS RELIABILITY DURING TEN YEARS OF SUCCESSFUL MANUFACTURE AND HONEST EFFORT TO GIVE PROMPT SERVICE, COURTEOUS TREATMENT AND APPARATUS WHICH WILL BE PERMANENTLY SERVICEABLE. CATALOG X OF RADIO APPARATUS AND GENERAL CATALOG OF ELECTRICAL APPARATUS AND PARTS WILL BE SENT UPON REQUEST FOR WHICH WE ASK THE COURTESY OF 6c. STAMPS TO COVER MAILING BOTH BOOKS.

GREBE RADIO APPARATUS

DESIGNED
BY EXPERTS
FOR THE
DISCRIMINATING
AMATEUR

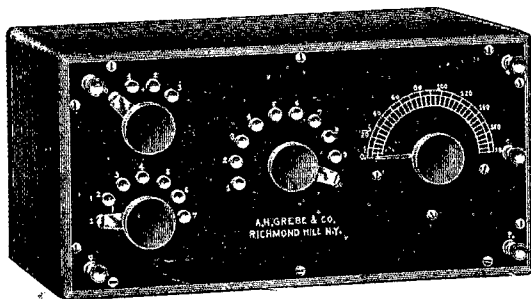

EFFICIENCY
SELECTIVITY
SIMPLICITY
SERVICE

SHORT WAVE REGENERATIVE RECEIVER. TYPE AGP 101

Our new type AGP 101 Short Wave Regenerative Receiver is specially designed for long distance relay work on wave lengths of 150 to 400 metres. It embodies all the latest PRACTICAL ideas in regenerative receiver construction which have proven most satisfactory in actual operation at our testing station. Designed primarily for short wave reception, this instrument will also operate very efficiently on wave lengths up to 1000 metres. A blueprint of connections and instructions for operating in conjunction with your audion equipment is supplied with each instrument.

SHORT WAVE REGENERATIVE RECEIVER, TYPE AGP 101, \$32.50

Send 2c Stamp for Catalog "R"

A. H. GREBE & CO. 10 Van Wyck Ave., Richmond Hill, N. Y.

Always Mention "QST" When Writing to Advertisers

Electricity

at your fingers' ends

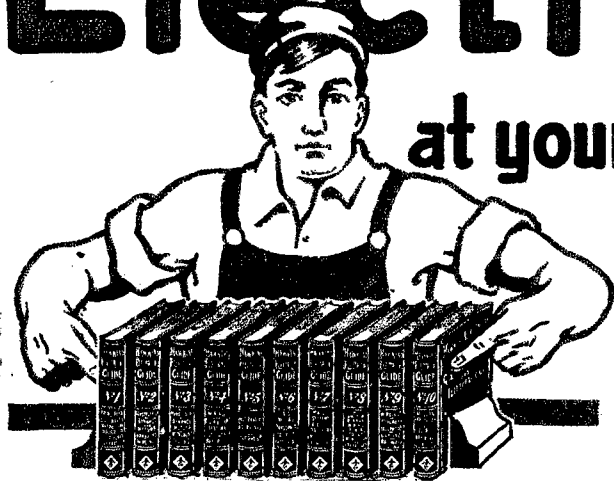

Know the *facts* in Electricity. They *count*—and mean more money and better position for you. You need the *exact* information, —in a practical form so that you can use it every day, to help you install electrical equipment, or make repairs, or operate machines, or do whatever else your present job —or the job ahead of you—calls for.

HAWKINS ELECTRICAL GUIDES

help you succeed through electricity

These books will answer every one of your electrical problems. They are written so that you can understand them. Arranged in the form of questions *you* would ask—and the answers to them—in plain, practical, everyday language, clear, concise and to the point. Thousands of men are using Hawkins Electrical Guides as a practical aid to greater success in the electrical field.

Read what users say:

"Every Electrician, Operating Engineer or Student who wants to advance himself in the Electrical field should have a set of these books." **JOHN KELLEY**, 116 Union St., Newark, Ohio.

"For the man not getting a college training, and even in that case, I can sincerely say I do not believe there is a better set of books on the market today." **LOYD D. HOFFMAN**, Dayton, Ohio.

"We consider Hawkins Electrical Guides the most compact and complete set of electrical references in the market." **NOGGLE ELECTRIC WORKS**, Monterey, Cal.

"I think they should be in the hands of everyone who has anything to do with Electricity." **T. E. MURPHY**, Orange, Va.

"For the practical electrician, they are the best books published—worth many times their price." **L. O. WAGNER**, Wyoming, Ill.

"I have gained valuable information from them which has helped me directly in my line of work." **HERMAN NODENBERG**, Hoboken, N. J.

"They are wonderful value. Everything is so clear and concise. Even one who had no knowledge of Electricity would have no difficulty in grasping the facts." **F. L. TAYLOR**, Amesbury, Mass.

"It is the best work an apprentice can study if he wants to get ahead in his trade. As a reference for the experienced worker Hawkins Electrical Guides are unexcelled." **I. MCLELLAN**, Chillicothe, Mo.

Specially Arranged for Home Study and Reference

They are bound in flexible covers that make them a pleasure to handle or have in your library. Size 5x6 1/4 inches and 3/4 to 1 inch thick. You can carry each separate volume about with you until you have mastered its contents. Hawkins Electrical Guides fit your pocket and your pocket book as well. Only \$1 per volume and owners of the set say there are no better electrical books at any price.

PARTIAL CONTENTS

Magnetism—Induction—Experiments—Dynamics—Electric Machinery—Motors—Armatures—Armature Windings—Installing of Dynamos—Electrical Instrument Testing—Practical Management of Dynamos and Motors—Distribution Systems—Wiring—Wiring Diagrams—Sign Flashers—Storage Batteries—Principles of Alternating Currents and Alternators—Alternating Current Motors—Transformers—Converters—Rectifiers—Alternating Current Systems—Switch Breakers—Measuring Instruments—Switch Boards—Wiring—Power Stations—Installing—Telephone—Telegraph—Wireless—Bell—Lighting—Railways. Also many Modern Practical Applications of Electricity and Ready Reference Index of the 10 numbers.

10 Practical Volumes—3500 Pages—4700 Illustrations

\$1 A Volume—\$1 A Month

These books are a complete and up-to-date course in Electrical Engineering—the standard works on Electrical Science. Contain no useless matter—only such information as is needed.

Shipped to You FREE

Send no money. Examine the books first. Decide for yourself that they are the most complete and clearest written electrical books ever published. Every book is complete in itself but the entire set is the best bargain. Accept this unusual offer now—mail the coupon today. If you decide to keep the books you can make settlement at only \$1 per month, until paid for.

Theo. Audel & Co.
72 Fifth Ave.
N. Y.

MAIL THIS FREE COUPON TODAY

Signature.....

Occupation.....

Business Address.....

Residence.....

Reference.....

Theo. Audel & Co.
72 5th Ave., N.Y.

Please submit me for examination Hawkins Electrical Guides (Price \$1 each). Ship at once, prepaid, the 10 numbers. If satisfactory I agree to send you \$1 within seven days and to further mail you \$1 each month until paid.

GST 9-16

ARE YOU PREPARED

for the long winter evenings? Now is the time to fit up your station. You will need some of our parts and raw materials. Better send for our **CATALOG E** at once.

SWITCH POINTS

No. 626—1-4 x 3-8 inches, tapped 6-32	Doz. 0.30	50 \$1.00	100 \$1.75
No. 627—1-4 x 1-4 " 1-2 in. shank threaded 6-32 "	.36	" 1.25	" 2.00
No. 628—" " " "tapped 6-32	.30	" .90	" 1.50

Prices are for plain brass finish. Nickered points furnished at 50 per cent. advance over above. Postage on 50 or less, 4c. On 100, postage on 1 lb



Maguire & Shotton

814 Lancaster Street

Albany - New York



"THERE'S MONEY IN IT"

AT HOME LEARN TELEGRAPHY AT HOME

MORSE AND WIRELESS



TEACH YOURSELF

in half usual time, at trifling cost, with the wonderful Automatic Transmitter, **THE OMNIGRAPH**, Sends unlimited Morse or Continental messages, at any speed, just as an expert operator would.

Adopted by U. S. Gov't. 4 Styles. Catalog Free

Omnigraph Mfg. Co. 35-39 Cortlandt St. New York



You May Learn Theory, Code and Laws of Radio Communication in Our School or at Your Home, fitting you for positions paying good salaries with wonderful chance to travel the world over. It's the most interesting profession known and the demand for skilled operators is increasing. Send stamp for catalog, which gives full information.

NATIONAL RADIO SCHOOL, 1405 U St. Washington, D. C.

EARN TELEGRAPH

Morse and Wireless—R. R. Accounting (Station Agency) taught. Splendid opportunities. Positions secured. Marconi Co. contracts to employ graduates. We own and exclusively occupy two large modern buildings equipped with R. R. and Western Union wires and complete K. W. Marconi Wireless Station. Largest school—established 42 years. Investment \$25,000. Endorsed by Railroad, Marconi and Western Union Officials. Expert practical teachers. Low living expenses; easily earned if desired. Tuition low. Easy payments. Correspondence courses also. Catalogs Free.

Dodge's Telegraph, Ry. & Wireless Institute
RADIO Street, Valparaiso, Ind.

Always Mention "Q S T" When Writing to Advertisers

Paragon Instruments Have Set New Standards

They are in a distinct class by themselves. There are no other instruments which can **EQUAL THEM IN ANY WAY**—regardless of price. **WE CAN PROVE THIS ASSERTION TO THE SATISFACTION OF ANYONE.**

It was designed especially and solely for reception of **AMATEUR WAVE LENGTHS** and its development has been carried on over a period of two years. It was the first and is the **only** worthy adaptation of the Armstrong circuit to short wave reception. The antenna inductance is arranged in steps. **ASIDE FROM THIS THERE ARE NO SWITCHES.** Continuously variable inductances—carefully designed variometers—are used in the closed circuits. **HIGH RESISTANCE CONTACTS,** the capacity of switch points and leads, end-turn losses and the necessity for a variable tuning capacity are thus **ENTIRELY DONE AWAY WITH.**

The antenna and closed circuits are **INDUCTIVELY COUPLED,** and the **COUPLING IS VARIABLE.** The com-

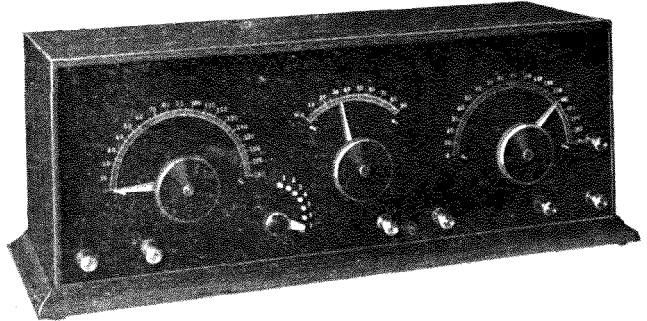

R. A.—6—PARAGON AMPLIFYING SHORT WAVE RECEIVER, \$35.00
Range 180 to 580 Meters

THIS INSTRUMENT IS SUPER-EFFICIENT, SUPER-SELECTIVE AND SUPER-SENSITIVE.

ponent parts of the instrument are not crowded into a small cabinet. The fact that **ALL** of these things are of extreme importance has been proven by the here-to-fore unheard of **SELECTIVELY** and **AMPLIFICATION** obtained by owners of this instrument. Signals may be read from stations at extreme distances or through heavy static and interference with this instrument **long** after other receivers have failed and **WEAK SIGNALS MAY BE AMPLIFIED UP TO ONE HUNDRED TIMES USING ONE AUDION ONLY.** We would be glad to furnish the names of prominent members of the American Radio Relay League who have offered unsolicited testimony as to the operation of the R. A.—6—, the amplification obtainable, and the distances covered both day and night.

UNQUESTIONABLY SUPERIOR TO ANYTHING ELSE ON THE MARKET

The methods employed in winding the coils eliminate leakage due to coloring matter in the insulation, put an end to the presence of moisture in the varnish, insulation and tube. The coils of the Paragon "No-End-Loss" transformers are divided into sections and fitted with **self cleaning, positive action** end turn switches which connect and disconnect the winding as required, **entirely cutting off from the circuit**

unused portions of the inductance and **completely eliminating end turn effects on all wave lengths.** These switches are enclosed and are automatically controlled by the primary and secondary inductance switches respectively.

Panels, housings, switch heads, etc., are of polished black **FORMICA,** which is superior in every way to hard rubber and costs more. All metal parts are of gold lacquered brass. These instruments are adapted to extremely close tuning and due to the absence end-losses are particularly recommended as the only receiving transformers on the market suited to the reception of amateur wave

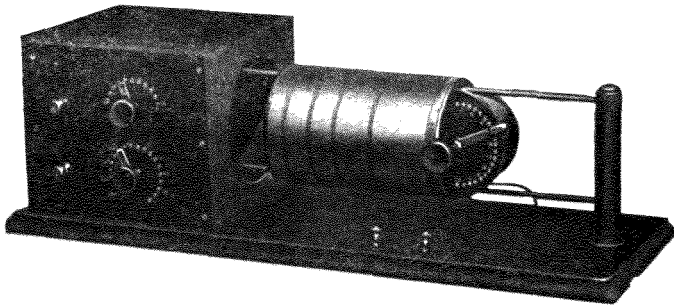

PARAGON RECEIVING TRANSFORMER

TYPE "L" \$22.50 TYPE "S" \$30.00 TYPE "X" \$35.00

lengths or for use in conjunction with the AUDION DETECTOR.

SEND STAMP TODAY FOR BULLETIN "O" WHICH DESCRIBES A VARIETY OF ENTIRELY NEW TRANSMITTING AND RECEIVING SPECIALTIES OF PARTICULAR INTEREST TO THOSE WHO DESIRE THE BEST.

SEND 6c. FOR OUR 232 pp. CATALOG

Our No. 7 Catalog shows several hundred different parts and also sets of materials for building your own apparatus. We do all the difficult work in our factory and give you the benefit of machinery and equipment

Contains complete description and prices of all the latest Wireless and Electrical Goods.

OUR PRICES WILL SAVE YOU MONEY AND OUR PROMPT DELIVERIES WILL SAVE YOU TIME.

THE BEST CATALOG OF ITS KIND IN AMERICA

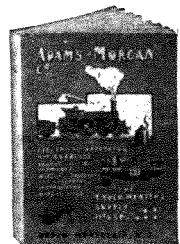

Adams-Morgan Co., Sixteen Alvin Place

Upper Montclair, N. J.

Always Mention "QST" When Writing to Advertisers

IT TELLS YOU HOW TO BUILD YOUR OWN APPARATUS

Everyday Mechanics

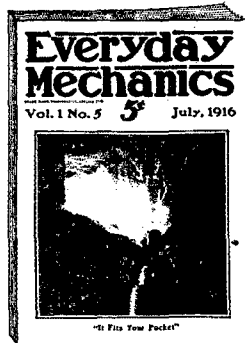

is the first and only magazine in the world devoted exclusively to constructional "how-to-make and how-to-do" material. It is edited by Thomas Stanley Curtis, whose articles and work you have known since the old days of **ELECTRICIAN AND MECHANIC**. It contains no war pictures, free write-ups of new devices, general news features. It is solidly and consistently filled, to the last of its ninety-six pages, with practical how-to-make and how-to-do articles.

EVERY FEATURE article that appears in the magazine is prepared from the data obtained in the actual construction and operation of the apparatus described. For every article, a model is constructed in the **EVERYDAY MECHANICS EXPERIMENT STATION**, Van Nest, N. Y., where it is given a practical working test. This means reliability and satisfaction.

EVERY NEW SCIENTIFIC discovery and achievement will be worked out in amateur form in the Experiment Station for the benefit of the readers of **EVERYDAY MECHANICS** in the future. A model showing the working principles will be described in detail in the magazine so that the serious experimenters of the country may strive to emulate the work done in the experiment station.

THIS MODEL SUBMARINE, CONTROLLED BY WIRELESS; has been described in past issues. The model is 5 ft. long; it is propelled by electric motor; it turns, dives, rises and fires a torpedo which explodes after leaving the boat, all at the will of the wireless operator on shore. Other models, just as ambitious, are in process of design. **OTHER FEATURES** have been the construction of high frequency apparatus to give gigantic sparks, trans-atlantic radio receiving apparatus, kicking coil apparatus, plant culture paraphernalia, and countless other articles that have delighted the hearts of the serious-minded experimenters of the country and have caused nearly 4000 of them to voluntarily write that **EVERYDAY MECHANICS** is the best practical magazine bar none, that has ever been published.

We want you to see and read **EVERYDAY MECHANICS** because we know you will need it and enjoy it. The subscription price is now 50 cents a year, but this is going to increase with the October issue to \$1.00. The news-stand price will then be 10 cents. A dollar bill pinned to the coupon brings you **EVERYDAY** for two years if sent **NOW**.

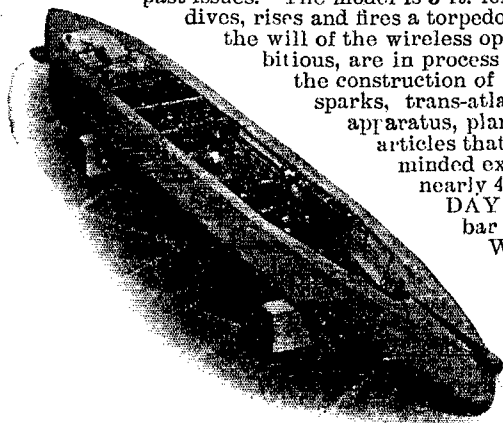

EVERYDAY MECHANICS CO., INC., 848 Aeolian Bldg., New York

Please book me for a subscription for **EVERYDAY MECHANICS** for _____

years, at fifty cents per year. I enclose \$ _____ to pay for same.

My Name is _____

My Address _____

Always Mention "Q S T" When Writing to Advertisers

"THERE IS ONLY ONE AUDION, THE DE FOREST"
DE FOREST ULTRAUDION DETECTOR
 FOR DAMPED AND UNDAMPED WAVES

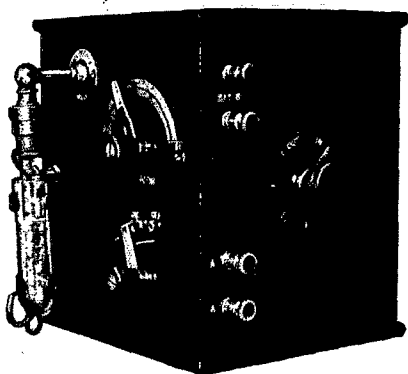

TYPE UJI
DeForest Ultraudion Detector
Price, \$27.50

The new DeForest Ultraudion Detector enables every operator to receive both spark and arc signals at minimum expense. This instrument is made for private or amateur use only, and is within the means of all. Heretofore the lowest priced genuine Ultraudion cost \$110.00.

We now offer the new amateur type at \$27.50. It is equipped with potentiometer control for the "B" or high voltage circuit, arranged for external batteries to be furnished by the purchaser, has an internal rheostat like our higher priced instruments, and is equipped with the genuine DeForest Tubular Audion with adapter.

No complicated circuits for tuning are necessary or desirable. Simply a regular tuner of proper size is used. No need of spending

money on large, expensive coils to receive Darien, Nauen, Eilvese and all the undamped stations.

The genuine DeForest Tubular Audion illustrated herewith is now within the means of all amateur operators. It is sold to anyone in any quantity without the return of the old one.

Fully 50 percent more sensitive than any other known form of detector and thoroughly reliable. Tests show an operating life of at least 800 burning hours when properly used, equal to at least a year's service.

With it the maximum receiving range can be covered. Suitable for receiving arc and spark signals and also for amplifying. Each equipped with a static shunt to prevent paralyzing from static and loud signals. Guaranteed to be delivered to you in perfect condition.

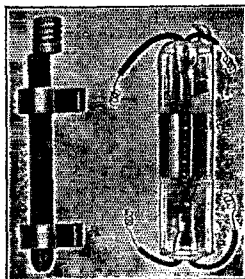

Genuine DeForest Tubular Audion
Price, \$5.50, delivered
Adapter, 40c extra

ACCEPT NO INFRINGING IMITATIONS.

INSIST ON THE GENUINE ARTICLE

Send stamp for Bulletins R16 on the Audion Detectors, Audion Receiving Sets
 the Tubular Audion and the Ultraudion

"WARNING—You are entitled to the genuine Audion, guaranteed by the owners of the Audion patents, when making an investment of this kind. Any evacuated detector having a filament, a grid and a plate, as well as other types, are covered by our patents, and several irresponsible infringers are being prosecuted. To be safe and get full value for your money, insist on the genuine DeForest Audion."

DeForest Radio
Telephone & Telegraph Company

101 PARK AVENUE

New York, N. Y.

Makers of the Highest Grade Receiving Equipment in the World

Always Mention "QST" When Writing to Advertisers



Price, \$7.50. Mailing Weight, 1 lb.

The New Turney Receivers

TAKE A GOOD LOOK AT THIS HEAD SET
IT IS SURELY PERFECTION

By looking at the cut you can almost feel the real comfort
this set affords

DESCRIPTION—This new Head set has all the good points you have been wanting, thinking about and trying to get. It has a full complement of instant adjustments without removing from the head. They are wound to 3000 ohms, have positive friction adjustments which stay put. Bakelite ear caps, German Silver top band, lenient back check, consequent poles and like all Turney apparatus is extremely handsome in appearance. The adjustable pressure head band affords real comfort, no matter how long you wear it. A circular giving complete information will be sent for the asking. NOTICE—All Turney head sets will be provided with the lenient back check which consists of a special woven canvas strap which fits the head perfectly.

Eugene T. Turney Company, Inc., 2595 Third Avenue, New York City

NORTHERN CONNECTICUT

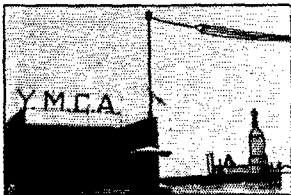

HARTFORD IS NOW CENTER of WIRELESS INSTRUCTION

YOU can get a Commercial License this winter if you study at the Y. M. C. A. Radio School under Clarence Tuska, the famous "QST" Editor. Class begins Oct. 2. Enter any time in October. Get our free "QR" signals and "key to Arlington Code" for Wireless Operators. They are suitable for posting near your sets. They are contained in a folder which will also tell you about the course. Mail this coupon today and we will send them to you FREE

Y. M. C. A., HARTFORD, CONN.

DEAR SIRS:

PLEASE SEND ME YOUR FREE FOLDER OF RADIO SCHOOL CONTAINING "QR" SIGNALS AND "KEY TO N.A.A. WEATHER REPORT CODE."

NAME _____

STREET _____

CITY _____

Always Mention "QST" When Writing to Advertisers

APPLICATION BLANK

American Radio Relay League, Inc.

INCORPORATED

Hartford - Connecticut

Your name Address
(Street, City and State.)

Your Age Your Station Call Letters

Are you a member of any Radio or Wireless Club, and if so give its name and address:

.....

Length of your Aerial..... Height above ground.....

Number of wires in Aerial and space between

SENDING EQUIPMENT

Do you obtain your power from Batteries or City Current?.....

Do you use a Spark Coil or a Transformer?.....

What is your Power Input?

Is your Spark Gap Rotary, Fixed or Quenched?

What Tone has your Spark?..... Approximate Wave Length.....

Give names and addresses of the FIVE most distant stations you communicate with:

State distance in miles

.....

.....

.....

.....

.....

.....

(OVER)

Describe your Receiving Set

Do you use an Audion Detector?

What is your approximate receiving range in miles?

Are you troubled by interference?

What are your usual listening hours and how many evenings a week do you average at your instrument?

Have you telephone connection in your house, or convenient?

Do you keep your station practically constantly in running order?

Can you copy Press News?

About how many words per minute can you receive with certainty?

What is the nearest Commercial or Government Station to you?

Have you a Government license, and if so what Grade and No.

Please make any remarks or comments which you think will be of help in perfecting a chain of Amateur Radio Relay Stations throughout the country. The object of the League is strictly confined to facilitating the relaying of radio messages among amateurs.

I HEREBY OFFER TO RELAY OR DELIVER ANY AMATEUR RADIO MESSAGES THAT ARE SENT TO ME.

Signature..... Date

MURDOCK "FIFTY-FIVE"

2000 Ohm Complete

Double Set

\$4.00



3000 Ohm Complete

Double Set

\$5.00

ALL AMATEUR STATIONS

now equipped with MURDOCK 'PHONES are getting ALL the signals, ALL the time. We want every amateur to know that we GUARANTEE these remarkably low priced 'phones to be equal in EVERY RESPECT to any for which you may pay DOUBLE the money. We could not, in justice, make such a guarantee, unless we had the goods to deliver. If YOU have never tried the MURDOCK 'PHONES, why not ORDER A SET TODAY? Your money back at once, if you don't care to keep them.

Other MURDOCK APPARATUS for amateur use, right in price and in performance:

Moulded Transmitting Condenser, per section..\$2.00
Oscillation Transformer No. 424..... 4.00
Variable Condenser No. 366, .001 mfd..... 4.00
Variable Condenser No. 368, .0005 mfd..... 3.00

The best stations are equipped with some MURDOCK instruments. How about YOURS? Our catalog is FREE to those interested.

Wm. J. Murdock Company
20 Carter St., Chelsea, Mass.



Mesco Short Wave Regenerative Receiver

This short wave regenerative receiver or receiver set is particularly recommended for long distance relay work on wave lengths approximating 180 to 450 meters. It is possible, however, to receive wave lengths up to nearly 1,000 meters sufficiently with reduced amplification.

The circuit employed is of the well known Armstrong regenerative type with constants accurately calculated for the wave lengths referred to above when employed in conjunction with any of the audion detectors described in this manual.

With this set it is possible to receive undamped and damped waves. When listening

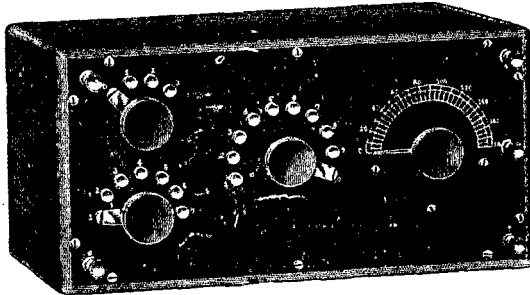

List No. 8467 MESCO Short Wave Regenerative Receiver
PRICE, \$32.50

to the latter although the tone of the incoming spark signal is somewhat changed, it is amplified many times when adjusted properly.

It is possible then, under these circumstances, to hear and read stations that would be totally inaudible with ordinary receiving sets. It will increase the receiving range of any station over 100 times.

The receiver is complete in every detail and ready for operation when connected to an aerial ground audion detector and telephone receivers. The cabinet is made of weathered oak having all connections brought out on a genuine hard rubber panel which decreases insulation losses.

A blue print of connections with detailed instructions for setting up and operating this receiver is supplied with each instrument. Both tube and round type audion detectors can be used successfully with it.

The metal parts are of brass nickel polished.

SEND FOR OUR NEW CATALOG H28

It is pocket size, 8x4½ inches, contains 248 pages, with over 1,100 illustrations, and describes in plain, clear language all about Bells, Push Buttons, Batteries, Telephone and Telegraph Material, Electric Toys, Burglar and Fire Alarm Contrivances, Electric Call Bells, Electric Alarm Clocks, Medical Batteries, Motor Boat Horns, Electrically Heated Apparatus, Battery Connectors, Switches, Battery Gauges, Wireless Telegraph Instruments, Ignition Supplies, Etc.

There exist a thousand and one ways where electrical devices may be used, and to know what is best for your purpose you need this catalog. It costs you nothing.

**Send 10c for copy of our Wireless Manual H9. You get your
money back on an order of \$1.00**

It contains 180 pages and tells how to erect and maintain wireless telegraph stations. Shows a number of diagrams. Has the Morse and Continental Telegraph Codes. Illustrates the best instruments to use; tells what they are for and how to use them. Has many new diagrams and other valuable information not contained in any other book. Do not wait. Send your request now. Get the best 10c. value you will ever buy.

Manhattan Electrical Supply Co.

NEW YORK
17 Park Place

CHICAGO
114 S. 5th Ave.
SAN FRANCISCO 604 Mission Street

ST. LOUIS
1106 Pine St.