

QST

A MAGAZINE DEVOTED EXCLUSIVELY TO THE WIRELESS AMATEUR.

RECEIVED



AMERICAN RADIO RELAY LEAGUE
RECEIVED AT *Startford* DATE *Sept. 8* 1916
No. *25* FROM *New York*
Prefix *10.45*
RADIO *Sept 7 '16*
TO *The Amateurs*
The topics for this month's QST are
as follows:-
The Propagation of Wireless Waves.
Proceedings of the Radio Club of America.
High Note Versus Low.
Interference
SIGNATURE *League News* Editor.

PRICE

10 CENTS

H.R. Hick.

Klitzen . Rotary . Gap . Motor

Introductory Price

\$6.50

1-16 H. P. 2000 to 8000 R P M.

110-130 volts AC or DC

25 to 60 cycles

Shipping weight, 5 pounds

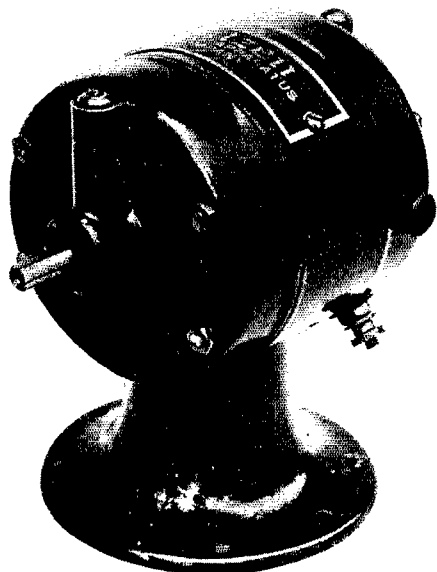

WATCH THIS SPACE FOR NAMES
of DEALERS HANDLING THIS MOTOR

Klitzen . Wireless Apparatus . Company

1123 Herrick Ave. - Racine, Wis.

GREBE RADIO APPARATUS

DESIGNED
BY EXPERTS
FOR THE
DISCRIMINATING
AMATEUR

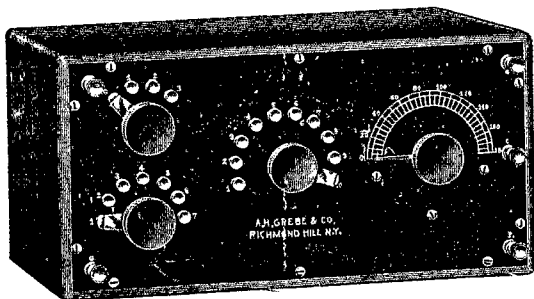

EFFICIENCY
SELECTIVITY
SIMPLICITY
SERVICE

SHORT WAVE REGENERATIVE RECEIVER. TYPE AGP 101

Our new type AGP 101 Short Wave Regenerative Receiver is specially designed for long distance relay work on wave lengths of 150 to 400 metres. It embodies all the latest PRACTICAL ideas in regenerative receiver construction which have proven most satisfactory in actual operation at our testing station. Designed primarily for short wave reception, this instrument will also operate very efficiently on wave lengths up to 1000 metres. A blueprint of connections and instructions for operating in conjunction with your audion equipment is supplied with each instrument.

SHORT WAVE REGENERATIVE RECEIVER, TYPE AGP 101, \$32.50

Send 2c Stamp for Catalog "R"

A. H. GREBE & CO. 10 Van WYck Ave., Richmond Hill, N. Y.

Always Mention "Q S T" When Writing to Advertisers

QST

Volume I

SEPTEMBER, 1916

No. X

CONTENTS

- 235 The Propagation of Wireless Waves
237 Rotten Articles
239 Applications of the Audion (concluded)
245 An Inexpensive but Serviceable Mast *Nelson Dunham*
247 Radio Message sent 114 miles from Aeroplane
248 Interference *Charles Wolfe*
249 The Edison Storage Cell *N. Maguire*
250 Successful Control of QRM *Experience*
250 Sixty Cycle Wireless Telephone *Seefred Bros.*
251 Efficiency *Thos. Appleby*
252 Receiving the Feb. 22nd Relay Message (Ill.)
253 U. S. S. Tallapoosa at Key West Navy Yard
253 Bomb Explosion prevents Radia Club's participation in Parade
254 Monthly Report of Trunk Line Managers
259 Editorials
262 Who's Who in Wireless
264 Radio Communications
266 Amateur Radio Stations
268 Queries Department
281 For Sale and Exchange
272 Subscription Contest
278 Special Land Stations

¶ QST is published monthly by Hiram Percy Maxim and Clarence D. Tuska at Hartford, Conn.
Subscription price, \$1.00 per year. Single copies, 10 cents. ¶ Entered as second-class
matter March 7, 1916, at the Post Office at Hartford, Conn., under the act of

Congress of March 3, 1879. ¶ Copyright, 1916, by Hiram Percy
Maxim and Clarence D. Tuska. Title registration

□ □ □ applied for at the United States Patent Office □ □ □

Cheer Up, Fellows!



Our Old Friend Winter Is Coming Once More

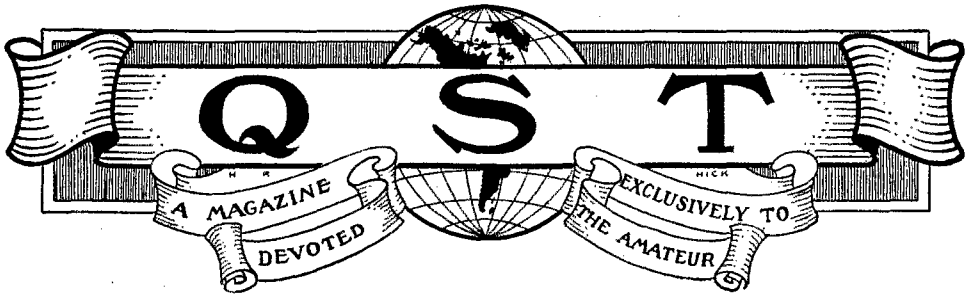

The Propagation of Wireless Waves

THIS description is based on Zenneck's Wireless Telegraphy and is written to extend the knowledge of our readers along lines which are becoming more and more important in experimental work. Little do we amateurs think of the manner in which our signals travel too and fro; of the ground they cover and how they do it. Have you ever stopped your work and sat down for a five minutes dream concerning your wireless wave? Does it pass through the neighboring hills, trees and houses, or is it bent around them?

In the case of sound waves we know they are bent, reflected, and refracted. We know that one can stand around the corner of a building and hear sounds which were originated in front of it. The sound waves have traveled out and around the corner of the house and through no end of changes in direction. Another illustration is shown in the case of a speaking tube; here, the sound waves sent out by the voice are reflected from the sides and bent around corners and sent up hill and down in every which way. What does a wireless impulse do?

We know of another illustration concerning waves. Are light waves bent? Light waves do not bend to any great extent around an opaque substance. Light waves can be bent through crystals. There are shadows where a light wave has been abruptly cut off and there are partial shadows as well. Now, what has all this got to do with wireless? It has been found that light, heat, and electric waves are not unlike. What happens to one, may happen to another. Just as light waves can be focused, so can electrical oscillations. As light waves penetrate, so do electrical. The sound waves bend; Hertzian waves can do the same.

There are three possible cases in which

the electrical waves can be pointed out as varying from their straight and narrow path. When a wireless disturbance encounters a hill or a mountain or a building, it may do one of three things. Take the case of a hill:

1. The wave may pass through the hill, Fig. 1.
2. It glides over the obstacle, Fig. 2.
3. It may strike the peak and bend down on the further side, Fig. 3.

The action in any particular case depends on the shape of the hill, its conductivity and the dielectric constant of its material. It is probable that in all cases, bending occurs. Bending is probably the most important factor. Observations have shown that a ship lying under the shelter of a hill could not receive the messages sent from a station located on the other side, but did receive them as soon as it had passed out of the shadowed region. If the hill in the path of the waves is built up of soil having a good conductivity and if the width is great compared to the wave length, the wave would probably follow the contour of the hill as described by Fig. 2. As shown in Fig. 1, the hill is not very wide and the material has a relatively low conductivity; for example, rocks.

In every case, the amplitude of the wave which passes over or through the hill is decreased and electro-magnetic shadow is thrown. The shorter the wave length, the more evident this becomes. Marconi has stated that the weakening of waves by hills or mountains occurs if the waves are relatively short, only in daylight, and never at night.

It has been observed that the mountains of Spain cast a shadow on waves sent from Nauen to ships on the Atlantic. Duddell and Taylor have demonstrated that groups of trees may interfere with the distribution of short waves. Dense woods are decidedly

unfavorable to transmission as well as high buildings and similar structures. This is especially so if they are in the immediate vicinity of the transmitter or receiver.

We can now see that uneven ground offers many obstacles to transmission. In the case of over sea transmission the results are quite independent of land obstacles. However, in many cases, waves are distributed over both land and water. Here it is found that the main portion of the wave may be guided by a stretch of sea

the atmosphere. It has been said that the atmosphere at certain times absorbs waves just as sounds are dampened under certain conditions. The absorption of waves depends probably on the condition of the atmosphere, the direction, and form of the waves, as well as the number of layers of atmosphere having different qualities. The main atmospheric conditions which effect transmission are ironization, humidity, atmospheric pressure, and temperature.

Numerous experiments have demonstrated

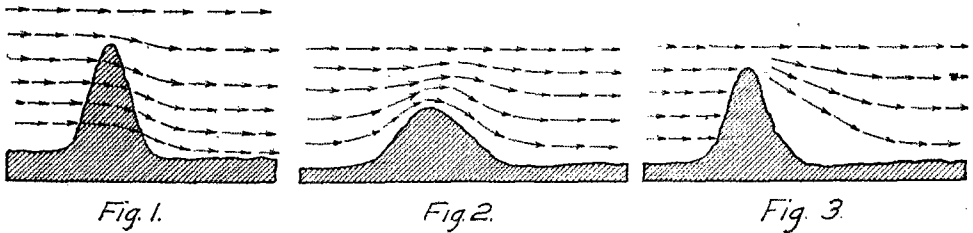

water, following this rather than a shorter land route. In the case of ships in the Mediterranean, transmitting to English coast stations, it is not impossible that a portion of the waves reach the ships by passing entirely over sea, instead of taking the shorter path across the Alps.

As extraordinary as it may seem, it has been noted that even rivers show this effect. In tests made on moving trains, it was found that the intensity of signals received was always increased when the train approached a river. This might show that the waves tend to follow the better conducting water paths.

It has been moreover noted that in directional tests, the indicator did not always point toward the transmitter. The waves in such cases evidently did not proceed in straight lines over the earth's surface, but followed the best conducting ground path.

In passing from water to land and vice versa, a partial reflection and possibly refraction as well as bending of waves must occur. A circular bay might act similarly to a concaved mirror. This leads us to believe that the amplitude of waves received from a transmitter at a given distance depends not merely upon the space traveled over land and sea, but also the shape of the coast encountered by the advancing waves. Perhaps this accounts for the so-called pockets which have been located along Long Island and the Southern Pacific coast. The shape of the coast may throw the waves out of focus for the path taken by steamships.

The foregoing discussion has been devoted mainly to the question of transmission over water or uneven ground. It might be well to note some of the effects due to

the effects of ironization; e. g., the variations between day ranges and night ranges. It is assumed that the rays of sunlight ironize the air during the daylight, while at night, this ironization disappears and the transmitting range is greatly increased. First observation of this effect was made by Marconi who found the night range to be about two and one-half times as great as the day. These observations agreed with measurements taken by L. W. Austin on wave lengths up to 3,750 meters. In addition, there have been numerous tests taken during an eclipse of the sun in which the intensity of wireless signals increased as the sun darkened and decreased again with increasing sunlight.

We can sum up the case by stating that numerous experiments indicate waves of great length are considerably more advantageous in the daytime but have no great increase in their action at night; while shorter waves, though weaker in the daytime, have their radius of action greatly increased at night. The early experiments of Duddell and Taylor show that electrical waves over the sea decrease in intensity proportional to their distance from the transmitter up to distances of about sixty miles. Recent experiments by Austin indicate that this factor changes at long distances as well as with wave length, and heights of sending and receiving transmitters.

“Rotten Articles”

The three accompanying articles were written by our readers who were so much entertained and inspired by the Old Man's "Rotten Stuff" that they've tried to produce "rottenest of the rotten" and you can read what they have done. Perhaps they are "rottener" than the Old Man's "rotten" and perhaps they are worse, but that's for you to decide when you read them.—Editor.

WORSE LUCK

By L'Operator.

IN our quiet little town of many wireless bugs there are often queer happenings. There is a certain fellow who knows nothing about wireless, but has the need for very correct time. While talking to some of his know-it-all friends he learned that with a 60/150 aerial at his disposal, it would be easily possible for him to receive time signals from Arlington. After three or four combinations of failure and success, he called on me as a commercial operator for help. I sealed over his period of failure by assuring him that it was possible for him to get time even before two or three home-made panel-switchboard-cabinet-squirrel-cage type sets had failed.

Now this fellow had queer ideas. He wanted the set in a dinky little recess in the wall where he couldn't see it, when out of use, and yet have it quickly accessible, when wanted. I sized up the whole thing and thought of a combination that would suit him. I left him then, for the goods.

All the next morning I worked, bringing things to quite a complete looking state. When noon came I went out and made a meal on armorplate (sometimes called steak), soft soap potatoes, and some kind of axle grease, the waiter called gravy. When I got back to my work I quickly finished the set and proceeded to test it out. I clapped on the phones, got the detector nervous, and expected to hear—darn if I know what. For some reason the phones wouldn't give a squeak. Just then I had a queer kind of itchy itch on the backest part of my back. The sensation made me start. Seeing this friend, Bug, made a jump.

“Who is he? Let me have him.”

Making an effort at my back, “Don't

know. I'll give him to you as soon as I get him.”

Just then a friend came in to hear the wireless.

“Come in tomorrow morning, and I'll have it ready, sure,” I said in a bad SPK. He seemed to be a little disappointed and went out. The set looked right in every respect, else my eyes were deceiving me, for I went all over it and could find nothing wrong. Connections were good; phones were all right.

Then I resorted to the detector. It was perfect as before. Then I fussed around it a while. The little dear wouldn't work, no matter how much I wiggled its whisker.

Suddenly I thought I heard something. I clapped the receivers on my head and listened intently. There was really somebody going. I listened a moment and got his sign. It was a five Kw. station, only nine miles distant, and he ought to have come in tearing.

Then I unhitched the set from the aerial and connected the phones across. Indications were that the aerial wasn't just right. It was grounded! Well I went back to take a squint at the aerial. There it was sure enough! Some boob raised to the tenth power had tied the lead in to a faucet in the wall to get it by the window! I had never dreamed of the trouble being with the aerial because I had been told that it was all right. I went back and things were fine. My friend had looked to me to fix him up without a falter. I certainly fixed him, but I don't know about the falter.

There have been many cases like this; you have probably experienced some yourself.

REDLANDS' ROTTEN LUCK

By a Radio Relayer of Redlands

Rotten luck is right! Redlands, among the amateur cities of the U. S. has, I believe, had the rottenest of all rotten luck! The Old Man's “Rotten Luck” is nothing

compared to what we have gone thru.

Back in the early days, when wireless was in its infancy, there were in Redlands four stations. As time passed, amateurs came

and went but these four lived on forever. They graduated from the spark coil to the transformer class. They grew and flourished until they were full-fledged radio stations. Two now boast of half Kw. transmitting sets. One has a quarter Kw. and last, but not least, is a one-inch coil. (House not wired).

But lo and behold, a change came. These stations, as well as others received letters from the local electric light company requesting a discontinuation of wireless instruments on the power lines. What a howl there was! Not a few armed themselves with indignation and marched to the local office. Here, by a man who risked hanging, they were informed that a special line had to be installed for their use, costing anywhere from fifty to one hundred dollars. Why this would even buy an audion amplifier!

To show that the transformers were injuring the power lines, the Managers produced a record of the load on a line that had two wireless stations. For the benefit of the wise ones, I might say this was during the morning. You know how much amateurs are apt to use their transformers then. The red line of the record sheet

during this particular morning was very irregular, so the Manager said. The record was taken on July 13th. Looking up that day, it was found to be Tuesday. Tuesday is ironing day, so that much is accounted for.

The amateurs of Redlands think it's pretty "rotten" to be unjustly accused. Are we to be shut out in the cold, cold world without any juice? We say no. If we do not injure in any way the lines or cause the subscribers to complain, the Company must sell us juice. On this basis, we expect to pull out of "rotten luck." Will the Editor please make some comment on this with some of his kind advice?

EDITOR'S NOTE: This is not an unusual case. In more than one city, the light company has felt the same. Their side of the case indicates there is no money, to be made by selling "juice" to amateurs. They don't wish to be bothered. However, they will usually supply current if it does not interfere with their other subscribers. Light companies are human like the rest of us. Try rubbing their fur the right way and see if they won't purr.—Editor.

ROTTEN MANAGEMENT (3IF)

Being now an enthusiastic "QST" fan, I feel at home in Joining the Old Man in the Rotten Luck stuff. I entertain some doubt, however, as to my experiences coming under the heading of Rotten Luck. I'm afraid it is inclined to be more personal.

Nevertheless, it was only last winter, "somewhere in January," I had dug several large holes in the wall and dislocated no small amount of plaster, trying to coax a brand new "pan cake" helix to stay in it's new home. The thing was home-made, yet all who had been privileged to behold it, knew right off that it was to be some helix. For size there was nothing to compare it to but the ocean. Even then you were cheating yourself.

The helix was the product of two weeks now and then work,—to say nothing of pounded finger nails, paint stains and 3452 trips upstairs to answer the door bell and as many more to let the dog in.

But now it was finished, hanging on the wall like the hands on a clock.

Confidentially, I might say, a helix was one of the things on which I was from Missouri. First: I didn't see any reason why it should work. Secondly: I had previously tried same and couldn't get a spark to cross the street. Now here's where the confidential stuff comes in.

One evening, while slowly coming to the conclusion that my fones must be burned out, the household was startled by the

clanging of the familiar door bell. In walked "3UP," of Philadelphia. Naturally he had but one thought, wireless. So after learning who he was and what was under his hat, we swung into the channel and dropped anchor just off the wireless table. My Rotten Results brought up the question of a helix. I had none then. So he volunteered data, for which I now thank him. He had an honest face, so I swallowed all he knew and then pumped him for more.

Two weeks later the helix was finished. Sunday A. M. the installation was started and completed. Then came the big question, would it work? (Note: one way to answer the foregoing question, TRY IT). So I did. I thought about twenty-five miles would be a good test. So I let go after "3SN," in Ocean City. Cutting off, I listened in. "Get you great, thought you were next door." (Extract from "3IF" log). This was encouraging, so I spilled some more. Back and forth it went as is customary among amateurs. "QRM." I listened. Familiar spark:—3if, 3if, 3if, de wcy wcy % 8 "\$% ' (- -) \$" WCY. So I did. Between knowing that my set worked o. k. for a ¼ K. W., and also, that if I shot again there would be more trouble, I decided to cash in, taking for the board-walk and incidentally grabbing dinner at my sister's. That afternoon I met friend Bessie B —. "Hear you had a fire at your house. Tell

Continued on Page 278

Applications of the Audion

By Paul F. Godley.

(Concluded)

(Copyright 1916 by the Radio Club of America.)

IN the construction or selection of receiving transformers or variometers for use on wave lengths, say, under 700 or 800 meters, I wish again to call attention to the importance of the free use of the wave meter in order that the natural wave length of the coils of which the instrument is comprised may be ascertained. (Fig. 6) For example, if

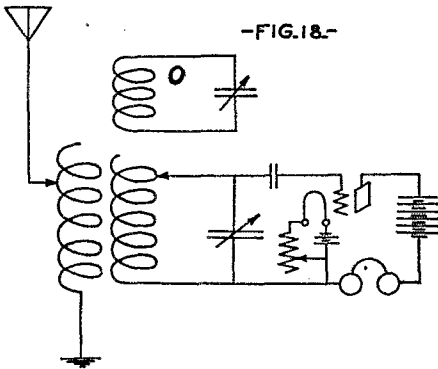

it should be found that the secondary coil of a receiving transformer had a natural wavelength of 300 meters (and this is by no means unusual) the coil would not be at all suitable for the efficient reception of waves nearer than 20% above or below 300 meters, e. i. waves between 240 and 360

lightening experiment may be performed by quite closely coupling a closed oscillatory circuit to the secondary of a receiving circuit as in Fig. 18. After the primary and secondary circuits have been tuned to an incoming signal, if circuit "o" is also adjusted it will be found that the signal strength decreases to a decided extent as the circuit approaches and passes through resonance.

The relation of this experiment to the foregoing discussion is apparent. If this experiment is tried in conjunction with a regenerative or oscillating audion circuit, the effects produced will be particularly marked.

A small no-end-loss receiving transformer designed by the writer is shown in Figure 19. This instrument is of the size usually purchased by the amateur. However, when constructed in the conventional manner both the primary and secondary coils have natural periods within the range for which the instrument was originally designed. Measurement showed the primary to have a natural wavelength of 235 meters, and the instrument shown in Figure 19, but of much greater range. Before division into sections the primary and secondary coils of this instrument had natural wavelengths of 390 and 360 meters respectively. The transformer was unsuitable for use on wavelengths below 1,000 meters. Though much more difficult to accomplish,

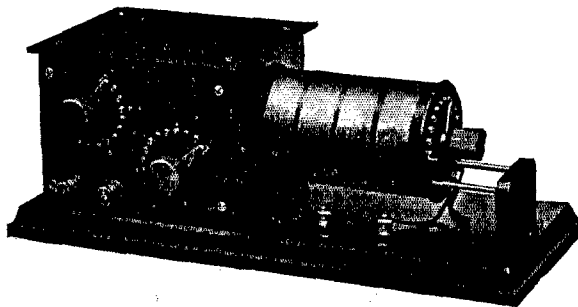

Fig. 19

meters. Provided such a transformer is to be used for reception through this range, it should either be altered to suit conditions, or substituted, for reasons which have been mentioned.

In this connection an interesting and en-

lightening experiment may be performed by quite closely coupling a closed oscillatory circuit to the secondary of a receiving circuit as in Fig. 18. After the primary and secondary circuits have been tuned to an incoming signal, if circuit "o" is also adjusted it will be found that the signal strength decreases to a decided extent as the circuit approaches and passes through resonance.

The relation of this experiment to the foregoing discussion is apparent. If this experiment is tried in conjunction with a regenerative or oscillating audion circuit, the effects produced will be particularly marked.

A small no-end-loss receiving transformer designed by the writer is shown in Figure 19. This instrument is of the size usually purchased by the amateur. However, when constructed in the conventional manner both the primary and secondary coils have natural periods within the range for which the instrument was originally designed. Measurement showed the primary to have a natural wavelength of 235 meters, and the instrument shown in Figure 19, but of much greater range. Before division into sections the primary and secondary coils of this instrument had natural wavelengths of 390 and 360 meters respectively. The transformer was unsuitable for use on wavelengths below 1,000 meters. Though much more difficult to accomplish,

this pattern, showing the type of end switch employed, and the divisions of the primary winding.

Figures 22 and 23 show a receiving set designed for the extreme ranges, e. i; 180 to 20,000 meters. The circuits employed

will usually be found to operate with less difficulty when the first audion is used to amplify signals at radio frequencies without generating local oscillations, the second audion serving the purpose of rectifier, generator and amplifier. This may be ac-

complished by the omission of the stopping, or grid, condenser in the circuit of the first audion. On spark signals the results obtained by the writer with this circuit have not been remarkable. On continuous waves,

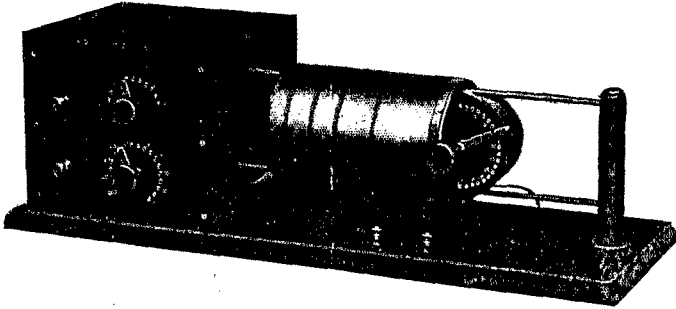

Fig. 20

are combinations of those given above. Below 4,000 meters variometers alone are used as inductances, coupling between the circuits being provided externally. Above 4,000 meters the circuits are "loaded." Loading inductances are of the "thin"

will usually be found to operate with less difficulty when the first audion is used to amplify signals at radio frequencies without generating local oscillations, the second audion serving the purpose of rectifier, generator and amplifier. This may be ac-

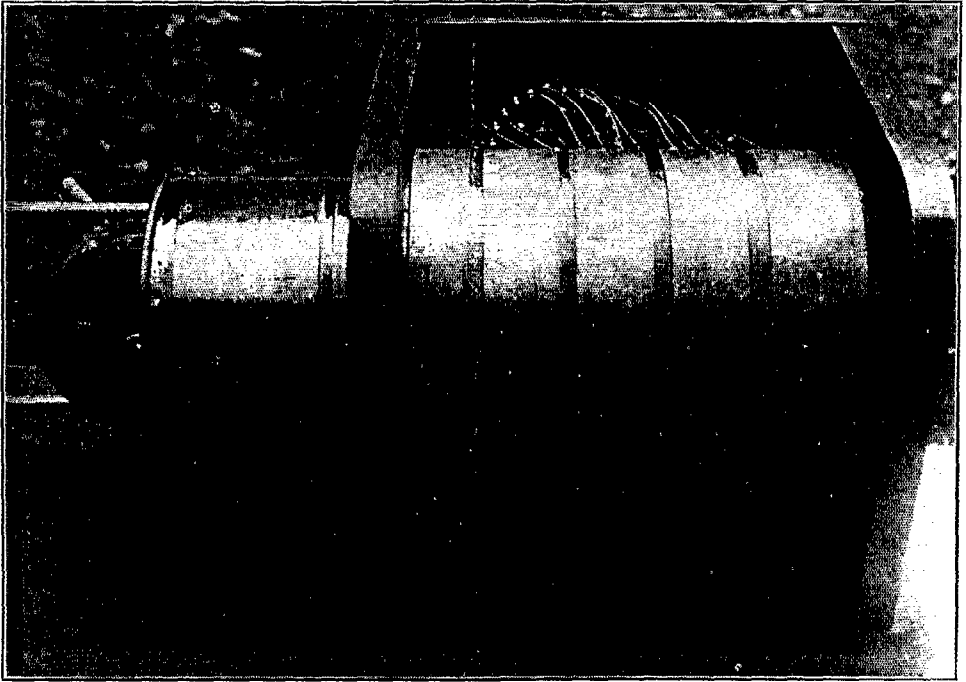

Fig. 21

multi-layer type, and the coupling between the loading coils is variable. Attention is called to the placement and directness of all leads, inasmuch as this is of material aid in keeping capacity effects at a mini-

multi-layer type, and the coupling between the loading coils is variable. Attention is called to the placement and directness of all leads, inasmuch as this is of material aid in keeping capacity effects at a mini-

however, amplifications as high as 500 to 700 times are easily possible.

In Figure 25 a circuit for a combined radio telephone and telegraph transmitter and receiver complete is shown. It will be noticed that the antenna and wing circuits

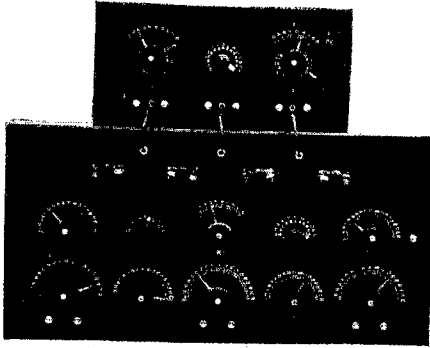

Fig. 22

are coupled directly to the grid circuit inductance. This makes for stability of operation and, greater radiation. The secondary of an ordinary telephone induction coil is placed in series with a leak resistance of somewhere in the neighborhood of 100,000 ohms (graphite rod) and the combination is of course placed in series with a transshunted direct from the grid to the filament. The leak resistance should be shunted by a capacity of approximately .0005 mf in order

place. Any increase in voltage will give a corresponding increase in radiation. Using one audion connected in this manner, the writer has found it possible to transmit with ease, either radio-telephonic or radio-telegraphic signals at will over a distance of 1,000 feet, using at the receiving station, which was incidentally in an automobile, a receiver of the regenerative type. Using this same circuit, several audions may be placed in multiple, providing their characteristics are not radically different. By placement in multiple, is meant the connection of all grids, wings and filaments together respectively, only one grid condenser, one high-tension battery and one lighting battery being used. In a circuit such as this where larger amounts of energy are dissipated, the small flash-light batteries

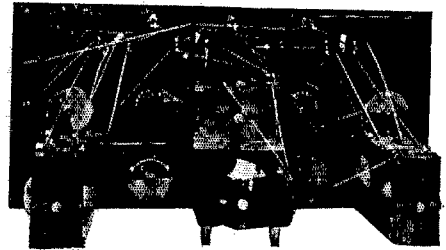
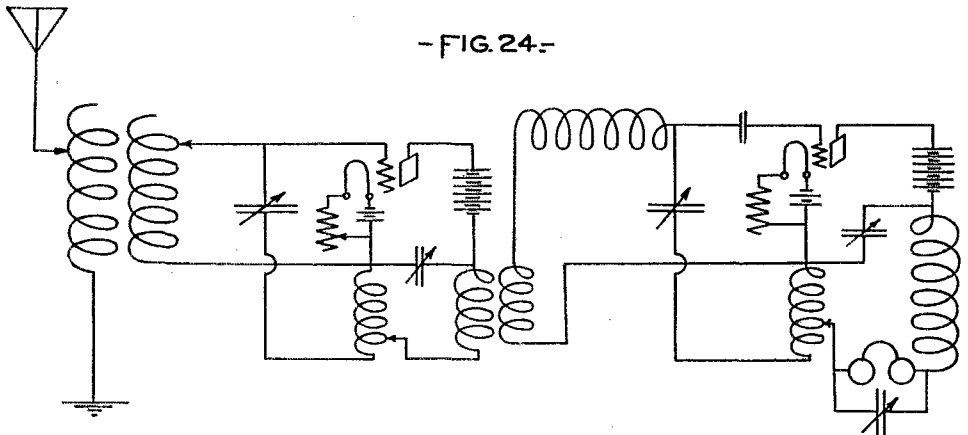

Fig. 23

usually used in connection with the audion, will give only short service. This may be gotten around



that the voice currents may pass freely. The primary of the telephone transformer mitter and battery. This arrangement gives the voice excellent control of the system. The key in the ground circuit permits the formation of telegraphic characters. Once oscillating, it is possible to increase the wing circuit voltage to quite an extent without causing ionization to take

economically by providing small storage cells which may be constructed with test tubes an inch in diameter and five or six inches deep. Strips of thin lead are cut for plates and scratched deeply with a sharp knife so that as much surface as possible may be presented to the electrolyte. Two plates are to be placed in each test tube and separated by a thin strip of porous

wood. Seventy-five or one hundred of these cells may be constructed in a fairly short time and placed in a rack made by boring holes in a board. After they have been "worked in" by charging and discharging a few times, they will take sufficient charge

exists between one end of the coil as a whole and the other end, as represented in Fig. 1 herewith. In other words, the capacity is due partly to dielectric flux passing from turn to turn, but mainly to dielectric flux passing through the surround-

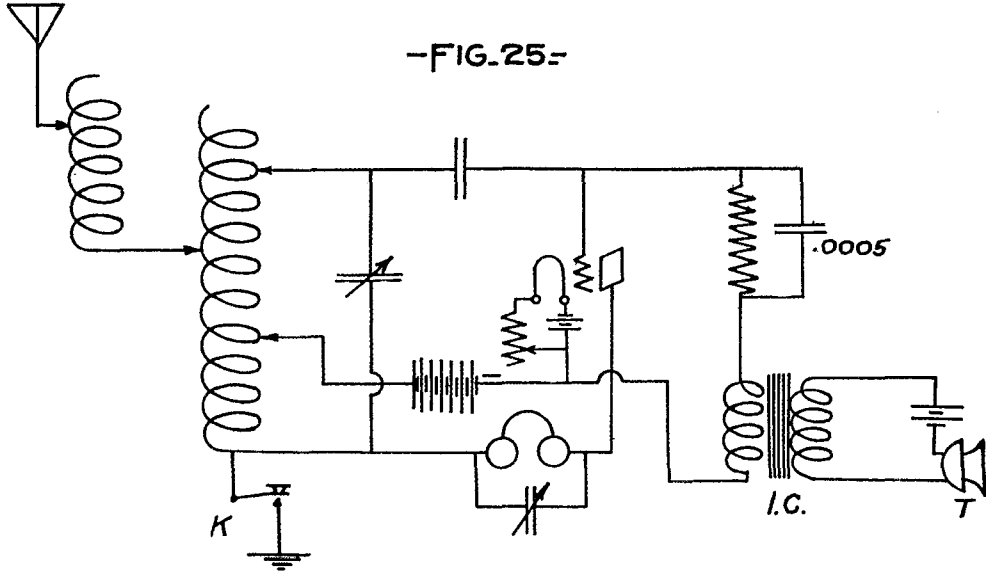

to supply several audions for a good many hours. A cell of this sort, if carefully constructed, should have about one-quarter ampere-hour capacity.

In conclusion, it might be said that every day new audion circuits are "discovered." They are, however, with but rare exceptions the ones with which we are familiar turned wrong side out, and unfortunately they have usually suffered in the turning. On the other hand, there are a great number of very excellent applications of the audion circuits mention of which time will not allow. It is to be hoped however, that what little of interest I have been able to present, may at least suggest to you something of greater interest.

DISCUSSION

Prof. L. A. Hazeltine.

Mr. Godley has properly emphasized the importance of minimizing the distributed capacity in radio receiving coils, especially for short waves. It is even more important, however, to minimize the resistance—or better, to make the quotient (L/r) of self-inductance by resistance as high as possible. It is my purpose to show that these results can be obtained better by the use of multilayer coils than single-layer coils.

In Mr. Godley's Fig. 5, he represents the distributed capacity of a single-layer coil as existing between adjacent turns only. In reality, the greater part of the capacity

ing space, inside and outside the coil, as represented in Fig. 2. This is proved by re-

- FIG. 1 -

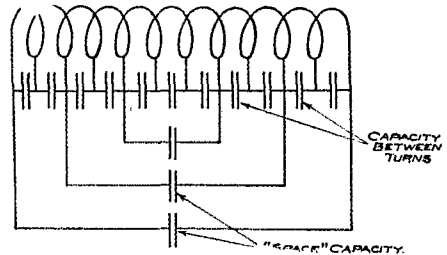

sults of Drude*, which show that substituting thin silk insulation for thick cotton insulation, and so decreasing the ratio

diameter outside insulation

- FIG. 2 -

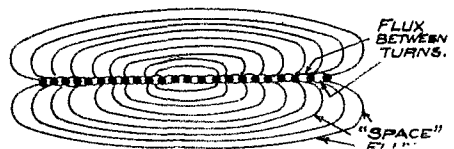

*Annalen der Physik, 1902, IX, p. 322. See also paper by Howe, Proc. Phys. Soc. (London), 1912, p. 251.

from 2.4 to 1.09, increases the capacity of a closely wound coil (having a length equal to its diameter) by less than 20%. The capacity between turns, however, would then be multiplied by about 3.6; so it must be a small part (less than 10%) of the total capacity. Further, Drude's results show that substituting an ebonite core for an air core increases the total capacity by nearly 40%, while it could have very little effect on the capacity between turns.

Bearing in mind the above results, it can be seen that a coil made up of pancake sections, having say 4 turns each, as represented in Fig. 3, will have very little in-

-FIG. 3-

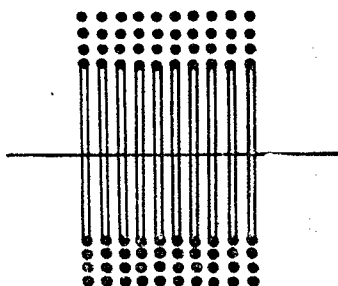

crease in capacity over a single-layer coil of the same dimensions; for the space capacity remains the same and the capacity between sections is still a small part of the total. The self-inductance however, has been increased nearly 16 times, and the resistance only 4 times; so the coil has been

-FIG. 4-

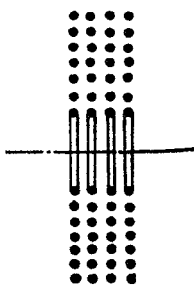

greatly improved by having a higher value of L/r . If we wish, we may now slightly reduce the dimensions of this coil until its capacity returns to that of the single-layer coil, when we will find its value of L/r is still several times that of the single-layer coil.

It is difficult to wind a coil as in Fig. 3, on account of the connections between sections, unless an excessive space is left be-

tween these. Hence it is convenient to interchange the length and depth of the winding cross-section, giving a short, deep multilayer coil, as in Fig. 3, having essentially the same constants as the coil of Fig. 4, with corresponding dimensions. The design of such coils has been taken up by the writer in this discussion of Mr. Eastham's recent paper before the Radio Club, and so will not be considered here in detail. It might be well to mention, however, that for most purposes it is not desirable to use such a short deep cross-section as in Fig. 4, as this unduly sacrifices L/r for the sake of a low capacity. In the coils designed and constructed by the writer, the capacity between layers (which corresponds to the "capacity between turns" of a single-layer coil) is considerably higher than the space capacity; but on account of the small dimensions, the total capacity is of the same order of magnitude as found in receiving sets using single-layer coils.

Taps for tuning should not ordinarily be employed in multilayer coils; for the turns are all so near one another that the coil would act as a step-up transformer, causing the effective capacity to increase nearly as fast as the self-inductance was decreased.

-FIG. 5-

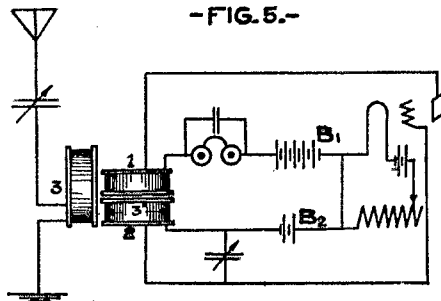

In fact, in the ideal case when all turns are linked with the same magnetic flux, the natural wave length would be the same, no matter what taps were in use. Tuning should therefore be done mainly by variations in capacity.

In Fig. 5 is shown the connections and general arrangement of the apparatus used by the writer for receiving undamped-wave signals up to 15,000 m. wave length. Coils 2 and 3 are 3 inches in diameter and are wound with about 1,200 turns of $10 \times$ No. 38 Litzendraht with 6.5-mil paper between layers. Coil No. 1 has about 200 turns, but 500 would probably be better. The antenna condenser has about 2 millimicrofarads (0.002 microfarad) maximum capacity. The maximum grid capacity is about half this. Instead of the usual stopping condenser, a biasing battery B_2 of 5 to 10 volts is often used.

The mathematical theory of the circuit of Fig. 5 is relatively simple, but would be

out of place here. Suffice it to say that with sufficient coupling between coils 1 and 2, the audion is capable of producing oscillations at the two natural frequencies of the coupled circuits 2 and 3. Under the following conditions these two oscillations will occur with equal ease; (a) very small or zero coupling between coils 1 and 3, as represented in Fig. 5; (b) circuits 2 and 3 tuned to the same frequency; and (c) coil 1 having a natural frequency much higher than that of circuits 2 and 3. If under these conditions a stopping condenser is used instead of the biasing battery B2, oscillations of the two natural frequencies may exist simultaneously, giving their "beat" note in the telephone receivers. With a biasing battery, as shown, this note will be heard only momentarily as a "tweet" when adjustments are being made; for only a single oscillation is then stable. If now the circuits are tuned up so that the audion oscillates at one natural frequency while the incoming signal has the other natural frequency, enormous amplification is possible. The note heard in the telephone receivers under this condition depends on the coupling between coils 2 and 3. In fact, the ratio of the audio frequency to the radio frequency is approximately equal to the coefficient of coupling, and should lie between about 2% and 5%, a result conveniently attained with the arrangement of Fig. 5. The greatest amplification of signals occurs when the audion is barely oscillating, which is attained by reducing the coupling between coils 1 and 2. The compactness and ease of manipulation of this arrangement are obvious.

For damped wave reception the writer uses the connections of Fig. 6, which gives only one frequency of oscillation at a time. Coupling between the coils can be made very loose, and even reduced to zero and

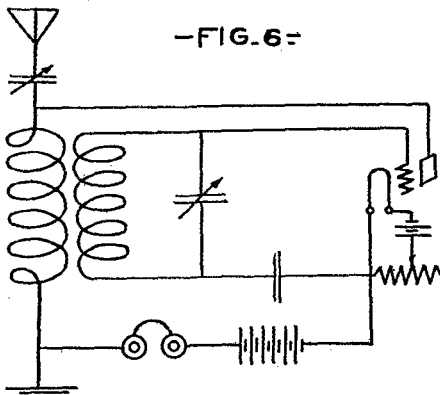

reversed, the greatest amplification occurring when oscillation just ceases. For wave lengths from 200 m. to 800 m., coils 1.5 in. to 2 in. in diameter have been used. Attention is called to the fact that the stopping condenser of Fig. 6 is shown adjacent

to the filament instead of adjacent to the grid as is common: this is to keep it near ground potential and so eliminate its capacity. For the same reason the wing is connected directly to the ungrounded side of the antenna coil, the telephone receivers and battery being on the ground side. With slight additions, this circuit has been used for transmitting and receiving undamped wave signals both for telegraphy and telephony.

Mr. Godley: In order to determine the relative merits between single layer coils and the multi-layer coils of which Professor Hazeltine speaks, I am of the opinion that information concerning the actual relationship existing between the inductance and capacity of such coils is essential. It is unfortunate that no such information is available. It is extremely doubtful whether or not the increase in value of L/C in this type of coil, if any, warrants constructional difficulties encountered, especially on the part of the experimenter, since, as I remember it, the specifications as given by Professor Hazeltine, call for coils with no core and no supports, because, as he pointed out the presence of a dielectric in and surrounding the coils very greatly increases the capacity.

Taps on a multi-layer coil are usually undesirable as Professor Hazeltine has stated. This would be especially true in connection with a multi-layer coil designed for covering the shorter ranges of waves. A variation of inductance is essential for good short wave reception (unless possibly a separate coil be used for each small range of wavelengths) and we are led to assume that the statement concerning the unsuitability of multi-layer coils for short wave work under any conditions, still stands.

When using a biasing battery to replace the grid or stopping condenser as in Fig. 5 of this discussion, a decrease in sensitiveness is to be expected. This arrangement, however, is sometimes advantageous during heavy static.

The circuit shown in Figure 6, is by no means a selective circuit due to the direct coupling of the wing and antenna circuits. The placement of the stopping condenser in the filament, or low potential lead (low potential with respect to the earth) also renders the circuit more susceptible to shock excitation. To be sure, the capacity of the stopping condenser has been greatly decreased as far as its relation to the rest of the circuit is concerned, but this may be completely accomplished by removing the condenser from the filament lead entirely, leaving but one connection from the closed oscillatory circuit, and this direct to the grid. The circuit will function as before though the signal amplification obtainable is not to be compared with that of the circuits shown in Figures 14, 16 and 17 of the paper under discussion.

An Inexpensive But Serviceable Mast

By Nelson Dunham

THE writer has constructed a number of poles of different design, among which might be mentioned an iron mast, sixty-five feet high, built of pipe strong enough to hold a man at the very top. Such a pole is, of course, desirable, but it has one serious drawback for the average amateur. That is its cost.

Many amateurs spend a great deal of time on their instruments, and neglect outside equipment. This is a mistake. Not that care is not essential—it is, but outside apparatus is also deserving of consideration. Many of us have had the shocking experience of a collapsed mast from a loose

have resulted in a first-class support, an improvement to the property on which it was erected.

Last Fall the writer built his pole and has yet to experience trouble with it. It has gone through some severe storms, which gave it a pretty thorough test.

Following are the plans of a mast that the writer built and found to be very serviceable. The cost is not prohibitive to secondary a natural wavelength of 310 meters. It is apparent that serious losses would occur in this instrument between 190 and 370 meters due to the end effects of both the primary and secondary.

Inasmuch as good practice puts the maximum range of the instrument at about 1,000 meters, when used with the audion detector, and since decided energy losses occur through one-third of this range, the instrument may be classed as unsuitable. The coils of the transformer shown in Fig. 19, however, have been divided into sections of such a size that, in this case, the natural wavelength of the sections, either singly or in series, are at all times well below the wavelength at which reception is being effected, the original range being maintained. A lever connected to the back of the primary and secondary switch levers, actuate small switches which connect or entirely disconnect the inductance as required. Figure 20 shows another receiving transformer of the writer's design, similar in general to the average experimenter.

Before beginning the actual construction of the pole find some perfectly level place, on which to work. A concrete sidewalk insures a straight mast. Material 1"x2" in cross section should be used throughout.

Each upright, of which there are nine, should be sixteen feet long. They are joined in sets, as shown in Fig. 1.

For the cross members cut out 33 pieces, each 24" long. These should be notched to fit the uprights, as shown in Fig. 2. The first set of cross members should be put in one foot above the ground line, the remainder four feet six inches apart. After cross members have been put in, up to fifteen feet, braces should be added.

The braces are nailed both to cross members and to uprights. They should be chamfered to fit corners.

To fasten the small pole to the top of the mast nail a board of regular stock over the last set of cross members. Place the pole in the center of this board and drive several nails through the base. To fasten the pole more securely use angle irons at

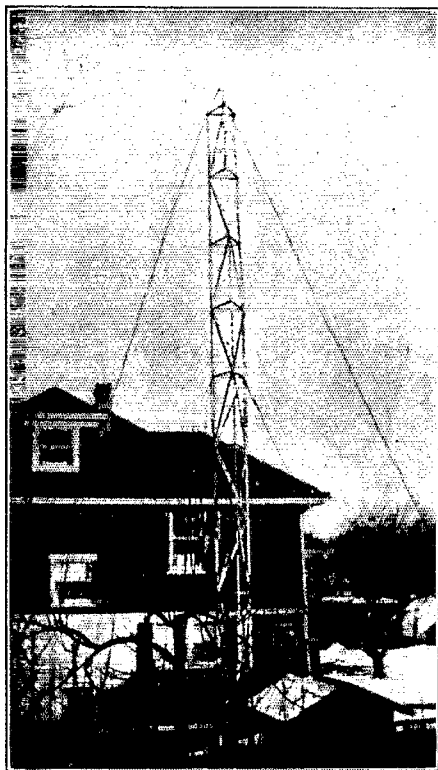

guy wire or poor construction. On little trips about the country the writer has seen antennas and aerial masts that look as if they had been shot into place, and were about ready to jump out again. A little work and thought at the beginning might

the base. It is very necessary that the pole be fastened firmly to the cross piece, or else the strain of the aerial will pull it loose. The three wooden braces which extend from the uprights to the small pole should be made to fit very exactly and should be well nailed. Where these braces meet the uprights, corner irons bent to the proper angle should be used. These should be made fast with screws.

To fasten the pulley to the pole take a long wagon bolt, slender enough to pass through the eye of the pulley, heat it to a cherry red, pass through the pulley eye, and bend to form an eye bolt. This fas-

from the two back uprights.

The guy anchorage was formed by joining two wires, one from each upright, ten feet from the mast where they were brought down as one wire to the "dead men." The seventh guy wire was not absolutely necessary, but took some of the direct strain of the aerial. All of the writer's "dead men," or anchors, are three-foot lengths of telegraph pole. From these logs a piece of iron wire or iron rod is brought up to connect with the guy wires. It is of utmost importance to have the guy wires tight. Hand pulling of wires will not give the necessary tension—they should be tightened

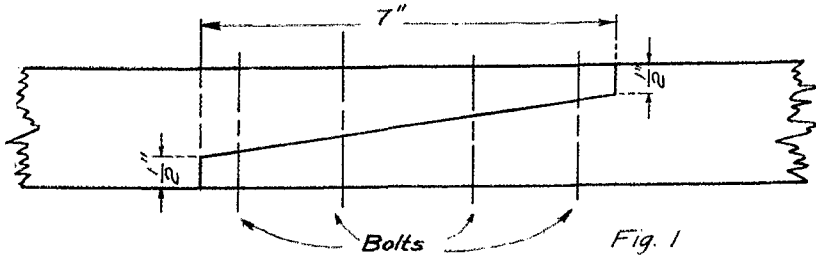

Fig. 1

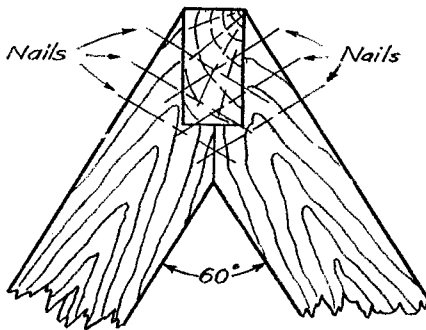

Fig. 2

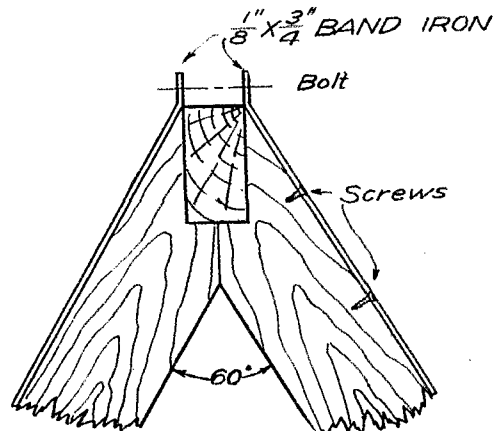

Fig. 3.

tens the pulley to the bolt, which is joined to the mast by drilling a hole through the small pole and fastening with a big washer and two nuts. (See Fig. 3).

The guy irons are placed around the mast and made fast with screws. This adds to the strength and at the same time gives the best method of fastening the guy wires. The guys should run out straight from the pole in such a manner that they do not tend to twist the pole. The writer used seven guys, six as shown in the diagram, two from each upright, and the seventh

with "come-alongs."

The base of the mast should rest on a concrete column, two or three feet deep. The depth is really optional, and varies with different parts of the country. The concrete must, however, be deep enough to get below the frost line. The foot of the mast should be imbedded seven inches in the concrete. This makes the mast firm and keeps it from twisting.

An additional word as to the construction. The spruce used should be planed on one side only, and should be given two

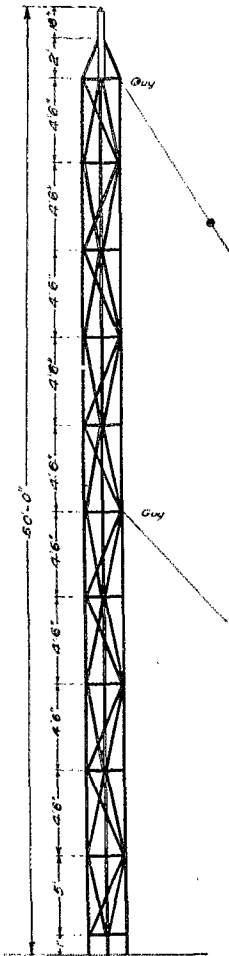

coats of paint, preferably white-lead. The descriptive matter given does not, by any means cover the total construction of the mast. By means of the drawings and the picture, however, the average amateur should have little difficulty in following the idea. The mast when completed can easily be picked up and carried by two men. Since it is so light, it can without much trouble be erected.

If the plans are carefully worked out, there is no reason why the maker should not have a first class antenna support, at a slight cost.

Radio Message sent 114 Miles from Aeroplane

A new world's record for flashing radio messages from an aeroplane in flight, was established July 27th, by Capt. Clarence Culver, of the Signal Corps Aviation School, when he succeeded in keeping in constant communication with San Diego, while on a reconnaissance flight to Santa Monica and return, a total one-way trip of 114 miles in an airline.

While flying at an altitude of a mile and a half over False Bay, Capt. Culver began to flash his radio messages to Lieut. W. A. Robertson, who handled the receiving instruments of Dr. R. O. Shelton of San Diego. While flying over La Jolla, Capt. Culver flashed a second message, giving his location. Every ten minutes thereafter, he continued sending, until he had passed over Venice, Santa Monica, and Los Angeles.

Capt. Culver's remarkable feat was accomplished with a radio set of his own invention. The power for the transmission set was derived from a 180 watt D. C. generator, driven by a 2 blade propeller. The generator, in turn, drove a small alternator with synchronous gap. The aerial, stretched across the top wing of the aeroplane, was 70 feet long. A counterpoise ground, 333 feet long was used. This was let down from the machine after rising. The complete set weighed less than 40 pounds. Transmission was on a wave of 250 meters.

For receiving Dr. Shelton used an Armstrong audion circuit, two step amplification, and mica diaphragm phones, which no doubt account for the great efficiency. The signals from Capt. Culver were stronger than those from any Los Angeles amateur station. In the near future, Dr. Shelton plans to carry on experiments with a plane equipped with both sending and receiving apparatus.

LAKE SHORE RADIO ASSOCIATION

Curses on thee little spark coil, thou of wheezy flabber tones, soon thy blubbers, jerks and gurgles will come coughing thru our phones. Many weary hours of misery, thou hast caused us in the past; may thy life be one of torture, strewn with troubles to the last. With the Fall and Winter seasons comes a hope and ardent prayer, that thy mournful tones of anguish, never more shall rent the air. Thou art Lord of all the ether, prince of jampers in our land. Aye, we scarcely do thee justice, as a drummer you're a band. May our feeble spark of protest, echo loud from sea to sea, may our battles turn to vict'ry, may we put the ban on thee. In thy thoughtless dome of ivory, in thy pessimistic way, thou art surely doomed to perish, may thy end be near we pray. We have asked thee like a brother, join our ranks and cease thy noise, make thy gloomy life a pleasure, be

a help to all the boys. Though thy troubles have been many, thou art running fast thy rope, we beseech thee as a brother, wake up jammer, change thy dope. Change thy drumming worldly menace, to a helping jamless cause, help perfect the jamless spark coil, read thy book of jamless laws. Give thy local club a tryout, just a fair and square man's trial; you'll be chuck full of repentance, once you've met their happy smile. Pray, thee hasten lest they evils, bring upon thee plagues of old; join the local ether order, ere thy welcome has grown cold; kindly reason what destruction, just one little jam can do, in the relay of a message, that some fellow's getting thru. Let us find our own sweet troubles, our mistakes and errors, too, then we'll not have time to grumble, we'll have more than we can do.

Interference

By Charles S. Wolfe

WHEN old man Hertz got busy and coerced a spark coil condenser and two chunks of zinc into uniting for the purpose of tormenting a broken hoop which was resting peacefully across the room, he started something, believe me.

He produced the Hertzian wave and as near as I can make out, Hertzian waves don't care who produces 'em. A learned college professor sits down, brushes his alfalfa field out of the way, covers a sheet of paper with x's and y's and a table with junk, and fires off a couple of Hertzian waves in an endeavor to ascertain whether figures ever lie. The kid across the street litters a table with similar junk, omits the x's and y's, and turns loose a whole darned air full of Hertzian waves, in order to ascertain whether or not he can disturb some one. He can! He's a success as a disturber.

There's a kid across the way from me. He's got an aerial and a Hertzian wave outfit. Nightly, he raises chaos to the N-th power, and my audion dutifully delivers to me an ear-full of a mixture consisting mainly of one part NAR and ninety-nine parts kid-produced Hertzian. Consider the gallows. Many a man dangles idly and aimlessly on it who should have been presented with a medal.

It is a well known fact, and sometimes I'm tempted to believe it's a fixed law of our game, that when a guy gets badly bitten by the wireless bug and buys himself a couple of dozen audion bulbs at \$4.00 per throw, and a handful of variables at prices ranging anywhere from petty larceny to highway robbery, and sits down in happy poverty to copy messages of all kinds from the very ends of the earth, invariably the kid two blocks down the street promptly installs a transmitting set animated by a one-inch coil and proceeds to omit waves

guiltless of all sharpness. Usually, he gives up a sample just when we're copying what we firmly believe to be an amateur in 'Frisco and frantic and profane experiments generally show that his signals are quite audible at 100 meters, also at 225 meters and likewise at any and all points between these two extremes.

No matter how much of a Christian a man may be, he's entitled to his righteous indignation and I hold that the possessor of a brand new audion amplifier is justified in considerable raving when he finds that apparently he has purchased the aforementioned lamp and accessories for the one and sole purpose of hearing the kid across the lane laboriously—and industriously—calling CQ.

Let me digress an instant, in a sort of a parenthetical paragraph, to observe that the operator at sea cannot read hearing the terrible S. O. S. any more than his experimental brother in a store attic dreads the equally horrifying CQ. It is usually begun just as you are ecstatically listening to the dull thrum of Constantinople's spark. Just about this time our ears record the awful CQ sounded slowly and distinctly 24 times, followed by 3 de's, 32 signatures, a baker's dozen —...—'s, and then repeated ad. lib. until the youthful Fleming's dry cells revolt.

A hint, brothers, go to the station of such fiends as I have described, look wise, praise the murderous outfit in general, but remark casually that you know of a much more efficient hook-up. Proceed then with diligence to make connections anew, leading all important wires to the post marked "G." Thereafter, the inspiring young Edison will transmit enthusiastically to himself, while you will be left to gleefully watch your filament flicker as Pekin roars into the phones.

RADIO CLUB ORGANIZE AT FRESNO, CAL.

The amateurs in the vicinity of Fresno, Cal. recently gathered at the home of O. M. Howard to organize a radio club. Mr. Howard, a member of The American Radio Relay League has done considerable experimenting in radio work and he hopes to assist the amateurs in perfecting their

apparatus and working toward "Preparedness."

At present there are about twenty-five members and more are joining from the surrounding towns. Mr. Howard is the Secretary and Treasurer and Mr. R. C. Denny is the Chairman.

The Edison Storage Cell

By N. Maguire

FOR amateurs who are considering a commercial examination, the accompanying data will prove very instructive. One of the most important parts of an auxiliary ship outfit is the storage battery. The Edison cell was named after its well-known inventor, Thomas Edison, and has become to be used world-wide.

First, the cell is contained in a thin steel case having corrugated sides. This insures a maximum strength with least possible weight. In this case container, we have a solution or electrolyte consisting of twenty-one per cent. pot ash solution. To this a small amount of lithia is added. While the function of the lithia is not exactly known to the laymen, it is found to improve the marking of the positive plate and at the same time affords a superior path for the flow of current. The specific gravity remains unvaried during charged and discharged. The old type of acid storage cell shows a change in gravity during charge and discharge. This effects the output noticeably. The solution of an Edison cell is not acid, but alkaline.

The positive plate is made of a steel supporting frame-work which contains thirty perforated steel tubes which are nickel-plated and contain nickel oxide.

The negative plate also has a steel frame-work but there are only twenty-four finely perforated nickelled steel pockets which are rectangular in shape. These pockets are filled with iron oxide.

After the substances have been pasted into the plates, they are subjected to an extremely high pressure so that the material really becomes a part of the plate. This insures the safety of the material which might otherwise loosen and fall to the bottom of the cell.

Now let us return again to the container which has been described as a thin corrugated pressed nickel steel case. The joints of this are all welded together. After the plates have been fitted properly, the top is welded on and three holes have been left in it. Two of which are where the posts terminate and the third is a gas outlet. The insulating material is special prepared hard rubber. Thin sheets insulate each plate and the plates are also held from the container's sides by a rubber bridge upon which they rest.

The capacity of an Edison cell varies according to its size and the number of plates which it contains. It is said that the Edison cell has twice the capacity of the

same weight lead cell. The capacity of any storage cell is rated in ampere hours; i. e., the currents supply in amperes per hours in time. Edison cells range from forty-five to four hundred and fifty ampere hours. Each cell has a voltage of one and two-tenths, whereas, the lead cells have a voltage of two. Edison cells are warranted to give perfect service for four years.

Action of cell.

The charging current is connected in the usual manner. The current flowing from positive to negative. The iron oxide in the negative plate is reduced to spongy metallic iron and oxygen is liberated. This is transferred through the electrolyte to the nickel in the positive plate. When the negative plate has given up all its oxygen which has been collected on the positive plate, the cell may be said to be fully charged. Upon discharge, the reverse action takes place. The oxygen moves back against the flow of current and from this we can assume a flow from P to N in the external resistance.

Advantages.

1. Can be charged at any time, regardless of amount of current in the cell.
2. Can be left in a charge or discharge condition for an indefinite period without attention and after two years will give back a great portion of the charge put into it.
3. Occupies less space than the lead type.
4. Overcharges or accidental short circuits do no harm.
5. Plates do not warp; no sediment at bottom of cell or corrosion.

The United Fruit Company's wireless department has recently ordered Edison cells for installation on all their ships as auxiliary power. Before installing the Edison cells, a great deal of experimenting has been done. Finding the Edison cell fulfilled all requirements, they have it for all their vessels as an auxiliary equipment.



LONG DISTANCE WORK WITH A SPARK COIL

E. H. Hartnell of Salem, Wis., has been able to work 75 miles either day or night with a three-inch coil consuming 24 watts. 8AEZ, 8NH, and other amateurs in their vicinity have heard this coil with the phones ten feet away when using an oscillating audion hook-up. Let's hear what the others have done.

Successful Control of QRM

By Experience

LAST winter, beyond all doubt, was the best long distance season yet experienced by the amateurs. In many cases the experimenters did better work in the long distance line than the commercials. This is probably due to experiments with the Armstrong circuit, oscillating audion, and all the various types of regenerative systems. There was one unfortunate draw-back,—local interference. QRM has caused many a good experimenter to give up the game. Interference is one of the problems which the A. R. R. L. must try to solve for the next year.

Tune them out? Ah, yes, my dear readers, but suppose you try to tune out the spark coil next door, the quarter kilowatt on the next block and perhaps the local Jonah who continually sits on his key whenever you work. Every city has its Jonah and his followers. They can't be tuned out with much satisfaction other than counter-attacks in QRM and that only stimulates more interference while long distance is going on.

Report them? That would only raise an unwelcome row and you would be probably reported yourself. Besides, some of the interferers might make good operators if not driven out of the game.

The most practical solution seems to be control by a local radio club. Not the usual half-hearted, occasional pressure, but a strenuous, progressive, forceful government by an Interference Committee who are active in long distance work. The members should be chosen with care and discretion, and authorized by the club to report all intentional interference in the club's name. A set of hours might be gotten up for testing, long distance, and local work.

The most important point to keep in mind is that local control no matter how well organized, is doomed to a speedy failure if the Interference Committee does not follow and act on each and every case without regard for personal feelings. This is a situation which must be handled thoroughly or not at all.

EDITOR'S COMMENT: This article was contributed by one of our readers. He makes a number of valuable suggestions. The idea of interference has been brought up time and time again and more than once we have stated that eighty-five or ninety per cent. of QRM is needless. Let us all get together and do some work which will rid us of this needless, useless, thoughtless, QRM.

Sixty Cycle Wireless Telephone

By Seefred Brothers

The accompanying diagram will prove of interest to QST readers who have been experimenting with a wireless telephone. The novelty of the system lies in the fact

two extremely hard carbons such as are found in dry cells. A close adjustment is necessary and it is left to the experimenter to develop this with the material on hand.

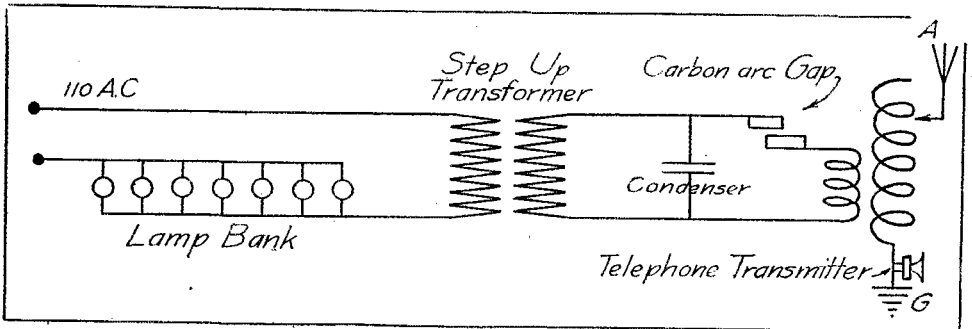

that a sixty cycle current has been made use of. The diagram is self-explanatory with the exception of the gap which is made of

The arc must be of a purple blue color to get the best results. If the arc turns to a

Continued on Page 278

Efficiency

By Thomas Appleby, President
Radio Apparatus Company of America

CERTAIN A. R. R. L. members have questioned our claims that we get 3 and 4 amperes radiation with our $\frac{1}{4}$ K. W. Hi-Tone Transmitting outfit. We have not only one but many examples in Philadelphia and throughout the United States to prove our claims. And why shouldn't we get this radiation,—is it supposed to be impossible? We think not. In the first place we use a high spark frequency, 1000 per second, and it is a well known fact that when the aerial is charged a greater number of times per second the radiation will be greater because there is only a short interval of time between the sparks and wave trains. Just like filling the bucket at the well, the oftener you fill the bucket the more gallons of water you will get. In the next place our transformer is designed to fully charge the transmitting condenser 1000 times per second; please notice our bucket is completely filled every time. The condenser by the way is one of the most efficient made, having much less losses than those of glass plate construction. Another important item is the Hi-Tone Rotary Spark Gap. Its construction is quite different from other amateur spark gaps. There are eight cast brass studs secured to the face of a bakelite ring, (see illustration) and two revolving studs fastened to a fibre revolving piece on the motor shaft. The revolving studs keep cool by their high velocity. While the stationary studs being eight in number are used only one-eighth of the time, the spark during one revolution of

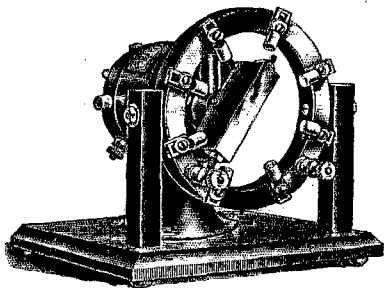

Hi-Tone Rotary Spark Gap.

the revolving arm being divided between eight cool stationary studs. With cool studs great quenching occurs, and when combined with the air pressure caused by the rapidly moving fan like revolving piece, a sharp wave is radiated.

We all know that when a quenched or semi-quenched gap is used the wave is so

sharp that an ordinary helix will suffice instead of the two coil loose-coupled oscillation transformer. We also know that tight coupling is more efficient than loose coupling, and by the way if you doubt it we would refer you to Professor Zenneck, and to take advantage of our quenching gap we have constructed our oscillation transformer with thirteen turns of strip on each coil in pancake form like that used by the Telefunken people. One coil being fixed and the other hinged, so that when they are parallel and near each other great transfer of energy

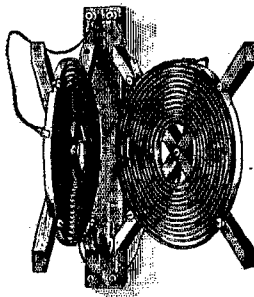

Telefunken Pancake Oscillation Transformer.

takes place between each and every turn on the primary and secondary coils. (See illustration). With the ordinary upright oscillation transformers having one coil above the other energy transfer only occurs between the lower turns of the upper coil and the upper turns of the lower coil, the great air space between the others prevents any large transfer of energy. It can be easily seen that with the upright type, tight coupling, for use with quenched spark gaps, cannot be obtained. Of course for low spark tone work in which the wave is more or less broad the upright oscillation transformer will answer but in this case the Telefunken pancake type can also be opened until the coils stand 90 degrees apart.

Perhaps those of Marconi experience with the new quenched panel sets remember that when the quenched gap is used tighter coupling is necessary than with the rotary spark to get the same or nearly the same radiation.

Combining high spark frequency, cool studs, air pressure at the studs, properly designed transformer and condenser and properly designed oscillation transformers always gives us one result, EFFICIENCY.

Receiving the February 22nd Message



The accompanying illustration shows Mr. Chambers of Philadelphia who received the February relay. A record was made for

quickness in which the Boy Scouts took part. Mr. Chambers' station is 3XC.

HILLSBORO RADIO ASSOCIATION

This association was organized on October 22, 1915 under the name of the Tampa Radio Club. At a later date it became known as the Hillsboro Radio Association. The President is P. H. Wall; Vice-President, J. J. Fogarty; Secretary, George Warner; Treasurer, V. C. McIlvaine; Assistant Secretary and Treasurer, Ed Cole; Corresponding Secretary, S. L. Boyett.

Meetings are held every Monday night at 707 Ayelee St., Tampa, Fla. Upon first organizing, there were only five members in the club, but now there are twenty-seven, two of whom have seen commercial service. The association is now preparing to make and install a club set. This will be carried on at the meetings for the next several weeks. Any amateur within a radius of fifty miles who would like to join will please address S. L. Boyett, 1047 Green St., West Tampa, Fla.

SALARIES OF RADIO OPERATORS OF ALASKA STEAMSHIP COMPANY INCREASE

The Alaskan Steamship Company has just announced the new schedule of salaries of their radio operators, has been increased as follows:

Grade	Former Salary	Present Salary
Junior Operator	\$50	\$55
Senior Operator	55	60
Combination Operator	65	75

A combination operator is one who, in addition to his radio duties, assists in the work of freight clerk while not on watch in the radio room. The salary of the freight clerk is \$90 per month, and vacancies for this position are filled by promotion from radio operator. By this policy, radio operators of this Company may rise, by promotion, to the highest position which the Company has to offer on shipboard.

U. S. S. Tallapoosa at Key West Navy Yard

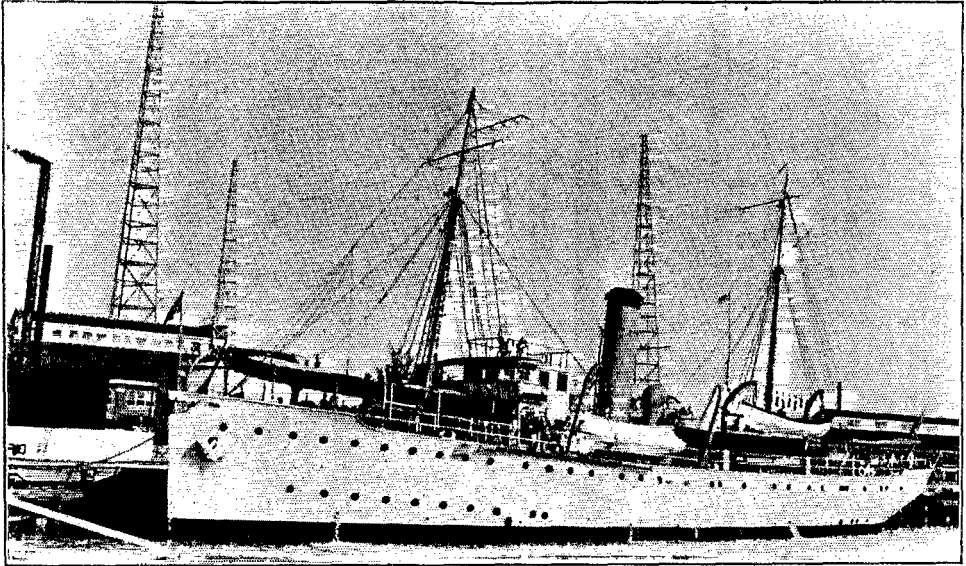

One of our readers, H. L. Brownlie, Radio Electrician of the U. S. Tallapoosa has sent us this photograph showing the Tallapoosa at the Key West Navy Yard and in

the back ground can be seen the three towers of NAR with the three antennas which are used.

Bomb Explosion Prevents Radio Club's Participation in Parade

Owing to the fact that a bomb was exploded while the great San Francisco Preparedness Parade was progressing up Market Street, the San Francisco Radio Club, as well as dozens of other organizations, were prevented from marching in the parade.

After two months of tireless work on the part of the President of the Club, Mr. H. W. Dickrow, and after seeing his entire work come to such a disgusting termination, he has not given up hopes of uniting the entire field of amateur operators in the city into one large organization. A large ten foot sign bearing the inscription "S. F. Wireless Club, Prepared" in letters two feet high, was completed some weeks before the date set for the parade.

The large American flag, the property of Mr. L. O. Fassett, which had been flown from the U. S. "Jamestown," was to lead

the members of the Club. The flag was twelve feet long, its age being indicated by the thirty-eight stars it possesses. Sixty commercial and amateur operators were signed up to march with the Club, all the members meeting at the Custom House at the appointed hour, only to find the Club could not fall into the line of march.

The Marconi Wireless Tel. Co., was supported by members of the Club, twelve members being furnished to march with the Marconi division and thence to march again with the Radio Club. In return, the Marconi Company requested all the operators to favor the Club by marching over again.

A bomb left in a suitcase on the corner of Market and Steuart Streets, exploded about five minutes after the Marconi division passed this spot. Six persons were killed and forty injured, the explosion being

Continued on Page 278



MONTHLY REPORT OF TRUNK LINES
"C" AND "D"

A. A. Hebert, Manager.

We are re-printing the routes of Lines C. and D. By comparing with the August issue, you will note several changes and additions. Several gaps have been bridged and more stations are needed to fill in the question marks.

LINE "C"

- Boston, Mass. to Key West, Fla.
- BOSTON, MASS.
1LE, Harvard University.
- READING, MASS.
1SH, A. O. Parmelee.
- MANSFIELD, MASS.
1IH, C. C. Fuller.
- FALL RIVER, MASS.
1ZF, Harold C. Bowen.
- PROVIDENCE, R. I.
1ZP, Ralph C. Watrous—1UQ, K. E. Barth.
- WESTERLY, R. I.
1TL, Carl O. Flint.
- NEW LONDON, CONN.
1DD, Paul Robillard.
- MIDDLETOWN, CONN.
1WW, Philip A. Bailey.
- HARTFORD, CONN.
1ZM, Hiram Percy Maxim—1ZT, C. D. Tuska.
- WATERBURY, CONN.
1DJ, Geo. E. Cole.
1WH, C. King Sam.
- ANSONIA, CONN.
1VC, Joseph Zander.
- PORT CHESTER, N. Y.
2ZP, John W. Hubbard—2AHN, L. H. Marshall.
- NEW ROCHELLE, N. Y.
2ZK, Geo. C. Cannon.
- PORT WASHINGTON, L. I., N. Y.
2FH, Jacob Weiss.
- YONKERS, N. Y.
2IB, Walter Feeney — 2IK, Martin Jensen.
- NEW YORK, N. Y.
2JD, Arthur R. Boeder.
- LEONIA, N. J.
2ZE, Paul F. Godley.
- LAKEVIEW, N. J.
2IM, I. L. Spangenberg
- NUTLEY, N. J.
2ZH, A. A. Hebert.
- NEWARK, N. J.
2AQ, D. N. Corson—2AAZ, V. F. Pennell.
- ELIZABETH, N. J.
2ES, Robert Campbell, Jr. — 2WG, Harry C. Lemkie.
- ROSELLE PARK, N. J.
20J, Robert H. Horning.
- WESTFIELD, N. J.
2MM, Chas. E. Appgar.
- NEW BRUNSWICK, N. J.
2CG, F. K. Shield, Nelson Dunham.
2ALI.
- TRENTON, N. J.
3DH, Harry E. Stahl, Jr.—3DC, Donald M. Bergen.
- BURLINGTON, N. J.
30H, Lewis Levy.
- ABINGTON, PA.
3AFA, Chas. W. Weber.
- BALA, PA.
3QZ, Chas. A. Service, Jr.
- PHILADELPHIA, PA.
3TQ, Edward C. Andrews—3XP, S. Delbert, Jr.—3JN, A. L. Frankenfield.
- ST. DAVID'S, PA.
3ZS, Chas. H. Stewart.
- PENN'S GROVE, N. J.
3FR, E. Craig Densten.
- WILMINGTON, DEL.
3TN, Silas N. Venn—3FO, Dr. W. G. Hudson.
- BALTIMORE, MD.
3RD, R. G. A. Dimling—3ME, Chas. A. Lamdin. 3AK, Edward B. Duvall.
- ARLINGTON, MD.
3QV, Robert S. Hall.
- LAUREL, MD.
3KI, John S. Stanley.
- HYATTSVILLE, MD.
3XR, J. Harris Rogers—3IG, Harry H. Lyon.
- WASHINGTON, D. C.
3ZW, W. A. Parks — 3PR, E. Frank Ramsey.
- ?
- ?
- ?
- RICHMOND, VA.
3ZK, Frank S. Splatt—3ST, Ralph R. Chappell—3SM, A. Elmo Burnett.
- NEWPORT NEWS, VA.
3TY, Julian E. Krone.

PORTSMOUTH, VA.
3SZ, L. C. Herndon — 3TV, Irving
Blanford.

SOUTH HILL, VA.
3KA, N. G. Smith.

TOWNSVILLE, N. C.
4CV, James E. Smith.

RALEIGH, N. C.
A. & M. College.

WILMINGTON, N. C.
4AF, Arthur L. Humphrey—4BA, Ma-
rion C. Avant.

SUMMERVILLE, S. C.
4BK, Mayrant Simons.

CHARLESTON, S. C.
4CB, Wm. F. Allston—4YC, S. C. Mil-
itary Academy.

SAVANNAH, GA.
4XL, Manning White—4CG, J. A.
Hussey.

WAYCROSS, GA.
4CN, Robert L. Falks.

JACKSONVILLE, FLA.
4AC, Elmer L. Rice—4AZ, Thos. R.
Dunk.

GAINESVILLE, FLA.
4AK, Chas. T. Whiting.

TAMPA, FLA.
4AW, Patrick H. Wall—4CT, Victor C.
McIlvaine.

ST. PETERSBURG, FLA.
4CE, Albert L. Conn—4CU, Glenn L.
Allen.

MIAMI, FLA.
4BF, Seymour Dane — 4AQ, Wm. A.
Marsh.

COCOANUT GROVE, FLA.
4AU, Hugh M. Matheson.

KEY BISCAYNE, FLA.
4BL, H. M. Matheson.

KEY WEST, FLA.
4XA, Geo. W. Almour — 4AB, Isador
Meltzer.

Secondary Route Between Washington and
Jacksonville, Fla.

WASHINGTON, D. C.
3ZW, W. A. Parks.

PROFFIT, VA.
3AHF, Clarence B. Lewis.

MINERAL, VA.
3KC, Thomas F. Flynn.

ROANOKE, VA.
3VF, E. R. Tompkins—3WE, John F.
Wohlford.

DANVILLE, VA.
3RO, W. T. Gravely.

WINSTON-SALEM, N. C.
4CK, Chas. W. Clodfetter.

GASTONIA, N. C.
4CA, Kenneth Babington.

ATHENS, Ga.
4AA, Wilbur B. Pope.

OXFORD, GA.
DECATUR, GA.
4CO, Geo. A. Howald

KIRKWOOD, GA.
4AL, Chas. E. Kruger.

ATLANTA, GA.
4CL, F. F. Merriam—4AM, R. A. De-
Vore — 4BY, Max A. Herzog — 4XG,
Georgia School of Technology.

COLUMBUS, GA.
4CC, R. A. Bowles—4CH, Stephen G.

OCILLA, GA.
4AX, Clarence M. Gordon.

WAYCROSS, GA.
4CN, Robt. L. Falks.

JACKSONVILLE, FLA.
4AC, Elmer L. Rice—4AZ, Thos. R.
Dunk.

LINE "D"

Between New York City and New Orleans,
La.

NEW YORK CITY
2JD, Arthur R. Boeder.

LEONIA, N. J.
2ZE, Paul F. Godley.

LAKEVIEW, N. J.
2IM, L. L. Spangenberg.

NUTLEY, N. J.
2ZH, A. A. Hebert.

CHATHAM, N. J.
2ARF, J. J. Allen.

MORRISTOWN, N. J.
3WN, John P. Gaty.

CLINTON, N. J.
3UC, S. Van S. Howell—3AHW, Walter
S. Leigh.

BETHLEHEM, PA.
3SS, Emil B. Brany—3JK, Stanley E.
Schnable.

READING, PA.
3QD, Frederick J. Andersen.

HARRISBURG, PA.
3PB, Daniel H. Zorger—3AGS, Alvin G.
Michael—3KX, G. Webber Knight.

STATE COLLEGE, PA.
8XE, Pennsylvania State College.

?

?

PITTSBURGH, PA.
8YI, University of Pittsburgh—8RN,
Allen Altman—8AKA, R. C. Bender—
8AEK, L. G. Young.

WHEELING, W. VA.
8ZW, John C. Stroebel, Jr.—8BF, Roy
B. Jarvis.

- FAIRMONT, W. VA.
8AEY, Floyd D. Morrow.
- ATHENS, OHIO
8YP, Ohio University.
- GALLIPOLIS, OHIO
8YP, Ezra L. Saunders.
- PORTSMOUTH, O.
8SR, B. C. Locke.
- IRONTON, O.
8UM, Paul D. Flehr—8ZG, Henry W. Campbell.
- HUNTINGTON, W. VA.
8ANA, D. S. Johnston — NNC, Guy Chambers.
- ASHLAND, KY.
9SW, Frank E. Gammon.
- LEXINGTON, KY.
9YL, Otto Holstein.
- SOMERSET, KY.
9UC, Harry L. Loveless.
- KNOXVILLE, TENN.
MY, May Powell.
- CLEVELAND, TENN.
5ZH, W. O. Horner.
?
?
- HUNTSVILLE, ALA.
5BS, Robert M. McLain.
- BIRMINGHAM, ALA.
5AM, Harold S. Brownell.
- BESSEMER, ALA.
5CR, Geo. D. Cockran.
- AUBURN, ALA.
5YA, Alabama Polytechnic Institute.
- MONTGOMERY, ALA.
5ZI, Wm. H. Amerinc.
?
?
- MOBILE, ALA.
5ZM, Ben W. Martin.
5CU, Daniel M. Booth.
- LAUREL HILL, LA.
5CC, W. J. King.
- FRANKLINTON, LA.
5BB, P. E. Greenlaw.
- COVINGTON, LA.
St. Paul's College.
- NEW ORLEANS, LA.
5AT, Frank M. Stone.
- NEWARK, O.
8AGF, Carl G. Howard.
- COLUMBUS, O.
8ER, Louis W. Elias—8YO, Ohio State University.
- SPRINGFIELD, O.
8PH, Wm. Haynes—8ZM, Ross McGregor.
- DAYTON, O.
8LT, Stanley Copp
8LJ, Carl Linxweiler.
- WAYNESFIELD, O.
8PI, James M. Day.
- HAMILTON, O.
8ZU, Doran Bros. Elec. Co.
- CINCINNATI, O.
8ZF, Henry M. Rubel, Jr.—8PO, J. M. Schaaf—8RY, Carl P. Goetz.
- NEWPORT, KY.
9BN, John H. Flynn, Jr.
- COVINGTON, KY.
9QJ, Kuper Hood, Jr.
- BELLEVUE, KY.
9PZ, Thos. Tallentire.
- IRONTON, O.
8UM, Paul D. Flehr—8ZG, Henry W. Campbell.
- LEXINGTON, KY.
9YL, Otto Holstein. Brannon.
- A number of criticisms have been received since the August report appeared—some favorable, some adverse. Members of the League must realize that we do not pretend to revolutionize existing conditions, which to some would appear unsumountable, in a month or two.
- It is believed that a good start has been made, and if every one will now co-operate, we feel quite sure that before the winter is half over we will have one of the best operating organization of Amateurs in the World.
- Now then, we desire to make the following suggestions to everyone who has been appointed on the Relay Trunk Lines:
- Communicate with the stations North and South or East and West of you and find out all about the sets, if you have already worked with them, and try to bring each other's stations to high efficiency. Practically every Relay Station on Lines "C" and "D," have not less than $\frac{1}{4}$ kw. transmitting sets, and great many have $\frac{1}{2}$ and 1 kw.
- The article by Mr. Paul F. Godley, in the August number, should be read carefully, and will be of great assistance to those who desire to have efficient receiving apparatus. Your manager stands ready at any time to help out any one with suggestions, if he is communicated with.
- The owners of stations between Philadelphia and Washington, should communi-
- Secondary Route, Between Pittsburgh and Lexington, Ky.
- PITTSBURGH, PA, 8YI, etc.
- STEBENVILLE, OHIO.
SLM, B. F. Collins—8ABD, Walter L. Myers.
- CANAL DOVER, OHIO.
8ZX, Harry S. Weber.
- CAMBRIDGE, O.
8CL, Roy W. Waller.

cate with each other, as there seems to be some trouble in handling through work, and undoubtedly this can be fixed up before long if every one will only do his share in finding out what the trouble is.

It is the intention of your Manager to again send test messages regularly, and beginning with September 15th, Friday, and September 19th, Tuesday, and every Tuesday and Friday, thereafter, a test message will be sent addressed to some distant stations.* It is desired that upon receipt of the test message at destination a postal card be dropped to your Manager, or wherever the message is held up in transmission for over two days, advice to this effect be sent to the Manager. This will enable us to check up the delays and give us an idea of the "breaks" in our Lines.

*at 11 P. M. Eastern time.

It is with pleasure that your Manager announces the appointment of Mr. L. L. Spangenberg, 2IM, of Lakeview, N. J., as his Assistant. He will have charge of most of the test work during the coming winter.

We have under consideration also the appointments of District Superintendents, to have charge of the stations in their Districts, which may cover one or two States, depending on the number of stations in each State. With this supervision it is felt, that we can keep in closer touch with each other, and be of assistance to every one, without putting the strain all on one man.

Again we ask to hear from all interested in the work we are trying to accomplish, which we hope to be a source of pleasure to every one of us for years to come.

ARTHUR A. HEBERT,
246 Highfield Lane,
Nutley, N. J.
August 14th, 1916.

♦♦

MONTHLY REPORT OF TRUNK LINES "A" AND "E"

R. H. G. Mathews, Manager.

Mr. Mathews reports that route A has been extended by the addition of
NORTHAMPTON, MASS.

1ZL, D. R. Lewis.

FALL RIVER, MASS.

1ZF, H. C. Bowen.

CAMBRIDGE, MASS.

1LE, Harvard University.

This gives a route through Boston and in the next issue your Manager will be able to report just how matters stand after a test has been tried. We need more stations between Chicago and Boston and it is hoped that many will send in many interesting data. We have been obliged to stay idle during the summer months, but beginning at about the middle of September actual practice will continue.

REPORT OF TRUNK LINES A AND E

The sending of test messages over routes A and E will be resumed on Thursday, September 10. The messages will be sent out on a 200 meter wave by station 9IK, at 10:15 P. M., every Monday and Thursday night until October first, after which they will be sent out on a wave of 425 meters by the same station. Under the latter conditions the call will be 9Z. Mr. Dillon, the radio inspector, has kindly consented to grant me a special license, which goes into effect on October first. I consider this favor quite an honor, as I am located on the lake shore, only two miles from the boat routes, and five miles from the local commercial station.

The routes are as follows:

ROUTE A (East From Chicago)

9IK R. H. G. Mathews, Chicago, Ill.
8NH Mrs. Chas. Candler, St. Mary's, Ohio.
(8ZT) J. J. Crossman, Tiffin, Ohio.
8JZ A. J. Manning, Cleveland, Ohio.
8JX L. H. McCandless, Rochester, Pa.
2AGJ J. K. Hewitt, Albany, N. Y.
2IB W. Feeney, New York, N. Y.

(West of Chicago)

9IK R. H. G. Mathews, Chicago, Ill.
9BD F. W. Keeler, Superior, Wis.
9XN University of North Dakota, Fargo, N. D.
7ZC A. C. Campbell, Lewiston, Montana.
(7ZD) E. Dawes, Bozeman, Montana.
7ZH La Grande, Oregon.

ROUTE E

9IK R. H. G. Mathews, Chicago, Ill.
9GY L. A. Kern, Mattoon, Ill.
9ZL C. Bridges, Louisville, Ill.
9NN H. B. Deal, Cape Girardeau, Mo.
9JT K. B. Warner, Mound City, Ill.
5XO E. Cornish, Little Rock, Ark.
5BV J. M. Clayton, Little Rock, Ark.
5ZC F. M. Corlett, Dallas, Texas.
5ED J. L. Autrey, Jr., Houston, Texas.

Stations in brackets are for use during adverse conditions.

As other stations become necessary, they will be added.

A new policy will be followed this fall. Each of the above mentioned Trunk Line stations will be made the center of a series of short 50 to 100 mile branch routes, which will radiate from each trunk station to the nearby towns. The owners of the Trunk Line stations will each organize these small chains. from the stations around them, and will report the line-ups to me, when completed.

Each operator of a main line station will thus become manager, under me, of a number of short branch lines. A message may be sent over the Trunk Line to the station among whose branches the destination lies, and may then be sent by the operator of

that station along the proper branch route. A maximum of service and speed, with a minimum of relaying may thus be secured.

The operators of the Trunk Line stations named above will please take immediate steps toward the organization of their branch routes to the more important towns near them, and will send me reports on their progress.

A circular letter will be sent to all stations on my routes about September 1st. This

letter will contain a list of all stations and routes appointed up till that time, and will give instructions for the handling of the test messages.

Anyone not understanding the new plan fully will confer a favor upon me by writing me for more detailed instructions.

We need stations in western Texas, Arizona, Oklahoma, and other states along Route E to the coast, and will appreciate reply from stations in that territory.

THE CONTEST

Our Subscription Contest has caught on. As we go to press with this issue, there has not been time for a great many to get started and therefore, our score printed elsewhere in this issue is not a big one. The blank forms printed in this issue are a great many and have signified their intention of entering but who have not had time to get their subscriptions and send them in. Next month will see a big addition to the number.

Everyone ought to lend a hand in this contest either by helping some young fellow who wants to get some good apparatus or by entering the contest himself. Every effort means success to every one of us

because the more we distribute QST, the stronger we become, the better the magazine, and the firmer is our League established. Therefore, if you do not enter yourself, get some one else to step in or boost the chances of somebody who has already entered.

We have been greatly helped by some of the manufacturers who have come forward and offered new apparatus. Just as fast as we can line this up, we shall add them to the list of prizes. We are hoping to get a regenerative receiving set and something else equally good. These will be added in their proper places among the prizes.

NEW NAVAL RADIO SERVICE REGULATION

The Superintendent of the Naval Radio Service announces that, effective on and after July 1, 1916, it will be obligatory on the part of a sender of radiograms to be handled by the Naval Radio Service to indicate in the address of the message the class of vessel it is desired to reach by this service, such as "SS" (steamship or steamer) or "USS" (United States ship), as the case may be. Example:

(Radio)
John Doe,
USS New Hampshire,
Charleston, S. C.

This order becomes necessary, owing to the confusion in proper handling of such traffic, inasmuch as a large number of names of ships are the same as those of cities, towns, etc.

The extra word will be charged for and counted in the check.

THE RENO RADIO CLUB

This club of those interested in the art of Wireless Telegraphy and Telephony in Reno, Nevada, has been in existence for some time and is making good progress in spite of the fact that Nevada, as a state, is somewhat backward in radio development.

Meetings of the Club are held on the first and third Wednesdays of every month.

The officers at present serving are: Hadley Beedle, Pres., Robert Carter, Vice-Pres., Al Heer, Sec., Clifford Sawyer, Treas., Willis Pressel, Chief Operator.



Did you know that you could purchase
the half-tone of your station if it ap-
peared in QST? See the advertisement



SEASON OPENS

The coming of September brings the opening of the season of 1916-17. While static does not ease off materially, yet the Fall officially opens, people begin to put away summer things and summer ideas, and we wireless bugs begin taking stock of what we are going to do. Many of us go away during the summer months and our stations are entirely closed as far as operating is concerned, but when old September gets around and we wander home among the first things we do is to give the set a look over. It is a good scheme. It marks a new chapter and we unconsciously take a brace and try to make things better.

This season is going to see the beginning of many new things among us amateurs. The manufacturers, for one thing, have waked up to the fact that we of the American Radio Relay League actually handle a respectable traffic, and that it will pay to produce the apparatus necessary to carry on this work and expedite it. This season sees the coming of the use of undamped waves among us amateurs. The DeForest Company, for example, have developed a special undamped wave transmitter which we shall report upon in these columns in our next issue. The amateur regenerative receiving set is also come, as Mr. Godley has pointed out in his article from the transactions of the Radio Club of America. Greater knowledge regarding the use of the audion de-

tector has come and many of us know the value of new combinations of condenser and voltage as well as different hook-ups.

In transmitting efficiency, the average amateur throughout the country is altogether better equipped than he was this time last year, and we do not hesitate to say that QST had a hand in bringing about this improved condition. Through the columns of our League paper, each one of us is brought face to face with the fact that some stations are heard distances out of all proportion to what others of us are able to do. This always makes for study of the problem and the determinations to do as well. Last season the big work was done by a handful of us. This season there will be several handfuls of us able to transmit two hundred miles and better.

The Government is also giving us more consideration than we ever were fortunate enough to possess before. Witness the number of special licenses issued in the interior states where it is shown that the operator means business and needs a special in order to fill gaps in our various trunk lines.

So, we repeat, things are going to happen this season, and it behooves every one of us amateurs to keep his eyes peeled and watch the columns of this rapidly growing magazine.

OUR ADVERTISING COLUMNS

We do not want to be criticised for egotism and especially repeating our egotism, but we cannot resist again directing attention to our advertising columns. We have labored long and persistently on these aforesaid columns because they are quite impor-

tant to us. We think ourselves that we have done pretty well because if you will think about it, these advertising columns make mighty interesting and instructive reading. We wonder if there is a more select list of wireless goods in any other

magazine printed. The number of advertisements is not only good considering the total number of manufacturers of really good apparatus in the country, but there is not a single one of them which is not high grade.

Most of us amateurs have been bitten when we were young by some manufacturers of wireless goods, and the Editors are among this number. We think we have a pretty fair knowledge of what is good and what is rotten, and we have tried hard to resist the entrance into our columns of any of the latter. Our readers must think of this when they have money to spend. We do not want to give the impression that no one is advised to buy apparatus not advertised in the columns of our magazine, but

we do wish to point out that no one can go wrong by buying of those manufacturers whose goods are described in QST.

And above all things, brother bugs, remember that you positively must mention QST whenever you write to any manufacturer, because this is what helps us secure and keep the advertising, and you all know how vitally important it is that we carry plenty of good advertising. New goods are being prepared for the market which will make your eyes stick out when you see them, and we are promised advertisements of these. Read the advertising just as carefully as you read the rest of the magazine. It is the only way to keep abreast of the times.

OUR WHO'S WHO

Our Who's Who in Amateur Wireless has turned out to be a hit. We have received all kinds of complimentary remarks about the idea of showing just how each of us look on the printed page, and what we are in real life. We already have the pictures of the owners of many of the most often heard stations, and we know the other fellows throughout the country will be interested in seeing them and hearing about the kind of people they are. We are going to print

first those whose spark is heard most. It is the next thing to actually getting personally acquainted with each other. If we had known what a fine thing we had originated when we started this little scheme, we would have got a patent on it or some other kind of protection. We wonder if it will be another one of the things which will be copied. Even if it is, remember fellows, we began it.

UNDAMPED WAVE SETS

Much discussion of undamped wave work is coming to us here at Headquarters. It seems that the amateurs financially able to bear the expense, are arranging to put in undamped transmitters. Their number is of course limited although it is growing rapidly. On the other hand, many amateurs are talking about undamped receiving sets. These are less expensive, as it is only a matter of hook-up which can be worked out by one's self without much additional apparatus.

Stations located on existing trunk lines must watch out for their laurels, if things go on, because it is not the geographic location which determines the route of a message, so much as the ability to span long distances. Our existing trunk lines would be modified very quickly should it develop that messages could be got through easier by way of other routes than those indicated

by our trunk lines. No one knows at this writing just how this matter is going to shape up, but here at Headquarters, it seems to us that the undamped wave stations are likely to exert quite an influence on long distance traffic, which we all feel is the most attractive and interesting stuff to handle.

The regenerative receiving station is also going to have a bending effect upon our routes because the regular spark signals are going to be handled better with these sets.

Between the two we expect to see the trans-continental traffic rapidly develop and probably confine itself to special routes of its own. It is a dead sure thing that those of us selected for the trans-continental work, will feel several pegs higher up in the list than those who handle the neighboring inter-state stuff only.

MAILING TIMES

QST is scheduled to be issued on the first day of each month. If you do not receive your copy after allowing sufficient time for handling the mail, notify us without fail. However, it is well to keep in

mind the fact that second-class matter travels more slowly than first. If you are on the Pacific Coast, QST may not reach you until as late as the fifth or sixth of the month. Also remember that there are

two mailing times; one on the first, when the magazine is issued, the other about the fifteenth, to fill new subscriptions and mis-sent copies. We hope you will not be too impatient if your copy is delayed a little.

One of the reasons why you may not receive QST is that you have moved without notifying us of your new address. Hardly

a month goes by but what we are troubled with twenty-five or thirty notices from the postmasters that so-and-so has moved or cannot be found. Second-class matter does not follow you around without paying postage on it. To avoid all this confusion, just drop us a line and QST will find you.

QUERIES DEPARTMENT

Now that fall is coming, we amateurs discover the great many questions which we want decided before starting in on the new season,—something about our rotary, or this condenser or that, why our audion won't work. All these things flood in with a number more to the Queries Department and if the Editor were to answer by mail, he would have no time for anything else. With our growing magazine and the small clerical force (when we're flush, we hire a

stenographer two nights a week) this is absolutely impossible. So remember, in the future your query will be answered only through the Queries Department. Now help us all by asking interesting questions which will earn a place in an early issue. Occasionally, the Editor runs across a "sticker," a question which seems to have a pro and con; he expects to refer some of these to the readers for solution. Watch out for them.

NAA MESSAGE

Our President has sprung a new one on us. This time it is nothing less than a relay from NAA. His idea is to develop the possibilities of the Government reaching in a few minutes, a Federal officer in every important town and city in the country. Such a thing might be extremely important some day.

His plan is to arrange with the Naval Radio Service to send out a short message from NAA after the weather report. This message is to be copied by us amateurs all over the country and immediately delivered to the Postmaster in each town. The latter is to endorse to the exact time when the message was delivered, sign his name, and official title, and forward it by mail to the Superintendent of Naval Radio Service at Washington, D. C. The Government would then know just how many different villages, towns and cities could be reached and how

long it would take to reach them. This information is not known at the present time and would be something well worth knowing.

If there are real working stations able to receive a message and deliver it in most of the towns of the country, and if NAA signals are strong enough to be read all over the country even by small amateur sets, it would look as though it had been a wise policy for the Government to encourage us amateurs as has been the policy in the past. Of course a date will be agreed upon when this test will be run and QST will give full particulars. It strikes us as one of the best tests yet suggested. It certainly will be an interesting thing to find out how many places in the country read NAA every night. Our bet is that the number will strike the Government officials dumb.

WESTERN CORRESPONDENT

Without an especially acute observation, it has been easy to note the gradual improvement in our Western news department and the circulation which has been derived therefrom. A great deal of credit is due Mr. Winsor who has assisted the work by taking charge of Pacific Coast news. We amateurs are becoming familiar with this Western news idea and are assisting the work, by reporting radio club activities.

It is hoped that everyone will remember

this and when they think of an idea which ought to be in QST, send it to the Correspondent. He will write it up and it reaches us in due season. Now, don't let modesty interfere with necessity. It is necessary for us to get the data somehow, so if you have a story about yourself remember we all want it. Address, Lindley Winsor, 200-22nd St., Bakersfield, Cal. or call by radio.

WHO'S WHO IN AMATEUR WIRELESS

We shall publish each month two pictures of amateurs who have become known by call letters. This will draw us all closer together. We often curious as to just what the other fellow looks like, and here's our chance to see.— Editor



LINDLEY WINSER
6ZW

It will be very pleasing for all our readers to meet Mr. Winser 6ZW, who is the Western Correspondent for QST. We have noticed the large amount of Pacific Coast news and this is the work of Mr. Winser.

Mr. Winser is twenty-one years old and has been for some time a member of the A. R. R. L. as well as an Associate I. R. E. His first interest in wireless dates back about nine years. Ever since then, it has steadily increased with growing enthusiasm. In 1915, he had a taste of commercial work with the Marconi Company on the Pacific Coast, but he says it is not half as exciting as relaying.

Not favoring the commercial game, he went in with his father in the wholesale fruit business. His spare time has been occupied as he says: "With the most absorbing of all hobbies—Amateur Wireless."



M. B. WEST
8 AEZ

We all know of the station 8AEZ and here is a chance to get acquainted with the owner. This is what Mr. West says for himself.

My first interest in wireless dates from the time that the details of Marconi's invention were published. I was then employed by the Bell Telephone Company and from the meagre details of publication, was able to construct two sets which occasionally exchanged signals over a distance of a short half mile. As these were the old coherer type and no stations were within range, other than the two I had built, my interest soon waned. The set finally became sort of a weather prophet because my wife became quite proficient in predicting thunder storms because of the clatter that our old friend static made. After a time, the

aerial was taken down and all thoughts of wireless vanished with it.

During the winter of 1914 a couple of boy friends came to me for information to put up wireless sets. After talking with them a while, I discovered my information on the subject was absolutely obsolete. I got some literature on the subject and after wading through stacks of old "Modern Electrics" and a couple of library books, we proceeded to erect a pair of masts and to build transformers, tuners, condensers, and everything but the phones and silicon. You may imagine my delight when we finally got things working. The air was full of signals from amateur and commercial stations. Many of you may have heard VAN and it was this station with whom we fought out the puzzling amateur problem. My interest grew by leaps and bounds and finally I decided to own a station of my own.

In the meantime, I had drifted into the automobile business, as have many of the older Telephone men. I suppose that the fascination of the Telephone business had something to do with the interest wireless held for me. The number of telegraph and telephone men who have taken up amateur wireless as a pastime shows the grip which work along these lines has for me.

After planning all summer and working during my spare time, I finally completed my outfit and was ready for a test. I listened in and had the pleasure of hearing 8FJ and 8YL for two hours and one-half before I had a chance to give a call. At last my time came, and I tried 8TI at Tiffin, Ohio, sixty miles away. He gave me an immediate answer and asked who and where BW was. He reported "sigs fine," etc. I went to bed feeling it was a pretty good start. Try to imagine my elation when a few days later I received a card from 9BD, friend Keeler, at Superior, Wis., saying he had copied my conversation with 8TI and also reported that my signals were fine at that distance, 600 miles.

Since that time I have been trying continually to improve my set. I have just finished raising my mast to 110 feet and have changed my antenna to a vertical fan type with fifteen vertical wires spaced 5½ feet at top and brought together 30 feet above the ground. If increased radiation can be taken as a basis for estimate, this should increase the range of 8AEZ considerably.

While I am older than many amateurs, being thirty-seven, it would be hard to find one more enthusiastic. Not the least of my wireless pleasures are the many interesting letters from fellow enthusiasts. Another of the pleasures is the monthly arrival of QST. To read the experiences of other amateurs, many of whom I have heard or worked and to see 8AEZ mentioned in their letters gives me as much pleasure as any.

I cannot help but feel a personal interest in the work the Editors are doing.

With best wishes for the continued success of QST and hoping to hear from all of you when "winter comes again," I remain,

Very truly yours,
(sgd.) M. B. WEST,
Lima, Ohio.

♦♦

SUBTERRANEAN WIRELESS PHONE

It has been announced that Dr. H. Barrington Cox had invented a subterranean wireless telephone. For the last five months Dr. Cox has been working at Los Olives with the United States Forest Service in effort to perfect a system of wireless signals for forest fires.

While thus engaged he discovered the possibilities of transmitting the human voice through the ground. Dr. Cox started for Washington with his invention which consists of an ordinary telephone transmitter connected with the new invention.

♦♦

WIRELESS AMATEURS

I wish to state that Mr. G. C. Sabin, who was in charge of my station last winter is no longer connected with this station, having moved to Springfield, Mass. sometime ago. Any correspondence before October 1st, may be addressed to the writer. Correspondence dated later than October should be addressed to Mr. H. J. Murphy, care of Radio Station. Mr. Murphy will be in charge of the station IZL during the winter.

(Signed) Dean A. Lewis,
Radio Station IZL,
Northampton, Mass.

♦♦

CORRECTION FOR APPLICATIONS OF THE AUDION ARTICLE

In looking over Mr. Godley's article in the August QST, we find the formula for inductance on page 195 should read:

$$L = \frac{2\pi^2 A^2 N^2}{BK} K$$

in centimeters (micro-millihenries)

A=Radius of coil in centimeters.

N=Number of turns in coil.

B=Length of coil in centimeters.

K=Constant.

L=Inductance in centimeters.

Radio Communications by the Amateurs

Log Book in QST

Magnolia, Ill.
Aug. 7, 1916.

Dear Fellow Amateurs:—

What do you think of QST? Personally I think it is THE one radio amateurs paper. It is without doubt the only magazine of its kind and for that reason, we appreciate it very much. I think the Editors are doing a grand work. Let us hope they keep it up and I am sure they will if only we readers do our part. When your subscription runs out, renew at once and don't be afraid to send a new name with it. Money makes the wheels go 'round. I think the contest plan is a good one. The more new readers the better the paper and from the looks of the issue each month I am sure we are getting new members.

I am in a small town. We have no regular day service and the lights go out at twelve. Some days the lights are on and then I make the meter go around by drawing one K. W.. The light man has a small wireless and on special occasions he runs for me. He is a good sport and furnishes the 'juice' while I send. He is the only amateur here and for that reason I am handicapped in the subscription contest. But never-the-less I am going to do my best.

In regard to the range of my station. I have copied the following:—9DU, 9DC, 9LR, 9IZ, 9RA, 9LW, 9BH, 9GY, 9UC, 9PL, 9FW, 9DT, 9UK, 9BT, 9LO, 9VR, 9GJ, 9GU, 9CF, 9AP, 9AB, 9CA, 9RP, 9UY, 9NW, 9IC, 9WN, 9SP, 9MK, 9HQ, 9AFE, 9ACO, 9IG, 9BA, 9AAU, 9DB, 9EM, 9AWR, 9IR, 9AH, 9EY, 9LM, 9AT, 9AGQ, 9TR, 9AGZ, 9AIS, 9NC, 9AC, 9AGN, 9AIL, 9WW, 9UO, 9NU, 9AU, 9IK, 9IH, 9HF, 9NB, 9JR, 9AEP, 9ADZ, 9HK, 9RX, 9WM, 9WT, 9AHM, 9WO, 9AIM, 9YA, 9XL, 9ZS, 9YI, 9XR, 9YG, 9XE, 9XC, 9XD, 9NH, 9AEZ, 9MY, 9PA, and 9XA. This is rather a large list to publish but even at that it is not complete. The above stations range up to seven hundred miles.

Several amateurs may see their call in the above list. This will help you to know how far you have been sending. All the above have been copied since January 1916 and many of them have been copied this summer.

In regard to my sending I may say that I

have sent as far as the eighth district east and have worked St. Louis at noon in the month of May (this year) with the sun shining bright.

If any other stations have heard me farther than Ohio, please let me know because it is very interesting to know just how far your etheric impulses are traveling.

Say, Mr. Editor, don't you think it is a good plan to send a list of the stations you have heard, as copied from ones log book, to the QST? In this way many interesting freak ranges could be unearthed.

Come on fellows send in a copy from your log. Show us what you have done. I am sure the Editor will not charge you for the space you use.

Hoping for the success of the League in the future, I remain,

Yours truly,

ALVIN C. SPENCER.

Editors Note:—

The idea of publishing lists of calls is a fine one. It gives us a chance to see if the other fellow hears our call. We have had a number; let's look for more. Is yours in this list?

☉☉

Audion Circuits

Mr. C. D. Tuska, Editor,
Hartford, Connecticut.

Dear Sir:

Various members and officers of the Radio Club of America have called my attention to an article by Mr. E. B. Andrews,—“The Chambers Aerial Circuit for Undamped Waves”—which appears in the August issue of “QST,” in the belief that, with due fairness to yourself and fellow-amateurs, several gross mis-statements contained therein should be corrected. Mr. Andrews intentions were, no doubt, of the best, but he has apparently allowed his enthusiasm for what (to him) appears to be a commendable contrivance, get the better of his good judgment.

I wish first to state, that, contrary to his assertion, a surprisingly great number of amateurs are familiar with and use the Armstrong circuit. Even in the latter part of 1914 this number was by no means small,

since which time at least a dozen manufacturers have "discovered" a new undamped wave receiver.

He states: "One feature of the oscillating audion when using the large inductances is the ease with which the body throws the circuit out of tune." This is, of course, a function of the relative values of L and C and is not a characteristic of any particular "hook-up." Any circuit may be made insensitive to the approach of the body by making L small and C large, but a great loss in sensitiveness to the signal invariably accompanies such a change. To one who is at all accustomed to the use of these circuits, this "feature" is not at all objectionable.

He continues: "All who have had experience with other methods know how easily static upsets the resonance in the coils used." This is nonsense. Heavy static paralyzes audions, not 'resonance' in coils, and will do so in any circuit unless the well known auxiliary leak is employed.

Again: "This does away with coils and windings which give a large amount of resistance to the feeble impulses and consequently stronger signals may be received." This is absolutely untrue both in regard to theory and practical results obtained. It is not the total resistance of a circuit which is of importance, but the ratio of the

L

inductance to the resistance, or— . When

R

inductance is added to a circuit, the resistance is increased, but with a reason-

ably efficient coil the increase of inductance in the circuit is far greater in proportion than the increase in resistance. As

L

a consequence — is increased and a greater

R

voltage applied to the grid of the audion.

Sliding contacts in an oscillating circuit are especially to be avoided. They are either so noisy in conjunction with a circuit of this type as to make good tuning on weak signals impossible, or they short circuit the turns and thereby effect alarming losses.

What he condemns in one case, he condones in another. The use of enameled wire, as well as the use of sliders has been bad radio practice for at least eight years due to the same reason for which he needlessly and unnecessarily discards taps on the primary. The high specific inductive capacity of the enamel insulation, makes it absolutely unsuited to radio use where silk and cotton are available. What little moisture may be absorbed by the cotton or silk insulation will do no appreciable harm, and even this small amount may be expelled, and a good insulating varnish used to keep it out.

Very cordially yours,

PAUL F. GODLEY,

Chairman, Committee on
Publications, Radio Club of
America, New York City.

Note: Mr. Andrews informs us that the resistance for the high potential battery should be 45,000 ohms instead of 450,000.

The San Francisco Radio Club

Officers: President, H. W. Dickow; Vice-President, Paul R. Fenner; Secretary and Treasurer, William Griffith; Sergeant-at-Arms, Thomas J. Ryan; Examining Officers, H. W. Dickow, D. B. McGown, H. R. Lee.

This Club formed to further the interest of radio telegraphy and telephony in the Bay Cities; it has become one of the best organized and progressive clubs on this coast. Meetings are held every Friday evening at 8:00 P. M. in a tastefully furnished club room, located at 737 Shrader Street. These meetings are alternately devoted to business and a social get-together. It has been proposed to hold a monthly "experimental meeting" at which practical demonstrations of all kinds, including code practice by hand, Vibroplex, and omnigraph will be given.

At each meeting, papers covering items of general interest to the membership are delivered by those best qualified to speak

with authority on their subjects. Papers so far delivered include the following: Mr. McGown on "Ultradions," Mr. Dickow on "Handling Commercial Wireless Traffic," Mr. Fenner on "Waves and Wavemeters," Mr. Heaney on "The U. S. Navy Station at NPI," illustrated with numerous views of the station, and Mr. Lee on "Condensers used in Modern Wireless Circuits."

The membership of the Club is divided into two classes, Full Members and Associates, only Full Members being allowed to hold office. Examination for Full Membership is held monthly and those successful in this examination are granted certificates of skill. Over half the members hold Commercial First Grade Licenses and many are prominent in the commercial wireless field.

Anyone desiring information regarding the Club will write the Secretary, Mr. Wm. Griffith, at the Club address, 737 Shrader Street, San Francisco, Cal.



Radio Station of Seefred Brothers, 6EA

The accompanying photos show the station belonging to Howard C., and Lyndon F. Seefred of Los Angeles, Cal., who are District Managers of Trunk Lines B and F. This station has done a tremendous amount of long distance work during the past winter and spring, carrying on communication with stations all over the State. 6BJ, in Centerville, near San Francisco, Cal., was worked regularly until he closed for the summer, about June 17th.

A one-half Kw. transformer is used for sending in conjunction with a rotary gap (in muffler beside the condenser) large plate glass condenser of rack type and oscillation transformer which looks like a helix, but which, in reality, has two separate coils.

The Seefreds are very partial to pancake type inductances in the receiving set and results would seem to justify them. Both

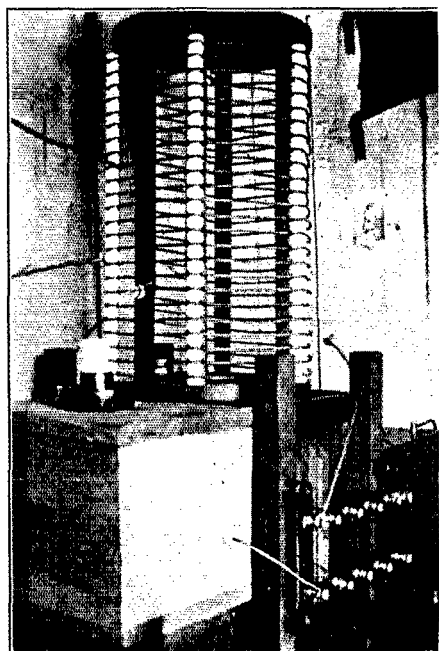

a double audion set, using tubular bulbs, is under construction which will be suited to the reception of both long and short, damped and undamped waves. The fan prominently placed in the photo is used to free the air of smoke when the local QRM gets bad during long distance reception. (This without the authority of 6EA—L. W.)

We are expecting great things from our managing station next season and without doubt will not be disappointed.

Lindley Winsor,
Western Correspondent.



the loose couplers shown are of this type, one for short waves, 150-1500 meters, and the other for longer waves. Galena has been used exclusively for receiving throughout the past season but at present writing

Receiving Set of W. G. George, Ithaca, N. Y.

This photograph illustrates the receiving set of W. G. George of Ithaca, N. Y. The outfit is of the usual amateur type and Mr. George says: "In comparison with those received by some of the League stations whose photographs appeared in QST the signals which I tune in have been very weak. Considering the size of the station, however, the results are very good. With the door of the operating room closed, a friend stood outside, about thirty feet from the instruments and plainly heard NAA and several of the coast stations. During the winter months, I heard NAW very clearly. The amateur stations heard most frequently are: 1ZL, 2SX, 8DN, 8RA, 8GX, 8YO, 8XA, and 9YA."

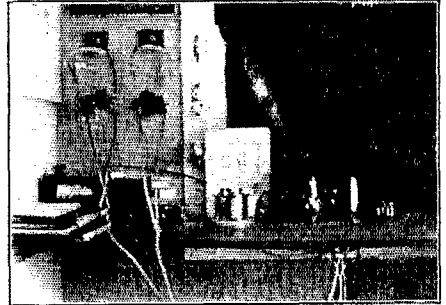

An A. R. R. L. Station in Illinois

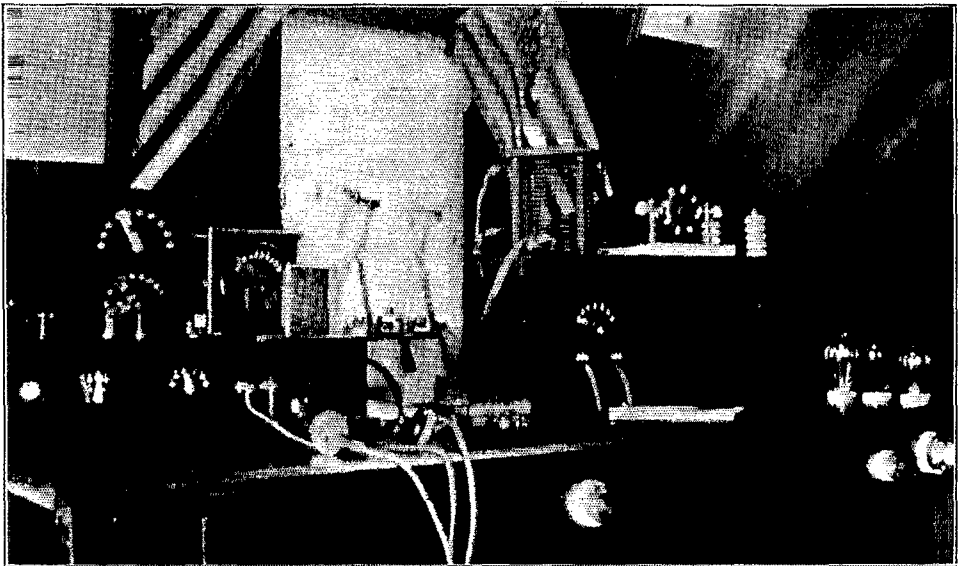

Mr. P. Tronske of Granite City, Ill. has constructed this outfit and everything has been made by him except the phones, rotary disc and motor. Since the picture has been taken, an Audio Tron detector was added to the set. The amateur stations which have been heard are: 9NN, 9FY, 9HX, 9PK, 9IT, 9AY, 9LO, 9IO, 9WF, 8AEZ, and

on one occasion, 8AGN of Rochester, N. Y. was copied. This receiving was all done with a Crystal detector and a pair of Brandes Trans-Atlantic phones. One Kw. is used with a four hundred cycle tone rotary. This gives a sending range of 500 miles, the signals having been heard by L. R. Collins, Akron, Ohio.



This new department has been opened up for the benefit of the readers of "QST". Letters should be addressed, "QST", care of The American Radio Relay League. The Queries Department, Hartford, Conn. The questions will be answered free of charge and as promptly as possible. The answers will in each case, appear in "QST", provided however, they are of interest to the average reader. We are not in a position to answer questions requiring a long, mathematical solution.

The Editor hopes to receive a large number of interesting questions for the next issue. He trusts that you will make your questions of general interest and will refrain from asking questions which you can answer by consulting the Radio Laws and the Call Letter Books. "QST" does not wish to pad this department out with a series of uninteresting, foolish, questions.

RICHARD HITCHCOCK, Chester, Mass.

Question 1. When my rotary is running extremely slowly (about 120 sparks per second) the antenna current rises very high. Would this indicate too much condenser?

Answer 1. This probably indicates too much condenser although since you say the safety gap is jumping, it might be too little. See the August discussion in the Queries Department about this same question.

Question 2. The leads in the closed circuit total thirty inches. If I cut them down to twenty, can I use a larger condenser and get the same wave length?

Answer 2. Yes. This brings up the old, old question which the beginners hardly ever understand. The formula for wave length is as follows:

$$\lambda = 59.6\sqrt{L \text{ cms} \cdot C \text{ mfd}}$$

This means that the inductance in centimeters, times the capacity in microfarads is constant for a given wave length. Then, if you increase L, you must decrease C or vice versa. In your case, you have decreased L so you can increase C and keep the same wave length.

HAROLD H. LEWIS, Lewiston, Idaho.

Question 1. Mr. Lewis asks us to calculate the wave length of a very complicated antenna.

Answer 1. In reply to your first question, the wave length of such a complicated antenna had better be determined by experiment rather than calculation. However, we believe the wave length would be in the neighborhood of 300 meters. The two aerials act similar to a T antenna. (We have

calculated the wave length for receiving. The single antenna for sending would be about 165 meters.)

Question 2. I have a loose coupler which is supposed to tune 1500 meters with an average antenna; in addition I have a 1000 meter loading coil. What would be the best way to increase my receiving wave length to 6,000 or 7,500 meters?

Answer 2. We would advise you to construct a loading coil along the lines suggested by writers in the various numbers of QST. Of course, it would be much more efficient and also more expensive to build a loose coupler for long wave lengths.

Question 3. If I wind wire on a tube to increase the wave length, would it be advisable to wind it in sections with binding posts between?

Answer 3. Yes, it would be advisable to either use binding posts or take out taps at frequent intervals.

Question 4. Could I wind enough wire on a tube 3¼" in diameter by 16½" long to increase the wave length the desired amount without using wire too small for the best efficiency?

Answer 4. This tube would be found satisfactory, but a larger one would prove more efficient since the wire could be about twenty-two instead of twenty-eight or thirty as would be needed in the other case.

Question 5. Would it be necessary to load the secondary circuit?

Answer 5. Yes.

Question 6. We do not understand. It means nothing to ask if a sixty-foot aerial is too large for a two-inch coil. Perhaps you mean, would the wave length be over

two hundred meters and if it were, would a two-inch coil interfere? If this is the question, you will have no trouble, since the wave length will be less than two hundred meters.

V. C. McILVAINE, Tampa, Fla.

Question 1. What wave lengths do the stations NAA, NAR, NAT, NAJ, WGG, and WSL use when sending on arc sets? What time do they usually operate?

Answer 1. See the Queries Department of the June QST for data on this question. Also:—

Call Station	Wave Length	Hours
NAA, Arlington,	1,200, 6,000, 7,500	continuous
NBA, Darien, Panama,	3,000, 10,000	no fixed
WGG, Tuckerton,	7,500, 8,400	continuous
WSL, Sayville,	2,740, 8,000, 9,400	continuous

Question 2. What would be the dimensions of a loose coupler to tune in these stations in connection with an antenna 150 feet long and 55 feet high?

Answer 2. See the article on the Chambers loose coupler in the August issue of QST.

Question 3. What is the best speed for a rotary gap motor?

Answer 3. All things considered, we would advise a speed of about 1800 R. P. M.

GEORGE A. SPRACKLING, Janesville, Wis.

Question 1. I have an audion, RJ9, and get hundreds of amateurs, but Arlington comes in faintly. With galena, we get fewer amateurs, but Arlington is much louder. What is the matter with the audion?

Answer 1. There is nothing the matter with the audion. It is your loose coupler. You have forgotten that an audion is a potentially operated device. While the construction of your loose coupler is all right for galena which does not care much about voltage, it is wrong for an audion. If you wish to go into the matter, turn back to the August issue of QST and read Mr. Godley's article.

Question 2. Will you please show the connections employed in an RJ9?

Answer 2. For audion connections, also consult Mr. Godley's article and you will find Figure 3 the simple audion hook-up.

CEDRIC E. HART, Salt Lake City, Utah.

Question 1. Is the enclosed diagram all right for an undamped wave receptor for an ordinary amplifier?

Answer 1. Your hook-up will work very well as an amplifier, but it will not prove very good for undamped waves. See some of the hook-ups in Mr. Godley's article in the August QST.

Question 2. What is the wave length of my antenna which is ninety-four feet long,

forty feet high, with a lead in of forty feet and a ground connection of fifteen feet? The wires are space $1\frac{1}{2}$ feet.

Answer 2. The wave length of this antenna is approximately 180 meters.

Question 3. Will you please explain something about Litzendraht?

Answer 3. Litzendraht wire consists of a large number of fine enameled wires made into one conductor. For example, seven strands of No. 32 enameled wire made into one and seven of these making 49 in all, form the wire. This big cable is covered with silk insulation and forms a wire not

much larger than No. 18 annunciator. Oftentimes, the conductors number nearly 150. Many of the higher priced receiving sets are connected with this wire as it is supposed to have a lowered dampening factor and less resistance than a single copper wire. In high frequency work, the currents flow on the surface and Litzendraht wire offers plenty of surface.

Litzendraht wire is supposed to have a much lower dampening factor and is therefore used in such instruments as wave meters and decimeters where accurate results are required.

BLAIR AND HAMILTON, Norwood, Ohio.

Question 1. Are potentiometer and batteries necessary when using a galena detector with an audion bulb as a single step amplifier?

Answer 1. No. They are not necessary. R. S. COPP, Dayton, Ohio.

Question 1. Is it possible to copper plate glass by using hydrofluoric acid to roughen up the glass? Does this lower the insulating properties? Is there any method of plating glass?

Answer 1. We believe it would be possible to plate the glass in this manner and the insulating properties would not be lowered appreciably. Electroplaters have no difficulty in electroplating glass with a curved surface, but in the case of a flat plate, it is not practical.

We know of one case where copper wire was fed into an oxyacetylene flame and the wire of course became molten and was blown right against the glass. It was still so hot that it fused the glass and stuck. This formed a copper coating which could be of any desired weight and it was impossible to peel it off. The leads were soldered right on the coating and it formed an admirable condenser in every way.

Question 2. The majority say that better results are obtained with very close spacing on a rotary gap but I get better

results with one-eighth inch between the stationary and the revolving plugs. What does this indicate? Is my condenser too large or too small?

Answer 2. We believe these results do not depend upon your condenser. It is a question of the construction of your rotary. By better results do you mean ampere readings? Or transmitting distance? You might get a high ampere reading, but a correspondingly undesirable high decrement with the long spark and the receiving results would not be as efficient as if you used a short spark with lower decrement.

Question 3. At which end of transmission are the signals effected most? That is, if the conditions at NAR are poor and the conditions at the receiving end are good, or vice-versa, will they be louder with good conditions at the receiving end?

Answer 3. Doctor Austin has done a great deal of work on the question of strength of signals in long distance tests, etc., but we do not believe he has made any statement along the lines you ask. Probably, better conditions at the sending end produce louder signals at the receiving end than vice versa. If you haven't got the signal, you can't get it loud. But in these days of amplifiers and regenerative sets, nothing is impossible.



Editor QST

Hartford, Conn.

Dear Friend:

I bin thinken lately uv going into the wireless bizness and I want sum good advise. I red an artucil in the Suffring Farmers Friend uv a feller who made a detkter with a peece uv cole and a bent saftee pin, and mownted the hole bizness on a hungk uv wood, konnekted it to a old condukschon coil, and with a stov pipe fer an aerial and a pipe (not one that you smok) fer a grownd he herd Arlingten. I kin hardlee beleev this and want to ask yure advise as to whether this is troo or not. I want to no how to mak a skwelched gap. Fer an aerial swich maybe I kin use my Ma's swich, if she dont ketch me. I wood lik to heer frum u soon. I hav bin awful sik and am gettin wers. Hop u are the sam.

Urz in hast,

ADONIRAM Z. FULLOBULL.

EDITOR'S NOTE: This letter was sent to one of our correspondents, who thought it might be of interest to the readers of "QST," and so sent it to us.

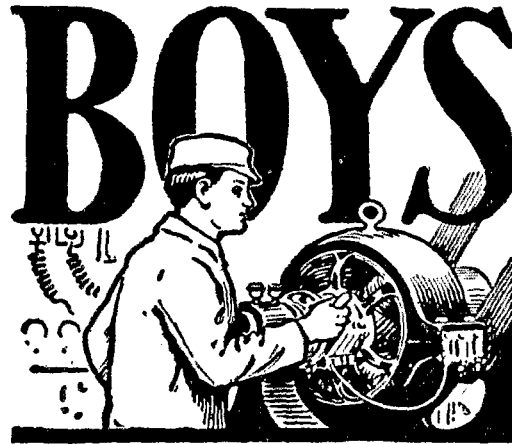

Big Money in Electricity

The electrical industries offer wonderful opportunities to boys with a liking for Electricity. The salaries paid to trained men are large, promotion comes rapidly and, best of all, the work is fascinating.

The discovery and development of new lines (such as wireless telegraphy and telephony), from time to time, promise attractive and paying fields to those who wish to specialize. The *will to do* and *Special Training* will bring success to you.

The International Correspondence Schools can help you to become an expert in electrical work, no matter what branch you like best. Thousands of young men have already won success through I. C. S. help. You can do as well as anybody, *if you try*. Everything is made so clear that you can learn in your spare time, regardless of where you live or what your work. No books to buy.

There's big money in Electricity. Get after it by marking and mailing the Coupon today. *Finding out costs you nothing.*

TEAR OUT HERE

INTERNATIONAL CORRESPONDENCE SCHOOLS

Box 6127, SCRANTON, PA.

Explain, without obligating me, how I can qualify for the position, or in the subject, before which I mark X.

<input type="checkbox"/> ELECTRICAL ENGINEER <input type="checkbox"/> Electrician <input type="checkbox"/> Electric Wiring <input type="checkbox"/> Electric Lighting <input type="checkbox"/> Electric Car Running <input type="checkbox"/> Heavy Electric Traction <input type="checkbox"/> Electrical Draftsman <input type="checkbox"/> Electric Machine Designer <input type="checkbox"/> Telegraph Expert <input type="checkbox"/> Practical Telephony <input type="checkbox"/> MECHANICAL ENGINEER <input type="checkbox"/> Mechanical Draftsman <input type="checkbox"/> Machine Shop Practice <input type="checkbox"/> Gas Engineer <input type="checkbox"/> CIVIL ENGINEER <input type="checkbox"/> Surveying and Mapping <input type="checkbox"/> MINE FOREMAN OR ENGINEER <input type="checkbox"/> Metallurgist or Prospector <input type="checkbox"/> STATIONARY ENGINEER <input type="checkbox"/> ARCHITECT <input type="checkbox"/> Architectural Draftsman <input type="checkbox"/> PLUMBING AND HEATING <input type="checkbox"/> Sheet Metal Worker	<input type="checkbox"/> CHEMICAL ENGINEER <input type="checkbox"/> SALESMANSHIP <input type="checkbox"/> ADVERTISING MAN <input type="checkbox"/> Window Trimmer <input type="checkbox"/> Show Card Writer <input type="checkbox"/> Outdoor Sign Painter <input type="checkbox"/> RAILROADER <input type="checkbox"/> ILLUSTRATOR <input type="checkbox"/> DESIGNER <input type="checkbox"/> BOOKKEEPER <input type="checkbox"/> Stenographer and Typist <input type="checkbox"/> Cert. Public Accountant <input type="checkbox"/> Railway Accountant <input type="checkbox"/> Commercial Law <input type="checkbox"/> GOOD ENGLISH <input type="checkbox"/> Common School Subject <input type="checkbox"/> CIVIL SERVICE <input type="checkbox"/> Railway Mail Clerk <input type="checkbox"/> Textile Overseer or Sup <input type="checkbox"/> AGRICULTURE <input type="checkbox"/> Spanish <input type="checkbox"/> Navigator <input type="checkbox"/> German <input type="checkbox"/> Poultry Raising <input type="checkbox"/> French <input type="checkbox"/> Automobiles <input type="checkbox"/> Italian
--	---

Name _____

Present Occupation _____

Street and No. _____

City _____ State _____

If name of Course you want is not in this list, write it below.

FOR SALE & EXCHANGE



FOR SALE—One audion bulb, round type, with one filament unused, \$4.25. One set of 12 high voltage batteries, brand new "Franco Radio" such as used in De-Forest equipment (list \$0.30 per cell) \$2.40. One nickel drop receptacle for audion bulb, new, for front of vertical case, \$0.60. Will exchange all of above for good Navy type receiving transformer; send description; write at once. Edgar Felix, 528 Riverside Drive, New York, N. Y.

EXCHANGE—For postal card size Kodak will exchange one 4x5 magazine plate camera, one 2¼x3¼ Premo film camera; two developing tanks, one variable condenser, one 2500 meter loose coupler, 12 electrose insulators, one 110 volt motor and knife switches of any kind. R. C. Bender, 2642 Norwood St., N. S., Pittsburgh, Pa.

FOR SALE—One Navy type coupler, \$5.00. One Radioson, \$3.50; one hot wire ammeter, 0-3, \$3.00; one loading coil, 500 meters, \$1.75; one E. I. interrupter, \$1.75; Gernsback variable, \$2.00; one Multi-Audi-Fone with phones, \$17.00, without, \$14.00. Geo. A. Chutter, Swanton, Vt.

FOR SALE—Amco double slide tuner, 2 four ohm telegraph instruments, 2 brand new 25 ampere silver key contacts, and one half inch spark coil without vibrator, apparatus guaranteed in first class shape. E. H. Hartnell, Salem, Wis.

FOR SALE—One 1" Mesco spark coil, \$3.50 and a Thordarson step down transformer, 110 A. C. to 3, 6, 9, 10, 16 and 19 volts; will sell for \$1.75, both instruments are practically new. Walter Belsky, 1134 Findlay Ave., Bronx, N. Y.

FOR SALE OR EXCHANGE—One E. I. Co. Universal detector, \$1.00; one set E. I. phones, \$4.00; one E. I. .0165 mf. condenser, \$.25; one Bunnell telegraph key, \$2.00; two 2-volt ten amp. hour storage batteries, \$1.50 each; one 30 amp. ten volt ammeter, \$1.00; one ten volt battery meter, \$.75; one type S. S. 6-volt, four amp., \$3.00; double head band, \$.75; 110 volt A. C. motor, \$3.00. A. Willhagen, 8-10 W. 109th St., New York, N. Y.

FOR SALE OR EXCHANGE — For high class drawing outfit, 4 amp. 500 volt D. C. motor or generator with sliding base. O. K. for Poulsen system or wireless telephone. W. M. Rowley, R. F. D. No. 1, Wheeling, W. Va.

FOR SALE—Complete sending set. 1 Kw. Blitzen transformer, condenser in oil, rotary gap with variable speed motor, 1/10 H. P., oscillation transformer ammeter, key and anchor gap. Write for photos, if interested. C. G. Fuss, Little Valley, N. Y.

FOR SALE—New Blitzen cabinet set. Cost \$27.50; will sell for \$18.50. Bunnell variable condenser, \$3.00. Parts for variable condenser, \$1.50. Perikon detector, \$1.75; cost \$3.50. Blitzen Ideal tuner, \$7.50. Chas. Massie, Jr., 2540 Bryant St, Minneapolis, Minn.

WILL EXCHANGE OR SELL — A 2Kw. transformer for X-Ray work, for a 1 K. Thordarson or Dawson-Winger transformer, must be in good condition. Roy C. Ehrhardt, 820 Monroe Ave., Scranton, Pa.

BARGAIN—E. I. Co. load coil, fixed variable condenser, galena detector marble base key, strap key, buzzer, tuning coil,

FOR SALE—¾ K. W. Thordarson transformer used but one month. Will sell for \$15.00, cash. F. J. Horgon, Hotel Aquidneck, Newport, R. I.

EXCHANGE—Pittsfield ignition outfit (4 coils, case, switch) in good condition for 3 Electron relays, 3 tubular audions, or pair of Brandes' Transatlantic phones, and three hundred feet No. 14 copper wire. Ignition outfit value at \$37.00. The Washburn, 302 Orange Place, Plainfield, N. J.

WANTED—110 volt dynamo, 10 amperes or more, 1½ K. W. or more, giving alternating current, 60 cycles. Must be cheap and in good condition. W. J. King, Laurel Hill, La.

WANTED — June and July numbers of "QST." Must be in good condition. Walter Lacock, Canonsburg, Pa.

CONTEST SCORES

The first month of the contest indicates there may be several dark horses. The contestants have had hardly time to get started, but this month suggests we are beginning to get under-way. Some of the entries have accomplished a little, while others have done nothing.

If one of your friends is trying, why not help him out? Send him a dollar or two to renew your subscription.

To the entries, the Contest Manager would suggest that you get out and find the amateurs in your town. Show them a copy, and get their subscription. Don't rely solely on the amateurs in your own town. Get up a letter and send it to every amateur you know. Your second cousin's sister may know some fellow who is interested in amateur wireless. Get him. The whole story is to get subscriptions and make them count.

One of our friends writes:

I'm in on the Subscription Contest with both feet and if I don't pull down one of the prizes, up near the head of the list, it won't be my fault. On the quiet, I have my eye on the first prize—but keep it mum. Please send me a boat-load of blanks for my campaign begins right now."

ENTRIES

H. R. Hick, Rocky Hill, Conn.	60 credits
Chas. Shanks, 2660 Sutton Ave., Maplewood, Mo.	41 credits
Hodge Alexander, 537 Center St., Grove City, Pa.	33 credits
Albert O. Parmelee, 155 Main St., Reading, Mass.	25 credits
Carl Linxweiler, 140 Eagle St., Dayton, Ohio.	13 credits
Alvin C. Spencer, Magnolia, Ill.	12 credits
Albert Bousquet, Braintree, Mass.	0 credits
Charles A. Servide, Jr., Bala, Pa.	0 credits
Phil. H. Betts, 238 Valley Road, Montclair, N. J.	0 credits
Adolph Stein, Jenkintown, Pa.	0 credits
V. C. McIlvaine, 208 Verne St., Tampa, Fla.	0 credits
C. R. Pardridge, 521 Nimons St., Saginaw, Mich.	0 credits
Valentine Harrington, Milton, Mass.	0 credits
Wm. Blum, 1811 Arctic Ave., Atlantic City, N. J.	0 credits
Ralph E. Kepler, 210 Allen St., Dayton, Ohio	0 credits
Harold H. Lewis, Lewiston, Idaho	0 credits
William F. Justice, Columbus, O.	0 credits
Ashley Williams, 4300 South St., Lincoln, Neb.	0 credits
Elmer Miller, 1024 Maple Ave., Los Angeles, Cal.	0 credits
Paul J. McGee, 2613 Richmond Ave., Mattoon, Ill.	0 credits
H. Fiedler, 1142 Diversey Parkway, Chicago, Ill.	0 credits

Q S T SUBSCRIPTION CONTEST

Many of the most promising amateurs are held back for the want of money to buy first class apparatus. We have worked out a plan for helping these fellows. We have arranged for twenty different pieces of the latest wireless equipment and all of it is to be distributed among those amateurs who are willing to put in a little work for QST.

The one who sends in the most subscriptions to QST before November 18, 1916, receives the first prize, a \$25 DeForest Audion Detector of the latest type.

The one who sends in the second highest number of subscriptions to QST receives a second prize, a pair of Brandes Navy Telephones.

The third, fourth and so on up to the twentieth, receives apparatus as stated in the list below.

The conditions governing the contest are simple. They are:—

1. You must send in your name and address, and we will send you a quantity of subscription blanks. Your subscriptions must be made out on these blanks, and sent in to Contest Department, American Radio Relay League, Hartford, Conn.
2. Any one interested in wireless is eligible.
3. *To be entitled to any of the first five prizes one must send in a minimum of 20 yearly subscriptions or their equivalent. To be entitled to any of the last 15 prizes one must send in a minimum of 10 yearly subscriptions or their equivalent.*
4. Weekly reports must be sent in beginning August 12th. The score will be printed in QST each month, so you can see how you stand with the other fellows.
5. Part time subscriptions are counted proportionately. For example, a full year subscription counts 12. Six months subscription counts 6, a three months counts 3. If you buy copies and sell them, they also count as one each.

Remember, the most unexpected people are interested in amateur wireless, and will gladly subscribe if you ask them. Your family doctor, sometimes is crazy to know about the extent to which wireless is practiced. We know one ourselves. The grown-ups are the best kind of material, because not only are they interested themselves, but their children might be made to take an interest from reading QST, and moreover, the grown-ups always have the cash.

THE AMERICAN RADIO RELAY LEAGUE, INC.
Subscription Contest Department.

PRIZES

Any one of these may become yours, if you are willing to do a little work in your spare time. QST subscriptions may be secured for the asking. Try and see.

FIRST PRIZE. VALUE, \$25.00

DeForest Audion Detector. Type RJ8

Licensed for Amateur or Private Use Only

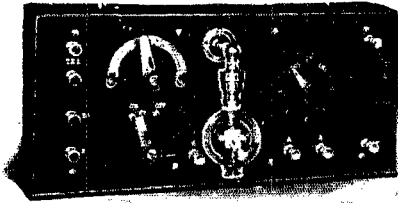

This NEW instrument excels every previous amateur type Audion Detector, thus placing it far above any other detector of any kind ever manufactured. It is provided with a POTENTIOMETER CONTROL for the "B" battery potential by means of a SPECIAL potentiometer designed especially for the Audion, thereby giving a closer regulation than ever before possible, resulting in greater efficiency and more service from the instrument and renewal bulbs.

The Type RJ8 Audion Detector has a hard rubber panel on which all the controls and potentiometer are mounted. The panel is set into a well finished oak cabinet measuring 13 $\frac{3}{4}$ inches long by 6 $\frac{1}{4}$ inches high by 3 inches deep. All of the metal parts are heavily nickel plated. The switch is of our well-known four-ply construction. It cuts the "B" BATTERY off from the potentiometer when the bulb is turned "off" preventing this battery from discharging slowly through the potentiometer. The rheostat for regulating the intensity of the filament is on the rear of the panel and controlled by the "OUT" and "IN" bulb. If the operator desires to incorporate this detector in a receiving cabinet, this can readily be done by removing the panel without disturbing any of the interior parts.

SECOND PRIZE. VALUE, \$14.00

Brandes Navy Type Receivers

This type possesses a peculiar, soft, clear tone—a great advantage for long distance reading. It possesses both extreme lightness and rigid construction. The case is made of hard drawn aluminum, through which the advantages of absolute permanency, lightness and handsome appearance are gained. The ear caps are of hard rubber and, instead of having one large hole in the center, are perforated by many small holes. This is done in order to protect the diaphragm from being damaged should the receivers be accidentally laid on some protruding object.

The wire used in the windings is of the best quality, pure enameled copper, .002 inch in diameter, covered with pure, uncolored silk. The receivers are wound to the fixed number of turns required for best results, giving an approximate resistance of 3,200 ohms to the set.

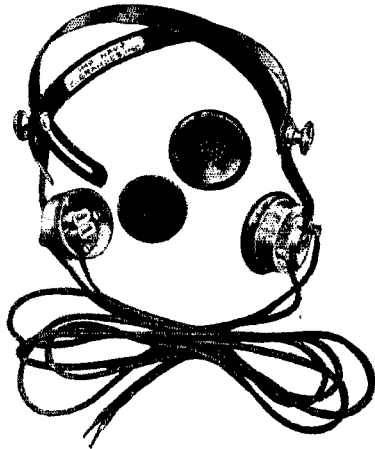

THIRD PRIZE. VALUE, \$14.00

DeForest Audion Detector Type RJ9

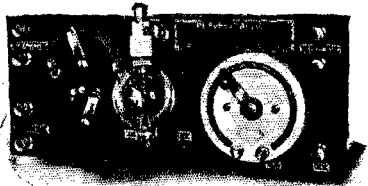

Licensed for Amateur or Private Use Only
This NEW pane' type instrument is the lowest priced Audion Detector. All the controls are mounted on the front of the mahogany panel, which measures 5 by 13 inches.

The control for the "B" battery is a POTENTIOMETER CONTROL giving very close regulation of the "B" battery potential. The switch controlling the filament brilliancy automatically cuts the "B" battery off from the potentiometer when the filament is turned off."

The Type RJ9 Audion Detector is provided with brackets so that it can be screwed to a table. If the operator desires to incorporate it in a receiving cabinet, this can be done readily without disturbing the wiring and parts.
The metal parts of this detector are of lacquered brass.

FOURTH PRIZE. VALUE, \$10.00

A Rotary Quenched Gap

This gap is an instrument which will be a valuable addition to any station. It is a special piece of apparatus which was designed by the Technical Editor. Several were made and gave wonderful results. It is completely enclosed in a bronze casting; this eliminates the noisy spark and at the same time it is built for rapid quenching. It is similar to the gap described in the July QST. There are twelve fixed and twelve moving electrodes. Only needs a motor. The motor is not given with it.

FIFTH PRIZE. VALUE, \$10.00

Brandes Transatlantic, 2,800 ohms

These Brandes' would prove a nice addition to your set; either as an extra pair or as an improvement over your present phones. They are all that is claimed.

The receivers are a trifle larger than the Navy type. Are very sensitive and have the same soft, clear tone that facilitates the reading of long distance signals.

Transatlantic receivers are fitted with diaphragms .006 inch thick, tin plated. The caps are of hard rubber and shaped in such a manner that they fit very closely and feel quite comfortable to the ears. They are wound with silk insulated, pure copper wire .002 inch in diameter, to the required number of turns for the best results; the resistance being approximately 2,800 ohms to the set.



PRIZES 6 TO 15. VALUE, \$5.50 EACH

DeForest Tubular Audion Bulbs

These bulbs are so useful and popular that we are offering ten. This gives you plenty of chance to get one. Show a little pep; it's worth it.

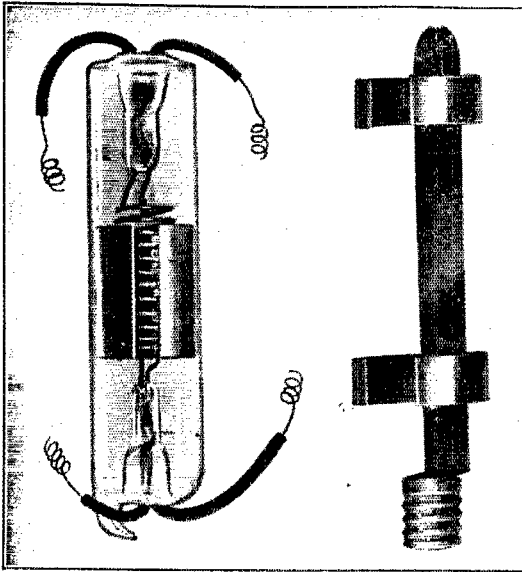

The Audion Detector is the most sensitive detector in existence. The Bulletin of the U. S. Bureau of Standards, Vol. 6, No. 4, Page 540, states that it is fully 50 per cent. more sensitive than any other known form of detector. It is the only reliable sensitive detector.

For the benefit of those amateurs who desire to experiment, and do not wish to buy complete Audion Detectors with the necessary accessories, and for those whose limited means will not permit the complete instruments to be purchased, we have brought out the Type T Tubular Audion Bulb.

Commencing March 15th, 1916, this type of Audion will be sold separately, without the other parts necessary for a complete Audion Detector. It is licensed for amateur use only and is NOT interchangeable with the regular round Audion Bulbs.

This type of Audion Bulb gives very loud response to signals. Every bulb passes two tests by our experts and is thoroughly up to our standard of sensitive qualities. It is finished in only one grade—the best.

The life of the Type T. Tubular Bulb is exceptionally long on account of the fact that the single straightline filament has no loops, and as there is no second filament, the Edison discharge to same is completely eliminated.

The plate or wing is in contact with the glass, preventing overheating. The filament is surrounded by a spiral grid.

This type of bulb is an excellent oscillator for the reception of continuous waves, being different in this respect than round Audion Detector Bulbs.

The grid is the spiral inside the tube and is connected to the green covered wire. The plate is connected to the red covered wire. The filament terminals are the white covered wires.

PRIZES 16, 17 AND 18. VALUE. \$5.50

Brandes Superior Phones

How often have you had visitors in your station and only one pair of telephones? It's inconvenient to say the least. You really should have an extra pair for your friends and this is the chance to get them.

Continued on following page



These receivers are without doubt among the best that can be bought on the market today for very little money. The case is made of aluminum, insuring rigid construction and lightness. All the interior parts are nickel plated and polished giving them a handsome appearance. The bobbins are wound with No. 40 pure copper enameled wire to the proper number of turns which register a resistance of one thousand ohms per receiver. The diaphragms are .006 thick, tin plated, and the receivers are fitted with hard rubber caps. None of the material is substituted by a cheaper grade such as, for instance in the cap and diaphragm which could be easily made of much less suitable materials and considerable money saved in the manufacture of these receivers. There is no question that these receivers are very substantially built and will do wonderful work for receivers sold at this price. In fact, we have reports from people who claim that they are better than receivers which cost as much as eight dollars per set.

PRIZES 19 AND 20. VALUE, \$3.50

Crystaloi Detector

Do you need a stand by detector? Here is a reliable one which is a prize well worth owning.

Start after it today!

The Crystaloi is a radical departure from any of the well-known types of detectors which depend on a metallic point in contact with an extremely minute portion of a sensitive mineral, which is subject to burn-outs, going dead, and the disadvantage of having to hunt around on the surface of the mineral for a sensitive point.

The principle of the Crystaloi is exactly opposite from that of any other detector, inasmuch as instead of a fine point of metal coming in contact with a minute portion of a sensitive mineral, the Crystaloi is constructed in such a way that a comparatively large surface of a very sensitive mineral is brought in contact with a great many points of a very light, finely divided alloy which becomes a conductor only when traversed by high-frequency oscillations. This arrangement renders the receiving apparatus remarkably free from static and other interferences, and is wonderfully sensitive.

It is only necessary to put the Crystaloi in circuit with a buzzer and while holding the key down, rotate the cylinder until the signals are loudest in the ear phones, at which time you are ready to receive anything that is in the air. The Crystaloi requires no battery or potentiometer and is ever ready to serve you under all conditions.

The Crystaloi is wonderfully sensitive, owing to the fact that the alloy is very light in weight and makes a very delicate contact.

Every Crystaloi detector is actually tested by putting it in service at our station and is guaranteed to do exactly what we claim for it or we will take it back and refund your money.



Rotten Management. Continued from p. 238

us all about it." Not having the liking of being a party to any jokes, I turned out "QRM" and got a repeat. Then it was I learned our roof had caught fire from the aerial-lead. Seems as how the rope which guyed the lead had stretched and the result was the house got too near the wire. It had burned slowly, thus allowing me to get far on my way. To help matters along the cook was sick at her home and the family were at church. Nobody home but the fire and that soon went out. However, the result was fire-horses, bells (fire), excitement galore, etc. Last but not least came an epistle from friend Radio Inspector: "Merry Xmas, but don't do it again."

Not to be forgotten, most of the fellows around about had long wires and borrowed neighbors' houses to assist in the decorating. As a result of the above the said neighbors had received the fright of their young lives and at once tabooed the long aerial idea.

Thus is the varied life of a wireless fan. I wouldn't call it "rotten Luck" in this instance, for what luck there was, was good luck. The house still stands. I christen thee **ROTTEN MANAGEMENT**. Best regards to the Old Man.

**Sixty Cycle Wireless Telephone
continued from page 250**

white glare, it shows the carbons are burning.

Throughout the experiments, a high voltage transformer (Packard) was used and the arc gave less trouble than when a low voltage transformer was used. The power varied from two to three amperes which were adjusted by the lamp bank.

One plate of condenser gave the right capacity for a two hundred meter wave. The writers have experimented three years with this sixty cycle phone and have talked twenty-two miles from Los Angeles to an amateur in Long Beach. They were also heard by another in Pomona, Cal., thirty miles distant.

Bomb Explosion Prevents Radio Club's Participation in Parade. Continued from p. 253

the cause of many organizations dropping out of the line of march, totally upsetting the plans of the San Francisco Radio Club. The spirit of the members has not changed; in fact, it has put new spirit into them.

Meetings of the Club are held every Friday evening at their Club room, 737 Shrader Street. Lectures are delivered bi-monthly, a printed copy of each lecture being sent to the members. A complete course of instruction in Radio Communication started on July 14th, the Fundamental Principles of Electricity and Magnetism being discussed at this meeting. The membership of the Club is rapidly increasing, from three to five new operators being admitted monthly.

Mr. D. B. McGown was elected Vice-President at a recent election, while Mr. L. O. Fasset was elected Examining Officer with Mr. C. M. Heaney as his Assistant. Mr. H. R. Lee succeeded Mr. W. M. Griffith as Secretary-Treasurer, Mr. H. W. Dickow remaining in office as President of the Club. The Social meeting was held on July 7th, and proved to be a great success, the members being entertained with music, card and checker games, smoking and singing. All radio operators of San Francisco are cordially invited to attend any meeting.

SPECIAL LAND STATIONS

Station	Call Signal	Wave Length	Service	Hours	Station Controlled by
Bakersfield, Cal.	6ZW	200, 425	P	X	Lindley Winsor
Beverly Farms, Mass.	1ZH	200, 300, 425, 600	P	X	Wilbur H. Hardy
Eldora, Ia.	9ZI	200, 425	P	X	Donald R. Lewis
Lewiston, Mont.	7ZC	200, 425	P	X	Arthur C. Campbell
Marlboro, Mass.	1XS	300, 600, variable	P	X	Lewis W. Stevens
Morgantown, W. Va.	8XG	650,	P	X	C. W. Waggoner, (W. Va. University)
New Rochelle, N. Y.	2ZK	280, 425	P	X	George C. Cannon
New York, N. Y.	2ZA	300, 450, 600	P	X	N. Y. Police Dept.
Pierre, S. Dak.	9ZP	200, 425,	P	X	Dana McNeil
Pittsburgh, Pa.	8XC	1800, 2100, 3000	P	X	Carnegie Institute of Technology
Seattle, Wash.	7XE	300, 600, variable	P	X	Marconi Company
Stillwater, Minn.	9YM	200, 300, 425	P	X	Fred B. Wood (Minn. Nat. Guard)
Van Couver, Wash.	7ZN	200, 300, 425, 600	P	X	George H. Wallace
Washington, D. C.	8ZW	200, 425,	P	X	Walther A. Parks

THESE FIVE INSTRUMENTS HAVE SET NEW STANDARDS

They are in a distinct class by themselves. There are no other instruments of their respective types on the market which can EQUAL THEM IN ANY WAY—regardless of price. We can prove this assertion to the satisfaction of anyone.

We have been in business for a good many years. The first receiving transformer ever designed for amateur use was manufactured and placed on the market by the Adams Morgan Company. We also were the originators of the Navy Type receiving apparatus wherein switches replaced sliding contacts. We have always led, and will continue to lead, and as a responsible organization, we guarantee our apparatus to be as represented. Upon receipt of price, any one of the instruments shown herewith will be forwarded subject to a 10-DAY TRIAL. If you do not wish to keep the instrument, your money will be cheerfully and promptly refunded.

SEND STAMP TODAY FOR BULLETIN "O" WHICH DESCRIBES A VARIETY OF ENTIRELY NEW TRANSMITTING AND RECEIVING SPECIALTIES, OF PARTICULAR INTEREST TO THOSE WHO DESIRE THE BEST.

Unquestionably Superior to Anything Else on the Market

The coils are wound with uncolored, double silk insulated copper wire upon heavy impregnated cardboard tubes and finished with a special transparent insulating varnish of unusually low specific inductive capacity. The methods employed eliminate leakage due to coloring matter in the insulation, put an end to the presence of moisture in the varnish, insulation and tube, and give to the coils the appearance of having been wound with highly polished bare copper wire. The coils of the "No-End-Loss" transformers are divided into sections, and fitted with self cleaning, positive action end turn switches which connect and disconnect the winding as required, entirely cutting off from the circuit unused portions of the inductance and completely eliminating end turn effects on all wave lengths. These switches are enclosed and are automatically controlled by the primary and secondary inductance switches respectively.

Particular pains are taken throughout in the wiring. Connections, leads and switch points are so arranged and designed that unnecessary capacity have been done away with. All switches have been carefully assembled,

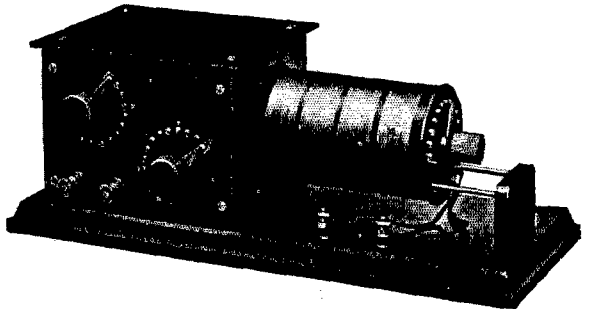

NAVY RECEIVING TRANSFORMER
No. 7729 Price, \$15.00 No. 7700 Price, \$18.50

and are smooth in action, positive, and of low resistance. Panels, housings, switch heads, etc., are of polished black FORMICA, which is superior in every way to hard rubber and costs more. All metal parts are of gold lacquered brass. These instruments are adapted to extremely close tuning and due to the absence of "No-End-Loss" transformers are particularly recommended as the only receiving transformers on the market suited to the reception of amateur wave lengths or for use in conjunction with the audion detector.

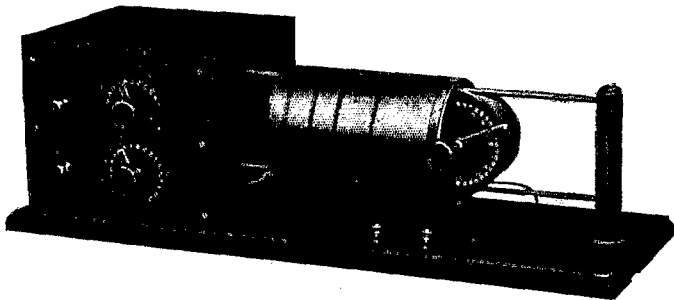

PARAGON RECEIVING TRANSFORMER
Type 'L' \$22.50 Type 'S' \$30.00 Type 'X' \$35.00

SEND 6c. FOR OUR 232 pp. CATALOG

Our No. 7 Catalog shows several hundred different parts and also sets of materials for building your own apparatus. We do all the difficult work in our factory and give you the benefit of machinery and equipment

Contains complete description and prices of all the latest Wireless and Electrical Goods.

OUR PRICES WILL SAVE YOU MONEY AND OUR PROMPT DELIVERIES WILL SAVE YOU TIME.

THE BEST CATALOG OF ITS KIND IN AMERICA

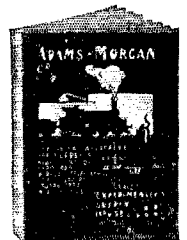

Adams-Morgan Co.,

Sixteen
Alvin Place

Upper Montclair, N. J.

Always Mention "QST" When Writing to Advertisers

UNDER MARCONI COMPANY'S CHIEF INSTRUCTOR

become a well-trained Radio Operator in 6 months. NEW EVENING CLASS NOW FORMING. Licensed employment department will assist out-of-town students to find temporary day employment. Comfortable dormitories in modern Association Bldg., centrally located for Jersey, Lower New York, Long Island City and Brooklyn. *The demand for radio operators now greatly exceeds supply.* The development of radio communication is demanding more and more skilled workers. Our course provides thorough foundation for future study, enabling operators to advance in the art. Great stress is laid on laboratory experiments, with complete commercial apparatus. Special training given on advanced types of trans-oceanic equipment. Course under the personal supervision of the Instructing Engineer of the Marconi Company. Write for folder.

EASTERN DISTRICT Y. M. C. A.

Marcy Ave., near Broadway

13 minutes from New York City Hall

BROOKLYN, N. Y.

18 minutes from Hudson Terminal

You don't know what Signals are until you have heard a Two Step M. A. F.

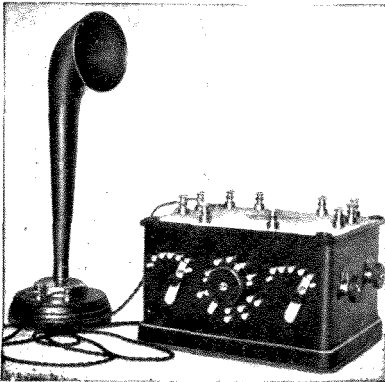

Multi-Audi-Fone	-	\$18.00
With Special Head Set	-	23.00
M. A. F. Detector Stand	-	4.25
M. A. F. Fixed Condenser		2.00
Pocket Wireless Receiving Set		5.74
Undamped Waver		45.00 and 100.00
Detector Fone		35.00

PRICE \$60.00
AFTER OCT. 1st 75.00

SEND FOR NEW CIRCULAR

Multi - Audi - Fone

275 Morris Ave.

Elizabeth - N. J.

A Turn your spare
G time into
E money
N
QST **T**
S

THE AMERICAN RADIO RELAY LEAGUE. HARTFORD, CONN.

QST needs bright young men in all parts of the country to act as circulation agents. This is an opportunity for you to earn some money in your spare time. If you would like to become a circulation agent for QST, send in your name and address for the "salesmen" proposition.

Always Mention "QST" When Writing to Advertisers

THE MOORHEAD TUBE

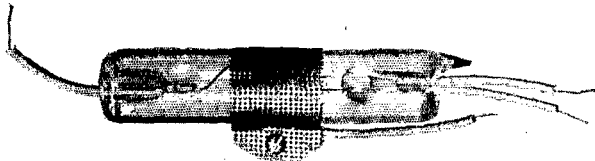

PATENT APPLIED FOR

AFTER several months experimental and research work we can now offer a new and original device for damped and undamped waves reception. *The Moorhead Tube contains no grid electrode.* The action is new and basic and does not infringe any known patents. Static elimination as high as 50 per cent. As this device contains no grid and is controlled by external means the static or atmospheric strays do not affect the detector. Guaranteed to be more sensitive than our TRONS and ELECTRON RELAY. *Persistent Oscillator — Powerful Detector — Super-sensitivity Detector.* OPERATES IN ANY CIRCUIT, 4 volt filament, 10 to 35 volt plate. Filament life guaranteed 1200 hours.

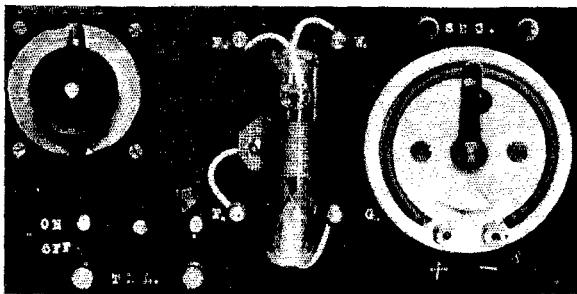

SPECIAL INTRODUCTORY
PRICE

\$6.50 Prepaid

Special Sets for Moorhead
Tubes

Potentiometer control
Special B Batteries

Complete

\$16.50 Prepaid

WRITE FOR CIRCULARS

DEALERS NOTICE. Get our proposition on this tube. We are not infringing any patents and are not concerned in suits.

PACIFIC RESEARCH LABORATORIES

SOLE MANUFACTURERS

Address: Pacific Laboratories Sales Department
534 PACIFIC BUILDING

SAN FRANCISCO, CAL.

Always Mention "QST" When Writing to Advertisers

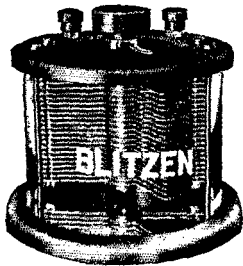

THE BLITZEN ROTARY
VARIABLE CONDENSER

has a glass case because we're proud to show its high grade material and workmanship. You'll only need one glance to see its aluminum plates, accurately machined brass separators and substantial bearings.

43 plate condenser, Price \$4.50.

17 plate condenser, Price \$3.50.

TO HIM

who seeks "Something for Nothing" is usually given "Nothing for Something"

TO YOU

who seek quality
who demand results
who crave satisfaction
who enjoy fair dealing
who will send 6 cts. postage

TO US

will be sent two catalogs of wireless and electrical apparatus describing products recognized as standard for ten years of continuous manufacture

**CLAPP-EASTHAM
COMPANY**

141 Main St.
CAMBRIDGE, MASS.

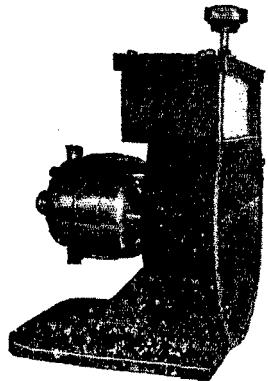

SEMI-QUENCHED
CAMBRIDGE ROTATING
DISCHARGER

The Cambridge Semi-Quenched rotating spark discharger is completely enclosed; has glass covered inspection opening, variable speed motor of the highest quality and operates on any wireless transformer.

Price \$32.50

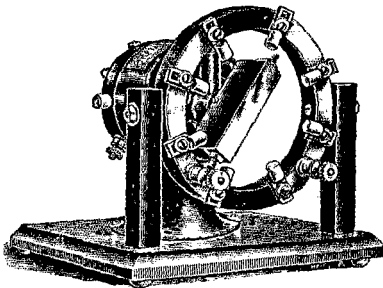

Hi-Tone Rotary Spark Gap
Price, \$12.50

Efficient
Transmitting
Apparatus

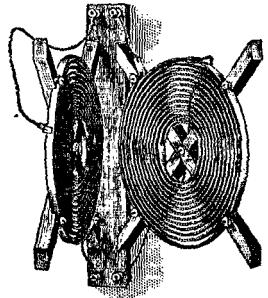

Telefunken Type Oscillation
Transformer. Price, \$6.25

We manufacture these and many other pieces of efficient radio apparatus. Send for copyrighted "Undamped" circuit, and other bulletins.

RADIO APPARATUS COMPANY OF AMERICA

PARKWAY BUILDING, PHILADELPHIA, PA.

Always Mention "QST" When Writing to Advertisers

THE NEW TURNEY VARIO VARIABLE CONDENSER

HAS SEVEN SCALES

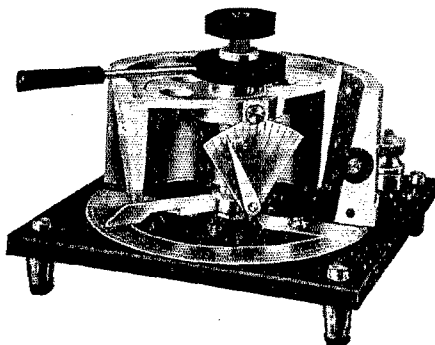

DIMENSIONS 6 in. x 6 in. x 3 in. SHIPPING WEIGHT 2 LBS.

SCALE READINGS

Scale No. 1-0 to .001 M. F.	Scale No. 4-0 to .00012 M. F.
Scale No. 2-0 to .0005 "	Scale No. 5-0 to .00007 M. F.
Scale No. 3-0 to 00025 "	Scale No. 6-0 to .000055 "
Scale No. 7-0 to .000035 M. F.	

PRICE \$8.00

POSTAGE
EXTRA

The new TURNEY VARIO VARIABLE CONDENSER is a real innovation in variables. It is seven complete Condensers in one, has seven different scales all of different maximum capacities and approaches an absolute zero heretofore unknown in Condensers. There are no plates to warp, therefore the instrument remains constant. The movable and stationary members are made of a special alloy which in appearance resembles silver and will not tarnish.

The new TURNEY VARIO VARIABLE CONDENSER is ideal for EXTREME MEASUREMENTS where absolute accuracy is demanded. It is incomparable for WAVE METERS, Regenerative Ionized Gas and pure Electron Detector circuits. The entire instrument (with the exception of the base which is of Bakelite) is engine turned and is made with the greatest care. Don't buy a Condenser until you have seen the TURNEY VARIO VARIABLE.

Eugene T. Turney Company, Inc.
2595 Third Ave., New York City

Always Mention "Q S T" When Writing to Advertisers

"THERE IS ONLY ONE AUDION, THE DE FOREST"
DE FOREST ULTRAUDION DETECTOR
 FOR DAMPED AND UNDAMPED WAVES

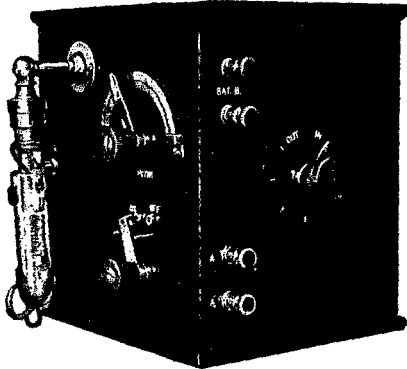

TYPE UJ1
DeForest Ultraudion Detector
Price, \$27.50

The new DeForest Ultraudion Detector enables every operator to receive both spark and arc signals at minimum expense. This instrument is made for private or amateur use only, and is within the means of all. Heretofore the lowest priced genuine Ultraudion cost \$110.00.

We now offer the new amateur type at \$27.50. It is equipped with potentiometer control for the "B" or high voltage circuit, arranged for external batteries to be furnished by the purchaser, has an internal rheostat like our higher priced instruments, and is equipped with the genuine DeForest Tubular Audion with adapter.

No complicated circuits for tuning are necessary or desirable. Simply a regular tuner of proper size is used. No need of spending

money on large, expensive coils to receive Darien, Nauen, Eilvese and all the undamped stations.

The genuine DeForest Tubular Audion illustrated herewith is now within the means of all amateur operators. It is sold to anyone in any quantity without the return of the old one.

Fully 50 percent more sensitive than any other known form of detector and thoroughly reliable. Tests show an operating life of at least 800 burning hours when properly used, equal to at least a year's service.

With it the maximum receiving range can be covered. Suitable for receiving arc and spark signals and also for amplifying. Each equipped with a static shunt to prevent paralyzing from static and loud signals. Guaranteed to be delivered to you in perfect condition.

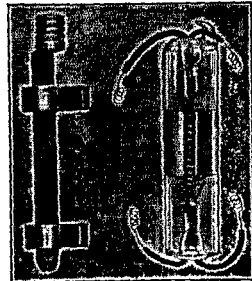

Genuine DeForest Tubular Audion
Price, \$5.50, delivered
Adapter, 40c extra

ACCEPT NO INFRINGING IMITATIONS.

INSIST ON THE GENUINE ARTICLE

Send stamp for Bulletins R16 on the Audion Detectors, Audion Receiving Sets
 the Tubular Audion and the Ultraudion

"WARNING—You are entitled to the genuine Audion, guaranteed by the owners of the Audion patents, when making an investment of this kind. Any evacuated detector having a filament, a grid and a plate, as well as other types, are covered by our patents, and several irresponsible infringers are being prosecuted. To be safe and get full value for your money, insist on the genuine DeForest Audion."

DeForest Radio
Telephone & Telegraph Company

101 PARK AVENUE

New York, N. Y.

Makers of the Highest Grade Receiving Equipment in the World

Always Mention "QST" When Writing to Advertisers

Has an Illustration of Your Station Appeared in QST ???

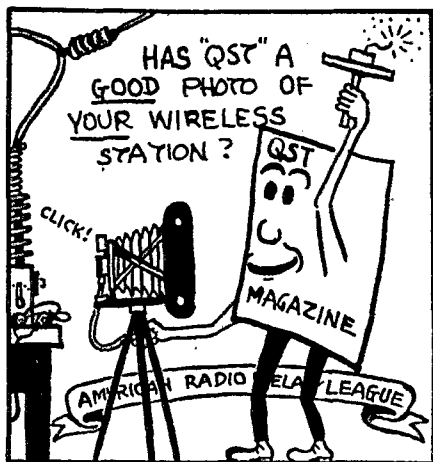

If it has, you are in luck. You can buy the half-tone and do what a great many amateurs have begun. The scheme is to print a photo on your stationery from the engraving. Then, when you write to a fellow-amateur, he can see just what your station looks like and all about it. It is a fine scheme and to help it we shall place on sale—for the owners—half-tones of stations which appear in QST.

These cost us from a minimum of \$1.25 up to \$2.50. We shall sell each one, regardless of size, for \$1.00. This gives you a chance to save some money and get in on a dandy idea. If your station has enjoyed the honor write today; just enclose a dollar, ask for your half-tone, and it will be sent post-paid by return mail.

ADDRESS: ILLUSTRATION DEPARTMENT

American Radio Relay League, Hartford, Connecticut

BRANDES RADIO HEADSETS

Superior Type, \$5.50



Made for Long Distance Reading

Send 4c in stamps for our new catalog "F"
of select wireless apparatus

C. BRANDES, Inc.

32 Union Square, Room 821
NEW YORK

We
Guarantee
First Grade
Commercial
Operators'
Licenses



The Largest,
Best Equip-
ped and ONLY
Practical
Radio School
in New
England

LEARN WIRELESS

"SEE THE WORLD AND GET PAID FOR
DOING IT."

Good positions secured.

Our graduates now with the Marconi Wireless Tel. Co. of America, Marconi Wireless Tel. Company of Canada, United Fruit Company, National Electric Signalling Company, U. S. Navy, U. S. Coast Guard Service, Private Yachts, etc.

Endorsed by Government and Marconi officials.

Fall classes both Day and Evening start September 18th. Send stamp for our prospectus which contains detailed information also free call list and other useful data.

Eastern Radio Institute

399 E. Boylston St.

BOSTON - MASS.

New Undamped Wave Coupler, No. 749

Special Introductory Price, \$18.00

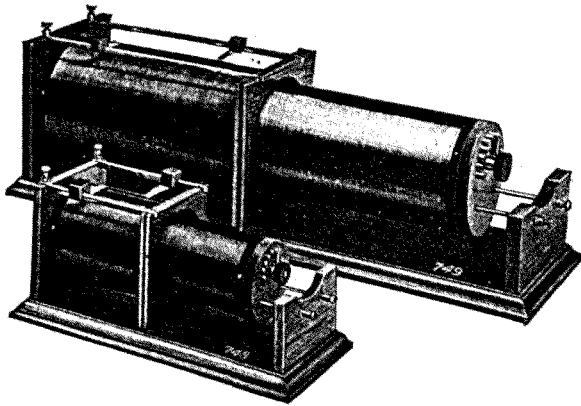

Our new Coupler No. 749 is 32 in. long, 9 in. wide and 10 in. high over all, and on the average sized antenna tunes up to 15,000 meters. This Coupler, used with the new CHAMBERS' SYSTEM OR CIRCUIT will bring in signals from domestic and foreign Arc Stations surprisingly loud and clear. Note the difference in size of our No. 748 and the new No. 749.

We claim to be the original inventors of a SYSTEM OR CIRCUIT, for the reception of the undamped waves without the use of Loading Coils or Oscillating Coils, as they are sometimes called; as with our system or circuit only two inductively coupled coils are necessary. Circuit supplied with each coupler.

This CHAMBERS' CIRCUIT saves you money. Think of it! No extra coils to pay for, and price of coupler only \$18.00.

Place order now so as to be in on the introductory price. Orders filled in rotation. Send for descriptive matter.

F. B. CHAMBERS & CO.

2046 Arch Street
Philadelphia, Pennsylvania

Announcing the Tubular De Forest Audion Bulb

"There is only one Audion—the De Forest"

The New Type T Tubular Audion Bulb gives very loud signals from powerful stations. It has a large cylindrical plate, a spiral grid and only one filament of tungsten. As this is a long, straight-line filament, it has a long life. Edison effects are completely eliminated. The plate is in contact with the heavy glass tube, preventing overheating.

Sold Separately, \$5.50 each

The special adapter fits this type to the screw base receptacles of De Forest apparatus, and is furnished at 40 cents extra.

**Send stamp for Bulletins D16
and B16**

**The Wireless Mfg. Co.
Canton, Ohio**

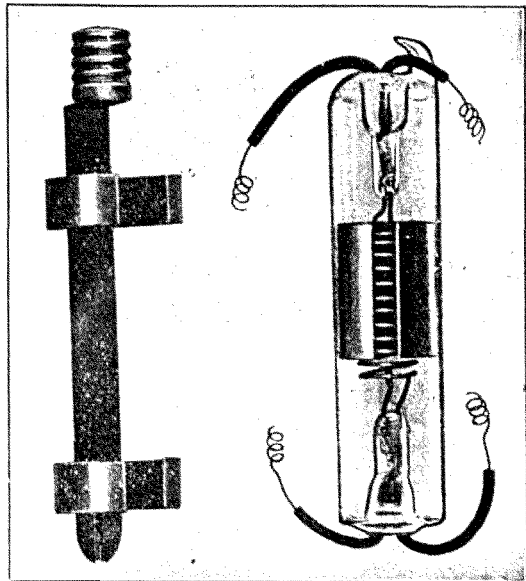

Always Mention "QST" When Writing to Advertisers

IT TELLS YOU HOW TO BUILD YOUR OWN APPARATUS

Everyday Mechanics

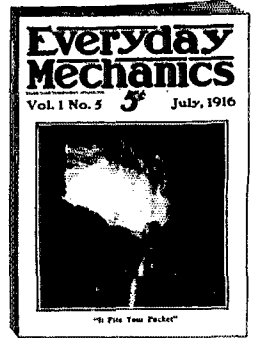

is the first and only magazine in the world devoted exclusively to constructional "how-to-make and how-to-do" material. It is edited by Thomas Stanley Curtis, whose articles and work you have known since the old days of **ELECTRICIAN AND MECHANIC**. It contains no war pictures, free write-ups of new devices, general news features. It is solidly and consistently filled, to the last of its ninety-six pages, with practical how-to-make and how-to-do articles.

EVERY FEATURE article that appears in the magazine is prepared from the data obtained in the actual construction and operation of the apparatus described. For every article, a model is constructed in the **EVERYDAY MECHANICS EXPERIMENT STATION**, Van Nest, N. Y., where it is given a practical working test. This means reliability and satisfaction.

EVERY NEW SCIENTIFIC discovery and achievement will be worked out in amateur form in the Experiment Station for the benefit of the readers of **EVERYDAY MECHANICS** in the future. A model showing the working principles will be described in detail in the magazine so that the serious experimenters of the country may strive to emulate the work done in the experiment station.

THIS MODEL SUBMARINE, CONTROLLED BY WIRELESS; has been described in past issues. The model is 5 ft. long; it is propelled by electric motor; it turns, dives, rises and fires a torpedo which explodes after leaving the boat, all at the will of the wireless operator on shore. Other models, just as ambitious, are in process of design. **OTHER FEATURES** have been the construction of high frequency apparatus to give gigantic sparks, trans-atlantic radio receiving apparatus, kicking coil apparatus, plant culture paraphernalia, and countless other articles that have delighted the hearts of the serious-minded experimenters of the country and have caused nearly 4000 of them to voluntarily write that **EVERYDAY MECHANICS** is the best practical magazine bar none, that has ever been published.



We want you to see and read **EVERYDAY MECHANICS** because we know you will need it and enjoy it. The subscription price is now 50 cents a year, but this is going to increase with the October issue to \$1.00. The news-stand price will then be 10 cents. A dollar bill pinned to the coupon brings you **EVERYDAY** for two years if sent **NOW**.

EVERYDAY MECHANICS CO., INC., 848 Aeolian Bldg., New York

Please book me for a subscription for **EVERYDAY MECHANICS** for _____

years, at fifty cents per year. I enclose \$ _____ to pay for same.

My Name is _____

My Address _____

Always Mention "QST" When Writing to Advertisers

Arnold Navy Type Loose Coupler Price, \$15.00

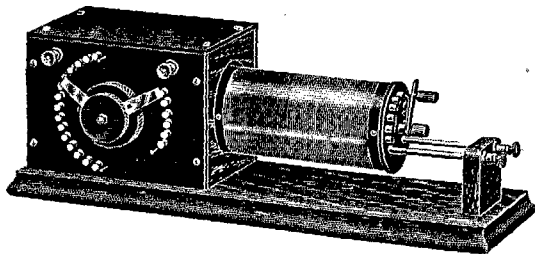

Perhaps you have noticed I specialize and this instrument is my specialty. One must excel when efforts are concentrated on a single instrument. These instruments are not and never were ground out in quantities and the personality of the maker lost. I make every instrument myself, test it and know just what enters into its construction.

With suitable inductance in conjunction with an Audion Detector, this instrument has proven very efficient for receiving undamped waves. This Hook-up will be furnished to prospective purchasers. I also carry the finest line of Switch Points, Rubber Knobs Cabinets and Accessories on the market.

PLEASE NOTE NEW ADDRESS

SEND 2c STAMP FOR BULLETIN No. 1

J. F. ARNOLD, 327 East 119th St., New York City

ARE YOU PREPARED

for the long winter evenings? Now is the time to fit up your station. You will need some of our parts and raw materials. Better send for our **CATALOG E** at once.

SWITCH POINTS

No. 626—1-4 x 3-8 inches, tapped 6-32	Doz. 0.30	50 \$1.00	100 \$1.75
No. 627—1-4 x 1-4 " 1-2 in. shank threaded 6-32 "	.36	" 1.25	" 2.00
No. 628— " " " tapped 6-32	.30	" .90	" 1.50

Prices are for plain brass finish. Nickered points furnished at 50 per cent. advance over above. Postage on 50 or less, 4c. On 100, postage on 1 lb



Maguire & Shotton

814 Lancaster Street

Albany - New York



You May Learn Theory, Code and Laws of Radio Communication in Our School or at Your Home,

fitting you for positions paying good salaries with wonderful chance to travel the world over. It's the most interesting profession known and the demand for skilled operators is increasing. Send stamp for catalog, which gives full information.

NATIONAL RADIO SCHOOL, 1405 U St. Washington, D. C.

EARN TELEGRAPH

More and Wireless—R. R. Accounting (Station Agency) taught. Splendid opportunities. Positions secured. Marconi Co. contracts to employ graduates. We own and exclusively occupy two large modern buildings equipped with R. R. and Western Union wires and complete 2 K. W. Marconi Wireless Station. Largest school—established 42 years. Investment \$25,000. Endorsed by Railroad, Marconi and Western Union Officials. Expert practical teachers. Low living expenses easily earned if desired. Tuition low. Easy payments. Correspondence courses also. Catalogs Free.

**Dodge's Telegraph, Ry. & Wireless Institute
RADIO Street, Valparaiso, Ind.**

Always Mention "QST" When Writing to Advertisers

MURDOCK "FIFTY-FIVE"

SUPREMELY SENSITIVE--ALWAYS DEPENDABLE

THE BEST WIRELESS RECEIVER
VALUE IN THE WORLD

2000 Ohm Complete

\$4.00

Double Set



3000 Ohm Complete

\$5.00

Double Set

Distinctively different in materials, workmanship, and operation from any 'phones hitherto offered at such low prices.

Equal or superior in SENSITIVENESS, looks, and dependable operation to 'phones selling for DOUBLE the prices.

FOURTEEN DAYS' TRIAL

allowed in competition with any 'phones obtainable anywhere. If, after trial, purchaser is not satisfied that these 'phones are the best value that can be secured, they may be returned, and purchase price will be refunded.

We manufacture a complete line of Wireless Apparatus suitable for the best experimental stations. Our catalog will be mailed FREE TO THOSE INTERESTED.

Wm. J. Murdock Company
20 Carter St., Chelsea, Mass.

New Mesco Radio Apparatus

ROTARY SPARK GAP

A Rotary Spark Gap is required in every transmitting station by the Federal authorities, for the reason that this type of gap produces a pure wave of low damping decrement. It also increases the efficiency of any transmitting station from 20 to 30 per cent.

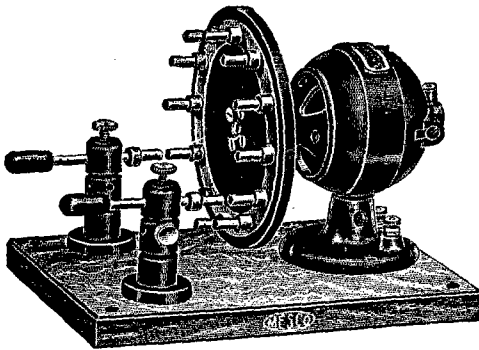

This Rotary Spark Gap emits a high musical note, more audible to the human ear, can be heard at greater distances than the note from the stationary type, and cannot be mistaken for static or other atmospheric disturbances, a fault common with the stationary gap due to its low frequency note.

The rotating member has twelve sparking points mounted on a hard rubber disk and is carried on the motor shaft.

Also fitted with two stationary electrodes with special adjusting devices.

The Gap can be successfully used on any of our spark coils or transformers up to and including 1 K. W. capacity.

Our standard Globe Motor is used, which will operate on 110 A. C. or D. C. circuits and attains a speed of 4,500 R.P.M. Also made with our

Globe Battery Motor, which can be operated on a six-volt circuit.

List. No.		Price
222	Mesco Rotary Spark Gap, 6 volt	\$12.00
228	Mesco Rotary Spark Gap, 110 v., A. C. or D. C.	13.00
216	Rotary Unit only, with two Stationary Electrodes, 1 3/16 in. shaft	5.00

UNIVERSAL DETECTOR STAND

This Stand has a heavy brass cup, with four binding screws, capable of holding crystals up to and including 3/4 in. diameter.

A hollow standard encloses a brass ball. Through an opening in the wall, a brass arm with hard rubber handle is secured fast to the ball, making a ball and socket joint, allowing it to be adjusted at any angle or used in any position.

A hole for the introduction of different size wires extends through the arm. A set screw in the side of the arm binds the wire.

Supplied with two binding posts. All mounted on a heavy genuine hard rubber base 2 1/4 x 4 1/4 x 3/8 in. All metal parts nickel plated. A spring rests on the ball in the hollow standard and sets into a cup under the adjusting screw, so that varying pressures can be had as circumstances require. Remains permanently in adjustment under jars and vibrations of every description.

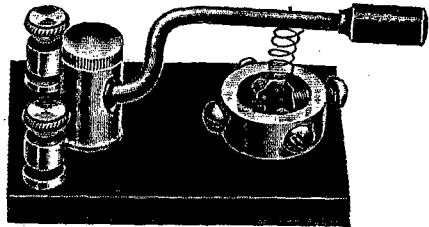

List. No.		Price
248	Universal Detector Stand	\$3.00

SEND FOR OUR NEW CATALOG H28

It is pocket size, 8x4 1/2 inches, contains 248 pages, with over 1,100 illustrations, and describes in plain, clear language all about Bells, Push Buttons, Batteries, Telephone and Telegraph Material, Electric Toys, Burglar and Fire Alarm Contrivances, Electric Call Bells, Electric Alarm Clocks, Medical Batteries, Motor Boat Horns, Electrically Heated Apparatus, Battery Connectors, Switches, Battery Gauges, Wireless Telegraph Instruments, Ignition Supplies, Etc.

There exist a thousand and one ways where electrical devices may be used, and to know what is best for your purpose you need this catalog. It costs you nothing.

SEND FOR OUR NO. 17 MANUAL WIRELESS TELEGRAPHY

You should have it even if only superficially interested. Around about you every day you read of some marvelous occurrence in which wireless played a distinguished part. It may not be entirely clear to you. The Manual will explain it. To the student of Wireless Telegraphy, the Manual contains much that is indispensable to a proper understanding of the art. A good portion of this is now published for the first time.

We ask ten cents (\$.10) for it—give you a coupon receipt which can be applied on any order amounting to One Dollar (\$1) or more.

Send your name and address now, and get one of the most complete, comprehensive and reliable wireless pamphlets published.

Manhattan Electrical Supply Co.

NEW YORK
17 Park Place

CHICAGO
114 S. 5th Ave.
SAN FRANCISCO 604 Mission Street

ST. LOUIS
1106 Pine St.