

Ham Radio TODAY



reviewed:

- Kenwood **TM-G707E** Dual-Band Mobile
- Cushcraft **X7** Multiband Beam
- Operating Abroad -
An Exclusive 'How To' Guide
- Springtime Radio Rallies -
Your Regular Guide
- Latest Product News
- Amateur Radio on the Internet
plus lots more!

www.rsgb.org/hrt





Lowe Electronics Ltd



Clear Digital Sound with the NEW JRC NRD-545 DSP Receiver

The latest model in the JRC range, the new NRD 545, which is their first receiver using DSP (Digital Signal Processing) from the IF stages onwards.

The DSP enables a wide choice of digitally implemented filters to be provided, together with IF shift and continuously variable passband width. The combination of these facilities gives the NRD 545 a level of performance than has previously been unheard of in a receiver costing less than £10,000.

Every equipment reviewer that has had the opportunity to try the NRD 545 to date has been amazed at the performance that JRC engineers have managed to cram into this small box.



A STUNNING receiver... here are just a FEW of the OUTSTANDING features:

- 0.1 to 29.999999MHz
- USB, LSB, RTTY, AM, FM
- 1Hz Tuning Steps (selectable)
- Huge Memory Capability
- DSP All-Mode Detection
- DSP Digital IF Filter
- DSP Pass-Band Shift
- DSP Noise reduction
- DSP Beat Canceller
- DPS Noise Blanker
- DSP Notch Filter
- DSP AGC
- DSP BFO
- DSP RF Gain
- DSP Squelch
- DSP Tone Control
- DSP S-meter
- High Sensitivity
- Wide Dynamic Range
- Variable Tuning
- Multiple Scan Modes
- Clock Timer
- Sleep Timer
- RTTY Fine Tuning

What Chris Lorek, G4HCL says about the NRD-545*

"sometimes has a dream, and it came true when he tried the NRD-545 in his shack"

"I believe the NRD-545 to be the very best HF receiver I've ever had the pleasure of using in my amateur shack"

"feel safe in the knowledge that the performance was well up to that of the very best receivers available"

"being able to narrow the IF bandwidth right down gave superb results"

"exceptionally good filter responses"

****Ham Radio Today Review**, April 1998**

Low Price
£1595.00
including VAT

NEW CATALOGUE

Lowe Electronics Catalogue

Yes, its true. Due to the outstanding success of our first catalogue which we delivered to 15,000 customers, we've decided to bring out the next issue -

Full of interesting products with comprehensive descriptions, and still FREE! We've added new products that are JUST shipping! Plus of course, the usual fantastic LOWE deals and our service back-up which is second to none.

Don't be left out - order yours today

- Communications
- Amateur Radio
- GPS Navigation
- Short Wave Listening
- Airband Radio
- Scanners
- Weather Monitoring

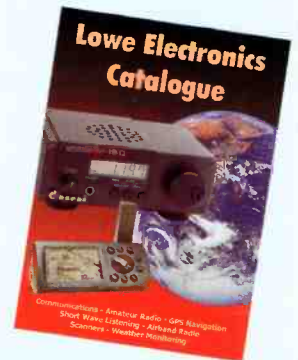

Just send four first class stamps to receive your own catalogue!

Lowe Electronics Ltd

Chesterfield Road, Matlock
Derbyshire, DE4 5LE
Telephone (General Enquiries) 01629 580800,
Fax 01629 580020

Orders FREEPHONE 0800 174749

Email: info@lowe.co.uk
URRL: http://www.lowe.co.uk

Showroom opening hours are 9.30am to 5pm Mon-Fri and 10am to 4pm on Sat, but check with our local branches as times may vary

Branches

- Bristol & Wales, 79 Gloucester Road, Patchway, Bristol BS12 5QJ,
Tel 0117 931 5263 Fax 0117 931 5270
- North East, Unit 18B, Airport Industrial Estate, Newcastle, NE3 2EF,
Tel 0191 214 5424, Fax 0191 214 0761
- South West, 117 Beaumont Road, St Judes, Plymouth PL4 9EF
Tel 01752 257224 Fax 01752 257225

regular columns

- net communication** 36
Jeremy Boot, G4NJH, uses the Internet to learn all about Slow Scan TV
- vhf / uhf message** 38
What a month! Geoff Brown, GJ4ICD, reports on spectacular 50 and 144MHz openings
- qrp corner** 40
Dick Pascoe, G0BPS, laments the passing of the NE602 and discusses the 'ugly bug' style of construction
- data connection** 42
Chris Lorek, G4HCL, finds a new APRS add-on for WinPack software, and shows how you can try multimode data without an expensive controller
- book browser** 45
The best Amateur Radio publications available to *Ham Radio Today* readers
- satellite rendezvous** 48
Richard Limebear, G3RWL, with the latest AMSAT-UK satellite and space news
- hf happenings** 50
How do you work HF DX if you only have a simple station? Don Field, G3XTT, gives some helpful hints

reviews

- cushcraft x7 'big thunder' beam** 25
John Cramond, GM4NHI, installed a new HF beam recently. Is he happy with the results? Read his review to find out!
- kenwood tm-g707e dualband mobile** 32
Chris Lorek, G4HCL, puts this new Kenwood rig on his test bench - and in his car

features

- beginner's guide to operating abroad** 10
Summer's coming soon, so now's the time to start planning your holiday operation abroad. It's easier than you think - our exclusive guide tells you how
- all in a day's work** 16
More thrifty tips from Harry Leeming, G3LLL

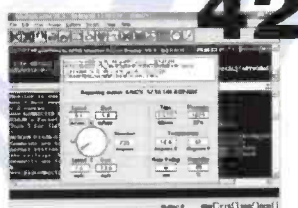

42



25

ham radio today **contents**
volume 16 no.5

news and views

- radio today** 5
The latest Amateur Radio news
- trade topics** 8
Hot news from the Amateur Radio trade
- letters** 20
Our readers have their say
- ham radio this month** 22
The latest rally and events news
- this month at the clubs** 53
Details of club events round the country, plus useful contact information
- free readers' ads** 55
For Sale, Wanted and Exchange, published free

construction feature

- build your own 50mhz mobile antenna** 24
With the new 50MHz repeaters coming on the air, Tony Webb, G3KCJ, offers an idea to improve your 6m mobile signal

32



readers' information

- subscription form** 19
- advertiser index** 58
- editorial & reader services contact information** 58

All reasonable care is taken in the preparation of the magazine contents, but the publishers, nor the Editor, cannot be held legally responsible for errors in the contents of this magazine, or for any loss arising from such errors, including loss resulting from negligence of our staff. Reliance is placed upon the contents of this magazine at readers' own risk.

Ham Radio TODAY

Editorial

Editor

Steve Telenius-Lowe, G4JVG
Tel: 01707 853300
Fax: 01707 645105
e-mail: hrt@rsgb.org.uk

Technical Consultant

Chris Lorek, G4HCL

Production

Designer

Wai-Yee Man

Technical Illustrator

Bob Ryan, 2E1EKS

Senior Designer

Jennifer Crocker, 2E1ENT

Production Assistant

Dani Angel

Editorial Secretary

Samantha Ralph, 2E1GGK

Printer

Heanor Gate, Langley Mill,
Nottinghamshire

Origination

JJ Typographics, Southend, Essex

Sales

Subscriptions

Sylvia Manco, 2E1CYL
Tel: 01707 853300
e-mail: subscriptions@rsgb.org.uk

Advertising

Malcolm Taylor Associates
Tel: 01202 777852
Fax: 01202 317902
e-mail: adman@mcmail.com

Management

General Manager

Peter Kirby, G0TWW

Publications Manager

Mike Dennison, G3XDV

Sales and Marketing

Marcia Brimson, 2E1DAY

Subscriptions

12 issues: UK £26.50. Europe and Eire
£36.50. Rest of the World (surface mail)
£38.50, (air mail) £54.00. Cheques should
be drawn on a UK bank and made payable
to the Radio Society of Great Britain.
Subscriptions and back issues hotline:
01707 853300.

Published by the Radio Society of Great
Britain, Lambda House, Cranborne Road,
Potters Bar, Herts EN6 3JE.

© RSGB Publications 1998.
All rights reserved. ISSN: 0269-8269

The publisher's written consent must be
obtained before any part of this publica-
tion may be reproduced in any form
whatsoever, including photocopyers and
information retrieval systems.

In *Radio Today* opposite, you will see that the Wireless Telegraphy Act 1998 recently received Royal Assent, and will come into force in June. The Act opens the door to 'Spectrum Pricing' for the first time in the United Kingdom.

This means that, in theory at least, the cost of an Amateur Radio licence *could* be increased considerably, if it was thought that the spectrum occupied by Radio Amateurs in this country was worth a lot of money. As a press release explaining the new Act, which was issued by the Department of Trade and Industry, put it: "The new Act will play a vital role as the new charging powers can be used to balance supply and demand."

Supply and demand. Think about it - which are the bands most under-utilised by Radio Amateurs at present? That's right, the microwave bands. And where is the greatest demand on amateur spectrum allocations? Right again - the microwave bands. Just think how much satellite broadcasters would be

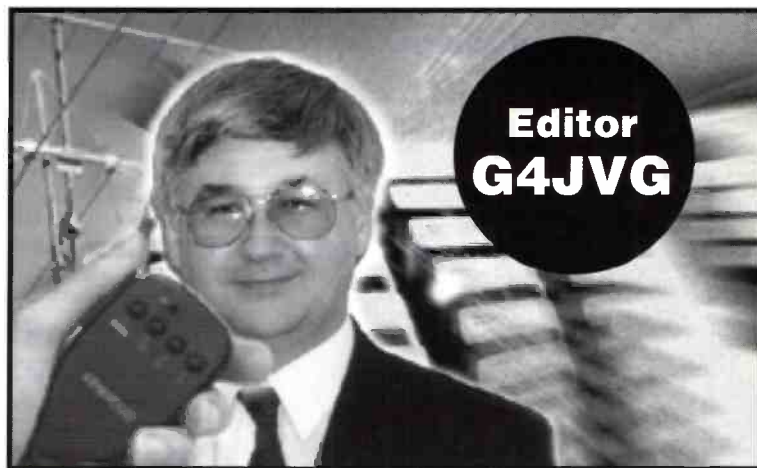

ing portions of spectrum, our VHF, UHF and SHF bands are wide-open wastelands of empty space.

There is a glimmer of hope on the horizon. The long-awaited Phase 3D satellite is due for launch shortly, and - if any of the hype is to be believed - will certainly increase awareness of, and therefore activity on, the microwave bands. Any such increase is obviously to be warmly welcomed.

the future. For example, it may be argued that the 10GHz band has a much higher 'value' than, say, 14MHz, because the demand on that part of the spectrum is far greater.

The Wireless Telegraphy Act 1998 highlights the demands on spectrum space. Radio Amateurs should not be complacent about the value of amateur allocations to other users: 'use or lose' is as relevant today as it ever has been.

Get active - and save our bands!
Ham Radio Today Editorial by Steve Telenius-Lowe, G4JVG

don't panic!

However, there's certainly no need to panic at present. Indeed, back in June 1996 the RA issued a White Paper entitled *Spectrum Management: into the 21st Century*, which stated that: "Spectrum pricing is unlikely to lead to higher charges for a number of services, for example where . . . users (because of international constraints for example) have little or no freedom to move to alternative frequencies or increase spectrum efficiency by technical means, and so have little scope to respond to price signals . . ." Amateur Radio and CB are amongst "the main licence categories to which . . . the above apply. . . In these cases, the Government sees no current need for spectrum charges to be set any higher in real terms under the new regime than present licence fee levels; and they might be set lower." (For those with Internet facilities, the White Paper can be found at www.open.gov.uk/radiocom/specintr.htm)

Nevertheless, the new Act does open the possibility of a different licence fee structure in

increase your activity

Any increase in activity on any amateur band is therefore always to be welcomed, despite the protestations of those who dislike contests or DX activity because they cause 'QRM' to their own operation.

One way you can increase your activity is to take your rig with you on holiday this summer. There are numerous destinations which are 'special' for Amateur Radio purposes, from the Isle of Wight, Anglesey, or the Isle of Skye, which count separately for the Islands on the Air awards, to the Isle of Man, Jersey and Guernsey, which are always sought-after by DXCC chasers. If you go abroad, taking your rig with you is a great way to meet local people who share a common interest with you. Very often you will experience terrific hospitality that, without the Amateur Radio 'connection', would certainly not be forthcoming.

To help you with your holiday plans, this month's *Ham Radio Today* contains an exclusive guide to operating abroad, which starts on page 10.

spectrum pricing

The Wireless Telegraphy Act 1998 received Royal Assent on 18 March. The Act provides a modern framework for management of the radio spectrum and substantially revises and updates arrangements for setting fees under the Wireless Telegraphy Act 1949, thus representing the first major modernisation of the radio licensing framework for almost half a century.

Under the 1949 Act, charges for licences were based on the administrative costs of the Radiocommunications Agency (RA), rather than the economic value of the spectrum which is used by licensees.

The new Act will come into force in June and the first set of fees based on the new powers will be introduced shortly afterwards. The RA has already consulted extensively about the fees which it proposes to introduce under the new powers and issued a consultation document, *Implementing Spectrum Pricing*, in May last year.

benefits for business

A press release issued by the Department of Trade and Industry on 18 March stated that: "As demand for the radio spectrum continues to grow rapidly, it is important to ensure that users have every incentive to use it as efficiently as possible. The new Act will play a vital role as the new charging powers can be used to balance supply and demand. Business will also benefit from a fairer and more rational fee regime under the new powers. Under the new legislation fees can only be increased where it is necessary for spectrum management reasons."

The Minister for Small Firms, Trade and Industry, Barbara Roche MP, said that radio "contributes over £13bn a year to the economy, supports over 400,000 jobs and delivers £12 - 15bn a year of consumer benefits . . . All this depends on the availability of the industry's raw material, radio spectrum. The spectrum is a finite resource. Unless we manage it effectively, we will not realise the full economic benefits and competitiveness gains from this successful and dynamic sector of the economy. . .

"The process of setting fees will be open and transparent. The Radiocommunications Agency is working closely with users to develop proposals . . . The first regulations under the new regime will reduce fees of over 20,000 localised 'on site' mobile radio systems. This will provide a more level playing field in mobile communications and be fairer for small business users of radio."



code-free in trinidad

Ham Radio Today editor Steve Telenius-Lowe, G4JVG, recently had an interesting QSO with Nigel, 9Z4CT, from the island of Trinidad on 21 MHz SSB. According to Fred Laun, K3ZO, Trinidad and Tobago recently allowed 'no-code licensees' (presumably previously on VHF only) access to all HF bands: the 9Z4 prefix is to distinguish them from the 'normal' prefix for Trinidad and Tobago, 9Y4.

radio today **radio today**
latest news on ham radio today

young amateur of the year '98

The RA and the RSGB have jointly announced the 1998 Young Amateur of the Year award. The award is open to any Amateur Radio enthusiast under the age of 18 at the closing date - **31 July 1998**. Candidates do not have to hold an Amateur Radio licence, but the following areas of activity will be taken into account when applications are assessed: radio construction, radio operation, community service (eg helping the disabled or assisting in emergency communications), encouraging others (eg through the Novice licence scheme), and school projects.

The most outstanding candidate and the runner-up will be presented with their prizes at the RSGB HF Convention in September. Prizes include cash sums and Amateur Radio equipment from the RA, RSGB and the radiocommunications industry, as well as an invitation to tour the RA's radio monitoring station at Baldock.

If you would like to nominate a young amateur for this prestigious award, please ask Marcia Brimson, 2E1DAY, for an application form. Contact her on tel: 01707 659015, or write to RSGB headquarters.



Last year's Young Amateur of the Year, Emma Constantine, 2E1BVJ, and runner-up Mark Haynes, 2E0APH, with just some of their goodies presented at the HF Convention in September.

GB2PPE will be on the air from **1 - 28 May** in memory of founder member of the BBC, Peter Pendleton Eckersley. For more details contact David Tanner, G0OZD, QTHR.

The Denby Dale Amateur Radio Society is again organising a windmills and watermills special event day to coincide with National Mills Day on **10 May**. Stations wishing to participate should register with Tony Barr, G4LLZ, by 30 April: for further information call him on tel: 01484 664360.

The Prudential Amateur Radio Society will be running GB150PRU from **25 May to 21 June**. For more details contact GW4XKE, QTHR.

GB5MU, representing the 60th anniversary of 5 Maintenance Unit, will be on the air from the second Kemble Air Show on **31 May**. Further information from Ian Carter, G0GRI, on tel: 01225 864698 (evenings / weekends).

special event stations

thanet club disbands

The Radio Club of Thanet has been disbanded. The club was founded in 1981 but recently had a membership of only 12.

new **iota** certificates

A new design of certificate is now being issued for the popular Islands on the Air (IOTA) awards. Each continental award features a satellite photograph of the appropriate continent, with a shot of the world from space being used for the IOTA-100 certificate.

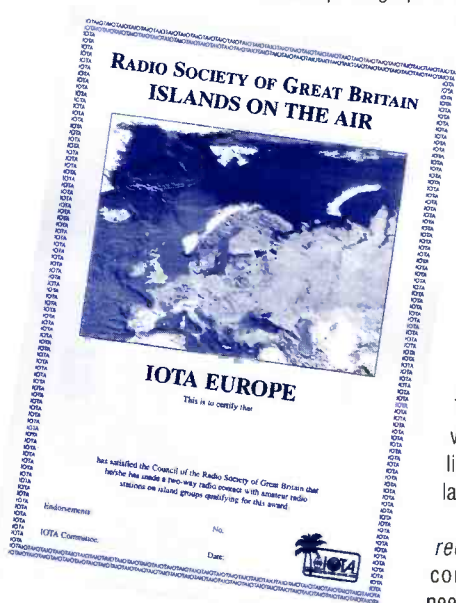

The 1998 IOTA Honour Roll has recently been published, with Jean-Pierre Guillou, F9RM, in lead position, with no fewer than 900 IOTA island groups verified. The leading UK station is Les Hamilton, GM3ITN, in ninth place, with 870 islands, hotly pursued by John Kay, G3AAE, with 869. There are now 1225 amateurs worldwide on the IOTA annual listings, with more than 100 island groups confirmed.

The new 1998 - 99 *IOTA Directory and Yearbook*, which contains all the information needed about IOTA is being published this month.

g3lxp rip

Derek Purchase, G3LXP, died on 9 March: less than two days earlier he was one of hundreds of visitors at the *Ham Radio Today* stand at the London Amateur Radio and Computer Show. He was one of the founding members of the Verulam Amateur Radio Club in St Albans and was probably its longest-serving committee member. Derek worked as a volunteer at the Mosquito Aircraft Museum near St Albans, setting up a permanent special event station and Amateur Radio exhibition at the museum. He leaves a wife and three children.

secret listeners

A reunion of WWII 'secret listeners' is being planned for **17 May** at Bletchley Park Mansion. Anyone involved in this work is invited to attend - please contact Bob King, G3ASE, tel: 01480 463129 for further details.

reunion

one for the diary

There is a change of venue for next year's Barry Amateur Radio Society Radio and Computer Fair. It will now be held at the Holmview Leisure Centre, Skomer Road, Barry on 21 February 1999. More details closer to the time.

wab - nominations needed

Nominations for the Worked All Britain (WAB) awards group 1998 - 99 President and / or committee members should be sent to the Honorary Secretary, G8UYD, by **16 May** at the latest. A seconder and a signature of acceptance by the nominee are also required. The WAB AGM will be held at the new venue of the Gothic Hall, Elvaston Castle, on 14 June at 2.00pm.

radio today **radio today**

latest news on ham radio today

new radio club

We are always pleased to report the formation of a new radio club. COLARS, the City Of London Amateur Radio Society, is a club with a difference.

COLARS is a company limited by guarantee, which has been registered as a charity. Its charitable purposes, or 'Objects', are: 1) To advance education in all matters concerning Amateur Radio; and 2) The relief of distress and sickness by assisting the 'User Services'.

To fulfil these objects, from September COLARS will be running RAE and Morse courses tutored by Mike Brooker, G0IBL, which will be held at St Jude's Community Centre, St George's Road, London SE1 (close to the Imperial War Museum, nearest tube Elephant & Castle). Secondly, COLARS plans to establish an emergency communications and co-ordination centre and offer their services to governmental and non-governmental organisations involved in emergencies and the relief of distress and disaster.

For further details about COLARS please contact Tony Hern, G1UFX, by e-mail: g1ufx@mcmail.com; by packet: G7UZN @ GB7HSN, or by writing to: COLARS, c/o Flat 7, Block H, Peabody Square, Blackfriars Road, London SE1 8JJ.

going to orkney?

Orkney Wireless Museum moved last year from St Margaret's Hope to Kilm Corner, Kirkwall. This year, the museum will be open every day from 6 April until 27 September. Orkney's wartime electronic history is strongly represented, together with wireless in the Orkney home, both pre- and post-war. Special displays this year will include German U-Boat radio, and WWII valves. There's also a permanent special event station, GB2OWM, at the museum. Further details are on the web site <http://www.lirona.demon.co.uk/owm.htm>

is there **anybody** there?

Ken Chattenton, G4KIR, and Trevor Unsworth, G0ECP, have been awarded the SETI League's highest honour - the Giordano Bruno Memorial Award - for their contributions to Amateur Radio Astronomy. The SETI League encourages and supports the Search for Extra-Terrestrial Intelligence by developing technologies for Radio Amateurs, amateur astronomers and other experimenters to set up 'SETI receiving stations'.

Ken and Trevor offered their services to Dr Paul Shuch, N6TX, the SETI League's Executive Director, three years ago, and became the group's first volunteer Regional Co-ordinators.

For more details about SETI, look at their web site at <http://www.setileague.org/> or send an e-mail: join@setileague.org or fax: 001 201 641 1771.



a pedestrian contact

What is believed to be the first pedestrian mobile contact across the Pacific took place on 10m on 28 March. Peter Parker, VK1PK, made contacts with KZ5MM and NE6GN, following a contact with ZL2RR earlier in the day.

Peter's station is a Johnson Viking converted CB rig, running about 12W PEP, to a 1.8m mobile whip, with 2.5m of wire acting as the ground radial. The power source is a 12V 6Ah battery.

ssl's contract extended



The RA has informed us that Subscription Services Ltd (SSL) will continue to administer Amateur Radio and Citizens' Band licences into the next millennium. SSL has issued licences on the RA's behalf since 1992. Their current contract was due to expire on 31 March 1998, but allowed for a further two year extension. This has been successfully negotiated and an extension has now been granted until 31 March 2000.

136kHz: more firsts

On 21 March, Peter Dodd, G3LDO, worked OH1TN for the first UK - Finland two-way QSO on the 136kHz band, at the same time setting a new world two-way distance record for the band. The QSO was made at 2155UTC, following a successful cross-band contact, with OH1TN transmitting on 3570kHz. Meanwhile, Malcolm Hamilton, G3KEV, has received a QSL card from OH1TN for the first 136kHz cross-band two-way QSO between the UK and Finland, which took place on 22 February. OH1TN transmitted on 136kHz and G3KEV on 1825kHz. The antenna system at OH1TN is a 28m vertical with a 500m top. Other Finnish stations active on the 136kHz band include OH3LYG (who uses a 35m tower, 800µH top-loading coil and 180m top), OH1XF, OH1LSQ and OH1RH.

Good luck to all candidates taking the first of the new-style revised City & Guilds Radio Amateurs Examinations (RAE) this month. The revised exam consists of a single multiple-choice paper of 80 questions in two parts, with a duration of 2.25 hours. There are 25 questions in Part A, 18 concerned with licensing conditions and seven on operating procedures and practices. The remaining 55 questions in Part B cover electronic principles and practice; receivers, transmitters and transceivers; transmitter interference; EMC; propagation and antennas; and measurements. Candidates need to pass Part A in order to pass the examination as a whole.

The revised RAE reflects a more modern approach whilst maintaining the present high standard. The single examination paper reduces the cost for potential candidates: the C&G charge is now £26.05 (plus any fee charged by the college). A list of colleges offering the RAE is available from C&G - contact the Customer Services Enquiry Unit.

City & Guilds is able to make special arrangements for blind or disabled candidates to take the exam at home. For further details contact the Assessment Services (Vocational) Department, City & Guilds, 1 Giltspur St, London EC1A 9DD; tel: 0171 294 2468.

lower cost rae

nrd-545 correction

In the 'Laboratory Results' table of the NRD-545 review published in the April 1998 *Ham Radio Today* (page 12), an error crept into the sensitivity and S-meter linearity figures. These figures should, of course, be µV pd and not mV pd. Apologies to readers and to JRC and their distributor, Lowe Electronics, for this error, which was caused by difficulties in typesetting Greek characters.

radio today **latest news on ham radio today** radio today

rally on telly

Viewers of BBC 1 daytime TV were recently treated to an insider's view of the 40th annual Longleat Rally, which took place in June last year. The series *Lion Country*, which is broadcast at 3.00 - 3.30pm Monday to Friday, is showing a 'year in the life' of the Longleat estate. The episodes on 20 and 23 March showed the organisers' preparation for the rally, and the rally itself. Organiser Shaun O'Sullivan, G8VPG, was interviewed, as was one of the founders of the rally, and several rally-goers.

This year's Longleat mobile rally will take place on 28 June.

rally on telly

lucky winners

Two *Ham Radio Today* readers are now the owners of brand-new rigs. They are the lucky winners of the *Ham Radio Today* prize draw competition which was run in March. John Nixon, M0ADS, of Sheffield wins the star prize - a new Icom IC-746 HF / VHF transceiver, worth nearly £1700. John said he was "flabbergasted" when he was told of his prize.

The runner-up was John Clayton, G4PDQ, of Cheltenham, who wins a Hora C-408 70cm miniature handheld transceiver, kindly donated by Waters & Stanton PLC for our competition. Congratulations to both winners.

anyone for cw?

County Morse code test teams will be on the air using special event station call signs over the weekend of 9 / 10 May, the 12th anniversary of the RSGB Morse test service. At least 26 stations will be active using GB0 prefixes, followed by the county code suffix, eg GB0IOW for the Isle of Wight and GB0LDN for London. The Chief Morse Examiner, Roy Clayton, G4SSH, will use GB0CW, whilst his deputy will use GB0MTS. Most activity will be on 80 and 40m (CW of course!) and each team will be encouraged to transmit above 3560kHz in the Novice section of the band.

Anyone making contact with at least 10 of the special event stations can apply for the Morse

Test 12th Anniversary certificate. It costs £2.50 (make cheque payable to RSGB), \$5 or 12 IRCs and is available from Roy Clayton, 9 Green Island, Irton, Scarborough, North Yorks YO12 4RN.



wab contest

Look for plenty of mobile activity around the UK on 17 May, when the Worked All Britain (WAB) 'LF' (160, 80 and 40m) Phone Contest takes place from 0900 - 1800UTC. Participants should send an RS report plus serial number starting at 001, plus their WAB area and county (the WAB area is the 10km National Grid square, which can be found in many UK road atlases). You may only work each station once per band - except that mobile stations may be worked again from different WAB areas. Five points are scored for each QSO, with one multiplier for each WAB area, county and DXCC country worked. There is a different scoring system for mobiles. The complete rules, which run to several pages, plus logsheets, can be obtained by sending an SASE to Graham Ridgeway, G8UYD, 6 Rosewood Ave, Blackburn, Lancs BB1 9SZ.



alinco dx-77

The **Alinco DX-77**, now available from Nevada, represents possibly the best-value HF base station transceiver available today. It's a 12V 100W output, 10 - 160m transceiver, with built in 500kHz - 30MHz general-coverage receiver. Despite its low price, the DX-77 is not a basic transceiver: it has all the features you would expect in a radio costing twice the price.

The DX-77 transmits SSB, CW, FM and AM (40W output on AM) and tunes in smooth 10Hz steps. A built-in speech processor is provided, whilst for CW fans full break-in, seven-step semi break-in or auto break-in modes are all available. The rig has 100 memory channels, each of which stores the frequency, mode, split, AGC, and RF attenuation or gain.

The Alinco DX-77 costs just £675. It is also available with three optional extras: a 500Hz CW filter, electronic keyer, and CTCSS unit, fitted for £775.

Nevada, 189 London Road, North End, Portsmouth, Hants PO2 9AE; tel: 01705 662145; fax: 01705 690626.

bargain
2m handheld

Waters & Stanton PLC have announced the introduction of the first keypad-entry 2m handheld retailing at under £100! Selling at £99.95 inc VAT, the Taiwanese **Hora C-150** is a fully featured 144 - 146MHz handheld with 20 memories, capable of providing up to 5 watts output on the 2m band. The LCD display offers clear indication of frequency and selected modes. A built-in 1750Hz tone is used for accessing repeaters and an optional CTCSS unit will be available shortly. Other features include band and memory scanning, battery save, dual watch, priority channel, keypad or rotary dial frequency selection, six channel steps including 12.5 and 25kHz, dial illumination etc.

Power for the transceiver is by a 6 x AA dry cell pack or an external 13.8V source. The package includes hand-book and helical antenna and there is provision for an external speaker-microphone.

The Hora C-150 is ideal for keeping permanently in the briefcase or the car glove box. Used with an external speaker microphone it forms a simple mobile installation and the sensitivity and power output matches similar, but more expensive units.

Waters & Stanton PLC, 22 Main Road, Hockley, Essex SS5 4QS; tel: 01702 203353; fax: 01702 205843.

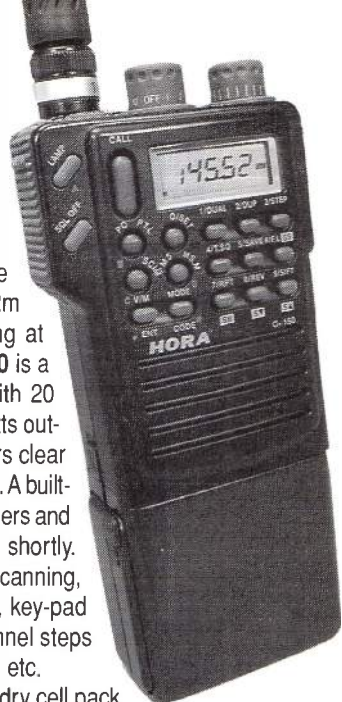

trade topics trade topics

the following information is based upon submissions by suppliers. we cannot be responsible for false information.

solderless
plugs

Waters & Stanton are introducing a range of **solderless coax**

cable connectors. Initially the range will comprise

PL-259, BNC and N types. Recent trends moving away from home-construction has also meant that the traditional soldering iron has vanished from many 'shacks'. Newcomers, in particular, find it difficult or inconvenient to have to solder plugs on to cable and there is obviously a use for these items in the field.

There is nothing more frustrating than finding that you have not got the correct lead to connect to a piece of equipment.

The plugs can be used for cables up to RG-213 size and include both straight and right-angle types. Prices are very similar to the standard solder types and further information can be obtained direct from Waters & Stanton PLC or by checking their web page at <http://www.waters-and-stanton.co.uk>

Waters & Stanton PLC, 22 Main Road, Hockley, Essex SS5 4QS; tel: 01702 203353; fax: 01702 205843.



qsp73 cd-rom

The **QSP73 Services** CD-ROM contains just about every up to date Amateur Radio freeware, shareware and public domain software currently available. Most of the files are compressed - when expanded there are over 1Gb of programs on the disk. The compilers search hundreds of Amateur Radio software sources every week and add the very latest versions of every known program to the CD-ROM, updating it on the first of every month. Even if you have an Internet connection, the QSP73 CD-ROM could save you a lot of time and money. It's available for £15 (make cheques payable to 'QSP 73 Services') and order from QSP73, Eastleigh SO53 4ZF.

new
alinco h/h

We're hearing rumours that a new **Alinco** dual-band handheld is in the offing. More just as soon as we know ourselves.

mfj catalogue

Waters & Stanton are offering the latest **MFJ** accessories catalogue free of charge. It includes many new products as well as discount vouchers. Please telephone or fax W&S with your name and address if you would like to receive one.

Waters & Stanton PLC, 22 Main Road, Hockley, Essex SS5 4QS; tel: 01702 203353; fax: 01702 205843.

vhf / uhf lpda

The **Scanmaster LP1300** wideband beam is a UK-made LPDA (log periodic dipole antenna) covering 105 - 1300MHz. It's a 16-element array which offers good forward gain (8.5dB claimed) and front-to-back ratio, on a 1.5m long boom. The longest element is 1.43m long. The VSWR is <1.8:1 and the antenna will handle up to 500 watts.

Ideal for amateurs who use the 2m, 70cm and 23cm bands, and also scanners who require a wideband antenna, the Scanmaster LP1300 is built to commercial standards using stainless steel and high-grade aluminium, and comes with an injection-moulded 'N'-type connector fitted. A mounting kit allowing for either horizontal or vertical polarisation on masts of up to 2in diameter is supplied. The LP1300 sells for just £99.95.

Nevada, 189
London Road,
North End, Port-
smouth, Hants
PO2 9AE; tel:
01705 662145; fax:
01705 690626.

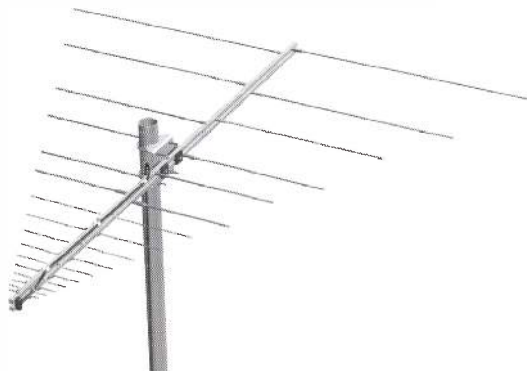

geisha Communications

On the application of the Secretary of State for Trade and Industry the High Court has appointed the Official Receiver as provisional liquidator of Geisha Communications Ltd, pending the hearing of a petition in May. Since December 1997 the company has traded in computer products and supplies under the name Prompt Peripherals.

Hardly a month goes by without a new kit from the prolific Walford stable: great news for QRP enthusiasts and inveterate kit-builders. The latest is the **Sparkford** - an 80m CW QRP transceiver which uses several new ideas recently developed by Tim Walford, G3PCJ. Its small size and minimum 9V supply should appeal to those wanting to try portable operation. The cost is just £34.

The development of the Sparkford is described in some detail in the Spring 1998 edition of **Hot Iron**, the journal of the Constructor's Club, which can be obtained on subscription from Walford Electronics. The cost is £6 per year for the UK (£8 overseas) from 1 September each year.

Contact Walford Electronics, Upton Bridge Farm, Long Sutton, Langport, Somerset TA10 9NJ; tel: 01458 241224; fax: 01458 241186; e-mail: walford@globalnet.co.uk

Walford's latest

trade topics trade topics

liars, and is not necessarily endorsed by ham radio today.
misleading claims by suppliers.

uk antennas

Art Hambleton, the man behind **Cushcraft** antennas, of New Hampshire, USA, was in the UK recently to do some research on the type of antennas needed by hams in the UK. We understand that as a result of his visit, Cushcraft will be designing some new HF and VHF antennas specifically for the UK market.

12.5 & 25kHz channels

The new **Icom IC-2100H** is the first Icom 2m mobile rig with true 12.5kHz and 25kHz switched filters and deviation. With a beefy 55W of output power (and medium and low power settings of 10W and 5W) the IC-2100H is a great rig for FM DX work, and the high power output will ensure you get into the repeater when mobile from poor locations.

There are the usual scanning facilities and a total of 113 memory channels. The IC-2100H replaces the IC-2000H, but the price has been reduced to an excellent-value £269. We plan to review the IC-2100H in *Ham Radio Today* in the near future.

Icom (UK) Ltd, Sea Street, Herne Bay, Kent CT6 8LD; tel: 01227 741741; fax: 01227 741742; e-mail: icomsales@icomuk.co.uk



business radio

Do you operate a small business where you need to keep in contact with your workforce out and about in the local area? Recent legislation has opened up spectrum for short-range business use and walkie-talkies made by well-known names such as Icom, Kenwood, Motorola and Maxon are available from £169 plus VAT. A three-year licence, which covers as many radios as your business needs, costs just £30. Talk to **Communications Hotline**, a division of London Communications PLC, on tel: 0990 30 40 20 for further details.

good news from watson

The range of **Watson** fibreglass base station vertical antennas has been reduced in price. The manufacturers say that a significant increase in export orders to the USA and Europe has enabled them to pass on savings created by the greater throughput.

The new prices are as follows:

The W-50 2m / 70cm antenna is now £49.95 (a saving of £5); the W-300 2m / 70cm £59.95 (£10 off); and the W-2000 6m / 2m / 70cm £69.95 (£20 off).

The full range of Watson antennas is available from Waters & Stanton PLC, 22 Main Road, Hockley, Essex SS5 4QS; tel: 01702 203353; fax: 01702 205843.

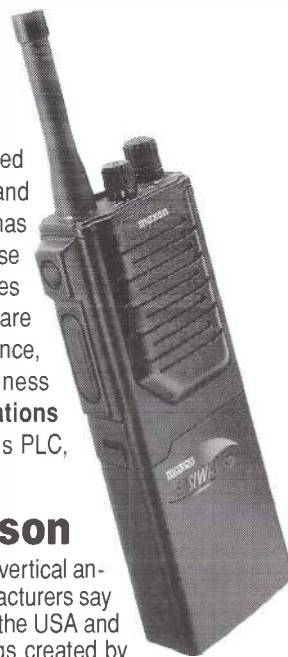

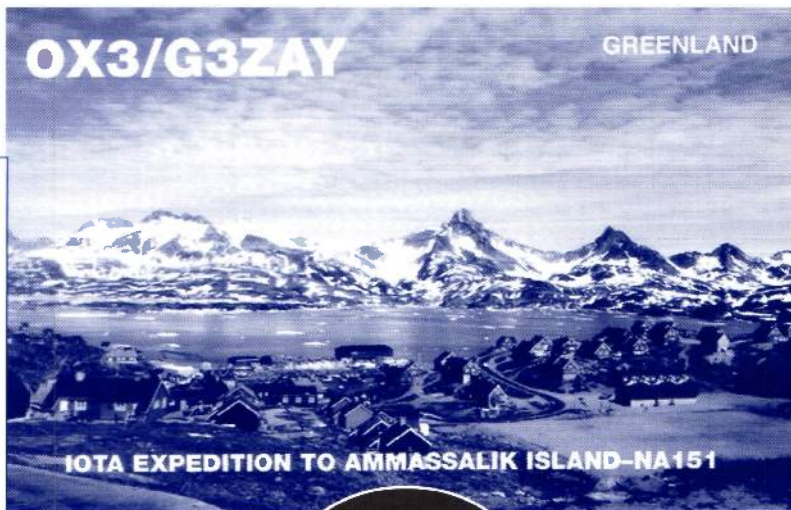
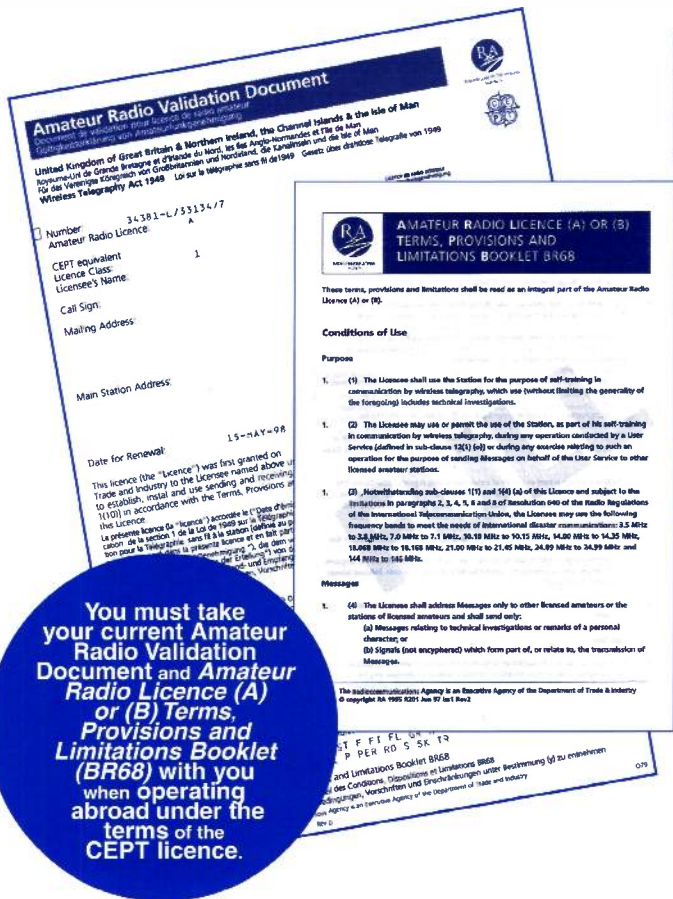

You must take your current Amateur Radio Validation Document and Amateur Radio Licence (A) or (B) Terms, Provisions and Limitations Booklet (BR68) with you when operating abroad under the terms of the CEPT licence.

You can operate from many locations well outside Europe, such as New Zealand, Peru - and even Greenland - by just using the CEPT licence.

Beginner's Guide to Ham Radio Today Editor Steve Telenius-Lowe, G4J

It has never been easier to operate Amateur Radio from abroad. It wasn't that many years ago that only the most dedicated DXpeditioners attempted it - most amateurs were put off by the difficulties of physically carrying the required amount of equipment, by perceived potential problems at customs controls, or by the difficulties of obtaining an overseas licence.

Nowadays, many of these problems no longer exist. However, before we go any further, it should be made clear that unfortunately the UK *Novice* licence (both class A and B) does not allow for any overseas operation at all: there is no reciprocal or unilateral agreement with any country, even those which have their own *Novice* licence schemes.

With tiny transceivers such as the Kenwood TS-50S, Alinco DX-70 or Icom IC-706, switch-mode power supplies, and lightweight wire or vertical antennas, a complete station can be carried easily in an aircraft carry-on bag - these days you don't even have to entrust your expensive and delicate equipment to airport baggage handlers.

customs

Customs formalities, however, *do* still need to be respected: operating permission does not give Radio Amateurs *carte blanche* to import equipment. The good news is that the majority of overseas Amateur Radio operation is likely to be from holiday destinations within the European Union (EU), such as France, Spain, Italy or Greece, and there are now no customs formalities between EU countries. All the EU countries are now covered by the 'CEPT Licence', of which more later.

Most non-EU countries where it is possible to obtain an Amateur Radio licence will also allow the temporary importation of a transceiver, power supply and antenna as part of your personal effects. It helps if the equipment is not brand new (take copies of receipts as proof) and it would do no harm to provide an inventory of your equipment, complete with serial numbers, for those rare occasions when you are stopped by customs officers. There is also a big difference between an individual amateur importing a single transceiver, power supply and antenna for his

own use, and a group of half a dozen amateurs on a major expedition wishing to import multiple stations with linears and monoband beams. If this is your intention, get customs papers beforehand.

licensing

That only leaves licensing as a potential headache. Depending on the country you wish to operate from, and for how long, there are five possible licensing routes you may need to take.

1. You could, of course, sit the examinations in the country concerned and take out a licence in the same way a national of that country would. Very few UK amateurs will need (or want) to do this, unless they plan to become a permanent resident of that country. An exception is for the USA, where it is possible to take the American exams, right up to their Extra Licence, at one sitting, here in the UK through their volunteer examiner ('VE') programme.
2. Secondly, there are numerous countries with which the UK has a *Reciprocal Licensing* agreement (eg Malta, Australia). This means that you will be

granted a temporary licence on the basis of your UK licence, and if you wish to operate from one of those countries you will need to apply on the appropriate application forms. A list of the countries with which the UK has reciprocal licensing agreements is published in the *RSGB Yearbook* [1].

Until last year, UK class B licensees could not operate in USA, but in August 1997 the Radiocommunications Agency (RA) announced that a Reciprocal Licensing agreement had been concluded and that class B licensees would now be granted a Technician Class licence in America. Good news indeed, as there are thousands of 2m and 70cm repeaters in the USA, which makes it really easy to get in contact with local hams, wherever you're staying, just by taking a handheld ('handie talkie', or 'HT' as they're known in America).

3. Even if the country you wish to operate from does not have a reciprocal agreement with the UK, all is not lost. Many countries recognise the UK Amateur Radio licence as a valid qualification and will still issue a tem-

Greece is a popular destination for CEPT licence holiday operations, particularly since many of the Greek islands count separately for IOTA purposes. This QSL is from Sfaktiria Island, EU-158.



Albania	AL	Malta	M
Austria	A	Moldova	MLD
Belgium	B	Monaco	MC
Bosnia and Herzegovina	BH	Netherlands	NL
Bulgaria	BG	New Zealand*	ZL
Canada*	VE	Norway	N
Croatia	HR	Peru*	PER
Cyprus	CY	Poland	PL
Czech Republic	CZ	Portugal	P
Denmark	DK	Romania	RO
Estonia	EST	Russian Federation	-
Finland	FI	San Marino	RSM
France	F	Slovak Republic	SK
Germany	D	Slovenia	SLO
Greece	GR	Spain	E
Hungary	H	Sweden	S
Iceland	IS	Switzerland	CH
Ireland	IRL	The Former Yugoslav Republic of Macedonia	-
Israel*	IL	Turkey	TR
Italy	I	Ukraine	-
Latvia	LV	United Kingdom of Great Britain and Northern Ireland	GB
Liechtenstein	FL	Vatican City	SCV
Lithuania	LT		
Luxembourg	L		

Table 1: List of CEPT member countries and the abbreviations by which they are identified (where known). Countries marked * are non-members of CEPT.

Operating Abroad

VG, guides you through the potential pitfalls of operating your

porary Amateur Radio permit, even though there is no formal reciprocal agreement in force. This is usually called a *Unilateral Licensing* arrangement, since an amateur from that country would not necessarily be able to obtain a licence in the UK. In some cases (eg Kenya, Singapore) licences will only be issued if you hold a residency permit (such as those issued to expatriates on work contracts), whilst others (eg Jamaica, Fiji) will issue short-term visitor's licences to holiday-makers. In some cases the licence can be obtained in advance, although usually it is much easier to obtain the licence in person after arrival in the country concerned.

4. The fourth category is the *HAREC licence*. This is the Harmonised Amateur Radio Examination Certificate, which was launched in this country in July 1996. The HAREC is accepted by a number of countries (eg Denmark, Sweden) as a qualification for a permanent full (not a temporary reciprocal) licence, thus avoiding the necessity of having to sit the local examinations. A normal callsign is issued, eg an overseas amateur using a

HAREC as qualification would be granted an M0 or M1 callsign in this country (depending on the class of his own licence). The HAREC is intended to be used by licensees who are either moving permanently to another country, or visiting that country on a regular basis, particularly for extended periods (eg greater than about three months).

5. Finally, there is the *CEPT Licence*. This is the one under which the vast majority of present-day overseas operation takes place and the remainder of this article assumes you wish to operate abroad under the terms of the CEPT Licence.

cept licence

So, just what is the CEPT Licence? CEPT stands for the European Conference of Postal and Telecommunication Administrations (in French) and it is their *Recommendation T/R 61-01* which allows Radio Amateurs from countries which have implemented the recommendation to operate from any of the other countries, with the minimum of formalities.

Many European countries,

east and west (though please note: not all!), have now implemented T/R 61-01, and a number of countries *outside* the CEPT area have also agreed to allow Amateur Radio operation under the terms of the CEPT licence. At present these countries are Canada, Israel, New Zealand and Peru. It is understood that South Africa and the USA have also expressed an interest in joining, although for the moment it is still necessary to apply for a reciprocal licence if you wish to operate from either of those countries. There are some important points to note about CEPT licence operation:

- T/R 61-01 allows for *temporary* portable operation only. This is generally regarded as meaning up to three months at a time. If you wish to operate for longer than this, you should apply for a HAREC or a Reciprocal Licence. ('Portable' in this context *includes* operation from buildings such as hotels, or from other Radio Amateur's stations.)

- CEPT allows for *lowest common denominator* operating privileges only. This means that although you are allowed to use

400W PEP output in the UK, you may only use 100W in Monaco, as that is the maximum permitted power there. Also, you may not operate on 6m if resident amateurs cannot use that band. In some countries, operation on 6m is by special permit only: if that is the case you may not use 6m under the CEPT licence. It works the other way too: eg an amateur from Majorca may not use 6m in the UK, even though we can, and amateurs from Sweden can only use 400W in the UK, even though their licence allows them to use 1000W whilst at home.

- The Class 2 CEPT licence (equivalent to the UK class B) only applies to frequencies of 144MHz and above. This means that UK Class B amateurs may *not* operate on 6m whilst abroad, *even* in those countries where residents have 6m privileges as standard. Hard luck, class B 6m fans, but that's the way the rules are at present.

- You must take your current licence Validation Document and a copy of the *Amateur Radio Licence (A) or (B) Terms, Provisions and Limitations Booklet*

(BR68) with you when operating abroad.

● Although you do not have to go through the procedure of applying for a local licence, it is the responsibility of the individual amateur to find out the frequency bands permitted by his or her class of licence, and the permissible power levels on each band, in the country from which (s)he intends to operate, by contacting the appropriate licensing authority. It must not be assumed that the licensing conditions are the same as the UK licence: often they're not! Because this information changes frequently, it is not possible for the RA, SSL or the RSGB to keep an up-to-date database of overseas countries' conditions, although in many cases, the national Amateur Radio society in the country concerned will be able to help you.

CEPT countries

Your licence Validation Document has a number of country

have not, as yet, implemented the recommendation may nevertheless still issue reciprocal licences to visiting amateurs, so all is not lost. Malta is one such country, and in these cases reciprocal licences should be applied for in the normal manner. The addresses of many of the world's licensing authorities can be found in the *RSGB Yearbook* [1] and, in greater detail, in Appendix 2 of the *Amateur Radio Operating Manual* [2].

Overseas readers should note that the information in Table 2 is intended for use by British amateurs only, as there are a few anomalies which apply in certain countries: eg New Zealand does not permit CEPT licence operation by radio amateurs from Spain, and Greece only allows it with amateurs from EU countries.

The countries in Table 2

Although a CEPT member country, Malta has not accepted Recommendation T/R 61-01, so it is still necessary to apply for a reciprocal licence if you wish to operate from Malta. Here, Dave Lawley, G4BUO, and Andy Chadwick, G4ZVJ, operate as 9H3XY and 9H3ZV respectively.

Whilst it is well known that France has implemented T/R 61-01, it is perhaps not so widely realised that you can operate from the French Caribbean islands, or Mayotte in the Indian Ocean, or even New Caledonia in the Pacific, under the terms of the CEPT licence. Note, however, that local permission

which require that you sign your own callsign first, eg G0XYZ/ZL.

Some countries, however, use a *call district* system. Let's take Sweden as an example. Gothenburg is in the 6th call district, and Stockholm is in the '0' call district. Use of the district indicator is not obligatory when operating with the CEPT licence in Sweden, so if I was in Gothenburg I could choose to use either SM/G4JVG (which I could use *anywhere* in Sweden) or SM6/G4JVG. However, in the latter case, I would, of course,

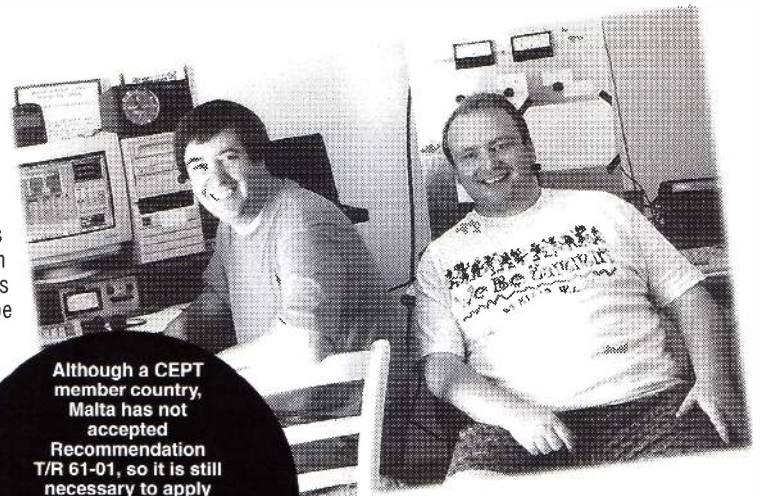

Beginner's Guide to Operating station from abroad

codes printed at the bottom. These are the countries which have implemented T/R 61-01 and which you may operate from under the terms of the CEPT licence. The country codes are defined in the *BR68* booklet. The RA also issues a useful information sheet called *Operation Under CEPT (RA247)*.

For completeness, a list of all CEPT countries is given in **Table 1**, but note that you are *not* allowed to operate from all of these, only the ones which have actually implemented Recommendation T/R 61-01. These countries are listed in **Table 2**. Four countries in Table 2 - Canada, Israel, New Zealand and Peru - are not members of CEPT, but nevertheless have agreed to (most of) the recommendations of the agreement.

For example, you may operate from Austria, but not Albania, because even though Albania is a CEPT member country it has not implemented the recommendation. You *may*, however, operate from Israel, even through Israel is *not* a CEPT country, because it has agreed to recognise the licences of amateurs from CEPT countries.

Some CEPT countries which

should be identical to the list of abbreviations at the foot of your Validation Document. However, don't forget that Validation Documents are only normally issued once a year, and countries are frequently being added. The most recent countries to have implemented the CEPT recommendation are Bulgaria, Canada, Croatia, the Czech Republic, Iceland, Latvia, Portugal, the Slovak Republic and Turkey, so it is possible that some of these may not appear on your Validation Document if it's a few months old. If you anticipate operating from one of these countries and it is *not* listed on your Validation Document, you should write to SSL explaining the situation and asking them to provide you with an updated Validation Document.

overseas territories

Most people realise that if they want to operate from a British overseas territory, such as Turks and Caicos or the Falkland Islands, they have to obtain a local licence. Such is not the case with French overseas territories, however.

must be obtained to visit and / or operate from certain French overseas territories.

what callsign?

It is not clear to many radio amateurs what callsign or prefix should be used when operating abroad under the terms of the CEPT licence (especially in those countries which use a *call district* system). This is because only the country code abbreviations and list of CEPT countries appears on the Validation Document, in the *BR68* booklet, and in the *RA247* leaflet - the callsign prefixes are *not* given in these documents.

So, what callsign should you use when operating from, say, Belgium? Belgium is listed as simply 'B' in the list of country codes, but the callsign prefix for Belgium (as allocated by the International Telecommunication Union, ITU) is 'ON'. Therefore the callsign you should use from Belgium would be 'ON' followed by an oblique stroke, followed by your own callsign, eg ON/G0XYZ. If you are operating mobile, you should add the '/M' suffix. Exceptions are New Zealand and Peru,

have to change to SM0/G4JVG if I moved on to Stockholm, or SM7/G4JVG from Malmö etc.

Those countries where use of the call district number is *optional* by visiting CEPT amateurs are marked with an asterisk (*) in Table 2.

The use of the call district indicator is *obligatory* in three countries: Italy, Greece and Estonia. Whether mandatory or not, its use is always to be recommended, as the information is of use to your fellow amateur. For example, although the use of the call district indicator is not obligatory in Spain, other amateurs would be interested to know whether you are operating from the Spanish mainland, the Balearic Islands (EA6), the Canary Islands (EA8) or Ceuta and Melilla (Spanish North Africa - EA9), as these count as four different countries for Amateur Radio purposes.

In some countries, the prefix to be used is dependent on the individual's own licence class. For example, in Germany a UK class A licence holder would sign DL/G0ZZZ, whereas a British class B licensee would sign DC/G7ZZZ. There are only two possible licence classes: **CEPT Class**

1, equivalent to a UK class A licence, and **CEPT Class 2**, equivalent to UK class B. Those countries which have more than two licence classes are gradually changing their licensing structure to conform.

the future

More countries are expected to implement the CEPT agreement soon, giving an even wider range of destinations where you can operate with the minimum of formality. Meanwhile, the CEPT licence already gives European Radio Amateurs more freedom to operate than ever before.

With the proliferation of cheap package holidays to attractive (from a radio point of view) destinations, and lightweight equipment and antennas, putting on a one-man DXpedition has never been easier. The enormous rise in popularity of the RSGB Islands on the Air (IOTA) awards programme also offers many dozens of potential locations in CEPT countries which you might not otherwise have considered as a holiday destination.

g Abroad

I hope this article has clarified some of the ambiguities and misconceptions regarding the CEPT licence and, perhaps, will also encourage more British amateurs to take greater advantage of the privileges conferred by their licences.

further reading

[1] *RSGB Yearbook*, 1998 Edition, edited by Brett Rider, G4FLQ. Available from the *Ham Radio Today Book Browser* service (see page 45), price £13.95 plus P&P.

[2] *RSGB Amateur Radio Operating Manual*, Fourth Edition, edited by Ray Eckersley, G4FTJ, available from *Ham Radio Today Book Browser* service (see page 45), price £12.23 plus P&P.

Table 2: List of countries which have implemented CEPT Recommendation T/R 61-01 and the prefix or prefixes which should be used when operating from those countries. Countries in which use of the call district system is optional (see text) are marked with an asterisk (*).

	CEPT Country Code	Prefix	CEPT Class 1	Prefix	CEPT Class 2
Austria	A		OE*		OE*
Belgium	B		ON		ON
Bulgaria	BG		LZ*		LZ*
Canada	VE		VE		VE
Newfoundland			VO		VO
Labrador, Yukon, Prince Edward Island			VY		VY
Croatia	HR		9A		9A
Cyprus	CY		5B4		5B4
Czech Republic	CZ		OK		OK
Denmark	DK		OZ		OZ
Greenland			OX		OX
Faroe Islands			OY		OY
Estonia		EST Use of call district indicator is obligatory.			
Hiiumaa, Saaremaa			ES0		ES0
Tallinn			ES1		ES1
Harjumaa			ES2		ES2
Laanamaa, Raplamaa, Jarvamaa			ES3		ES3
Laane-Virumaa, Ida-Virumaa			ES4		ES4
Jogevamaa, Tartumaa			ES5		ES5
Polvamaa, Valgamaa, Vorumaa			ES6		ES6
Viljandimaa			ES7		ES7
Parnumaa			ES8		ES8
Finland	FI		OH*		OH*
Aland Islands			OHO		OHO
France	F		F		F
Guadeloupe			FG		FG
Mayotte			FH		FH
St Barthelemy			FJ		FJ
New Caledonia			FK		FK
Martinique			FM		FM
French Polynesia (Tahiti etc)			FO		FO
St Pierre et Miquelon			FP		FP
Reunion			FR		FR
St Martin			FS		FS
Kerguelen Island, Amsterdam and St Paul Islands,					
Crozet Island, French Antarctica			FT		FT
Wallis and Futuna			FW		FW
French Guyana			FY		FY
Corsica			TK		TK
<i>Note that in certain cases local permission must be obtained to visit and / or operate.</i>					
Germany	D		DL		DC
Greece		GR Use of call district indicator is obligatory.			
Attica (including Athens) and Biotica			SV1		SV1
Macedonia			SV2		SV2
Peloponnesus			SV3		SV3
Thessaly			SV4		SV4
Dodecanese Islands (Rhodes, Kos etc)			SV5		SV5
Epirus			SV6		SV6
Eastern Macedonia and Thrace			SV7		SV7
Adriatic and Ionian Islands (inc Corfu, the Cyclades etc)			SV8		SV8
Crete			SV9		SV9
<i>Note that a special entry permit, as well as operating permission from the monk's council, must be obtained before operating from Mount Athos. This is not usually granted to foreign amateurs.</i>					
Hungary	H		HA*		HG*
Iceland	IS		TF*		TF*
Ireland	IRL		EI		EI
Israel	IL		4X or 4Z		4Z7
Italy	I	I Use of call district indicator is obligatory.			
Umbria, Lazio			IK0		IW0
Valle d'Aosta, Piemonte, Liguria			IK1		IW1
Lombardy			IK2		IW2
Alto Adige/Trentino, Veneto, Friuli Venezia (Venice)			IK3		IW3
Gulia, Emilia, Romagna			IK4		IW4
Tuscany and Tuscan islands			IK5		IW5
Marche, Abruzzi			IK6		IW6
Puglia, Basilicata, Tremiti islands			IK7		IW7
Malise, Campania, Calabria, Ventotene etc			IK8		IW8
Sicily and surrounding islands			IK9		IW9
Sardinia and surrounding islands			IK0		IW0
Latvia	LV		YL		YL
Liechtenstein	FL		HB0		HB0
Luxembourg	L		LX		LX
Monaco	MC		3A		3A
<i>Because of the extremely small size of the territory, the exact location of operation of an amateur radio station must be indicated to the Direction Generale de Telecom, 25 Bd de Suisse, MC98030 Monaco, Cedex, or by telephone to 93 25 05 05. (Also note that the maximum power output is 100W and that 50MHz operation is not permitted.)</i>					
Netherlands	NL		PA		PA
New Zealand	ZL		ZL*		ZL*
<i>Note that New Zealand requires the use of ZL as a suffix after the callsign instead of before it, eg G0ZZZ/ZL.</i>					
Norway	N		LA		LA
Svalbard (Spitzbergen) and Bear Island			JW		JW
Jan Mayen Island			JX		JX
Bouvet Island, Peter 1st Island and Norwegian Antarctica			3Y		3Y
<i>Operation from 3Y may only take place with the special permission of the Ministry of the Interior.</i>					
Peru	PER		OA		OA
<i>Note that Peru requires the use of OA and a district indicator as a suffix after the callsign instead of before it, eg G0ZZZ/OA4.</i>					
Portugal	P		CT1		CT1
Azores			CU*		CU*
Madeira			CT3		CT3
Romania	RO		YO*		YO*
Slovak Republic	SK		OM		OM
Spain	E		EA*		EB*
Sweden	S		SM*		SM*
Switzerland	CH		HB9		HB9
Turkey	TR		TA*		TA*

**1686 Bristol Road South
Rednal
Birmingham B45 9TZ**

SRP TR

**(COM213)
100 CHANNEL SCANNER**

A high-specification scanner offering 100 channels in 10 banks, with 1 Priority Channel in each bank. For speed and ease of use it offers Jetscan, which can scan 100 channels per second, and also Jetsearch, which can search at up to 100 steps per second. It also features programmable band search, lock-out for up to 10 frequencies, channel look-out, 2 second scan delay, data noise/birdies skip, a key lock and a green back-lit display. 66-88, 108-174, 406-512, 806-956.

£119.99 + £5 P&P.



**(COM102)
10 CHANNEL SCANNER**

This state of the art 10 channel scanner is fully programmable and can receive a variety of PMR communications. It is robustly designed and offers a full frequency LCD display for ease of use. Also features an in-built circuit for recharging Nicad batteries. 66-88, 137-174, 380-512.

£49.99 + £5 P&P.



**(COM205)
400 CHANNEL SCANNER**

The B111 is the last word in programmable scanners. A free standing desk top unit covering nine radio bands in the 25-512MHz and 806-1300MHz ranges. Operates from AC mains or car cigar lighter via suitable adaptor. It incorporates a microprocessor avoiding the need to change crystals and gives special functions such as scan delay, memory back-up, priority channels and many more.

£249.99 + £5 P&P.



**(COM215)
200 CHANNEL SCANNER**

A highly-featured desktop scanner offering 200 channels arranged in 10 scanning banks, with one Priority Channel in each bank. For ease of use it offers Turbo Scan at 100 channels per second max with Autosort for maximum scan speed and Turbo Search at up to 100 steps per second. Other features include direct search programmable band search, auto station program mode, lock-out for up to 10 frequencies, manual frequency sort, programmable auto-recording and optional CTCSS tone squelch. The unit is powered by AC mains or 13.8Vdc. 66-88, 108-174, 216-512, 806-956.

£219.99 + £5 P&P.



SANGEAN ATS 909 FM-Stereo/MW/LW/SW PLL Synthesized receiver

The ATS-909 is a continuously tunable receiver from 153kHz-29999kHz. This receiver is capable of receiving and tuning all the short wave bands and any stations in between

- 307 memories (261 in SW, 18 each in MW/FM, 9 in LW plus priority station)
- Five tuning methods – direct frequency tuning, auto scan, manual tuning, memory recall and rotary tuning
- ATS (auto tuning system) – auto scan and preset in priority of signal strength in FM/MW/LW bands
- E2 PROM for memories back-up
- FM stereo via earphones
- 29 pages SW stations name memory, 9 memories in every page
- Automatic search strongest signal station within SW station pages
- SSB (USB/LSB) 40Hz/step on fine tuning
- AM RF gain control
- Built-in 42 world cities time plus D.S.T. device
- 3 individual timers
- Adjustable sleep timer
- Alarmed by radio or HWS (Humane Wake System) buzzer
- Battery and signal strength indicator
- Direct key to recall favourite station in one button
- Dual conversion device
- REC out and standby control output
- Pre-programmed station name and frequency according to customer's requirements before ex-factory
- AM wide/narrow filter and FM mono/stereo selector
- Optional features for European market
- RDS (Radio Data System) on PI, PS and CT for station name and clock time
- Size in mm: 215 x 133 x 37.5
- Weight: 850g without batteries



£169.95 + £5 P&P.

- ★ Free batteries
- ★ Free SW frequency book
- ★ Free SW antenna
- ★ Free headphones

READING

Telephone: 0121-457 7788
0121-460 1581
Fax: 0121-457 9009



Super Syncro 1100 – 1100mAH Nickel Metal Hydride (NiMH) AA size rechargeable cells. No memory effect. Twice the capacity of NiCds. **£3.00** inc P&P.



Skyscan DX-V1300 base disconn – Most disconnes only have horizontal elements and this is the reason that they are not ideal for use with a scanner. Most of the transmissions that you are likely to receive on your scanner are transmitted from vertically mounted antennas. The DX-V1300 has both vertical and horizontal elements for maximum reception. Constructed from best quality stainless steel and aluminium and comes complete with mounting pole. **£49.95** + £3 P&P.



Skyscan Desktop Antenna Model Desk 1300 disconn – Built and designed for use with scanners. Coverage: 25 to 1300MHz. Total height 36" and 18" wide at widest point. Comes complete with 4m of RG58 coax cable and BNC connector. High performance antenna, ideal indoor or as a car antenna when vehicle is stationary. **£49.00** + £3 P&P.



Airband mini-mag antenna – Civil (108-137MHz) and military (225-400MHz) dual band receive antenna featuring super strong miniature magnet and coax cable terminated in BNC connector. **£24.95** + £3 P&P

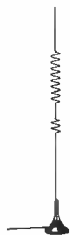

Wideband mini-mag antenna – Wideband (25-1300MHz) receive antenna featuring super strong miniature magnet and coax cable terminated in BNC connector. **£29.95** + £3 P&P.



Yaesu FRG-100 communications receiver – Award winning 50kHz to 30MHz base station AM, CW, USB, LSB, FM (optional) communications receiver. Features include two clocks and timer, 50 memories, FM option, remote control jack. Superb value at **£449.95** + £7 P&P.



Roberts R861 – compact digital world band receiver – Fully featured 153kHz to 30MHz (AM, SSB) and 87.5MHz to 108MHz (FM) portable digital world band receiver. Features include RDS, world time clock, 306 memories, RF gain control, direct frequency entry. Comes complete with free PSU, antenna, frequency guide and case. **£199.00** + £5 P&P.



Radio shack DX-394 communications receiver – 150kHz to 30MHz base station AM, CW, USB, LSB communications receiver. Features include clock and timer, signal meter, 100+ memories, RF gain control and direct frequency entry. A steal at **£149.95** + £7 P&P.



Uniden Bearcat 9000 XLT – AM/FM/WFM switchable base station HF/VHF/UHF scanning receiver. Covers 25-550 and 760-1300MHz. Features 500 memories, auto sorting, backlit orange LCD display. Scan rate of 100/300 channels/sec. **£249.95** + £10 P&P.



AKD Target HF3 communications receiver – 30kHz to 30MHz mobile or base station AM, USB, LSB communications receiver. Very simple to operate. Ideal for the novice, but with a performance more demanding listeners will appreciate. **£159.95** + £5 P&P.



Commtel COM 206 – AM/FM handheld VHF/UHF scanning receiver. Covers 66-88MHz (FM), 108-137MHz (AM), 137-174MHz (FM), 380-512MHz (FM). Full civil airband coverage, comes complete with free case and rechargeable batteries. **£129.95** + £5 P&P.



Yupiteru MVT-7100 – All mode switchable handheld HF/VHF/UHF scanning receiver. Covers 0.5-1650MHz. Features 1000 memories, over 500 pass memories, 10 limit search banks, 12 step sizes. Comes complete with earpiece, belt clip, wrist strap, rechargeable batteries, PSU, in-car adaptor and telescopic antenna.

£199.99 + P&P (10 only)



Realistic PRO-2042 – AM/FM/WFM switchable base station HF/VHF/UHF scanning receiver. Covers 25-520 and 760-1300MHz. Features 1000 memories, 100 monitor channels, backlit orange LCD display. Scan rate of 50 channels/sec. **£249.95** + £10 P&P.

WE ALSO HOLD A LARGE RANGE OF SECOND USERS SHORTWAVE AND SCANNING RECEIVERS. PLEASE CALL WITH YOUR REQUIREMENTS

Peter called in to ask if I could do anything for his FT-290 2.5W 2m multimode. He explained that half of the figures on the LCD display were missing. "I rang up xxx and they said that even if they could get the part it would cost well over £100 and it just wasn't worth it", he said.

Now good commercial sense should have made me book the rig in, and produce it in a week or so with an appropriate bill. Sometimes, however, I just can't resist a little showmanship ("male ego" my wife calls it!) and so I took the set away for a couple of minutes and much to Peter's surprise returned it to him in perfect working order. What had I done?

LCD displays have a sensitive layer which is electrically connected by being pressed on to a conductive pad. When they start to 'play up', either they can be stripped and cleaned, or squeezed tighter together. In the case of the FT-290 Mk1 the lat-

ter approach only requires the lid to be opened, and a piece of sponge rubber jammed in behind the display. Not very technical, but it saves a couple of hours, and it works!

a high swr

John was not happy with the 2m vertical antenna he had purchased. "The old one had an SWR of below 1.1:1, but I can't even get this one to come down to below 2:1."

Time after time I get this complaint, but in the vast majority of cases there is nothing wrong. Many of the cheaper SWR meters are very sensitive to any RF on the outside of the coax, and hence depending on the length of this, can show totally misleading readings. Under these circumstances it will usually be found that altering the length of the coax will cause a considerable alteration in the SWR reading, whilst not really altering the actual SWR at all.

To prove the point I let Peter have the loan of a good quality meter, and he duly reported back that everything was OK. So be-

john's war dance

fore deciding that an antenna system is faulty, do be sure that your SWR meter is not telling lies.

John's neighbours thought that he was a little eccentric (aren't we all), but what really convinced them was what they described as his 'strip tease war dance'.

One day he was walking down the road as usual, talking into his FT-50, when all of a sudden he was seen leaping in the air, and then sitting on the floor,

empty battery box John had given neither himself, nor the transceiver, any protection and was very forcibly brought to realize this.

The cost of an empty

battery box John had given neither himself, nor the transceiver, any protection and was very forcibly brought to realize this.

become pitted, and that cleaning was now only a very short-term measure. He had tried dealers



around most of the U K, and I was his last hope! I was happy to be able to tell him that he didn't need a new relay, and

that his existing one would probably be good for an-

All in a Day's Work

Our thrifty fixer Harry Leeming, G3LLL, with

trying to remove his trousers, with smoke coming from his pocket. The problem was that he had placed his spare nicad pack loose in his pocket, forgetting that it also contained his door key, and this had short circuited.

John had wondered why the empty battery box had been marked "do not use rechargeable batteries". He had fitted nicads and everything had seemed OK. He was able to contemplate this as he was examined at the local hospital, and was fortunate to find that his burns were only superficial. Later in the week he was in the shop telling me the tale, and I explained to him where he had gone wrong.

Nicad batteries are of very low internal resistance, and can produce extremely large currents under short circuit conditions. Commercial nicad packs are designed with this in mind, and have some form of fuse fitted internally to stop just the kind of accident that had occurred to John. They also stop the associated transceiver being melted, should an internal short occur. By fitting his own nicads to an

half of that of the full Yaesu nicad pack, and so many people use these. This shouldn't be done, however, without incorporating a fuse link, as it is just too risky.

I like saving money as much as anyone else, but I don't like to take unnecessary risks. I can't say that I would recommend anything except the official battery pack, but if you do want to use your own nicads in an empty battery box treat the following as the absolute minimum safety measure.

Dismantle the battery box and find an internal connection between the batteries. Cut this leaving a space of a few centimetres. Across this space solder a piece of 2 amp fuse wire. At least now if you do manage to short out the battery, it won't get red hot in your pocket.

ft-101zd ant relay

Peter telephoned from the north of Scotland to ask about the availability of an antenna change-over relay for his FT-101ZD. He explained that the contacts had

other 10 or 20 years. The antenna change-over relay on the FT-101ZD has two pairs of contacts, but only one pair is used. When these become worn, no problem, just unsolder the wires from the worn contacts, and attach them to the unused ones.

an impossible fault

Peter came in with his FT-101ZD. "R06 is getting hot and burning out, but I can't find a short, will you have a look at it, Harry?"

Examination showed that Peter had fitted a five watt resistor in place of the original two watt R06, but a quick test showed that even this was overheating when the mic was keyed. I could find no sign of a short circuit, and so I measured the DC voltage across the R06. A quick calculation gave a dissipation of not much over one watt, but R06 was getting a lot hotter than this. What could the trouble be?

My memory jumped back over 40 years to when, as an apprentice radio and TV engineer, I had a similar problem with a resistor

in the power supply of a five valve radio. I was eventually rescued by an experienced engineer, but I didn't forget. Here it was, same fault but different equipment.

I put the test meter on the AC range, put a 0.1µF capacitor in series with it and checked the AC voltage across R06. It was nearly 70 volts, hence R06 was dissipating 10 watts AC as well as 1 watt DC.

The cause of the trouble? C07 was open circuit, and hence C08 was trying to act as the reservoir capacitor. The ripple current to C08 was flowing via R06, hence the burn up. Fitting a replacement capacitor and a new 2 watt resistor cleared the problem.

blowing fets

Rod's money was burning a hole in his pocket at the rally, and so he decided to treat his FT-902 to a new set of valves. When he got home he soon put them in, but was a little disappointed to find

didn't want to risk blowing the new FET so I then removed the plug-in RF board, and gave the 12BY7A driver valve a slight tap whilst it was operating. I was rewarded by an internal firework display, and so I gave it a few more clouts until the display stopped.

Rod had just been unlucky as the valve that he had purchased had a little loose dust between the electrodes. The resulting flashover from anode to control grid, blew the RF FET, which shared a tuned circuit with the grid of the driver valve. The valve would have probably have been OK after the bashing I had given it, but to be on the safe side, I fitted a new one.

The 10% cut in power? I am afraid I have often noted this when fitting new valves, and I can only presume that some of the manufacturing plant is wearing out. If you had a few million pounds to spare would you spend it on making a new valve factory?

that he was a bit muffled. Robert liked to do his own servicing, and had set the sideband carrier frequencies with a counter on his FT-401 as per the manual. If everything was correct this should have given a nice balance of audio. "What is the best way to check?" was his question.

With almost new equipment one can expect things to fall neatly into place if everything is set up as per the maker's instructions. With older equipment, however, this is not necessarily the case. Even items like crystal filters alter with age, and sometimes drift a little off frequency, or become 'lop sided'. When setting the frequencies of the carrier oscillators on older SSB equipment, compromise is the rule of the day, and one has to try to get the best results possible. Sound quality and balance is difficult to quantify, and whilst frequency response can be measured, this cannot tell one how it sounds.

Fortunately, transceivers use the same crystal filters and car-

rier oscillator frequencies are correctly set. An even better way is to tune in an AM broadcast station by zero beating it in the sideband mode first in upper sideband, and then in lower sideband. The sound quality should be the same in either mode once the tuning is correctly set. If it is not, remove the antenna and then carefully tune the relevant oscillator trimmer so that the pitch of hiss goes higher or lower, depending on whether you require the audio response to sound brighter or deeper. Ideally you should end up with bright crisp clear audio on both sidebands, with the background hiss sounding identical on each.

In practice, when using a rig fitted with a filter that is past its best, you will just have to strive for the best possible audio quality. If you listen to a good number of SSB stations on USB and LSB, the average tonal balance will be more-or-less what you sound like in the transmit mode.

One final point to note is that

All in a Day's Work

more secrets from his workshop

that instead of more power, he had about 10% less output. Not to worry, but then after a couple of days the receiver went dead. He was soon in my shop telling the sorry tale.

Investigation showed that the RF stage FET had blown, and so I replaced it, and all was well. I

tweaking audio

Robert was not happy about his audio quality, as he seemed to get conflicting reports. On 20 metres he was told that his audio sounded rather 'thin', whilst the lads on the 80 metre net said

rier oscillators on transmit as they do on receive. Because of this, the easiest way to judge the tonal balance is to listen to what the rig sounds like on receive. With practice I have found that just by listening to the background hiss and switching sidebands, I can get quite a good

if you set the audio too deep in pitch, you will find it almost impossible to get good carrier suppression. If this should be the case on a particular sideband, turn the carrier trimmer slightly, until the pitch of hiss goes slightly higher, and then check the carrier suppression.

If the antenna changeover relay on an FT-101ZD fails, don't panic! Just use the spare set of unused contacts.



STORNO 5662 UHF synthesised 12v mobiles supplied with pre-programmed EPROM, BCD switches etc and full info to make 100CH. 70cms mobile, 15w O/P, just needs 2 crystals, mic and L/S (not supplied) to complete the kit.....£45

STORNO 4662 UHF synth h/helds supplied with Ni-Cad no ants£15

STORNO 4114 VHF as above.....£15

STORNO 2-way desktop chargers for above series.....£15

STORNO 5114s VHF high band mobiles synthesised supplied sets only but with circuits and 2m. Modification info.....£35

PYE WHITEHALL 12V mobile units low-band 68-88 MHZ AM/FM bootmount with control box but no cable with info.....£25

YAESU 545L14 UHF synth h/helds need external programmer supplied with desktop charger, batt, ant no info.....£50

PYE PF85 3CH FM h/helds for 2m with Ni-Cad + ant.....£30

PYE M293 'E' band AM 6CH mobiles, OK to mod for 4m or RAC rally channel etc with MIC+L/S.....£25

PYE 5002 'E' band FM h/helds no batts or ants but supplied in original ex MoD packing, 2 units for.....£25

VINTAGE - new/unissued hand microphones for wireless sets No. 18 in original ex MoD packing, 2 units for.....£15

BARGAIN PARCEL - 4 assorted handhelds - mixed, eg low/high/UHF, with batteries/ants as available.....£45

WILD ARK-1 GYROSCOPIC THEODOLITE in as new condition with power supplies, tripod, and info, last one....£210 + VAT + carr

We have a wide range of 'one or two offs' please ring for particular requirements, receivers, PMR h/helds, mobiles etc.

Please send self stamped addressed envelope for mail list.

NOTE CLOSED ALL DAY ON WEDNESDAYS

All goods are supplied in "as is" condition but are checked for completeness before despatch.

All goods include UK mainland p/p and VAT.

Technical Modification enquiries after 4.30p.m. please.

Most credit cards accepted.

G.W.M. RADIO LTD

40/42 PORTLAND ROAD, WORTHING, WEST SUSSEX BN11 1QN
 TELEPHONE: 01903 234897 FAX: 01903 239050

Essex Amateur Radio Services

The little dealer with the big heart

BUYERS ARE WAITING NOW FOR YOUR PRE-ENJOYED EQUIPMENT!

* VHF/UHF *
 * HF Transceivers *
 * Station Accessories *

AVOID Part Exchange WE PAY TOP PRICES

We pay cash same day or 24 hours by post. Always large stock available. Phone today for the best deals. Silent Key sales handled efficiently and personally.

**4 Northern Avenue, Benfleet
 Essex SS7 5SN
 Telephone
 01268 752522
 7 days a week 8am to 8pm**



JOIN THE RSGB - Your National Society

and we'll show you how to make a 12-month year grow!

When it comes to amateur radio we have a wealth of experience and background advisers to call upon to help you enjoy your hobby to the full - but YOU are the most important ingredient in the formula - without you there is no amateur radio. Together we are a winning combination and will ensure that amateur radio continues to thrive and grow into the next millennium.

We put you, the radio amateur and short wave listener first - help us to fight your cause and keep this hobby alive.

Sign up for Direct Debit, and we will give you an extra three months' membership completely FREE!

That's how we make a 12-month year grow!

To: Radio Society of Great Britain, Lambda House, Cranborne Road, Potters Bar, Herts EN6 3JE. Tel: 01707 659015.

Fax: 01707 645105. Web: www.rsgb.org. E-mail: Sales@rsgb.org.uk

I would like to join the RSGB. My payment for £36* is enclosed with this form.

Name Callsign (if licensed)

Address

Post/Zip Code:

Credit card number:

Expiry date: Switch Issue No. Start date:

Signed: Date:

HRT5/98

SUSSEX SURPLUS

13 STATION ROAD, HORSHAM, WEST SUSSEX RH13 5EZ

Telephone: (01403) 240257 Fax: (01403) 270339

Test Equipment • Components • Accessories
Electromechanical • Mechanical • Engineering

VALVES WANTED

A2900.....£4.00	GZ34.....£4.00
ACO44.....£10.00	KT61.....£5.00
DA100.....£150.00	KT66 clear.....£30.00
DA30.....£80.00	KT66 grey.....£20.00
DA60.....£150.00	KT66 Marconi..£25.00
DO25.....£30.00	KT77.....£10.00
DO26.....£50.00	KT88.....£50.00
DO60.....£150.00	LP4.....£20.00
ECC32.....£3.00	LS6A.....£10.00
ECC33.....£4.00	NR47.....£50.00
ECC35.....£2.00	NR56.....£30.00
ECC82.....£2.00	NT18.....£30.00
ECC83.....£3.00	NT36.....£30.00
EF86.....£3.00	NT40.....£60.00
EL34.....£15.00	PX4.....£40.00
EL37.....£15.00	PX25.....£80.00
GZ32.....£4.00	PX650.....£25.00

SEND S.A.E. FOR FULL LIST

The CW Centre! ©

A new batch of the Ω mega pocket Morse trainer has just arrived. This will help the beginner or experienced operator to improve their reading ability by providing practice in the form of groups of characters, words or complete QSOs at a range of speeds (including Farnsworth mode), Crib sheets and interactive modes enhance the flexibility of this trainer. Morse practice oscillator is built in. Earphone supplied. Needs 9-volt battery.



G3TUX Ω mega Morse trainer £39.95
UK P&P £2.50



G3TUX



The QRP Component Company

PO Box 88 Haslemere Surrey GU27 2RF

Tel: 01428 661501 Fax: 01428 661794

G3TUX@aol.com

Subscribe to Ham Radio Today!

Now you've seen the new-look *Ham Radio Today*, we're sure you'll want to read it every month. To be certain of being able to get hold of a copy every month, the best way is to subscribe. That way, you'll have *Ham Radio Today* delivered to your door as soon as it's published. At £26.50 per year (for UK readers), including postage, it's also cheaper than buying each copy at the newsagent.

All you have to do is fill in the form and send your cheque or credit card authorisation to the address below. If you do not want to cut your copy of *Ham Radio Today*, please feel free to photocopy this page.



To: Ham Radio Today Subscriptions, RSGB Publications, Lambda House, Cranborne Road, Potters Bar, Herts EN6 3JE.

Subscription rates (12 issues/year) UK - £26.50; Europe & Eire - £36.50; Rest of the World - Surface £38.50, Air Mail £54.

Name _____ Callsign (if appropriate) _____

Address _____

Post Code _____

Credit Card No _____ Exp Date _____ Switch Start Date _____ Issue No _____

Signature _____ Date _____

Do you have something constructive to say on the state of amateur radio today? Perhaps you'd like to put your viewpoint to the readers, get some discussion going, or give an answer to one of the issues raised? We'll pay £10 for the best letter we publish each month (paid 6-8 weeks following the publication date). So write in with your views to; Letters Column, ham radio today, Lambda House, Cranborne Road, Potters Bar, Herts EN6 3JE or send an e-mail to hrt@rsgb.org.uk We reserve the right to edit letters for length, grammar and clarity for publication. Letters must be original and not have been sent to any other magazines, and must include name and address plus callsign if held (name and callsign will be withheld from publication if requested). Reader's views published here are not necessarily those of the magazine.

letter of the month letter of the month letter of the month

Dear Ham Radio Today,

It's nice to drool over the latest presentations and reviews, but why not help to keep the old ones running and give newcomers the chance of cheaper radios? We are all supposed to be able to read diagrams and should be capable of carrying out minor repairs. Can you reproduce circuits of older equipment and known modifications, this would help everyone?

Roger Dicks

Editorial comment:

Thanks for your comments - in fact, we do this already. The series All in a Day's Work does exactly what you suggest! I hope you enjoy reading the new-style Ham Radio Today.

Dear Ham Radio Today,

Congratulations on the new look and feel of *Ham Radio Today*. It's great; *Ham Radio Today* makes a good complement to *RadCom*. How about a problem page, though?

Charles Ivermee

Editorial comment:

We would always be pleased to include readers' problems under 'Help Wanted' in the Free Readers' Ads section. Keep the query to 40 words or less and send it in on the Free Readers' Ads form printed in Ham Radio Today every month.

letters letters letters

£10 for letter of the month

Dear Ham Radio Today,

I was astounded to read one reader's letter (Vol 16, No. 2) in which he called for an end to home-constructural features, with a view to getting young people into the hobby. What should be remembered is that there is a considerable number of readers who are of mature years and due to the prevalent view that the world is only for young people, are perhaps no longer welcome in the workforce. We cannot all use a credit card to get on the air and therefore have to build our own equipment.

When your magazine was introduced, there were several constructional articles, many of which I have built and enjoyed using. So let us have more 'build it yourself' articles, instead of transforming the magazine into a manufacturer's review of the latest (expensive) all-singing all-dancing black boxes, which only some can afford to buy, and try to maintain the experimental aspects of our hobby. Thank you.

Peter Morgan, GW1RZE

Editorial comment:

The popularity of BBC TV's Top Gear programme, which regularly tests cars such as Ferraris, Porsches and many others well beyond the means of most viewers, suggests that people enjoy watching programmes about expensive products. The same people probably also enjoy tinkering with their C-reg Ford Escort! It's the same with Amateur Radio equipment. And many, many people do buy such new equipment. If you were looking to buy a new (or even a cheap second-hand) rig, wouldn't you want to read all about it before you parted with your hard-earned cash? It is true that people also enjoy reading constructional articles, even if they have no intention of building the equipment described, so if you have designed something, why not share it with Ham Radio Today readers?

And many, many people do buy such new equipment. If you were looking to buy a new (or even a cheap second-hand) rig, wouldn't you want to read all about it before you parted with your hard-earned cash? It is true that people also enjoy reading constructional articles, even if they have no intention of building the equipment described, so if you have designed something, why not share it with Ham Radio Today readers?

Dear Ham Radio Today,

How I agree with the Editorial comment about the RAE (Vol 16 No 2). I found RAE classes invaluable. There were people who knew all about ham radio, as the content of the classes was part of their occupation. The test is to make sure you can retain the information gained. Your comments, that there should be more operating practice, is so true.

If it were possible, I would like to see an independent committee that could look at disputes over operating practice. I have come across so many stations that have their own rules on operating, that have nothing to do with the official guidelines. A committee could look at the problem, monitor it, then come to a decision if there has been bad operating, or a demand by another station that is unreasonable.

So perhaps not only should we be looking at newcomers to the hobby and their operating practice, perhaps we all should get the rule book out and make sure our practice is correct, also the manner we talk to other. I feel there is more to the hobby than being number one. Way above this is consideration for other stations. Any wise owls that could act as ombudsman?

Kerry Brown

"TONE" BURST

by G6DMEN



With apologies to John Cramond, GM4NHI (see his review on pages 25 - 27!)

Dear Ham Radio Today,

I am writing to you regarding Harry Leeming's, G3LLL, comments in Vol 16 No. 2 on the risks of electrocution. Any work station power supply should be protected by an RCD (Residual Current Device). This will switch off the supply if a current in excess of 30mA flows to earth. (A current of 50mA can be fatal.)

An RCD can be fitted adjacent to the work station socket or purchased as a combined unit for about £30.00. A small price to pay for your protection, or that of an inquisitive child or grandchild.

Peter Utting

letters letters letters

£10 for letter of the month

Dear Ham Radio Today,

One of the major problems that most amateurs have is the security problem, due to the fact that the size and number of external antennas tells all and sundry that 'here lives an Amateur Radio operator', who probably has a few thousand pounds-worth of radio equipment, as well as accessories. Insuring each and every item is, as I know personally, a wee bit on the expensive side, and something that goes up each and every year.

So security, not just for my home but for my Amateur Radio equipment, has become the top item on my list of 'don't forget to do this each and every year'. I started off, way back in 1983, by locking my equipment away in a steel cabinet, with an expensive combination lock fitted. Then, after I had moved from Cheshire to my present home in Durham, I had to find a better way. So I have converted one room into a combined radio shack and computer room. The door has a lock and padlock, as well as motion detector alarm.

Outside the house I first fitted spotlights that come with Passive InfraRed detectors, then a few years later I changed them over to audio alert spotlights. Now, if anyone, during daylight hours, comes into the range of the PIR the light does not switch on, but the audio response does, so I hear the rather loud 'ding dong, ding dong, ding dong' that it produces for as long as there is someone or something within the PIR's range. At night there is also the glare from the 500 watt halogen bulb.

The latest modification that I have added to my security system is three CCTV cameras, which are small and contain both a PIR as well as a microphone. So now, coupled to the audio alert spotlights, I have sound and vision, plus the fact that all three cameras are connected to a four-channel switching unit that constantly switches between the cameras at intervals I have set, plus a video switching unit, that switches the video to record when the camera's PIR is activated. I can manually set the video recorder on, either in short or long play mode, which then will record everything that the camera sees during the time of recording.

This is a boon, when one is either away from home or engaged in communication or when one is watching one's favourite TV programme. I know that I could have purchased some rather good second-hand equipment for what I have paid for the CCTVs and audio spotlights, but I now have a much greater feeling of security, even though I know it will probably not deter the most determined or aggressive thief. Hopefully, however, it might suggest to most that there are better and less secure domiciles than mine.

J Davies-Bolton, G4XPP

ham radio today event news

rallies

3 May

Anglo-Scottish Rally - details tel: 01573 226372.

4 May

Dartmoor Radio Rally, Yelverton Memorial Village Hall, Meavy Lane, Yelverton, Devon. The event features trade stands and a bring and buy stall. Doors open 10.30am. Details tel: 01822 852586.

Mid Cheshire ARS Rally - details tel: 01606 77787.

9 / 10 May

The Sandown Model Symposium takes place at Sandown Park Exhibition Centre, Esher, in Surrey (the same venue as the RSGB VHF Convention in February). The event covers the whole gamut of model making, model engineering and radio control, and includes an outdoor model flying demonstrations. This year, there will be an Amateur Radio and Amateur TV demonstration. Admission is £7.50 on the door (£6 if booked in advance) and there are concessions for senior citizens, children, families, groups, school and for two-day tickets. For further details tel: 01442 244321.

10 May

MARS-Drayton Rally, Drayton Manor Park, Fazely - see 'Rally of the Month' opposite.

National Vintage Communications Fair will be held in Hall 11 at the NEC in Birmingham. Features vintage radio and broadcasting, classic valve audio and hi-fi, early telephones and PO equipment, gramophones, phonographs and recordings, film and television, antiques etc. Doors open at 10.30am - 4.00pm.

10 May

Dunkirk Amateur Radio Rally, France. A coach trip is being organised from Sandy, Beds, at 6.00am, returning late evening. For further details contact Brian Elliot, G4MEO, tel: 01767 680 043.

15 - 17 May

Dayton Hamvention, Dayton, Ohio, USA. Details from Tom, N8YFW, tel: 001 513 276 6931.

17 May

Dunstable Downs Radio Club will be holding its Annual Amateur Radio Car Boot Sale, at Stickwood Country Park, Luton, Bedfordshire. Site open 0900 - 1500. Leave M1 at junction 10A, turn left and follow signs for 'Mossman Collection'. Talk-in on V44 (145.550MHz). Please note new address for bookings, please do not use any other address or phone number: DDRC, PO Box 4053, Dunstable, Beds LU5 5ZJ.

Harrogate Rally at the Pavilion, Great Yorkshire Showground, Harrogate. The event features traders, a bring and buy stand, and refreshments. Details tel: 01765 640229.

Mid-Ulster ARC Rally, Silverwood Hotel, Lurgan, Co Armagh, starting at 12 noon. Details tel: 01762 851179.

24 May

The Plymouth Radio Club Rally at the College of Further Education, Kings Road, Devonport, Plymouth. Doors open 10.30am to 4.00pm. Morse tests on demand, ample free car parking, easy access for disabled visitors, talk-in on S20 (venue will be signposted from the Manadon junction of the A38 Devon Expressway), refreshments and licensed bar available. For further details contact Stephen Ramsden, tel: 01752 662051 during office hours.

The Three Counties Radio and Computer Rally will now take place on 24 May and *not* on 5 July as previously advertised. The rally is held at Perdiwell Leisure Centre, Bilford Road, Worcester, and features trade stands, radio and computer dealers, parts and accessories, a bring and buy stall, refreshments and a licensed bar. Admission is £1.50 and the rally is open 10.30am - 5.00pm. For more details contact Eddie Cotton on tel: 01905 773181.

East Suffolk Wireless Revival, Stoke High School, Ipswich. Tel: 01394 448495 (evenings).

30 / 31 May

Peterborough Radio Festival 98, 'RadFest', replaces the East of England Radio and Computer Rally. Jointly organised by the Peterborough Radio and Electronics Society and the Elite Breakers CB Club, RadFest will be held over two days at the Sacrewell Farm and Country Centre, Wansford, near Peterborough. Camping and caravanning facilities are available and visitors are encouraged to stay the whole weekend. There will be a disco and BBQ on Saturday evening and the radio car boot sale on Sunday. Further details from Vince Edwards, G8NGZ, tel: 01733 331211, e-mail g8ngz@compuserve.com

31 May

Southend and District Radio Society Radio and Computer Boot Sale at Scout HQ, 191 Eastern Ave, Southend on Sea, Essex. Includes a bring and buy stand, under cover and refreshments. Admission just 50p. Doors open 10.00am and talk-in is on 145.550MHz. Details from GOUAW, tel: 01702 304439.

7 June

Spalding & District ARS 30th annual rally, Springfields Exhibition Centre, Spalding (signposted from Spalding bypass). Amateur radio, scanners, shortwave and CB, satellite TV, books and components. Licensed bar and catering. Huge car boot area, plenty of free parking. Starts 10.00am, talk-in 145.550MHz. For further details contact Mick Pell, G1APV, tel: 0976 271796, or Dennis Hoult, G4OO, tel: 01775 750382.

Royal Naval Amateur Radio Society mobile rally, at the Playing Fields, opposite HMS Collingwood, Fareham, Hants. Trade stands, bring and buy stall, Raynet, SUNPAC, club stands, children's play area, talk-in via PC / PH repeaters. All in three large marquees. Doors open 10.30am. Further details from the Secretary, RNARS, 103 Torrington Road, North End, Portsmouth.

To include your rally in this section, please make sure you send us details of your event in time: the deadline for the June issue is 5 May; for July; 21 May, and for August, 15 June. The address for submissions is: The Editor, Ham Radio Today (Rallies), RSGB Publications, Lambda House, Cranborne Road, Potters Bar, Herts EN6 3JE; fax: 01707 645105. We would be grateful if Ham Radio Today readers would ask their local rally organiser to send information on their rally to this address. If you're travelling a long distance to attend rallies, we recommend you contact the organisers of the events first, to check if there has been any changes since this magazine went to press.

rally of the month

Over 80 traders are housed in four large marquees.



There are numerous more traders' stands in the Outdoor Traders Flea Market.

10 May

The **MARS-Drayton Rally**, also known as the **Drayton Manor Radio and Computer Rally**, has been held annually at the Drayton Manor Family Theme Park for over 30 years. Drayton Manor Park is located on the A4091 at Fazely, Tamworth, Staffordshire. The park is near junctions 9 and 10 of the M42 and is well signposted by the tourist board. The event, for all radio and computer enthusiasts, is organised by MARS, the Midland Amateur Radio Society.

This year's rally will be located on the 'Fair Field' - just follow the rally signs once inside the park. Admission to the rally is free, although there is a charge of £3 to enter the park (£2 for children under 16, senior citizens and wheelchair visitors). There are special concessions for organised groups - contact Drayton Manor Park on tel: 01827 287979 for full details.

There will be in excess of 80 traders in four marquees, plus a large Outdoor Traders Flea Market (pitches to be pre-booked, contact the organisers for details). For *private* sales only, car boot spaces can be booked on the day from 9.00am. However, please note that since this is a radio and computer rally, toys, clothes, plants, household effects, food and drink must not be sold. There is also a grand bring and buy sale, organised by the Wythall Radio Club, to which you are invited to bring equipment for sale. Local radio clubs and special interest groups, including Raynet, Scouts radio, and packet radio and repeater groups, also have their own stands.

For the family, the Drayton Manor Leisure Park offers a boating lake, garden centre, parkland, a farm, zoo, three museums, restaurants and much more.

The MARS-Drayton Rally opens at 10.00am. Full details from Norman Gutteridge, G8BHE, on tel: 0121 422 9787, or Peter Haylor, G6DRN, on tel: 0121 443 1189 (evenings please).

other events

- | | |
|---|---|
| <p>25 April International Marconi Day (details tel: 01209 212314).</p> <p>1 May RSGB Slow Speed Cumulative Contest (1900 - 2030UTC, 80m CW).</p> <p>1 - 3 May Spanish IOTA Convention, Las Palmas, Canary Islands.</p> <p>2 May RSGB 1st 432MHz Backpackers Contest (1300 - 1700UTC).</p> <p>2 May RSGB 432MHz Trophy Contest (1400 - 2200UTC).</p> <p>2 / 3 May IARU UHF / SHF Contest (432MHz - 248GHz, 1400 - 1400UTC).</p> <p>8 - 10 May WACRAL Anniversary Activity Weekend. Details from Harold, G4YRH, tel: 01274 679597.</p> <p>9 / 10 May Morse test service anniversary weekend. More details from Roy Clayton, G4SSH.</p> <p>10 May Drayton Manor Radio and Computer Rally, Drayton Manor Park, Fazely, Tamworth, Staffs (see 'Rally of the Month').</p> <p>10 May Windmills & Watermills Special Event Day,</p> | <p>15 - 17 May Dayton Hamvention, Dayton, Ohio, USA.</p> <p>16 / 17 May RSGB 144MHz Contest (1400 - 1400UTC).</p> <p>17 May ITU World Telecommunication Day.</p> <p>17 May RSGB 1st 144MHz Backpackers Contest (1100 - 1500UTC).</p> <p>17 May WAB LF Phone Contest (0900 - 1800UTC). See page 7. Full details from G8UYD QTHR.</p> <p>17 May Reunion of WWII 'secret listeners', 10.00am, at Bletchley Park Mansion. Details from Bob King, G3ASE, tel: 01480 463129.</p> <p>19 May <i>Ham Radio Today</i> June publication date.</p> <p>30 May WACRAL Whitsun Welcome Day. Details: Charles, G4UJW, tel: 01283 791213, or packet G4UJW @ GB7RUG.</p> <p>30 / 31 May CQ WPX CW Contest (10 - 160m, 0000 - 2400UTC).</p> |
|---|---|

ham radio this month

ham radio today event news

Build Your Own 50MHz Mobile Antenna

With the new 50MHz repeaters coming on the air, Tony Webb, G3KCJ, offers an idea to improve your mobile signal

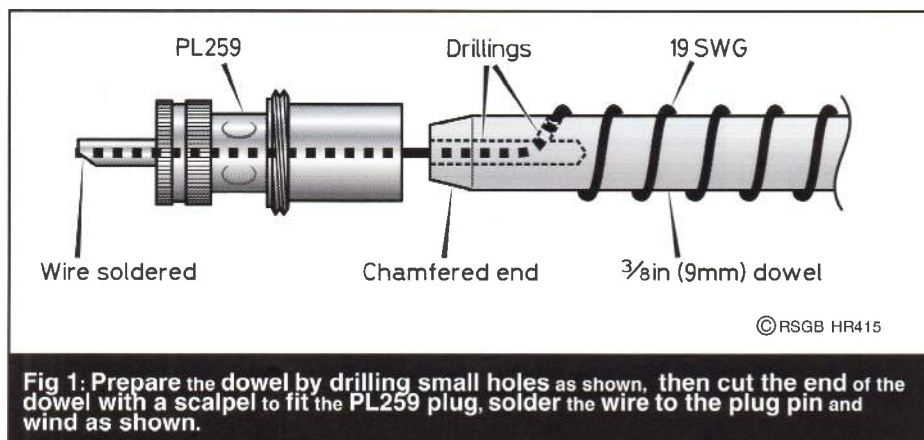

Fig 1: Prepare the dowel by drilling small holes as shown, then cut the end of the dowel with a scalpel to fit the PL259 plug, solder the wire to the plug pin and wind as shown.

The purchase of an AKD model 6001 6m FM transceiver led me to investigate an alternative mobile antenna to the few commercial ones available. My first thoughts were that a redundant CB whip (a 'Rain-bow', which is a form of continuously-loaded fibre-glass rod with a screw-threaded mount) would fill the bill. This in fact gave a low SWR across 50 - 52MHz after about half of the close-wound top winding had been removed, but the fact that a magnetic mount was needed on the roof of the car resulted in the following home-made design as a replacement.

construction

A PL259 plug with a reducer was bought. The reducer was not needed for this application. A length of wooden dowel of 3/8in dia (approx 9mm) was purchased and one end of the dowel was carefully carved with a scalpel, so that about 0.25in would fit through the restriction in the plug and butt against the plastic insulator where the pin is secured. This is to ensure that the dowel is held securely when the end is covered with Araldite and forced home. But, before the Araldite is applied, it is necessary to drill a small hole (about 1/16in is right) up through the centre of the bottom end for about 1.25in. Drill another hole to join it, at an angle, to ease the insertion of the enamelled copper wire used for the coil. See Fig 1.

Push the end of a reel of 19SWG wire through the angled hole and into the central hole. Scrape off 0.5in of insulation from the end and solder it to the pin. Now Araldite the bottom 0.75in of dowel, and push it home firmly. Leave it to set overnight.

The next task is to mark the dowel at 1in intervals from the hole where the wire exits with a pen or pencil. Do this over a distance of 27in. Putting tension on the wire, carefully wind 27 turns, using the marks to guide you (see Fig 2).

Next, a further 100 turns are close wound. These last should occupy around 4.75in, so the total length is now nearly 32in. Secure the top few turns with adhesive plastic tape to prevent them from unwinding.

adjustment

My advice is to smear Araldite over all but the top 0.5in of the close wound section to protect and hold the turns. When the

Araldite has set, fit the antenna to the mating SO239 UHF socket on the mag mount or gutter mount (preferred), connect the antenna cable via an SWR meter to your 50MHz rig (set to low power) and transmit at the low frequency (LF) end of the band, just above 50MHz. You will probably find a SWR reading of around 3:1. De-mount the antenna rod, remove four turns, refit and try again. Hopefully, the reading will have fallen to between 2.5:1 and 2:1. If so, good. Before transmitting always ensure the channel is not in use.

Now remove *only* one turn at a time and check after each removal.

When the reading at the LF end of the band is around 1.3:1, check at mid-band (around 51MHz) and at the high frequency (HF) end, just below 52MHz. You should see SWR readings of 2:1 and 2.5:1 respectively. If so, you are home and dry.

Again remove one turn at a time, checking after each re-

moval at LF, mid-band and HF. You will probably end up removing about 10 or 12 turns in total, but don't try other than one turn at a time before checking. When you get readings of LF 1.3:1, mid 1.1:1 and HF 1.5:1, stop. You won't get any better.

finishing touches

Cut off the piece of dowel above the top coil. Now is the time to smear Araldite over the unprotected top few turns, with a few dabs on the wide spaced turns, say every sixth turn. For appearance's sake you could put black paint over the whole antenna, this should not affect the performance unless the paint contains metallic particles. Alternatively, wrap black adhesive PVC tape over the whole antenna.

Results? Nothing outstanding to date, but with 5 watts output to this antenna, firing through my garage and bungalow I can access the GB3AM repeater in Amersham on channel R50-13, which is about 18 miles away, without any trouble. Also it has withstood speeds of up to 70MPH without breaking.

If you have an old CB antenna and a mag mount you can save yourself a deal of trouble by stripping off about 1/3 of the top close-wound coil then following the advice here on removing a turn at a time and checking.

Just a thought, anyone out there fancy adapting this antenna for 70MHz? I can't think why it should not work as well on that band. It might also go up to 145MHz. So, go ahead and make your own mobile 50MHz antenna, see you on the band.

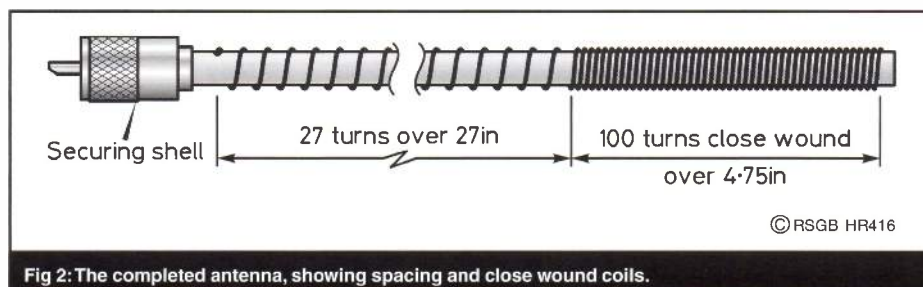

Fig 2: The completed antenna, showing spacing and close wound coils.



John Cramond, GM4NHI, in his Aberdeenshire shack.

Early November with the wind howling outside and the first touch of snow blowing against the window: definitely a day for being in the shack. I was feeling pleased with myself, having completed all my antenna maintenance during the summer and thinking that for another few years, I could now enjoy the fruits of my labours. Funny how it is at times like this, when things seem to be going so well, that things start going wrong. 'Murphy's Law' it's called! My trusty tribander sud-

denly developed a very high SWR on 15 metres and a much higher than normal SWR on 10 and 20m. It looked as though I had a faulty 15m trap on the driven element, but I would now have to wait until the weather improved to confirm this.

denly developed a very high SWR on 15 metres and a much higher than normal SWR on 10 and 20m. It looked as though I had a faulty 15m trap on the driven element, but I would now have to wait until the weather improved to confirm this.

Over the past twenty years of operating, I had lost two tribanders, both having failed through faulty traps on the driven element. As I never run more than 200 watts of power, in both cases it would appear that moisture ingress had been the cause of the failure. I remember thinking to myself, wouldn't it be nice if someone could produce a tribander without traps on the driven element.

As I was confined indoors because of the weather, I now had time to consider what action to take, if a faulty trap was confirmed. I had the option of repairing the possible faulty trap, or alternatively replacing the existing antenna. As I was a bit out of touch with the latest models, I had a look through *RadCom* to see what was available. There was an advert from Cushcraft,

offering just what I had dreamt about: the new 'Big Thunder' beam, a triband seven or nine element antenna, with no traps on the driven elements and suggesting a performance close to that of a monoband antenna. The Cushcraft specifications are shown in **Table 1**.

decision time

I just had to know more about this and decided to have a look at the Cushcraft web site. It all looked good and I made up my

Total number of elements	7
Maximum gain (dB) at one wavelength	20m 12.5 @ 14 deg
	15m 13.0 @ 12 deg
	10m 12.9 @ 14 deg
Maximum front-to-back ratio (db)	30
Number of elements per band	3
VSWR minimum	1.1:1
VSWR 1.5:1 bandwidth (kHz)	20m 600
	15m 750
	10m 1700
Longest element, ft (m)	37.2 (11.33)
Turning radius, ft (m)	20.0 (6.09)
Boom length, ft (m)	18.0 (5.49)
Boom diameter, in (cm)	2.5 (6.35)
Maximum wind survival, MPH (KPH)	>100 (>161)
Maximum wind surface area, ft ² (m ²)	7.9 (0.73)
Windload at 80MPH, lb (kg)	202 (92)
Maximum power handling (kW)	2
Weight, lb (kg)	60 (27.2)

Table 1: The Cushcraft X7 (adapted from Cushcraft specifications).

days were just around the corner and the weather was anything but nice, a few more weeks would allow me to plan the change-over properly.

At the end of January I decided to give Waters & Stanton

assembly

Now the fun could really begin. Find the assembly instructions and spend the evening reading all about it. The X7 antenna, as you might expect, has seven el-

Cushcraft X7 'Big Thunder'

John Cramond, GM4NHI brings us a user's report on

"Now let's see, which is piece 497?"
John pours over the 500-plus bits and pieces which make up the Cushcraft X7 beam.



a call to receive an update on anticipated delivery. It appeared that they had just received a shipment and my antenna would be dispatched that day. True to word, 48 hours later the carrier arrived and I took delivery of two rather large cardboard boxes. One 85 inches long and one 63 inches long, marked A and B respectively.

ements, one trapped director, followed by four driven elements acting as a log periodic, and finally two reflectors. The feed is via a 4:1 balun to the matching straps feeding each driven element.

Let me stress here that if you decide to go for this antenna, assembly should not be rushed. There are in excess of 500 bits

and pieces, and the first thing is to identify all the parts. A permanent marker pen should be an essential part of your tool box, along with two small adjustable spanners, a heavy-duty screwdriver and a measuring tape. This is all the tools that would be required, although a small ratchet / socket set would make life much easier.

After unpacking the parts, my first impressions were of quality. I am a mechanical engineer by trade and believe that if you are going to expose metal to the extremes of the Scottish climate, the mechanical construction has to be of the highest standard. No-one could fail to be impressed by the quality and precision fit of the components supplied. The Cushcraft X7 is constructed entirely with .058in wall tubing, heavier wall thickness than that used in any antenna I had previously owned, but the weight had still been

Close-up of the centre portion of the beam, showing the four driven elements acting as a log periodic cell.

mounting

The finished assembly is a sight to behold! My first impressions on quality were confirmed when I saw the completed article. As far as I was concerned, the assembly was the easy part. Tower mounting was not going to be quite as simple.

Although my Versatower will tilt over, this is not an easy task at my QTH. The tower is attached to the house and the eaves of the old croft house are only six feet above ground level.

but does it work?

Now comes the time when we can decide if the antenna works as well as it looks. I have been working the States with a local amateur, Sandy, GM3BCL. Sandy is one of

to-back comparison figures over all five bands - yes, I did say *five* bands. Although the X7 is advertised as a tribander, with the aid

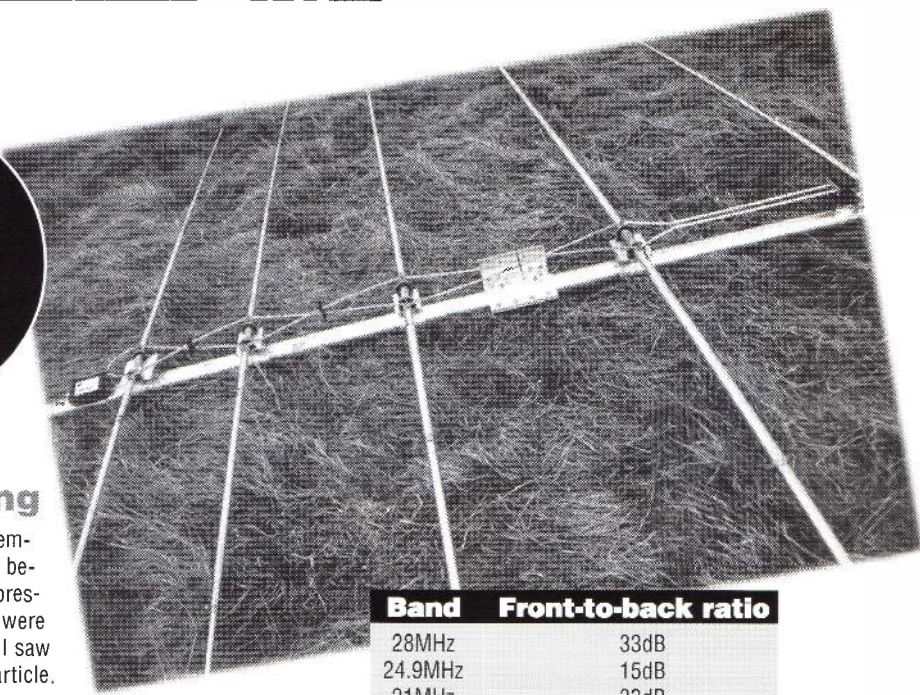

Band	Front-to-back ratio
28MHz	33dB
24.9MHz	15dB
21MHz	33dB
18MHz	9dB
14MHz	24dB

Table 2: Front-to-back ratio measurements made at GM4NHI (see text).

Beam Cushcraft X7 'Big
 this new multiband HF beam

kept down to 60 pounds. The element and boom brackets are constructed from extruded 6061-T6 aluminium. All the hardware is stainless steel and all nuts have a nylock insert. The instructions come in a 10-page leaflet which is clear and precise and no-one should have any problem with the assembly, providing time is taken to identify and mark the various tubes.

The only minor problem I had was one of my own making. I had talked my wife into allowing me to assemble the boom in the living room, but an 18ft boom is not the easiest of things to get out of the patio window!

Time for the assembly of the antenna was three days, without rushing. It could probably be built in a weekend if two people were involved, but I would strongly recommend a one-man operation. It is so easy to get confused as to who has done what, and the last thing you want is to have the antenna up in the air and discover that there is confusion over who did what.

This rules out the use of the normal winch and involves the use of a two ton chain block, attached to the house, should tilting be required. I have never been concerned about the strength of the chain block, but with the pivot and loading points being only four feet apart, the force exerted on the wall of the house can well be imagined and in the past, I have had visions of the wall of the house coming down! I had already removed the faulty tribander by mounting a gin pole on the top of the mast and this was going to be the method used for installing the X7.

In my case this operation was going to entail the services of three people. One to do the raising and two to keep the antenna clear of the house and other obstructions. This operation could be the subject of a complete article on its own, so I will not get into it too deep at the moment. Suffice to say that the X7 eventually made it to the top of the tower without mishap.

the few stations in the UK to have worked all USA counties and he has a great take-off to the west. In the past, both using Cushcraft A3S antennas, Sandy was always two 'S' points better than I was. We are now receiving similar reports, which suggests that the X7 is better than the previous tribander by one, or perhaps even two, 'S' points. Sandy was soon on the phone to Waters & Stanton to check on the delivery of an X7!

So what has happened over the past few weeks? Well for a start, Sandy now has an X7 on top of his tower! I was roped into assembling the antenna for him, and this time I assembled the antenna in two, rather than three, days. They do say that practice makes perfect.

The comparison between the standard tribander and the X7 is probably still the best test to give an indication of forward gain. Sandy of course is totally delighted, as he has regained the distinction of being a full 'S' point up on me!

I have taken a full set of front-

of an ATU, it appears to offer some gain over a dipole on 12m, and certainly being able to reduce signals off the back of the beam on 12m and 17m can be very useful indeed.

I have measured the front-to-back readings as carefully as possible, using fixed attenuation and the station of GM3BCL as the source. Sandy is exactly 10 miles from me as the crow flies and was able to give me a steady tone on all five bands for the tests.

The front-to-back readings obtained are shown in **Table 2**. Cushcraft suggest a maximum of 30dB, and I have no doubt that their equipment would be more accurate than mine, so my figures could be slightly on the high side. There could also be some distortion of the figures from ground wave, but you can take them as a general guide.

As I said previously, it was not possible to give any clear indication of forward gain and that has been judged to a large extent on the reports received, along with the comparison

against the standard tribander antenna.

VSWR readings were all within specification, except on 15m. There the readings ranged from 1.4:1 up to 2.1:1. I was pretty certain that this would be the result of the close proximity of my 14-element 2 metre Yagi, which was mounted only five feet higher on the same mast. Cushcraft have a technical support service which will assist with tuning, and a fax sent to them resulted in a reply within two hours. They more or less confirmed what I had been thinking, and suggested inserting a short length of additional feeder prior to checking the SWR again. They also offered further help if the extra feeder did not do the trick. A few trial attempts brought the matching within specification across all three bands.

I have now had the opportunity to compare DX signal reports with other GMs using standard tribanders and to say that I am delighted would be an understatement. I received a 59+ report from a VK7 who stated

and even New Zealand, which I always found very difficult to work in the past. I have also worked KP2AD on 12m and received 59+ reports from USA on 17m, where being able to reduce the signal off the back of the

and 20m has to be believed. If you invest in this antenna, you will not be disappointed. It is not cheap, retailing at just under £500, but that is only about £100 more than a standard tribander with traps. Having trapless

age to the antenna.

I have been asked if I found anything that I did not like about the antenna, but the truth is that I can't find anything bad to say, and Sandy is of the same opinion. The only thing I would recommend is fixing the telescopic sections with self tappers. An anti-oxide compound is supplied with the parts and this makes it quite difficult to fix the telescopic sections securely with the hose clamps alone.

Cushcraft technical support have sent on an optional set of wider feeder straps, which they suggest should further improve the VSWR. The only bands where this would be required would be 12m and 17m, where the SWR is 1.8:1 and 2.2:1. This is well within what could be handled by an ATU, but it would be nice to further improve the SWR if at all possible. I will try to get time to experiment with these straps over the next few weeks, but to be perfectly honest, I'm having far too much fun working with this antenna to take it off the air!

editorial note

The Cushcraft X7 is available from Waters & Stanton plc (tel: 01702 206835), Nevada (tel: 01705 662145), and M L & S (tel: 0181 566 1120) for £499.95. An optional 40m driven element is available. Its big brother, the nine-element X9, is also available and this can optionally be fitted out as a two-element beam on 40m.

Installation work on the tower.



Thunder' Beam

that I was by far the best signal coming out of the UK, and I certainly never had this type of report before! I have had excellent reports from Japan, North and South America, Canada

beam was very much appreciated.

summing up

I would say that the claim made by Cushcraft, suggesting virtual monoband performance on 10m, 15m

driven elements, to my way of thinking, makes it worth the extra money, even more so when you throw in the 12 and 17m bands for good measure. The quality of construction is such that I have no doubt that the 100MPH survival figures quoted by Cushcraft could be exceeded, without dam-

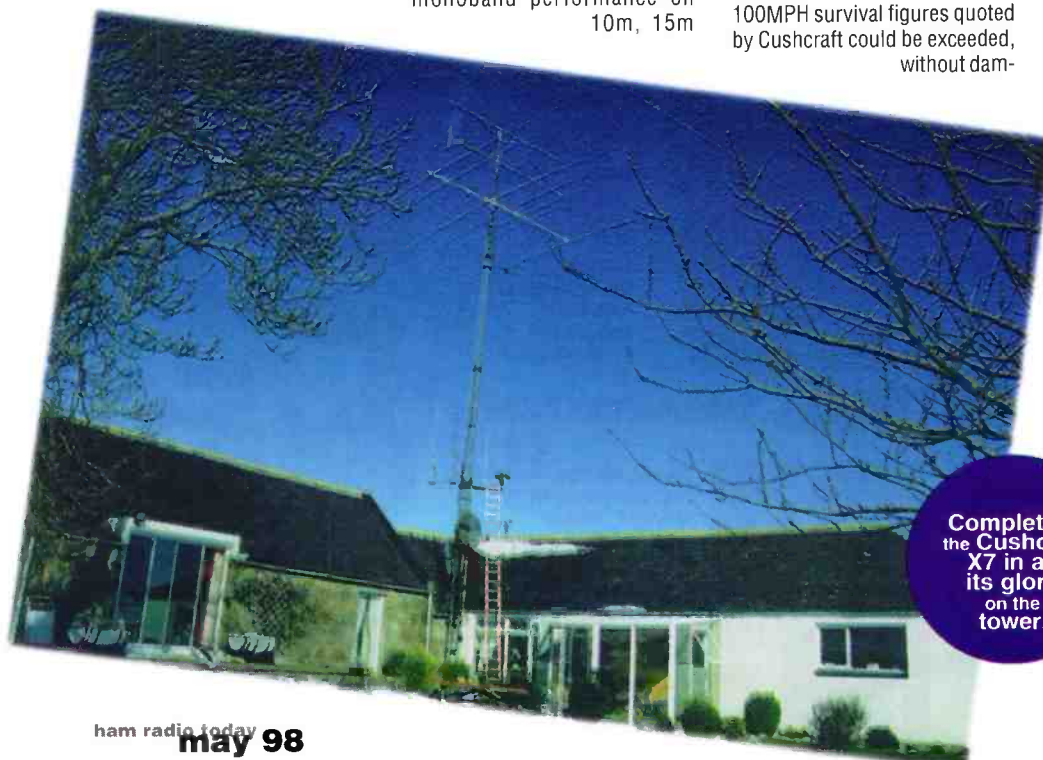

Completed the Cushcraft X7 in all its glory on the tower.



Waters & Stanton PLC

FREE-PHONE ORDER LINE

0500 73-73-88



Peter Waters G3OJV / G0PEP



22, Main Road, Hockley, Essex. SS5 4QS

Open Mon-Sat 9.00AM - 5.30PM

New Web Site:- <http://www.waters-and-stanton.co.uk>

25th YEAR of Service to UK Amateurs

This is our 25th Year of retailing Ham Radio equipment - unmatched by any of our competitors. We shall be offering some unique deals - also unmatched by our competitors! UK's TRUE Number One Dealer

Read the latest Hot News on our Web

Orders: 0500 73 73 88

01702 206835

Enquiries 01702 206835

01702 204965

FAX 01702 205843

E-mail sales@wsplc.demon.co.uk



YAESU FT-3000M 2m



SAVE £110!

£289

- * Wideband Receive
- * AM airband
- * Alphanumeric display
- * CTCSS
- * Spectrum scope

NEW C-408



From HORA
70cms Handheld
Full CTCSS

£89.95!

FREE Postage

SPECIAL OFFER PRICE

Full CTCSS; 20 memories; 1.6MHz repeater shift; Priority channel, Scanning; Dual watch; Dual mode squelch; PTT lock; 12.5/25kHz steps, 230mW output - all from just 2 x AA cells

SGC-2020 QRP HF Transceiver



NEW £599

1.8 - 30MHz

0 - 20 Watts SSB and CW with full break-in. Can run from 12 volts or Internal pack. Delivery expected at the end of March

Kachina 505DSP HF Transceiver

Send for Brochure



A complete PC controlled remote HF rig - In stock

Main Features £1995

100W HF All bands + Receive 100kHz - 30MHz
Filters for SSB 3.5, 2.7, 2.4, 2, 1.7kHz
Filters for CW 1kHz, 500Hz, 200Hz, 100Hz
Band Scope, DSP filter, Memory keyer, log book, VSWR meter, Smith Chart, pre-amp, 20dB attenuator, plus many software controlled functions.

HORA C-150

2m FM Handheld

NEW



£99.95

Can you believe your eyes?

- 25 / 12.5kHz Steps
- 130 - 170MHz Rx
- 1750Hz Tone
- 20 Memories
- Scanning
- Battery Save
- 5W (Ext. 12V)
- LCD Readout
- Keypad Entry

Includes:
6 x AA cell case
Antenna
Instruction Book
12 Month's Wtty.

Limited Stocks

WATSON W-MM1 Multimode Modem



- * Packet, AMTOR, £69.95
- * CW, SSTV, Fax, RTTY
- * NAVTEX, SYNOP
- * Transmit and receive
- * Powered from RS-232 port

ADI AR-146 2m 50W FULL CTCSS



£199

- * 3 Power levels - Wideband receive
- * 40 Memories plus call channel
- * 7 Programmable steps
- * Channel or frequency display
- * The best sensitivity in the business
- * Keypad mic and mounting kit
- * CTCSS Encode and Decode!

ADI AT-600 Dual Bander

New Low Price £249



AM Air Band

PW says: "an incredibly well priced radio - amazingly sensitive - audio - worked very well with 12.5kHz channel spacing - An Absolute Cracker!"

- * 2m / 70cm
- * CTCSS encode/decode
- * Full DTMF + 1750Hz tone
- * Alphanumeric memories
- * Full duplex
- * CTCSS tone reader
- * 29 programmable features
- * AM airband receiver
- * Rx up to 990MHz
- * Ni-cads and charger

1998 Catalogue



- * Largest in Europe
- * 176 Colour Pages
- * 1000 Photographs
- * 1400 Products
- * Technical Specifications
- * News Snippets

Now established as the foremost equipment guide this edition is completely new with every page in full colour and almost every item illustrated. For the cost of a magazine you can get the best guide ever.

£2.95 plus £1 postage

WATSON

Hunter

Frequency Counter

Features:

- 10MHz - 3GHz
- Ni-cad Pack
- AC Charger
- BNC Antenna
- Full Instructions

£59.95

Add £2.50 Post & Ins.



FREE frequency guide worth £12.95 on orders during Feb. & March

Check your base or handheld transceiver, or hunt out frequencies of nearby transmitters or handhelds. The "hold" button lets you lock on and store the frequency.

Phone For Details

Extended Warranty Now Available

ADI AT-201 2m FM Handy



FULL CTCSS

£149

- * 40 Channels
- * 5W on 12V
- * Illuminated keypad
- * Full CTCSS
- * 1750Hz tone
- * DTMF
- * Channel Reasout or
- * Frequency Readout
- * Set to Set Cloning
- * Uses AA cells

YAESU FT-847 it's Here!



Includes 70MHz Transceiver

100W 1.8 - 50MHz * 50W 2m/70cm * SSB - CW - FM - AM * CTCSS * Alphanumeric * 0.1Hz steps * Packet ready 1200 & 9600 * DSP filtering * Dual display * squelch * IF shift * Notch filter * Power control * Tx monitor * Electronic keyer * 12.5 / 25kHz switched FM filtering * Switchable pre-amp * Size 260 x 86 x 270mm * weight 7kg

£1495
1.8MHz to 432MHz

Plus FREE Base Mic

ICOM IC-706 Mk II 1.8 - 146MHz £995



Plus FREE DSP

PRICE MATCH

DSP Module Separately £59.95

The IC-706 Mk II transceiver as the best compact hf mobile bar none. It out performs and out specities any other model. The only choice left is which dealer you buy it from! We offer you an unbeatable price and an unbeatable back-up service plus optional extended 5 year warranty for an extra £98!

This Month Lowest Yaesu Prices Ever!
10 Day Approval 24 Month's Warranty

YAESU FT-920 1.8 - 54MHz £1269



+ Free FM board & AM Filters

PRICE MATCH

* 1.8 - 54MHz 100W * DSP filter * MOSFET PA * Internal ATU * Auto notch * Twin VFOs * Auto glow display * Shuttle jog * Digital voice memory * Electronic keyer * RS-232C converter * Quick memory bank + lots more phone or e-mail for colour leaflet

YAESU FT-1000MPDC (AC £1995) £1895



PRICE MATCH

* 1.8 - 30MHz 100W * SSB - CW - FM - AM * Rx 100kHz - 30MHz * Message memory * Dual in-band rx * EDSP filter * RF processor * RF pre-amp * Electronic keyer * IF shift width * Collins filters * omprehensive menu system * RS-232 interface and more - send for details

Last Few IC-77E Dual Band handy £199.95



- * 2m & 70cm Handy
- * 70 Memories
- * Full CTCSS
- * Tone scan function
- * Up to 4W out
- * 8 tuning steps
- * DTMF
- * Auto power saver
- * 600mAh 7.2v ni-cad
- * AC charger and helical

Alinco Prices Down!



Limited Stock £599.95

- * 1.8 - 54MHz
- * SSB CW FM AM
- * 100W HF 10W 50MHz
- * CTCSS Tone unit

ICOM IC-746 1.8 - 146MHz £Phone!



PRICE MATCH

* 100W 1.8 - 146MHz * SSB - CW - FM AM * Electronic keyer * Gen. cov receiver * Spectrum scope * DSP noise filter * Notch filter * IF pass band tuning. Delivery from stock.

YAESU FT-8100 Dual Bander Mobile £369



Save £100!

YAESU FT-50R 2m/70cms Handy £229



- * Wideband Rx (AM Airband)
- * FM Broadcast receive
- * CTCSS & 1750Hz
- * 112 Alphanumeric Memories
- * Dual Watch - Military rated
- * 5W from 12v DC input
- * Ni-cads and AC Charger

This is a very solid rig that is proving one of the most popular dual band handhelds

KENWOOD THG-71E Dual band Phone £279

- * Dual Band 2m/70cm
- * 200 memories
- * Alphanumeric Display
- * Full CTCSS
- * DTMF
- * Up to 6W out
- * Wideband Receive
- * Illuminated Keypad
- * PC Compatible
- * Windows Programming

Special Price



ICOM New IC-2100 2M Mobile £269

With Switched 12.5kHz & 25kHz Filters



New Model

The IC-2100 Mobile transceiver from ICOM features switched filtering, 55 Watts with 113 memories. And all this at a very competitive price. In stock NOW

ICOM IC-207H 2m/70cm Mobile £329



PRICE MATCH

- * 2m & 70cm
- * Packet 9600 bps ready
- * 50W / 30W
- * 180 Memory channels
- * Detachable head
- * CTCSS & 1750Hz tone

KENWOOD New TM-G707 £299



New Model

- * 144 & 430MHz 50/35W
- * AM / FM Rx
- * RX 118-174/300-524/800-1000MHz
- * 180 Memories
- * Detachable front head
- * CTCSS & 1750Hz Tone

+ FREE ACARS Software

New DSP Module Available £59.95
Computer controlled Receiver 10kHz - 1.3GHz
SSB CW AM WFM NFM Unlimited Memories
FREE Software, AC Supply and whip antennas



£349

PRICE MATCH



Rechargeable Alkaline Cells For Starter Kit

- * Rechargeable Alkaline
- * 1.5V cells
- * No memory effects
- * Charge mid cycle is OK
- * 5 year charge shelf life
- * 3 x capacity of ni-cads
- * Very low cost

In stock now! * Note: you must use the special charger supplied with Starter Kit.

Starter Kit: Comprise 4 x AA cells and dedicated AC wall charger **£13.99 + £2 p&p**

- 4 x AA cells (ready charged) £5.99 (£1.00 post)
- 8 x AA cells (ready charged) £10.99 (£1.50 post)
- 4 x AAA cells (uses standard charger) £6.25 (£1.00 post)

YAESU VX-1R Dual band Save £50!

The world's Smallest HT From the UK's Biggest Dealer!

£219.95

Our best selling dual bander and one we would be happy to own.



ICOM IC-T8E Dual Band handy 6m 2m 70cms £349.95

All in one small package.

- * 5W output (13V)
- * 25 / 12.5kHz ready
- * Wideband Rx
- * Nickel Hydride batt
- * Wide FM broadcast
- * AM for airband
- * Rapid scanning
- * Alphanumeric





CORPORATE SPONSOR OF THE UK SPRATLY ISLANDS EXPEDITION

FIVE YEAR EXTENDED WARRANTY

ML&S was the first company to introduce a meaningful 5 Year cover plan for your equipment. Don't let high servicing costs put you off!

£25 DEPOSIT

Most of the products advertised by ML&S are available from a small £25 deposit and if you choose to pay more you can enjoy a reduced monthly payment.

DELIVERY TO YOUR DOOR

Our next day couriers are waiting to safely deliver your new purchase direct to your door, anywhere in the U.K. or most overseas locations.

FLEXIBLE FINANCE

Let our professional sales team tailor a finance package to suit your individual requirements. Our super new Budget Plan makes paying for your new purchase so much easier.

PART EXCHANGE

We desperately need your part exchange right now - top prices paid. Don't let it depreciate over another twelve months, we'll take your current transceiver now at an agreed CASH price and still have your new rig on finance if you wish!

CASH-IN

If the value of your part exchange is greater than the value (or deposit) of the new purchase, we'll give you back the difference! Turn the value of your old gear into cash for the start of the year.

DIAL-A-DEAL

Call any of our sales hot lines now - we're eagerly awaiting your call - everything sorted over the phone, model, trade-in, collection, delivery and finance! Even if you do not live locally you can still have the peace of mind feeling when dealing with ML&S!

OPENING TIMES

Open 6 days a week - 9:30-6.00

Call now
0181-566 1120

EASY TO REMEMBER MAIL ORDER NUMBER: DIAL 07000 73 73 73
There is a small increase in call rate when using the 07000 number.

MARTIN LYNCH
& Sons
THE AMATEUR RADIO EXCHANGE CENTRE
140-142
NORTHFIELD
AVENUE, EALING,
LONDON W13 9SB

yaesu FT-847GX

70MHz NOW AVAILABLE ON THIS MODEL FROM ML&S

Due to the enormous interest world-wide for this product, deliveries have unfortunately been delayed. We now expect our first volume shipment to take place during early May, hopefully sooner.

We hope all of you that visited the ML&S stand at the recent London Show enjoyed the ishoot out! between the FT-847GX & the Icom IC-746. Looks like those VHF/UHF users are going one way and HF operators are going the other... Call us and we'll tell you how hundreds of Amateurs felt over the two day "Judgement Day". If you have placed a deposit, not only will you be GUARANTEED the earliest delivery but enjoy an additional offer, over and above the original deal. Hang in there!

PRICE MATCH
AVAILABLE

yaesu VX-1R

£269

Guaranteed UK's
Lowest Price!

Latest edition from the Yaesu stable. Ultra-compact, Dual Band transceiver with wide band coverage receiver.

- 500mW output on 2/70
- Lithium Ion Battery
- 5-1300MHz receive
- 6 Character Alpha-Numeric display
- Built-in CTCSS function
- Dual watch feature
- AM Airband RX
- Size: H81xW47xD25mm
- Weight: 125g with antenna & battery



ML&S ON THE AIR
PRICE MATCH

The NEW Kenwood THG-71E

Full feature, 6W Dual band hand held (with optional battery pack), 200 memories and PC link-up with software (not inc.)



£249.00 ON THE AIR
NOW AVAILABLE FROM STOCK

ACCESSORIES

A full range of accessories for all main equipment is always in stock or on order with the manufacturer. You can include a selection of filters, a power supply or Tuner in the new finance deal.

WIDEST CHOICE

As the official U.K.'s largest dealer of Yaesu, Icom, Standard & Kenwood products, you'll find everything you could ever dream of under one roof. Our friendly (and non pushy) sales team will be delighted to show you around and supply you with as much coffee as you can drink.

SELLING YOUR EQUIPMENT

We're always short of good quality used gear and currently have £150,000 to spend on increasing our used stock. So if you're wanting to sell your current transceiver (or accessory) for cash we would be pleased to hear from you.

CALL TODAY FOR THE LARGEST SELECTION OF NEW & USED EQUIPMENT IN EUROPE.

■ TEL: 0181 - 566 1120 ■ FAX: 0181 - 566 1207 ■ CUSTOMER CARE: 0181 - 566 0 566
■ WEB SITE: MLandS.co.uk ■ E-MAIL: sales@MLandS.co.uk

ALL ITEMS ARE AVAILABLE ON THE ML&S BUDGET PLAN

- 100W HF
- 10W 4m
- 100W 6m
- 50W 2m
- 50W 70cm

- 100 Watts on HF & Six Metres
- 10 Watts on Four Metres
- 50 Watts on Two Metres & Seventy-Centimeters
- SSB/CW/FM & AM
- Built In DSP
- Tracking for satellite operation
- Full duplex crossband operation
- Voice announcement
- IF Shift
- Built In Keyer
- 1200/9K6 Ready
- CTCSS built in
- New 'cool blue' display
- Optional external Auto ATU
- Keypad entry with idet for blind operators on 5
- Only a little larger than the FT-900



ON THE AIR
~~£1695~~
CALL NOW
£27.84 DEPOSIT & 42 x £50 p.m.

Martin Lynch being presented with the worlds first production FT-847GX by Yaesu UK staff at the recent London Amateur Radio Show.



With the manufacture of IC-756 finished, take a closer look at the new IC-746. It leaves the discontinued model for dead! A serious HF, 6M, 2M, all at 100W Base Transceiver including an excellent DSP system n thatis easy to use.

icom IC-746
REPLACES IC-756
£1695

- HF to 2M (incl 6M), 100W on 2M
- All modes on all bands PBT, APF
- Built in Keyer
- Auto ATU fitted
- Gen Cov receiver
- Built in spectrum scope (similar to IC-756)
- 100 Memories
- Excellent noise blander. Automatic DSP for noise, notch and passband
- Twin Pass Tuning
- Optional Voice Module
- 12.5kHz FM Narrow Capability
- Quad RX Conversion
- AM TX & RX



ON THE AIR
£1695
ON THE AIR
£27.84 DEPOSIT & 47 x £50 p.m.

RRP £1695, offered with matching ICOM PS85 Power Supply worth £249, FREE!

ML&S PRICE MATCH AVAILABLE ON THIS PRODUCT

ICOM IC-T8E

Who's first to have a TRIPLE BAND 2/6/70 Handie then? Icom of course! Enter the IC-T8E. Read the specification and get your deposit in quick!



£349.00 ON THE AIR
£21.17 DEPOSIT & 13 x £28 p.m.

YAESU FT-8100



£369.00 ON THE AIR
£18.53 DEPOSIT & 14 x £28 p.m.

ICOM IC-207



£339.00 ON THE AIR
£34.15 DEPOSIT & 12 x £28 p.m.

NEW...KACHINA 505DSP

HF Transceiver



Full DSP HF PC Controlled Transceiver. Supplied with Auto ATU

£1599.00 ON THE AIR
RRP £2295 ML Price £1599 or without ATU RRP £1999, ML Price £1599

NEW YAESU FT-920AF



Fitted with AM/FM options as standard. FREE Yaesu MD-100 Desk Microphone - not a cheap Taiwan model!

LOW PRICE **£1269.00** ON THE AIR
£20.06 DEPOSIT & 52 x £35 p.m.

NEW TMG-707E

Latest Dual Band Remote Head 2/70 FM Transceiver.
RRP: £349. ML PRICE £329
£24.15 DEPOSIT & 12 x £28 p.m.

NEW LOWER PRICE



STANDARD C156

PRICE BUSTER
£129.95

FULL FEATURE 2M HANDIE

STANDARD C510

Full feature Twin Banded Handie with Wide Band RX. Including Airband AM
Only **£199.95**



20% PLUS OFF TONNA PRICES!

To ease the burden of putting up new antennas during spring, check out our LOW prices on TONNA ANTENNAS!

20505 5 ele 50MHz RRP £86.95 ML £69.50

20804 4 ele	144 MHz	RRP £44.95 ML £35.95
20809 9 ele	144 MHz	RRP £52.95 ML £42.25
20811 11ele	144 MHz	RRP £79.95 ML £63.95
20817 17ele	144 MHz	RRP £97.95 ML £77.95
20818 9 ele X	144 MHz	RRP £87.95 ML £69.95

20438 21 ele X	432 MHz	RRP £61.95 ML £49.50
20909 9 ele	432 MHz	RRP £45.95 ML £36.75
20919 19 ele	432 MHz	RRP £53.95 ML £42.95
20921 21 ele	432 MHz	RRP £69.95 ML £55.95

Plus selection of 23cm antennas in stock!!

YAESU FT-1000MP/AC



PHONE FOR TODAYS LOWEST PRICE
£2199.00 ON THE AIR
CALL NOW FOR LOWEST PRICE

NEW ICOM IC-706MKII DSP

NOW FITTED AS STANDARD WITH THE NEW JT-106 DSP MODULE



THE ONLY HF+6+2m MULTIMODE/BASE
RRP: £1099
£949.00 ON THE AIR
£23.86 DEPOSIT & 55 x £25p.m.

ICOM IC-821H



If you are serious about your Two & Seventy operating then take a close look at the IC-821H. It's very good.

£1399.00 ON THE AIR
£31.25 DEPOSIT & 60 x £35 p.m.

ICOM IC-775DSP



The Icom flagship, 200W HF, PSU/ATU & DSP.

£175 CASHBACK
£2775.00 ON THE AIR
£65.16 DEPOSIT & 53 x £75 p.m.

STANDARD C-5900D



The only triple Band 2/6/70 mobile available!

NOW ONLY **£599.00** ON THE AIR
£16.99 DEPOSIT & 29 x £25 p.m.

KENWOOD TS-870S



The only 'real' DSP H.F. Transceiver.

£1849.00 ON THE AIR
£42.44 DEPOSIT & 53 x £50 p.m.



AMATEUR RADIO 'BUDGET PLAN'

AN AMATEUR RADIO BUDGET PLAN - THAT WORKS!!!

The Martin Lynch & Son A.R. "Budget Plan" A simple solution to spreading the cost of buying equipment without huge deposits and massive monthly payments. We can even buy your part exchange for CASH and you can still walk out with a new FT-847 for under £30! (Actually £27.82!)

Take a closer look at the ML&S A.R. Budget Plan - many of you already have. Call the sales desk today for any product listed in this magazine. If its available and approved by my buyers the Sales team will quote you a monthly repayment package suited to you.

DON'T FORGET!!

You can pay off the loan much quicker if you like and even send a lump sum one month if you wish. Trade-in your old gear or add to the minimum deposit, reducing the amount of monthly repayments. You tell us what you can afford per month and we'll tell you the deposit you require.

Just call for an instant quotation!*

* Budget Plan requirements: Full time employment (or disabled/retired), over 18 and below 71, Current bank account (or building society). For instant finance please ensure you have UK driving licence and cheque guarantee/credit card or Electricity/Gas/BT bill with your current name and address. Finance subject to status. APR 19.9%

Martin Lynch can also offer finance terms up to 60 months. Deposits from a minimum of £25. We welcome your part exchange against any new (or used!) product, provided its clean and in good working order. Call the Sales Desk today. APR: 19.9%. Payment protection is also available up to 36 months. All units are brand new and boxed and offered with full manufacturers RTB warranty. All prices quoted for cash/cheque or Switch/Delta card. No additional charges for credit cards. Martin Lynch is a licensed credit broker. Full written details are available on request. Finance is subject to status. E&OE. £10 p&p on all major items.

Last week I fitted a Kenwood car hi-fi, for my wife Sheila, G8IYA, into her car (it was her birthday present from me). The hi-fi had the now-usual quick-detach fascia control unit to deter theft. The idea of this is that, when you leave the vehicle, a quick button press lifts off the fascia which contains all the controls and display, from the main body. The small fascia slips into your pocket and goes with you, whilst the otherwise unusable main unit stays in the car.

But an Amateur Radio mobile rig is also an expensive piece of electronics, isn't it? Like their in-car hi-fi systems, Kenwood have taken the step of progressing this facility to their latest mobile rigs, starting with their TM-V7E 2m / 70cm mobile transceiver which I reviewed in *Ham Radio Today* Vol 15 No 5, exactly a year ago. The TM-G707E follows this trend, and until you switch it on, you could easily mistake it for a TM-V7E, as they look virtually identical. The difference is that whilst the earlier (and more ex-

in an Amateur Radio showroom how little Kenwood's new set retailed at, bearing in mind their reputation of high quality products with excellent technical performance.

'There must be some catch' I thought, and I must confess to honestly thinking the showroom retailer had initially made a mistake in the price! One of the savings is probably by the use of the same 'mechanics' as the earlier set, both for the front panel and the main body. The '707 uses a single concentric volume and squelch control, and where the '7E's additional control would be (for the other simultaneous band) there's an equivalent sized 'band' button to switch between frequency ranges. The other difference is in the LCD. The '707 retains the large panel, but instead of the blue backlit dot-matrix display, which admittedly some users reported was difficult to read in certain lighting conditions, the '707 uses a large segment-based yellow / orange backlit display. It's very readable



On Test - Kenwood TM-G707E

Chris Lorek, G4HCL, reviews Kenwood's dual-band mo

pensive) set is a full-duplex capable dual bander, ie with simultaneous 2m and 70cm receive, as well as offering cross-band full duplex operation, the '707 is a 'one band at a time' set, although cross-band simplex operation is available at the touch of a button. This brings down the price a lot, and I was rather surprised when I was told

indeed, giving a large display of the selected frequency or memory channel.

bands

The TM-G707E covers the usual 144 - 146 and 430 - 440MHz bands and offers a transmit power output of 50W maximum on 2m and 35W maximum on 70cm, with switchable low power levels of 10W and 5W on either band. Extended receive range is available as a dealer-modification option in countries where this is allowed. The main body measures just 140 x 40 x 189mm, and the size is kept down by the use of a controlled fan on the rear panel together with an internal airflow-ducted heatsink.

For frequency control, a click-step rotary knob on the front steps you through the

channels, and pressing the knob face inwards momentarily changes the VFO to 1MHz steps so you can get from one part of the band to another more quickly. Further buttons above the tuning knob change between VFO and memory operation, as well as selection of a quick access 'Call' channel. As well as a separate 'Call' channel for each band, there are 180 available memory channels, a 'Priority' channel, and 12 extra channels to store lower and upper limits for six programmable VFO scan ranges. Each of the normal memories (ie not the 'Call' channel) can be user-programmed with an alphanumeric channel name of up to seven characters in place of the frequency, so that you can easily see what you've stored in each channel. There's a variety of scan modes, such as memory scan, priority scan, selected limit VFO scan, 1MHz range scan etc, enough to satisfy virtually all listening needs.

The transceiver has full CTCSS (sub-tone) encode and decode facilities, useful for UK repeater operation if your local repeater has this fitted, as well as for quiet

monitoring of a given channel between similarly-equipped stations. A CTCSS scan can also be enabled, to display which, if any, CTCSS tone is being used on the channel you're tuned to. For 'traditional' repeater access, a 1750Hz toneburst is also built in, this facility can be assigned to any one of the programmable microphone buttons. A 'menu' mode allows setting of the rig's various functions, such as CTCSS frequency, repeater offset for each band, and so on. One such setting is for 1200 baud or 9600 baud packet operation on either band, and pulling off a small cover at the bottom left of the set's front body reveals a dedicated six-way mini-DIN connector for a packet TNC. This socket also has a useful 'mic mute' input, which can mute the front-panel microphone audio to prevent any audio corruption of transmitted data.





panel brings up a sub-display of '1', '2', '3' and '4' each appropriately just above the four buttons next to the LCD. All one needs to do is press the appropriate button to change between 'personalities'. This can also be useful when you're switching between shack and mobile use of the rig. For example, for home use in strong signal areas, the squelch can be changed between a noise squelch (as found on most rigs, which will lift on weak signals) and an S-meter squelch, where the squelch will only raise on signal levels above the level you've set. There's also a selectable 'AIP' (Advanced Intercept Point) facility, which switches out the front-end preamp to improve the strong-signal handling of the set, albeit with a slight loss in sensitivity. These latter two facilities could be quite useful for home use, but for mobile use the highest sensitivity coupled with a noise squelch to lift on weak but still readable signals would typically be

having a substantial read first. The manual usefully gives a one-page, seven-step, 'your first QSO' guide, which gets you on the air quickly. It then says "After trying the set for a while, settle back in your most comfortable chair with this manual and your favourite drink for an hour or two". This I did, and maybe that's why my amateur friends on the local repeater heard me sounding quite relaxed one evening! But the manual gives excellent operating instructions, and I was soon ready to make good use of the rig's many facilities.

The buttons on the front panel below the LCD are used as 'soft keys', with their function changing depending upon the operation mode selected, the LCD indicating the varying function each time. The transceiver also has an 'Easy Operation' mode, which could be quite useful for mobile operation. Here the first three buttons just select between three pre-programmed memory channels, with the fourth button selecting

On Test - Kenwood TM-G707E

mobile transceiver - with a personality of its own

A transmit time-out timer is fitted, which limits the transmission time to either 10, 5, or 3 minutes. This can't be disabled, so although it's useful for unattended packet operation and for mobile work with an external hands-free mic, to prevent any 'locked mic' problems, you'll need to remember this facility if you're having a long 'waffle' with the set in low power mode. To save your car battery being flattened overnight if you've accidentally left the rig switched on, there's a selectable auto power-off, which automatically powers-down the set if it isn't used for a period of time.

The supplied hand microphone has the usual PTT and up/down buttons for frequency/channel control, plus four extra buttons labelled 'CALL', 'VFO', 'MR' and 'PF'. The 'PF' stands for 'Programmable Function' which, you've guessed

it, can be programmed to do whatever one of the set's other controls would do, eg power on/off, squelch defeat, high/low power selection etc. In fact all of the four mic buttons are programmable in this way, giving you a very versatile remote control to suit your needs. The mic uses the now-usual 8-pin RJ type connector, which is readily available from component dealers if you wish to wire up your own alternative mic. However, an optional converter lead is also available if wish to use an existing mic fitted with an earlier round 8-pin connector.

personalities

In operation, everyone has their own preferences, like channel steps, power output level and VFO tuning limits on each band, display backlight level and so on, and when two or more amateurs share the use of a transceiver in a car it's often annoying to find these have been changed. But the '707 comes to the rescue, with four selectable 'personalities'. Pressing the 'PM' button on the front

more useful. This gives the 'best of both worlds' (or four different worlds, to be precise) at the press of a button - well done Kenwood!

on the air

The transceiver is supplied with a 77-page user manual, possibly rather daunting at first, but I quickly found I was operating the set using just the 'basics' without

the transmit power level. Operating the set this way was just like using a car radio. After I'd tuned in a frequency, a press of one of the channel buttons for more than a second automatically stored that into memory, recall being a quick press of the same button - very

Top view with the cover removed.



View of underside of the rig.

The facia of the TM-G707 can be removed from the body of the transceiver to allow for easy installation.



easy!
The detachable front panel contains all the user controls, and even though the transceiver's body is already quite small, an optional 'remote' kit is available so that you can mount the control / display unit wherever you wish, the main body fitting elsewhere. In this way, even the 'tightest' of car

dashboards should be able to accommodate the rig, making not only operation but installation even easier.
In use, I found the receiver to be exceptionally sensitive on 2m, easily capable of receiving distant repeaters, the high transmit power level allowing me to reciprocate in getting back to these to join in with QSOs. An automatic repeater shift was enabled on 2m whenever I tuned to the European repeater output sub-band, so in VFO mode on 2m I didn't need to worry about having to press further 'shift' buttons. The receiver was fairly sensitive on 70cm, receiving all the 'usual' signals I'd come to expect from other equipment I've used - it's just a pity the auto-repeater shift was available on this band as well.
I often suffer from strong-signal breakthrough when I use a dual-band rig from home with it connected to my rooftop antenna system, primarily with handhelds but also with the occasional mobile. Likewise whilst driving in my local city centre, with 2m of-

natural sounding. But here it's readability that matters, and I was certainly readable as long as I remembered not to shout down the microphone. My only slight complaint was that the mic lead was rather near the concentric volume / squelch knob, and if I used my right hand for adjustment there was little room for my fingers to get in to adjust the squelch level whenever the mic lead was in the way.

in the lab

The measured results show the receiver to be very sensitive on 2m and quite adequately so on 70cm. What was significant was the good all-round strong-signal handling capability, both in terms of blocking and intermodulation. The IF filtering was a very good compromise between 12.5kHz and 25kHz channel spacing in a

indicating good efficiency. The harmonics were also quite reasonably suppressed, and the frequency accuracy was excellent.

conclusions

Kenwood's TM-G707 should fulfil a number of mobile and indeed base operation needs, not just for a 'no-nonsense' and easy-to use set, but also one with the facility of mic-mounted remote control and alphanumeric memory channels galore. The quick-selection multiple personalities of the set make it even more useful, it's also a set that should cope with the increasing number of strong unwanted signals that are continually populating the spectrum. As I said at the beginning, I'd just fitted a detachable-facia Kenwood broadcast radio / hi-fi in the car for my wife's birthday present. My birthday is in a few week's time, and I was so impressed with the TM-G707E's overall performance and price that I'm seriously thinking of treating myself with one of these transceivers.

On Test - Kenwood TM-G707E

good, even though it's set up and supplied as a 25kHz transceiver, ie with 5kHz transmit deviation on both bands (I'm sure I could turn the 2m deviation down to 2.5kHz if I wished to in the future with an internal adjustment).

single rig, the 25kHz adjacent channel rejection being exceptionally good. On transmit, the set gave a substantial and well-controlled output level at each power setting, with reasonably low current consumption at the high power level on each band,

Out and about mobile, the set performed equally impeccably, with good, loud audio from the set's top-panel mounted speaker, and with a very easily-read display which I certainly appreciated, no squinting here! The mic-mounted remote control buttons were a pleasure to use, I wish more mobile rigs had this facility. Both from my home shack and out mobile I received 'punchy audio' reports on my transmitted signal, although it was stated that I wasn't particularly

The TM-G707E costs around £439 inc VAT. Thanks to South Midlands Communications Ltd (tel: 01703 251549) for the loan of one of the first rigs available in the UK for review.

An alphanumeric display can be substituted for the frequency, for example to indicate the repeater in use.



laboratory results

All measurements taken using set powered from stabilised 13.8V power supply using supplied power lead, high power transmit and receiver AIP off, unless otherwise stated.

receiver

sensitivity:

Input level required to give 12dB SINAD.

144MHz	0.11µV pd
145MHz	0.11µV pd
146MHz	0.11µV pd
430MHz	0.18µV pd
435MHz	0.18µV pd
440MHz	0.17µV pd

squelch sensitivity:

	145MHz	435MHz
Threshold:	0.06µV pd (3dB SINAD)	0.11µV pd (3dB SINAD)
Maximum:	0.55µV pd (31dB SINAD)	0.39µV pd (28dB SINAD)

adjacent channel selectivity:

Measured as increase in level of interfering signal, modulated with 400Hz at 1.5kHz deviation, above 12dB SINAD ref level to cause 6dB degradation in 12dB on-channel signal.

	145MHz	435MHz
+12.5kHz:	42.1dB	45.2dB
-12.5kHz:	35.6dB	26.6dB
+25kHz:	75.6dB	73.4dB
-25kHz:	74.5dB	72.7dB

blocking:

Increase over 12dB SINAD level of interfering signal modulated with 400Hz at 1.5kHz deviation to cause 6dB degradation in 12dB SINAD on-channel signal.

	145MHz	435MHz
+100kHz:	85.2dB	85.3dB
+1MHz:	96.4dB	92.0dB
+10MHz:	96.0dB	94.7dB

maximum audio output:

Measured at 1kHz on the onset of clipping (10% distortion), 8Ω load.

	145MHz	435MHz
	2.90W RMS	2.98W RMS

image rejection:

Increase in level of signal at 1st IF (38.85MHz) and 2nd IF (450kHz) image frequencies, and half 1st IF, over level of on-channel signal, to give identical 12dB SINAD signal.

	145MHz	435MHz
Half 1st IF	92.9dB	73.9dB
1st Image	75.9dB	86.5dB
2nd Image	>100dB	>100dB

intermodulation rejection:

Increase over 12dB SINAD level of two interfering signals giving identical 12dB SINAD on-channel 3rd order intermodulation product.

	145MHz	435MHz
AIP off:		
25 / 50kHz spacing:	76.2dB	64.6dB
50 / 100kHz spacing:	75.8dB	64.3dB
AIP on:		
25 / 50kHz spacing:	75.5dB	67.3dB
50 / 100kHz spacing:	74.5dB	69.6dB

s-meter linearity

	145MHz		435MHz	
	Sig Level	Rel Level	Sig Level	Rel level
S1	0.42µV pd	-13.4dB	0.27µV pd	-15.4dB
S3	0.56µV pd	-10.9dB	0.41µV pd	-11.6dB
S5	0.84µV pd	-7.4dB	0.66µV pd	-7.5dB
S7	1.27µV pd	-3.8dB	1.00µV pd	-3.9dB
S9	1.96µV pd	0dB Ref	1.56µV pd	0dB Ref
S9+	2.80µV pd	+3.1dB	2.34µV pd	+3.5dB
S9++	3.93µV pd	+6.0dB	3.61µV pd	+7.6dB

transmitter

tx power and current consumption:

Freq	Power	10.8V Supply	13.2V Supply	15.6V Supply
145MHz	High	40W/7.0A	57W/8.0A	57W/8.2A
	Mid	10.2W/4.2A	13.4W/4.3A	13.4W/4.4A
	Low	5.8W/3.1A	5.8W/3.2A	5.8W/3.1A
435MHz	High	29W/7.0A	36W/7.1A	36W/7.0A
	Mid	12.1W/4.3A	12.1W/A	12.2W/4.4A
	Low	4.8W/3.1A	4.9W/3.3A	4.9W/3.2A

harmonics:

	145MHz	435MHz
2nd Harmonic:	-68dBc	-65dBc
3rd Harmonic:	-75dBc	-72dBc
4th Harmonic:	<-80dBc	<-80dBc
5th Harmonic:	<-80dBc	-
6th Harmonic:	<-80dBc	-
7th Harmonic:	<-80dBc	-

peak deviation:

145MHz	435MHz
5.23kHz	5.27kHz

toneburst deviation:

145MHz	435MHz
2.94kHz	3.01kHz

frequency accuracy:

145MHz	435MHz
-70Hz	-220Hz

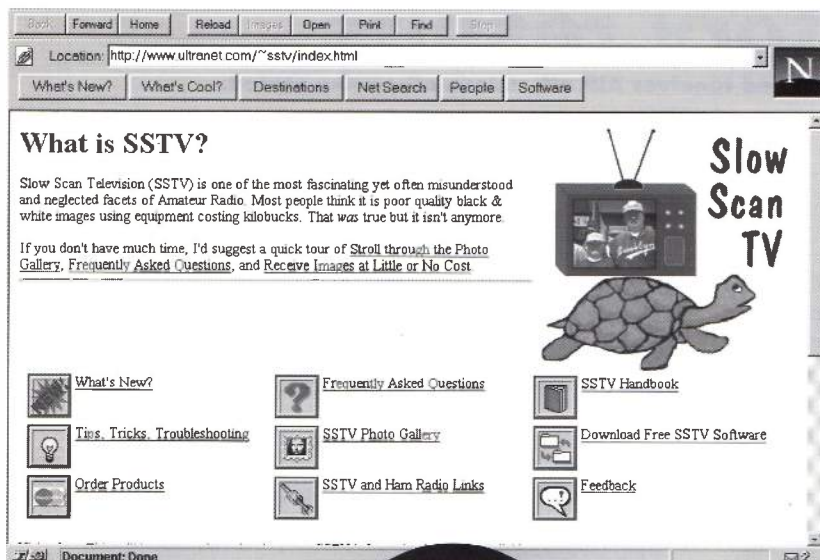

The Internet pages of John Langner, WB2OSZ, almost form an SSTV handbook.

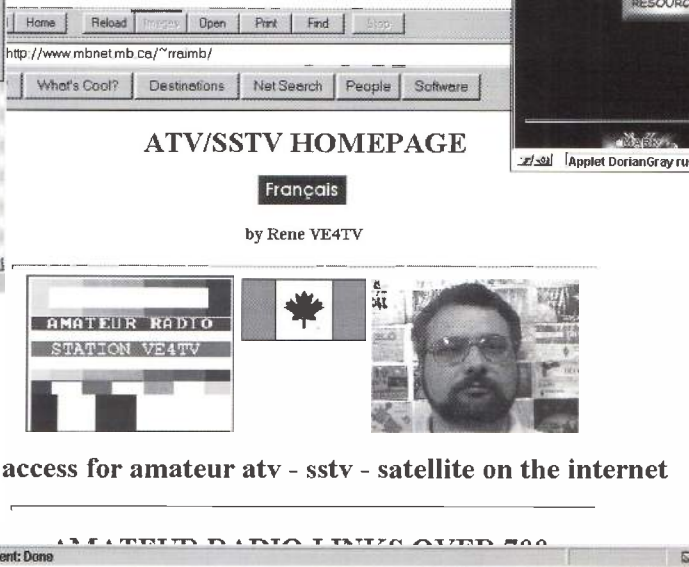

Net Communication

One use for the Internet is to find out more about different aspects shares what

Following the pattern of the last article, I thought it would be a good idea to search the Internet for a specific theme of Amateur Radio about which I was not in any way an expert. Well, you may say, that will keep the horizons wide enough! One of the great services Internet can do us, is to give us some new interest or tell us something new about our hobby or whet somebody's appetite out there which could be just that first step towards a licence. So this month I am looking at slow-scan television (SSTV).

On the general topics page of my own net pages, one of the recurring themes of the e-mail I receive is one of surprise that Radio Amateurs can send TV pictures (slow scan or fast) at all. The idea of us all crouched over a microphone or poised over a Morse key is fine, but tell them about TV, satellites, packet etc and they are definitely impressed. Show them a captured image from the modern SSTV set-up and they're hooked.

'when i were a lad ...'

In those distant days when I owned a 2m Liner 2 (which could receive on almost the whole of the 2m band at once) there were two G2s nearby who could wipe out, as it seemed, the entire band by transmitting pictures of the allotment and their roses. "Should those sunflowers be purple, then, Harry?" one said. "No - ah, yes - it's the balance, Tom. Sorry about that", would come the reply. And so it continued. I found it safest to keep off the air during those skeds.

My own later experience of SSTV only really came when I first possessed a computer. Playing with JVFax (freeware), I discovered that sending and receiving SSTV pictures and faxes was really quite easy: the sound for reception was taken from the line out on the transceiver and the sound for transmissions was generated from the computer speaker and fed to the computer via a small interface. Many people are using just that system now.

first class uk page

Back to the Internet, though. Following the good example lately set in *RadCom*, I will list the sites I found in **Table 1**, rather than including URLs, which are often complicated, and refer to the link which you can look up. I am deeply indebted to Robin Dexter, GOITP, whose pages (see the table) are a really first class example of a UK amateur who has followed through an interest and done an enormous amount of research which he is passing on to the others on a specific subject. He has saved me a job in writing this article too!

On Robin's pages you can see a list of software links, software writers pages, hardware, TV links, enthusiasts' home pages, club pages, home pages - the list goes on and on. Much of the table is from Robin's own list (with his kind permission).

recommended

As suggested by Robin's pages, I first visited John Langner's, WB2OSZ, pages, which are es-

entially an SSTV handbook: 'What is SSTV?', FAQs, tips, tricks, products, programmes. Very useful.

Masaru Hirano's, JA1XVY, pages were already known to me. Some good stuff here too, but more to do with the Japanese Amateur SSTV Association (JASTA) than the general. Good pages though.

I was impressed with WB4EJC's pages. They are full of interest both to beginners and old hands. I note they overlap to a degree with Internet developments, with a review of Iphone 4 (which will not please the purists), but I see that there is a lot of peripheral information. I wasn't previously aware for example that in Belgium there is an experimental SSTV HF repeater on 28700kHz USB: ON4VRB [this was also covered in *Data Connection* in the March *Ham Radio Today* - Ed]. I'll watch out for that if Sporadic-E allows this season.

Not one to keep a low profile, billing itself as "Best access for amateur ATV - SSTV - satellite on the Internet", Rene's, VE4TV, pages are a good read. W2PQC's

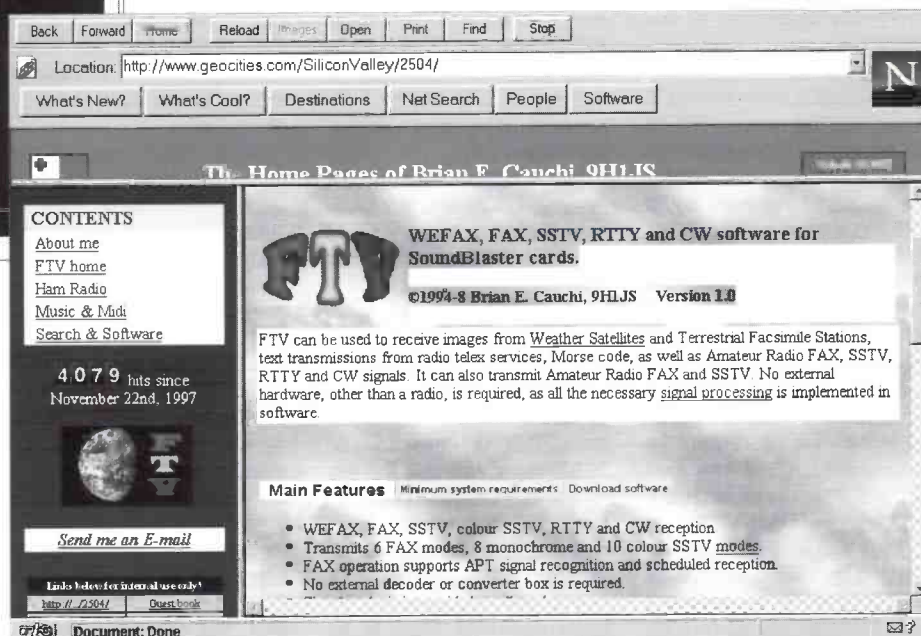
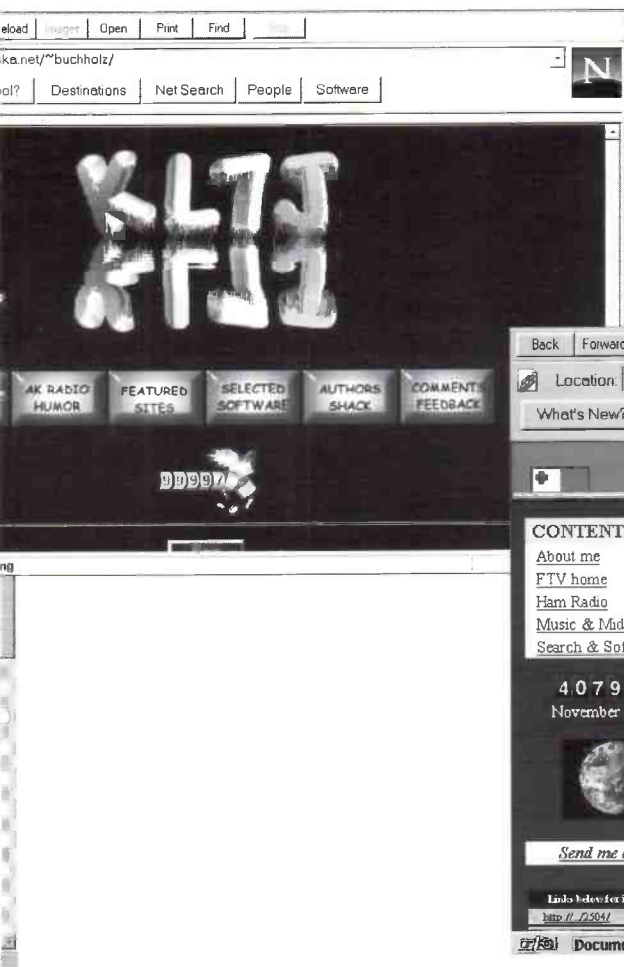

Net Communication

of Amateur Radio. Jeremy Boot, G4NJH, learns about SSTV, and he discovered

pages are useful for links. GMOEJW's pages are obviously born of true enthusiasm. He waxes fondly on the EZSSTV programme and offers a download of it from the site.

super graphics

From a chilly Alaska come the pages of Les Buchholz, KL7J, which are amongst the best I have seen: graphically pleasing, carefully put together, informative and interesting. What more do you want from the Internet? I have no patience with people who turn off graphics to save a minute or two on the phone bill. The Internet is a visual medium as much as anything. Webmasters go to great lengths to make their pages attractive. If you want text only, stick to e-mail!

software & hardware

Indeed what do you use for software? Besides the ubiquitous JVFax there seems to be a good selection: DL4SAW's program,

GSHPC12, PROSKAN, SSTVBL (for SoundBlaster cards), Vester M+, WinPixPro, Mscan 211 were all unknown to me I must confess, but mainstream no doubt to the enthusiast. Then there are programmer pages such as Brian Cauchi's, 9H1JS, page which is nicely produced. Many others appear in Robin's list.

Talking of software inevitably leads one to hardware. A good variety of hardware reviews of Grabbers is on WB2OSZ's pages, previously mentioned, with an idiot's guide where appropriate. A serial port interface known as TUCCOMM even I have heard of.

From Belgium, the SSTV 96 is described as "a low cost upgrade of the classic Hamcom interface" with full details of circuitry and interface. The pictures they show from its use are quite startlingly good.

conclusion

It's high time I did some more SSTV and paid more attention to this fascinating aspect of the hobby. Have a look for yourself at some of these pages and read through what you can do with really quite easy hardware and

Key Page: G0ITP's SSTV pages: <http://www.nwnet.co.uk/dexter/sstv2.html>.

- Other pages mentioned:**
- John Langner, WB2OSZ:**
<http://www.ultranet.com/~sstv/index.html>
 - JASTA pages:**
<http://www.ask.or.jp/~jasta/>
 - WB4EJC:**
<http://www.icanect.net/~rlehman/>
 - Rene, VE4TV:**
<http://www.mbnnet.mb.ca/~rraimb/>
 - W2PKC:**
<http://members.tripod.com/~pqc/>
 - GMOEJW:**
<http://wkweb1.cableinet.co.uk/warden/>
 - Brian Cauchi, 9H1JS:**
<http://www.geocities.com/SiliconValley/2504>
 - TUCCOMM:**
<http://www.wp.com/TUCCOMM/>
 - SSTV96:**
<http://www.umh.ac.be/~boelpaep/sstv96/sstv96.htm>

Table 1: List of Internet site URLs referred to in the text.

software. It is great fun and a thoroughly enjoyable way to communicate, whether through a repeater, HF or VHF. I think, like me, you will be amazed by the quality of the image now possible and surprised how many

people out there are involved. I know there are amateurs who are worried about the 'invasion' of the computer, but here surely is the way to harness the beast and make it work for the hobby.

February saw some really nice action on the VHF / UHF bands and it happened just a few days before the RSGB VHF Convention at Sandown Park [see report in April *Ham Radio Today - Ed*], so this gave everybody something to talk about.

Things started to happen early on 17 February, when stations in Japan reported working VKs on 50MHz via TEP (trans-equatorial propagation, ie above and below the equator). Later in the day it was noticed that a solar disturbance was taking place and 28MHz opened up to the USA. During the USA 28MHz opening an aurora started, and TEP was logged on 144MHz!

Several stations in the USA reported the OX3SIX beacon on 50.045MHz via aurora. Stations in northern England had good auroral conditions on both 50MHz and 144MHz.

Andy Cook, G4PIQ, made 144MHz contacts with LY2BAW (K025) for a new square, along with SM4VQP, ES2RJ (K029),

South Africa. He says: "ZS6s had their first major European opening of 1998 on the afternoon of Sunday, 22 February. The band opened at about 1300UTC and remained open for about three hours. At least six ZS6 operators are known to have caught the opening, and European and Asian Countries heard / worked included 4X, 5B4, 9A, 9H, F, YU and many, many Italians (including IT9 and IS0)".

Mario, S56A, reports that Slovenia has new radio regulations permitting beacons on 40 and 70MHz. More information later.

Alan, 3C5I, in Equatorial Guinea, is now very active on 50MHz, and so far has had contacts with 9H, I, CT3, SV and IT9, all via TEP. He has also copied the ZD8VHF beacon on 50.0325MHz. Alan asks that you let him fully complete QSOs before calling him. His QSL information is: Alan Isaachsen, MEG1, PO Box 139082, Dallas, TX 75313, USA. The slot time for these openings seem to be

approach the cycle peak.

Both Ed, WP40, and KP4EIT report daily contacts with LU / PY (Argentina and Brazil) on 144MHz. LU5EJW is a constant station who is worked on 144MHz as well as 50MHz. This is amazing propagation at this stage of the solar cycle, so let's just hope that the propagation extends further north as the cycle increases.

Peter, PY5CC, reported that during the aurora on the 18th he worked a station in Spain on 50MHz. A few days later he heard the beacon on KH6! Wow - some people seem to live on another planet!

On the 19th Kazu Ogasawara, JA1RJU, one of the operators of the 9MOC DXpedition from the Spratly Islands [see *9MOC - Spratly Islands 1998* in last month's *Ham Radio Today - Ed*], worked all call areas in Japan on 50MHz. Mike, G3SED, another of the team members, said he had hoped that they would have at least some propagation to that area. The only other country

analysis it seems that the opening was via TEP.

During the latter half of the month, stations in Japan reported daily openings to VK (Australia) on 50MHz via TEP. The consistency of reports were quite unusual, to say the least.

march: what a month!

March produced spectacular results on the 50MHz band with fantastic reports of openings via TEP, and some other modes that have left us all puzzled.

1 March produced TT8JE from Chad. Eric worked into France (F9DI in JN33) and IN92 at 1400UTC. Eric also worked OD5SK, SV1DH, 4X5JA and Is and IT9s at 1500UTC. Later reports were 4X to 7Q7 and ZD8VHF and EH5 to ZD8 at 2000UTC, the latter reports were via TEP as they were conducted over the equator.

The contacts between TT8JE and Southern Europe may well have been Sporadic E as several

VHF / UHF Message

Geoff Brown, GJ4ICD, reports on the 50MHz band

ES1AJ (K029) LA3BO (J059), LA5KO, and various other stations around Europe.

No European auroral contacts were spotted on 432MHz, but in the USA several stations worked each other on this band.

On the 22nd (VHF Convention day!) the following report came in from Hal, ZS6WB, in Pretoria,

around 1300 to 1400UTC. Alan also runs a CW beacon on 50.107MHz. He notes that his local TV station on 48MHz comes on the air at 1500UTC, and this causes him terrific interference problems. Keep a look out for Alan on 144MHz via TEP as we

worked was Hong Kong. Brett Graham, VR2BG / VR98BG, reported that a group of Hong Kong class B amateurs camped out on a local hilltop overnight in the hope of working 9MOC on 6 metres. They were not to be disappointed! Charlie, VR2XMT, in Hong Kong also reported that about 10 VR2s worked 9MOC on 50MHz.

The 20th brought a repeat of PY5CC's KH6 opening on 6 metres, when again he heard the KH6 beacon. After careful

reports were received of Sporadic E openings within the Mediterranean area during that day.

On the same day, JA1VOK reported the following 50MHz DX: "I worked VK5GN on 50.160MHz SSB with RS57 - 57 at 0353UTC, as well as VK4s, VK4BRG/B, 539 and VK8RAS/B 599 and then I worked FK1TK, Henri in RG37 on 50.110MHz SSB with RS59 - 59 at 0400UTC. Henri was heard on 50.130MHz SSB with RS59+ until 0445UTC here".

On the 2nd, Peter, PY5CC, in Brazil reported working into Europe on 6m. He had 35 contacts with Spain, Portugal and Ceuta (EA9), again via TEP. Meanwhile, on the other side of the world, John, VK4FNQ, had a brilliant opening to Japan. John managed to contact over 30 JA stations on 50MHz.

4 March again produced Eric, TT8JE, in Europe. At 1330UTC Eric made contact with Italy and by 1418UTC he was 55 on SSB into GJ.



Just one of the 50MHz high-power amplifiers which can be found on the Internet. This one uses an 8877 valve and has been designed and built by columnist Geoff Brown, GJ4ICD.

Fig 1: Graphs of the solar flux, sunspot number and A index for January and February.

This mode of propagation is rather strange to explain fully: it can't be TEP because Eric is some 16 degrees north of the equator. The possibility of multi Sporadic E seems viable, or some other unexplained ionisation mode.

On the 7th stations in Spain had an opening into South Africa (ZS6) and Namibia (V51), sadly it did not propagate any further north!

Ed, WP40, in the Caribbean reported working stations in CX (Uruguay) on 50MHz on the 8th. This is nothing special for Ed as he has a fantastic path and site for South American openings, but what made the

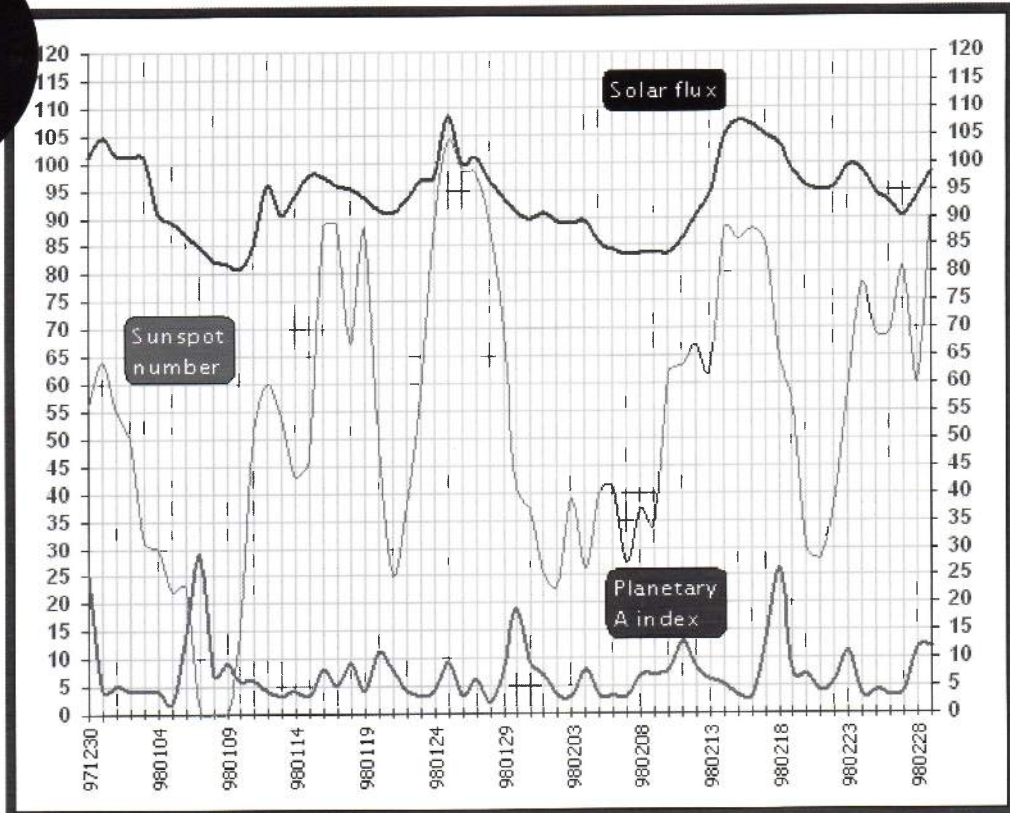

VHF / UHF Message

DX worked on 50 and 144MHz recently

opening special was the fact that the CX stations he worked were operating mobile! Ed also completed contacts with stations in LU (Argentina) via 144MHz TEP. On the 9th another big opening was reported between JA and VK4 areas.

Ron, 7Q7RM, in Malawi reported that he too had QSOs as far north as the EA1 area on the 10th at 1900UTC. More on the March openings next month.

In *VHF / UHF Message* last month, I mentioned the Internet site <http://user.itl.net/~equinox> which has several VHF constructional projects including power amplifiers and filters for 50MHz. Here's a picture (above) of one of the amplifiers to be found on this site.

dxcc news

Congratulations to the following on obtaining their 50MHz DXCC certificates: DK9KX, JA6BSW, JO1HQQ, GOLCS, G3SDL, HC2FG, DJ5JK. This information was supplied by Bill Moore at the ARRL DXCC desk.

I was also advised that 7X (Al-

gerian) 50MHz QSOs are not valid for DXCC, because no paperwork has been received by ARRL HQ. Therefore all claims over the past several years will now have 7X deducted from their total of DXCC countries. In my opinion this is really stupid: if the country has an allocation and general release for 50MHz or 144MHz then it should count, what do you think?

Finally, on the expedition front, Mike, VE9AA, may well appear from CY9 (St Paul Island, off the coast of Canada) again this year. Mike is trying to get sponsors for his 50 / 144MHz expedition in July.

beacon news

There is a new 6 metre beacon on the air from grid square FM28 in Southern Delaware. It signs K3DEL/B and is on 50.070MHz, but we don't have any data about the antenna, power etc.

Neil, G0JHC (Lancashire), reports the following after a phone conversation with Bo, OX3LX. The OX3SIX beacon on 50.012MHz will not be QRV un-

til June / July (at the earliest). That's when Bo, OX3LX, expects to visit the HP15/16 area where this beacon will be located. Crossed dipoles look like making up the antenna configuration. Bo confirmed that OX3VHF on 50.045MHz is still QRV.

Another new beacon is on 50.071MHz signing "KOETC/B in EM27 and jrpar@clandjop.com" It runs 10 watts to a north-south indoor dipole. Is this the first beacon with an e-mail address in the keying?

repeating sunspots

If you followed the sunspot activity that produced the 50MHz and 144MHz TEP openings in January, February and March, you will certainly have seen an interesting pattern formed. For those who have not seen the Internet information, take a look at **Fig 1**, which is courtesy of DXLC, and then compare the dates of when openings were logged around the world.

The graph shows a repeat of

January's sunspots in February, with near-identical VHF TEP openings, which took place on:

Jan 16, 18, 19, 20, 24, 26

Feb 14, 15, 16, 18, 19, 20, 22, 23, 24, 25, 26, 27, 28

Mar 1

The repeat cycle is quite easy to see from January to February, along with several days like 22 February that brought a *big* TEP opening to South Africa (perhaps a pre-enhancement?)

If the repeat cycle each month was stable I'm pretty sure we could even predict most openings to the south from the UK.

That's all for this month. Good DX on the VHF / UHF bands. Please send photos, e-mails, 'snail mail' etc to: Geoff Brown, GJ4ICD, TV Shop, Belmont Rd, St Helier, Jersey, C I JE2 4SA; or fax: 01534 877067, or finally e-mail: equinox@itl.net

mixer with an input amplifier, on board oscillator and voltage regulator. It was designed for high performance, low power communication systems such as mobile telephones. The 'Gilbert Cell' multiplier configuration typically provides 18dB of gain to 45MHz. It can be configured as a crystal oscillator (usual in amateur circuits), a tuned tank oscillator or a buffer for an external LO (thanks to Paul, NA5N, for this description).

ugly bugs

I shall be doing a talk on construction without a PCB at Dayton this year at the QRP Forum and it was suggested that I share some of the ideas with the readers here. It would be too much to cover in one column so I shall cover parts of it throughout the year.

Most builders will have heard of the 'ugly bug' style of building (often referred to as 'dead bug' style, depending on your country of domicile), but may not

be aware of how it is achieved. Both of these titles conjures up a picture in the mind of the builder. We have all seen a pile of dead insects in the corner of the window somewhere. This method of construction follows that idea to its logical (or sometimes illogical) conclusion.

Think again of the pile of dead bugs or insects and mentally change each one into an electronic component. This is what we are intending to achieve. There will be problems of course but these can easily be overcome as we progress.

Back to the building. The easiest way to start is with a piece of PCB material. Take one single resistor in the proposed circuit that goes to ground ('deck') and guess at where it should appear in the circuit in relationship to the piece of PCB material. Trim one lead back and bend it at 90 degrees to the resistor body. Solder the resistor to the copper groundplane and ensure that it stands upright. This is the first

It is unlikely that a resistor of this value will alter the operation in any way. But do remember it is there, should there be any faults later.

The whole finished project will look just like a pile of dead bugs when completed, but also it will provide the facility to change components as you progress. To update, to change values, to get the very best out of the circuit.

This type of construction is an ideal way to test a circuit as each component can be lifted out and a replacement soldered in. It is also an ideal way to teach construction, as it is easy to show the relationship between each component and how it affects the circuit as you change the value of a resistor or capacitor.

i-qrp club

I received a copy of the Italian QRP Club's magazine recently which, despite being mostly in Italian (not surprising really, but it did have a few pages in English too) I did find interesting.

with their 10 watts or less of SSB. I am continually amazed at what can be worked by low power and I love to tell people that I am running just a few watts. Especially when I receive an S6 or S7 report from a station that is running a kilowatt. Most will not try to try down the wick at they consider the high power essential. The few that do switch off the amp and drop to the 100-watt level often are surprised at still being heard easily. I try to then get them to turn it down further but usually get the reply "I don't know how."

On packet and the Internet I am often asked about turning down the power levels on HF rigs. I have often discussed the usual method of a negative voltage on the ALC line with a pot in line to set the power out. This is connected to the rig usually via the accessories socket on the back of the rig. Jeff, AC6KW, reminded me that the Alinco DX70 has a microswitch inside that changed the High / Low power

QRP Corner QRP Corner

and discusses the ugly bug style of construction

of the mounts for the remainder of the circuit.

Each component is added to the next and suspended from it. Of course there will come the point where it starts to droop and sag down to the board. If there are no other components that can be used to keep it up then a high value resistor such as a 1M Ω can be used.

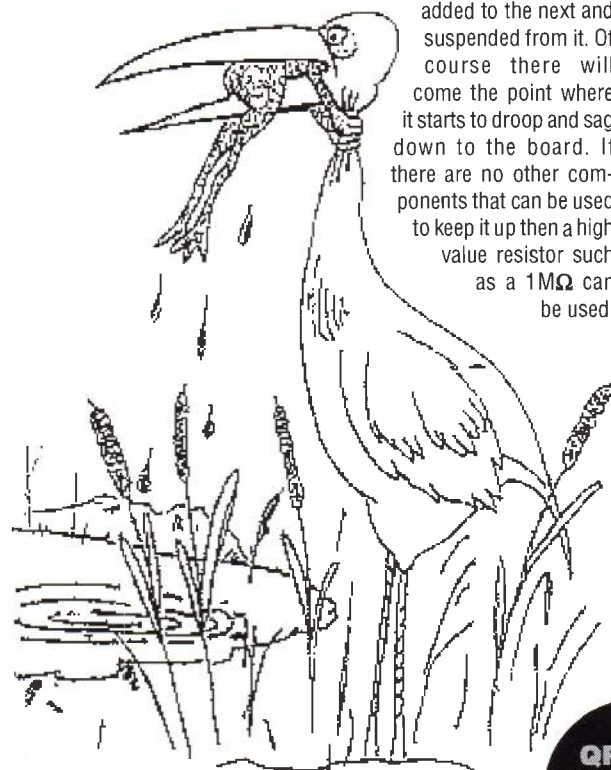

I just loved the cartoon on the front page and offer it to you to enjoy as well. Apparently it was drawn by AI, KB1FK, and adopted by the club. The photograph shows a rig built by A Bollani, IK2NBU, a member of the club, and the circuit of the 'Step 40' transmitter is shown in Fig 1.

The I-QRP Club also boasts having the southernmost QRP operator as a member, Tom, VK7LF. Members may contact Tom to gain the VK-I QRP Award. 12 QSOs are required and Tom will give progressive numbers to those asking. The contact must be QRP on CW, SSB or RTTY and the cost is \$5 or 5 IRCs. The starting date is 1 January.

turn it down!

Roger, GOAOX, has just joined the G-QRP Club and asks about SSB activity. Whilst the primary mode for most QRP activity is, and almost always will be, CW, there are a few dedicated SSB activists such as Leighton, GW0LBI, and others who love to burn up the airwaves

factory setting from 100W/10W to 50W / 5W: ideal for us QRP types. If memory serves me right, the Kenwood TS-50 also had this facility, but on the microphone buttons.

I must remind you that the 5 watt level is not exact and may, perhaps, be slightly over. A check into a dummy load will show if this is the case. Remember even 5.1 watts CW is not QRP for competitions or awards, although it would be OK for any SSB contacts.

Many non-QRPers just don't know how to reduce the power level of their rigs. If you are reading this and are not a dedicated low power operator, do you know how? If not - get the manuals out and find out! It will often be easier than you think, and you may be surprised at what you can work.

That's it for another month, news and views to me via packet: at GB7RMS, or e-mail to: Dick@kanga.demon.co.uk or snail mail to Seaview House, Crete Road East, Folkestone CT18 7EG. 72 de Dick.



My comments on APRS (Automatic Position Reporting System) have apparently stirred up some interest, from the sudden increase of bulletins on the packet network on this subject! Harry, M1BYT, in West Yorkshire asks if anyone is actually using APRS on packet. He says that until recently he was using a BayCom system (which doesn't directly support APRS) although he now has a TNC and, having given APRS, a 'spin' didn't get any results.

On this subject, also in the West Yorks area, Dave, G0DJA, says he's managed to set up a reasonable antenna to try out some APRS tests and have given copies of the program to some others in his area. Dave can run 6m, 2m and 70cm and asks if anyone would like to give it a go? Dave also asks for UK maps, saying he has a UK-wide one, but no detailed maps. I have a collection for the UK and Europe here, including detailed maps for

But do you have a detailed APRS map for your area? In my location, I can regularly see a number of stations, mainly individual users and personal nodes, on my APRS screen. You don't need to actually be using APRS software in your shack to allow others to see where you are, as all that's required is to add your geographical co-ordinates to your TNCs UNPROTO text. The APRS software at other stations can then build up a very useful map of all the nodes it hears. Mobile packet stations with a GPS receiver plugged into the TNC can also be plotted as an up to date moving point on the APRS map. In fact I was doing this just a couple of days ago, with a Garmin GPS-III connected into a Tiny-2 TNC, leaving it to beacon every so often whilst I drove around my locality. With the Tiny-2 plugged into the dedicated data socket on the rear panel of the mobile rig, I could also use the mic / speaker as normal in between the short packet

the APRS coverage in this column, adding for the benefit of other readers: "If you fancy helping out those around you to test APRS, it's done very easily by adding 21 characters to your beacon text. Here's mine: !5442.50N/00612.23W-/***** All you do is change the Lat and Long (get it through your BBS) to your location, or one just down the road if you want to remain a bit anonymous, and replace the ***** with any other info you want to broadcast". Ciemon adds that this way, anyone running APRS will pick up your beacon and your station will appear on their map.

Using the system whilst mobile also has a number of possible uses. A station in the US even watched his stolen car being driven across town on his APRS map. The police couldn't believe it when he told them his car was still on the move and that he was tracking it!

A further bulletin from Andy, G0FTD, says that he has got the

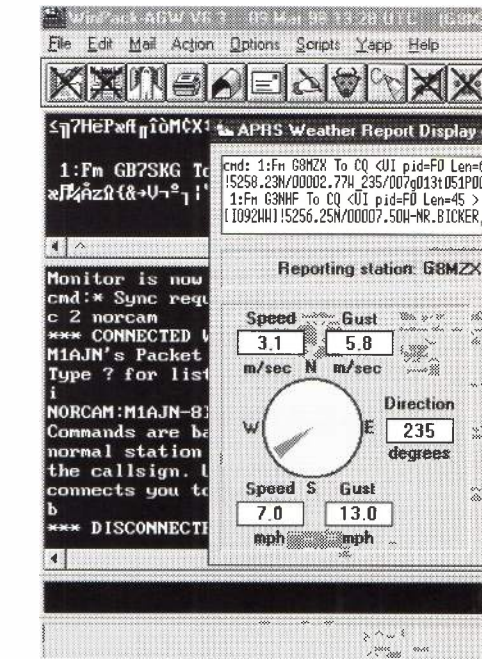

beacon is an essential first step to getting any real interest in the mode in the UK. I have written

Data Connection Data Con

Chris Lorek, G4HCL, finds a new APRS add-on for WinPack software expensive multimoo

the Lake District and other areas such as Kent, Liverpool, the North West, Cheshire and Penrith, which I hope Dave by now will have received. I've also started to configure a map for my area of the central South Coast, which I'll make available when it's completed.

bursts, having the occasional QSO with my friend in the shack who was also delighted to be able to see on the map exactly where I was at any time!

Ciemon, G10TRT, sent me an e-mail to say thanks for

WinAPRS software but never uses it, questioning: "Does one really only want to have the equivalent of a Windows terminal with no dedicated packet facilities, yet having the APRS feature?", adding that if he could have a simple APRS facility in a dedicated packet terminal software it might be worth having. Well, I'm glad to be the bearer of some good news here:

winpack wxnode

Roger, G4IDE, who's the author of the superb WinPack program, kindly dropped me an e-mail to say: "I am currently running a WX node, which beacons a report in APRS format on 144.950 and 432.675 every 15 minutes. Also, a few other locals have APRS-style location information in their beacons. I think that for packet users to start putting their location in the correct APRS format in their

an add-on for WinPack (WXAPRS), which gives a pretty display of APRS WX information when it is received. It also dumps any position reports that are received into a log file, which can be loaded into the APRS software and displayed. All I need is to be able to receive a few position beacons from farther away than the local users, and I could get quite enthusiastic about it!" Thanks for that Roger, it's nice to know that we can now have the best of both worlds!

Shown above is a typical screen from the WXAPRS information within WinPack, where in the small window at the top of the WXAPRS display you can see the raw data in the beacon from G8MZX.

20m sstv

SWL Karl Drage says that the other day he was listening to the 14226.5kHz DX net run by W8GIO and others, when they were completely swamped by SSTV operators. Karl says he has nothing against SSTV and that he

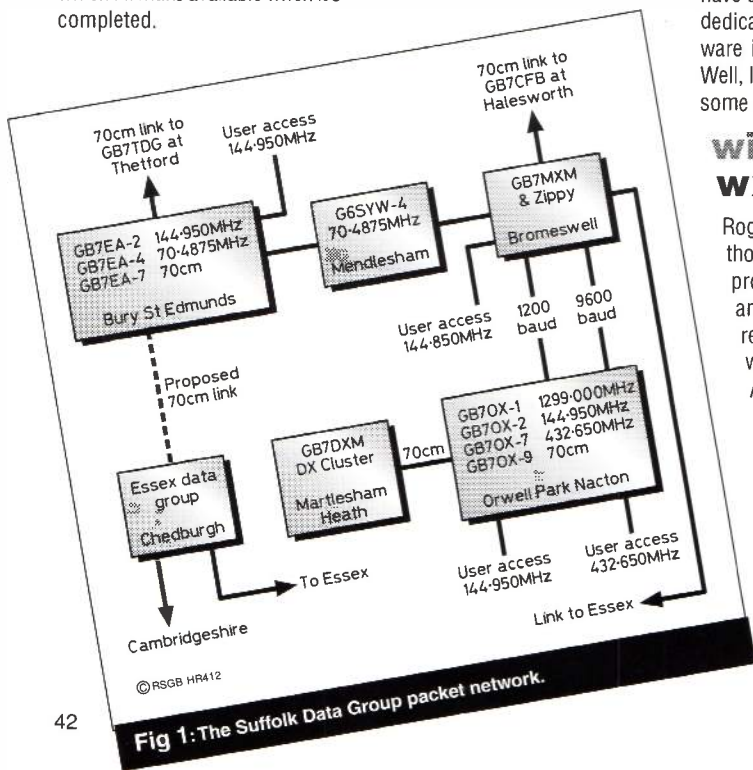
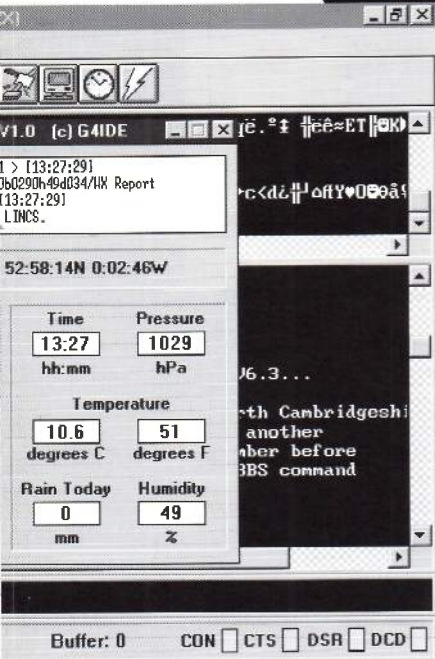

Fig 1: The Suffolk Data Group packet network.

The WXNode add-on for WinPack.



often spends time decoding the pictures being sent, but is it not about time, with the growing

software that's currently available (Table 1), which uses either a PC sound card or an easily-made external decoder (often just a single OP-amp type). If you have Internet access, you could download any or all of these programs (although it might take you a long time!) from: <http://ourworld.compuserve.com/homepages/hffax/toc6.htm> Alternatively, as a service to amateurs, all of these programs are included on the current *QSP73* CD-ROM (details on last month's *Ham Radio Today* cover-mounted CD-ROM, or tel: 01703 263429 for info).

10m dxcluster

Pablo, LW7EDS, is the SysOp of the LW7EDS BBS in Mar del Plata, Argentina, which runs on 28180kHz LSB. Pablo is now also running a *DX PacketCluster* on the same frequency, under the callsign LW7EDS-5 and accessible also via the Network Node of LW7EDS-4 (alias: JERRY). He's

cluding a 'packet starter pack', at a very reasonable cost of just £1.00 for each disk plus 50p P&P to the total.

The Suffolk Data Group's packet network is shown in Fig 1. If you live in the area, do consider joining the group. You can get further details from the chairman, Andy, G3ZYP @ GB7MXM.

News from the group is of some recent changes at the GB7EA:BSE2 node at Bury St Edmunds, which has changed its 2m port frequency from 144.650 to 144.950MHz. GB7TDG also has user access on 144.950MHz, which makes a useful reserve link for MXM and TDG mail. BSE2 currently runs BPQ node software, although it may be changing to FLEXNET soon, which offers driver support for sound cards and other modem-based equipment.

high-speed packet tnc

I bumped into many friends at the London show in March. If

me the first prototype of a new TNC he'd been developing. It looks very interesting indeed. It's a small, self-contained unit about the size of the Kantronics KAM, and with its extremely versatile built-in modem it can handle over-air packet speeds right up to 56kbps. It can also be used as a digital regenerating speech repeater, as well as having a number of other 'bells and whistles', and a projected price of under the £300 mark makes it even more interesting! I've been promised a review sample in a few weeks, so you'll be seeing a lot more of it very soon in the pages of *Ham Radio Today*.

slough packet

With the recent closure of GB7TVG in the Slough area in late February (although it may be 're-vitalised' by another SysOp in the future), it's worthwhile giving a reminder that, if you'd like to try TCP/IP packet operation, that in the same area gb7bvg.ampr.org 44.131.242. 248 op-

Connection Data Connection

and shows how you can try multimode data without needing an external controller

popularity of the mode, that a larger frequency range was made available to the mode, for everyone's benefit? This is a thorny problem, and even though the band plan in the 1998 *RSGB Yearbook* gives 14225 - 14235kHz for SSTV use, so the SSB net was operating within the agreed SSTV segment [in fact this segment is shared with SSB and CW activity - Ed], this is only a 'gentleman's agreement', at least in most countries (some countries do stipulate that certain modes may only be used in given frequency ranges). With the increase in the use of digimodes, these will I'm sure naturally 'spread out' over the years as needed to prevent inter-mode interference. But what do other readers think?

multimode software

If you'd like to give other data modes a 'go', without the need to buy an expensive multimode data controller, here's an overview of some popular PC-based

looking forward to maintaining a link with some European or North American *PacketClusters*. You can contact Pablo via packet with a message to LW7EDS @LW7EDS.MDP.BA.ARG.SA or by e-mail: lw7eds@htc.statics.com.ar

suffolk data group

Andy, G3ZYP, kindly sent me a copy of the Suffolk Data Group's winter newsletter. It's published quarterly, one each season, so the spring issue will undoubtedly be out by the time you read this. The winter issue is a ten-page A4 newsletter packed with information on local packet news, plus an 'RTTY Notebook', 'Novice Report', a useful construction article on how to make a simple 70cm collinear aerial, and details of the group's disk library. The latter offers a selection of amateur and data programs on ten individual disks, in-

you came along to the *Ham Radio Today* stand in the Red Hall at the show to say hello, then many thanks! One visitor, Matthew, whom I last met over 15 years ago, showed

erates as a gateway to and from the NTS. As well as carrying the full NTS bulletin output transferred to Network News (NNTP), this AMPR network host is fully routed in the Thames Valley areas and beyond, so should be readily accessible.

Software	Modes	System	Decoder
JVFAX	FAX (FM/AM)	SSTV	DOS
WXSAT	FAX (FM/AM)	SSTV	Win95
SSTV WIN95	FAX (FM/AM)	SSTV	Win95/NT
EZSSTV	SSTV	SSTV	DOS
HISCAN	SSTV	SSTV	DOS
WEATHERMAN	FAX (FM)	SSTV	DOS
WINPIXPRO	FAX (FM)	SSTV	DOS
HAMCOMM	SSTV	SSTV	DOS
RADIORAFT	RTTY	SSTV	Win3.x/95
SSTVFAX	RTTY	SSTV	DOS
FTV	FAX (FM) SSTV	SSTV	DOS
PROSKAN	FAX (FM/AM) SSTV	RTTY	DOS
VESTER-1	FAX (FM) SSTV	SSTV	DOS
EASYFAX	SSTV	SSTV	DOS
SSTVBL	FAX (FM)	SSTV	DOS
MSCAN	SSTV	SSTV	DOS
ATFAX	SSTV	SSTV	DOS
GSH-PC	FAX (FM) SSTV	SSTV	DOS
WINSKAN	SSTV	SSTV	DOS
	SSTV	SSTV	Win3.1/95

Table 1: Overview of multimode software available on the Internet and on the QSP73 CD-ROM.

BUY YOUR COPY NOW!

PMR CONVERSION HANDBOOK

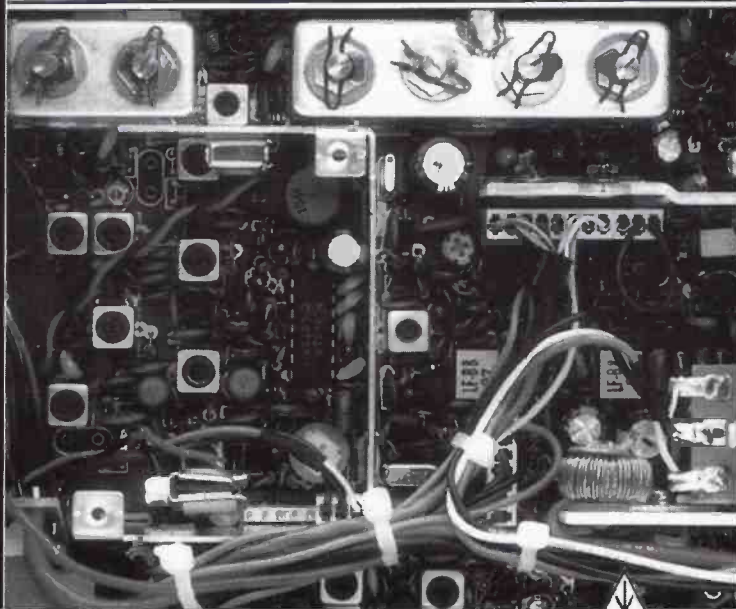

BY CHRIS LOREK, G4HCL



£15.28

+P&P

Once private mobile radio (PMR) equipment used by commerce and the emergency services is replaced by more advanced systems, it rapidly appears on the surplus market and can be acquired very cheaply at rallies. Often it can be converted to amateur band usage quite easily and without expensive test equipment, giving high performance at a fraction of the cost of purpose-designed amateur gear. However you do need to know what you are buying because some sets on sale are difficult to convert.

This handy book clearly shows you how to identify, choose and buy those PMR sets which are suitable for conversion. It gives step-by-step conversion instructions, and is packed with practical tips, photos and diagrams to help you all the way. Don't be without it at a rally!



Radio Society of Great Britain

Lambda House, Cranborne Road, Potters Bar, Herts EN6 3JE

☎ 01707 659015

<http://www.rsgb.org>

444

Book Browser

Ham Radio Today's great new service to readers. You can order by e-mail, phone, fax or post. See below for details.

Radio Communication Handbook

edited by Dick Biddulph, G8DPS
A comprehensive guide to the theory and practice of Amateur Radio communication. If you're into Amateur Radio, this is the book to buy!
6th Edn, 763 pages
£21.00 (plus P&P)

PMR Conversion Handbook

by Chris Lorek, G4HCL
Private mobile radio (PMR) equipment rapidly appears on the surplus market and can be acquired very cheaply at rallies. Often it can be converted to amateur bands quite easily and without expensive test equipment. This book tells you what to buy and how to convert it.
1st Edn, 192 pages
£15.28 (plus P&P)

VHF/UHF Handbook

edited by Dick Biddulph, G8DPS
Guide to the theory and practice of Amateur Radio reception and transmission on the VHF / UHF bands including antennas, EMC, propagation, receivers and transmitters, together with constructional details of many items of equipment. One of the most complete guides around for VHF / UHF operators. See the review in *Ham Radio Today* December 1997!
317 pages
£18.80 (Plus P&P)

VHF / UHF DX Book

edited by Ian White, G3SEK
VHF / UHF DX is one of the growing points where Amateur Radio shows that it still has a real future - and that's what this book is all about.
1st Edn, 447 pages
£18.00 (plus P&P)

Amateur Radio Operating Manual

edited by Ray Eckerstey, G4FTJ
This book covers the essential operating techniques required for most aspects of Amateur Radio, taking the reader from the principles of basic contacts right through to the secrets of working DX and winning contests.
4th Edn, 249 pages
£12.23 (plus P&P)

RSGB Yearbook - 1998

edited by Brett Rider, G4FLQ
Formerly known as the RSGB Callbook, the Yearbook has been enhanced to include a wealth of information for all Radio Amateurs. Includes all UK and Republic of Ireland callign listings, plus over 120 information pages. Reviewed in *Ham Radio Today* December 1997.
1998 Edn, 517 pages
£13.95 (plus P&P)

Passport to World Band Radio

edited by Lawrence Magne
How to find hundreds of programmes you won't find on ordinary radio or TV, from the BBC's incomparable reporting to music from the South Seas. Passport to World Band Radio covers it all - what's on, what to buy, how to get started, and how to get the most from your listening.
1998 Edn, 560 pages
£14.99 (plus P&P)

World Radio & TV Handbook

edited by Andrew Sennitt
The comprehensive guide to broadcasting, including domestic and international radio listings, web sites, e-mail addresses, frequency listings, English broadcasts, 1998 survey of shortwave receivers and accessories, worldwide TV station addresses and contacts.
1998 Edn, 608 pages
£22.94 (plus P&P)

Radio Logbook - Receiving

Spiral bound 100 pages
£3.67 (plus P&P)

Radio Logbook - Transmitting

Spiral bound 100 pages
£3.67 (plus P&P)

Your First Amateur Station

by Colin Redwood, G6MXL
How to set up a station and get on the air as cheaply and effectively as possible. It covers all bands, with special emphasis on VHF / UHF. A 'must' for everyone who has just passed the RAE or NRAE. (See the review in *Ham Radio Today* December 1997!)
1st Edn, 124 pages
£5.74 (plus P&P)

Your First Packet Station

by Steve Jelly, G0WSJ
How to set up a basic packet radio station and enter the world of data communications from your shack. Explanations are kept as simple and non-technical as possible, making this book an ideal choice for the beginner.
1st Edn, 76 pages
£5.74 (plus P&P)

The Antenna Experimenter's Guide

by Peter Dodd, G3LDO
Take the guesswork out of adjusting any antenna, home-made or commercial, and make sure it's working with maximum efficiency. An invaluable companion for everyone who wishes to get the best results from their antennas.
2nd Edn, 160 pages
£15.00 (plus P&P)

Practical Wire Antennas

by John Hey, G3BDQ
A 'down to earth' guide to the construction of many different types of wire antennas, ranging from simple dipoles to ingenious multi-wire systems. Boring and unnecessary theory is kept to a minimum - instead the author shares his years of experience, offering advice for beginners and enthusiasts alike.
1st Edn, 96 pages
£8.92 (plus P&P)

Practical Receivers for Beginners

by John Case, GW4HWR
Contains a selection of easy-to-build receiver designs suitable for amateur bands, together with simple 'fun' projects and test equipment. The theory and practice of receiving techniques is outlined to help with understanding the circuits presented. This book is of value to anyone who is building receivers for the first time, or who is considering moving up to microwaves.
1st Edn, 165 pages
£12.50 (plus P&P)

Ferrell's Confidential Frequency List

Compiled by Geoff Halligey
Including full reverse callign list: aero; CW; coast; fax; fixed; embassy; military; Navtex; time; Volmet. Published by PW Publishing.
10th Edn, 450 pages
£19.95 (plus P&P)

to order

fax 01707 645105

e-mail prt.sales@rsgb.org.uk

telephone 01707 659015

internet www.rsgb.org/books/bookmenu.htm

postage and packing

Ham Radio Today,
RSGB Sales, Lambda House,
Cranborne Road, Potters Bar,
Herts EN6 3JE.

UK

For one item £1.25, two items or more £2.50.
Delivery by Parcel Force (7 - 10 working days).
For next day service (on orders received before 12 noon): £4.85.

OVERSEAS

For one item £2, two items £4. Extra books over two items, an additional 50p per book.
Delivery by surface mail. Air mail rates available on request.

NB

all prices include VAT (where applicable) and are subject to change without notice.



Products from our range designed to increase your range

HF

Our superb Alpha amplifiers need no introduction! With an easy 1.5kW out, these loaf along at the UK limit. See Feb 97

RadCom review by Peter Hart for an independent verification of their quality. We reproduce his verdict on the 9lb manual-tuning amplifier (£2,199)



"An excellent amplifier in all respects", and he called the no-tune 87A (£5,295) "The Rolls-Royce of all amplifiers". As the 87A interfaces with all brands of HF radio (unlike other "no-tune" amplifiers), you can change your radio to *any make* without losing amplifier compatibility.

Antennas? What a choice, from HyGain, Cushcraft, KLM, M-squared, Force 12 and GemQuad. In stock now, the amazing C-4SXL (£795) from Force 12. This antenna implements 40-20-15-10 yagis on one 24ft boom and weighs only 48lbs. For those who would like to have as super signal on 20 through 10m, including the 17 and 12m bands, the GemQuad is an excellent choice. For only £380, the WARC version of the Gem takes a lot of beating. We have *lots* of others, and as we list everything from 10m verticals to a 4 ele 80m yagi, we have something for you!

Rotators? Rotators 'r us! Call us for the latest and best.

Planning Probs? They can't touch you for this one! The amazing Force 12 ZR-3 triband vertical dipole (£449) is less than 6ft high, yet retains good bandwidth and high efficiency, on 20-15-10m with no tuning.

. . . . **And specials?** . . . We have good stocks of baluns, cable, wire, remote antenna switches, tribander stacking units, "four-square" vertical phasing systems, and (nice one this) an antenna switch that can be driven by any "band data output" Yaesu or ICOM transceiver, or from your PC LPT port (with appropriate software) to change up to six antennas automatically, triggered by a band change on the radio.

**9M0C
Spratly!**

Did you work (or hear) the splendid 9M0C expedition to Spratly in February? If you heard their signal on 80 and 40m you will have heard a Vine **foursquare vertical array phasing unit** in action. We can't do better than quote DxPedition members on the performance of these units "The foursquare units were a dream... Switch off EU and switch on JA. As easy as that!... Truly amazing!"

Vine foursquare units comprise the outdoor phasing unit (IP65 protection in heavy duty die cast box) plus indoor control unit. Units are available for 80/75 and 40m bands. Price - £275 complete. We can also supply suitable vertical antennas.

Just in - What many of you have been waiting for. **A MINIBEAM THAT WORKS!** The Force 12C-3SS (£439) is primarily designed for 20-15-10- but will work on 17 and 12m through a tuner with reduced gain and f/b ratio. It has a maximum element length of 24.5ft. (full size elements on 15 and 10m) boom 11.8ft and turning radius of only 13.5ft, with no lossy traps or loading coils to heat up. Full VSWR bandwidth is also maintained. Gain on 20m is 11.5dB (Cushcraft method). Weight - 26 lbs.

VHF

NEW! From T E Systems, a series of the highest-quality VHF/UHF amplifiers. All have GaAsFET preamps, with RF VOX, or PTT switching. What is more - the output specified is what you get. Here is just some of T E's range -

Band	P In	P Out	£	Band	P In	P Out	£
6m	10	170	319	2m	25	350	509
6m	10	375	499	2m	80	350	459
6m	25	375	459	70cm	10	100	359
2m	2	150	319	70cm	10	185	569
2m	10	200	329	70cm	25	185	529

Our opening hours are 9am to 10pm, Monday to Saturday. We welcome personal callers, but by appointment only please.

Vine Antenna Products - The Vine, Llandrinio, Powys, SY22 6SH. Tel 01691 831111, fax 01691 831386. Email ron@gw3ydx.demon.co.uk

RADIO + TELECOMMUNICATIONS CORRESPONDENCE SCHOOL

AT OUR NEW OFFICE
2 SOMERSET PLACE, TEIGNMOUTH
DEVON TQ14 8EP

START training now with the specialists for the following courses:

Telecomms Tech CG 2720, Radio Amateur Licence "A" or "B", Micro Processor and introduction to Television.

FOR our FREE Brochures write to the above address or call
01626 772414

advertise hrt

To advertise in
**Ham Radio
Today**

**Phone 01202 777852
Fax 01202 317902**

**Email:
adman@mcmail.com**

The **SHORTWAVE** Shop

18 FAIRMILE ROAD,
CHRISTCHURCH, DORSET BH23 2LJ
Phone/Fax 01202 490099 • Mobile 0836-246955

KEYWORD
Authorised
Dealer

KENWOOD
Communications
Centre

THE SCANNER & RECEIVER SPECIALISTS

Scanners & Receivers from £75 - £5999.

Call & discuss which part of the Radio Spectrum you wish to monitor & we will advise you on the most cost effective way of doing it.

- Full range of New & Second Hand Equipment Available.
- We Stock All Famous Brands.
- AOR, YUPIITERU, BEARCAT, SCANMASTER + ALL THE ACCESSORIES



AMATEUR RADIO

We are the Kenwood main dealer for the South Coast and appointed dealers for Yaesu & Icom equipment

Same day despatch on all postal sales quoting your Visa / Access number. Call for best prices on equipment.



4 MILES FROM BOURNEMOUTH INTERNATIONAL AIRPORT ON B3073.
300 YARDS FROM CHRISTCHURCH RAILWAY STATION. FORECOURT PARKING FOR DISABLED



.... **NO WAY!** This was the result of a professionally planned operation by experienced operators. The team chose **Cushcraft Antennas** for the main HF Bands. **Cushcraft Antennas** are rugged, reliable and deliver a real punchy signal - ask our boss **MIKE G3SED** - he was part of the 9MOC team! At **NEVADA** we don't just sell **Cushcraft Antennas** - we use them on the air everyday.....call now for the very best **Cushcraft "Hands On" advice!**

9MOC 65,500 QSO's BY ACCIDENT?



NEWSFLASH! **NEW R6000 VERTICAL**
Covers 6 mtrs to 20 mtrs
ARRIVING THIS MONTH!

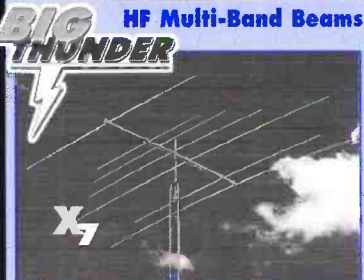

- HIGH THUNDER**
- HF Multi-Band Beams**
- X7.....10, 15, 20 mtr 7 element Yagi.....£499.95
 - X9.....10, 15, 20 mtr 9 element Yagi.....£749.95
 - A35.....10, 15, 20 mtr 3 element Yagi.....£389.95
 - A45.....10, 15, 20 mtr 4 element Yagi.....£469.95
 - A3WS.....12, 17, mtr 3 element Yagi.....£299.95
 - A743.....30, 40, mtr kit for A35.....£129.95
 - A744.....30, 40, mtr kit for A45.....£129.95
 - A103.....30 mtr kit for A3WS.....£119.95
- postage and packing £10 on each item

- HF Mono Band Beams**
- TEN-3.....10 mtr 3 element beam.....£139.95
 - 104CD.....10 mtr 4 element beam.....£269.95
 - 154CD.....15 mtr 4 element beam.....£289.95
 - 203CD.....20 mtr 3 element beam.....£359.95
- postage and packing £10 *£8 on TEN-3 & 104CD.

- HF Rotary Dipoles**
- D3W.....12, 17, 30 mtr Dipole.....£199.95
 - D4.....10, 15, 20, 40 mtr Dipole.....£259.95
 - D40.....40 mtr rotary Dipole.....£229.95
- postage and packing £8 on each item

R7000 HF Vertical

THE ULTIMATE IN MULTIBAND VERTICALS!
The R7000 is a half wave vertical which features 10 - 40 meters including WARC bands expandable to 80m. Slim profile, ruggedly constructed traps, no ground radials required make it the ideal choice for small gardens.

R7000.....10, 12, 15, 17, 20, 30, 40 meter.....£369.95

R80.....80mtr add on kit for R7000.....£129.95

APR18A.....Radial kit for vertical antennas.....£54.95

VHF Verticals

- AR2.....2mtr RINGO 1.2m long 3.75 db.....£39.95
- ARX2.....2mtr RINGO RANGER 2.8m 5.5 db.....£49.95
- ARX2B.....2mtr RINGO RANGER 114.3m 7 db.....£59.95
- AR6.....6mtr RINGO 3.1m 3.75 db.....£59.95
- ARX6.....6mtr RINGO RANGER 7.3m 5.5 db.....£199.95

postage and packing £8 on each item

*** NEW Euro Design YAGIS**
A new range designed especially for the European market

- VHF/UHF Beams**
- 13B2N.....2mtr 13 element Yagi 15.8 dbd.....£129.95
 - 17B2.....2mtr 17 element Yagi 18 dbd.....£199.95
 - A14410N.....2mtr 10 element Yagi 13.2 dbd.....£85.95
 - A148-20T.....2mtr 20 ele. crossed 11.1 dbd.....£105.95
 - 719B.....70cm 19 element Yagi 15.5 dbd.....£109.95
 - 729B.....70cm 29 element Yagi 17.8 dbd.....£169.95
- postage and packing £8 on each item

Dual Band Yagis

- A2704S.....2m/70cm 3+3 element 7.8 dbd.....£59.95
- A2710S.....2m/70cm 5+5 element 10 dbd.....£79.95

postage and packing £8 on each item

Satellite Antennas

- 22XB.....2mtr 22 el. OSCAR Yagi 14 dbdc.....£229.95
- 738XB.....70cm 38 el. OSCAR Yagi 15.5 dbdc.....£209.95

22XB and 738XB feature circular polarisation switching feature
postage and packing £8 on each item

6 Meter Antennas

- A503S.....6mtr 3 element Yagi 8 dbd.....£89.95
- A503S.....6mtr 5 element Yagi 10.5 dbd.....£149.95
- A504S.....6mtr 6 element Yagi 11.6 dbd.....£249.95

postage and packing £8 on each item

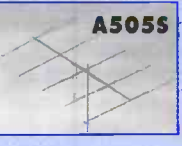

Palstar®

Power Supplies
The Palstar® range of power supplies are designed for use with transceivers automotive and marine electronic equipment. They are of high quality design and sturdy construction ensuring stability and reliability. All models are fully LVD and CE compliant.



- PS-30M 30 AMP max.**
- 3-15V adjustable
 - Thermatically controlled fan
 - Volt and current metering
 - Overcurrent warning indication
 - Short circuit protection

£99.00 £8 P&P



- PS-15 15 AMP max.**
- 13.8V fixed voltage
 - Foldback current protection
 - Thermatically controlled fan
 - DC output 4mm sockets & 2 pairs of snap in terminals

£59.95 £8 P&P



- WM-150**
- Reads average or peak power in 2 ranges 300W/3KW
 - Cross needle instant SWR reading
 - 1.6 - 150MHz

Introductory price £79.95 £8 P&P



- Compact Tuners**
- Matches diodes, centre fed doublets, GSIV's, Balanced feeders, Verticals, Single wires, Delta loops, Beams, Windoms and Inv V's.
 - Built in 4:1 Balun
 - 8 pos. antenna selector
 - Built in dummy load
 - Average power reading to 230W
 - Power/SWR

AT300 150W STANDARD MODEL

£129.95 £6 P&P



AT300 CN 150W CROSS NEEDLE MODEL

£139.95 £6 P&P



- NEW KH-6**
6 metre Handy Transceiver
- 50 - 54MHz
 - 4W RF out (12V) 2W RF out (9V)
 - UK Repeater offsets
 - Intelligent Power Save circuit
 - CTCSS Encode/Decode
 - Scan functions + Memory recall
 - C/W with 8 cell AA battery case (batteries not inc)
- Optional Extras**
P&P £2.75 on each item
KH6/NP-126
NiCad pack (12V)
£29.95
NIC 060
Charger
£9.95
- only £149** £6 P&P

End of Year STOCKTAKING CLEARANCE

MANY ONE OFF BARGAINS AT PRICES TOO LOW TO PRINT!



ICOM T8
TRIBAND HANDHELD

- 50/144/430MHz
- Receives 50-230MHz 300-1GHz
- 12.5/25kHz selectable
- NiMH Battery pack

NEVADA
RETAIL DIVISION

tel: 01705 662145 fax: 01705 690626

• 189 London Rd • North End • Portsmouth • Hants • PO2 9AE

• <http://www.nevada.co.uk> • info@nevada.co.uk

Send SAE 4 x 1st Class stamps to receive our latest catalogue

AO-10's apogee continues to move into the northern hemisphere. It will carry on this way for the rest of 1998, peaking in December. Stacey Mills, W4SM, at the command station, reports that signals are improving and are quite strong, even at apogee, except for periods of deep QSB, which can often be corrected by changing antenna polarisation. These findings suggest that AO-10 has switched itself to its high-gain aerials. There is probably also a component of Z-axis 'wobble' adding to the QSB. As illumination has improved, the FMing heard earlier seems to have disappeared. The switch to high-gain would also explain the often poor signals near perigee when the 'squint angle' is particularly bad.

W4SM has updated his web page to include discussions of AMSAT-Oscar-10's status, as well as smoothed Keplerian elements for the spacecraft. The URL is: <http://www.cstone.net/~w4sm/AO-10.html>

that RS-12 is going well on Mode KA. The 15m uplink is very sensitive, especially when the 'alligators' are not too prominent.

digital satellites

DO-17 (Dove) is still around, downlink on 145.825MHz FM, 1200 baud AFSK (the beacon on 2401.220MHz is also operational). Telemetry is being sent about every 30 seconds. A scanned image of the Dove's QSL can be seen at the *425 DX News* web site: <http://www-dx.deis.unibo.it/htdx/>

Requests for Dove QSL cards continue to roll into the QSL manager, Dianne White, N0IZO. Dianne reminds those who would like a Dove QSL card that a printout or listing of Dove's telemetry is not needed to obtain a card. Just send a QSL or SWL card, or even a note, listing the date, time and frequency you heard Dove, to: Dianne White, N0IZO, 45777 Rampart Road, Parker, CO 80138-4316, USA. Be

software for capturing data, and decoding ASCII telemetry and WOD. There is an archive of raw data (mainly WOD) for analysis, which is continually being expanded, as new data is captured. The URL is: <http://www.users.zetnet.co.uk/clivew/>

phase 3d

On 20 January, Phase 3D Project Leader Dr Karl Meinzer, DJ4ZC, met ESA officials in Paris to discuss the possible launch of the Phase 3D satellite on the third test flight of the Ariane 5 launch vehicle, AR-503.

The ESA officials indicated a willingness to consider a launch on AR-503, but made no commitment. They stated that they are also investigating the possibility of placing another payload on the mission, which would preclude launching Phase 3D. Nevertheless, ESA did agree to make an initial study of the configuration that would be associated with Phase 3D, were it to be launched on AR-503 along with several other payloads. They

The URL is: http://www.jamsat.or.jp/scope/scope_e.html

short bursts

B J Arts, WTON, known as 'BJ' to all of his friends, passed away in February. BJ, who was only 37 years old, had suffered for a number of years from acute diabetes, and reportedly succumbed to 'flu. BJ had been acting as ANS Bulletin Editor for several years and had been doing an exemplary job in that position. BJ had been very active on the satellites and the VHF bands. He will be missed by all of his friends around the world. BJ's family has requested that any memorials in BJ's name be made to the AMSAT Phase 3D fund as a fitting tribute to WTON. In the wake of BJ's sudden and untimely death AMSAT-NA have announced that Dan James, NNODJ, has assumed the ANS Editor duties.

Ray Soifer, W2RS, wishes to thank all who participated in AMSAT-NA's Oscar Straight Key activity on New Year's day. Al-

Satellite Rendezvous

Richard Limebear, G3RWL, with the latest news

russian satellites

Australian-born US astronaut Andy Thomas is now on board Mir. An Australian callsign, VK5MIR, has been provided for his use and he will be there until June. He also might use his US callsign, KD5CHF. The current Mir crew consists of Commander Anatoly Solovyev; Flight Engineer Pavel Vinogradov; Talgat Musabayev, R03FT; Nikolai Budarin, RV3DB and R4MIR, as well as Andy Thomas. The next shuttle docking mission is currently scheduled for 28 May.

The Mir packet radio PMS and the SAFEX II repeater seem to be mainly turned off but this changes from time to time; the Mir crew has been too busy with higher priority projects to spend much time on Amateur Radio. They have occasionally turned it on for random contacts; Andy seems to turn up at least once per day on the 70cm frequency and noises are sometimes heard on 145.985MHz.

Pat Gowen, G3IOR, reports

sure to include your callsign or name and a return address.

The Korean command station reports that although KO-23 has two receivers, Rx2 is not operating properly. They believe this problem is due to a fault and the only solution they have is a full reset of KO-23. At present, due to ground station problems, they need to delay this procedure for a while and suggest that you use the 145.900MHz uplink instead of 145.850MHz until then.

G3CWV's UO-11 report indicates that the spacecraft is operating normally and telemetry is nominal. The operating schedule is unchanged. Oscar-11 users are welcome to visit Clive's web site. He has recently added some audio files, including a Mode-S recording from KC6SZY, which plays for 20 seconds. The other audio files are examples of each type of data transmitted by Oscar-11, and each one plays for about ten seconds. They should help listeners identify the various types of data, and give an indication of the signal quality required for successful decoding. The web site also contains some

also agreed to investigate other possible launch opportunities, including Ariane-4s. Another meeting was scheduled for the end of February, at which time it is hoped that more definite information would be available.

If you can obtain a copy, there's an interesting cover story article on Ariane 5 in the 9 February edition of *Aviation Week and Space Technology*. The article presents some of the challenges that ESA has successfully met to place the Ariane 5 into service. The authors also present discussion on how the A-503 launch is proceeding with a tentative launch date in mid-July 1998. Lots of pretty pictures too!

On the Phase-3D spacecraft itself, information about the camera resolution has now been published. P3D will carry two cameras (the JAMSAT Scope Project) with different fields of view. The information is summarised at the JAMSAT home page.

though activity was down from previous years due to the loss of

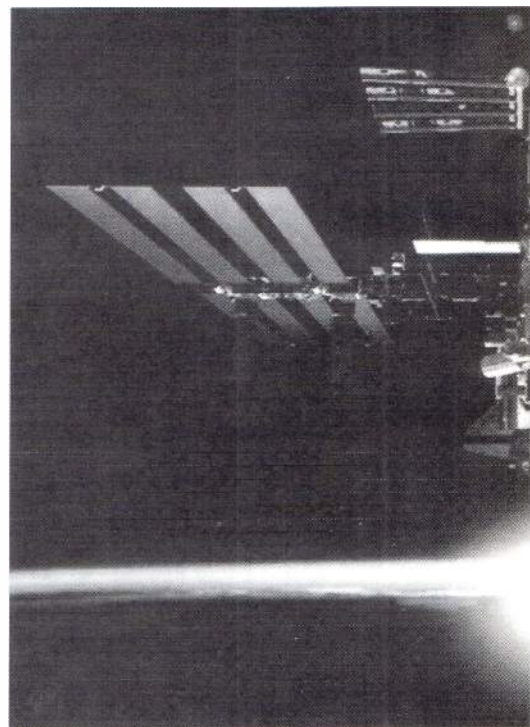



Columnist Richard Limebear, G3RWL, with AMSAT-UK treasurer Jenny Southwell, G1LIT, on the AMSAT-UK stand at the London Amateur Radio and Computer Show in March.

RS-10, the temporary loss of Mode K on RS-12 and the unfavorable position of AO-10, a good time was had by those who took part. Once again the first-place winner was Rusty, NM1K, who received five separate nominations. Two more 1998 winners also had been nominated in previous years: G3RWL and W1NU. Joining the winners' circle for the first time in 1998 were AG2R, K4IPH and VE5SWL.

The ARRL is considering an attempt to change voluntary compliance of amateur band

growing problem of FM incursion into what is traditionally non-FM spectrum, including frequencies normally used for satellite communications. The ARRL may ask the FCC to put 'teeth' into the voluntary band plan concept by asking the Commission to issue a declaratory ruling where any operation that conflicts with established, voluntary band plans and causes interference or adversely affects others operating in accordance with applicable band plans, is considered poor amateur practice. As such it would be also be considered a rules violation. Watch this space.

There have been no additional news or announcements about the FO-29 operating schedule; it is currently in analogue mode. The satellite normally rotates between analogue and digital modes, but has recently been left in analogue mode after a soft-

tor with a trackbox (to add to the trackbox that AMSAT-UK kindly provided), an 11-element XY Yagi for 70cm and a five-element XY Yagi for 2m. These will be used to set up two new independent command stations, one in Korolev headed by RV3DR for the International Space Station, and one headed by RK3KPK for the coming RS-18 and future RS satellites.

Some of you may have access to Internet e-mail but not to FTP, so you may have been frustrated by announcements of materials available for FTP that you'd like to get. Now there's a way for you to get files from ftp.amsat.org by e-mail.

The service is called FTPmail, and you use it by sending specially-formatted e-mail messages to ftpmail@amsat.org To get started, send a message containing just these lines in the body of the message: help quit

It doesn't matter what the subject of the message is. The server just reads the body. The 'quit' command is important if your

just completed and published a set of Frequently- Asked Questions (and their answers!) for InstantTrack. You can find it on the web at <http://www.amsat.org/amsat/intro/itfaq.html>

It is also available by FTP from ftp.amsat.org as /amsat/docs/itfaq.html The file is about 40kbytes long.

amsat-uk news

At a recent AMSAT-UK committee meeting there was discussion about the provision of a Mode-A transponder on a UoS spacecraft. An appeal was sent out via electronic media. We needed to determine whether a new Mode-A package would a) be wanted; b) be used; and c) be supported. In other words: a) Do satellite operators want it to happen? Is it worth someone's time and effort to design, produce, and launch such a satellite? b) How many people would use it? It would be pointless to

Satellite Rendezvous

Round-up of satellite news from AMSAT-UK

plans into federal law. The league believes many amateurs face a

ware glitch in the operating system was detected; the JARL Homepage has not been updated with scheduling information for the satellite.

Pat Gowen, G3IOR, has received information about plans for RS-18. Apparently it is a joint AMSAT-LU and AMSAT-R project, using "... the higher bands and 29MHz ..." and that the launch vehicle is "... a new type using electrical system for propulsion not chemical ...". Pat takes this to mean an ion drive, but it may be water to hydrogen / oxygen electrolysis by solar power and the use of this as propellant. More information as and when we get it.

Pat also passes on the news that funds raised by the recent Sputnik anniversary operations will be used by John, G7HIA, for helping to equip a satellite command station. John will be sending them a Yaesu 5400B az / el rota-

mail program (or mail provider) appends a signature to your outgoing messages. The server will respond right away by e-mailing a help file back to you. This file will tell you how to use the service to get files from the FTP archives.

No human will read your message, so stick to the format. Transfers are logged for statistics and debugging. If you have trouble with the service and need human assistance, send mail to ftpmail-manager@amsat.org.

This server will only get files from ftp.amsat.org, not from any other FTP site on the net. We don't have the resources to provide FTPmail to every user on the net for every purpose. The list of available sites may be expanded in the future to include other Amateur Radio FTP sites. Another possible future enhancement would be to add the capability of retrieving HTML web pages from www.amsat.org

For now, consider this service an experiment. If it turns out to be more trouble than it's worth, it may be discontinued.

Paul Williamson, KB5MU, has

spend several hundred thousand pounds if it only attracted a few hundred users. c) This several hundred thousand pounds doesn't just appear magically. The money has to be raised by satellite operators. Would respondents give their own money to a group who promised to develop and launch a Mode-A transponder? I had over 140 replies, which I consider to be encouraging.

AMSAT-NA have announced the arrival of the new *Satellite Handbook* by Dr Martin Davidoff, K2UBC. This brand new edition contains everything you need to know on operating, antennas, software, Internet sites, profiles of all the active satellites and more. The book is 376 pages long and the cost is \$35 in Europe, from AMSAT-NA. AMSAT-UK has about a dozen copies of the older version of the book left and these are being disposed of for £10 each. We expect to get the new book very soon so watch this space for availability. The UK price will be announced as soon as we are able to calculate it.

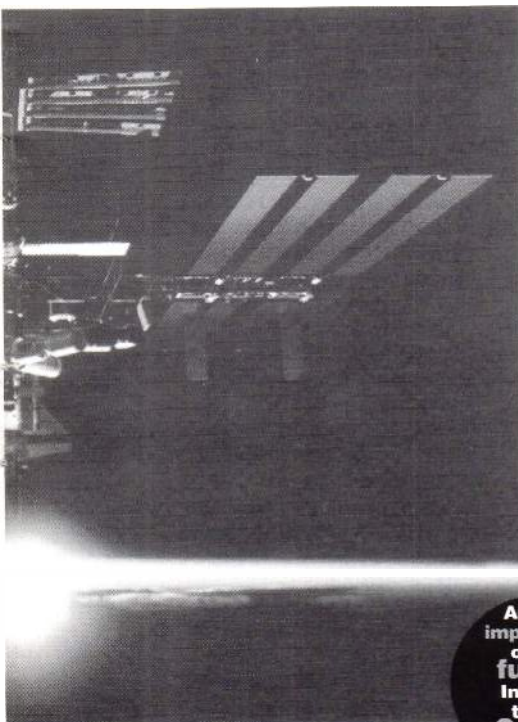

Artist's impression of the future International Space Station.

Since I put last month's column to bed there have been several DXpeditions of note, the most important of which was that to Baker and Howland Island (KH1). The group who activated this one were not DXpeditioners, and put their plans together at short notice when an opportunity arose to visit Palmyra Island, Kingman Reef and Baker and Howland Island. In the event, they managed to put on a reasonable effort, though they were by no means easy to work in Europe. This could also be said of the Wake Island (KH9) operation that was in progress round about the same time. This latter was put on by seasoned expeditioners who, I know, were making a determined effort to work into Europe, but who were frustrated by propagation. On a number of occasions, for example, they could hear the ZL7DK (Chatham Island) expedition working into Europe, especially on the low bands, but had no propagation themselves.



A big beam isn't necessary to work HF DX (see text). But it does no harm at all! Here is G3XTT's new Force 12 C-4 antenna being assembled and in place.

ing case. When we were on Spratly it was notable that UK stations were the last Europeans to be heard, and usually the weakest compared with Eastern and Southern Europe, and Scandinavia. In contrast, UK stations frequently had ZL7DK all to themselves. ZL7 dusk was at almost the same time as UK dawn, when it was already daylight across Europe, and I was able to work ZL7DK on 160, 80, 40 and 20 metres (the latter on RTTY), each time at the very first call. On 40 me-

to them). Veteran DXpeditioner OH2BN and friends were quick off the mark, announcing a DXpedition to this group of islands, to start operating as the clock strikes midnight on 31 March. The official announcement stated that "the South China Sea DX Team (SCSDXT) has teamed with the Solomon Islands' IARU member organisation, SIRS (Solomon Islands Radio Society), in or-

OH2BN either direct (Jarmo J Jaakola, Kiillette 5C30, Helsinki 00710, Finland) or through the QSL bureau.

other dx news

F5LMK will be active (10 - 80 metres SSB) as CN/F5LMK from Morocco between 9 and 16 May. John Rouse, W3JLR (ex-

HF Happenings HF Happenings

How do you get through those big pile-ups to work HF DX?

To an extent we had the same problem during our recent Spratly Islands operation. We knew that the hardest area to work would be the East Coast of the US, and this indeed was the case. Band openings were short, and signal strengths limited. Whenever there was an opening, we made a determined effort to work the East Coast, rather than going for the easier to work contacts with, say, Europe or West Coast US. Even so, we had more negative feedback from the East Coast than from any other area. One of our pilot stations, G3ZAY, who was channelling feedback to us, came up with a new 'law' for expeditions, that the amount of negative feedback will be in proportion to the square of the distance from the DXpedition. The other law, related to this one, is that the level of adverse feedback falls as the expedition progresses. Even the most outspoken critics often change their spots when they finally put the expedition into their logbook!

The ZL7DK expedition, which I mentioned briefly last month, and also above, was an interest-

tres I did not even bother to turn on my linear amplifier.

dxcc news

The ARRL Membership Services Committee announced on 13 March that both the ARRL DXAC and Awards Committee have voted to delete Southern Sudan, ST0. Contacts made before 1 January 1995 will count for the deleted country. The 'current' countries are now 328 and the deleted are 58. The 'deleted country' concept will come to an end when the new DXCC 2000 rules are implemented, that is on 31 March 1998. According to the new rules, no new countries will be added to the deleted list in the future. Deleted entities simply will be removed.

Another impact of the new rules is that the old rule about 'separation by distance' has been changed to use metric distances (kilometres) rather than miles, and some rounding has taken place. It appears that, as a result, the Santa Cruz Islands in the Temotu Province of the Solomon Islands just scrape in as a possible new 'country' (or 'entity' as the ARRL now refers

organising a full-scale DXpedition to Temotu, as well as preparing the application for new DXCC status". Team members H44GP, H44GR, JA5DQH, N4GN, N7NG, OH0XX, OH1RY, OH2BC, OH2BE, OH2BH, OH2TA, W6OSP and 9V1YC were due to begin arriving on 21 March, and would operate under their individual H44 callsigns (QSL via their respective home calls) while making final preparations for the main event. Until 31 March these operations would count for the Solomon Islands, of course. At 2359UTC on 31 March, the team would then start operating as H40AA (the Solomon telecommunications authorities have agreed to assign the previously unused H40 prefix to Temotu for all future amateur operations). From then on QSOs should count for Temotu DXCC credit, presuming the application for new DXCC status is eventually approved. Martin Atherton, G3ZAY, has agreed to be the 'pilot' for this DXpedition. The H40AA operation was due to continue for approximately two weeks. If you worked them, QSL H40AA via

KA3DBN) will be in Africa from 1 to 21 May, travelling through South Africa, Botswana, Lesotho, Swaziland, Zimbabwe and Mozambique. He will try to be as active as possible from as many locations as possible on CW, RTTY and SSB.

Lorenzo, IK5MDF, will be active from the Maldives (AS-013) 2 - 8 May. He will use the callsign 8Q7DF. Look for him on 3780, 7080, 14180, 21280 and 28480kHz. For more information and updates, check his web site: <http://www.qsl.net/ik5mdf>

Two members of the Oklahoma DX Association will be operating from Antigua from 26 May until 2 June. Jim, K5TT (ex-WV5S), and Dave, W5AO (ex-N5CG), will operate 160 through 10 metres, including the WARC bands. They will also enter the CQ WPX CW Contest (last full weekend of May). Probable callsigns are V26TT and V26GG respectively. Additional information is available via k5tt@contesting.com

VE7ARS and VE7FYO will celebrate the 125th anniversary of the Royal Canadian Mounted Police by operating from Trutch

Island in the Estevan Group (NA-181) during the weekend of 23 May. Check <http://mypage.direct.ca/f/carey/> for more details.

The special callsign PT163MP will be used to commemorate 163 years of freedom from the Military Police in Santa Catarina State, Brazil, and will be aired from Guarazes Island (SA-026) from 1 to 5 May on SSB and CW. In addition, Mel Island (SA-047) will be activated by PQ5L, 28 - 31 May, using SSB and CW. QSL both of these via PP5LL.

Indonesian amateurs were off the air from 23 February until 14 March during the pre-election period.

Nick, YU7XX and VK2ICV reports that he will be back on Lord Howe Island as VK9LX from 23 to 31 May. QSL to Nick Hacko, PO Box 730, Parramatta 2124 NSW, Australia. Lord Howe Island is an Australian possession and has good tourist facilities, so there have been a number of expeditions over the years, but it remains a tough

working dx

When, as above, I mention forthcoming DX, I realise that many of you may consider these operations beyond your reach. It is easy to assume that you will never hear the stations mentioned or, if you do, that your signal will never be strong enough to make it through the pile-up. Even though we made over 65,000 contacts from 9MOC, there were still those who claimed never to have heard us though, frankly, I found this surprising. We had published propagation predictions for the main HF bands before we went, and analysed actual propagation when we were on the island. The match was remarkable, with actual band openings being very close to what the computer program had predicted. So, even if you didn't have access to *PacketCluster*, it should still have been possible to check the propagation predictions, and

Phil 9M6CT (also G4JMB) in his shack. Brett VR2BG recently operated from here as 9M6BG.

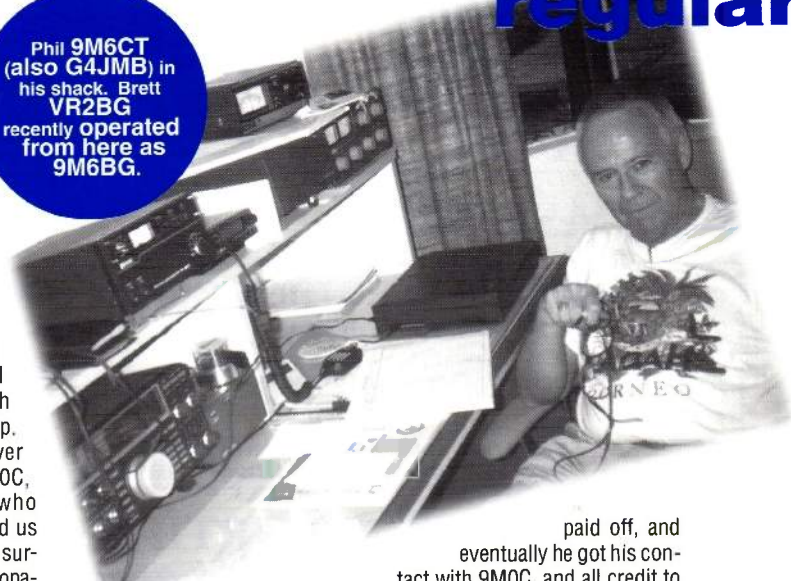

expedition, do you have a hope of putting it into your logbook? Even after all those contacts from Spratly, the pile-ups were still fierce, and several of my local club members told me that they heard us, but had not been able to get through the pile-ups, despite the fact that we made every effort to work into the UK. As I said earlier in this column,

paid off, and eventually he got his contact with 9MOC, and all credit to him for doing so. Of course, if you don't want to take on that kind of challenge, there are plenty of other pre-announced operations that will be much easier to work. Those to European islands for islands on the Air (IOTA) chasers, for example. Check the popular IOTA frequencies (especially 21260 and 14260kHz), and you should get a contact without too much trou-

openings HF Happenings

Don Field, G3XTT, gives some advice and encouragement

one from Europe, especially on the low bands. Interestingly, the VK9LX callsign has been issued to at least three different individuals over the years, including my good friend Martin, G3ZAY, who was there briefly in the mid-80s. I guess this is inevitable when there are only 26 possible callsigns to go round (VK9LA to VK9LZ), but it certainly causes confusion!

And plans for the January 1999 expedition to Auckland and Campbell Islands (ZL9) are going well, with the necessary permissions now having been obtained. Declan Craig, EI6FR, has joined the team, and will ensure that everything is done to make sure Europe gets a fair crack at this rare one. He welcomes feedback from European amateurs on bands / modes on which ZL9 is most needed.

Ernie, LU4AXV, and Hector, LU6UO, have now closed down as LU1ZC after logging more than 37,000 QSOs from Deception Island, South Shetlands (AN-010). QSL via LU6EF (Raul M Diaz, GACW, Box 9, 1875 Wilde, Buenos Aires, Argentina).

then check the published expedition frequencies for the bands which the predictions indicated would be open at any given time. We stuck pretty closely to the announced frequencies.

And this technique certainly worked. I have a letter from one British ham who worked us on seven of the nine HF bands. He simply programmed our announced frequencies into his transceiver and then checked them all at regular intervals until he heard and worked us on the various bands. Of course, if it is a one-man expedition, rather than the multi-operator multi-station type that we put on, then there is more to consider than propagation predictions. The poor guy has to sleep and eat, and even when operating he can only be on one band at a time. But most of the expeditions you read about here and in other ham radio publications have every intention of spending significant amounts of time on the bands, and you should be able to hear them at some stage during their efforts.

The next step, of course, is more difficult. Having heard the

to some extent this a consequence of propagation. S E Asia, for example, is a tough area for UK amateurs, because eastern and southern Europeans have much better propagation into that area. Conversely, though, we get better propagation than them into, say, the US or the Caribbean. So it's perhaps understandable that some Gs found 9MOC a tough nut to crack. But equally, those who persevered were frequently rewarded. As an example, my local club chairman, Jim, GOLHZ, decided he was going to work 9MOC one way or another. He consulted the propagation predictions and decided that 30 metres was the best bet, both because propagation would be favourable at times that he would be at home (UK evening) and also because very few hams have 'gain' antennas on 30 metres. So, even though Jim would be using a simple dipole and 100 watts, he would stand a better chance on 30 metres than on, say, 20 metres, where he would be up against those with Yagi beams. Even so, he didn't work us the first evening he tried, but patience

ble. I have also been delighted to receive a large number of enquiries about the Expo 98 and Vasco da Gama awards (see March *HF Happenings*). It is easy, but fun, to chase the special Portuguese prefixes, and at the end you can put a nice certificate on the shack wall which even your wife and offspring may appreciate. There are, of course, many hundreds of such awards available, and chasing them can be a very fulfilling activity which makes almost every contact, even the relatively mundane ones, into something a bit more special, because they will almost certainly count towards one or more awards.

So please don't imagine that the information I provide is only of value to the 'big guns'. Some of the expeditions may indeed be tough ones to work, but many will be relatively straightforward, especially if you can operate on a weekday when competition is less intense, and can still be very satisfying, both for the contact itself and because you may well be able to count it towards some sort of longer-term goal. Happy DXing!

LANCASHIRE

AMATEUR ELECTRONICS/HOLDINGS G3LLL.

YAESU, AOR, ICOM, ETC. FT 101 EXPERTS

6JS6C 6146B 12BY7A Original type approved valves and our own Double Balanced Mixer and new band WARC Kits for original FT101 MK1-E. S.A.E. List Full Yaesu range. 15 mins Junction 31 M6. Free parking. Call and consult G3LLL without obligation. Holidays? Phone, check we are open before calling. Lunch 12-1.30pm.

45 JOHNSON STREET, BLACKBURN BB2 1EF

(01254) 59595. OPEN: Thursdays, Fridays and Saturdays ONLY from July '96

NORTH WEST & NORTH WALES

AMATEUR RADIO COMMUNICATIONS LIMITED

OPEN
Tues to Sat
10-5pm

We are official factory appointed stockists and approved Service Centre for all the major brands.

ICOM - YAESU - KENWOOD - ALINCO

TEL/FAX: 01925 229881/2

We are 1 mile from J23 M6,
4 1/2 miles off J9 M62



38 Bridge Street, Earlestown, Newton le Willows, Merseyside WA12 9BA

CORNWALL

For All Your Marine Radio Communications

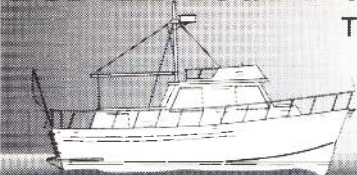

Try us first for all your Radio amateur and marine communications

ICOM YAESU

NAVICO JAYBEAM

Give Mike G1DDK a call today!

SKYWAVE MARINE SERVICES, SQUARE SAIL BOAT YARD, CHARLESTOWN HARBOUR, ST AUSTELL, CORNWALL P25 3NT. TEL: 01726 70220

SCOTLAND

JAYCEE ELECTRONICS LTD

20 Woodside Way, Glenrothes
Fife KY7 5DF
Tel: 01592 756962

NEW OPENING HOURS:

Tues-Fri 9 am to 5 pm, Sat 9 am to 4 pm. Closed Sunday & Monday
Good range Kenwood, Yaesu & Icom etc, plus quality secondhand equipment

KENT

KANGA QRP KITS

Our books: Introducing QRP £7.95

Pascoe's Penny Pinchers £5.95

(All about wire antennas)

QRP crystals from £1.00

Send an SAE now for our free Catalogue to:

Seaview House, Crete Rd East, Folkestone, Kent CT18 7EG

Tel/Fax 01303 891106 (0930-1900)

<http://www.kanga.demon.co.uk>

PLEASE MENTION
HAM RADIO
TODAY
WHEN REPLYING
TO ADVERTISEMENTS

£50 BT INSTRUMENT FOR ONLY £7.50

We refer to the BT insulation tester and multi-meter with which you can read insulation directly in megohms, AC volts up to 230, 4 ranges of DC volts up to 500, 3 ranges of millamps and one 5A range and 3 ranges of resistance. These are in perfect condition, have had very little use, if any, tested and fully guaranteed. Complete with leads and prods £7.50, Order Ref 7.5PA. Carrying case which will take small tools as well, £2 extra. Postage £3 unless your order is £25 and over.

J & N Factors

Dept HRT, Pilgrim Works, Stairbridge Lane, Bolney, Sussex, RH17 5PA
Telephone: (01444) 881965

CAMBRIDGE

CAMBRIDGE MULTICOMM 2000

- Wide range of new and used equipment always in stock
- International mail order service
- Fast friendly service

Unit 3, 86 Cambridge Street,
St Neots, Cambridgeshire

PE19 1PJ

Tel: 01480 406770

CHARITY RADIO

CQ CHRISTIAN AMATEURS!

The World Association of Christian Radio Amateurs and Listeners actively promotes Christian fellowship worldwide, regular nets, activity days, Annual Conference, handbook, magazine etc. Call our UK Sunday SSB nets 3747 kHz at 8am and 2pm, or 144.205 MHz at 3pm.



For full info write to our Membership Secretary
WACRAL
51 Alma Road, Brixham,
South Devon TQ5 8QR

See Web [HTTP://www.GOPPO.DEMON.CO.UK/](http://www.GOPPO.DEMON.CO.UK/)

VALVES

WILSON VALVES

(PROP JIM FISH G4MH)
Over 50,000 valves stocked,
2000 different types,
vintage, military, audio, etc.
Fast service. Send SAE for list
VALVES WANTED FOR CASH
28 Banks Avenue, Golcar, Huddersfield,
West Yorks HD7 4LZ
Tel: 01484 654650
Fax: 01484 655699



HOLIDAYS

NORTH WALES HOLIDAYS - Caravan - bunkhouse - camping. Elevated rural site, two miles from beach, use of shack and antennas, open all year. Tynrhos, Mynytho, Pwllheli. Tel: 01758 740712.

advertise hrt

To advertise in

Ham Radio Today

Phone 01202 777852 Fax 01202 317902

Email: adman@mcmill.com

To include your club in this section, please make sure you send us your events details in time: deadline for the June issue is 5 May, for July: 21 May, and for August, 15 June. We only list active clubs, ie those who send us their diary of planned talks / events. Send your club event details to: The Editor, Ham Radio Today (Club News), RSGB Publications, Lambda House, Cranborne Road, Potters Bar, Herts EN6 3JE; fax: 01707 645105.

Aylesbury Vale RS

meets at 8.00pm on 1st and 3rd Wednesday of month, at Hardwick Village Hall, 3 miles north of Aylesbury on the A413. 6 May - HF / VHF night on the air, Gerry, G7VVF, and Les. G0DFC. 20 May - discussion: choose a subject. Secretary Gerry, G7VVF, tel: 01296 432234.

Bangor & DARS

meets on the first Wednesday of each month (except Jun / Jul), 8.00pm at Clandeboye Lodge Hotel, Bangor, Co Down. 6 May - barbecue, QRP talk / demo. 3 Jun - rally preparations, CW night, Morse keys display. Roy, G10WVN, tel: 01247 460716.

Barking Radio & Electronics Society

meets 7.00pm Thursdays at Westbury Centre, Ripple Road, Barking, Essex. It's an informal club and members have use of HF, VHF and UHF equipment. The club is a registered centre for City & Guilds RAE and NRAE courses. Harry Coots, G7WJE, tel: 01708 746731.

Weds 2m, Mon & Thurs 1960kHz, Fri 70cm all at 9.00pm: Sun 1848kHz at 10.00am. 1 May - Badger Boards, John Badger. Details from the Secretary, Mrs Patricia Thom, G1NKS, tel: 01242 241099 (9.00am - 9.00pm); e-mail: g1nks@g3nks.demon.co.uk

Cheshunt & DARC

meets 8.00pm Wednesdays at the Church Room, Church Lane, Wormley, Herts. 6 May - night on the air. 13 May - ATV on Baas Hill Common. 20 May - natter night. 27 May - Rob Mannion, G3XFD, PW. Details John Crabbe, G3WFM, 47 Torrington Dr, Potters Bar EN6 5HU or at GB7HSN.

Christchurch ARS

is the new name for the former Siemens Plessey Christchurch Amateur Radio Society. The club meets 8.00pm Thursdays in the radio club room, behind the Sports and Social Club, Grange Road, Somerford, Christchurch. A broad-based programme of events for 1998 is currently being compiled. Secretary K P

ing frequency. 11 May - clandestine radio, Pat Hawker, G3VA. Secretary, Alan Bartle, G6HC, tel: 0181 684 0610.

Coventry ARS

meets at 2000 every Friday at Binley Church Hall, Brinklow Road, Coventry. Visitors are always welcome. 1 May - Indoor DF. 8 May - Cheese and wine. 15 May - portable evening. 22 May - HF, VHF, packet night on the air. 29 May - quiz night, Brian, G1AVF. Secretary, Robin Tew, G4JDO, tel: 01203 673999.

Dorking & DRS

meets 7.45pm on 4th Tuesday of month except July / August, at the Friends Meeting House, South St, Dorking (opposite the Spotted Dog). Informal meetings held on 2nd Tuesday at various venues. Club net 8.30pm Sunday on 144.775MHz. 26 Apr - Amateur VLF, Derek Atter, G3GR0. 26 May - D-day radio aids, Walter Blanchard, G3JKV. Details John Greenwell, G3AEZ, tel: 01306 631236.

G3SSY. 21 Jul - the sun, L M Dougherty. 18 Aug - junk sale. 21 Sep - AGM. D Moss, G0DLM, tel: 01422 202306.

Hambleton ARS

meets 7.30pm at Allertonshire School, Northallerton. 7 May - Peter Kirby, G0TWW, RSGB General Manager. 21 May - soldering skills, G3KJX. John Hampson, G0VXH, tel: 01845 537547, or packet: G0VXH @ GB7CYM.

Hastings Electronics & RC

meets 7.30pm on third Wednesday of month at West Hill Community Centre, Croft Road, Hastings. The club run RAE and Novice courses and is a registered City and Guilds examination centre. 20 May - marine radio. Doug Mephram, G4ERA, tel: 01424 812350.

Hoddesdon Radio Club

meets 8.00pm alternate Thursdays at Conservative Club, Rye Road, Hoddesdon, Herts. 30 Apr - electronics in the kitchen, Roy Chapman,

This Month at the Clubs
ham radio today latest club news

Bristol (RSGB) Group

meets on the last Monday of the month, 7.15 for 7.30pm, at Avon Combined Services Club, St Pauls Rd, Clifton, Bristol. 27 Apr - burglar alarms and EMC, Hugh Pearson, G7KET. 25 May - Gibraltar and Barbados, Martyn Phillips, G3RFX / ZB2FX. Robin Thompson, G3TKF, tel: 01225 420442; e-mail: robin@g3tkf.demon.co.uk

Bristol (South) ARC

meets 7.30pm Wednesdays at Whitchurch Folkhouse Association, Bridge Farm House, East Dundry Road, Whitchurch, Bristol. 29 Apr - refurbishment of contest antennas. 6 May - 20m activity evening. 13 May - HF workshop for newcomers. 27 May - Amateur Radio software demo. Jean Fletcher, G0AWX, on tel: 01275 834282 (24hr answerphone).

Bromley & DARC

meets 7.30pm for 8.00pm on the third Tuesday of each month, at Victory Social Club, Kechill Gardens, Hayes, Kent. 19 May - packet radio, Alan Messenger, G0TLK. Alan Messenger, G0TLK, tel: 0181 777 0420; e-mail: alangm@clara.net

Cheltenham ARS

meets at 7.45 for 8.00pm on the first Friday of the month at the Prestbury Library, The Burgage, Prestbury, Cheltenham. Visitors and prospective members welcome. Club nets:

Harris, G7WSN, tel: 01202 484892 (evenings).

Cockenzie & Port Seton ARC

has 'normal club nights' on the first Friday of every month at the Thorntree Inn, High Street, Cockenzie, from 1900 'till late'. The club participates in many weekend contests. 15 May - 144MHz DF hunt night. Bob Glasgow, tel: 01875 811723.

City of London ARS

is a new club in central London. For details please contact Tony Hern, G1UFX, by e-mail: g1ufx@mcmail.com; by packet: G7UZN @ GB7HSN, or by writing to: COLARS, c/o Flat 7, Block H, Peabody Square, Blackfriars Road, London SE1 8JJ.

Cornish RAC

meets 7.30pm on the first Thursday each month at Perranwell Village Hall, near Truro. 25 Apr - International Marconi Day, run by the Cornish RAC from Penair School, Truro. 7 May - photography and processing, by Les. Robin Worsley, G0MYR, tel: 01209 820118.

Coulsdon ATS

meets 7.45pm on second Monday each month at St. Swithun's Church Hall, Grovelands Road, Purley. Club 2m net: Sunday 11.00am on 145.500MHz initially, then to a work-

Dover Radio Club

meets 8.00pm Wednesdays during term time at Duke of York's Royal Military School, Guston, near Dover (Novice and Morse training classes 7.00 - 8.00pm). 29 Apr - AGM. Secretary, Brian Hancock, G4NPM, tel: 01304 821007.

Dragon ARC

meets 7.30pm first and third Monday of month at Ebenezer Hall, Foel Graig Lane, Higher Village, Llanfairpwll. 4 May - the 'scope: shack's best friend? Secretary Tony Rees, GW0FMQ, tel: 01248 600963.

Dunstable Downs Radio Club

meets 8.00pm Friday at Chews House, 77 High Street South, Dunstable, Beds. 15 May - car boot preparation. Paul McVay, G7TSJ, tel: 01582 861936.

Exeter ARS

meets 7.45pm on second Monday of month at Moose International Centre, Blackboy Road, Exeter. 11 May - visit (TBA). 8 Jun - fox hunt (provisional). Theo, G3EQM, tel: 01392 875498.

Halifax & DARS

meets 7.30pm on third Tuesday of month at Tap and Spile Pub, Wards End, Halifax, for committee and Morse tuition. 19 May - Appleton & ionosphere, Dr P Excell. 16 Jun - HF propagation, Gerald Edinburgh,

G0NLG. 14 May - visit to Herts Display Co. 28 May - video. Don, G3JNJ, tel: 0181 245 8119.

Horndean & DARC

meets 7.30pm first and fourth Tuesday of month at Lovedean Village Hall, 160 Lovedean Lane, Lovedean, Hants. The first Tuesday is usually a 'Natter Night'. Club nets are Sundays 1955kHz 9.00am CW, 9.30am SSB, and 7.30pm Wednesdays on 145.350MHz. 28 Apr - 9MOC Spratly Island DXpedition by CDXC member Mike, G3SED. Stuart Swain, tel: 01705 472846.

Horsham ARC

meets 8.00pm on first Thursday of month at Guide Hall, Denne Road, Horsham, West Sussex. 7 May - how Channel 5 works, Robin Powell, G30GP. David Milier, G4JHI, tel: 01403 252101, or e-mail: davidmiller2@compuserve.com

Leiston ARC

meets at 7.30pm at Leiston Town Athletic Association, Victory Rd, Leiston. 5 May - talk by Dave Powis. John Rabson, G3PAI, tel: 01394 460298; fax: 01394 420795; e-mail: word.factories@zetnet.co.uk

Lincoln Short Wave Club

meets 7.45pm Wednesdays at Railway Sports and Social Club, Rope-walk, Lincoln. 20 May - BARTG, Ian Brothwell. Cliff Newby, G3EBH, tel: 01522 750637.

Liverpool & DARS

meets 8.30pm every Tuesday at Churchill Club, Church Road, Wavertree, Liverpool. 28 Apr - surplus sale. 5 May - TBA. 12 May - on the air. 26 May - surplus sale. Publicity Officer, Ian Mant, G4WWX, tel: 0151 722 1178.

Lothians Radio Society

meets 7.30pm on second and fourth Wednesday each month at Orwell Lodge Hotel, Colinton Road, Edinburgh. 13 May - DF set tune up. 27 May - DF hunt. 30 May - Lothian's Challenge 98. Tommy Main, GM4DCL, tel: 0131 663 8501, or GM3HAM@GB7EDN

Loughborough & DARC

meets at Science Lab, Hind Leys Community College, Forest St, Shepshed, on Monday evenings for general chat / operating and on Tuesdays as follows: 28 Apr - 2nd DF. 5 May - aerial tests, Art, G3KWY. 12 May - adding extras to your computer, John, G4CCI, Alan, G0PHT. 19 May - 3rd DF. 26 May - Deans Lane, operate /P. Ian, G8SNF, tel: 01509 218259.

Malvern Hills RAC

meets 8.00pm at Town Club, 30 Worcester Road, Malvern. Club call G4MHC. 12 May - construction contest. Secretary Dave Hobro, G4IDF;

Nunsfield House ARG

meets Fridays at Nunsfield House Community Association, 31 Boulton Lane, Alvaston, Derby. 1 May - on the air evening. 8 May - VHF NFD preparation. 15 May - photography, Chris Dalby. 22 May - junk sale. 29 May - quiz, Frank Whitehead, G4MLL. Neil Davison, M1AFB, tel: 01332 736362.

Radio Society of Harrow

meets 8.00pm every Friday at Harrow Arts Centre, Uxbridge Rd, Hatch End, Middx. 4 May - display and radio shack at Heritage Centre, Headstone Manor. 8 May - kites, by the kite shop, inc flying aeriels. Jim Ballard, G0AOT, tel: 01895 476933 (evenings / weekends); tel: 0171 278 6421 (day).

Reading & DARC

meets 8.00pm 2nd and 4th Thursdays at the Pavilion, Woodford Park, Woodley, Reading. 14 May - EMC, David Lauder, G0SNO. Chris Nunn, G0MZN, tel: 0118 987 4870.

Shefford & DARS

meets 8.00pm every Thursday at the Church Hall, Ampthill Road, Shefford, Beds. CW practice from 7.30pm. 7 May - aircraft instruments, Derek, G4JLP. 14 May - 50th anniversary wine & cheese evening. Old friends welcome. 21 May - visit Eaton Socon substation. 28 May - natter night. Derek Clarkson, G4JLP, tel: 01462 851722.

145.375MHz, 70cm 433.525MHz, 10m Mon (Tues on club weeks) and Fri 8.00pm, Wed 9.00pm, 28050 CW. 4 May - bank holiday: no meeting. 18 May - TBA. Gordon Bryant, G0TZV, tel: 01384 395206.

Stratford upon Avon & DRS

meets 7.30pm for 8.00pm on second and fourth Mondays at Home Guard Club, Main Road, Tiddington, Stratford upon Avon. The club runs RAE, NRAE and Morse courses: contact Mr J Harris tel: 01789 295257 for details. 27 Apr - AGM. 11 May - annual 2m DF contest. 25 May - on the air. Secretary Jeff Porter, G40HJ, tel: 01789 773286.

Sudbury & D Radio Amateurs

meets on first Tuesday of the month at the Old School on the junction of Head Lane, Wells Hall Rd, Great Cornard, and on third Tuesday of the month, at a new venue: The Brook PH, Bures Road. May - is there extra-terrestrial life?, Tony Dagnall. Secretary Mark Bean, G7UTC, on tel: 01787 377493.

Sutton and Cheam RS

meets s7.30pm for 8.00pm on first Thursday (natter night) and third Thursday (formal meeting), at Sutton United Football Club, Borough Sports Ground, Gander Green Lane, Sutton, Surrey. Club nets: Mon 2000 145.500MHz then QSY; Tue 1030 3770kHz; Tue 1500 144.300MHz then

the air. 12 May - sea life. 19 May - radio treasure hunt. 26 May - on the air. John Carter, G7JTH; tel: 01924 251822.

Warrington ARC

meetings 8.00pm Tuesdays with Morse classes Wednesdays at Grappenhall Youth & Community Association, Bell House Lane, Grappenhall, Cheshire. Club nets Thursday 8.00pm 144.775MHz. 5 May - 'chemistry for everyday life'. Secretary John Ripley, GORPG, tel: 01925 762722.

West Somerset ARC

meets 7.30pm first Tuesday each month in Room GB7, Gibbs Block, West Somerset Community College, Minehead, Somerset. RAE and Morse instruction available. 5 May - TBA. Alan C Elliott, MOAOJ, tel: 01643 707207.

Wirral & DARC

meets 8.00pm every Wednesday at Irby Cricket Club. 13 May - QRP DF hunt. 27 May - complimentary therapies, Elaine and Sue of 'Body and Soul'. Other Wednesdays are social evenings. Andy, tel: 0151 677 4448 or packet CLUB @ GB7OAR.

Wirral ARS

meets 8.00pm at Club Room, Ivy Farm, Arrove Park Road, Birkinhead, opposite Landican Cemetery. There

This Month at the Clubs

ham radio today latest club news

tel: 01905 351568 (evening / weekend), or via e-mail: DHobro@aol.com

Newbury & DARS

meets 7.30pm on fourth Wednesday of month at Memorial Hall, Upper Bucklebury, near Newbury. Club nets: Sun 0830 3632kHz, Sun 1145 1920 to 1940kHz, Sun 1200 28305kHz. 27 May - 3rd method SSB, Peter Rhodes, G3XJP. Secretary, tel: 01635 863310.

Norfolk ARC

meets each Wednesday at the Ugly Bug Public House, Colton. Informal evenings, including night on air, construction QRP, and Morse practice, on 1st, 3rd & 5th Wednesdays, plus: 13 May - DXing for absolute beginners, Victor Brand, G3JNB. 27 May - NFD briefing. Hon Sec, Sandra Simpson, 2E1FOF.

North Kent RS

meets 8.00pm 1st and 3rd Tuesday of month at Pop-in-Parlour, Graham Rd, Bexleyheath. 5 May - AGM. 19 May - sunspots / astronomy questions & answers, Norman Walker. Secretary G8MLQ.

North Wakefield RC

meets 8.00pm Thursdays at East Ardsley Cricket Club, Wakefield. No information on meetings in May. Write to PO Box 73, East Ardsley, Wakefield WF3 2XD for details.

Silverthorn Radio Club

meets 7.30pm each Friday at Adult Education and Community Centre, Friday Hill House, Simmons Lane, Chingford, London E4 6JH. The club offers Morse code tuition and Morse tests. 17 May - MFJ antenna analyzer, G0CIB. Dave, G0KHC, tel: 0181 505 1871; packet: G1NPT@GB7TUT, e-mail: andrew@acolaid.demon.co.uk

South Birmingham Radio Society

meets on first Wednesday of month at West Heath Community Centre, Hampstead House, Fairfax Rd, West Heath, Birmingham. The club is "generally" open Mondays, Thursdays and Fridays from 8.00pm. 6 May - rig check night. Don Keeling tel: 0121 458 1603.

Southgate ARC

meets 7.30pm on 2nd and 4th Thursday of month at Winchmore Hill Cricket Club, The Paulin Ground, Firs Lane, Winchmore Hill, London N21. Bernie Godfrey, G4AOG, tel: 01923 674542.

Stourbridge & DARS

meets 8.00pm on first and third Monday of month (except Bank Holidays), at the Radio Shack, Old Swinford Hospital, Heath Lane, Stourbridge. Club Nets 2m Mon, Wed, Fri, 7.00pm

QSY; Sat 1100 3700kHz; Sat 1200 145.500MHz then QSY. 21 May - AGM. John Puttock, G0BWV, tel: 0181 644 9945.

Torbay ARS

meets 7.30pm every Friday at ECC Social Club, Highweek, Newton Abbot. Informal meetings most Fridays and talk / event once a month. 22 May - industry on Dartmoor, Mike Wright. Peter Tanner, G4VTO, tel: 01803 864528 (working hours).

Trowbridge & DARC

meets 8.00pm at Southwick Village Hall, Southwick, on A361 Trowbridge / Frome road. 'Natter nights' held on 3rd Wednesday of month. 6 May - interpreting radiofax charts, with Richard, G4MUF. Ian Carter, G0GRI, tel: 01225 864698 (evenings / weekends).

Verulam ARC

meets 7.30pm for 8.00pm at RAF Association HQ, New Kent Road, St Albans., 28 Apr - Rob Mannion of *Practical Wireless*. 26 May - Raynet, Martin Green, G4PMG. Walter Craine, G3PMF, tel: 01923 262180.

Wakefield & DRS

meets 8.00pm Tuesdays at Community Centre, Prospect Road, Ossett, West Yorks. There's a well-equipped club station, library, licensed bar and Novice and Morse tuition. 5 May - on

are activity nights every first and third Wednesday, 'natter nights' every Tuesday from 7.30pm and Morse tuition every Thursday evening. 21 May - Thailand, Bob Blain, G3NTI. John Phillips, G3PXX, tel: 0151 336 4452, @GB7OAR, or e-mail: vectis@nordee.u-net.com

National and International Groups

British Amateur Radio Teledata Group (BARTG)

has a quarterly magazine, *Datacom*, and holds a rally and HF RTTY contest each year. For more details about the group contact Membership Secretary Bill McGill, G0DXB, 14 Farquhar Road, Maltby, Rotherham, S.Yorks S66 7PD, tel: 01709 814010 (Tues, Thurs & Fri, 7.00pm to 9.00pm. Sat/Sun before 9.00pm), or via GB7WRG. Internet: <http://www.bartg.demon.co.uk>

British Amateur Television Club (BATC)

produces a quarterly magazine, *CQ-TV*, and holds its own rally each year. BATC has an Internet site at <http://www.batc.org.uk> For details contact: Dave Lawton, G0ANO, Grenehurst, Pinewood Road, High Wycombe, Bucks HP12 4DD.

continues on page 56

56

for sale

- **KENWOOD TM-255E** 40W 2m multimode mobile transceiver with detachable front panel, boxed, like new, with instructions. Used by non-smoker and never used mobile. Bargain at £395. No offers. Barry, MOAPO, tel: 01274 880895.
- **SOMMERKAMP FT-277ZD** 160-10m DC-DC converter 12V or 240V, £300 ono. FT-7B 50W var mobile HF £195 ono. Alinco DR-110T 2m mobile used daily CTCSS 45W or 5W £100 ono. Call Alan tel: 01277 624386. G4OJH. QTHR. (Essex).
- **ICOM IC-751A** with microphone, handbook, £575. Yaesu FT-4700RH 2m / 70cm 50W FM mobile extended receive £275. RN Electronics 4m transverter 2m IF 10W £110. Katsumi keyer EK150 £40. Pye A200 6m linear amplifier 50W for 6W in £40. G4OHJ, tel: 01789 773286 (Warks).

mic, fist mic, basemount, manual, never used mobile, £350 ovno. Len. tel: 0151 346 9062. (Merseyside).

- **2 DRAE** mag loops complete with dual controller, built, ready to use. £175. Tel: 0151 287 0821.
- **ALINCO 2 METRE** handheld model DJ-S1E with nicads spare battery case DC power lead car adaptor. £110 ono. G4BRX QTHR, tel: 01242 675321. (Cheltenham).
- **ALINCO DJ-580E** 2m / 70cm h/held, CTCSS, case, spkr / mic, two extra battery packs and mobile holder, boxed, as new, hardly used, £225 ono. Kenwood AT-230 ATU vgc £120 ono. Transverter MML 144 / 28 vgc £50 ono. Prefer buyer collects. G0KRL, tel: 01359 270527 after 6pm. (Suffolk).
- **50CH H/HELD** Pro-90 Realistic scanner exc cond £90 with nicads and new boxed battery pack, instruction manual. VHF.

LSB / CW / FM boxed transceiver with manual and microphone £100. Preset ATU and antenna £20. SWR / power meter £15. VHF / UHF wavemeter £20. John, G4UBB, tel: 0181 868 7684.

- **ALINCO DJ-G5EY** VHF / UHF handheld transceiver includes nicads and desk-top charger, new, unused, still boxed, unwanted gift, cost £299 accept £260, no offers. P&P £6. Tel 0114 2466457.
- **ALINCO DJ-X10E** scanner, latest version 100kHz to 2000MHz AM WFM NFM SSB CW 1200 channels. Loads of features inc nicads and charger. Brand new, still boxed, unwanted gift, cost £349. Accept £290 (will post P&P £6). No offers. Tel: 0114 2466457.
- **YAESU FT-290R** 2m transceiver with 30W linear amp and PSU. £265. Uniden 2830 10m transceiver with 20A PSU £255. Tel: 0121 704 4482, mobile: 0973 400550.
- **EDDYSTONE 840C** receiver, 480kHz to 30MHz in five overlap-

ping bands. £99. Carl, G4GTW, tel: 01489 789960 (Southampton).

- **DRAKE TR-4C** tcvr with mic, PSU, and manual. Overhauled, new PA valves fitted. Mint appearance. £250. Ron, G0GHX, tel: 01202 880194 (Dorset).

wanted

- **WANTED KENWOOD SM-220**, portable scope, Thandar SC110 and *Electronics Today* magazine June 1982. Dave, tel: 01603 745512 weekends.
- **2M HANDHELD**, HF Tx / Rx, ants for both, PSUs if needed. Good working order essential. Cyril, G3JGH, Thames Side, Beldham Gdns, Hurst Park, West Molesey KT8 1TF or tel: 0181 979 1956. Could be slight delay.
- **MATCHING EXTERNAL** speaker for Drake R8E receiver. Tel: 01492 878107 (Llandudno).
- **MFJ ANTENNA** Tuner 989C, 986, 962D. MFJ Antenna Analyzer 259. Geoff Barnes, G3AOS, tel: 01260 252287 (Macclesfield).

free readers ads

sell your equipment fast with ham radio free private ads

- **YAESU FT-790RII** as new boxed, includes free 9-ele Tonna £425. Yaesu FTC-740A 4 metre FM, three channels fitted. boxed £65. Baycom packet modem board £20. G4BWW, tel: 01704 229036 (Southport).
- **TRIO TS-530S** with mic and manual £275. David, G4JHI, tel: 01403 252101 (West Sussex).
- **YAESU FC-700 ATU** £70. Alan ADI-AT18 2m h/h, boxed good condition £75. Sadelta MB30 desk mic £20. Team Maxi 3000 CEPT CB h/h £40. Alan 48 CEPT CB mobile, exc cond, boxed, £50. Jon, G0IUE, tel: 01225 791645 eves or 01264 382282 office hours.
- **REALISTIC 200** channel 1.3GHz scanner transformer and speaker also umbrella roof aerial still has 12 month guarantee was £400 plus. New, little used, genuine reason for sale. Will accept £200. Pat or Malcolm, Lincoln area, tel: 01529 460682.
- **TR-9130 2 METRE** multimode for sale 25 watts with mobile bracket, Adonis AM805-G desk

- air, amateur, UHF, 70cm UHF 'T' band with charger, rubber duck ant, not boxed post paid to you. Tel: 01443 437345 or 436073.
- **SILENT KEY SALE: NRD-525** general coverage shortwave receiver £550 ono. Realistic PRO2022 200 channel scanning receiver £125 ono. MFJ-16010 random wire antenna tuner 160-10m £25 ono. Telco low-pass filter 50 - 70 ohm £20 ono. Micronta multimeter 50k/ohm per volt £15 ono. Tel: 0121 430 2929.
- **PSION 3A 2MB** complete with 1MB RAM disk, 2MB flash disk, mains adaptor, printer cable, stand, PSWin application, money application, £180 ovno or exchange for HF Rx or Tx / Rx. Tel: 01234 240877.
- **ALINCO DJ-580** dual band handheld, 2m / 70cm, hardly used, with Alinco speaker / microphone and DC lead, boxed, as new with charger. Home use mainly. £200. Tel: 01492 878107 (Llandudno).
- **ICOM 290E 2M** 10W USB /

- ping bands. £75. Trevor, tel: 0118 9701163 (nr Reading).
- **STORM EASY** photo reader. Picture scanner for PC. New, unused in original sealed box. Maybe suit SSTV fan. Any reasonable offer. Collect or add postage. Bernard, G4ICZ, QTHR, tel: 01543 472054 (East Staffordshire).
- **KENWOOD TS-870** HF transceiver DSP plus Mansion EP925 PSU all boxed with manuals. £1250 ono. Icom IC-701 HF transceiver plus Icom IC-P520 PSU and manuals. £385 ono. Datong Morse tutor plus keyer. £50 ono. Contact B Brown, tel: 01222 832253.
- **KENWOOD TS-120** HF tcvr £250. SP-120 £30. Nova 2m mobile £90. Kenwood BC10 charger £10. Kenwood TH-26E h/h £100. Dual trace scope £50. Dave, tel: 01603 745512 weekends.
- **YAESU FT-900AT** absolutely mint, few hours use, a serious performer. Removable front panel and internal ATU, mic, manual, box, £749. Yaesu FRG-7 general coverage receiver with

exchange

- ◆ **YAESU FT-77** with microphone power lead mobile mounting bracket workshop + operator's manuals plus FC-700 manual ATU + leads and operator's manual, for: Icom 6m multimode or Icom 2m / 70cm dual-bander multimode. G4XPP QTHR, or tel: 01388 747018 after 1830.
- ◆ **QUARTZ CRYSTALS**. Take note any Raynet groups to keep costs down due band plan changes! 144.625 144.650 144.675 for 144.825 144.850 144.875. Pye M294 W15FM LW15FM T17FM R18FM T30FM R18FM Motorola MC80. Dave, G6BSK, tel: 01768 868367 (Penrith).

help needed

- **EUROPA B 2M** transverter by SSM, circuit, manual, any info, needed to restore a piece of radio history. All expenses paid. Call Tim, tel: 01706 350834. Thanks.

CDXC (Chiltern DX Club) - the UK DX Foundation

membership is open to all amateurs and SWLs who have worked (or heard) more than 100 DXCC countries. It is the UK's first and largest grouping of amateurs interested in HF DX / contesting. Internet site: <http://www.cdxc.org.uk> For prospectus and further details please contact the Secretary, Alan Jubb, G3PMR, 30 West St, Gt Gransden, Sandy, Beds SG19 3AU.

G-QRP Club

publishes a quarterly journal, *SPRAT*, devoted to low power communication, and holds regular get-togethers at their rally stands throughout the country. For membership details, contact their Secretary, Rev G Dobbs, St Aiden's Vicarage, 498 Manchester Road, Rochdale, Lancs OL11 3HE; tel: 01706 31812 or see their web site at <http://www.btinternet.com/~g4wif/ggrp.htm>

International Short Wave League (ISWL)

who, as well as running an international QSL bureau for amateurs and SWLs, has a monthly magazine (*Monitor*) and regular get-togethers at their rally stands plus on-air nets on HF and VHF. For more details send an A4 sized SAE to: ISWL HQ, 267 Pelham Road, Immingham DN40 1JU. Internet: <http://www.aber.ac.uk/~srj5/iswl.htm>

Irish Radio Transmitters Society (IRTS)

publishes regular newsletters giving details of local activities, and the yearly IRTS Callbook. They also have a video library. For further details of IRTS, contact Joe Ryan, EI7GY; tel: (Eire) 01 2854250 or by e-mail: jryan@iol.ie Book Sales: Dave Moore, EI4BZ, 12 Castle Ave, Carrigtwohill, Co Cork; tel: (Eire) 021 883555.

Radio Amateurs' Emergency Network (RAEN)

can be contacted at Hunters Moon, Newton le Willows, Bedale, N Yorks DL8 1SX. 24hr national emergency contact line: tel: 0141 621 2121. Other contact points: Training Team, PO Box 2, Chinnor, Oxon OX9 4JY; Raynet supplies, tel: 01842 860475; packet@GB7NRC; Internet web site: <http://www.reality.sgi.com/csp/raynet/>

Radio Amateur Invalid and Blind Club (RAIBC)

is a registered charity which raises money for radio / computer equipment, and audio cassette courses for home study, for blind, deaf and disabled amateurs. The club attends rallies throughout the year, and collects surplus equipment for resale. Please contact Honorary Treasurer / Membership Secretary Mrs Shelagh Chambers, 78 Durlley Ave, Pinner, Middx HA5 1JH. Web site address: <http://www.gurney.co.uk/raibc>

Radio Amateur Relief Expeditions (RARE)

is a registered charity made up of radio amateurs and friends who take aid to Eastern Europe and organise summer camps for young people to learn about amateur radio, English language and life in the UK. New members are required to support this work both at home and by taking part in expeditions. Please contact: The Secretary, RARE, 1 Allfield Cottages, Conover, Shrewsbury SY5 7AP; tel: 01743 873815; fax: 01743 874729; packet: G6FHM@GB7PMB; e-mail: rare@donsun.demon.co.uk

Radiocommunications Agency (RA)

is the licensing authority for all UK radio amateurs. They have a large number of free publications, including the booklet *How to Become a Radio Amateur*, and their *Novice Licence Information* sheet and can offer advice on many aspects of licensing. New Kings Beam House, 22 Upper Ground, London SE1 9SA. Amateur Radio line, tel: 0171 211 0160. General enquiries, tel: 0171 211 0211. Answerphone service, tel: 0171 211 0591.

Radio Society of Great Britain (RSGB)

is the internationally-recognised national society, which has been representing UK Radio Amateurs and short

wave listeners for 85 years. Members of the RSGB receive a 100-page colour magazine sent to their home each month, and also have the advantage of free QSLing, automatic entry in RSGB contests, and help in obtaining planning permission for antennas, and much other technical support. A network of over 2000 volunteers is on hand to help the Radio Amateur and short wave listener with any enquiry. Address is: Lambda House, Cranborne Road, Potters Bar, Herts EN6 3JE; tel: 01707 659015; Internet site: <http://www.rsgb.org> and e-mail: into@rsgb.org.uk

Subscription Services Ltd (SSL)

handles the issuing of amateur licences in the UK on behalf of the Radiocommunications Agency. SSL can help regarding enquiries concerning individual licences (rather than general licensing matters, which the RA handles, see above). Contact details: The Radio Licensing Centre, SSL, PO Box 884, Bristol BS99 5LF; tel: 0117 925 8333.

United Kingdom Radio Society (UKRS)

is a new society for UK Radio Amateurs. They can be contacted at Box 100, Meadow Street, Northwich, Cheshire, CW8 1FA. tel: 01606 783270, or 0115 925 6597, packet: UKRS@GB7OAR, or e-mail: admin@ukrs.org; Internet: <http://www.ukrs.org>

This Month at the Clubs

ham radio today latest club news

free readers' ads

name _____
 signature _____
 address _____

date _____ send this coupon to: Free Readers' Ads, Ham Radio Today, RSGB Publications, Lambda House, Cranborne Road, Potters Bar, Herts EN6 3JE.

The above details will not be published. Enter all that is to be published, including contact information, in the boxes below (Amateur Radio and electronic equipment only please).

(BLOCK CAPITALS OR TYPED PLEASE, ONE WORD PER BOX)

FOR SALE / WANTED / EXCHANGE / HELP NEEDED*

*Delete as appropriate

May 1998

free readers' ads conditions

1. Free Readers' Ads will be inserted as and when space becomes available, on a first-come, first-served basis, subject to these conditions. If you require a *guaranteed* immediate insertion of your ad, please use the pre-paid Classified Ads section at the rear of this magazine.
2. These advertisements are offered as a free service to readers for the sale, exchange, wants, or help with, privately-owned amateur radio and electronics equipment. Ads from traders, or apparent traders, will be rejected. Readers should use our Retail Network and Classified Ads section for ads not fulfilling these conditions, our Advertising Department (tel: 01202 777852) will be pleased to accept prepaid ads.
3. All submitted free ads must be on a recent form printed in Ham Radio Today. Photocopies are not acceptable. Include your name and / or callsign, and either a contact telephone number (with STD code) and location (eg town or country) or a full address, or both, for readers to reply. These details must be included within your advertisement. Advertisements must be no longer than 40 words. Only one advertisement per section ('For Sale', 'Wanted' etc) per reader per month. Each advertiser must also fill in their name and address in the space provided (these details will not be published), and must sign the form to indicate acceptance of these conditions.
4. We cannot be held responsible for transcription errors, however, we will attempt to ensure that legible submissions are reproduced correctly. Please write clearly and include punctuation. In the event of a gross error, at the request of the advertiser and at the editor's discretion, a corrected version of the advertisement will be printed in the earliest issue in which space is available.
5. Neither the magazine nor its publishers will accept any responsibility for the contents of the advertisements, and by acceptance of these conditions the advertiser undertakes to indemnify the publisher against any legal action rising out of the contents of the advertisement.
6. Advertisements are accepted in good faith; however, the publisher cannot be held responsible for any untruths or misrepresentations in the advertisements, nor for the activities of advertisers or respondents.
7. As this is a free service, postal or telephone communication regarding publication of ads *cannot* be accepted unless an error is involved. Please remember, all ads received fulfilling these conditions will be published as space permits.
8. Advertisements which are suspected of including illegal equipment will not be published. The magazine reserves the right to either refuse to accept entirely, or to delete any sections, or the entire text, of any advertisements not fulfilling the above conditions.

Classified advertisements

Classified advertisements 58p per word (VAT inc.) minimum 14 words £8.70.

All classified advertisements MUST be prepaid.

Please write clearly. No responsibility accepted for errors. Latest date for acceptance is 1st of issue month.

Cheques should be made payable to RSGB.

Copy and payment to Malcolm Taylor Associates, P.O. Box 3241, Bournemouth BH8 8WT.
Telephone: 01202 777852
Fax: 01202 317902

FOR SALE

BUY A HAM RADIO SHOP! G3LLL wants to retire early autumn. Stock, business, and fixtures and fittings for sale, shop on cheap rental. Until then business even better than usual. Holdings Amateur Electronics, 45 Johnston Street, Blackburn BB2 1EF. 01254 59595. Normally open Thurs, Fri, Sat. Closed full week Easter? Check.

We'h' FOLDING ANTENNA >6db Smaller Gammaless HB9CVI 10m-70cm Versions £20-£35. Literature available. John (GOWEH) 01705 466522, QTHR 1998. Email: john.j.hill@gecm.com

RESTRICTED SPACE AND FULL SIZE MULTIBAND AERIALS, 28/132ft, built, kits, parts, baluns, data sae. Aerial Guide £1.50. G2DYM, Uplowman, Devon EX16 7PH. Tel: 01398 361215 anytime.

LIMITED SPACE ANTENNA 160-10 metres 84' overall with 76' of balanced feedline £59.95 plus £5.00 P&P. Choke Baluns Std model £36.85, Yagi model £37.45 (state boom size) G5RV £28.50 all inc P&P. Amidon Cores, limited stocks available. Send SAE for full details of all the above. Ferromagnetics, P.O. Box 577, Mold, Flintshire, CH7 1AH.

"RAYNET" YELLOW REFLECTIVE TABARDS with "RAYNET". Medium £11.00, Large £11.50, XLarge £12.00. "RAYNET CONTROLLER" 50p extra. EPSON PX4+ lap top computer, built-in printer, charger Eprom for packet £46.50 inc. pp. Non reversible battery connectors line/panel mounting (10 pairs/pack) £7.00. Mike Watson G8CPH, Ipswich (01473) 831448.

QSL CARDS printed to your own specification on white or coloured gloss card. SAE for sample pack to: The Caswell Press, 11 Barons Way, Woodhatch, Reigate, Surrey. 01737 244916.

QRP Crystals 3555, 3560, 3565, 7030, 10116, 14050 and 14060 kHz. HC49/U wire ended. £3.50 each + £1.50 p&p any quantity. G3TUX QRP Component Co. PO Box 88 Haslemere GU27 2RF. 01428 661501.

ALUMINIUM TUBE. Heavy-duty (scaffold) tube approx. dimensions 20' long, 2" dia. 1/4" (4.5mm) wall thickness, 20' and 10' lengths available @ £1.80 + VAT per ft. C.W.O. Rusper Hire (Crawley) 01293 871621 office hours only.

QSL CARDS - low cost, quick delivery, superior designs, quality guaranteed, personal designs our speciality. L.S.A.E. for samples: The Standfast Press, 5 South Drive, Inskip, Preston PR4 0UT.

ESSEX AMATEUR RADIO SERVICES. New and used amateur equipment bought and sold. PX welcome. All warranted and serviced. 8am till 9pm. Ring Alan - 01268 752522, 4 Northern Avenue, Benfleet, Essex SS7 7SN.

G4TJB QSL CARDS printed to your specification, send large SAE for samples and full product list. Unit 6, Worle Industrial Centre, Coker Road, Worle, Weston-super-Mare BS22 0BX. Tel/Fax: (01934) 512757.

CTCSS ENCODERS £20 each, Decoders £39 each + postage £1.75 (inc vat) CWO MDH radio telephones. Tel/Fax 01646 651599 (GW4CBB QTHR).

LANDWEHR VHF/UHF MASTHEAD PREAMPLIFIERS, 2 metre 145MAS £150 and 70cm 435MA £155 plus £4.50 p&p. Write, phone, fax or email for leaflet. Qualitas Radio, 23 Dark Lane, Hollywood, Birmingham B47 5BS. Note new telephone numbers, 0121 246 7267. Fax 0121 246 7268. Email: g0eyo@compuserve.com

POWABEAM ANTENNAS - from G4CQM Optimised Current Vector Yagis. 2M-2.5WL (9 ELE) 15DBi £84.95. Leaflets 01288 381289.

QSL CARDS. Gloss or Tinted Cards. SAE for samples to Twrog Press, Penybont, Gellilydan, Blaenau Ffestiniog, Gwynedd LL41 4EP.

TECHNICAL MANUALS for WW.II Radio & Radar. Hundreds in stock. RAF, Army, Navy, Luftwaffe, Wehrmacht, US Forces. Tel: 0151-722 1178 or SAE with requirements to Vintage Technical Services, 28 Welbourne Road, Liverpool L16 6AJ.

PROGRAMMED PROMS FOR PMR EQUIPMENT. Details, S.A.E.: Atlanta Communications (RC), PO Box 5, Chatteris, Cambridgeshire PE16 6JT.

COURSES

CITY & GUILDS RADIO AMATEURS EXAM. Pass your exam the easy way with an RRO homes study course. For details write or phone THE RAPID RESULTS COLLEGE, Dept. JT400, Tuition House, London SW19 4DS. Tel: 0181 947 2211.

RSGB AMATEUR RADIO INSURANCE SCHEME

"ALL RISKS" INSURANCE for portable/mobile/base station amateur radio and ancillary equipment. A service for RSGB members only. Also public liability and equipment for affiliated clubs and societies. Details and leaflets from Amateur Radio Insurance Services Ltd, Freeport, 10 Philpot Lane, London EC3B 3PA. Telephone: 0171 338 0111. Fax: 0171 338 0112.

MISCELLANEOUS

VIDEO TAPE CONVERSIONS to and from all modes N.T.S.C.: S.E.C.A.M.: P.A.L.N.: P.A.L.M. Digital processing. Fast and economic service. Also 'cine' conversions. Phono G4WMP 01932 846139.

PATENTS, TRADE MARKS, DESIGNS, COPYRIGHT. For professional advice contact KINGS PATENT AGENCY LTD (Est 1886 by Benj, T. King). Dir J.B. King (G5TA mem. RSGB) Regd. Patent and Trade Mark Agent. Information, fees and literature on request. Phone 0171-248 6161. Fax: 0171-831 0926. 73 Farringdon Road, London EC1M 3JB.

CALL IN ON THE 'GOOD NEWS' CHRISTIAN NETS! Every Sunday at 8am and 2pm around 3747 KHz and 144.205 Mhz at 2pm sharing Christian fellowship over the air. Info from WACRAL, 51 Alma Road, Brixham, South Devon TQ5 8QR - Tel: 01803 854504.

VHF/HF valve amplifiers repaired/serviced, all USA, Japan, EU makes. Collection/delivery available. Very competitive rates. Faircrest Services, Mon/Sat, 08.00-17.00, 24hr answerphone 01744 637271.

NORTH DERBYSHIRE COMMUNICATIONS. Service and Sales to most Amateur Radio Equipment. Unit 6, Ireland Close, Staveley, Chesterfield, Derbyshire S43 3PE. Tel/Fax: 01246 280358.

COMPUTER SOFTWARE & HARDWARE

INSTRUCTOR MORSE PROFESSIONAL - The ultimate Morse Code training package for beginners and advanced users (for IBM PCs & Compatibles). As used by the US Military, Canadian Military and the British Military! Price £169.00 + PP + VAT - Tel 01526 833042 - email imorse@sdesign.demon.co.uk

SHACKLOG 4.4 the PC logging system. Real time and post event QSO logging. QSL labels. Database analysis, reports, import, packet terminal. Plus lots more!! Only £29.50!! SASE (+disk for demo copy) for full details. IOTA database (G3KMA) £7.50. IOTA Awards Manager £5.00 Alan Jubb, G3PMR, 30 West Street, Gt. Gransden, SANDY SG19 3AU. 01767 677913.

G4UXD's 'UK-QSO' MORSE TUTOR-PRACTISE DOES EVERYTHING! Reviewed Feb/94/95 'Novice News'. PC-compat. Everything adjustable, 150 tests! Teaches correct keying! £10-99. SAE details. P. Brandon, 1 Woodlands Rd., Chester CH4 8LB, 01244-683563.

SUPER-DUPER, EI5DI's CONTEST LOGGER. "Highly recommended" - RadCom, September 1993. HF £25.00, VHF £25.00, both £39.00. Paul O'Kane EI5DI, 36 Coolkill, Sandyford, Dublin 18 (00 353 1295 3668). www.iol.ie/~okanep Version 9.00 is ready now for the new RSGB District Code multipliers. Clubs - please enquire about group registration rates.

G4TYF LOG. Try before you buy. Send S.A.E. for Demo. Updates £5.00. 64 Gurney Valley, Bp Auckland DL14 8RW. Tel: 01388 607500.

PC SOFTWARE BY G4BMK FOR RTTY AMTOR PACTOR CW with call sign database and on-screen tuning aid, plus built modem £165. State call sign. BMK Communication Ltd, 2 Beacon Close, SEAFORD BN21 2J7. (01323) 893378.

PC SSTV-DATA Tx/Rx pack £35.95 PC/AMIGA SSTV/Packet Interfaces. SAE leaflets, 1.44 demo £1. G8SLB Peter Lockwood, 36 Davington Road, Dagenham RM8 2LR. 0181-595 0823

HOLIDAY ACCOMMODATION

NORTH WALES. CARAVAN, BUNK HOUSE, CAMPING. Elevated site. Use of shack and beam antenna. Open all year. Rural setting. "Tynrhos", Mynytho, Pwllheli, LL53 7PS (01758 740712).

BED AND BREAKFAST/MEALS. SCOTLAND NORTH COAST. GMOEXN QTHR. HF available. Packet/Pactor. Tel: 01847 851774. email: bandb.farnorth@btinternet.com.

NORTH WALES, DENBIGH. Small town pub, B&B. Tel: 01745 815115. E-Mail: gw0syn@globalnet.co.uk Web Site: http://www.users.globalnet.co.uk/~gw0syn/

MARTIN LYNCH & Son
THE AMATEUR RADIO EXCHANGE CENTRE
NEWSFLASH

YAESU VX - 1R
The UK's
Lowest Price

0181-566
1120

advertiser index

Amateur Electronics	52
Amateur Radio Communications Ltd	52
Essex Amateur Radio Services	18
GWM Radio Ltd	18
ICOM UK Ltd	IBC
J & N Factors	52
Jaycee Electronics	52
Kanga QRP Kits	52
Lowe Electronics Ltd	IFC
Martin Lynch & Son	30, 31
Multicomm 2000	52
Nevada Communications	47
Radio & Telecommunications School	46
Radio Society of Great Britain	18, 44
Skywave Marine Services	52
SRP Trading	14, 15
Sussex Surplus	19
The QRP Component Co Ltd	19
The Shortwave Shop	46
Vine Antennas	46
WACRAL	52
Waters & Stanton plc	28, 29
Wilson Valves	52
Yaesu UK Ltd	OBC

Ham Radio TODAY

publication dates

Make a note of these dates so that you can be the first with all of the news, reviews and features in Ham Radio Today.

issue date	publication date
June	Tuesday 19 May
July	Wednesday 10 June
August	Wednesday 8 July

Don't Miss Out - Place a regular order with your newsagent.

Dear Newsagent, Please deliver / save me a copy of *Ham Radio Today* magazine every month.

Name: _____

Address: _____

Ham Radio Today is available from: Comag Magazine Marketing, Tavistock Road, West Drayton, Middlesex UB7 7QE. Tel: 01895 444055. Fax: 01895 433602. ISSN No 0269-8269

Ham Radio TODAY

contact information

Ham Radio Today Editorial: RSGB Publications, Lambda House, Cranborne Road, Potters Bar, Herts, EN6 3JE. E-mail: hrt@rsgb.org.uk. Tel. 01707 853300. Fax 01707 645105.

Ham Radio Today Advertising: Malcom Taylor Associates. E-mail: adman@mcmail.com Tel: 01202 777852. Fax: 01202 317902.

regular contributors:

Data Connection: Chris Lorek, G4HCL. E-mail g4hcl@qsp73.demon.co.uk. Packet:G4HCL@GB7SUN. #48.GBR. EU. Post; via Editor.

HF Happenings: Don Field, G3XTT. E-mail: g3xtt@lineone.net. Post: 105 Shiplake Bottom, Peppard Common, Henley on Thames, Oxon RG9 5HJ.

Net Communication: Jeremy Boot, G4NJH. E-mail: asperges@innotts.co.uk. Post: via Editor.

QRP Corner: Dick Pascoe, G0BPS. E-mail: dick@kanga.demon.co.uk. Packet: G0BPS@GB7RMS. Post: Seaview House, Crete Road East, Folkestone CT18 7EG.

Satellite Rendezvous: Richard Limebear, G3RWL. E-mail: g3rwl@amsat.org. Post: via Editor.

VHF/UHF Message: Geoff Brown GJ4ICD. E-mail: equinox@itl.net. Post: TV Shop, Belmont Road, St Helier, Jersey, Channel Islands. Tel/Fax 01534 877067.

subscriptions:

Subscription rates: 12 issues (1 year) - UK £26.50. Europe and Eire £36.50. Rest of the World (surface mail) £38.50, (airmail) £54.00. Cheques should be drawn on a UK bank and made payable to the Radio Society of Great Britain. Available from: RSGB Publications, Lambda House, Cranborne Road, Potters Bar, Herts, EN6 3JE. E-mail: subscriptions@rsgb.org.uk. Tel. 01707 853300. Fax 01707 645105.

Back Issues:

Back issues are normally available for the last twelve months, at £3.20 per issue inc post and packing. Please telephone or E-mail first to check availability of the issue you require. Cheques should be drawn on a UK bank and made payable to the Radio Society of Great Britain. Available from: RSGB Sales, Lambda House, Cranborne Road, Potters Bar, Herts, EN6 3JE. E-mail: sales@rsgb.org.uk. Tel. 01707 659015. Fax 01707 645105.

Article Photocopies:

If the back issue you require is not available, we can photocopy individual articles for you. The cost is £2.75 for the first article, and £2.00 for follow-up articles. Multiple parts count as separate articles. Post and packing is £1.25 (UK) and £2.00 overseas by surface mail. *Note: when requesting photocopies, please specify Ham Radio Today and give the article title and which issue it appeared in.* Cheques should be drawn on a UK bank and made payable to the Radio Society of Great Britain. Available from: HRT Photocopy Service, RSGB Sales, Lambda House, Cranborne Road, Potters Bar, Herts, EN6 3JE. E-mail: sales@rsgb.org.uk. Tel. 01707 659015. Fax 01707 645105.

Ham Radio Today Distribution:

UK newstrade distribution by Comag Magazine Marketing, Tavistock Road, West Drayton, Middlesex UB7 7QE, Tel. 01895 444055, Fax. 01895 433602. Overseas and non-newstrade sales by RSGB Sales, Lambda House, Cranborne Road, Potters Bar, Herts, EN6 3JE. E-mail: sales@rsgb.org.uk. Tel. 01707 659015. Fax 01707 645105.

ICOM

IC-706MkII - the mobile that just keeps on moving on!

ICOM's latest IC-706MkII pushes mobile communications even further up the road!

Exciting NEW Options:

- UT-106 DSP Receive Unit.
- AH-4 Automatic Antenna Tuner.

Other Great Features:

- Crossband Split.
- Band stacking register memorizes preamp/attenuator settings and tuner on/off condition as well as frequency and mode.
- 'S' menu has 3-band quick access.

- Enhanced 30kHz~200MHz broadband, all-mode receive.
- Slots for 2 optional crystal filters.
- Tone-squelch available (option UT-86 required).

- Sub dial for easier access to RIT/second VFO.
- 20 watts on 2 meters and individual band change key.
- Narrow FM deviation is set for 2.5kHz, ideal for new 12.5kHz channels.

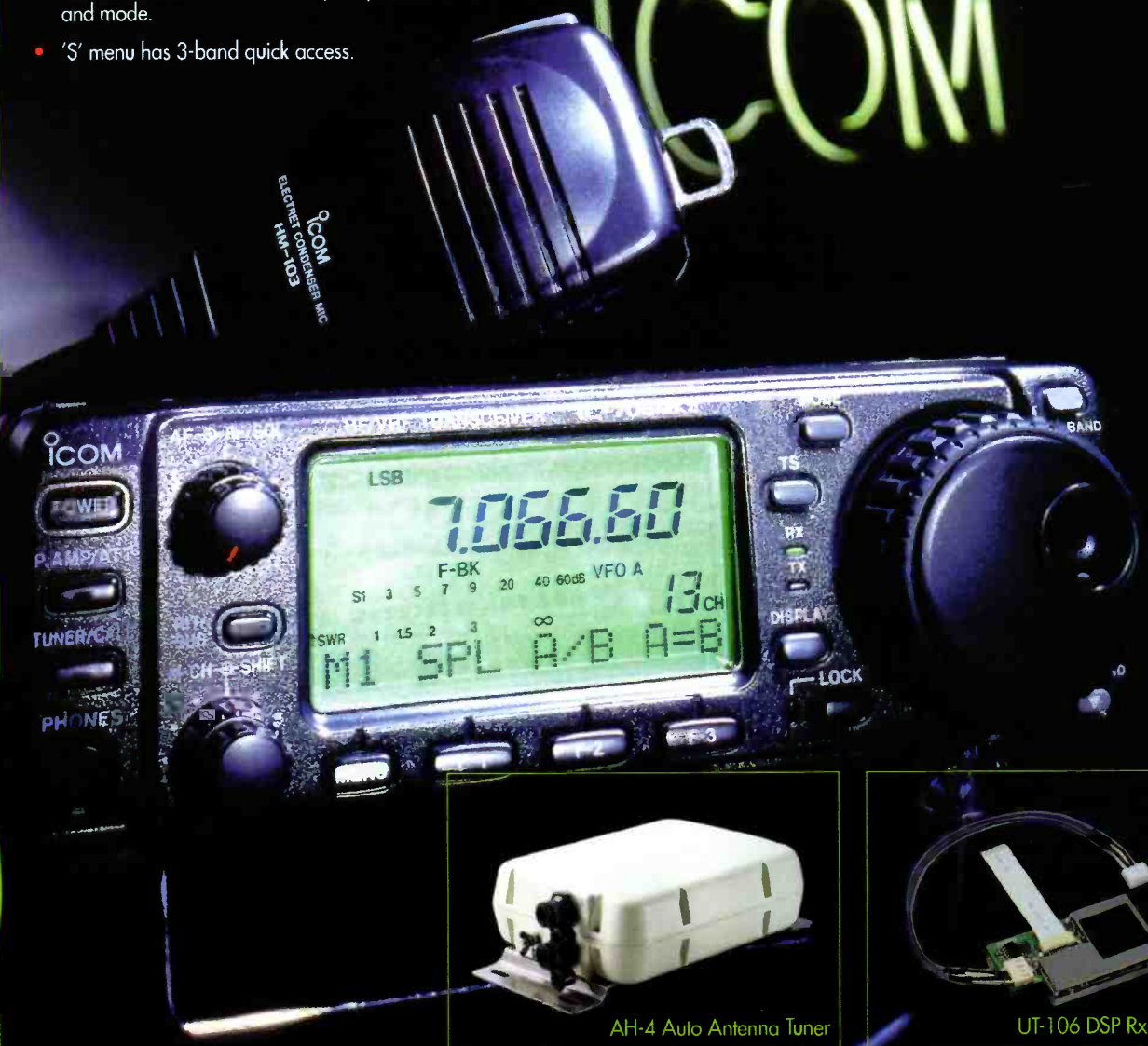

AH-4 Auto Antenna Tuner

UT-106 DSP Rx Unit

Icom (UK) Ltd. Sea Street Herne Bay Kent CT6 8LD. Telephone: 01227 741741. Fax: 01227 741742.
internet: <http://www.icomuk.co.uk> e-mail: icomsales@icomuk.co.uk

Count on us! 59

FT-847

Ultra-Compact Satellite and All Mode Transceiver

FEATURES

- All band performance (SSB, CW, FM, AM)
- 100 Watt output on HF/50MHz bands
- 50 Watt output on 144/430 MHz bands
- Cross-band full Duplex operation
- Normal/Reverse tracking for satellite operation
- CTCSS & DCS encode/decode built-in
- High resolution 0.1Hz tuning steps for ultra smooth tuning
- Digital Signal Processing filters (Bandpass, Notch, Noise Reduction)
- Simplified tuning with Shuttle Jog control
- Direct frequency keypad entry
- Dedicated satellite memories, with 8-character Alpha Numeric Labels
- TX Freq. (MHz): 1.8 - 50 (amateur band) 144-146/430-440
- RX Freq. (MHz): 0.5-30/50-54 108-174/420-512
- Emission modes: LSB, USB, CW, AM, FM, PACKET(9600/1200bps: External input.)
- Freq. Steps(Min): 0.1Hz for SSB and CW 10Hz for AM and FM
- Modulation Types:
 - SSB: J3E Balanced, filtered carrier
 - AM: A3E Low-level (early stage)
 - FM: F3E Variable reactance
 - FSK: J1D, J2D, F2D Audio frequency shift keying (external input), F1D Frequency shift keying (V/UHF: external input)
- Options:
 - FC-20 Automatic Antenna Tuning Unit (External)
 - FVS-1A Voice Synthesiser
 - ATAS-100 Active Tuning Antenna System

4 into 1 does go!

Technology moves inexorably onward, evolving, adapting, forever changing. At the same time, today's Radio Amateur puts even more demands upon designers to build quality, sophisticated, but easy to use stations for Voice, Packet, Satellite, CW, VHF, UHF, HF, just to mention a few. Yaesu's designers took on that challenge, and following in the footsteps of the revolutionary FT1000, FT1000MP and FT920 are now proud to offer today's Radio Amateur the station in a box - the all new FT-847!

The Yaesu FT-847 Ultra-Compact Satellite and All Mode Transceiver has jumped the technology with a transceiver ready for the new millennium. With it's high-tech design

and revolutionary features, the FT-847 is truly the one radio that can do it all! Massive band-width coverage from a single unit, the FT-847 has many features to keep it at the top of the evolutionary pile. These include crystal clear 100 watts on HF and 50MHz, a massive 50 watts on 2 meters and 70cms, Yaesu's effective DSP for bandpass, noise reduction and notch filter, and direct input of frequency on the supplied keypad. Silky smooth tuning with 0.1MHz tuning steps, Cross band and full duplex, CTCSS and DCS encode and decode built in. And for Satellite reception, normal and reverse tracking. A matching ATU (Automatic Antenna Tuning Unit) is also available as an option.

YAESU

...choice of the World's top DX'ers



<http://www.yaesu.co.uk>

Specifications subject to change without notice. Specifications guaranteed only within amateur bands. Some accessories and/or options are standard in certain areas. Check with your local Yaesu dealer for specific details.

FT-920

The highest performing III/6 meter rig in its price class with Yaesu's renowned Omni-Glow™ display



YAESU UK LTD. Unit 2, Maple Grove Business Centre, Lawrence Road, Hounslow, Middlesex, TW4 6DR, U.K. 0181-814-2001