

Ham Radio TODAY



World Exclusive

Review: JRC NRD-545

Previewed: SGC SG-2020 QRP rig

**Full colour feature
on the 9M0C Spratly
Islands DXpedition**

www.rsgb.org/hrt



A SMALL SELECTION

of Superior Used Equipment all available
on our super BUDGET PLAN – from
Martin Lynch & Son

Call now

0181 - 566 1120

EASY TO REMEMBER MAIL ORDER
NUMBER: DIAL 07000 73 73 73

There is a small increase in call rate when using
the 07000 number.

All available with FIFTEEN MONTHS WARRANTY at a small extra charge

QUALITY USED
EQUIPMENT

* Budget Plan requirements: Full time
employment (or disabled/retired), over 18 and
below 71, Current bank account (or building
society). For instant finance please ensure you
have UK driving licence and cheque
guarantee/credit card or Electricity/
Gas/BT bill with your current name and address.
Finance subject to status. APR 19.9%.



CORPORATE SPONSOR OF
THE UK SPRATLY ISLANDS
DXPEDITION

Yaesu

FC-902	500W Antenna Tuner Twin Metres.....	£149
FC-757AT	Automatic Antenna Tuner	£139
FT-757GX	100W HF All mode Transceiver incl. CW Filter & Keyer.....	£395
FT-1000MP/AC	100HF DSP Base Transceiver with PSU/ATU.....	£1595
FT-1000	200W Twin RX Base Transceiver	£1895
FT-290Rmk1	2.5W Multimode Transceiver	£189
FT-290Rmk11	2.5W Multimode c/w 25W amp	£379
FT-480R	10W Multimode 2M transceiver.....	£225
FT-50R	As new Twin Band Handie	£199
FT-530R	DualBand Handie, lots of extras	£150
FT-650	100W 6/10/24 Base with PSU/CTCSS	£549
FT-690Rmk11	2.5W 6M Multimode Transceiver	£299
FT-726R	2/6/70 All Mode Base Transceiver	£695
FT-747GX	100W HF Transceiver	£295
FT-767GX	100W HF, 10W 2/6/70 All Mode Base	£895
FT-890AT	100W HF All mode with internal ATU	£650
FT-900ATC	Brand new 100W Collins Filtered HF TCVR with ATU.....	£899
G-600RC	Medium Duty Antenna Rotator	£175

Icom

IC-2410H	High Power 2/70 FM Mobile	£150
IC-251E	All Mode 2M 10W Base Transceiver	£349
IC-275E	All Mode 25W, 2M Base TCVR with PSU.....	£549
IC-275H	All Mode 100W 2M Base, 13.8V	£695
IC-290D	25W All mode mobile/base 13.8V.....	£249
IC-290E	10W All mode mobile/base 13.8V	£195
IC-725	100W HF Transceiver easy to use	£395
IC-735	100W HF All mode, excellent RX	£425
IC-736	100W HF/6M Base all mode PSU/ATU	£895
IC737A	100W HF Base Transceiver with ATU	£695

IC751A	100W HF Base, old but very good!.....	£425
IC-756	100W HF/6M 100W with screen & ATU.....	£1100
IC-775DSP	200W Twin RX Base Transceiver PSU/ATU	£2195
IC-820H	100W 2M all mode Base Station	£695
IC-970E	Flagship Base Transceiver 2/70	£1295
IC-W32E	Excellent dualband Handie as brand new.....	£149

JRC

JST-245	Our demonstrator 150W HF/6M Base Transceiver	£2195
---------	--	-------

Kenwood

PS-52	Heavy Duty 20A matching PSU	£175
SP-31	Matching Speaker with filters	£45
TH-25E	2M Handie Transceiver	£75
TH-78E	DualBand 2/70 Handie	£139
TH-79E	DualBand 2/70 Handie	£199
TM-701E	TwinBand 2/70 FM mobile Transceiver.....	£249
TM-702E	TwinBand 2/70 FM mobile Transceiver	£249
TR-751E	25W All Mode 2M base/mobile Transceiver	£449
TR-9000	10W Multimode 2M transceiver with PSU	£199
TS-140S	100W simple to use HF base Transceiver.....	£449
TS-440S	100W HF all mode transceiver	£495
TS-450SAT	100W HF all mode, excellent performance	£649
TS-520SE	Golden Oldie 100W HF, no WARC!	£225
TS-570D	Brilliant 100W DSP HF Transceiver. 1 year full warranty.....	£895
TS-711E	25W Multimode 2M Base Transceiver, PSU	£550
TS-850S	Superb HF 100W Base TCVR, with/without ATU from	£795
TS-950SD	150W HF Base Station, twin RX	£1695
TS-950SDX	Flagship 150W HF twin RX Base Transceiver	£1995



MARTIN LYNCH & SONS
140-142 NORTHFIELD AVENUE,
EALING, LONDON W13 9SB

■ Martin Lynch is a licensed credit broker. Full written details are available on request. Finance is subject to status. E&OE. £10 p&p on all major items.

- Martin Lynch can also offer finance terms upto 36 months. Deposits from a minimum of 10%. We welcome your part exchange against any new (or used!) product, provided its clean and in good working order. Call the Sales Desk today. APR: 19.9%. Payment protection is also available.
- All units are brand new and boxed and offered with full manufacturers RTB warranty. All prices quoted for cash/cheque or Switch/Delta card.
- Finance on all products is also available. (Subject to status).

- CALL TODAY FOR THE LARGEST SELECTION OF NEW & USED EQUIPMENT IN EUROPE.
- TEL: 081 566 1120
- FAX: 0181 - 566 1207
- CUSTOMER CARE: 0181 - 566 0 566



OPENING TIMES
MON - SAT : 9.30 - 6.00

■ WEB SITE: MLands.co.uk
■ E-MAIL: sales@MLands.co.uk

regular columns

- net communication** 36
The first monthly Amateur Radio column devoted to the Internet. This time Jeremy Boot, G4NJH, uses the 'net to delve into the archives
- vhf / uhf message** 38
Geoff Brown, GJ4ICD, with exciting news for 6m and 4m operators
- qrp corner** 40
some ideas for crystal oscillators - and lots more - from Dick Pascoe, G0BPS
- data connection** 42
The leading edge of Amateur Radio technology explored by Chris Lorek, G4HCL
- book browser** 44
The best Amateur Radio publications available to *Ham Radio Today* readers
- satellite rendezvous** 48
Latest round-up of AMSAT-UK satellite and space news compiled by Richard Limebear, G3RWL
- hf happenings** 50
If you don't know where St Brandon is, you need to read Don Field's, G3XTT, column of HF news!

readers' information

- ham radio today reader survey** 24
- subscription form** 35
- ham radio today back issues** 56
- advertiser index** 58
- editorial & reader services contact information** 58

reviews

- jrc nrd-545 receiver** 10
A world first for Ham Radio Today - Chris Lorek, G4HCL, carries out a full technical review of this highly impressive DSP receiver
- sgc sg-2020 qrp transceiver** 25
The first preview of this long-awaited QRP transceiver which supersedes the Index QRP and QRP Plus

features

- all in a day's work** 16
More money-saving hints and kinks from Harry Leeming, G3LLL
- 9m0c spratly islands dxpedition** 27
A full colour feature on this, the biggest UK DXpedition ever, by our HF Happenings columnist, Don Field, G3XTT

ham radio today contents

volume 16 no.4 april 1998

news and views

- radio today** 5
The latest Amateur Radio news
- trade topics** 8
Hot news from the Amateur Radio trade
- the london amateur radio and computer show** 19
A special report on this top Amateur Radio exhibition
- letters** 21
Our readers have their say
- the vhf convention** 45
Our second special rally report this month
- ham radio this month** 47
The latest rally and events news
- this month at the clubs** 53
Details of club events round the country, plus useful contact information
- free readers' ads** 57
For Sale, Wanted and Exchange, published free

**27**

All reasonable care is taken in the preparation of the magazine contents, but the publishers, nor the Editor, cannot be held legally responsible for errors in the contents of this magazine, or for any loss arising from such errors, including loss resulting from negligence of our staff. Reliance is placed upon the contents of this magazine at readers' own risk.

Ham Radio TODAY

Editorial

Editor

Steve Telenius-Lowe, G4JVG

Tel: 01707 853300

Fax: 01707 645105

e-mail: hrt@rsgb.org.uk

Technical Consultant

Chris Lorek, G4HCL

Production

Designer

Wai-Yee Man

Technical Illustrator

Bob Ryan, 2E1EKS

Senior Designer

Jennifer Crocker, 2E1ENT

Production Assistant

Dani Angel

Editorial Secretary

Samantha Ralph, 2E1GGK

Printer

Heanor Gate, Langley Mill, Nottinghamshire

Origination

JJ Typographics, Southend, Essex

Sales

Subscriptions

Sylvia Manco, 2E1CYL

Tel: 01707 853300

e-mail: subscriptions@rsgb.org.uk

Advertising

Malcolm Taylor Associates

Tel: 01202 777852

Fax: 01202 317902

e-mail: adman@mcmail.com

Management

General Manager

Peter Kirby, G0TWW

Publications Manager

Mike Dennison, G3XDV

Sales and Marketing

Marcia Brimson, 2E1DAY

Subscriptions

12 issues: UK £26.50. Europe and Eire £36.50. Rest of the World (surface mail) £38.50, (air mail) £54.00. Cheques should be drawn on a UK bank and made payable to the Radio Society of Great Britain.

Subscriptions and back issues hotline: 01707 853300.

Published by the Radio Society of Great Britain, Lambda House, Cranborne Road, Potters Bar, Herts EN6 3JE.

© RSGB Publications 1998.

All rights reserved. ISSN: 0269-8269

The publisher's written consent must be obtained before any part of this publication may be reproduced in any form whatsoever, including photocopies and information retrieval systems.

I am writing this less than a week after the London Amateur Radio and Computer Show - 'Picketts Lock' to its many fans - where *Ham Radio Today* had a stand as usual. As the new editor of the magazine, I was delighted to meet so many readers, most for the first time.

Columnist Jeremy Boot, G4NJH, was wielding his digital video camera and has uploaded some pictures (including video) taken at the show to his Internet home pages (<http://www.innotts.co.uk/~asperges/>). I haven't had a chance to look at them yet, but was relieved when Jeremy assured me there was nothing remotely embarrassing in them!

There's a full report on the show, starting on page 19, and a second 'rally report' - this time on February's RSGB (Sandown) VHF Convention - on page 45.

positive feedback

The feedback we were getting from the London Show was that,



**Editor
G4JVG**

month. If they say they do not know where to get it from, the distributor's address and a cut-out order form are at the foot of page 58. Our web site carries an order form, too, for anyone who doesn't have the latest magazine (<http://www.rsgb.org.uk/hrt/shop/newsagnt.htm>).

for a lucky *Ham Radio Today* reader in our joint competition and reader survey. Turn to pages 23 and 24 to find out how to win this superb new receiver.

Chris Lorek also tells me that he is working on a new PMR conversion, which we hope to publish in the magazine shortly. *Ham Radio Today* has, over the years, made PMR conversions its trademark, thanks mainly to Chris's efforts. We'd like to con-

Ham Radio Today Editorial by Steve Telenius-Lowe, G4JVG

whilst almost everyone who had seen the magazine liked the new-look *Ham Radio Today*, many - perhaps even a majority - said they had found it difficult to obtain at their local newsagent.

In some cases, this is good news for us, as it means that all the copies sent out by Comag, our distributors, have sold out. But in some parts of the UK it seems that it is difficult to find a newsagent who stocks *Ham Radio Today* at all. Either way, it presents a problem for potential readers. However, there is a solution. The magazine distribution system is 'demand driven', and that means that if the customer tells the retailer that he wants to buy a copy of *Ham Radio Today*, he will do his best to make it available. Unfortunately it doesn't work the other way around, the shops will not increase the numbers of magazines they hold in stock just because we tell them that there are thousands of potential customers out there.

So, please help us to help you. Place an order with your newsagent for *Ham Radio Today* every

reviews & conversions

There were two big talking points at the London Show. One was the 13-band Yaesu FT-847 (yes, I did say 13, just after our last edition went to press, it was announced that UK models will run 10W on the 4m band). We would have liked to have brought you a full technical review of the FT-847 - which we previewed last month - but it was not to be. Five pre-production models were imported just in time for the show, but there hasn't been time to carry out a review yet. We'll be bringing you a full review of this exciting new rig just as soon as the first production models arrive in the country.

The other talking point was the JRC NRD-545 DSP receiver on the Lowe Electronics stand. Our Technical Consultant Chris Lorek, G4HCL, has used numerous receivers in his time, but he was waxing lyrical about the new JRC NRD-545 when we spoke at the show. I'm delighted to report that JRC and Lowe Electronics have made an NRD-545 available

continue with this, but there is a limit to the amount one man can do. If you have successfully carried out a conversion of ex-PMR equipment to an amateur band, I'd be pleased to hear from you, with a view to publishing an article on how you did it. Please get in touch - my contact details are in the panel to the left.

Finally, there are a smaller number of Free Readers' Ads than usual this month. This is because some readers have been continuing to send input to the magazine to the previous publishers, Nexus Specialist Interest Ltd. Thus far, Nexus have been forwarding the material on to us, but naturally this has incurred an additional delay, causing many to have just missed the deadline. Nexus have now closed down their Hemel Hempstead offices, so please ensure that you send your Free Readers' Ads to the new *Ham Radio Today* Potters Bar address. The same applies to readers' letters, club news and rally news and any input to the magazine.

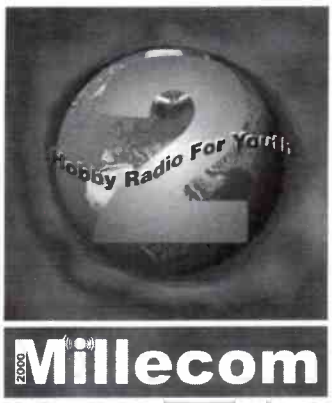

millecom 2000

A new project, 'Millecom 2000', to celebrate the year 2000 by promoting radio communication between young people world-wide throughout the year, was launched on 7 March at the London Amateur Radio and Computer Show.

Millecom 2000 involves a wide range of youth organisations in the operation of a network of radio stations manned by young people. Events already planned include a ring of stations to link the different time zones as they each see in the new millennium, a link of participating stations each weekend throughout the year, and a concerted activity period during two weekends during the summer.

Project co-ordinator, ATC Wing Commander Gordon King, 2E1GEX, told *Ham Radio Today*, "it's envisaged that many special event stations will be set up to participate for one, or a few, weekends only. Others may take part every weekend. It is hoped that special event stations set up for other purposes, such as Jamboree on the Air, will also become involved in Millecom."

The two activity periods will include holiday activities and camps during schools' summer holidays.

Objectives of Millecom 2000 are to expand international friendships between young people, to promote interest in the science of communication with a view to long-term study and involvement, and to provide an insight into the international electronics and communications industries for young people.

Further information can be obtained from the co-ordinator, Geoff King, via RSGB headquarters: Lambda House, Cranborne Road, Potters Bar, Herts EN6 3JE, or by e-mail: millecom@rsgb.org.uk

Representatives of the Scouts, ATC, RSGB, and three hobby radio magazines were present at the launch of Millecom 2000. In the photo (right) they are, from left to right: Chris Harden, M0BIJ; Elaine Richards, Editor *Radio Active*; Ray Degg, G0JOD; David Hazeldine, 2E1CVD; Malcolm Wood, G7VRT; Steve Telenius-Lowe, G4JVG, Editor *Ham Radio Today*; Ian Kyle, G18AYZ, President RSGB; Rob Mannion, G3XFD, Editor *Practical Wireless*; Geoff Dellbridge, G0PMF; and his son Robin, G0PMG.



radio today radio today

latest news on ham radio today

back from spratly

Ham Radio Today editor, Steve Telenius-Lowe, G4JVG, and *HF Happenings* columnist, Don Field, G3XTT, were amongst the team of 13 operators who put on the UK's biggest-ever DXpedition, to the Spratly Islands, in February. The full story is told by Don on pages 27 - 34 of this issue. The DXpedition was organised by CDXC (Chiltern DX Club), the UK DX Foundation. For a CDXC prospectus please contact the secretary, Alan Jubb, G3PMR, 30 West Street, Great Gransden, Sandy, Beds SG19 3AU, or e-mail Alan at SHACKLOG@aol.com

All members of the DXpedition team would like to thank the sponsors:

AEA Timewave, *CQ Ham Radio*, Cushcraft, Dunestar, Gladiator, Martin Lynch & Son, Nevada, Radio Active Publications, 59(9) *DX Report*, Yaesu, Camel, Layang Layang Resort, Malaysian Tourism Promotion Board, NCT Forwarding & Shipping, Sabah Boys' Brigade, Sabah Tourism Promotion Corp, Arkansas DX Assn, Battle Creek DX Group, CDXC, Central Arizona DX Assn, Clipperton DX Club, Danish DX Gp, Dateline DX Assn, Eastern Arizona DX Club, Eastern Iowa DX Assn, EuDXF, German DX Foundation, GACW Argentina, GM DX Gp, INDEXA, LA-DX Gp, NCDXF, Northern Ohio DX Assn, OK DX Foundation, Oklahoma DX Assn, RSGB DXpedition Fund, SE Michigan DX Assn, Stockport Radio Society, Virginia DX Century Club, and G0WAZ, G2FNK, G3JNB, G30FW, G3PEM, G3PMR, G4JMB, G4VJM/M, GW4VEQ, JH1AJT, JH1UUT, K4QD, NI6T, VK5WO, XE1CI.

wacral celebrates 40 years

The World Association of Christian Radio Amateurs and Listeners was founded in 1958 by Rev Arthur W Shepherd, G3NJB, from the Huddersfield South Methodist Radio Club. To celebrate its fortieth year, WACRAL is organising a number of special events, in which all amateurs and families are invited to participate.

Special event station GB40WR will be on the HF bands and 2m between **8 and 10 May** from WACRAL's original location, Berry Brow in Huddersfield, for the 'Anniversary Activity Weekend'. In the UK check 3747kHz; the full frequency list and more information can be obtained from Harold, G4YRH, Riding Hill House, Riding Hill, Shelf, Halifax HX3 7TS, tel: 01274 679597.

The WACRAL 'Whitsun Welcome Day' will be on **30 May** at the historic and beautiful village of Alrewas, Staffs. Members and visitors will meet at the QTH of Charles, G4UJW, and Margrit, G1DQU, for a relaxing day of fun activities with the theme 'Christian Ham Radio is Superb Together'. The full programme and location guide is available from G4UJW, 52 Wellfield Road, Alrewas, Burton-on-Trent DE13 7EZ, tel: 01283 791213, or via packet G4UJW @ GB7RUG.

Finally, bookings for WACRAL's 40th Birthday Conference at Brunel Manor in Torquay between **2 and 4 October** are now being taken. Non-members are especially welcome. The conference will include a full programme of Christian and radio-based lectures, a simple construction competition and non-denominational services of worship. More information from the organiser, Geoff, G4EZX, 124 Darnley Road, Gravesend DA11 0SN, tel: 01474 533686.

WACRAL says that it is currently organising a series of short talks for local radio clubs and would be pleased to hear from club secretaries who may have a slot to fill in their programme. Contact G4UJW as above.

An information pack is available for anyone wishing to know more about this very active organisation. Contact WACRAL's membership secretary, G3XNX, 51 Alma Road, Brixham TQ5 8QR, or tel: 01803 854504.

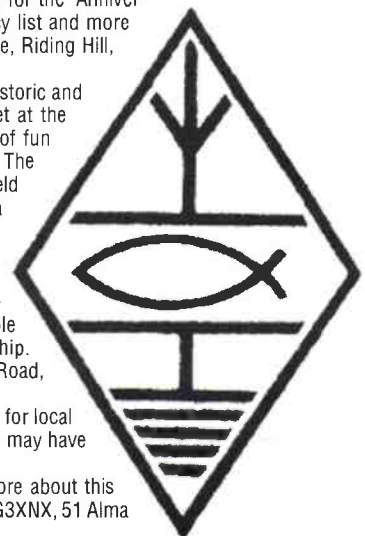

polar radio

Two British marines are attempting the first British unsupported polar expedition from Canada to the North Pole. Sergeant Sean Chappel and Corporal Alan Chambers set off on 3 March carrying enough food for around 80 days. The pair will attempt weekly radio contact with Laurence 'Flo' Howell, GM4DMA. They will be using a modified Hands 12 channel 30W SSB amateur radio transceiver weighing just 1kg. Power will be provided by a lithium source capable of supplying power for the whole expedition. A previous polar expedition involving similar communications provided by GM4DMA was featured on the C4 TV programme *To the Ends of the Earth* on 9 March.



Laurence Howell, GM4DMA, with the modified Hands amateur radio transceiver being used on the polar expeditions.

Lighthouses have always had a fascination for Radio Amateurs - it must be the idea of having a 300ft 'tower' with a perfect sea take-off! Donald Michael, GM0KCY, has been in the enviable position of being the Butt of Lewis, Outer Hebrides, lighthouse keeper for the last four years. Technical progress means the light is becoming automated and Donald is retiring to the mainland on 1 April.

light work

new ra boss

David Hendon will become the new Chief Executive of the Radiocommunications Agency on 4 May, succeeding Jim Norton, whose appointment is coming to an end.

David Hendon, 48, has held a series of senior posts in the telecommunications field, in mobile communications, radiocommunication systems and radio spectrum management for the emergency services. He has been Chairman of the Board of the European Telecommunications Standards Institute since 1995.

microwave round table

A Microwave Round Table will be taking place at the Rutherford Appleton Laboratory, Oxfordshire, on **26 April**. The event gives microwavers the chance to exchange items and information. For more details contact Geoff Grayer, G3NAQ, by e-mail: grayer@rl.ac.uk or Jon Eastment, GW4LXO, at: jde@rcru.rl.ac.uk

dunkirk trip

A coach trip is being organised to the Dunkirk Amateur Radio Rally in France on **10 May**. The coach leaves Sandy in Bedfordshire at 6.00am and returns late in the evening the same day. For further details contact Brian Elliot, G4MEO, tel: 01767 680 043.

radio today radio today

latest news on ham radio today

136 records

Some more records have been achieved on the new 136 kilohertz band. Four stations in S E England have worked EIOCF who is located at Malin Head, on the northernmost tip of Ireland. On 13 February G3LNP in Hertfordshire worked EIOCF for the first two-way contact on the band between two different countries. G3LDO, G3GRO and G3KAU, all in Sussex, also worked the Irish station. The distance between G3LDO and EIOCF is 673km, which is currently a world record for a two-way on 136kHz.

The first 136kHz RTTY transmission took place on 8 February, when G4FEV transmitted 170Hz shift RTTY to G4FFC. G3LNP has been experimenting with frequency-tailored SSB transmission on the band.



you have been warned!

The Radiocommunications Agency tells us that they have recently monitored an upsurge in 'amateur-style' illegal radio activity, particularly around 6.6MHz. The frequency band 6.525 - 6.765MHz is assigned to the Aeronautical Service and unauthorised operation in this band is viewed very seriously by the RA and by overseas administrations.

The RA says that it is determined to take action against those "who insist on using this part of the radio spectrum for personal radio communications without regard for authorised use. Those detected can expect to be prosecuted."

According to the RA, initial monitoring indicates that some illegal operators may hold valid Amateur Radio licences. These people risk losing their licences, as the RA would have no alternative but to consider revocation. Colin Richards of the RA told *Ham Radio Today*, "I am sure the great majority of licensed operators will support the Agency's response to this problem."

new wab awards

A revised series of Worked All Britain awards will be launched at the 1998 WAB AGM, which will be held on 14 June at a new venue - the Elvaston Castle rally in Derbyshire.

The revised award will merge the existing areas with the new unitary authorities and counties. Members will not have to start again collecting areas from scratch (unless they want to) - the existing series of awards will continue to be available.

help wanted

Charles Inermee has a Yaesu FRG-100, Global 2000 ATU and a very small garden. His antenna is a 40ft wire with a coil (20 turns 4in dia) at the the far end. Earthing is copper pipe 3ft into the gound. He would appreciate tips on how to improve reception on 160m. Please reply by e-mail to: civermee@tcp.co.uk

biggest ever prize

Ham Radio Today, in conjunction with Lowe Electronics Ltd, of Matlock, Derbyshire, is offering readers the chance to win the most valuable Amateur Radio prize ever offered by a UK magazine in a free competition! The JRC NRD-545 DSP receiver, worth nearly £1600, which is reviewed by Technical Consultant Chris Lorek, G4HCL, on page 10, can be won by a lucky *Ham Radio Today* reader who return our reader's survey on page 24 and answers three simple questions about the NRD-545. Turn to page 23 for the application form - and good luck!

JRC (UK) Ltd's
Technical Manager,
James Moon; Richard
Mclachlan, G3OQT, of
Lowe Electronics Ltd,
and *Ham Radio Today*
Technical Consultant
Chris Lorek, G4HCL,
at our stand at the
London Show.

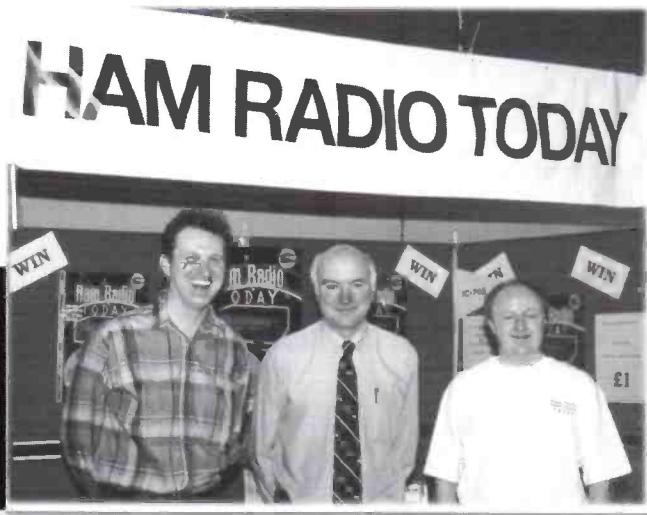

rallies cancelled

Unfortunately, there seems to be a spate of cancelled rallies recently. We have been informed that the Pontefract & District ARS Component Fair (due to take place on 29 March), the Cheltenham Radio Rally (5 April), and the East of England Radio Rally (at Peterborough) have all been *cancelled*. The good news is that there is now a full weekend 'Peterborough Radio Festival 98' which will take place on 30 / 31 May - more details next month.

Please note that CARA, the Cheltenham Amateur Radio Association, was *not* the organiser of the cancelled Cheltenham Radio Rally, as implied in the March *Ham Radio Today* (CARA was only organising the bring and buy stand at this rally). Thanks to CARA secretary Patricia Thom, G1NKS, for this correction.

club calls - new rules

The Radiocommunications Agency has announced a change to the rules for applying for club licences. Ordinarily, three licensed amateurs must be part of the club, but there was an exception for educational establishments where it was difficult to comply with this regulation. The RA has extended this facility to youth organisations such as the Brownies, Guides, Cubs and Scouts. In all other cases, three licensed amateurs will still be needed to apply for a club licence.

radio today radio today

latest news on ham radio today

marconi day

This year, International Marconi Day takes place on the birthday of the great man himself, **25 April**. Over 50 special event stations throughout the world are expected to be on the air, mainly from historical sites associated with Marconi's work. Many of these stations can easily be identified from their callsign letters which end in 'MD' or 'IMD', eg GB0IMD from Alum Bay on the Isle of Wight or GB4MD from Carnafon, Wales.

International Marconi Day is organised by members of the Cornish Radio Amateur Club, who will be operating GB4IMD from their site in Truro. The club is offering awards for making different numbers of contacts with participating stations (it's also available to SWLs on a 'heard' basis). For full details about International Marconi Day take a look at the web site www.users.globalnet.co.uk/~straff or tel: 01209 212314. Full information about the award is also available from the CRAC awards manager, Sue Thomas, G0GPX, PO Box 100, Truro, Cornwall TR1 1RX (please enclose an SASE).

emergency comms

The RSGB has appointed Thomas Reilly, G0NSY, as Emergency Radio Liaison Officer and Simon Lloyd Hughes, GW0NVN, as Deputy Emergency Radio Liaison Officer. They are updating details of all groups (whether RSGB affiliated or not) involved in providing emergency communications and invite all interested parties to contact them, with a view to arranging a series of liaison meetings around the country.

Further information about Raynet can also be obtained from Tom or Simon, c/o RSGB headquarters, tel: 01707 659015.

going stateside?

Rumours reaching the *Ham Radio Today* editorial office suggest that the USA is about to enter the CEPT T/R 61-01 agreement. This would mean that British amateurs could operate in the USA (and many American territories throughout the world) without the need to apply for an American reciprocal licence - and vice versa.

British class A amateurs will be allowed to operate in America on all bands which are common to both the USA and the UK, whilst class B amateurs will be able to do the same on bands above 144MHz. The scheme is not open to Novice licensees from either country.

At the time of writing, the agreement had *not* yet been signed - so don't go rushing off to the States without a reciprocal licence just yet! - but we understand that the CEPT has given the scheme the green light and that FCC approval should be forthcoming soon.

iswl award for non-members

The International Short Wave League, ISWL, has made its Monitor Award available to all Radio Amateurs and SWLs (not just ISWL members). To qualify, applicants should have confirmed contacts with 25 ISWL members. The cost is £3 (UK).

Full details of the award may be obtained from ISWL Awards Manager, Belle Fleurs, Wade Reach, Walton on the Naze, Essex CO14 8RG (please enclose an SASE).

club milestones

The **Siemens Amateur Radio Club** in Nottingham is holding a meeting of all past and present members to celebrate its 25th anniversary. The event takes place on 7 May and all those wishing to attend should contact Chris, G4VFK, tel: 0115 943 3387 (office hours).

The **Shefford and District Amateur Radio Society** is celebrating its 50th anniversary with a special gathering on 14 May. Past and present members are invited. For more information contact Derek, G4JLP, tel: 01462 851722.

m l & s

Martin Lynch & Son recently unveiled their new corporate logo. Now known as 'M L & S', here's the new logo to look for . . .



walford midney rx

The Walford Electronics Midney receiver is a new Somerset range single band HF superhet receiver kit. It's designed for those who want uncomplicated SSB reception on any one band between 1.8 and 14MHz. The receiver is built on a well spaced out 100 x 160mm PCB and can easily be incorporated into your own box.

The Midney costs just £49 plus £1 P&P - and when ordering don't forget to state which band you want!

Contact Walford Electronics, Upton Bridge Farm, Long Sutton, Langport, Somerset TA10 9NJ; tel: 01458 241224; fax: 01458 241186; e-mail: walfor@globalnet.co.uk

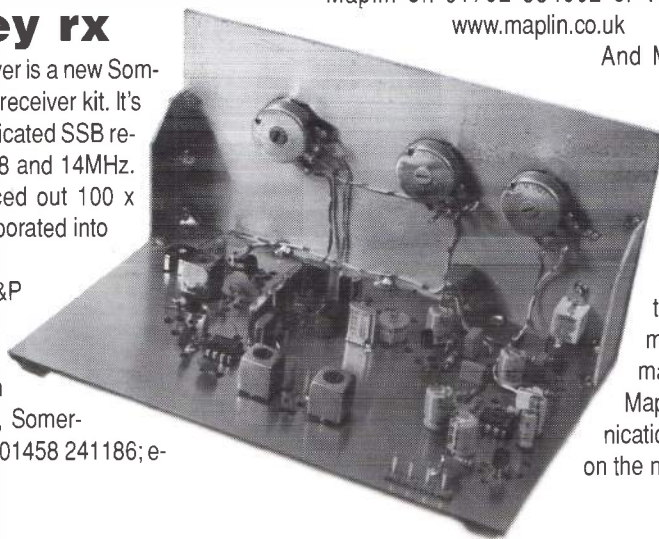

hi-tech catalogue

Electronics retail and mail order company Maplin now issues its catalogue on CD-ROM. Product information is easy to access via the comprehensive search facilities and enhanced picture quality is another bonus offered by the CD-ROM.

For those unfamiliar with Maplin, the CD-ROM includes a video of the company history, and a number of 'how to' videos, together with hundreds of data information sheets, FAQs etc. Both the traditional printed catalogue and the CD-ROM version will be updated twice a year. To order the catalogue call Maplin on 01702 554002 or visit their website at www.maplin.co.uk

And Maplin has signed a 'membership deal' with the British Citizens' Band Confederation, BCBC. The deal demonstrates Maplin's commitment to both Amateur Radio and the CB market. For more information on the BCBC or Maplin's range of communications products, call them on the number above.

trade topics trade topics

the following information is based upon submissions by suppliers we cannot be responsible for false

sun mag

Neil Clarke, G0CAS, produces a monthly publication called *Sun Mag* (*Sunspot* and *Magnetic Data*). It contains articles pertaining to studies of the sun and the earth's atmosphere, and their effects on radio propagation, along with historical solar data in the form of tables. An annual subscription (12 issues) costs £10. Contact Neil on tel: 01302 531925, or e-mail neil@g0cas.demon.co.uk for details.

mary's in the pink

Congratulations to Mary Pink, manageress of regular *Ham Radio Today* advertisers SRP Trading's Radio Centre in Birmingham. Mary is now the proud owner of the callsign M0BMH. She took the RAE in May 1997 and became M1BUB, but quickly 'upgraded' to the class A call.

Mary, who is a member of the Sandwell Amateur Radio Club, has now worked in the radio communications field for almost 20 years. If you are passing, call into the shop at 1686 Bristol Road South, Rednal, Birmingham B45 9TZ, to say hello.



personal navigator

The *Personal Navigator* software package can be used as a stand-alone reference, or linked to a GPS receiver to give satellite navigation and real-time tracking of the movement of your vehicle. Digital maps give full colour coverage of the UK. They include the *Good Pub Guide* and the *Egon Ronay* guide, together listing more than 15,000 restaurants and pubs. A database of 1.6 million postcodes allows you to read the full address, whilst the map shows the exact location.

The recommended retail price of *Personal Navigator* is £119. However, it is available as an introductory offer to *Ham Radio Today* readers at just £99 inc P&P. Contact Nevada, 189 London Rd, North End, Portsmouth, Hants PO2 9AE; tel: 01705 662145.

business opportunity

Holdings Amateur Electronics in Blackburn, Lancs, which has been run by *Ham Radio Today* 'All in a Day's Work' columnist Harry Leeming, G3LLL, for nearly 40 years, is up for sale. Harry wishes to retire by late summer this year and is offering the business as a going concern.

Harry told *Ham Radio Today*, "With a younger person with plenty of drive it could be a really good business."

If you are interested in finding out more about this opportunity, contact Harry on tel: 01254 59595.

more on ft-847

Yaesu has announced that the UK version (only) of their new FT-847 HF / VHF / UHF transceiver will also have the 4m band included. There will be 10W output on the 70MHz band. This must make it the only 13-band transceiver ever offered! The first production models of the FT-847 are expected to start arriving in the UK in April.

A revolutionary new mobile antenna system will be offered as an accessory with the FT-847. The ATAS-100 'Active Tuning Antenna System' automatically adjusts itself to the best SWR on HF and 50MHz, by changing the length of the antenna's unique motorised 'accordion' tuning section. On 144 and 430MHz, the ATAS-100 requires no tuning, functioning as a quarter-wave and five-eighths wave antenna respectively.

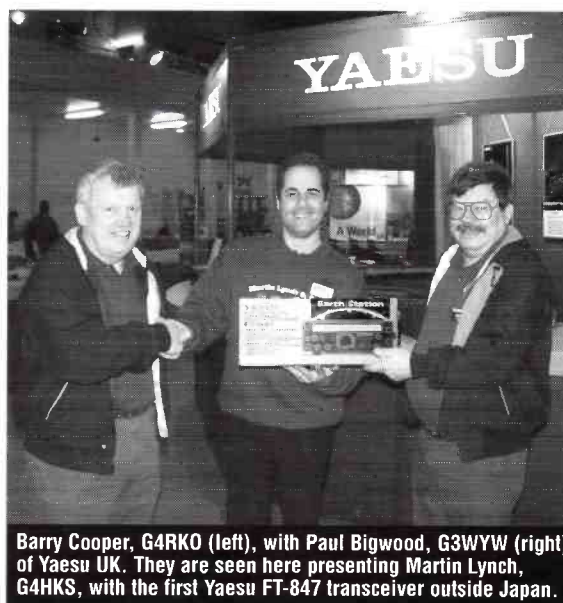

Barry Cooper, G4RKO (left), with Paul Bigwood, G3WYW (right), of Yaesu UK. They are seen here presenting Martin Lynch, G4HKS, with the first Yaesu FT-847 transceiver outside Japan.

barry cooper leaves yaesu

Good luck to Barry Cooper, G4RKO, who has been 'Mr Yaesu UK' for many years. A familiar sight at radio rallies and conventions throughout the country, Barry is now moving on to pastures new.

Paul Bigwood, G3WYW, is taking over for the time being. All at *Ham Radio Today* would like to thank Barry for his friendship and cooperation in the past, and we wish him well in his new job.

trade topics **trade topics**
 liers, and is not necessarily endorsed by ham radio today.
 misleading claims by suppliers.

hamcalc 31

Version 31 of Hamcalc - over 200 painless maths and design programs for radio amateurs and professionals - has been released by George 'Murph' Murphy, VE3ERP, on a 3.5in 1.44Mb DOS / Windows disk. The programs are free, but please send US\$5.00 to cover the cost of the disk and airmail postage. Write to George Murphy, 77 McKenzie St, Orillia, ON, L3V 6A6, Canada.



ar8000 mods

Javiation has produced a couple of 'mods' for the AOR AR8000 receiver. The first is a narrow AM board, which allows the 4kHz SSB filter to be used in the AM mode on the MF and HF broadcast bands. The DX-8000 narrow AM PCB costs £35.00 inc VAT and can be fitted by Javiation if you wish.

diplomat ups

The Forte uninterruptible 12V DC power supply has been upgraded and is now directly compatible with universal mains voltages from 90 to 264V AC. The unit provides a mains to 12V PSU with 12V battery back-up in case of mains power failure. The unit is ideal for applications where DC power must be guaranteed in the event of a mains failure.

The Forte is CE marked and costs around £200. Contact Diplomat Communications Ltd, Unit 3, Summerlea Court, Herriard, Basingstoke, Hants RG25 2PN; tel: 01256 381656; fax: 01256 381571.

Secondly, the JAV-232 computer interface allows AR8000 users to connect the receiver to a PC and take advantage of any of the software packages that support the AR8000. The JAV-232 is also fully compatible with the AR2700, Icom CI-V, Optoelectronics Scout and other models. It costs £69.99 inc VAT and can be ordered from Javiation, Carlton Works, Carlton St, Bradford BD7 1DA; tel: 01274 732146; fax: 01274 722627; e-mail info@javiation.co.uk

Every so often, one imagines owning a 'dream' receiver, one that's perfect in every detail, with superb on-air performance. In this respect, over the years names like Collins, Eddystone, Drake and the like have sprung to the memory of many 'old hands' in the amateur radio field. The name of JRC (Japan Radio Company), founded in December 1915, has also been synonymous in the professional radio field with a reputation for top-quality radio communication equipment. Look in the radio room of most ocean-going liners and large cargo ships (yes, I've been there, on both types) and if you see any professional radio equipment it's more than likely to bear the JRC badge. A select group of amateurs, those who want the best, also share the joy of having JRC equipment in their shack.

JRC's latest receiver, the NRD-545, will I'm sure be carrying on this tradition. Why do I think this? Because first impressions often make their mark, and after I'd used it only for just a few hours on the air, I knew this was

ance. Modes offered are CW, USB, LSB, AM, Synchronous AM, ECSS (Exalted Carrier Selectable Sideband, which gives you selectable sideband AM reception), and RTTY, complete with a built-in RTTY demodulator. An optional unit that fits within the receiver case extends the coverage up to 2GHz with operating modes of AM and FM, as well as adding Wideband FM capability; it will also receive the other front-panel selectable modes, but again without guaranteed performance.

dsp

Many receivers and transceivers nowadays have digital signal processing (DSP) 'thrown in', but JRC have taken it a step further in the NRD-545. Following the first IF of 70.455MHz and 2nd IF of 455kHz, signals are then down-converted to 22.3kHz where the DSP IC takes over completely. Yes, that's it, no switchable crystal or mechanical IF filters, no analogue SSB or AM

Is this the best amateur receiver ever? Chris Lorek thinks it could be.



interested to know this is achieved with a simultaneous Chebyshev type digital filter with an IIR (Infinite Impulse Response) configuration.

The Passband Shift is also taken care of by the digital filter, which can be moved in its cen-

A DSP noise blanker is also available, which detects noise amplitudes and reduces the noise depending on the amplitude level on the time axis. Either of two blanking widths, NB1 (narrow) and NB2 (wide) can be selected, and in each case the noise blanker level is adjustable

World Exclusive Review

Chris Lorek, **G4HCL**, says that he sometimes has a dream, and it

probably one of the very best receivers I had ever operated.

OK, enough of the praises (although I make no excuses for the enthusiastic introduction!) let's get down to what the radio actually does. It's an all-mode general coverage HF receiver, operating over 100kHz to 30MHz, although the actual tuning range can go down to 30kHz if you wish but without guaranteed perform-

demodulators or AGC circuitry, it's all done with ones and zeros, digitally.

The DSP completely handles the signal detection of LSB, USB, CW, RTTY, FM, AM and ECSS modes. It also controls the signal selectivity, with a receiver bandwidth variable anywhere between 10Hz and 9.99kHz in 10Hz steps; any bandwidth on any mode. Technical types might be

tre frequency up or down in 50Hz steps by up to 2.3kHz. Even the AGC is digital on all modes apart from WFM, and not only is there an AGC loop inside the DSP, but a digital-to-analogue converter is used to feed this to the first IF amplifier. On SSB, CW and RTTY modes, the AGC discharge time constant can be varied anywhere between 40ms and 5.1 seconds in 20ms steps, the time constant being fixed on the other modes. The RF Gain control uses an analogue-to-digital converter to transfer the setting into digital format for digital processing, the DSP then uses this to adjust the gain of the first IF amplifier. Likewise, the squelch operation is fully DSP controlled, if the signal input level is small then a noise squelch is used, a carrier level squelch being used for higher signal levels. As you

might expect from this, the S-meter level is also digitally generated, and it's displayed as a curved fine-step bargraph on the front panel LCD.

from a dedicated front panel rotary control. A switchable 20dB front-end attenuator is also fitted to help in cases of monster signal level reception.

There's also a manually adjustable notch filter, which uses the steep attenuation characteristic of the IIR notch filter. It's adjustable over ± 2.5 kHz in 10Hz steps, and offers at least 40dB attenuation of an unwanted beat signal. A 'tracking' system is also available for this, which will automatically follow a tuning range of ± 10 kHz if you subsequently use the main tuning dial.

signal enhancements

As well as all the above, the DSP also offers the usual features, such as multiple audio beat cancellation and noise reduction. Here the spectrum of periodic and random signals is examined by the DSP, the Noise Reduction system reduces non-correlated random signals to bring the wanted (ie correlated) audio out of the noise whilst reducing the noise itself. Alternatively, the

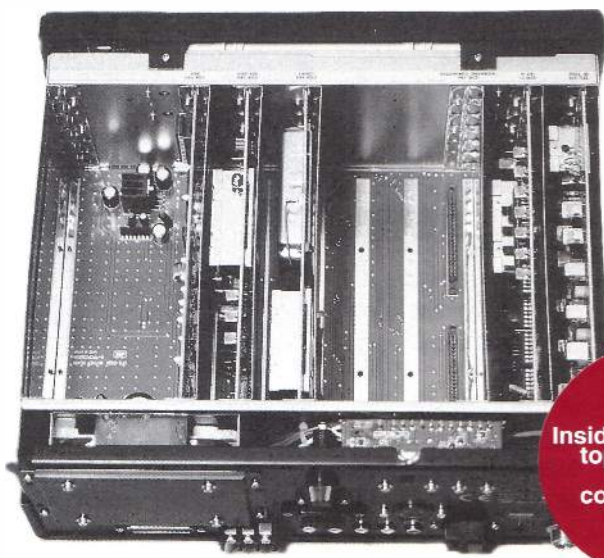

Inside view from the top shows the modular construction.



Beat Cancel system can be selected, which automatically reduces the level of tones such as heterodynes or unwanted CW signals. The signal processing level of both of these systems can be independently adjustable in 256 pre-set levels, to allow for a wide range of audible condi-

switch the receiver on and off at pre-set times.

round the back

The rear panel of the receiver sports a number of connectors. There are antenna connectors for

provided as a sample program. This also contains software for displaying received RTTY signals as well as panoramic reception software, ie a 'spectrum scope', although this isn't interlocked with the receiver's main tuning dial or the controls on the receiver.

physical features

As you can see from the accompanying photo, the front panel of the receiver has a variety of easy-to-use rotary controls, these all being fed to the digital circuitry of the receiver via suitable A/D converters. An easily-read multi-colour LCD panel shows you the receiver's status such as the tuned frequency, memory channels, bandwidth and passband settings, as well as the S-meter reading which can be pre-set for either a bargraph, a single bar, or 'peak hold' setting.

The receiver itself measures 330W x 130H x 285Dmm and weighs 7.5kg, which is reasonably light for its size.

a 'run-of-the-mill' HF receiver from a high-performance HF receiver, besides the front-end strong signal handling capabilities (which can, arguably, be somewhat improved in terms of out-of-band problems by the use of a good external preselector as well as a defined and resonant antenna system together with experienced use of RF and IF gain controls) are the available IF bandwidths, and the skirt characteristics of the fitted filters.

If you've ever used a set with mechanical Collins 455kHz filters fitted, you'll have learned to appreciate the level passband and sharp cut-off characteristics of these, which give an exceptionally 'clear' sound to received signals. I have to say that I found the NRD-545 replicated this experience, the filtering was absolutely superb.

Better still, being able to continuously vary the bandwidth and retain the very sharp cut-off was a remarkable experience, you really need to use the receiver on air to see how good this is. As an example, during an SSB contact, a strong RTTY station ap-

JRC NRD-545 Receiver

came true when he tried the NRD-545 on the air from his shack

tions to be catered for in each case. As a finishing touch, the DSP also handles the audio spectrum, with a front-panel adjustable tone control.

tuning and timing

The receive frequency can be directly entered via the front panel keypad, or the large main tuning knob which steps in 1000 frequency increments per rotation. This can be electrically slowed down for even finer tuning if you wish. There are 1000 memory channels fitted, each of which can save the frequency, mode, IF filter bandwidth, AGC, attenuator, and tuning step settings. Switching between the VFO and memory channels is done by a simple front panel button push, and a small rotary knob is used to select the required memory channel. A channel scan facility is available, as well as a 'sweep' mode which continuously sweeps between two pre-set frequencies. The receiver also has built-in clock and timer functions, which can

both 50Ω (ie dipole) and high impedance (ie long wire) inputs, selected by a small slide switch, and there's a separate N-type socket for the optional VHF / UHF wideband unit. Phono sockets are fitted for external speaker and audio line output (with separate left and right audio outputs for wideband FM), together with a mute terminal if you're using the receiver with an accompanying transmitter. A low-current DC output giving 10.8V at a maximum current of 30mA is fitted, and a timer output provides relay-switch 'make' and 'break' connections controlled by the receiver's internal timer control.

A 25 pin RS-232 connector allows for remote PC control of the receiver, and the supplied user manual gives comprehensive details of the various commands required for the many control functions available. The manual also states that computer control software for operating the receiver under *Windows 95* can be

on the air

My main interest on the HF bands, that being low-band DXing with its inherent challenges of QRN (man-made noise), QRM (interference from other stations, both on-frequency and off-frequency) and a mixture of weak (wanted) and strong (unwanted) signals, is probably rather appropriate as a test of the capabilities of this receiver. This combination also nicely sums up what most people would look for from a receiver that would be used in virtually every other operating condition.

What often separates

peared only about 1kHz away, almost flattening the wanted station. Moving the passband shift only slightly gave a very rapid cut-off, none of this 'gradual reduction' in the QRM as I've found with other sets using normal IF filters, the RTTY signal completely disappearing. As for CW use, being able to narrow the IF bandwidth right down gave superb results, with no 'ringing' whatsoever, likewise for narrow-bandwidth data modes such as Pactor II.

From my on-air tests, I found that the automatic beat cancel operated at audio frequencies, and not at the final 'IF'. In other words, if a beat signal came up, the automatic system would

Rear panel, with connectors for almost every conceivable function.



laboratory results

All measurements carried out in default intermediate bandwidth (2.4kHz) ssb mode, with attenuator and dsp noise / beat reduction facilities disabled, unless otherwise stated

sensitivity:

Input level in mV pd required to give 12dB SINAD:

Freq	CW (1.00kHz)	SSB (2.4kHz)	AM (4.5kHz)	FM
1.8	0.08	0.25	0.54	0.23
3.5	0.06	0.21	0.43	0.20
7.0	0.07	0.23	0.46	0.19
10.1	0.07	0.22	0.45	0.19
14.0	0.07	0.24	0.49	0.22
18.1	0.09	0.26	0.50	0.24
21.0	0.09	0.31	0.62	0.29
24.9	0.08	0.26	0.57	0.25
28.5	0.08	0.28	0.59	0.26
29.5	0.09	0.29	0.63	0.30

blocking

Measured on 21.4MHz as increase over 12dB SINAD level of interfering signal, unmodulated carrier, causing 6dB degradation in 12dB SINAD on-channel signal:

±10kHz	76.9dB
±20kHz	82.5dB
±50kHz	91.3dB
±100kHz	97.7dB
±200kHz	101.1dB

image rejection:

Increase in level of signal at the first IF image frequency, and the first IF itself, over level of on-channel signal, giving identical 12dB SINAD signal:

Freq	Image Rej	IF Rej
1.8	>110dB	>110dB
3.5	>110dB	>110dB
7.0	>110dB	>110dB
10.1	>110dB	>110dB
14.0	>110dB	>110dB
18.1	>110dB	>110dB
21.0	>110dB	>110dB
24.9	>110dB	>110dB
28.5	>110dB	>110dB
29.5	>110dB	>110dB

nically mute this but it would not give any notch effect to the signal level itself. I needed to use the manually-tuned notch here, which I must say did work extremely well. For example, a very strong CW station calling CQ suddenly appeared slap bang in the middle of an existing contact in the data modes section of 20m. The 'BC' certainly did notch out the interfering CW signal, although with the other stations being weaker at my end it also caused the others to be unreadable as well. But less than a couple of seconds with the manual notch control effectively notched the offending station into oblivion, my data controller then continuing to receive the other signals very nicely with no discernible interference whatsoever.

For the rest of the operational

side, I found the front panel controls easy to use, the large front panel tuning knob being a pleasure to operate when tuning around the bands. Three quick-touch filter bandwidth buttons let me quickly switch between narrow, intermediate and wide filter settings for each mode, which I appreciated. My only wish would have also been for a quick selection of pre-stored frequencies, separate to the 1000 memories, similar to that of a 'band selection switch' on an amateur transceiver. However, this is a personal preference, as on the air I quickly learned to use a group of memory channels for this. After recalling any channel, a twist of the main tuning knob let me tune away from these as I wished. If I remembered to overwrite the channel with the last-tuned frequency each time

selectivity:

Measured using default intermediate filter bandwidths as indicated:

	CW (1.00kHz)	SSB (2.4kHz)	AM (4.5kHz)
-3dB	1.02kHz	2.42kHz	4.52kHz
-6dB	1.03kHz	2.43kHz	4.53kHz
-20dB	1.09kHz	2.49kHz	4.59kHz
-40dB	1.19kHz	2.61kHz	4.69kHz
-60dB		(see text)	

3rd order intermodulation rejection:

Increase over 12dB SINAD level of two interfering signals giving identical 12dB SINAD on-channel 3rd order intermodulation product, measured at 21.4MHz:

10 / 20kHz spacing	81.2dB
20 / 40kHz spacing	89.4dB
50 / 100kHz spacing	89.4dB
100 / 200kHz spacing	84.0dB

s-meter linearity:

Measured at 14.25MHz:

Indication	Sig Level	Rel Level
S1	2.05mV pd	-24.5dB
S2	2.86mV pd	-21.5dB
S3	4.04mV pd	-18.5dB
S4	6.09mV pd	-15.0dB
S5	8.41mV pd	-12.2dB
S6	12.0mV pd	-9.1dB
S7	16.8mV pd	-6.2dB
S8	23.8mV pd	-3.2dB
S9	34.4mV pd	0dB ref
S9+20dB	140mV pd	+12.3dB
S9+40dB	920mV pd	+28.6dB
S9+60dB	9.7mV pd	+49.0dB

before I switched to a different channel, it effectively gave me a virtually unlimited number of freely-tuneable VFOs. The noise reduction and beat cancel level controls were a sub-menu setting, which I found a little awkward to use at first.

lab results

My measured results are shown in the accompanying table, and if you're not a 'techie' type then just feel safe in the knowledge that the performance was well up to that of the very best receivers available! I must, however, point out the exceptionally good filter responses I measured. These more than confirmed what I'd found on air, with a performance that I'd never, ever, been able to measure on any earlier receiver I've tested. I did, however, have

a problem in measuring the ultimate rejection, as quantisation effects gave a 'pumping' response from a high-level off-frequency signal input, with an indeterminate measurement as a result.

conclusions

After having testing the receiver over the review period, on a variety of modes and bands, I believe the NRD-545 to be the very best HF receiver I've ever had the pleasure of using in my amateur shack. This really sums it up and I can't sing its praises highly enough. If you can afford the £1595 price tag, you probably won't be disappointed with the result. Our thanks go to Lowe Electronics Ltd, tel: 01629 580800, for the loan of the receiver for review.

NARS A

NARS A

Don't miss the **LARGEST** single day show in the U.K.

NORBRECK

Radio, Electronics and Computing Exhibition

by the Northern Amateur Radio Societies Association at the

**NORBRECK CASTLE HOTEL EXHIBITION CENTRE
QUEENS PROMENADE, NORTH SHORE, BLACKPOOL**

on Sunday, March 15th, 1998

Doors open at 11 a.m.

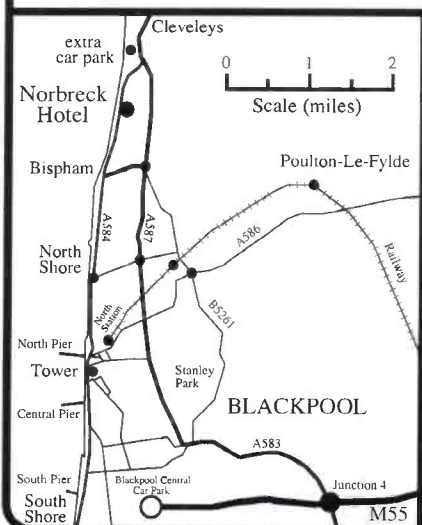

- * Over 100 trade stands
- * Bring & Buy stand
- * RSGB stand and book stall
- * Organised by over 50 clubs
- * Facilities for the disabled (wheelchair access to all stands)
- * Overnight accommodation at reduced rates (contact hotel direct)
- * Club stands
- * Amateur Computer stands
- * Construction competition
- * Free car parking

RADIO TALK-IN ON S22

Admission £2 (OAP's £1, under 14's free) by exhibition plan

Exhibition Manager : Peter Denton, G6CGF, 0151-630-5790

Products from our range designed to increase your range

HF

Our superb Alpha amplifiers need no introduction! With an easy 1.5kW out, these loaf along at the UK limit. See Feb 97

RadCom review by Peter Hart for an independent verification of their quality. We reproduce his verdict on the 91b manual-tuning amplifier (£2,199)

"An excellent amplifier in all respects", and he called the no-tune 87A (£5,295) "The Rolls-Royce of all amplifiers". As the 87A interfaces with all brands of HF radio (unlike other "no-tune" amplifiers), you can change your radio to *any make* without losing amplifier compatibility.

Antennas? What a choice, from HyGain, Cushcraft, KLM, M-squared, Force 12 and GemQuad. In stock now, the amazing C-4SXL (£795) from Force 12. This antenna implements 40-20-15-10 yagis on one 24ft boom and weighs only 48lbs. For those who would like to have as super signal on 20 through 10m, including the 17 and 12m bands, the GemQuad is an excellent choice. For only £380, the WARC version of the Gem takes a lot of beating. We have *lots* of others, and as we list everything from 10m verticals to a 4 ele 80m yagi, we have something for **you!**

Rotators? Rotators 'r us! Call us for the latest and best.

Planning Probs? They can't touch you for this one! The amazing Force 12 ZR-3 triband vertical dipole (£449) is less than 6ft high, yet retains good bandwidth and high efficiency, on 20-15-10m with no tuning.

. . . . **And specials?** . . . We have good stocks of baluns, cable, wire, remote antenna switches, triband stacking units, "four-square" vertical phasing systems, and (nice one this) an antenna switch that can be driven by any "band data output" Yaesu or ICOM transceiver, or from your PC LPT port (with appropriate software) to change up to six antennas automatically, triggered by a band change on the radio.



**9M0C
Spratly!**

Did you work (or hear) the splendid 9M0C expedition to Spratly in February? If you heard their signal on 80 and 40m you will have heard a Vine **foursquare vertical array phasing unit** in action. We can't do better than quote DxPediton members on the performance of these units "The foursquare units were a dream... Switch off EU and switch on JA. As easy as that!... Truly amazing!"

Vine foursquare units comprise the outdoor phasing unit (IP65 protection in heavy duty die cast box) plus indoor control unit. Units are available for 80/75 and 40m bands. Price - £275 complete. We can also supply suitable vertical antennas.

Just in - What many of you have been waiting for. **A MINIBEAM THAT WORKS!** The Force 12C-3SS (£439) is primarily designed for 20-15-10- but will work on 17 and 12m through a tuner with reduced gain and f/b ratio. It has a maximum element length of 24.5ft. (full size elements on 15 and 10m) boom 11.8ft and turning radius of only 13.5ft, with no lossy traps or loading coils to heat up. Full VSWR bandwidth is also maintained. Gain on 20m is 11.5dB (Cushcraft method). Weight - 26 lbs.

VHF

NEW! From T E Systems, a series of the highest-quality **VHF/UHF amplifiers**. All have GaAsFET preamps, with RF VOX, or PTT switching. What is more - the output specified is what you get. Here is just some of T E's range -

Band	P In	P Out	£	Band	P In	P Out	£
6m	10	170	319	2m	25	350	509
6m	10	375	499	2m	80	350	459
6m	25	375	459	70cm	10	100	359
2m	2	150	319	70cm	10	185	569
2m	10	200	329	70cm	25	185	529

Our opening hours are 9am to 10pm, Monday to Saturday. We welcome personal callers, but by appointment only please.

Vine Antenna Products - The Vine, Llandrinio, Powys, SY22 6SH. Tel 01691 831111, fax 01691 831386.
Email ron@gw3ydx.demon.co.uk

**1686 Bristol Road South
Rednal
Birmingham B45 9TZ**

SRP TR

(COM213)

100 CHANNEL SCANNER

A high-specification scanner offering 100 channels in 10 banks, with 1 Priority Channel in each bank. For speed and ease of use it offers Jetscan, which can scan 100 channels per second, and also Jetsearch, which can search at up to 100 steps per second. It also features programmable band search, lock-out for up to 10 frequencies, channel look-out, 2 second scan delay, data noise/birdies skip, a key lock and a green back-lit display. 66-88, 108-174, 406-512, 806-956.

£119.99 + £5 P&P.



(COM102)

10 CHANNEL SCANNER

This state of the art 10 channel scanner is fully programmable and can receive a variety of PMR communications. It is robustly designed and offers a full frequency LCD display for ease of use. Also features an in-built circuit for recharging Nicad batteries. 66-88, 137-174, 380-512.

£49.99 + £5 P&P.



(COM205)

400 CHANNEL SCANNER

The B111 is the last word in programmable scanners. A free standing desk top unit covering nine radio bands in the 25-512MHz and 806-1300MHz ranges. Operates from AC mains or car cigar lighter via suitable adaptor. It incorporates a microprocessor avoiding the need to change crystals and gives special functions such as scan delay, memory back-up, priority channels and many more.

£249.99 + £5 P&P.



(COM215)

200 CHANNEL SCANNER

A highly-featured desktop scanner offering 200 channels arranged in 10 scanning banks, with one Priority Channel in each bank. For ease of use it offers Turbo Scan at 100 channels per second max with Autosort for maximum scan speed and Turbo Search at up to 100 steps per second. Other features include direct search programmable band search, auto station program mode, lock-out for up to 10 frequencies, manual frequency sort, programmable auto-recording and optional CTCSS tone squelch. The unit is powered by AC mains or 13.8Vdc. 66-88, 108-174, 216-512, 806-956.

£219.99 + £5 P&P.



SANGEAN ATS 909 FM-Stereo/MW/LW/SW PLL Synthesized receiver

The ATS-909 is a continuously tunable receiver from 153kHz-29999kHz. This receiver is capable of receiving and tuning all the short wave bands and any stations in between

- 307 memories (261 in SW, 18 each in MW/FM, 9 in LW plus priority station)
- Five tuning methods – direct frequency tuning, auto scan, manual tuning, memory recall and rotary tuning
- ATS (auto tuning system) – auto scan and preset in priority of signal strength in FM/MW/LW bands
- E2 PROM for memories back-up
- FM stereo via earphones
- 29 pages SW stations name memory, 9 memories in every page
- Automatic search strongest signal station within SW station pages
- SSB (USB/LSB) 40Hz/step on fine tuning
- AM RF gain control
- Built-in 42 world cities time plus D.S.T. device
- 3 individual timers
- Adjustable sleep timer
- Alarmed by radio or HWS (Humane Wake System) buzzer
- Battery and signal strength indicator
- Direct key to recall favourite station in one button
- Dual conversion device
- REC out and standby control output
- Pre-programmed station name and frequency according to customer's requirements before ex-factory
- AM wide/narrow filter and FM mono/stereo selector
- Optional features for European market
- RDS (Radio Data System) on PI, PS and CT for station name and clock time
- Size in mm: 215 x 133 x 37.5
- Weight: 850g without batteries



£169.95 + £5 P&P.

- ★ Free batteries
- ★ Free SW frequency book
- ★ Free SW antenna
- ★ Free headphones

RADING

Telephone: 0121-457 7788
0121-460 1581
Fax: 0121-457 9009



Super Syncro 1100 – 1100mAh Nickel Metal Hydride (NiMH) AA size rechargeable cells. No memory effect. Twice the capacity of NiCds. **£3.00** inc P&P.

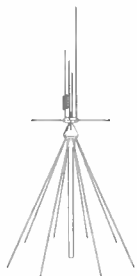

Skyscan DX-V1300 base discone – Most discones only have horizontal elements and this is the reason that they are not ideal for use with a scanner. Most of the transmissions that you are likely to receive on your scanner are transmitted from vertically mounted antennas. The DX-V1300 has both vertical and horizontal elements for maximum reception. Constructed from best quality stainless steel and aluminium and comes complete with mounting pole. **£49.95** + £3 P&P.



Skyscan Desktop Antenna Model Desk 1300 discone – Built and designed for use with scanners. Coverage: 25 to 1300MHz. Total height 36" and 18" wide at widest point. Comes complete with 4m of RG58 coax cable and BNC connector. High performance antenna, ideal indoor or as a car antenna when vehicle is stationary. **£49.00** + £3 P&P.



Airband mini-mag antenna – Civil (108-137MHz) and military (225-400MHz) dual band receive antenna featuring super strong miniature magnet and coax cable terminated in BNC connector. **£24.95** + £3 P&P

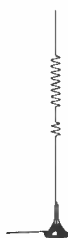

Wideband mini-mag antenna – Wideband (25-1300MHz) receive antenna featuring super strong miniature magnet and coax cable terminated in BNC connector. **£29.95** + £3 P&P.



Yaesu FRG-100 communications receiver – Award winning 50kHz to 30MHz base station AM, CW, USB, LSB, FM (optional) communications receiver. Features include two clocks and timer, 50 memories, FM option, remote control jack. Superb value at **£449.95** + £7 P&P.



Roberts R861 – compact digital world band receiver – Fully featured 153kHz to 30MHz (AM, SSB) and 87.5MHz to 108MHz (FM) portable digital world band receiver. Features include RDS, world time clock, 306 memories, RF gain control, direct frequency entry. Comes complete with free PSU, antenna, frequency guide and case. **£199.00** + £5 P&P.



Radio shack DX-394 communications receiver – 150kHz to 30MHz base station AM, CW, USB, LSB communications receiver. Features include clock and timer, signal meter, 100+ memories, RF gain control and direct frequency entry. A steal at **£149.95** + £7 P&P.



Uniden Bearcat 9000 XLT – AM/FM/WFM switchable base station HF/VHF/UHF scanning receiver. Covers 25-550 and 760-1300MHz. Features 500 memories, auto sorting, backlit orange LCD display. Scan rate of 100/300 channels/sec. **£249.95** + £10 P&P.



AKD Target HF3 communications receiver – 30kHz to 30MHz mobile or base station AM, USB, LSB communications receiver. Very simple to operate. Ideal for the novice, but with a performance more demanding listeners will appreciate. **£159.95** + £5 P&P.



Commtel COM 206 – AM/FM handheld VHF/UHF scanning receiver. Covers 66-88MHz (FM), 108-137MHz (AM), 137-174MHz (FM), 380-512MHz (FM). Full civil airband coverage, comes complete with free case and rechargeable batteries. **£129.95** + £5 P&P.



Yupiteru MVT-7100 – All mode switchable handheld HF/VHF/UHF scanning receiver. Covers 0.5-1650MHz. Features 1000 memories, over 500 pass memories, 10 limit search banks, 12 step sizes. Comes complete with earpiece, belt clip, wrist strap, rechargeable batteries, PSU, in-car adaptor and telescopic antenna.

£199.99
+ P&P.
(10 only)



Realistic PRO-2042 – AM/FM/WFM switchable base station HF/VHF/UHF scanning receiver. Covers 25-520 and 760-1300MHz. Features 1000 memories, 100 monitor channels, backlit orange LCD display. Scan rate of 50 channels/sec. **£249.95** + £10 P&P.

WE ALSO HOLD A LARGE RANGE OF SECOND USERS SHORTWAVE AND SCANNING RECEIVERS. PLEASE CALL WITH YOUR REQUIREMENTS

Beware of changing the 6JS6C power amplifier valves in the venerable old FT-101 (see text).



All in a D's work

Harry Leeming, G3LLL, with more money-saving

George came in with his FT-77. "Mechanically the tuning won't always stay on station, and it seems like the gearbox is worn at some points in the rotation. Can you fit a new one?"

Well, I certainly hadn't got one, and the trouble and expense of trying to obtain one and fit it would be hardly justified. I therefore showed him how to fix the problem himself. The simple solution is to remove the tuning knob, and to fit a felt washer behind the knob. The knob is then refitted so as to trap the washer tightly between the knob and the front panel. This provides a little extra friction, and unless the gearbox is really bad provides a complete cure. This dodge also works on the FT-101ZD, FT-902, FT-707 and quite a lot of other rigs. George was sent away with full instructions, raided his wife's sewing box for a piece of felt, and soon had the job done at zero cost.

ft-101 pa valves

Clarence came in with a long face and an FT-101. He explained that

the rig had been running perfectly, but he thought he would treat it to a new set of valves. He found the 6JS6C power amplifier valves a little too expensive in the UK, and from a friend in the USA he had obtained a pair of genuine RCA 6JS6C tubes. His friend, who had been in TV service, told him that they were really the best that could be got, and that he had held them in stock for many years as they were no longer made. They were specially constructed to give long life in colour TVs, as they had extra heat dissipating plates added to the electrode system.

Clarence had fitted them, but as the rig had warmed up, he had noted a strange noise on receive followed by the sound of arcing in the PA compartment. He had switched off quickly and refitted his old valves, but now found that the rig had PA current, but no RF output. "What has happened, Harry, were the valves duff and can you do anything about the rig?"

I had to explain that all valves are not equal, and that some are much better for one purpose that

an other. Many valves used as driver and power output devices in Amateur Radio equipment were actually designed for use in TV sets. Line output valves such as the 6JS6C, 6KD6 and 6HF5 were designed to run at around 15kHz, and so have no agreed standard for inter-electrode capacity (at 15kHz a few pF one way or other isn't going to make much difference). Also, these valves were intended to be used only to pass pulses, and so once again the characteristics of the control grid, as regards to how much bias was required, seems to differ widely between brands.

When Yaesu, Swan and KW were designing modestly-priced transceivers they found that using *certain brands* of mass-produced TV valves worked well, were cheap, and therefore gave them a competitive edge. What must not be forgotten, however, is that these valves are being used outside their maker's specification, and hence the valve which is best in a TV can be a disaster in an Amateur Radio transceiver. Differing inter-elec-

trode capacity can make them impossible to neutralise, and, as in Clarence's case, differing bias levels allows some to conduct in the receive mode.

Clarence's rig had gone into violent oscillation in the PA stage. No load was connected and so high RF voltages had been produced. This had caused the PA anode RF choke to arc over, making it go short circuit. Fortunately this was the only damage that had occurred, but it still lost Clarence a lot more than if he had purchased a pair of the correct valves in the first place.

Before using television valves in a transceiver, do check that they are suitable for use in the equipment you have. It is much better to be safe than sorry.

burnt out psu

Tom came in to complain about a power supply he had bought from a competitor. "I've only had this 20A PSU for a month, and it's burnt out. Look: all the insulation on the wires around the power transistors has melted." Somewhat suspicious, I asked him if he was sure that he hadn't

overloaded it, but of course he assured me that he definitely had not. "Why, it says in the instructions that it is rated for continuous communications service at 20A 13.8V, and I was only running it at 6V 15A to quick charge a motor cycle battery. I am going to take them to court. My solicitor wants you to examine it and write a report". I then had to try and point out to Tom that he had, on his own admission, grossly overloaded the power supply by several hundred percent, and that any attempt at court action was bound to fail.

A typical 20A variable voltage PSU when used at full power takes about 17V into the series pass transistors (ie the big ones on the heat sink) and it delivers 13.8V out (3.2 volts lost in the transistors). The wattage dissipated in these transistors is therefore equal to amps times volts, and so 60 - 70W of heat has to be dissipated by the heat sink. In normal 'continuous communications service' only

the word 'continuous'.

Always remember that variable voltage PSUs get very hot if you run them at low voltage. The 'lost' voltage doesn't just disappear, it is converted to heat in the power supply. If you run them at half maximum voltage, you must also run them at considerably less than half maximum current.

costs a packet

Mark had brought several 2 metre rigs in to me with blown audio ICs and it was obvious that he was doing something wrong. Was he using an extension speaker of very low impedance, or had he a short on his leads, I asked. It transpired that his main interest was digital communications and that he normally took the output to his terminal unit from the loudspeaker socket.

There are a host of possibilities for creating short circuits when taking audio to external units, and many packet enthusiasts manage to blow the audio

worked perfectly. Alarm bells from previous experience rang, and I told him to bring down his rig as well as the ATU.

I wired up John's FT-50B to my dummy load and spectrum analyser - perfect. I then connected it via the ATU and there were a multitude of parasitic oscillations right across the screen. I explained to John that his rig was only just stable, and whilst it was OK into a dummy load, it was touch and go into an ATU. Some ATUs it would just about work with, others would cause it to take off. I tried a few different ATUs and found one that did work OK, but warned John that really it was his rig that was at fault.

This kind of fault can usually be cured by replacing the PA transistors with a carefully selected low gain matched pair. On the other hand, with older rigs the expense can hardly be justified, and it is better to 'leave well alone'.

because it peaks up with the preselector, but try as I will I can't find the cause."

Fred left the rig with me and, as I thought, it was the same fault as I had had about a dozen times on various rigs over the last 10 years. In less than an hour I had the rig up and running, but Fred got a bill for a little more than this, why?

The first time I had this troublesome intermittent fault it took me the best part of a week to find - a few hundred pounds if I had charged that customer on an hourly basis. I charged that particular gentleman for a couple of hours work, and ever since I have added an hour to the time when ever the fault has reoccurred in someone else's equipment. I reckon that most other people would have thrown the 25-year old rig out as 'uneconomical to repair' but at least now I am in profit, and Fred got his rig repaired.

The fault? Fig 1 shows the transmit neutralising circuit, and the neutralising voltage is fed back across C40. In Fred's rig

All in a Day's Work

ways of keeping old rigs on the air

half the time would be spent transmitting, and so the average dissipation would be just over half of this, say 40W.

In Tom's case the voltage drop at 15A across the regulators would have been much more. At 15A the input voltage would increase by about a volt, and so the voltage drop would increase to 18 minus 6 = 12volts. The continuous dissipation therefore would have been 12 x 15=180W. Over four times what the heatsink was intended to dissipate at its normal 50 / 50 duty cycle full load.

Terms like 'Continuous Output' are meaningless, unless the phrase is qualified by a length of time. Industrial power supply units might be rated so that this means 'for ever'. Amateur equipment, or other equipment intended to be used with a radio transmitter, is usually rated on the basis of half transmit and half receive. Unless a PSU specifically states that it will deliver full power on a 24 hour basis, play safe and reckon that the makers probably mean on a 50 / 50 duty cycle, even if they use

output stage of their rigs. Terminal units do not need a power audio feed, but only a voltage feed, and so it is preferable to use the low level or tape recorder output of a rig when feeding them. If this is not available connect a resistor of about 10 or 15 ohms in series with the audio feed. This will stop any damage being caused to the audio output chip, as it will prevent the output stage being short circuited.

faulty atu?

John came in with the ATU he had bought from me the previous week. "There seems to be something wrong with this, Harry, I can't get it to bring the SWR down, and it seems to be giving me TVI." I wired up the unit to a rig, and tuned it into a dummy load, when it was perfect. To further prove the point I then connected it to my G5RV, and once again it tuned up a treat. John was puzzled, went home to try again, but was soon on the phone saying that it was still no go. He explained that he had tried a friend's ATU, and that

noisy ft-200

Fred came in with his FT-200. "I know it's old but it's been spot on for years, and it's still perfect apart from an intermittent 'sizzling' sound on receive. I know it's somewhere at the front end,

(and quite a few other FT-200, FT-101, and FT-401 transceivers), C40 was found to be slightly leaky. This caused no trouble on transmit, but created the intermittent interference on receive. Replacing the capacitor cured the fault.

© RSGB HR411

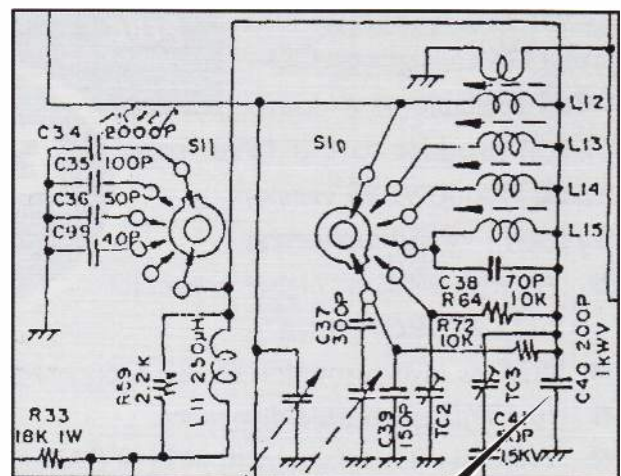

Fig 1: FT-200 transmit neutralising circuit. Replacing C40 can fix an intermittent interference on receive fault.

RSGB YEARBOOK



1998 EDITION

(incorporating all UK callsigns)

This new edition of the ever popular RSGB Call Book and Information Directory has been further enhanced with the inclusion of even more information on amateur radio than ever before!

- 100 page information directory providing essential information for the radio amateur - all in one place!
- UK Callsign listing
- WAB Square/locators
- Irish Callsigns
- Trade information
- Plus, much more . . .

£13.95

Plus P&P

**And by
special
demand**



£13.95

Plus P&P

CallSeeker '98

For the first time - the complete RSGB 1998 Yearbook, including the latest UK callsigns on CD-ROM available as a companion product to the 1998 Yearbook! Windows 95 version.

System requirements:

- PC with a 486 or higher processor and a CD-ROM drive.
- VGA or high-resolution screen supported by Microsoft Windows
- 10-15MB spare hard disk space
- Windows 95 or later with 8MB of RAM (16MB recommended) or Windows NT Workstation version 3.51 or later with 16MB of RAM (24MB recommended)

BUY THEM

BOTH

TOGETHER AT

THE SPECIAL

PRICE OF

£22.90 (plus P&P)

A SAVING OF

£5.00 ON THE

INDIVIDUAL

PRICES!

CALL RSGB SALES ON 01707 660888 TO ORDER



There were queues around the corner for early arrivals on both the days of the show.

Rally Report - London Amateur

Ham Radio Today Editor Steve Telenius-Lowe, G4JVG, wanders

The March edition of *Ham Radio Today* came out about a week before the London Show, which took place at the usual venue, the Lee Valley Leisure Centre, Picketts Lock Lane, in Edmonton, on 7 / 8 March. It was therefore an ideal opportunity for yours truly to talk to *Ham Radio Today* readers and find out what they thought of the new-look magazine. The stand was manned by Technical Consultant Chris Lorek, G4HCL; Emma Lund, 2E1GHL, from the Sales Department, and myself. I'm delighted to say that the feedback we received was very enthusiastic. We sold many hundreds of copies of the March issue and it was a real pleasure to talk to so many readers of the magazine.

Steve White, G3ZVW, wearing his Radiosport hat, reported that more than 7000 visitors attended the show over the two days. There were queues to get in on both days for those who arrived early. Steve also says that a number of small items of lost property were handed in to ▶



The main talking point on the Yaesu stand: the new FT-847 HF / VHF / UHF transceiver.



Walter Spieth, DK9SQ, with his *Portable Antennen*, a 10m long, extremely lightweight, telescopic fibre-glass mast. Ideal for a 40m vertical, for inverted-Vs, or to support a small VHF or UHF antenna. (Just love that hat, Walter!)

Val Wagstaffe of AKD with the bargain-priced HF3 receiver.

◀ the organisers. If you lost anything, call Radiosport on tel: 01923 893929.

Although it was very busy on the *Ham Radio Today* stand (particularly on the Saturday), I did manage to take some time off on the Sunday afternoon to chat to some of the dealers. In the Blue Hall, Peter Waters, G3OJV, of Waters & Stanton PLC, reported that sales had been excellent and that they had been kept very busy throughout the show.

Barry Cooper, G4RKO, on the Yaesu UK stand, said that there was "tremendous interest" in the new Yaesu FT-847 transceiver. "It's going to be a real winner for us", he said. The rig had arrived in the country just in time for the show, and the new transceiver took pride of place on the Yaesu stand, along with the new VL-1000 HF - 50MHz linear amplifier. Yaesu's free raffles caused a lot of interest, as always. This time, four lucky winners went off with

What?, I asked. He wasn't saying: we shall just have to wait and see!

Martin Lynch & Son introduced their new corporate image at the show. They're now known as 'M L & S' and all 'the Lynch mob' were to be seen wearing their snazzy blue and yellow sweat shirts bearing their new logo. Martin himself was delighted to have received the first Yaesu FT-847 in the country!

The FT-847 is up against the new Icom IC-746 HF - VHF transceiver, which featured on Icom UK's large and well laid out stand. "What's the difference between the IC-756 and the IC-746?", I heard someone ask Icom's Dennis Goodwin, G4SOT. Well, both were on display on the stand, so all interested visitors could find out for themselves.

Meanwhile, in the Green Hall, Val Wagstaffe of Stevenage-based AKD also reported excellent sales. On the Sunday, lucky

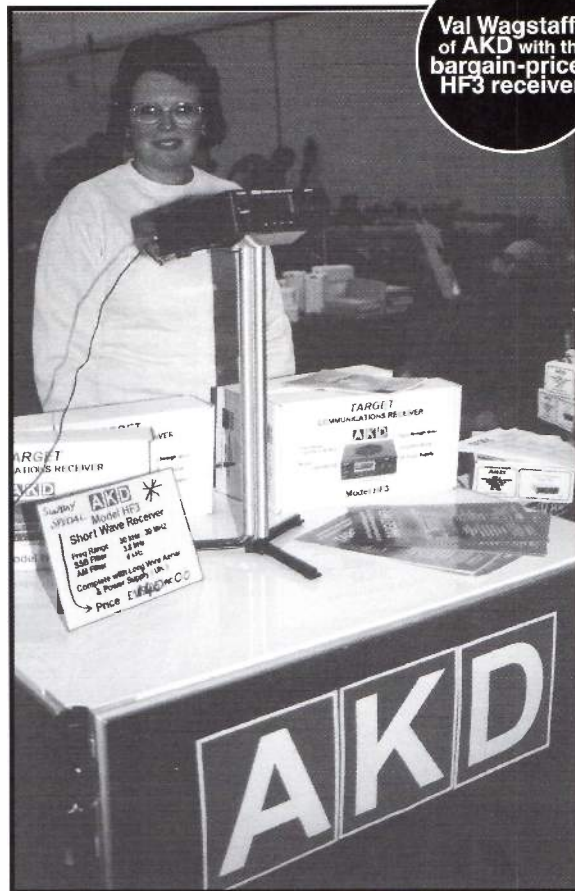

Radio & Computer Show

around the London Show

Yaesu FT-41R 70cm handhelds, with lots of minor prizes for runners-up. Barry also hinted that Yaesu was developing "something interesting" for the car.

customers could take advantage of some real 'show special' prices: the Target HF3 receiver was reduced to £140, whilst their VHF and UHF single-band

mobile FM transceivers were being sold for just £170.

For many people, a visit to the show is also the opportunity to catch up with friendships made

over the air and I met up with an amateur whom I had not seen since 1979. A lot of socialising was going on, and to this end I can report that the two bars were thronged with people around lunchtime on both days.

It was good to see so many overseas amateurs at the show too. Wes Lamboley, W3WL, came to say hello at the *Ham Radio Stand*, as did Ghis Penny, ON5NT, who was with a large contingent of amateurs from Belgium. I also spotted Hungarian, Japanese, German, Swiss, Indian and Irish callsign badges, and I'm sure there must have been many other nationalities present.

If it's some time since you have been to a rally or Amateur Radio show, do try to take the time out to attend one soon. Even if you do not go with the intention of making a major purchase, there is always something of interest for everyone at these events. Whether it's a 50p coax plug, 'junk', ex-PMR equipment, cables, the latest software, or a new £1600 rig, there's always *something* of interest . . .



Do you have something constructive to say on the state of amateur radio today? Perhaps you'd like to put your viewpoint to the readers, get some discussion going, or give an answer to one of the issues raised? We'll pay £10 for the best letter we publish each month (paid 6-8 weeks following the publication date). So write in with your views to; Letters Column, ham radio today, Lambda House, Cranborne Road, Potters Bar, Herts EN6 3JE or send an e-mail to hrt@rsgb.org.uk We reserve the right to edit letters for length, grammar and clarity for publication. Letters must be original and not have been sent to any other magazines, and must include name and address plus callsign if held (name and callsign will be withheld from publication if requested). Reader's views published here are not necessarily those of the magazine.

letter of the month letter of the month letter of the month

Dear HRT,

I am completely astounded at reading a fellow reader's letter in HRT Letters (Vol 16 No 2). He suggested that home brew projects be abolished from HRT and be replaced with rig reviews and integrating the youth of today into Ham Radio. I am a keen SWL and I am currently trying to find out where I can study for and sit my NRAE. I am part of the youth of today and I would and do spend time on home brew projects. Far from abolishing the practical articles I would like to see more. It is home-brew that makes Ham Radio for myself and many others.

David Passey, age 13

Dear HRT,

I was delighted to see in the January 1998 issue of HRT the very nice write-up about the ISWL change of Honorary Officers and in particular the kind comments expressed about myself. It was a very pleasant surprise and much appreciated.

The ISWL is recognised by both licensed amateurs and SWLs as a very worthwhile club to join and we are very pleased with the interest shown by the radio fraternity. Having celebrated our 50th Anniversary in 1996 we hope to continue for many more years.

All the very best to the staff at HRT.

Evelyn May, G00ZI, G-17197

letters letters letters

Dear HRT,

I do not normally write to magazines, but comments made in this issue [Vol 16 No 2] have changed this.

I agree with the comments by John Mallard, but who is going to pay for all this equipment? I doubt if packet users will.

I know theory says that audio bandwidth on 2m is inadequate, but understand that a normal telephone line has similar bandwidth to a radio channel and works well at 33.6kb. In the fine amateur tradition of debunking professional theory, has anyone actually tried using a computer modem system over a radio channel?

To the anonymous correspondents I would say take care. We hold our frequencies by international convention for "self training in wireless telegraphy". This could mean that we self train in button pushing, but I doubt it. Reported comments of the Minister at the recent 'Young Amateur of the Year' award noted that Amateur Radio is a foundation for future radio and electronic engineers, of which there is a shortage. In other words, the authorities believe that we are self-training in how it all works. For that, you need to know some theory, and have experience of putting things together. If this is ever lost we will lose our bands - it is that simple.

Young people (my own included!) have short attention spans. Those who want simply to communicate with others will probably gravitate to IRChat (providing mum and dad can afford the phone bill!), but those who have a spark of interest in how it all works could be attracted into Amateur Radio. However, they will only do that if it seems relevant to them, which brings me back to the first point; Amateur Radio's image is 1958 and not 1998.

All hobbies seem to be in decline, not just Amateur Radio. Is this related to recent survey results showing the UK having the longest working hours in Europe, and poor transport? The net result is little spare time.

Licensed readers could do much to reinvigorate this hobby - by simply answering CQ calls. Busy people will try to operate in a spare half-hour, but if they spend it fruitlessly calling CQ they get bored and do something more productive. I know - it happens to me.

Alan Messenger

Dear HRT,

Congratulations on the new-look March 98 Ham Radio Today. The current issue is of much better quality, which includes the paper that it is printed on. I do hope that there will be more items of home construction in future editions as this is what attracts me to radio and electronic magazines. I also find that there is quite a number of reviews on ham radio rigs, which no doubt will be useful to hams which are thinking of purchasing a new one.

I like the feature *All in a Day's Work* by G3LLL, it was very interesting to read, especially the feature on the Datong unit causing a short on the rig it was connected to via the jack plug. A much safer way is to change the DC connector to a DC socket and plug as used in radios and cassette recorders etc, as these cannot short out if removed from the equipment with the power still switched on.

Free Readers' Ads is a good idea: it makes it cheaper for readers to dispose of items.

It looks as if HRT will be a good mag for non-members of the RSGB who are radio hams / short wave listeners.

R O Broome, G1YKO

"TONE" BURST



by GMBMEN

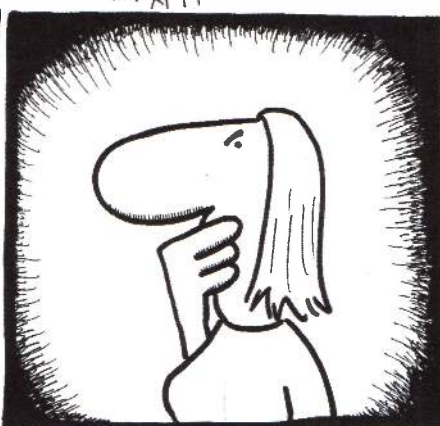

Dear HRT,

I have found that buying ham radio equipment can be a lottery. One time my wife and myself stood in an empty shop for 40 minutes, we thought we had gone invisible. In the end we walked out and the shop lost £2000 in sales. How many times have I ordered equipment, then had to chase the supplier for months? So this year I thought I would see who is the best.

I sent a letter to five ham radio suppliers, asking for a quote on equipment, book price about £3500, and asking what was their best price for cash. I was not surprised when only one, Waters & Stanton, sent a reply. So we gave them a call, to find to my great pleasure they would give a good discount.

At their shop I was treated so well, it was great. To test the after sales service, I sent an e-mail to Waters & Stanton and the manufacturers, the reply from Waters & Stanton came in under 12 hours. The manufacturers - I am still waiting. I would like to give my thanks to Waters & Stanton for a good experience.

Kerry Brown

letters letters letters

10 for letter of the month

Dear HRT,

I do not often write to magazines but I think it is about time someone drew to your readers' attention a very unpleasant change in attitude amongst certain Radio Amateurs over the last few years. It seems to have affected most parts of the hobby, but is most prevalent amongst those who claim to want to do something for others in the hobby, but appear to have a strange set of motives. These manifest themselves in the following ways:

1. Told that there are certain standard procedures that they need to follow before they can gain what they want their immediate reaction is on the lines of "I do not think those rules are necessary, they do not apply to me, I want what I want just because I want it, and so when are you going to give it to me."

2. Given that the person they are dealing with (RSGB, RA, RIS or whoever) refuses to grant them what they want within a very few days they threaten and bully, and on the sidelines spread malicious gossip and invented untruths on the Internet and / or packet.

3. When that does not work either then they write letters to the RA or to their MP decrying the appalling service they are getting from this that or the other body so creating yet more work for those, both full-time and volunteers, already trying to deal with the honest and straightforward applicants who did follow the rules and procedure.

4. If even that does not work then they either go ahead and do what they wanted to do anyway, citing the lack of service as their justification, or else use other less savoury routes to achieve a large percentage of their aims by what most of us would call improper, barely legal and undoubtedly suspect means.

So I simply ask two questions:

A. What drives these radio louts to make so many other peoples' lives so difficult? Would it not be just as simple for them to go ahead and do what they want anyway, or do they have some hidden agenda?

B. As this is only a hobby why do we see such oafish and loutish behaviour in any case, unless by some strange chance the practitioners of this 'art' stand to make financial gain out of their activities?

Howard Cummings

Dear HRT,

I've just retrieved the March Ham Radio Today from the doormat and it isn't nearly as scary as I feared it might be. I must disagree with one of your correspondents in the previous month's 'Letters' who advocated the complete removal of all projects / technical articles from the magazine. I buy this magazine primarily for the PMR conversion articles which have become the 'trademark' of the magazine, and also for G3LLL's *All in a Day's Work* and G0BPS's *QRP Corner*. In other words, I buy it for the technical content, and if anything, would prefer to see it increased, rather than disposed of.

Graham Galbraith, M0ADR

Editorial comment:

I'd never really considered Ham Radio Today to be a scary magazine - but I think I know what you are getting at! Suffice to say we will be continuing the PMR conversion articles, All in a Day's Work and QRP Corner, of course. However, there is definitely a shortage of good articles about PMR conversions: so if anyone has successfully done a conversion recently, please do let us know. In the meantime, HRT Technical Consultant Chris Lorek, G4HCL, tells me he's working on a new one now, which should appear in a few month's time. Keep buying Ham Radio Today and keep a look out for it!

Dear HRT,

When I received the March issue of Ham Radio Today I felt a sense of relief. I have been a reader of HRT since 1991, largely for its ex-PMR conversions, and I had become increasingly concerned about the deterioration in quality, increasing number of self-advertisements and increased print size. When Sheila Lorek resigned as editor I suspected that the end was nigh.

The latest issue is like a breath of fresh air. The quality is back and the mag is now backed by an organisation which has the interests of its market at heart. I look forward to the April issue!

J Richard Hardcastle, G7EML

This page was a customer survey sheet

This page was a customer survey sheet



"Weighing in at nearly 2kg, it's no lightweight but its size is an acceptable 70H x 152W x 178Dmm. Built into a die-cast case and finished in mid grey, it certainly has the appearance of a rugged unit..."

Ham Radio Today is the first magazine to take a sneak preview at

Last spring, the American company SGC Inc announced its acquisition of Index Laboratories, the makers of the Index QRP HF transceiver and subsequently the QRP Plus. Although very popular and well-respected in QRP circles, the Index Plus in many ways became a victim of its own success. The designer, Bruce Franklin, was operating from a small factory unit in Canada. He was having problems in meeting the growing demand, and had no capacity for future product development. For these reasons he eventually decided to hand over control to SGC. This left Bruce free to concentrate on the new design, to be known as the SG-2020, whilst SGC organised the production and marketing.

Delivery of the new SG-2020 was scheduled for September 1997 but then SGC announced the product release would be delayed until January of 1998.

In fact it was not until the beginning of March that the first pre-production unit reached the UK distributors, Waters & Stanton, with a request from the factory that it be returned within a few days together with an assessment report. Whilst this shows determination on the part of SGC to make sure their product fully measures up to its promised performance, it only gave *Ham Radio Today* a day to carry out a sneak preview.

features

Weighing in at nearly 2kg, it's no lightweight but its size is an acceptable 70H x 152W x 178Dmm. Built into a die-cast case and finished in mid grey, it certainly has the appearance of a rugged unit and perhaps reflects the manufacturer's strong presence in the professional market place.

The SG-2020 offers SSB and CW operation on all ham bands from 1.8 to 30MHz and a gen-

eral coverage receiver throughout the range. AM reception would have been nice for broadcast listening, but at least you can switch between USB and LSB anywhere in the range, something you couldn't do on the old Index model. Power is quoted as 20 watts maximum with continuous control down to zero (see later comment), a feature which is a must for any serious QRP transceiver. The microphone supplied is a dynamic fist type, which looks somewhat large when placed beside the transceiver. The built-in speaker provides 1 watt of audio output, and the LED meter serves to indicate signal strength and RF output. All control buttons are of the rubberised type with rubberised surrounds for the main tuning dial, volume and RF controls.

Twenty programmable memories are provided and split frequency operation is possible using the RIT and XIT facilities.

For the CW operator, a built-in iambic keyer is included with full break-in and a speed range of 5 - 60WPM. Current drain on standby is a very modest 430mA from the nominal 13.8V input requirement.

design

The receiver is a single conversion design with a 60MHz IF, the selectivity being achieved by a seven pole ladder filter followed by variable SCAF digital filters that cover the range 2.7kHz down to 100Hz. RF signals from the antenna terminal are fed through switched filters, common to both transmit and receive, and then directly to a double balanced mixer. SGC claim their front-end design has a wide dynamic range and this combined with a single conversion design and low noise synthesiser makes for a very clean receiver. Transmitter design is conventional with RF speech processing and a well-

rated 40 watt PA that easily handles the 20 watt design requirement.

switching on

As time was short, it seemed sensible to try the transceiver on the air and see how it would cope with today's crowded bands and some of the strong signals on 7MHz. The SG-2020 was connected to a multiband dipole at 40ft. The tuning proved to be very smooth and the LCD display with the switchable backlight gives a readout accuracy to 100Hz. Tuning steps are not quoted but appeared to be 10Hz. The recovered receiver audio was clear, with more than adequate output to the internal speaker. By pressing the BW control and rotating the main dial, the bandwidth is variable in 1kHz steps from 2.7kHz to 1kHz and then in 100Hz steps down to 100Hz. This makes adjustment very quick and easy, and in a similar manner pass-band

tuning and band changing can be achieved by pressing the appropriate button and rotating the main dial. There is no RF attenuator, but the RF gain control seems to provide more than adequate attenuation at the mixer and the receiver showed no signs of distress when tuning weak signals on a busy 7MHz band at night. Sensitivity also seemed more than adequate with a lively feel right up to 10 metres - even though there were no signals to be heard other than the noise of passing cars (and the noise blanker handled this!)

Power output is controlled in 1 watt steps from 25 watts down to 1 watt with digital confirmation in the LCD window. Although the minimum power setting in the LCD window is 1 watt, it seems that further rotation of the power control reduces the level down to about 500mW. Running 20 watts SSB on 80

metres the first reply gave an RS 59 and reported excellent audio. This was followed by a contact who reported the audio as being "very natural." There is no external control for microphone gain and one must assume that the RF speech processor is permanently switched in, as there was no obvious way of selecting it and no clue given in the draft instructions. Several QSOs followed on 20 metres with similar success.

On CW, the keying characteristics appeared to be good and the built-in keyer behaved very much like those in many of today's popular rigs. The manufacturers claim full break-in although in truth there is a small delay. The sidetone level is controlled by the receiver AF gain and nicely matched the received audio level. It seems that there is no way to adjust the dot / dash ratios but the factory settings appeared to be perfectly acceptable.

summing up

The first impression was of a transceiver that was simple in design, yet technically advanced. The single conversion and the apparently excellent dynamic range offers a package that almost any QRP operator would be happy with. Indeed, with a beefed-up power output it would probably perform very well as a main base station transceiver.

The introductory price is £599 inc VAT, and at about two-thirds of the price of its predecessor, it certainly offers excellent value for money. It would also seem to offer possibilities for mobile operation. Out thanks go to Waters & Stanton PLC for making it possible to be the very first magazine to get our hands on this lovely little radio. At the time of writing, the importers expect the first production units to arrive in the UK in early April.

SGC SG-2020 QRP Transceiver

this new rig designed specifically for dedicated QRP types

"Although the minimum power setting in the LCD window is 1 watt, it seems that further rotation of the power control reduces the level down to about 500mW."





Most of the antennas were mounted on push-up masts. Here, Ray, G3NOM, and Vince, K5VT, put finishing touches to the Cushcraft A3WS WARC bands beam.

Landing at Layang-Layang can be hazardous - for the birds, at least.



9MOC - Spratly Islands 1998

Ham Radio Today special colour feature on the biggest

The Spratly Islands in the South China Sea hold a unique fascination for radio amateurs. Ownership is disputed, with several adjacent countries laying claim to some or all the islands of the archipelago, and two ham radio DXpeditions to the Spratlys have come under gunfire, one with fatal consequences.

In recent years the political situation has clarified a little. To drive out modern-day pirates, who used some of the islands as bases for their nefarious activities, and to establish the legitimacy of their claims, the various surrounding countries have themselves occupied the islands closest to their territory. So although ownership continues to be disputed, a *de facto* resolution is emerging. The DXCC program now only recognises ham radio operations from the Spratlys which have used a call sign issued by one of the occupying powers, rather than the 'self-issued' 1S call signs which were used in years gone by.



Layang-Layang from the air. The sea wall and landing strip were built in 1991.

layang-layang

While most of the islands remain uninhabited except for the various occupying military, Malaysia has developed Layang-Layang (formerly known as Swallow Reef) 160 nautical miles off the coast of Sabah as a dive resort and bird sanctu-

ary. Layang-Layang is a coral atoll, of which only a handful of rocks and two sandbanks used to be above water. The two sandbanks have now been linked to form the resort, and a runway constructed. A small naval detachment also occupies one end of the island. There is excellent accommodation, and

a regular air service to the island from Kota Kinabalu on the mainland. Since the resort was built there have been several amateur radio operations from there. The first and biggest was 9MOS in 1993 which made over 36,000 contacts, despite a limitation then in force that they could not use linear amplifiers. Subsequent operations have been lower-key, often by hams who were there mainly for the diving (Layang-Layang is recognised as having some of the best scuba diving in the world).

Nevertheless the Spratlys remained high on 'Most Wanted Country' surveys, especially with amateurs on the East Coast of the US, who have a difficult polar path to that part of the world. In 1996 *Ham Radio Today* editor Steve Telenius-Lowe, G4JVG, became fired with the idea of mounting a large-scale DXpedition to Layang-Layang which would take enough equipment and antennas to be able to lay down good signals on all bands and into all areas. Others

Up she goes! The 85ft Titanex vertical for 160, 80 and 40m was 'walked up' with ease.



help from sponsors

Yaesu agreed to make available four high-power HF stations, each consisting of an FT-1000MP and the newly-released VL-1000 linear amplifier, as well as two FT-920s, one of which would primarily be for 6m use, and the second as a general-purpose back-up.

Cushcraft, through their UK importer Nevada, provided a 3-element 20m Yagi, two A3S HF tribanders, one with an extended driven element for use on 40 metres, an A3WS tribander for 30, 17 and 12 metres and a 6-element Yagi for 6m. On 40 and 80 metres we would use four-square arrays based on vertical radiators from Gladiator of the US. We had also been offered the loan of a Battle Creek Special (BCS). This is a trapped inverted-L which is built very substantially and for idiot-proof assembly, specifically for loan to DXpeditions. The BCS programme is run and financed by a group of low-band enthusiasts

lications (UK), 59(9) Report of the US, Camel (who loaned us a satellite phone to permit links to the Internet while on the island), Malaysian Tourism Promotion Board (QSL cards), the Layang Layang Island Resort, and the Sabah Tourism Promotion Corporation. We also received many donations from DX associations, clubs and foundations, as well as from a number of generous individuals, all of which we acknowledge with thanks.

arrival

The crates of heavy equipment (1.5 tons in all) were sent by sea, and trans-shipped to Layang-Layang by fishing trawler, accompanied by four intrepid 9M6 amateurs, all of whom fell victim to the heavy seas. However, they did achieve one notable 'first', by working back to Sabah on 2m through the repeater high on Mount Kinabalu.

We intended to be on the air for two full weekends, to give as many people as possible the opportunity to work us. On 9 February, a day before the rest of the

9MOC - Spratly Islands 1998

ever British HF / VHF radio operation, by Don Field, G3XTT

were quickly co-opted into the team: Tony, G00PB; Neville, G3NUG; Don, G3OZF; John, G3WGV, and myself. Donald, 9M6SU, was also an early recruit, to be our link-man on the ground in Sabah. Later we brought in Vince, K5VT; Ray, G3NOM; Mike, G3SED; John, G4DQW; Jeff, 9H1EL; and Kazu, JA1RJU.

planning

We quickly decided that to make a major impact in the specialist areas (low bands, WARC bands, RTTY and 6m), as well as satisfying basic demand for Spratly, we would need to run at least four stations round the clock, limited only by band openings. We would also need substantial amounts of aluminium, to achieve strong signals across the globe.

Our choice of high-band antennas was based on being able to operate on any of the bands, with 20m being a basic 'run' band on which we would try to have a signal whenever the band was open, but with the flexibil-

ity to run two signals (one on CW or RTTY, one on SSB) on 20, 15 or 10 during significant band openings, especially to the US.

We set a QSO target of 40,000, which we thought would get us beyond contacts with the bigger stations (those with beams and linears) and really start to make inroads into the demand from less well-equipped HF operators worldwide. With this QSO target, computer logging would be essential, and would also ease the job of the DXpedition's QSL manager, a task for which Phil Whitchurch, G3SWH, proved to be a willing volunteer, with top SWL Bob Treacher, BRS32525, agreeing to take on QSLing listener cards.

Having set ourselves these targets and agreed an expedition motto "to reach those parts that other Spratly DXpeditions have not reached", it was clear we had a major exercise in logistics on our hands. It was time to divide up the work, and to start looking for some external help.

from Battle Creek, Michigan, who do so in order to encourage expeditions to focus on 160, 80 and 40m operation.

Yaesu also provided UHF handhelds and Timewave AEA provided TNCs in order that we could link the stations by packet radio, to be able to back-up the logs to a central server in real time and to provide communications between the stations. Along with computer interface to the radio, this meant, for example, that at any operating position there would always be information about who the operator was at other stations and on which frequency he was operating.

Martin Lynch & Son helped us with a vast quantity of ancillary equipment. For example, we ended up taking 2km of Westflex cable, all but 100m of which ended up being used! Dunestar of the US kindly agreed to loan us three complete sets of filters to minimise inter-station interference. Other corporate sponsors included *CQ Ham Radio* magazine (Japan), Radio Active Pub-

Mike, G3SED, adjusting a 160m receive antenna. In the background, the Cushcraft 6-ele 6m beam and one of the A3S tribanders.

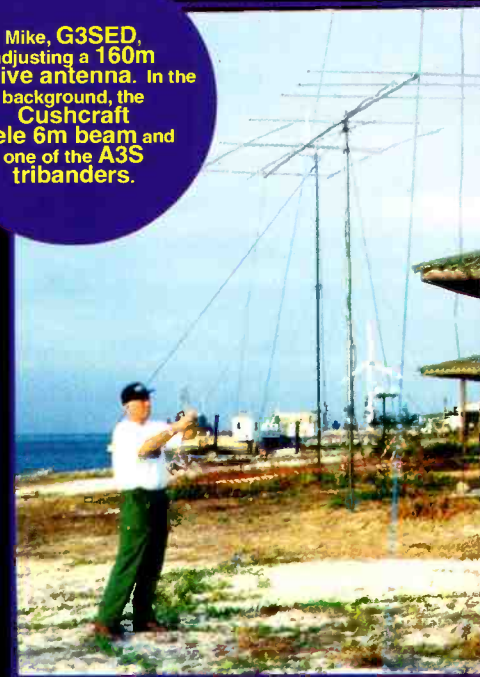

team, G3NOM and G3OZF flew out to Layang-Layang, and surveyed the site for best location of antennas etc. We were able to speak to them from the mainland, thanks to Phil Weaver,

Left to right:
G0OPB, G3SED, G3OZF,
G3WGV, N2QW,
9M6SU, G3NUG,
9H1EL, G3XTT,
G4JVG, K5VT,
G3NOM and JA1RJU.
The Malaysian flag
flew on top of the
bamboo pole!

9M6CT (ex-VS6CT), before attending a welcome dinner hosted by the Sabah and Borneo radio clubs.

After a 70-minute flight by Twin Otter the following day, we received a warm welcome on Layang-Layang by resort managers Steve and Coralie Stewart, two outgoing Australians who did everything they could to make our operation a success.

Station assembly took two days, and we had agreed at an early stage that we wanted to get as much done as possible before actually taking to the bands. As well as the antennas described above, we had added a Titanex vertical for 160, 80 and 40m, a pair of phased verticals for 30m (made from modified CB whips), and a 2m Yagi (to work back to the mainland via the Mt Kinabalu repeater). The Titanex is a formidable beast. 85ft high, it is made of very light titanium alloy, and can be erected by just two people. 9M6SU had also brought along several bamboo



poles on the island after our departure for possible future use by visiting hams.

Our antenna farm was quite a sight when complete, with the main antennas lined up along the shoreline just feet from the sea.

time during the first evening, for example, we were working into Europe on 160, 80, 40 and 30 metres, whilst working the US on 20 metres. The *PacketClusters* must have been buzzing with activity. There were always two

Yoichi Sakurada, JP1NWZ, took on the job for Asia; Don Greenbaum, N1DG, for the Americas; and Martin Atherton, G3ZAY, for Europe and Africa, as well as being 'chief pilot' with responsibility for updating our

9MOC - Spratly Islands 1998

Ham Radio Today special colour feature on the biggest



poles, up to 40ft long, which he had cut from the jungle and which we pressed into service for supporting wire antennas such as a low 160m dipole for receiving purposes. We left these

The 80m four-square, which took up the most space, was at the far side of the aircraft apron, some 300 metres from the 'shack' (a large conference room in which we set up all six stations).

on the air

After dinner on the Wednesday evening we sat down for a final conference to agree operating schedules for Day 1. Finally, around 11.30pm local time (1530UTC) all the preparatory work came to fruition when G4JVG made the first 'official' QSO: K5DV on 20m (the advance party had already made a few QSOs under the 9MOC call). The world must have been waiting, because in the first 24 hours we made 8000 QSOs! It didn't take long to realise that when 6m was closed its operating position and the backup station could also be pressed into use on the HF bands, and we frequently found ourselves operating on six bands simultaneously. We could only imagine what impact this was having in our target areas - at one

or three bands open, and around dawn and dusk we often found all nine HF bands open simultaneously and had to decide on priorities.

The big disappointment early on was the high noise level on 160m. This wasn't just a matter of static crashes, but continuous static above S9, which made it difficult to copy all but the loudest signals. This was especially frustrating because early reports indicated that we were being heard very well indeed, both in Europe and across the US.

on the 'net

One of the lessons we had taken to heart from previous big DXpeditions was the need for interaction with the amateur population at large. This helps hams around the world to feel a part of what is happening, and permits the DXpedition team to be aware of what they are doing right and what they are doing wrong (for example, by missing important band openings). Accordingly, we appointed 'pilots' to perform the liaison role.

Web pages as the expedition progressed.

The role of the pilots was extremely valuable. We quickly fell into a routine of holding a short team meeting once a day, where we reviewed their feedback and adjusted our operating schedule accordingly. We were also able to use the pilots to disseminate information, for example about when we proposed to operate RTTY.

We used the satellite link to upload logs and photographs to the Internet on a daily basis, with Don, N1DG; and Richard Everitt, G4ZFE, operating log servers. John Clayton, G4PDQ, provided a similar service for *Packet Cluster* users. This enabled hams to check within 24 hours or so of a contact that they were indeed in the log, and by the time we closed down the servers had recorded well over 20,000 'hits'.

some stats

We were delighted to see so many UK contacts in the log - 1799 at the final

turn to page 34



Waters & Stanton PLC

FREE-PHONE ORDER LINE

0500 73-73-88

22, Main Road, Hockley, Essex. SS5 4QS

Open Mon-Sat 9.00AM - 5.30PM

New Web Site:- <http://www.waters-and-stanton.co.uk>



Peter Waters G3OJV / G0PEP

Part Exchange Welcome

Download our latest second hand list from our web site



25th YEAR of Service to UK Amateurs

This is our 25th Year of retailing Ham Radio equipment - unmatched by any of our competitors. We shall be offering some unique deals - also unmatched by our competitors! **UK's TRUE Number One Dealer**

Read the latest Hot News on our Web

Orders: 0500 73 73 88

01702 206835

Enquiries 01702 206835

01702 204965

FAX 01702 205843

E-mail sales@wspc.demon.co.uk



NEW C-408



From HORA
70cms
Handheld
Full
CTCSS

£89.95!

FREE Postage

SPECIAL OFFER PRICE

Full CTCSS; 20 memories; 1.6MHz repeater shift; Priority channel, Scanning; Dual watch; Dual mode squelch; PTT lock; 12.5/25kHz steps, 230mW output - all from just 2 x AA cells

SGC-2020 QRP HF Transceiver



NEW £599

1.8 - 30MHz

0 - 20 Watts SSB and CW with full break-in. Can run from 12 volts or internal pack. Delivery expected at the end of March

Kachina 505DSP HF Transceiver



Send for Brochure

A complete PC controlled remote HF rig - In stock

Main Features

£1995

100W HF All bands + Receive 100kHz - 30MHz
Filters for SSB 3.5, 2.7, 2.4, 2, 1.7kHz
Filters for CW 1kHz, 500Hz, 200Hz, 100Hz
Band Scope, DSP filter, Memory keyer, log book, VSWR meter, Smith Chart, pre-amp, 20dB attenuator, plus many software controlled functions.

HORA C-150

2m FM Handheld

£99.95

Can you believe your eyes?

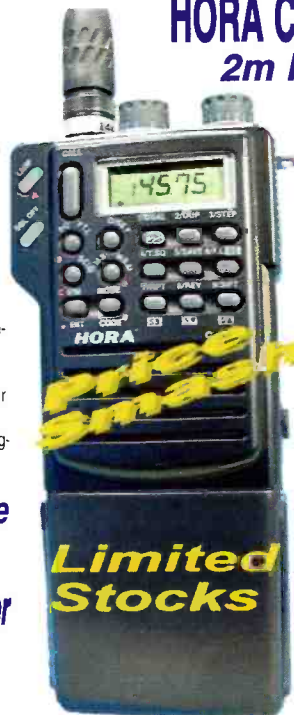

Limited Stocks

25 / 12.5kHz Steps
130 - 170MHz Rx
1750Hz Tone
20 Memories
Scanning
Battery Save
5W (Ext. 12V)
LCD Readout
Keypad Entry

Includes:
6 x AA cell case
Antenna
Instruction Book
12 Month's Wtly.

KENWOOD TM-451E 70cms Mobile

Save £210!



£249

A chance to purchase this top range 70cms mobile at a silly price! 35 Watts output, 41 memories and CTCSS encoder gives you all you need to enjoy mobile or base station operation. 12.5kHz/25kHz steps are featured together with a clear LCD.

ADI AR-146 2m 50W



£249

FULL CTCSS

- * 3 Power levels - Wideband receive
- * 40 Memories plus call channel
- * 7 Programmable steps
- * Channel or frequency display
- * The best sensitivity in the business
- * Keypad mic and mounting kit
- * CTCSS Encode and Decode!

1998 Catalogue



- * Largest in Europe
- * 176 Colour Pages
- * 1000 Photographs
- * 1400 Products
- * Technical Specifications
- * News Snippets

Now established as the foremost equipment guide this edition is completely new with every page in full colour and almost every item illustrated. For the cost of a magazine you can get the best guide ever.

£2.95 plus £1 postage

WATSON

Hunter

Frequency Counter

Features:

10MHz - 3GHz

Ni-cad Pack

AC Charger

BNC Antenna

Full Instructions

£59.95

Add £2.50 Post & Ins.



FREE frequency guide worth £12.95 on orders during Feb. & March

Check your base or handheld transceiver, or hunt out frequencies of nearby transmitters or handhelds. The "hold" button lets you lock on and store the frequency.

WATSON W-MM1 Multimode Modem



£69.95

- * Packet, AMTOR,
- * CW, SSTV, Fax, RTTY
- * NAVTEX, SYNOP
- * Transmit and receive
- * Powered from RS-232 port

ADI AT-600 Dual Bander

New Low Price £249



AM Air Band

PW says: "an incredibly well priced radio - amazingly sensitive - audio - worked very well with 12.5kHz channel spacing - An Absolute Cracker"

- * CTCSS encode/decode
- * Full DTMF + 1750Hz tone
- * Alphanumeric memories
- * Full duplex
- * CTCSS tone reader
- * 29 programmable features
- * AM airband receiver
- * Rx up to 990MHz
- * Ni-cads and charger

ADI AT-201 2m FM Handy



FULL CTCSS

£149

- * 40 Channels
- * 5W on 12V
- * Illuminated keypad
- * Full CTCSS
- * 1750Hz tone
- * DTMF
- * Channel Reasout or
- * Frequency Readout
- * Set to Set Cloning
- * Uses AA cells

Phone For Details

Extended Warranty Now Available

UK's Top Dealer for YAESU, KENWOOD & ICOM

W&S

YAESU FT-847 it's Here!



£1495

1.8MHz to 432MHz

Includes 70MHz Transceiver

100W 1.8 - 50MHz * 50W 2m/70cm* SSB - CW - FM - AM * CTCSS * Alphanumeric * 0.1Hz steps * Packet ready 1200 & 9600 * DSP filtering * Dual display * squelch * IF shift * Notch filter * Power control * Tx monitor * Electronic keyer * 12.5 / 25kHz switched FM filtering * Switchable pre-amp * Size 260 x 86 x 270mm * weight 7kg

ICOM IC-706 Mk II 1.8 - 146MHz **£995**



PRICE MATCH

We are pleased to endorse the performance and design of the IC-706 Mk II transceiver as the best compact hf mobile bar none. It out performs and out specifies any other model. The only choice left is which dealer you buy it from! We offer you an unbeatable price and an unbeatable back-up service plus optional extended 5 year warranty for an extra £98!

Alinco Prices Down!



DJ-C1E
2m FM

Credit card size with full CTCSS - 300mW
20 memories - AM Air
Review February RadCom
Normally **£169.95**

£139.95

DJ-C4
70cm FM

Slip it into your pocket for rally use or the local repeater. Earpiece and AC charger included.
See page 52 of Feb RadCom

Normally **£99.95**
£169.95

This Month Lowest Yaesu Prices Ever!
10 Day Approval 24 Month's Warranty

YAESU FT-920 1.8 - 54MHz **£1269**



PRICE MATCH

+ Free FM board & AM Filters

* 1.8 - 54MHz 100W * DSP filter * MOSFET PA * Internal ATU * Auto notch * Twin VFOs * Auto glow display * Shuttle jog * Digital voice memory * Electronic keyer * RS-232C converter * Quick memory bank + lots more phone or e-mail for colour leaflet

YAESU FT-1000MPDC **£1895**



PRICE MATCH

* 1.8 - 30MHz 100W * SSB - CW - FM - AM * Rx 100kHz - 30MHz * Message memory * Dual in-band rx * EDSP filter * RF processor * RF pre-amp * Electronic keyer * IF shift width * Collins filters * Comprehensive menu system * RS-232 interface and more - send for details

ICOM IC-746 1.8 - 144MHz **£Phone!**



PRICE MATCH

* 100W 1.8 - 146MHz * SSB - CW - FM AM * Electronic keyer * Gen. cov receiver * Spectrum scope * DSP noise filter * Notch filter * IF pass band tuning. Delivery from stock.

YAESU FT-8100 Dual Bander Mobile **£369**



Save £100!

Yaesu's new dual band mobile makes the competition look old and out-dated. You get a detachable head, 300 memories, true dual same band rx, CTCSS encode and the best display in the business.

KENWOOD THG-71E Dual band

* Dual Band 2m/70cm
* 200 memories
* Alphanumeric Display
* Full CTCSS
* DTMF
* Up to 6W out
* Wideband Receive
* Illuminated Keypad
* PC Compatible
* Windows Programming
Send For Brochure

Phone **£279**
Special Price



ICOM IC-756 HF + 50MHz **£1495**



PRICE MATCH

* 100W of pure Magic
* 160 - 6M
* SSB - CW - AM - FM
* Spectrum display
* Auto ATU
* Superb DSP built-in
* CW Memory keyer
* 100% duty cycle
* Keypad entry option
* DXers choice in the USA

YAESU FT-50R 2m/70cms Handy **£229**



* Wideband Rx (AM Airband)
* FM Broadcast receive
* CTCSS & 1750Hz
* 112 Alphanumeric Memories
* Dual Watch - Military rated
* 5W from 12v DC input
* Ni-cads and AC Charger

This is a very solid rig that is proving one of the most popular dual band handhelds

YAESU VX-1R Dual band

The world's Smallest HT From the UK's Biggest Dealer! **£219.95**



Our best selling dual bander and one we would be happy to own.

ICOM IC-207H 2m/70cm Mobile **£329**



PRICE MATCH

* 2m & 70cm
* 50W / 30W
* Detachable head
* Packet 9600 bps ready
* 180 Memory channels
* CTCSS & 1750Hz tone

Rechargeable

Alkaline Cells For Starter Kit



Now **£13.99**

* Rechargeable Alkaline
* 1.5V cells
* No memory effects
* Charge mid cycle is OK
* 5 year charge shelf life
* 3 x capacity of ni-cads
* Very low cost

In stock now! * Note: you must use the special charger supplied with Starter Kit.

Starter Kit: Comprise 4 x AA cells and dedicated AC wall charger **£13.99 + £2 p&p**

4 x AA cells (ready charged) **£5.99 (£1.00 post)**
8 x AA cells (ready charged) **£10.99 (£1.50 post)**
4 x AAA cells (uses standard charger) **£6.25 (£1.00 post)**

KENWOOD New TM-G707 **£439**



New Model

* 144 & 430MHz 50/35W
* Packet Ready
* 180 Memories
* Detachable front head
* CTCSS & 1750Hz Tone
* Large clear display

ICOM IC-T8E Dual Band handy
6m 2m 70cms **£349.95**

All in one small package.

* 5W output (13V)
* 25 / 12.5kHz ready
* Wideband Rx
* Nickel Hydride batt
* Wide FM broadcast
* AM for airband
* Rapid scanning
* Alphanumeric





Lowe Electronics Ltd

Chesterfield Road
Matlock
Derbyshire, DE4 5LE
Telephone
(General Enquiries)
01629 580800,
Fax 01629 580020

**Orders
FREEPHONE
0800 174749**

Branches

Bristol & Wales
79 Gloucester Road, Patchway
Bristol BS12 5QJ
Tel 0117 931 5263
Fax 0117 931 5270

North East

Unit 18B
Airport Industrial Estate
Newcastle, NE3 2EF
Tel 0191 214 5424
Fax 0191 214 0761

South West

117 Beaumont Road
St Judes, Plymouth PL4 9EF
Tel 01752 257224
Fax 01752 257225

Showroom opening hours are
9.30am to 5pm Mon-Fri and
10am to 4pm on Sat, but check
with our local branches as times
may vary

**Make
sure you
visit our
web site
at
http://
www.lowe.co.uk**

HORA C408 UHF Transceiver

The new C408 Hora super mini amateur UHF transceiver has many features associated with larger models but still fits into the palm of your hand or top pocket. It has full UHF coverage with the option of extended receive from 380 - 460 mhz.

The full specification is:

- Frequency range: 430 - 440 Mhz
- Mode: FM
- Ch steps: 5, 10, 12.5, 20, 25, 50 khz
- RF Power: 230 mw (3v) max
- CTCSS: 67 - 131.8 Hz
- Memory Channels: 20



Incredible value

ONLY

£89.95

plus FREE p&p

**ALL ITEMS AVAILABLE BY MAIL ORDER -
YOU CAN RELY ON LOWE
PHONE FOR BEST DEALS ON SHORT WAVE**

Mail order catalogue available for 4 first class stamps

What Chris Lorek, G4HCL says about the NRD-545*

“Every so often one imagines a ‘dream’, receiver, one that’s perfect in every detail”

“I believe the NRD-545 to be the very best HF receiver I’ve ever had the pleasure of using in my amateur shack”

“the performance was well up to that of the very best receivers available”

“being able to narrow the IF bandwidth right down gave superb results”

“performance that I’d never, ever, been able to measure on any earlier receiver”

***Review by the respected UK reviewer, Chris Lorek, G4HCL in “Ham Radio Today”, April 1998. Call Lowe for a copy of the review and a colour leaflet with full specifications**

It's SIMPLY the BEST . . .

Clear Digital Sound with the NEW JRC NRD-545 DSP Receiver



WIN one now in our easy to enter competition

The Japan Radio Company are one of the oldest established and most respected electronics manufacturers in Japan. They are best known in the amateur radio world for their top of the range HF transceiver, the JST 245, but their main business is in the area of marine radio and radar equipment. They also produce excellent HF receivers for the SWL enthusiast, and their NRD 525 and NRD 535 models are widely used throughout the world. The latest model in this range is the new NRD 545, which is their first receiver using DSP (Digital Signal Processing) from the IF stages onwards.

The DSP enables a wide choice of digitally implemented filters to be provided, together with IF shift and continuously variable passband width. The combination of these facilities gives the NRD 545 a level of performance than has previously been unheard of in a receiver costing less than £10,000.

Every equipment reviewer that has had the opportunity to try the NRD 545 to date has been amazed at the performance that JRC engineers have managed to cram into this small box. Now you have the opportunity to win one of these superb receivers from the very first shipment out of the factory. JRC, in conjunction with Lowe Electronics, the exclusive UK distributors and "Ham Radio Today"

magazine are offering one as a prize in our simple competition. Just answer the questions below and return the completed form to Lowe Electronics. All correct entries will be entered into a draw together with those from a similar competition in the next issue of Ham Radio Today. The first entry drawn out will be the winner! (A clue - most of the answers can be obtained from a study of the front panel of the radio and by reading the specification sheet. The rest are contained on the JRC Japanese web site and in the review by Chris Lorek that will be published in the April issue of "Ham Radio Today".

A STUNNING receiver... here are just a FEW of the OUTSTANDING features:

0.1 to 29.999999MHz	DSP BFO
USB, LSB, RTTY, AM, FM	DSP RF Gain
1Hz Tuning Steps (selectable)	DSP Squelch
Huge Memory Capability	DSP Tone Control
DSP All-Mode Detection	DSP S-meter
DSP Digital IF Filter	High Sensitivity
DSP Pass-Band Shift	Wide Dynamic Range
DSP Noise reduction	Variable Tuning
DSP Beat Canceller	Multiple Scan Modes
DSP Noise Blanker	Clock Timer
DSP Notch Filter	Sleep Timer
DSP AGC	RTTY Fine Tuning

1. In what month and Year was JRC founded ?
2. How many rotary control knobs are there on the front panel of the NRD -545?
3. How many memories does the receiver have ?
4. What does ECSS stand for ?
5. What is the function of the grey button below and to the right of the main tuning knob?
6. What is the claimed dynamic range at 300 Hz IF bandwidth ?

Name:

Address:

Post Code:

Telephone:

Return your completed entry form to:
Competition
Lowe Electronics
Chesterfield Road
Matlock
Derbyshire DE4 5LE



Closing date for entries is 30th April, 1998. There is no cash alternative and no correspondence will be entered into. No purchase necessary

29 continued from page

count. A number of UK mobiles got through as the pile-ups started to diminish, including one on 40m. Particular congratulations are due to G3FPQ, G3GIQ, G3HTA, G3KMA, G3PJT, G3ZAY and G0WAZ who made it into the 9MOC log on all nine HF bands.

In the event, although there will inevitably be those who were disappointed, we can reasonably claim to have met our expedition goals. Our 160m tally was over 1100 contacts in 58 countries, which included 39 UK stations. This was largely thanks to a drop in the static level on the last couple of nights, when it became apparent that, static excepted, Layang-Layang was a very quiet location, with background noise not even registering on the S-meter. On RTTY we ended with 2075 QSOs, putting us ahead of any similar DXpedition, so far as we can tell. On 6m we exploited every opening, and ended with 389 QSOs, exclusively in Japan and Hong Kong. Our WARC-

"Champagne on the house at 60,000 QSOs", said our hosts Coralie and Steve Stewart. Here's Steve filling author Don Field's, G3XTT, glass.

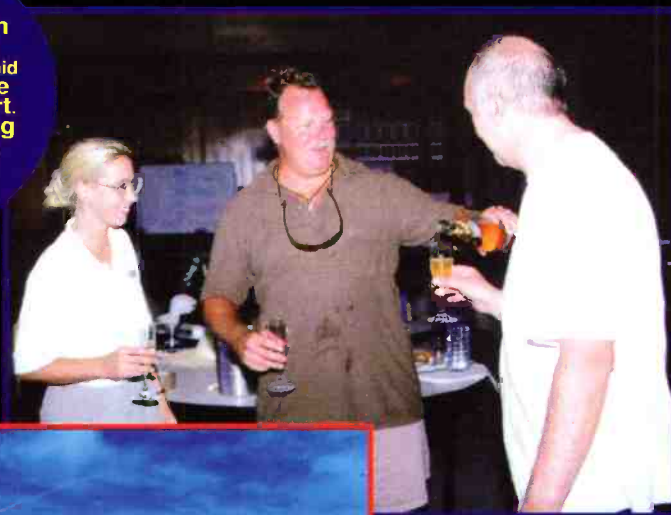

The Cushcraft 203CD 20m monoband beam was raised to 40ft by the gin pole method.

9MOC - Spratly Islands 1998

ever British HF / VHF radio operation, by Don Field, G3XTT

band totals were equally imposing, and we were particularly surprised to find the pile-ups on 30m never-ending, with almost six thousand QSOs. Our overall tally of 65,558 QSOs puts 9MOC at fourth all-time, after VK0IR, 4J1FS and ZA1A. Naturally, at the 50k and 60k mark we paused briefly for a celebratory bottle of bubbly and photo-call.

highlights

It is worth saying that throughout 12 days of continuous operation, making more contacts than many amateurs would make in a lifetime, all our equipment performed flawlessly. We were particularly impressed with the Yaesu VL-1000 amplifiers, which are so well integrated with the FT-1000MP as to be practically 'invisible' to the operator. Our only mishap of any note was the demise of a couple of filters when tired operators changed bands without remembering to change the filter.

One particular highlight on the first Sunday was the arrival of the Sunday edition of the Sabah

Daily Express. The colour supplement featured a cover photograph of the team erecting one of the antennas, and inside there was a full page regarding our operation. This level of local interest continued, with the Minister for Tourism attending a press conference after our return to the mainland. We were also welcomed back with a dinner hosted by the Sabah Tourism Promotion Corporation. Of course, taking down all the antennas and closing the station was a source of regret, but our timing was impeccable as the resort was down to its last can of beer!

Several of us wanted to air our individual 9M6 callsigns from Sabah before returning home, so we headed for Hillview Gardens Resort at Keningau, owned and run by Doris and Alfons Udans, 9M6DU and 9M6MU. A station and antennas are available for



Just a few of the 9MOC antennas at sunset. Left to right: the 85ft Titanex vertical, Cushcraft A3S tribander, 203CD 20m monobander, and Battle Creek Special.

use by visiting hams and we spent a couple of pleasant days recuperating and playing radio before returning home.

Of course, the story is by no means over. G3SWH was already receiving over 100 direct QSL requests a day, even before we had closed down, and his postman will no doubt be complain-

ing about overwork by the time this article appears in print. The heavy equipment has to find its way back by sea to the UK, and there will be the inevitable wrap-up meeting, to understand where things could have been improved, so that we can do even better next time. Which leaves only the inevitable question, "where next?"

STORNO 5662 UHF synthesised 12v mobiles supplied with pre-programmed EPROM, BCD switches etc and full info to make 100CH. 70cms mobile, 15w O/P, just needs 2 crystals, mic and L/S (not supplied) to complete the kit.....**£45**

STORNO 4662 UHF synth h/helds supplied with Ni-Cad no ants.....**£15**

STORNO 4114 VHF as above.....**£15**

STORNO 2-way desktop chargers for above series.....**£15**

STORNO 5114s VHF high band mobiles synthesised supplied sets only but with circuits and 2m. Modification info.....**£35**

PYE WHITEHALL 12V mobile units low-band 68-88 MHZ AM/FM bootmount with control box but no cable with info.....**£25**

YAESU 545L14 UHF synth h/helds need external programmer supplied with desktop charger, batt, ant no info.....**£50**

PYE PF85 3CH FM h/helds for 2m with Ni-Cad + ant.....**£30**

PYE M293 'E' band AM 6CH mobiles, OK to mod for 4m or RAC rally channel etc with MIC+L/S.....**£25**

PYE 5002 'E' band FM h/helds no batts or ants but supplied in original ex MoD packing, 2 units for.....**£25**

VINTAGE - new/unissued hand microphones for wireless sets No. 18 in original ex MoD packing, 2 units for.....**£15**

BARGAIN PARCEL - 4 assorted handhelds - mixed, eg low/high/UHF, with batteries/ants as available.....**£45**

WILD ARK-1 GYROSCOPIC THEODOLITE in as new condition with power supplies, tripod, and info, last one....**£210 + VAT + carr**

We have a wide range of 'one or two offs' please ring for particular requirements, receivers, PMR h/helds, mobiles etc.

Please send self stamped addressed envelope for mail list.

NOTE CLOSED ALL DAY ON WEDNESDAYS

All goods are supplied in "as is" condition but are checked for completeness before despatch.

All goods include UK mainland p/p and VAT.

Technical Modification enquiries after 4.30p.m. please.

Most credit cards accepted.

G.W.M. RADIO LTD

40/42 PORTLAND ROAD, WORTHING, WEST SUSSEX BN11 1QN
 TELEPHONE: 01903 234897 FAX: 01903 239050

Essex Amateur Radio Services

The little dealer with the big heart

BUYERS ARE WAITING NOW FOR YOUR PRE-ENJOYED EQUIPMENT!

* VHF/UHF *
 * HF Transceivers *
 * Station Accessories *

AVOID Part Exchange WE PAY TOP PRICES

We pay cash same day or 24 hours by post.
 Always large stock available. Phone today for the best deals.
 Silent Key sales handled efficiently and personally.

**4 Northern Avenue, Benfleet
 Essex SS7 5SN
 Telephone
 01268 752522**

7 days a week 8am to 8pm

Subscribe to Ham Radio Today!

Now you've seen the new-look *Ham Radio Today*, we're sure you'll want to read it every month. To be certain of being able to get hold of a copy every month, the best way is to subscribe. That way, you'll have *Ham Radio Today* delivered to your door as soon as it's published. At £26.50 per year (for UK readers), including postage, it's also cheaper than buying each copy at the newsagent.

All you have to do is fill in the form and send your cheque or credit card authorisation to the address below. If you do not want to cut your copy of *Ham Radio Today*, please feel free to photocopy this page.



To: Ham Radio Today Subscriptions, RSGB Publications, Lambda House, Cranborne Road, Potters Bar, Herts EN6 3JE.

Subscription rates (12 issues/year) UK - £26.50; Europe & Eire - £36.50; Rest of the World - Surface £38.50, Air Mail £54.

Name _____ Callsign (if appropriate) _____

Address _____

Post Code _____

Credit Card No _____ Exp Date _____ Switch Start Date _____ Issue No _____

Signature _____ Date _____

The Canadian Hammond Museum of Radio's Internet site includes features on Marconi, as well as commercial and Amateur Radio in the 1920s.

Hammond Museum of Radio

- Home Page
- The Collins Collection
- Hammond Museum
- Fred Hammond VE3HC
- The Early Years
- The War Years
- Antique Radio Links
- Hammond Mfg History
- Visit the Museum

The Marconi Spark Era
This section provides an early look at GUGLIELMO MARCONI inventions from his first wireless success up to the World War I era

<http://www.kwarc.on.ca/hammond/links.html>



Net Communication

Jeremy Boot, G4NQH, has 'Something Old, Something New' in

If there is one thing that the Internet has to offer, it is information - tons of it, on every conceivable subject. I thought that this month I should like to dig for something about the history of radio, to include vintage radios, antique, or at least the pioneering variety. I really like the idea of using the latest technology to discover the oldest. It's a nice paradox.

Although I intended at first to go for early amateur equipment, I strayed quickly into the realm of broadcasting too. After all, the founders of those early years of the BBC, NBC and most, if not all, professional radio stations were radio amateurs. They shared a common aim: furthering radio. It's fascinating reading.

But where to begin? Besides your favourite amateur sites with useful links, the obvious starting point is the search engine pages - Lycos, Excite, Yahoo and the like. Learn how to refine your search: a return of 300,000 links for "amateur" can be disheartening, but "vintage radio AND

ham" (or something similar) will considerably narrow the scope of the search. Even if you don't find what you want first time, it should set you on a useful trail. I have to admit that this subject took more digging for than I had anticipated. But it was worth it.

history of radio

Starting with Vintage Radio Links at <http://www.NostalgiaAir.org/NostalgiaAir/Links/links.htm>, which covers most aspects commercial, I did visit a link I had seen before: <http://www.northernnet.com/bchris/> with a good potted history of radio, which does touch upon Amateur Radio of the very early days. There is also Real Audio of an early CW QSO. Read about Farraday, Leyden, Henry, Maxwell, Braun, Siemens, Tesla and many more names we know so well, all of whom contributed either to electrical research, telegraphy, or wireless. What an exciting century the last one was - and what consequences there

were to be for the future.

Under the same URL, read about the Fleming Valve and the discovery of the Triode and Heterodyne receivers. No sooner had budding amateurs begun to experiment themselves with radio, than all such radio experiments were banned during WWI - a scenario to be repeated in WWII, of course.

I also discovered that suspicious Customs Officials smashed Marconi's original equipment as he entered the UK, in the belief that it was some sort of weapon and that he was probably an Italian anarchist!

more sites more facts

Visit the History of Communication Site at <http://www.databahn.net/library/inet/history/radio/> for a quick guided tour of radio and TV. There's not much here though about amateurs, although I did come upon an article, *United States Early Radio History* by Thomas H White, which details the earliest radio

identifier letters (G and M appear for Great Britain), following the Service Regulations of the 1906 Berlin International Wireless Telegraph Convention.

Around 1908 most of the Marconi-equipped stations began using three-letter calls starting with M (hence the *Titanic's* callsign, MGY). The London International Radiotelegraphic Conference made a partial allotment of call letters modified in 1913. You can see this fascinating early list at <http://www.ipass.net/~whitetho/recap.htm#early>. Isn't it amazing what you find on the Internet?

The site of the Hammond Museum of Radio in Canada, VE3HC, <http://www.kwarc.on.ca/hammond/early.html> although by a manufacturing company, brings us at last closer to the early Radio Amateurs, with a feature on *The Roaring Twenties* where radio grew and grew, both in ham and commercial fields. The design of this web site is particularly pleasing. See too the feature on RCI and homebrew equipment. Drool at the single

You can download pictures of early transmitters and receivers from the www.alpcom.ithamradio.com site.

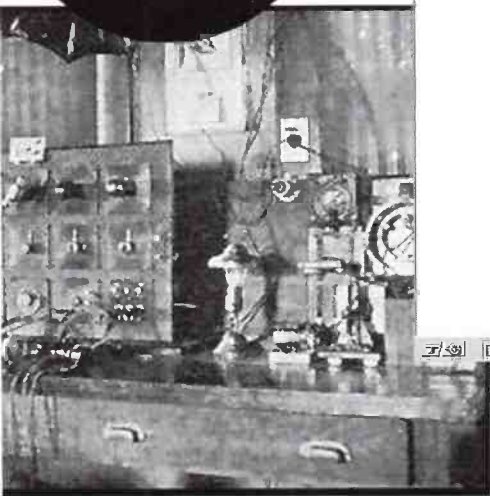

The Catalan language '100 Anys de Radio' site includes a Real Audio recording of Marconi.

Net Communication

this, the UK's only monthly Amateur Radio Internet column

Myers tube design and a five-valve design of the '20s.

Closer to home, the GEC Marconi Site at <http://www.gec.com/marconi/> quotes Marconi's daughter, Princess Elettra Giovannelli Marconi's speech at the centenary celebrations in 1997. There is a biography of the great man and other interesting features.

More extensive, celebrating the 100 years of radio, <http://www.alpcom.it/hamradio> provides a site with plenty of jumping-off points. You can see the wonderful two-valve 'Persisting Wave Radio Transmitter' of 1918, a selection of receivers, and the 'Marconi Magnetic detector' of 1903 and also download some fine picture of Morse keys.

overseas sites

With the one small snag that it is in Catalan, '100 Anys de Radio' is a nice site, with a Real Audio recording of Marconi. Under the link marked

'Radioaficonats' there were ham links and a links page. Click the 'radio antigues' link and you will find yourself at 'The Web Site of The History of Telecommunications' (Fachhochschule für Technik Esslingen, Germany) <http://www-stall.rz.fht-esslingen.de/telehistory/> which is thorough and well-written (and in English). Little about hams though. 'RadioNostalgia' is an Italian site at <http://radio-nostalgia.net/valvole.html> It includes spare parts, circuits, but many of its links were "under construction" (why *do* people do that?)

uk & us sites

For the UK, start at Paul's Radio Museum at <http://www.paulplu.demon.co.uk/radio/index.htm> and follow his list. For another, try Jonathan Warburton-Brown's Vintage Radio Collection at <http://www.accessone.com:80/~philn/jwbhome.htm>; stop by briefly at Valve and Vintage Page <http://www.oldpark.demon.co.uk/v1.htm> then be sure to see G3UKL's Elegant Vintage Radio

Page at <http://www.valve.demon.co.uk/> with a useful list of jumping-off points. All tend more towards domestic / commercial radio, rather than amateur, but are none the poorer for that.

Broadcast History <http://www.aa.net/~jfs/> is all about radio in San Francisco, and has 170 photo archives for you to browse. Hooray the for the Bellingham Antique Radio Museum at <http://www.antique-radio.org/toc/oldtransmit.html> with its pictures from 1920 shacks. Interesting - and at least it does cover Amateur Radio.

What is it about the Americans that makes them genuinely enthusiastic and bigger and better in every way? Look at the NJ Antique Radio Club Home Page at <http://www.cyberhost5.com/eht/oldradio/index.html>. There is obviously a very keen following: lots of enthusiasm and some really interesting features. Aircraft radios, a magazine, how to remagnetise your old headphones, the recent meeting on horn speakers and lots of photos.

amateur radio sites

Of specifically ham-related sites, I found AF4K's page at <http://www.mnsinc.com/bry/mega/antiques.htm> (where-to-find page); AC6V's pages at <http://pw2.netcom.com/~ac6v/pagex.html> with some useful links, including the Boatanchors WWW Page at <http://www.mindspring.com/~johnmb/> - they also run a newsgroup: rec.radio.amateur.boatanchors which leads you to all sorts of joys, including the National Museum. Lots of links here too. For some more amateur links, see <http://www.mikrolog.fi/SRHS/Radiolinkit.html>

Well, space has run out for another month, but I will be revisiting this subject soon. Don't forget the rec.antiques.radio+phono newsgroup. Once you get a taste for the early years of radio, it is a real attraction. I learned a great deal I didn't know before and I hope you enjoy following these links as much as I did.

What a lot I've got!
That's JL1ZCG
amongst his 960
elements on 23cm
at his station
near Tokyo.

Those who have Internet facilities may like to look at several VHF constructional projects on the net, which include power amplifiers and filters for 50MHz. They can be found at <http://user.itl.net/~equinox> Included are ideas for a single 4CX250B, a 3CX800A7 and an 8877, the later two include power supplies. It is hoped that 144MHz amplifiers will also be put on the site at a later date.

Also, those interested in the microwave bands may like to look up Sam Jewell's, G4DDK, new pages at <http://www.btinternet.com/~jewell/> and Peter Day's, G3PHO, pages at <http://freespace.virgin.net/p.day/ghz.htm>

50mhz dx

Don't forget to look out for Eric, F5JJK, who is operating in Chad as TT8AQ. Eric will be there until May this year and will be operating on 50.105MHz on CW. Eric has an Icom IC-706 and a 6-element beam.



VHF / UHF Message

Get those 6m and 4m stations ready for the new VHF DX season. Geoff Brown,

Roger, G4HBA, passed on news of HZ1AB the club station in Saudi Arabia. Paul, G7SLP / KD5CRJ is presently working in Dhahran, Saudi Arabia and will be out there for some time to come. He returns there from home leave in the near future. Paul is very interested in working 6 metre DX, and is taking an FT-920 back with him to use from HZ1AB. He will also be erecting antennas for 17 and 6 metres. Paul assures us that HZ1AB will be active for the whole of the summer Sporadic E season. Now that's really good news, as only three stations in the UK have worked HZ!

On 11 January, Pedro, CT1DYX, reported a Sporadic E event on 50MHz, when he worked UK stations. The following day the band opened again in the UK at 1630UTC, when Italy was worked.

HK0HEU is now active on 50MHz, and has been worked by WP40.

Three new TV frequencies have been heard in Europe: 48.2657MHz at 45 degrees from

GJ; 49.7552MHz 90 degrees from GJ; and 49.7655MHz, east from GJ. Does anybody have any information on them please, as they do not appear in any listing?

beacon news

A new beacon, N8PUM in EN66AM, is in operation on 50.0665MHz. It is running 1 watt to a dipole. Another new USA beacon is W3CXX/B on 50.080MHz in FM29JW, running 4 watts to a halo antenna.

Bo, OX3LX, reports that the OX3SIX beacon is almost 'ready for launch'. The output will be 50 - 100W depending on the site and interference. More news on this later.

Now news from France on the microwave beacon scene. On 27 December a 'three band beacon' came on the air. Located in IN88HL, south-west of the city of Guingamp, the beacon is based around a G4DDK unit on 1152MHz. It has three outputs: 6cm on 5760.060MHz with 10W ERP (callsign F1XAO); on 3cm

the exact frequency is 10.368.108MHz and is also 10 W ERP (F1XAP); finally the 24GHz frequency is 24192.252MHz (F1XAQ). It runs 100mW on this band, and all the antennas are slotted waveguide omni-directionals.

70mhz news

News has come through that pressure is being put on European national societies for a general 70MHz allocation. More information is available on the Internet at: www.ero.dk/eroweb/dsi2.doc

Allan, GM4ZUK, reports the following news regarding TEP test beacons on his www pages. John, GW3MHW, writes: "I have been testing a 40W RMS output amplifier for use with the 70.147MHz beacon. Also, the 6-element Yagi has been on test. To do this I have had to remove the 2-ele array facing north, and as a result the 70.071MHz north firing beacon has been off temporarily. What I propose, in the hope of listeners in South Africa at TEP times, is to fire 40W into

a 6-element Yagi in that direction. For the next equinox, spring 1998, I have in mind to arrange an aerial system of greater gain, to use an altogether larger valve amplifier, and an accurately timed arrangement of 30 seconds sending and 30 seconds listening, so that I will have a change of monitoring African signals. Sending to commence on each minute for 30 seconds, and listening for the remaining 30 seconds. Timing pulses will be taken from the arrangement already in operation for regulating my '071 beacon."

The first 4m beacon is now operational in South Africa. It is ZS5MTL/B on 70.005MHz from KG50IG. It runs 50W to a horizontal turnstile antenna and keys using FSK. At this stage it would appear as if the first 4m permits will be issued on 1 January 2000. Other good news is that ZR stations (no-code VHF-only licensees) will also be granted access to this band in South Africa. At the moment SATRA (the regulatory body in ZS) has prescribed a maximum

world top 50MHz listing

posn	call	wkd/cfmd
1	GJ4ICD	160/159
2	PA0HIP	159/157
3	JA4MBM	157/157
4	G3WOS	153/152
5	PY5CC	153/151
6	SV1DH	151/151
7	JA1BK	151/151
8	PA3BFM	151/149
9	PA2VST	151/149
10	9H1BT	151/148
11	G4CCZ	147/147
12	G4IGO	146/141
13	G3K0X	144/140
14	G4UPS	144/140
15	G3ZYY	144/139
16	ON4KST	143/142
17	ON4ANT	141/141
18	JE1BMJ	140/140
19	SM7FJE	140/?
20	G0JHC	139/138

Eight British stations are now listed in the world's top 20 on 50MHz. Note that no USA or Canadian stations are above 138 countries!

Yagis, which is the equivalent of a four metre dish. The gain is estimated at 32dBd and is used for EME ('moonbounce') along with a power amplifier consisting of six 2C39 tubes! Wow.

Also, famous EMER K2UYH now has a 28ft dish in his back garden.

meteor scatter news

Not a lot to report on this subject this month. January's Quadrantid shower, which is one of the main showers of the year, produced very poor results. This may have been caused by the gales and storms that ravaged Europe over the festive season and New Year, causing people

shire, whose tower came down and went straight through his house causing horrendous damage.

Very little activity was spotted on the DX *PacketCluster*, and 50MHz was totally dead when I listened.

silent keys

It is with regret that I have to report the passing away of famous VHF DXer Basil O'Brien, G2AMV, whom I first met in the early 1980s at the Blackwood Convention in Wales, when he was president of the RSGB. Basil passed away in February 1998.

Also Günter, OE6DGG, passed away unexpectedly on 1 November last year, less than two months after taking part in the Libyan 5A28 50MHz expedition. Günter was very active on the VHF bands and passed much useful information to us over the years.

That's all for this month.

VHF / UHF Message
GJ4ICD, gives Ham Radio Today readers the low-down on the high bands

power output of 14dBW EIRP for these beacons. It is hoped that this will change in the year 2000 when all commercial stations presently occupying 70.025 - 70.300MHz would have been cleared. At the moment 70.000 - 70.025MHz is not allocated anywhere in ZS, and the portion between 70.000 and 70.01875 has already been made available for propagation beacons. South Africans should be active on 4m at the peak of the solar cycle and will in all probability work their first DX during March or April 2000.

eme news

Have you ever seen anything like

this before? 960 elements on 23cm! The array (picture opposite) belongs to JL1ZCG in Japan and consists of 32 x 30-element

to leave their towers retracted. There were reports of flying towers with antennas still attached! One such report was of an amateur in Shrop-

Please send news and views to Geoff Brown, TV Shop, Belmont Rd, St Helier, Jersey, Channel Islands JE2 4SA, or tel / fax: 01534 877067, or even e-mail to: equinox@itl.net

Basil O'Brien, G2AMV, with his XYL Eileen, G3WIO, and columnist Geoff Brown, GJ4ICD, taken during the O'Brien's visit to Jersey in 1995.

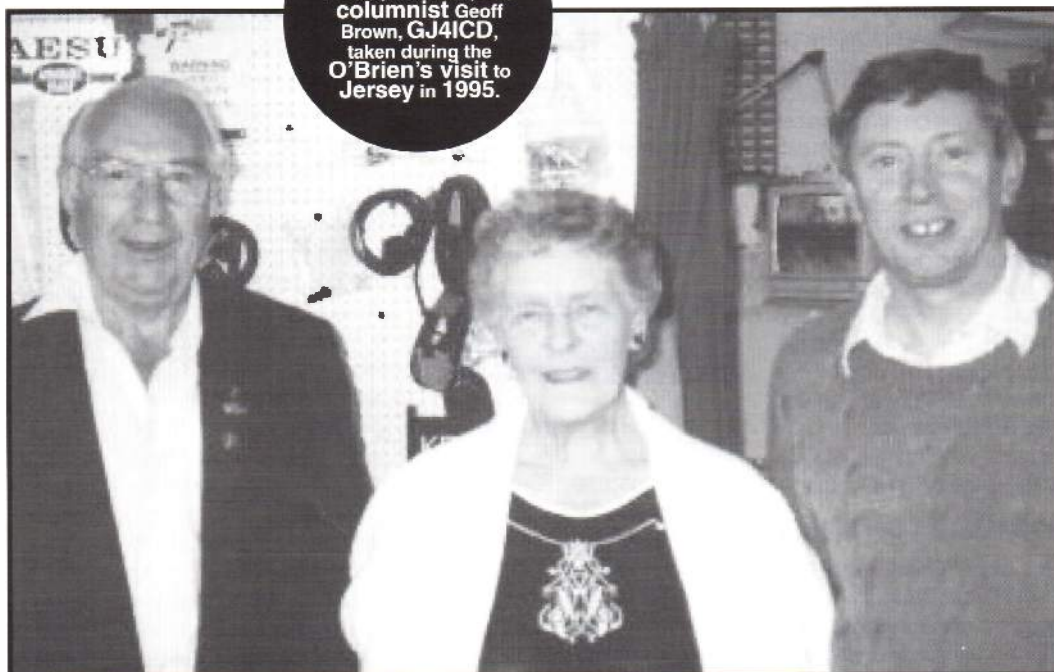

First, some news on the bands: Frank, G3YCC, was surprised to work Jacky, 3B8CF, in Mauritius on 14060kHz recently. Frank was running 5 watts from his GQ2000. 3B8CF was not QRP and gave Frank an RST 559 report. Frank's 579 reply shows just how small the difference is between QRO and QRP.

qrp league

Frank also runs a 'QRP League', both on the Internet and on packet throughout the world. It is amazing to see the callsigns that pop up on the list. The last league finished with Valery, RW3AI, well in top spot with 530 points. In second place was GOTUE with 301 points and LY2FE in third place with 256. One of the interesting things was the number of non-UK calls in the league: W, EA, DL, ZL, LY, I, G, GI, and of course RW. Well done, Frank, and let's have another one soon. I didn't partici-

put the solar information on the qrp-I list, which is a great idea. He is also into lots of 'hints and kinks', little ideas that brighten up the day for the QRP operator and the builder. Paul wrote a book called *The Electronic Data Book for Homebrewers and QRPers* which is another that should be on every homebrewer's workbench. It is full of ideas, circuit samples and analysis, component data sheets and information on QRP rigs, especially American ones. The book is available from Five-Watt Press, 740 Galena Street, Aurora, Colorado (ISBN 0-913945-57-9) and costs \$25, post-paid to Europe. They also accept Visa and MasterCard credit cards and can be contacted by e-mail at: qrpbook@aol.com

projects & tips

This time we look at three different designs for crystal oscillators can be BC108, BC182 or even Paul's choice of 2N2222s. This circuit is so simple it can be built ugly style, on Veroboard, or, if you fancy getting mucky, by making a PCB.

Another tip, this time from another US buddy, about etching PCBs. Gary Diana, N2JGU, (he of the TiCK keyer fame) wrote that, when etching PCBs, it is better to keep the solution clean by laying the board face down in the solution. This way any debris falls away from the board.

A reminder that, if you do try this, to ensure that you enter the PCB into the solution at an angle, to preclude any air bubbles forming under the board. The solution should be warm, not cold. Gary also considers that this method requires less agitation, although I prefer to keep the board moving.

Andy Cunningham, GMONWI, operating a special event station for 'Riding for the Disabled' in Stirling, Scotland, last year.

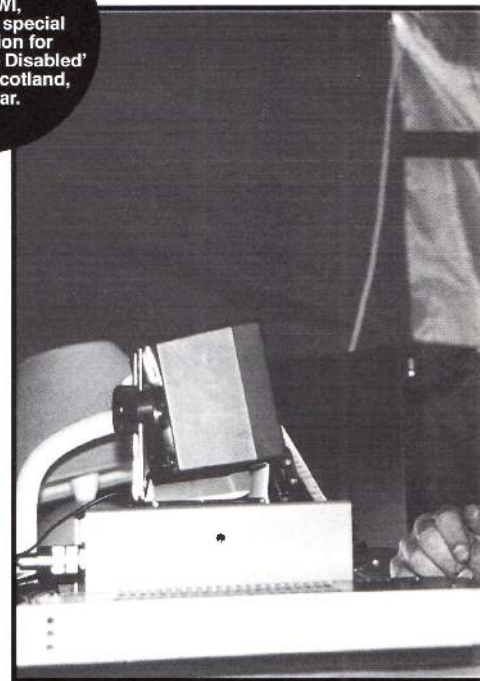

QRP Corner QRP Corner

Dick Pascoe, G0BPS, gives 'bread board construction' a whole

pate in this league, although I did in a previous one. My 700mW didn't do too badly either, getting quite a few contacts into Europe. Mind you, it was on 2m and SSB. Good fun, this QRP lark!

Frank also tells me that his www pages have moved. He has one of the biggest, and best, QRP-related www pages around. I am also pleased to see the change of name - it was getting disconcerting having two G-QRP club sites! Frank's site is now at <http://www.homeusers.prestel.co.uk/g3ycc>

Talking of moving pages, the official G-QRP club site has also moved. Tony, G4WIF, as the keeper of the club's pages, has moved from CompuServe and the G-QRP site can now be found at <http://www.btinternet.com/~g4wif/gqrp.htm>

news from us

One of my American friends, Paul Hardin, NA5N, who is a genius at electronics and all to do with the subject, offered to

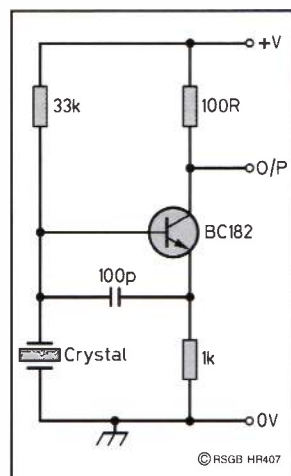

Fig 1: the OXO transmitter crystal oscillator.

lators. The first two are from the well-known G-QRP Club projects, the OXO (Fig 1) and the ONER (Fig 2). The third design of crystal oscillator is from our old friend Paul Hardin, NA5N (Fig 3), and I offer it to you to try. It is simple and easy to throw together. The transis-

bread board construction

As mentioned last month, the Dayton QRP Forum Building Competition is hotting up, with several comments being made on the qrp-I. Several people were asking for ideas on circuits to try, whilst others were offering ideas for prospective builders. I was getting despondent about it all, trying to come up with an original idea that hadn't been done before.

Eventually a (British this time) friend suggested making a transceiver in a bread board style. I told him this was too obvious and I wanted to try something different. Well, as it is now getting too close to the show for anyone to copy me I shall reveal what he meant by 'bread board'.

First take two slices of bread, and some yacht varnish... getting the idea yet? Toast the bread and when cool paint the two sides with varnish. Eventu-

ally a firm, hard surface will be achieved where components can be soldered to tiny panel pins knocked into the bread. I decided to add a small touch of my own and add the circuit diagram under the panel pins so that those viewing the transceiver could follow the circuit. Unfortunately a computer crash lost me the couple of hour's work on the circuit diagram, but all else was not lost.

So, to embellish my 'bright' idea I am going to offer a prize to the best 'bread board' brought to the QRP Convention in Rochdale this year. You will have to use real bread and added points may be given for using wholemeal or rye bread instead of plain white (well, it is so much better for you). Don't forget, the Rochdale convention is on Saturday 24 October this year.

qlf?

During my annual visit to the HamRadio exhibition in Friedrichshafen, Germany, last

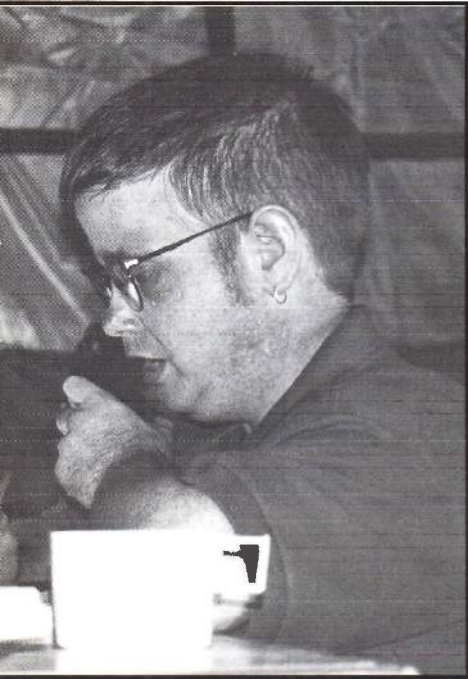

any foot mind you, right-handed people had to use their left foot and left-handed their right foot.

I was so impressed with all this that I decided there and then that, when back home, I would build one and take it to Rochdale to have fun there. Like so many other things last October I couldn't get all the stuff into the car as well as the boss and myself. Better luck next time, and I do have a bigger car now.

Plans are going ahead for the G-QRP Club's annual visit to Friedrichshafen in June. We shall be having a bigger stand this year, enabling us *all* to get behind the table, all being well. In previous years this has been a problem. Sheldon from Hands Electronics, Peter from JAB Electronics, Dick from Kanga Products and of course George of the G-QRP Club will be there. Each will be promoting their own wares, but overall the idea is to promote the club. This actually works as the wares on

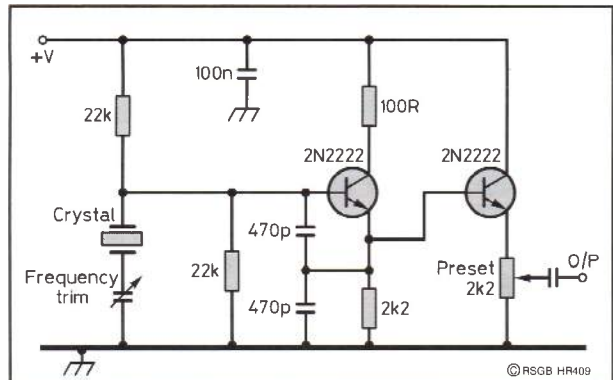

Fig 3: crystal oscillator design by Paul Hardin, NA5N. BC108 or BC182 transistors can be used instead of 2N2222s.

Mike Bryce, WB8VGE, also gave information on similar articles but included the HW7 and the later HW9. The former has become a bible for enthusiasts, the latter didn't.

As an aside from this we discussed making a photocopy of my copy of this book and making it available. We were not

the twin feeder linked to the antenna wire, which was hung parallel with the underside of the balloon. The other side of the feeder was not connected to anything.

The rally in Friedrichshafen is held just a short distance from the factory where these balloons were built and later tested out

QRP Corner **QRP Corner**

new meaning and recommends some books for QRPers

June I saw a wonderful exhibition of CW operating in the club hall.

The Morse code sent didn't always sound right, but it was mostly readable. The German club involved had decided to have a bit of fun with the amateurs attending and brought along their very own Morse key. Anyone could have a try, the only rule was simple: you had to send the Morse using your foot! Not

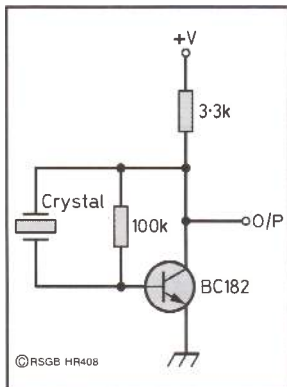

Fig 2: the ONER transmitter's crystal oscillator.

sale attract visitors to the stand and many get their arms twisted to sign up as members.

books

Andy Cunningham, GMONWI, has been busy building the ONER transceiver and has borrowed a copy of the QRP ARCI (Amateur Radio Club International) quarterly magazine, as he hopes to join. He has also been chasing a copy of the *Hot Water Handbook* by Fred Bonavita, W5QJM, first published in 1985. If any reader has a spare copy he would love to hear from you. Drop me a line for his contact point.

For those who have never heard of this book, it is all about the Heathkit HW8 transceiver and is a collection of articles and ideas put together by Fred for the QRP fraternity. It includes ideas mostly from US amateurs but also our own Tom, GM3MXM, and Mike, G4HWZ / PA3ASC, have ideas included. The later *HW8 Handbook* by

sure if this would be of interest and we would have to check with Fred first, which I am trying to do. If any reader would be interested could you please let me know. My contact point is at the end of the column.

zepps

A note from Paul, MOBMN, who was asking for information about small holiday antennas. Most amateurs at some time or another have experimented with portable antennas. QRP seems to go with them too. Paul was asking about the Zepp antenna as he was considering one of these.

It was strange that I was writing the paragraph above about Friedrichshafen when I spotted his request.

The Zepp antenna was named after the Zeppelin balloons, where it was first used. It was slung under the balloon in an 'upside down' configuration, compared with how we now know it, with only one side of

over Lake Constance (Bodensee), just a few tens of metres away. It must have been quite a sight seeing them rise from the factory and float away over the lake!

It is a long time since I tried one of these, perhaps readers may enlighten me as to their experiences with this antenna's performance. As for my choice on portable / QRP antennas, my holiday antenna in October last year in Cyprus was a delta loop hung up on a fishing pole. Readers may well remember the discussion we had in this column about poles. I tried mine tuned to 14060kHz with little success. Even the 100m long wire down the villa's garden didn't work too well either. Better luck next time.

Well, that's it for this time, news and views to me via the editor, direct via packet to GB7RMS, e-mail to: Dick@kanga.demon.co.uk or 'snail mail' to Seaview House, Crete Road East, Folkestone CT18 7EG. 72 de Dick.

I'm writing this just a week before the London Show, and I'm looking forward to meeting many amateurs on the Ham Radio Today stand. If you did come and say 'hello', and maybe even to pick my brains a little, I hope I managed to provide the required answers!

gps interfacing

A few weeks ago, I had an interesting conversation with a member of a UK mountain rescue team who was having difficulty in getting his team's GPS (Global Positioning System) receivers to 'talk' to a packet TNC for GPS-over-radio use. A recent packet bulletin from Ken, GM7APK, who asked about interfacing and decoding the information from a GPS and what type of interface and software would be needed, reminded me that many other amateurs could also be having difficulty.

One comment from the UK PacComm distributors was that it had been reported that Garmin GPS receivers and PacComm Tiny-2 TNCs had difficulty in

teur rig's mic socket, although the pin diameters are different. Next to this socket are marked +, -, R and T, which refer to supply voltage positive, negative, RS-232 RX data and RS-232 TX data. The negative pin is also used as a common ground for the RS-232 data.

As soon as the GPS receiver acquires enough satellites to provide a position, you'll find your terminal screen filling with repeated one-line strings of position data, although depending upon your GPS receiver you may need to enable the output in the set-up menu. The RS-232 input (RX data connection) on the GPS is usually reserved for RCTM differential input data, although it can also be used with proprietary programs for inputting waypoints etc.

gps + tnc = aprs

Many TNCs have a GPS mode, eg by issuing the 'GPS ON' command from your terminal to the TNC (remember to set your TNC to 4800 baud first!) The impor-

base, I've found it works very well with a directly-connected GPS. So my next goal is to get it working over the air, and I'd be interested in comments from readers who have had experience of this. My thanks go to Siskin Electronics (tel: 01703 251549), who are currently supplying complete TNC and GPS / APRS packages for amateurs, for the provision of the TNCs and software to test.

first bbs connection

Graham, M1CHP, recently asked me for help in using his local BBS (Bulletin Board Station), as he'd just got on the air with packet radio and wanted to know how to use his local BBS. He had successfully connected to it, but being bewildered with the string of available commands. This is a commonly-asked question, and the first advice I would give is to type the simple command of "H" or "?" followed by your terminal's enter key, upon which the BBS will usually send back a help index, showing which com-



mands of subdirectories, and you can list what each of these contain in the same way. For example, if there is one named HELP, you can list its contents with the command W HELP or if you need to go down another level you use the \ symbol, ie W HELP\BBS (if

Data Connection Data Con

Chris Lorek, G4HCL, shows how beginners can get help with their first packet BBS con

communicating, which I felt a little difficult to believe, so here goes.

Most GPS receivers have a serial output data capability, this being in a standard NMEA (National Marine Electronics Association) format. Other proprietary output formats may also be available, eg Garmin have their own format available as well as NMEA, but the latter is the standard used throughout the GPS industry. You'll find this will interface directly with the RS-232 port of your PC, there's no level interface needed, and to see what's happening you'll only need a simple terminal program running, eg Windows Terminal, or for DOS users a program such as ProComm. You'll need to set the terminal parameters to 4800 baud, 8 data bits, no parity. Note that *all* NMEA compatible GPS receivers use 4800 baud as standard, and not 1200 or 9600 baud which most amateur TNCs are set to. You'll need to refer to your individual GPS receiver manual for details of the pinouts, as many use proprietary connectors. Garmin for example use a four pin connector with a locating moulding, not unlike an ama-

tant thing to note here when interfacing the GPS to your TNC is *not* to connect your TNC's RS-232 output data line to the GPS RXD connection - you'll invariably confuse the GPS which could even temporarily halt its data output to your TNC. I'd advise you only connect the GPS output data line to your TNC's input data line, giving a 'one-way' RS-232 stream.

A few weeks ago as a test I used a Garmin GPS-3 receiver together with two PacComm Tiny-2 TNCs each connected to a commercial VHF transceiver. I'd placed the transmitting TNC into GPS mode, with GPS beacons timed appropriately for automatic periodic transmissions, the receiving TNC being in 'normal' mode and connected to a PC running APRS V8.08 software. I selected the 'England' map and, within a minute of switching the GPS receiver on, my location was graphically displayed on the PC screen.

But have any amateurs had experience of using this system with *Personal Navigator* software? Having recently used a copy of this superb software with its detailed UK maps and data-

mands will give help on specific operations. Having your PC's printer switched on and printing out the information you have received, will often give you a good start, but many BBSs also have files available for download, which often include help information files. It's a *Catch 22* situation, as you need to know how to download them in the first place! So here's what you need to do, and my thanks go to John, G80QN, for the following helpful explanation.

You can see the directory structure available by entering the command W at the prompt. This will normally give you a list

that subdirectory exists on your BBS. On my local BBS, GB7SUN (as I am sure are also on many others), there is an archive of many of the useful HELP files sent out by Brian, G8ASO, as bulletins in the past (see **Table 1**). For users there is an index file available to these help files, which you can download by typing D HELP\INDEX.ASO at the BBS prompt. I've included here a list of ASO files currently available on my local BBS. To download any of these files use the command D HELP\HELP-0xx.ASO, where xx is the appropriate index number shown in the table.

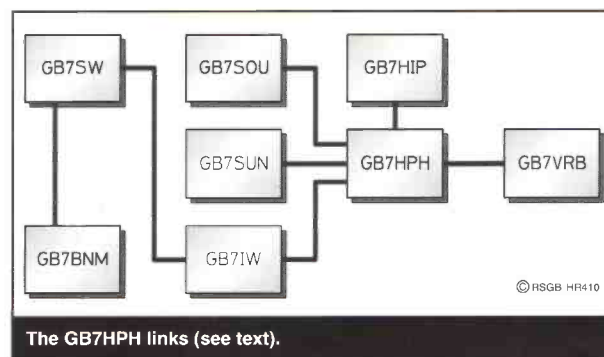

The GB7HPH links (see text).



A small 'plug' which I'm sure the Editor will allow me, is for the very helpful and well-written pocket guide by Steve Jelly, GOWSJ, entitled *Your First Packet Station*. It's published by the RSGB, and I'm told it's been such a best-seller that an extra

operated by Robert, G3RCE, has now taken over the forwarding of all bulletins between GB7VRB, SUN, SOU, HIP and BNM. This is an NTS BBS, with *no provision for users* - so please don't waste your time trying to connect to it! It has already significantly reduced the traffic being carried by several of the backbone links in the Portsmouth area, which is helping to improve the response times for users connecting across the network to other facilities such as GB7SUN and GB7DXW. The contact point here is G3RCE @ GB7SUN.

To summarise, GB7HPH can be considered as the hub of main mail forwarding links to GB7VRB (Worthing), GB7HIP (Waterlooville), GB7SUN (Portsmouth), GB7SOU (Chandlers Ford) and GB7BNM (Verwood), as shown by Fig 1. In addition, GB7HPH will provide the main mail feed for the new GB7PFD (Petersfield) BBS via GB7HP node later this year.

SUNPAC is a non-profit making organisation dedicated to the improvement and development of the packet network in Hampshire, Dorset, Isle of Wight,

1200 and 9600 baud packet modems. You can get further details from Richard, G1NZZ @ GB7MAX, or tel: 0973 262287 (1900 - 2200 Mon - Fri, 1000 - 2200 weekends).

sstv in hants

Mick, 2E1AKW, in Central Portsmouth (IO90LT) sent the following report, which I hope will be of interest to other Novice licensees in showing what can be worked on this mode on 6m and 70cm, and cross-band to 2m. If you'd like to arrange a sked, maybe even cross-band, you can contact Mick on packet with a message to 2E1AKW @ GB7SUN.#48.GBR. Here goes, and my thanks to Mick for his excellent report.

"SSTV activity in the S E Hants area is on the increase in recent months, and more recently a few newcomers to the mode. Activity on 70cm, 2m and even recent activity on 6m as well, 432.500MHz is the centre of most activity, along with 144.500MHz, with some cross-band between the two bands on

- 00 Background to these files
- 01 Mailboxes and message types
- 02 Nodes & Linking 1
- 03 Nodes & Linking 2
- 04 Mailboxes & HAS
- 05 DX Clusters
- 06 Personal Mail Systems (PMSs)
- 07 What is 7+
- 08 White Pages
- 09 Zip or postcode
- 10 Who or What is CLIVE
- 12 Packet deletion characters
- 13 Bids and Mids - the differences
- 15 Guidelines for the use of packet
- 16 Guidelines for SysOps of BBSs
- 17 Message and bulletin duplicates
- 18 Australian areas / HAS
- 19 Canadian areas / HAS
- 20 USA areas / HAS
- 23 UK BBSs and regions / HAS
- 24 ReqDir and ReqFil servers
- 25 UK callsign prefixes
- 26 REDIST server (targeting SBs)
- 27 CEPT licensing and callsigns
- 28 Guidelines for 7+ (1993)
- 30 Irish Provinces / Counties
- 34 Reciprocal / special callsigns
- 35 Garbled CW IDs

Table 1: Useful BBS 'Help' files from G8ASO.

nection **Data Connection** nection, and gives some helpful hints on interfacing a GPS receiver to your packet TNC

print run has been needed to refresh stocks! You'll find it is available from the Ham Radio Today *Book Browser* [see page 44 - Ed] as well as from many Amateur Radio retailers.

sunpac news

GB7PFD in Petersfield has now received its NoV (Notice of Variation - in effect its licence). The SysOp, Peter, G6HJP, hopes to have the system operational shortly following an initial test period, with user access ports on 144.950MHz and 432.650MHz. It is hoped this BBS will provide coverage for users in the area with Petersfield, Selborne, Bordon, Headley, Haslemere, Billingshurst, Petworth, Midhurst and Harting as its perimeter, and reports from these and surrounding districts are welcome. In particular, if you know someone in those areas who has previously been unable to obtain reasonable service on packet, and is currently inactive as a result, please pass this information on to them. You can get further information from G6HJP @ GB7PFD.

GB7HPH near Portsmouth,

South Wiltshire and surrounding areas. You can get further information on the group from the group's secretary, John, G8OQN @ GB7SUN or by e-mail: g8oqn@theshorts.demon.co.uk

maxpak news

The Midlands AX25 packet Group MAXPAK sent me a copy of their latest newsletter *Digicom*, which as usual is packed with interesting information on packet as well as local news. The Feb / March 1998 issue contains details of how to modify your FT-290 transceiver for 9600 baud operation, regional node maps for Wales and London / Thames Valley, and the next section of their ongoing 9600 baud handbook pages.

Locally, in order to comply with the new band plan, the BLOX node 2m user port frequency changed to 144.9375MHz, and the 2m user port of the DY22 node is due to change to 144.8625MHz in the very near future.

Maxpak hold regular local meetings and attend a number of rallies in the Midlands area. They can also supply kits for

some evenings. I have also recently worked a station in Eastleigh (Dave, G1GVM) at the weekends on 50.510MHz. With me being vertical, and Dave using horizontal polarisation, I also worked Dave on 70cm SSTV and much to both our surprises, Dave managed to work Larry, G7TDJ, in Bembridge, Isle of Wight, with little problem at all.

"Up to 10 stations calling in on 70cm in all is a good response really, and some evenings it does get a little hectic sometimes. Two recent newcomers to the mode are Simon, M1AMK, and Pete, G7RPG, both using the Win95 SSTV program, and so far so good. Both are not quite set up 100% but are getting there soon. Most others are using the GSH2.22 program by DL4SAW.

"Colin, MOASE, is having a problem with getting the GSH2.22 program running properly on his 486, it seems the display is coming up in mono, he's even had pictures upside down yesterday when I spoke to him. If anyone can assist him in getting it running 100% they can

contact him via packet; MOASE @ GB7SUN or call in one evening on 432.500 or 50.510. I'm sure he'll be glad to get it running properly.

"As there is not much SSTV on 6m at the moment, the 50.510 frequency is used as a talk-back frequency alongside the 70cm freq. There are a few capable of 6m operation, but so far not many sending SSTV there. I hope we might be able to arrange a get-together once the weather gets warmer, more news on that soon, I hope. Anyone interested in SSTV is welcome to call in on any of the 6m, 2m, or 70cm frequencies, there is usually someone there after 2100 most evenings."

I intend this column to cover all data-over-radio modes, so please do let me know what your interests are, maybe even what you've been doing or what you'd like to see me cover in future columns. My contact details are now given in each issue of the magazine under the 'Regular Contributors' contact info section on page 58. See you next month!

Book Browser

Ham Radio Today's **great new service** to readers. You can **order by e-mail, phone, fax** or the good old postal service. **See below for details.**

Radio Communication Handbook

edited by Dick Biddulph, G8DPS

A comprehensive guide to the theory and practice of Amateur Radio communication. If you're into Amateur Radio, this is the book to buy!

6th Edn, 763 pages **£21.00 (plus P&P)**

PMR Conversion Handbook

by Chris Lorek, G4HCL

Private mobile radio (PMR) equipment rapidly appears on the surplus market and can be acquired very cheaply at rallies. Often it can be converted to amateur bands quite easily and without expensive test equipment. This book tells you what to buy and how to convert it.

1st Edn, 192 pages **£15.28 (plus P&P)**

VHF / UHF Handbook

edited by Dick Biddulph, G8DPS

Guide to the theory and practice of Amateur Radio reception and transmission on the VHF / UHF bands including antennas, EMC, propagation, receivers and transmitters, together with constructional details of many items of equipment. One of the most complete guides around for VHF / UHF operators. See the review in *Ham Radio Today* December 1997!

317 pages **£18.80 (Plus P&P)**

VHF / UHF DX Book

edited by Ian White, G3SEK

VHF / UHF DX is one of the growing points where Amateur Radio shows that it still has a real future - and that's what this book is all about.

1st Edn, 447 pages **£18.00 (plus P&P)**

Amateur Radio Operating Manual

edited by Ray Eckersley, G4FTJ

This book covers the essential operating techniques required for most aspects of Amateur Radio, taking the reader from the principles of basic contacts right through to the secrets of working DX and winning contests.

4th Edn, 249 pages **£12.23 (plus P&P)**

IOTA Directory and Yearbook

edited by Roger Balister, G3KMA

The explosion in 'IOTA' (Islands on the Air) activity in recent years has been enormous. If you're on HF, you'll want to be part of it. The IOTA Directory gives you a complete listing of all the islands which 'count', and lots of articles about activating islands. Even includes a £5 discount voucher off new RSGB membership, so it's got to be good value! Don't be left out: become an IOTA operator today! 96 pages

£8.47 (plus P&P)

RSGB Yearbook - 1998

edited by Brett Rider, G4FLQ

Formerly known as the RSGB Callbook, the Yearbook has been enhanced to include a wealth of information for *all* Radio Amateurs. Includes all UK and Republic of Ireland callsign listings, plus over 120 information pages. Reviewed in *Ham Radio Today* December 1997.

1998 Edn, 517 pages **£13.95 (plus P&P)**

Passport to World Band Radio

edited by Lawrence Magne

How to find hundreds of programmes you won't find on ordinary radio or TV, from the BBC's incomparable reporting to music from the South Seas. Passport to World Band Radio covers it all - what's on, what to buy, how to get started, and how to get the most from your listening.

1998 Edn, 560 pages **£14.99 (plus P&P)**

World Radio & TV Handbook

edited by Andrew Sennitt

The comprehensive guide to broadcasting, including domestic and international radio listings, web sites, e-mail addresses, frequency listings, English broadcasts, 1998 survey of shortwave receivers and accessories, worldwide TV station addresses and contacts.

1998 Edn, 608 pages **£22.94 (plus P&P)**

Radio Logbook - Receiving

Spiral bound 100 pages

£3.67 (plus P&P)

Radio Logbook - Transmitting

Spiral bound 100 pages

£3.67 (plus P&P)

Your First Amateur Station

by Colin Redwood, G6MXL

How to set up a station and get on the air as cheaply and effectively as possible. It covers all bands, with special emphasis on VHF / UHF. A 'must' for everyone who has just passed the RAE or NRAE. (See the review in *Ham Radio Today* December 1997!)

1st Edn, 124 pages

£5.74 (plus P&P)

Your First Packet Station

by Steve Jelly, G0WSJ

How to set up a basic packet radio station and enter the world of data communications from your shack. Explanations are kept as simple and non-technical as possible, making this book an ideal choice for the beginner.

1st Edn, 76 pages

£5.74 (plus P&P)

The Antenna Experimenter's Guide

by Peter Dodd, G3LDO

Take the guesswork out of adjusting any antenna, home-made or commercial, and make sure it's working with maximum efficiency. An invaluable companion for everyone who wishes to get the best results from their antennas.

2nd Edn, 160 pages

£15.00 (plus P&P)

Practical Wire Antennas

by John Hey, G3BDQ

A 'down to earth' guide to the construction of many different types of wire antennas, ranging from simple dipoles to ingenious multi-wire systems. Boring and unnecessary theory is kept to a minimum - instead the author shares his years of experience, offering advice for beginners and enthusiasts alike.

1st Edn, 96 pages

£8.92 (plus P&P)

Practical Receivers for Beginners

by John Case, GW4HWR

Contains a selection of easy-to-build receiver designs suitable for amateur bands, together with simple 'fun' projects and test equipment. The theory and practice of receiving techniques is outlined to help with understanding the circuits presented. This book is of value to anyone who is building receivers for the first time, or who is considering moving up to microwaves.

1st Edn, 165 pages

£12.50 (plus P&P)

to order

post: Ham Radio Today, RSGB Sales, Lambda House, Cranborne Road, Potters Bar, Herts EN6 3JE.

tel: 01707 659015

fax: 01707 645105

e-mail: hrt.sales@rsgb.org.uk

Internet: www.rsgb.org/books/bookmenu.htm

postage and packing

UK: For one item £1.25, two items or more £2.50. Delivery by Parcel Force (7 - 10 working days). For next day service (on orders received before 12 noon): £4.85.

OVERSEAS - For one item £2, two items £4. Extra books over two items, an additional 50p per book. Delivery by surface mail. Air mail rates available on request.

NB: all prices include VAT (where applicable) and are subject to change without notice.

Rally Report - RSGB

VHF Convention

Ham Radio Today's VHF columnist, Geoff Brown, GJ4ICD, made the journey across the channel for the UK's premier VHF / UHF / SHF event

There were plenty of world-wide DXers at this year's RSGB VHF Convention at Sandown Park, Esher, which took place on 22 February. Those in attendance this year included Bob, W6BYA, all the way from California; Steve, VK3OT, who did a talk on working Europe from 'down under'; Hat, JA1VOK, who is very active on 6 metres from Japan, and who has worked the highest number of 'grid fields' in the world on that band; a very large contingent from the Netherlands headed by Frank, PA3BFM; Angelo, I2ADN, well known for his 'grid square hopping' around the rare squares in Italy; Tom, DL7AV, who was part of the 1994 50MHz Jordan expedition, plus others from Denmark and throughout the British Isles.

On the Sunday evening I took a taxi to the Hilton Hotel in Cobham, which is about five ►

Trade was brisk on the **Martin Lynch & Son** stand. Here's Graeme Platts, G4XOF, Jez Alexander, and Martin, G4HKS, himself, ready to demonstrate the latest VHF goodies.

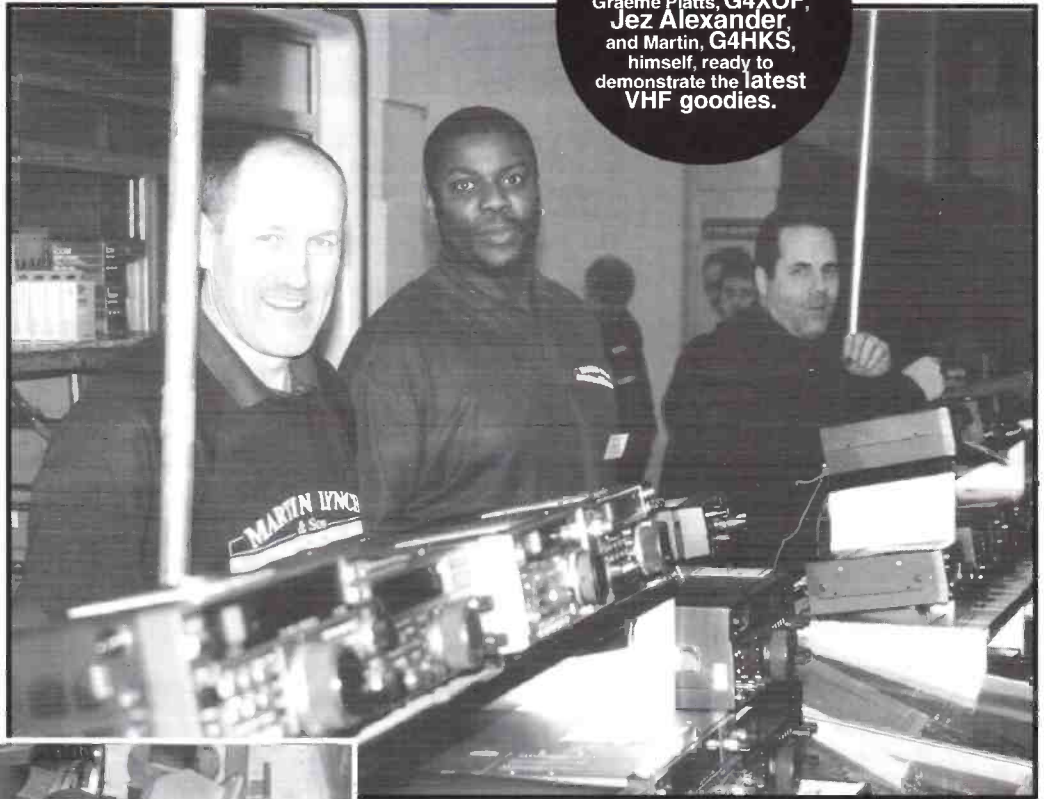

Bargains galore - waveguides from just £2.

An antenna here for all locations: this is the Sandpiper Communications stand.

Everything from junk up to professional test equipment is available at the VHF Convention.

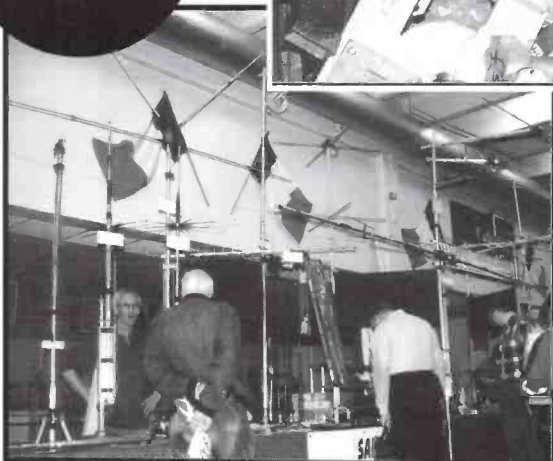

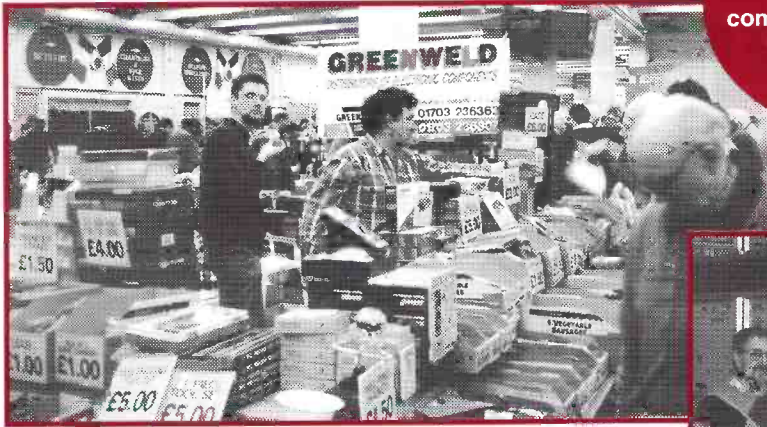

Tools, leads, printers, disks and numerous components on the Greenweld stand.

One of the most popular operating award schemes on the VHF bands, the Worked All Britain group had an important presence at the VHF Convention.

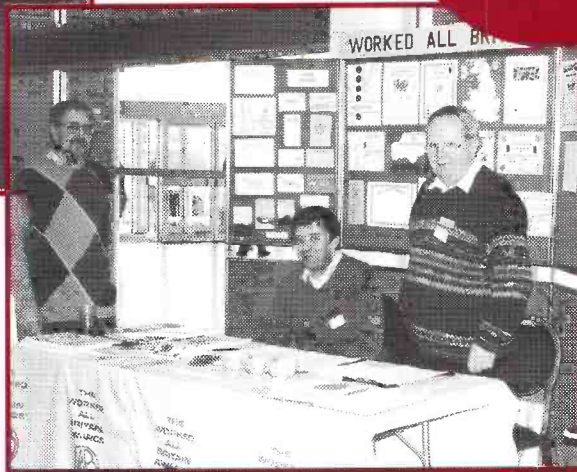

◀miles away from Sandown Park, and had an excellent chat with Bob, W6BYA. Bob has some really ambitious plans for 50MHz DXpeditions in the Indian Ocean during 1999 - 2000. News of these will appear in *VHF / UHF Message* in *Ham Radio Today* of course!

The VHF Convention seemed to lack sales of surplus equipment, more and more computer-related equipment now seems to appear at this event. However, I did spot some rather nice ceramic tubes for VHF use, 3CX800s, 7213s, and 3CX1500s, including bases new in their

boxes were to be had, but for a price! They remained unsold on the stand for some time, that was until I did a talk on amplifiers for VHF, then suddenly they vanished!

Chris, G3WOS, the former UKSMG (UK Six Metre Group) Chairman produced his carbon copy of my 50MHz amplifier / power supply design. That certainly opened many people's eyes as to the simple construction techniques using die-cast boxes for the chassis, and compactness using toroidal transformers in the power supply boxes. You can view this project on the Internet at: [http://](http://user.itl.net/~equinox/8877.html)

user.itl.net/~equinox/8877.html
Many visitors to the Convention showed a very keen interest in building power amplifiers, which resulted in over 70 keen listeners attending the lecture on VHF amplifiers.

Socially, it was the best event

I have ever attended. Over 25 50MHz DX fiends attended the Saturday evening dinner at the Bear Pub, whilst further up the road at the Hilton Hotel over 60 'VHF old timers' had a reunion dinner. It was certainly nice to have a chat with you all.



JOIN THE RSGB - Your National Society and we'll show you how to make a 12-month year grow!

When it comes to amateur radio we have a wealth of experience and background advisers to call upon to help you enjoy your hobby to the full - but YOU are the most important ingredient in the formula - without you there is no amateur radio. Together we are a winning combination and will ensure that amateur radio continues to thrive and grow into the next millennium.

We put you, the radio amateur and short wave listener first - help us to fight your cause and keep this hobby alive.

Sign up for Direct Debit, and we will give you an extra three months' membership completely FREE!

That's how we make a 12-month year grow!

To: Radio Society of Great Britain, Lambda House, Cranborne Road, Potters Bar, Herts EN6 3JE. Tel: 01707 659015, Fax: 01707 645105. Web: www.rsgb.org. E-mail: Sales@rsgb.org.uk

I would like to join the RSGB. My payment for £36* is enclosed with this form.

Name Callsign (if licensed)

Address Post/Zip Code:

Credit card number:

Expiry date: Switch Issue No. Start date:

Signed: Date:

HR1198

rally of the month

The rally of the month for April is the **Yeovil Amateur Radio Club QRP Convention**. It takes place just across the county border at Digby Hall, Sherborne, in Dorset on **19 April**. Regular attendees should note that this is *one month earlier* than usual!

Although there are trade stands and a bring and buy stall, one of the main attractions of this convention is the excellent series of lectures. Each year the Yeovil convention features well known speakers from the QRP world, which attracts visitors from all over the country and even from overseas to this increasingly popular event. At last year's convention, the 13th such annual event, all three lectures had capacity attendance. There were also displays of vintage radios, Novice equipment, packet radio and weather satellite reception.

The Yeovil ARC QRP Convention also features special interest groups' stands, RSGB Morse code tests on demand, catering and facilities for disabled visitors. Talk-in is provided on 145.550MHz and admission is £2. Doors open at 9.00am. For further details, please tel: 01935 813054.

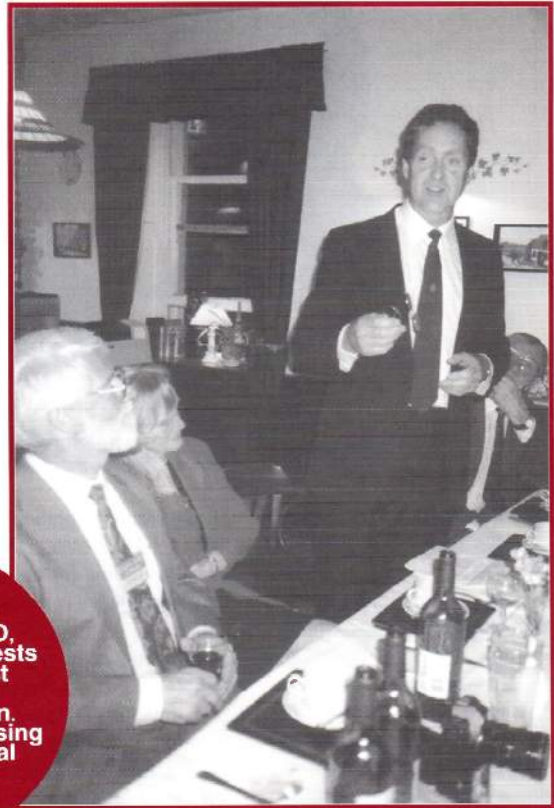

Ian Keyser, G3ROO, was one of the guests of honour at last year's Yeovil QRP Convention. Here he is addressing the club's annual dinner.

Ham Radio this month

ham radio today event news

rallies

29 March

Pontefract & District ARS Component Fair - please note this event has been *cancelled*.

5 April

The Cambridgeshire Repeater Group annual rally, at the Bottisham Sports Centre (part of village college), Lode Road, Bottisham, near Cambridge (please note this is a *new venue*). Details from Paul Dyke, G0LUC, 41 High Street, Puckeridge, Ware, Herts SG11 1RX; tel: 01920 821536.

5 April

Cheltenham Radio Rally - please note this event has been *cancelled*.

5 April

Launceston Amateur Radio Rally at Launceston College, tel: 01288 354564 for further details.

5 April

Red Rose Rally, Horwich Leisure Centre, Horwich, Bolton, near junction 6 of M61. For further details tel: 01204 494308.

18 April

SAMS '98 Computer & Electronics Show, Bingley Hall, Staffordshire Showground, Weston Rd, Stafford. Details tel: 01473 741533.

19 April

Swansea Amateur Radio and Computer Show, Swansea Leisure Centre. For further details, tel: 01792 404422.

26 April

British Amateur Television Club Rally Sports Connexion, Leamington Road, Ryton-on-Dunsmore, near Coventry. For further details tel: 01788 890365, or e-mail: rally98@batc.org.uk

other events

28 / 29 March

CQ WPX SSB Contest (10 - 160m, 0000 - 2400UTC).

30 March

RSGB Slow Speed Cumulative Contest (1900 - 2030UTC, 80m CW)

31 March

RSGB 144MHz SSB Fixed Station Cumulative Contest (1900 - 2100UTC)

5 April

RSGB 'RoPoCo' Contest (0700 - 0900UTC, 80m CW)

7 April

RSGB Slow Speed Cumulative Contest (1900 - 2030UTC, 80m CW)

8 April

RSGB 144MHz SSB Fixed Station Cumulative Contest (1900 - 2100UTC)

15 April

RSGB Slow Speed Cumulative Contest (1900 - 2030UTC, 80m CW)

16 April

RSGB 144MHz SSB Fixed Station Cumulative Contest (1900 - 2100UTC)

19 April

RSGB 50MHz Fixed Station Contest (0900 - 1300UTC)

19 April

Yeovil QRP Convention, Sherborne, Dorset (see *Rally of the Month*, above)

23 April

RSGB Slow Speed Cumulative Contest (1900 - 2030UTC, 80m CW)

24 April

Ham Radio Today May publication date.

25 April

International Marconi Day, organised by Cornish Radio Amateur Club. Special event stations operating from sites around the world associated with G Marconi. For further details tel: 01209 212314.

To include your rally in this section, please make sure you send us details of your event in time: the deadline for May issue is 6 Apr, for June: 5 May; July: 21 May. Please note the new address for submissions: The Editor, *Ham Radio Today* (Club News), RSGB Publications, Lambda House, Cranborne Road, Poiters Bar, Herts EN6 3JE; fax: 01707 645105. We would be grateful if *Ham Radio Today* readers would alert their local rally organiser to this change of address. If you're travelling a long distance to attend rallies, we recommend you contact the organisers of the events first, to check if there has been any changes since this magazine went to press.



transmitted for about one month. The beacon, on 145.820MHz, was widely monitored and recorded around the world and the satellite was built by students in Russia and on Reunion Island.

mir

In January the PMS 2m radio station was temporarily moved from the core module and installed in the Priroda

Module. The crew also installed a new modem some time ago but, due to the crew's heavy work load, all of the TNC parameters had not been properly configured.

The SAFEX repeater has been active intermittently and the crew have turned off the CTCSS tone feature of the repeater, making it easier for weak



Oscar 10 is still operational in Mode-B. W4SM, one of the command stations, reports that AO-10 is at least partially functional. However, observations over several weeks strongly suggest that the spacecraft is no longer stable in its Z-axis (the normal axis of spin) and is slowly tumbling. This conclusion is based on several findings:

strong FMing, sounding almost like an eclipse onset. The only explanation that he has for the non-FMing fades is a change in antenna orientation, which requires non-Z-axis motion (ie a tumble). As these fades have been noted at multiple points in the orbit, both before and after perigee, masking of the antenna due to the rotation of an other-

up, 10m (down). Pat also reported that RS-12's robot 15m uplink suffers from unexplained deep signal fades with a period of about four seconds. This phenomenon is seen only through the robot, and not when operating through

Satellite Rendezvous

The latest roundup of AMSAT-UK

1. For some time it has been noted that the spin rate had become quite slow, of the order of 1 to 1.5RPM or less. At these slow speeds, gyroscopic stability is quite low and the nutation dampers are much less functional. At some point in the future the satellite will become Z-axis unstable.

2. For the last two eclipse cycles, AO-10's beacon never completely went dead, though it did show long deep fades. Given the range of probable attitudes if AO-10 were Z-axis stable, at some time during these periods the solar angle should have gone to 90 degs (illumination = 0) and AO-10 should have gone completely dead for a week or more.

3. At present, signals go through several long, deep periods of fading with a cycle measured in the range of 15 - 20 minutes. During this time, W4SM has observed a cycle of two deep fades without FMing, followed by one deep fade with

wise Z-axis stable three-lobed spacecraft would not seem to account for this effect at unrelated points in the orbit. The FMing fade could be due to the failure of one or more solar panels such that during slow rotation the power output drops. However, given the above, W4SM suspects that the FMing fades represent a component of the tumble during which the solar angle increases to a point where the power level drops significantly.

If the above is true, then the ability to predict AO-10s functional status over periods of months will be non-existent. The satellite will simply continue to show periods of slow QSB, followed by periods of rather strong signals over a cycle of multiple minutes.

russian satellites

Pat Gowen, G3IOR, reports that the RS-12 satellite has been placed in Mode KA (2m + 15m

the analog transponder.

The Sputnik mini-satellite RS-17 ceased transmitting on 29 December shortly after 1100UTC. The last report came from G6HRH. Those tracking the satellite reported that the beacon signal got weaker as the end approached. Even after the 'beep-beep' ceased, however, the satellite's unmodulated oscillator continued to transmit for a while longer. The last data indicated an internal temperature of 40 degrees centigrade.

The satellite, a one-third scale replica of the original Sputnik 1, 'beep-beeped' its way around the globe for 55 days, more than two weeks longer than it was expected to last. The 100mW transmitter was powered by lithium batteries.

The Sputnik was launched by hand from the Russian Mir space station on 4 November to commemorate the 40th anniversary of the launching of the original Sputnik by the USSR in 1957. The original Sputnik only

stations to access the repeater. It also has the side effect of keeping the repeater up and transmitting static for long periods of time followed by short time-outs. Make sure you compensate for Doppler for each transmission. The uplink is on 435.750MHz FM, and downlink on 437.950 MHz.

The 12-year-old space station may stay in orbit until the first components of the International Space Station are in place in 1999. That's a few months longer than Mir was supposed to stay up. The first ISS units are supposed to be launched later this year. Amateurs are scheduled to be among the first crew members to populate the ISS, but the US presence aboard Mir comes to an end this June.

US astronaut David Wolf, KC5VPF, now aboard Mir, was scheduled to be replaced by Australian-born US astronaut Andy Thomas. An Australian callsign, VK5MIR, has been provided for use by Dr Thomas

while aboard Mir; he will be there until June.

Also, two new Russian crew members, both amateurs, were due to arrive at the end of January. They are Talgat Musabayev, RO3FT, and Nikolai Budarin, RV3FB.

MIREX have an Internet Web page containing information regarding Mir and the various Amateur Radio experiments taking place from the space station. The pages are still 'under construction', but some good information can be gathered from what has been put together. URLs include the following: <http://www.ik1sld.org/mirex.htm>, <http://www.ik1sld.org/mirex>, <http://www.geocities.com/~ik1sld/mirex.htm> or <http://www.geocities.com/~ik1sld/mirex>

digital satellites

Clive, G3CWW's monthly Oscar-11 report says that UoSat-2

Space Agency press release, one of their main events is the third launch of Ariane 5 (A503), from Kourou, French Guiana. The launch is currently scheduled for late May. At this time there is no word about whether or not P3D will be on board.

Those interested in tracking events via the Internet may want to watch <http://www.newspace.com/feature/newsline/rocket.html> which seems to be the best unofficial source of this kind of information that has been found so far.

I am starting to put together a book on the Phase-3D satellite, and current intentions are for it to have a similar content to the AO-10 and AO-13 books. If anyone has any suggestions for extra bits please let me know.

short bursts

A memory error has been detected in the onboard computer system of FO-29. Restarting and

cluding one labelled 'AMSAT'. Clicking on the AMSAT button will automatically start the connection, and your name will appear in the 'room'. You are then in a round table conference mode and can talk to anyone else who may also be connected.

To obtain Internet Phone 4.X or 5.0 programs, W7KPW has provided a link to download the correct software. The W7KPW web site is available at the following URL: <http://www.vvm.com/~rjett/iphone.html>

NASA has selected Barbara Morgan, an elementary school teacher from Idaho to join the next astronaut candidate class as a mission specialist and she has accepted. NASA's strong commitment to education, and its unique position to advance the US goals to improve science, mathematics and technology education, means that they now consider it appropriate to include educator mission spe-

ematically and technology will be selected and trained in the astronaut corps. These mission specialists will carry out educational programs in addition to their other assigned flight duties.

amsat-uk news

Here's a repeat of last month's news that Ron Broadbent, MBE, G3AAJ, has retired from the position of AMSAT-UK Secretary as of the end of the year. The task has been taken on by Fred Southwell, G6ZRU (pictured below), so the telephone and fax numbers have also changed. AMSAT-UK's phone number is now 01273 495733 and fax is 01273 492927. As always, a big SASE sent to Fred at 40 Downsview, Small Dole, Henfield BN5 9YB gets a membership info pack, and SWLs are, of course, welcome.

There were also other changes to the AMSAT-UK Com-

Satellite Rendezvous

NEWS, collated by Richard Limebear, G3RWE

continues to work well and interest in the mode-S beacon continues as stations prepare for Phase 3D.

The telemetry is nominal; internal temperatures have continued to fall and, at present, are 6.4C and 4.2C for battery and telemetry electronics respectively. This fall in temperature is due to increasing solar eclipse times, which were expected to reach a maximum in early February.

22 January was the eighth birthday of the MicroSats: UO-14 and UO-15, Pacsat (AO-16), DOVE (DO-17), WeberSat (WO-18), and LUSAT (LO-19). Most of these are still operational after eight years.

phase 3d

Folks interested in testing mode-S receive equipment can use either the DOVE S-band transmitter on 2401.220MHz or UO-11's transmitter (which is weaker). The AO-16 S-band transmitter is usually off.

According to a European

software reloading is going on but is taking a long time due to poor uplink efficiency. The operation of FO-29 to the end of January is cancelled, it will stay in analog mode (mode JA) continuously.

A year-end problem showed up in WISP. A new version of GSC has been uploaded to the digital satellites and is also available on the Internet at <ftp://ftp.amsat.org/amsat/software/win32/wisp>. It is GSC201.ZIP. It also corrects some other minor problems in GSC.

Satellite operators who have an Internet connection and have installed Internet phone software may be interested in the W7KPW web site. There are several conference 'chat' rooms in-

cluding the astronaut corps. In addition to meeting the astronaut selection requirements, mission specialists with education and teaching backgrounds in science, math-

mittee. In particular, members renewing their annual donation should note that it should now be sent to Fred's address (or rather Jenny Southwell's - which is the same).

A copy of the latest 'Keplers' is available on request by mail or packet; my mailbox is GB7HSN but please note that AMSAT-UK Keplers are put out on packet weekly anyway and sent to KEPLER @ GBR. When asking me for Keplers please say which satellites - 'all' means about 250 satellites.

The new AMSAT-UK Secretary
Fred Southwell, G6ZRU,
seen here at the
RSGB VHF
Convention in
February.

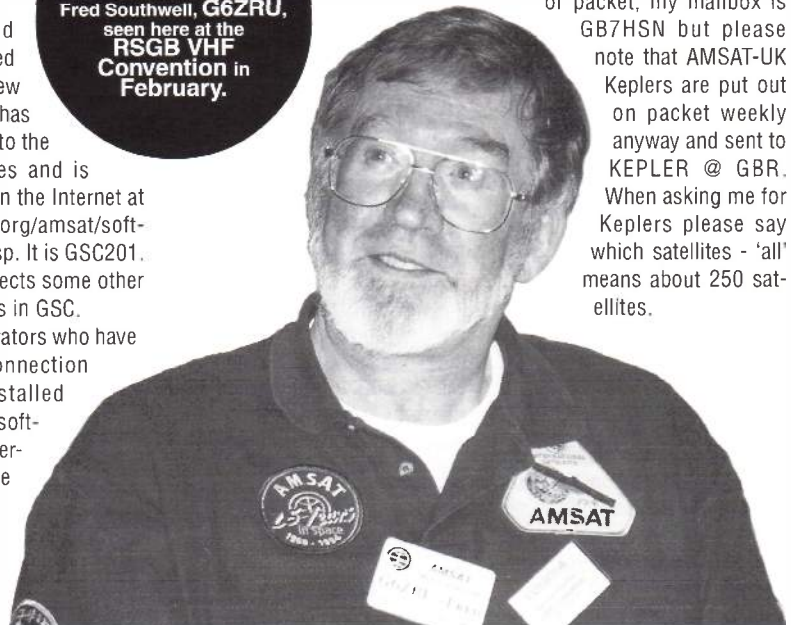

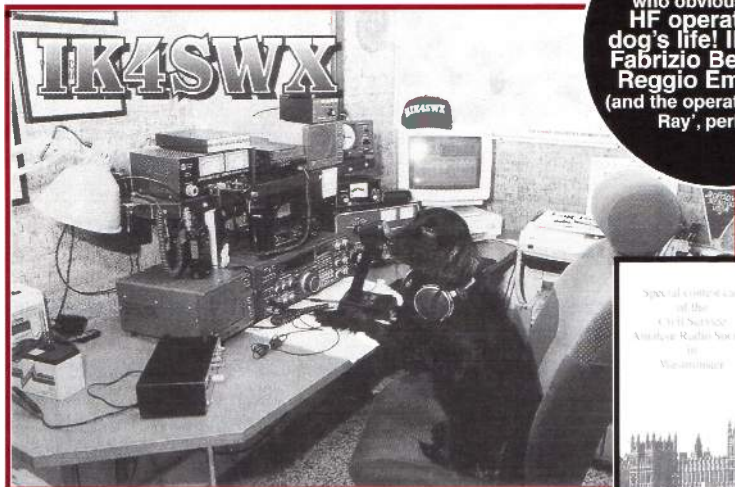

Here's one amateur who obviously thinks HF operation is a dog's life! IK4SWX is Fabrizio Bedeschi in Reggio Emilia, Italy (and the operator is 'Dog X-Ray', perhaps?)

I am just back from the 9MOC expedition, which I have written up separately for this issue of Ham Radio Today. Quite apart from having a great time on my first trip to South East Asia, I was struck by a number of aspects of Amateur Radio operation from that part of the

Tokyo to get on the air but, again, they are not loud enough to be noticeable in Europe.

Conversely, I was amazed at the strength of signals from both Europe and West Coast USA, given that both those areas were around 6000 miles from us. Maybe our salt-water location



The attractive QSL card sent out by the Civil Service Amateur Radio Society for their 1996 '1 x 1' special contest call. This year's calls will use the digit '8' during the major international contests, such as the CQ WPX SSB contest on 28 / 29 March.

plans afoot for an operation from St Brandon, a dependency of Mauritius, and paired with Agalega Island as a separate DXCC country. More information

Karl, K4YT, veteran of many operations from Africa and elsewhere during the course of his work, will be reassigned

HF Happenings HF Hap

Don Field, G3XTT, with full details of the upcoming St

world. Firstly, any operations are hindered both by the high levels of static, especially on the 'low bands', and by the large number of pirate stations which occupy the bands. This is a particular problem on 40 metres, but is something we are relatively unaware of from Europe, where the high level of amateur activity discourages unlicensed users from occupying our spectrum.

Another feature of operating near the equator is the rapidity of dusk and dawn. Twilight is non-existent, and it was interesting how low band signals disappeared within moments of the sun appearing above the horizon.

I was also struck by the relatively large number of stations we heard and worked from China, Korea, Indonesia and India. We only tend to hear the strongest ones in Europe, and are largely unaware that there is increasing interest in Amateur Radio in these countries. I was also intrigued by the number of Japanese mobile stations we worked. Maybe this is one way for the apartment-dwellers of

helped, but many of the signals were very strong indeed, even on the low bands.

dx news

Apart from our Spratly operation (which a large number of Europeans worked on all nine HF bands), there were several other rare ones active during February and early March. These included a last-minute operation from Palmyra (KH5) and from Kingman Reef (KH5K) with the team then due to move on to Baker and Howland Island (KH1). However, from what I have seen of band reports, this group didn't make a big impact in Europe. In contrast, the Germans who operated from Chatham Island as ZL7DK appear to have done a great job, and were relatively easy to work from the UK on all HF bands except 10 metres. The Wake Island (KH9) operation also appeared as promised, though again this is proving to be a tough one from Europe on most bands, at least as I write this piece.

I mentioned a couple of months back that there were

is now available. A large group of operators will activate this rare location from 6 - 17 May. Several stations, under the callsign 3B7AZ, will be on the air 24 hours a day on all bands operating on CW, SSB, RTTY and SSTV. Operators and participants are: 3B8CF, 4X1DF/A, HB9ABO, HB9ADP, HB9AFH, HB9AFI, HB9AHL, HB9AJW, HB9BQI, HB9BQW, HB9BXE, HB9JAI and K5KG. The organisers are the Union of Swiss Short Wave Amateurs (USKA), Section Zug, HB9RF; and project initiator HB9JAI. To assure the necessary funds for their DXpedition, they are asking for help from the DX community. To help, contact Josef Meier, HB9AJW, e-mail address: 100450.540@compuserve.com A dedicated Web site is under construction at <http://www.uska.ch> (see under 'Links', 'DXpedition').

Unfortunately, the operation from Annobon Island which was expected to take place during March has been cancelled for a second time, this time due to an armed coup. This one could start to get very rare indeed!

to the US embassy in Tel Aviv for three years from March and expects to be active from there.

A group of seven Italian amateurs will operate as JT1Y from Ulan Bator, Mongolia, for one week starting on 7 April. The team includes I0SNY, I0TIC, I1JQJ, I8NHJ, IK0AEH, IK0FUX, IV3FSG, IK5/EA8AFJ, IK0SHF, IV3ZAC, IZ0AZQ and IZ0AEH. It is planned to keep at least two HF stations on the air round the clock, to maximise band openings. A third station will operate satellite and 6m. All HF bands will be activated, on SSB, CW and RTTY. The activity will take place from JT1KAA, the club station of the Mongolian Radio Sports Federation. QSLs go to Nicola Sanna, I0SNY, Strada Gualtarella 8/M, I-06132 S Sisto - PG, Italy.

A further operation will take place from Mongolia in May with a two or three station effort by Hungarian Pannon DX Club members HA0HW, HA4GDO, HA6NL, HA7SK and HA7VK. Dates and callsign will be announced later. Check their Web page at <http://www.dunonet.hu/pannondxc/>

iota news

Albert, HB9BCK, is due to operate from Niue (OC-040) as ZK2CK between 2 and 16 April on 80, 40, 20 and 15 metres. QSL to his home call. JM1LJS and JE10YE will be active as 3D2LJ/P and 3D2TS/P from Yasawa Group, Fiji (OC-156) from 1 to 3 May. They will then move to Viti Levu (OC-016), from where they will be active as 3D2LJ and 3D2TS until 7 May. QSL both via JM1LJS.

DS4CNB plans an operation as DS4CNB/4 from Korean islands AS-085 (1 - 3 April) and AS-060 (4 / 5 April). QSL to Box 111, Kwangsan Kwangju 506-050, South Korea. Nearer to home, GB0SM will be activated from the Isles of Scilly (EU-011) between 25 April and 2 May by the Taunton and District Amateur Radio Club.

Peter, PB0ALB, will be active again as 9M8CC from Sarawak (OC-088) between 10 April and 22 May. PR5L will activate Sao Francisco Island (SA-027) between 16 and 20 April. QSL to PP5LL. And finally, CE0ZAM ex-

callsigns such as LR2DW (by LU2DW) or AY7D (by LU7DW) are contest / special event calls for the CQ World Wide DX Contest.

dxcc changes

The ARRL has announced a number of changes to the DXCC awards program, following its recent review. The changes were introduced with the following statement from the ARRL:

"Approved by the Board were rules changes for the DXCC program that had been recommended by the DXCC 2000 Committee. Under the new criteria, no countries currently on the DXCC list will be removed. In the future, countries will be referred to as entities. A political entity will be added to the DXCC list if it meets any one of three criteria: it is a UN member state, it has an ITU prefix block assigned, or it has a separate IARU member society. The new criteria also replace all DXCC measurements, including physical separation

decision to press ahead with field checking of cards (see last month's column for information about arrangements for field checking in the UK). To add a little to what I said last month, UK amateurs may send the checking fee to these UK checkpoints in sterling amounts as follows: First DXCC application £7; First submission in a calendar year £7 (ARRL member) or £14 (non-member); additional submissions £14 (member) or £21 (non-member); new or replacement certificates £7. The first submission in a calendar year may contain claims for up to 120 QSOs. Second or subsequent submissions in a calendar year may contain claims for up to 100 QSOs. In both cases, additional QSOs are charged at 10p per QSO.

The 5-band DXCC is no longer checked as a separate award. When you send cards for DXCC checking, credit is given according to the band on which the QSO took place. Your totals for each band are shown on the computer printout you will receive back

desk will be checking cards in person.

most wanted countries

The latest survey by *The DX Magazine* has a number of changes in position from last year. For example, XZ and 5A continue to drop down the list as a result of increasingly frequent operations. And, of course, the VKOIR operation made a major dent in the demand for Heard Island, dropping it from 6th to 78th position.

Some of the 'most wanted' in this year's list are also DXpedition targets, for example 3B7 should be coming up soon and a Bouvet Island expedition is at the planning stage. But others, like P5 and A5, seem destined to remain near the top for some years yet. **Table 1** shows the world and European 'top ten' Most Wanted.

What I do suspect is that these 'Wanted Country' surveys only give part of the story. The massive demand for contacts with our 9MOC expedition suggests

Evenings HF Happenings

Brandon operation - and all the other HF DX news

pects to be active as XQ0X from San Felix Island for about 20 days during April.

argentinian calls

Trey, N5KO, put some useful information about Argentinian callsigns on the Internet Contest Reflector recently. Here is a summary. LU call areas are based on the first letter of the suffix. A, B and C (eg LU2AH, LU8AQE, LU6BEG) indicate the city of Buenos Aires, D and E (eg LU8DQ, LU6ETB) the province of Buenos Aires, F (eg LU4FM) the province of Santa Fe, and so on. People operating outside their call area sign 'stroke x' where x is the new call area. For instance, LU6ETB/F is more likely operating portable in the Santa Fe province than in France.

A while back, the LUs ran out of callsigns in the D / E district, so they started issuing LW calls in this area. The same thing happened more recently for the H call area. Therefore, whenever you hear an LW, his suffix should start with a D, E or H. An LW station is not necessarily a Novice.

distances, with metric system figures roughly equivalent to the former distances. While the 57 entities on the deleted list will remain, no new countries will be added to the deleted list in the future. Deleted entities simply will be removed. In addition, the new rules specify a minimum 'island' size of 100 metres measured in a straight line. The DXCC field checking program will remain in place. The effective date of the changes will be announced later this year. The DXCC 2000 Committee was discharged with the Board's thanks."

It is clear that the intention has been to remove some of the contradictions and tensions which have caused problems for DXCC in recent years, for example by the acceptance of Scarborough Reef (just a few rocks appearing above the surface of the sea) as a 'country'. At the same time there is obviously some pandering to the old guard by keeping the existing 'deleted' list, which consists of 'countries' many of you will be far too young to remember.

Perhaps best news of all is the

from the ARRL. When you have 100 or more confirmed on each of the five relevant bands, then you can claim 5BDXCC. By the way, for cards not on the list of 250 countries eligible for field checking (I can provide a list of the 250 in return for an SASE), there will be one opportunity to have these checked this year in the UK, which is at the RSGB HF Convention, where Bill Kenamer, K5FUV, of the DXCC

that many people who are not normally DX chasers are interested in working a rare one, if it is loud enough and active enough. And some countries, while arguably not rare overall, can be very rare indeed on certain bands and modes. For example, from Europe it is easy enough to work some Pacific islands such as Tahiti - but Tahiti on, say, 80 or 160 metres is very rare indeed.

Posn	World	Europe
1	N Korea (P5)	N Korea (P5)
2	Pratas (BV9P)	Macquarie (VK0)
3	Bhutan (A5)	Bouvet (3Y)
4	Scarborough (BS7)	Bhutan (A5)
5	Andaman (VU4)	Pratas (BV9P)
6	Yemen (70)	Clipperton (FO)
7	Bouvet (3Y)	S Sandwich (VP8)
8	Tromelin (FR/T)	Auckland Is (ZL9)
9	Macquarie (VK0)	Annobon (3C0)
10	Agalega / St Brandon (3B6)	Yemen (70)

Table 1: The World and European 'top 10' most wanted countries, according to the recent survey by *The DX Magazine*.

LANCASHIRE

AMATEUR ELECTRONICS/HOLDINGS G3LLL.

YAESU, AOR, ICOM, ETC. FT 101 EXPERTS

6JS6C 6146B 12BY7A Original type approved valves and our own Double Balanced Mixer and new band WARC Kits for original FT101 MK1-E. S.A.E. List Full Yaesu range. 15 mins Junction 31 M6. Free parking. Call and consult G3LLL without obligation. Holidays? Phone, check we are open before calling. Lunch 12-1.30pm.

45 JOHNSON STREET, BLACKBURN BB2 1EF

(01254) 59595. OPEN: Thursdays, Fridays and Saturdays ONLY from July '96

NORTH WEST & NORTH WALES

AMATEUR RADIO COMMUNICATIONS LIMITED

OPEN
Tues to Sat
10-5pm

We are official factory appointed stockists and approved Service Centre for all the major brands.

ICOM - YAESU - KENWOOD - ALINCO

TEL/FAX: 01925 229881/2

We are 1 mile from J23 M6,
4/4 miles off J9 M62



38 Bridge Street, Earlestown, Newton le Willows, Merseyside WA12 9BA

CAMBRIDGE

CAMBRIDGE MULTICOMM 2000

- Wide range of new and used equipment always in stock
- International mail order service
- Fast friendly service

Unit 3, 86 Cambridge Street,
St Neots, Cambridgeshire

PE19 1PJ

Tel: 01480 406770

CORNWALL

For All Your Marine Radio Communications

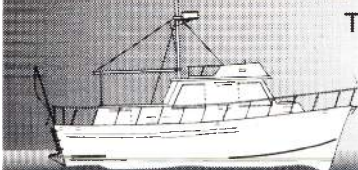

Try us first for all your Radio
amateur and marine
communications

ICOM YAESU

NAVICO JAYBEAM

Give Mike G1DDK a call today!

SKYWAVE
OF CORNWALL

SKYWAVE MARINE SERVICES, SQUARE SAIL BOAT YARD, CHARLESTOWN HARBOUR, ST AUSTELL, CORNWALL P25 3NT. TEL: 01726 70220

SCOTLAND

JAYCEE ELECTRONICS LTD

20 Woodside Way, Glenrothes

Fife KY7 5DF

Tel: 01592 756962

NEW OPENING HOURS:

Tues-Fri 9 am to 5 pm, Sat 9 am to 4 pm. Closed Sunday & Monday

Good range Kenwood, Yaesu & Icom etc, plus quality secondhand equipment

PLEASE MENTION
HAM RADIO
TODAY
WHEN REPLYING
TO ADVERTISEMENTS

£50 BT INSTRUMENT FOR ONLY £7.50

We refer to the BT insulation tester and multi-meter with which you can read insulation directly in megohms, AC volts up to 230, 4 ranges of DC volts up to 500, 3 ranges of millamps and one 5A range and 3 ranges of resistance. These are in perfect condition, have had very little use, if any, tested and fully guaranteed. Complete with leads and prods £7.50. Order Ref 7.5P4. Carrying case which will take small tools as well, £2 extra. Postage £3 unless your order is £25 and over.

J & N Factors

Dept HRT, Pilgrim Works, Stairbridge Lane, Bolney

Sussex, RH17 5PA

Telephone: (01444) 881965

KENT

KANGA QRP KITS

Our books: Introducing QRP £7.95

Pascoe's Penny Pinchers £5.95

(All about wire antennas)

QRP crystals from £1.00

Send an SAE now for our free Catalogue to:

Seaview House, Crete Rd East, Folkstone, Kent CT18 7EG

Tel/Fax 01303 891106 (0930-1900)

<http://www.kanga.demon.co.uk>

advertise hrt

To advertise in

Ham Radio Today

Phone 01202 777852 Fax 01202 317902

Email: adman@mcmail.com

CHARITY RADIO

CQ CHRISTIAN AMATEURS!

The World Association of Christian Radio Amateurs and Listeners actively promotes Christian fellowship worldwide, regular nets, activity days, Annual Conference, handbook, magazine etc. Call our UK Sunday SSB nets 3747 kHz at 8am and 2pm, or 144.205 MHz at 3pm.



For full info write to our
Membership Secretary
WACRAL
51 Alma Road, Brixham,
South Devon TQ5 8QR

See Web [HTTP://www.GOPPOQ.DEMON.CO.UK/](http://www.GOPPOQ.DEMON.CO.UK/)

VALVES



(PROP JIM FISH G4MH)

Over 50,000 valves stocked,

2000 different types,

vintage, military, audio, etc.

Fast service. Send SAE for list

VALVES WANTED FOR CASH

28 Banks Avenue, Golcar, Huddersfield,

West Yorks HD7 4LZ

Tel: 01484 654650

Fax: 01484 655699

HOLIDAYS

NORTH WALES HOLIDAYS - Caravan - bunkhouse - camping. Elevated rural site, two miles from beach, use of shack and antennas, open all year. Tynrhos, Mynytho, Pwllheli. Tel: 01758 740712.

To include your club in this section, please make sure you send us your events details in time: deadline for May issue is 6 Apr, for June: 5 May; July: 21 May. We only list active clubs, ie those who send us their diary of planned talks / events. Send your club event details to: The Editor, Ham Radio Today (Club News), RSGB Publications, Lambda House, Cranborne Road, Potters Bar, Herts EN6 3JE; fax: 01707 645105.

Appledore and District ARC

meets on the third Monday of each month at 7.30pm at the Appledore Football Club room. Club nets: Tue 2000 on 145.475MHz, Wed on 28350kHz: slow CW 2000 - 2030 then SSB 2030 - 2100. 20 Apr - EMC by John Wilson, G3PCY. Contact Den Williams, G0UMT, on tel: 01237 471802 for further information.

Bangor and District ARS

meets on the first Wednesday of each month (except in June and July), 8.00pm, at the Clandeboye Lodge Hotel, Bangor, Co Down. Everyone welcome, especially newcomers interested in the hobby. 1 Apr - Talk by RSGB President Ian Kyle, G18AYZ / M10AYZ. 6 May - Barbecue and QRP talk and demo. Contact Roy, G10WVN, on tel: 01247 460716 for further details.

Cheltenham AR Association

meets on the first Friday of the month at the Prestbury Library, The Burgage, Prestbury, Cheltenham, at 7.45pm for 8.00pm. Visitors and prospective members welcome. Club nets: Wed 2m, Mon and Thu 1960kHz, Fri 70cm all at 9.00pm; Sun 1848kHz at 10.00am. 3 Apr - The Future of Amateur Radio by Ian Kyle, G18AYZ, RSGB President. Details can be obtained from the Secretary, Mrs Patricia Thom, G1NKS, tel: 01242 241099, e-mail g1nks@g3nks.demon.co.uk

Christchurch Amateur Radio Society

is the new name for the former Siemens Plessey Christchurch Amateur Radio Society. The club meets Thursday evenings at 8.00pm in the radio club room, behind the Sports and Social Club, Grange Road, Somerford, Christchurch. Visitors are

tact Club Secretary, Alan Bartle, G6HC, tel: 0181 684 0610.

Coventry Amateur Radio Society

meets at 2000 every Friday at Binley Church Hall, Brinklow Road, Coventry. Visitors are always welcome. 3 Apr - TBA. 10 Apr - VHF, HF and packet night on the air. 17 Apr - 2m DF competition. 24 Apr - VHF, HF and packet night on the air. For further details contact the Secretary, Robin Tew, G4JDO, tel: 01203 673999.

Cray Valley Radio Society

meets on the first and third Thursday of each month at the Progress Hall, Admiral Seymore Road, Eltham, London SE9. 2 Apr - RSGB EMC Committee. 16 Apr - AGM. To contact the club, please call Tony Fishpool, G4WIF, tel: 0171 739 5057 (office hours).

Centre, Blackboy Road, Exeter, starting at 7.45pm. 13 Apr - Inter-club quiz. For further details contact Theo, G3EQM, tel: 01392 875498.

Hambleton ARS

meet 7.30pm, at Allertonsire School, Northallerton. 2 Apr - meeting cancelled. For further details contact John Hampson, G0VXH, tel: 01845 537547, or via Packet @ GB7CYM.

Hastings Electronics and RC

meets, 7.30pm, on the third Wednesday of each month at West Hill Community Centre, Croft Road, Hastings. The club run RAE and Novice courses and is a registered City and Guilds examination centre. 15 Apr - Auction. For further details contact Doug Mephram, G4ERA, 8 The Close, Fairlight, E.Sussex TN35 4AQ, tel: 01424 812350.

This Month at the Clubs

ham radio today latest club news

Bristol (RSGB) Group

holds meetings on the last Tuesday in every month at 7.00pm for 7.30pm at Avon Combined Services Club, St Pauls Rd, Clifton, Bristol. 31 Mar - Norman Lockyer Observatory, Jack Wickins. 28 Apr - Burglar alarms and EMC, Hugh Pearson, G7KET. Further details from Robin Thompson, G3TKF, tel: 01225 420442.

Bristol (South) ARC

meets at 7.30pm every Wednesday at the Whitchurch Folkhouse Association, Bridge Farm House, East Dundry Road, Whitchurch, Bristol. The club hold regular 'activity nights'. 1 Apr - 10GHz activity evening. 8 Apr - Amateur radio software demo. 15 Apr - Cheese and wine evening. 22 Apr - How to use an oscilloscope. 29 Apr - Refurbishment of contest antennas. For more information contact Jean Fletcher, G0AWX, on tel: 01275 834282 (24hr answerphone).

Bromley and District ARC

meets on the third Tuesday of each month, 7.30pm for 8.00pm at the Victory Social Club, Kechill Gardens, Hayes, Kent. 21 Apr - Railway signalling, Andy Brooker, G4WGZ. Further details from Alan Messenger, G0TLK, tel: 0181 777 0420; e-mail: alangm@clara.net

welcome. A broad-based programme of events for 1998 is currently being compiled. For further information, please contact the Secretary, K P Harris, G7WSN, tel: 01202 484892 (evenings).

Cockenzie & Port Seton ARC

has 'normal club nights' on the first Friday of every month at the Thorntree Inn, High Street, Cockenzie, from 1900 'till late'. The club participates in many weekend contests. 17 Apr - Quiz night, Susan, 2M1EPK, and Colin, G0MCLN. For further details contact: Bob Glasgow, tel: 01875 811723.

Cornish RAC

meets on the first Thursday each month, 7.30pm, at Perranwell Village Hall, near Truro. 2 Apr - AGM. 25 Apr - International Marconi Day, run by the Cornish RAC from Penair School, Truro. For further details contact Robin Worsley, G0MYR, tel: 01209 820118.

Coulsdon ATS

meets on the second Monday each month, 7.45pm, at St. Swithun's Church Hall, Grovelands Road, Purley. Club 2m net: Sunday 11.00am on V40 (145.500MHz) initially, then to a working frequency. 13 Apr - Ten pin bowling. For further details con-

Dover Radio Club

meets every Wednesday during term periods at the Duke of York's Royal Military School, Guston, near Dover, from 8.00pm with Novice and Morse training classes between 7.00pm and 8.00pm. 29 Apr - AGM. Further details may be obtained from the Secretary, Brian Hancock, G4NPM, tel: 01304 821007.

Dragon ARC

meets on the first and third Mondays of each month at the Ebenezer Hall, Foel Graig Lane, Higher Village, Llanfairpwll, at 7.30pm. Visitors and new members are welcome. 6 Apr - discussion. 20 Apr - History of the magic lantern, John Hughes. 4 May - 'the scope: shack's best friend? Further details from the Secretary Tony Rees, GW0FMQ, tel: 01248 600963.

Dunstable Downs Radio Club

meets every Friday from 8.00pm at Chews House, 77 High Street South, Dunstable, Beds. 10 Apr - No meeting (Good Friday). 24 Apr - On the air evening. For more details contact Paul McVay, G7TSJ, on 01582 861936.

Exeter ARS

meets on the second Monday each month, at The Moose International

Hoddesdon Radio Club

meets alternate Thursdays at the Conservative Club, Rye Road, Hoddesdon, Herts, from 8.00pm. 2 Apr - video. 16 Apr - informal. 30 Apr - electronics in the kitchen, Roy Chapman, G0NLG. Further details from Don, G3JNJ, tel: 0181 292 3678.

Hordean and District ARC

meets on the first and fourth Tuesday of each month, 7.30pm, at Lovedean Village Hall, 160 Lovedean Lane, Lovedean, Hants. The first Tuesday is usually a 'Natter Night'. Visitors welcome. Club nets are Sundays 1955kHz 0900 CW, 0930 SSB, and Wednesdays 145.350MHz at 1930. 7 Apr - Club social evening. 28 Apr - 9MOC Spratly Island DXpedition by CDXC member Mike, G3SED. Further details can be obtained from Stuart Swain, tel: 01705 472846.

Horsham ARC

meets on the first Thursday each month 8.00pm, at The Guide Hall, Denne Road, Horsham, W. Sussex. 2 Apr - Inertial Navigation, Brian Kendal G3GDU. For further details

more clubs over the page

contact David Miller, G4JHI, tel: 01403 252101 or e-mail: davidmiller2@compuserve.com

Lincoln Short Wave Club

meets at the Railway Sports and Social Club, Ropewalk, Lincoln, each Wednesday from 7.45pm. The club is holding an exhibition: 'The World of Communication 1900 - 1998' at the Central Library, Lincoln, 31 March - 4 April. 15 Apr - The Lincoln Aircraft Recovery Group. For further details, please contact Cliff Newby, G3EBH, on tel: 01522 750637.

Liverpool and District ARS

meets at 8.30pm every Tuesday at the Churchill Club, Church Road, Wavertree, Liverpool. 31 Mar - surplus sale. 7 Apr - Robotics. 14 Apr - Club on the air. 28 Apr - Surplus sale. For further details please contact the publicity officer, Ian Mant, G4WWX, 28 Welbourne Rd, Childwall, Liverpool L16 6AJ; tel: 0151 722 1178.

Loughborough & District ARC

meets at Science Lab, Hind Leys Community College, Forest St, Shepshed, on Monday evenings for general chat, operating etc and on Tuesdays as follows: 7 Apr - 'Audio 4', quad sound. 21 Apr - Aerial construction, Art, G3KWY. 28 Apr - 2nd DF. 5

More information from G1NPT@GB7TUT or call Dave, G0KHC on tel: 0181 505 1871.

South Birmingham Radio Society

meets on the first Wednesday of the month at West Heath Community Centre, Hampstead House, Fairfax Rd, West Heath, Birmingham. The club is "generally" open Mondays, Thursdays and Fridays from 8.00pm. 1 Apr - 75 years and more, Bill Moorwood. 6 May - Rig check night. Contact Secretary Don Keeling on tel: 0121 458 1603.

Spalding and District ARS

meets every Friday night at 7.30pm at the Old Fire Station, Spalding, Lincs. For details phone 01775 750382 or 0976 271796. 18 Apr - Talk on computers.

Stourbridge and District ARS

meets at 8.00pm on the first and third Mondays each month (except Bank Holidays), at the Radio Shack, Old Swinford Hospital, Heath Lane, Stourbridge. Club Nets 2m Mon, Wed, Fri, 7.00pm 145.375MHz, 70cm 433.525MHz, 10m Mon (Tues on club weeks) and Fri 8.00pm, Wed 9.00pm, 28050 CW. 20 Apr - History lesson, Dennis, G0HTJ. Further

meeting) each month, 7.30pm for 8.00pm, at the Sutton United Football Club, The Borough Sports Ground, Gander Green Lane, Sutton, Surrey. Club nets: Mon 2000 145.500MHz then QSY; Tue 1030 3770kHz; Tue 1500 144.300MHz then QSY; Sat 1100 3700kHz; Sat 1200 145.500MHz then QSY. 2 Apr - 'Natter night'. 16 Apr - 10GHz DX, Peter, G4ZXO. For further details contact John Puttock, G0BWV, tel: 0181 644 9945.

Torbay ARS

meets every Friday at the ECC Social Club, Highweek, Newton Abbot at 7.30pm. They have informal meetings most Fridays with a talk / event once a month. 17 Apr - Islands on the Air, John Forward, G3HTA. Further details from Peter Tanner, G4VTO, tel: 01803 864528 (working hours).

Trowbridge & D ARC

meets at 8.00pm at the Southwick Village Hall, Southwick, on the A361 Trowbridge / Frome. 'Natter nights' are usually held on the 3rd Wednesday of the month. 1 Apr - SSTV with Brian, G0IER. 6 May - Interpreting radiofax charts, with Richard, G4MUF. For further details please contact Ian Carter, G0GRI, on tel: 01225 864698 (evenings / weekends).

Wisbech Amateur Radio and Electronics Club

meets at the RAFA club, Old Market (next to the TSB). 20 Apr - AGM. Further details from Bill, G3XZF, on tel: 01945 588102.

national and international groups

British Amateur Radio Teledata Group (BARTG)

have a quarterly magazine, *Datacom*, and hold a rally and HF RTTY contest each year. For more details about the group contact Membership Secretary Bill McGill, G0DXB, 14 Farquhar Road, Maltby, Rotherham, S.Yorks S66 7PD, tel: 01709 814010 (Tues, Thurs & Fri, 7.00pm to 9.00pm. Sat/Sun before 9.00pm), or via GB7WRG. Internet: <http://www.bartg.demon.co.uk>.

British Amateur Television Club (BATC)

is particularly active with Amateur Television (ATV) - the transmission and reception of vision. They produce a quarterly magazine entitled *CQ-TV* and have regular get-

This Month at the Clubs

ham radio today latest club news

May - aerial tests, Art, G3KWY. Further information from Ian, G8SNF, on tel: 01509 218259.

Newbury and District ARS

meets on the fourth Wednesday each month at the Memorial Hall, Upper Bucklebury, near Newbury from 7.30 - 10.00pm. Club nets: Sun 0830 3632kHz, Sun 1145 1920 to 1940kHz, Sun 1200 28305kHz. 22 Apr - AGM. For further details contact the club secretary, tel: 01635 863310.

Norfolk ARC

meets each Wednesday at the Ugly Bug Public House, Colton. 1 Apr - AGM. 8 Apr - Informal. 15 Apr - Quiz, G3ASQ. 22 Apr - Informal. 29 Apr - GB3NB repeater group AGM. Informal evenings include night on air, construction QRP, and Morse practice. For further details please contact the Hon Sec, Sandra Simpson, 2E1F0F.

Silverthorn Radio Club

meets each Friday at 7.30pm at the Adult Education and Community Centre, Friday Hill House, Simmons Lane, Chingford, London E4 6JH. The club offers Morse code tuition and Morse tests. 17 Apr - Junk sale.

details from Gordon Bryant, G0TZV, tel: 01384 395206.

Stratford upon Avon & D RS

meets on the second and fourth Mondays, at the Home Guard Club, Main Road, Tiddington, Stratford upon Avon, at 7.30pm for 8.00pm. The club also run RAE, NRAE and Morse courses, write to Mr J Harris, 57 Evesham Road, Stratford upon Avon CV31 2PB enclosing an SAE or tel: 01789 295257 for details. 13 Apr - Night on the air. 27 Apr - AGM. Further details from Club Secretary Jeff Porter, G4OHJ, tel: 01789 773286.

Sudbury and District Radio Amateurs

meets on the first Tuesday of the month at the Old School on the junction of Head Lane, Wells Hall Rd, Great Cornard, and on the third Tuesday of the month at a new venue: The Brook PH, Bures Road. Apr - Our first CW QSOs, Jonathan Mitchener, G0DVJ. May - Is there Extra-terrestrial Life, Tony Dagnall. Contact Secretary Mark Bean, G7UTC, on tel: 01787 377493.

Sutton and Cheam RS

meets on the first Thursday (natter night) and third Thursday (formal

Verulam ARC

meets at the RAF Association HQ, New Kent Road, St Albans, at 7.30pm for 8.00pm. 28 Apr - Talk by Rob Mannion of *Practical Wireless*. For further details contact Walter Craine, G3PMF, tel: 01923 262180.

Wirral and District Amateur Radio Club

meets every Wednesday at 8.00pm at the Irby Cricket Club. 8 Apr - Wirral Past in Pictures, Glyn Parry. 22 Apr - Great Egg Race. Other Wednesdays are social evenings. More information from Andy on tel: 0151 677 4448 or packet CLUB @ GB7OAR.

Wirral ARS

meets 8.00pm at The Club Room, Ivy Farm, Arrowe Park Road, Birkinhead, opposite Landican Cemetery. There are activity nights every first and third Wednesday evening, 'natter nights' every Tuesday from 7.30pm and Morse tuition every Thursday evening. Visitors welcome. 16 Apr - George Robbins, G3LNG. The society will put on a special event station at the National Guide Jamboree 24 - 31 July 1998. For further details contact John Phillips, G3PXX, tel: 0151 336 4452, @GB7OAR, or e-mail: vectis@nordee.u-net.com

together at their rally stands, and hold their own rally each year. BATC has an Internet site at <http://www.batc.org.uk> For details of BATC membership write to: Dave Lawton, G0ANO, Grenehurst, Pinewood Road, High Wycombe, Bucks HP12 4DD.

CDXC (Chiltern DX Club) - the UK DX Foundation

is the UK's first and largest grouping of amateurs interested in HF DX and contesting. They have an Internet site at <http://www.cdxc.org.uk> and are a national affiliated society of the RSGB. Membership is open to all amateurs and SWLs who have worked (or heard) more than 100 DXCC countries. For a prospectus and further details please contact the Secretary, Alan Jubb, G3PMR, 30 West St, Gt Gransden, Sandy, Beds SG19 3AU.

G-QRP Club

publishes a quarterly journal, *SPRAT*, devoted to low power communication, and holds regular get-togethers at their rally stands throughout the country. For membership details, contact their Secretary, Rev G Dobbs,

more club news on p56

Classified advertisements

Classified advertisements 58p per word (VAT inc.) minimum 14 words £8.70.

All classified advertisements MUST be prepaid.

Please write clearly. No responsibility accepted for errors. Latest date for acceptance is 1st of issue month.

Cheques should be made payable to RSGB.

Copy and payment to Malcolm Taylor Associates, P.O. Box 3241, Bournemouth BH8 8WT. Telephone: 01202 777852 Fax: 01202 317902

FOR SALE

BUY A HAM RADIO SHOP! G3LLL wants to retire early autumn. Stock, business, and fixtures and fittings for sale, shop on cheap rental. Until then business even better than usual. Holdings Amateur Electronics, 45 Johnston Street, Blackburn BB2 1EF. 01254 59595. Normally open Thurs, Fri, Sat, Closed full week Easter? Check.

We'H' FOLDING ANTENNA >6db Smaller Gammaless HB9CVI 10m-70cm Versions £20-£35. Literature available. John (G0WEH) 01705 466522, QTHR 1998. Email: john.j.hill@gecm.com

RESTRICTED SPACE AND FULL SIZE MULTIBAND AERIALS, 28/132ft, built, kits, parts, baluns, data sae. Aerial Guide £1.50. G2DYM, Uplowman, Devon EX16 7PH. Tel: 01398 361215 anytime.

LIMITED SPACE ANTENNA 160-10 metres 84' overall with 76' of balanced feedline £59.95 plus £5.00 P&P. Choke Baluns Std model £36.85, Yagi model £37.45 (state boom size) G5RV £28.50 all inc P&P. Amidon Cores, limited stocks available. Send SAE for full details of all the above. Ferromagnetics, P.O. Box 577, Mold, Flintshire, CH7 1AH.

"RAYNET" YELLOW REFLECTIVE TABARDS with "RAYNET". Medium £11.00, Large £11.50, XLarge £12.00. "RAYNET CONTROLLER" 50p extra. EPSON PX4+ lap top computer, built-in printer, charger Eprom for packet £46.50 inc. pp. Non reversible battery connectors line/panel mounting (10 pairs/pack) £7.00. Mike Watson G8CPH, Ipswich (01473) 831448.

QSL CARDS printed to your own specification on white or coloured gloss card. SAE for sample pack to: The Caswell Press, 11 Barons Way, Woodhatch, Reigate, Surrey. 01737 244916.

QRP Crystals 3555, 3560, 3565, 7030, 10116, 14050 and 14060 kHz. HC49/U wire ended. £3.50 each + £1.50 p&p any quantity. G3TUX QRP Component Co. PO Box 88 Haslemer GU27 2RF. 01428 661501.

ALUMINIUM TUBE. Heavy-duty (scaffold) tube approx. dimensions 20' long, 2" dia. 1/4" (4.5mm) wall thickness, 20' and 10' lengths available @ £1.80 + VAT per ft. C.W.O. Rusper Hire (Crawley) 01293 871621 office hours only.

QSL CARDS – low cost, quick delivery, superior designs, quality guaranteed, personal designs our speciality, L.S.A.E. for samples: The Standfast Press, 5 South Drive, Inskip, Preston PR4 0UT.

ESSEX AMATEUR RADIO SERVICES. New and used amateur equipment bought and sold. PX welcome. All warranted and serviced. Bam till 9pm. Ring Alan – 01268 752522, 4 Northern Avenue, Benfleet, Essex SS7 7SN.

G4TJB QSL CARDS printed to your specification, send large SAE for samples and full product list. Unit 6, Worle Industrial Centre, Coker Road, Worle, Weston-super-Mare BS22 0BX. Tel/Fax: (01934) 512757.

CTCSS ENCODERS £20 each, Decoders £39 each + postage £1.75 (inc vat) CW0 MDH radio telephones. Tel/Fax 01646 651599 (GW4CBB QTHR).

LANDWEHR VHF/UHF MASTHEAD PREAMPLIFIERS, 2 metre 145MAS £150 and 70cm 435MA £155 plus £4.50 p&p. Write, phone, fax or email for leaflet. Qualitas Radio, 23 Dark Lane, Hollywood, Birmingham B47 5BS. Note new telephone numbers, 0121 246 7267. Fax 0121 246 7268. Email: g0eyo@compuserve.com

POWABEAM ANTENNAS – from G4CQM Optimised Current Vector Yagis. 2M-2.5WL (9 ELE) 15DBI £84.95. Leaflets 01288 381289.

QSL CARDS. Gloss or Tinted Cards. SAE for samples to Twrog Press, Penybont, Gellilydan, Blaenau Ffestiniog, Gwynedd LL41 4EP.

TECHNICAL MANUALS for WW.II Radio & Radar. Hundreds in stock. RAF, Army, Navy, Luftwaffe, Wehrmacht, US Forces. Tel: 0151-722 1178 or SAE with requirements to Vintage Technical Services, 28 Welbourne Road, Liverpool L16 6AJ.

PROGRAMMED PROMS FOR PMR EQUIPMENT. Details, S.A.E.: Atlanta Communications (RC), PO Box 5, Chatteris, Cambridgeshire PE16 6JT.

COURSES

CITY & GUILDS RADIO AMATEURS EXAM. Pass your exam the easy way with an RRO homes study course. For details write or phone THE RAPID RESULTS COLLEGE, Dept. JT400, Tuition House, London SW19 4DS. Tel: 0181 947 2211.

RSGB AMATEUR RADIO INSURANCE SCHEME

"ALL RISKS" INSURANCE for portable/mobile/base station amateur radio and ancillary equipment. A service for RSGB members only. Also public liability and equipment for affiliated clubs and societies. Details and leaflets from Amateur Radio Insurance Services Ltd, Freeport, 10 Philpot Lane, London EC3B 3PA. Telephone: 0171 338 0111. Fax: 0171 338 0112.

MISCELLANEOUS

VIDEO TAPE CONVERSIONS to and from all modes N.T.S.C.: S.E.C.A.M.: P.A.L.N.: P.A.L.M. Digital processing. Fast and economic service. Also 'cine' conversions. Phono G4WMP 01932 846139.

PATENTS, TRADE MARKS, DESIGNS, COPYRIGHT. For professional advice contact KINGS PATENT AGENCY LTD (Est 1886 by Benj. T. King). Dir J.B. King (G5TA mem. RSGB) Regd. Patent and Trade Mark Agent. Information, fees and literature on request. Phone 0171-248 6161. Fax: 0171-831 0926. 73 Farringdon Road, London EC1M 3JB.

CALL IN ON THE 'GOOD NEWS' CHRISTIAN NETS! Every Sunday at 8am and 2pm around 3747 KHz and 144.205 Mhz at 2pm sharing Christian fellowship over the air. Info from WACRAL, 51 Alma Road, Brixham, South Devon TQ5 8QR – Tel: 01803 854504.

VHF/HF valve amplifiers repaired/ serviced, all USA, Japan, EU makes. Collection/delivery available. Very competitive rates. Faircrest Services, Mon/Sat, 08.00-17.00, 24hr answerphone 01744 637271.

NORTH DERBYSHIRE COMMUNICATIONS. Service and Sales to most Amateur Radio Equipment. Unit 6, Ireland Close, Staveley, Chesterfield, Derbyshire S43 3PE. Tel/Fax: 01246 280358.

COMPUTER SOFTWARE & HARDWARE

INSTRUCTOR MORSE PROFESSIONAL – The ultimate Morse Code training package for beginners and advanced users (for IBM PCs & Compatibles). As used by the US Military, Canadian Military and the British Military! Price £169.00 + PP + VAT – Tel 01526 833042 – email imorse@sdesign.demon.co.uk

SHACKLOG 4.4 the PC logging system. Real time and post event QSO logging. QSL labels. Database analysis, reports, import, packet terminal. Plus lots more!! Only £29.50!! SASE (+disk for demo copy) for full details. IOTA database (G3KMA) £7.50. IOTA Awards Manager £5.00 Alan Jubb, G3PMR, 30 West Street, Gt. Grassden, SANDY, SG19 3AU. 01767 677913.

G4UXD's 'UK-QSO' MORSE TUTOR-PRACTISE DOES EVERYTHING! Reviewed Feb/94/95 'Novice News'. PC-compat. Everything adjustable, 150 tests! Teaches correct keying! £10-99. SAE details. P. Brandon, 1 Woodlands Rd., Chester CH4 8LB, 01244-683563.

SUPER-DUPER, EI5D's CONTEST LOGGER. "Highly recommended" – RadCom, September 1993. HF £25.00, VHF £25.00, both £39.00. Paul O'Kane EI5DI, 36 Coolkill, Sandycroft, Dublin 18 (00 353 1295 3668). www.iol.ie/~okanep Version 9.00 is ready now for the new RSGB District Code multipliers. Clubs – please enquire about group registration rates.

G4TYF LOG. Try before you buy. Send S.A.E. for Demo. Updates £5.00. 64 Gurney Valley, Bp Auckland DL14 8RW. Tel: 01388 607500.

PC SOFTWARE BY G4BKM FOR RTTY AMTOR FACTOR CW with call sign database and on-screen tuning aid, plus built modem £165. State call sign. BMK Communication Ltd, 2 Beacon Close, SEAFORD BN25 2J7. (01323) 893378.

PC SSTV-DATA Tx/Rx pack £35.95 PC/AMIGA SSTV/Packet Interfaces. SAE leaflets, 1.44 demo £1. G8SLB Peter Lockwood, 36 Davington Road, Dagenham RM8 2LR. 0181-595 0823.

HOLIDAY ACCOMMODATION

NORTH WALES. CARAVAN, BUNK HOUSE, CAMPING. Elevated site. Use of shack and beam antenna. Open all year. Rural setting. "Tynrhos", Mynytho, Pwllheli, LL53 7PS (01758 740712).

BED AND BREAKFAST/MEALS. SCOTLAND NORTH COAST. GM0EXN QTHR. HF available. Packet/Pactor. Tel: 01847 851774. email: bandb.farnorth@btinternet.com.

NORTH WALES, DENBIGH. Small town pub, B&B. Tel: 01745 815115. E-Mail: gw0syn@globalnet.co.uk Web Site: http://www.users.globalnet.co.uk/~gw0syn/



MARTIN LYNCH
& Son
THE AMATEUR RADIO EXCHANGE CENTRE

NEWSFLASH

20% OFF ALL TONNA AERIALS DURING APRIL



0181-5661120

St Aiden's Vicarage, 498 Manchester Road, Rochdale, Lancs OL11 3HE; tel: 01706 31812 or see their web site at <http://www.btinternet.com/~g4wif/grrp.htm>

International Short Wave League (ISWL)

who, as well as running an international QSL bureau for amateurs and SWLs, have a monthly magazine (*Monitor*) and regular get-togethers at their rally stands plus several on-air nets on HF and VHF. For more details send an A4 sized SAE to: ISWL HQ, 267 Pelham Road, Immingham DN40 1JU. Internet: <http://www.aber.ac.uk/~srj5/iswl.htm>

Irish Radio Transmitters Society (IRTS)

publishes regular newsletters giving details of local activities, and the yearly IRTS Callbook. They also have a video library. Their Annual General meeting this year takes place on 22 March at the Limerick Rally. For further details on the IRTS contact Joe Ryan, EI7GY; tel: (Eire) 01 2854250 or by e-mail: jryan@iol.ie and for Book Sales: Dave Moore, EI4BZ, 12 Castle Ave, Carrigtwohill, Co Cork; tel: (Eire) 021 883555.

Radio Amateurs' Emergency Network (RAEN)

can be contacted at Hunters Moon, Newton le Willows, Bedale, N Yorks DL8 1SX. 24hr national emergency contact line: 0141 621 2121. Other contact points: Training Team, PO Box 2, Chinnor, Oxon OX9 4JY. Raynet Supplies, tel: 01842 860475. Packet @ GB7NRC. Internet Web Site: <http://www.reality.sgi.com/csp/raynet/>

Radio Amateur Invalid and Blind Club (RAIBC)

is a registered charity which raises money for radio / computer equipment, and audio cassette courses for home study, for blind, deaf and disabled amateurs. The club attends rallies throughout the year, and collects surplus equipment for resale. Please contact Honorary Treasurer / Membership Secretary Mrs Shelagh Chambers, 78 Durlay Ave, Pinner, Middx HA5 1JH.

Radio Amateur Relief Expeditions (RARE)

is a registered charity made up of radio amateurs and friends who take aid to Eastern Europe and organise summer camps for young people to learn about amateur radio, English

language and life in the UK. New members are required to support this work both at home and by taking part in expeditions. Please contact: The Secretary, RARE, 1 Allfield Cottages, Conover, Shrewsbury SY5 7AP; tel: 01743 873815; fax: 01743 874729; packet: G6FHM@GB7PMB; e-mail: rare@donsun.demon.co.uk

Radiocommunications Agency (RA)

is the licensing authority for all UK radio amateurs. They have a large number of free publications, including the booklet *How to Become a Radio Amateur*, and their *Novice Licence Information* sheet and can offer advice on many aspects of licensing. They're currently in temporary offices: New Kings Beam House, 22 Upper Ground, London SE1 9SA. Direct Amateur Radio line, tel: 0171 211 0160. General enquiries, tel: 0171 211 0211. Answerphone service, tel: 0171 211 0591.

Radio Society of Great Britain (RSGB)

is the internationally-recognised national society, which has been representing UK radio amateurs and short wave listeners for 85 years. Members of the RSGB receive a 100-page colour magazine sent to their home each

month, and also have the advantage of free QSLing, automatic entry in RSGB contests, and help in obtaining planning permission for antennas, and much other technical support. A network of over 2000 volunteers is on hand to help the radio amateur and short wave listener with any enquiry. Address is: Lambda House, Cranborne Road, Potters Bar, Herts EN6 3JE, tel: 01707 659015; Internet site: <http://www.rs.gb.org> and e-mail: info@rs.gb.org

Subscription Services Ltd (SSL)

handles the issuing of amateur licences in the UK on behalf of the Radiocommunications Agency. SSL can help regarding enquiries concerning individual licences (rather than general licensing matters, which the RA handles, see above). Contact details: The Radio Licensing Centre, SSL, PO Box 884, Bristol BS99 5LF; tel: 0117 925 8333.

United Kingdom Radio Society (UKRS)

is a new society for UK radio amateurs. They can be contacted at Box 100, Meadow Street, Northwich, Cheshire, CW8 1FA. tel: 01606 783270, or 0115 925 6597, packet: UKRS@GB7OAR, or e-mail: admin@ukrs.org; Internet: <http://www.ukrs.org>

This Month at the Clubs

ham radio today latest club news

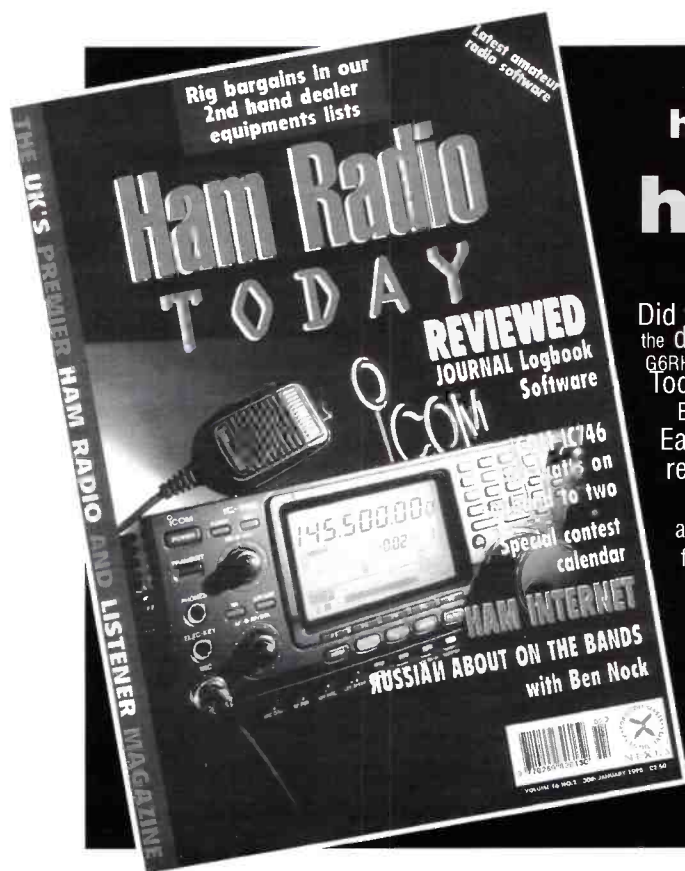

ham radio today back issues

Did you miss that Kenwood TH-G71E review (Vol 15 No 13)? Or perhaps the digital controller project for converted PMR transceivers by G6RHB (Vol 15 No 7). If so, you'll want to take advantage of the Ham Radio Today Back Issues service.

Back numbers are normally available for 12 months after publication. Each issue costs £3.20 inc P&P, but please check the issue you require is available before sending your cheque.

If the issue you require is not available we can photocopy individual articles for you. The cost is £2.75 for the first article, and £2.00 for further articles. Multiple parts count as separate articles. Please add £1.25 (UK) and £2 (overseas - surface mail) P&P.

to order
post: Sales Department, Ham Radio Today, RSGB Publications, Lambda House, Cranborne Road, Potters Bar, Herts EN6 3JE.
Tel: 01707 659015; fax: 01707 645105 or e-mail: hrt.sales@rs.gb.org

for sale

● **ICOM IC-745** HF radio CW & SSB, filters, FM, mint. 200W PEP with schematics, with Icom IC-SM2 base mic. Sell for £550 ono or swap Kenwood TM-V7 dualbander. AR3000XL aerial rotator with AR1201 alignment bearing with VHF 21 ele Tonna 15ft boom 14dB gain with 25ft Westflex and rotator cable £80 ono. Mike, 2E1FCG, tel: 01226 742971 after 6pm (Barnsley).

● **RACAL RA17** in vgc £165. Yaesu FR101 immaculate £145. Tel: 01257 263403 (Lancs).

● **ICOM IC-706** Mk2 mint condition, virtually unused £925. Also Nova 281, 4m conversion, slight fault £50. Tel: 0116 2697440 (Leicester).

● **AR-3030** bought 16/9/97 as new cost £684. Fitted 2.5kHz filter and VHF converter 140 - 169.999MHz boxed manuals p/supply plus G5RV ant. 50ft CTU8 antenna tuner shortwave freq book sell £450. Mr Rigby, tel 01524 833506 (Morecambe).

● **AEA PK900** multimode TNC as new with software £225 ovno. Tel: 01276 709083 most eve-

nings (Camberley, Surrey).

● **AR8000 SCANNER** purchased 14/10/97 inc batts and charger 500kHz-1900MHz no gaps £220 inc p&p. Graham, mobile tel: 0976 281429, or 0121 789 9611 after 6pm.

● **FT-1000D 200W** heavy duty built-in PSU dual Rx £400-worth of filter fitted inc b/pass filter mic box manuals very reluctant sale, as new £1995. FT-900 cat mic box manual superb radio as new £749. Carl, G4GTW, tel: 01489 789960, (Southampton).

● **ALAN 2M** transceiver, handheld, in mint condition with case and accessories £85. Mark, tel: 01481 52417 (Guernsey).

● **KENWOOD TS-950SDX** (digital) tcvr immaculate £1750 ono. Prefer buyer collect. Contact Ken anytime, tel: 0191 2530504 (Whitley Bay).

● **EDDYSTONE 730/4** model receiver in good condition £90 ono. Tel: 01509 507259 (Loughborough).

● **CHELCOM 80M** vertical £70. Hustler 6BTV vertical £100. Commercially made 6m vertical £15. 2m 7 ele ZL special never

used £20. 15m pro-AM mobile still in package £15. MFJ world band radio £20. Tel: 01386 48056 (Evesham).

● **MFJ Morse keyboard** perfect condition £90. MM 2001 RTTY to TV converter £45. Dave, G4EZF, 27 Shaw Street, Mottram, Hyde, Ches, tel: 01457 762799.

● **FT-480R** vgc not used mobile £240. Standard FM 2m good radio £120. Both with manuals MML 144/100S linear amp with preamp £75. All plus postage. Instant Morse CD ROM £20. Tom, tel: 01472 602335 (Cleethorpes).

● **LOWE HF-225** receiver with key pad. PR-150 pre selector active aerial handbooks new condition £300 ono. Tel: 01484 654650.

● **YAESU 2M** handheld transceiver with charger adaptor also circuit diagram and manual 20TR. Good condition for its age, boxed with new battery £40. Tel: 01384 411871.

● **YAESU FT-480 2M**. All modes boxed manual GWO £275 ono. Martin, GOMVP, tel: 01903 690518 (after 8pm).

wanted

* **PYE/PHILLIPS** P5001 handhelds must be E2 (77-88MHz) AM and in good condition. Richard, G7EML, tel: 0113 2584903 (Leeds).

* **Wanted:** Ex PMR for packet only must be on 144.950. Roy, G7UVO. tel: 01707 275920.

* **Wanted:** 2m crystals for search receiver. 145.725 and 144.500MHz. HC25/U (very small ones!) All costs paid. Mike, tel: 01634 306691 or e-mail mtr.swl@cableinet.co.uk

* **VERY GOOD** price offered for old studio TV camera and other TV gear. Andy, G8PTH, tel: 01604 844130 (Northampton).

exchange

◆ **ALINCO DJ580** 2m/70cm handie with 12V and 7.2V nicads, DC cable, speaker mic, hands-free headset, excellent cond exchange for AKD2001 70cm and AKD7003 2m mobile units or similar. Mark, G7MTE, tel: 01205 343598 evenings only please.

free readers' ads

send your equipment fast with ham radio free private ads

free readers' ads

name _____

signature _____

address _____

date _____ send this coupon to: Free Readers' Ads, Ham Radio Today, RSGB Publications, Lambda House, Cranborne Road, Potters Bar, Herts EN6 3JE.

The above details will not be published. Enter all that is to be published, including contact information, in the boxes below (Amateur Radio and electronic equipment only please).

(BLOCK CAPITALS OR TYPED PLEASE, ONE WORD PER BOX)

FOR SALE / WANTED / EXCHANGE / HELP NEEDED*

*Delete as appropriate

April 1998

free readers' ads conditions

- Free Readers' Ads will be inserted as and when space becomes available, on a first-come, first-served basis, subject to these conditions. If you require a *guaranteed* immediate insertion of your ad, please use the pre-paid Classified Ads section at the rear of this magazine.
- These advertisements are offered as a free service to readers for the sale, exchange, wants, or help with, privately-owned amateur radio and electronics equipment. Ads from traders, or apparent traders, will be rejected. Readers should use our Retail Network and Classified Ads section for ads not fulfilling these conditions, our Advertising Department (tel: 01202 777852) will be pleased to accept prepaid ads.
- All submitted free ads must be on a recent form printed in Ham Radio Today. Photocopies are not acceptable. Include your name and / or callsign, and either a contact telephone number (with STD code) and location (eg town or country) or a full address, or both, for readers to reply. These details must be included within your advertisement. Advertisements must be no longer than 40 words. Only one advertisement per section ('For Sale', 'Wanted' etc) per reader per month. Each advertiser must also fill in their name and address in the space provided (these details will not be published), and must sign the form to indicate acceptance of these conditions.
- We cannot be held responsible for transcription errors, however, we will attempt to ensure that legible submissions are reproduced correctly. Please write clearly and include punctuation. In the event of a gross error, at the request of the advertiser and at the editor's discretion, a corrected version of the advertisement will be printed in the earliest issue in which space is available.
- Neither the magazine nor its publishers will accept any responsibility for the contents of the advertisements, and by acceptance of these conditions the advertiser undertakes to indemnify the publisher against any legal action rising out of the contents of the advertisement.
- Advertisements are accepted in good faith; however, the publisher cannot be held responsible for any untruths or misrepresentations in the advertisements, nor for the activities of advertisers or respondents.
- As this is a free service, postal or telephone communication regarding publication of ads *cannot* be accepted unless an error is involved. Please remember, all ads received fulfilling these conditions will be published as space permits.
- Advertisements which are suspected of including illegal equipment will not be published. The magazine reserves the right to either refuse to accept entirely, or to delete any sections, or the entire text, of any advertisements not fulfilling the above conditions.

Advertiser Index

Amateur Electronics/Holdings G3LLL ..	52
Amateur Radio Communications.....	52
Essex Amateur Radio.....	35
GWM.....	35
ICOM UK Ltd.....	IBC
J & N Factors.....	52
Jaycee Electronics Ltd.....	52
Kanga QRP Kits.....	52
Low Electronics.....	32,33
Martin Lynch & Son.....	IFC
Multicomm 2000.....	52
Norbreck.....	13
Radio Society of Great Britain.....	46
Skywave Marine Services.....	52
SRP Trading.....	14,15
Vine Antenna Products.....	13
WACRAL.....	52
Waters & Stanton plc.....	30, 31
Wilson Valves.....	52
Yaesu UK Ltd.....	OBC

Ham Radio TODAY

publication dates

Make a note of these dates so that you can be the first with all of the news, reviews and features in Ham Radio Today.

issue date	publication date
May	Friday 24 April
June	Tuesday 19 May
July	Wednesday 10 June

Don't Miss Out - Place a regular order with your newsagent.

Dear Newsagent, Please deliver / save me a copy of *Ham Radio Today* magazine every month.

Name: _____

Address: _____

Ham Radio Today is available from: Comag Magazine Marketing, Tavistock Road, West Drayton, Middlesex UB7 7QE. Tel: 01895 444055. Fax: 01895 433602. ISSN No 0269-8269

Ham Radio TODAY

contact information

Ham Radio Today Editorial: RSGB Publications, Lambda House, Cranborne Road, Potters Bar, Herts, EN6 3JE. E-mail: hrt@rsgb.org.uk. Tel. 01707 853300. Fax 01707 645105.

regular contributors:

Data Connection: Chris Lorek, G4HCL. E-mail: g4hcl@qsp73.demon.co.uk. Packet: G4HCL@GB7SUN. #48.GBR. EU. Post; via Editor.

HF Happenings: Don Field, G3XTT. E-mail: g3xtt@lineone.net. Post: 105 Shiplake Bottom, Peppard Common, Henley on Thames, Oxon RG9 5HJ.

Net Communication: Jeremy Boot, G4NJH. E-mail: asperges@innotts.co.uk. Post: via Editor.

QRP Corner: Dick Pascoe, G0BPS. E-mail: dick@kanga.demon.co.uk. Packet: G0BPS@GB7RMS. Post: Seaview House, Crete Road East, Folkestone CT18 7EG.

Satellite Rendezvous: Richard Limebear, G3RWL. E-mail: g3rwl@amsat.org. Post: via Editor.

VHF/UHF Message: Geoff Brown GJ4ICD. E-mail: equinox@itl.net. Post: TV Shop, Belmont Road, St Helier, Jersey, Channel Islands. Tel/Fax 01534 877067.

subscriptions

Subscription rates: 12 issues (1 year) - UK £26.50. Europe and Eire £36.50. Rest of the World (surface mail) £38.50, (airmail) £54.00. Cheques should be drawn on a UK bank and made payable to the Radio Society of Great Britain. Available from: RSGB Publications, Lambda House, Cranborne Road, Potters Bar, Herts, EN6 3JE. E-mail: subscriptions@rsgb.org.uk. Tel. 01707 853300. Fax 01707 645105.

Back Issues:

Back issues are normally available for the last twelve months, at £3.20 per issue. Post and packing is £1.25 for one copy, £2.50 for two or more. Please telephone or E-mail first to check availability of the issue you require. Cheques should be drawn on a UK bank and made payable to the Radio Society of Great Britain. Available from: RSGB Sales, Lambda House, Cranborne Road, Potters Bar, Herts, EN6 3JE. E-mail: sales@rsgb.org.uk. Tel. 01707 659015. Fax 01707 645105.

Article Photocopies:

If the back issue you require is not available, we can photocopy individual articles for you. The cost is £2.75 for the first article, and £2.00 for follow-up articles. Multiple parts count as separate articles. Post and packing is £1.25 (UK) and £2.00 overseas by surface mail. *Note: when requesting photocopies, please specify Ham Radio Today and give the article title and which issue it appeared in.* Cheques should be drawn on a UK bank and made payable to the Radio Society of Great Britain. Available from: HRT Photocopy Service, RSGB Sales, Lambda House, Cranborne Road, Potters Bar, Herts, EN6 3JE. E-mail: sales@rsgb.org.uk. Tel. 01707 659015. Fax 01707 645105.

Ham Radio Today Distribution:

UK newstrade distribution by Comag Magazine Marketing, Tavistock Road, West Drayton, Middlesex UB7 7QE, Tel. 01895 444055, Fax. 01895 433602. Overseas and non-newstrade sales by RSGB Sales, Lambda House, Cranborne Road, Potters Bar, Herts, EN6 3JE. E-mail: sales@rsgb.org.uk. Tel. 01707 659015. Fax 01707 645105.

IC-706MkII - the mobile that just keeps on moving on!

ICOM's latest IC-706MkII pushes mobile communications even further up the road!

Exciting NEW Options:

- UT-106 DSP Receive Unit.
- AH-4 Automatic Antenna Tuner.
- Other Great Features:
 - Crossband Split.
 - Band stacking register memorizes preamp/attenuator settings and tuner on/off condition as well as frequency and mode.
 - 'S' menu has 3-band quick access.
- Enhanced 30kHz~200MHz broadband, all-mode receive.
- Slots for 2 optional crystal filters.
- Tone-squelch available (option UT-86 required).
- Sub dial for easier access to RIT/second VFO.
- 20 watts on 2 meters and individual band change key.
- Narrow FM deviation is set for 2.5kHz, ideal for new 12.5kHz channels.

IC-706MkII



Icom (UK) Ltd. Sea Street Herne Bay Kent CT6 8LD. Telephone: 01227 741741. Fax: 01227 741742.
 internet: <http://www.icomuk.co.uk> e-mail: icomsales@icomuk.co.uk

FT-847

Ultra-Compact Satellite
and All Mode Transceiver

FEATURES

- All band performance (SSB, CW, FM, AM)
- 100 Watt output on HF/50MHz bands
- 50 Watt output on 144/430 MHz bands
- Cross-band full Duplex operation
- Normal/Reverse tracking for satellite operation
- CTCSS & DCS encode/decode built-in
- High resolution 0.1Hz tuning steps for ultra smooth tuning
- Digital Signal Processing filters (Bandpass, Notch, Noise Reduction)
- Simplified tuning with Shuttle Jog control
- Direct frequency keypad entry
- Dedicated satellite memories, with 8-character Alpha Numeric Labels
- TX Freq. (MHz): 1.8 - 50 (amateur band) 144-146/430-440
- RX Freq. (MHz): 0.5-30/50-54 108-174/420-512
- Emission modes: LSB, USB, CW, AM, FM, PACKET(9600/1200bps: External input.)
- Freq. Steps(Min): 0.1Hz for SSB and CW 10Hz for AM and FM
- Modulation Types:
 - SSB: J3E Balanced, filtered carrier
 - AM: A3E Low-level (early stage)
 - FM: F3E Variable reactance
 - FSK: J1D, J2D, F2D Audio frequency shift keying (external input), F1D Frequency shift keying (V/UHF: external input)
- Options:
 - FC-20 Automatic Antenna Tuning Unit (External)
 - FVS-1A Voice Synthesiser
 - ATAS-100 Active Tuning Antenna System

4 into 1 does go!

Technology moves inexorably onward, evolving, adapting, forever changing. At the same time, today's Radio Amateur puts even more demands upon designers to build quality, sophisticated, but easy to use stations for Voice, Packet, Satellite, CW, VHF, UHF, HF, just to mention a few. Yaesu's designers took on that challenge, and following in the footsteps of the revolutionary FT1000, FT1000MP and FT920 are now proud to offer today's Radio Amateur the station in a box - the all new FT-847!

The Yaesu FT-847 Ultra-Compact Satellite and All Mode Transceiver has jumped the technology with a transceiver ready for the new millennium. With it's high-tech design

and revolutionary features, the FT-847 is truly the one radio that can do it all!

Massive band-width coverage from a single unit, the FT-847 has many features to keep it at the top of the evolutionary pile. These include crystal clear 100 watts on HF and 50MHz, a massive 50 watts on 2 meters and 70cms, Yaesu's effective DSP for bandpass, noise reduction and notch filter, and direct input of frequency on the supplied keypad. Silky smooth tuning with 0.1MHz tuning steps, Cross band and full duplex, CTCSS and DCS encode and decode built in. And for Satellite reception, normal and reverse tracking. A matching ATU (Automatic Antenna Tuning Unit) is also available as an option.

YAESU
...choice of the World's top DX'ers



<http://www.yaesu.co.uk>

Specifications subject to change without notice. Specifications guaranteed only within amateur bands. Some accessories and/or options are standard in certain areas. Check with your local Yaesu dealer for specific details.

FT-920

The highest performing HF/6 meter rig in its price class with Yaesu's renowned Omni-Glow™ display



YAESU UK LTD. Unit 2, Maple Grove Business Centre, Lawrence Road, Hounslow, Middlesex, TW4 6DR, U.K. 0181-814-2001