

# HAM RADIO HORIZONS

Special on Antennas

June 1980 / \$1.50

Ten-Tec  
Triton  
540/544  
Owners'  
Report

Easy to  
Build,  
SWR/  
Wattmeter  
for your  
shack

Join the  
County  
Hunters

Antennas on  
your horizon:  
Special 3  
features

Plus

- Bill Orr
- DX by K5FUV
- Q & A section
- and more



**ANTENNAS  
FOR THE  
1980's**



Move over imports, here's the new TEN-TEC

# DELTA

the notable change in hf transceivers



## All new, all **nine** hf bands and only \$849!

**DELTA** — the symbol of change—the name of a great new TEN-TEC transceiver. A transceiver for changing times, with new features, performance, styling, size and value.

**TOTAL SOLID-STATE.** By the world's most experienced manufacturer of hf solid-state amateur radio equipment.

**ALL 9 HF BANDS.** First new transceiver since WARC, 160-10 Meters including the three new hf bands (10, 18 & 24.5 MHz). Ready to go except for plug-in crystals for 18 and 24.5 MHz segments (available when bands open for use).

**SUPER RECEIVER.** New, low noise double-conversion design, with 0.3  $\mu$ V sensitivity for 10 dB S+N/N.

**HIGH DYNAMIC RANGE.** 85 dB minimum to reduce overload possibility. Built-in, switchable, 20 dB attenuator for extreme situations.

**SUPER SELECTIVITY.** 8-pole monolithic SSB filter with 2.4 kHz bandwidth, 2.5 shape factor at 6/60 dB points. And optional 200 Hz and 500 Hz 6-pole crystal ladder filters. Eight pole and 6-pole filters cascade for 14 poles of near ultimate skirt selectivity. Plus 4 stages of active audio filtering. To sharpen that i-f response curve to just 150 Hz bandwidth. 4-position selectivity switch.

**BUILT-IN NOTCH FILTER.** Standard equipment. Variable, 200 Hz to 3.5 kHz, with notch depth down to -50 dB. Wipes out interfering carriers or CW.

**OFFSET TUNING.** Moves receiver frequency up to  $\pm 1$  kHz to tune receiver separately from transmitter.

**"HANG" AGC.** For smoother, clearer, receiver operation.

**OPTIONAL NOISE BLANKER.** For that noisy location, mobile or fixed.

**WWV RECEPTION.** Ready at 10 MHz.

**"S"/SWR METER.** To read received signal

strength and transmitted standing wave ratio. Electronically switched.

**SEPARATE RECEIVER ANTENNA JACK.** For use with separate receiving antenna. linear amplifier with full break-in (QSK) or transverters.

**FRONT PANEL HEADPHONE AND MICROPHONE JACKS.** Convenient **DIGITAL READOUT.** Six 0.3" red LEDs.

**BROADBAND DESIGN.** For easy operation. Instant band change—no tuneup of receiver or final amplifier. From the pioneer, TEN-TEC.

**SUPER TRANSMITTER.** Solid-state all the way. Stable, reliable, easy to use.

**200 WATTS INPUT.** On all bands including 10 meters (with 50 ohm load). High SWR does not automatically limit you to a few watts output. Proven, conservatively rated final amplifier with solid-state devices warranted fully for the first year, and pro-rata for five more years.

**100% DUTY CYCLE.** All modes, with confidence. 20 minutes max. key-down time. Brought to you by the leader in solid-state finals, TEN-TEC.

**QSK — INSTANT BREAK-IN.** Full and fast, to make CW a real conversation.

**BUILT-IN VOX AND PTT.** Smooth, set-and-forget VOX action plus PTT control. VOX is separate from keying circuits.

**ADJUSTABLE THRESHOLD ALC & DRIVE.** From low level to full output with ALC control. Maximum power without distortion. LED indicator.

**ADJUSTABLE SIDETONE.** Both volume and pitch, for pleasant monitoring of CW.

**SUPER STABILITY.** Permeability tuned VFO with less than 15 Hz change per F<sup>2</sup> change over 40° range after 30 min. warmup—and

less than 10 Hz change for 20 Volt AC line change with TEN-TEC power supply.

**VERNIER TUNING.** 18 kHz per revolution, typical.

**SUPER AUDIO.** A TEN-TEC trademark. Low IM and HD distortion (less than 2%). Built-in speaker.

**SUPER STYLING.** The '80s look with neat, functional layout. "Panelized" grouping of controls nicely human engineered for logical use. New, smaller size that goes anywhere, fixed or mobile (4 $\frac{1}{4}$ "h x 11 $\frac{1}{2}$ "w x 15"d). Warm, dark front panel. Easy-to-read contrasting nomenclature. Black "clam-shell" aluminum case. Tilt bail.

**MODULAR/MASS-TERMINATION CONSTRUCTION.** Individual circuit boards with plug-in harnesses for easy removal if necessary. Boards are available.

**FULL ACCESSORY LINE.** All the options: Model 282 200 Hz CW filter \$50; Model 285 500 Hz CW Filter \$45; Model 280 Power Supply \$139; Model 645 Dual Paddle Keyer \$85; Model 670 Single Paddle Keyer \$34.50; Model 247 Antenna Tuner \$69; Model 234/214 Speech Processor & Condenser Microphone \$163; Model 215 PC Ceramic Microphone \$34.50; Model 283 Remote VFO; Model 287 Mobile Mount, and Model 289 Noise Blanker available soon.

Experience The Notable Change In HF Transceivers. Experience DELTA. See your TEN-TEC dealer or write for full details.

**TEN-TEC, INC.**  
SEVIERVILLE, TENNESSEE 37862  
EXPORTS: 110 COLBY AVE. CHICAGO, ILL. 60642

# Introducing . . . .

## the All New DTR Component Series.

*Is your operating ability superior to the equipment you're using?*

If you're a serious amateur who takes pride in his talent you should own the best, the new DTR Communication System.

Amateur Radio has developed over the years into a sophisticated hobby. We all recognize the thrill of transmitting global signals, but to many hams it is the finesse with which those signals are transmitted that determines his pride and success as a ham.

The DTR 1200 linear amplifier provides 1200 watts SSB and 1000 watts CW input, continuous duty. We used large, 3 1/2" shadow box, back-lit meters for easy reading, and tuned input for compatibility with solid state or tube transceivers.

The DTR 3KA antenna tuner handles a full 3KW PEP. It features a built in 2KW dummy load with thermostatically controlled forced air cooling, a remote sensor box to insure meter accuracy and 50 ohm impedance.

The DTR stackable components are designed to give you a complete communication system with mobility and versatility. Rack mount the DTR components on either a stationary rack or one on wheels. The DTR components are equipped with heavy-duty handles for easy rack mounting. If you opt for a desk-top station, the DTR components may be stacked or used separately.

Isn't it time you owned equipment to match your ability and increase your station's success?



*This is just the beginning of the new DTR Components from DenTron, racks also available.*

FCC TYPE ACCEPTED



**DenTron**®

1605 Commerce Drive  
Stow, Ohio 44224  
(216) 688-4973



# THIS MONTH'S

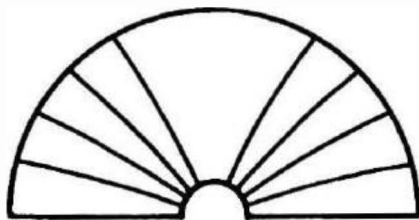

# HORIZONS

## An Antenna For DX — The Trap Yagi

Kits are available for high-performance Yagi antennas using trap elements. Here's an account of how one ham solved his antenna problem by using a well-known triband antenna kit. Considering cost and space, this may be the way to go.

## Which Antenna Is Best?

The subject of antennas has always been great for stimulating discussions, even arguments, about which one does what, and whether one is better than another. W4MB's interpretation of data collected over the years provides some fascinating new fuel for those discussions. The information presented here may help you decide which antenna is for you, or it may show you how to do some research on your own. Either way, we're betting that the discussions will continue — but with new insight.

## Alcatraz Invasion

Not too long ago, hundreds of permanent residents of "The Rock" in San Francisco Bay were plotting ways to get off of it. Who in the world would plot and scheme to get on it? Right! A group of hams, of course. Security systems and a foggy voyage through the harbor notwithstanding, they made it. Furthermore, they made contacts on several bands, and got off the island again in spite of Murphy and tourists. How things have changed. See page 26.

## Net Hopping

Ready for something new and exciting in Amateur Radio? Check in with the County Hunters. You can do it from your home station or from your car, and you will be surprised how many counties are "rare." You'll also be amazed at how hard you need to work for the "one" you need to complete your list. Long-time traffic-net attendant W8DUV and OM discovered this "new" facet of their hobby on a trip to Florida, and she shares the fun with you on page 28.

## Multi-Band Inverted Vee Antennas

The inverted-vee antenna is very popular because it is easy to put up, requires only one support, and works well in places where a stretched-out half-wave wouldn't fit. Many are one-band affairs, however. W3FQJ describes how you can do a little simple calculating and find dimensions that allow one antenna installation to work on two or three bands. The modern engineering term for this is "frequency-agile," but we'd rather just say "versatile." Before you grab the wire cutters, start reading on page 42.

## Ham Radio Techniques

The subjects so aptly treated this month include a filter for eliminating broadcast-station interference in your receiver, matching a ground-plane antenna so your new solid-state rig will like it, and a touch of 10-meter fm. The information starts on page 46.

## An SWR/Wattmeter You Can Build

Here's a neat, fast project that will dress up your shack and serves a purpose too. It makes use of some surplus meters with dual scales so you can read power and SWR in real numbers, instead of relative ones. The circuit is an update of one that appeared in *QST* back in 1969, and author Winter tells you how he did it, starting on page 50.

## Ten-Tec Owners' Report

A summary of the reports from many Ten-Tec owners, showing the good things they found after using the equipment, and the problems as well. Comments about the quality, performance, abound, but the owner reaction to service and help provided by Ten-Tec people is perhaps the most interesting part of the report. Get their reaction starting on page 52.

## The Cover

Does your yard look like this as you prepare for next fall's operating season of DX contests, QSO parties, or just plain ragchewing? This collection of hardware should put you in the running, provided you can find space to assemble it all. This original in acrylic by staffer KA1DXQ is our way of welcoming you to our "Emphasis On Antennas" issue, which will help inspire some aerial creations of your own.

**HAM RADIO HORIZONS** June 1980, Volume 4, Number 6. Published monthly by Communications Technology, Inc., Greenville, New Hampshire 03048. Telephone (603) 878-1441. Second Class Postage paid at Greenville, New Hampshire and at additional mailing offices. ISSN 0147-8818.

Subscription price: Domestic, one year, \$12.00; two years, \$20.00; three years, \$27.00. Canada and Worldwide, one year, \$12.00; two years, \$22.00; three years, \$30.00, payable in United States funds.

Subscription inquiries and changes of address should be directed to *Ham Radio Horizons*, Greenville, New Hampshire 03048. Please include address label from most recent issue if possible.



# NEW MFJ Dual Tunable SSB/CW filter

lets you zero in SSB/CW signal and notch out interfering signal at the same time.

**Ham Radio's  
Most Versatile Filter**

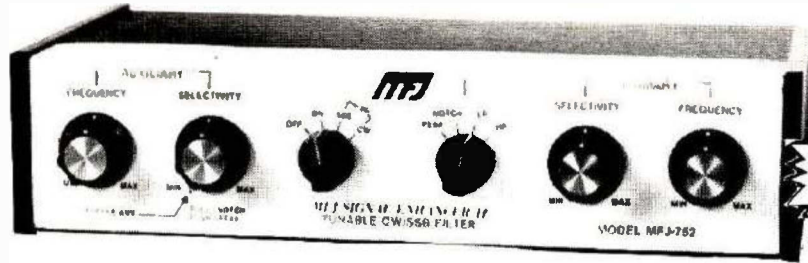

**BRAND  
NEW**

**\$79<sup>95</sup>**

The MFJ-752 Signal Enhancer is a dual tunable SSB/CW active filter system that gives you signal processing performance and flexibility that others can't match.

For example, you can select the optimum Primary Filter mode for an SSB signal, zero in with the frequency control and adjust the bandwidth for best response. Then with the Auxiliary Filter notch out an interfering heterodyne . . . or peak the desired signal.

For CW, peak both Primary and Auxiliary Filters for narrow bandwidth to give skirt selectivity that others can't touch. Or use Auxiliary Filter to notch out a nearby QSO.

The Primary Filter lets you peak, notch, low-pass, or highpass signals with double tuned filter for extra steep skirts. The Auxiliary Filter lets you notch a signal to 70 db. Or peak one with a bandwidth down to 40 Hz.

Tune both Primary and Auxiliary Filters from

300 to 3000 Hz. Vary the bandwidth from 40 Hz to almost flat. Notch depth to 70 db.

MFJ has solved problems that plague other tunable filters to give you a constant output as a bandwidth is varied. And a linear frequency control. And a notch filter that is tighter and smoother for a more effective notch.

Works with any rig. Plugs into phone jack. 2 watts for speaker. Inputs for 2 rigs.

Switchable noise limiter for impulse noise; trough clipper removes background noise.

Simulated stereo feature for CW lets ears and brain reject ORM. Yet off frequency calls can be heard.

Speaker and phone jacks. Speaker is disabled by phones. OFF bypasses filter. 110 VAC or 9 to 18 VDC, 300 ma. 10x2x6 inches.

Every single unit is tested for performance and inspected for quality. Solid American construction, quality components.

The MFJ-752 carries a full one year unconditional guarantee.

Order from MFJ and try it — no obligation. If not delighted, return it within 30 days for a refund (less shipping).

To order, simply call us toll free 800-647-1800 and charge it on your VISA or Master Charge or mail us a check or money order for \$79.95 plus \$3.00 for shipping/handling.

Don't wait any longer to use Ham Radio's most versatile filter. Order your MFJ Dual Tunable SSB/CW Filter at no obligation, today.

**MFJ ENTERPRISES, INC.**  
P. O. BOX 494

MISSISSIPPI STATE, MS 39762  
CALL TOLL FREE . . . 800-647-1800  
For technical information, order/repair status, in Miss., outside continental USA, call 601-323-5869.

# NEW MFJ-624 Deluxe Hybrid Phone Patch

Feature Packed: VU meter for line level and null. Has receiver gain, transmitter gain, null controls, bypass switch. Beautiful hum-free audio. RF filtered. VOX or push-to-talk. Works with any rig. Simple patch-in-patch-out installation.

**Crisp, clear hum-free audio**  
is what phone patching is  
all about and MFJ has it.



**BRAND  
NEW**

**\$59<sup>95</sup>**

This new MFJ-624 Telepatch II hybrid phone patch gives you a combination of performance, features, and quality that you won't find in other phone patches.

**PERFORMANCE:** Gives you crisp clear, hum-free audio which is what phone patching is all about. Use automatic VOX or push-to-talk. RF pi-filters and PC board construction eliminates RF feedback. Works with any rig.

**FEATURES:** VU meter monitors telephone line level to prevent crosstalk between telephone channels. Also lets you adjust null depth for maximum isolation between receiver and transmitter.

Separate transmitter and receiver gain controls eliminate readjusting rig's controls after patching. Null control for maximum isolation.

Function switch: OFF for normal operation. ON connects your rig to phone line for patching. NULL switches VU meter to let you adjust for maximum null.

Simple 2 cable installation (plus phone line) when rig has patch-in-patch-out jacks. Connects easily to any rig.

Phone jacks for patch-in-patch-out, speaker, microphone. Screw terminals for phone lines.

Eggshell white, walnut sides. 8x2x6 inches.

**QUALITY:** Every single unit is tested for performance and inspected for quality. Solid American construction, quality components.

**MFJ-620 TELEPATCH  
HYBRID PHONE PATCH.**  
Same as MFJ-624 but less VU meter. 6x2x6



inches. \$49.95 plus \$3.00 shipping and handling.

One year unconditional guarantee.

Order from MFJ and try it — no obligation. If not delighted, return it within 30 days for refund (less shipping).

Order today. Call toll free 800-647-1800. Charge VISA, MC or mail check, money order for \$59.95 plus \$3.00 shipping for MFJ-624 and \$49.95 plus \$3.00 shipping for MFJ-620.

**CALL TOLL FREE . . . 800-647-1800**

For technical information, order/repair status, in Miss., outside continental USA, call 601-323-5869.

**MFJ ENTERPRISES, INC.**  
BOX 494, MISSISSIPPI STATE, MS 39762

# WILSON SYSTEMS, INC. PRESENTS

## THE NEW SYSTEM 40 TRIBANDER

3 MONOBAND ANTENNAS IN ONE — EACH WITH FULL MONOBAND PERFORMANCE

FACTORY DIRECT  
ONLY

**\$299<sup>95</sup>**

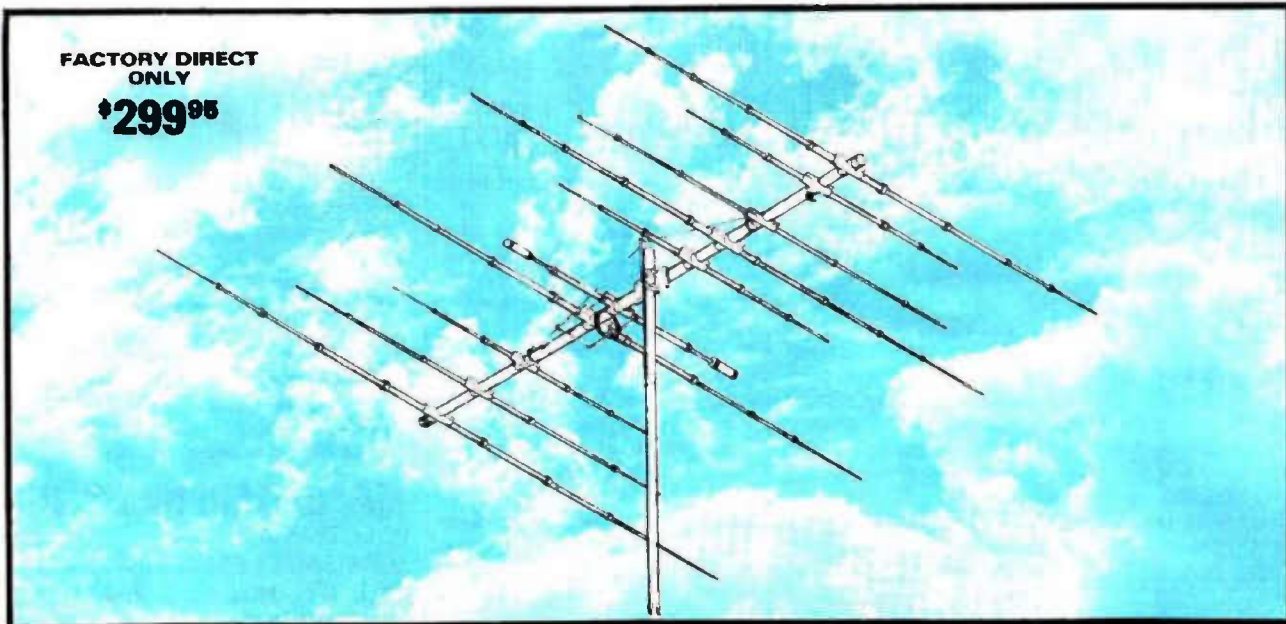

### A NEW CONCEPT IN ANTENNA DESIGN USING A 26 FT. BOOM

- FOR THE SERIOUS DXer WHO WANTS MONOBANDERS ON 10-15-20
- FOUR FULL SIZE 20 MTR ELEMENTS WITH 10 dbd GAIN
- THREE WIDE SPACED 15 MTR ELEMENTS WITH 8.2 dbd GAIN
- FOUR WIDE SPACED 10 MTR ELEMENTS WITH 10.2 dbd GAIN
- ONLY ONE FEED LINE REQUIRED
- DESIGNED WITH NO INTERACTIONS BETWEEN ELEMENTS
- ALL DRIVEN ELEMENTS AND DIRECTOR ELEMENTS ARE INSULATED FROM BOOM
- ALL PARASITIC ELEMENTS ARE FULL SIZE
- BROADBAND—NO SEPARATE SETTINGS REQUIRED FOR PHONE OR CW
- SAME QUALITY HARDWARE AS USED IN ALL WILSON ANTENNAS

#### SPECIFICATIONS

Max. Pwr. Input .....	Legal Limit .....	Longest Element .....	36'
VSWR @ Res .....	1.2:1 .....	Turning Radius .....	22' 6"
Impedance .....	50 ohm .....	Surface Area .....	12.1 sq. ft.
Feed Method ..	Coax Balun Supplied ..	Wind Loading @ 80 mph ..	309 lbs.
Matching Method ..	Modified Beta ..	Assem. Weight ..	75 lbs.
F/B Ratio .....	25 db .....	Shipping Weight .....	84 lbs.

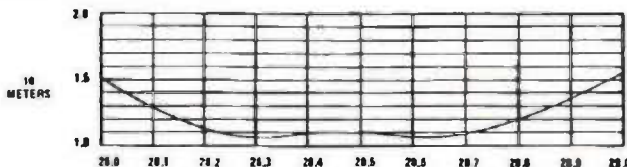
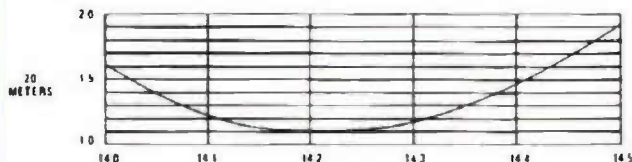

AVAILABLE ONLY  
FACTORY DIRECT  
CALL

**1-800-634-6898 TOLL FREE**

**WSI WILSON SYSTEMS, INC.**

4295 S. Praters, Las Vegas, Nevada 89103

PRICES AND SPECIFICATIONS SUBJECT TO CHANGE WITHOUT NOTICE.



June, 1980  
Volume 4, Number 6

# HAM RADIO HORIZONS

## CONTENTS

**T.H. Tenney, Jr., W1NLB**  
Publisher  
**James R. Fisk, W1HR**  
Editor-in-Chief

**Editorial Staff**  
Thomas F. McMullen, Jr., W1SL  
Managing Editor  
Martin Hanft, WB1CHQ  
Administrative Editor  
Robert Schneider, N6MR  
Joseph J. Schroeder, W9JUV  
Alfred Wilson, W6NIF  
Assistant Editors  
W.E. Scarborough, Jr., KA1DXQ  
Production Manager



**Publishing Staff**  
J. Craig Clark, Jr., N1ACH  
Assistant Publisher  
Advertising Manager  
James H. Gray, W1XU  
Assistant Advertising Manager  
Susan Shorrock  
Circulation Manager

Cassette tapes of selected articles from *Ham Radio Horizons* are available to the blind and physically handicapped from Recorded Periodicals  
919 Walnut Street, 8th Floor  
Philadelphia, Pennsylvania 19107

Microfilm copies are available from  
University Microfilms, International  
Ann Arbor, Michigan 48103

Copyright 1980 by Communications Technology, Inc. Title registered at U.S. Patent Office

Ham Radio Horizons is published monthly by  
Communications Technology, Inc  
Greenville, New Hampshire 03048  
Telephone 603-878-1441  
ISSN 0147-8818

 <b>Trap Vertical Antennas</b>	12	
Alfred Wilson, W6NIF		
 <b>Which Antenna Works Best?</b>	18	
Robert P. Haviland, W4MB		
<b>Hams Invade Alcatraz</b>	26	
Lyle E. Meek, N6BLN		
<b>Mobile Net-hopping</b>	28	
Kay C. Anderson, W8DUV		
<b>DX Horizons</b>	34	
William E. Kenamer, K5FUV		
<b>Questions and Answers</b>	38	
 <b>Multi-Band Inverted V Antenna</b>	42	
Edward M. Noll, W3FQJ		
<b>Ham Radio Techniques</b>	46	
William I. Orr, W6SAI		
<b>Homebuilt SWR/Wattmeter</b>	50	
William P. Winter, Jr., WB8JCQ/LU1AKO		
<b>Ten-Tec Owners' Report</b>	52	
Thomas F. McMullen, Jr., W1SL		
<b>Activities Calendar</b>	76	<b>Horizons Locator</b> 72
<b>Ad Check</b>	78	<b>Newline</b> 11
<b>Ad Scan</b>	70	<b>Postbox</b> 62
<b>Advertiser's Index</b>	78	<b>Product Showcase</b> 64
<b>Benchmarks</b>	59	<b>Propagation Chart</b> 75
<b>DX Column</b>	34	<b>Questions and Answers</b> 38
<b>DX Forecaster</b>	74	<b>This Month's Horizons</b> 2
<b>Focus and Comment</b>	8	<b>The View From Here</b> 6
<b>Ham Radio Techniques</b>	46	



## THE VIEW FROM HERE

The widely vacillating precious metals market and Amateur Radio; what, you might ask, does one have to do with the other? For starters, consider the fact that practically every electronic component in that new transceiver you're thinking about buying depends on the use of gold, silver, or palladium; and while the prices of these raw materials have dropped somewhat in recent months, over the past year their cost has grown significantly faster than the rate of inflation. Those inexpensive and innocent looking ceramic bypass capacitors that are used by the hundreds, for example, use thin silver layers deposited on ceramic substrates. Most transistors, diodes, and integrated circuits use gold contact wires and many are built within a tiny gold frame; and palladium is often used in precision monolithic resistors. When you add the precious metals in these common components to the more obvious ones like silver-mica capacitors and silver-plated switch contacts, tank circuits, and variable capacitors, it's suddenly apparent that the transceiver on your operating desk is a source of hidden wealth. More important, it is indicative of the great increases in the cost of Amateur equipment that are likely in the future.

Not too many years ago the cost of precious metals used in the manufacturing processes of electronic components was relatively minor, and the manufacturers simply factored that cost into the selling price of the part. The commodities market was fairly stable, so the manufacturers simply absorbed any minor fluctuations in material costs. With the recent volatility of the precious metals market, however, the manufacturers are no longer able to absorb the huge cost burden and are beginning to pass it along to their customers in the form of a surcharge. At the present time a 10 to 15 per cent surcharge is not uncommon for many components; it is even higher on some high-grade parts that depend heavily on the use of gold.

And while the dizzying costs of gold and silver have been capturing the headlines, the prices of other commodities which are important — often vital — to electronics are also going out of sight. Consider for a moment that penny in your pocket; at one point recently the cost of copper reached the point where the Lincoln penny's monetary value was essentially the same as its copper value; translate that into the huge amounts of copper used by industry in the manufacture of printed-circuit boards, hookup wire, coaxial cable, and a hundred other electronic products, you are struck with the enormity of the situation — and the great impact it will eventually have on the costs of all electronics equipment.

The costs of equipment will also be greatly affected in the future by the OPEC oil cartel because of the great quantities of petroleum-based materials used in electronics: epoxy-fiberglass circuit boards, thermoplastic insulation, polyethylene coaxial cable — the list goes on and on. If you have watched the price of coaxial cable for the past six months, you've probably noticed that the prices quoted in the magazine advertisements seem to be higher in each new issue; ditto for rotator cable and hookup wire. Quite frankly, if I were planning a new antenna installation this summer, I wouldn't procrastinate about buying the feedline and rotor cable. Indeed, if you're thinking about buying any new Amateur Radio equipment, the longer you hold off your decision, the more it is likely to cost.

Jim Fisk, W1HR  
editor-in-chief



The Question we seem to get most often from our customers:

# "WHEN IS ICOM COMING OUT WITH A HAND-HELD?"

## ICOM IC-2A SYNTHESIZED 2 METER HAND-HELD

### FEATURES YOU'VE WANTED

- 800 T/R Channels. Synthesized.
- 1.5 Watt Output High/Low Power Battery Saving Switch to .15 Watt.
- Separate built in Speaker & Mic. Excellent audio quality.
- Compact. About the size of a dollar bill.
- Variable size NiCd Power Pack, 3 sizes available to suit your needs. (250 MA standard). Makes the IC-2A the most compact synthesized HT on the market.
- ICOM level Receiver Performance-ICOM Quality Receiver in a compact package (.2uv/20db typical)
- Optional Tone Pad, Desk Charger, Speaker/Mic available.
- With slip on/slip off Bottom NiCd Pack, you can vary the size of the HT from about 116 mm high to 175 mm high. Easy to carry extra Snap-on packs with you for extended trips.

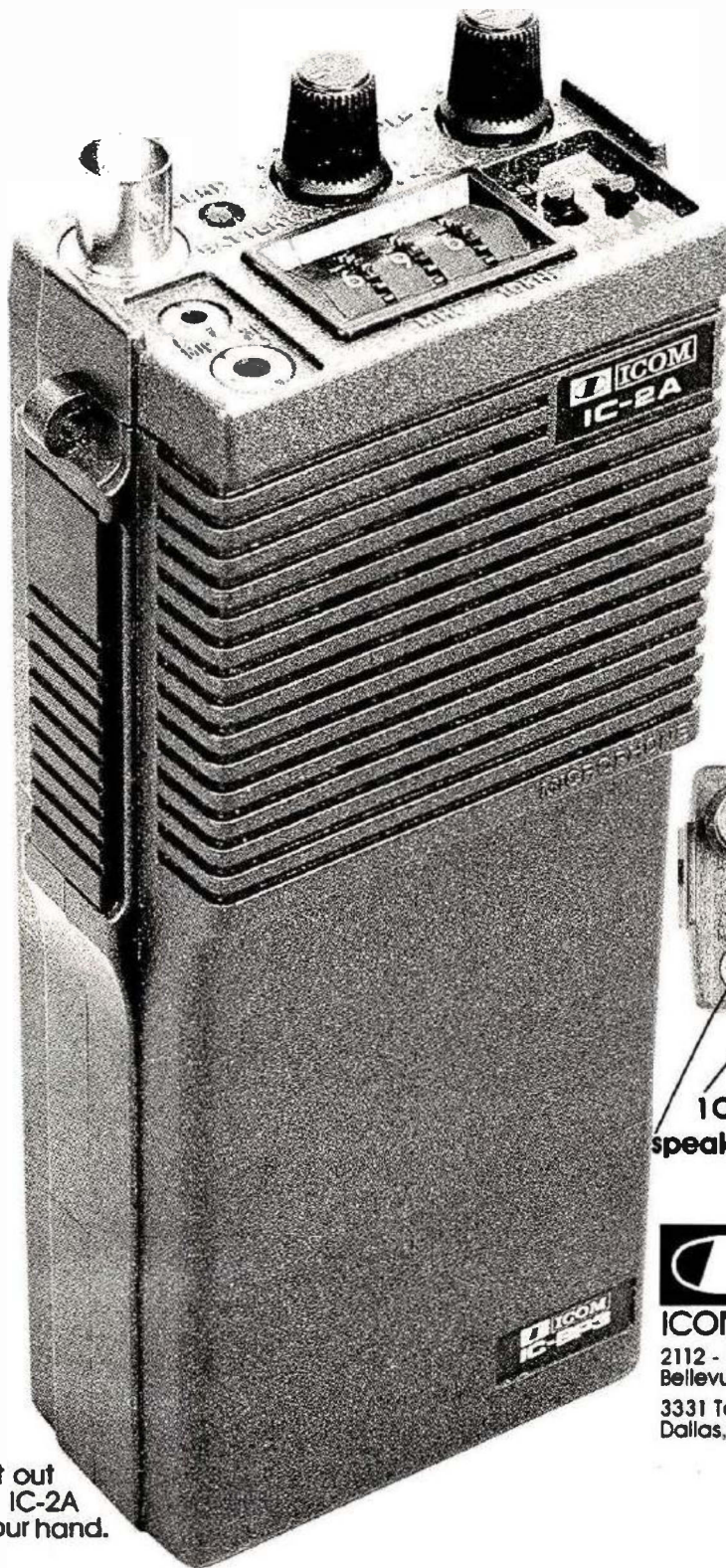

BACK VIEW  
±600 kHz offset  
simplex/duplex  
Hi/lo power

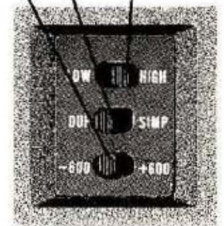

TOP VIEW

BNC antenna connector "Rubber Duckie" standard

transmit indicator  
squelch  
volume control

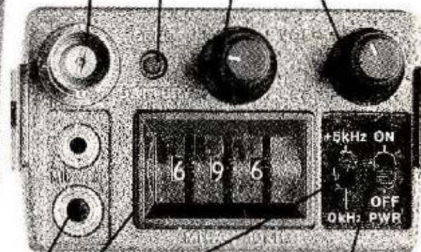

on/off  
5 kHz channel selection  
10 kHz channel selection  
speaker/mic jack

Actual size: Cut out and put the ICOM IC-2A in the palm of your hand.



ICOM AMERICA, INC.

2112 - 116th Avenue NE  
Bellevue, WA 98004

3331 Towerwood Dr., Suite 307  
Dallas, TX 75234

# THE ANSWER IS: NOW!

All 800 channels of it!



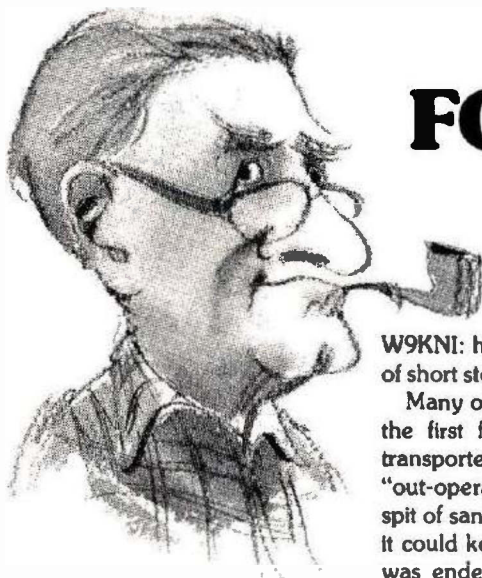

# FOCUS & COMMENT

I have some good news for you would-be DXers and other fans of W9KNI: his call will appear again in the pages of *Horizons*. There'll be a series of short stories, called "DXer's Diary," starting in the August issue.

Many of you remember his earlier descriptions of stalking DX from some of the first few issues of *Horizons*. These articles had a magic quality that transported you right into the shack as Bob found the rare stations, and then "out-operated" the pack to work an Amateur on some far-away land or lonely spit of sand and coral in the middle of an ocean. The telling was so realistic that it could keep you on the edge of your chair as you read, and, after the story was ended, fired you with a desire to get to the rig and try for some DX yourself.

Well, Bob has been considering writing some more of his "instructional" pieces on the art of DXing (and, as he tells it, it is an art), and has finally decided to operate the typewriter with as much skill as he does his rig. The first of the series is in the pipeline right now, and I can promise that you'll enjoy every bit of it. Watch for the August issue, and see if I'm right.

Different subject. This is our "Antenna" issue, and you'll find a couple of interesting "how-to" articles on antennas you can put together — one talks about the virtues of a trap style three-band Yagi; another is made of wire and also covers more than one band.

Then, if you have heard some of the endless discussion (argument?) about which antenna is best, there's a well-documented comparison between some popular types, with some data that takes power and propagation into account as well.

All of which tends to point out that there is still a vast area that can be explored by hams who are looking for something unusual or challenging to do with their hobby.

The subject of antennas probably comes under more investigation, and causes more arguments, than any other part of Amateur Radio. Many hams do not really understand how an antenna is *supposed* to work, and the picture is even further confused by the well-known fact that you and I can each take identical pieces of wire, attached to identical insulators, and fed by identical length and type of cable, and, when we install these "antennas," we certainly will not obtain identical results.

Furthermore, if a whole club full of Amateurs put up the "same" antenna, you would have one group that loved it, another that said it was a lousy antenna, and others who would classify it as "so-so," and begin to modify the design.

That's only a small sample of the challenge of antennas. This field is one of the greatest for the "I wonder what would happen if . . ." mentality, and the results of pursuing that line of thought can be either discouraging or ego-inflating — and always unpredictable.

The answer is to read all you can about antennas, and try as many as your time and resources permit. You'll find a particular type that works best for you, and will come back to it again and again. A friend of mine always used a Windom (off-center fed) antenna, and could make one work under almost any circumstances. He never failed to get results, no matter whether he was handling messages on 80 meters or chasing DX on 40 and 20. He was never happy with any other type.

After repeated cajoling from my friend, I sometimes relented and installed a Windom at my house, and it never failed to give me trouble — rf in the shack; rf in the neighbor's house; lousy signal reports in all directions, etc. I guess I'm just not a Windom man. Back to the center-fed half-wave dipole — which always works (for me).

There are thousands of hams who have the same sort of experiences with the Quad vs Yagi vs Delta Loop school of antenna construction, and it's not an unhealthy thing. More investigators means greater interest, which leads to more activity. So, read about antennas, and try them out (we've even included a SWR meter/power meter story to help you test your latest skywire). You could do worse.

Another sub-section of the antennaphile cult is filled with those who take their pet antenna out to some dusty (wet, remote, frozen, mountain-top, deep woods, or urban) site and hook them to "portable" Amateur gear in what is known as Field Day. It's both a contest and emergency preparedness, but, since we couldn't feature more than one major subject in a single issue, you'll read about Field Day in next month's *Horizons*. The issue goes in the mail during the first week in June, so there'll still be time to get fired up with enthusiasm and trudge off to the great outdoors, transceiver in hand and dipole (or Windom, or Yagi) trailing behind.

*Tom*

Thomas McMullen, W1SL  
Managing Editor



# SERIOUS READING

## Practical ANTENNAS for the Radio Amateur

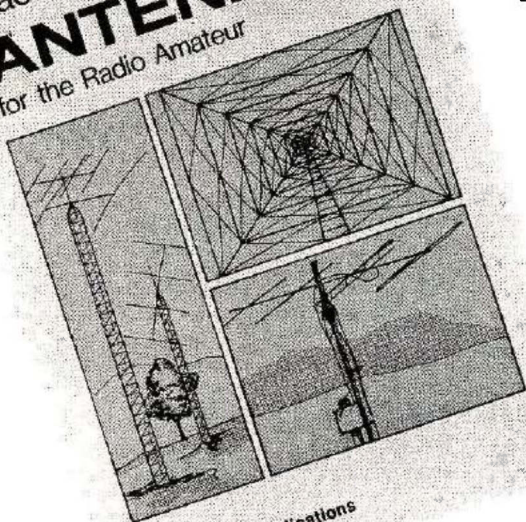

SCELBI Publications

## Practical Antennas for the Radio Amateur

You've never seen an antenna book quite like this! It tells you how to choose, use and build your antenna system. Here's what you get:  How to build practical beams, quads and wire antennas  Computer-generated beam headings to every known country in the world  Charts and tables to eliminate tricky calculations  Practical ideas for the newcomer  OSCAR antennas  Complete bibliography of magazine articles on antennas  Antenna safety  Trick antennas for portable work  Tips on how to keep your antenna up. Durable vinyl cover. Only \$9.95

## Personal Information Management System

Keep an automatic log. Compare antenna performance. Catalog your parts and equipment. Keep a mailing list for your club. Plain-talk booklet tells how. Includes ready-to-use program for home computer systems. A bargain at just \$9.95.

## Introduction to Low Resolution GRAPHICS

Produce amazing computer graphics — even if you can't draw a straight line. Literally! Learn how to draw lines and shapes, make graphs, draw pictures and even do animation. All the simple secrets are contained in this brand new book. Only \$9.95.

## Calculating with BASIC

Use a home computer to calculate voltage across a capacitor, find the value of inductance, determine the capacitance of parallel plates, compute the time to charge a capacitor and convert power, voltage and current to decibels. All the routines needed and more! Just \$7.95.

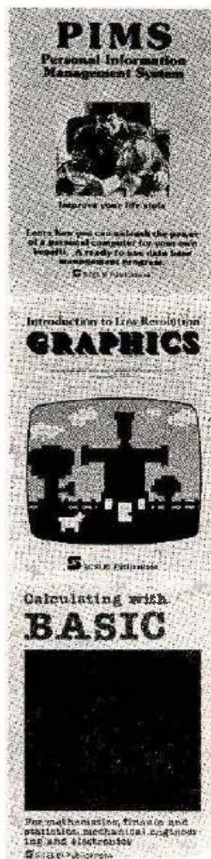

## Brand New Antenna Book!

New format . . . Big diagrams . . . Easy-to-read

By well-known author, Robert Myers, W1XT

In a Hurry? Order Toll Free 1-800-258-5353

## Ham Radio's Bookstore

Greenville  
NH 03048

- Practical Antennas     Personal Information Management System  
 Introduction to Low Resolution Graphics     Calculating with Basic

Name \_\_\_\_\_

Street \_\_\_\_\_

City \_\_\_\_\_ State \_\_\_\_\_ Zip \_\_\_\_\_

Please enclose proper amount for books plus \$1.00 shipping or credit card information.

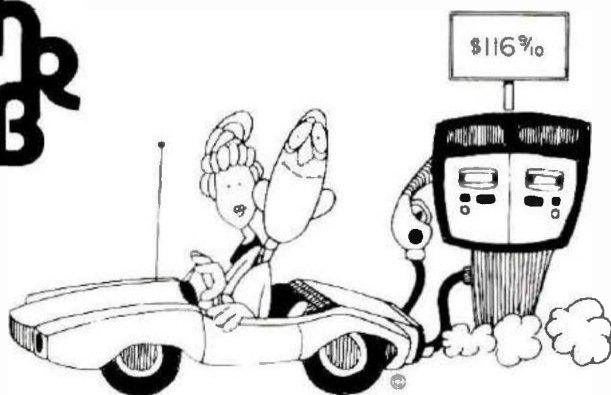
**h  
R  
B**

# SAVE TIME & MONEY!

## Shop By Mail

**NEW**

### RSGB AMATEUR RADIO OPERATING MANUAL

Edited by R. J. Eckersley

Compiled by the RSGB, this exciting new book covers just about every facet of Amateur Radio. Starting with a precise description of the Amateur Service worldwide, the Amateur Radio Operating Manual leads the Amateur through the steps to setting up a station correctly, how to operate properly, DX, contests, satellites, RTTY and Slow Scan Television. You also get 5 big appendices jam-packed with more information, call signs in use, maps, DXCC country list, time zones and international call sign assignments. 190 pages. © 1979

RS-OM

Softbound \$9.95

### GENERAL CLASS AMATEUR LICENSE STUDY GUIDE

by Phil Anderson, WØXI

This book was written in simple laymen's language with uncomplicated explanations and examples used to present electronic radio concepts and ideas. Throughout each chapter, questions and answers are used to strengthen your understanding of the terms and concepts presented. This book also covers several methods that can be used to improve code reception skills. The final chapter is a sample FCC exam which the author feels he would ask if he were to give the FCC exam. 160 pages. © 1979

21617

Softbound \$6.50

### RADIO PUBLICATIONS SPECTRUM CHART

Here's how to tune in the world! Organized by frequency, this big, attractive, multi-colored wall poster is a must for every ham shack. Covers 10 kHz to 30 GHz using stations or services assigned by frequency. You also get a time chart that shows each time zone and its relation to GMT. © 1978

RP-SC

\$4.95

### OWNER REPAIR OF RADIO EQUIPMENT

by Frank Glass, K6RQ

"The successful repair of any device results in restoring its operation at least to the level it had just before it quit." With this basic concept in mind, author Frank Glass gives you step by step instructions on how to repair all kinds of electronic equipment. Fourteen chapters cover every aspect of repair procedure from component use and failure and how to read schematic diagrams to a most important subject, safety. This book is a must for the amateur new to servicing his own equipment. 85 pages. © 1979.

RQ-OR

Softbound \$7.95

### NEW 1980 34th EDITION WORLD RADIO & TV HANDBOOK

The world's only complete reference guide to international radio and television. This 1980 edition has complete information on each station including address, frequency and scheduling. Much additional information such as solar activity and World Time Table is included. Unquestionably the leading book of this type. 554 pages. © 1980

WR-TV

Softbound \$14.95

### RADIO HANDBOOK 20th Edition

by William I. Orr

Here's an unbeatable bargain! The Twentieth Edition of the Radio Handbook features:

- A long list of HF/VHF linear amplifier designs using popular high-power tubes.
- Many of the receiver, transmitter, antenna and accessory construction projects which have made the Radio Handbook series so popular.
- A large measure of current reference material.

Lots of usable and valuable information for an unbeatable low price. 986 pages. 1975. Hurry. Quantities limited!

24032 was \$18.50

Hardbound \$8.95

SAVE over 50%

### KANTRONICS THEORY CASSETTE

Here's a new, easy way to study theory for your Novice, General, Advanced or Extra class exam. Designed for folks on the run. All you have to do is drop in the cassette at home, work, or in the car and listen to an interview-style tape covering Novice, General, Advanced or Extra class theory. A great way to reinforce other study methods.

- KT-NT Novice Class Theory Cassette
- KT-GT General Class Theory Cassette
- KT-AT Advanced
- KT-ET Extra

One tape \$4.95

Two tapes \$8.95

One tape \$4.95

One tape \$4.95

**NEW**

### ADVANCED CLASS TEST GUIDE

by Dick Bash, KL7IHP

Based upon the FCC exam syllabus and feedback from actual test experiences, this new book is probably one of the best study guides available today. Over 190 sample questions cover each major subject area completely. You also get helpful hints on how to study successfully and on how to prepare yourself mentally before you take the exam. You aren't fully prepared if you don't have this book. © 1979.

DB-AG

Softbound \$9.95

# For Even Faster Service Call Toll Free 1 (800) 258-5353

## HAM RADIO'S BOOKSTORE • GREENVILLE, NH 03048

Please allow 2-3 weeks for delivery. Prices subject to change without notice.



# NEWSLINE

---

AMATEURS WOULD NEED GIVE only their own calls when signing clear with another station, under a Notice of Proposed Rule Making released by the Commission April 9. Personal Radio Docket 80-136 would amend Part 97.84(a) of the rules to drop the present requirement, frequently ignored in contests and often overlooked at other times, that an Amateur sign clear with another station when ending a contact. With the proposed amendment, an Amateur station would need give only its own callsign at the beginning or end of each transmission or series of transmissions (and at 10 minute intervals, of course), with no need to send any other station's call at any time during a contact.

International Third-Party traffic would provide the only exception to the proposed rules relaxation. International regulations do require both stations to send both callsigns when they are handling international third-party traffic.

Comments On PR Docket 80-136 are due at the Commission by July 16, and Reply Comments by August 15.

INCREASING CONGESTION ON the high end of 10 meters is causing confusion and some conflict among users. A long-standing "gentlemen's agreement" has placed FM users between 29.5 and 29.7 MHz, OSCAR's downlinks from 29.4 to 29.5, and AM and SSB below 29.4 (though the Russian Amateur Spacecraft have also operated just below 29.4). Recently, however, an increasing number of SSB signals have been tearing up FM contacts at the high end as congestion at the lower part of the band has led some operators to seek relief in the "empty" top end.

OSCAR Users Are In Trouble as well, with AM, FM, and SSB from both fixed and mobile stations all competing with the CW and SSB satellite downlink signals and 29.4 and 29.5 MHz telemetry during OSCAR passes. Fortunately, much of the activity above 29 MHz is low power reducing the interference level, but the basic incompatibility of the various modes makes it an irritating problem even when there's little disruption.

FM Users Are Creating their own interference problems, with many of the fixed-frequency older rigs and remote bases set up on the 29.6-MHz national FM calling frequency. After working hours, and on weekends, the channel is next to unusable, and during late afternoons the JA QRM often sounds like a DX contest pileup! Increased use of frequency-agile radios like the FT-901DM and Comtronix FM-80 does enable users to move off 29.6 after establishing contact, but all too often they move up or down onto repeater outputs or inputs or farther down into the OSCAR passband.

The Top End Of 10 meters needs more attention to, and some revision of, the present "gentlemen's agreement" bandplan, before the conflicts cause more problems than they already have.

LAUNCH OF THE AMSAT PHASE III-A satellite is now slated for May 23 from Korou, French Guiana. Vibration testing on the spacecraft has been successfully completed at the CNES facility in Toulouse, France. On completion of the vibration tests the satellite was returned to Marburg, West Germany, for final testing, matching of the antennas, and final integration of the flight computer. The computer has a new memory and other modifications.

A STATION IDENTIFYING AS RS3A has been monitored on 29.330 MHz sending a recorded message concerning a ground test of a Soviet RS satellite transponder. The RS3A report says the transponder input is from 145.910 MHz to 145.950 MHz and the output is between 29.410 MHz and 29.450 MHz. The transponder, which signs RS0, also has a beacon with seven channels of telemetry operating on 29.450 MHz.

Reception Reports For the RS0 ground tests should be sent via Box 88, Moscow, Attention RS3A.

AMATEUR RADIO IS PERMITTED in airport concourse areas, although some security guards have been giving Amateurs a hard time because of their handhelds. After WD4NEK was told by a guard at the Atlanta airport that he had to remove the battery from his transceiver before entering the concourse or "he'd be in a lot of trouble," he complied, but later research with Delta Airlines and the guard service established that no such requirement exists.

FCC AUTHORIZATION IS REQUIRED for maritime mobile operation from a U.S. flag vessel, according to Section 302(s) of the Communications Act. Regulations for maritime mobile operators on U.S. vessels are the same as those for operation from U.S. territory, so violators would be subject to such penalties as seizure of equipment, fines, or even imprisonment upon return to a U.S. port.

THE AMATEUR WHO THREATENED the FCC engineers who were investigating his possible jamming activities in Los Angeles last fall was indicted by a federal grand jury March 19. John W. Munson, Jr., K6EOA, was jailed for 20 days in October as a result of that incident, but released when the U.S. attorney in the case decided not to proceed on felony charges against him at that time. The two-part indictment was handed down after the grand jury heard transcripts of transmissions from K6EOA. Trial has been set for May 6 in Los Angeles. In the meantime he's reported still active on 2-meter FM.



# Trap Yagi Antennas

BY ALFRED WILSON, W6NIF

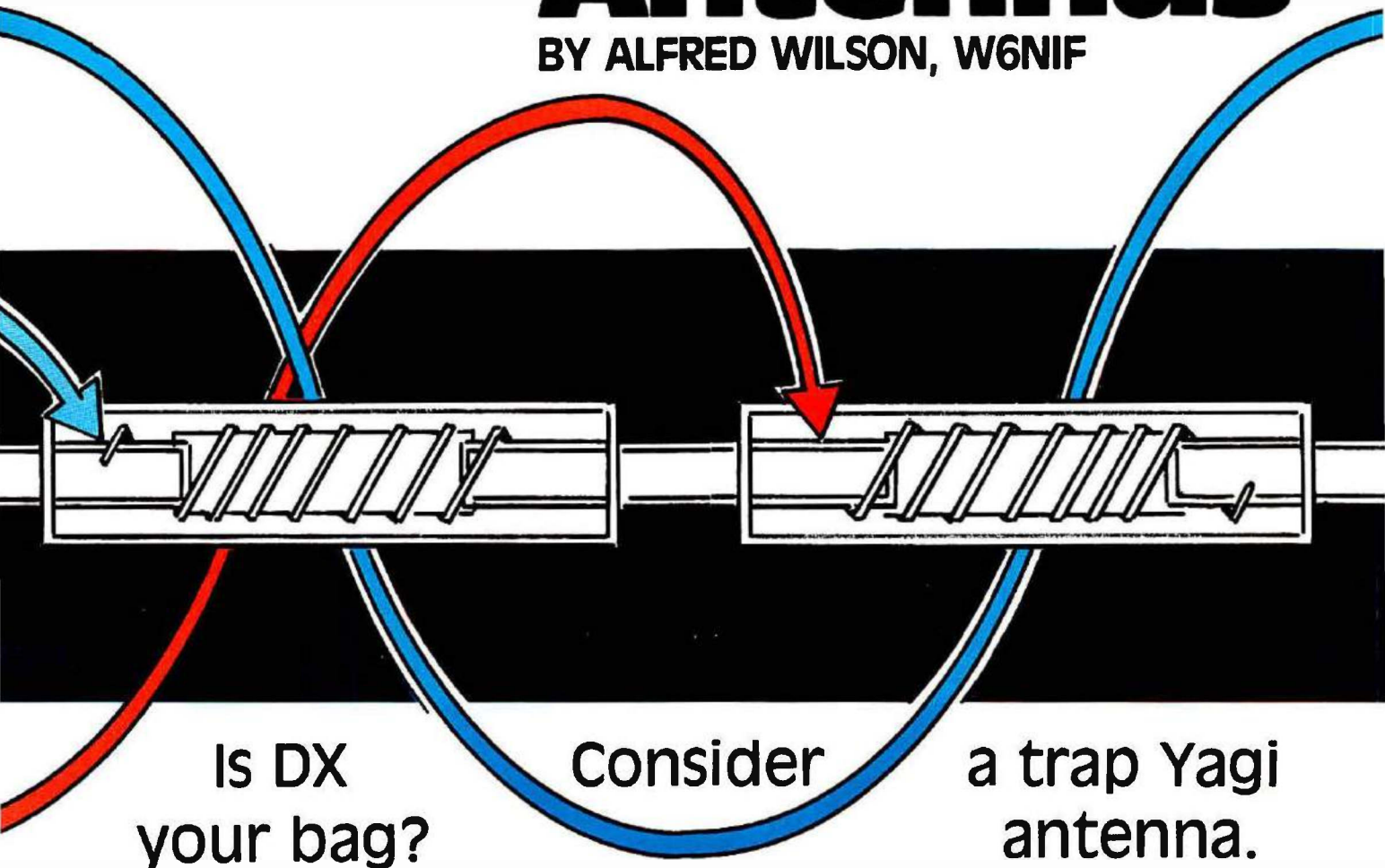

Is DX  
your bag?

Consider

a trap Yagi  
antenna.

The choice of an antenna is an important decision. If you're interested in casual contacts on the low-frequency bands, a simple dipole will do the job. If you're interested in working foreign stations, a beam antenna is the answer. But what kind of beam? The Amateur literature describes many beam-antenna designs, from the simple phased array using wire elements to sophisticated beams using elements made of tubing, such as the Yagi antenna. All are designed to concentrate your signal, however small, in the desired direction. As with most things, a compromise can be made. If you are on a limited budget and don't have much space for a full-size Yagi beam, the trap beam may be your answer.

In this article I discuss my experiences with a popular trap beam Yagi for the 14-28 MHz Amateur bands. I considered all the ads for trap beams and chose the ATB-34 made by Cushcraft. I've had excellent results with my choice. The antenna has given good results in DX pileups and has withstood extremes of weather, including winds up to 90 mph (144 km/h) at my seacoast location.

#### Choosing a beam antenna

Let's say you're new to Amateur Radio. Your license and equipment are in place. You've decided on a beam antenna. You don't have enough room for an extensive "antenna farm" and have a limited bud-

get. Why not consider a trap Yagi antenna? The trap beam antenna is available in kit form from several manufacturers. It has many features that should appeal to those who want an antenna with reasonable gain, small size, and good front-to-back ratio. Of course it won't outperform a full-size Yagi designed for single-band operation, but then who can afford stacked full-size beams for all the high frequencies? Look over the antenna ads in the Amateur magazines. You'll find several sources of multiband trap beams. Compare prices and features. If you need more information, write to the manufacturers. Most will be glad to send you additional material on their antennas.



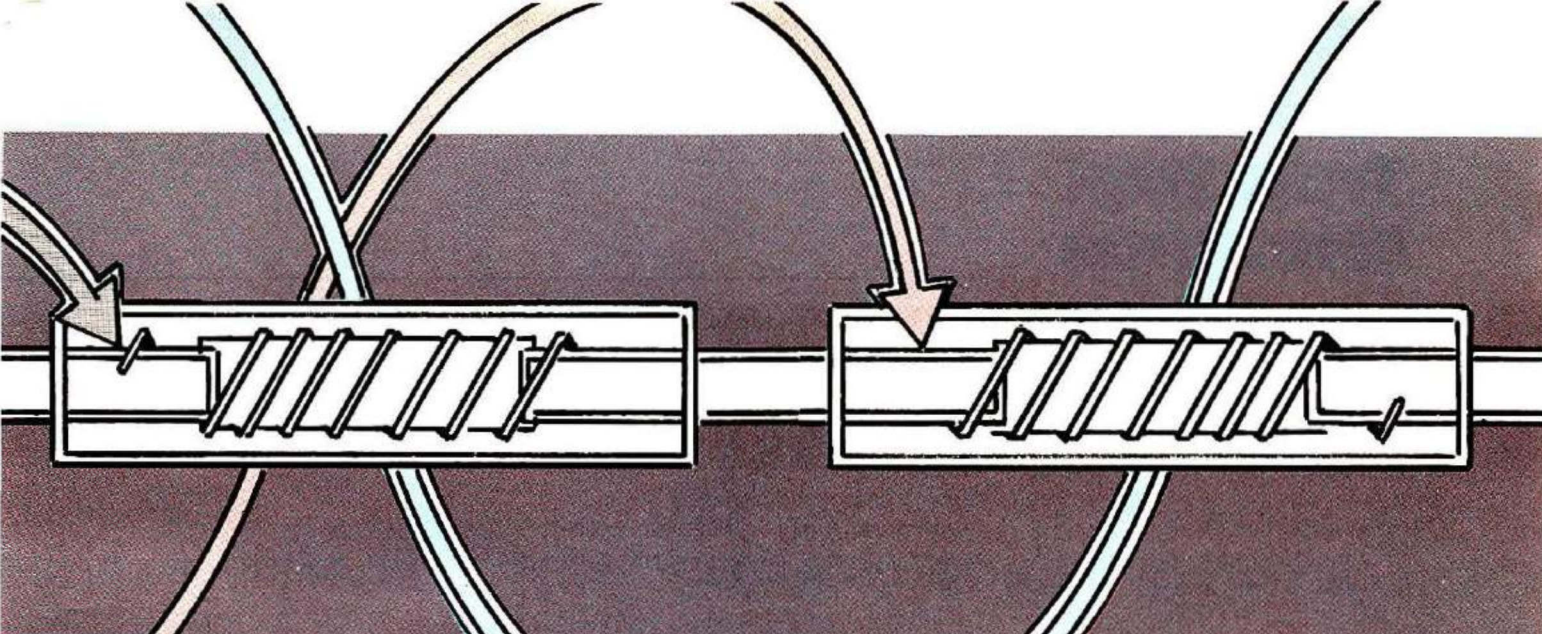

Trap beams have been around for a long time. References 1 and 2 give a good description of trap antennas. The design is based on the fact that, if a parallel-tuned resonant circuit consisting of a coil and capacitor is placed in the antenna elements, a high impedance will be presented to the frequency to which the trap is tuned. This means that, whatever the element length, the portion of the element between the feedpoint and the trap will be resonant at the trap frequency. For example, if your trap beam is operating on, say, 21 MHz, the traps for 21 MHz act like an open circuit, preventing rf current at 21 MHz from flowing into the rest of the antenna element. At 14 MHz the antenna performs as if the 21-MHz traps weren't in the circuit.

#### Trap efficiency and durability

High rf voltages appear on the traps, so trap design is extremely important. The traps must have high *Q* (low loss), high dielectric strength, and must be mechanically rigid. I believe the trap elements are the heart of this type of antenna; if the traps break down because of excessive rf voltage or corrosion, the antenna is worthless.

Years ago, I built a trap beam from surplus aluminum tubing. I made the traps from heavy copper wire (inductive elements) and concentric aluminum tubing (capacitive elements). The inductors were of open-wire construction, wound over the tubing capacitors. I used aluminum clamps to secure the inductors to the capacitors. And that caused some problems!

After a few months' exposure to the salt air at my seacoast location, all of the traps broke down. I traced the problem to corrosion between the clamps holding the inductors and the capacitive elements.

Even though I wrapped each trap with polyethylene sheet secured with nylon fish line at each end, the design was not good enough. Before you decide on which antenna kit to buy, find out all you can about the traps; how they're designed electrically and mechanically. Nothing is so frustrating as having a trap break down after you've spent a lot of time and effort getting the antenna on a tower or mast.

One of the reasons I chose the ATB-34 for my new beam was because of the excellent trap design. The beam is rated at 2 kW PEP, which means the traps have to be pretty good to withstand that kind of power. The ATB-34 traps are made of large-diameter copper wire and solid-aluminum capacitors using air dielectric. The trap forms are made of fiberglass and coated with epoxy, so weather-proofing is no problem.

The first thing I did after my ATB-34 arrived was to check the traps. I coupled a grid-dip meter to each trap and measured the resonant frequency. Then, with the antenna mounted on a step ladder, I applied power and watched for smoke. No smoke; no problems. I've been using the beam for the last three years,

operating at full legal power on all bands. No breakdowns, no hassles, and no added expense. Many gale-force storms have hit it; the antenna just sits there on the tower, waiting for the next DX pileup.

#### Antenna gain

Everyone wants the most gain from a beam antenna. What is antenna gain? It's usually given in dBd. For example, the ATB-34 gain is advertised at 7.5 dBd. This means that the antenna will provide 7.5 decibels gain over that of a reference dipole antenna.

A gain of 7.5 dBd is quite respectable for a trap Yagi antenna. Translated into power ratio, a gain of 7.5 dBd means that the beam will deliver a power gain 5.62 times that of the reference dipole. For example, if you apply 100 watts into a 7.5-dBd gain antenna, the radiated power from the antenna will be

$$5.62 \times 100 = 562 \text{ watts} \quad (1)$$

In this case you have a bootstrap power increase of more than five times your output power (compared with a reference dipole). Also, the radiated power is concentrated into a beam 62 degrees wide at the half-power points.

Many Amateurs try to squeeze the last dB of power into their antennas. But, consider the real world: to increase your signal one-half S-point at the receiving end means that you must increase your output power by 3 dB. In other words, you must increase power from 100 to 200 watts. Such an increase doesn't mean very much at the high frequencies. If

# Trap Yagi Antennas

you're in a DX pileup with thousands of stations trying to work a rare station, I doubt if a 3-dB increase in output power will help. But an increase of 7.5 dB is another story! A good beam antenna just might make the difference between working the rare DX station and not.

Don't pay too much attention to S-meter readings from any station. Most are relative and are subject to interpretation by the operator at the other end. If your signal is readable, however weak, you've made the contact and that's what matters.

## Make or buy?

Right after World War II, sources of seamless aluminum tubing were easy to find. Surplus outlets had real bargains in telescoping Duraluminum tubing, which had been dumped onto the market by the aircraft industry. Not so today. Before I purchased my trap-beam kit I checked around for seamless telescoping tubing. A few hobby shops had some tubing, but it wasn't seamless and had a very thin wall — hardly usable for a beam antenna. The selection of tubing length and diameter was poor. I could find nothing suitable for a triband beam, so I decided to go the "buy" route.

I wanted a triband Yagi of modest dimensions that could be rotated with a HAM-M rotator, which I had on hand. After checking all the ads in the Amateur literature, I decided on the Cushcraft ATB-34. Among other features, it has a modest turning radius (18 feet, 9 inches; 5.7 meters), which is important in my case because my backyard is small, and high-voltage power lines are fairly close to the antenna location.

The advertised front-to-back ratio of the ATB-34 is 24 dB, and the beamwidth at the 3-dB points is 62 degrees. Not bad. This antenna uses an 18-foot-long boom (5.5 meters), which means that a good compromise in design was achieved between element spacing and turning radius.

## Standing-wave ratio

In years past, standing-wave-ratio (SWR) wasn't a big deal. I've used

Zepp antennas, made of copper wire, that had standing-wave ratios of 10 or more. The antenna and transmitter didn't know the difference between a low or high SWR. As long as the antenna took power, some radio-frequency energy was radiated. It's a different story today. Solid-state transmitters are most unforgiving of high SWR.

Unless your solid-state rig automatically shuts down the transmitter when working into a high SWR, you may be faced with replacing final-amplifier devices and possibly other components. I took this factor into consideration when selecting my new triband antenna. The ATB-34 has an excellent SWR response on the 10-15-, and 20- meter bands. The high-

---

***In years past, standing wave ratio (SWR) wasn't a big deal!***

---

est SWR (about 2.4) appeared at the band edges. It was less than 1.3 at the center of each band. The SWR was measured with the antenna mounted on a 65-foot (19.8-meter) tower. The measurements were made with a Drake MN-2000 matching network, which includes a wattmeter/SWR meter. Even when mounted on a step ladder in the backyard (before installation on the tower), the antenna had an SWR on all bands of about 2.5 at the band edges.

## Baluns

I'm a firm believer in baluns. A balun is a device that matches an unbalanced coaxial transmission line to a balanced load, such as a dipole (in this case, the Yagi antenna driven element).

A balun is necessary between a coaxial-cable transmission line and a beam such as a Yagi antenna if you

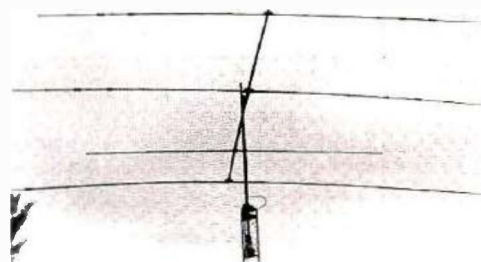

Author's ATB-34 triband trap Yagi mounted on a crankup tower and ready for action. For durability and performance, this antenna is hard to beat.

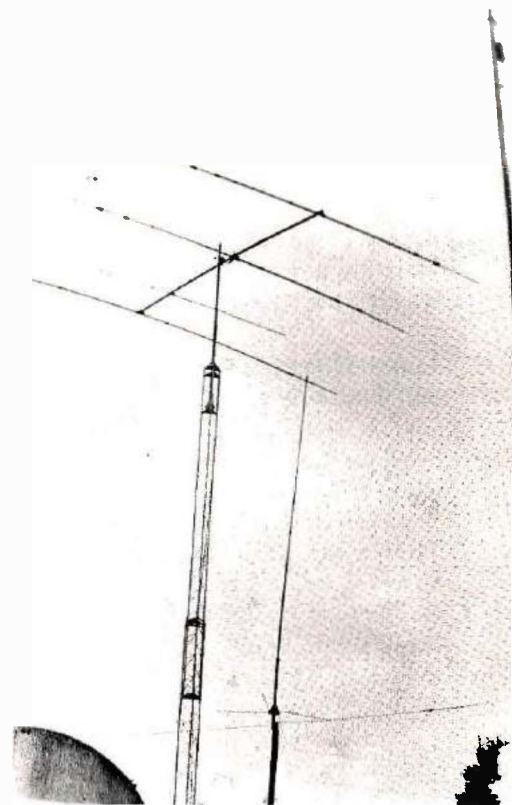

View of author's antenna farm. Mast at right supports an inverted V antenna now used for the 7-MHz band. It is the predecessor of the ATB-34 tribander in the background. Antenna in the center is a collinear vertical used for 2 meters.



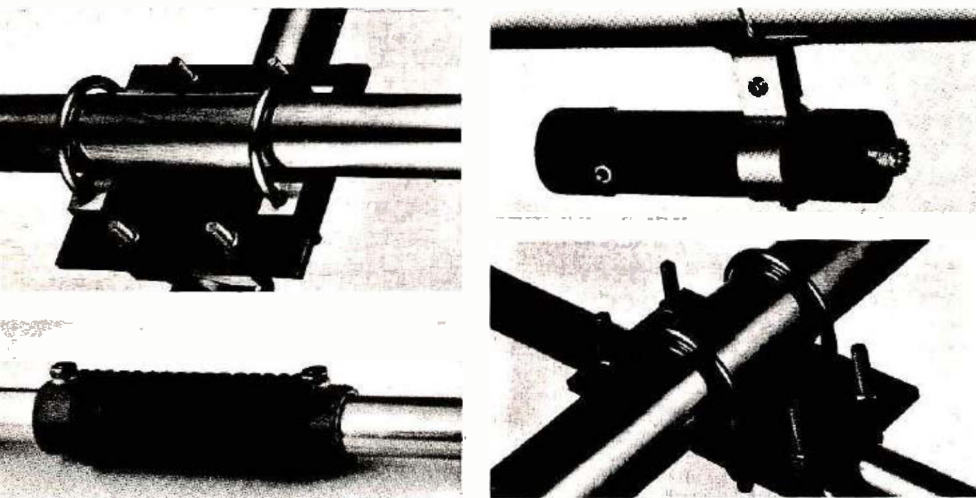

Details of some of the hardware in the ATB-34 trap Yagi. Top photo shows the sturdy construction used to mount the 20-15 meter reflector to the boom. Next is a view of a typical trap. Third photo illustrates the 1:1 balun, which is included in the antenna kit. The bottom photo shows the boom-to-mast assembly. *Photos courtesy of Cushcraft Corporation.*

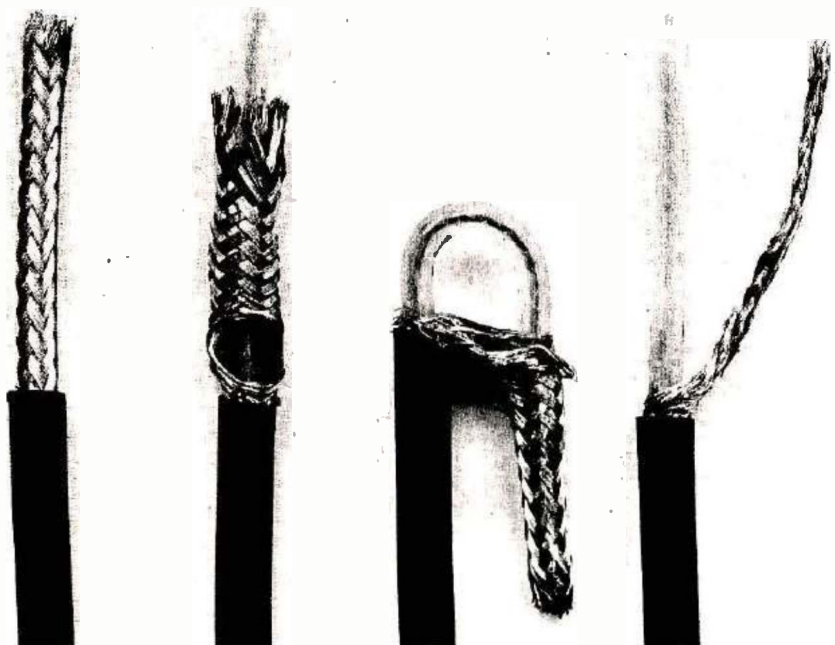

The proper way to prepare your coax cable for connection to the antenna driven element if you wish to use the alternative balun discussed in the text. First remove about a foot (306 mm) of the outer insulation. Use a sharp knife and don't nick the wire braid. Next, push back the braid and make a hole in the braid as shown. Now pull the inner conductor through the hole in the braid. Make a pigtail of the braid and remove enough insulation from the center conductor to accept a heavy solder lug. Attach another heavy lug to the pigtail. After assembly, wrap pigtail and center conductor with a tight layer of PVC tape and coat each with a good weatherproof compound. *Photo courtesy of Bill Orr, W6SAI, (reference 3).*

want to preserve the antenna radiation pattern. Without such a device, antenna currents will appear on the coax line. The antenna radiation pattern will suffer, and you may be faced with television interference (TVI).

The ATB-34 tribander comes equipped with a very good balun. You can erect any triband antenna without a balun, but it's not recommended. Here's how to make a homebrew balun.

### Homebrew Balun

1. Prepare the coax cable as shown in the photo.
2. Wind an 8-inch (204-mm) diameter coil of coax cable in six turns at the antenna end.
3. Tape the coil to the standing part of the coax cable.
4. Attach the coax-cable shield to one-half of the antenna driven element, and attach the coax-cable center conductor to the other half of the antenna driven element.

The coaxial cable forms its own balun, and you'll find that it will work great, with excellent SWR on all high-frequency Amateur bands, 10 through 20 meters.

### Assembly

I had never put together an antenna from a kit before, so I was somewhat anxious when the antenna arrived. The first thing I did was to check the package against the parts list. No problem whatsoever; everything had been included down to the last bolt and nut. I'm sure that if anything had been missing, a note to the manufacturer would have produced the missing parts posthaste.

I was particularly impressed by the ATB-34 instruction manual. It is well written, concise, and contains all the information needed to complete the antenna assembly. All you need in the way of tools are a screwdriver and some common open-end wrenches.

# Trap Yagi Antennas

The elements are plainly marked to show where to mount the hardware. Also included in the instruction manual are tips on grounding, how to mount a vhf antenna, what type of mast to use, and antenna location.

I chose a typically beautiful southern California day on which to assemble the antenna. I enlisted the aid of two local hams and we had the beam assembled in about four hours, aided by plenty of beer and sandwiches.

## Tuning

The ATB-34 antenna elements are marked for operation in the phone portion of each band. If you'd like peak performance at band center or in the CW portion of the bands, a table is included in the instruction manual for the appropriate dimensions. Again (and this is my opinion), it's doubtful if you'll notice any increase in performance, regardless of where in the band you optimize the antenna. The difference is so small in practice that the added work of measuring element lengths for peak performance at band center or at the CW portions is hardly worthwhile. So, I assembled my beam according to the instructions, and obtained peak performance in the Amateur phone bands. If I want to work CW stations at the lower band edges, I just activate

my Drake MN-2000 antenna matcher, which is set for minimum SWR at these frequencies. On the phone bands, I switch the MN-2000 to DIRECT, which means the matching network is out of the circuit and the SWR is about 1.25.

It's interesting to watch the MN-2000 wattmeter during these frequency changes. I could barely detect any difference in wattmeter output between operating in the phone or CW portions of the bands. This, I think, proves my point that too much emphasis is placed on small differences in power output. If you want to sweat out the last watt into your antenna, fine. But remember: you must increase power by a factor of two to make a perceptible difference in your signal at the other end of the circuit.

## Final assembly

After the antenna had been assembled and checked out, I coated all metal-to-metal connections with a corrosion-proof paint. I used Rustoleum paint; other brands are available. From time to time I examine these connections with binoculars to determine how the antenna is withstanding the corrosive seacoast environment where I live. The coating has held up well during the past three years.

Raising the antenna to its final position on my tower was easy; the ATB-34 weighs only 42 pounds (19 kg). The antenna was pulled up to the top of the tower with a length of line, clamped to a steel-pipe mast protruding from the top of the tower, and connected to the coax cable. Full power was applied to the antenna, and I was in business.

The biggest problem was fitting the rotor into the top section of the tower. It took some work to position the HAM-M inside the small section at the top of the tower. Make sure the top section of your tower will accept the rotor you plan to use!

The new trap-beam antenna made a world of difference compared to the simple inverted-V antenna I'd been using previously. I've worked all the choice DXpeditions since July, 1977, and have picked up five new DXCC countries.

Consider the trap Yagi. It's a good choice if you're cramped for space and have a limited budget for antennas.

## References

1. *The Radio Amateur's Handbook*, American Radio Relay League, 1978 edition, page 20-6.
2. *The ARRL Antenna Book*, American Radio Relay League, 1964 edition, page 277.
3. Bill Orr, W6SAI, "Ham Radio Antennas," *Ham Radio Horizons*, August, 1977, page 36.

HRH

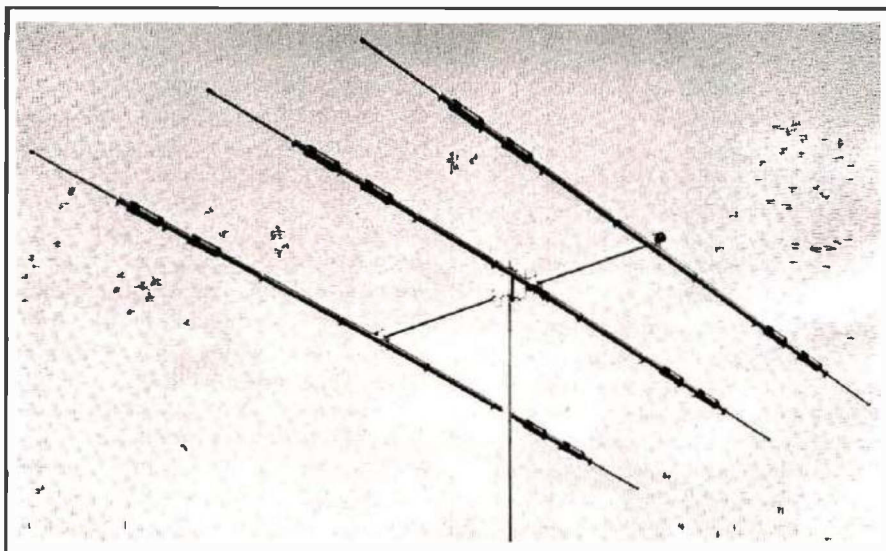

The new Cushcraft A3 tri-band beam.

## A New Tri-bander

As this article was being set in type, we received an announcement of a new tri-band beam from Cushcraft. It's called the A3, and sports three trapped elements on a 14-foot boom. The A3 will handle a full 2-kW; a typical VSWR is 1.2:1 or better. This lightweight (35 pounds) beam with a short (15-foot, 6-inch) turning radius should fill the bill for hams who have neither the room or desire to go for the larger version, yet need a beam to stay competitive. It's also less expensive. — \$199 suggested price.



**Operate Legally Without  
An FCC License in  
the 160-190 kHz Band**



**LOW & MEDIUM FREQUENCY RADIO  
SCRAPBOOK (3rd Edition)**  
by Ken Cornell, W2IMB

Here's your chance to get on the air and have some legal license-free excitement in the 160-190 kHz range. Explore the enticing world of the low frequencies and uncover some new fun! Complete details on assembling homebrew to work these frequencies plus full info on FCC rules and regulations. A book you just can't afford to miss. 110 pages. ©1977.

HR-LF **Softbound \$6.95**



**ADDENDUM '77/'78  
for the Low & Medium Frequency  
Radio Scrapbook**

by Ken Cornell, W2IMB

Even more goodies from the 160-190 kHz region, Addendum '77/'78 is designed to complement The Low & Medium Frequency Radio Scrapbook. The technical data is excellent and will provide you "lowfers" even more information, applications, and techniques for these enticing frequencies. Latest revised FCC rules governing the non-licensed communication bands. 68 pages. ©1977.

HR-LFA **Softbound \$3.95**

**Be a LOWER**

Join the fun and get on  
160-190 kHz

Send your order today or call

**TOLL FREE  
1 (800) 258-5353**

Clip & Mail Today!

HR-LF **\$6.95**  
 HR-LFA **\$3.95**  
Plus shipping **\$1.00**

Total enclosed

Charge  MC  VISA

Expiration \_\_\_\_\_

Card Number \_\_\_\_\_

Name \_\_\_\_\_

Address \_\_\_\_\_

City \_\_\_\_\_

State \_\_\_\_\_ Zip \_\_\_\_\_

**Ham Radio's Bookstore**  
GREENVILLE, NEW HAMPSHIRE 03048



**THE NEW AEA MORSEMATIC!  
37 FANTASTIC FEATURES!**

**The amazing AEA MorseMatic.** Whether you are a contester, serious VHF DXer, learning code for the first time, studying for a marine radio operator's ticket, or simply a CW enthusiast, you can now own the finest electronic Morse keyer ever built and program it to your specific needs. Count these features!

1. Two custom designed microcomputer chips. 2. Two wpm to 99 wpm in one wpm increments. 3. Selectable dot and/or dash memory.

4. **MorseMatic is a memory keyer.** 5. 500 Morse character memory (optional to 2,000 characters) 6. Unique "Soft-Partitioning"™ to eliminate wasted memory space. 7. Use entire memory for one message or divide memory in up to ten messages. 8. Message loading begins with first character sent. 9. Easy to load memory. Choice of automatic mode for perfect format or real-time mode for individualizing messages. 10. Special editing mode for memory load correction. 11. Load memory in automatic keyer mode or semi-automatic "bug" mode (garbage in/perfection out). 12. Low power memory hold. 13. Memory limit indicator lights when 20 characters are left in memory. Monitor tone changes when memory overflows.

14. **MorseMatic is a Morse trainer.** 15. Computer generated Morse trainer. Incorporates ten repeatable (answers available) and one random starting position. 16. Programmable speed-up of code rate from beginning to end of practice session. 17. Select "slow code" or "fast (Farnsworth) code" method. 18. Select five character code groups or random group lengths. 19. Selectable, unselectable, uncommon characters for advanced radio operator training. 20. Use trainer mode to key transmitter for on-air practice.

21. **MorseMatic is a beacon.** 22. Unique beacon mode for beacons; moon-bounce, scatter or tropospheric DX scheduling.

23. Computers set message code speed to fit programmed transmitting window.

24. **MorseMatic has serial number.**

25. Automatic serial number sequencing for sweepstakes and other contests. 01 - 9999 (even beacon mode). 26. Serial number placement at any point within message. 27. Serial number repetition within same message. 28. Easy serial number repeat in next message.

29. Operates with all popular paddles. 30. Easy to learn and use keypad control for all features. 31. Plug in IC's. 32. Independently selectable dot and/or dash weighting. 33. Can be used to key transmitter for tuning. 34. Transmitter keying output for grid block, cathode or transistor circuits. 35. Operates off 8 to 16 volts DC. 36. Fully tested and 96 hour burn-in. 37. Introductory price only \$199.95.

The MorseMatic is also available strictly as a non-memory keyer for only \$79.95 (introductory price). For your free MorseMatic booklet explaining these and more features, or for information about ordering a MorseMatic, write or call Advanced Electronic Applications, Inc., P.O. Box 2160, Lynnwood, WA 98036. Phone 206/775-7373. (Dealer inquiries invited.)

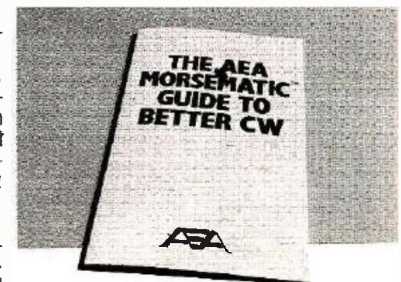

**AEA**  
**Brings you the  
breakthroughs!**



# Which Antenna is BEST?

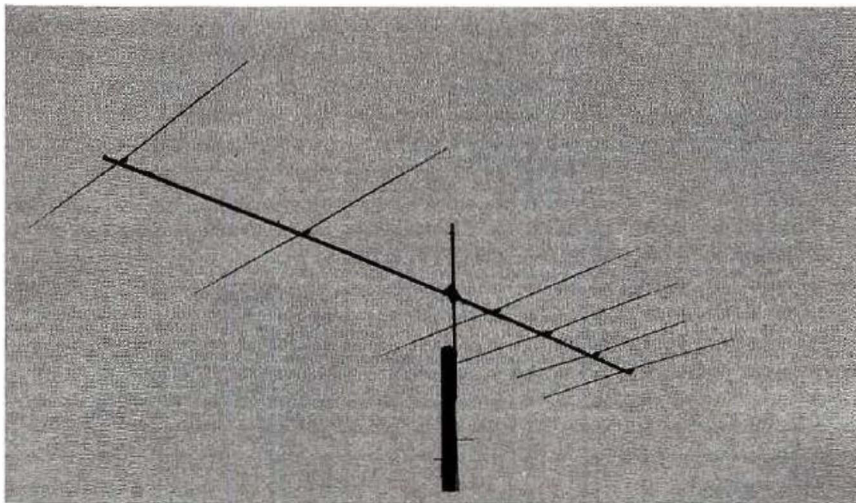
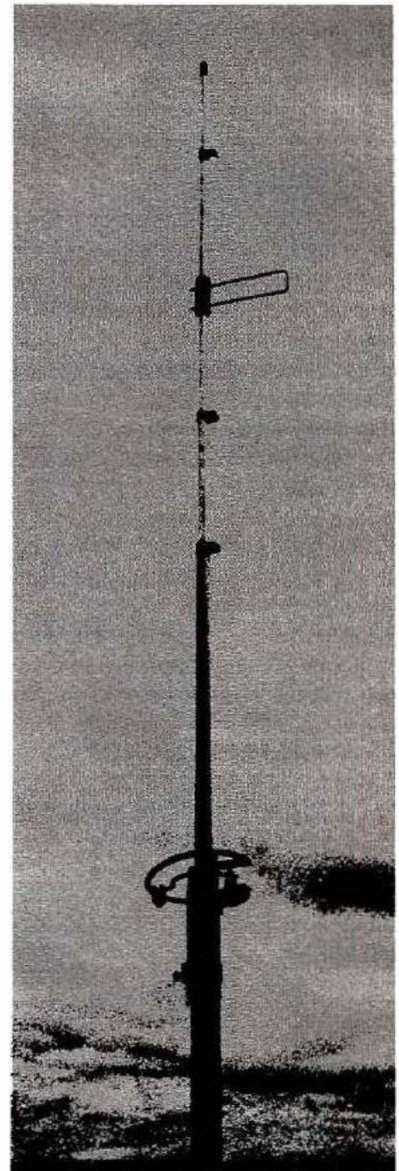
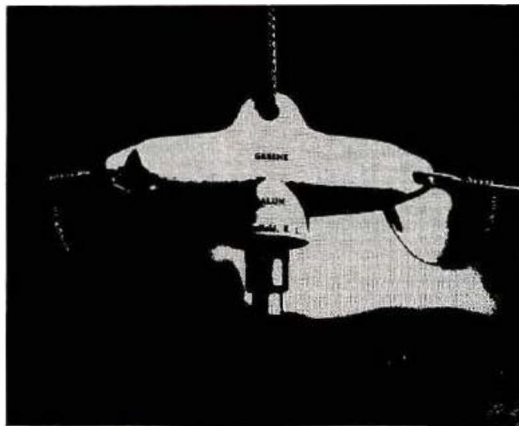
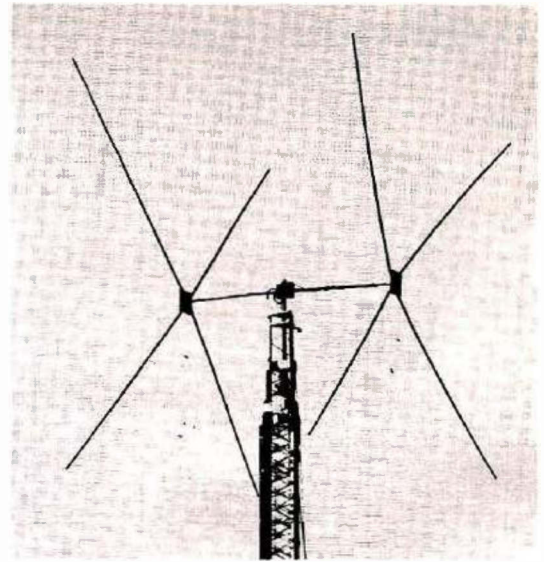

An interesting comparison of  
antennas based on

logbook data  
**Robert P. Haviland**  
**W4MB**



I have always made a practice of logging the information which comes across in DX QSOs. Typically, this includes antenna type and height, and rig type or power.

Some years ago, a question of antenna usage prompted me to do a short analysis of the logs, to develop antenna type and height data. Very recently, a similar analysis by ZL1OI, but of U.S. stations, was reported. Also very recently, thoughts of a new antenna system for W4MB prompted an extensive review of log data. The idea was to try to get an answer, or at least an indication of answers, to typical questions, such as:

- Which antenna is the best?
- How important is height?
- How important is power?

This is a report of these studies.

### Relative antenna usage

The analysis started with a review of usage, of the two studies previously reported, plus the data from the latest logs. The results are summarized in Table 1.

Results of the three analyses are very similar, showing exactly the same relative order of usage and surprisingly small differences between U.S. and DX stations. Very nearly three-fourths of the stations use beams, and one-fourth use simple antennas. The Yagi dominates the beam usage; almost three times as many as its closest competitor, the quad. Vertical antennas are somewhat more popular than dipoles.

The data at W4MB is primarily for 15-meter contacts, and is markedly influenced by European practices, since a majority of QSOs are with these stations. Comments received indicate that a major factor in the use of verticals is space for installation. This seems to be true for the suburbs, where many of the verticals are at ground level, and for the cities, where antennas are at roof height. Other comments indicate that the quad would be more popular if space were available, and that ready availability of commercial triband Yagis is a factor in their popularity.

Table 1. Relative antenna usage.

Antenna Type	Average of use, per cent	DX Stations(1) per cent	U.S.A. Stations(2) per cent	DX Stations(3) per cent
Yagi	48.7	51.1	48	47.0
Vertical	18.9	15.7	21	20.0
Quad	14.6	14.9	13	15.9
Dipole	13.0	11.0	13	15.0
Other	5.0	8.0	5	2.0

(1) Data by W4MB, of QSOs between April and December, 1976. Reported in QST, May, 1977, page 71.  
 (2) Data by ZL1OI, reported in ham radio, September, 1979, page 4.  
 (3) Data by W4MB, of QSOs between January and June, 1979.

It will be noted that the difference between any of the three usage figures and the average of the three is small, at most just over 3 per cent. This difference may not be significant. For example, for the W4MB data, 3 per cent would amount to a ten- to fifteen-station change. However, there is some reason to believe that some of the indicated difference is real. The last data are for a period of relatively high solar activity, and reflects a change in QSO area. For example, the recent data include more USSR stations, which are often users of quads. As will be seen, the improved conditions can be responsible for the increased percentage of simple antennas. No reason for the decrease in the use of "other" antenna types has appeared; these others include rhombics, long wires, log periodics, and so on.

### Signal strength as a measure of performance

The only performance measure available from the logs at W4MB is the signal-strength report given to the DX station. For the last five years, I have taken some effort to make these reports meaningful. The report is the S-meter reading on my TS-820, with enough attention being given to ensure that it was the maximum, interference-free signal. The meter calibration of the 820 was checked just after purchase and found to be almost exactly 5 dB per S-unit. The relative and absolute values have been checked at intervals since, most often by checking the crystal calibrator signal, but

also by using a signal generator. Signal-strength-indication stability seems to be excellent.

In most radio circuits, signal strength is a statistical variant following a Rayleigh distribution.\* However, this analysis is dealing with many circuits and a combination of factors, including transmitter power, antenna design, and solar activity. Thus, it seemed that the signal strengths should follow the Gaussian distribution fairly closely.† Also, it seemed that the distribution data could be used to check the results for bias, since a systematic change would change the distribution in some respect.

Accordingly, a section of the log was examined for signal-strength probability. The results are shown in Fig. 1, the curve indicated by the Xs. On this type of graph paper, a Gaussian, or "normal," random distribution plots as a straight line. Since the curve is not straight, the distribution departs from Gaussian. However, it should be noted that there are upper limits, due to legal restrictions on radiated power, and practical limits on antenna height. These have the effect of bending the upper part of the curve downward, as observed. Neglecting

\*Rayleigh distribution — A mathematical statement of a natural distribution of random variables.

†Gaussian distribution — A distribution of random variables comparable to that found in nature, characterized by a symmetrical and continuous distribution decreasing gradually to zero on either side of the most probable value.

# Which Antenna is BEST?

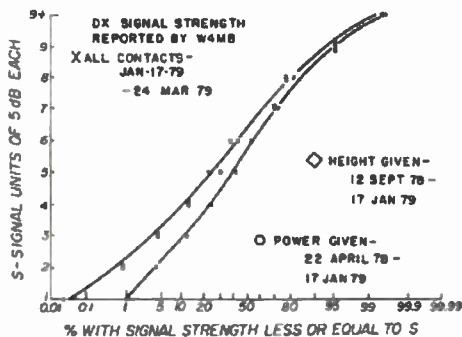

Fig. 1. Distribution of signal strength reports given by W4MB to the DX station, for three conditions. The horizontal coordinate is graduated for the Gaussian or "normal" probability distribution.

this effect, the distribution below about S7 is very nearly Gaussian.

Also shown are points for two other types of data, for contacts where height was given, and where power was given. (In QSOs, often only power or type of transmitter is given). These samples fall very close to the upper curve. Overall, the data indicates that the height and power data are associated with about a one S-unit stronger signal, as compared with an average contact. The difference becomes smaller as signal strength increases.

Inspection of the raw data showed a tendency for the QSOs where power and height were given to be longer than QSOs where they were not. They tended to be more "rag chews" than "hello-goodbye" contacts. Partly, these occurred under conditions of better signal or less QRM. Also, the longer period gave a greater chance of observing a short-term increase in signal strength. Thus, the observed difference in the three sets of samples seems to be an observable fact, rather than some fault of the method of analysis.

## Performance of simple antennas

The performance of simple antennas — dipoles and verticals — was considered first. For each value of signal strength, the percentage of stations using these antennas was deter-

mined. The results are shown in Fig. 2. The performance character is striking, and the trend is definite. Simple antennas do get signals through, but the signals tend to be on the low side; markedly lower than the signals from beams.

The measured data can be approximated reasonably well by a simple relation: for each unit increase of signal strength, there will be about a five per cent reduction in the number of signals from dipoles, and about another five per cent reduction in the signals from verticals; there will be a corresponding increase in the number of signals coming from beams.

While these antennas tend to produce weaker signals, the performance is not really that bad. Verticals, for ex-

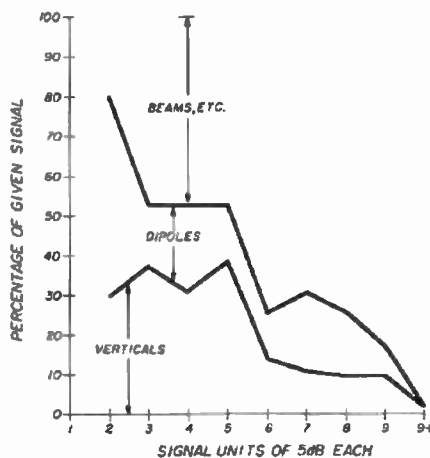

Fig. 2. Percentage of simple antennas giving a stated signal strength, plotted against signal strength. Example: for S 5, 34 per cent of the reports are to stations using verticals, and (53-34) or 21 per cent are to stations using dipoles. The remainder, (100-53) or 47 per cent, are to stations using beams or miscellaneous antennas.

ample, account for about 18 per cent of all antennas. Comparing this value with the curve in Fig. 2 shows that the average expected signal from a vertical is nearly S6. For a dipole the usage is 13 per cent, which intersects the dipole curve at (18 + 13) or 31 per cent, again nearly S6. These are perfectly respectable signals, some 25 dB above normal noise levels; not

broadcast quality, but excellent communications quality. To the limits of analysis accuracy, verticals and dipoles, as used, give identical results.

## Performance of beam antennas

For this analysis, the amount of data restricted beam consideration to only two types, Yagis and quads. The percentage of these at each signal level is shown in Fig. 3. This seems to indicate a striking, indeed startling, result: as a family, Yagis seem to outperform quads. Over the range of S4 to S9 signals, those from quads are nearly constant in percentage, while over the same range, those from Yagis increase in percentage, by about 5 per cent use for each unit of signal strength.

Obviously, this is an important finding. If it is really true, it could settle the long arguments of quad *vs* Yagi. Accordingly, some additional tests were made. The first of these was to re-examine the source data for antenna size. Since the usual quad has two elements, any antenna with more than two elements was considered a "large quad." Also, since a two-element quad is usually considered to be equal to a three-element Yagi, designs with four or more elements were considered "large Yagis." While some of the antenna notes recorded the

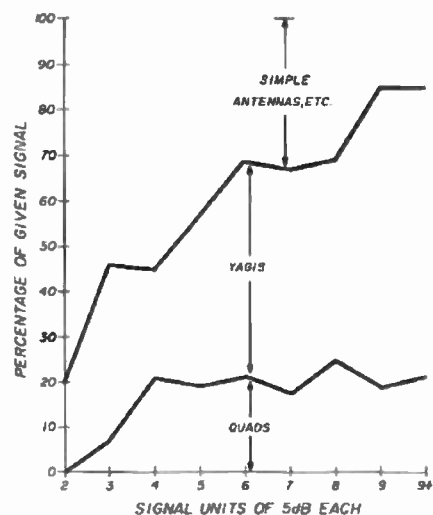
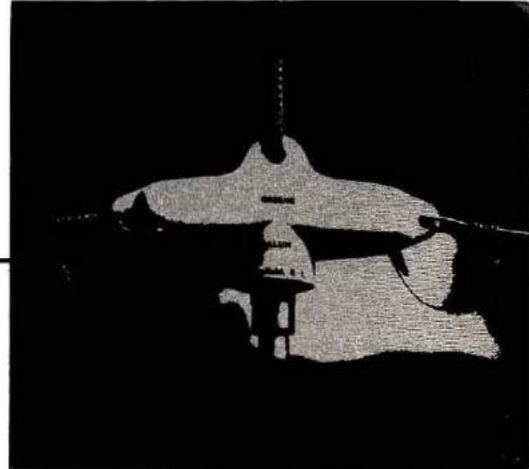

Fig. 3. Percentage of two types of beam antennas giving a stated signal strength.



**Table 2. DX antenna height, W4MB data.**

Height	April-December 1976 Data, per cent	September 1978-January 1979 Data per cent
10 ft. or less	2	12
34 ft. or less	34	48
50 ft. or less	50	70
60 ft. or less	64	80
80 ft. or less	88	92
100 ft. or less	98	96



Results are tabulated in Table 2, and plotted in distribution form in Fig. 6.

A small difference, up to about 10 per cent deviation from the average, is found between the two data periods. This may be real, or it may be due to "sampling noise." There are some differences between the two periods. The second covers a period of improved propagation, which would tend to increase the percentage of marginal signal contacts, as observed. The second period also includes a larger fraction of 10-meter contacts, where height is known to be less important.

More important than the matter of usage is the effect of antenna height. To study this, signal reports were tabulated for height blocks of 0-15 feet, 15-30 feet, and up to 120-240 feet. The reason for this grouping choice was the sometimes-used approximation that doubling the height will improve the signal by one-half to one S-unit. The results of this analysis are shown in Fig. 7.

While five height-groups are plotted, only three curves are shown. The data for the 0-15 height, shown by Xs, follows a Gaussian distribution almost exactly. Data for the groups

specific design, TA33, Th-6, and so on, there were not enough recorded as these or as mono-banders to permit detailed evaluation.

The results of this size analysis is shown in Fig. 4. Here, the percentage of the smaller Yagis is plotted first. The trend to increasing percentage with increasing signal still appears, but the larger Yagis seem to be increasing at a faster rate. This suggests that the apparent better performance of Yagis as compared with quads is partly due to larger antennas.

A different way of looking at the data is shown in Fig. 5. This is developed from the number of antennas of a given type producing a given signal, plotted as a percentage of the total number of that type. It seems clear that there are two main groupings, one for the simple antennas — verticals and dipoles, and the other for the beams — the quads and Yagis.

On the average, the beam group produces about 1½ S-units, about 7½ dB greater signal level than do the simple antennas. Interestingly, this is very nearly the theoretical gain of three-element Yagis and two-element quads. Also interestingly, the beam group seems to produce a more consistent signal: at low signal levels the beams are about two S-units better than the simple antennas.

Data for the big antennas, the four or more element Yagis and three or more element quads, are also shown. The number of such antennas is rather small, so the points are rather scattered. It seems to indicate about one-half S-unit improvement in signal as compared with the smaller beams. Again, this is interesting in that it rep-

resents about the expected gain increase.

Plotted in this way, the type/signal-strength data indicates that there is no difference between quads and Yagis, or between dipoles and verticals. Instead, the data suggests strongly that

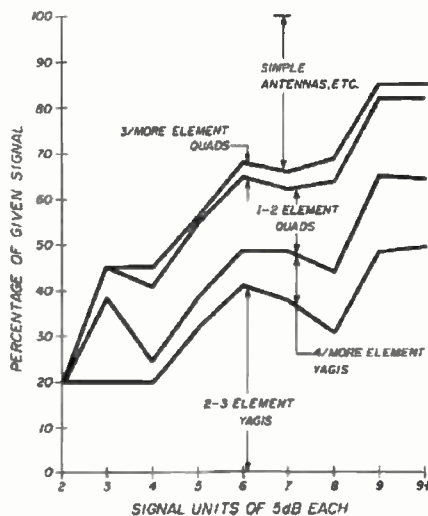
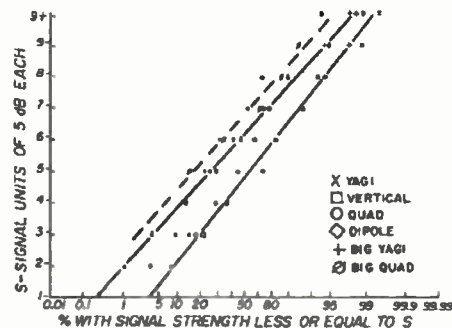

**Fig. 4.** Percentage of two types of beam antennas giving a stated signal strength, for two antenna sizes each. The division of size is arbitrary, but corresponds to a commonly claimed point of equivalence.

the significant factor is the amount of gain, rather than the type of antenna which produces the gain, at least for the types surveyed. However, before considering this relative comparison, factors common to all antenna use should be looked at.

#### Effect of antenna height

The early W4MB study included evaluation of antenna height. This was done again for this second study.



**Fig. 5.** Distribution of signal-strength reports for simple and beam antennas. The quad data includes all quads, but the "Big Quad" data shows only reports to stations using three or more element quads.

# Which Antenna is BEST?

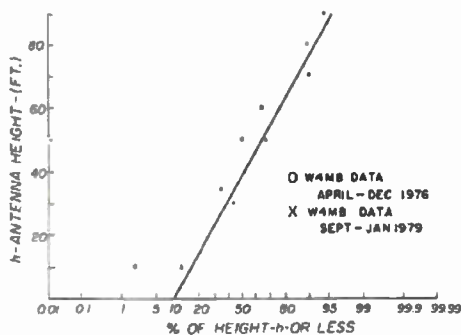

Fig. 6. Distribution of antenna height for two periods, for all types of antennas.

15-30 feet and 30-60 feet follow the distribution fairly closely, but with a different slope, and with a small increase in average signal strength. The change in slope indicates that the signal for these groups is more consistent than that for the low group. The slope change is also apparent for the 60-120 foot group, which shows a further increase in average signal strength.

The 120-240 foot group seems to fall along a line which is parallel to, but above, the 0-15 foot group. A check of the source data did indicate that this high antenna group included many simple antennas mounted on apartment roofs. An attempt was made to evaluate the effect of antenna type, but there were not enough such contacts to be meaningful.

Overall, it appears that high antennas behave according to reputation. There is a definite increase in average signal strength, in the range of 1-2 S-units. There is also good indication of greater signal consistency; a high antenna will make contacts, where a low one may not.

## Effect of transmitter power

The first W4MB study did not evaluate power, but an evaluation was done for this study. These data are tabulated in Table 3, together with the ZL1OI data for comparison. The influence of the one-package transceiver, of about 180 watts input, seems clear. Comparison of the two sets indicates a greater percentage of

high-power stations in the U.S.A., certainly in line with our reputation.

There seems to be increasing use of powers in the range of 1 to 30 watts. It is most pronounced on 10 meters, partly due to new commercial transceivers of this class, partly due to CB conversion, and partly due to power/band restrictions of some license classes in some countries. However, QRP operation is not restricted to 10 meters; growth seems to be occurring on all bands.

The results of the signal strength/power study are shown in Fig. 8. With one exception, the trend is clear — higher power produces stronger

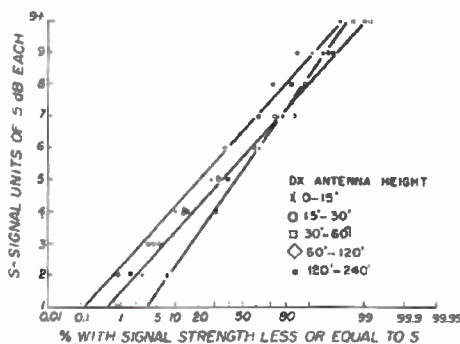

Fig. 7. Distribution of signal strength reports in five antenna-height groups.

signals, and more consistent signals. The average increase is almost exactly in accord with power, i.e., two S-units for 10 dB increase.

The exception is for the power class 10-30 watts, which appears to be better than the 30-100 watt class. This may be real — several QRP operators have indicated that they took special

care with the antenna installation. Many more samples would be needed to separate the effects of power and antenna size.

Some time ago, W4MB ran a two-month check of power benefit by operating at 180 W PEP rather than the usual 1500-1600 watt level. The number of contacts made in a month did not change greatly, but a difference in operating practice was necessary to do this. Whereas, with the linear, a short CQ had a high probability of one or more replies, the CQ replies dropped way down when operating "barefoot," and it was necessary to start replying to DX stations CQs to keep the number of contacts up. Power does make a difference.

## Re-evaluation of beam antenna type

Several methods of checking the possible difference between quads and Yagi beams were considered. The two finally adopted are covered here.

If one type of beam is truly better, it should perform better under poor conditions. This would be reflected as an increase in the percentage of contacts using that type of antenna.

The measure of conditions adopted was the A index, the second numerical value transmitted by WWV. It was found that a reasonable sample size could be obtained by selecting contacts where A was ten or less for good conditions, and A of fifteen or greater for poor conditions. Contacts for intermediate values, or for days when the A index was not recorded, were ignored. For comparison, the percentage of antenna use for all values

Table 3. Transmitter powers.

### U.S.A. stations (ZL1OI Data)

Less than 100 watts	13 per cent
100-500 watts	59 per cent
More than 500 watts	28 per cent

### DX stations (W4MB Data, April, 1978-July, 1979)

10 - 30 watts	4.1 per cent
30 - 100 watts	14.6 per cent
100 - 300 watts	68.8 per cent
300 - 1000 watts	12.6 per cent



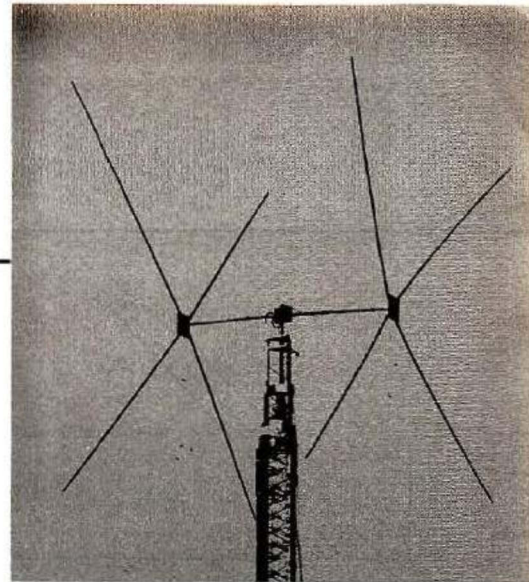

of A was also tabulated. The results are shown in Table 4.

First, it is noted that the variations between the three sets of data is small. The largest is for dipoles, changing by 4.6 per cent from the all-A-value column to the poor column. For small Yagis, the percentages show a small increase from poor to good conditions, but almost exactly a compensating decrease for large Yagis. For quads, there is a decrease of 4.2 per cent between good and poor conditions; the small increase in large quads does not compensate, so there is a net decrease in the number of quad contacts under poor conditions.

A check of the logs was made to see if this decrease were real. One factor noted was the almost complete absence of USSR contacts under poor conditions. Since a high percentage of these stations use quads, the observed change could be real. However, it must be remembered that one percentage point is only two contacts for the poor column. Accordingly, the sampling noise is large.

Because of this, a second method of checking was sought. The logs were again reviewed. It was found that a fair amount of QSO data gave height, power, and type of antenna. Since height and power are shown to be important, this data was checked for two groups; one included all antenna types, but only those stations

running linears or over 400 watts (assumed to be the lower limit of linears). The second group included only Yagis, for stations operating at the same power level.

The results of this analysis are shown in Fig. 9. The curve shown is copied from Fig. 1, the contacts giving height, the other remaining variable. The o-points are for linear-power level contacts in general, compared with the x-points for contacts using Yagis. As seen, there is essentially no difference in signal performance, and no difference when compared with contacts stating height.

The number of contacts used in this compilation is not great, sixty-five for

***“If one type of beam is truly better, it should perform better under poor conditions.”***

the all-antenna group, and thirty-six for the Yagi group. As a result, there is appreciable chance for error. However, the indication that there is no real difference seems clear.

Comparing the four tests of beam type makes it appear that there is little

or no difference between Yagis and quads. The important factor, as noted before, seems to be antenna gain.

### Summary and conclusions

While there is some possibility of error due to sampling noise, this statistical analysis indicates the following:

Beam antennas produce better signals than simple antennas on the average, by almost exactly the antenna gain. For the common beams this amounts to about two S-units. There is good indication that the beams produce a more consistent signal.

Higher antennas produce better signals, by approximately one-half S-unit for doubled antenna height. Antennas above thirty feet appear to produce somewhat more consistent signals than lower ones.

Increasing the power improves signal strength, almost exactly a 10 dB increase of signal for each 10 dB increase of power. Higher power signals also appear to be appreciably more consistent than low-power ones.

Although some tests appear to indicate that the Yagi beam produces stronger signals than the quad beam, other tests indicate absolutely no difference. It appears that the gain of the particular antenna is much more important than the type, and it may be the only significant factor.

The most important single variable in received signal strength is propagation variability, typically a range of 35 dB over the 5-95 per cent limits. (The range of signals in this log period is from S0 to S9 +40 dB, a total range of 85 dB). The range is so great that a combination of legal power limit, and maximum practical antenna height and gain cannot compensate for it.

Table 4. Effect of propagation absorption.

Antenna Type	Percentage of antenna use		
	data period	data period	
	January-June, 1979 All values of A <sup>(1)</sup>	October, 1978-June, 1979 A less than 10	A greater than 15
Small Yagi	35.3	32.2	33.9
Large Yagi	9.2	12.5	11.3
Small Quad	15.3	15.5	11.3
Large Quad	3.0	3.3	3.4
Verticals	19.8	17.4	17.2
Dipoles	15.1	15.5	19.7
Other	2.2	3.5	2.9
No. of QSOs	399	482	203

(1) A is the second number given by WWV Propagation report.

# Which Antenna is BEST?

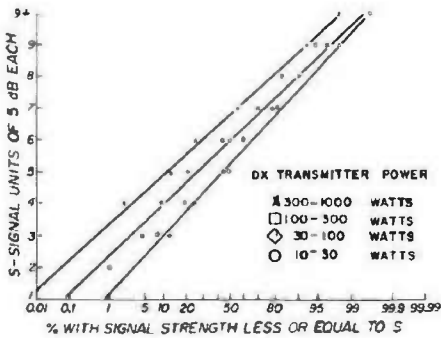

Fig. 8. Distribution of signal strength reports to stations in four power-level groups.

However, the super station is appreciably more likely to get some signal through under poor condition.

There is one overall conclusion: *The single most important factor in getting good signal reports is choice of frequency band and time, as needed to catch optimum conditions. Using this variable, any station can be a good DX station.*

### Notes on extending the study

The solution to reducing the sampling noise mentioned several times is to increase the sample size — the number of contacts studied. For example, a tenfold increase in the number of samples will reduce the noise to about one-third. This may not be easy. The data segment of the W4MB logs is limited by rig and power changes at one end, and antenna changes at the other. It seemed best to avoid these added variables. Even so, some 1800 contacts were examined — not all QSOs give useful data.

Since an improvement in analysis will require looking at some ten to twenty thousand QSOs, an extended study might make a good club project — especially if the club has a computer available. The extra number of QSOs would allow some additional studies, such as variations in usage between continents or even countries. Just for example, it appears that UA antennas are much more likely to be quads, and DLs are much more likely to use linear amplifiers.

If this club approach is used, some checks of the data will be needed. Different operators have different reporting practices, and a "station correction factor" may be required. Developing this from the data will take extra work.

It is probably best to avoid analysis of contest and pile-up data. Contest reports are too stylized (5 x 9), and pile-up QSOs are apt to be influenced by the well known "DX-report" factor.

Such an extended study would be interesting. Well done, it should provide a definitive answer as to whether it is gain that is important, or whether antenna type also enters the picture. And perhaps it could look at the less common antenna types for usage and performance.

*"... an improvement in analysis will require looking at some ten to twenty thousand QSOs ..."*

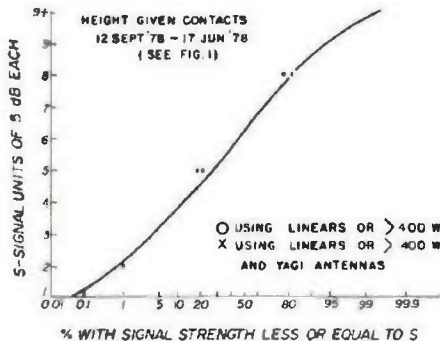

Fig. 9. Distribution points of signal-strength reports to high-power stations using quads, or to high-power stations using either quads or Yagis, as compared with the distribution curve for all reports to stations which gave height data.

Oh yes: W4MB's new antenna? It's a quad, except on 10 meters, where it is a Quagi. Why? It seemed a good idea at the time. It still seems so.

HRH



# ANTENNA SYSTEMS/TOWER HARDWARE

## HY-GAIN ANTENNAS

TH5DX	New 5-Element Triband Beam	\$195
TH6DX	6 Element Triband Beam	\$225
TH3MK3	3 Element Triband Beam	\$165
TH3JR	3 Element Triband Beam	\$119
TH2MK3	2 Element Triband Beam	\$109
HY-QUAD	2-Element Triband Quad	\$199
402BA	2-Element 40-mtr Beam	\$175
205BA	5-Element 20-mtr "Long John"	\$225
155BA	5-Element 15-mtr "Long John"	\$145
105BA	5-Element 10-mtr "Long John"	\$94
204BA	4-Element 20-mtr Beam	\$175
153BA	3-Element 15-mtr Beam	\$64
103BA	3-Element 10-mtr Beam	\$54
DB1015A	3-Element 10/15-mtr Beam	\$115
64B	4-Element 6-mtr Beam	\$42
66B	6-Element 6-mtr Beam	\$89
18HT	Hy Tower 80-10 mtr Vertical	\$249
18AVT/WB	80-10 mtr Trap Vertical	\$75
14AVQ/WB	40-10 mtr Trap Vertical	\$55
20B	8-Element 2-mtr Beam	\$24
214	14-Element 2-mtr Beam	\$29
28DQ	80/40 mtr Trap Dipole	\$49
58DQ	80-10 mtr Trap Dipole	\$85
BN86	80-10 mtr KW Balun	\$14

## KLM ANTENNAS

KT34A	4-EI Tribander	\$299
KT34XA	New 6 EI Tribander	\$449
160V	160-mtr Vertical	\$89
7 0 7 3-4A	4 EI 40 mtr Beam	\$589
7 2 1	40 mtr Dipole	\$139
10-30 7A LP	7 EI 10 30 MHz Beam	\$599
13 9-14 4-6A	6 EI 20-mtr Beam	\$629
21 0-21 5-6A	6 EI 15-mtr Beam	\$379
28-30-6A	6 EI 10 mtr Beam	\$199
50 52 11	11 EI 6 mtr Beam	\$169
144 148 13LB	13 EI 2 mtr Long Boomer	\$69
219 226 14	14 EI 220 MHz Beam	\$49
432 16LB	16 EI 432 MHz Beam	\$59
3-80-1 I	1 1/4-KW PEP Balun	\$24
3-60-4 I	4 1/4 KW PEP Balun	\$24

CALL FOR OTHER KLM MODELS!

## CUSHCRAFT ANTENNAS

AT8-34	4 Element 1-Band Beam	\$209
ATV-4	40-10 mtr Trap Vertical	\$78
ATV-5	80-10 mtr Trap Vertical	\$85
15-4CD	New 4-Element 15-mtr Beam	\$89
10-4CD	New 4-Element 10-mtr Beam	\$67
A50-5	5 Element 6-mtr Beam	\$55
A617B	New 6-Element 6-mtr Beam	\$149
ARX-2	2-mtr "Ring Range"	\$30
A-3219	19 Element 2-mtr "Boomer"	\$66
A-214B	14 Element 2-mtr "Boomer"	\$53
A-214FB	14 Element 2-mtr F.M. "Boomer"	\$53
A-228FB	28 Element 2-mtr F.M. Power Pack	\$165
A-147 11	11 Element 2-mtr F.M. Beam	\$30
A-147-22	22 Element 2-mtr F.M. Power Pack	\$90
DX-120	20-Element 2-mtr Circular	\$45
ARX-450	450 MHz "Ring Range"	\$30
A-144-10T	10 Element 2-mtr "Oscar" ant	\$37
A-144-20T	20 Element 2-mtr "Oscar" ant	\$53
A-432-20T	20-Element 432 MHz "Oscar" ant	\$49
LAC-1	"Blitz Bug" Male/Female	\$6
LAC-2	"Blitz Bug" Female/Female	\$5

## ANTENNA ROTORS

Athletic HD-73 Hated Inr	10 7 sq ft	\$99
Athletic U 100 Hated Inr	Elevation Rotor	\$39
CDE CD 45	Hated Inr 9 sq ft	\$115
CDE HAMIV	Rotted Inr 15 sq ft	\$149
CDE Telecaster	Rotted Inr 30 sq ft	\$199
8 Conductor Rotor Cable		\$ 15 ft
Heavy Duty 8 Conductor Rotor Cable		\$ 32/ft

For a quote on your antenna system needs call today!

## TEXAS TOWERS

1309 Summit Ave. Plano, Texas 75074  
9 am - 6 pm Mon-Fri, 9 am - 1 pm Sat

TELEPHONE: (214) 423-2376

A Texas Communications Products Company (TEXCOM)

## ROHN TOWERS

20G \$29.50	25G \$38.50	45G \$83.60	55G \$115.50
HDBX48	Free-standing 48-ft tower (118 sq ft)		\$305
H8X96	Free-standing 96-ft tower (110 sq ft)		\$335
FK2558	48-ft 25G Foldover tower		\$659
FK2558	58-ft 25G Foldover tower		\$729
FK2568	68-ft 25G Foldover tower		\$799
FK4548	48-ft 45G Foldover tower		\$829
FK4558	58-ft 45G Foldover tower		\$1029
FK4568	68-ft 45G Foldover tower		\$1111

(Freight paid on all foldover towers. Prices 10% higher west of Rocky Mountain states.)

## GALVANIZED STEEL TOWER HARDWARE

3/16" EHS (3890 lb rating)	\$9.50/100 ft	\$90/1000 ft
1/4" EHS (6000 lb rating)	\$12/100 ft	\$111/1000 ft
5/32" 7 x 7 Aircraft cable (2700lb)		\$8/100 ft
3/16 CCM cable clamps (3/16" or 5/32" cable)		\$0.30
1/4 CCM cable clamps (1/4" cable)		\$0.40
1/4 TH Tumble nuts all sizes		\$0.25
3/8 EE 13/8" Eye and eye turnbuckle		\$5.80
3/8 EJ 13/8" Eye and jaw turnbuckle		\$8.00
1/2 EE 11/2" Eye and eye turnbuckle		\$8.50
1/2 EJ 11/2" Eye and jaw turnbuckle		\$9.00
3/16" Perfomed guy dead-end		\$1.45
1/4" Perfomed guy dead-end		\$1.65
6" dia 4-ft long earth screw anchor		\$11.50
2" dia 10 ft long heavy duty mast		\$35.00
500D Guy insulator (5-32" or 3/16" cable)		\$0.85
507 Guy insulator (1/4" cable)		\$1.80

## COAXIAL CABLE AND CONNECTORS

RG 213/U (Multi-gate RG 8-U)		\$ 29 ft
RG-8X new 1 1/4" diam. low loss foam		\$ 15/ft
1 1/2" 50 ohm Poly Jacketed Hardline		\$ 65 ft
Male Hardline Connector (PL 259)		\$8.00
Female Hardline Connector (SO-239)		\$9.00
Male Hardline Connector (T Type-N)		\$10.00
Female Hardline Connector (T Type-N)		\$10.00

## HY-GAIN, TOWER MASTER AND TELE-TOWER CRANK-UPS

Direct factory shipment to save freight expenses. Call for our competitive quote on these towers. We can ship tower bases from stock to allow you to complete foundation work while tower is being prepared for shipment.

## From RSGB the Fifth Edition of the RADIO COMMUNICATION HANDBOOK

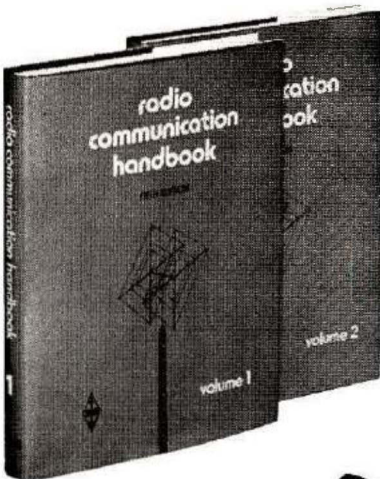

# no other choice . . . it's simply the best Handbook available!

First published in 1938, the *Radio Communication Handbook* is the world's largest and most comprehensive textbook on the theory and practice of amateur radio. The text has been completely revised and reset for this fifth edition. Chapters on image and satellite communication have been added which reflect the current interest in these fields. Although written primarily for the amateur radio operator, the authoritative treatment of the subject matter will also ensure that the book finds a place on the shelf of the professional radio engineer.

### Volume I

1. PRINCIPLES
2. ELECTRONIC TUBES AND VALVES
3. SEMICONDUCTORS
4. HF RECEIVERS
5. VHF AND UHF RECEIVERS

6. HF TRANSMITTERS
7. VHF AND UHF TRANSMITTERS
8. KEYING AND BREAK-IN
9. MODULATION SYSTEMS
10. RTTY

Order RS-RCH1, © 1976 **\$20.95**

### Volume II

11. PROPAGATION
12. HF AERIALS
13. VHF AND UHF AERIALS
14. MOBILE AND PORTABLE EQUIPMENT
15. NOISE
16. POWER SUPPLIES

17. INTERFERENCE
18. MEASUREMENTS
19. OPERATING TECHNIQUE AND STATION LAYOUT
20. AMATEUR SATELLITE COMMUNICATION
21. IMAGE COMMUNICATION

Order RS-RCH2, © 1977 **\$18.50**

Both volumes available

Regularly \$39.45  
**SAVE OVER 15%**  
Now Only \$34.95  
ORDER RS-RCH12

Save

ORDER  
TODAY  
FROM



Ham Radio's  
Bookstore  
Greenville, NH 03048

BY LYLE E. MEEK, N6BLN

# Alcatraz Invasion

Reprinted from the Sonoma County Radio Amateurs publication *Short Skip*.

Sonoma County Radio Amateurs Inc.

## ALCATRAZ ISLAND

EXPEDITION

SAN FRANCISCO BAY

W6CJ Chuck  
 W6ATP George  
 W6LFL Lyle  
 W6ALP Len  
 W6WLA Wayne

W6LQ Don  
 W6WFB Ron  
 W6GAJR Dave  
 Z6GJQS Mike  
 Z6GDF Alan

CONFIRMS CONTACT WITH AMATEUR RADIO STATION \_\_\_\_\_  
 DURING THE ALCATRAZ ISLAND EXPEDITION CONDUCTED 2000 UTC Dec. 1 to  
 2000 UTC Dec. 2, 1979.

SSB CW

\_\_\_\_ 10 \_\_\_\_\_

\_\_\_\_ 15 \_\_\_\_\_

\_\_\_\_ 20 \_\_\_\_\_

\_\_\_\_ 40 \_\_\_\_\_

\_\_\_\_ 60 \_\_\_\_\_

2 Meters \_\_\_\_\_

Expedition IWMAPE

We gratefully acknowledge the cooperation of the GOLDEN GATE RECREATION AREA

It was early morning on the first of December when the first of two Alcatraz invasion teams met at a small slip in San Rafael. Heavy equipment was loaded aboard the 21-foot invasion ship owned and operated by Bob Whitmire. The weather was heavy fog that would certainly make navigation difficult, but would conceal the team as they approached the island. Gen-

erators, fuel, antennas, food, transceivers, and assorted equipment were loaded with precision.

Three members of the invasion team, the ship captain and first mate set sail at 7:35 AM. The heavy shroud of fog made visual navigation impossible, but the ship was equipped with radar so the team was able to navigate the narrow channel and make it into

the open bay. Once into the bay the fog lifted somewhat but the radar was needed to locate the small, 12-acre island of Alcatraz; approach to the island was made from the north side. The small ship slid into the island slip and the team began unloading. Again the precision teamwork was evident as the approach and almost all of the unloading was completed before the



# Liberated signals from a liberated island

team was caught by an island guard.

The team leader quickly produced the necessary permit and the guard went on his way. The ship set sail again, this time bound for Sausalito to pick up the remaining eight members of the team and more equipment. Back on the island, the first team began moving equipment up and over "Cardiac Ridge" to the north-west corner of the island. The operation was to take place within the confines of an abandoned warehouse.

The team moved rapidly, but after three trips and with only a third of the equipment moved, it was obvious the strain was becoming too much and they would have to await the arrival of the others. Additional complications began settling in as the first boat of 155 island tourists began to arrive; fortunately the operation was going to take place out of sight of these new arrivals.

At about 10:30 the second team arrived and the last of the equipment was unloaded. The problem still existed of how to move the remaining equipment over "Cardiac Ridge." Thanks to the careful negotiation of one of the second team members, we were able to borrow a vehicle to move the equipment. Once in place, everyone immediately began setting up the various communications sites and equipment. Time was of the essence as the operation was scheduled to begin at 2000 UTC.

Verticals, dipoles, and beams were erected at various points around the warehouse. Card tables were set up in several abandoned rooms and the transceivers were placed on them. Generators and power cords were put in place and checked out. Sleeping quarters were tentatively set and the dining hall established.

At 2000 UTC, December 1, 1979, the mission was launched: CQ, CQ from Alcatraz Island — W6LFJ. What was to become a continuous barrage had begun. For the next twenty-four hours, Amateur Radio operators from the Sonoma County Radio Amateur Club would attempt to work as many fellow hams as they could from Alcatraz Island, home of the former federal prison.

Equipment was set up to operate on 2 meters SSB, 10 meters, 15 meters, 20 meters, 40 meters, plus novice 40 and 15 meters CW. It was immediately obvious that the team was to be struck by "Murphy's Law;" the novice rig could not be properly tuned, so was not operable. The 15-meter SSB station was plagued by antenna problems and intermod with the CW station. The 20-meter SSB had no audio on the transceiver and had to shut down; the 15-meter SSB station was placed on 20 SSB. Things

formal approval until two weeks before the date of scheduled operation. As a result of the delay, everyone had assumed it would not materialize and advance announcements to the various Amateur Radio magazines were not made. Consequently not as many Amateurs were contacted as we had hoped although the team was able to work 1050 QSOs with ten countries and thirty-six states. A nice certificate to confirm contact with the Alcatraz teams was prepared and mailed out in January.

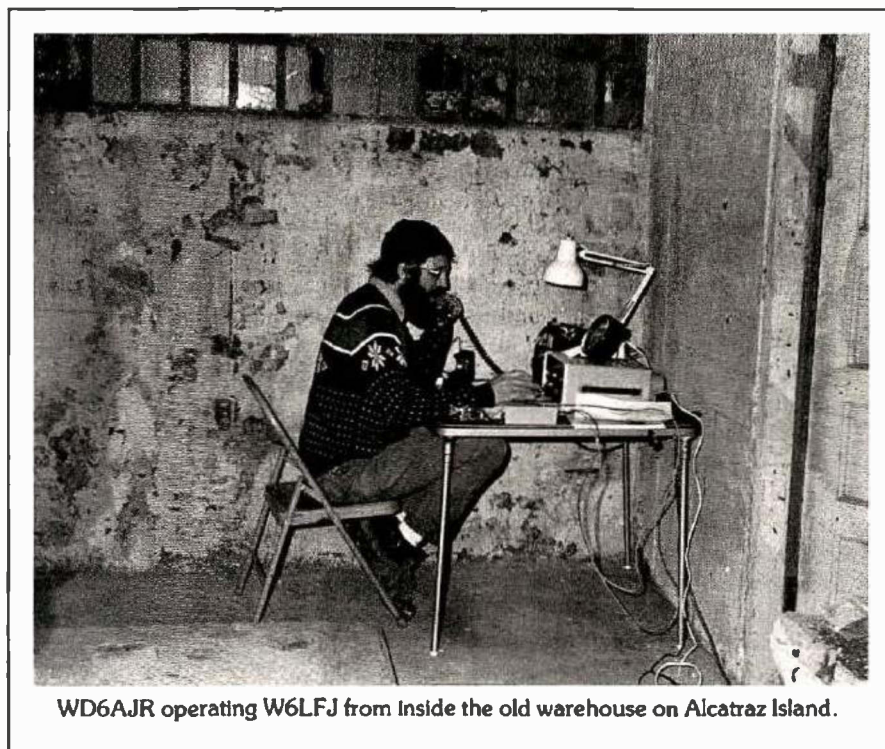

WD6AJR operating W6LFJ from inside the old warehouse on Alcatraz Island.

finally settled down to a steady rhythm, but Murphy was to strike at least once more. The main course for the evening was a large pot of carefully prepared beans. During the excitement of setting up, the pot of beans which had been placed on the stove to thaw out was forgotten, and, when it was remembered, the beans were burned. However, with the ocean breezes and fog to stimulate the appetite, when dinner was over not a single bean was left.

Although the plans had been formulated four months in advance and permits requested, it was not given

Members of the Alcatraz Invasion Team were N6BLN (Lyle), KB6LO (Don), N6OJ (Chuck), W6RIA (Wayne), K6ANP (Len), WB6NBR (Ron), WD6AJR (David), KA6AQS (Mike), KA6GDB (Alan), N6AUP (George), and George's son, Rob.

Murphy struck his final blow: the Callbook address for W6LFJ is incorrect so the Post Office is returning all correspondence sent to that address. If you worked Alcatraz Island and had your QSL card returned, send your SASE to Post Office Box 116, Santa Rosa, California 95402.

HRH



# Net Hopper

BY KAY ANDERSON,  
W8DUV

## The Mobile County Hunter's Net — 14336 kHz

We had gotten ourselves into an operating rut, the OM and I. Every day was like the day before: early morning MARS traffic nets, monitor the 2-meter repeater frequency all day, evening MARS traffic nets, and the state phone traffic net. It was a comfortable rut. We knew everyone, knew the procedures, felt at home. After several years of this, however, it did get somewhat boring. Occasionally, one or both of us would venture off these net frequencies to give out a few contest numbers. But, it was always back to the net in time to check in. We were not alone. Often we'd hear a friend say, "see ya here tomorrow, same time." Nothing wrong with that; it's nice to keep appointed schedules. What's bad is that, for some of us, it was the only operating we did. Once I looked at our little 5-band transceiver and thought, "What a waste! It might as well have been a single-bander with two crystals on 75 meters!" Today is different; we've changed our operating habits and sampled some of the many facets of our wonderful hobby. We've still got a lot more to try, but it's like rediscovering Amateur Radio; like the time when the "bug" first bit us. It's exciting and fun.

It began to happen last year as we prepared for a trip to Florida. Ed wanted to know if he should put the Bandspanner antenna on the car so we could check into our traffic nets. The poor old Chevy already had three antennas: broadcast radio, 2-meters, and CB. With one more, it would look like a porcupine.

"Sure, put it on. What's one more antenna?"

"Well, I could wait until just before net time then stop and take it out of the trunk."

"Tell you what — let's put it on now and tune up on 20 meters. We can give the county hunters some contacts."

We'd never had much success on 20 from the mobile. "Okay, but you'll have to do the operating." Ed adjusted the whip, tuned, adjusted the whip, tuned, adjusted, tuned.

I was packed and ready to go. "Just forget it. Leave it tuned on 75 and we'll stay in our little rut."

Finally, with the use of his grid-dip meter and a field-strength meter, he had it tuned to suit him. On twenty meters we found phone patches, and rag chowers, traffic nets, QRM, and teletype — but no county hunters. It was either too early in the morning, or I hadn't found the right frequency. I answered a CQ from a VK station. He came back to a K2. We couldn't hear the 2. Tuned some more. A mobile was calling "QRZ."

"QRZed. Is there a net control station on this morning?" he was asking.

When no one answered him, I did. "W8DUV mobile. Do you copy me?"

He didn't but someone else did. "W8DUV mobile, what is your county?"

"I'm in Cabell County, West Virgin-









# The Net Hopper

ia, right now. We'll be in Kentucky in a few minutes."

"Okay. Let's see if we can get things going and you can run Cabell County, West Virginia." He proceeded to announce that I was going to run the county, got someone else to announce it in another direction, then gave me a starting time and said "go ahead."

"This is W8DUV mobile 4 in Kentucky. I don't know what I'm supposed to say." (Why didn't I keep quiet and let the other mobile get in first.)

"You're in Kentucky? What county?"

"Boyd County."

"Okay. We've got W8DUV mobile in Boyd County, Kentucky. Strike out the Cabell County, West Virginia. We'll announce it to the west, then you can go ahead." It was announced again — I felt like such a dummy while someone explained that I was in Kentucky, not West Virginia — and again, the net control said to go ahead.

"This is W8DUV mobile 4 in Boyd County, Kentucky. I don't know what else I'm supposed to say, over."

"W#\$%&K4" &!W7KOI."

"All I got out of that was a W7KOI."

"W7KOI 55, 55, 55."

"This is W8DUV mobile 4 in Kentucky. Roger 55, you are 57."

"QSL 57, thank you."

"WW\$c% @!WT."

"I heard a Whiskey Tango."

"33, 33, 33, 33, 33, 33."

"Roger 33, but what is your call-sign?"

"Give him a report, DUV."

"Okay. He is 55, but who is it?"

"That was W8WT. Would it help if I relayed the calls to you?"

"Yes, it sure would."

The whole operation continued in an orderly fashion with NCS feeding me callsigns one at a time, an exchange of reports, "thank you," and "QSL PLEASE!" Twenty minutes later we'd exhausted the pack of callers and a new mobile began to "run" his county. Unlike me, he knew what he was doing.

I flipped back the pages of the little mini-log book. Six pages filled up! "Look at all the 59 reports we got." The mobile must be getting out after all.

Ed allowed that he'd heard the reports, and how could he miss hearing with the volume turned up so high.

"I'm sorry," I countered, "but some of them were just barely readable and I turned the volume up, then the next one would be loud and I couldn't reach the knob in time." (Our mobile rig has just two levels — "comfortable copy" and "blast you into the back seat.")



I was perspiring after the work out. Ed turned on the air conditioner and laughed. "Just wait till you have to answer all those QSL cards."

I knew what he meant. My supply of cards, which had lasted more than ten years, had suddenly dwindled to zero after a YL-OM contest. Since the new supply came in, I'd hardly mailed out more than ten or twelve. Oh well, I'd cross that bridge later.

We were nearly out of Kentucky and into Tennessee before I called in again. There were quite a few mobiles on frequency, so we were given a number and asked to wait. Finally,

NCS called me. "Where have you been?"

"Oh, we turned the volume down for a while."

"Well, someone needed Carter County and we couldn't raise you."

"Oh, golly. That was hours ago."

"Where are you now?"

"Laurel, I think. That's the last sign I saw."

"Is that Laurel County, Kentucky?"

"Roger."

This time things went a bit more smoothly. After announcing that I would run Laurel County, and someone else announced it in the other direction, I was given the starting time by the NCS and I knew what to do.

"QRZ. W8DUV mobile 4." I exchanged reports and logged, exchanged reports and logged, flipped the pages of the log book, and kept doing the same, until finally NCS asked if anyone needed a relay. A few did.

"I think we're in Whitley County now," advised Ed.

"How do you know — did we pass a sign?"

"About a mile back."

NCS was relaying the first "weak" station. "Listen for . . ."

"Okay, but I'm now in Whitley County."

"You are in Whitley County?"

"Roger."

"Your sign-out time is 1529. Thank you for running Laurel County. The next mobile on the list is . . ."

"I guess I should have stopped and let those last few get Laurel?" Ed asked.

"No. They wouldn't expect us to do that, I'm sure."

"You could have just not said anything, just kept on giving out reports."

"No. That wouldn't be right."

"No, guess not."

"Wonder if anybody would want this county?"

"Let's give it a rest. Besides, it's almost lunch time."

For the rest of the trip to Florida, we gave out counties in Tennessee, Georgia and Florida. It didn't take long to learn that we couldn't run every county we went through. Only



the mobiles who had time to stop and wait could satisfy all the callers on frequency. We were in a hurry to get to our destination, so, in some counties, only a few exchanges could be made. I hated disappointing those who waited in vain. We promised we'd call in again on our way back.

Ed wondered about the many people we heard on the frequency. Some were heard over and over, others just now and then. We heard an old friend from our Novice days. "I know that guy has worked all states, worked all continents, worked all everything — what's he doing chasing counties?"

"Well, just think — over 3000 counties in the United States, that's a pretty big challenge." (Later, I'd learn that some of the stations were working all counties for the second and third time! First time, they'd worked mobiles, fixed stations, anybody. This time they wanted YL's, or YL-OM teams. "Perhaps," we laughed at the idea, "next they'll want all-counties-with-a-grandma-driving-a-Volkswagen.")

"Well, it makes as much sense as checking into a net every night 'QRU'."

"Yeah, or getting in a contest and telling everybody they are 59."

"To each his own."

"We've never even worked all states."

"Oh, yes we have. We got the certificate in Virginia."

"Yeah. But we were Novices then. We haven't done it over again in West Virginia."

It was true. We'd moved to West Virginia 16 years before. Surely we'd worked all states, but we hadn't applied for the certificates. "I'll check our QSL cards when we get back and see if we need any states."

"Speaking of QSLs, you know these contacts won't count don't you?"

"Yep, more than 25 miles from home, right?"

"Right." I wondered what, if anything the QSLs would be good for. It didn't matter, though. We were having fun, and making contacts made the trip seem much shorter.

We stopped over in Georgia, just outside of Atlanta. Ed wanted to get back on 75 meters and keep our net schedules; old habits are hard to break. I reluctantly relinquished the mike. He adjusted the antenna — now he had little marks made with nail polish — and retuned the rig. They could just barely hear us back home. The ignition noise was worse on 75 than on 20. I couldn't wait to get back on 20.

It was the next morning before I did get to check back with the county hunters, and only after Ed had made one more try to talk to our home



state. They heard him better in the early morning on 75, but it still was not solid copy. We stopped trying after that.

While Ed paid close attention to the traffic creeping along, and tried to figure which lane was best, I tuned back and forth near the spot where I'd left the county hunters. They weren't there. Probably didn't open the net this early, I reasoned. I heard an Australian YL talking to someone state-side whom I couldn't hear. It wouldn't be nice to break in when I couldn't hear both sides, but golly, I sure would like to talk to Australia! Down a

bit further, there was a traffic net. DX stations were checking in and asking for certain states and locations. Just as soon as they checked in, they moved off frequency.

"Up to the top, and down one by one."

"Roger. QSY."

Up to the top I went to try to hear the traffic. They weren't there. I tuned around, couldn't find them . . . back to the net frequency. DX stations were still checking in. This was frustrating. They weren't making contacts as they do in a contest. I wanted to work them! NCS asked for more check-ins.

"This is W8DUV mobile 4 in Georgia." He didn't hear me, but someone relayed me in.

"W8DUV mobile, call your traffic."

"No traffic, QRU," I said, lamely. Apparently there was no great demand for a mobile YL in Georgia. We didn't get any calls. So it was back to 14336 to see if the county hunters had started. Again, just ragchewers, noises, phone patches.

"Why don't you call CQ?" suggested the OM.

"Why don't YOU call CQ?" I retorted. (He knows I *hate* to call CQ, except during a contest.)

"Give me the mike." He found a "clear" frequency and called.

"THIS FREQUENCY IS BUSY OLD MAN!"

"Sorry, I didn't hear anything." Ed handed the mike back to me.

Back to 14336. Good! A mobile was giving out signal reports. We listened to the now familiar routine. It was like coming into a room full of old friends. Before we knew it, we were all the way past Atlanta and its early morning traffic jams. Eventually, the NCS asked for more mobiles.

"W8DUV mobile in Georgia."

"What county DUV?"

"Golly, I don't know. (I searched the road map frantically — it didn't show the county.) "We are just outside of Atlanta on I-75, heading for Florida."

"Decatur," someone said with authority.

"We have W8DUV mobile in Deca-

# The Net Hopper

tur County, Georgia." It was announced to two other people, then I was told to run it.

I "QRZed" several times; no one came back. NCS asked if anyone needed a relay. No one did. He gave me a sign-out time. Chagrined a bit, I turned the volume down and we listened to music on FM radio. Probably a lot of mobiles go through Atlanta and Decatur County. Everyone has worked it already, I rationalized to myself.

Near Macon, Georgia, we tried again. This time I had a road map showing the county lines clearly. I'd spotted it at the last gas station. (It cost a dollar — maps aren't free anymore.) It was worth the price, however. I can't always see the little signs along the highway that tell you when you are leaving one county and going into another.

"Go ahead and run Bibb County," NCS directed.

About 20 people exchanged reports with me. Someone asked if we were going to Jones County. The map showed that we wouldn't go through it. "But it's only about a quarter of an inch from the Interstate." (I was afraid to look over at Ed. He hates to detour for any reason.)

"Don't go out of your way, but it's the last one I need in Georgia." (He'd already worked us in almost every county we ran. We felt like we knew him personally.)

"Well, we could look for some hot coffee," Ed said, as he angled the car onto the exit ramp. "You sure get me into some goofy situations," he added.

Half an hour later we sat parked on a country road with two cups of cold coffee. (Next trip I'm taking a Thermos.) Finally, it was our turn to run the county. It was like being on a DX-pedition, almost. This must have been a rare one. Every county is rare, I learned, to those who haven't worked it yet. A CT1 station called, and so did a UA6! So many stations called that I ran out of log sheets. Ed found two postcards and a cash register tape under the front seat. I used them. Then I wrote on the Gulf of

Mexico and the Atlantic Ocean — but that was the old road map, the one that didn't show county lines. At last, the sign-out time was given. We turned back toward our intended route. It was lunch time.

"Boy, are you going to have fun answering QSLs," Ed teased again.

"You already said that."

Thus the trip to Florida was made — 18 hours of driving seemed much shorter. Two weeks later, we were back home in "Almost Heaven" West Virginia. Ed was partly right about the QSLs. There were several envelopes stuffed full. They had come from the

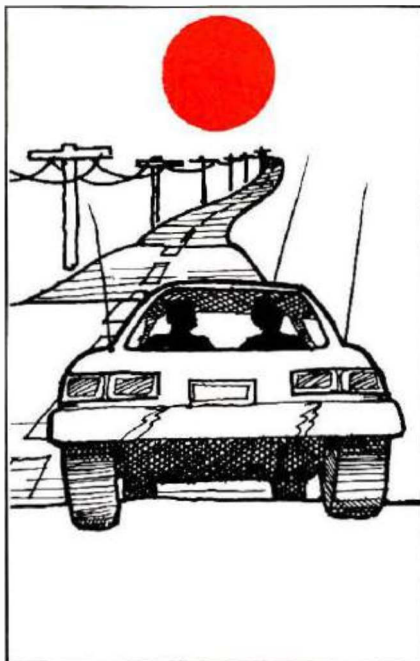

QSL bureau in California. Each envelope included an SASE for me to return cards. Many stations had enclosed their personal QSL along with a card listing all the counties in which they had contacted me. All I needed to do was sign the card and return it. (First I checked the contact in my not-so-neat log.) With over 200 contacts on that trip, only two did not jibe with my records! So the QSLing was no big chore. The burden is more with the fixed station, he initiates the card, pays the postage, keeps his records. They make it easy on the mobile operator.

That was the beginning of a friendship with a bunch of real nice people. It would be so easy to just start working for counties from the home QTH, and stay on that one frequency every day. That has been our habit in the past — find an enjoyable rut and stay in it. However, we decided to try other types of operation — look for OSCAR, Work All States on RTTY, work some DX, try for 5-band WAS within a specific time limit — anything, except fall into a new rut. Oh, we still check in with the county hunters from time to time. We live in West Virginia, but play golf in Ohio, so now and then I'll call in "mobile in Lawrence County, Ohio," and believe it or not, there's always someone for whom Lawrence County is "rare."

Did we simply leave all our old friends on the traffic nets? Well, yes. But only for a short spell. We still call in occasionally, just to keep in touch. But we are trying to convince some of them to join us in some new adventures; to get out of the rut. New goals put spice and sparkle back into our lives, give us a "reason" for getting on the air. Amateur Radio is far from boring, and we know we haven't scratched the surface yet. I hope we live long enough to try all of it. NEXT: 14332 kHz. The YL System. (YL International Single Sideband Communication System, Inc.).

**Helpful hints for mobile operators who want to try the County Hunters Net.**

1. Listen, until you get the hang of how they operate.
2. Keep a good atlas or map handy. You sometimes miss the road signs and don't know how large or small a county is.
3. Have plenty of log sheets and more than one pencil or pen.
4. Have someone else do the driving, or the logging. You can't do both safely.
5. Try to check in BEFORE you reach the county you wish to run. And if you want to really be nice . . .
6. Stop the car to finish giving out contacts before leaving a county. It will probably delay you for a few minutes, but it makes a lot of people happy.

**HRH**



## USA-CA Program

The United States of America Counties Award, sponsored by CQ, is issued for confirmed contacts with specified numbers of U.S. counties.

The USA-CA is issued in seven different classes, each a separate achievement as endorsed on the basic certificate by use of special seals for higher class. Also, special endorsements will be made for all one band or mode operations, subject to the rules. The classes are:

Class	Counties Required	States Required
USA-500	500	any
USA-1000	1000	25
USA-1500	1500	45
USA-2000	2000	50
USA-2500	2500	50
USA-3000	3000	50
USA-3077-CA for all counties and Special Honors Plaque		



USA-CA is available to all licensed Amateurs everywhere in the world, and is issued to them as individuals for all county contacts made, regardless of calls held, operating location, or dates.

Special USA-CAs are also available to SWLs on a heard basis.

The USA-CA program is administered by a CQ staff member acting as USA-CA Custodian.

The scope of USA-CA makes it mandatory that special Record Books be used for application. For this purpose, CQ has provided a 64-page, 4¼ inch × 11 inch Record Book which contains application and certification forms, and which provides record-log space meeting the conditions of any Class award and/or endorsement requested.

Record books are obtained directly from CQ for \$1.25 each. You should get two of them; one for application use and one for your personal file copy. The books are shown in the photograph below. The address for ordering the books and obtaining a complete list of USA-CA rules is: CQ, 76 North Broadway, Hicksville, NY 11801.



# Reliability Service Experience



**KENWOOD  
TR-9000**



**Check our price last!**

## Up Your Hand-Held Power with VoCom Power Amplifiers

Model 2C025 - 200 mW	\$74.95
Model 2C025-2W	\$62.95
Model 2C050-2W	\$99.95
Model 2C100-2W	\$152.95

**ALLIANCE  
HD-73**

**\$109.95  
prepaid**

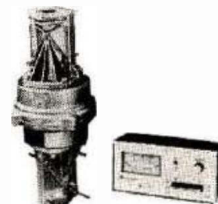

**KENWOOD  
TR-2400**



**Check our price last!**

**PREPAID SHIPPING  
CONTINENTAL 48 ONLY**



Quantities limited. Michigan residents add 4% sales tax. Please include your area code and telephone number with any correspondence.



# RSE HAM SHACK

1207 W. 14 MILE, CLAWSON, MI 48017  
(313) 435-5660

31155 PLYMOUTH, LIVONIA, MI 48150  
(313) 522-4232

**MAIL ORDER TELEPHONE  
(313) 435-5660**

# DX Horizons

BY BILL KENNAMER, K5FUV

*"To most DXers, two things are important in his life: first, the contact, and second, the QSL card."*

A few short years ago, DX heard, much less worked, was a novelty. We were then on the down side of a declining solar cycle. Now, with cycle 21 near its peak, DX is plentiful — available to all who care to work. Many previously scarce countries are now active, and, around our part of the world, it seems many hams may now be jaded from working too much DX.

What can be done to increase your interest in DXing? Try a different awards program. At the present, the most challenging achievement in DXing is the 5-Band WAZ (worked all zones) offered by CQ magazine. The degree of difficulty is increased by the fact that one must work each of the forty zones five times. Since these zones encompass the whole world, the requirement of working each five times is much more difficult than the ARRL's 5-Band DXCC. Also, since the 5-Band DXCC is not endorseable, the more difficult countries required by 5-Band WAZ are simply not required in the ARRL program. So, come on and join the fun. Get up the 40- and 80-meter antennas, and start on the program.

## The QSL bureau

To most DXers, two things are important in his life: First, the contact, and second, the QSL card. A good volume of these cards flow through the volunteer bureaus around the world. Since the bureaus are volunteer, a short discussion on how you can use and help these bureaus is in order.

First, there is some confusion as to whether or not one must be a member of ARRL to use the bureau. The only requirement is that you maintain an envelope on file at your district's

bureau. The address for your district's bureau may be found in the *Radio Amateur's Callbook* or quarterly in *QST*.

As for the envelopes, use only 5 × 7½" envelopes. Other sizes, especially larger ones, are difficult to file. Smaller ones may result in cards being folded to fit. Some district bureaus will provide a number of envelopes and postage if you will send them a dollar, but check first.

Who should have an envelope on file? Anyone who works any DX, whether you are a serious or casual DX operator. There are many cards in the dead files of bureaus around the country, waiting for someone to send in an envelope to claim them. Please help the volunteers do their job in distributing your cards.

## TT8, Chad

Jim Bullington, N4HX/TT8, was assigned to the U.S. Embassy in N'Djamena, Chad, as Charge d'Affaires. While there, he obtained permission from the President of Chad to operate Amateur Radio from the Embassy, and went on the air for the first time on November 1, 1979, with limited hours of operation.

Jim came home for a while, but returned in January, with plans to work weekends on 21.262 MHz at 1830 UTC each Saturday and Sunday. He will try to work major contests also. Plans have been announced for him to go to TY in June. QSL to ON5NT.

## A7X, Qatar

Mike, ex-EP2LI, received his license as A7XD on December 6, 1979. He is with the U.S. State Department in Doha, Qatar. Mike left Tehran in a rather large hurry in Feb-

ruary, 1979, and lost all of his equipment and most of his possessions. By working through people in Iran, he was able to recover most of the equipment, but the effort was somewhat costly.

Mike is renting a villa outside of Doha, and has plenty of room for antenna installations. Currently, he is using a 204BA on 20 meters, with a Wilson DB43 for 10 and 15 meters, and a 70 foot, tilt-over, crank-up tower. He prefers list type operations, and may be found most mornings on 20 meter long-path. QSL to WA4PYF.

## 5N, Nigeria

Nigeria has been most active again during the last year, due mostly to the efforts of Dave Guthrie, 5NØDOG. Dave, who is from Falls Church, Virginia, has been on assignment with his company in Nigeria, and has been extremely cooperative with DXers. He has been active in every contest, and operates all bands. Dave is a very relaxed fellow, so if you hear him on the bands, stop and visit awhile. With his TS-820S, Alpha 374A, and a tri-bander at 60 feet, he has a big signal that's easy to hear. QSL via W4FRU.

## ET, Ethiopia

After many years of inactivity, ET3PG is now very active again. At present, two operators are involved. The license appears to be that of a club station located in a police station in Addis Ababa. Activity began in early January, with almost no U.S. contacts until early February. Since then, they have been quite busy. Operating techniques have been to create a pile-up, and move frequency if it gets to be too frantic.



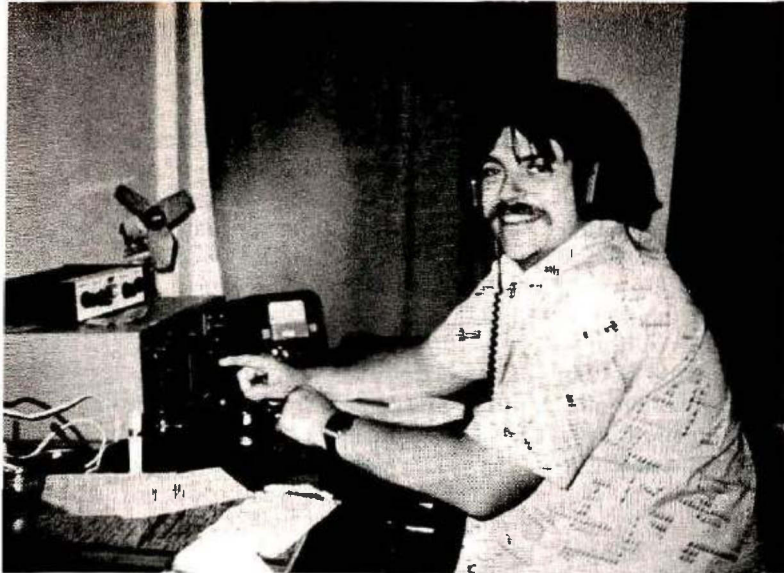

Above, Bob, N200, shown at the operating position of VS500, as liaison on the Spratley expedition, 1979. (photo courtesy of N200). Upper right, the 1S1DX crew in the Spratley group. From left, Stew, K4SMX, Bill, K1MM, and Harry, VK2BJL (photo courtesy of K4SMX). Lower right, Frank, DJ9ZB, at the operating position of OE6XG/A, the Abu Ail expedition of May, 1979 (photo courtesy of DJ9ZB).

The two operators QSL to different addresses: Vekelle QSLs to Box 5327, Addis Ababa. Girma, the other operator, QSLs to Box 21321, Addis Ababa.

#### The visiting Amateur

Anyone who is a true DXer at heart often finds himself wishing to be in a rare spot, such as XZ, BY, or ZA, with a good rig and a large pile-up calling. Of course, for most of us, that time will never come. But some will find themselves in such a rare spot at sometime in the future. The manner in which they handle the temptation is something that could affect the state of Amateur Radio for years.

In some countries, Amateur Radio is not viewed in the same way as it is in most of the world. For whatever reason, it is sometimes severely restricted or not allowed. However, in the past, some overzealous operators have abused the wishes of their host countries, and put a station on the air anyway. In many cases, irreparable harm has been done by such operation. In fact, even verbal permission to a privileged person has been looked upon with disfavor by government officials. In one case, it is reported that an operation was so frowned upon by the government that all Amateur activity there was stopped following the departure of the privileged one, thus making a rare country even more so.

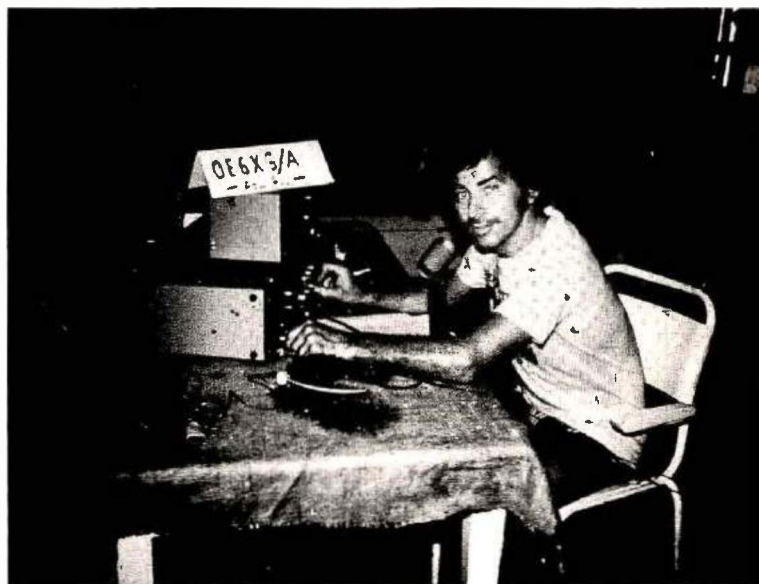

As a visitor in a country where Amateur Radio is restricted, it is best to exercise restraint. Work within the system to obtain permission to operate. If there is no system, do what you can to promote Amateur Radio. Try to build some understanding of what we are doing in Amateur Radio, and how it can build technology in the country.

In connection with this type of approach to Amateur Radio, Tom Wong, VE7BC, a Canadian citizen of Chinese descent, is working in China at the present, to help get China back on the air. He has obtained permission to bring technical books on Amateur Radio into China, and is getting them to the proper place for distribution to prospective Chinese Amateurs. Tom feels that progress is being made, and that China will be back on the air soon. If you would like to help, please send some old technical books, such as the ARRL Handbook, antenna

books, or other basic material to him at his Callbook address. (No periodicals, please.) Mark the package "Educational Materials, No Commercial Value." In this way, you, too, can have a hand in aiding to bring a rare country back on the air.

#### Look for:

##### HV, Vatican City

HV3SJ is on quite frequently around 1400-1800Z, 28 MHz. The operator's name is Peno, QSL to IØDUD.

##### ON, Belgium

John, ON4UN, is on 28.540 MHz  $\pm$  10 kHz almost daily, looking for rare American counties. He can also be found on the County Hunter's Net on 14.333 MHz.

##### KH7, Kure

WD8QGQ/KH7 is active now on Kure, and seems to favor weekends, around 2200Z. QSL to KH6JEB.

### VP8, South Georgia

VP8SU, on South Georgia, seems to favor 14.210-14.220 MHz, around 0200Z.

### Upcoming

#### HK0, Baja Nuevo

A group of twelve Columbian Amateurs will be visiting Baja Nuevo, off the north coast of Columbia, in July. They are planning to operate all bands, all modes, for about one week.

### Club news

Officers for the Southern California DX Club for 1980 are: John Browning, W6SP, President; Joe Merdler,

N6AHU, Vice President; Perry Esten, W6PN, Secretary; Fried Heyn, WA6WZO, Treasurer; Bob Kogen, W6DN, Membership; Steve Orland, AA6AA, Director; and Jim Stevenson, W6EKL, Director.

Again this month, we thank the contributors to *QRZ DX*. Without their help, this column would not be possible. If you have information and pictures you would like to share with our readers, please drop us a note.

### 4U1ITU

The club station of the International Telecommunications Union — 4U1ITU — in Geneva can be operated by any visitor with a valid Ama-

teur license. 4U1ITU is considered a separate country for DXCC purposes, so operating from this well-equipped station can be quite a treat. Take note, however, that *each operator must act as his own QSL manager for 4U1ITU QSOs*. We were reminded of this just recently when DL7SU pointed out that he most certainly is not QSL manager for the station, regardless of the latest *Callbook* listing.

A good idea for anyone working 4U1ITU is to ask for the operator's home callsign, and QSL to that station, not 4U1ITU or any "manager." If the operator is on the ball, you can be sure of picking up a confirmation for this "country."

QSL Route		QSL Route	
Station	QSL via	Station	QSL via
A4XGY	K2RU	J7DAY	KB4SA
A7XA	DJ9ZB	J7DBB	YASME, Box 2025, Castro Valley, Ca. 94546
A7XAH	DJ9ZB	KC4AAD	W6MAB
CO5GV	Box 43, Jaguey, Cuba	KC6MJ	W7PHO
CT2BD	W4JVU	KP2A	WB2VFT
CT2CF	WA4MAV	KP2A/J7	K2TJ
CT2CO	WA4MAV	LU4MEE	WD8ILW
D68AR	F6ACB	LU7MAJ	WD8ILW
EA6BG	W4JVU	M1C	Direct
EA6GB	WB1DQC	NP4A	W3HNC
EA8AK	EA8CR	N4HX/TT8	ON5NT
EA8VV	Box 265, Las Palmas	PZ1BT	Phil, Box 113, Paramaribo, Surinam
EA9GK	Box 556, Ceuta	SU1BA	WA4GKR
EA9HG	Box 613, Ceuta	SV0AA	N200
EA9IB	Box 213, Melilla	(from 12/7, 1979)	
EI9CB	WA1UVX	SV0AA/5	K5VT
FG7XA	Box 444, Guadeloupe	(1979 only)	N200
FG0AMR/FS7	K8ND	SV0AA/9	WB8LFO
FG0FJD	W2GHK	SV0AC	Direct Only
FK8DH	VE5AAP	TD4NX	WD8MOV
FO8BW	W6JFM	TG4NX	K8HV
FR7BE	W4LZZ	TG9AL	K8HV
FR7BJ	WB9MFC	TG9GI	K9KXA
HH2VP	N4XR	TU2GA	WA4OUF
HI8GGL	WD8MOV	TU2GO	ON6BC
HI8LC	W2KF	TZ4AQS	UA1OSM
HK4CYB	Box 4112, Medellin, Colombia	UA1PAL	WB8ZJW
HM1QD	W7RQ	UI8LAG	UK1AAA
HS1WR	Box 155, Bangkok	UL1A	UK4ABZ
HS5AID	AG6D	U4DP	WB3KHY
HT9TM	K2TV	VE2VEJ	WB0TNY
JT1BG	Box 158, Ulan Bator, Mongolia	VP1A	W4BSO
JT0DJT	UA3DJT	VP1JEC	
JW8FG	LA5NM	VP2E (March 29 and 30, 1980 only)	K8ND
JY3ZH	DJ9ZB	VP2EEV	K8ND
JY8ZB	DJ9ZB	VP2SAA	W4UG
JY9DX	WA4ZXA	VP2VEG	W0DVZ
J6LOU	Box 93, Castries, St. Lucia, W.I.	VP2VFW	K2TJ
		VP5NX	K8ND
		VP5WJR	WB5UEP



### QSL Route

Station	QSL via
VP8PE	WB9MFC
VQ9DM	K1BZ
VQ9KJ	KØKJ
VU2RAK	WBØTNY
VU2RX	W2LOG
VU2UH	SP9AJT
WA4QDE	N2CW
WA7JRL/SU	W8LZV
WB5LBJ/DU6	W7HPI
WB8VLG/DU2	WB9MFC
WD4KMD/DU2	N2CW
WD8QGQ/KH7	KH6JEB
W7LPF/DU2	N2CW
YI1BGD	Box 5864, Bagdad, Iraq
YS9PBE	W8QWI
YS9RVE	WAØJYJ
YV2BYT	K8IC
ZD8TC	
(from 1/11, 1980)	N2CW
ZF2DA	N4AJO
ZK1CI	G3ZXD
ZL3MA	WB8WMS
ZS5LB	Box 453, Vry Heid, 3100, Republic of South Africa
	WA1UVX
ZS6N	EA1QF
3C1AB	W5RBO
3D2ER	WB2VFT
4S7DX	OE8HFL
5B4IJ	WB9MFC
5N2NAS	WB9MFC
5NØOBA	WB9MFC
5Z4PG	WB9MFC
5Z4RG	WB9MFC
5Z4YV	JA2ARA
5Z4YW	VE3ACY
6W8AR	WB4LFM
6W8IA	Art, Box 387, St. Louis, Senegal
	Ahmed Berchi, Box 43, Setif, Algeria
7X5AH	IØLCJ
	Box 2949, Accra, Ghana
9G1AP	WA1YYX
9G1DY	N2DO
9H1ED	DJ9ZB
9H4P	WB9MFC
9K2FN	N7EB
9M2PV	
9N1MM	

Gun, YN1Z, H7Z (Ex-YN1CW), advises that he was active from Managua through the end of June, 1979, and all outstanding QSLs will be answered by K4CLA, 562 Oak Drive, Lexington, South Carolina 29072.

### The National Contest Journal

Here's a neat little publication some of you may be interested in. It's called the *National Contest Journal* (NCJ), and is made-to-order for hams who are active in various types of contests. Six issues are published each year, and in them you'll find operating tips, short stories of expeditions, operator's reports on activities, scores, news of upcoming events, letters, sunrise/sunset times keyed to countries by callsign, and more.

If this sounds like something you've been waiting for, the subscription is \$5 for 6 issues (\$6 in Canada), or \$9.50 for 12 issues (\$11.50 in Canada). For more information, or to sign up, write Randy Thompson, W5ZD, P.O. Box 732, Round Rock, Texas 78664.

### IYØKOW

This is the Italian Radio Club For Blind Operators (RCCI) in Rome, and is the only station authorized to use the IYØ prefix. The station started operation in March, and will run until June 15th. Operating schedule (ex-



IØLL, the chairman of RCCI (Italian Radio Club for Blind Operators), in his shack. He is showing instruments manufactured by RCCI for blind operators. Until June 15th he will use the special call IYØKOW.

cept Thursdays) is 21390 kHz at 1400 GMT; 14290 at 2000 GMT. Thursdays — 3650 at 2100 GMT; and 3800 at 2300 GMT. QSL manager is IØWHY.

The RCCI has a program for their new DX Award, which will allow the top three stations to earn a gold medal, a silver cup, or a silver plaque, in that order (see photographs). For a complete list of rules and scoring details, write to Radio Club Ciechi d'Italia, Via Lima 22, Roma 00198, Italy.

Winners in the 1978 classification were:

- Gold Medal — IN3ANE
- Silver Cup — IT9VQC
- Silver Plaque — F6CYE



The awards program is open to all Radio Amateurs, worldwide. HRH

# Questions & Answers

*There is only one cause of SWR — mismatch between the load and the transmission line.*

Entries for this column must be by letter or post card, only. No telephone requests will be accepted. All entries will be acknowledged when received and those judged to be most informative to the most Amateurs will be answered in this column. No questions will be answered by return mail. Questions must relate to Amateur Radio.

Readers are invited to send a card naming the question they feel is most useful in each issue. Each month's winner will receive a prize, and there will be a prize for the most popular question of the year. In case of two or more questions on the same subject, the one arriving here the earliest will be used.

## FCC Notification

*I have a general-coverage transceiver, and also a 2-meter transceiver, at my home. My license gives my home address as the station location. I have a camp six miles away and would like to have one of the transceivers there on a permanent basis. Is this permissible, and should the FCC be notified for modification of my license? — Clement Bourgeois, Jr., N5ADK.*

At one time, you had to notify the local FCC Field Office of all portable operation that exceeded forty-eight hours in duration. These requirements have now been relaxed, and notification is no longer necessary. So, you are free to move either transceiver to your camp. One caution, however: You still must observe the rule that no unauthorized persons will be able to use the equipment, so, unless your camp is really secure, you should remove some vital part of the transceiver and thus render it inoperative during your absence.

## SWR Testing

*My question regards the proper procedure for making SWR tests. Since it is against regulations to transmit an unmodulated carrier, how does one properly measure antenna SWR without the use of an unmodulated carrier? — Robert Chapman, NØARM.*

The obvious procedure is to use a modulated carrier, which is legal, and then get yelled at by fellow Amateurs for causing interference.

Seriously, though, unmodulated carriers have always been allowed for test purposes with the provision that they be of short duration and cause no interference to communications. Obviously, tuning up in the middle of the "DX window" on 20 meters when the band is open is going to cause interference, and thus is a no-no.

Commercial antenna-test facilities use low, low power, such as from signal generators, and very sensitive SWR bridges, to check antenna performance. Unfortunately, such equipment is far too expensive for most Amateurs.

The only practical solution for the Amateur is to pick a time when the band is not open or not being used, use as low a power as you can and still obtain a reading on your test instrument, and take several breaks in the tune-up session to see if anyone is trying to use the frequency.

However, even milliwatts of power will travel around the world on many bands, so it might be difficult to run a meaningful check of an antenna's performance across a band or on several bands. For this reason, many Amateurs are turning to the "noise bridge" type of antenna test. The in-

strument is relatively inexpensive, low power, and requires as extra equipment only a receiver that will cover the frequency of interest.

## Recommended reading

Jack Althouse, K6NY, "Antenna Tuning With A Noise Bridge," *Ham Radio Horizons*, November, 1978, page 38. (Back issue or photocopy of article, \$2.)

## Antenna resonance and SWR

*If the transmitter and antenna are in exact resonance for a particular frequency, but the coax is either more or less than an electrical half-wave-length, will there still be standing waves? — C. H. Wolfe.*

The transmitter has nothing to do with it. If it is out of resonance, you'll get an overheated transmitter. Period. The length of the transmission line has nothing to do with it, other than the fact that the "wrong" length can "fool" your instruments into thinking you have (or do not have) a high SWR.

There is only one cause of SWR, and that is a mismatch between the load and the transmission line. If you hook a perfectly good 50-ohm dummy load to the end of a piece of 75-ohm coaxial cable, you'll have standing waves on the cable; if you use 300-ohm twin lead and a 50-ohm dummy load, the SWR will be higher. Very few antennas have 50-ohm impedances, so they must have a matching network of some sort to transform their natural impedance to match that of the cable you feed them with. In Yagi antennas, quads, delta loops, and the like, this is done by



means of gamma rods and capacitors, hairpin loops at the feed point, and so on. Wire antennas, such as slopers, half-wave dipoles, verticals, inverted vees, and the like have impedances that can vary from less than 30 to more than 100 ohms. This will change, depending upon the antenna height above ground, and nearby metallic objects.

To relate more directly to your question, consider this: A resonant 1/4-wave vertical antenna, over a ground plane or good ground screen, will have a feed impedance of about 35 ohms. Unless you have some 35-ohm cable in your goodie-bin, you'll have SWR on the feedline.

### Schematic diagrams

Are there some good sources of schematic diagrams and operations manuals for old equipment, war surplus, etc.? — Larry Jessip.

Advertisements for manuals appear in the classified sections of Amateur publications from time to time, and two that come to mind are: Hobby Industries, Inc., Box 864, Council Bluffs, Iowa 51501 (25¢ for a list of manuals); and W3IHD, 7218 Roanne Dr., Washington, D.C. 20021 (50¢ for list — leans heavily to surplus equipment).

If these sources fail, try placing a classified ad yourself. The cost is low, and lots of people read them.

### Tubes?

If view of the abundance of all-transistor transceivers, and the rumors of future scarcity of receiving and transmitting tubes, should I consider getting rid of my quality tube-type transceiver? — Sam Grider, WD8LIK.

If it still does the job you intended it to do, and does not suffer chronic breakdown to the point of driving you up the wall, then hang on to it.

Although many U.S. tube makers are no longer turning out tubes by the thousands, a number of foreign manufacturers have stepped in to fill the gap. It is not uncommon for several "brands" of tube to be cranked out on the same Japanese, German, Dutch, or other assembly line. (Unknown to many is the fact that this was true when U.S. makers were in their heyday, as well.) Additionally, most

equipment manufacturers still stock and sell replacement tubes for their equipment (Collins, for example, stocks replacement tubes for their sets, and will maintain a supply for several years. You may not be able to get the discount you are accustomed to at your nearby TV-parts house, but you'll be able to get the tubes you need.)

If it's a good, reliable, lovable old piece of gear, then you should build up a stock of tubes to keep it running. Even if you decide to swap it for an irresistible modern rig, the "nest egg" of spare tubes will be a great attraction to any potential buyer.

### Ground

What constitutes a good ground, and how might one be obtained in the desert southwest, for example? — L. J. Kane, AJ7H.

A good rf ground is one that introduces no losses in the radiating system. The best one I can think of would be to plant your antenna in the middle of a copper sheet that is 1/2-wave in diameter (or more). However, to be practical about it, a system of radial wires, placed like spokes in a wheel at the base of a vertical antenna, will do a pretty good job. The more "spokes" the better, up to the point of becoming ridiculous. Usually, four is a minimum number to start with, and you'll notice an improvement with each one you add, up to about thirty or forty. Beyond that, there is still an improvement, although the results are difficult to measure. For antennas other than a vertical, a similar system applies, although they might have to be in a square-grid configuration. A screen of wire mesh often does well, such as the so-called "chicken wire." Another solution is to use an antenna that doesn't require a good rf ground, such as a center-fed antenna with balanced feedline and an antenna coupler.

For a safety ground, for lightning protection, several copper rods driven into the ground as far as practical, and connected to each other and to your radio system ground with a heavy braid, is a wide-spread recommendation.

HRH

# Toroid Cores



- All the popular sizes and mixes.
- Fast Service. Same day shipment via first class mail or air.
- No minimum order.

### IRON POWDER TOROIDS:

CORE SIZE	MIX 2 5-30 MHz u = 10	MIX 6 10-90 MHz u = 8.5	MIX 12 60-200 MHz u = 4	SIZE OD [in.]	PRICE USA \$
T-200	120			2.00	3.25
T-106	135			1.06	1.50
T-80	55	45		.80	.80
T-68	57	47	21	.68	.65
T-50	51	40	18	.50	.55
T-37	42	30	15	.25	.45
T-25	34	27	12	.37	.40

### RF FERRITE TOROIDS:

CORE SIZE	MIX Q1 u = 125 .1-70 MHz	MIX Q2 u = 40 10-150 MHz	SIZE OD (in.)	PRICE USA \$
F-240	1300	400	2.40	6.00
F-125	900	300	1.25	3.00
F-87	600	190	.87	2.05
F-50	500	190	.50	1.25
F-37	400	140	.37	1.25
F-23	190	60	.23	1.10

Chart shows uH per 100 turns.

Ferrite Beads slip over 18 ga. wire  
\$2.00 per doz.

Wide Band Chokes, Ferrite 1/4" dia.  
95c ea.

### EXPERIMENTERS KITS Iron Powder Toroids

Includes:

- 1 ea. T25-12, T80-2, T106-2.
- 2 ea. T25-6, T37-6, T50-2, T50-6.
- 3 ea. T68-2

Price \$7.50

### RF Ferrite Toroids

Includes:

- 1 ea. F23-Q1, F23-Q2, F87-Q1.
- 2 ea. F37-Q1, F37-Q2, F50-Q1.

Price \$10.00

TO ORDER: Specify both core size and mix for toroids. Packing and shipping 50 cents per order USA and Canada. Californians add 6% sales tax.

Fast service: Free brochure and winding chart on request.

# Palomar Engineers

Box 455, Escondido, CA. 92025

Phone: (714) 747-3343

# YAESU CPU-2500RK

## 2-meter FM transceiver with central processing unit

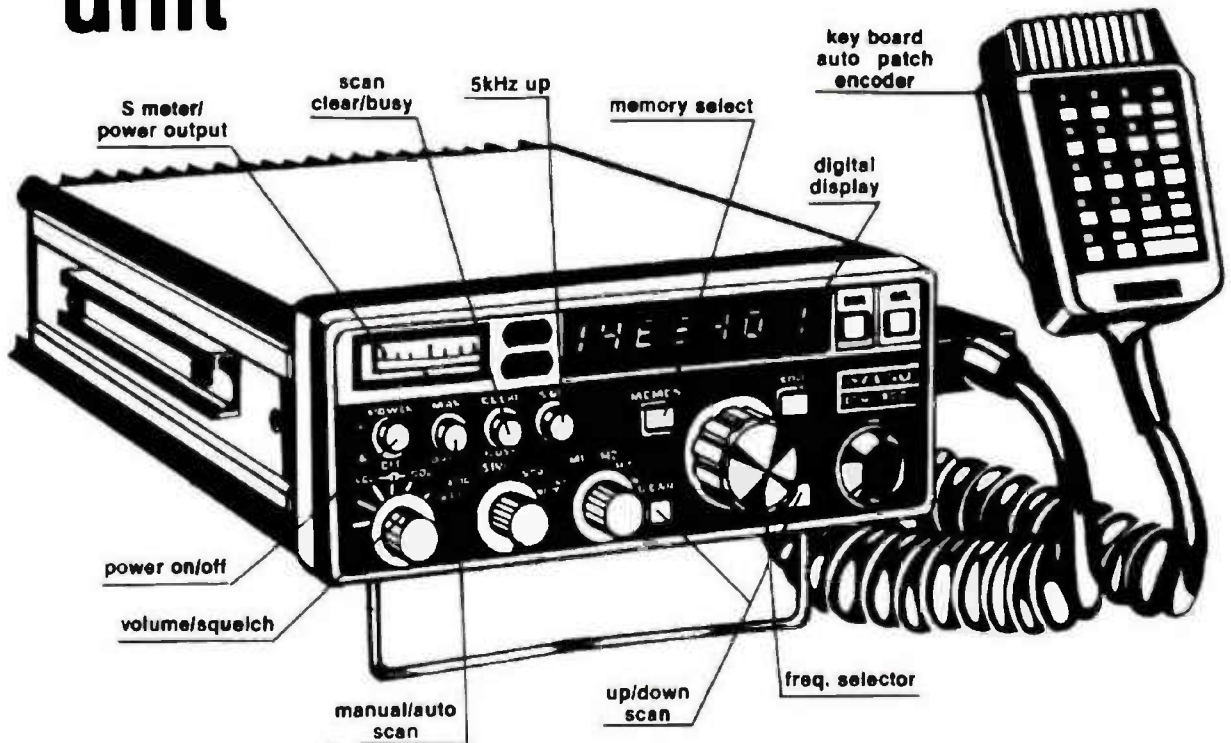

Just flick a switch and the CPU-2500RK will perform complex control operations. The CPU scanner moves you instantly up or down the band, and will search for a busy or clear channel, as desired. In the manual mode, a press of the mic PTT switch will halt the scan instantly. 800 PLL synthesized channels are available in 5 kHz steps over the entire 2-meter band. A photo-interrupter frequency selection technique is used, and full 6-digit frequency display is provided. Four memory channels are available for simplex or repeater operation, and an additional memory channel may be used for a split of up to 4 MHz. The keyboard microphone contains up/down scanner controls, a two-tone encoder for autopatch, and remote provision for dialing in operating or memory frequencies. A dual gate FET front end lets you pull in those weak signals, while the transmitter puts out a solid 25 watts at Hi power. (3 watts Low power) Convenience features include "busy channel" and "on the air" lights, a memory backup feature, single-shaft control for volume and squelch, and manual or automatic tone burst selection. Engineered for performance, using the latest technology, the CPU-2500RK is the dawning of a new age for 2-meter FM transceivers. Mobile mounting bracket included.



**Price**  
**419.95**

# Long's



Use your Master Charge or BankAmericard/VISA when you order.

# Ham Radio Department Store

MAIL ORDERS: P.O. BOX 11347 BIRMINGHAM, AL 35202 • STREET ADDRESS: 2808 7TH AVENUE SOUTH BIRMINGHAM, ALABAMA 35233



Call  
Toll Free

# 1-800-633-3410

ALABAMA CALL 1-800-292-8668 9 AM TIL 5:30 PM CST, MONDAY THRU FRIDAY

## KENWOOD SPECIAL! For a limited time, get a free SSB filter, plus save over \$380 when you buy the TS-180S plus accessories!

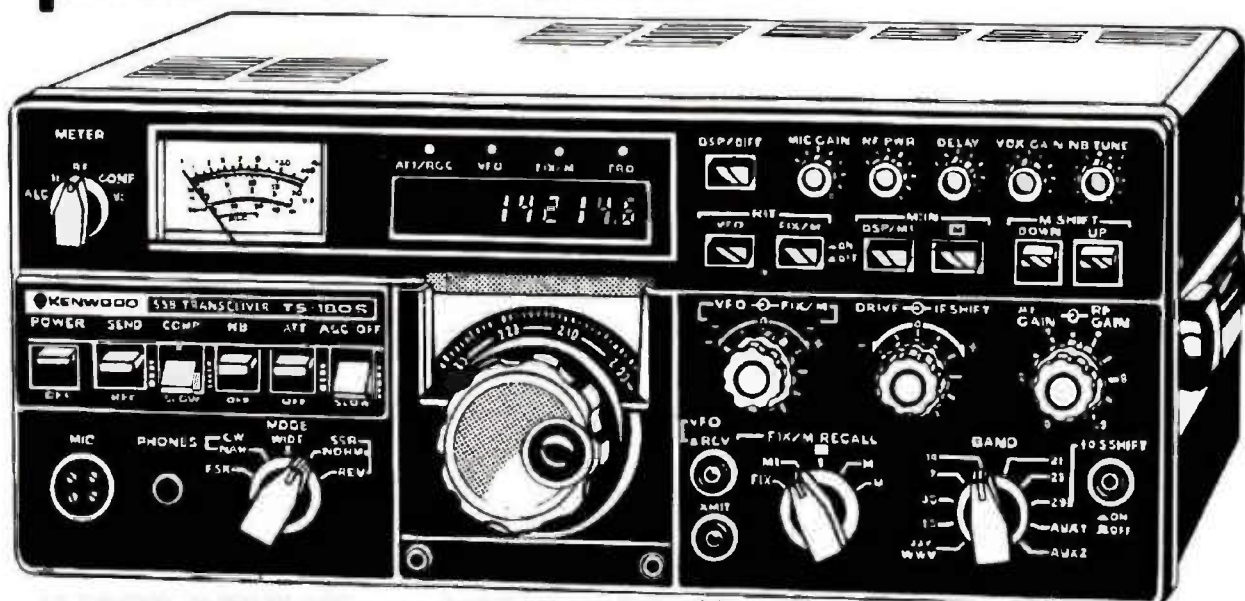

The TS-180S with DFC (Digital Frequency Control) is Kenwood's top-of-the-line all solid state HF SSB/CW/FSK transceiver covering 160 thru 10 meters. Features include four memories with digital up/down paddle-switch tuning. Memories are usable in transceiver or split modes, and can be tuned in 20 Hz steps up or down, slow or fast, with recall of the original stored frequency. Adaptable to three new bands and VFO covers more than 50 kHz above and below each band. Digital display flashes blinking decimal points to indicate "out of band." Other features are tunable noise blanker, dual RIT, RF speech processor, RF attenuator, and VSWR protection circuit. Power: 13.8 VDC at 20 amps. Input: 200W PEP/160W DC on 160-15 meters and 160W PEP/140W DC on 10 meters. Receiver sensitivity: 0.25uV at 10dB S/N. Hurry and get a free YK-88 SSB filter with the purchase of the TS-180S and accessories. That's a 59.95 value!

**Price 939.95** TS-180S W/DFC

TS-180S w/o DFC price 799.95

### Accessories for TS-180S

AT -180 matching antenna tuner .....	Price 127.05
VFO-180 matching remote variable frequency oscillator .....	Price 138.82
*SP-180 matching external speaker .....	Price 49.95

\*Speaker must be purchased with another Kenwood item worth over \$100.00.

Buy the TS-180S  
and the  
accessories and  
save \$383.98 plus  
get a SSB filter  
FREE  
(a 59.95 value)!



BY  
ED NOLL  
W3FQJ

# How to Build Multi-Band Inverted V Antennas

An antenna of the inverted-vee configuration, using proper wire lengths, can provide efficient multi-band operation of a single antenna. Such an antenna most often operates as an inverted dipole on the lowest frequency band, and as a long-wire inverted-vee (longer than a half-wavelength) on higher frequency bands.

The long-wire inverted-vee antenna can be used in conjunction with a tuner, or can be end-tuned to permit multi-band operation. End-tuning involves the attachment of small lengths of wire that tune the antenna to specific resonant lengths on various bands. When a tuner is used, critical "pruning" is not necessary, and a single proper cut often permits multi-band operation.

For best multi-band operation it is important that the length of the antenna wires be such that each section, Fig. 1, is a quarter-wavelength (dipole) or an odd multiple of a quarter-wavelength. In so doing, a maximum-current point exists at or near the highest point of the antenna system, and will provide the most effective an-

tenna performance on each band. These dimensions also ensure a relatively low-impedance feedpoint, and keep the standing-wave ratio on the transmission line at a reasonably low value. This article considers the logic and practical dimensioning of these special inverted-vee antennas.

## Impedance

As you know, the resistive impedance seen at the center of a half-wave dipole is approximately 70 ohms. The actual value depends upon height above ground and whether the dipole is a straight horizontal antenna or an inverted dipole. Nevertheless, a suitable match is made to 50- or 70-ohm transmission line. The resistive impedance seen at the center of a longer antenna, with legs that are an odd multiple of a quarter-wavelength, is somewhat higher. Thus, an inverted-vee antenna with legs that are three-quarter wavelength or longer will have a somewhat higher resistance than one with legs of only one-quarter wavelength. I have developed a preference

for 70-ohm line in matching to the longer inverted-vee antenna.

## Dimensions Charts

The basic equation for determining the overall length of a resonant antenna greater than a half-wavelength is:

$$\begin{aligned} \text{Antenna length in feet} &= \frac{492(N - 0.05)}{F(\text{MHz})} \\ &\text{in meters} = \frac{150(N - 0.05)}{F(\text{MHz})} \end{aligned}$$

*N* represents the multiple of a half wavelength.

This calculated value represents the overall end-to-end length of the antenna, and takes into consideration end-effects. The end-effect, of course, diminishes with antenna length. For example, an antenna that is nine half-wavelengths long on a given frequency is nearer to the free-space dimension value than one which is a quarter-wavelength long. The above equation takes this factor into consideration. If you wish to determine the length of each of the two legs of a center-fed antenna, the above equation is divided by 2.

Inasmuch as we are concerned with the antennas that are an odd multiple of a half-wavelength long (each leg an odd multiple of a quarter-wavelength long) the data given in Table 1 represents a substantial simplification of the

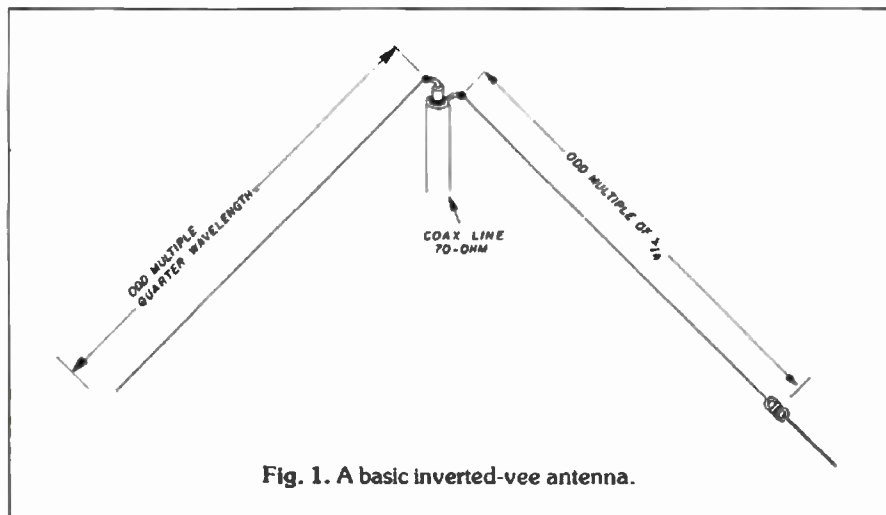

Fig. 1. A basic inverted-vee antenna.

Table 1. Basic equations.

Antenna size	For Length in feet	For Length in (meters)
1/4λ	234/F(MHz)	150/F(MHz)
3/4λ	720/F(MHz)	220/F(MHz)
5/4λ	1215/F(MHz)	375/F(MHz)
7/4λ	1710/F(MHz)	525/F(MHz)
9/4λ	2214/F(MHz)	675/F(MHz)



previous equation. For example, as is standard practice, each leg of a dipole antenna can be calculated by dividing frequency (in megahertz) into 234. If you wish to make each leg three-quarter wavelengths, then you would divide the frequency into 720. For example, if you wish to determine the size of a three-half-wavelength antenna for 15 meters, each three-quarter wavelength leg of the center-fed antenna would have a length of:

3/4 wavelength segment

$$\text{in feet} = \frac{720}{F} = \frac{720}{21.3} = 33.8 \text{ feet}$$

$$\text{in meters} = \frac{220}{F} = \frac{220}{21.3} = 10.33 \text{ meters}$$

To compare antenna leg lengths, a chart can be drawn up as shown in Table 2. This one has been planned for the SSB portions of the 10-through 75-meter bands. Values were obtained by substitution of the basic relations given in Table 1. Such a chart can be useful in determining leg lengths that are near to each other in value. Note, for example, that a dipole cut for 7.2 MHz (40 meter SSB) is 32.5 feet per leg. Close to this value, at 33.8 feet per leg, is a three-half-wavelength antenna cut for 21.3 MHz (15 meter SSB). In the following discussion of practical antennas, a number of these favorable relationships are used to advantage.

### Practical Antennas

Two practical two-band antennas, and how they are constructed, are shown in Fig. 2. The example A antenna operates on 20 and 75 meters. On 75 meters, it functions as an inverted dipole cut for SSB operation. On 20 meters, it functions as a three-quarter wavelength inverted vee. When operation on 20 meters is desired, the two wire jumpers are disconnected. For 75-meter operation, the jumpers connect across the intermediate insulators. Each jumper is a short length of wire with alligator clips attached to the ends.

The two sets of insulators are approximately 9.3 feet (2.8 meters) apart, and both sets are positioned close to ground level. In constructing

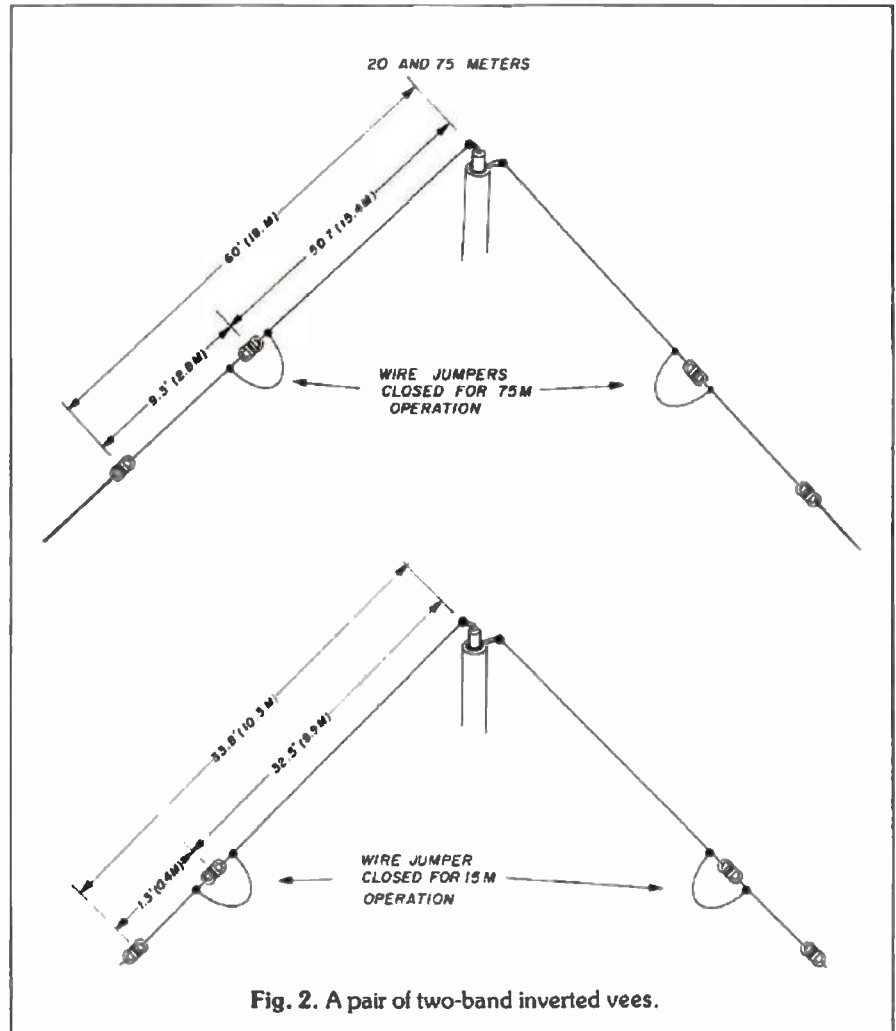

Fig. 2. A pair of two-band inverted vees.

your inverted antenna, arrange it so the jumpers can be reached conveniently by simply releasing one leg at a time to make the appropriate changes when changing bands. In my test antenna, two metal fence posts were used to bring the antenna close to ground. In fact, it was possible to make the jumper changes without re-

leasing the end wires from the fence post.

Some pruning of leg lengths may be necessary to obtain resonance at some precise frequency. This can be done conveniently because the antenna ends are so near to ground. Actual antenna length for a particular resonant frequency does depend upon

Table 2. Sample calculations for SSB segments of bands.

Band	MHz	1/4λ feet (meters)	3/4λ feet (meters)	5/4λ feet (meters)	7/4λ feet (meters)	9/4λ feet (meters)
75	3.9	60.0 (18.2)	189.5 (57.7)	—	—	—
40	7.2	32.5 (9.9)	100.0 (30.4)	168.5 (51.3)	—	—
20	14.2	16.5 (5.0)	50.7 (15.4)	85.6 (26.0)	120.4 (36.7)	156.0 (47.5)
15	21.3	11.0 (3.3)	33.8 (10.3)	57.0 (17.3)	80.3 (24.4)	104.0 (31.7)
10	28.6	8.2 (2.5)	25.2 (7.7)	42.5 (12.9)	59.8 (18.2)	77.4 (23.6)

# QHH?

Are you using HHP Logs?

## CONTEST LOG and PORTFOLIO

Designed exclusively for contests.  
Summary Sheets, QSO Map/Record  
a complete contest package.

Books or Pads \$2.35 ppd.  
(½ pound wt.!)  
for **FIELD DAY** we recommend:

our **BOOKS**—Single Operator's  
**PADS**—Club/Group STN's  
(Clubs—\$2.00 ea. with 2 or more)

**OPR STATION LOG SHEETS** \$2.45 ppd.  
(50 sheets)

3-ring log systems. GP log sheets for  
everyday (or night) QSO's, DX, rag chews

**RADIOGRAM FORMS** \$1.35 ppd.  
50 sheets

Send SASE for catalogue, samples  
We ship same day UPS/USPS.

GL es 73 de HHP!!!  
Send check, VISA/MC to:

**HAM HOBBY PUBLISHERS**

P.O. Box 757  
Socorro, New Mexico 87801

## JUNE Features IN



- 220 MHz Amplifier
- Yagi Antennas
- "Woodpecker" Noise Blanker
- Linear Amplifiers
- And More!

Don't miss the exciting June issue. Available soon in your local radio store. Not there? Then subscribe today. Just \$15 for 12 big issues.

**HAM RADIO**  
GREENVILLE, NH 03048

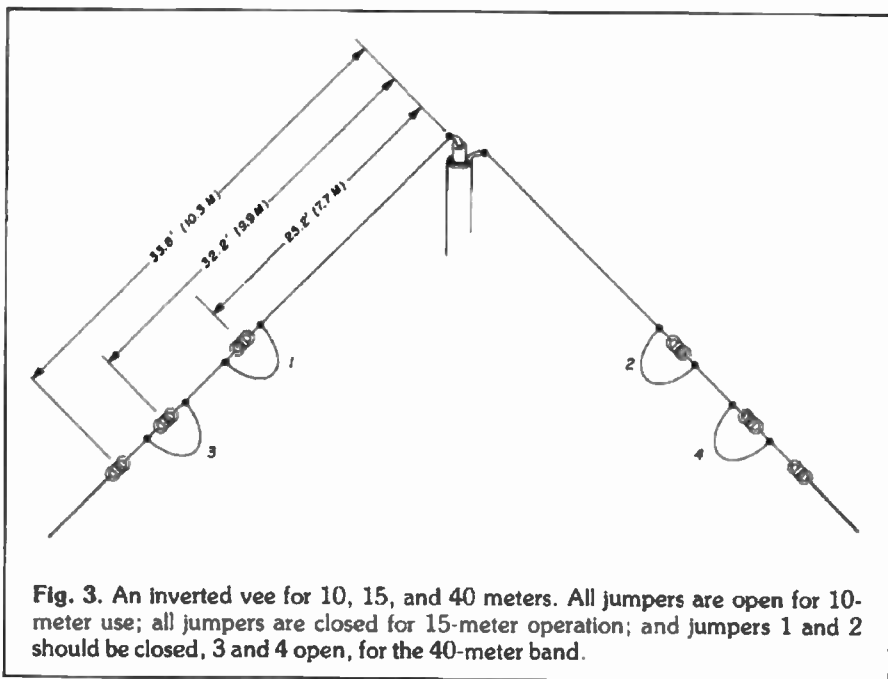

Fig. 3. An inverted vee for 10, 15, and 40 meters. All jumpers are open for 10-meter use; all jumpers are closed for 15-meter operation; and jumpers 1 and 2 should be closed, 3 and 4 open, for the 40-meter band.

the nearness of the antenna to ground, as well as the apex angle.

By critically cutting the element lengths for antenna A, it was possible to operate on 20 or 75 meters with a low SWR and without a tuner. The use of a tuner makes the leg-length cutting less critical.

A 15- and 40-meter combination is shown in example B. This antenna works as an inverted dipole on 40 meters, and a three-half-wavelength antenna on 15 meters. Again, the antenna element values are taken from Table 2. A quarter-wavelength dipole segment on 40 meters is 32.5 feet (9.9 meters); a three-quarter-wavelength segment on 15 meters is 33.8 feet (10.3 meters). Note the nearness of their overall lengths.

In this arrangement, the jumpers are closed for 15 meter operation and open for 40 meters. This antenna arrangement can be operated without the use of a tuner.

This same basic idea can also be extended to include more than two bands in operating capability. In fact, the simple antenna of Fig. 2A can be operated effectively on four bands, 10, 15, 20, and 80. With the jumpers disconnected, it will operate on 20 meters. When the jumpers are in place, and with the use of a tuner, the antenna will also perform well on 10, 15, and 75 meters. The chart shows

why this favorable relationship occurs. Note that on 15 meters the length of each leg for five-quarter-wavelength operation is 57 feet (17.3 meters), and for 10-meter operation the overall length indicated for a seven-quarter-wavelength leg is 59.8 feet (18.2 meters). Both of these values are close to the 60-foot (18.2 meter) dimension indicated for 75 meter SSB operation. The addition of a tuner makes the 10 and 15 meter dimension non-critical because an appropriate match can be made to the transmitter.

A three-band possibility is demonstrated in Fig. 3. In this arrangement, two sets of jumpers are used, and with careful pruning, no tuner is necessary. Such an antenna will operate as an inverted dipole on 40 meters, and as three-half-wavelength antennas on 10 and 15 meters. For 15 meter, operation jumpers 1 through 4 need to be closed. For 10-meter operation all jumpers are open. Closing jumpers 1 and 2 and opening jumpers 3 and 4 will set it up for 40-meter SSB use.

If desired, a tuner can be used to make the pruning less critical. The dimensions given in Fig. 3 can be used without change for tuner operation. Otherwise, a cut-and-try procedure is necessary to overcome the influences of variables on the antenna lengths.

HRH



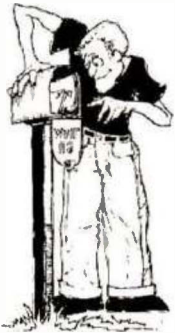

## Feel like you're missing something?

You are if you don't have a subscription to the "NEW" Ham Radio HORIZONS.

Here are some exciting features from the upcoming July issue:

- Field Day
- Surplus
- DX Lessons
- Bill Orr
- And much, much more!

More than ever HORIZONS is your kind of magazine, written with your interests in mind. Try a subscription today. Just use the handy bind-in card found between pages 76 and 77 or send \$12 for a year's subscription to:



Greenville, NH 03048

**AMATEUR RADIO'S CHANGING AND SO ARE WE**

## ANTENNA BOOKS by Bill Orr, W6SAI ALL ABOUT CUBICAL QUAD ANTENNAS

The cubical quad antenna is considered by many to be the best DX antenna because of its simple, lightweight design and high performance. In Bill Orr's latest edition of this well known book, you'll find quad designs for everything from the single element to the multi-element monster quad, plus a new, higher gain expanded quad (X-Q) design. There's a wealth of supplementary data on construction, feeding, tuning, and mounting quad antennas. It's the most comprehensive single edition on the cubical quad available. 112 pages. ©1977.

RP-CQ **Softbound \$4.75**

## THE RADIO AMATEUR ANTENNA HANDBOOK by William I. Orr, W6SAI and Stuart Cowan, W2LX

If you are pondering what new antennas to put up, we recommend you read this very popular book. It contains lots of well illustrated construction projects for vertical, long wire, and HF/VHF beam antennas. But, you'll also get information not usually found in antenna books. There is an honest judgment of antenna gain figures, information on the best and worst antenna locations and heights, a long look at the quad vs. the yagi antenna, information on baluns and how to use them, and some new information on the increasingly popular Sloper and Delta Loop antennas. The text is based on proven data plus practical, on-the-air experience. We don't expect you'll agree with everything Orr and Cowan have to say, but we are convinced that *The Radio Amateur Antenna Handbook* will make a valuable and often consulted addition to any Ham's library. 190 pages. ©1978.

RP-AH **Softbound \$6.95**

## BEAM ANTENNA HANDBOOK

Here's recommended reading for anyone thinking about putting up a yagi beam this year. It answers a lot of commonly asked questions like: What is the best element spacing? Can different yagi antennas be stacked without losing performance? Do monoband beams outperform tribanders? Lots of construction projects, diagrams, and photos make reading a pleasurable and informative experience. 198 pages. ©1977.

RP-BA **Softbound \$4.95**

Please add \$1.00 to cover shipping and handling.

**HAM RADIO'S BOOKSTORE**  
GREENVILLE, N. H. 03048

## JUST GETTING STARTED?

do it right with

## MADISON ELECTRONICS AND KENWOOD

The folks at Madison Electronics have long been happy to serve the newest members of the amateur community, and are proud to present these two "Getting started" packages. Pick the one that's right for you, and get started right.

### STARTER PACKAGE 1



Here's your chance to start with one of the hottest new rigs around and receive a free accessory in the deal. The TS120S solid state transceiver, featuring 80-10 meters, SSB and CW with VOX and IF shift. Small enough to go mobile! Top it with a free Palomar Keyer, and you're on your way.

TS-120S	\$699.00
PALOMAR KEYER	our gift
<b>TOTAL</b>	<b>\$699.00</b>

### STARTER PACKAGE 2



You simply can't buy better reliability, performance and reputation than the 520 series from Kenwood, and the TS520 SE is no exception. This is a just plain good radio at a tremendous savings, when you consider the free CW filter (YK-88) and microphone (MC-50) too.

TS 520 SE	\$829.00
MC-50 MIC	our gift
YK-88 CW FILTER	
<b>TOTAL</b>	<b>\$829.00</b>

# MADISON

Electronics Supply, Inc.

1508 McKinney • Houston, Texas 77002 • (713) 658-0268

# Ham Radio Techniques

BY BILL ORR, W6SAI

A few days ago a friend called me on the telephone. He was agitated and upset. He'd just bought a new, solid-state high-frequency transceiver, and was dismayed to hear distorted music and speech all over the dial. Obviously, the transceiver was no good and what should he do about it? Take it back to the store and ask for his money back?

As soon as I found some time I went over to his house and listened to the "defective" transceiver. Sure enough, there was voice and music coming in at various spots on the ham bands, and weak voices could be heard in the background on any band at any point on the dial. When the station antenna was removed, the interference disappeared.

The only obvious clue to this perplexing problem was that my friend lived very close to an a-m broadcast station. My guess was that the station was overloading the front-end of the transceiver. We placed a high-impedance VOM on the feedline to his antenna and measured the rf pickup at more than a quarter of a volt!

Removing the transceiver to my QTH, more than 10 miles from the broadcast station, immediately cleaned up the crosstalk and interference. But, the transceiver was useless at my friend's location which was less than a half-mile from the station.

What to do about it? The easy solution was to return the transceiver and request a "fix" (which might take months), or to solve the problem ourselves. The latter course was chosen after a short debate as to whether the equipment guarantee would be voided by any modifications made to the transceiver.

Once we removed the transceiver from the cabinet it became readily apparent that long ground-returns between circuit boards were causing the problem. The microphone ground, in particular, ran between boards and covered quite a distance before an actual circuit ground was reached. Removing the microphone plug, in fact, reduced the amount of interference heard on the receiver. After a quick examination, we decided that it was better not to fool around inside the transceiver, as the manual was not inclusive enough to give voltage measurements and, indeed, the full circuit of the transceiver was not given.

We finally agreed to build a "music filter," to be inserted in the transmission line between transceiver and antenna, that would attenuate broadcast-band signals sufficiently to remove the overload and cross-modulation. Here's the filter data for those of you experiencing this problem with solid-state equipment.

## The "music filter"

We decided to build a simple, high-pass filter that would attenuate signals below 80 meters that otherwise might overload the transceiver. Design of

*I'll bet that not one ham in ten knows of the interesting world of FM on 10 meters.*

the filter was made easier by the fact that my good friend W6PO had a complete filter program loaded into a laboratory computer. The problem was to design a filter that could be built out of standard components — ones that did not have oddball values of capacitance which would be difficult to obtain or measure.

Before the computer program was started, we realized that the filter should be left in the coaxial line, otherwise some form of switching would be needed to remove the filter during transmission (Fig. 1). Either approach was possible; if the filter were switched, ordinary receiving-type silver-mica capacitors could be employed. If the filter were left in the line, transmitting-type capacitors would have to be used to carry the higher power.

Small, encased, 1200- or 2500-volt mica transmitting capacitors can usually be found on the surplus market, so we decided to build the filter to be left in the transmission line. These capacitors are rated to carry several amperes of rf current in the hf region, while the current-carrying capability of receiving-type capacitors is unknown (Fig. 2).

A Butterworth filter configuration

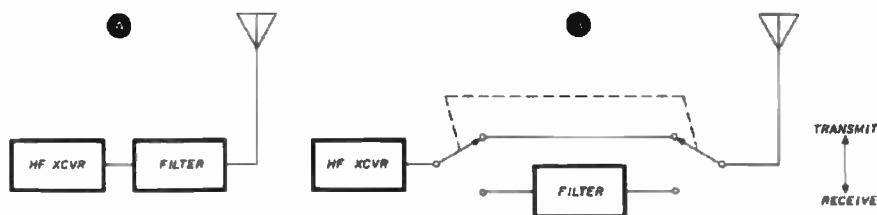
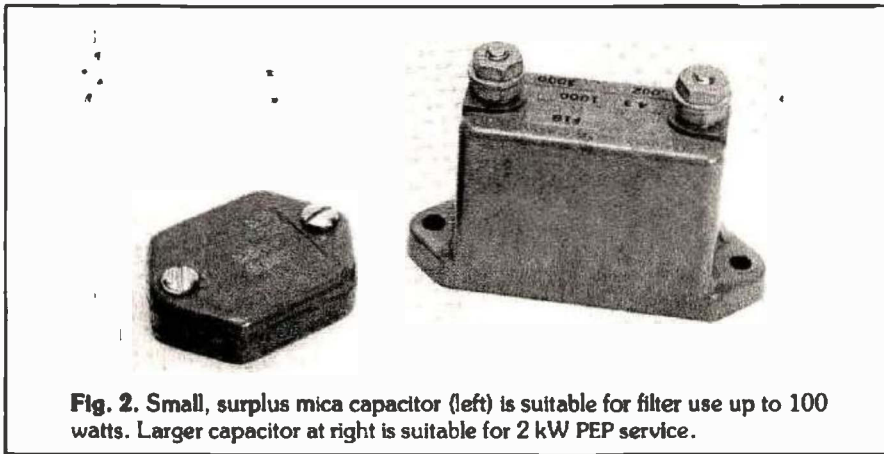

Fig. 1. "Music filter" can be left in coax line to antenna if transmitting-type mica capacitors are used in construction (A). If receiving-type mica capacitors are used, the filter must be switched out of the circuit in the transmit mode (B).





**Fig. 2.** Small, surplus mica capacitor (left) is suitable for filter use up to 100 watts. Larger capacitor at right is suitable for 2 kW PEP service.

was chosen so as to reduce the SWR caused by insertion of the filter in the line. The frequency of cutoff of the design was chosen to be below the 80-meter band, and was varied until the capacitor values came out to be in units that were available on the surplus market (Fig. 3). The frequency of cutoff turned out to be about 2.35 MHz with the capacitor values listed.

The filter was built up on a section of printed circuit board, as shown in Fig. 4. No shielding was used for the first try, which was an instant success. Placing the filter in the coaxial line from transceiver to antenna immediately knocked out the annoying interference, and did not measurably alter the SWR on any ham band.

### Building the filter

For maximum attenuation, the filter should be built up in a metal box. We used pieces of circuit board to build up an enclosure having one internal partition, as shown in the sketch. The coils were fabricated from preformed coil stock, and placed at right angles to each other in the compartments. The ground lead of each coil was soldered directly to the circuit board. Coaxial receptacles were mounted on the box ends, and a form-fitting hole was cut and filed in the middle partition to pass the center filter capacitor. The completed filter didn't look very pretty but it worked very well, eliminating all signs of broadcast voice and music from the ham bands.

As easier approach is to buy a miniature aluminum box that is about the same size as the circuit board box. The *Bud CU-482* "Converta-box," measuring 2 x 8 x 4 inches will do. An aluminum shield plate can be cut to pass across the middle of the box and can be bolted in position with

small angle brackets and 4-40 hardware.

### The popular ground-plane antenna

One wet, rainy Sunday, I browsed through a whole box of QSL cards that I had collected in the past ten years. The cards represented both DX and local contacts on 10, 15, and 20 meters. I was curious to see what antennas were most popular on those bands and I thought I could get a clue from the station data included on most QSLs. While this was not a scientific survey, one fact was immediately apparent. A large proportion of hams use the simple, inexpensive, and uncomplicated ground-plane antenna.

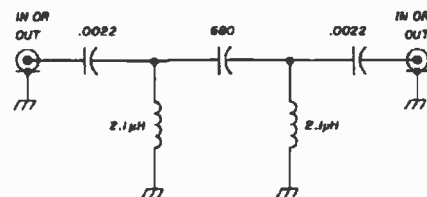

**Fig. 3.** Schematic of the "Music filter." Each coil consists of 20 turns, 3/4 inch diameter, 8 turns per inch (B&W mini-inductor, or equivalent, may be used).

tenna. This fact was strongly confirmed a few days later during a telephone conversation with a friend in the antenna business. He confirmed that it was fun and profitable to sell big beam antennas, but the meat-and-potatoes end of the business was selling ground-plane antennas. Almost as an aside, he mentioned that he'd gotten a few letters from owners of some modern, solid-state transceivers complaining about his antennas — the new transceivers wouldn't load up — obviously the fault of his antenna!

Our discussion further revealed that the problem probably lay in the fact that many makes of transceivers incorporate a fail-safe circuit that gradually turns off the final amplifier stage as the SWR on the transmission line to the antenna rises. High power transistors, in the main, don't like to work into a reactive load created by a high value of SWR on the transmission line, and can self-destruct if the SWR is too high. To prevent this, the canny transceiver manufacturer protects his device, his warranty, and his reputation by incorporating an SWR-sensing circuit in his equipment.

This is a good idea, but what happens to the Amateur who has a too-high value of SWR on his coax line? The answer is obvious: his transceiver runs at reduced power, or else it turns itself off.

Some (but not all) ground-plane antennas provide a simple "hair-pin" match that transforms the input impedance of the antenna to 50 ohms; most do not. After the conversation with my unhappy friend, I searched my records to find out if I had access to any matching information for the ground-plane antenna. I found the data, and, by piecing together various charts and consulting several handbooks and magazine articles, I came up with a summary of the so-called hair-pin match which any ham can apply to his home-made ground plane antenna at virtually no cost and little effort.

All the scheme consists of is a simple L-network made up of a parallel-connected inductor and the natural series capacitance of the antenna. To make things work out properly, we have to make a few assumptions. The first assumption is that a 50-ohm transmission line is used. The second assumption is that the input (base) resistance of the ground plane is 30 ohms. I know that the input resistance

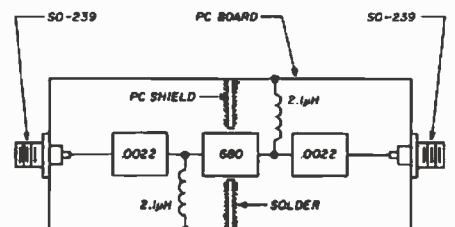

**Fig. 4.** The Test filter was built up on a section of PC board. Coaxial receptacles and a shield plate were soldered to the board, as were the ground ends of the inductors.

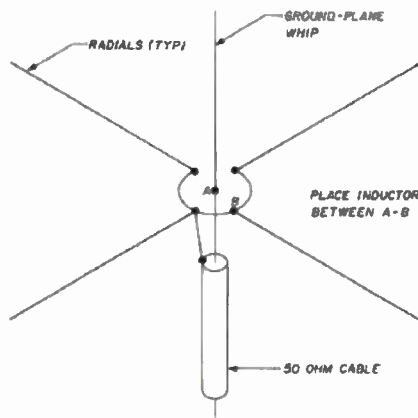

Fig. 5. Inductive match for ground-plane antenna.

Let  $Z_0$  = line impedance = 50 ohms  
and  $R_R$  = input resistance of antenna = 30 ohms

Inductive reactance ( $X_L$ ) required across antenna terminals (A-B) to achieve match:

$$X_L = \frac{Z_L}{\sqrt{\frac{Z_0}{R_R} - 1}} = \frac{50}{\sqrt{\frac{50}{30} - 1}} = \frac{50}{\sqrt{1.67 - 1}} = \frac{50}{0.8}$$

$$X_L = 62.5 \text{ ohms}$$

For this value of  $X_L$ , a coil calculator provides:

Band (meters)	Inductance ( $\mu\text{H}$ )	Coil dimensions, inches (mm)
6	0.20	4 turns No. 12 (2.1 mm), 1/2" dia., 1/2" long (13 x 13)
10	0.35	7 turns No. 12 (2.1 mm), 1/2" dia., 7/8" long (13 x 21)
15	0.48	9 turns No. 12 (2.1 mm), 1/2" dia., 1-1/8" long (13 x 28)
20	0.70	8 turns No. 12 (2.1 mm), 3/4" dia., 1" long (19 x 25)
40	1.40	14 turns No. 12 (2.1 mm), 3/4" dia., 1-3/4" long (19 x 45)
80	2.80	12 turns No. 14 (1.6 mm), 1" dia., 1" long (25 x 25)

is a function of conductor diameter, length of the radials and the whip, the number of radials, and other factors, but, taking 30 ohms as par, the data of Fig. 5 indicates the size of the shunt coil that will match the antenna to the transmission line.

And it works! In spite of all of the assumptions, the little coil really does the job. Compressing or expanding the coil, or altering the number of turns, will zero-in on a very low SWR figure at the resonant frequency of the antenna.

This matching technique was used in conjunction with a popular high-frequency transceiver and a ground plane antenna. It dropped the resonant SWR of the antenna from about 1.7-to-1 to below 1.1-to-1, and the output of the transceiver went from 55 watts to better than 100 watts.

All you have to do is to insert the

coil between the base of the vertical section of your antenna and the radial system, with the shortest possible leads. The approximate value of required capacitive antenna reactance is achieved by shortening the antenna element about two per cent.

Let's say your 20-meter ground-plane whip is 16 feet 6 inches (5.02 meters) long. Shortening by two per cent is equivalent to multiplying the length by 0.98. Thus,  $16.5 \times 0.98 = 16.17$  feet, or about 16 feet 2 inches (4.92 meters). If you are lazy, you can omit this minor change. The only penalty you will pay is that the resonant frequency of the antenna will drop a bit. On 20 meters, for example, the resonant frequency of the antenna drops about 150 kHz if the whip is not shortened. In any case, the ground-plane radials are not modified.

What do I do? The first few times I used this network I took down the whip and trimmed it to length. After that, I grew lazy and left the whip as is. I didn't notice any appreciable difference, either.

You can check operation of the simple network by making a "before and after" SWR sweep across the band in question. Plot SWR versus frequency for the ground-plane with and without the matching coil. Finally, adjust the coil slightly, and/or the length of the antenna itself, until the SWR approaches unity at your desired design frequency. That's all there is to it!

### What about a tri-band vertical?

Will this system work with a trap-tuned, tri-band vertical antenna? The reply is a qualified yes. You'll note that the SWR is the worst and the bandwidth the least on the lowest frequency band of your tri-bander. You can install the network for that band, however; it will have little effect on the higher bands.

If your SWR is highest on one of the higher bands, you're out of luck. You can improve the SWR on the 15 meter band on a tri-band vertical, for example, by using a 15-meter network. It won't disturb operation on 10 meters, but it will upset operation on 20 meters. Sorry about that!

### "What's new?" department

I warned you a few columns ago that from time to time I would discuss new equipment, or other interesting aspects of ham radio. This "What's New?" section deals with high-frequency fm operation.

I'll bet that not one ham in ten knows of the interesting world of fm centered about 29.6 MHz on the 10-meter band. If you tune up there with your transceiver, all you'll hear is gibberish that sounds like a lopsided, maladjusted a-m transmitter. Not so! This is the interesting world of fm and more and more Amateurs are finding it is alive and well on 10 meters. Sure, 2-meter fm is old hat, but how about 10 meters? Long a retreat for avid fm operators who built or converted old commercial rigs, 29.6 MHz is fast becoming a popular calling and working frequency for more Amateurs who are discovering the fun of long-distance fm operation. For better or



worse, there's a lot of action on 10 fm. While running only 10 watts, I've been able to contact five continents and over thirty countries and many of the DX contacts have been clearer and better than an equivalent contact on SSB. My best piece of DX was a 20-minute chat with UB5KBC in the Ukraine, who called me unexpectedly one day when I was down on 29.4 MHz fm. And, when the band is open, Japan, South America, and Europe put dazzling signals into W6-land on narrow-band fm.

No doubt 10-meter fm (which was once quite popular in the post-World War II days) is coming to life, spurred in part by the appearance of a few transceivers that permit this mode of operation. The Yaesu FT-901DM for example, works the fm mode, and you'll hear a lot of them on 29.6 MHz. Less expensive and more popular is the 80-channel Comtronix FM-80. This is as well-known on 10-meter fm as the famous "DX-100" transmitter was on 80 meters during the late fifties. Imagine working the world with a 10-watt fm transceiver smaller than a good book! It can be done, and hundreds of happy hams prove it every day.

I hesitate to expound the virtues of 10-meter fm because more hams on the channel means more QRM. However, there are plenty of channels each side of 29.6 MHz to take up the overflow (fm channels, by agreement, are spaced 20 kHz apart). And, finally, this is a plea to SSB operators to stay clear of the region between 29.5 and 29.7 MHz. There's plenty of space for you lower in frequency in the 10-meter band, and SSB and fm are definitely *not* compatible!

#### A final note

Since this column is written almost three months in advance of the publication date, my "turn-around" time isn't very fast. However, I am always interested in hearing about novel ideas from my readers. If you have an interesting antenna, or other piece of equipment, I urge you to communicate your idea to other Amateurs via this column. For each item used, the sender will receive a one year subscription to *Ham Radio Horizons*. If you are already a subscriber, your subscription will be extended a year. How about that!

HRH

# Antenna Tuner



**\$299.95**

Here is a new tuner that puts more power into your antenna, works from 160 through 10 meters, handles full legal power and then some, and works with coax, single wire and balanced lines. And it lets you tune up without going on the air!

#### WE INVESTIGATED

All tuners lose some rf power. We checked several popular tuners to see where the losses are. Mostly they are in the inductance coil and the balun core.

So we switched from #12 wire for the main inductor to 1/4" copper tubing. It can carry ten times the rf current. And we've moved the balun from the output, where it almost never sees its design impedance, to the input where it always does. Thus more power to your antenna.

#### IMPOSSIBLE FEAT

The biggest problem with tuners is getting them tuned up. With three knobs to tune on your transceiver and three on the tuner and ten seconds to do it (see the warning in your transceiver manual) that's 1 1/2 seconds per knob.

We have a better way; a built-in 50-ohm noise bridge that lets you set the tuner controls without transmitting. And a switch that lets you tune your transmitter into a dummy load. So you can do the whole tuneup without going on the air. Saves that final; cuts QRM.

#### BROCHURE AVAILABLE NOW

For further details on this exciting new high-power low-loss, easy-to-use tuner send for our new brochure. Or visit your Palomar Engineers dealer.

To order send \$10 shipping/handling. California residents add sales tax.



# Palomar Engineers

Box 455, Escondido, CA. 92025 • Phone: (714) 747-3343

# Build an SWR / Wattmeter

BY WILLIAM WINTER, Jr.  
WB8JCQ/LU1AKO

Putting some meaningful scales on your homebrew meter.

Doug DeMaw, W1FB, wrote a very good article on wattmeters that appeared in the December, 1969, issue of QST.<sup>1</sup> This instrument has appeared in subsequent editions of the ARRL *Radio Amateur's Handbook*. This is a basic design used by many manufacturers, as DeMaw states.

Some time back, I built a wattmeter using that article as a guide. I used point-to-point wiring because printed circuit board construction is impractical for a one-of-a-kind unit. It worked very well, except for the fact that, because I had available only a linear meter movement, the calibration did not follow the dial markings. I used it this way for many years, as a relative-output indicator. I thought that someday I would have the means to calibrate it more satisfactorily.

One day, I noticed a meter advertised (catalog No. TM21K401) in the "This Month" flyer from Herbach & Rademan, Inc., 401 East Erie Ave., Philadelphia, Pennsylvania 19134. This meter has the following scales: SWR, 0-10, 0-25, 0-500 watts, 0-100 per cent modulation, and 0-10 linear scale. The meter movement is a 100-microampere, full-scale unit. Their price was \$5, so I purchased one. These are brand new, high quality units, probably intended for a multi-use instrument.

The only difficulty I encountered in mounting the new meter to replace the old surplus unit was the mounting bolts. These bolts have metric threads, and no nuts were supplied; but I found the required nuts in my junk box. I made a few component changes in the original DeMaw circuit. The diagram, Fig. 1, shows the circuit I used. The original DeMaw circuit used two switches: one to switch from low to high power and the other to

switch from forward to reverse. Because it is not advisable to read SWR at high power (the transmitter could be damaged if operated at high-power under conditions of excessive SWR), I changed the switching arrangement. Only one single-pole, four-position switch is needed, but, because I already had two switches mounted, I retained that arrangement. S1 position one reads SWR at a 25-watt level. Position two reads forward power. S2 selects 25, 500, or 2500-watt scales.

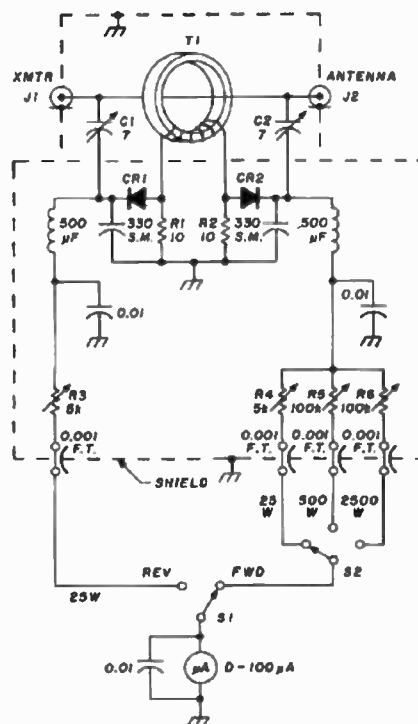

Fig. 1. The schematic of the SWR/wattmeter. T1 is a toroidal transformer consisting of 35 turns of No. 36 (0.13 mm) enameled wire spaced to cover entire core. The core is a Micrometals T-68-2. R1 and R2 are 10-ohm carbon composition resistors, and must be matched for resistance. CR1 and CR2 are matched Germanium diodes.

The series-trimmer values were selected according to this meter movement and the diodes used. The diodes I used were unidentified germanium types, removed from a surplus computer board. I used an ohmmeter to select a matched pair. Different diodes and meter movements may require changes in resistance beyond the range of the trimmers specified.

## Balancing the bridge

Connect the transmitter to J1, and a 50-ohm dummy load to J2. Be sure the dummy load is non-inductive; wire wound or metal-film resistors or light bulbs are no good here, as they will cause an impedance mismatch. Also, be sure the restive load can handle the amount of power used.

Apply enough transmitter power for a full scale reading on the lowest forward scale. Switch to reflected power and, using an insulated screwdriver, adjust C2 for a null. It may be necessary to temporarily jumper power across R3 and/or increase transmitter power to get enough meter movement for a meaningful null. Remove the jumper.

Reverse the coax connections to J1 and J2. Switch to reflected power and apply enough drive for full-scale reading. Switch to forward 25 watts, and adjust C1 for a null. Here again, it may be necessary to temporarily short R4 and adjust transmitter power for a meaningful null adjustment.

Repeat these steps until no further improvement is achieved.

## Calibrating the meter scales

Using a calibrated wattmeter connected between the J1 terminal and the dummy load as a standard, couple enough power to J2 to achieve 25



watts output as read on the calibrated power meter (I used a Bird 43 and Heath Antenna). Switch to reverse power and adjust R3 for a full-scale (25-watt) reading.

Reverse the coax connections so that the transmitter is connected to J1 and the calibrated wattmeter is between J2 and the dummy load. Switch to forward power and calibrate R4 for 25 watts full scale.

Following the procedure of this last step, adjust R5 and R6 for the full-scale ranges you have chosen (500 watts and 2500 watts, in my case). Be sure to increase the transmitter power output to achieve at least mid-scale or higher reading to get accurate calibration. Be careful not to exceed the dummy load ratings. Use short key-down times; a 10 to 1 ratio for key-up to key-down, for example (5 seconds key down to 50 seconds key up).

#### Measuring SWR

Standing wave ratio readings are made as follows: Couple enough forward power to the antenna for a 25-watt full scale reading. Next, switch to reverse power, and read SWR directly off the scale.

If the meter specified is no longer available, Herbach & Rademan also list a smaller meter, catalog No. TM21K436. It appears to have only a 0-1 linear scale and SWR scale. This could be useful for SWR applications only, if power readings are not needed. B & F Enterprises, 119 Foster St., Peabody, Massachusetts 01960, advertise a 2½-inch power-meter movement for \$3.38, catalog No. 9W0078. It does not appear to have an SWR scale.

These unused, surplus meter movements are apparently from the CB industry: probably discontinued production, parts overstock, etc. Their appearance on the surplus market makes it very attractive to build your own wattmeter. It is now possible to home brew your own and have a unit with performance and appearance equal to that of commercial units, at a fraction of the cost.

#### Reference

1. Milton F. DeMaw, W1FB, "In-Line RF Power Metering — Some Practical Considerations," QST, December, 1969, page 11.

HRH

# Our smart machine reads sloppy copy.

New! Includes 24-hour UTC clock, 110 and 300 baud ASCII, & tuning eye!



## Kantronics Field Day<sup>®</sup>

\$449.95

If someone tells you they offer the same features we do, check them out with the list below. Kantronics offers the finest in state-of-the-art technology through over 35 dealerships in the United States, Canada and West Germany.

- Morse copying ability
- 3 to 80 WPM Morse range
- Computer programs for improving sloppy Morse
- Radioteletype copying ability - 60, 67, 75 and 100 WPM Baudot
- ASCII radioteletype ability - 110 and 300 WPM baud
- Copies any shift of RTTY
- 24-hour UTC clock available in any mode
- Entire unit contained in one package
- Automatic code-speed tracking
- Full 10-character, large-size display
- Displays code speed
- Tuning eye for faster tuning
- Full year limited warranty
- Internal speaker
- Requires no TV set for use
- Advanced demodulator circuits
- Internal 200 Hz bandwidth filter
- All letters, numbers and punctuation plus 8 special Morse characters and 5 special RTTY characters
- 15-day trial period

Send for our free brochure that explains the Field Day system of Morse and RTTY decoding. Or you can order from one of our dealers or our factory today. Our number is below, give us a call.

Special SWL model - \$464.95

Free

Code Reading Made Simple

Okay, tell me more.

Name

Address

City

State

Zip

**Kantronics**  
1202 E. 23rd Street (913) 842-7745  
Lawrence, Kansas 66044

# Ten Tec Owners' Report

BY THOMAS McMULLEN, W1SL

Over 200 owners talk about their Ten-Tec Tritons

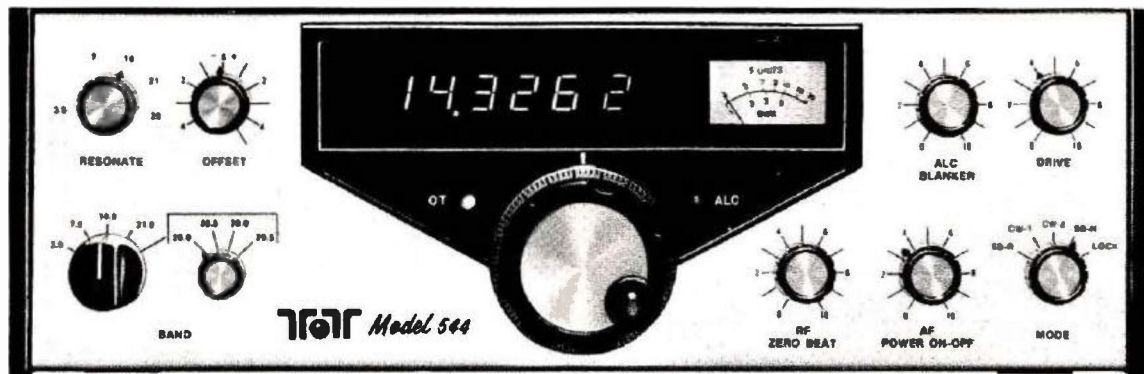

The Ten-Tec Triton, another made-in-America rig, was one of those listed on the owners' report form in our December issue of *Horizons*, and the response has been terrific. The number of replies is greater than from previous surveys, and the comments are extremely favorable, both toward the equipment and the people who make, sell, and service Ten-Tec rigs. In fact, to quote one reader ahead of the summary, "This (rig) has the quality and pride of workmanship that one used to expect of U.S.-made gear."

You'll note from the tabulations and comments, the Ten-Tec Triton has not been free of gremlins, but, as I've pointed out before, most Amateurs take an occasional trouble in stride, as long as they feel they are getting good service from concerned people at the manufacturer or dealer level. The numbers in this summary tell the tale. Enough of this — let's get into the meat of the report.

## The good features

Anyone who thinks that CW is a lost or dying art has only to look at the list of best features to find that Morse is alive and well. The feature most

often mentioned is the full break-in CW capability (QSK) of the Triton; it leads the list at 67 per cent. Close behind is the no-tune feature when changing bands, with a popularity of 51.8 per cent. A similar trait, under the name of ease of operation, also gets a high score at 31.8 per cent. (Yes, I know that totals more than 100 per cent; that's because almost everyone listed more than one feature. Sometimes it was hard to choose, because the list looked like advertising copy with every desirable feature a rig could have. In such cases, I just had to draw the line at the first three, or else take a year off to get this report ready.) Table 1 shows how the best features stack up. Now for some comments from the replies:

"It has many good features, but I especially like the simple, uncluttered front panel. I just want to use it to communicate with, not fly it." — K7MS.

"It's solid-state, and you don't have to peak (the final) every time you change bands." — WB4BYG.

"I have received numerous favorable signal reports on the fine-sounding CW tone." — WB9DFR.

"Solid-state, no tuning for QSY. A wonder to operate!" — WD4MKQ.

"This is a fun rig — ease of operation (is its best feature)." — WBØVCA.

"Easy to move around bands and between bands due to no-tune capability. Receiver is very selective and sensitive, noise blanker is effective, and the audio is clean and sharp. It is a real pleasure to sit and operate for long periods." — (unnamed by request.)

"With the Ten-Tec, you cannot limit the admirable features to one choice." — WD4ENA.

"Simplicity, ease of operation — since purchase, I have logged about 30,000 miles of road travel, some pretty rough, with no mechanical or electrical problems. It provides stable SSB operation while car is in motion." — WA4KTH.

"Tune-up-free operation and full break-in CW are 2 major features, but the fantastic people at Ten-Tec also deserve mention. I have never met a more helpful manufacturer." — KB4LX.

"Frequency stability, even from a cold start." — W8ISG.



**Table 1. Best-liked features and worst features listed in over 200 replies to the Ten-Tec questionnaire.**

Best feature Item	Per Cent
Full break-in (QSK) CW	67.0
No-tune finals	51.8
Ease of operation	31.8
Good audio quality	8.9
Stability	7.4
Solid-state, no warmup	7.4
Digital display	6.6
Excellent receiver	6.6
Good duty cycle for RTTY	2.5
Remote VFO	2.5
RIT	2.5
Good SWR protection	1.5
Reliability	1.5
Noise blanker	1.5
Pulsed calibrator signal	1.5
Compact	1.5
American made, good quality, 12-V operation; each less than	1.0
Worst features Item	Per Cent
VOX (location, doesn't work, susceptible to rf)	22.5
RF feedback problems	17.0
Cabinet (style, plastic, inadequate shielding)	17.0
Microphone, key jacks in rear	10.3
CW filter	8.9
Receiver overloads easily	6.7
SWR circuit too sensitive	6.7
Lettering on panel wears off easily	5.2
Dial slippage, backlash	3.7
No separate filter	3.0
Hand capacitance on VFO	3.0
External power supply	2.5
No I-f shift	2.4
Poor ALC	1.6
Tuning rate too fast	1.6
No spot switch	1.6
Birdies	1.6
Poor AGC action	1.4
Speaker location, no phone patch, images, no speech processor, dial lamps hard to replace, noise blanker, SWR meter, touchy antenna switch, price; all less than	1.0
None	16.2

"Best CW rig on the air. Full break-in, ease in tuning, sharp 150 Hz CW filter." — WBØVCA. (Note — this guy had five Tritons and two other Ten-Tecs! Editor.)

"All solid-state, no finals to load." — VE1BRY.

"Easy to operate, beautifully designed, very reliable. It does a great job, made in U.S.A. by very good people!" — KA3BGP.

"I like its CW; it has fantastic break-in." — WA4SCL.

"No drift, no warm-up time, no-tune finals." — WB5MMM.

"The no-tuning feature is beautiful, this should be mandatory for all those dummies that don't use dummies." — WB3HZZ.

"Automatic shut-off if wrong antenna is accidentally used or if SWR goes up for any reason." — WD5JRF.

"It is the easiest-to-operate rig that I know of." — W4JTL.

"Have to call it a tie. I can't decide

---

### *"You cannot limit the admirable features to one choice."*

---

whether it's the no-tune, broadband, solid-state output or the fantastic CW break-in operation." — W3JF.

"Operates directly from a 12-V auto battery with no fuss and with good efficiency. I didn't have to sacrifice any performance, convenience, reliability, or money to get that feature on top of everything else." — WB3FDS.

"100-per cent duty cycle on RTTY on all bands." — WD4CKA.

"QSK is the best feature of the Ten-Tec, but it is also easy to operate, and a joy to receive the compliments on audio quality and smooth CW that the rig produces." — KØARO.

"Ease of operation . . . on second thought, the rig's best feature may just be the people who designed and built the Triton. The Ten-Tec folks are of very high caliber." — N3FM.

"Its durability is superb. I have used it in 130-degree desert heat, and in freezing snow, to provide communi-

cations for off-road races. It has never failed in 11 races." — K6WS.

"Receiver sensitivity and lack of distortion. This is the only rig that makes the higher-pitched female voice sound natural." — K3RH.

"QSK . . . this rig is made for CW operation, which I use more than SSB. However, this is not at the expense of SSB — it works great on both modes." — W9NG.

"Full break-in CW . . . also, the factory people have been terrific. I make my living at electronics, and I wish that all electronic companies were as concerned with their product." — AE6Z.

"Ease of operation, no peaking and dipping, etc., just change bands and go. But, I can't forget full QSK — this makes CW operation fun; conversations instead of monologues." — K3ZHD.

"Receiver is great — very low noise." — K2MO.

"Full break-in CW. Sounds like the receiver never goes off — very good for DX and contest work." — WDØGAF.

### The disliked features

The VOX circuitry in the Triton came under the heaviest fire, showing up in the "Worst feature" column 22.5 per cent of the time. A related item, susceptibility to rf feedback, tied with the plastic cabinet (which may be related to both problems) for second place at 10.7 per cent. In third place is the location of the microphone and key jacks in the rear of the transceiver. A note about the rf feedback and the plastic cabinet — one reader commented that he had applied a generous amount of aluminum foil to the inside of the cabinet to provide better shielding. This may be worth a try, but if you have this problem, check with the people at Ten-Tec to see if they have any other suggestions. Here are a few comments about features that were less than the best:

"(The Triton) being a sharply styled unit, the overall mechanical design is functional but abbreviated. It resembles more of a mechanical prototype than a marketed unit." — KØYQX.

"VOX is not the best in the west — or east." — N4BYU.

"The external power supply I don't like." — WB4BYO.

"Case is not really rugged enough." — WB9DFR.

# Ten Tec Report

"Rf feedback through VOX in power supply. I resolved this by not using VOX." — WA8FOW.

"They don't give them away — make you pay real money!" — KA0AZQ.

"Plastic side panels on case." — WA5WFP.

"Could be better rf protected. When I'm using a long-wire antenna, the display goes crazy. I've tried everything . . . well, almost everything." — WD4MKQ.

"Local broadcast station rips me up on 80 meters. Local stations (within 5 miles) desense the front end even with the gain reduced." — K8DD.

"Tunes much too fast on 10 meters. VOX is worthless." — W3TES.

"LED for ALC is not sensitive enough — seems like a cheap thing for the price of the rig." — N6AWJ.

"Meter monitors SWR only, and leaves the operator to assume that full power is going out." — W8AU.

"Too many essentials in the back of rig. Have to fumble around to locate the plugs." — WD6DLL.

"Dial mechanism is cheap, binds, and makes tuning for RTTY somewhat difficult." — W8ISG.

"Headset jack in back, and issue microphone is sorry; I suggest using a Shure 444." — WB5MMM.

"Lack of analog dial to go with digital; microphone plug in rear of set, making a long cord necessary and very inconvenient; VOX control in power supply (bad, bad); even with these poor features, this is a tremendous rig!" — W8SUE.

"Labels should be more permanent." — WB3HZZ.

"The only bad feature that I know of is the silk-screened lettering is wearing off the front panel." — W4JTL.

"Poor shielding of the cabinet makes the rig susceptible to rf feedback into VOX/speech amplifier . . . and also produces local (in-house) TVI." — W3JF.

"I would say cabinet construction, although this has its advantages

— damaged panels can easily be replaced." — WB7OTC.

"On the back panel is a slide switch that has almost no detent. When it slips out of position, the transmit antenna is disconnected from the receiver." — WB3FDS.

"Lack of built-in VOX . . . accessory VOX is very susceptible to rf feedback." — WA8VEB.

"The VOX in the 262M power supply just doesn't work in the presence of stray rf." — WB0HUX.

"Hand capacitance changing the VFO frequency when the metal part of the tuning knob is touched." — WA5KCZ.

"Receiver could be a little more selective with better crystal filter. Also, immunity from overload could be better. There's a problem with pulses from the clock circuit on the digital display, audible in several places on different bands." — AK4B.

"Will not heat my cold shack! Ser-



iously, no bad feature I can think of." — AG8A.

"Bought the 540 in October, and haven't found a bad feature yet." — WB1CXJ.

"If it has any bad features, I haven't found them yet." — W7DBE.

"If it had a bad feature, I would never have bought it!" — WB2IVX.

## Troubles

Then we get to the problem question, No. 11 (Have you had any problems?). In response to this one, the answers stack up like this:

No = 29.5 per cent  
Yes = 70.5 per cent

Troubles named by owners are shown in Table 2, along with the number of times reported. It seems that the old bug-a-boo, the VOX circuit, was a problem, but the real villain was the power supply.

Table 2. Troubles reported by Ten-Tec owners.

Item	Number of instances
Power supply (pass transistor failed, shorted, blows circuit breaker)	19
VOX (inoperative, false triggering)	15
T/R relay sticking	10
Final amplifier transistor blew	10
ALC (component failed)	7
Dial lamps short-lived	7
Self-oscillation in final	6
Crystals quit oscillating	5
Band switch failed	4
Digital readout failed	4
T/R switch (on back) failed	4
Not giving full power output	3
CW filter inoperative	3
Bad audio output stage, VFO drift, poor soldering, bad PC board contacts, receiver intermod, IC failed, shipping damage, bad PC-board foil, mode switch failed, meter not working, bad microphone, noise blanker quit, balanced modulator inoperative, would not receive WWV — each	2
RF feedback, microphone plug, hum, FMing, transistor in receiver failed, dial string problem, spurious signal in receiver, VFO regulator IC failed — each	1

Here are some of the comments about troubles, along with some interesting reports about the Ten-Tec people and the help they provide in curing problems:

"ALC malfunctioned, allowing a final transistor to burn. The factory people seemed eager to help — very refreshing." — WD4AQK.

"80-meter heterodyne crystal failed, I called Ten-Tec and they sent the



**Table 3. Accessories purchased for the Triton.**

Item	Per Cent
CW filter	72
Noise blanker	52
Power supply	26
Antenna tuner	20
Remote VFO	18
Microphone	17
Keyer	15
Digital readout	15
10-meter crystals	14
VOX	14
Ammeter	9
160-meter converter	7

crystal at no charge — even though the rig was 1-1/2 years old — because the problem began before the warranty was up. Super attitude.” — K2JAO.

“Only two. First was after two hours of operation, the transmitter quit. Dealer repaired it in minimum time. Second problem after about a year of operation, it would not operate on 80 meters. Found the band switch for the VFO was not being positioned properly. I aligned linkage and the problem was solved.” — W9NG.

“My CW filter had to be replaced. The factory technician told me how to do it and sent me a new one. I had it replaced in three days.” — WBØVCA.

“Had to replace VOX board in power supply due to false triggering.” — WA8LAY.

“Had VFO problems caused by my mishandling. Sent rig back to factory and they repaired it at no charge.” — N3ND.

“Antenna relay failed twice. Ten-Tec was very cooperative in assisting me with repairs during and after warranty period. Second antenna relay was of much better quality, and it is still performing well.” — AE6Z.

“Final amplifier is sensitive to inductive loads. It becomes unstable even at what appears to be low (1.5:1) SWR. Can get around the problem by using low power — 50 to 70 watts output instead of 100.” — AB1F.

“Function switch did not operate correctly.” — N4CJQ.

“The bridge rectifier in the power

supply went bad. The factory is the best thing about Ten-Tec. One call, and they sent the part the next day and billed me later.” — WB4QJT.

“Dirty contacts in T/R switch on rear panel. Factory suggestion over the phone corrected the problem.” — W2ZY.

“Intermittent receive, traced to a broken circuit-board foil. The method of attaching the 8-pole filter to its mother board is mechanically very poor. I was very satisfied with the factory help, though.” — K9BQ.

“Initial VFO would never stop drifting. Worked with the factory for two years to solve the problem — never cost me a cent. Third VFO, now 6 Hz/hour maximum; outstanding!” — W8EGB.

“Rig not working to its rated power. Excellent service from Ten-Tec, via mail.” — VE7BUL.

“Power supply transistor went shortly after rig was purchased — also finals went. Dealer said this was a fluke, and have had no problems in last two years.” — WB2VNR.

“Diode on ALC board failed within a week. Rig was still usable, no downtime. Dealer got new board from Ten-Tec in 3 days, and I replaced it in his shop. I’m really impressed with ease and speed of repair.” — AI9W.

“On 20 meters, the rig will break into oscillation, causing high-SWR indication on the meter. Once it starts, the condition will continue until the mic button is released. This condi-

tion makes no difference in the signal according to the receiving station, but if allowed to continue, it will trip the circuit breaker in the power supply.” — W5PDG.

### Accessories

When it comes to the question of accessories, 93.5 per cent said they had been able to obtain all they needed, 2 per cent said no, and 4.5 per cent didn’t buy any (or didn’t answer the question). Table 3 shows the accessories bought for the Ten-Tec, with the CW filter and the Noise Blanker leading the pack.

In answer to 16, “Have you been satisfied with these accessories?” 86.6 per cent said yes, 9.3 per cent said no, and 4.1 per cent said nothing.

### Features wanted

In thumbing through the stack of reports, I note that the wanted feature most-often mentioned is “additional filters (better filters, or selectable filters).” This was followed closely by “notch filter,” and “additional band coverage.”

Other ideas that cropped up were built-in power supply, cooling fan for finals, QSK control, more power, built-in keyer, phone-patch input/output, better metering, overvoltage protection in power supply, vhf transverter output, keying for RTTY, and an adjustable agc.

Better than 40 per cent of the answers said “None needed,” or words to that effect.

**TEN-TEC, INC.**  
SEVIERVILLE, TENNESSEE 37862  
EXPORT: 6715 LINCOLN AVE. CHICAGO, ILL. 60648



“Here’s a photograph I took of the Ten-Tec plant in 1978. It doesn’t show the entire building, but it is a neat, modern facility. Their products are neat and modern, too. No, I don’t work for Ten-Tec — I’m a pharmacist!” KA3BGP.

# Ten Tec Report

No = 64 per cent  
Yes = 36 per cent

tailed reply. I was very pleased." — N6BVH.

## The source

Turning back to the question about where the rig was purchased, I find that 67 per cent bought their Triton at a dealer, 15 per cent by mail order, 8 per cent each through an 800 number and from an individual, and 2 per cent from "other." Nobody found one at a flea market (or if they did, they are not talking).

Along this same line of thought, 89 per cent would buy from the same source again, 10 per cent would not, and 1 per cent didn't answer.

## The big question

In answer to the all-things-considered question, No. 23, the totals look like this:

Yes = 77.5 per cent

No = 20.5 per cent

Maybe = 2.0 per cent

Of those who said they would not buy the same rig again, all but two or three

Of those who had the rig serviced, 98 per cent said it was satisfactory, 1 per cent said no, and the remaining 1 per cent didn't answer. A few owners had to send the rig back for service two or three times, but still rated the service as satisfactory. Here are some comments about Ten-Tec service:

"Very good service — best rig I've had in 40 years." — K4RAO.

"Fantastic service department." — W8TK.

"Ten-Tec has been very helpful and prompt over the telephone, and has sent whatever parts were needed, speedily." — K7UQH.

"Factory service is exceptional. Experienced personnel who work with the rig are easy to contact . . . rig was returned to factory to check and realign. Excellent turnover time — they even replaced pilot lamps while rig was out of case." — W9MLT.

"I wrote factory with description of problem, and received a prompt, de-

## Ratings

The scoreboard of Ten-Tec ratings is shown in Fig. 1. The "skyline" seems to be heavy toward the high-numbered end of town, and many owners gave the rig a "perfect" score (10), even though many of these same ones listed troubles, worst features, and features that should be added. (Does this mean that, after these features were added, the rig would be better than perfect?) At any rate, the profiles in the various categories indicate a group of very happy people.

## Service

When I punch the buttons for a tally of those who had the rig serviced, it comes out like this:

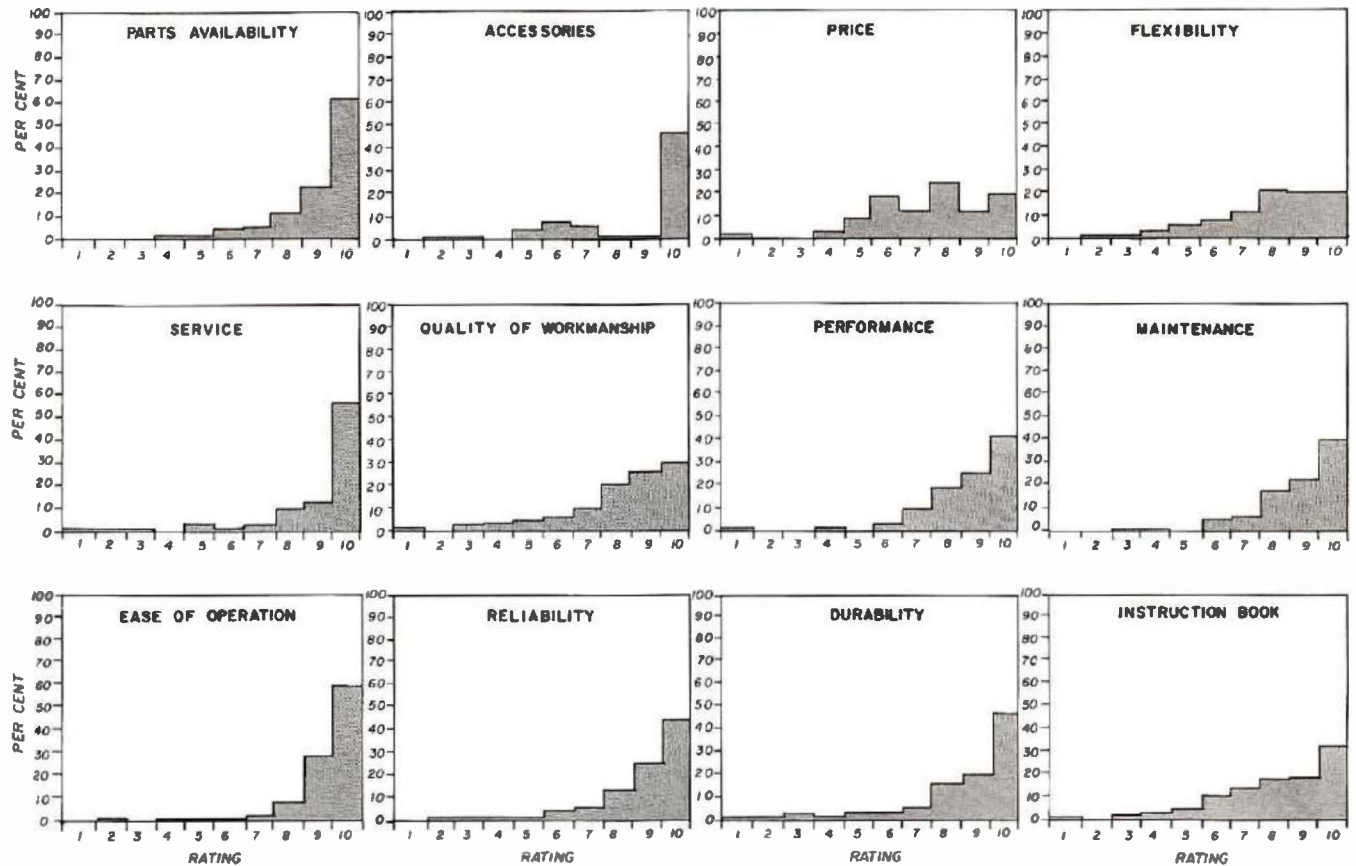

Fig. 1. The answers to question 19, the ratings, provide this group of "skyline" profiles for the various categories. They show percentages of the number of respondents who answered each category. The features receiving a predominately good rating have more weight at the upper end of the scale.





said they would go for the newer Omni series (the new Delta 580 had not been announced at the time this survey was in progress). Overall, it appears that somewhere between 90 and 95 per cent of the Triton owners are loyal Ten-Tec fans and happy users. Here are a few additional comments from the stack of forms:

"My interest in ham radio had been dwindling for about 10 years, but the purchase of the Ten-Tec put the fun back in radio for me. I do recommend the purchase of a good antenna tuner

***"I have not seen any other manufacturer . . . as dedicated to their customers as the folks at Ten-Tec."***

for the solid-state finals — it makes a world of difference." — KB5EK.

"Ten-Tec Triton is an excellent rig for the beginner. All CW transceivers should have full QSK." — WD4MOM.

"Over the years, I've owned over 30 different rigs, and there was always something about each rig that would bug me. The Triton is as close to perfection as any rig, in my opinion." — WB2HMY.

"As a beginner's rig, this Triton IV has been the ultimate. I have seen a few of my friends work for as long as a minute tuning up on a different frequency." — WD8IJZ.

"A few things should be mentioned that are not made clear in the report. In my 25+ years as a ham, I have not seen any other manufacturer, supplier, or importer as dedicated to their customers as (are) the folks at Ten-Tec. Their obvious pride in workmanship and service, and their desire to keep their customers satisfied is unique. I own the 544 and the 509 Argonaut, and both are truly excellent." — W9NHV.

**On the other hand . . .**

"I am a Ten-Tec owner who is very displeased. The receiver is just great, but I've not been satisfied at all with the 10-15 watts output, at an SWR of 1.2 to 1.3 — something is wrong. I know Ten-Tecs are better than that. I've sent the 540 back to them, and they did not charge me anything except shipping, but the rig still gets only 10-15 watts out . . ." — KA4KYK.

"I purchased this unit because of all the good reports. Either a lot of people don't tell it like it is, or I have a bit of a lemon. It's not a bad rig, but at the price, it does have some engineering that galls me. One thing in its favor is that it's American Made." — W5NI.

**Later . . .**

For all of you who asked to see reports on the new Omni, the new Collins, and a couple who asked about the Delta 580 (on late reports), stay tuned in. As soon as we feel that there are enough of them in use to get a fair sample of their performance, we'll send out the forms. Meanwhile, thanks for the attention and response you've given to this survey.

**HRH**

# CALL TOLL FREE

**For the best deal on**

- AEA ●Ameco ●Apple ●ASP
- Belden ●Bencher ●Bird
- CDE ●CES ●Cushcraft
- Daiwa ●DenTron ●Drake
- Hy-Gain ●Icom ●KLM
- Kenwood ●Larsen ●MFJ
- Midland ●Mosley ●NPC
- Newtronics ●Nye ●Palomar
- Regency ●Shure ●Swan
- Standard ●Tempo ●Ten-Tec
- Tonna ●Transcom ●Wilson
- Yaesu

**Apple II (or Plus) ..... \$999**  
with 48k ..... **\$1239**

**FT-207RA now in stock for immediate delivery...**

**Call for our low price!**

**Dentron Clipperton L amp, delivers 2 kW at only 25¢ per watt! ..... \$499**

**GLA-1000 closeout .. \$249!**

**TS-700SP...call toll free for our super low price!**



**CALL TOLL FREE**  
(outside Illinois only)

**(800) 621-5802**



Hours:

9:30-5:30 Mon., Tues., Wed. & Fri.

9:30-9:00 Thursday

9:00-3:00 Saturday



**ERICKSON**

COMMUNICATIONS, INC.

5456 N. MILWAUKEE AVE

CHICAGO, IL 60630 (312) 631-5181

# the Ultimate 1:1 BALUN

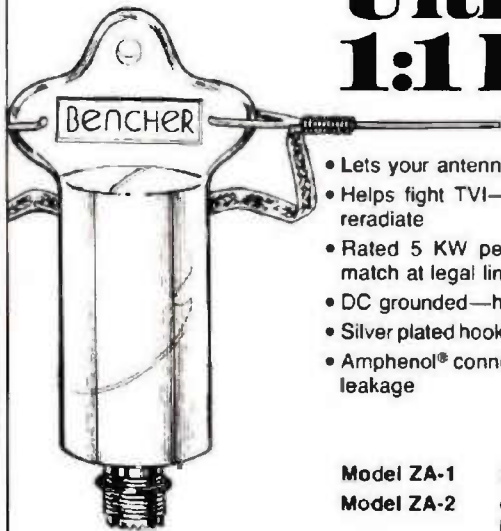

- Lets your antenna radiate—not your coax
- Helps fight TVI—no ferrite core to saturate or reradiate
- Rated 5 KW peak—accepts substantial mismatch at legal limit
- DC grounded—helps protect against lightning
- Silver plated hook-up braids; Custom molded case
- Amphenol® connector; Rubber ring to stop water leakage

Model ZA-1	3.5-30 mHz	\$15.95
Model ZA-2	optimized 14-30 mHz includes hardware for 2" boom	\$17.95

Available at selected  
dealers, add \$2.00  
postage and handling  
in U.S.A.  
WRITE FOR LITERATURE

## BENCHER, INC.

333 West Lake Street, Dept A  
Chicago, Illinois 60606 (312) 263-1808

# 1980 US Radio Amateur Callbook

Don't be one of those who waits until the year is half over to buy a new callbook. Invest in a callbook today and get a full year's use out of your purchase. Crammed full of the latest addresses and QSL information.

You'll find:

Boldface calls, names and addresses for every licensed Amateur in the U.S.

1 CB-US Softbound \$16.95

**BOTH BOOKS  
AVAILABLE NOW**

## The Foreign Callbook

DXing is a real joy, but it's even better when you get back QSL cards from the countries you've worked. The most important tool in getting those cards is to have a copy of the 1980 Foreign Callbook on your operating table. Stations are listed by country, call, name and address in bold, easy-to-read type.

1 CB-F Softbound \$15.95  
Please include \$1.75 additional shipping for each Callbook ordered.

## HAM RADIO'S BOOKSTORE

GREENVILLE, N. H. 03048

(800) 258-5353

# Radio World

CENTRAL NEW YORK'S FASTEST GROWING HAM DEALER



Featuring Yaesu, Icom, Drake, Ten-Tec, Swan, DenTron, Midland, KDK, MFJ, Microwave Module, Tempo, Astron, KLM, Hy-Gain, Mosley, Larsen, Cushcraft, Hustler, Mini Products, Bird, DSI, Mirage, Vibroplex, Bencher, Info-Tech, Universal Towers, Callbook, ARRL, Astatic, Shure. We service everything we sell! Write or call for quote. You Won't be Disappointed. We are just a few minutes off the NYS Thruway (I-90) Exit 32

ONEIDA COUNTY AIRPORT TERMINAL BUILDING  
ORISKANY, NEW YORK 13424

Warren  
K2IXN

Call Toll Free: 1-800-448-7914

Bob  
WA2MSH

New York State Residents Call: 315-337-2622 or 315-337-0203

... at last ...

## your shack organized!

A beautiful piece of furniture — your XYL will love it!

### \$16450 S-F RADIO DESK Deluxe - Ready to Assemble

Designed with angled rear shelf for your viewing comfort and ease of operation.

FINISHES: Walnut or Teak Stain.

Floor Space: 39" Wide by 30" Deep

Additional information on Request.

Checks, Money Orders, BankAmericard and Master Charge Accepted

F.O.B. Culver City. (In Calif. Add 6% Sales Tax.)

DEALER INQUIRIES INVITED

S-F Amateur Radio Services

4384 KEYSTONE AVENUE • CULVER CITY, CALIF. 90230 — PHONE (213) 837-4870



Radio equipment  
not included

Also Available . . .  
Floor Space: 51" Wide by 30" Deep  
\$192.50

\$9

1980  
1980  
HANDBOOK  
See page 79 for super value  
on 1980 ARRL Handbook.  
1980



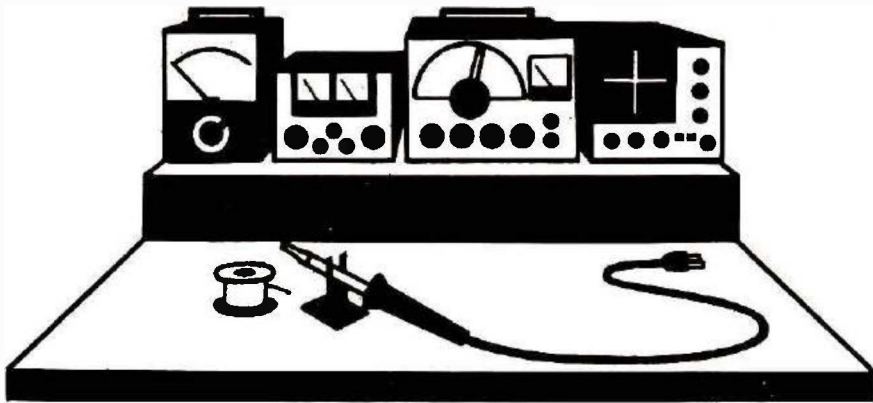

# BENCHMARKS

## TS-520 Wide/Narrow Filter Selection

Why not take advantage of a simple and free modification to your Kenwood TS-520? I noted that on the SE model the heater switch was gone and in its place is a CW filter-select switch. This is a very useful feature that can be installed in any early TS-520 simply by removing the wires from the heater switch and tying them together. For normal installation of the CW filter, you have to move a brown wire from the SSB pin over to the CW pin to allow the CW filter to be used in the CW mode. Note that when the CW filter is not installed, the SSB filter is used in the CW mode. Why not be able to select filters? A

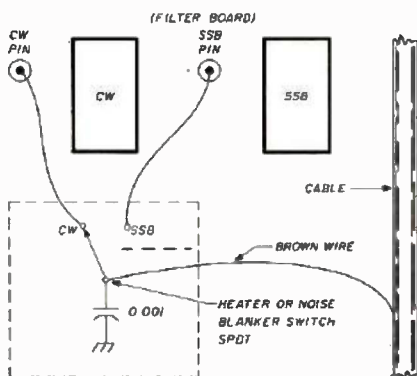

**Fig. 1.** A filter-select modification for your TS-520. Add two wires, one each from the SSB and CW pins, to the normally open and normally closed positions of the switch. Place the brown wire on the switch "common" connector. Bypass this wire with a 0.001  $\mu$ F disk ceramic capacitor. You can use either the "heater" or "noise blanker" switches, or you can drill a hole and mount a separate switch in an inconspicuous place.

small switch can be installed in the compartment on the side, or you can use the "heater" switch. If you prefer to install one by drilling the cabinet, it would probably be best to do it on the bottom of the left side so as not to degrade the rig for resale value. This is the simplest modification that can be done, with little experience, to increase the flexibility in the CW mode. I have modified several of these and found it most rewarding to the user. I think you will like it too. The drawing should be self-explanatory (Fig. 1).

Jerome F. Walsh, WA2LSU

## Easy Entry for Antenna Feeders

No matter how great your antenna system is, and how neat your radio shack appears, somehow you have to get feeders from the antenna (outside) to the radio equipment (inside), and that is frequently where things get messy.

Several desirable objectives should be met in bringing cables into the house. You should be able to do it easily, without too much work, and you should be able to add an additional feedline without going through a whole new project. Feeders should maintain impedance at the point of entry, and they should be protected from stress at that point. The feeders should come in, but rain, dirt, and bugs should stay out. You should not have to tear into the house to make an entryway.

For years, I envied the simplicity of the telephone and power-line systems, but I could not bring myself to

drill holes in the brick work. I used twin lead or single-wire feeders; these I simply let in through the window, slamming the window down on them. Wire will take just so much of this, and then it has to be replaced. Coax will not let you close a window on it at all.

My present arrangement offers all of the flexibility, safety, and convenience that I want, and was extremely easy to set up. It was planned for my special window arrangement — a high, two-pane, half-sized window in a basement — but it can be adapted for any kind of window that you may have.

The first step is to remove one pane of the window, and this can be most easily done if it is accidentally broken, as mine was. If you are so unfortunate as to have an intact window, remove the glass carefully. Usually this involves chipping out the putty around one side of the pane, then taking out the glaziers' points, then removing the glass. Be careful, but expect that somewhere along the line you will break the glass. No loss. Note exactly how the glass was put in.

Now, replace the glass with a sheet of 1/8 inch hardboard (Masonite), put in just as you would install a pane of glass, using glaziers' points or clips and new putty. If you have any doubts, your friendly local hardware man will tell you precisely what you have to do.

On the inside (room side) of the hardboard panel, using glue and screws, fasten a horizontal strip of 1 x 4 wood, across the full width, as in Fig. 1. Cut a slot, 5- or 6-inches long by one inch high in this; the center is

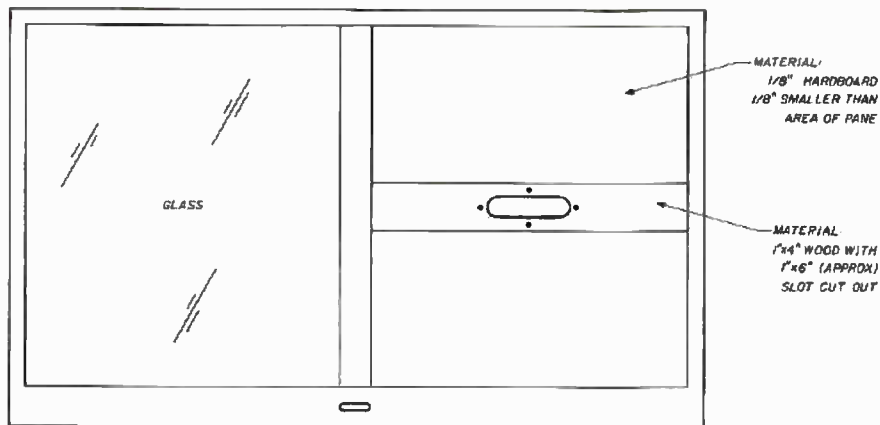

Fig. 1. A removed, or broken, pane of glass can be replaced with hardboard panels and a strip of wood to provide safe entry of feeders, rotator-control cables, and the like.

probably the best location. The easiest way to do this is to drill two 1 inch holes, about 5-6 inches apart, through both the board and the hardboard panel, and then cut out the material between them. Give both sides of the panel a couple of coats of shellac and exterior-grade paint.

You now have a solid window pane which will admit a coax cable or two (with connectors), rotor cable, ground wire, twin lead, plus the rain, dirt, and bugs we mentioned earlier. The final step is to make a barrier against the latter.

Find two pieces of material about 8 x 4 inches, and about 1/8 inch thick. This can be plywood, hardboard, aluminum, galvanized sheet metal, or glass-epoxy PC board. Do not use phenolic board; it warps. Also, find four 8-32 machine screws (two inches long) with matching washers and wing nuts. Center the two pieces of material over the slot, and drill the whole works for the screws. The holes should go in the center of the sides and ends of the material, not in the corners. Make the holes in the window panel a bit undersized so that the screws have to be threaded from the outside to the inside of the panel and will remain seated firmly. The holes in your 8 x 4 pieces can be a little larger for an easy fit. Put washers under the

heads of the screws, run them in, and set the panel aside.

How many feeders do you have? You will want that many holes in the two plates, drilled along the horizontal center line (Fig. 2) and made just large enough to fit the cable. After you have drilled the holes, make slots of them, right up to the edge of the plates. One slot will go from the hole to the bottom edge of one plate; the other will go to the top edge of the other plate. When you slip the cable into one slot from the bottom, and slip the other plate over the cable from the top, you will have a seal right around the cable, which will clamp it in place. Put both plates against the larger slot in the window panel, with the screws going through the matching holes, drop a washer on each screw, tighten down the wing nuts, and you have a permanent installation — until you wish to change it.

When you are drilling the holes in the plates for the cables, remember that you can change things around any time you wish, simply by drilling additional holes. For that reason, start bringing your cables in at one end of the slot, leaving room for additional feeders as your ham activities expand.

Julian N. Jablin, W9IWI

## High Voltage Putty

All Amateur Radio operators can find use for this permanently soft, non-staining sealer which is used extensively by electric utility companies.

One such compound, known as Sealflex and manufactured by the M and W Electric Manufacturing Company, P.O. Box 350, East Palestine, Ohio 44413, can be used to seal all antenna connections from weather, moisture, dust, and salt spray. It can be used to seal antenna entries, indoors and outdoors.

It's a soft-putty type of compound that can be molded to any shape or sheet. It has great adhesive properties, but is easily removed for making changes. Protected connections retain their new look.

The putty is sold in 1- and 5-pound packages. If you have a friend who works with an electric power company, I suggest you check with him about it.

Frank Bolen, WA2KWC

## Rotating Traps

Here is a photograph of my rotatable trap dipole for 40 through 10 meters. It is made out of two old 14AVQ trap verticals. When the

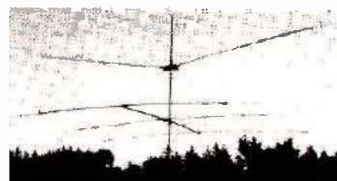

shunt feed at the bottom of these antennas broke, I simply replaced the bottom connector with a brass screw and nut arrangement, with a soldering lug attached. After the wire is soldered to the lugs, I screwed them on and encapsulated the screws in epoxy. Using the manufacturer's roof-mount dimensions, and common RG-8/U coax for feedline, I achieve a match and SWR comparable to the vertical, over a similar frequency spread. The coax is connected to the bases of the verticals (now horizontal) as you would connect coax to any common dipole. I primarily use this antenna on 40 meters, and the results have been very satisfying. On overseas contacts (Europe) I notice as much as three S-units difference when I swing the antenna from "off the end" compared to "broadside."

Wayne D. Mitchell, K6VFN

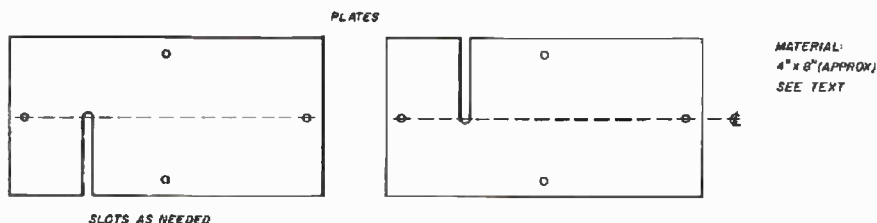

Fig. 2. The upper and lower pieces of hardboard have slots cut in them to provide a seal around each cable as it enters.



# Gift a ham.

Anytime is a great time to give HORIZONS!

Share the fun and excitement of Ham Radio HORIZONS with a special friend — that would-be ham, beginner or old-timer. HORIZONS is definitely a thoughtful, inexpensive, and unique gift . . . actually it's 12 gifts all year long. Just for the fun of it, **GIFT A HAM today!**  
1 year (12 issues), \$12.00



**ORDER TOLL FREE**  
**800-258-5353**  
or send gift instructions and payment to:

**Ham Radio HORIZONS**  
Greenville, NH 03048

# New!



**Twice as much for less.**

**QJHR-LB** Here's the log book every one is talking about. This new offering from HRB is far superior to any other log available today! With over 2,000 entries, you have twice as much space for less cost in comparison to its nearest competitor. There are 80 big (8 1/2 x 11) pages, 30 entries per page for an "easy-count" during contests, a frequency spectrum chart, call sign prefixes and much more. This is unquestionably the best log book value anywhere. 80 pages © 1978. Spiralbound

**\$1.75**

Send check, money order or credit card information plus \$1.00 shipping to:

**Ham Radio's Bookstore**  
Greenville, NH 03048



**At Barry**

**KITTY**

advises . . .

Take a look at BARRY'S *antenna specials* for JUNE . . . Rotors . . . Towers . . . Beams . . . Verticals . . . Dipoles . . . cable . . . fittings . . . connectors . . . everything you need to complete that super new layout. WE STOCK antenna goodies by:

- |                     |                  |
|---------------------|------------------|
| AEA                 | ALLIANCE         |
| ANTENNA SPECIALISTS | CORNELL-DUBILIER |
| CUSHCRAFT           | E-Z WAY          |
| HUSTLER             | HY-GAIN          |
| KLM                 | MOSLEY           |
| MURCH               | ROHN             |
| TRI-EX              | . . . and more.  |

If you don't see it here, ASK!

We Also Stock . . .

ASTRON  
B & W  
BIRD  
COMMUNICATIONS  
SPECIALISTS

**JUST CALL OR  
WRITE FOR THE  
BARRY PRICE.  
BETTER STILL . . .  
STOP IN!!**

COLLINS  
CUSHCRAFT  
DSI  
DENTRON  
DRAKE  
EIMAC  
ICOM

KDK  
MFJ  
MIRAGE  
ROBOT  
SHURE  
STANDARD

SWAN  
TEMPO  
TEN-TEC  
YAESU  
VHF  
ENGINEERING

We have:

- REPEATERS
- MICROPHONES
- KEYS & KEYSERS
- TUBES and much, more

**Amateur Radio License Classes:**

**Wednesday & Thursday: 7-9 pm**

**Saturday 10 am-Noon**

The Export Experts Invite Overseas orders

**¡ AQUÍ  
HABLA  
ESPAÑOL !**

— We Ship Worldwide

**BARRY ELECTRONICS**

**512 BROADWAY, NEW YORK, N.Y. 10012**

**TELEPHONE (212) 925-7000**



# POST BOX

## Dear Horizons:

Thanks for a great magazine! Not only did your magazine break the barrier of basic theory while I was trying to get my ticket, it helped me with my first Amateur project.

I built the tuner in the article "Build An Antenna Tuner" in the November, 1979, issue. My only problem was in finding the Barker and Williamson 2008T coil stock. Bud (K2PMA) said it might be a problem in the article. I don't mind at all though; I wound my own (it was good experience for me). I can now load on 15, 40, and 80 meters, the bands I have.

Keep up that good work, *Ham Radio Horizons*, and keep it as I have known it, in "Plain English." I've been a ham about six months, and my age is 14 years.

**Chris Felten, KA6GPZ**  
Chatsworth, California

## Dear Horizons:

I am excited to hear about the new features coming up in *HRH*. They will certainly add to the quality of an already excellent Amateur Radio magazine.

I hope though, that you don't become too technical, like the other ham magazines, and that all we'll get out of it are the ads.

Keep up the good work.

**Mike Witenko, N8AX**  
Springfield, Ohio

## Dear Horizons:

Your latest issue (December, 1979) is the best yet. I read every article and they were all of interest to me, which is a first for any magazine I have ever read.

I found the article on ICOM especially informative. I would like to see more articles on such factories. I also

enjoy fiction stories with a ham-radio theme.

Not only do I like your articles, I like the format and the large size print which I can read without straining.

I have a copy of every issue of *Ham Radio Horizons*. Keep up the good work.

**Gareth D. Baker, WD8ARB**  
Garden City, Michigan

*Thanks, Gareth. Let us know what you think of our new format and type.*  
**Editor**

## Dear Horizons:



I read with interest the "Benchmark" by WB9VTF in July, 1979, *HRH*. Being in the Marine Corps, I move quite a bit, and live mostly in apartments.

My current duty station (Atlanta, Georgia) found me in a two-bedroom townhouse. A space for the station itself wasn't too difficult, as I displaced only a few square feet of my 3-year-old harmonic's room. The antenna, now that's a story.

Just outside the bedroom window was a nail in the mortar. It was at this point that I suspended the center of a three-band inverted V. Actually, I started with a 20-meter dipole, broke the antenna into three segments, and added alligator-clip jumpers to add 15 and 10 meters. I brought the leg of the dipole that was fed by the center conductor away from the building at 90°, and drooped it 45°.

The leg that was fed by the shield was drooped at 45°, but was flat against the building.

I used a KLM 1:1 balun and fed the system with some RG-213/U cable. I found the SWR on 20 no greater than 2:1 at 14.35, and it was about 1.3:1 at 14.0. It was uniformly flat across 15 meters (my favorite band, CW my mode) at about 1.8:1. Ten meters

checked in at about 1.3:1 at 28.1 MHz, and 1.9:1 at 28.65. After that, the SWR turned into the Navy (all wet). (Sorry, Marines can't resist Navy jokes!)

My tour is over in Atlanta, and I'm on my way to California and a west-bound Amphibious Landing Ship (I work on helicopters). Now, how to talk the skipper into a longwire out of a porthole . . .

**Sgt. Steven J. Robeson,**  
USMC, WD4DEV  
Orville, Ohio

## Dear Horizons:

I wish to take this time to thank you for a great magazine. I never thought I would ever get interested in becoming a ham. It wasn't until a wonderful friend who is also a ham (WB2QBO) started bringing his copies of *Ham Radio Horizons* to my house that I began getting interested. The articles are easy for anyone to understand, and you always have a good selection of articles for the Novice all the way up to Extra.

For Christmas, my friend gave me a subscription for my own *Ham Radio Horizons*. This month I will be going for my Novice ticket. By the way, I am a 30-year old housewife with two children. Keep up the good work, guys!

**Madeline Loiacano**  
Frankfort, New York

*Thanks, Madeline; we'll keep trying. Best of luck to you from all of us here at HRH.*  
**Editor**

## Dear Horizons:

I have been a ham operator for several months now, and really think it's great. My friend John, WB1FDY, who is an Advanced-class operator, introduced me to ham radio. He gave me all kinds of reading material before I got my ticket, including your magazine which really convinced me that ham radio was for me. Your magazine is not only good for the Novice, but is great for all class licenses. The articles are great and I look forward to receiving my copy every month.

I would like to say for every Novice like myself, "you can't go wrong with *Ham Radio Horizons*." Keep up the fine work, and thanks again for an excellent magazine.

**Kenneth M. Ferreira, KA1DUV**  
Centerdale, Rhode Island



**Dear Horizons:**

You printed a nice article by John J. Edwards, WB2IBE, on VOMs and Their Uses, (February, 1980).

One word of caution rechecking transistors: Never use the R X I scale. Some transistors can be destroyed by the instrument voltage.

Also, the plus lead (terminal) on some instruments is not necessarily positive in the ohms function. On some instruments it is a negative voltage in respect to the other terminal. Determine what yours is before trying to check for PNP or NPN.

**Herb Tuell, W4IRA**  
Clearwater, Florida

**Dear Horizons:**

Because Novice call signs are not published in International callbooks, could I pass this information via Horizons to U.S. Novices looking for their first UK contact.

I am on 21.121 MHz most Wednesdays and Sundays at 1300 GMT, looking for contacts with my 20-watt rig. Because I attempt to keep the CW to 5 WPM I get jeered a little by Europeans, but, as I get wheelspin above 35 WPM, they don't present many problems. The 20-watt transmitter is loaded to an indoor 130-foot wire, which has raised eyebrows in JA, VK, VP8, and PY with 550 to 579 reports.

After operating professional radio stations in Australia, Borneo, Malaysia, Singapore, Hong Kong, and West Germany before hitting the ham bands, I don't think I am exactly a novice to the game, but I still get a kick out of giving U.S. Novices their first GB QSL card.

**Dave Logan, G4EZF**  
Mottram, Cheshire, England

**Dear Horizons:**

Our local newspaper carries an article on CBers and Amateur Radio. Not long ago, this article noted the amount of illegal activity of HFers below the Amateur 10-meter band, and above the 11-meter band. This sparked my curiosity enough to investigate to see what was going on there.

At about 27,950 kHz, I tuned in a QSO which had obviously just begun; the parties were exchanging reports. To my astonishment, these two operators also gave out their Amateur calls! I have listened in on several QSO's in which the parties gave

enough information to allow me to find them. If a casual observer can identify them, why can't the FCC?

If every dedicated ham would help, we might not lose the 10-meter band to the HFers!

**Kevin W. Prouty, N9BEB**  
Marquette Heights, Illinois

*The problem is, Kevin, that most of the "Amateur" calls you hear used on those frequencies are made-up, borrowed, or otherwise bogus calls. It doesn't sound reasonable that a true-blue, bona-fide Amateur would risk losing his license by operating between 10 and 11 meters, when there are "acres" of room on 10 meters.*

*Editor.*

**Dear Horizons:**

I wrote to thank you for printing the story about Larry, WB3IGT. I also want to thank Robert (WB3IGG) for writing the article. I have contacted Larry on the air two times, and I never knew that he was a quadriplegic.

I found Larry to be very friendly on the air. He deserves a big hand for his achievement of becoming a ham — I find it hard to see how he does it, but he is doing just great.

I look forward to many more contacts with WB3IGT.

**Larry McKinney, WB3FJO**  
Adamstown, Pennsylvania

**Dear Horizons:**

Thank you for the finest Amateur Radio magazine published today. It is written in understandable terms for the layman Amateur (right down where most of us live).

I certainly appreciated your article on the Kenwood TS 820-S. I wired the 500-Hz CW filter to the unused fixed-crystal switch.

**Clyde B. Stanfield, WA6HEG**  
Upland, California

**Dear Horizons:**

I have been reading your magazine for about a year now, and I would like to say that I think that you are doing a wonderful job.

With the help of your magazine I passed my Novice exam with no trouble, and I am now studying for my General.

But in your article about QRP

(November 1979) on pages 13 and 14, you transposed the Heath HW-8 and the Heath HW-104 pictures.

Keep up the good work!

**Bob Drastura, KA2GGM**  
Edison, New Jersey

*Oh-Oh! Now three people caught our goof!*  
*Editor*

**Dear Horizons:**

I enjoy reading your fine magazine, but you only give the author's name and call. Many times I cannot find their addresses in my old Callbook, and many of us cannot afford up-to-date Callbooks. We need the full addresses for exchange of letters, etc.

**Kenneth Hand, WB2EUF**  
East Hampton, New York

*You can always send a letter to any of our authors by addressing them, c/o Ham Radio Horizons, Greenville, New Hampshire 03048.*  
*Editor*

**Dear Horizons:**

The Muskogee, Oklahoma, Amateur Radio Club is asking all Amateurs to write their congressmen and urge them to recommend the issuance of an Amateur Radio Postage stamp.

We are suggesting that the stamp be in either the 10¢ or 31¢ air-mail denomination, since these are the ones most used in sending out QSL cards. For the 31¢ air-mail stamp, we hope that the design would include the American flag in color, since this stamp would be sent in volumes to every country on earth, and would place our flag in the hands of people of every nationality.

The theme of the stamp should be "International Peace and Fellowship through Communications."

An Amateur Radio stamp was issued several years ago, in the 5¢ denomination, but we believe the time has come for another issue.

**Loren Carlberg, WB5WDG**  
Muskogee, Oklahoma

**Dear Horizons:**

I sure enjoyed the article on radio chess. If anyone wishes to play, please check in on 7.235 MHz — we tend to congregate on that frequency. Also, I am looking for an opponent to play WW-III.

**Charles E. Martin, AB4Y**  
Bowling Green, Kentucky

# PRODUCT SHOWCASE

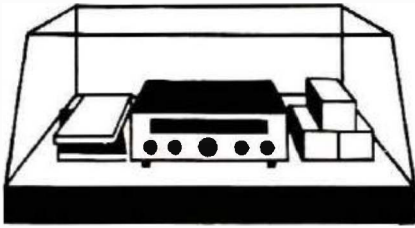

## Antenna Specialists Low-Cost Yagi

Exceptional performance at moderate cost were the key design requirements for a new uhf Yagi antenna, model ASP-766, announced by The Antenna Specialists Co., Cleveland, Ohio. The five-element beam antenna is applicable to both point-to-point or repeater-control station installations, where large gain values are secondary in importance to reliability. Directivity necessary to repeater control stations is ensured by the antenna's 15-dB front-to-back ratio. The antenna is designed to provide 50 degree E-plane beamwidth for appropriate azimuthal selectivity in crowded rf environments. Construction is of aluminum, with gold iridite for both appearance and resistance to pitting and corrosion. The ASP-766 is a broadband antenna covering the 450-470 MHz range, exhibiting 7.5 dB gain in conformity with EIA specification RS-329. Maximum rf power rating is 100 watts. For detailed product information, write to Professional Products Division, The Antenna Specialists Co., 12435 Euclid Avenue, Cleveland, Ohio 44106.

## Micronta Power Inverters

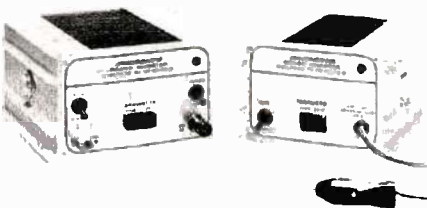

Just introduced by Radio Shack are two new Micronta Power Inverters for converting 12 Vdc and 120 Vac to power ac appliances from your car, boat, or recreational-vehicle battery.

The 300-watt inverter is said to be capable of powering color TVs, electric typewriters, small hand drills, sewing machines, and many other items requiring no more than 300 watts continuous power. The 100-watt inverter is suitable for powering small TV sets, electric razors, transistor radios, Amateur and CB two-way radio equipment, and other small appliances.

Both inverters feature a NORMAL/BOOST switch to provide extra power to compensate for low battery-input voltage. Automatic overload protection causes the inverters to turn themselves off if overloaded. Circuit breaker automatically resets 3-4 seconds after the overload has been removed.

Full-load input current is given as 25 amps for the 300-watt model; 12 amps for the 100-watt inverter.

The Micronta 300-watt Power Inverter is priced at \$79.95; 100-watt Inverter, complete with cigarette lighter plug, is priced at \$39.95.

Micronta Power Inverters are available exclusively from participating Radio Shack stores and dealers, nationwide.

## New WARC Frequencies Covered By All-Band Vertical Antenna

"First Commercial Amateur Radio antenna to provide coverage of the new 10, 18, and 24 MHz Amateur bands resulting from the recent World Administrative Radio Conference" is the claim of Antenna Supermarket's new AV-2 "Alltenna," which also covers all the present Amateur bands from 160 through 10 meters. With a maximum height of 26 feet, the AV-2 is designed to provide effective performance at full legal input on any Amateur band, without the use of radials (when ground mounted).

Sturdy but lightweight, the AV-2 is ideal for vacation or Field-Day use, as well as for home stations — it can be taken down and set up in minutes, without tools, by one man. Tuning or band change can be accomplished in seconds. For transport or storage, the AV-2 knocks down to a handy five-foot package.

The AV-2 is the ideal antenna for the Amateur with space restrictions, or who wants to effectively expand his coverage of the high-frequency spec-

trum at a nominal cost. It's priced at only \$89.95, F.O.B. Chicago. For further details, or to order your AV-2, contact Jim Meadow, WD9JVB, Antenna Supermarket, Box 563, Palatine, Illinois 60067; telephone (312) 359-7092.

## New Heath Remote Coax Switch

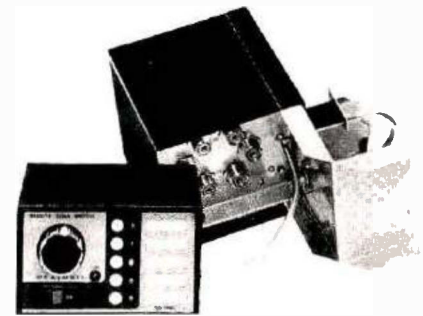

Heath Company, the world's largest manufacturer of electronic kits, announces a new remote coax switch, the SA-1480 which allows the Amateur Radio operator to select any of five antennas by simply turning a knob at his bench. One feedline from the inside control box to the outside switching box replaces five separate antenna cables, saving coaxial cable. A special grounding position grounds all antennas for lightning protection.

A specially shielded switching box protects the switching circuitry from the elements. Silver-plated switch contacts help lower SWR. The SA-1480 operates on frequencies up to 150 MHz, and will handle full legal power.

Heath engineers say the new remote coax switch can be easily assembled in six to eight hours. A U-bolt assembly is included to facilitate mounting the outside switching box on an antenna mast or tower leg.

The Heathkit SA-1480 remote coax switch is mail order priced at \$84.95 F.O.B. Benton Harbor, Michigan. Write for a free catalog to Heath Company, Dept. 350-220, Benton Harbor, Michigan 49022, or pick up a copy at the nearest Heathkit Electronic Center (Units of Veritechnology Electronics Corporation), listed in the telephone directory white pages.

Based in Benton Harbor, Michigan, Heath Company is a subsidiary of Zenith Radio Corporation.



## Transistor replacement guide

A 1980 edition of the RCA Solid-State Replacement Guide offering 1080 solid-state replacement devices which replace more than 161,000 domestic and foreign types is now available from RCA SK Device Distributors.

Published in January, the 1980 RCA SK Replacement Guide contains easy to read information on RCA's full line of replacement transistors, rectifiers, thyristors, integrated circuits, and high voltage triplers including many MRO (maintenance and repair operations) replacements. The Guide also includes an index and a comprehensive data section with listings grouped according to type of device. Dealers can ask for the 368-page 1980 SK Guide at their local RCA Distributor or they may send check or money order for \$1.50 to RCA Distributor and Special Products, Post Office Box 597, Woodbury, New Jersey 08096.

## Free Heathkit winter catalog



The new 104-page Heathkit winter catalog describing the latest in electronic kits is now available from Heath Company, Dept. 350-200, Benton Harbor, Michigan 49022.

The free catalog lists nearly 400 kits for home, work, and pleasure, including the latest in home computers, color TVs, Amateur Radio, audio components, precision test instruments, educational self-instruction programs,

and innovative electronic devices for the home.

In this catalog, Heath Company is introducing foreign-language self-instruction programs for the first time. Heath claims that now anyone can learn Spanish, French, German, or Italian in the comfort of his own home.

The foreign-language programs are aided by a special electronic translator that displays the spelling and at the same time pronounces the foreign-language equivalent of the word entered in English.

The catalog also introduces new self-instruction programs in statistics, and, for the Amateur, a new high-gain, tri-band antenna.

The complete catalog is available free by writing Heath Company, Benton Harbor, Michigan 49022. Heath Company, the world's largest manufacturer of electronic kits, is a subsidiary of Zenith Radio Corporation.

## Interference Reduction System

RadMic Systems, Limited, of Sussex, England, are now producing an electronic system which may be added to conventional Yagi, quad, or other triband/monoband beam antennas to provide remote control and adjustment of the beam polar-diagram on reception.

The Antenna Vector Processor, developed by Ken Franklin, G3JKF, enables the beam pattern to be optimized to reduce QRM over a wide arc, giving much greater rejection of interference than conventional antennas, especially towards the band edges where standard beams fall off in front-to-back performance.

A controllable rear null, 20 to 50 dB deep, may be positioned within an arc of  $\pm 70$  degrees on 14, 21, and 28 MHz (for a triband antenna) and slewed by the operator to attenuate particular sources of interference at any frequency in the band.

Performance is limited only by propagation characteristics which introduce multipath and scatter components in addition to the direct ground- or sky-wave signal.

Beam performance on transmit is unchanged, and the processor may be selected as required on reception, with automatic by-passing when transmitting.

Beam reversal on reception is also possible, to give QRM-free reception to the rear. Transmission is always to the front, however.

The system uses a Vector Processor Unit adjacent to the Amateur transceiver, coupled to the modified reflector of the beam antenna via a low-grade coaxial feeder and an Antenna Unit fitted on the boom at the reflector.

The system provides a means of experimentation on different antenna types, and control of director or active additions to conventional parasitic antennas, while maintaining the basic beam performance substantially unchanged. It also allows two beam antennas to be combined to combat QRM.

A 30-page instruction manual is provided with the equipment, and it is expected that further applications data will become available in Amateur journals as experience is gained by other Amateurs.

Obtain further information from RadMic Systems Limited, 10, Weald Drive, Crawley, Sussex, England RH10 6JU.

## Zulu II Clock Kit

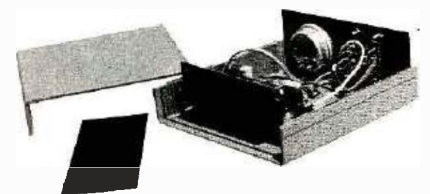

The new six-digit Mobile/Fixed-Station Zulu Clock Kit is now available from Bullet Electronics. The kit features quality G-10 plated and drilled PC boards, detailed step-by-step instructions with illustrations and schematics and all the required parts.

The kit is called the Zulu II, and has as standard features large, 1/2-inch character LED readouts, quartz crystal and brightness control, noise-rejection circuitry, and a calendar on demand.

The Zulu II will be sold without a case for \$16.95, or with an attractive injection-molded case in either blue or beige for \$22.95. The addition of a small 12-Vac transformer allows standard ac operation. The kit is the result of numerous customer requests for a clock of this design.

# Upgrade Your CW Easily

DATONG



## Model D70 MORSE TUTOR

- Produces random five character groups: all letters, all figures, or mixed.
- Calibrated variable speed (6% to 37 words per minute) and variable delay (up to 3 seconds) between letters for optimum learning efficiency.
- Internal loudspeaker, plus personal earpiece for private listening. And pocket size.
- Battery operated therefore always ready for use. Current drain is very low for long battery life.
- Eleven IC, CMOS circuit for long internal battery life.
- Built-in tone oscillator for sending practice (key required).

**\$159.95** Including Pre-Paid Shipping & Full Insurance

Dealer Inquiries Invited  
Made in England • 90 Day Warranty  
Visa/Mastercharge Accepted

(Exclusive Importers of DATONG FL-1's)

**AR** Technical Products Corp. Dedicated to Excellence

Box 62  
Birmingham, Michigan 48012  
Telephone 313/644-5698

## Larsen Electronics Expands Kūlduckie Line

Larsen Electronics, Inc., has added another Kūlduckie antenna series to its rapidly growing line. The new Larsen KD-4 antenna series fits all radios using a BNC connector for antenna attachment, and is available in ranges of 136-174 and 406-512 MHz.

Larsen now has a Kūlduckie antenna to fit all of the most commonly used hand-held radios. These antennas are ruggedly built to withstand the rough use common to this type of antenna. Vhf and uhf models are spring wound for flexibility, and plated with high-conductivity material for maximum radiation efficiency.

They are protected from the elements by a tough, heavy duty coating which prevents detuning from shorting and adds flexibility. They handle a full 25 watts, and are flexible enough to bend 180 degrees in all directions.

For more information write Larsen Electronics, Inc., P.O. Box 1686, Vancouver, Washington 98668.

frequencies from 3.9 to 12 MHz (ideal for receiving WWV time signals on 5 and 10MHz). Controls include a band-select switch, tunable dial for A-M and SW, and volume control coupled with an ON-OFF switch. Audio output is via the supplied earphone only, and the receiver is powered by two hearing-aid-type batteries (included).

The Model EP-8 has built-in ferrite rod antennas for both bands. While shortwave reception is satisfactory for powerful stations such as the BBC, Radio Canada International, Radio Nederland, Deutsche Welle, and others, better SW sensitivity can be obtained by placing the receiver near a telephone or ac-line outlet. No direct antenna connections are necessary.

Priced at \$24.95 postpaid in U.S.A., the Model EP-8 is available from: Radios International, P.O. Box 6053, Richardson, Texas 75080; phone (214) 784-0862.

## New Amateur Radio Tri-Band Beam from Heath

Heath Company, world's largest electronic kit manufacturer, appears to have good news for any radio Amateur who ever tried assembling a beam antenna. The new Heathkit SA-7010 Tri-band Yagi beam comes with a step-by-step assembly manual, something Heath says the ham community has been asking for.

This 4-element 20-, 15-, and 10-meter beam features three active elements on each band, and is said to give 8.3 dB gain over a dipole. Front-to-back ratio is listed at 25 dB. A separate reflector is provided for correct monoband spacing on 10 meters. VSWR, according to Heath, is less than 1.5:1 at resonance on each band. The SA-7010 is rated for full legal Amateur power.

The boom length of this tri-bander is 16 feet (4.8 meters), with a longest element of 31 feet (9.4-meters). Turning radius is 17 feet, 5 inches (5.3 meters) and wind surface area is 5.8 square feet (0.53 sq. meter).

Because of the detailed instruction manual, Heath expects this new beam to be popular not only with individual hams, but also with Amateur Radio clubs who seek assembly for Field Day use.

The antenna is mail order priced at \$219.95, FOB Benton Harbor, Mich-

## Pocket Shortwave Receiver



Measuring only 45 x 73 x 25 mm, the Model EP-8 is believed to be the smallest A-M/SW, two-band receiver available in the U.S. In addition to the standard "broadcast" band (A-M), the EP-8 receives shortwave fre-

**Hobbyists**

Here is an interesting general electronics hobby magazine. It's loaded with lots of interesting and simple circuits and ideas, not only about radio, but in all phases of electronics including test gear, audio, remote control and security systems. We are sure that you will find a number of worthwhile projects in this British magazine.

For a sample copy, please send \$1 to cover postage and handling costs. Your dollar is applied to the cost of the subscription when ordered.

**1 Year (12 issues) \$20.00**

**Radio & Electronics Constructor**  
Greenville, NH 03048



igan. It is described in the latest 104-page Heathkit catalog, along with nearly 400 other build-it-yourself electronic kits. A free copy of the catalog may be obtained by writing Heath Company, Dept. 350-210, Benton Harbor, Michigan 49022. Catalogs are also available at 54 Heathkit Electronic Centers (units of Veritechnology Electronics Corporation) nationwide. Locations are listed in telephone directory white pages. Retail prices of some items may be slightly higher.

Heathkit is a subsidiary of Zenith Radio Corporation.

### Smaller Thumbwheel Switch

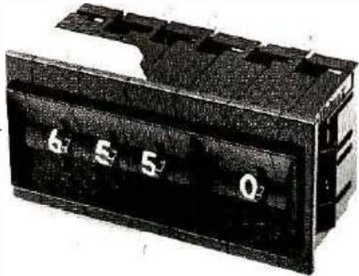

A new line of subminiature, digital thumbwheel switches are now available from Unimax Switch Corporation, a subsidiary of the Unimax Group, Inc. Designated "Series S2D," these single, rear-mounted switches (with up to sixteen positions) will require a panel cutout only 0.748 inch (19 mm) high by 0.670 inch (17 mm) wide. This size reduction for this type of switch will greatly simplify the job of laying out crowded control panels of modern electronic equipment.

In addition to their small size, the new switches offer all the "traditional" benefits found in Unimax standard digital thumbwheel switches. These include the unique degree of freedom in mounting — any Series S2D switch can be mounted either from the front or the rear of the panel simply by using different sets of end plates (in both instances, end plates fit either the left or right side, which translates into smaller inventories and simplified assembly).

Like standard Unimax digital thumbwheel switches, the new Series S2D units offer Unimax's "No-

## Microcraft's New Morse-A-Word

Eight character moving display.  
Built-in code practice oscillator.  
Excellent for learning Morse Code.  
Complete — no CRT or expensive extras needed.

Decodes audio CW signals from your receiver's speaker and displays letters, numbers, punctuation and special Morse characters as the code is received.

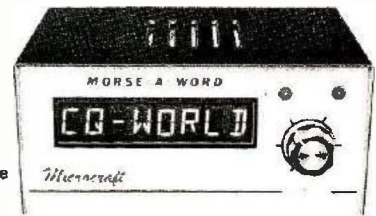

MORSE-A-WORD Kit with 4 character readout . . . . . MAWK-4 \$149.95  
MORSE-A-WORD Kit with 8 character readout . . . . . MAWK-8 \$169.95  
MORSE-A-WORD wired & tested with 8 character readout . . . MAWF \$249.95

Send check or money order. Use your VISA or Master Charge. Add \$3.50 shipping and handling for continental U.S. Wisconsin residents add 4% State Sales Tax.

*Microcraft*

Corporation Telephone: (414) 241-8144  
P. O. Box 513HRH, Thiensville, Wisconsin 53092

## KLAUS QUALITY AMATEUR RADIO EQUIPMENT & ACCESSORIES

### KENWOOD



TS 520 SE  
HF TRANSCEIVER

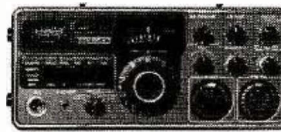

TS 600  
MULTIMODE 6-M  
TRANSCEIVER

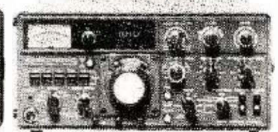

TS 820 S  
HF TRANSCEIVER

... call or write for the KLAUS price ...

### YAESU

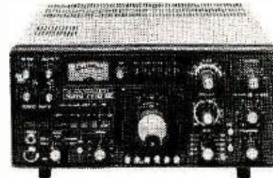

FT-101 ZD  
HF TRANSCEIVER



FT-227 R  
2-METER FM TRANSCEIVER

... call or write for the KLAUS price ...

### CUSHCRAFT

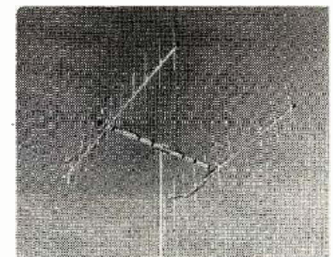
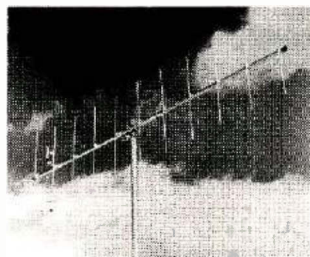

We have a complete stock of Cushcraft antennas — too many to mention in detail, so ask about our 2-meter line of verticals and beams for special low, low prices.

## KLAUS RADIO Inc.

8400 N. Pioneer Parkway, Peoria, IL 61614

Phone 309-691-4840

Tim Daily, Amateur Equipment Sales Manager

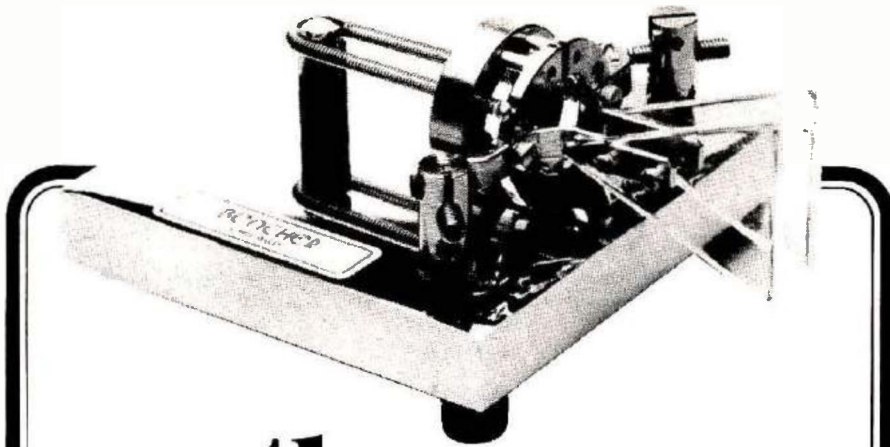

# the Ultimate IAMBIC PADDLE

WRITE FOR LITERATURE

**BENCHER, INC.**

333 W. Lake Street, Dept. A  
Chicago, Illinois 60606 • (312) 263-1808

- Full range of adjustment in tension and contact spacing.
- Self-adjusting nylon and steel needle bearings.
- Solid silver contact points.
- Polished lucite paddles.
- Precision-machined, chrome plated brass frames.
- Standard model has black, textured finish base; deluxe model is chrome plated.
- Heavy steel base; non-skid feet.

Available at selected dealers or send \$42.95 (\$52.95 for chrome model) plus \$2.00 shipping and handling. Overseas amateurs invited to request quotation for air parcel post shipment.

Hardware" feature — meaning that a wide variety of switching assemblies can be made by simply snapping together standard switch bodies, dividers, blank bodies, and end plates. Other Series S2D features include a high degree of reliability due to the fact that each switch consists of only five components and has a life of 1,000,000 operations.

The new Series S2D offers as standard the nine most widely used output codes; other codes can be supplied on request. Standard output codes include Single-Pole Decimal, 10-Position; 10-Position BCD, Complement only; 10-Position BCD only; 10-Position BCD with Complements; Single-Pole, 16-Position, Binary; and Single Pole, Repeating. For more information contact Unimax Switch Corporation, Ives Road, Wallingford, Connecticut 06492.

## Heath IC Timers Self-Instruction Program



Heath Continuing Education, a division of Heath Company, Benton Harbor, Michigan, announces a new self-instruction program which covers integrated-circuit timers. The new program, Model EE-103, includes an introduction to the common types of IC timers, how each works, what they do, and where they are used.

Among the types of IC timers covered are the popular 555 and 556 series general-purpose timers; the 322 and 3905 wide-range, precision, monostable timers, and programmable timer/counters — including the 2240 binary programmable timer/counter; the 2250 BCD programmable timer/counter; and the 8260 seconds/minutes/hours BCD programmable timer/counter.

The program's self-teaching text,

## RADIO WAREHOUSE

No Frills, Just Low Prices

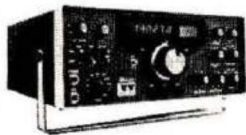

**\*899<sup>95</sup>**

**TEN-TEC OMNI-D**

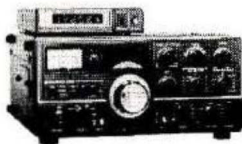

**\*545<sup>95</sup>**

**KENWOOD TS-520 SE**

**ICOM IC-255 A \*309<sup>95</sup>**

**HM-8 TOUCHTONE® MIKE \*34<sup>95</sup>**



**\*199<sup>95</sup> ICOM  
IC-2A "TALKIES"**

Call or Write for Quote  
All Major Brands

P.O. BOX 2728  
DALLAS, TX 75201  
Telephone: (817) 496-9000

## STUDY AIDS

### HI/LO SERIES — Code Study Tapes

In this unique series, characters are sent at high speeds with long pauses between each character. For example, HLC4 (15/2.5 wpm) consists of characters sent at a 15 wpm rate, but with 2.5 wpm spacing between each character. These tapes are excellent for the beginner who wants to practice copying higher speed code without the frustration of constantly getting behind.

- HR-HLC1 — \$4.95**  
22.5/2.5 wpm code for 80 minutes
- HR-HLC2 — \$4.95**  
22.5/5 wpm code for 20 minutes  
22.5/7.5 wpm code for 20 minutes  
22.5/10 wpm code for 20 minutes  
22.5/13 wpm code for 20 minutes
- HR-HLC3 — \$4.95**  
15/5 wpm code for 28 minutes  
15/7.5 wpm code for 28 minutes  
15/10 wpm code for 28 minutes
- HR-HLC4 — \$4.95**  
15/2.5 wpm code for 80 minutes

Please add \$1.00 to cover postage and handling.

Available from  
**HAM RADIO'S BOOKSTORE**  
GREENVILLE, NH 03048



with the assistance of review quiz questions and lab experiments, completely covers how each timer works and how each is used — in logic functions, output drive circuits, time-delay relay circuits, wide-range pulse generators, phase-locked loops, universal appliance timers, as precise clock sources, and many others.

All of the electronic components required to perform the experiments are included with the program. The Heathkit ET-3300 Laboratory Breadboard is a recommended option.

The EE-103 IC Timers course is one of four Electronic Technology Series self-instructional programs. They are designed to provide detailed knowledge for engineers, technicians, and other technical people. Other programs in the series include Operational Amplifiers (EE-101, \$39.95), Active Filters (EE-102, \$29.95), and Phase-Locked Loops (EE-104, \$49.95).

For more information on the EE-103 IC Timers Self-Instruction Program — priced at \$39.95 mail-order FOB Benton Harbor, Michigan — send for a free catalog containing more than 400 other useful electronic kits. Write Heath Company, Dept. 350-230, Benton Harbor, Michigan 49022, or pick up a copy at the nearest Heathkit Electronic Center (units of Veritechnology Products Corporation).

Heath Company is a subsidiary of Zenith Radio Corporation.

## Keithley Hand-Held DMM



Keithley Instruments announces its first hand-held digital multimeter (DMM). The 3½ digit Model 130,

with a large LCD display is intended to be a technician's tool. Priced at only \$99, it is a basic instrument, designed to meet the needs of the field service technician. It is easy to use and rugged.

A survey conducted by Keithley found that most service technicians prefer rotary switches and liquid-crystal displays (LCD). They also want a hand-held model that is convenient on the bench, so the display is the same size, 0.6 inch, as the displays on Keithley's bench instruments.

In addition, the simplicity of construction makes the Model 130 the most rugged hand-held DMM on the market. For more information, write Keithley Instruments, Inc., 28775 Aurora Road, Cleveland, Ohio 44139.

## New Energy-Efficient Voltage Controls

A new and convenient style of portable, variable ac-control system has just been announced by Staco Energy Products. Operating from standard 120-volt ac line current, the system enables the user to select and adjust ac voltage at any level from zero to 140 volts to provide power for applications requiring up to ten amperes continuous duty, or to 100 amperes surge, depending upon the unit selected.

An all-new, rugged, aluminum housing provides a complete enclosure, and on the largest unit provides an integral carrying handle for ease of portability. All units feature fused, three-wire grounded circuitry for user safety, and provide an on-off switch and pilot lamp in addition to the voltage-level adjustment knob. All controls are located on the front panel of the unit, which is recessed into the outer housing to minimize accidental readjustment. Models include the L-221 rated 1.75 A, the L-501 rated 4.5 A, and the L-1010 rated 10 A. All models are available from franchised Staco distributors throughout the country.

Applications include portable use, laboratory or bench applications, and incorporation into new or existing machines and equipment. The housing provides a means of custom mounting from either side, top, bottom, or rear of the unit, as the application requires.

## NEW HYDRAULIC TELESCOPING TUBULAR TOWER!

50 ft., Retracts to 21½ ft.  
(Mod. 50HT3)

**TILT OVER**

**MANY OTHER SIZES  
AVAILABLE**

MODELS  
FOR:

RV's  
ENG



EMERGENCY  
VEHICLES

INDUSTRIAL

MARINE  
ETC.



**CLEAN, NOT MESSY!  
LOW PRESSURE SYSTEM**

**SAFE**

**AVOID WIND LOSS.  
AVOID LIGHTNING.**

**RAISE TO USE,  
LOWER WHEN NOT  
IN USE.**

**SEE IT AT THE  
DAYTON & SEATTLE  
CONVENTION!**

## N-PRO

HIGHEST Quality Materials  
and Parts Used. Write or Call  
for FREE BROCHURE and  
Accessory Catalog.

P.O. Box 604  
Oregon City, OR 97045  
(503) 656-5500  
NORM - W7UJF





**RATES** Regular classified is available to commercial advertisers at 50¢ per word; and to non-commercial advertisers at 15¢ per word. Display classified (1 inch deep x 2 1/4 inches wide) is \$65, or at the 12x rate is \$50. All Ad Scan payable in advance. No cash discounts or agency commissions allowed.

**HAMFESTS** Sponsored by non-profit organizations receive one free regular classified ad (subject to our editing). Repeat insertions of hamfest ads pay the standard rate.

**COPY** No special layout or arrangements available. Material should be typewritten or clearly printed (not all capitals) and must include full name and address. We reserve the right to reject unsuitable copy. *HORIZONS* cannot check each advertiser and thus cannot be held responsible for claims made. Liability for correctness of material limited to corrected ad in next available issue.

**DEADLINE** 15th of third preceding month.

**SEND MATERIAL TO:** Ad Scan, Ham Radio Horizons, Greenville, N. H. 03048.

**DISTINCTIVE QSL's** — Largest selection, lowest prices, top quality photo and completely customized cards. Make your QSL's truly unique at the same cost as a standard card, and get a better return rate! Free samples, catalogue. Stamps appreciated. Stu, K2RPZ, Box 412, Rocky Point, NY 11778, (516) 744-6260.

**TRS-80 and 6500 SOFTWARE** for hams: CW, RTTY, and others. Prices start at \$3. S.A.S.E. brings latest flyer. WB2DSA, 6 Terrace Avenue, New Egypt, N.J. 08533.

**SPECIAL SALE:** Alliance HD-73 Heavy Duty Rotor \$99.99 plus \$3.00 shipping Continental USA. MC and Visa accepted. Scanner World, USA., 10 New Scotland Ave., Albany, N.Y. 12208. 518-438-9606.

**HAMS:** Try the new *Ad Scan!* Non-commercial ads only 15¢ per word. Commercial ads, as before, are 50¢ per word. Payment with ad, please.

**HAM RADIO REPAIR,** alignment. Hassle-free from anywhere via UPS. Expert, prompt, reasonable. Modern lab. "Grid" Gridley, W4GJO, Route 2, Box 138B, Rising Fawn, GA 30738.

**QSLs** — Clean, distinctive designs — raised printing, design flexibility — samples 50 cents (refundable) — K3QK, 191 Irwin, Pittsburgh, PA 15202.

**WANT TO BUY TOOLS AND OTHER MERCHANDISE CHEAP?** Send \$1.00 for details to: "Jess' Bargains", RR3, Box 48, Orleans, Ind. 47452.

**THE MOR-GAIN HD DIPOLES** are the most advanced, highest performance multi-band HF dipole antennas available. Patented design provides length one-half of conventional dipoles. 50 ohm feed on all bands, no tuner or balun required. Can be installed as inverted VEE. Thousands in use worldwide. 22 models available including two models engineered for optimum performance for the novice bands. The Mor-Gain HD dipoles N/T series are the only commercial antennas specifically designed to meet the operational requirements of the novice license. Our 1-year warranty is backed by nearly 20 years of HD dipole production experience. Write or call today for our 5-page brochure. (913) 682-3142. Mor-Gain, P.O. Box 329N, Leavenworth, KS 66048.

**MOBILE HF ANTENNA 3.2 — 30 MHz** inclusive, 750 watts PEP, center loaded, tuned from the base, eliminating coil changing or removing from mount. Less than 1.5 to 1 VSWR thru entire coverage. 129.95 ea. plus shipping. Contact your local dealer, if none in your area order direct. Antek, Inc., Route One, Hansen, Idaho 83334. (208) 423-4100. Master Chg. and VISA accepted. Dealer and factory rep. Inquiries invited.

**QSLs SECOND TO NONE.** Same day service. Samples 50 cents. Include your call for free decal. Ray, K7HLR, Box 331, Clearfield, UT 84015.

**MAGAZINE SAMPLES!** For a free list of over 135 magazines offering a sample copy, send a stamped, addressed envelope to: Publishers Exchange, P.O. Box 1368, Dept. 26A, Plainfield, NJ 07061.

**MOBILE IGNITION SHIELDING** provides more range with no noise. Bonding strap sale less than 50¢ each. Literature. Estes Engineering, 930 Marine Drive, Port Angeles, Wash. 98362.

**QSL INSURANCE.** No more QRL DX operators, managers, or bureaus. New product called "Confirmation Mailer" is your best guarantee in Amateur Radio of receiving a fast direct reply. \$5.50 brings you 30 Policies! Bob Zittman, K9UJA, P.O. Box 94973, Schaumburg, IL 60193.

**QSLs with class!** Unbeatable quality, reasonable price. Samples: 50¢ refundable. QSLs Unlimited, 1472 SW 13th Street, Boca Raton, FL 33432.

**DX — YOU BET!** The DX Bulletin — Best weekly DX info in the world — send for FREE sample copy. The DX Bulletin, 308 Vernon Avenue, Vernon, Connecticut 06066.

**QSLs & RUBBER STAMPS — Top Quality!** QSLs: Glossy Inks and Cardstock. Rubber Stamps: Report forms, Call Letter, Address, State outlines — More! Stamp Catalog and Card Samples 50¢. Ebbert Graphics 5H, Box 70, Westerville, Ohio 43081.

## CODE got you stumped?

RELAX and worry not! Learn International Morse Code the EASY, Rus Farnsworth way. No books, no gimmicks, just listen & learn. Using the word method, based on modern psychological techniques, you can zoom past 13 w.p.m. in less than half the time! Available in cassettes @ \$10.95 and LP records at \$9.95 — you get over two hours of instruction!

**EPSILON RECORDS**  
P.O. Box 626  
San Jacinto, CA 92383

**USED CALLBOOKS Buy/Sell, S.A.S.E. WB1ASX.**

**DRAKE TWINS:** R4B/T4XB recently reworked by Drake to meet new specs. Sell with matching AC power supply, speaker, manuals. \$775. WA1YTP, Sgalia, Box 54 Mad Tom Road, Dorset, VT 05253. Telephone (802) 362-1912.

**QSL's** — No stock designs! Your art or ours; photos; originals. 50¢ for samples, details (refundable). Certified Communications, 4138 S. Ferris, Fremont, MI 49412.

**VERTICAL USERS:** Hustler endorses it! MorGain, Cushcraft, Palomar bought it! "Most interesting . . . very well put together . . ." says Ham Radio Publishing Group. 21 nationwide dealers are advertising it! What is it? Send 15¢ stamp for details about "The Comparison of Relative Performance of Commercial Trap Vertical Installations Under Less than Ideal Geographic Conditions." Danrick Enterprises, Dept. 10H, 213 Dayton Ave., Clifton, N.J. 07011.

**CUSTOM EMBROIDERED EMBLEMS** — Your design, low minimum. Informational booklet. Emblems, Dept 65, Littleton, New Hampshire 03581.

**SCANNERS, CRYSTALS** at low Wholesale Prices! Wholesale to Everybody! Prompt Service! Send stamped envelope! Alford, Box 339-A1, Middlesex, N.C. 27557.

**CB TO 10 METER PROFESSIONALS** — Your rig or buy ours — SSB/AM/CW. Certified Communications, 4138 S. Ferris, Fremont, MI 49412. 616-924-4561.

**STOP LOOKING** for a good deal on amateur radio equipment — you've found it here — at your amateur radio headquarters in the heart of the Midwest. Now more than ever where you buy is as important as what you buy! We are factory-authorized dealers for Kenwood, Drake, Yaesu, Collins, Wilson, Ten-Tec, Atlas, ICOM, DenTron, MFJ, Tempo, Regency, Hy-Gain, Mosley, Alpha, Cushcraft, Swan and many more. Write or call us today for our low quote and try our personal and friendly Hoosier service. HOOSIER ELECTRONICS, P.O. Box 2001, Terre Haute, Indiana 47802. (812) 238-1566.

**ELECTRONIC BARGAINS, CLOSEOUTS, SURPLUS!** Parts, equipment, stereo, industrial, educational. Amazing values! Fascinating items unavailable in stores or catalogs anywhere. Unusual FREE catalog. ETCO-059, Box 762, Pittsborough, N.Y. 12901.

**YAESU FT-207R OWNERS:** We have an automatic scan module for your rig. 15 minutes to install; scan restarts when carrier drops off; busy switch controls automatic scan on-off; includes module and instructions. Model AS-1. Send \$25 to Engineering Consulting Services, P.O. Box 94355, Richmond, B.C., V6Y2A8 Canada.

**HAMS FOR CHRIST** — Reach other Hams with a Gospel Tract sure to please. Clyde Stanfield, WA6HEG, 1245 Sandra Ct., Upland, Calif. 91786.

**KENWOOD INTERNATIONAL USER'S CLUB** — Details S.A.S.E. N8RT, Pohorence, 9600 Kickapoo Pass, Streetsboro, OH 44240.



**NEW, Exciting Amateur Operators' Picture Yearbook**, sponsored by the First United Pentecostal Church, Inc. Send call sign, address, photo, and \$20 to Lee Kent, WD0FFZ, P.O. Box 236, Malden, MA 02148. You will receive one copy of the book for each \$20. Tell everyone.

## COMING EVENTS

**TENNESSEE:** Knoxville Hamfest May 24-25, 1980. Admission: \$2 each, or three for \$5. Tables, \$4 per day or \$6 for two days. Major prizes: TS-120, FT-207R. Talk-in on 147.90/30; 146.13/73; 146.52 simplex; and 3980 kHz. For information, S.A.S.E. to: WD5FJN, 12108 W. King's Gate Drive, Concord, TN 37922; or K4YFF, 2109 Needlum Drive, Knoxville, TN 37912.

**RADIO EXPO '80' — Lake County Fair Grounds, Rt. 45 & 120. September 6 and 7. Advance tickets \$2.00, \$3.00 at gate. Write Radio Expo Tickets, P.O. Box 1532, Evanston, IL 60204. Exhibitor information call (312) BST-EXPO.**

**JUNE 1 — SRRC Hamfest.** Furnish large SASE for complete info. Starved Rock Radio Club — W9MKS/WR9AFG, RFD #, Box 171, Oglesby, Illinois 61348 — (815) 667-4614.

**ONTARIO:** Lake Simcoe Hamfest, June 13th, 14th and 15th, at Molson's Park, Barrie, Ontario, Canada. Registration: \$4 by mail, \$5 at gate. Children under 18 admitted free. Doors open at 12:00 noon on Friday the 13th, with talk-in on VE3LSR 146.25/.85 and 146.52 simplex, or 3780 kHz SSB. For information, reservations, or tickets, write to Lake Simcoe Hamfest, P.O. Box 2283, Orillia, Ontario L3V 6S1, Canada.

**MAINE:** Yankee Radio Club's Yankee Hamfest '80, Saturday, June 28th, Oxford County Fairgrounds, Oxford, Maine. Computer displays, talks, ladies' program, youth program, swap tables, door prizes, buffet dinner. Registration \$8, includes dinner and door prize chances; \$7 early registration. Admission only, gate \$2.50. Camper hookups available, Friday, Saturday nights @ \$2 per night. Talk-in on 146.28/.88 and 146.52 simplex. For more information and registration, send S.A.S.E. to Lynda Mount, 198 Cony Extension, Augusta, Maine 04330.

**INDIANA:** Lake County ARC Dad's Day Hamfest, June 15th, Lake County Fairgrounds, Crown Point, Indiana, to be held indoors at the Industrial Arts Building. Tickets \$1.50 advance, \$2 at the door. Take I-65 to exit 231, go west to State Route 55 South, and follow signs. Talk-in on 147.84/.24 or 146.52 simplex. Tickets and information via P.O. Box 1909, Gary, IN 46409.

**MICHIGAN:** Chelsea Swap & Shop, Sunday, June 1, 1980, Chelsea Fairgrounds, Chelsea, Michigan. Gates open for sellers 5 AM; for public 8 AM - 2 PM. Admission: \$1.50 advance; \$2 at gate. Children under 12, and non-ham spouses, admitted free. Talk-in 146.52 simplex and 146.37/.97. For information, write to William Altenberndt, 3132 Timberling, Jackson, Michigan 49201.

**CALIFORNIA:** 1980 Santa Maria Swapfest and BBQ, Sunday, June 15th. Best steak and biggest hamfest in the west. Prizes include the Yaesu FT-707. Swap tables available. QLF and QBK contests. Tickets \$7 adults, \$3.50 children 6-12. Write Santa Maria Swapfest, P.O. Box 1615, Vandenberg AFB, CA 93437 or call KA6AKC (805) 734-1380.

**MICHIGAN:** Central Michigan A.R.A. Swap & Shop, June 21, 1980, Midland County Fairgrounds, Midland, Michigan. Computer demonstrations, door prizes. Talk-in 146.13/.73 and 146.52 simplex. Tickets and information: S.A.S.E. to R.L. Wert, W8COI, 309 East Gordonville Road, Route 12, Midland, Michigan 48640.

**INDIANA:** Muncie Area A.R.C. Amateur Spectacular, Sunday, June 1, 1980, on Ball State University Campus. Over one acre of columnless, ground level, indoor space. Food prices of the 1960's. Thousands in awards. Forums: Computers, Traffic and Nets, The ARRL, etc. Talk-in on 13/73, 223.30/224.90, 52/52. Advanced tickets \$2.00, \$3.00 at the door. Children under twelve free. For registration please contact, M.A.A.R.C., P.O. Box 3111, Muncie, Indiana 47302.

Staco Energy Products Co. has been a major supplier of voltage controls for over forty years. Their new facilities include over 82,000 square feet of manufacturing space, and their voltage-control capabilities extend from 0.19 kVA through 1500 kVA.

Styles range from manual panel-mounted units through closed-loop voltage-regulator systems. Requests for engineering assistance may be addressed to the attention of Sales Manager, 301 Gaddis Boulevard, Dayton, Ohio 45403.

## Programmable encoder

Communications Specialists has introduced a programmable 12-tone encoder, model TE-12P, available in either sub-audible or burst-tone configuration.

In the sub-audible range, this encoder allows the programming of 12 standard frequencies from 67.0 Hz to 203.5 Hz. In the audible range, burst tones may be selected in the range of 1600 Hz to 2550 Hz in 50 Hz increments. Additionally, there are 13 other frequencies available for either burst or test purposes.

This encoder is housed in a durable plastic case measuring 5.25 x 3.3 x 1.7 inches and is complete with mounting bracket and hardware. It may be powered by 6 to 30 Vdc, unregulated at 8 mA and provides a low-impedance, low-distortion, adjustable sine-wave output of 5 V p-p. Reverse polarity protection is built-in.

Programming each channel can be done in seconds. A five position DIP switch is furnished for each of the 12 channels and it is merely a matter of setting each switch to the proper ON and OFF positions to achieve a binary-coded frequency.

The output level is flat to within 1.5 dB over the entire range of frequencies selected. In the low-frequency range, the frequency accuracy is  $\pm .1$  Hz and in the high-frequency range, the accuracy is within  $\pm 1.0$  Hz. Sub-audible tones are designated as Group A tones and audible frequencies are Group B tones. No counter or other frequency measuring device is needed to set frequencies.

The TE-12P is priced at \$89.95, wired and tested, complete with instructions. For more information write Communications Specialists, 426 West Taft Avenue, Orange, California 92667.

## Digitrex Electronics

### PA-19 Wideband Preampifier

- 2 to 200 MHz Bandwidth (3dB Points)
- 19 dB Gain!
- 50 Ohms Input & Output Impedance
- Tiny PC Board Size (7/8" x 1-5/8")
- Absolutely No Tuning Required
- Extremely Stable
- Draws only 20 mA @ 12VDC
- Great Way to Increase Sensitivity of Receivers, Counters, etc.
- Fully Assembled and Tested
- Instructions Provided, Full Warranty

only **\$8.95**  
• .50 Shipping/Handling

### Portable 600 MHz Frequency Counter

- 1600 MHz Range
- 1 KHz or 100 Hz Resolution
- Assembled and Tested
- Full Lifetime Warranty
- See U.L.A.Z. Exhibits
- BNC Whip Antenna Opt. \$8.95



**\$59.95** ppd (Best Deal.)

C.O.D. Orders Welcome  
**Digitrex Electronics**  
4412 Fernlee, Royal Oak  
Michigan 48073 313-651-9247

• 75 mV Sensitivity

## HI-Q BALUN

- For dipoles, yagis, inverted vees & doublets
- Replaces center insulator
- Puts power in antenna
- Broadbanded 3-40 MHz
- Small, lightweight and weatherproof
- 1:1 Impedance ratio
- For full legal power and more
- Helps eliminate TVI
- With SO 239 connector



**\$10.95**

## HI-Q ANTENNA CENTER INSULATOR

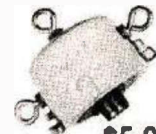

Small, rugged, lightweight weatherproof Replaces center insulator Handles full legal power and more

**\$5.95** With SO 239 connector

## HI-Q ANTENNA END INSULATORS



Rugged lightweight nylon mounted on top quality metal. Atmospheric ion doublets and increased weather ability. End insulators are constructed in a special angled fashion to permit winding of loading coils or parallel wiring for tuning traps.

May be used for:
 

- Guy wire strain insulators
- End or center insulators for antennas
- Construction of antenna loading coils or multiband traps

**\$4.95**

Patent No. 4,091,350

## DIPOLES

MODEL	BANDS	LENGTH	PRICE WITH HI-Q BALUN	WITH HI-Q CENTER INSULATOR
<b>Dipoles</b>				
D 80	80-75	130	\$28.95	\$24.95
D 40	40-15	66	25.95	21.95
D 20	20	13	24.95	20.95
A 15	15	22	23.95	19.95
D 10	10	16	22.95	18.95
<b>Shortened dipoles</b>				
SD 80	80-75	88	14.95	12.95
SD 40	40	48	28.95	24.95
<b>Parallel dipoles</b>				
PD 801C	80-40/20/15	141	39.95	35.95
PD 401C	40-20/10/15	88	33.95	29.95
PD 8040	80-40/15	130	35.95	31.95
PD 4020	40-20/15	66	29.95	25.95

Dipole shorteners - only, same as included in SD models  
S 40 80-75 40 \$11.95 pp  
S 40 40 40 \$13.95 pp

All antennas are custom built with Hi-Q Balun with Q Antenna Center Insulator. No. 14 terminals with ceramic insulators. Full range antenna supports for SD models only. SO 239 connectors. U.L.A.Z. Antennas may be used as an inverted V and may also be used by NARS or SWLs.

Antenna accessories - available with antennas orders  
Metal Guy Wire (4500 ft.) 10' dia. \$3.49  
Guy Wire (4500 ft.) 1/2" dia. \$3.99  
SO 239 connector (10 pack) \$5.95

All prices are postpaid in USA. In. Outside U.S. add \$10.00. Add \$1.00 per lb. shipping.

**Van Gorden Engineering**  
BOX 21205, S. DUBLIN, OHIO 43021 Dealer Inquiries Invited

# HRH LOCATOR

TO HELP YOU FIND YOUR LOCAL AMATEUR RADIO DEALER

## Arizona

**POWER COMMUNICATIONS CORP.**  
6012 N. 27th AVENUE  
PHOENIX, AZ 85017  
602-242-6030 or 242-8990  
Arizona's #1 "Ham" Store, Kenwood, Yaesu, Icom, and more.

## California

**JUN'S ELECTRONICS**  
11656 W. PICO BLVD.  
LOS ANGELES, CA 90064  
213-477-1824 Trades  
714-463-1886 San Diego  
The Home of the One Year Warranty  
— Parts at Cost — Full Service.

**SHAVER RADIO, INC.**  
1378 S. BASCOM AVE.  
SAN JOSE, CA 95128  
408-998-1103  
Atlas, Kenwood, Yaesu, KDK, Icom, Tempo, Wilson, Ten-Tec, VHF Engineering.

**TELE-COM**  
15460 UNION AVENUE  
SAN JOSE, CA 95124  
408-377-4479

## Connecticut

**HATRY ELECTRONICS**  
500 LEDYARD ST. (SOUTH)  
HARTFORD, CT 06114  
203-527-1881  
Connecticut's Oldest Ham Radio Dealer.

**THOMAS COMMUNICATIONS**  
95 KITTS LANE  
NEWINGTON, CT 06111  
203-667-0811  
Authorized dealer for Kenwood, Yaesu, Drake, Icom, etc. - CALL US.

## Delaware

**DELAWARE AMATEUR SUPPLY**  
71 MEADOW ROAD  
NEW CASTLE, DE 19720  
302-328-7728  
Icom, Ten-Tec, Swan, DenTron, Wilson, Tempo, KDK, and more.  
One mile off I-95, no sales tax.

## Florida

**AGL ELECTRONICS, INC.**  
1898 DREW STREET  
CLEARWATER, FL 33515  
813-461-HAMS  
West Coast's Only Full Service Amateur Radio Store

**AMATEUR RADIO CENTER, INC.**  
2805 N.E. 2ND AVENUE  
MIAMI, FL 33137  
305-573-8383  
The Place For Great Dependable Names in Ham Radio

**RAY'S AMATEUR RADIO**  
1590 US HWY. 19 SOUTH  
CLEARWATER, FL 33516  
813-535-1416  
Sales and Service. Your Complete Amateur Radio Store.

**SUNRISE AMATEUR RADIO**  
1351 STATE RD. 84  
FT. LAUDERDALE, FL 33315  
(305) 761-7676  
"Best Prices in Country.  
Try Us — We'll prove it."

## Illinois

**AUREUS ELECTRONICS INC.**  
1415 N. EAGLE STREET  
NAPERVILLE, IL 60540  
312-420-8629  
"Amateur Excellence"

**ERICKSON COMMUNICATIONS, INC.**  
5456 NORTH MILWAUKEE AVE.  
CHICAGO, IL 60630  
312-631-5181  
Outside Illinois 800-621-5802  
Hours 9:30-5:30 Mon., Tues., Wed.,  
Fri.; 9:30-9:00 Thurs.; 9:00-3:00 Sat.

**KLAUS RADIO, INC.**  
8400 NO. PIONEER PARKWAY  
PEORIA, IL 61614  
309-691-4840  
Let Us Quote Your Amateur Needs.

## Kansas

**ASSOCIATED RADIO COMM**  
8012 CONSER  
OVERLAND PARK, KS 66204  
913-381-5900  
America's No. 1 Real Amateur Radio Store. Trade - Sell - Buy.

## Maryland

**THE COMM CENTER, INC.**  
LAUREL PLAZA RT. 198  
LAUREL, MD 20810  
800-638-4486  
Kenwood, Drake, Icom, Ten-Tec, Tempo, DenTron, Swan & Apple Computers.

## Massachusetts

**TEL-COM, INC.**  
675 GREAT RD., RT. 119  
LITTLETON, MA 01460  
617-486-3040  
The Ham Store of New England  
You Can Rely On.

## Minnesota

**PAL ELECTRONICS INC.**  
3452 FREMONT AVE. NO.  
MINNEAPOLIS, MN 55412  
612-521-4662  
Midwest's Fastest Growing Ham Store. Where Service Counts.

## New Hampshire

**EVANS RADIO, INC.**  
BOX 893, RT. 3A BOW JUNCTION  
CONCORD, NH 03301  
603-224-9961  
Icom, DenTron, Yaesu, Drake.  
We service what we sell.

## New Jersey

**RADIOS UNLIMITED**  
P. O. BOX 347  
1760 EASTON AVENUE  
SOMERSET, NJ 08873  
201-469-4599  
New Jersey's Fastest Growing Ham Store.



# HRH LOCATOR

Continued

**ROUTE ELECTRONICS 46**  
225 ROUTE 46 WEST  
TOTOWA, NJ 07512  
201-256-8555  
Drake, Swan, DenTron, Cushcraft,  
Hy-Gain, Hustler, Larsen and more.

**WITTIE ELECTRONICS**  
384 LAKEVIEW AVE.  
CLIFTON, NJ 07011  
201-772-2222  
Same location for 62 years.  
Full-line authorized Drake dealer.

## New Mexico

**PECOS VALLEY AMATEUR  
RADIO SUPPLY**  
115 W. WALNUT STREET  
ROSWELL, NM 88201  
505-623-7388  
Your DX, Contest and Antenna  
Headquarters featuring A.E.A., Hy-  
Gain, Azden, Butternut, and Most  
Major Brands.

## New York

**GRAND CENTRAL RADIO**  
124 EAST 44 STREET  
NEW YORK, NY 10017  
212-599-2630  
Drake, Kenwood, Yaesu, Atlas,  
Ten-Tec, Midland, Hy-Gain,  
Mosley in stock.

**HAM-BONE RADIO**  
(Div. Stereo Repair Shop)  
3206 ERIE BOULEVARD EAST,  
SYRACUSE, NY 13214  
315-446-2266  
We Deal, We Trade,  
We Discount, We Please!  
2-Way Service Shop on Premises!

**HARRISON RADIO CORP.**  
20 SMITH STREET  
FARMINGDALE, NY 11735  
516-293-7990  
"Ham Headquarters USA®"  
since 1925.  
Call toll free 800-645-9187.

**RADIO WORLD**  
ONEIDA COUNTY AIRPORT  
TERMINAL BLDG.  
ORISKANY, NY 13424  
800-448-7914  
315-337-2622 } NY  
315-337-0203 } Res.  
New & Used Ham Equipment. See  
Warren K21XN or Bob WA2MSH

## Ohio

**UNIVERSAL AMATEUR RADIO, INC.**  
1280 AIDA DRIVE  
COLUMBUS (REYNOLDSBURG)  
OH 43068  
614-866-4267  
Complete Amateur Radio Sales and  
Service. All major brands · spacious  
store · near I-270.

## Pennsylvania

**HAMTRONICS, DIV. OF  
TREVOSE ELECT.**  
4033 BROWNSVILLE RD.  
TREVOSE, PA 19047  
215-357-1400  
Same Location for  
More Than 30 Years.

**LaRUE ELECTRONICS**  
1112 GRANDVIEW STREET  
SCRANTON, PENNSYLVANIA 18509  
717-343-2124  
ICOM, Bird, Cushcraft, CDE,  
Ham-Keys, VHF Engineering,  
Antenna Specialists.

**SPECIALTY COMMUNICATIONS**  
2523 PEACH STREET  
ERIE, PA 16502  
814-455-7674  
Service, Parts, & Experience  
For Your Atlas Radio.

## Dealers:

You should be  
here too! Contact  
HORIZONS today  
for complete details.

TOLL FREE **800-258-5353**

When it comes to  
**AMATEUR  
RADIO QSL's...**



it's the  
**ONLY BOOK!**  
US or DX Listings

1980  
**callbooks**  
NOW READY!

Here they are! The latest editions. World-famous Radio Amateur Callbooks, the most respected and complete listing of radio amateurs. Lists calls, license classes, address information. Loaded with special features such as call changes, prefixes of the world, standard time charts, world-wide QSL bureaus and more. The new 1980 Radio Amateur Callbooks are available now. The U.S. Edition features over 400,000 listings, over 120,000 changes from last year. The Foreign Edition, over 315,000 listings, over 90,000 call changes. Place your order now.

	Each	Shipping	Total
<input type="checkbox"/> US Callbook	\$16.95	\$1.75	\$18.70
<input type="checkbox"/> Foreign Callbook	\$15.95	\$1.75	\$17.70

Order both books at the same time for \$34.65 includes shipping.

Order from your favorite electronics dealer or direct from the publisher. All direct orders add \$1.75 for shipping. Illinois residents add 5% Sales Tax.



**SPECIAL LIMITED OFFER!**  
Amateur Radio  
Emblem Patch  
only \$2.50 postpaid

Pegasus on blue field, red lettering. 3" wide x 3" high. Great on jackets and caps. Sorry, no call letters.

**ORDER TODAY!**

RADIO AMATEUR **callbook** INC.  
Dept. EB 2  
925 Sherwood Drive  
Lake Bluff, IL 60044

# TOWERS

by ALUMA

HIGHEST QUALITY  
ALUMINUM & STEEL

80 Ft. Aluminum,  
Crank-Up  
Model T-60-H

40' Steel  
Crank-Up  
Model SHD-40

★ TELESCOPING  
(CRANK UP)

★ GUYED (STACK-UP)

★ TILT-OVER MODELS

Easy to install. Low Prices.  
Crank-ups to 100 ft.

EXCELLENT FOR  
HAM COMMUNICATIONS

SPECIAL  
Four Section 50 Ft.  
Van Mounted Crank-Up  
Aluma Tower

Over 36 types aluminum  
and steel towers made—  
specials designed and  
made—write for details

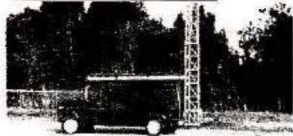

ALUMA TOWER CO.  
Box 2806 HH  
VERO BEACH, FLA. 32960  
PHONE (305) 567-3423  
TELEX 90-3405

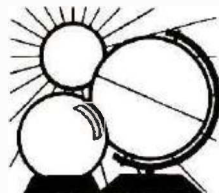

## DX FORECASTER

### Last-minute predictions

The first two weeks of the month are likely to provide some extensive ionospheric disturbances, including possible magnetic storms (perhaps flare-induced), and even some atmospheric or other geophysical effects. In particular, the 1st through the 5th, and the 9th through the 16th will be times to watch for unusual propagation conditions — including the possibility of some extraordinary vhf propagation!

The last two weeks in June are expected to be relatively uneventful and quiet — perhaps recovering from the first two weeks!

Moon perigee is on the 9th, full moon on the 28th, and the summer solstice on the 21st, bringing with it the beginning of summer and the longest day of the year.

Summertime DX conditions are not among the best of the year, because of high absorption levels during the day on the lower-frequency bands, and static from thunderstorms during evening hours. Over-excitation of the ionosphere tends to limit its usefulness for DX propagation because signals tend to be absorbed rather than reflected. However, the beneficial effects of Cycle 21 are still with us, so DX will be adequate, if not exceptional, between 20 and 6 meters. Use the chart for your best times and directions. Note that the asterisk (\*) means to look at the next higher band in addition to the one indicated.

Vhf enthusiasts will have opportunities to work storm-front related conditions, meteor-trail propagation, sporadic-E, and even some F2 skip this month. Short-lived MUF enhancements sometimes occur during magnetically disturbed periods.

### Band-by-band forecast

Ten meters should provide excellent daytime propagation, particularly north-south path DX to South America, Africa, and Pacific areas. Expect conditions to peak during the afternoon hours. There will also be some

good short-skip, and even Sporadic-E conditions on many days of the month, to distances of between 500 and 1500 miles (800-2400 km) or more.

Fifteen meters will provide good worldwide DX during the daylight and early evening hours on most days of the month. You can expect conditions to peak during the late afternoon, and short-skip signals out to distances of between 500 and 2500 miles (800-4000 km) will be common into the evening hours.

Twenty meters will be open to some area of the world or another for the entire twenty-four hour period on most days of the month. The band should peak in all directions just after local sunrise, and again toward the east and south during late evening hours. During the hours of darkness, the band will peak toward the west, in an arc from southwest through northwest, and will take in Pacific areas at this time. Short skip during the day will extend from about 350 to 2500 miles (560-4000 km), and during the darkness hours will extend from about 1000 to 2500 miles (1600-4000 km).

Forty meters can often provide good DX from sunset, through the hours of darkness, until just after sunrise, in spite of the atmospheric noise levels (static) mentioned earlier — provided you pick times when storm-related static is at a minimum, coinciding with favorable days for propagation. Not exactly like shooting fish in a barrel, but not bad. Short daytime skip out to about 750 miles (1200 km), and out to about 2500 miles (4000 km) at night will prevail.

Eighty meters can sometimes provide openings to DX areas during the hours of darkness and at sunrise, but signals will be weak and static will be strong. For these DX conditions, coastal stations often have a better chance of snagging rare ones than do stations in the center of large land masses. Daytime skip to 250 miles (400 km) will be limited by absorption levels, but at night you can work stations out to 2500 miles (4000 km).

One-sixty meters is not quite hopeless during the hours of darkness, but during the daytime, forget it! However, be advised that "DX" here means about 1000 miles (1600 km), and will be limited by static interference on many evenings.

HRH

## STUDY AIDS

### KANTRONICS THEORY CASSETTE

Here's a new, easy way to study theory for your Novice, General, Advanced or Extra class exam. Designed for folks on the run. All you have to do is drop in the cassette at home, work, or in the car and listen to an interview-style tape covering Novice, General, Advanced or Extra class theory. A great way to reinforce other study methods.

- KT-NT One tape \$4.95  
Novice Class Theory Cassette
- KT-GT Two tapes \$8.95  
General Class Theory Cassette
- KT-AT One tape \$4.95  
Advanced Class Theory Cassette
- KT-ET One tape \$4.95  
Extra Class Theory Cassette

Please add \$1.00 to cover  
postage and handling.

Available from  
**HAM RADIO'S BOOKSTORE**  
GREENVILLE, NH 03048



**WESTERN USA**

**MID USA**

**EASTERN USA**

GMT	WESTERN USA										MID USA										EASTERN USA									
	PDT	N	NE	E	SE	S	SW	W	NW		N	NE	E	SE	S	SW	W	NW		N	NE	E	SE	S	SW	W	NW		EDT	CDT
0000	5:00	—	15	—	15*	15	10	15	15	—	—	15	—	20	15	15	15	—	—	—	20	—	10	15	15	15	15	—	8:00	7:00
0100	6:00	—	20	—	15	15	15*	15	15	—	15	20	—	20	15	15	15	—	—	15	20	—	20*	20	15	15	—	9:00	8:00	
0200	7:00	—	20	—	20	20	15*	15	—	—	15	20	—	20*	20	15	15	15	—	15	20	—	20*	20	15	—	10:00	9:00		
0300	8:00	—	20	—	20	20	15*	15	—	—	15	20	—	20*	20	15	15	15	—	15	20	—	20*	20	15	—	11:00	10:00		
0400	9:00	15	20	—	20	20	15	15	—	—	15	20	—	20*	40*	15	15	15	—	15	20	—	20*	20	15	—	12:00	11:00		
0500	10:00	15	20	—	20	20	15	15	—	—	20	20	—	20	40*	15	15	—	—	20	20	—	20	20	15	—	1:00	12:00		
0600	11:00	15	20	20	20	20	15	20	20	—	20	20	20	20	40*	20	20	—	—	20	20	—	20	20	20	—	2:00	1:00		
0700	12:00	—	20	20	20	20	20	20	20	—	20	20	20	20	20	20	20	—	—	20	20	—	20	20	20	—	3:00	2:00		
0800	1:00	20	—	20	40*	20	20	20	20	—	—	20	—	20	40*	20	20	—	—	—	20	—	40*	20	20	—	4:00	3:00		
0900	2:00	20	—	—	40*	20	20	20	20	—	—	—	—	40*	20	20	40*	—	—	—	—	—	40*	20	40*	—	5:00	4:00		
1000	3:00	20	—	—	40*	20	20	20	40*	20	—	—	—	40*	20	40*	40*	20	—	—	—	—	40*	20	40*	—	6:00	5:00		
1100	4:00	20	—	—	—	40	40*	40*	40*	20	—	—	—	20	—	40*	40*	40*	20	—	—	—	20	20	40*	20	7:00	6:00		
1200	5:00	20	—	—	—	40	40*	40*	40*	20	—	—	—	20	—	40*	20	40*	—	—	—	—	20	20	20	20	8:00	7:00		
1300	6:00	20	20	—	—	40	40*	20	—	—	20	20	20	20	—	20	20	20	—	—	20	—	20	—	20	20	9:00	8:00		
1400	7:00	20	20	20	—	—	40*	20	—	—	20	20	20	20	—	20	20	20	—	—	20	—	15	—	20	20	10:00	9:00		
1500	8:00	20	20	20	—	—	20	20	—	—	20	20	20	20	—	20	20	20	—	—	20	—	15	—	20	20	11:00	10:00		
1600	9:00	15	15	20	—	—	20	20	—	—	20	20	20	15	15	—	—	—	—	—	20	—	15	15	—	—	12:00	11:00		
1700	10:00	15	15	15	—	—	—	—	—	—	15	15	15	15	15	—	—	—	—	—	15	—	15	15	—	—	1:00	12:00		
1800	11:00	15	15	15	10	—	—	—	—	—	15	15	15	15	—	—	—	—	—	—	15	—	15	10	—	—	2:00	1:00		
1900	12:00	15	—	15	10	—	—	—	—	—	15	20	15	15	—	—	—	—	—	—	15	—	20	10	—	—	3:00	2:00		
2000	1:00	15	—	—	10	—	—	—	—	—	15	20	10	10	—	—	—	—	—	—	15	—	20	15*	15	—	4:00	3:00		
2100	2:00	—	—	—	15	—	—	—	—	—	—	—	—	10	—	—	—	—	—	—	—	—	20	15*	15	—	5:00	4:00		
2200	3:00	—	15	—	15*	—	—	—	—	—	15	—	10	15	15	15	15	—	—	—	15	—	15*	15	15	15	6:00	5:00		
2300	4:00	—	15	—	15*	—	—	—	—	—	15	—	10	15	15	15	15	—	—	—	15	—	15*	15	15	15	7:00	6:00		

Sunday	Monday	Tuesday	Wednesday	Thursday	Friday	Saturday
<p>The Chelsea Swap and Shop — Chelsea Fairgrounds, Chelsea, Michigan — 1</p> <p>Muskegon Amateur Radio Club's Amateur Spectacular — Ball State University Campus, Muncie, Indiana — 1</p> <p>The Old Virginia Home ARC, Inc.'s Sixth Annual Manassas Hamfest — Prince William County Fairgrounds, Manassas, Virginia — K4PPT — 1</p>	<p>Florida Ham News — Swap Net By the Broward ARC 146.31- 91 at 7:30 PM</p> <p>Glenhurst Radio Society Transmits Amateur Radio News — 222.66/224.26 MHz via WR2APG and 21.400 MHz USB</p>	<p>AMSAT Eastcoast Net 3850 kHz 9:00 PM EDT 10100Z Wednesday Morning!</p> <p>AMSAT Mid-Continent Net 3850 kHz 9:00 PM CDST 0200Z Wednesday Morning!</p> <p>AMSAT Westcoast Net 3850 kHz 8:00 PM PDT 10300Z Wednesday Morning!</p>	<p>AMSAT Eastcoast Net 3850 kHz 9:00 PM EDT 10100Z Wednesday Morning!</p> <p>AMSAT Mid-Continent Net 3850 kHz 9:00 PM CDST 0200Z Wednesday Morning!</p> <p>AMSAT Westcoast Net 3850 kHz 8:00 PM PDT 10300Z Wednesday Morning!</p>	<p>AMSAT Eastcoast Net 3850 kHz 9:00 PM EDT 10100Z Wednesday Morning!</p> <p>AMSAT Mid-Continent Net 3850 kHz 9:00 PM CDST 0200Z Wednesday Morning!</p> <p>AMSAT Westcoast Net 3850 kHz 8:00 PM PDT 10300Z Wednesday Morning!</p>	<p>AMSAT Eastcoast Net 3850 kHz 9:00 PM EDT 10100Z Wednesday Morning!</p> <p>AMSAT Mid-Continent Net 3850 kHz 9:00 PM CDST 0200Z Wednesday Morning!</p> <p>AMSAT Westcoast Net 3850 kHz 8:00 PM PDT 10300Z Wednesday Morning!</p>	<p>AMSAT Eastcoast Net 3850 kHz 9:00 PM EDT 10100Z Wednesday Morning!</p> <p>AMSAT Mid-Continent Net 3850 kHz 9:00 PM CDST 0200Z Wednesday Morning!</p> <p>AMSAT Westcoast Net 3850 kHz 8:00 PM PDT 10300Z Wednesday Morning!</p>
<p>Monroe County Radio Communication Association's Hamfest — Monroe Community College, Monroe, Michigan — W0BRITZ — 8</p> <p>The Milton Amateur Radio Club, Inc.'s Hamfest — Allenwood Firmen's Fairgrounds, Allenwood, Pennsylvania — 8AM-5PM, EST — WA3JLU — 8</p> <p>Six Meter Club of Chicago, Inc.'s Twenty-Third Annual ABC Hamfest — Santa Fe Park, Willow Springs, Illinois — N2ZMV — 8</p>	<p>Florida Ham News — Swap Net By the Broward ARC 146.31- 91 at 7:30 PM</p> <p>Glenhurst Radio Society Transmits Amateur Radio News — 222.66/224.26 MHz via WR2APG and 21.400 MHz USB</p> <p>West Coast Bulletin Edited &amp; Transmitted by W6ZF 8:00 PM PST 3540 MHz A.1.22 WPM</p>	<p>AMSAT Eastcoast Net 3850 kHz 9:00 PM EDT 10100Z Wednesday Morning!</p> <p>AMSAT Mid-Continent Net 3850 kHz 9:00 PM CDST 0200Z Wednesday Morning!</p> <p>AMSAT Westcoast Net 3850 kHz 8:00 PM PDT 10300Z Wednesday Morning!</p>	<p>AMSAT Eastcoast Net 3850 kHz 9:00 PM EDT 10100Z Wednesday Morning!</p> <p>AMSAT Mid-Continent Net 3850 kHz 9:00 PM CDST 0200Z Wednesday Morning!</p> <p>AMSAT Westcoast Net 3850 kHz 8:00 PM PDT 10300Z Wednesday Morning!</p>	<p>AMSAT Eastcoast Net 3850 kHz 9:00 PM EDT 10100Z Wednesday Morning!</p> <p>AMSAT Mid-Continent Net 3850 kHz 9:00 PM CDST 0200Z Wednesday Morning!</p> <p>AMSAT Westcoast Net 3850 kHz 8:00 PM PDT 10300Z Wednesday Morning!</p>	<p>AMSAT Eastcoast Net 3850 kHz 9:00 PM EDT 10100Z Wednesday Morning!</p> <p>AMSAT Mid-Continent Net 3850 kHz 9:00 PM CDST 0200Z Wednesday Morning!</p> <p>AMSAT Westcoast Net 3850 kHz 8:00 PM PDT 10300Z Wednesday Morning!</p>	<p>AMSAT Eastcoast Net 3850 kHz 9:00 PM EDT 10100Z Wednesday Morning!</p> <p>AMSAT Mid-Continent Net 3850 kHz 9:00 PM CDST 0200Z Wednesday Morning!</p> <p>AMSAT Westcoast Net 3850 kHz 8:00 PM PDT 10300Z Wednesday Morning!</p>
<p>Jacksonville Area Amateur Radio Club's Fifteenth Annual Hamfest and Flea Market — Morgan County Fairgrounds, Lawrenceville, Georgia — W4LAL — 15</p> <p>Southern Amateur Radio Club, Inc. — 1980 Santa Maria Swapfest and BBQ — K46AKC — 15</p> <p>Lake County Amateur Radio Club, Inc.'s Eighth Annual Day's Day Hamfest — Lake County Fairgrounds, Crown Point, Indiana — W9FOT — 15</p> <p>Frederick Amateur Radio Club's Third Annual Hamfest — Frederick Fairgrounds, Frederick, Maryland — WB3LJK — 15</p>	<p>Florida Ham News — Swap Net By the Broward ARC 146.31- 91 at 7:30 PM</p> <p>Glenhurst Radio Society Transmits Amateur Radio News — 222.66/224.26 MHz via WR2APG and 21.400 MHz USB</p> <p>West Coast Bulletin Edited &amp; Transmitted by W6ZF 8:00 PM PST 3540 MHz A.1.22 WPM</p>	<p>AMSAT Eastcoast Net 3850 kHz 9:00 PM EDT 10100Z Wednesday Morning!</p> <p>AMSAT Mid-Continent Net 3850 kHz 9:00 PM CDST 0200Z Wednesday Morning!</p> <p>AMSAT Westcoast Net 3850 kHz 8:00 PM PDT 10300Z Wednesday Morning!</p>	<p>AMSAT Eastcoast Net 3850 kHz 9:00 PM EDT 10100Z Wednesday Morning!</p> <p>AMSAT Mid-Continent Net 3850 kHz 9:00 PM CDST 0200Z Wednesday Morning!</p> <p>AMSAT Westcoast Net 3850 kHz 8:00 PM PDT 10300Z Wednesday Morning!</p>	<p>AMSAT Eastcoast Net 3850 kHz 9:00 PM EDT 10100Z Wednesday Morning!</p> <p>AMSAT Mid-Continent Net 3850 kHz 9:00 PM CDST 0200Z Wednesday Morning!</p> <p>AMSAT Westcoast Net 3850 kHz 8:00 PM PDT 10300Z Wednesday Morning!</p>	<p>AMSAT Eastcoast Net 3850 kHz 9:00 PM EDT 10100Z Wednesday Morning!</p> <p>AMSAT Mid-Continent Net 3850 kHz 9:00 PM CDST 0200Z Wednesday Morning!</p> <p>AMSAT Westcoast Net 3850 kHz 8:00 PM PDT 10300Z Wednesday Morning!</p>	<p>AMSAT Eastcoast Net 3850 kHz 9:00 PM EDT 10100Z Wednesday Morning!</p> <p>AMSAT Mid-Continent Net 3850 kHz 9:00 PM CDST 0200Z Wednesday Morning!</p> <p>AMSAT Westcoast Net 3850 kHz 8:00 PM PDT 10300Z Wednesday Morning!</p>
<p>Wood County Amateur Radio Club (K5THH) — Sixteenth Annual Wood County Ham-A-Rama — Wood County Fairgrounds, Bowling Green, Ohio — W8ET — 29</p> <p>Champaign-Logan Amateur Radio Club, Inc.'s Annual Hamfest — Memorial Hall, Belle Center, Ohio — N8BK — 29</p>	<p>Florida Ham News — Swap Net By the Broward ARC 146.31- 91 at 7:30 PM</p> <p>Glenhurst Radio Society Transmits Amateur Radio News — 222.66/224.26 MHz via WR2APG and 21.400 MHz USB</p>	<p>AMSAT Eastcoast Net 3850 kHz 9:00 PM EDT 10100Z Wednesday Morning!</p> <p>AMSAT Mid-Continent Net 3850 kHz 9:00 PM CDST 0200Z Wednesday Morning!</p> <p>AMSAT Westcoast Net 3850 kHz 8:00 PM PDT 10300Z Wednesday Morning!</p>	<p>AMSAT Eastcoast Net 3850 kHz 9:00 PM EDT 10100Z Wednesday Morning!</p> <p>AMSAT Mid-Continent Net 3850 kHz 9:00 PM CDST 0200Z Wednesday Morning!</p> <p>AMSAT Westcoast Net 3850 kHz 8:00 PM PDT 10300Z Wednesday Morning!</p>	<p>AMSAT Eastcoast Net 3850 kHz 9:00 PM EDT 10100Z Wednesday Morning!</p> <p>AMSAT Mid-Continent Net 3850 kHz 9:00 PM CDST 0200Z Wednesday Morning!</p> <p>AMSAT Westcoast Net 3850 kHz 8:00 PM PDT 10300Z Wednesday Morning!</p>	<p>AMSAT Eastcoast Net 3850 kHz 9:00 PM EDT 10100Z Wednesday Morning!</p> <p>AMSAT Mid-Continent Net 3850 kHz 9:00 PM CDST 0200Z Wednesday Morning!</p> <p>AMSAT Westcoast Net 3850 kHz 8:00 PM PDT 10300Z Wednesday Morning!</p>	<p>AMSAT Eastcoast Net 3850 kHz 9:00 PM EDT 10100Z Wednesday Morning!</p> <p>AMSAT Mid-Continent Net 3850 kHz 9:00 PM CDST 0200Z Wednesday Morning!</p> <p>AMSAT Westcoast Net 3850 kHz 8:00 PM PDT 10300Z Wednesday Morning!</p>



# First family of power... **ALPHA**

See all the ALPHAS  
at **DAYTON 1980**  
A GREAT CHANCE TO STUDY ALL THE  
SUPERB ALPHAS INSIDE AND OUT...  
TALK WITH ETO FACTORY EXPERTS...



Glen Eyrie, Garden of the Gods in ETO's backyard  
Photo By RIC HELSTROM

... THEN TAKE IMMEDIATE DELIVERY OF YOUR NEW ALPHA LINEAR from one of these outstanding dealers who'll be stocked and exhibiting at the 1980 DAYTON HAMVENTION, April 25 thru 27:

- AMATEUR ELECTRONIC SUPPLY
- COMMUNICATIONS CENTER
- G.I.S.M.O.
- HAM RADIO OUTLET
- HAMTRONICS
- MADISON ELECTRONICS
- PAYNE RADIO
- ROSS DISTRIBUTING
- UNIVERSAL AMATEUR RADIO

**ETO**

EHRHORN TECHNOLOGICAL OPERATIONS, INC.  
BOX 708, CAÑON CITY, CO. 81212 (303) 275-1613

# AD CHECK

... for literature, in a hurry — we'll rush your name to the companies whose names you check.

Place your check mark in the space between name and number. Example: HRH  150.

## INDEX

AR Tech. ___ 687	Klaus ___ 430
A. E. A. ___ 677	Larsen ___ 078
Aluma ___ 589	Long's ___ 468
Antenna Mart ___ 009	MFJ ___ 082
Antenna Specialists ___ 010	Madison ___ 431
Antenna Supermarket *	Microcraft ___ 774
Barry *	Microwave Filter ___ 637
Benchner ___ 629	NCG ___ 829
Bullet Elec. ___ 328	N-Pro ___ 836
Comm. Spec. ___ 330	Oak Hill Academy A. R. S. *
DenTron Radio ___ 259	Palomar Eng. *
Digitrex ___ 823	RCA Distr. ___ 782
E. T. O. *	RSE Ham Shack ___ 607
Erickson Comm. *	Callbook ___ 100
Hal *	Constructor *
Ham Gear Mart *	Radio Warehouse *
Ham Hobby Publ. ___ 811	Radio World *
HRB ___ 150	Radios Intl. ___ 838
HORIZONS *	RadMic Sys. ___ 839
Heath *	S-F A. R. S. ___ 640
Icom *	Staco ___ 840
Kantronics *	Ten-Tec *
Keithley Instr. ___ 837	Texas Towers ___ 681
Kenwood *	Unimax ___ 841
	Van Gorden ___ 737
	Wilson Sys. ___ 787

\*Please contact this advertiser directly.

Limit 15 inquiries per request.

JUNE 1980

Please use before July 31, 1980

Tear off and mail to  
**HAM RADIO HORIZONS — "Ad Check"**  
 Greenville, N. H. 03048

NAME \_\_\_\_\_

CALL \_\_\_\_\_

STREET \_\_\_\_\_

CITY \_\_\_\_\_

STATE \_\_\_\_\_ ZIP \_\_\_\_\_

# JUNE JOULES

ALPHA 76, 374, 78 in Stock ..... Call  
 Cushcraft "boomer" ..... 69.95  
 OMNI-J 2 Meter Antenna ..... 39.95  
 Bird 43 and slugs, UPS paid in USA . stock  
 Microwave Modules, Less 10% off list  
 stock  
 Telrex TB5EM, in stock ..... 415.00  
 Telrex TB6EM ..... 520.00  
 Complete Line Monobanders ..... stock  
 New Telrex TB5ES, 2KW  
 Pep version ..... 315.00  
 New Palomar Transceiver preamp . 89.50  
 Benchner Paddles, Standard ..... 39.95  
 Benchner Paddles, Chrome ..... 49.95  
 Vibroplex Paddles and bugs ..... stock  
 Lunar 6M-2M-220 In-line Preamps . . stock  
 Janel QSA-5 ..... 41.95  
 HAM-X Tailtwister Rotor ..... 239.00  
 HAM-4 Rotor ..... 169.00  
 Cetron or GE 572B ..... 32.00/ea  
 GE, AMPEREX, Raytheon 6146B . . 9.95  
 Motorola HEP170 ..... 0.29  
 Mallory 2.5A/1000 PIV Epoxy diode . . 0.19  
 Sprague 100MFD/450VDC Cap .... 2.00  
 Aerovox 1000PF/500V Feedthru Cap 1.95  
 Adel Nibbling Tool ..... 8.45  
 Technical books: Ameco, ARRL, Sams,  
 TAB, Rider, Radio Pub., Callbook,  
 Cowan, WRTVH, etc. .... Call  
 New Belden 9405 (2#16) (6#18) 8 wire  
 Rotor cable, heavy duty for  
 long runs ..... 0.38/ft  
 8448 8 wire Rotor Cable ..... 0.24/ft  
 9888 Double Shield PG8 Foam ... 0.56/ft  
 8214 RG8 Foam ..... 0.32/ft  
 8237 RG8 Regular ..... 0.28/ft  
 8267 RG213 ..... 0.36/ft  
 9251 RG8 A/U ..... 0.42/ft  
 Belden #8000 14GA  
 Stranded Antenna wire ..... 0.10/ft  
 Amphenol Silverplate PL259 (831SP) 1.00  
 Bertek RG8X 52 OHM, KW ..... 0.19/ft.  
 Robot "Slow Scan" 400 ..... 549.00  
*Need a schematic?  
 We've got 'em — \$2.00*

ICOM IC 2A HANDHELD  
 W/TTP, battery pack, Rubber Duck  
 and charger \$229.00

Looking for antique parts?  
 Write specific need to W5GJ.

## THIS MONTH'S SPECIALS:

New IC701, AC, MIC \$1195.00.  
 New ICOM, IC251A — 2M \$599.00.  
 IC551D — 6M-100W \$599.00.  
 IC551 \$399.00

Dentron GLA1000B ..... 295.00  
 Dentron Clipperton L ..... 599.00  
 Bearcat 250, 220 ..... 299.00  
 Bearcat 300 ..... 399.00

## MASTERCHARGE • VISA

All prices fob Houston except where indicated. Prices subject to change without notice, all items guaranteed. Some items subject prior sale. Texas residents add 6% tax. Please add postage estimate. \$1.00 minimum.

# MADISON

Electronics Supply, Inc.

1508 McKinney • Houston, Texas 77002  
 713/658-0268

# AD INDEX

AR Technical Products, Inc.	66
Advanced Electronics Applications	17
Aluma Tower Co.	74
Antenna Mart	79
Barry Electronics	81
Benchner, Inc.	58, 68
DenTron Radio	1
Digitrex Electronics	71
Ehrhorn Technological Operations	77
Erickson Communications	57
Hal Communications Corp.	Cover III
Ham Gear Mart	80
Ham Hobby Publishing	44
Ham Radio's Bookstore	9, 10, 17, 25, 44, 45, 58, 61, 68, 74, 79, 80
Ham Radio HORIZONS	68
Icom	7
Kantronics	51
Trio-Kenwood Communications, Inc.	Cover IV
Klaus Radio, Inc.	67
Long's Electronics	40, 41
MFJ Enterprises	3
Madison Electronics Supply	45, 78
Microcraft Corporation	67
Microwave Filter, Inc.	80
NCG Companies	79
N-Pro	69
Oak Hill Academy Amateur Radio Session	79
Palomar Engineers	39, 49
RSE Ham Shack	33
Radio Amateur Callbook	73
Radio & Electronics Constructor	66
Radio Warehouse	68
Radio World	58
S-F Amateur Radio Services	58
Ten-Tec	Cover II
Texas Towers	25
Van Gorden Engineering	71
Wilson Systems, Inc.	4

## Foreign Subscription Agents for Ham Radio HORIZONS

Ham Radio Austria  
 F. Bassi  
 Hauptplatz 5  
 A-2700 Wiener Neustadt  
 Austria

Ham Radio Holland  
 MRL Electronics  
 Postbus 68  
 NL-2204 Delft  
 Holland

Ham Radio Belgium  
 Sierckhoofweg  
 Brusselsesteenweg 416  
 B-9218 Gent  
 Belgium

Ham Radio Italy  
 G. Vulpatti  
 P.O. Box 37  
 I-22063 Cantù  
 Italy

Ham Radio Canada  
 Box 400, Goderich  
 Ontario, Canada N7A 4C7

Ham Radio Switzerland  
 Karin Ueber  
 Postfach 2454  
 D-7890 Loerach  
 West Germany

Ham Radio Europe  
 Box 444  
 S-194 04 Upplanda Vasby  
 Sweden

Ham Radio France  
 SM Electronic  
 20 bis, Ave des Clairons  
 F-89000 Auxerre  
 France

Ham Radio UK  
 P.O. Box 63, Harrow  
 Middlesex HA3 6HS  
 England

Ham Radio Germany  
 Karin Ueber  
 Postfach 2454  
 D-7890 Loerach  
 West Germany

Holland Radio  
 143 Greenway  
 Greenbide, Johannesburg  
 Republic of South Africa



# 1980 HANDBOOK

STEP INTO THE 80'S WITH THE LATEST HANDBOOK FROM THE EDITORS AT ARRL

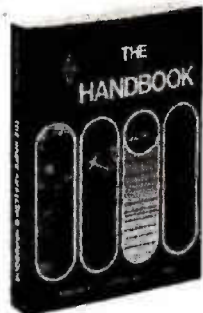

NEW LOW PRICE!! WAS \$10, NOW JUST \$7<sup>95</sup>

Full of exciting new features for the 80's, NOW is the time to order your copy of the 1980 ARRL "RADIO AMATEUR'S HANDBOOK." Internationally recognized and universally consulted, every Amateur should have the latest edition. The new HANDBOOK covers virtually all of the state-of-the-art developments in electronics theory and design. Novices will find it to be an indispensable study guide, while the more advanced Amateur will enjoy building the many new projects.

- Order AR-HB80 Softbound \$7.95
- Order AR-BB80 Hardbound \$15.75

**HAM RADIO'S BOOKSTORE**  
GREENVILLE, N. H. 03048  
(800) 258-5353

1980  
1980  
CALLBOOKS  
See page 58 for super value  
on 1980 Callbooks.  
1980

More details? Ad Check page 78.

## ANTENNA MART



**REMOTE CONTROLLED ANTENNA SWITCHING ALLOWS YOUR FEEDLINE TO WORK FIVE TIMES HARDER**

Antenna Mart's Model 50 allows instant switch selection of up to five antennas with a single feedline and a control cable between the operating position and the remote switch location. Eliminate the tangle of feedlines and manual switches usually associated

with multiple antennas. Antenna Mart's Model 50 has a 3KW power rating, high-speed low-loss operation, rugged weather-proof construction and LED indication of antenna in use. Order factory-direct or write for complete information on our line of available models.

**MODEL 50**  
Remote Antenna Switch  
\$150.00 + \$3.00 shipping

**ANTENNA MART**

P.O. BOX 1010  
ISU Station  
AMES, IOWA 50010  
(515) 292-7114



**July 26 thru August 8, 1980**

*Our 21st year of successful teaching*

**Boost your Ham Skills on the Blue Ridge**

**"A Vacation with a Purpose"**

Two weeks saturation learning program in Amateur Radio:

- Novice to General
- General or Technician to Advanced
- Advanced to Amateur Extra

Expert Instruction starting at your level. Code and Theory in depth along with Friendly Amateurs, Who Care About You.

C. L. PETERS, K4DNJ, Director  
Oak Hill Academy Amateur Radio Session  
Mouth of Wilson, Virginia 24363

Name \_\_\_\_\_ Call \_\_\_\_\_  
Address \_\_\_\_\_  
City/State/Zip \_\_\_\_\_

## 21 MHz SSB-CW PLL DIGITAL TRANSCEIVER



NCG-15-SB

### SPECIFICATIONS:

- Frequency Range: 21,000-21,495 MHz ± VXO adj.
- VXO Range: Approx ± 5 kHz from display
- Sweep Scan Range: Same as VXO
- Power Output: 15W (PEP) nominal max.
- Spurious Radiation: Down 60 dB or more
- Carrier Suppression: 40 dB or more, CW or SSB
- RX Sensitivity: 0.5 uV or better for 10 dB S/N
- RX Selectivity: 2.2 kHz at 6 dB; 4.6 kHz, 50 dB
- Image Rejection: 60 dB or more
- RX Spurious Response: Down 50 dB or more
- Power Required: 13.8 VDC, 2.5 A (peak)
- XMIT, & positive or negative ground
- Modulation: USB (Suppressed Carrier) or CW

### FEATURES:

- Active noise blanker
- Squelch
- RX RF gain control
- 5 digit frequency display
- CW sidetone
- Transmit ALC & HI/LO power switch

*A fine Novice/Tech Base & General/Adv/Extra Mobile*

Call or write for price  
Dealer Inquiries Invited

**NCG COMPANIES**

1275 NORTH GROVE ST., ANAHEIM, CA 92806  
(714) 630-4541

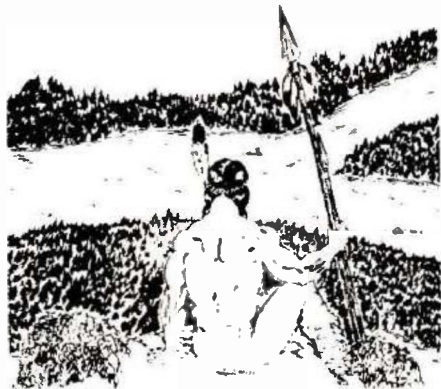

# UNADILLA

FULL POWER - QUALITY

HAM ANTENNA ACCESSORIES  
at your dealer

the Big Signal  
W2AU  
Balun

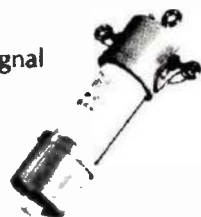

LONDON:  
VICTORIA:  
CONCEPCION:  
BUENOS AIRES:  
COL. ANAHUAC:  
HELSINKI:

AMCOMM 01 804 1166  
Scalar 725 9677  
Telecom Trans Chile 25471  
Multi-Radio 773-1266  
Radiac 2-50-32-40  
Erikoismediat (90) 611258

HAMS - call for our  
free catalog PC-80

DEALERS - join over 400  
dealers world-wide. Call  
us today for no-risk deal.

HAMFEST MANAGERS -  
UNADILLA cooperates!  
Call us.

US - TOLL-FREE 1-800-448-1666  
NY & Canada - COLLECT -  
1-315-437-3953

Ask for Hugh Gunnison, WA2ZOT,  
or Bonnie, or Emily.

For over 20 years, the choice  
of Hams, Armed Forces and  
Commercial Communications - world-wide.

the Old reliable  
W2VS Traps



5-Band  
Antenna  
Kit

- Lo-Pass Filter 2000W
- Quad Parts
- Baluns / Traps
- Insulators
- Wire & Cable
- Connectors

UNADILLA / REYCO Division Microwave Filter Co., Inc., E. Syracuse, NY 13057



**A FLEA GROWS IN AMERICA!**  
**YES, A NATIONAL MARKET PLACE**  
**FOR DEALINGS IN USED GEAR.**

1879 POST RD., P.O. BOX 66, SOUTHPORT, CT 06490

HGM matches Buyers with Owners of used equipment. Perfectly! Register your want to sell or buy, nationally, for only \$3.73. At least once a week, HGM compares Buyer specifications to all available equipment registered by Owners. For each perfect match, HGM writes Buyers the particulars about the gear. Buyers contact Owners directly, and all negotiations are strictly between Owners and Buyers.

HGM GUARANTEE Just \$3.73 per registration (a "sell" or a "buy"), and your Registration remains active for 17 unique matchings or 17 months (No HGM commissions! We cannot warrant nor guarantee any equipment found through HGM since everything is between Owners and Buyers. But we do guarantee unique matchings and 17 matchings or months. A fabulous service for the amateur service!

REGISTER NOW. Use this form or facsimile and enclose the \$3.73 fee for each Registration. OWNERS: Describe unit by Type, Brand, and Model indicate exact Sell Price and purchase data. BUYERS have two choices. Choice #1: Type of Gear. Indicate Type and use Price Range. Example: Transceiver, \$700-899. Choice #2: Specific Unit, regardless of price. Indicate specific Brand and Model you want. Example: Transceiver, Ten-Tec, Century 21.

YES, hamgearmart, I need your help! I understand your Guarantee, and I'm enclosing \$3.73 with this Registration. Enter my Registration immediately. Please register me as a . . .

**OWNER**  **BUYER**

SELL PRICE	TYPE OF GEAR	PRICE RANGES
GEAR YEAR	BRAND NAME	A 40 - 99
PURCHASED	MODEL NUMBER	B 100 - 199
NEW/USED		C 200 - 299
		D 300 - 399
		E 400 - 524
		F 525 - 699
		G 700 - 899
		H 900 - 1099
		I 1100 - 1399
		J 1400 AND UP

NAME \_\_\_\_\_ CALL \_\_\_\_\_ CLASS \_\_\_\_\_

ADDRESS \_\_\_\_\_ TELEPHONE \_\_\_\_\_

CITY \_\_\_\_\_ STATE \_\_\_\_\_ ZIP \_\_\_\_\_

hamgearmart 1879 Post Road, P.O. Box 66  
Southport, Connecticut 06490



## Bind 'em and Find 'em

Keep those valuable issues of both Ham Radio and HORIZONS like new. Prevent smears, tears and dog ears. Bind 'em together and enjoy for years to come. You'll be happy you did!

★ ★ ★

### HAM RADIO BINDERS

Beautiful buckram binders complete with date labels. Available in our new large size to accommodate HAM RADIO'S hefty issues.

HR-BDL Each Just \$8.95, 3 for \$17.95

### HAM RADIO MAGAZINE FILES

Your collection of HAM RADIO Magazines is a valuable resource. Here's a brand new, inexpensive way to store them. These sturdy cardboard magazine files keep them clean, neat and up front where you can use them for quick and easy reference.

HR-HRMF \$1.95 each, 3/\$4.95

### HAM RADIO HORIZONS BINDERS

Handsome washable binders complete with date labels.

HR-HRDL Each Just \$8.95, 3 for \$17.95

### HORIZONS MAGAZINE FILES

Your collection of Ham Radio HORIZONS is a valuable resource. Here's a brand new, inexpensive way to store them. These sturdy cardboard magazine files keep them clean, neat and up front where you can use them for quick and easy reference.

HR-HRMF \$1.95 each, 3/\$4.95

ORDER TODAY

## Ham Radio's Bookstore

GREENVILLE, NEW HAMPSHIRE 03048

OR CALL TOLL FREE 1 (800) 258-5353

### BINDERS

HR-BDL \$6.95 ea.  HR-HRDL 3/\$17.95  HR-HRMF \$1.95 ea.  HR-HRMF 3/\$4.95

CASH  CHARGE  MC  VISA

Exp. \_\_\_\_\_ Card Number \_\_\_\_\_

Name \_\_\_\_\_

Address \_\_\_\_\_

City \_\_\_\_\_ State \_\_\_\_\_ Zip \_\_\_\_\_



# WHEN OUR CUSTOMERS TALK...WE LISTEN.

DS3100 ASR



## We've Been Taking Notes.

Combining your ideas with some of our own, we've come up with what has to be the most advanced and convenient terminal available. These are some of the conveniences you can now enjoy by putting the DS3100 ASR in your RTTY and CW station:

### ASR Operation (Compose your transmission WHILE receiving)

- 150-line Receiver Buffer
- 50-line Transmit Buffer
- Split Screen to Show Buffers
- Internal Real-Time Clock
- 10 Programmable Messages
- Automatic Answer-Back (WRU)
- Morse, Baudot, or ASCII Operation
- RTTY and CW Identification
- Full 128-Character ASCII
- 110-9600 baud ASCII
- 60-130 WPM Baudot
- 1-175 WPM Morse

Write or call for the DS3100 ASR specifications and see how YOU have helped design the new standard in amateur radio terminals.



HAL COMMUNICATIONS CORP.  
Box 365  
Urbana, Illinois 61801  
217-367-7373

For our European Customers Contact:  
Richter & Co., Hannover  
I.E.C. Interelec, Bissone

# TS-120S... A big little rig.

MC-50

It's a compact, up to 200 watts PEP input, all solid-state HF transceiver with such standard features as built-in digital readout, IF shift, new PLL technology...and requires no tuning!

PS-30

SP-120

TS-120S

VFO-120

Exciting and perfect for car or ham shack use! But, there's more to say about the TS-120S! This unique all solid-state HF, SSB/CW transceiver produces a hefty signal and also offers a lot of other features in a very attractive, compact package. See this new model at your Authorized Kenwood Dealer!

 **KENWOOD**

*...premier in amateur radio*

TRIO-KENWOOD COMMUNICATIONS INC.  
1111 WEST WALNUT/COMPTON, CA 90220