

Amateur Radio
for You and Me

CC 02636

APRIL 1979 / \$1.25

HAM RADIO HORIZONS

New Project:
Boost your receiver
coverage with this
20-15-10 meter
converter.



PREDICTING RADIO SKIP CONDITIONS
SWL RECEIVER KITS OF YESTERYEAR
PLUS • LATEST EQUIPMENT • NEWS EVENTS
• DX FORECASTER • AND MORE . . .



From **Vlf**
to **Uhf...**

R.L. Drake systems advance the technology
of worldwide
radio communications...



with innovative system engineering that offers you
a number of "first in the world" features.

The Drake 7-line system:

Drake TR-7: The first amateur transceiver in the world to offer full general coverage (0-30 MHz) reception capability, 1.8 to 30 MHz transmission capability, and synthesized "up-conversion" design techniques. It's ready now for future band expansions, MARS, and other services.

Drake R-7: The first amateur receiver in the world to combine full general coverage (0-30 MHz) reception and synthesized "up-conversion" design techniques, with transceive capability, full passband tuning, notch filter and dual receive antenna circuitry.

The Drake UV-3 system:

Drake UV-3: The first amateur fm transceiver in the world to offer 3 fully synthesized bands (144-220-440 MHz) in a single transceiver, and bandswitched from the front panel. A remote mounting kit, PS-3 matching ac supply and 1525EM pushbutton microphone round out the system.

For a FREE Drake Full Line Catalog contact your favorite Drake Dealer.

R. L. DRAKE COMPANY



540 Richard St., Miamisburg, Ohio 45342
Phone: (513) 866-2421 • Telex: 288-017

Dentron Super Buys 1-800-633-3410

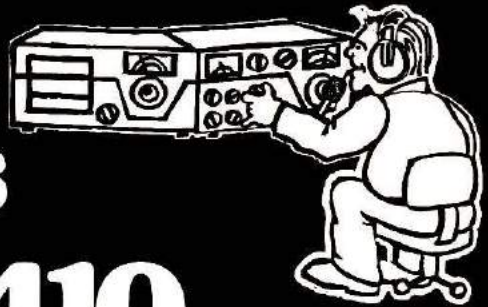

Dentron



DENTRON Clipperton L linear amplifier

HI/LO power switching, covers 160 thru 15 meters, 2000W PEP SSB, 1000W DC on CW, RTTY, SSTV, continuous duty power supply 2500 idle SSB, 1800V idle CW, covers most MARS freqs. just outside ham bands, easily changed 117V or 234V AC 50/60 Hz. Final Tubes: 4-572B.

599.50 Call for quote.

DENTRON GLA-1000 linear amplifier

Freq. 80 to 15 meters, covers most MARS frequencies. RF drive: max 125, power consumption: 117 VAC 50/60 Hz 12.5 Amps, factory fused at 15 Amps, 234 VAC 50/60 Hz 7 Amps, DC input: 1 KW CW and 1200W PEP SSB, Final Tubes: 4 D-50A tubes (6LQ6).

379.50 Call for quote.



DENTRON MT-3000A antenna tuner

Dentron's ultimate tuner! For coax, random wire, and balanced feed systems, built-in antenna selector switch for 5 different antennas, power handling 3 KW PEP, built-in 50 ohm 250W dummy load, dual watt meters, 3 core heavy duty balun, continuous tuning: 160 to 10 meters.

349.50 Call for quote.

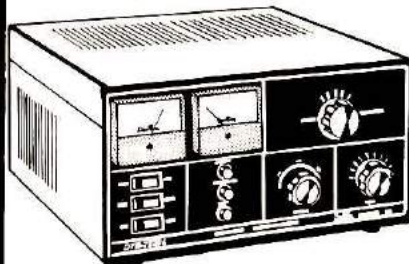

DENTRON DTR-2000L 2000W precision linear amplifier

Features a Broadcast proven 8877 tube, freq. coverage 160 thru 15 meters, covers most MARS frequencies, modes: USB, LSB, CW, 234/117 VAC 50/60 Hz, RF drive power 125W max and 65W RMS min. for 1 KW DC input, 1.8-21 MHz 2000W PEP.

1199.50 Call for quote.



DENTRON MT-2000A antenna tuner

A full power tuner with continuous tuning 1.8 to 30 MHz, front panel grounding switch, handles 3KW PEP, inputs: unbalanced coax (SO-239 connectors), random wire, balanced line, built-in heavy duty balun (3 cores), capacitor spacing 6000V, transforms load impedance to 50-75 ohms.

199.50 Call for quote.



Long's Electronics



MAIL ORDERS: P.O. BOX 11347 BIRMINGHAM, AL 35202 • STREET ADDRESS: 2808 7TH AVENUE SOUTH BIRMINGHAM, ALABAMA 35233

Remember, you can Call Toll Free: 1-800-633-3410 in the U.S.A. or call 1-800-292-8668 in Alabama for our low price quote. Store hours: 9:00 AM til 5:30 PM, Monday thru Friday.

THIS MONTHS

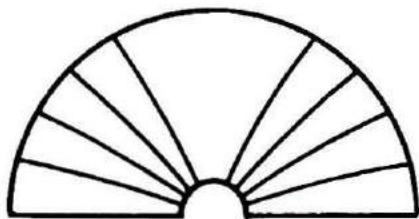

HORIZONS

A Converter For 20/15/10 Meters

When W8YFB built the beginner's receiver for our February and March issues, he kept it as simple as possible, while maintaining a goal of better-than-average performance. Accordingly, it was limited to coverage of 80 and 40 meters. Realizing that most amateurs would not be content to listen to just that part of the spectrum, especially now that the sunspot cycle is creating a wonderland out of our higher bands, Bill had a matching converter ready to go as soon as we asked for it. It's equally simple — a couple of transistors, two PC boards, a switch, some crystals, and a handful of small parts. It'll do wonders for a general-coverage receiver, too, so build one even if you didn't tackle the receiver project.

An Amateur Convention In The Far East

Conventions are always fun. They provide the opportunity to see old friends, to meet new ones, to learn about new equipment and techniques, and to enjoy the friendship of ham radio.

But what about a convention where the call signs of the attendees read like the latest DX bulletin — HS1, 9M2, YB0, DU, VK, 9N1, S76, A6, 9V1, and so on? There is only one such affair, the annual conference of the South East Asia NETWORK, SEANET. Let's share the adventures of N1RM as he takes us on a guided tour during the 1977 SEANET convention in far-off Thailand.

Robot Circuits Simplified

What's a robot? Webster defines it as "an automatic apparatus or device that performs functions ordinarily ascribed to human beings or operates with what appears to be almost human intelligence." W6HDM explores the concept of robots in the ham shack — simple circuits that can be used to perform a variety of electronic tasks.

Amateur Radio For You And Me

Amateur Radio is easier to get into than you think, and it's never too late to take part in the fun offered by this worldwide hobby. Whet your appetite on this sample of what hams are up to — read about who they are, then join the group.

What's The Band Like?

You've heard those propagation forecasts from WWV. What does the information mean to you as an amateur? Author W2XQ presents an easy-to-understand interpretation of propagation information, together with some handy operating aids to enhance your DX activities.

Golden Years — The Doerle Shortwave Receiver

Here's the story of an early pioneer in shortwave receiver design, Walter Doerle, who made it possible for fellows in the early thirties to get in on the new world of shortwave radio. He came up with a simple and easy-to-build set that was inexpensive even during the depression years. Old timer Bill Orr gives the details.

The Cover

W8YFB designed the receiver described in the previous two issues of *Horizons*, and he planned ahead with a converter to make it work on 20, 15, and 10 meters. It's easy to build, and requires only a few parts. Tom Broscius, WA2RWA, caught the spirit of the project in his original painting. The story starts on page 12.

HAM RADIO HORIZONS April 1979, Volume 3, Number 4. Published monthly by Communications Technology, Inc., Greenville, New Hampshire 03048. Telephone (603) 878-1441. Second Class Postage paid at Greenville, New Hampshire and at additional mailing offices. 155N 0147-8818. Address all editorial and advertising correspondence to Greenville, New Hampshire 03048.

Subscription price: Domestic, one year, \$10.00; two years, \$18.00; three years, \$24.00. Canada and Worldwide add \$2.00 per year, payable in United States funds please.

Subscription inquiries and changes of address should be directed to Ham Radio Horizons, Greenville, New Hampshire 03048. Please include address label from most recent issue if possible.

This NEW MFJ Versa Tuner II . . .

has SWR and dual range wattmeter, antenna switch, efficient airwound inductor, built in balun. Up to 300 watts RF output. Matches everything from 1.8 thru 30 MHz: dipoles, inverted vees, random wires, verticals, mobile whips, beams, balanced lines, coax lines.

MFJ LOWER PRICES!

NEW, IMPROVED MFJ-941B HAS . . .

- More inductance for wider matching range
- More flexible antenna switch
- More sensitive meter for SWR measurements down to 5 watts output

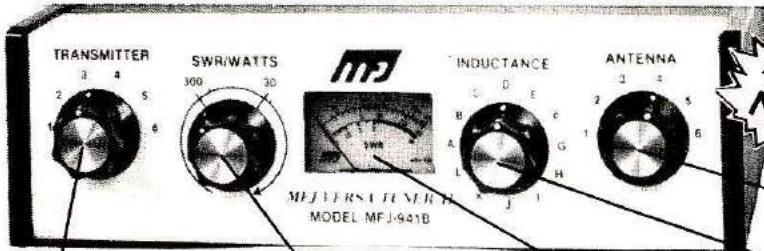

NEW LOWER PRICE

\$79⁹⁵

Transmitter matching capacitor. 208 pf. 1000 volt spacing.

Sets power range, 300 and 30 watts. Pull for SWR.

Meter reads SWR and RF watts in 2 ranges.

Efficient airwound inductor gives more watts out and less losses.

Antenna matching capacitor. 208 pf. 1000 volt spacing.

Only MFJ gives you this MFJ-941B Versa Tuner II with all these features at this price:

A SWR and dual range wattmeter (300 and 30 watts full scale) lets you measure RF power output for simplified tuning.

An antenna switch lets you select 2 coax lines direct or thru tuner, random wire/balanced line, and tuner bypass for dummy load.

A new efficient airwound inductor (12 positions) gives you less losses than a tapped toroid for more watts out.

A 1:4 balun for balanced lines. 1000 volt capacitor spacing. Mounting brackets for mobile installations (not shown).

With the NEW MFJ Versa Tuner II you can run your full transceiver power output — up to 300 watts RF power output — and match your

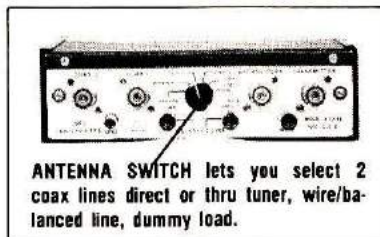

ANTENNA SWITCH lets you select 2 coax lines direct or thru tuner, wire/balanced line, dummy load.

transmitter to any feedline from 160 thru 10 Meters whether you have coax cable, balanced line, or random wire.

You can tune out the SWR on your dipole, inverted vee, random wire, vertical, mobile whip, beam, quad, or whatever you have.

You can even operate all bands with just

one existing antenna. No need to put up separate antennas for each band.

Increase the usable bandwidth of your mobile whip by tuning out the SWR from inside your car. Works great with all solid state rigs (like the Atlas) and with all tube type rigs.

It travels well, too. Its ultra compact size 8x2x6 inches fits easily in a small corner of your suitcase.

This beautiful little tuner is housed in a deluxe eggshell white Ten-Tec enclosure with walnut grain sides.

S0-239 coax connectors are provided for transmitter input and coax fed antennas. Quality five way binding posts are used for the balanced line inputs (2), random wire input (1), and ground (1).

NEW 300 WATT MFJ VERSA TUNER II'S: SELECT FEATURES YOU NEED.

NEW MFJ-945 HAS SWR AND DUAL RANGE WATTMETER. NEW LOWER PRICE

\$69⁹⁵



Same as MFJ-941B but less 6 position antenna switch.

NEW MFJ-944 HAS 6 POSITION ANTENNA SWITCH ON FRONT PANEL. NEW LOWER PRICE

\$69⁹⁵



Same as MFJ-941B but less SWR/Wattmeter.

NEW MFJ-943 MATCHES ALMOST ANYTHING FROM 1.8 THRU 30 MHz. NEW LOWER PRICE

\$59⁹⁵



Same as MFJ-941B, less SWR/Wattmeter, antenna switch, mounting bracket. 7x2x6 in.

ULTRA COMPACT 200 WATT VERSA TUNERS FOR ALL YOUR NEEDS.

MFJ-901 VERSA TUNER MATCHES ANYTHING, 1.8 THRU 30 MHz. NEW LOWER PRICE

\$49⁹⁵



Efficient 12 position air inductor for more watts out. Matches dipoles, vees, random wires, verticals, mobile whips, beams, balanced lines, coax. 200 watts RF, 1:4 balun, 5x2x6 in.

MFJ-900 ECONO TUNER MATCHES COAX LINES/RANDOM WIRES. NEW LOWER PRICE

\$39⁹⁵



Same as MFJ-901 but less balun for balanced lines. Tunes coax lines and random lines.

MFJ-16010 RANDOM WIRE TUNER FOR LONG WIRES. NEW LOWER PRICE

\$29⁹⁵



1.8 thru 30 MHz. Up to 200 watts RF output. Matches high and low impedances. 12 position inductor. S0-239 connectors. 2x3x4 inches. Matches 25 to 200 ohms at 1.8 MHz. Does not tune coax lines.

For Orders **Call toll-free 800-647-1800**

Order any product from MFJ and try it. If not delighted, return within 30 days for a prompt refund (less shipping).

Order today. Money back if not delighted. One year unconditional guarantee. Add \$2.00 shipping/handling. For technical information, order/repair status, in Mississippi, outside continental USA, call 601-323-5869.

Order: By Mail or Call TOLL FREE 800-647-1800 and Charge It On



MFJ ENTERPRISES, INC. P. O. BOX 494 MISSISSIPPI STATE, MISSISSIPPI 39762

DSI**DSI INTRODUCES**

THE FIRST FULL LINE OF FREQUENCY COUNTER ACCESSORIES

Performance You Can Count On

DON'T SCRAP THAT OLD FREQUENCY COUNTER

**600 MHz PRESCALER ÷ BY 10
WITH BUILT IN PREAMP**

- 10 MV @ 150 MHz & 250 MHz
- 50 MV @ 450 MHz
- INCLUDES 115VAC SUPPLY
- OPERATES ON 8-12 VDC
- RUGGED CAST ALUMINUM CASE
- READY TO USE ON ANY COUNTER

**69⁹⁵**

MODEL PS-600

**SUPER PRE-AMP
15 DB PRE-AMPLIFIER
20 MHz TO 800 MHz**

- OUTSTANDING AS A PROBE AMPLIFIER
- INCREASE SENSITIVITY OF A COUNTER WITH 100 MV TO 12 MV TYP.
- INCLUDES 115VAC SUPPLY
- OPERATES ON 8.2-13.5 VDC
- RUGGED CAST ALUMINUM CASE

**69⁹⁵**

MODEL PA-800

**RTTY-PL-AUDIO
AUDIO SCALER**

- x10, x 100 MULTIPLIER
- .01 Hz RESOLUTION WITH 1 SEC GATE TIME
- 20 MV SENSITIVITY 10 Hz to 10 KHz
- HI Z INPUT 1 MEG OHM
- A MUST FOR PL REEDS, RTTY AND LOW AUDIO WORK WHERE ACCURACY IS MANDATORY

**49⁹⁵**

MODEL AS-100X

**PROTECT YOUR COUNTER
T-TAP****160 METERS TO 450 MHz**

- POWER LEVELS — 1 WATT TO 250 WATTS
- USE IN LINE WITH TRANSCEIVER
- LOW LOW LOSS
- PROVIDES LEVEL OUTPUT TO COUNTER AT ALL POWER LEVELS
- USE IN LINE WITH DUMMY LOAD OR ANTENNA
- RUGGED CAST ALUMINUM CASE

**32⁹⁵**

MODEL T-100

ALL UNITS ARE FACTORY ASSEMBLED, TESTED AND CARRY A FULL 1 YEAR WARRANTY.

SEE YOUR LOCAL DEALER

OR

CALL TOLL FREE (800) 854-2049

California Residents add 6% State Sales Tax and Call Collect (714) 565-8402

7914 Ronson Road No. G, San Diego, CA 92111

April, 1979
Volume 3, Number 4

HAM RADIO HORIZONS

T.H. Tenney, Jr., W1NLB
Publisher
James R. Fisk, W1HR
Editor-in-Chief

Editorial Staff

Thomas F. McMullen, Jr., W1SL
Managing Editor
Patricia A. Hawes, WA1WPM
Executive Editor
Martin Hanft, WB1CHQ
Administrative Editor
Charles J. Carroll, K1XX
Joseph J. Schroeder, W9JUV
Alfred Wilson, W6NIF
Assistant Editors

Publishing Staff

C. Edward Buffington, WB1AMU
Assistant Publisher
Fred D. Moller, Jr., WA1USO
Advertising Manager
James H. Gray, W1XU
Assistant Advertising Manager
James R. Wales
Art Director
Susan Shorrock
Circulation Manager

Copyright 1979 by Communications
Technology, Inc. Title registered
at U.S. Patent Office

Microfilm copies
are available from
University Microfilms, International
Ann Arbor, Michigan 48103

Cassette tapes of selected articles
from *Ham Radio Horizons* are available to
the blind and physically handicapped
from Recorded Periodicals
919 Walnut Street, 8th Floor
Philadelphia, Pennsylvania 19107

Ham Radio Horizons
is published monthly by
Communications Technology, Inc
Greenville, New Hampshire 03048
Telephone 603-878-1441
ISSN 0147-8818

CONTENTS

Three-Band Converter for Beginners	12	
William A. Wildenhein, W8YFB		
SEANET Convention in Thailand	22	
Douglas A. Blakeslee, N1RM		
Robot Circuits Simplified	30	
Irving M. Gottlieb, W6HDM		
Amateur Radio — Adventures for You and Me	34	
Thomas F. McMullen, W1SL		
Propagation Information You Can Use	42	
Thomas R. Sundstrom, W2XQ		
The Golden Years of Radio — Doerle Receivers	50	
William I. Orr, W6SAI		
Activities Calendar	76	Newsline 11
Ad Check	78	Postbox 60
Ad Scan	73	Product Showcase 62
Advertiser's Index	78	Propagation Chart 75
DX Forecaster	74	This Month's Horizons 2
Focus and Comment	8	The View From Here 6
Horizons Locator	70	

THE VIEW FROM HERE



This is the time of year when many high-school seniors are scurrying around, planning their future education, sending applications off to the college of their choice, and taking entrance exams. Seniors who are also Radio Amateurs are probably considering a career in electronics. If they're lucky, they will have a knowledgeable guidance counselor who can steer them in the right direction; if not, they'll probably pick a school with a good reputation and work from there. Sometimes this works out, and sometimes it doesn't — it depends entirely on what the student is looking for.

Electrical and electronics engineers who graduated more than ten years ago would probably not recognize the engineering curriculum now offered by their old alma mater because, in the past few years, there have been significant changes in engineering education. During the 1960s the classical engineering educational programs tended to become more and more theoretical oriented, with less emphasis on applied engineering. The backgrounds of some electrical engineering staffs changed from being primarily applied electronics to applied mathematics, and attempts to develop practical engineering programs were not all that successful. In recent years, however, some engineering colleges have restructured their curriculums for a better balance between the theoretical and the practical. On the other hand, some colleges have continued to stress the theoretical aspects of engineering science, so the prospective student is faced with a very important, but difficult, choice.

Not too long ago, the prestige of an engineering school was almost always gauged by the theoretical emphasis of its courses; each school tried to outdo the others in the theoretical sophistication of its curriculum. Unfortunately, the majority of jobs within the sphere of electronics engineering does not require such an advanced mathematical sophistication as they do a "gut" understanding of electronics. If you talk to students at a *theoretical* school, you'll find that many of them don't know how to solve a simple steady-state ac problem, although they can invert a matrix and use state-variable techniques.

The difficulty with this type of engineering education is that graduates are not adequately prepared to solve the day-to-day engineering problems they will be presented with in industry. Employers are faced with the prospect of several months of on-the-job training before the newly hired engineer becomes a fully contributing member of the staff. Obviously, a new engineer who can solve problems quickly and practically in the real world is a valuable asset.

In the 1970s several colleges introduced four-year electronic technology programs in an attempt to get back to the old practical engineering concept; the courses at these colleges emphasize electronic hardware and laboratory techniques as well as electrical theory. Although graduates of these Bachelor of Science Technology programs have been pictured as fitting into the occupational spectrum somewhere between the technician and the engineer, many professors see technology graduates as having much wider employment opportunities. In fact, technology graduates now have opportunities in many areas of electronic applications and design traditionally occupied by engineering graduates, jobs vacated because of the change in emphasis in engineering education programs.

Students who are interested in this type of engineering program should be aware that there is a wide difference in B.S. programs parading under the "Technology" banner. Some curriculums are managerially oriented, others are slanted toward applications and design, while still others are little more than two-year electronic technician training programs with added courses in the arts and humanities to fill out four years. Students who wish to enter this area should obviously choose a school carefully to be sure they get exactly what they want.

Jim Fisk, W1HR
editor-in-chief

Imagine All The Places You Can Tuck ICOM's Remotable IC-280. (Think small.)

The **IC-280** 2 meter mobile comes as one radio to be mounted in the normal manner: but, as an option, the diminutive front one third of the radio detaches and mounts by its optional bracket, while the main body tucks neatly away out of sight. Now you can mount your 2 meter radio in pint-sized places that seemed far too cramped before.

Measuring only 2 1/4" h x 7" w x 3 3/8" d, the bantam-sized microprocessor control head fits easily into the dash, console or glove box of even the most compact vehicle. Or if those places are already taken by the rest of your "mobile shack," the **IC-280** head squeezes into leftover niches under the dash, overhead, under the seat or even on the steering column.

But don't be misled by the petite size of this subdivided radio: the **IC-280** is jam packed with the latest state of the art engineering and convenience features. No scaled down technology here!

With the microprocessor in the detachable control head, your **IC-280** can store three frequencies of your choice plus the dial, which allows you to select from four frequencies with the front panel switch without taking your eyes off the road. These frequencies are retained in the **IC-280's** memory for as long as power is applied to the radio, even when power is turned off at the front panel switch. And if power is completely removed from the radio the ± 600 KHz splits are still maintained!

The **IC-280** works frequencies in excess of the 2 meter band with ICOM's outstanding single-knob tuning, so you can listen around the entire band without fooling with three tuning knobs. With steps of 15 KC or 5 KC, the **IC-280** puts rapid and easy frequency change at your single fingertip and instantly displays bright, easy to read LED's.

- Available Options:**
- Touch Tone pad/microphone combination, which fits the mic plug on the radio face with absolutely no modification
(Fits all ICOM 4-pin mic radios.)
 - 15' unassembled cable kit for long distance remote mounting of the detachable control head



IC-280
2 meter FM, 4+ MHz
Mobile Transceiver

If you are a newly licensed novice, send for ICOM's catalog and discount purchase coupon. Mail your name, call sign and date of license to your ICOM distributor (see the bottom of this ad).

All ICOM radios significantly exceed FCC regulations limiting spurious emissions.

Specifications subject to change without notice.

IC-280 Specifications: Frequency Coverage: 143.90—148.11 MHz Operating Conditions: Temperature: -10°C to 60°C (14°F to 140°F), Duty Factor: continuous Frequency Stability: ± 1.5 KHz Modulation Type: FM (F3) Antenna Impedance: 50 ohms unbalanced Power Requirement: DC 13.8V $\pm 15\%$ (negative ground) Current Drain: Transmitting: 2.5A Hi (10W), 1.2A Lo (1W), Receiving: 0.630A at max audio output, 0.450 at SQL ON with no signal Size: 58mm(h) x 156mm(w) x 228mm(d) Weight: approx. 2.2 Kg Power Output: 10W Hi, 1W Lo Modulation System: Phase Max. Frequency Deviation: ± 5 KHz Spurious Output: more than 60 dB below carrier Microphone Impedance: 600 ohms dynamic or electret condenser type, such as the SM-2 Receiving System: Double superheterodyne Intermediate Frequency: 1st: 10.695 MHz, 2nd: 455 KHz Sensitivity: 1 μ v at S+N/N at 30 dB or better, Noise suppression sensitivity 20 dB, 0.6 μ v or less Selectivity: less than ± 7.5 KHz at -6 dB, less than ± 15 KHz at -60 dB Audio Output: More than 1.5W Audio Output Impedance: 8 ohms

HF/VHF/UHF AMATEUR AND MARINE COMMUNICATION EQUIPMENT

DISTRIBUTED BY:



ICOM

ICOM WEST, INC.
Suite 3
13256 Northrup Way
Bellevue, Wash. 98005
(206) 747-9020

ICOM EAST, INC.
Suite 307
3331 Towerwood Drive
Dallas, Texas 75234
(214) 620-2780

ICOM CANADA
7087 Victoria Drive
Vancouver B.C. V5P 3Y9
Canada
(604) 321-1833



FOCUS & COMMENT

Who says the free-enterprise system doesn't work? Or that the Radio Amateur has but a tiny voice crying in the wilderness of the business world?

Let's take a look at some recent developments in equipment for the beginning Amateur, for example. Just a few years ago there were no *simple*, effective, low-priced transceivers on the market. One company, Heath, tested the temperature of the pool by producing the HW-7 in kit form. It was as much aimed at the low-power enthusiast as at the beginner. Hams far and wide suggested improvements and modifications, many of which showed up in the successor model, the HW-8.

There was a short lull in the proceedings, as though other manufacturers were watching, waiting, and thinking. Many beginners, faced with the prospect of assembling a kit (a new experience — frightening to some of them), and further bewildered by the use of transistors (another new experience), went the flea-market route and bought older equipment. Some of it worked, some didn't. New equipment was generally tailored to the Big Operator, the Rag Chewer, the DXer, and the guy who didn't worry about the cost as long as it was the very latest and best.

Things started getting better just a year or so ago. Some new names appeared on the marketplace, producing some very simple equipment at reasonable prices. Kantronics comes to mind, with their simple, two-band receiver and a crystal-controlled transmitter — the pair could be obtained for just a shade under \$100. They also produced a VFO in a separate package to add flexibility to the transmitter.

Another basic rig that became available was the Ten-Tec Century 21, a 5-band CW transceiver with simplified controls and 70-watt capability. Its price was a bit more than the Kantronics combination, but still under \$300 — not bad for a decent 5-band rig.

More recently, another well-known manufacturer has added his equipment to the beginner's lineup. Atlas has introduced a 5-band receiver that is just about as simple to operate as any you'll see, the RX-110. It has only three controls; audio gain, tuning, and a band-selector switch. This receiver fits nicely into a Novice budget at slightly over \$200. An interesting feature of this deal is that they have designed a companion transmitter module to go with it when you're ready for it — at a price that's not out of line, considering inflation and the complexities of making a CW/ssb transmitter.

There's another encouraging note to all of this — these are all American companies. Being closer to the consumer, they can keep in touch with the needs of the market, and respond more easily to the requirements of beginning hams.

Now, before you take all of this as an endorsement of some sort, let me state that I have not operated and evaluated any of these rigs — I'm just observing a trend. It's a good trend, and I hope you'll do your part to encourage it by providing feedback to the designers of these (and other) rigs. If you like them, say so. If you have a gripe, tell them about it. They will respond — the free-enterprise marketplace demands it.

And, as a consequence, all newcomers to Amateur Radio will have a wider choice of better, low-cost rigs available when they want to get on the air.

Thomas McMullen, W1SL
Managing Editor

FROM THE COMPANY WITH A LONG LINE OF RTTY FIRSTS

RVD-1002
1st RTTY
Video Generator



1971

1972



DKB2010
1st RTTY & MORSE
Keyboard

1973

RVD-1005
Improved RTTY
Video Generator



1974



1975

ST6000
High-performance
RTTY Demodulator

DS3000 KSR Version 2
1st Microprocessor
Controlled Amateur Equipment
with Editing for Baudot & ASCII



1976

1977

1978

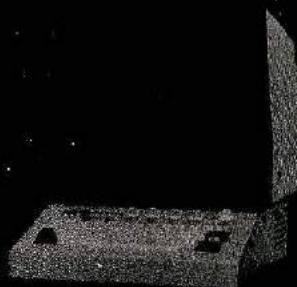

DS3000 KSR Version 3
1st 3-mode Amateur Send-Receive Terminal
for Baudot, ASCII, and MORSE

1979



ST5000
Low-cost, Big-performance
RTTY Demodulator

AND NOW... DS3100 ASR

The **FIRST** Automatic Send-Receive Electronic Terminal for Baudot, ASCII, and MORSE

- Type and edit your message **while** receiving
- 200 line storage
- Non-volatile and programmable HERE-IS
- Internal real-time clock
- WRU answer-back
- 24 line screen
- RTTY and CW ID
- Upper **and** lower case ASCII

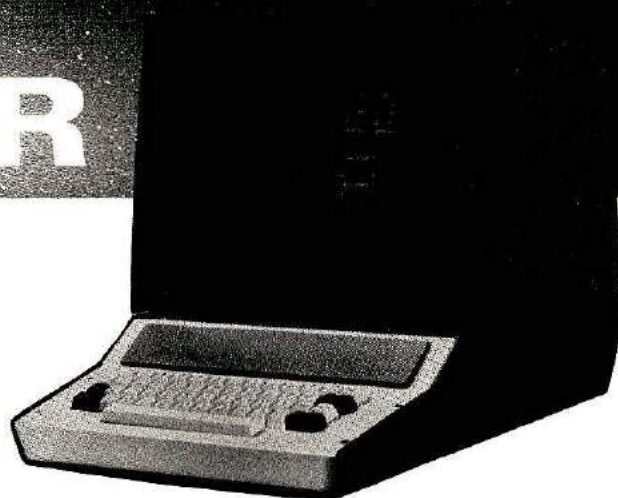

\$1995.00
Call or write
for complete
new catalog



HAL COMMUNICATIONS CORP.
Box 365
Urbana, Illinois 61801
217-367-7373

In Europe contact:
Richter & Co.; Hannover
I.E.C. Interelco; Bissone

See what just
some of the many
satisfied Hams
say about
the Wilson Antennas.

THE Wilson GIVE-A-WAY

Wilson Electronics
announces a factory
authorized rebate program.
Here's how it works:

Purchase a TT-45 and a System Three at the same time and Wilson will give you a factory 5% rebate from the price you paid for the package. You can use this to pay for the concrete to install it, or buy the XYL a little something to keep her happy! Or . . . we will give you, at no charge, a M-27, the best 7 element, 2M beam available today! The choice is yours to make!

Just send Wilson the receipt of your purchase from your dealer, showing your cost, and let us know what you want — 5% cash, or a M-27. But hurry! This offer starts April 1, expires midnight, April 30, 1979, and receipt must be mailed before June 1, 1979.

Don't wait! See your nearest dealer to take advantage of this great Give-A-Way!

SPECIFICATIONS

TT-45 TOWER

- Maximum height, 45'
- 800 lbs. winch with padlock feature
- 2800 lb. raising cable
- Totally freestanding with proper base
- Total weight, 189 lbs.

Recommended accessories:
RBRF-10, SBRF-10, CBRF-10.

The TT-45 is a freestanding tower. Ideal for installations where guys cannot be used. If the tower is not being supported against the house, the proper base fixture accessory must be selected.

SY-3 TRI-BAND ANTENNA

Band MHz	144-148	Turning radius	15° 9"
Maximum power input	Legal limit	Maximum mast diameter	2" O.D.
Gain (dBd)	8 dB	Surface area	5.7 sq. ft.
VSWR at resonance	1.3:1	Wind loading @ 80 mph	114 lbs.
Impedance	50 ohms	Assembled weight (approx)	37 lbs.
F/B Ratio	20 dB	Shipping weight (approx)	42 lbs.
Boom (O.D. x length)	2" x 14' 4"	Direct 52 ohm feed or balun	
No. of elements	3	Maximum wind survival	100 mph
Longest element	27' 4"		

M-27 - 7 ELEMENT 2M BEAM

Band MHz	144-148 MHz	Beam width @ 3 dB pt.	27 degrees
Gain	11 dB	Turning radius	37.13"
VSWR	1.2:1	Mast diameter (O.D.)	1" - 1 1/2"
Impedance	50 ohms	Surface area	44 sq. ft.
Boom (O.D. x length)	1" x 64"	Wind loading @ 80 mph	5.5 lbs.
Number of elements	7	Shipping weight (approx)	6.5 lbs.
Longest element	40"	Assembled weight (approx)	3.5 lbs.

Consumer Products Division
Wilson Electronics Corp.
A Subsidiary of REGENCY ELECTRONICS, INC.

4288 South Polaris Avenue • P. O. Box 19000 • Las Vegas, Nevada 89119
Telephone (702) 739-1931 • TELEX 684-522

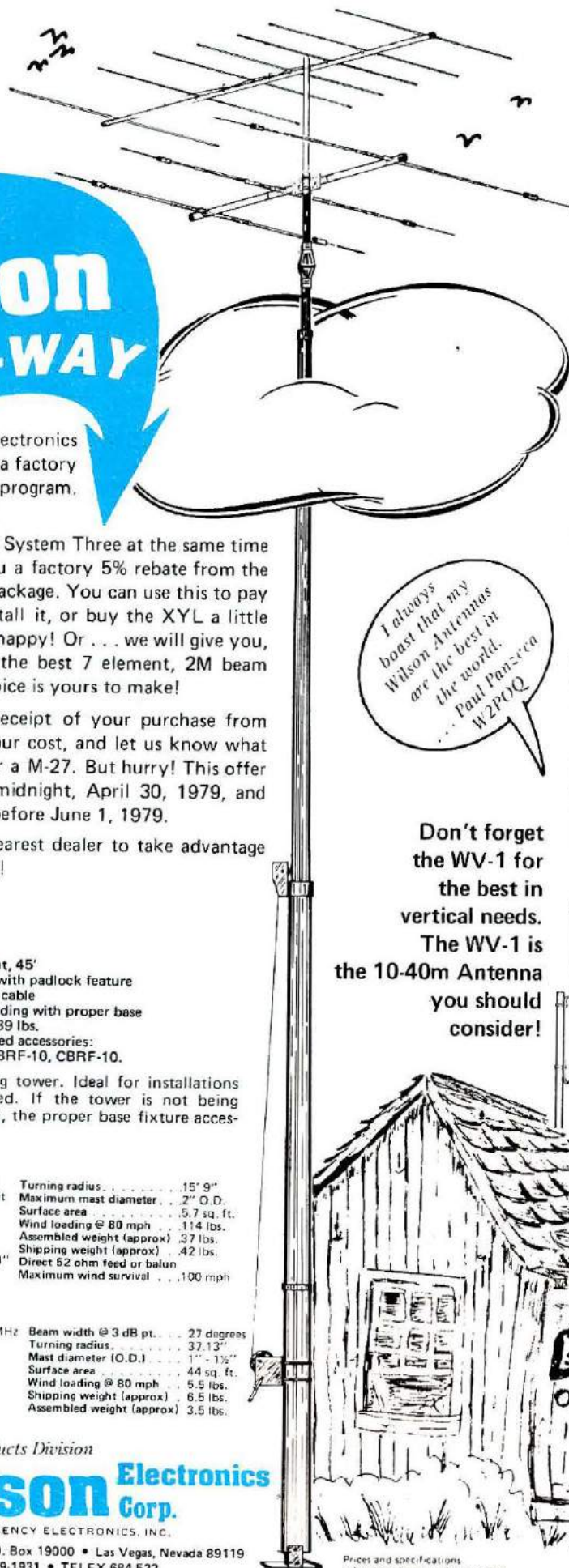

My SY-3
performs like
a Monobander, and
loads up as easy as a
dummy load!
... Jim Rafferty
N6RJ

I always
boast that my
Wilson Antennas
are the best in
the world.
... Paul Panzeca
W2POQ

Best noise I've
ever made in my Hamming
career. Tnx for a great
antenna!
... John Sklephowycs
VE3JPR

Don't forget
the WV-1 for
the best in
vertical needs.
The WV-1 is
the 10-40m Antenna
you should
consider!

ACT NOW!

Buy the WV-1
and Wilson
will treat you
to the Radial Kit
... FREE
of charge!

WV-1 SPECIFICATIONS:

- Input impedance: 50 ohms
- Power handling capability:

Legal limit

- Two High-Q traps with large diameter coils
- Low angle radiation omnidirectional performance
- Taper swaged aluminum tubing
- Automatic bandswitching
- Mast bracket furnished
- SWR: 1.1:1 on all bands
- 1 1/2" O.D. heavy wall aluminum tubing
- Does not require guying
- Overall length: 19' 8"

Prices and specifications
subject to change without notice

NEWSLINE

FCC'S PERSONAL RADIO DIVISION is being abolished as part of a sweeping reorganization of the Safety and Special Services Bureau approved by the Commissioners! In the reorganization, Safety and Special Services is to be arranged functionally rather than by service, into four divisions: Policy Development, Rules, Licensing, and Compliance.

Safety And Special Services presently has three "service" divisions: Personal Radio, Aviation and Marine, and Industrial Safety and Public Service, all of which are going out of existence in the reorganization. In addition, there is also an Industrial and Public Safety Rules Division, plus a Legal, Advisory and Enforcement Division. With the reorganization, people working on rules, policy, legal or enforcement within the present service divisions will, for the most part, probably end up in the appropriate new division. However, at this point little is known as to who, how or when the shuffle will be accomplished.

Net Result Of The Change is expected to be an improvement in Safety and Special Services overall efficiency, with much more flexibility in shifting workloads. What it will mean for the FCC licensees such as Amateurs is less clear cut. Improvement in such routine matters as license processing seems certain, but where to go to get a question answered or discuss a problem could become difficult and confusing compared to the present setup.

LICENSE FEE REFUNDS came a step closer to reality with Commission adoption of a first Report and Order on its fee refund inquiry, General Docket 78-316. Only fees above \$20 are to be refunded in this first phase, which will begin after the necessary fee refund applications and instruction packets can be printed and distributed.

Commission Staff Work has already begun on Phase II of the refund program, which will cover fees of \$20 or less.

FCC'S INVESTIGATION of licensing irregularities in the Indianapolis area, which began in mid-1976, is still in progress. A number of central Indiana Amateurs received letters from the Commission in mid-February asking them to explain questionable aspects of their licenses or calls.

POSSIBLE "POINT-OF-SALE" control of Amateur transmitters has been nixed again by FCC's legal staff. Legally, however, it does appear retailers and manufacturers can impose such restrictions.

THE SAN ANTONIO REPEATER Organization received the National Weather Association's 1978 Award, for Outstanding Contributions to Meteorology by a Volunteer Organization, at a ceremony in San Antonio last Friday. Presenting the award was Mr. E.A. Diloreto, Meteorologist in Charge for the San Antonio National Weather Service Office.

The Organization was cited for "invaluable and sacrificial service by the volunteer operators in obtaining and transmitting meteorological and hydrological reports during the devastating August 1978 Texas Hill Country floods," its "3½ years of service to Bexar County, Texas, as severe-storm spotters and stream-gauge watchers with the National Weather Service's Skywarn Program," and the "considerable personal expenditures made by the Amateur operators in keeping a modern, effective communications system working and ready for the benefit of all in times of crises." Congratulations to SARO's members.

PROPOSAL TO SHARE 220 MHZ with the Maritime Services as contained in the FCC's final Report and Order on WARC 79, was formally challenged in a Petition for Reconsideration filed January 22 by the 220 MHz Spectrum Management Association of Southern California. In its well-done document, the 220 SMA pointed out that Amateurs were not given a chance to comment on the proposed sharing or on the change in Amateur status from primary to secondary. It further discusses the heavy 220 MHz use by Amateurs in coastal areas, and cites the role of Amateurs and Amateur repeaters in emergency situations. Several alternative locations for short range maritime communications were also cited.

"W6JAM," SCOTT LOOKHOLDER (WB6LHE), was sentenced February 6 to one year probation and a \$1000 fine by Judge Lawrence Lydig in Los Angeles Federal District Court. Lookholder had pled guilty on January 10 to three counts of using abusive language over the air. A provision of his probation was that he was not to use Amateur Radio for a year, and the judge also recommended that he receive psychiatric help.

Despite Widespread Interest in the case, which involved much of the Los Angeles area repeater jamming over the past year, only four Amateurs were in the courtroom for the sentencing. Only eight area Amateurs had submitted written statements to the prosecution about the jamming's effects, a disappointment to those who felt the case warranted more effort. FCC action against Lookholder's license is also considered likely.

ARIANE'S LAUNCH HAS BEEN PUSHED back an estimated five months, and with it the launch of the Phase III Amateur satellite. The delay will be used to advantage in further polishing and refining the performance of the Phase III bird.

This little converter was designed to be used with the 80/40 meter beginner's receiver, but will work with any receiver covering 3.5 to 4.0 MHz. If you have one of the less expensive general-coverage receivers, and it is not too peppy on the high bands, this converter can be used to give you better sensitivity, and, what is often very significant, it will have a drift characteristic the same as on 80 meters. When used with the beginner's receiver it results in sensitivity of much better than 1 microvolt — typically about 0.25 microvolt — so it is capable of snagging the weak DX stations for you.

The original views of the beginner's receiver showed the converter installed in the same enclosure as the speaker and power transformer. The converter in that unit required too

much sheet-metal work, so it was completely redesigned to eliminate all such work except for a small mounting bracket. This second converter is electrically identical, and was checked out with the 80/40 receiver to verify performance.

The circuit is shown in Fig. 1. A dashed line separates the circuit into its two functions, bandswitched oscillator and mixer. The only bandswitching function in the mixer is to switch it in or out. Actual selection of any of three bands in the mixer portion is done by setting C1. The tuned output circuit, L7/C2, is set once in the middle of the 80-meter band and then left alone. The oscillator portion of the circuit requires a bit more explanation.

Oscillator

In this circuit, one section of

the bandswitch selects the crystal, and the other switch section selects the proper tuned circuit for that crystal. If you are inexperienced at this construction game, you may have seen advertisements for crystals in the frequency range of 15 MHz and up, and may think the crystal will automatically oscillate at that frequency. Not so! These crystals are "overtone" crystals, which have a fundamental frequency of 1/3 to 1/5 of the output frequency. By the same token, lower frequency crystals will often operate as overtone crystals in the right circuit. The actual output frequency will not be precisely three or five times the fundamental, but will be close enough for our purposes. More about crystal choices later. In either case, we "force" the crystal to operate on the over-

CONVERTER PROJECT FOR 20/15/10 METERS

BY BILL WILDENHEIN W8YFB

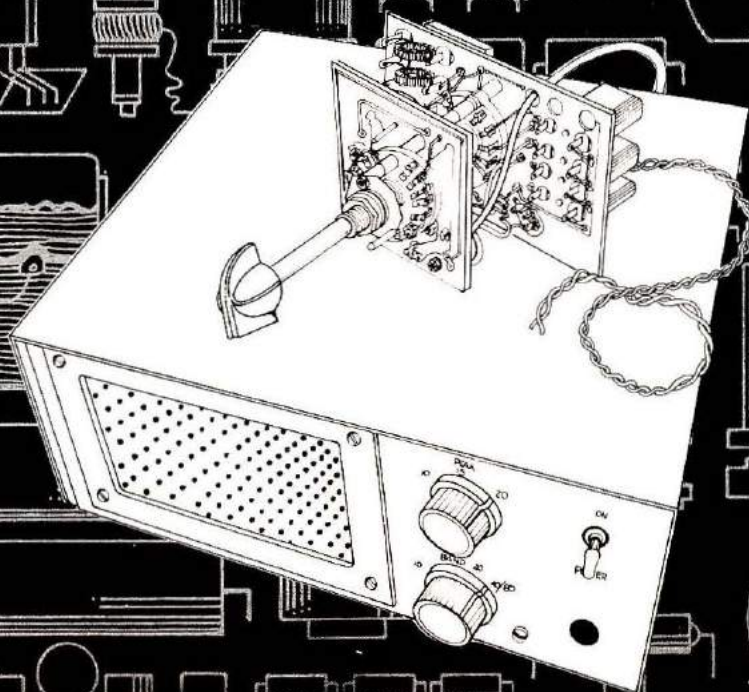

Receiver Articles Available

This converter was designed as a companion to the Beginner's Receiver, described in February and March, 1979, *Ham Radio Horizons*. A Beginner's Transmitter was featured in July, August, and September, 1978. These back issues are available for \$2.00 each, postpaid from *Ham Radio Horizons*, Greenville, New Hampshire 03048.

tone frequency by selecting an output tuned circuit operating on the desired frequency.

A test oscillator

A handy gadget for checking crystals is shown in Fig. 2. This is the same circuit as used in the converter, and you can build it almost entirely from scrap parts out of TV and broadcast radio sets. The circuit board need not be etched, but can be unclad board or perforated board, wired as in Fig. 2B and mounted on the back of the capacitor as in Fig. 2C.

You can check for oscillation by first setting the capacitor to *minimum* capacitance (plates unmeshed). Insert a crystal, apply voltage to the power supply leads, and connect an rf probe (such as the one described in part 2 of the receiver article) with the probe tip inserted in the pin of the *unused* crystal socket. The ground lead of the probe goes to the capacitor frame. Slowly rotate the capacitor toward the meshed direction until the rf-probe meter shows a deflection. The reason for starting with the capacitor unmeshed is that this combination of coil and capacitor will tune as low as 8.0 or 8.5 MHz, and if a crystal is made for that frequency, or higher, it will oscillate on its fundamental frequency when the tuned circuit is resonant.

Some crystals may operate in a fundamental mode but not in an overtone mode, particularly if they are rather inactive crystals. However, I find that almost all HC6/U or CR18/U crystals work fine. The shorter CR7/U crystals do not normally work too well in this circuit. They appear to need a parallel resonant, rather than a series resonant, mode. A test oscillator for these (CR7/U) crystals is shown in Fig. 3A, with a board layout in Fig. 3B. In operation, it is used exactly as the oscillator in Fig. 2. So if you have a collection, or source, of CR7/U crystals at very low prices, it

would pay to investigate the possibility of using them. The circuit-board layout used in the converter will accommodate both circuits. In both circuits, keep the leads as short as possible. Both physical layouts are drawn to scale, and give you an idea of permissible lead length. Fig. 4 is the schematic diagram of the alternative overtone oscillator. Notice the use of jumpers in both Fig. 1 and Fig. 4. These are just bits of No. 22 solid, bare wire used for the interconnections needed to convert from one form of oscillator to another.

Fig. 5 shows how the two boards are mounted to the

switch assembly. Notice that the switch wafers are mounted backwards, with their lugs toward the front-panel end of the switch. This makes wiring a bit easier. The oscillator circuit board should be completely wired before installing it on the switch. All components should be mounted, and pieces of No. 22 solid tinned bare wire soldered to the appropriate points on the circuit board to provide connections to the switch. The same size wire is used for connections from the oscillator board to the mixer board. This does not have to be shielded wire, since the distance is very short. You can

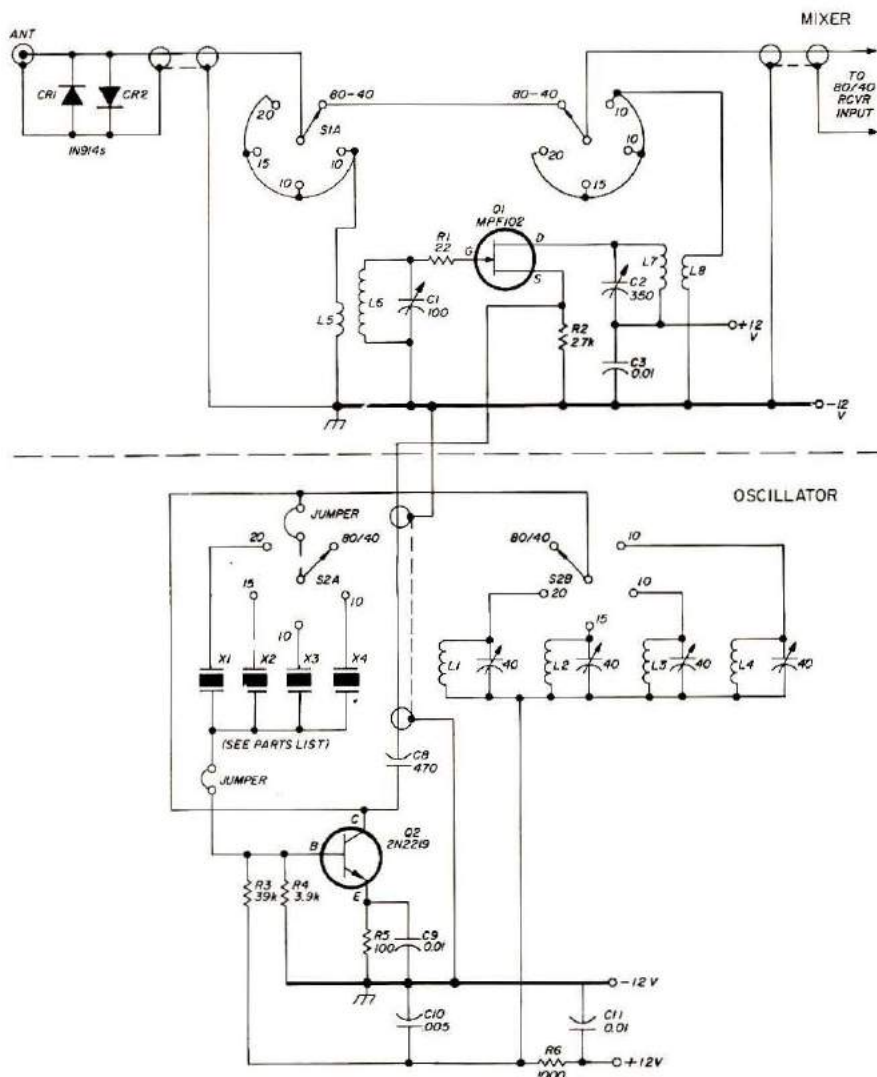
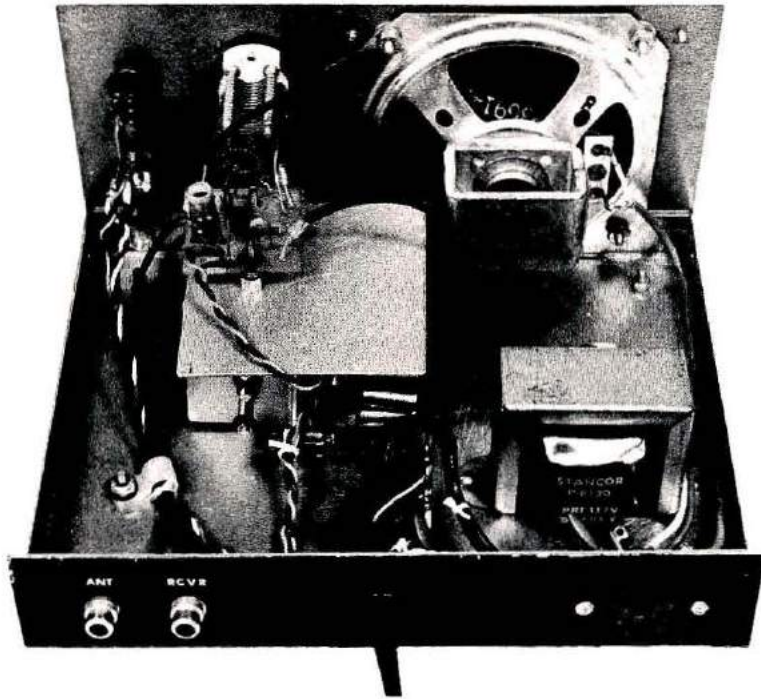

Fig. 1. Schematic diagram for the switchable converter. It was designed to work with the 80/40-meter beginner's receiver described in the February and March, 1979, issues of *Ham Radio Horizons*, but will work with any receiver that tunes the range of 3.5 to 4 MHz. See Fig. 13 for a list of parts for the converter.



An interior view of the converter box. The transformer in the lower right corner supplies ac to the rectifier diodes in the receiver. The converter in this model is a prototype, used to engineer and "debug" the circuit. It will be much easier for you to build a converter using the PC boards shown in Figs. 10 and 11. The PC-board model fits in the same space as this earlier one, and mounts to the front panel by means of the threaded bushing on the switch shaft.

connect one set of power leads to the oscillator board, and from the same pads run another set of wires to later connect to the power points on the mixer board.

After all this work is done, thoroughly scrub the circuit board with a toothbrush and 90 per cent isopropyl alcohol to remove the flux residue. Inspect the board carefully to be sure every joint is perfect.

Troubles

I spent a couple of agonizing hours trouble-shooting this little converter — just to find one bad joint. The converter worked fine on 20, but not on 15 and 10 meters. First the rf-output of the individual crystals was checked at the mixer. Each band showed adequate oscillator injection. Next, output frequency was checked on each crystal. Again everything was okay. I thought perhaps the oscillators might be working marginally, and only showed output when the capacitance of the rf probe was added. So they were again

checked by listening to the oscillator in a receiver with the probe on and off. Still the oscillators ran nicely. As a last verification, I listened in the receiver at each oscillator frequency as I turned the oscillator voltage on, to be sure that the oscillators started briskly. Again, no problem. Next, I recalculated the crystals to verify that the ones selected were correct for the desired range. Then I checked the signal generator on the general coverage receiver to verify its output was correct. At such moments, particularly at 3:00 AM — you begin to wonder who is crazy. All oscillator ranges were correct, and were feeding the mixer enough power on the correct frequency. The mixer stage is known to be working fine since it works as expected on 20 meters. After all that effort I checked the board! A careful check with the

Fig. 2. This is a test oscillator you can build to check crystals for activity and frequency. It can be built on a piece of plain phenolic or perforated board, then bolted to the end of a broadcast-set variable capacitor, as shown at C. If the variable capacitor has one large and one small section, connect to the small one. L2 is 18 turns No. 24 (0.5 mm) enameled wire on T-37-6 core.

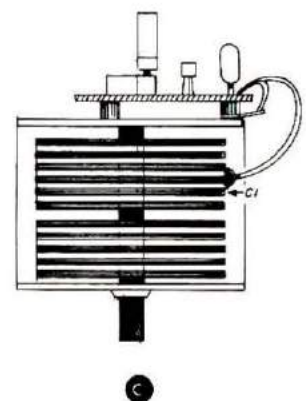
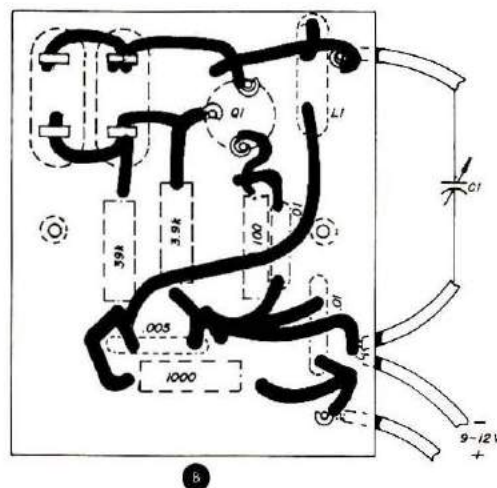
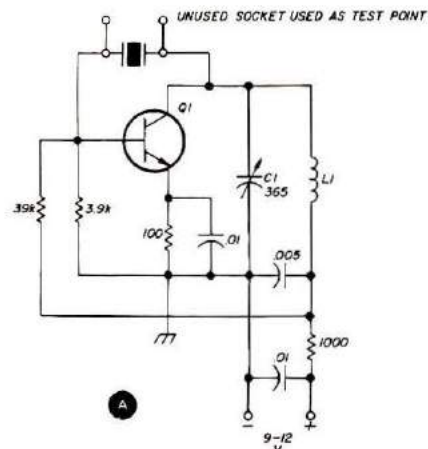

naked eye and plenty of light failed to show any error. When I used a magnifying glass I finally spotted one wire to the switch deck that was suspicious. (I left it for the following evening to show my boy, who is building some solid state gear. He had difficulty seeing the mistake, but one touch with the soldering iron and the converter came to life on all bands!) If I can goof, rest assured you can too! Take the time to *very carefully* examine the finished and cleaned board!

Now, begin the assembly as in Fig. 6. Notice that the switch screws are "going the wrong way." However, this is okay, because they temporarily secure the switch wafer while you wire the leads to the various switch lugs. Next, completely wire the mixer

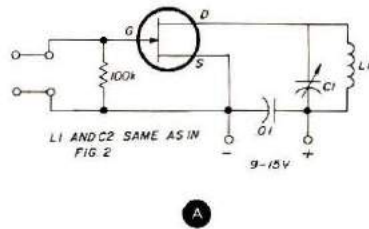

Fig. 3. Some crystals require a parallel-mode oscillator, such as this one. You can build it in the same manner as the one shown in Fig. 2, and fasten it to the capacitor frame just as with the other board.

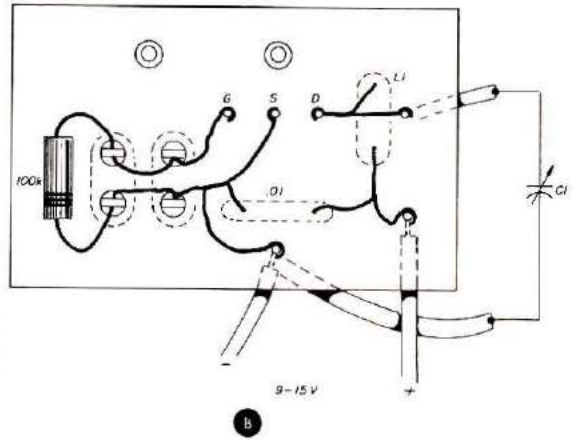

Fig. 7A. When a wire is fastened to a pad like that, it is easy for you to exert enough pull to lift the pad from the board. To be safe, clinch a very short end of wire on the other side of the board as shown in Fig. 7B. Now assemble the mixer board and its wafer switch as shown in Fig. 8, and wire the switch wafer. Finally, you can slide the shaft down through the switch wafers to complete the assembly. This requires great care. Under no circumstances should you exert any force on the switch wafers! You can align the movable section of the rear wafer by sticking the shaft through the front wafer, sliding it down to the rear wafer, then rotating the shaft gently to match the hole in the rear wafer. Tighten the nuts just enough to take the "wobble" out of the assembly, then try rotating the switch. If it binds, loosen the nuts, wiggle the wafers a bit and retighten. When it's finally assembled, switch operation should be crisp and smooth. This means you must be very careful to do a precise job of drilling the switch-screw holes and shaft-clearance hole in the circuit boards. You can make the screw holes just a little oversize; use a 3.5 mm (9/64 inch) drill instead of a 3-mm (1/8-inch) drill. The switch assembly, as supplied, has enough of the phenolic shock absorber washers, but not enough of the ceramic spacers.

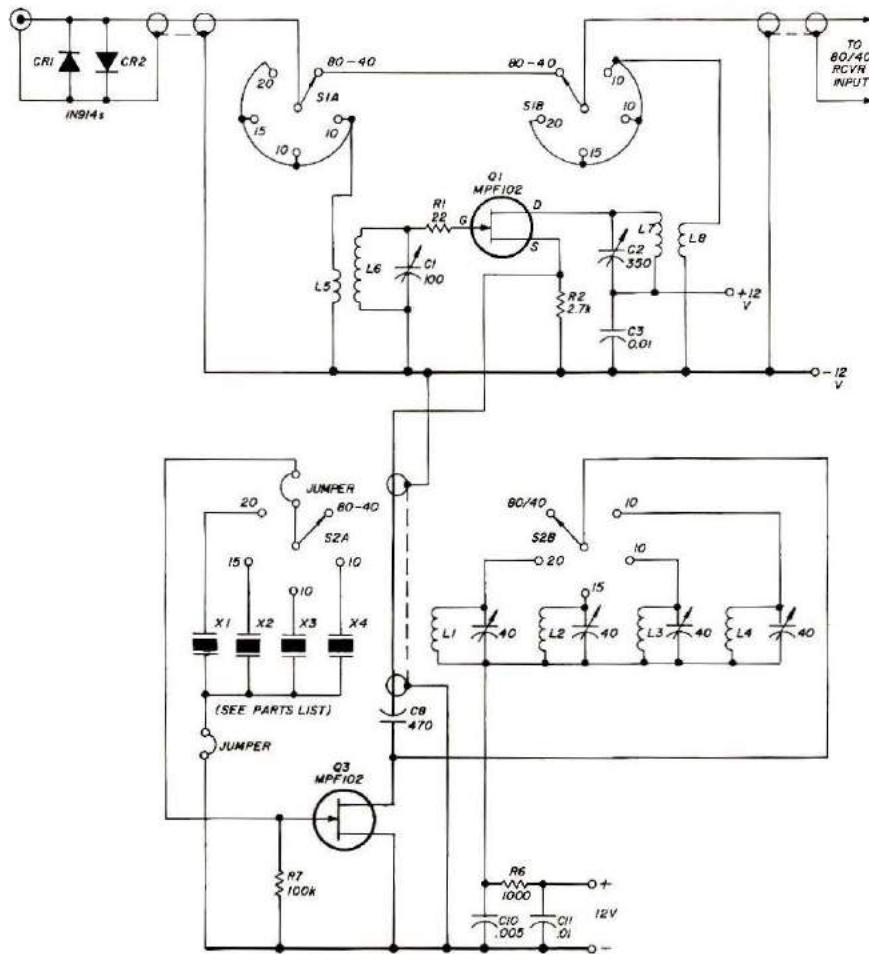

Fig. 4. If your crystals require the FET circuit of Fig. 3 to oscillate in the overtone mode, use this circuit for the converter, instead of Fig. 1. The printed-circuit boards shown later will work for either one. All parts values are the same as in Fig. 1, unless otherwise noted.

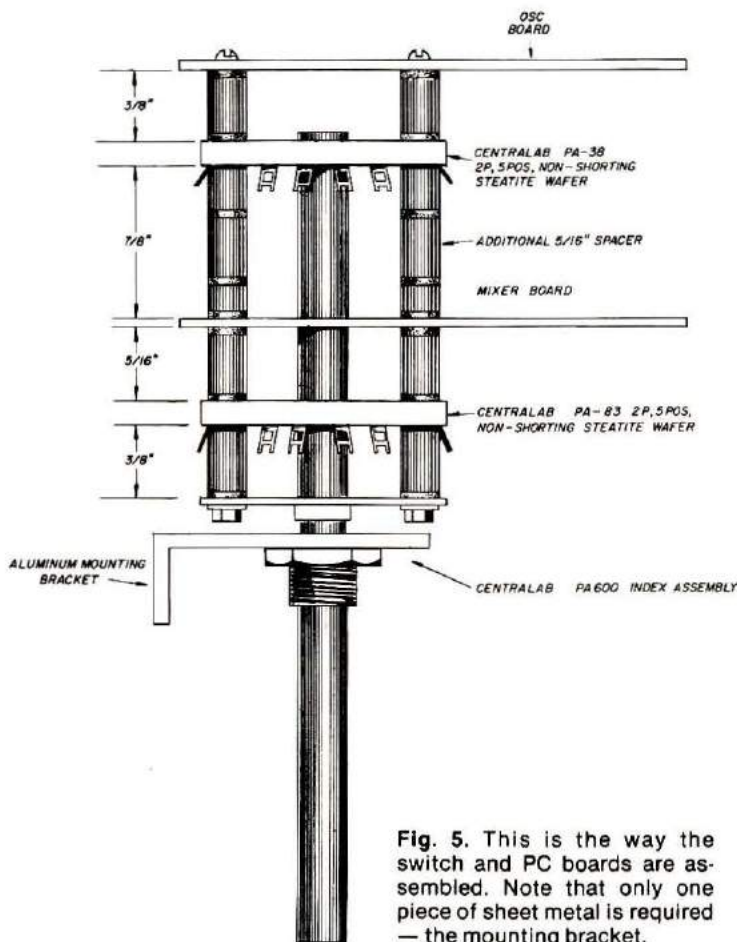

Fig. 5. This is the way the switch and PC boards are assembled. Note that only one piece of sheet metal is required — the mounting bracket.

You need two spacers 8 mm (5/16 inch) long (it is important that they be the same length). These can be made from 3mm (1/8-inch) I.D. tubing, such as automotive gas lines, or from brass tubing stocked by better hobby shops. Spacers from old switch-type TV tuners will do the job as well.

Testing

Now you can proceed with the checkout. With just the power leads connected, rotate the switch to the 80/40 position. In this position, no oscillator power is fed to the mixer. Connect a VOM (preferably 20,000 ohms-per-volt) or VTVM on the 10 Vdc range

Fig. 6. This is the first stage of assembly after you have the oscillator board wired. The nut is only temporarily in place to hold the wafer and spacers while you complete the wiring.

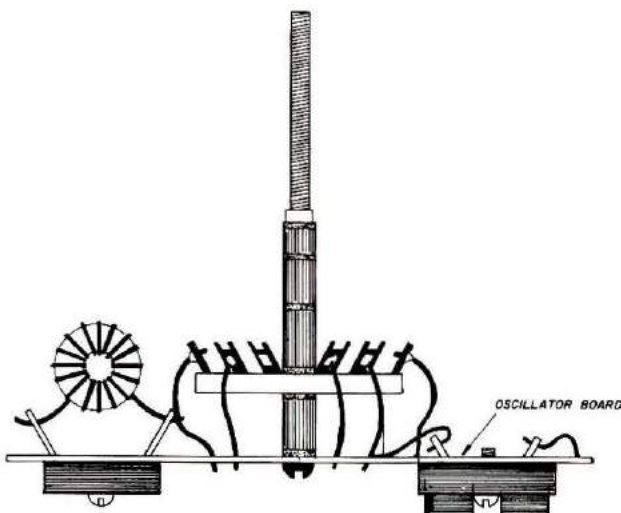

across R2 in the mixer. The positive meter lead goes to the source end of the resistor. This reading will vary quite a bit with different transistors. Perhaps you'll read 2 volts; note this reading. Insert the crystals in their correct sockets and switch to 20 meters. Again measure across the resistor R2 as you tune C4. As the oscillator pops into oscillation, the voltage across R2 increases. Notice that when you tune C4,

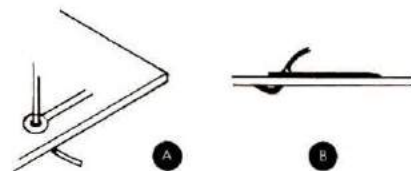

Fig. 7. The wires from the PC board to the switch wafer are on the foil side of the board. To prevent pulling the foil loose, let a short tail of wire stick through the hole (A), and bend it over as shown (B).

on one side of resonance the crystal seems to suddenly go into oscillation. As you continue tuning, the reading decreases on the other side (of resonance) rather gradually. Always leave the tuning on the side where changing C4 results in a gradual drop-off in voltage. You can afford to throw away a little output in order to gain this point of tuning, which is where the oscillator will start dependably every time you switch to that position.

In the same way, go to the 15-meter position of the band-switch and tune C5 for the correct point of tuning. Next, switch to 10 meters and set C6 correctly. If you have included another 10-meter crystal, switch to that range and set C7 correctly.

Now you can connect the output of the mixer to your receiver. With an antenna connected to the converter and the receiver tuned between 3.7 and 4.0 MHz, rotate C1. You may hear 20-meter signals with the converter range switch set for 20. If so, adjust C2 for maximum signal strength, then (if you are using the 80/40

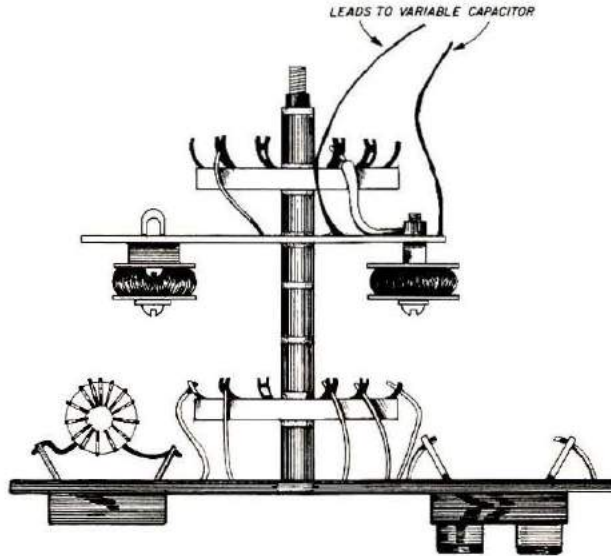

Fig. 8. This is the second stage of assembly, after the mixer board has been wired. Don't tighten the nuts all the way down — you'll need to move the wafers and boards slightly when you install the shaft and index assembly.

beginner's receiver) peak up the mixer input capacitor of that receiver — C1. Switch to 15 meters and all you should have to do is repeak C1 of the converter. Switch to 10 and again repeak C1 in the converter. If you are able to tune it up using only on-the-air signals, C2 in the converter can be set once and then left alone. It is rather noncritical. Best general results would be obtained if you tune the 80/40 receiver to about the middle of the 80-meter band, then, with the converter on any of the high bands, adjust C2 for a maximum. If you are unable to get it to tune using on-the-air signals, you can use a 40-meter crystal oscillator as a signal generator. A reliable circuit is shown in **Fig. 9.** Again, it can be built

primarily from scrap TV and broadcast-set components. This is a Colpitts oscillator that runs on the fundamental frequency of the crystal. The tuned circuit, C4/L1, can be replaced with an rf choke, if desired, but high-frequency output will be reduced. The rf choke can be one of the windings from an old style 455-kHz i-f transformer, one of the 500-microhenry video chokes from a scrap TV, or even one of the windings from a 4.5-MHz TV i-f transformer. If you use a 40-meter crystal, you will get output on 40, 20, 15, and 10 simultaneously. Output on the higher frequencies will be on exact multiples of the crystal frequency. For example, a 7100-

kHz crystal will also deliver output at 14200 kHz, 21300 kHz, and 28400 kHz. The oscillator need not be connected directly to the converter but can feed a clip-lead "antenna" lying near the input tuned circuit of the converter. You can listen to this oscillator on your 80/40 receiver to verify that it is oscillating. Again, it is not necessary to make a connection to the receiver. With this gadget you have a sufficiently powerful signal to tune up the mixer of the converter regardless of how much C1 and C2 are detuned. If you can't hear the signal from the converter as you tune the 80/40 receiver, it is probable that you have a wiring error in the converter.

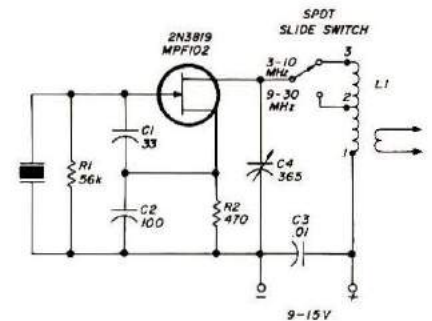

Fig. 9. This is a test oscillator you can use as a signal source to align the converter. Build it on a scrap of perforated board. To use the oscillator, plug in a crystal and listen for its harmonics on the converter/receiver combination. L1 is 43 turns No. 26 enamel covered wire on T-50-6 core. Tap at 16 turns from bottom. Link is one turn of same size wire.

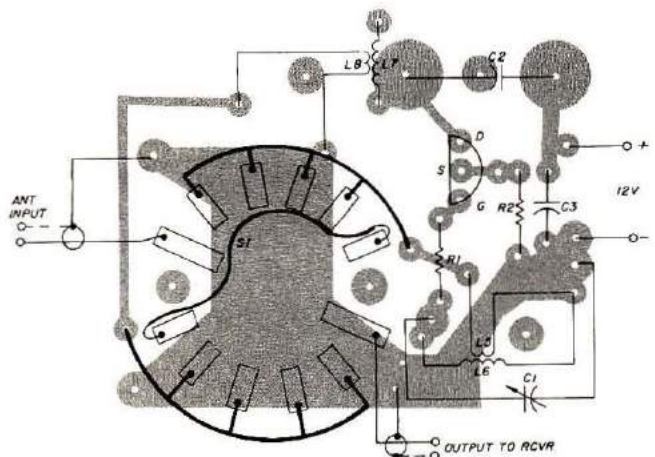
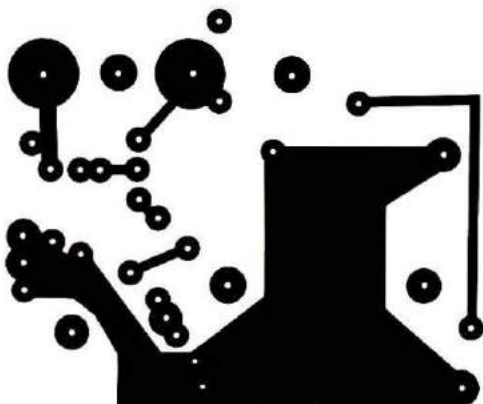

Fig. 10. PC-board pattern for the mixer section, left, and a parts placement guide, right. See **Fig. 15** for details on mounting the compression trimmer, C2.

Crystal choices

Now let's see how to choose the crystal frequencies so you'll know what to look for in surplus crystals. If your 80-meter receiver is similar to mine it will have some extra range; mine covered from about 3450 to 4150 kHz. This allows some leeway in selecting crystals. For 20 meters, select a crystal frequency on the high side of 20 meters, thus: 14 MHz plus 4 MHz = 18 MHz. For the other end of 20 meters: 18 MHz (crystal frequency) minus 3.5 MHz = 14.5 MHz. Thus you could select either an 18-MHz overtone crystal, or divide that by 3 (6-MHz fundamental frequency), and use it in an overtone mode. Perhaps you can't find an 18- or a 6-MHz crystal — possibly you can see a 5970-kHz crystal. Will it work? $5970 \times 3 = 17910$ kHz. 17910 minus 3500 = 14410 kHz; 17910 minus 4000 = 13910 kHz. Obviously that crystal will work nicely, allowing you to tune from 13910 to 14410 kHz.

Similarly, on 15 meters the converter oscillator operates on the "high side," so you can use the same technique: 21000 kHz plus 4000 kHz = 25000 kHz. So you could use a 25-MHz overtone crystal, or, 25 MHz divided by 3 = 8333 kHz. The top end of 15 would then be 25000 kHz minus 3500 kHz = 21500 kHz. Notice that this crystal allows only 50 kHz extra at the top end of 15 meters. It must be chosen a little more carefully than the 20-meter crystal. If you chose the 25-MHz (or 8333-kHz) crystal, there is another advantage: 25000 plus 3500 = 28500 kHz! and 25000 plus 4000 kHz = 29000 kHz. Thus the 15-meter crystal will also let you tune a 500-kHz portion of 10 meters. You may wonder how this can be, when the bandswitch is on the 15-meter position. Remember, the mixer input circuit is not bandswitched! You can put the bandswitch on 15 meters, then tune the mixer input capacitor,

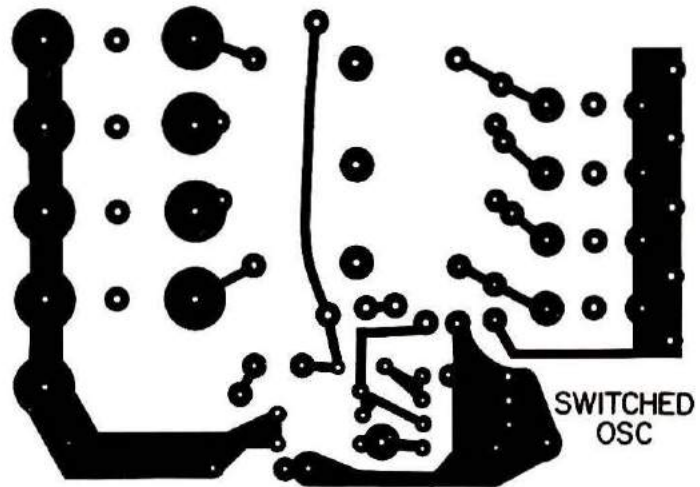

Fig. 11. At the top is the PC-board pattern for the oscillator section of the converter. The parts-placement guide (below) is for a bipolar transistor, as shown in Fig. 1.

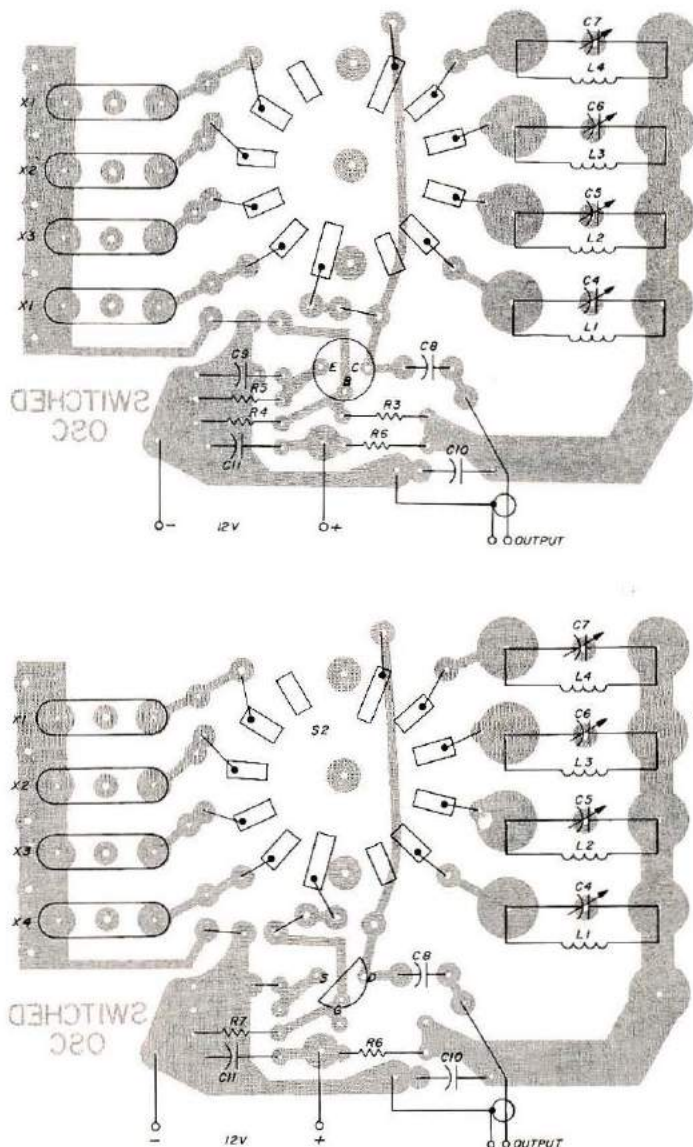
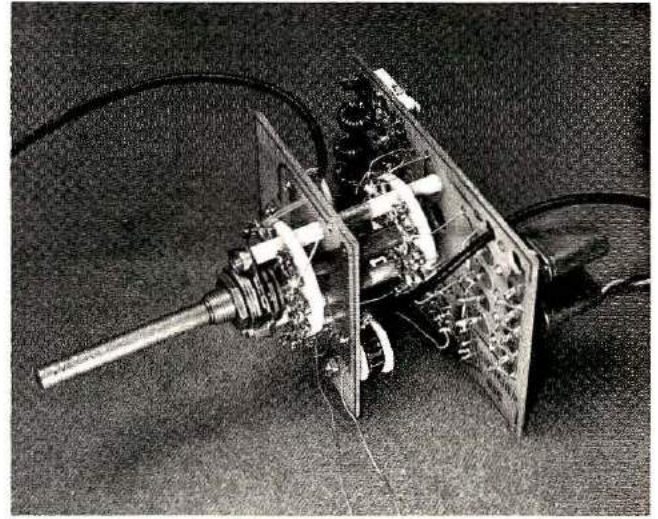
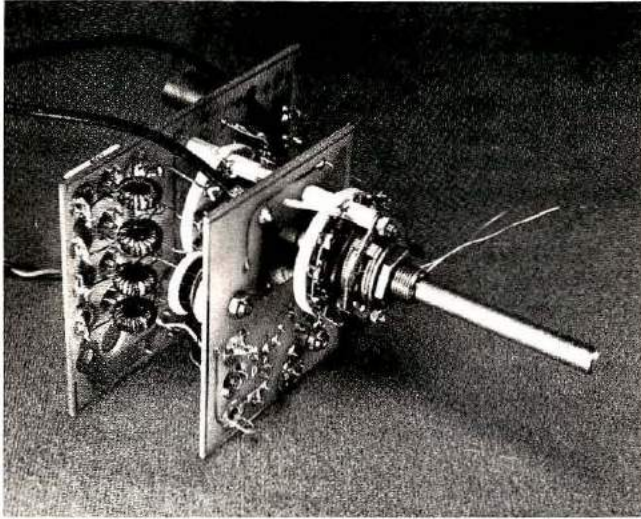

Fig. 12. This is the same oscillator board, but arranged to use an FET (Fig. 4) instead of a bipolar transistor.



Here are two views of the "real" converter. Note how the PC boards are mounted on the frame of the bandswitch. The two bare wires extending out to the right of the switch should be connected to the input tuning capacitor, C1. This capacitor is adjusted by means of the knob marked "PEAK" at the top center of the front panel. In the photo at the left, you can see how the toroid coils are mounted by their leads, connected to the trimmer capacitors. The right-hand view shows the crystal sockets and their wiring.

C1, to 10 meters and receive 28.5 to 29 MHz!

On the first 10-meter switch position you'll then want to tune 28 to 28.5 MHz. You can operate the crystal on the "low" side of 10, so figure it thus: 28.5 minus 4.0 MHz = 24.5 MHz (24500 kHz).

This same 24500-kHz crystal plus 3500 kHz = 28000 kHz. So you can choose a 24.5 MHz overtone crystal (or that frequency divided by three = 8166 kHz). For the second 10-meter bandswitch position choose a range of 29 to 29.5 MHz. Again, figure it as:

29.5 MHz minus 4 MHz = 25.5 MHz. And, 25.5 MHz plus 3.5 MHz = 29 MHz. Thus, with just two crystals for 10 meters you'll get practically the entire band.

If you take time to work this out very carefully, you can calculate a range of acceptable

Fig. 13. Parts list for the converter. The crystals listed here are those used by the author — don't hesitate to try bargain crystals with slightly different frequencies. Examples of how to work out the coverage are given in the text.

Designation	Description	Designation	Description	Designation	Description
Capacitors		Coils		Resistors	
C1	100 pF air variable (Hammarlund MAPC 100 or equivalent)	L1	33 turns No. 24 (0.4 mm) e.c. on T-37-6 core	R1	22 to 56 ohm, ¼ watt
C2	70 to 350 pF; ARCO 428 mica compression trimmer	L2, L3, L4	26 turns No. 24 (0.4 mm) e.c. on T-37-6 core	R2	2700 ohm, ¼ watt
C3, C9, C11	0.01 µF, 25 V (or higher) disk ceramic	L5	1 turn No. 24 (0.4 mm) e.c. over L6	R3	39k ohm, ¼ watt
C4, C5	4 to 40 pF; ARCO 403	L6	18 turns No. 24 (0.4 mm) e.c. on T-50-6 core	R4	3900 ohm, ¼ watt
C6, C7	mica compression trimmer	L7	34 turns No. 28 (0.3 mm) e.c. on T-50-2 core	R5	100 ohm, ¼ watt
C8	470 pF, 25 V (or higher) disk ceramic	L8	5 turns No. 28 (0.3 mm) e.c. over L7	R6	1000 ohm, ¼ watt
C10	0.005 pF, 25 V (or higher) disk ceramic	Note:	e.c. = enameled covered wire	R7	100k to 220k ohm, ¼ watt (used in Fig. 4)
Diodes		Transistors		Switches	
CR1, CR2	1N914 or 1N4148 Silicon diode	Q1, Q3	MPF 102, HEP 802, 2N3819, or 2N5459	S1, S2	Centralab PA-83, 2-pole, 5-position, nonshorting steatite switch wafer with Centralab PA600 shaft and index assembly
				Crystals	
				X1	18 MHz overtone (see text)
				X2	25 MHz overtone (see text)
				X3	24.5 MHz overtone (see text)
				X4	25.5 MHz overtone (see text)

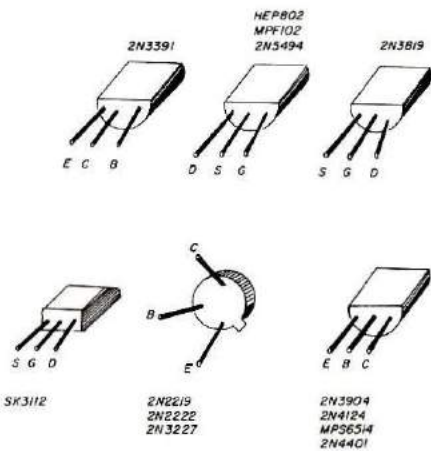

Fig. 14. Basing diagrams for the transistors used in the converter.

crystals for each band. Then, when you go to a radio club auction or flea market you may end up with a complete set of crystals for less than the price of one new crystal. All the crystals in the prototype receiver and the second version of the converter were lower frequency crystals operated in an overtone mode.

P.C. Boards

Finally, let's look at the board layouts: Fig. 10 is the foil side of the mixer board. The components are on the other side, except for the band-switch, and the variable capacitor is located off the board on the front panel. Fig. 11 is the oscillator used in both converters. Again, it is the foil side of the board. All components are on the other side except for the bandswitch, and coils L1, L2, L3, L4. Fig. 12 shows the alternative oscillator for use with an FET circuit. Again, this is the foil side, and components are on the other side except for the switch and coils.

In the recommended list of coil cores, do not substitute others unless you know the core materials and are able to recalculate the correct number of turns. I have built this converter many times in a number of different layouts,

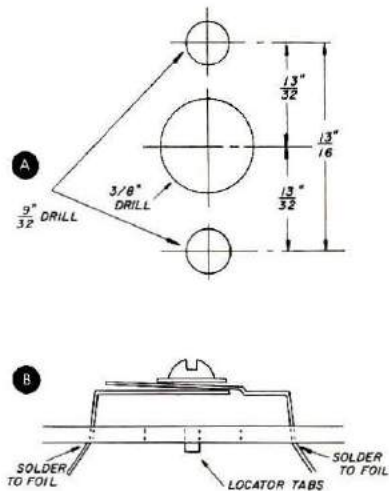

Fig. 15. The Arco compression trimmers are difficult to mount and solder to the board unless you make the holes the right size and at the right spacing. This layout will help. Be careful with the large drills and the thin PC board material — be sure to have a wooden block to support the board, and don't force the drill through.

and have always had success, so I don't foresee any problems unless you get components in the wrong holes, poor solder joints, or force the switch assembly together, thereby ruining the switch wafers. Since I have also used surplus crystals in practically all of my converters, I don't see many problems with crystals. FT243 crystals have given me a little trouble in the past, but are still usable. To use them in this layout would require about 1.5 mm (1/16-inch) greater spacing between crystal holders.

I should also mention how to mount the compression trimmer capacitors. Fig. 15 shows the hole locations and dimensions, and method of mounting. Incidentally, this converter works well with a surplus BC454 80-meter Command receiver for either CW or ssb. Those old sets had exceptional stability — really state of the art.

In conclusion, I hope you enjoy the success I've had with this simple little converter, and I hope it encourages you to experiment further with homebrew, solid-state equipment. Happy tinkering!

Sources of Materials for the Converter

Variable capacitors, APC capacitors compression trimmers, toroid coil forms, rf chokes, enclosures	G. R. Whitehouse 15 Newbury Drive Amherst, New Hampshire 03031
Variable capacitors, compression trimmers, power transformers, rotary switches	Fair Radio Sales 1016 E. Eureka Box 1105 Lima, Ohio 45802
Resistors, fixed capacitors, transistors, diodes, PC board material	Gull Electronics 12690 Route 30 North Huntingdon, Pennsylvania 15642
Crystals, crystal sockets	JAN Crystals 2400 Crystal Drive Ft. Meyers, Florida 33901
Crystals, crystal sockets	Jess B. Lebow, Jr. 355 Mower Road Pickney, Michigan 48169
Diodes, transistors, FETs, integrated circuits, components	Adva Electronics Box 4148A Woodside, California 94062
Fixed capacitors, switches, resistors, transistors, FETs, integrated circuits	Digital Research Corporation Box 401247 Garland, Texas 75040
Transistors, diodes, integrated circuits	Integrated Circuits Unlimited 7889 Clairemont Mesa Blvd. San Diego, California 92111
Capacitors, diodes, transistors, integrated circuits	Bullet Electronics P.O. Box 19442 Dallas, Texas 75219

HRH

for the experimenter

INTERNATIONAL CRYSTALS & KITS / OSCILLATORS • RF MIXERS • RF AMPLIFIER • POWER AMPLIFIER

OX OSCILLATOR



Crystal controlled transistor type. 3 to 20 MHz, OX-Lo, Cat. No. 035100. 20 to 60 MHz, OX-Hi, Cat. No. 035101.

Specify when ordering
\$5.22 ea.

MX-1 TRANSISTOR RF MIXER

A single tuned circuit intended for signal conversion in the 30 to 170 MHz range. Harmonics of the OX or OF-1 oscillator are used for injection in the 60 to 179 MHz range. 3 to 20 MHz, Lo Kit, Cat. No. 035105. 20 to 170 MHz, Hi Kit, Cat. No. 035106.

Specify when ordering.

\$5.80 ea.



OF-1 OSCILLATOR



Resistor/capacitor circuit provides osc over a range of freq with the desired crystal. 2 to 22 MHz, OF-1 LO, Cat. No. 035108. 18 to 60 MHz, OF-1 H, Cat. No. 035109.

Specify when ordering.
\$4.48 ea.

PAX-1 TRANSISTOR RF POWER AMP

A single tuned output amplifier designed to follow the OX or OF-1 oscillator. Outputs up to 200 mw, depending on frequency and voltage. Amplifier can be amplitude modulated 3 to 30 MHz, Cat. No. 035104.

Specify when ordering.

\$6.06 ea.



SAX-1 TRANSISTOR RF AMP

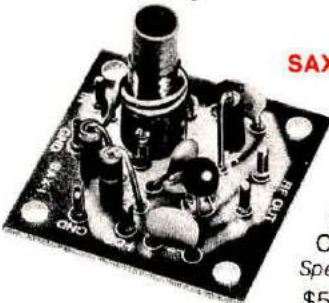

A small signal amplifier to drive the MX-1 Mixer. Single tuned input and link output. 3 to 20 MHz, Lo Kit, Cat. No. 03512. 20 to 170 MHz, Hi Kit, Cat. No. 035103.

Specify when ordering.
\$5.80 ea.

BAX-1 BROADBAND AMP

General purpose amplifier which may be used as a tuned or untuned unit in RF and audio applications. 20 Hz to 150 MHz with 6 to 30 db gain. Cat. No. 035107.

Specify when ordering.

\$6.06 ea.

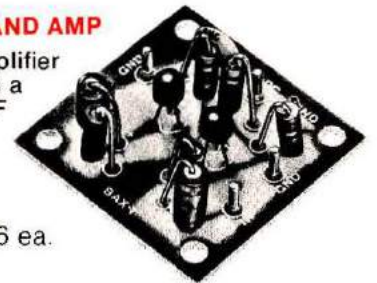

.02% Calibration Tolerance

EXPERIMENTER CRYSTALS

(HC 6/U Holder)



Cat. No.	Specifications	
031080	3 to 20 MHz — for use in OX OSC Lo	\$6.25 ea.
	Specify when ordering	
031081	20 to 60 MHz — For use in OX OSC Hi	\$6.25 ea.
	Specify when ordering	
031300	3 to 20 MHz — For use in OF-1L OSC	\$5.22 ea.
	Specify when ordering	
031310	20 to 60 MHz — For use in OF-1H OSC	\$5.22 ea.
	Specify when ordering	

Shipping and postage (inside U.S., Canada and Mexico only) will be prepaid by International. Prices quoted for U.S., Canada and Mexico orders only. Orders for shipment to other countries will be quoted on request. Address orders to:

M/S Dept., P.O. Box 32497,
Oklahoma City, Oklahoma 73132

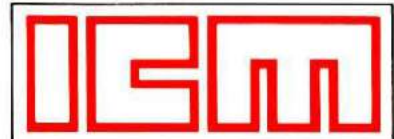

INTERNATIONAL CRYSTAL MFG. CO., INC.
10 North Lee / Oklahoma City, Okla 73102

SEANET convention



IN THAILAND

BY DOUG BLAKESLEE, N1RM

In 1976 my good friend WA1UHB attended the annual conference of the South East Asia NETWORK (SEANET), which was held in Jakarta, Indonesia. He came back raving about how great it was. When the opportunity arose for me to go it took only a matter of microseconds to decide that if SEANET '77 was going to be held in Bangkok in November, I'd be there.

Such a decision must, sooner or later, be imparted to one's spouse. My wife is a veteran of more than a few ham conventions. So when I announced that I'd made plans to go to yet another, she answered, "That's nice, dear." (For those not married, this roughly translates to: "It's okay if you go as long as I don't have to.") She added, "Is this another of those affairs in New

York City?" With no way out of that question, I told her it was the SEANET convention in Bangkok. "But . . . but . . ." she sputtered, "that's on the other side of the world." After some additional sputtering, she added, "And what's a SEANET, anyway?"

What's a SEANET, anyway?

Hams have a natural tendency to get together, both in person and on the air. The South East Asia NETWORK wasn't formed; it just happened. When propagation wasn't too good to other parts of the world, amateurs in Asia and around the Indian Ocean got together for a rag chew. The ham population in this part of the world is sparse, so it was fun to talk with "close" neighbors.

The scope of SEANET is hard for someone like me to comprehend. I was broken in years ago as a net control

operator on the Connecticut Phone Net covering a little state only 96 by 64 km (60 by 40 miles). SEANET covers more than one-third of the world with regular check-ins by stations from Hawaii to East Africa, from Japan to Australia. It serves as an on-the-air club for amateurs who often don't have enough local hams to form a club — who often don't have any local hams at all!

SEANET meets nightly on 14.320 MHz using usb (upper sideband voice) at 1200 UTC (0700 EST, 0400 PST). This club of the air has no officers, no dues, and no members — only "regulars" on the net. It's popular, to be sure: up to 150 stations check in each evening. Their general purpose is camaraderie among amateurs; but like most amateur networks, they provide a resource for emergency communications unmatched by

other services. For example:

Recently a distress call heard on SEANET made headlines. A 12-meter (39-foot) cutter, the *Brillig*, sailed by 28-year-old Cornelia "Cricket" Dellenbough and two companions, was waylaid on a voyage from Pattaya to Brunei. The distress call said *Brillig* was being fired upon by four gunboats, flying no flags, off the Vietnamese coast. (First press reports said two "fishing boats" were responsible.) The story caused international concern, and the next day SEANET stations reported an additional message from Cricket Dellenbough: she and her crew were being "escorted" to Saigon and they expected to be released shortly. No doubt the SEANET-generated reports, which were repeated by the world press, had much to do with the ultimate safety of *Brillig* and her crew. As I am writing this, negotiations are being completed with Vietnam for Cricket's release.

In late December 1971, some 25 SEANET members got together on Penang Island in West Malaysia for the fun of a convention. They started a trend. The spirit persisted, and the next year a group met in Bangkok. This convention was called the second SEANET, and it was institutionalized as an annual affair. Conventions followed in Singapore, Manila (Philippines), Kuala Lumpur (Malaysia), and Jakarta

(Indonesia). SEANET '77 returned to Bangkok, and that's the subject of this story.

Getting there is . . .

The airlines once tried to convince us that "getting there is half the fun." Or maybe it was the steamship lines. Anyway, it was long before jumbo jets started leap-frogging continents and before the Japanese "Red Army" and other terrorist groups began hijacking some flights and blowing up others. With today's international airports resembling Stalag 17, complete with barbed wire, armed guards, and armored vehicles, the weary traveler is happy just to arrive in one piece.

The international-airline moguls have decreed that Japan is the gateway to the Far East; all of the popular flights go through Tokyo. It's a good stop on any ham itinerary because you can visit the famous radio-parts and equipment-sales district, Akihabara, a fabulous experience for those of us who must depend on Radio Shack and mail order. Businessmen in a hurry prefer the Pan-Am direct flight from New York to Tokyo. In my view, it's a good way to damage your physical and mental health. The Boeing 747SP (for Special Performance) used by Pan-Am is a technical marvel. It carries fewer passengers but a larger fuel load, two full crews, and



HM2KL led the Korean delegation.

flies 1.6 km (1 mile) higher than other 747s. In this marvelous flying machine you sit in a seat for 18 hours straight and can watch two movies. Let out in Tokyo, you find that midnight is noonday and vice versa, which causes the best case of jet lag known to man. An average person takes at least a week to get his internal clock reset.

Travel tips

My own survival plan for international travel includes the dictum *never sleep on an airplane!* So I fly from New York to Honolulu, have a late dinner — that wonderful island food — and a good sleep. Because of the time change, you tend to awaken early. But you have the opportunity for a swim and a leisurely breakfast before setting out. From Hawaii to Japan, I fly Japan Air Lines (JAL). The value of the Japanese yen vs. the dollar has made the Hawaiian Islands the favorite vacation spot for hordes from the Land of the Rising Sun. Factory workers and honeymooners pack every JAL flight, which practically assures that if you're not on a tour, you get bumped to first-class. I've made the trip four times and wound up in first-class every time. It's great to relax in a big

The boys from Penang who made the 24-hour train trip to Bangkok pose for a group photograph.





Three of SEANETs well-known members, Mayuree Chotikul, HS1YL, Father Moran, 9N1MM (under a portrait of the Queen of Thailand), and Dr. Edurado Garcia, DU6EG.

first-class seat, and enjoy Western and Oriental cuisine.

The morning flight from Honolulu arrives in Tokyo in the early afternoon, providing a chance to get downtown to a hotel before rush hour in the world's largest city. And what a rush hour it is!

The second stop on the way to Bangkok is Hong Kong. Out of Tokyo, get a window seat on the right-hand side of the aircraft. The sights along the China coast are not to be missed. The approach to Hong Kong's airport, flying between volcanic mountain peaks, then below the level of the skyscrapers on either side of the bay onto a single runway built on landfill, is an experience you'll appreciate — once the plane is on the ground.

From Hong Kong, it's another trip through security and another plane for the final destination, Bangkok. Today, the flight must head all the way around Vietnam and back up to Thailand.

No one seemed to mind the extra hour of flying time caused by the wide sweep around what had been South Vietnam. The new rulers are very touchy about their air space. Who'd want to find out if there were any SAM missiles left about!

Every major international airport has a best way to get

downtown. In London you take the airways bus; in Munich a taxi; in Tokyo the high-speed monorail. In Bangkok you take a "limousine." These limos are a Thai Airways concession and aren't limousines at all in our sense of the word. They're an odd collection of small Japanese cars with a back seat large enough for two pygmies, maximum. For someone like myself, with a 1.8-meter (6-foot) frame, the trip into town is a 45-minute ride with your chin resting on your knees.

The area around Bangkok is an absolutely flat river delta. First impressions are of a countryside with short but lush greenery, interspaced with puddles, rice paddies, and small streams. A fine, reddish-brown dust is everywhere, even immediately after a rain shower. It's a permanent part of the environment.

To the edges of the road, farmers work their paddies as they have done for endless generations. Sometimes all you see is a domed straw hat moving among the reeds; the worker is in water up to his chin. At each major intersection is a bus stop, a platform built over a rice paddy. Each platform is made of wood with a high, arched roof that has a sweep and curve as

The antennas for HS0SEA were mounted atop the Erawan hotel. The OSCAR antennas are on the crossbeam.

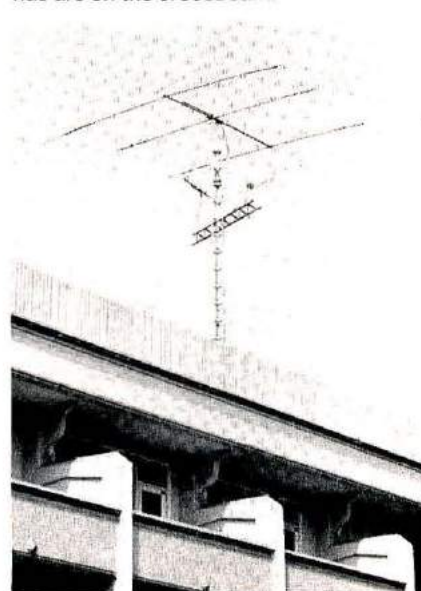

Two well-loved Malaysian Amateurs, 9M2EE, Sardjit, and 9M2DN, Keen.

elegant as any on the finest temple. There are no seats or benches; people wait for transportation while squatting, unmoving, like statues. The lack of movement, no doubt, is in deference to the high heat and humidity.

Bangkok's outskirts are made up of low, two- or three-story cement buildings where the first floor is invariably a shop, store, or garage. This type of construction is seen throughout Southeast Asia, from Taiwan to Singapore. As you get into town, the buildings get taller. The unique features of Bangkok are its temples and palaces — unique, breath-taking, beautiful. Hotels, restaurants, and even private homes have their own small temples — every bit as elaborate in gold and color as the large ones — like miniature doll houses mounted on poles near the entrance or front wall.

Soon my pint-sized limo swung into the entrance of the convention hotel, the Erawan. It's an older hotel, built years ago in the low rambling style of Thailand. Each room has a balcony and long windows, which can be opened to catch evening breezes. It's a country long on heat and humidity and short on breezes. Central air conditioning had been added to each floor of the Erawan. The hotel is run by the government, and run well. It surely has the finest service of any hotel I've seen anywhere in the world. The Erawan is mentioned frequently in John Le Carre's best-selling spy novel, *The*

Honorable Schoolboy. This new notoriety has attracted an interesting odd lot of guests, mostly Europeans.

SEANET '77

A large, blue banner over the main entrance of the Erawan proclaimed with huge gold letters, "Welcome to the delegates for SEANET '77." And welcome it was. Col. Kamchai Chotikul, HS1WR, president of the Radio Amateur Society of Thailand (RAST), welcomed each newcomer to the registration room. For 500 baht or some \$24 (about the price of a banquet at a U.S. convention), we received a whole weekend of meals, banquets, and cocktail parties, plus entry to all convention events. In addition, we received a potpourri of Thai items including powder, hair tonic, a stamp collection, a handmade silk tie, a bottle of local cognac, a handmade fish mobile, and so on, as gifts. I'd just arrived and already I was wondering how to fit all the loot into my suitcase! Thailand is called the "land of a thousand smiles." All thousand were being used to welcome hams to SEANET '77.

A luncheon provided the opportunity to meet the delegates. These were

No convention is complete without an exhibit. Here equipment made in Thailand by Kamchai Electronics attracts delegates.



Two girls in traditional Siamese costume dance during the Friday banquet.

among the better known:

HS1WR — Col. Kamchi Chotikul, "Kam," mentioned earlier, is president, mentor, and international good-will ambassador for RAST (having visited some 60 countries). Besides being a colonel in the Royal Thai Artillery, Kam is director of radio station HSAAA and owner of Kamchi Electronics, a manufacturing and importing firm. His wife, HS1YL, and daughter, HS1DC,

are active hams and beautiful ladies. Their charm as hostesses permeated the convention.

9N1MM — Father Moran is a ham-radio legend. A Catholic priest, he's the long-time leader of the Saint Xavier School in Katmandu, Nepal. A ham for some 54 years, he's been one of the mainstays on 20-meter ssb and on SEANET. 9N1MM tends to drop in on conversations between U.S. amateurs when he hears someone he knows, just to say hello. Just as quickly, he can disappear before the entire band turns to a bedlam of stations calling for their first Nepal contact.

S79R — Carl, otherwise known as WB8JDR, is a rag chewer with an improbable call from an almost unknown corner of the world, the Seychelles Islands. Because of his location at the African end of the Indian Ocean, Carl is in a unique position to be net control for SEANET, and it is clearly his favorite pastime.

BV2A — Tim Chien is one-of-a-kind, the only amateur licensed to operate on Taiwan. His mild manners and easy laughter are infectious. When asked about the chances of



Carl, S79R, opens the Southeast Asia net using the special call HS0SEA. Carl is a regular net control from his station in the Seychelles Islands, in the western Indian Ocean.

other amateurs being licensed, he relates that his country is in a state of siege from mainland China, and, until these problems can be solved, ham radio will be in a holding pattern. Otherwise he has the same problems as the rest of us. He can't operate from his apartment, so he has another site — where his neighbors object to his antennas. A typhoon ate his triband beam some time ago, so he's been using a vertical antenna.

A7 — The Sultanate of Oman (located at the southern end of the Persian Gulf) sent a whole delegation led by A7XFE and A7XGX. They brought everyone — wives, children, girl friends, and two SWL (short-wave listeners). They promptly were christened the "green gang" because each had a green shirt with call or affiliation embroidered on the back, along with the emblem of the Sultanate.

The RAST gang accomplished the organization and implementation of the convention. The society is a collection of Thai, European, and American hams. (In general, Thais have two-letter HS calls, while others have three letters.) They were an odd mixture of people and

backgrounds, but boy, what a convention they put on!

The largest delegation was the "boys from Penang." Penang, on the west coast of the Malay peninsula, has become a center for semiconductor assembly by U.S. companies. While the group, 15 in total, came from all over Malaysia, they met in Penang and took the train to Bangkok. It's a long way up the peninsula; the trip took 24 hours. You can't imagine a more tired, more happy, more enchanted group than the boys from Penang. Coming from many cultures and several different religions, they had occupied the train for a day and night, eating and talking ham radio. Arriving in Bangkok, they invaded the convention and continued talking radio with an enthusiasm that led some to believe that 9M2 and 9M6 amateurs never sleep.

Station HS0SEA

An operating ham station is usually a convention feature. The SEANET '77 station was, appropriately, given the call sign HS0SEA. Each attendee was invited to operate the station; a rare country with a special prefix was guaranteed to drive the prefix hunters wild.

The station was located on the fourth floor of the hotel in a special room. The high-frequency gear was Collins, with additions for OSCAR work and an fm transceiver. The antennas were on a roof-mounted tower, so the triband beam was over 31 meters (100 feet) above ground.

The amateurs of Bangkok have experimented with a 2-meter fm repeater, although it was not working during the convention. A few hams were seen to be clutching hand-held transceivers; occasionally they talked into the little black boxes.

A small exhibit area was set up on the same floor as the station. The exhibits were mostly commercial communications equipment, accessories, and services. Even so, the exhibits were very well attended. A special favorite was the Kamchai Electronics stand, which featured a RTTY-to-video converter built by the firm. It was copying a news-service transmission and displaying the copy on a TV screen.

The convention really got under way Friday evening with a cocktail party in the hotel garden. The Erawan Hotel is constructed in a U shape, with the center consisting of a garden, a pool, an outdoor cafe, and a backdrop that looks rather like a temple. We learned the purpose of the backdrop on Saturday night. Just as the party was getting warm, the guest of honor and chairman for the convention, Sribhumi Sukhanetr, arrived.

In Thailand, as in most countries, the telephone company, the post office, and the local equivalent of the Federal Communications Commission are all one government agency. Mr. Sukhanetr is head of this government function which, in Bangkok, is called the Post and Telegraph Department. It's not useful to describe the past difficulties of ham radio in Thailand in this article. Suffice to say, RAST, ably led by

HS1WR, has been working hard for a close relationship with the government, lobbying hard for amateur radio.

When Mr. Sukhanetr agreed to serve as chairman of the convention, a breakthrough of major importance was achieved. Even more important for the future, he's become sufficiently interested in ham radio to join us — as HS1SS. Local television and newspapers covered the opening of the convention, a good public-relations effort by RAST.

The party then moved to the Erawan's banquet hall for formal opening ceremonies. Mr. Sukhanetr led a short Buddhist prayer ceremony consisting of lighting the candles at a small shrine. Then, a toast was made to the young king and queen of Thailand, and the national anthem was played. Thais have deep-felt allegiance to their monarchs.

Mr. Sukhanetr and Col. Chotikul then made their opening statements. This was done in a formal way, with a beautiful young lady bringing the speeches in a white envelope on a silver tray. The ceremonies wound up with S79R opening the net at 1900 local time, as usual. The ham gear was brought down to the

banquet hall so that, whatever else, the net would go on as usual.

When the net was over, the banquet began. Consider the problem of the Erawan's chefs: The convention visitors not only came from many countries, but came representing five of the world's major religions. The meals had to be planned so that no religious dietary laws were violated. The first banquet, and every subsequent meal, was superbly done, and all religious traditions were observed. A native band started, with each musician sitting cross-legged at his wooden instrument. The music consisted of Thai classics. Then, wonderful surprise, two Thai dancers appeared in costumes right off a travel poster, wearing the tall, spiral gold headgear. The girls danced in bare feet, using the classic movements of feet and fingers — truly a sight to behold. Their fingers *must* be double-jointed, for often they lay back to the wrist in the dance movements! As a finale, the girls danced through the hall throwing handfuls of rose petals over the delegates. It's not often you can end your evening in a shower of rose petals.

All convention delegates were allowed to operate HS0SEA. Here, A4XGX from the Sultanate of Oman takes a turn at the mike. Dave is wearing his special "green gang" shirt.



Friends from Taiwan, Republic of China: Frank, W9ZNY and Tim, BV2A. Frank runs a business in Taipei and acts as antenna advisor for BV2A, the only licensed Amateur in Taiwan.

Saturday was taken up with technical talks and net meetings, the standard fare for any convention. The high point of the day was a film by the Japanese delegation of their latest DXpedition. In a hall filled with amateurs holding many of the world's rarest DX callsigns, a DXpedition was the big hit! Between sessions, delegates reviewed the exhibits and took turns operating HS0SEA.

Lunch was set up in the garden and the food tables again overflowed. A large, yellow, carved RAST emblem graced the table. I asked an HS amateur how the emblem was made. He replied that it was carved from butter by the hotel chef. I can only assume there was something lost in the language exchange, or they have a type of butter unknown in the West. In the high noon-time temperature of Bangkok's winter season, the butter we know would have turned to soup in minutes. But, the RAST emblem didn't drip or sag.

Saturday evening was a jewel, an oriental jewel in Bangkok (which claims to be the gem capital of the world). Friday evening (rose petals and all) was called formal, and HS1WR declared that Saturday would be informal, in the Thai tradition. The dinner tables were moved out into the garden. By evening, the winds



Our local temple dog recently ate 5 postmen, your QSL could have been among them. Could you please send a replacement QSL. Thank you in advance — UDO

This unusual QSL card is used by Udo Blaes, HS1ALB, to attract replies.

had blown the heat of the day to Vietnam or somewhere east. The evening was clear, providing a mantle of stars for our "informal" dinner. The meal was excellent, and the service was even better.

After dinner, the native band was back, this time with a large dance troupe. They performed classic Siamese dances from different parts of the country, using the Erawan's temple backdrop. Each dance sequence was performed with a unique set of costumes.

After the entertainment, the prizes and awards, a primary feature of any convention, were scheduled. There were no after-dinner speeches (U.S. convention planners take note!) SEANET sponsors an annual DX contest in which the rest of the world tries to work Southeast Asian countries. Winners of last year's contest were announced, and those who were present collected their awards. There were other special awards. The plaques, which were made in the Philippines, were the most magnificent I have ever seen. See you in the contest next year!

All evening, Kim, HM1KL, (who uses the phonetics "Korean Lady") was getting rave reviews. She came to the dinner dressed in a spectacular, traditional Korean costume.

The RAST officials did a quick huddle and came up with a special award for the best costume. The boys from Penang, who had acted as a cheering section for Kim all evening, went wild with applause. I'm sure that when Kim became interested in amateur radio through her brother, she never dreamed that one night she would be crowned an impromptu Queen of Beauty in Bangkok. Many things are possible through the magic of ham radio.

The prizes

The prizes were next. There were a few door prizes, but the big items were all in the raffle. The raffle grand prize was a new Atlas 210X. All day there had been a long line at the raffle ticket counter, for radio parts are impossible to find in most SEA countries, and manufactured gear is very expensive. Dreams of a 210X were in many eyes.

RAST had a lot of raffle prizes, enough so that every third ticket holder got one. As prize after prize was awarded, the tension mounted.

I bought a ticket but didn't expect to win. In one hundred conventions, I hadn't won anything worthwhile. But I did win something this time: a book on antennas by Bill Orr, W6SAI. All evening I'd been

sitting with Tim Chien, BV2A. Tim had been talking about his antenna problems earlier in the evening. After looking at the book for a minute, I said, "Tim, you take this book. At the moment you need it a lot more than I do." But he handed the book back, with his shy smile, replying, "I won't take it — unless you write something under the cover for me." I did, and when the evening was over, he left with the antenna wisdom of Orr tucked under one arm.

As for the Atlas rig, the gods of Siam smiled on a young man from Malaysia, an SWL (short-wave listener), who hadn't yet been able to earn his ham ticket. Again, the Penang cheering section went wild. It was a grand finale to see the main prize go to someone who could really use it.

Sunday morning was devoted to tours. HM2KL and a few others arose hours before sunrise to look for treasures at Bangkok's famous floating market. You must be up early because the vendors among the boat people will have closed shop and gone by 6 AM. Other visitors took tours of Bangkok. When you visit Bangkok, the "water" tour, the tour of the royal palace, and the temple tour are "musts." For the tourist with money, shops feature Thai silk, gems, wood carvings, ivory, and antiques.

On Sunday evening, Kam, HS1WR, invited the entire convention to his home. You need something more than the average home to hold a convention! Kam provided a bus for those who wanted to make the trip. In talking with a group of U.S. amateurs, Kam had promised them that they could use his station to work stations back home. He allowed that the band was usually open from his station to the U.S. Considering that Kam runs a kilowatt and has a six-element, full-size 20-meter beam antenna on a 140-foot tower, I'm sure he can make his own band openings, any time. **HRH**

Novice, QRP, 200 w, deluxe — good, better, best — \$299, \$369, \$399, \$699, \$869, \$899, \$1069. TEN-TEC has them all. A choice of seven HF transceiver models — a choice of power levels — a choice of operating features (and accessories) for beginner or old timer. Best of all, there's a wide choice of prices to fit every amateur budget.

TEN-TEC "OMNI" TRANSCEIVERS — REALLY CHOICE.

Top of the line. Deluxe in every respect. Deserving of a place in the finest of operating positions. All solid-state 100% duty cycle 200-watt final amp.; 8-bands (160-10 m plus convertible 10 MHz and "Aux" band positions); broadband design for no tune-up; built-in VOX and PTT; built-in Squelch; 4-position CW-SSB filter and 8-pole crystal filter with separate mode switch to permit using all filters in all modes; 2-speed break-in; 2-range offset tuning; optimized sensitivity from 2 μ V on 160 m to 0.3 μ V on 10 m; greater dynamic range (typically better than 90 dB) plus PIN diode switched 18 dB attenuator; WWV at 10 MHz; front panel control of linear/antenna bandswitching; phone patch jacks; "timed" crystal calibrator (on "A" model only); zero-beat switch; SWR bridge; adjustable ALC and sidetone; dual speakers; plug-in boards; "clamshell" aluminum case with black vinyl covering plus warm dark metal front panel; full shielding, optimum size for convenient operation: 5 $\frac{3}{4}$ "h x 14 $\frac{1}{4}$ "w x 14"d. Model 545 OMNI-A with analog dial, only \$899; Model 546 OMNI-D with six 0.43" LED digital readouts, \$1069. Model 645 keyer, \$85, Model 243 Remote VFO, \$139, Model 248 Noise Blanker, \$49, Model 252MO AC Power Supply, \$119.

TEN-TEC "ARGONAUT" TRANSCEIVER—QRP CHOICE.

The challenge and excitement of working the world on 5 watts. And every feature you need: all solid-state; 5 bands (80-10 m); full amateur band coverage SSB/CW; sensitivity less than 0.5 μ V; offset tuning; 4-pole IF crystal filter, 2.5 kHz bandwidth; analog dial; vernier tuning; automatic sideband selection; built-in speaker; 5-watt input to broadband push-pull final amplifier; PTT; full CW break-in; adjustable sidetone volume and pitch; built-in SWR bridge; TVI filter; plug-in boards; small and light weight enough to go anywhere (4 $\frac{1}{2}$ "h x 13"w x 7"d and 6 lbs.). World beating price, too: Model 509 only \$369; Model 210 AC Power Supply just \$34.

TEN-TEC 540/544 TRANSCEIVERS—POWER CHOICE.

200 watts from the bottom of 80 m to the top of 10 m — SSB or CW. No compromise from the leader in solid-state HF technology. Instant band change without tune-up; sensitivity 0.3 μ V; offset tuning; 8-pole crystal-lattice filter; WWV at 10 & 15 MHz; push-pull solid-state final amp.; 100% duty cycle; adjustable ALC with LED indicator; built-in SWR bridge; PTT; full CW break-in; adjustable sidetone pitch and vol.; zero-beat switch in Model 544. Choose the value leading Model 540 with analog dial and built-in 25 kHz pulsed calibrator for just \$699 or the Model 544 with six 0.43" LED digital readouts for \$869. Model 240 160M converter, \$110; Model 262M AC Power Supply with VOX, \$145; Model 252M AC supply only, \$119.

TEN-TEC CW TRANSCEIVERS—BUDGET CHOICE.

The "Century 21" series. Unique. Modern technology with old-fashioned value. Fine performance, reliability, and simplicity of operation, all at low cost. Win raves from novices and confirmed brass pounders alike. All solid-state; 5 bands (80-10 m) full amateur band coverage; receive CW and SSB, transmit CW; sensitivity 1 μ V or less; offset tuning; 3-position selectivity (2.5 kHz, 1 kHz, 500 Hz); 70 w input to push-pull Class C final amp.; broadbanded for no tune-up or resonating; full break-in; adjustable side-tone level; built-in AC power supply. Choose Model 570 with analog dial for only \$299; Model 574 has a 5 LED digital readouts for only \$399.

The choice is all yours when you choose TEN-TEC HF transceivers; see your nearest dealer or write for full details.



WIDEST CHOICE IN HF TRANSCEIVERS: TEN-TEC



ROBOTS IN THE HAM- SHACK

BY
IRV GOTTlieb, W6HDM

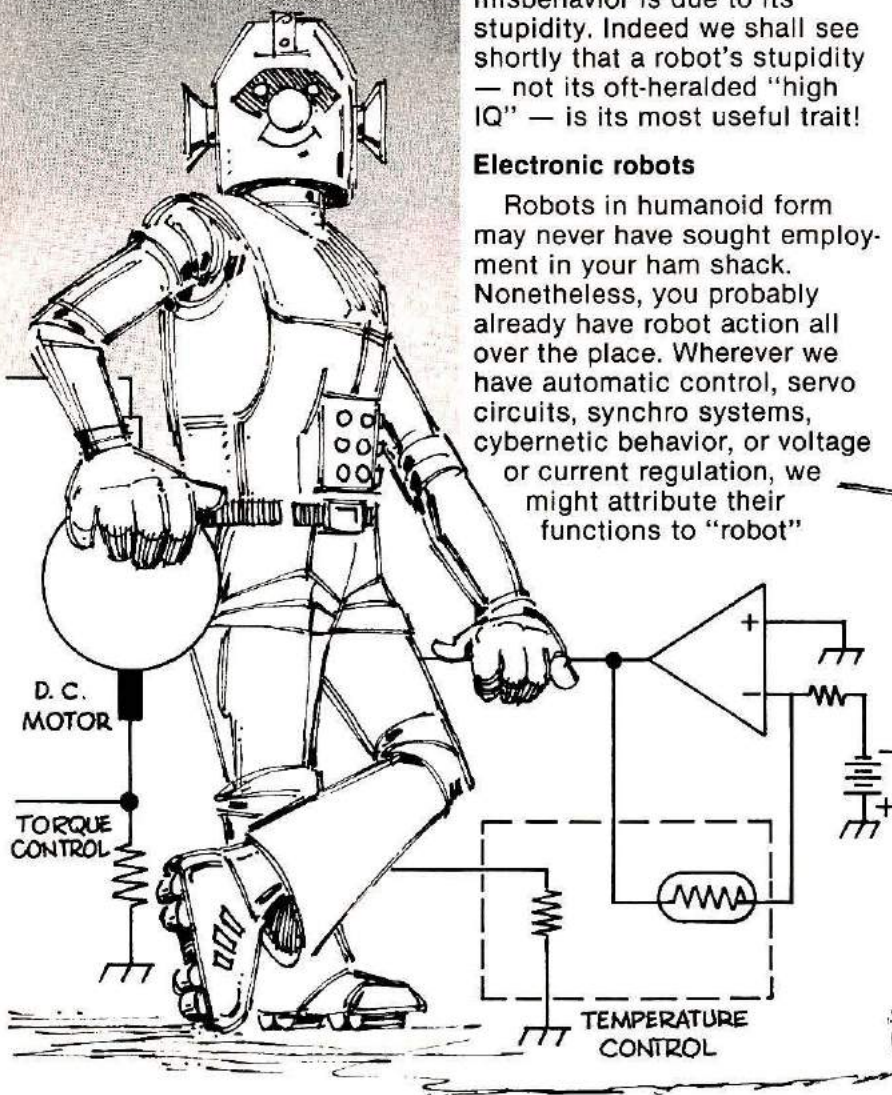

The word "robot" conjures various images and associations. For example, a goggle-eyed electro-mechanical monster programmed to perform tasks considered routine or boring by the flesh-and-blood masters who impart the programs. We tend to think that the critters can execute their programmed functions with a minimum of supervision. We recall that the science fiction writers have given robots abilities and inclinations quite different from those intended by their creators.

If a robot responds to its "instinctive" urge to push by shoving over a skyscraper, rather than by putting a lawn mower or vacuum cleaner through its paces, we say such misbehavior is due to its stupidity. Indeed we shall see shortly that a robot's stupidity — not its oft-heralded "high IQ" — is its most useful trait!

Electronic robots

Robots in humanoid form may never have sought employment in your ham shack. Nonetheless, you probably already have robot action all over the place. Wherever we have automatic control, servo circuits, synchro systems, cybernetic behavior, or voltage or current regulation, we might attribute their functions to "robot"

action. Automatic gain control in the receiver, automatic level control in the transmitter, and your rotary-beam antenna-positioning circuitry are a few examples. And how about voltage-regulated power supplies? The automatic stabilization of dc operating voltage as a function of line and load variations is an application of robot action.

The regulated power supply is the basis of our discussion of robot action. The regulated supply has far more extensive skills than that of merely disciplining its own behavior. At the same time, it exhibits stupidity as mentioned above. Consider the following discussion of its operating principles. It will then be shown how we can gain our own ends by treating this robot-like circuit like the idiot it actually is!

In the simple, voltage-regulated power supply of Fig. 1, the operational amplifier is usually referred to as a comparator, or error-signal amplifier. The regulating action of the overall circuit occurs as a result of its tendency to

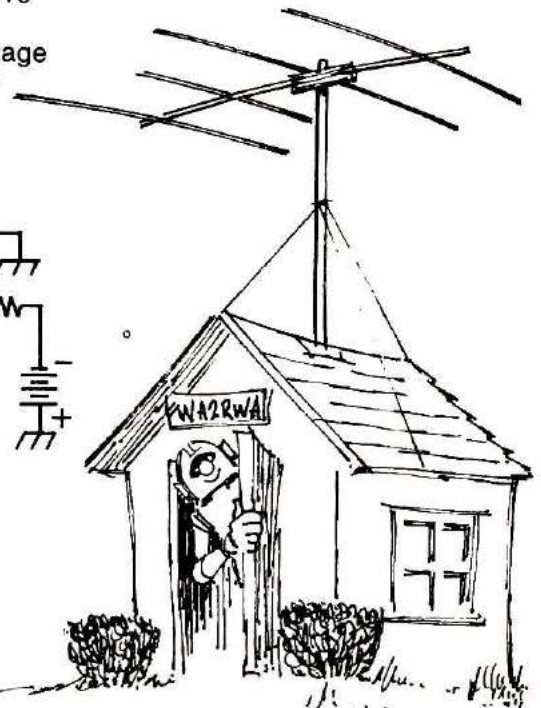

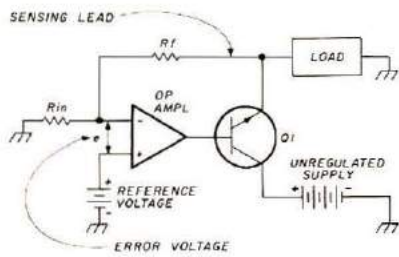

Fig. 1. A simple voltage-regulated power supply. Such an arrangement involves robot action in a "self-disciplined" mode of operation.

minimize the error voltage, e . Ideally, the action is such that e will be nulled to zero as the inverting terminal ($-$) is driven to the same voltage as the non-inverting terminal ($+$). Actually, e will not quite attain zero voltage because the operational-amplifier gain isn't infinite and because inherent voltage and current offsets occur.

Suppose feedback resistance R_f is adjusted to provide a certain regulated voltage across the load. Thereafter assume that resistances R_{in} , R_f , and the reference voltage remain "steady as a rock." Suppose, however that the unregulated supply voltage increases. (Although shown as a battery for simplicity, the unregulated supply is generally a rectifier-filter arrangement operating from the ac power line.)

Any attempt the load voltage makes to increase is counteracted, because the accompanying increase in error voltage, e , causes a reduction of forward bias at the base of the series-pass transistor, $Q1$. In turn, this increases the resistance of the collector-emitter current path, thereby decreasing the load voltage. If the overall circuit amplification is high, the load voltage is restored very nearly to its set value. A similar action takes place if the load decreases.

If the voltage from the unregulated supply drops, or if the load increases, the converse sequence of events occurs, again restoring the load voltage to its set value. Indeed, a continual "hunting" process

occurs. The error signal fluctuates above and below a near-zero value. If we label the connecting wire between R_f and the load as the sensing lead, we can attribute the feedback and regulating action to the fact that the load voltage is "sensed."

Current-regulated power supply

Let's now disconnect the sensing lead from the load and reconnect it as shown in **Fig. 2**. Assuming the added sensing resistance, R , is very small compared to the load resistance, the sensing lead now monitors a small voltage that's directly proportional to load current. The overall scheme thereby becomes a current-regulated power supply. The significant aspect of this arrangement is that the regulator circuit operates in the same way as in the voltage-regulated supply of **Fig. 1**, *i.e.*, it's too stupid to know that the monitored voltage is being produced in a different way.

General-purpose robot

We now find ourselves in an excellent position to apply a bit of logic ju-jitsu, so to speak. In so doing, we'll cause a regulator to perform as a robot in controlling and stabilizing many diverse functions. We accomplish this by setting up the regulator circuit as shown in **Fig. 3**. The salient feature of this arrangement is that the sensing lead is free to be used in various ways. (The output capacitor, C , hitherto omitted

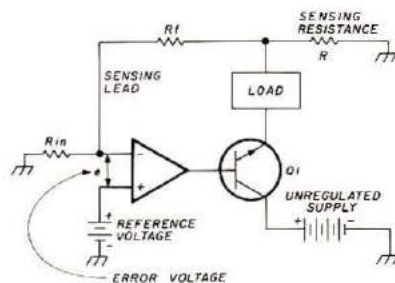

Fig. 2. Current-regulated power supply. A simple change in the sensing-lead connection allows the robot action of the circuit to stabilize load current rather than voltage.

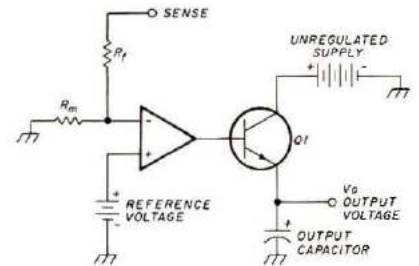

Fig. 3. The general-purpose robot — it's essentially a regulated power supply with remote sensing provision.

for simplicity, prevents feedback instability.) Designating **Fig. 3** as our general-purpose robot, let's explore what we can do by associating the robot with various circuits and systems.

Controlling light intensity:

When the lamp and photocell shown in **Fig. 4** are appropriately connected to our robot, we have a useful scheme for controlling and stabilizing light intensity. Such a technique might be used for projectors, in slow-scan TV, photography, or in display illumination, and also by those who can use photometer methods for measuring rf power. The accuracy of such measurements can be greatly enhanced if a nonvarying standard of illumination is available.

Dc-motor speed control: the speed of a dc motor can be controlled and stabilized with the setup shown in **Fig. 5**. The dc tachometer is mechanically coupled to the dc-motor output shaft. The robot will vary the voltage applied to the motor so that constant tachometer voltage is maintained. Suppose the no-load motor speed is 1000 rpm and the tachometer generates 10 volts. When the motor is loaded, its speed may drop to, say, 900 rpm, whereupon the tachometer would produce only 9 volts. The robot counteracts this situation by increasing the motor voltage sufficiently to restore rotation at 1000 rpm, so that the tachometer again generates 10 volts.

If you now find you've run

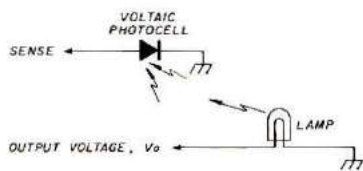

Fig. 4. Control and stabilization of light intensity. When used with the general-purpose robot of Fig. 3, this setup provides both constant and adjustable light intensity.

into a mental impasse, don't be dismayed — it's merely an indication that you've been paying close heed to our robot's operating behavior. It may appear strange that the stabilizing action applies to the sensed quantity (the tachometer output) rather than to V_o , the output voltage. However there's no inconsistency here with the more familiar regulating action of a voltage-regulated power supply.

In the voltage-regulated supply, even though we casually say the output voltage is regulated, the regulator accomplishes this *indirectly* by actually stabilizing the sampled portion of the output voltage — this just happens to stabilize the closely associated output voltage, V_o , also. But in the robot-motor setup, this one-to-one relationship between sampled (tachometer) voltage and output voltage does not exist. Rather, the output voltage has freedom to maintain the tachometer voltage, and thus the motor-speed, constant. Think it over!

In the setup of Fig. 6, the robot maintains constant current through the motor, thereby causing it to exert constant *torque*. The operation of this arrangement closely resembles that of the constant-current power supply of Fig. 2. Here, also, R is a very small resistance, and the sensing lead monitors the voltage drop developed across it.

An interesting feature of these two motor-control schemes is that the robot regulator impresses its "will" on the motors. That is, no matter what the textbooks show for the speed or torque

behavior of the motors, when they are connected in the indicated circuits they exhibit either constant speed or constant torque characteristics. This means that any kind of dc motor can be used — permanent magnet, shunt, or series-wound types will be applicable. However, the manufacturer's horsepower rating must not be exceeded. In most instances the permanent magnet type will be easiest to implement.

Temperature control: Robot control and stabilization of temperature for an oven or heat chamber is shown in Fig. 7. An additional op amp is employed

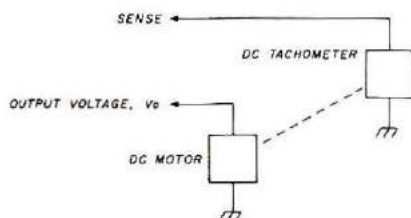

Fig. 5. Control and stabilization of dc-motor speed. Used with the general-purpose robot of Fig. 3, this setup provides both constant and adjustable motor speed.

to convert the resistance of the thermistor to a dc voltage. The robot then senses this voltage and controls the voltage delivered to the heater so that constant temperature is maintained within the heat chamber. The "set" temperature level can be adjusted either at the robot or at the resistance-to-voltage converter.

Between the two adjustments, you can obtain a reasonably wide temperature range. The fan helps distribute the heat uniformly throughout the

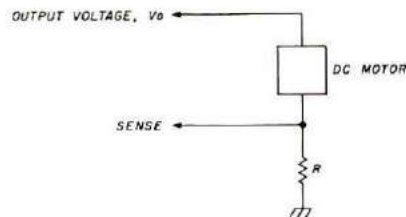

Fig. 6. Control and stabilization of dc-motor torque. Another arrangement that can be used with the circuit of Fig. 3 to provide both constant and adjustable dc-motor torque.

chamber and speeds up the regulating action. A negative temperature coefficient thermistor can be used by interchanging the input and feedback resistances associated with the op amp. Not shown is a small power supply needed for the op amp.

Controlling microwave power: An increasing number of amateurs are experimenting with microwave communications. Although several good semiconductor devices are now available for generating these high frequencies, the traveling-wave tube (TWT) remains an eminently satisfactory oscillator, amplifier, and frequency multiplier. Once-costly hardware packages designed around these tubes are now often available from surplus at bargain-basement prices. And our robot is just as happy controlling microwave power from a TWT as it is regulating motor speed. (Frankly, it doesn't know the difference!)

The power output of a gridded TWT is governed by grid bias in a way analogous to that of a conventional vacuum tube, although the internal mechanisms giving rise to the

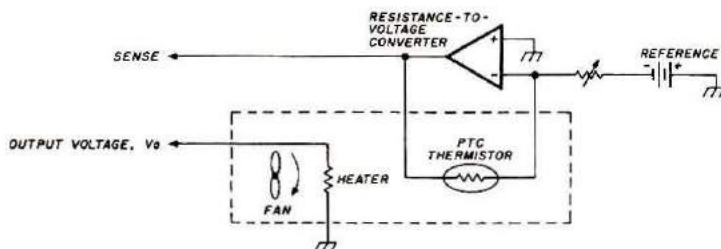

Fig. 7. Temperature control in a heat chamber. When associated with the general-purpose robot of Fig. 3, this setup provides both stabilization and adjustment of temperature.

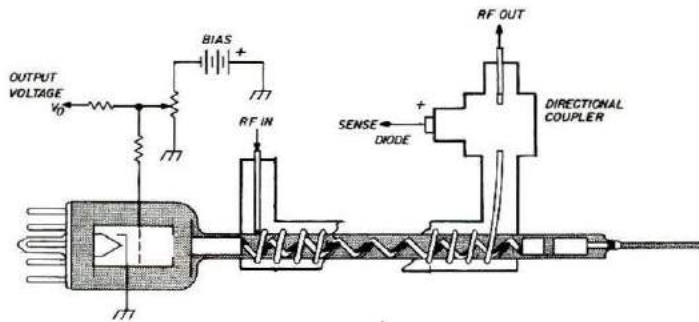

Fig. 8. Control and stabilization of microwave power. Still another use for the general-purpose robot circuit of Fig. 3. When used with the general-purpose robot, this arrangement provides management of microwave power from a traveling-wave tube (TWT).

relationship are somewhat different. In the setup of Fig. 8, the TWT grid is set at some nominal negative bias but can be made more or less so by V_o , the robot regulator output. The microwave output is sampled and rectified by a directional coupler and its accompanying diode. Thus a dc voltage representing the TWT output is available for the robot sensing lead.

From our previous examples of robot action, we can readily see that the proper conditions for stabilization and control exist in this scheme. Indeed, the same basic idea is applicable to conventional tubes operating at lower frequencies. For example, such output stabilization might merit consideration for signal generators used for test and calibration purposes. Or, perhaps more effective regulation of oscillation amplitude in the vfo could be

attained with this method rather than by the lamp filaments often employed. (Amplitude stabilization of a vfo leads to improved frequency stability.)

Bench-type regulated power supply: The regulator portion of a typical bench-type regulated supply is illustrated in the simplified circuit of Fig. 9. Strapping options are commonly provided so that remote sensing of the load can be implemented. Obviously, the sense terminals can be used for various robot control techniques. Inasmuch as both plus and minus sense terminals are available, even greater flexibility prevails than with the op amp regulators shown in the previous robot applications. (Only the plus sense-terminal was available in those examples.)

Three-terminal IC regulators: Some of the three-terminal

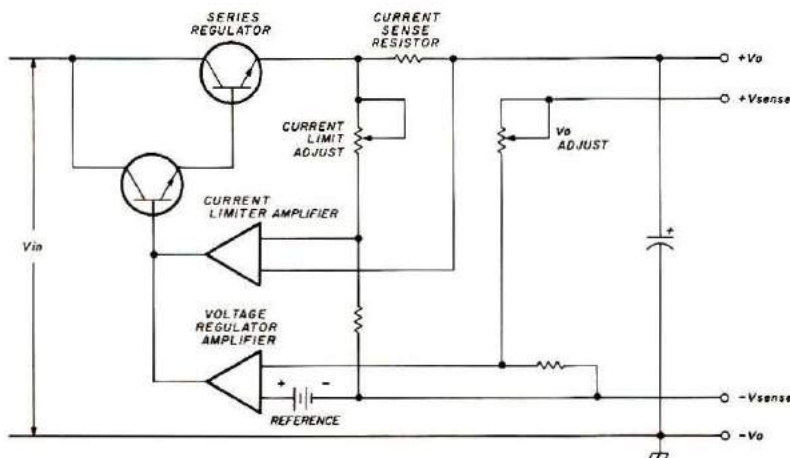

Fig. 9. Simplified circuit of a typical bench power supply. The two free sense terminals provide exceptional flexibility for implementing robot-control techniques.

regulator ICs can also be used as robot controllers. Although not as amenable to circuit analysis as the regulated supplies with separate sense terminals, the overall operation is essentially similar. Fig. 10 shows a popular three-terminal regulator in a robot arrangement that performs the same function as the setup of Fig. 4. The No. 1 terminal is ordinarily the ground or common connection when the IC is used as a simple voltage regulator. The fact that terminal No. 1 may be used for sensing can be gleaned from various circuits in

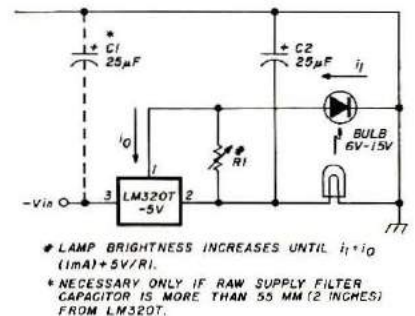

Fig. 10. Control of light intensity with a 3-terminal IC regulator. This setup performs similarly to that of Fig. 4. (Courtesy National Semiconductor Corporation.)

which a dc voltage is applied to this terminal to change the "fixed" output voltage. However, not all three-terminal regulators will work equally well in this manner. In general, those which are prescribed as adjustable types are better bets for robot applications.

Conclusion

Sufficient information and an adequate number of examples have been given to enable the experimentally inclined ham to get the gist of robot control techniques. Surely, other novel and useful applications will reward the imaginative mind. In addition to the electrical and optical feedback paths shown, you might want to work with rf radiation, acoustic energy, and various transducers actuated by temperature, mechanical displacement, or low-frequency induction fields.

HRH

Amateur Radio for you and me.

The name of the game is communicating with your fellow man through Amateur Radio, and the cards are all winners. You can turn the trick by operating mobile, by using a handheld vhf unit, talking through a satellite, or by working for some of the hundreds of awards from all over the world. Other hidden aces include radio-teletype, television, experimenting, designing your own antennas, handling messages, or dozens of other fun ways to play the game.

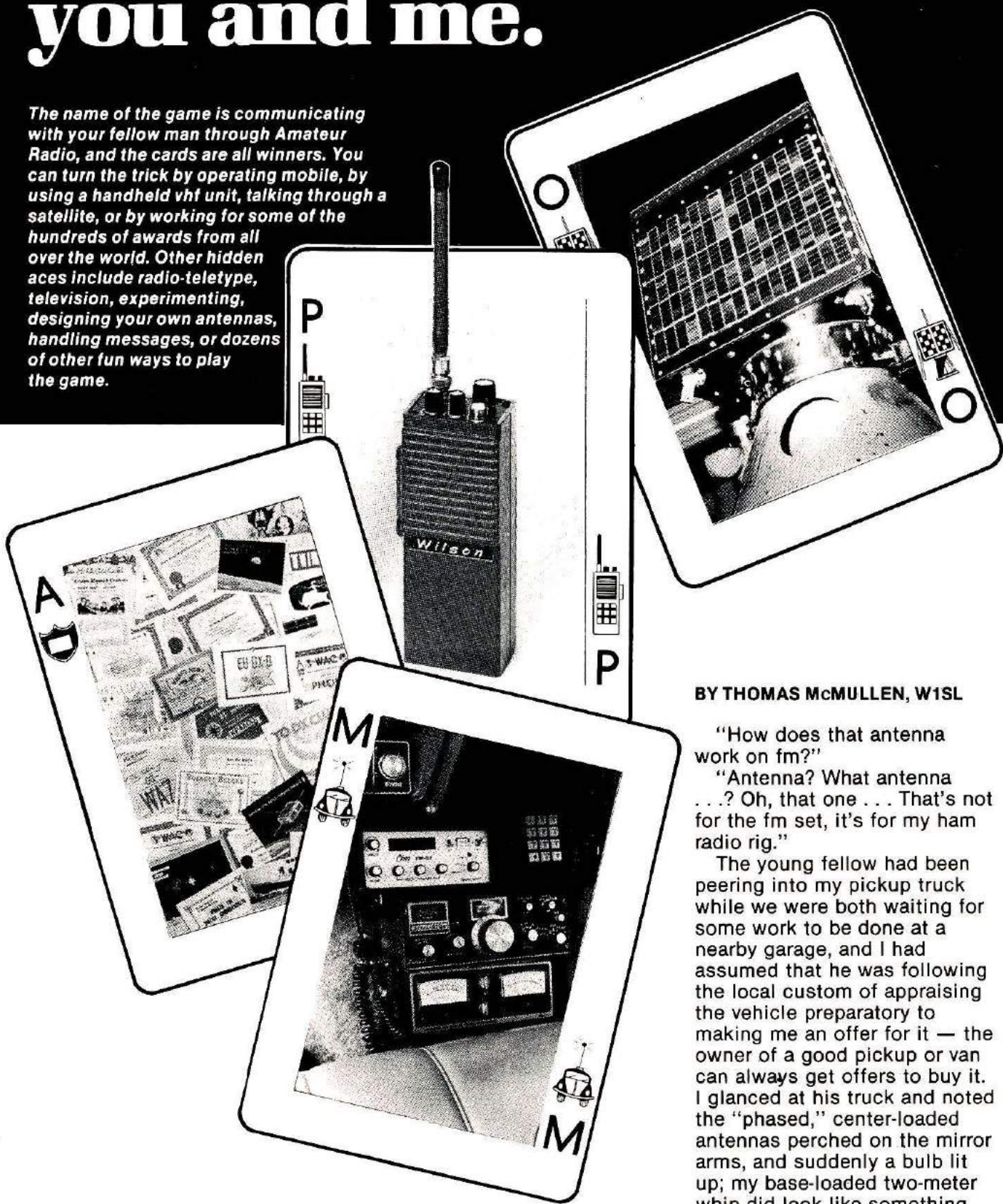

BY THOMAS McMULLEN, W1SL

"How does that antenna work on fm?"

"Antenna? What antenna . . . ? Oh, that one . . . That's not for the fm set, it's for my ham radio rig."

The young fellow had been peering into my pickup truck while we were both waiting for some work to be done at a nearby garage, and I had assumed that he was following the local custom of appraising the vehicle preparatory to making me an offer for it — the owner of a good pickup or van can always get offers to buy it. I glanced at his truck and noted the "phased," center-loaded antennas perched on the mirror arms, and suddenly a bulb lit up; my base-loaded two-meter whip did look like something

for CB, but he couldn't spot a rig in my car. The natural conclusion was that I was using the whip for fm broadcast reception.

"What kind of set?" he went on.

"A Kenwood TR-2200." Blank expression . . . the name didn't register.

"How many channels?"

"Twelve."

"I didn't know they made any with only twelve. I still got a 23, but I'll probably get a 40 pretty soon. How far can you get with that Kenwood CB?"

"No, not CB, Amateur Radio. I can cover a pretty good part of New England by talking through Amateur repeaters."

"Yeah? That sounds great. Where's the rig — I didn't see it. And what's this Amateur Radio stuff?"

"I left the rig at home for security, and Amateurs can talk all over the world, to other Amateurs."

Another blank stare. I felt compelled to reach him, somehow. No rig . . . no demonstration. Oh, well . . . I happened to glance toward the back of the garage where a radio was attempting to provide background music to accompany the thud of hammers on tires and wheel rims, the whine of electric drills, and the thump of the air compressor. Aha! A not-too-old Grundig a-m/fm/shortwave set.

"Hey, Eric, did you ever try that radio on short wave?" I asked the shop owner.

"Yeah, when I first got it, but I never could get Sweden on it, so gave it up."

"Mind if I try it?"

"Help yourself."

Crossed fingers. I hope it'll hit a ham band, and hope the band is open to some place interesting. Yep, it has the 19-meter broadcast band marked on the dial. Success! The 20-meter band is there, barely as wide as a whisker on this tuning system, and full of ssb. Oh-oh! I forgot about that. I

turned to the inquisitive visitor, "You've heard sideband on your CB, haven't you?" He nodded. "Well, this is Amateur sideband, and the signals are probably from somewhere in Europe." Right on cue, a heterodyne from someone tuning up provided a carrier and a voice came through loud and clear: "CQ CQ CQ, THIS IS FRANCE, F9FT IN REIMS CALLING CQ C . . . The carrier went away, and so did the voice from France.

"Hey, that's neat," said my CB friend, "Get him again, I know French."

"I wish I could, but this set was made for entertainment and commercial broadcast stuff — it just doesn't work well with ssb signals. If I were at home we could talk to that French station."

"Yeah? Legally? You wouldn't get a visit from Uncle Charlie?"

"That's right. Amateurs do it all the time."

"Well, I'll be . . . Hey, tell me more."

How do you sum up a thing as interesting as Amateur Radio in the relatively short time my CB friend and I spent waiting in that service garage? There's just so much going on, so many people involved in so many different pursuits that the mechanic could have rebuilt both our trucks before I got it all told. I guess the first step is to talk about the people.

Who?

Amateur Radio takes in people from all parts of the world, all walks of life, and with almost every interest you can think of. Do you have to be a technical whiz to be a ham? No way! Anyone, and I do mean anyone, can become a ham with just a bit of study and practice.

Age? There's no limit. Some Amateurs are as young as 7 or 8, and others are at the opposite end of the time scale. I recently got a letter from a

"new" ham who was 82. Handicaps are no hindrance, either. In fact, Amateur Radio brings the world right to the chairside of the shut-in. I just read a story about one Amateur who was so crippled with arthritis that he operated his rig by blowing on a special air-activated switch his buddies rigged up for him. He talks to the world and loves it!

You've heard of this thing called Morse code — I know because I saw you frown when you thought of it. Relax, it's not that bad at all. A few minutes a day with a cassette player and a stack of tapes and you'll have it made. A fellow I know learned the code well enough to pass the test just by listening to it in his car every day as he drove to work. It's easier than most languages; you don't have to worry about inflections and glottal stops and all those stumbling blocks that you hit when you want to learn French, Russian, German, or whatever. It may surprise you to learn that even people who cannot hear have mastered the Morse code. They learned to "feel" it vibrating against their fingertips from a special speaker hooked to their radio! So, when I say there are no limits set by age or ability, that's what I mean.

Something for everyone

One of the fascinating things about Amateur Radio is that you can find kindred souls to communicate with, no matter what your interests are. It covers the whole globe, and embraces so many people that you're sure to meet other hams who will be both interested and interesting. Are you into personal computers? Thousands of Amateurs are, and they often gather on the air for "brainstorming" sessions, comparing hardware and software and ideas.

How about controlling model planes, boats, or autos by means of radio signals? Ama-

teur Radio is a natural for that — hundreds of model fliers have found that the lack of crowding on the Amateur vhf bands makes possible hours of interference-free air time for their pet craft. Do you go for chess? There are plenty of other hams who do, and they often conduct games and tournaments right over the air — it's far faster than playing a game by mail, and the winner can usually count on a challenge from another ham who happened to be listening in.

Speaking of listening in — there are hundreds of "networks" of Amateur stations on the air every day, and if you'll listen to our 20-meter (14-MHz) band any weekend you can hear some intriguing communications. There is a Maritime Net, with stations calling in from ships at sea; a Post-Office Net, populated by Amateurs who work for, or have an interest in, the Postal Service; an RV Net for people who have campers, trailers, or self-contained recreational vehicles; and many, many more on-the-air get-togethers where Amateurs of similar interests swap information or just chat.

In addition to these "hobby within a hobby" networks, there are hundreds of stations that get together every night to pass messages along. They range from local coverage, such as a town, county, or area, up to continent-spanning hook-ups. Messages handled are, for the most part, greetings and relatively non-vital personal communications, and are both practice in the technique of handling messages and a form of acquainting the Amateur's neighbors with some of the good work we do. When a

disaster strikes, such as a tornado, flood, fire, or earthquake, the Amateurs are ready and can put their skills to use immediately. Often an Amateur station is the first to get the word out in case of trouble, and teams of Amateurs handle messages relating to emergency supplies, medical aid, and the welfare of those in the afflicted area — sometimes for several days, until normal communications are restored. A California Amateur has just written a book about this helping-hand type of operation performed by Amateurs all over the world,* and there is even a monthly newspaper that reports these stories on a regular basis.†

No Language Barrier

In spite of the fact that Amateur Radio covers the whole world, embracing more than 300 countries, you'll find no language barrier. Whether you talk to Zaire, India, Japan, Nepal, Ecuador, Argentina, France, Poland, Hungary, or Russia, you'll understand the basic information they exchange with you. It's all part of a "universal" language that

Amateurs have developed; an offshoot from the commercial radiotelegraph services. The vital parts of the exchange are in the form of coded signals and abbreviations. A group of three letters, such as RST, followed by numbers, can tell you how strong and readable your signal is, and its quality as well. A list of coded signals, each starting with the letter Q, covers most of the things one ham would want to tell another — for example, the signal QTH would be sent to mean "my location is . . .," and the signal QSB would be the same as saying "your signal is fading in and out." These messages can be sent either by voice or by Morse code, and represent a universal language among Radio Amateurs and many commercial radio operators everywhere.

Equipment

Is Amateur Radio expensive? Not necessarily. It depends upon what you want to do with it, and how much you feel like spending. By doing a bit of careful shopping and shrewd bargaining, you can pick up used equipment at less than



If you are in school, or live where a home station just isn't practical, then a club station may be the way to join the fun of Amateur Radio. Here is the Amateur Radio Club station at Michigan State University being given a workout by one of its student members. Many clubs provide help for newcomers who want to study for their license exams, and some of the stations (and operators) take part in contest operation with fierce, but friendly, competition.

**Radio Angels*, by Paul Jerome Stack, WA6IPF; available from Ham Radio's Bookstore, Greenville, New Hampshire 03048, for \$4.50 plus \$1 shipping and handling.

†*Worldradio*, 2120 28th Street, Sacramento, California 95818; 12 issues for \$6.75.

\$200 for a basic station that will reach any part of the world; you might even find some gear for under \$100. Do-it-yourselfers can buy kits costing from \$100 or so up to nearly \$1000. New equipment prices vary widely (from \$200 to \$2000), just as in any other hobby. But, you don't have to spend that kind of money for a station that you can have a lot of fun with. Many Amateurs have talked to every state in the U.S. while using homemade rigs that put out about as much power as a CB handheld unit — and they've gotten award certificates for doing so! At the other extreme, some Amateur stations have transmitters that use the full legal limit of 1000 watts, and have monster antenna arrays to go with the equipment. That's one of the beauties of our great hobby — you can mix and match to suit yourself. You're not stuck with one power level or one type of antenna. Nowhere else can you find such variety.

Take it with you

It has been said that ours is a mobile society, and you'll find that Amateur Radio has

Thanks to the many Amateur-built and maintained repeaters, a ham on foot can enjoy making contacts over distances that can range up to 50 or 75 miles. This operator is carrying a 5-watt rig that keeps him in touch with mobile or home stations no matter where he hikes.



kept pace with it. Amateurs who commute to work, or who travel a lot for business or pleasure, usually take a small rig with them. Most often, it's a vhf (2-meter) hand-held or portable unit, and they use it to talk to other Amateurs who have similar equipment. A recent development called a repeater allows them to talk over distances of 30, 50, or even 100 miles from their car or from their office, hotel room, or at the beach. The repeater is a special station that receives a weak signal and amplifies it, then retransmits it again.

Portable equipment is not limited to the vhf bands, however. Many boating enthusiasts have equipment for the Amateur bands aboard as they set off for a weekend sail, a race, or a cruise to far-away places. They've found that this form of communications allows them to develop friendships that last much longer than the voyage.

Then, too, hikers and campers take Amateur Radio with them. Some have gear

installed in their campers or vans, and some take small rigs in their knapsacks. It is not unusual to talk to a backpacker on top of a rugged mountain where he has fired up a rig no larger than a couple of sandwiches, hooked to a piece of antenna wire that seems no heavier than a spider's web. Yes, indeed, Amateurs are an active bunch.

There's A Satellite In Your Future

How would you like to join the Space Age? It's easier than you think. Radio Amateurs can talk through no less than four satellites that have been placed in orbit for their own use. Two of them were sent aloft by the Americans, and two more by the Russians.

These satellites orbit the earth several times a day, with an average interval of about 100 minutes between them. As the earth turns below the orbital paths, each of the satellites will come within range of your Amateur station two or three times each day, so there's

OSCAR 7	
Saturday, April 7	
East (VA, PA, OH, MI)	0017 GMT (7:17 PM EST)
West (TX, CO, MT, UT)	0210 GMT (8:10 PM CST)
Sunday, April 8	
Midwest (FL, MS, IA, WI)	0109 GMT (8:09 PM EST)
West Coast (CA, OR, WA, AK)	0305 GMT (7:05 PM PST)
OSCAR 8	
Tuesday, April 10	
New England	0045 GMT (7:45 PM EST)
Midwest (FL, MS, IA, WI)	0225 GMT (9:25 PM EST)
West Coast (CA, OR, WA, AK)	0410 GMT (8:10 PM PST)
Friday, April 20	
East (VA, PA, OH, MI)	0135 GMT (8:35 PM EST)
West (TX, CO, WY, MT)	0315 GMT (9:15 PM CST)

Fig. 1. Some representative orbits of the Amateur Radio satellites OSCARs 7 and 8 during the month of April, 1979. The path will be over the states listed, and will be heard first in the states at the southernmost end of the path. The satellites will be travelling from south to north, and will take 10 to 15 minutes to traverse from the first state listed to the last (with the exception of Alaska — it'll take several additional minutes to get that far north). Amateurs transmitting through the satellites can be heard on the 10-meter band, between 29.4 and 29.5 MHz on the days listed. On other days, the output of the spacecraft will be near 146 or 435 MHz. For more information on Amateur satellites, write to AMSAT, Radio Amateur Satellite Corporation, P.O. Box 27, Washington, DC 20044.

plenty of chance to try your hand at talking through them. You can do it with a comparatively modest station, too. Some low-powered equipment for one or more of our very-high-frequency bands (such as two meters), plus a simple antenna which you can make or buy, and you're ready to talk to other Amateurs anywhere within range of the satellite's signal. If you're curious about how they sound, how well you can receive them, tune a short-wave receiver to the upper part of the Amateur ten-meter band, around 29.4 to 29.5 MHz (see Fig. 1). A few feet of wire strung around the room or hung out the window, will work as an antenna when the satellite is nearly overhead on its way by. The ten-meter band serves as one of the "down-link" frequencies for the satellites — Amateur stations can talk "up" to the "birds" on either 145 MHz (two meters) or 435 MHz (the 70-centimeter band, in the "ultra-high-frequency" world).

To reach the satellites when they are not directly overhead, Amateurs have built antennas which will pick up signals from hundreds of miles away — and will transmit back to the spacecraft at the same distances, of course. These antennas are less complicated than most of the ones people use for TV reception, and they can be rotated and tilted to follow the path of the satellites as they go by.

The satellites launched by the United States are called OSCAR, for Orbiting Satellite Carrying Amateur Radio. The 7th and 8th ones put up are still there, doing their thing after many months in space, and show every possibility

of continuing for years to come. Amateurs in Canada, Germany, Japan, Australia, and the United States combined their efforts to build and test the satellite

lites, and they into orbit as "piggy-back" packages on one of NASA's rockets.

Another OSCAR is being built, and more are in the planning stage.

Russia has just recently launched two Amateur satellites at the same time, and named them RS1 and RS2. Both were part of a larger payload sent aloft on huge rockets for other purposes, as were the American

OSCARs. All four satellites have rechargeable batteries and solar cells to keep them in top shape to operate the transmitters and receivers which relay the Amateur signals all over the world. Each satellite has an elaborate control system to turn various circuits and functions on and off, and each sends coded signals about the bird's health back to earth — signals that tell us how hot or cold it is inside the satellite, what the batteries are doing, how much current the equip-

ment is using, and so on.

These signals are called telemetry, and have been used by many schools to demonstrate space-age physics in the classroom. By proper interpretation of the signals you can tell exactly where the satellite is, how fast it is moving, when it will appear again, how much sunlight it has received, and, by very precise measurement of distance and speed, you can even predict when its orbit will decay and allow it to enter the atmosphere and burn up (it'll be a long time coming, though, so don't wait up nights for it to happen).

So, there are plenty of scientific experiments you can do with the OSCAR and RS satellites, but the most important one is much more personal — you can talk to your fellow man and get to know him.

The Experimenter

So far, I've told you about using Amateur Radio to communicate with other Amateurs, for fun or in emergencies. There's another side to this great hobby that you shouldn't overlook — the experimenting. It's a natural for anyone who wants to try his hand at designing circuits, developing a piece of equipment, or just plain investigating "how does that work?" Did you ever get really interested in a lab experiment in school, and, just

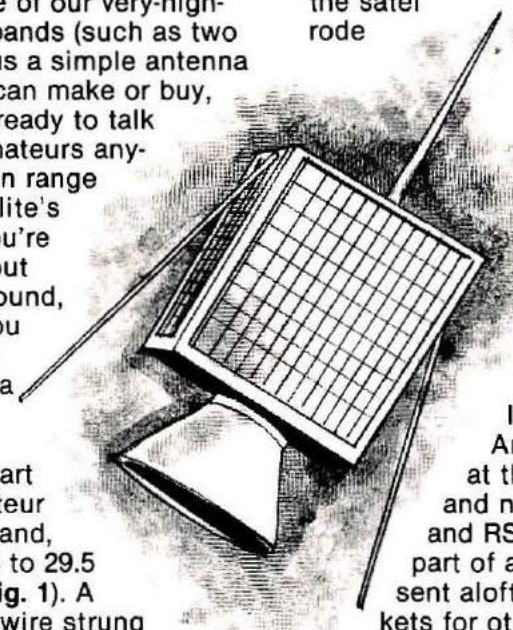

Amateur Radio equipment does not have to be fancy, nor does it need to cost a lot. In addition to buying used equipment, and building kits, you can make your own transmitters and receivers, as shown here. The unit at the left is a 50-watt transmitter, described in a three-part series that started in July, 1978; the two smaller units are a receiver and the power supply/converter for it, from the February, March, and April, 1979, issues of *Ham Radio Horizons*.

as you thought you had a grip on things, your instructor said, "Okay, that's it for today. Clean it up and store it." Well, thousands of Amateurs have their own labs at home. Some build equipment from kits or from "scratch," and others try out ideas they've read about or dreamed up on their own. The only time limit is your endurance (or the patience of your family), and the possibilities are limited only by your imagination.

Can something useful come of such home-style experiments? You bet! Many of today's electronic circuits were first proved by Amateur experimenters, trying a pet circuit in the quiet of their hamshack or basement workshop. Other circuits have been improved upon by the ham who felt that "there must be a better way," or, "gosh, that thing costs a fortune — I wonder if I could get the same performance at a lower price." Additionally, there's no way of knowing just how many solutions to problems at his work were triggered by an experience or a bit of

knowledge picked up from a ham's tinkering and operating pastime.

Talking pictures

Amateur communications is not limited to Morse code, or to talking, for that matter. Hams can send pictures to each other. Many of our bands permit sending photographs on a worldwide basis using what we call "slow-scan television." This is a system, developed several years ago by an Amateur, in which a complete picture is sent over the airwaves every eight seconds. There are networks of hams from many countries who meet on a regular basis every week to exchange favorite photographs, a "live" shot of themselves at their desk, or a live or still shot of their family or friends. They exchange information about other stations that may be joining them soon, or about new equipment or techniques to improve the quality of their signals.

On a more local basis, Amateurs can send regular

"fast-scan" pictures, just the same as you receive on your TV broadcast set. Some of them have quite elaborate equipment and "studio" setups, and use modified commercial TV receivers to pick up signals from Amateur TV enthusiasts. They have recently developed a "repeater" method of relaying their pictures to gain coverage of large areas, such as New York City or Washington, D.C. and suburbs. This works in the same way as the repeater for the portable and mobile units used for voice communications — each Amateur directs his TV signal toward a tall building or tower where a receiver picks it up, amplifies the picture information, and retransmits it at a power level that will reach dozens of miles.

Interested?

I feel that I've only skimmed the surface of what you can do as a Radio Amateur, but I hope you get enough of the idea to become interested in joining us. It's not hard, really, and the rewards are great. There are all sorts of study aids available to help you along. Cassette tapes for your Morse code practice, study guides and handbooks for the Rules and Regulations, basic theory, operating procedures, and even books to help you build your own equipment if that's what turns you on.

A large section of our Bookstore here at Ham Radio is devoted to helping you get started in Amateur Radio, so if you would like to know more, just drop me a line — Tom McMullen, *clo Ham Radio Horizons*, Greenville, New Hampshire 03048, and tell me you want to become a ham. I'll send an information package out to you right away. The package will tell you what to start with, what forms you'll need, and will include a catalog of dozens of interesting books that deal with the "hobby with a future" — Amateur Radio.

HRH

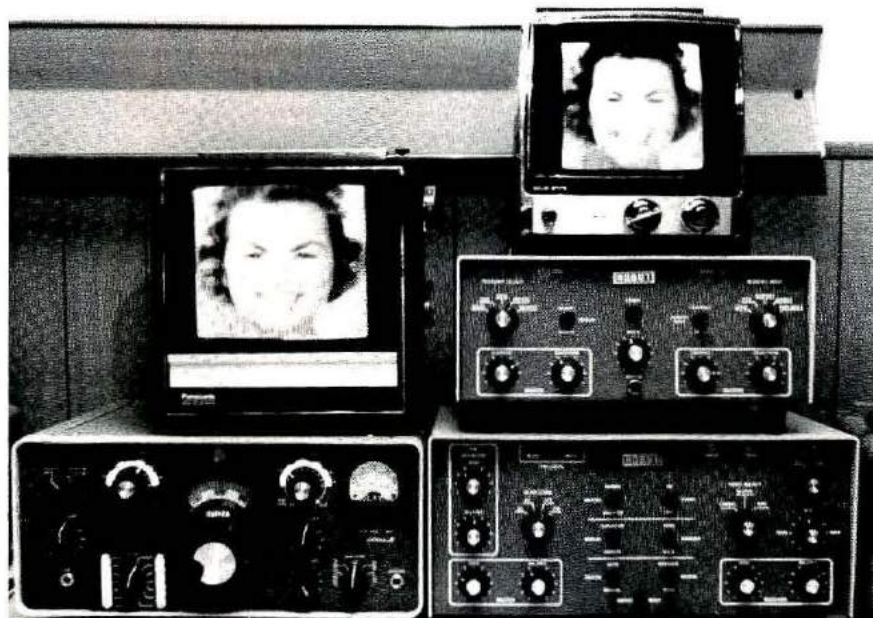

You can meet people in all parts of the world by Amateur Radio, and you can swap photographs with them as well. This is called slow-scan television (SSTV), in which you transmit or receive a complete picture once every eight seconds. The station shown here belongs to Bill DeWitt, W2DD, a well-known SSTV Amateur and author of many articles on the subject, one of which appeared in the November, 1977, issue of *Ham Radio Horizons*.

UPGRADE TO AN EXTRA CLASS SIGNAL

ATB-34

THE COMPLETE 3 BAND ANTENNA

BY



Cushcraft

IN STOCK WITH YOUR LOCAL DEALER

IN CANADA:

SCOTCOMM RADIO LTD. - 4643 Levesque Blvd. - Chomedey, Laval, Quebec

WORLDWIDE:

MAGNUS - 5715 North Lincoln Ave. - Chicago, Ill., U. S. A. 60659

CORPORATION

P.O. BOX 4680, MANCHESTER, N. H. 03108

10-15-20 METERS



ATV-3 Cushcraft's ATV-3 multiband vertical provides low VSWR operation for both SSB and CW on 10, 15, and 20 meters. Matched to 50 ohms; built-in connector mates with standard PL-259. Stainless-steel hardware is used for all electrical connections. The ATV-3 is a compact 166 inches (4.2 meters) tall. Rated at 2000 watts PEP.

10-15-20-40 METERS

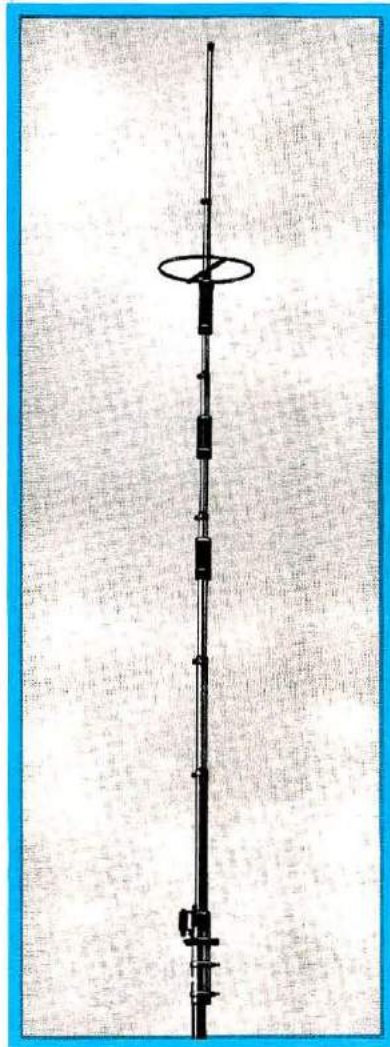

ATV-4 The Cushcraft ATV-4 four-band vertical antenna has been optimized for wide operating bandwidth on 10, 15, 20, and 40 meters. SWR is less than 2:1 over the CW and SSB segments of 10, 15, and 20. The 2:1 SWR bandwidth on 40 meters is approximately 240 kHz; may be quickly and easily adjusted to favor any part of the band. Coaxial fitting takes 50-ohm transmission line with PL-259 connector. Overall height, 233 inches (5.9 meters). Rated at 2000 watts PEP.

10-15-20-40-80 METERS

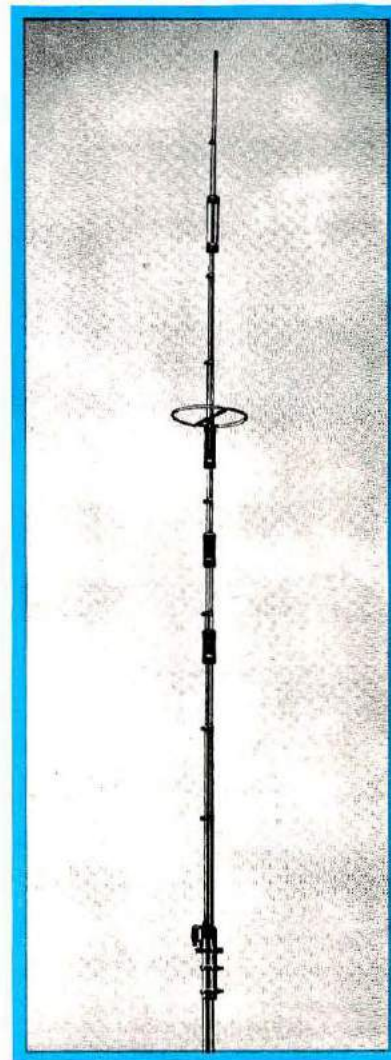

ATV-5 The ATV-5 trapped vertical antenna system has been engineered for five-band operation on 80 through 10 meters. The high Q traps are carefully optimized for wide operating bandwidth: 2:1 SWR bandwidth with 50-ohm feedline is approximately 1 MHz on 10 meters; more than 500 KHz on 15 and 20 meters; 160 kHz on 40 meters; and 75 KHz on 80 Meters. Instructions are provided for adjusting resonance to your preferred part of the band, CW or SSB. Built-in coaxial connector takes PL-259. Nominal height, 293 inches (7.4 meters) Rated at 2000 watts PEP on all bands.

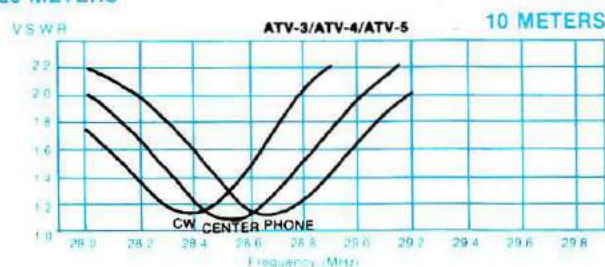
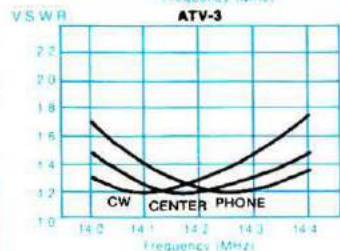
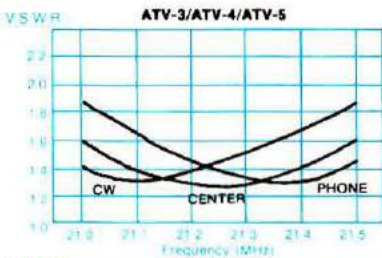

TYPICAL
V.S.W.R.



cushcraft
CORPORATION

HF VERTICALS

Cushcraft's new multiband vertical antenna systems have been optimized for wide operating bandwidth and provide the low angle of radiation which is essential for long-haul DX communications on the high-frequency amateur bands. The high Q traps which were designed especially for these verticals use large diameter enamelled copper wire and solid-aluminum air-dielectric capacitors; the trap forms are manufactured from filament-wound fiberglass for minimum dielectric loss and high structural strength. High strength 6063-T832 aluminum tubing with 0.058" (1.5 mm) walls is used for the vertical radiator. The massive 2 inch (50 mm) OD double-walled base section and heavy-duty phenolic base insulator ensure long life and durability. For maximum performance with limited space, choose a Cushcraft multiband vertical; all models may be roof or ground mounted on a 1 1/4" - 1 1/2" (32 - 48 mm) mast. A good ground system is recommended for maximum performance.



Understanding and Using Propagation Information

BY THOMAS R. SUNDSTROM,
W2XQ

"What's the band like?" "Are you hearing any DX? The bands are dead." "Can you hear anything?" "Did my antenna fall down?" Do these questions sound familiar? On the high frequencies you'll probably hear them echoed by DX hunters prowling the ssb or CW bands.

Have you wondered how you can tell what the band conditions are without tuning through the phone and CW segments looking for stateside or DX stations that might give a clue as to what's going on? There's an easier way to determine the state of propagation on the high frequency bands.

Propagation

High frequency communications that cover any distance depend upon skywave signals reflecting off the ionosphere. The state of activity in the several ion layers — the D, E, F₁ and F₂ layers — determines whether a signal on

any given frequency will be reflected to earth.

Propagation forecasts are available in a variety of forms. Long- and short-range forecasts, some detailed and some general, predict the maximum usable frequency (MUF), above which signals will not reflect, and the approximate time of day during which certain areas of the world will be open for signal paths.

This article recaps some of the various sources of information and explains how to use that information.

Magazines

Propagation forecasts in the various magazines are usually written from 45 to 60 days in advance of the publication date. The forecasts are based on extrapolations of current data on sunspots and other measures of solar activity.

Forecasts can't account for short-run variations of solar activity. Longer-range solar

disruptions can loosely be forecast by extrapolating the rule-of-thumb 27-day rotation of the sun. The propagation columns include *Horizons'* "DX Forecaster," *QST's* "How's DX?" charts, and *CQ's* "Propagation."

Other sources

A biweekly newsletter is available on a subscription basis; it offers detailed propagation forecasts. For further information, write Mail-A-Prop, Box 1714, Silver Spring, Maryland 20902.

Mail-A-Prop also supplies tapes for the recorded telephone Dial-A-Prop: 516-883-6223. Although not a toll-free call, the message is available twenty-four hours a day seven days a week. The message tape is usually changed each Tuesday morning before noon Eastern time.

The Ham Radio Publishing Group publishes the weekly newsletter *HR Report*; propagation information

appears on page 4 of each issue. In addition to the useful propagation information, this newsletter covers current news of amateur activities and regulations, new equipment coming on the market, personalities in the news, and DXpedition activities. Once a month an updated calendar of activities is included. See the ad in this issue for additional information.

The American Radio Relay League, through its station W1AW, runs a weekly propagation bulletin in its daily airing of news bulletins and OSCAR schedules. Check a recent copy of *QST* for a current schedule of the phone, CW, or RTTY bulletins.

WWV geophysical alerts

The problem with even a weekly forecast is that it can't account for daily or hourly variations in solar activity. The closest thing we have available to us is a daily report, with a portion of the message updated every six hours.

WWV, the National Bureau of Standards time and frequency

station, broadcasts from a location near Boulder, Colorado, on frequencies of 2.5, 5, 10, 15, and 20 MHz. Among its many services are the geophysical alert messages aired at 18 minutes past the hour, 24 hours a day, 7 days a week.

Unlike the information sources described earlier, which are tailored to the radio amateur, the geophysical alert message is designed for the scientific community at large.

Let's look at a typical message, broadcast at 2018 GMT on July 22, 1978:

"Solar terrestrial indices for 21 July follow: solar flux 136 and A index 5 . . . repeat . . . solar flux 136 and A index 5. The Boulder K index at 1800 UT on 22 July was 2. Solar terrestrial conditions for the last 24 hours follow: solar activity was moderate to low; the geomagnetic field was quiet. A solar flare occurred at 1857 UT 21 July. Forecast for the next 24 hours follows: solar activity will be low; geomagnetic field will be unsettled to active."

The message is changed each day at 0000 GMT (or, Universal Time). The first part of the message gives the solar

flux from Ottawa at 2695 MHz, the A index value at Fredericksburg, Virginia, and the K index value at Boulder. The K index is updated every six hours, at 0000, 0600, 1200, and 1800 GMT. The second part of the message recaps the previous day's solar and geomagnetic activity, and a forecast for the current (GMT) day.

Solar flux: The solar flux is a measure of the intensity of solar electromagnetic radiation; a number of different frequencies are monitored by the Algonquin Radio Observatory in Ottawa, but 2695 MHz is normally taken as a standard. The solar flux has a range from about 60 to 400 units; there is a positive correlation to the sunspot number. The solar flux is normally a better indicator in the process of predicting MUFs than is the sunspot number.

A index: The A index is a measure of geomagnetic activity, ranging from 0 to 400 units. Zero units is extremely quiet and 400 units is very disturbed.

K index: The K index is a quasi-logarithmic index of geomagnetic activity ranging from 0 to 9 units. The K indices of the day are averaged to determine the A index for the 24-hour period. The reason why the average K index doesn't equal the A index later aired by WWV is that the former is measured at Boulder, and the latter is taken at Fredericksburg; there is a variation in radiation levels at different places on the earth.

Table 1 illustrates the relationship between the A and K indices. By comparing yesterday's A index with the current K index, you can see whether the geomagnetic activity is increasing, holding steady, or decreasing. You can also compare activity levels within the same day by noting successive six-hour K indices. The greater the difference of values (either up or down) in a

WWV transmits from a site near Boulder, Colorado, on 2.5, 5, 10, and 15 MHz. WWV is the only outlet that transmits the geophysical alert information at 18 minutes past each hour. WWV announces each minute in Universal Time, equivalent to GMT.

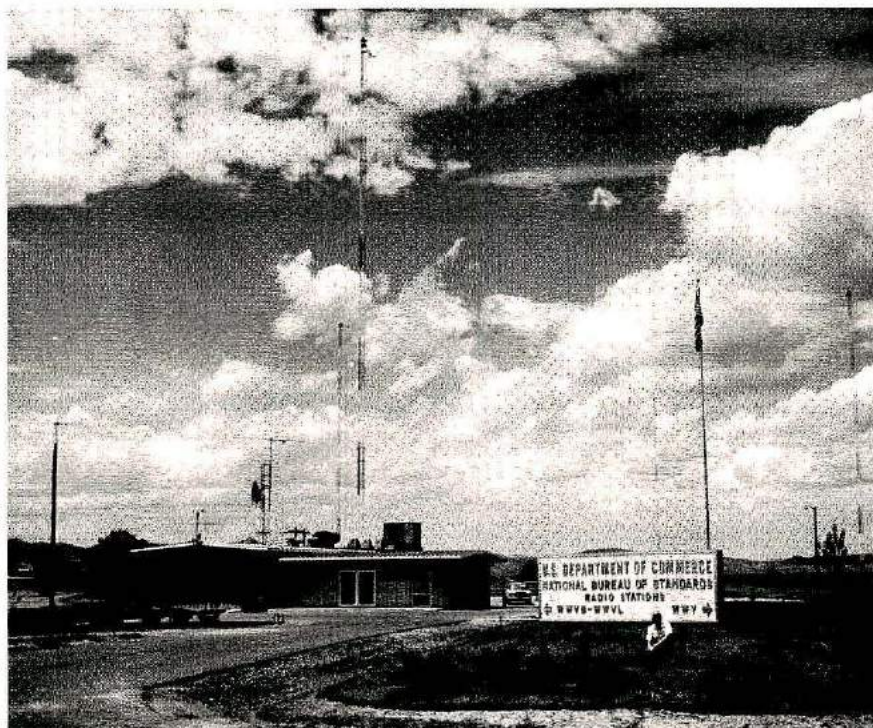

	1	2	3	4	5	6	7	8	9	10	11	12	13	14	15	16
SOLAR FLUX																
A - INDEX																
0000 Z																
0600 Z																
1200 Z																
1800 Z																
FLARE START (Z)																

	17	18	19	20	21	22	23	24	25	26	27	28	29	30	31
SOLAR FLUX															
A - INDEX															
0000 Z															
0600 Z															
1200 Z															
1800 Z															
FLARE START (Z)															

A K
 0 0
 3 1
 7 2
 15 3
 27 4
 48 5
 80 6
 140 7
 240 8
 400 9

Fig. 1. You can use this chart to record WWV radio propagation data on a daily basis. Use the information in the article to plan your DX activities.

short time interval, the more rapidly band conditions will change.

Usually the start of a radio communications disruption is relatively quick in changing conditions from good to bad, whereas the end of a disturbance — the recovery phase — is drawn out over a longer period of time.

Solar activity can be classified as very low; low; moderate; high; and very high. These terms relate to the state of the regions on the solar disk capable of producing disruptive flares. There is a positive correlation between the solar flux and solar activity. The terminology describing geomagnetic activity in terms of K and A indices is listed in **Table 1**.

The auroral zone

There are ever-present auroral zones over the north and south poles. When geomagnetic activity increases, so does the size of the auroral zones; when it decreases, the size of the auroral zones decreases, but at a slower rate.

WWVH, Kauai, Hawaii, also transmits on 2.5, 5, 10, and 15 MHz. No propagation information is transmitted over WWVH, but the female announcer can often be heard on the East Coast as she announces each minute, just ahead of the WWV announcement.

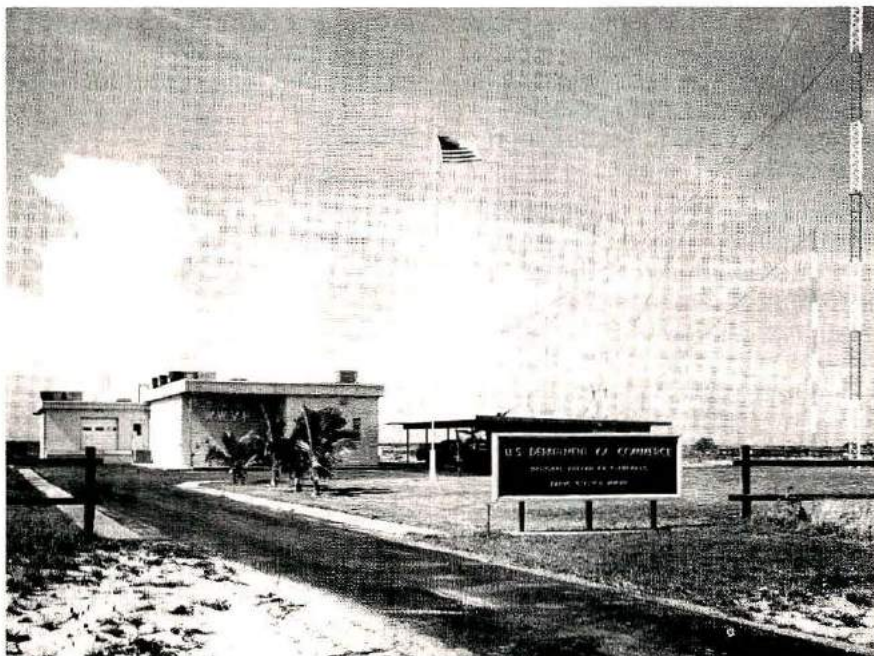

Table 1. Relationship of the A and K indices transmitted by the National Bureau of Standards station WWV.

K	A	classification (geomagnetic activity)
0	0	quiet
1	3	quiet
2	7	quiet
3	15	unsettled
4	27	unsettled-to-minor storm level
5	48	minor storm level
6	80	major storm level
7	140	major storm level
8	240	major storm level
9	400	major storm level

If a skywave signal passes through the auroral zone, the signal is usually affected; a characteristic polar flutter is induced upon the signal. Amateurs on the East Coast will note the flutter on JA signals on 15 and 20 meters during East Coast evening hours; West Coast amateurs will notice the same rapid flutter on signals from Europe.

Given enough geomagnetic activity, the signal transverseing the zone will not be reflected but will be absorbed. On the

East Coast, the high-latitude great-circle path to Japan will be the first affected, then high-latitude paths into northern Europe will disappear. As the intensity of the geomagnetic storm increases, the reflection points of lower-latitude paths will be encompassed by the enlarged auroral zone.

If the geomagnetic storm is severe enough, there can be a total loss of skywave signals from the east, north, and west of the listener's location. Reflection points of skywave signals coming from the south may still be outside the enlarged auroral zone; the signals will seem to be stronger than usual, but this is because of the lack of other interference rather than enhanced propagation.

Using the information

The next step in using the WWV geophysical alert information is to develop a frame of reference for your location and equipment, including antennas. For example, the better your antennas, the longer you can get results despite worsening or marginal propagation conditions. No matter how much power *you* run, if you can't hear 'em, you can't work 'em.

An example: Given my location, antenna, and suburban environment, I find a solar flux of 150 is more or less the breaking point for determining if 20 or 15 meters will stay open all night during the summer. A flux of 140 during the quiet winter months means realistic 40-meter CW DX possibilities into JA and VK land at sunrise here (assuming the A index is low).

Similarly, I find that an A count (or its equivalent K index) around 30 takes out all but the Central- and South-American signals. With a flux of 150 and K of 4, I'd expect to find strong signals from the south on 15

RADIO AMATEUR CALLBOOKS



Respected worldwide as
the only complete authority
for radio amateur
QSL and QTH information.

The U. S. Callbook has nearly 350,000 W & K listings. It lists calls, license classes, names and addresses plus the many valuable back-up charts and references you come to expect from the Callbook.

Specialize in DX? Then you're looking for the Foreign Callbook with almost 285,000 calls, names and addresses of amateurs outside of the USA.

U.S. Callbook \$15.95

Foreign Callbook \$14.95

(Plus Shipping)

Order from your favorite electronics dealer or direct from the publisher. All direct orders add \$1.75 for shipping. Illinois residents add 5% Sales Tax.

RADIO AMATEUR
callbook INC.
Dept. E 925 Sherwood Drive
Lake Bluff, Ill. 60044

and 20 meters.

Characteristically, A counts of 10 to 20 usually mean northern Europeans (F-G-DL-SM-LA) are reduced in strength (JA has long since disappeared when the A index hits 5), and signals coming in on lower-latitude great-circle paths (such as EA-I-YU-UB5) from southern Europe and Russia dominate the high frequency bands during the evening hours.

In analyzing the forecast for July 22 illustrated above, I'd judge that 10 and 15 meters would be closed, and 20 may or may not propagate at night. The previous day's flux was 144, dropping eight points, and the forecasted activity went from moderate to low, dropping the MUF. Although the present absorption levels, with the low MUF, will wipe out paths over the northern Pacific for me, other areas of the world should be reasonable until the effects of the solar flare hit, by late in the GMT day of July 22. I'll probably wind up on 40 CW before the night is over, assuming the atmospheric noise from summer thunderstorms is not too severe.

By the way, it's possible to move too low in frequency. With a high flux count or geomagnetic activity, signal absorption of lower frequencies can occur, establishing a lower usable frequency (LUF). Sometimes the term window is used; it can be defined as the range of frequencies between the MUF and the LUF.

Operating aid: I've provided the chart in Fig. 1 for those who are interested in recording the information broadcast by the National Bureau of Standards stations. It is designed for a one-month period. If you enter the data transmitted by WWV or WWVH in the appropriate squares, you'll find the chart quite useful in planning your DX activities, based on the information in this article.

What you'll find at your location, as I said earlier, will depend on your equipment and

antennas. For example, during unsettled to minor storm level conditions I've heard good signals coming in from Cuba and Puerto Rico. These amateurs are still working European and Japanese amateurs, because CO and KP4 are farther south; the reflection points along their great-circle paths are at a lower latitude, outside the enlarging auroral zone. Those paths won't be affected until the geomagnetic storm intensifies.

In conclusion

Just remember that you don't have to be an engineer or an astrophysicist to use the propagation sources detailed above. All but the WWV geophysical alerts are in plain English for the radio amateur, and once you have constructed a set of references you'll be on your way to having one step up on those choosing operating frequencies on a hit or miss basis.

What makes this hobby fun is that there can be exceptions to the rules. Sometimes DX stations will suddenly show up and have very good signals in a short-run aberration in what otherwise seems to be absolutely impossible conditions. An occasional CQ in a seemingly dead band may produce a surprise. Beware of the normal, watch for the exceptions, and have fun.

Bibliography

Howe, Sandra L., *NBS Time and Frequency Dissemination Services*, NBS Special Publication 432, January, 1976. Available from the Time and Frequency Division, National Bureau of Standards, Boulder, Colorado 80302.

Mangis, Stephen J., *Introduction to Solar-Terrestrial Phenomena and the Space Environment Services Center*, NOAA Technical Report ERL 315-SEL 32, January, 1975. Available from the National Oceanic and Atmospheric Administration, Environment Research Laboratories, Boulder, Colorado 80302.

HRH

TOO STRONG TO GIVE THE WIND A BREAK!

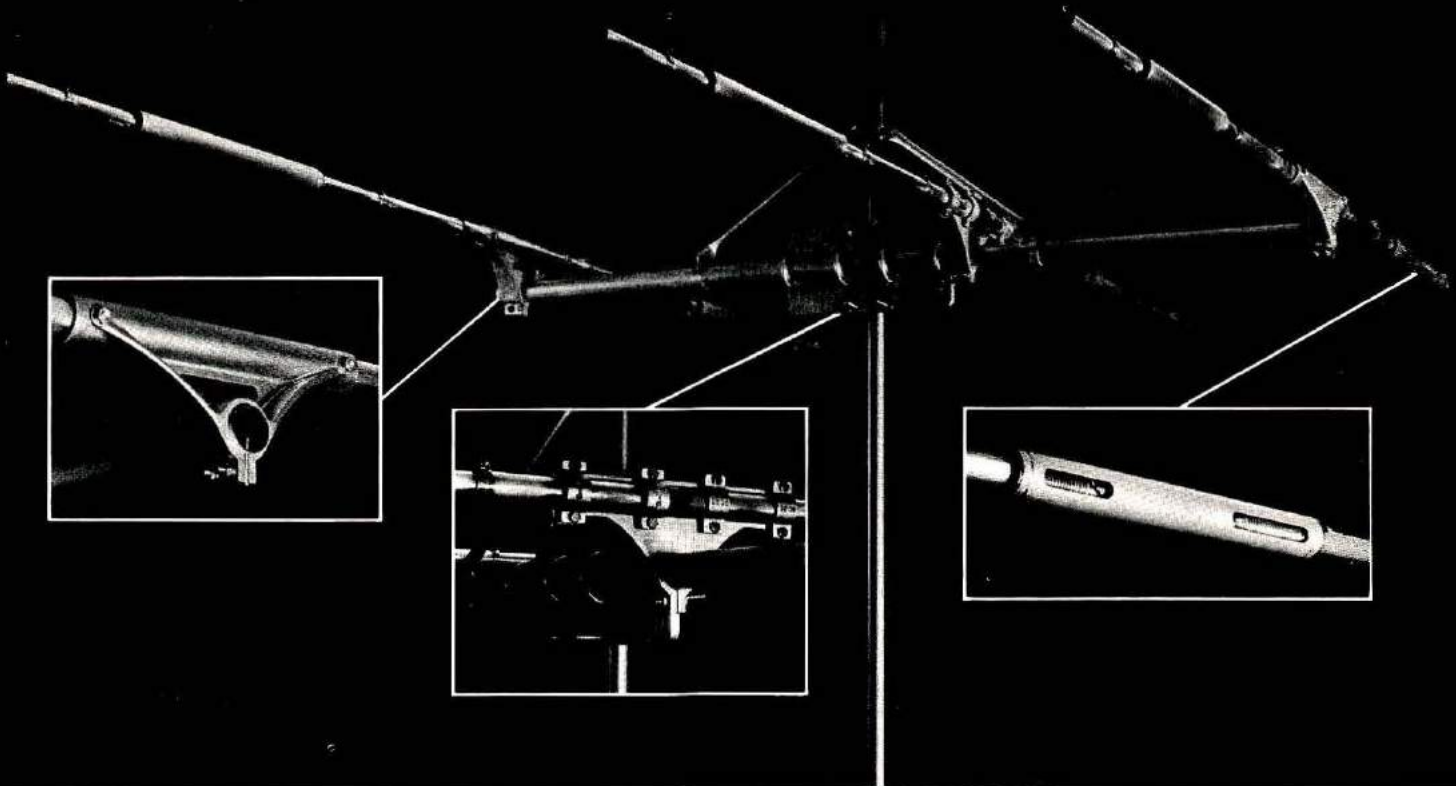

Braced against the elements as only Swan can do it! Even hurricane winds to 100 MPH can't lower the boom on your operations.

The Swan TB3HA Tri-Bander:
a really heavy-duty 20-15-10 meter beam. 3 solid elements, all work-

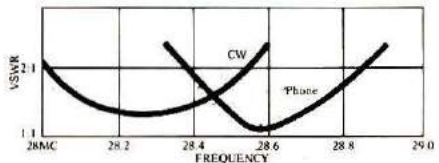
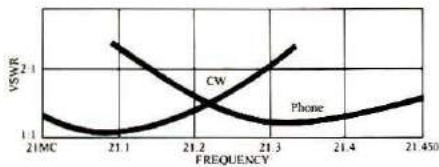
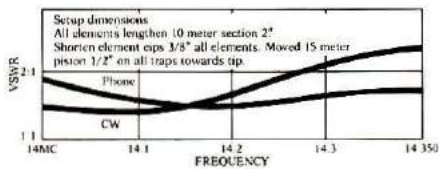

ing on all bands. With a VSWR of 1.5:1 or better at resonance, plus a full 2000-watt PEP rating, our TB3HA is built to work up a storm!

Strongest fittings available:
this you've got to see. Exclusive cast-aluminum braces grasp tubes at every joint, spreading stress over an 11 $\frac{3}{4}$ " span. Compared to slipshod U-bolt plates — no contest!

- Reinforced by super specs,**
TB3HA's one tough competitor:
- 8dBd average forward gain.
 - 20-22 dB front to back ratio.
 - 16' turning radius.
 - longest element: 28'2".
 - 16' boom, optimum spacing.
 - direct 52 Ohm coaxial feed.
 - wind load @ 80 mph: 110 lbs.
 - 44 lbs. net weight.
 - Swan Credit Card accepted.

Available at your local Swan dealer, you can start operating tri-band from a position of real

strength — because TB3HA is Swan-engineered to work under pressure!

Please rush full information on Swan's Heavy Duty Tri-Band Beam Antennas:

- 3-element TB3HA
 4-element TB4HA

Name _____

Address _____

City _____

State _____ Zip _____

Write for free brochures on Swan's Vertical and Mobile Antennas.

SWAN
ELECTRONICS
a subsidiary of Cubic Corporation

305 Airport Road, Oceanside, CA 92054
Phone: (714) 757-7525

Swan's continuing commitment to product improvement may affect specifications and prices without notice.

DAYTON **HAM CONVENTION** '79

April 27, 28, 29, 1979

HARA ARENA AND EXHIBITION CENTER DAYTON, OHIO

- Technical Forums
- ARRL and FCC Forums
- GIANT Flea Market
- New Products and Exhibits
- Grand Banquet
- FCC Exams
- Special Group Meetings
- Fabulous Prizes
- CW Proficiency Tests
- Amateur of Year Award
- Special Achievement Awards
- Expanded Parking

Information Brochure Available in March.

FOR MOTEL RATES AND RESERVATIONS WRITE BOX 44, DAYTON, OH 45401
OR CALL (513) 228-0016 9 A.M.-5 P.M. EST WEEKDAYS

FOR OTHER INFORMATION CALL (513) 293-0459 — 5-10 P.M. EST

Bring Your Family and Enjoy A Great Weekend in Dayton

Sponsored by The Dayton Amateur Radio Assn., Inc., Box 44, Dayton, OH 45401



Radio World



CENTRAL NEW YORK'S FASTEST GROWING HAM DEALER







Featuring Yaesu, Icom, Drake, Atlas, Ten-Tec, Swan, DenTron, Pace, Palomar, Alda, Midland, Wilson, KDK, MFJ, Microwave Module, Standard, Tempo, Astron, KLM, Hy-Gain, Mosley, Larsen, Cushcraft, Hustler, Mini Products, Universal and Tristao Towers. *We service everything we sell!* Write or call for quote. **You Won't be Disappointed.**
We are just a few minutes off the NYS Thruway (I-90) Exit 32

Warren
K2IXN
Call Toll Free: 1-800-448-7914

ONEIDA COUNTY AIRPORT TERMINAL BUILDING
ORISKANY, NEW YORK 13424

Bob
WA2MSH
New York State Residents Call: 315-337-2622 or 315-337-0203



July 28 thru August 10, 1979

Our 20th year of successful teaching

**Boost your Ham Skills
on the Blue Ridge**

"A Vacation with a Purpose"

Two weeks saturation learning program in Amateur Radio:

- Novice to General
- General or Technician to Advanced
- Advanced to Amateur Extra

Expert Instruction starting at your level. Code and Theory in depth along with Friendly Amateurs, Who Care About You.

C. L. PETERS, K4DNJ, Director
Oak Hill Academy Amateur Radio Session
Mouth of Wilson, Virginia 24363

Name _____ Call _____
Address _____
City/State/Zip _____

Hobbyists:

Here is an interesting general electronics hobby magazine. It's loaded with lots of interesting simple circuits and ideas, not only about radio, but in all phases of electronics including test gear, audio, remote control and security systems. We are sure that you will find a number of worthwhile projects in this British magazine.



1 Year (12 issues) \$15.00
**Radio & Electronics
Constructor**
Greenville, NH
03048

WE KNOW YOU WANT THE VERY BEST!

In a market already over crowded by others, all making claim to being "THE BEST", we knew we had to be better. ***COMMUNICATOR I** our 6 channel, 3 watt handheld, and **COMMUNICATOR II** our 800 channel synthesized 25 watt mobile offer all the

features of the "BEST" — and a few extra, including our one year warranty and a toll free 800 number answered by other hams who speak your language.

PACE COMMUNICATOR — THE VERY BEST!

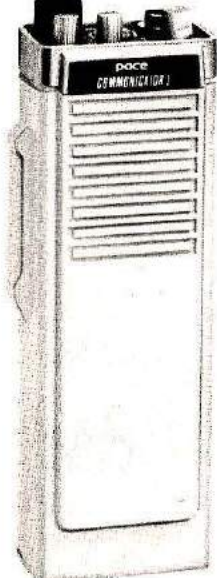

pace COMMUNICATOR

AMATEUR PRODUCTS GROUP **PATHCOM INC.** 24105 SOUTH FRAMPTON • HARBOR CITY, CA 90710

*Communicator I will be available in the fall, Communicator II is in stock for immediate shipment.



100 watts speaks for itself!

The NEW Swan 100 MX Mobile Transceiver

Just imagine... over 100 watts of mobile power on 10 thru 80 meters, at your fingertips! The Swan MX-100 is compact in size, but not in performance. Noise blanker circuitry, RIT control ± 15 KHz and a host of other features are built in. Swan's reputation for value engineering backed by their 90 day warranty policy make this 100 watt solid state mobile the right rig for you. Call and order yours today and be "rag-chewing" tomorrow! Suggested Manufacturer's List, \$849.95

Technical Specifications: Semi-CW break-in, built-in VOX, operates from 11 to 15 VDC, current drain 130ma receive and 20 amps maximum in transmit at 13.0 VDC. Internal speaker, mobile mount bracket, retractable tilt stand. PSU-5 power supply with speaker for ham shack operation. ST-3 Matching Antenna Tuner available, as matching accessory.

Call Jim for your AR Net Price Quote **(716) 235-7540**

Amateur Radio of Rochester

FREE... while they last. Send Today!

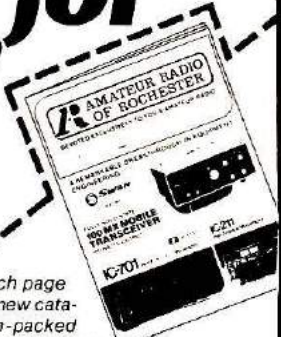

Each page of our new catalog is jam-packed with photos & literature highlighting the many fine lines of fine amateur equipment available to you at substantial savings. Supplies are limited, send for your free catalog today.

Name _____ Call _____
 Address _____
 City _____ State _____ Zip _____

AMATEUR RADIO OF ROCHESTER 1185 Scottsville Road Rochester, New York 14624



BY WILLIAM I. ORR, W6SAI

The Doerle Shortwave Receiver

It's December, 1931. New York City is snowbound after weeks of bad weather and is in the midst of a paralyzing financial depression. Over 30 per cent of the work force is unemployed. The stock market has plunged to new depths of gloom. The radio industry is at a standstill. The broadcast-set construction boom had collapsed, and the ac-operated receiver had not yet reached the market in quantity.

In the lower New York City area, the many small radio distributors were in trouble. Some of them closed their doors forever, and the ones that had managed to stay open had few customers. Something was needed to break out of the dismal cycle of bad weather, unemployment, and economic stagnation. For the nation as a whole the bad weather would soon dissipate, but the economic picture looked black — all except for a handful of small, grimy, radio stores in the Vessey-Cortland-Dey-street area that had unexpectedly stumbled onto a gold mine that proved to be their salvation for a few years.

Shortwave radio! It caught the public's fancy some time in 1931. Young men, unemployed,

with plenty of time on their hands, started the craze. For only a few dollars you could buy a small shortwave receiver that would literally "pull in the world." And the interest was aroused by an obscure radio fan in Oakland, California, who popularized a two-tube regenerative receiver.

Little is known today about Walter C. Doerle of Oakland. He's not listed in the telephone book, and he faded from fame about 1934. In any event, he designed and built a simple two-tube shortwave receiver and wrote about it for publication in the December, 1931, issue of *Short Wave Craft* magazine. The little set was inexpensive to build and sure-

fire in operation. This was the right radio at the right time!

No doubt Doerle was surprised at the explosive interest in his little radio! Requests for more information poured into the magazine, along with glowing reports of how the inexpensive, easy-to-build radio pulled in stations all over the globe. The Doerle receiver became famous overnight.

The Doerle receiver

After the original article on the receiver, Walter Doerle gradually faded from the scene. He wrote one or two other radio articles, but his fame was quickly taken over by a group of small radio stores on New York City's "radio row," who knew a good thing when they saw it. It's not known if Doerle made any financial profit from his radio, but his name became a household word for any simple shortwave set. "Doerle clubs" sprang up around the country and "Doerle circuits" were sold as kits and as complete radios.

Amazingly, most radio hams had never heard of the Doerle receiver. It seemed to be advertised only in radio magazines catering to the

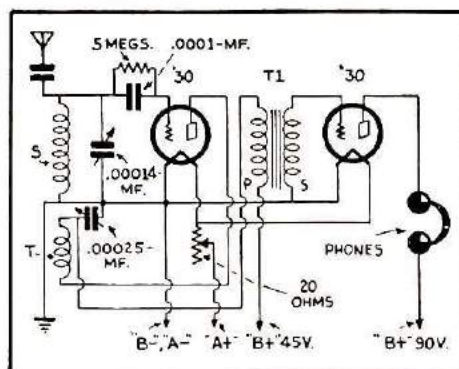

Fig. 1. Circuit used by Mr. Doerle for the 2-tube "globe circler."

shortwave listener (SWL) and the home constructor. But as shortwave listening became a popular pastime (much as CB radio is today), the Doerle designs were duplicated by the uncounted thousands.

The Doerle receiver was simplicity in itself (Fig. 1). It was a simple, two-tube regenerative receiver. One tube served as a regenerative detector and one tube as an audio amplifier. An "A" battery for the filament supply, and 90 volts of "B" battery, were required to run the receiver. Figs. 2 and 3 show modified versions of the receiver.

Originally designed for the low-drain type 30 tubes, the receiver worked equally well with the cheap, plentiful type 201A tubes and a second-hand 6-volt automobile battery for the filament supply. And later, the Doerle circuit would be redesigned for the new type 227 ac-operated triode tubes.

Building the Doerle receiver

Most builders ignored the Doerle kits, even though they sold for less than five dollars for the economy-model receiver. Two tubes could be obtained for less than 25 cents at a rummage sale or radio junk shop. The audio transformer? Free, or perhaps 15 cents from the same source. Tube sockets were easy to obtain and cheap, even if bought new. Coils?

Wind them on bases from burned-out tubes. And the tuning condensers* could be bought new for less than a dollar, or could be cut down from larger condensers

*Yep, they were known as condensers in those days. Today we call 'em capacitors. *Editor.*

salvaged from an old battery receiver.

According to the pictorial drawing, the Doerle was built on a wooden base: plywood or "breadboard," measuring about 203 by 305 mm (8 by 12 inches). That gave plenty of room for parts. The parts were arranged so that the panel was reason-



Doerle type regenerative receiver built from a 1938 kit. This battery-operated receiver uses a 1F4G as a detector, a 1H5G audio amplifier, and a 1C5G second audio stage. The 1F4G detector is in the center with a metal shield over the tube. Shortwave spectrum from 10 to 200 meters is covered with four plug-in coils. When wired up, the receiver worked right off the bat!

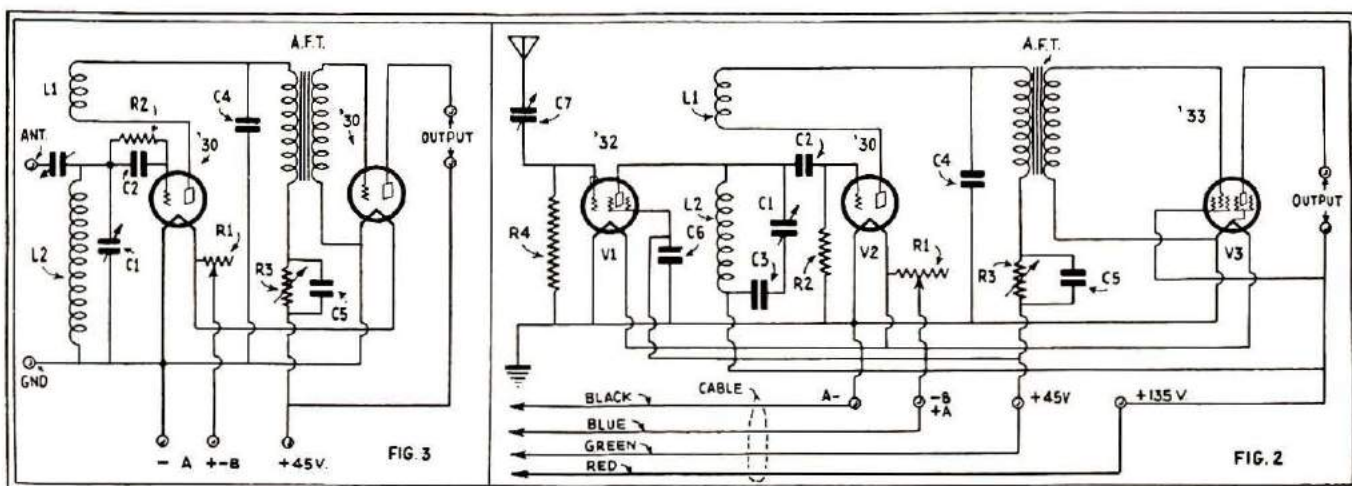

Fig. 2. The same two-tube receiver shows up in the schematic diagram at left, but with a few parts changes — note the variable coupling capacitor from the antenna terminal. Inevitably, the circuit was adapted for mobile use, shown at right with an rf amplifier ahead of the detector.

HARRISON RADIO CO.

★ QUALITY ★ LOWEST ★ REAL ★ EVERYTHING
★ MERCHANDISE ★ PRICES ★ SERVICE ★ GUARANTEED

Now!

The Improved Doerle 12,500 Mile Two Tube Short Wave Receiver

\$4.75



DC MODEL

Uses two 230 tubes. Batteries required are two dry cells (or a 2-volt storage cell) and two 45 volt B Batteries. If you have a 9-volt storage battery you may use 201-A's.

COMPLETE KIT \$4.75
Coils Wound 50c extra

ACCESSORIES

234 volt Filament Transformers, 95c. Heavy Duty, \$1.35. RCA Heated TUBES. Fully guaranteed for three months. 230-75c. 201-A—30c. 227—45c. 5c—50c. 292-45c. Other types at lowest prices. Large Dry Cells—29c. Large 45 volt B Batteries—50c. Impregnated light weight phones—\$1.33. Better grade, very sensitive, \$1.75.

The sensationaly popular DOERLE 12,500 MILE receiver—improved—refined—and available in complete kits that are so easy to assemble! Read the letters in Short Wave Craft from constructors of this remarkable two tube receiver, praising its exceptional performance. Many are from purchasers of our modernized kits!

Our Engineering Department invents, developed new features such as velvet regeneration control with no detuning effect, ultra low loss condensers of advanced design, friction drive (no backlash) variable dial for easy tuning, metal chassis and panel for efficient shielding, eliminating hand capacity, and other carefully selected and tested refinements, resulting in a receiver that by far outperforms the original!

These kits contain every necessary part of highest quality. All high frequency loadings in ceramic bakelite. The coils, each tune from 15 to 115 meters are wound on polished bakelite forms. The sockets are Bakelite. All losses are minimized! The attractive crystal finished chassis and panel has all holes needed to mount the apparatus and this, together with our complete, detailed instruction sheets, simplifies construction.

Only by purchasing in large quantities are we enabled to offer these most professional appearing sets at such an amazingly low price! And the parts are all first grade, test

AC MODEL

Uses two of the new type 56 tubes or two 27's. Power is obtained from the Model ED pack lined below or from any good eliminator delivering 90-200 volts and 254 volts. Or it may be run on a 234 volt filament transformer and two 45 volt Batteries.

COMPLETE KIT \$4.95
Coils Wound 50c extra

Either set or power pack completely wired and tested—\$2.25.

MODEL ED Power Pack—Delivers all power for AC Receiver. Heavy transformer and extra filtering assures quiet reception on short waves. Plugs into 110 volt, 60 cycle house line. Stamped metal chassis. Uses a 250 tube.

COMPLETE KIT \$4.85
For 110 volt, 25 cycle—\$5.85

Harrison Radio Company sold a Doerle receiver kit for less than five dollars. To save cost, regeneration was controlled by varying the detector plate voltage by potentiometer R3. The feedback capacitor, C4, was fixed.

ably symmetrical. The antenna coupling capacitor (oops! condenser) was cut from two small sheets of brass, or from a tin can if brass wasn't available.

Rarely mentioned was the phenomenon of hand capacitance. Touching the tuning or regeneration-control dial severely changed the reception frequency unless a grounded, metal panel was used. Since aluminum panels were expensive, most builders lined the back of the panel with aluminum cigarette-package paper and connected it to the ground circuit of the receiver.

The "smoke test"

Finally, the great moment is at hand! The receiver is complete and coils wound. You apply filament voltage carefully and examine the type 30 tubes in a darkened room to make sure the filaments are lighted.

A recheck of the wiring is usually necessary at this point, as inadvertent application of the B voltage to the filament circuit guarantees instant burnout of the two tubes, each of which draws only 60 mA of filament current.

Reassured that all is proper, you then apply plate voltage and gradually advance the regeneration control. If you're lucky (and most builders were) you'll instantly hear a signal or two as you adjust the main tuning dial.

The long-distance reception pours in!

Tuning the Doerle receiver was an art. The tuning and regeneration control had to be adjusted simultaneously as the receiver was tuned across the band. Too little regeneration meant no signal; too much meant a howl in the headphones. The adjustment of the

antenna capacitor was attempted, too — the plates being bent back and forth in relation to each other. More daring experimenters tried various values of "grid leak" (grid resistor). From 2 to 5 megohms seemed about right.

Once the tuning technique was established, the world was at the fingertips of the listener. Old standbys such as Rugby, England; VK2ME and VK3ME in Australia; and HVJ in the Vatican poured in along with lesser lights such as PCJ in Holland and VE9GW in Canada. The most sought-after station was a home-built 7-1/2 watt broadcaster in Costa Rica, on the air with a call "borrowed" from the U.S. Navy. The listener who heard NRH in Heredia, Costa Rica, was lucky indeed.

When SWLing was a fine art

Unlike today, radio amateurs in the prewar era received SWL cards from all over the world. Since ssb was unknown in those dear dead days, amateurs used simple amplitude modulation (a-m) which could be easily received on a simple Doerle receiver (just reduce the regeneration control). Collecting SWL reports was a hobby that was probably greater than amateur radio (there were about 30000 amateurs at that time). Ed Chorlain, operator of SU1CH in Cairo, Egypt, once complained that his 150-watt phone brought in more than 3000 SWL reports in a six-week period in early 1935! And the Indian post office finally refused to deliver the thousands of SWL letters and cards sent to VU7FY in Mysore State. United States amateurs were swamped with SWL reports, too. Most took the burden gracefully, especially if return postage was included. I remember the walls of my room when, as a high-school student, I roamed the shortwave bands as an eager SWL. When I got my ham ticket, I stripped the walls of

TEC
OMNI

TEN-TEC OMNI



the hf transceiver

AVAILABLE AT:

Cohoon Amateur Supply



307 McLean Ave., Hopkinsville, Kentucky 42240



TELEPHONE NUMBER

502-886-4534



Doerle Radio Clubs sprang up all over the country in the 1930s. Homebuilt shortwave radio receivers were the rage, especially among the high-school set. This 1935 photograph shows the radio club of the Waupun High School of Waupun, Wisconsin. (Photo reproduced from *Short Wave Craft* magazine).

SWL cards, hoping to fill them with *real* QSLs from the contacts I hoped to make.

The Doerle becomes an industry

After the original excitement,

the Doerle circuit gave way to more exotic receivers. Three-, four-, five- and six-tube Doerle receivers appeared on the market, some rigged up in good-looking, crackle-finished metal cabinets. Most, however,

were merely the original circuit adapted to ac, with audio stages added to work a loud speaker. But they remained the first receiver of thousands of shortwave enthusiasts, many of whom became radio amateurs after their initial, thrilling exposure to shortwave radio through the sure-fire Doerle circuit.

By 1938 the Doerle fad had expired. The two-tube regenerative receiver, while still built by some beginners, was eclipsed by low-cost shortwave super-heterodyne receivers. Modeled after the inexpensive broadcast receivers, the little superhets quickly took over the shortwave beginner's market. The depression was fading, more money was changing hands, and the radio enthusiast could afford a more expensive receiver. Soon the Doerle circuit was forgotten. But it had done its part to sustain the New York radio industry when the days were black and the future insecure.

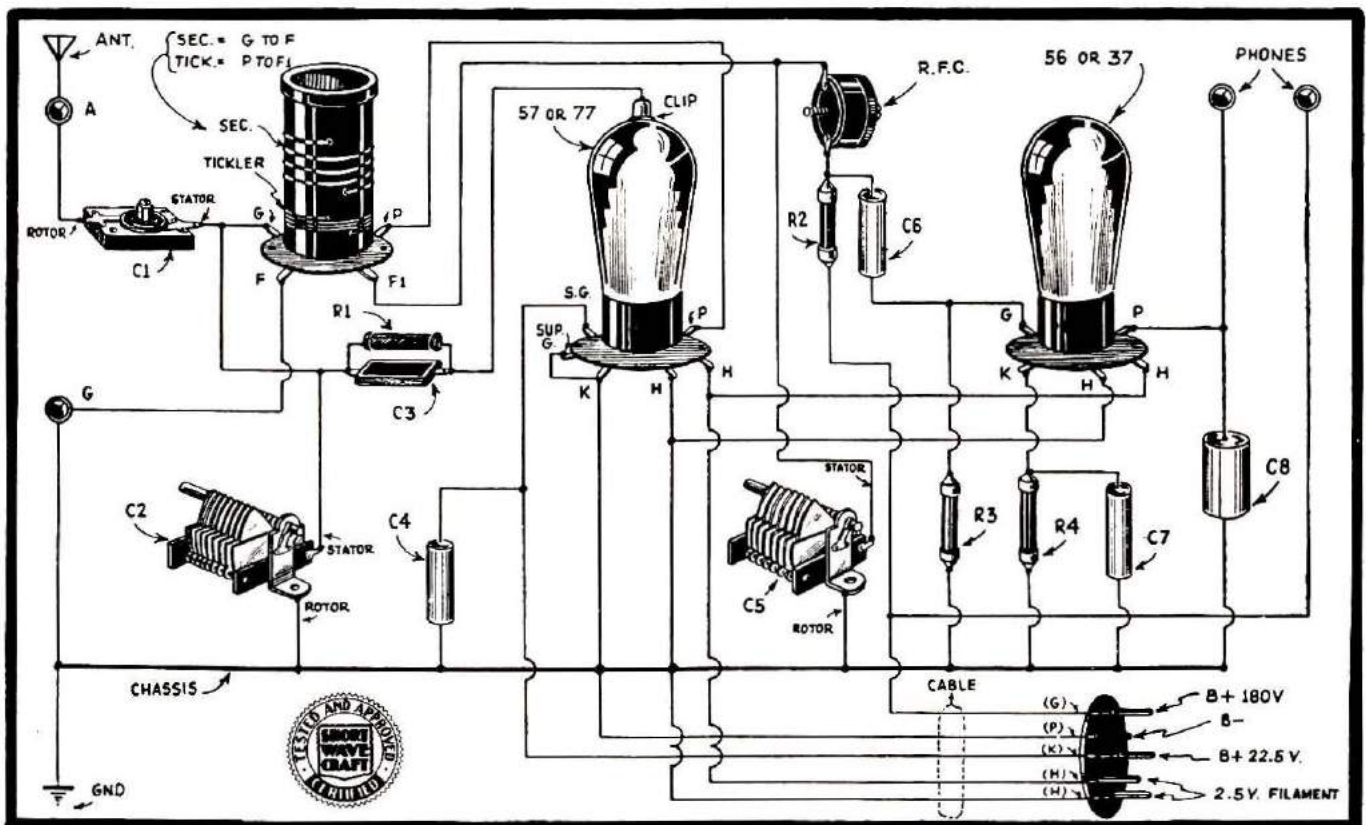

Fig. 3. The schematic diagram is typical of those seen in the early 1930s, and experimenters were helped by the clear picturized diagram" like the one above. Tube sockets were used for the plug-in coil forms, and carried their original filament, grid, and plate designations as a means of identifying where the wires were to be connected. Note the seal of approval of *Short Wave Craft* magazine, a means of inspiring builder confidence.

CALL TOLL FREE

1-800-228-4097
Communications Center
 443 N 48th Street
 Lincoln, Nebraska 68504
 In Nebraska Call (402)466-8402

1-800-634-6227
Communications Center
West
 1072 N. Rancho Drive
 Las Vegas, Nevada 89106
 In Nevada Call (702)647-3114

Antenna Sale!



18HT



CUSHCRAFT
ATB-34



RINGO RANGER 48TV

	HY-GAIN	Regular	Special
TH6-DXX	Super Thunderbird	\$296.95	\$ 209.95
TH3-MK3	3 ele. 10, 15, 20 Mtr. beam	219.95	179.95
Hy-Quad	2 ele. Quad 10, 15, 20 Mtr.	229.95	199.95
TH3-Jr.	3 ele. 10, 15, 20 Mtr. beam	144.50	129.95
18 HT	Hy-Tower 10-80 Mtr. Vertical	299.95	259.95
14AVQ/WB	10-40 Mtr. Trap Vertical	67.00	57.00
18AVT/WB	10-80 Mtr. Trap Vertical	97.00	84.95
205 BA	5 ele. "Long John" 20 mtr.beam	289.95	249.95
203	3 ele. 2 Mtr. beam	14.95	
205	5 ele. 2 Mtr. beam	16.95	
208	8 ele. 2 Mtr. beam	24.95	
214	14 ele. 2 Mtr. beam	31.95	

MOSLEY

Classic 33	3 ele. 10, 15, 20 Mtr. beam	304.75	219.95
Classic 36	6 ele. 10, 15, 20 Mtr. beam	392.75	289.95
TA-33	3 ele. 10, 15, 20 Mtr. beam	264.00	199.95
TA-36	6 ele. 10, 15, 20 Mtr. beam	392.75	289.95
TA-33 Jr.	3 ele. 10, 15, 20 Mtr. beam	197.00	149.95
TA-40KR	40 Mtr. add on	119.50	89.95

CUSHCRAFT

ATB-34	4 ele. 10, 15, 20 Mtr. beam	259.95	209.95
ARX-2	2 Mtr. Ringo Ranger	36.95	32.95
A147-20T	2 Mtr. Twist	59.95	52.95
A144-10T	10 ele. Twist 2 Mtr.	39.95	32.95
A144-20T	20 ele. Twist 2 Mtr.	59.95	52.95
A147-11	11ele. 146-148 MH2	34.95	30.95
A147-22	Power Pack 22 ele.146-148 MH2	99.95	88.95
A432-20T	430-436 MH2 20 ele. TWIST	54.95	49.95
ATV-4	10,15,20,40 MTR Vertical	89.95	79.95
ATV-5	10,15,20,40 MTR Vertical	109.95	94.95

HUSTLER

48TV	10-40 Mtr. Trap Vertical	99.95	82.95
RM-75	75 Meter Resonator	16.95	14.50
RM-75s	75 Meter Super Resonator	31.95	27.50
G6-144-A	6 db. 2 Mtr. Base Colinear	79.95	64.95
G6-144B	7 db. 2 Mtr. Base Colinear	119.95	99.95

WILSON

System One	5 ele. 10, 15, 20 Mtr. beam	274.95	239.95
System Two	4 ele. 10, 15, 20 Mtr. beam	219.95	189.95
System Three	3 ele. 10,15,20 MTR beam	179.95	159.95
WV-1 Vertical	10-40 MTR Vertical	79.95	69.95

CDE ROTORS

Ham III	\$125.00	T2X Tail Twister	\$225.00
---------	----------	------------------	----------

We carry all major brands of ham radios
AT DISCOUNT PRICES

Yaesu — Kenwood — Drake — ICOM — Dentron —
 Ten-Tec — Swan — Tempo — Midland — E.T.O. — Wilson



Build a Doerle receiver today?

Why not? The Doerle is a fun radio and can be built for little or nothing if you have a good junk box, or are a good scrounger at a flea market. Choose one of the many circuits shown in this article. I suggest you make it on a piece of plywood and use a grounded aluminum panel to reduce the effects of hand capacitance. Probably the ac circuit is best today, as dc tubes are microphonic, hard to find, and require a hum-free filament supply. The ac circuit can use any of the following tube types: 2Z7, 56, 76, 6C5, 6J5, or 6C4. Surely you have two of these in your junk box!

The audio transformer can be a replacement "three-to-one" type, and the rf choke can be a 2.5 millihenry pi-wound affair. If you feel like a pioneer, you can wind the coils on 4-prong tube bases or other insulating material, about 32 mm (1-1/4 inches) in diameter. The lucky scrounger might come up with a set of commercially wound coils made for these little receivers! As for the rf choke, the original Doerle used a home made one. It consisted of 300 turns of 0.13-mm (no. 36) double silk covered wire, close wound on a 13-mm (1/2-inch) diameter wood dowel rod. Operation of the choke can be checked by pressing the earphone cord in your hand when the set is operating. If no change occurs in the received signal, the choke is doing its duty.

Listening in today

Today's radio spectrum is far different from what it was in the early thirties. Hearing a signal was a significant feat then; today the powerful signals and heavy congestion of the short-wave channels make reception a problem of receiver overload. The little Doerle (in common with all regenerative receivers) is highly susceptible to signal

overload. The pigmy antenna-coupling capacitor helps, but you should use a short antenna with this set — 5-6 meters (15-20 feet) of wire is sufficient. A longer antenna will lead to severe receiver blocking and overload. To prevent instability, moreover, the antenna should be firmly supported so it won't swing about in the wind. A moving antenna will affect the tuning of the receiver. An indoor antenna is suggested.

Why not have the fun of

building a Doerle receiver? I can't think of any circuit that will provide more simple pleasure in construction and use than the Doerle circuit. You'll be surprised at how the signals pour in on the little set. The signals will not be loud, as the circuit lacks audio power. But the signals will be there, and the sensitivity of a regenerative set is equal to that of the more expensive receivers of 1978! With patience and experience, the Doerle receiver will

SHORT WAVE SETS

Sets Which Work At Your Command

And Now **The Electrified Official Doerle**

2 And 3 Tube Receivers

Operate On Either A. C. or Batteries—May Also Be Used For 2-Volt Operation

Only **\$14.22**

And Now These Doerle Sets Have Been Completely Electrified

3-Tube Doerle Signal Gripper

REAR VIEW of A. C. Model with 2-Mill. Transformer



2-Tube 11,000 Mile Doerle Set

Rear View—Both A. C. and 2-Volt Models



Only **\$8.92**

SPECIFICATIONS

No. 2174. Electrified 2 Tube 11,000 Mile Doerle Receiver; completely wired and tested, low tubes, Monitors 49 tube a 9" high 1 1/2" wide. Shipping wt. 6 lbs. **\$9.47**

No. 2175. Electrified 2 Tube 12,500 Mile Doerle Receiver; in a 4 tube, low tubes, but including transformer, Monitors, 49 tube a 9" high 1 1/2" wide. Shipping wt. 6 lbs. **\$9.27**

No. 2176. Complete set of tubes for above, either one 40 and one 56 for A. C. operation, or one 2Z7 and one 56 for battery operation. **\$7.84**

No. 2177. Electrified 3 Tube Doerle Signal Gripper; completely wired and tested in a 4 tube. Monitors 49 tube a 9" high 1 1/2" wide. Shipping wt. 6 lbs. **\$14.22**

No. 2178. Electrified 3 Tube Doerle Signal Gripper in 4 tube, including transformer and transformer windings. Shipping wt. 7 lbs. **\$12.77**

No. 2179. Complete set of tubes, either one 56, one 2Z7 and one 56 for A. C. operation, or one 2Z7 and one 56 for battery operation. **\$2.72**

BATTERY SETS

No. 2140. TWO TUBE 11,000 MILE 2-VOLT DOERLE SIGNAL GRIPPER; COMPLETELY WOUND AND TESTED. 39-30, wt. 5 lbs. **\$8.92**

No. 2141. TWO TUBE 11,000 MILE 2-VOLT DOERLE SIGNAL GRIPPER; COMPLETELY WOUND AND TESTED. 39-30, wt. 5 lbs. **\$8.92**

No. 2142. COMPLETELY WOUND AND TESTED 2-TUBE 11,000 MILE 2-VOLT DOERLE SIGNAL GRIPPER; COMPLETELY WOUND AND TESTED. 39-30, wt. 5 lbs. **\$8.92**

No. 2143. THREE TUBE 2-VOLT DOERLE SET; COMPLETELY WOUND AND TESTED. 39-30, wt. 5 lbs. **\$11.87**

No. 2144. THREE TUBE 2-VOLT DOERLE SET; COMPLETELY WOUND AND TESTED. 39-30, wt. 5 lbs. **\$10.51**

No. 2145. COMPLETELY WOUND AND TESTED 2-TUBE 11,000 MILE 2-VOLT DOERLE SIGNAL GRIPPER; COMPLETELY WOUND AND TESTED. 39-30, wt. 5 lbs. **\$11.02**

FREE Short-Wave BOOKS

YOUR CHOICE

of either one of books illustrated herewith—FREE OF CHARGE—with the purchase of any of the short-wave receivers listed in this advertisement.

Book No. 866 explains in a most thorough-going manner the ways and means of obtaining an amateur transmitting license. Furthermore, all government rules regulating amateur transmissions are reviewed. Book No. 830 is a comprehensive and thorough compilation of the most prominent short-wave receiver circuits published during a period of two years. Build up your radio library with one of these books.

Book No. 866

Book No. 830

Special Short-Wave Hum-Free A. C. Power Pack

Designed Especially For The Doerle Receivers

Everyone knows that an A. C. power pack is not as better than the power pack which supplies the power. A power pack for about \$6.27 will be constructed with extreme care. It must be absolutely free from hum or other disturbance caused by insufficient filtering, or faulty alignment.

This unit has a transformer-like circuit, employing two heavy duty 30 Henry chokes and a tremendous amount of capacitors. This means PURE A. C. with practically no ripple at all, a source for the filament. These warm voltages are obtained from non-inductive power resistors, and the filament is connected to ground by means of a dynamic speaker. Any speaker having a field resistance of from 1500 to 2500 ohms may be this original. All the component parts of this pack are built into a rugged metal case which is black, crackle finished. The power transformer and one of the chokes are the only units which are mounted on top of the chassis. The pack consists of a type 200 inductor section which is inserted in a socket on top of the case. A convenient switch is mounted on the side of the pack to enable you to connect with four feet of connecting cord, terminating in a special battery clip holder. Monitors 49 tube a 9" high 1 1/2" wide. Shipping wt. 2 lbs. **\$6.27**

No. 2149. Special Short-Wave Hum-Free A. C. Power Pack, including 280 tube. **\$6.27**

MONITOR 49 TUBE

Our Own Tests

Every one of these Doerle receivers, without exception, is tested in our laboratory under actual operating conditions. We obtain from giving you this outstanding list of stations which we ourselves have heard during the course of our tests, for we do not wish to let our enthusiasts run away with us. We would much rather have you and your many other short-wave friends talk about the results. Incidentally, we have had to receive a single complaint on any of these sets although we have sold many hundreds of them. Such record is accompanied by schematic diagrams and wiring diagrams, as well as a complete set of detailed instructions.

Only First-Class Parts Are Used

It may be possible to buy parts or assembled sets at a lower price, but without concern. For we have used only the best parts available in the construction of our sets. We have included in the list of those components. In those receivers with the best music circuits, we have used 250 ohm resistors and 250 ohm resistors. These are used for a considerably low amount of the most expensive components. We use 250 ohm resistors. And this goes for everything in our sets.

If you are interested in the results obtained with these receivers, read the letters from our many short-wave fans, and printed on the opposite page.

FRONT VIEW, showing several representative all-Doerle receivers



By 1933 "electrified" Doerle receivers were the big sellers. You could get one completely wired and tested for less than 15 dollars. Of course, tubes were extra, for \$2.68 a set.



Fig. 4. The only published photograph of Mr. Doerle was in *Short Wave Craft* magazine for November, 1932. He is shown demonstrating his new DX receiver which was capable of driving a loudspeaker. Doerle's article describing the receiver was entitled "A 3-Tube Signal Gripper."

perform wonders for you and you'll gain appreciation of some of the heritage that's behind today's hobby of amateur radio.

Further reading

The formative years of radio (or electronics as we know it today) make interesting reading for newcomers and old timers alike. The bibliography that follows lists some articles published by *ham radio* and *Ham Radio Horizons* that describe how it used to be. Your local library probably has copies of some of the early radio magazines. During those years you could find these radio magazines on the news stands sandwiched between *Collier's*, *Liberty*, and *The Women's Home Companion*.

Bibliography

Nagle, John J. K4KJ, "Those Good Ol' Radio Magazines," *Ham Radio Horizons*, December 31, 1977, pages 38-47.

Orr, William I., W6SAI, "1929 — 1941, The Golden Years of Amateur Radio," *ham radio*, April, 1976, pages 34-38.

Orr, William I., W6SAI, "The Golden Years of Radio," *Ham Radio Horizons*, May, 1978, pages 40-43.

Orr, William I., W6SAI, "The Golden Years of Radio — The Way it Was — 40 Years Ago," *Ham Radio Horizons*, March, 1977, pages 32-36.

HRH

Touch-Tone Decoders

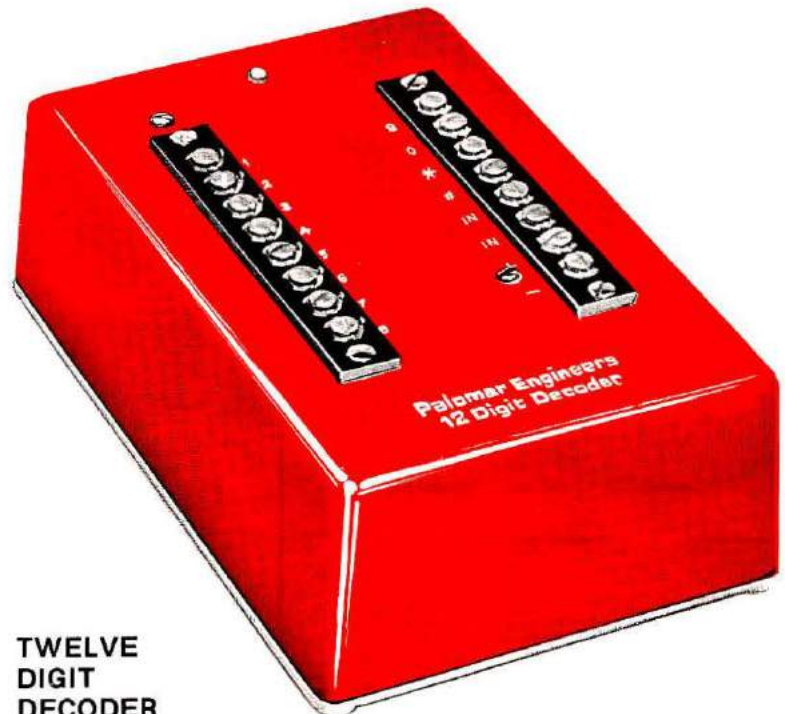

**TWELVE
DIGIT
DECODER
\$145.00**

- Decodes digits 1, 2, 3, 4, 5, 6, 7, 8, 9, 0, * and #.
- Twelve 5-volt output lines.
- Isolated 5000 ohm input.
- Operates from any DC voltage +12 to +30 volts.
- Output drives TTL logic or relays.



MODEL T2 \$49.95

- Decodes one Touch-Tone digit.
- Available for digits 1, 2, 3, 4, 5, 6, 7, 8, 9, 0, *, and #. Also for digits A, B, C, D.
- Relay output SPST ½ amp.
- Operates on any DC voltage +12 to +30 volts.

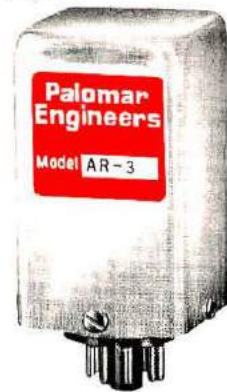

MODEL AR-3 \$49.95

- Sequence decoder.
- Connects to 12-digit decoder.
- Three digits must appear in correct order and timing to close output relay.
- For foolproof secure signalling.

Send for free brochure. ORDER TODAY. Add \$2 shipping/handling. Add sales tax in Calif.

Palomar Engineers

Box 455, Escondido, CA. 92025 • Phone: [714] 747-3343

NEW

APRIL
FEATURE



NEW!

Brand New 4th Edition CONFIDENTIAL FREQUENCY LIST

Here's a necessary companion to any general coverage receiver. This completely new edition of the very popular CFL is the most recent listing of station frequencies, call signs, locations, emission modes and power for just about any non-ham signal you can pick up from 4 to 26 MHz. Stations are listed by frequency for easy identification and location. From foreign military to weather broadcasts, the CFL is 96 pages of the most up-to-date short-wave listening information available. 96 pages.

©1979.

GL-CF

Softbound \$6.95

Available March 1979

NEW!

HORIZONS MAGAZINE FILES

Your collection of Ham Radio HORIZONS is a valuable resource. Here's a brand new, inexpensive way to store them. These sturdy cardboard magazine files keep them clean, neat and up front where you can use them for quick and easy reference.

HR-HRHF

\$1.95 each, 3/\$4.95

**IN A HURRY?
ORDER
TOLL FREE
1-800-258-5353**

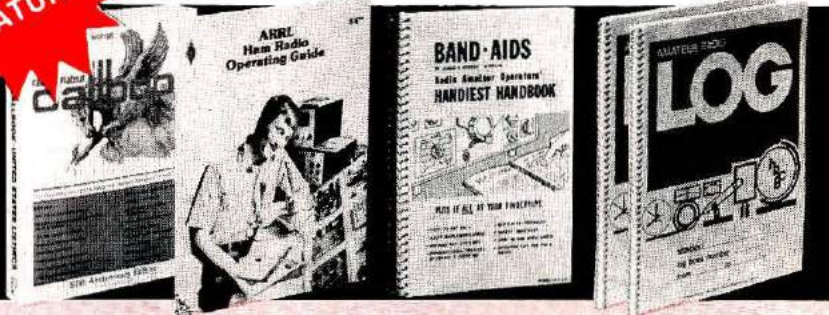

OPERATOR'S PACKAGE

Here is a collection of books which no ham should be without. Whether you're a beginner or old-timer, DXer or Ragchewer, you'll find much valuable information in this package. Included is:

1) The 1979 U.S. Callbook with the listings of 374,487 U.S. Hams, including 41,245 new listings and over 100,000 listing changes. To keep up with all the new hams and new calls, you need the latest edition of the Callbook. 2) The ARRL Operating Guide. Separate chapters cover basic operating skills needed for handling emergency and message traffic, using repeaters, DXing, contesting, QRPing, and other subjects. 3) Band Aids compiled by James Dersh, WD0AJE, a collection of 60 different operating aids, charts, and tables including the National Traffic System listing, a decibel ratio chart, Ohm's Law table of formulas, WWV and W1AW operating schedules, and much more, all in one handy spiral book. 4) Two Ham Radio Log Books — each has space for over 2,000 entries, or a total of over 4,000 QSOs! You also get Q signals, international prefixes, and the amateur frequency spectrum chart — all spiralbound for easy use.

The Operator's Package — an incredible amount of information for \$27.95.

HR-OPER

U.S. Callbook	\$15.95
ARRL OP Guide	4.00
Band Aids	7.95
2 HR Logs	3.50

SPECIAL JUST \$27.95

**\$31.40
Value**

Already BEST SELLERS from the ARRL

FM and REPEATERS FOR THE RADIO AMATEUR by the ARRL Staff

This is a completely new and updated version of the mobile operator's favorite. This new edition features the latest in FM technology and design theory, highlighted by microprocessor control circuitry and a phase-lock loop 2-meter transceiver. More on FM — receivers, transmitters, antennas and repeater operation. If you are into FM, get this book today! 176 pages. ©1978.

AR-FM

Softbound \$5.00

THE ARRL ANTENNA ANTHOLOGY by the ARRL Staff

This brand new book pulls together a wide selection of antenna articles from QST. Written for Amateurs of all levels and interests. Included are phased arrays, verticals, Yagi's . . . even the VHF Quagi! Detailed instructions and full illustrations make this a really useful book for any antenna buff. 152 pages. ©1979.

AR-AA

Softbound \$4.00

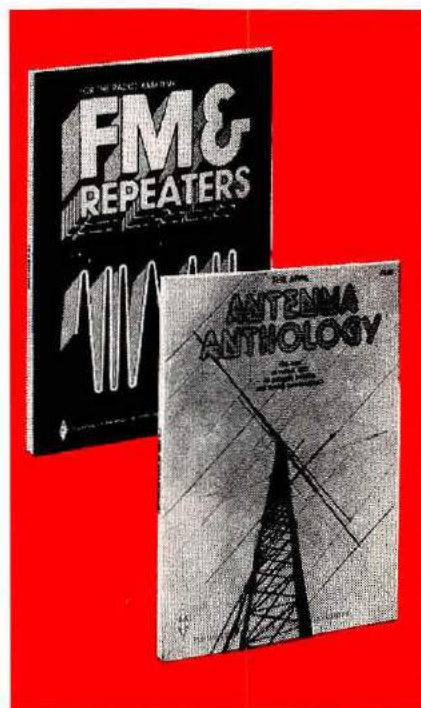

BEST BETS

Member
AMERICAN BOOKSELLERS ASSOCIATION

Very Popular!

THE RADIO AMATEUR ANTENNA HANDBOOK

by William I. Orr, W6SAI and Stuart D. Cowan, W2LX

RP-AH One of Amateur Radio's most notable authors Bill Orr, W6SAI has combined with W2LX to provide you with a clearly written, understandable book on antennas. All types of beam, quad, horizontal and sloping wire antenna information is included in this useful volume. Location decisions, height, ground loss, towers, rotors, SWR meter reading — it's all here in one great book. 148 illustrations, charts and diagrams. An antenna book you have just got to read! 190 pages. ©1978.

Softbound \$6.95

NEW!

BASIC ELECTRICITY

by Charles W. Ryan

Teach yourself basic electricity at home. This new course leads you through the basic principles which underly all electronic applications. Following a programmed instruction format, you work problems on Ohm's Law and simple AC circuits as you read. Learning is greatly enhanced through this method and you can proceed at your own pace. Self tests at the end of each chapter evaluate your mastery of the material presented. No special background needed to take this extremely well thought out and critically acclaimed course. 280 pages. ©1976.

JW-74787

Softbound \$5.95

NEW!

ELECTRONICS — A SELF-TEACHING GUIDE

by Harry Kybett

Here's a great follow-up to Basic Electricity. You can obtain at home a thorough, practical knowledge of modern electronics without getting lost in a maze of theory and circuit diagrams. By concentrating on basic circuit components — diodes, transistors, capacitors, inductors — and basic oscillator and amplifier circuits you'll progress to the practical build-it-yourself world of electronics. This self-teaching guide uses the same effective problem solving approach to learning used in Basic Electricity reinforced by self tests and a final exam. It's one of the best roads we know of to a practical knowledge of modern electronics. 260 pages. ©1979.

JW-01748

Softbound \$5.95

HAM RADIO LOG BOOK

Ham Radio's new Log Book has room for 2100 QSO's — that's over twice as many entries as other popular log books. There's sharp ruling too for all FCC-required information, plus extra space for the name and address of each station you contact all on a convenient horizontal format. For contesters, there is a consistent 30 entries per page for easy counts. In addition you'll find a handy frequency spectrum chart showing the exact band segment from novice to extra, plus a listing of all worldwide Amateur prefixes currently in use. And, it's all spiralbound to lay flat on your operating table. This is unquestionably the best log book value anywhere! 8-1/2 x 11. 80 pages. ©1978.

HR-LB2

Spiralbound \$1.75



NEW

NOVICE INSPIRATION

Great Licensing Aids

SAVE OVER 10%



TUNE IN THE WORLD WITH HAM RADIO

by ARRL Staff

Learn what Amateur Radio is, how to pass your Novice exam and how to talk to other hams in the U.S. and around the world. *Tune In the World With Ham Radio* gives an exciting overview of ham radio highlighting various facets of this great hobby. In addition, it has everything you need to pass the novice exam — from a plain talk, basic radio electronics manual and study guide to a Morse Code cassette instruction course — here in one package. Tens of thousands of hams have started with this package.

AR-HR

Complete package \$7.00

Includes booklet, study guide, and cassette tape.

COMMUNICATE WITH THE WORLD THROUGH HAM RADIO

from Ameco

Here's a complete, simple novice license course not requiring any technical background. One of the very best available. If you know enough about ham radio to want to get started immediately, then this package is for you. It contains Ameco's popular Novice Theory Course as well as a Morse Code training package featuring a cassette tape and 32 page instruction booklet. Radio theory, Morse Code training, FCC type practice code and theory exams, it's all here in this complete and economical package. A great way to get your ticket to worldwide communication.

NP-1

Complete package \$6.95

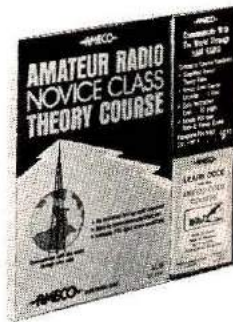

Send me the books I've checked below.

ORDER FORM

- | | | |
|-------------------------------------------------|-------------------------------------------------|--------------------------------------------------|
| <input type="checkbox"/> GL-CF \$6.95 | <input type="checkbox"/> AR-FM \$5.00 | <input type="checkbox"/> JW-01748 . . . \$5.95 |
| <input type="checkbox"/> HR-HRHF . ea. \$1.95 | <input type="checkbox"/> AR-AA \$4.00 | <input type="checkbox"/> HR-LB2 \$1.75 |
| <input type="checkbox"/> HR-HRHF . . 3/\$4.95 | <input type="checkbox"/> RP-AH \$6.95 | <input type="checkbox"/> AR-HR \$7.00 |
| <input type="checkbox"/> HR-OPER . . . \$27.95 | <input type="checkbox"/> JW-74787 . . . \$5.95 | <input type="checkbox"/> NP-1 \$6.95 |

Check or money order enclosed VISA Master Charge

Acct. # _____ Expires _____ MC Bank # _____

Name _____ Call _____

Address _____

City _____ State _____ Zip _____

Please include \$1.00 additional for shipping

Mail payment and order form to:

Ham Radio's Bookstore
Greenville, NH 03048



Dear Horizons:

I just received my November issue and, as usual, found it contained several interesting and informative articles.

I particularly enjoyed "Signals from Safariland," by N. Steven-Hubbard . . .

I am only a Novice and may never get a General ticket. I work second shift in a truck manufacturing plant, and the classes for upgrading licenses, given by a local Radio Club, are held during evening hours — so I'm unable to attend. I do, however, want to renew my ticket . . .

I just read a letter to the "Post Box" from a ham who said you had the forms needed to apply for a license renewal. Could you please send me one of those forms? I will be very grateful . . .

Richard B. Swart, WB8SLV
Springfield, Ohio

Thanks for your letter, Richard. By the time you read this, you'll have the forms and, most likely, have renewed your license. I'm sure that with plenty of on-the-air experience and some study, you'll be able to get that General ticket even if you cannot get to classes. Good luck.

Editor

Dear Horizons:

I have been a reader of *Ham Radio Horizons* ever since it was first published. I am not a new ham, as I have been licensed since May, 1936. Still, I enjoy every article in *HRH*. In addition, my wife started to read it, and that generated enough interest to result in getting her Novice license and the call KA0BCP. Thank you, *Ham Radio Horizons*.

I have done some experimenting

with very narrow-band fm, and I have been wondering if anyone else has had the inclination to get into this interesting method of modulation? If the receiver i-f bandwidth is narrowed to 500 Hz, I found that the fm deviation can be narrowed to the point where there is not much more bandwidth than that occupied by a good CW signal.

I would like to have other hams consider this idea, and see if we can stir up some interest in super-narrow-band fm. I know they will be amazed at the results.

Milton Sarchett, W0YBK
Ely, Iowa

Dear Horizons:

I first wrote to you after you published your first issue of *Ham Radio Horizons*. I was an Advanced Class licensee, and found your magazine very understandable.

Well, I've been an Extra for about a year now, and I still enjoy (and understand) *HRH*. To prove how great it is, I just renewed for another year (my subscription wasn't due to run out until 1982). If you keep up the good work, I may renew until 1984!

Mike Witenko, N8AX
Springfield, Ohio

Dear Horizons:

I am a new subscriber to your fine publication. The first issue I received was the December, 1978, Special Issue. I found many interesting articles.

I will never be a writer, nor do I want to be. Nonetheless, I read "Write That Article" with interest. Alf Wilson made some very good points.

Then I turned to another interesting article, "Camouflage Your 2-Meter Antenna" by Warren Hodges. I thought it was unique, to say the least. A problem came up. All items are marked, measured and described, just as the previously read article suggested, except one — just the one I wanted to know something about. On page 34, **Fig. 2**, you show a "hub." Of what material is this item made? Everything else is either aluminum or brass or stainless steel, but this piece, who knows? It seems to me that it must be an insulator. Am I right?

At this time I am a Novice. I'm trying to see that this status

doesn't remain too long. In your DX forecaster I found new and wonderful things. With a little work I figured out the baffling page 97 — well, almost! On certain squares the band designation is followed by an *. That must have some significance, but what? I'm sure an experienced operator would have no trouble with this, but I'm not experienced.

Excellent article by Earl Savage, and an excellent article by Douglas Blakeslee. I like the magazine!

Arthur Dickett, WA2TUH
Thornwood, New York

*Thanks for your comments, Arthur. I have a "gotcha" reply to that question about the weathervane antenna hub. At the top of page 35, **Fig. 3**, is a drawing of the "Aluminum Hub," clearly marked. As to the asterisk in the DX chart — you have a good point. When space permits, we include a paragraph at the end of the DX Forecaster page. This explains that the use of an asterisk indicates that you should check the next higher band as well, as there is a good possibility that it, too, is open. The December issue just didn't have enough space to include that helpful paragraph.*

Editor

Dear Horizons:

Since I started taking *Ham Radio Horizons* a little over a year ago I have found it to be much more valuable than any other Amateur magazine. You can pride yourself in good articles dealing in Amateur Radio. These articles are of more benefit than pages and pages of meaningless contest scores mixed in with excessive advertisements.

In addition to Amateur Radio I have gained an interest in stamp collecting. Where would a person find information about a group of Amateurs with an interest in stamps having a net? I've heard of Space Exploration and Medical nets, as well as others. Has there been an attempt by anyone to compile a list of special-interest nets, including enough information to help contact a member of the net? I feel it would be very useful and a way to link Amateur Radio to our other interests and occupations.

James H. Couey, WB0RIM
Towanda, Kansas



Puts the World at Your Fingertips

Get your antenna high enough with a TRI-EX tower and bring the world to you.

Receive signals which you have never heard before.

Send your call to other HAMS who have never heard you.

A TRI-EX tower will give you listening power...calling power...and stay-up power that means durability.

Durability comes from TRI-EX's 25 years of building quality towers. These years of experience combined with the latest engineering knowledge and materials are used to design and build towers which stay up under the antenna loads and wind speeds specified. After manufacture our steel towers are hot dipped in molten zinc (galvanizing). All exposed steel is covered inside and out - including the inside of tubing.

Our aluminum towers are self-resistant to corrosion. TRI-EX TOWERS makes them all: GUYED TOWERS, CRANK-UP TOWERS, FREE STANDING TOWERS, STACKED TOWERS.

And we will install a tower on your site, upon request.

Call, or write TRI-EX now for information on the right TRI-EX tower for you. We will send you our complete list of prices, delivery dates, installation information and the name of your nearest dealer. **Call TOLL FREE.**

**Call our New Number
1-800-528-6050, Extension 1025**

**In Arizona, dial:
1-800-352-0458, Extension 1025**



7182 Rasmussen Avenue, Visalia, California 93277

PRODUCT SHOWCASE

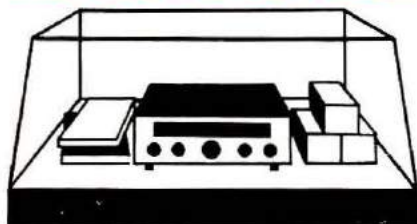

Fast-Scan ATV Transmitter/Converter



P.C. Electronics, of Arcadia, California, has put their ATV modules into a single attractive enclosure for those hams who are more interested in operating than building. All that is needed with the TC-1 is a Technician or higher Amateur license, a TV set tuned to channel 2 or 3, a 435-MHz antenna, and a video source. The video source can be a closed-circuit TV camera, computer video, teletype video, or video tape recorder.

The TC-1 ATV transmitter/converter contains a sensitive, varactor-tuneable, 420 to 450-MHz converter with output on TV channel 2 or 3. No modification to your TV set is necessary to receive fast-scan ATV because the same standards are used as in commercial broadcast. The transmitter section of the TC-1 runs 10 watts peak output on 439.25 or 434.0 (or any other ATV frequency by special order).

Computer alphanumeric, graphics, and color can be transmitted because the modulator has a bandwidth of 8 MHz. This allows you to play Star Trek or blackjack over the air.

Price of the TC-1 is only \$399 delivered in the U.S. Options in-

clude AC/12 Vdc for portable work, \$30; off-the-air video detector and monitor driver (to see the actual transmitted picture), \$25; and on-carrier audio for those areas with an inband ATV repeater, \$50. The 117 Vac, 50-60 Hz power supply is built in. UPS delivery prices are included to save you the trouble of trying to figure out the charges. Direct mail-order sales saves you the cost of dealer markup.

Send an addressed, stamped envelope for a catalog of modules, cameras, and monitors. Write P.C. Electronics, 2522 Paxson Lane, Arcadia, California 91006, or use *ad check* on page 78.

MIMIC Programmable Keyer

The MIMIC memory keyer is the newest of Daytronics Company's fine line of quality electronic keyers for the Amateur Radio operator. The MIMIC has four programmable memories which can each store an average of 60 letters, or about ten minutes of 5-wpm text total for all four memories. This is three to four times the memory capacity of other keyers. It is also a fully iambic keyer with both *dit* and *dah* paddle memories, self-completing characters, automatic spacing, automatic weighting, a built-in sidetone monitor, built-in regulated power supply (instead of batteries) that can operate from 115 Vac or 8 to 5 Vdc, and a fully RFI protected keying output that will key either grid-blocked or cathode-keyed tubed transmitters as well as all the solid state rigs.

Additionally, when you are recording into any one of the four memories, the sidetone from the internal speaker will change pitch when the memory is half full, allowing you ample time to finish your message before you run out of room in that memory.

The MIMIC has a triggered clock, which means that you have total control of the keyer and that you do not have to use

precise timing or wait for the keyer to catch up to you in order to record your message into the memory without making mistakes. Also, should you pause while recording, the MIMIC's memory will not continue to chug along eating up memory space, but will insert a maximum of three spaces and then stop. It will resume only when you begin sending again.

The MIMIC is extremely easy to use and a pleasure to operate during contests as well as casual rag chewing. Recording into the memory is as simple as selecting the memory by pushing the desired MEMORY button,



pressing the WRITE button and sending your message exactly as you would for a QSO. The MIMIC senses letter and word spaces and inserts them automatically so that the message is an exact duplicate of what you sent. Pushing the END button erases the remainder of the memory so that any previously recorded message will not be sent. To send a recorded message, simply push the desired MEMORY button and push the SEND button. You can stop a message by simply pushing the RESET button.

The MIMIC is available in either kit form or an assembled and thoroughly tested version. The kit version is only \$79.95, and the assembled version is only \$99.95. Paddles are also available as a package deal of \$104.95 for the kit and a set of paddles, or \$124.95 with the MIMIC assembled. The paddles are a quality set and are fully adjustable for tension and spacing. They're a fine addition to your shack. For more information write Daytronics Company, P.O. Box 426, Selden, New York 11784; or use *ad check* on page 78.

J. W. Miller Catalog

A new 100-page catalog with specifications for more than 5,000 coils, filters, and communications essentials is now available from the J. W. Miller Division of Bell Industries, Compton, California.

Newest additions to their catalog include direct reading SWR/power meters, an rf speech-processor, and coaxial switches. Included also is the broad line of highpass, lowpass, audio, and ac power-line filters.

Catalog 79 gives detailed specifications for rf coils, chokes, filters, and related communication components. To assist in selection, coils are categorized by frequency from 0 through 500 MHz in the table of contents. Schematic diagrams for all shielded and unshielded coils, showing adjustment accessibility, are given.

For additional information, contact Jerry Hall, Operations Manager, Bell Industries, J. W. Miller Division, 19070 Reyes Avenue, P.O. Box 5825, Compton, California 90224, or use *ad check* on page 78.

New Astatic Microphone



A microphone designed for repeater-control and phone-patch operations has been introduced by the Astatic Corporation, Conneaut, Ohio. It's the new Astatic T2M amplified microphone with touch-pad encoder.

For fingertip convenience, the touch-pad encoder is an integral part of the microphone itself. It has a tactile twelve-key keyboard and provides visual feedback through a front-mounted LED.

Priced comparably to a conventional microphone, the T2M is of an advanced design that

has such high-quality features as a preamplified electret element with tailored response and integral modulation control; a digital, integrated tone-generator circuit with 3.5795 MHz crystal for stable frequency control; and a mixer amplifier with up to 15 dB gain for impedance matching and audio and tone mixing.

NEWS Update

from **DRAKE**

WARC-79

The 1979 World Conference that will propose new and expanded Amateur Radio bands.

What will you do with your present gear if we get some or all of these new frequencies (10, 18, 25 MHz, and expanded 40 and 15 meters)?

Will you have to trade your gear or can you readily put it on any or all of these new ranges?

If you have the Drake TR-7 system or the Drake R-4/T-4X series you can simply keep them, program them in a few minutes time and join the action! With this Drake equipment you won't miss a single kHz of fun no matter where it is.

A specially priced, low cost WARC kit will be available to TR-7 owners and the range crystals are available to R-4/T-4X series owners.

These thoughts of interest are provided by Drake,
"The Newsmakers"

For a FREE Drake Full Line Catalog contact your favorite Drake Dealer.

R. L. DRAKE COMPANY  **DRAKE**

540 Richard Street, Miamisburg, Ohio 45432 • Phone (513) 866-2421 • Telex 288-017

The attractive Cicolac housing resists abusive treatment. It also features shielding to reduce external interference and rf feedback. The T2M operates from filtered 6 to 16 volt dc sources. Included is an eight-foot, three-conductor (one shielded) cable and coiled cord.

For additional information on the new Astatic T2M amplified

microphone with touch pad encoder, write The Astatic Corporation, Conneaut, Ohio 44030, or use *ad check* on page 78.

EICO 4A4 Multimeter

EICO Electronic Instrument Company is adding a new multimeter, Model 4A4, to its Truohm line of low-cost, high-

quality factory-assembled VOMs.

The new multimeter is a 4000 ohms/volt general-purpose instrument with 17 ranges. The meter measures up to 1000 volts dc and ac, up to 250 mA dc, and up to 2 megohms resistance. Accuracy is ± 3 per cent on dc and ± 4 per cent on ac. It features a recessed selector switch and an easy-to-read 3-inch meter with mirror-back scale. The meter movement is diode-protected. The high-impact plastic case measures 12.7 x 8.8 x 3.6 cm (5 x 3-1/2 x 1-7/16 inches). Suggested price of the new Model 4A4 is \$17.95, assembled and complete with batteries and test leads.

The EICO Truohm line includes a highly sensitive 100k ohms/volt bench-size multimeter, a clamp-on ac current tester and seven other instruments ranging from a simple, inexpensive 1000 ohms/volt meter to a 20,000 ohms/volt mirrored-scale meter.

For further details, contact EICO Electronic Instrument Company, Inc., 108 New South Road, Hicksville, New York 11801, or use *ad check* on page 78.

Soldering-Tool Holder and Mini-Soldering Station



Edsyn, Incorporated, of Van Nuys, California, announces a low-cost soldering tool holder which also serves as a compact soldering station. Designated the Idle-Rest TL194 General Purpose Holder, the unit holds most available soldering tools due to its specially designed tool cradle. The exterior of the holder

Attention HAMS LOOKING for a great tower?

Do not attempt to raise antenna or antenna support near power lines—YOU CAN BE KILLED!

Three good reasons to use Universal Towers

- 1. LIGHT WEIGHT**—In addition to its weight advantages, aluminum offers maintenance-free lifetime beauty. Eliminates painting and ugly rust inherent in steel towers.
- 2. EASY ASSEMBLY**—Child's play to assemble. You can easily put together a tower on the ground and walk it up, or assemble it erect section by section.
- 3. STRENGTH**—Important to your choice of a tower. Universal Towers are tested to withstand the force of 80 m.p.h. winds and are designed to resist winds exceeding that velocity.

In addition to all of these advantages, the total cost of a Universal Aluminum Tower is less than that of similar steel towers extended over the life of the tower.

If you have any questions regarding our product line, please contact your local distributor or call or write for information.

UNIVERSAL TOWERS

Universal Manufacturing Co. 12357 E. 8 Mile Rd. Warren, Mich. 48089 (313) 774-4140
FREE STANDING ALUMINUM TOWER

remains within safe skin-touch temperature limits because of the low heat transfer characteristics of the molded Bakelite housing. Also, an efficient heat shield and ventilating-grill system helps keep heat concentrated to the soldering tip area.

The holder sits securely on the bench top without tipping. If desired, the integral fastener nut may be used for permanent installation to the bench top.

In addition, the holder contains a supply of desoldering wick and solder (included with purchase), parts or tip-storage tray, and a large tip-cleaning sponge which self-wets at the touch of a finger. The sponge may be removed if desired to obtain an additional storage tray for components or soldering supplies.

For more information, contact an authorized Edsyn distributor; for the name of the one nearest you, write Edsyn, Incorporated, 15958 Arminta St., Van Nuys, California 91406.

Chemtronics Desoldering Tool

Chemtronics Inc., of Hauppauge, New York, recently announced the latest addition to its popular line of solder and industrial-chemical products: the D5 Desoldering Tool. The unique new product, which features Chemtronics' highly effective desoldering wick in a specially engineered, refillable dispenser tool, helps technicians remove solder more efficiently while economizing on wick use. D5 may be used alone, or as an integral part of Chemtronics' new SD5 Solder/Desolder System.

The D5 Desoldering Tool consists of a 25 mm (1-inch) clear plastic cylinder which contains a visible supply of 152 cm (5 feet) of the company's specially formulated desoldering wick. Braid is fed to the wick through a Teflon* probe that extends from one end of the wick supply. The heat-resistant Teflon probe

*Teflon is a registered DuPont trademark.

allows users to desolder with pinpoint accuracy and without burnt fingers, even in high-density circuitry. In addition, the D5 Tool's exclusive probe permits the user to shape or "web" the wick, providing maximum absorbency and further economizing on wick use. When the wick supply is exhausted, the user simply snaps the Tool's probe

into the D5 Desoldering Tool Wick Refill.

Chemtronics' D5 Desoldering Tool uses the highest-quality braid in natural copper color, which permits the user to see the absorption of solder. The braid, which meets all MIL-specs and NASA publications requirements, is treated with a pure, water-white rosin flux

KLAUS QUALITY AMATEUR RADIO EQUIPMENT & ACCESSORIES

KENWOOD

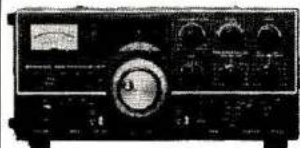

TS 520 S
HF TRANSCEIVER

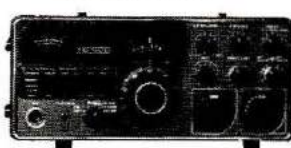

TS 600
MULTIMODE 6-M
TRANSCEIVER

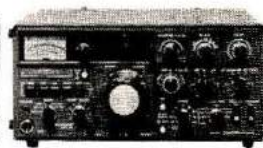

TS 820 S
HF TRANSCEIVER

... call or write for the **KLAUS** price ...

YAESU



FT-901 D
HF TRANSCEIVER

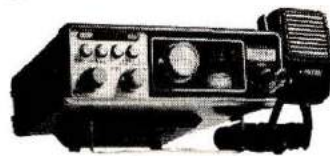

FT-227 R
2-METER FM TRANSCEIVER

... call or write for the **KLAUS** price ...

CUSHCRAFT

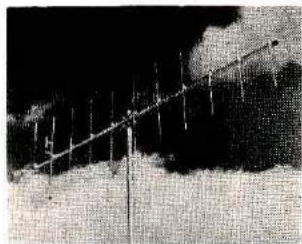

We have a complete stock of Cushcraft antennas — too many to mention in detail, so ask about our 2-meter line of verticals and beams for special low, low prices.

KLAUS RADIO Inc.

8400 N. Pioneer Parkway, Peoria, IL 61614

Phone 309-691-4840

Tim Daley, Amateur Equipment Sales Manager

... at last ...
your shack organized!

A beautiful piece of furniture — your XYL will love it!

\$149⁹⁵ S-F RADIO DESK
Deluxe - Ready to Assemble

Designed with angled rear shelf for your viewing comfort and ease of operation.

FINISHES: Walnut or Teak Stain.
 Also available in Unfinished Birch, \$134.95.
 Additional Information on Request.
 Checks, Money Orders, BankAmericard and Master Charge Accepted.

F.O.B. Culver City. (In Calif. Add 6% Sales Tax.)

S-F AMATEUR RADIO SERVICES
 DEPT. HZ-12 • 4384 KEYSTONE AVENUE • CULVER CITY, CALIF. 90230 — PHONE (213) 837-4870



which is nonactivated and free from halogens and corrosive chlorides. This assures complete solder absorption without leaving harmful residue.

The pocket-sized D5 Desoldering Tool is available alone or as part of the SD5 Solder/Desolder System, where it telescopes or snaps in and out of a pound or half-pound spool of Chemtronics' solder. D5 wick refills are also available, in two diameters, allowing the D5 Tool to be economically reused for years. More information is available at Chemtronics distributors or directly from Chemtronics, Inc. Solder Products Division, 45 Hoffman Avenue, Hauppauge, New York 11787; or use *ad check* on page 78.

Fox-Tango Club Newsletters Free Tape Recordings

Blind amateurs who own (or who are interested in) Yaesu equipment can obtain free recordings of the Annual Sets of the International Fox-Tango Club's newsletters for the years 1976, 1977, and 1978 by sending blank 90-minute cassettes to Tom Warrenburg, Route 3, Box 625, Delavan, Wisconsin 53115. Tom, who is handicapped and struggling to pass the Novice examination, will transcribe the newsletters master tapes he has prepared, and return the cassettes. There is no charge of any kind in the U.S.; others send postage.

The newsletters contain much useful information about Yaesu equipment, including operation, modification, and servicing. Back issues are available through 1972 when the club was first organized by N4ML. Recordings of all back issues are being made and will be available on the same basis when completed.

More information about the club can be obtained by writing to N4ML, Box 15944, West Palm Beach, Florida 33406, or listening to the Fox Tango Net on Saturdays; 14.325 MHz beginning at 1700 UTC.

**HENRY RADIO
 ANNOUNCES THE
 TEMPO K6FZ*
 LOOP ANTENNA**

**NOW YOU DON'T HAVE
 TO BE OFF THE AIR
 BECAUSE YOU LIVE IN AN
 APARTMENT,
 CONDOMINIUM,
 BOAT, R/V, OR???**

At last! Now you can put a good signal on the air with an unobtrusive antenna. The Tempo K6FZ Constant Current Loop Antenna is basically for 20 meter operation, but with the addition of optional elements it also offers 10 and 15 meter capability. It is a totally new concept in quick assembly fiberglass antenna design. The K6FZ is a full half wavelength horizontal loop radiator only eight feet square. It exhibits forward gain, front-to-side and front-to-back ratios and uses no lossy inductive loading coils or traps.

Install it in a fixed position or rotate it with any inexpensive TV rotor... in the attic, on the roof, or hang it in a tree. Your neighbors will think it's just another FM or TV antenna. Wherever it ends up, you'll have fun getting on the air again.

Specifications (Typ 20 meter characteristics)

Gain: +1 dB over dipole (full sized)	Power rating: 2kw PEP
Impedance: 50 Ω balanced—balun recommended (W2AU or BN86)	Dimensions: 8 feet (2.44 meters) square; Shipping box 98 inches long
VSWR: Better than 2 to 1 over entire band	Turning radius: 5.8 feet (1.8 meters)
Polarization: Horizontal	Weight: 10 lbs (4.55 kg)
Front-to-back ratio: 1.5 to 2 S units (9 to 12 dB)	Price: \$159.00
Front-to-side ratio: 1.8 to 2.5 S units (10 to 15 dB)	Accessories:
	W2AU Balun \$14.95
	15-K6FZ 15 meter adapter kit (TBA)
	10-K6FZ 10 meter adapter kit (TBA)

*U.S. & Foreign Patents Pending
 Prices subject to change without notice

Sold at Tempo dealers throughout the U.S. and abroad. Please call or write for further information.

NEW TOLL FREE ORDER NUMBER: (800) 421-6631
 For all states except California.
 Calif. residents please call collect on our regular numbers.

Henry Radio

11240 W. Olympic Blvd., Los Angeles, CA 90064	(213) 477-6701
931 N. Euclid, Anaheim, CA 92801	(714) 772-9200
Butler, Missouri 64730	(816) 679-3127

NEW! 5-Band Trap Dipole (80 thru 10Meters)

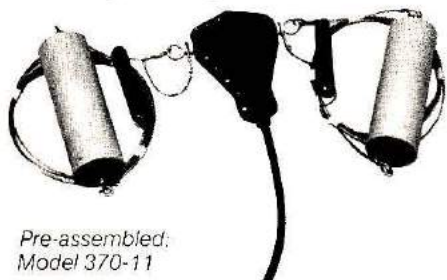

Pre-assembled:
Model 370-11

Power rated 2kW PEP, approx. 110-ft span

Complete with • wire • traps •
end insulators • 50 ft RG-8/U,
PL-259 connector • heavy
duty cast aluminum and stea-
tite center connector.

At your 4-Band (40 thru 10M),
B&W dealer, 55 ft model 370-13
also available, pre-
assembled only.



Made in Bristol, Pennsylvania, by

Barker & Williamson Inc.

10 Canal Street □ Bristol, PA 19007

MAXI TUNER SOLVES ANTENNA PROBLEMS



THE FINEST ANTENNA TUNER AVAILABLE

- Presents 50-75 Ohm Resistive Load to Your Transmitter Using Virtually Any Antenna System
- Improved Ultimate Transmatch Circuit Matches Coax, Random Wire and Balanced Antennas
- Continuous 1.7-30 MHz Coverage
- 229-203 Rotary Inductor (28 μH)
- Rugged Cast Aluminum Turns Counter
- Handles 3 KW PEP
- Heavy Duty Balun
- Velvet-Smooth 6 to 1 Vernier Tuning
- 0-100 Logging Scale on Capacitors
- Available in Kit Form or Assembled
- One Year Factory Warranty
- Use with your present SWR meter or wattmeter.
- Custom Vacuum Capacitor Designs and Individual Components Available

Call or Write for Pricing, Spec Sheet, and FREE Amateur Market Antenna Tuner Comparison Chart That Tells It Like It Is!

RF POWER COMPONENTS
Ladysmith, WI 54848
(715) 532-3971

P. O. Box 11
Ladysmith, WI 54848
(715) 532-3971

Larsen Kūlrod.®

the
antenna
that
keeps
its cool!



Looking for a mobile antenna that goes on easily, looks super . . . and performs like gangbusters! Then you should take a squint at the Larsen Kūlrod Antenna. It's the cool one.

Yes, the fact is that Larsen Kūlrod Mobile Antennas are built differently for a communications *difference you can HEAR*. You can easily prove it to yourself with this simple touch test:

Apply 100 watts of power for a full minute or so to a competitive brand antenna A, B or C . . . any brand with the usual stainless steel whip. Then turn off the power and feel the antenna . . . carefully. It'll likely be hot, even hot enough to raise a blister.

Now put a Larsen Kūlrod to the same test. Surprise! That's right . . . *no* heat! The power has gone into communicating—not heating. The Larsen isn't called the Kūlrod for nothing.

Larsen Antennas fit all styles of mobile mounts and cover Amateur frequencies from 10 meters through the 440 MHz band.



Write for antenna catalog and name of Larsen dealer nearest you.

Larsen Antennas

11611 N.E. 50th Ave.
P.O. Box 1686
Vancouver, WA 98663
Phone: 206/573-2722

In Canada write to:
Unit 101
283 E. 11th Avenue
Vancouver, B.C. V5T 2C4
Phone: 604/872-8517

®Kūlrod is a Registered trademark of Larsen Electronics, Inc.

Escape from the rockpile.



only
\$64.95

Kantronics Freedom VFO

With over 350,000 licensed amateurs on the air, variable frequency operation isn't a luxury, it's a necessity.

If you've tried to operate a rock-bound transmitter on the HF bands today, you know there must be a better way. There is.

The **Kantronics Freedom VFO** will drive the high impedance oscillator tubes of transmitters like the HW-16, DX-160, DX-35, 2-NT and many other "oldies-but-goodies."

The **Freedom VFO** sets you free to roam from 3.650 to 3.750 MHz, 7.000 to 7.200 MHz, and 21.000 to 21.200 MHz. Its compact size is HWD 3" by 5" by 7".

Stop slaving over the rockpile and order a Freedom VFO today. Or write us for information and a list of authorized **Kantronics** dealers.

KANTRONICS

The Lightweight Champs.

1202 East 23rd Street
Lawrence, Kansas 66044

Phone: 913-842-7745

We accept Visa, Master Charge, check and money orders.

LUNAR Preamplifiers

Tired of talking farther than you hear?

The LUNAR preamp series is the most complete on the market.

- Both receiving and inline models available
- Special application preamps at your request

MODEL	DESCRIPTION	LIST
PA 28	28 MHz preamp, BNC or RCA	\$35.95
PA 50	50 MHz preamp, BNC or RCA	35.95
PA 144	144 MHz preamp, BNC or RCA	35.95
PA 220	220 MHz preamp, BNC or RCA	35.95
PA 144K-T	144 MHz preamp, RCA w/TS-700A kit	5.00
PA 144K-F	144 MHz preamp, RCA w/FT-221 kit	5.00
PAI 28	28 MHz inline preamp, BNC or SO-239	49.95
PAI 50	50 MHz inline preamp, BNC or SO-239	49.95
PAI 144	144 MHz inline preamp, BNC or SO-239	49.95
PAI 20	220 MHz inline preamp, BNC or SO-239	49.95
PAD-144	144 MHz dual preamp, 22 dB gain	45.95
PAD-220	220 MHz dual preamp, 20 dB gain	45.95
PAI-50D-s	50 MHz inline mini-preamp	51.95
PAI-144D-s	144 MHz inline mini-preamp	51.95
PAI-220D-s	220 MHz inline mini-preamp	51.95
PA 432-2	420-450 MHz preamp	41.95
PAF 432-2	420-450 MHz preamp, w/input filter	51.95
PAE 432-5	420-450 MHz preamp, ultra-low NF	64.95



MADISON ELECTRONICS

1508 McKinney • Houston, TX 77002

(713) 658-0268

THIS IS IT

Webster



MODEL 4431 THRULINE®

RF DIRECTIONAL WATTMETER
with VARIABLE RF
SIGNAL SAMPLER - BUILT IN
IN STOCK FOR PROMPT DELIVERY

AUTHORIZED DISTRIBUTOR

Webster

associates

115 BELLARMINE
ROCHESTER, MI 48063

CALL TOLL FREE

800 - 521-2333

IN MICHIGAN 313 - 375-0420

HELP!

Anytime you have a question about your Ham Radio HORIZONS subscription, please include a mailing label to insure prompt service on your inquiry.

CHANGE OF ADDRESS

Moving? Please let us know 4-6 weeks beforehand. Or, if anything is wrong with your current mailing label, please carefully print the updated information below and affix your present label above.

PLEASE HELP US TO SERVE YOU BETTER

HAM RADIO HORIZONS Greenville, NH 03048

Call _____

Name _____

Address _____

City _____

State _____ Zip _____

AFFIX
LABEL
HERE

STEP UP TO TELREX

WITH A
TELREX "BALUN" FED—"INVERTED-VEE" KIT
THE IDEAL HI-PERFORMANCE
INEXPENSIVE AND PRACTICAL TO INSTALL LOW-FREQUENCY
MONO OR MULTIPLE BAND, 52 OHM ANTENNA SYSTEM



Telrex "Monarch" (Trapped) I.V. Kit
Duo-Band / 4 KWP I.V. Kit \$63.50
Post Paid Continental U.S.

Optimum, full-size doublet performance, independent of ground conditions! "Balanced-Pattern", low radiation angle, high signal to noise, and signal to performance ratio! Minimal support costs, (existing tower, house, tree). A technician can resonate a Telrex "Inverted-Vee" to frequency within the hour! Minimal S/W/R is possible if installed and resonated to frequency as directed! Pattern primarily low-angle, Omni-directional, approx. 6 DB null at ends! Costly, lossy, antenna tuners not required! Complete simplified installation and resonating to frequency instructions supplied with each kit.

For technical data and prices on complete
Telrex line, write for Catalog PL 7 (HRH)



THE BIG SIGNAL UNADILLA "W2AU" Baluns

DEMANDED BY
PROFESSIONALS
WORLD-WIDE
OVER 12 YEARS

- The Original Lightning Arrest
- 650⁺ Strength
- Stainless Hardware
- Sealed
- GUARANTEED



FULL-POWER, QUALITY
HAM ANTENNA PARTS
AT YOUR DEALER

- BALUNS-TRAPS-INSULATORS
- QUAD PARTS-ANTENNA KITS
- BOOM-MAST MOUNTS-WIRE
- CABLE-CONNECTORS

WRITE FOR FULL CATALOG
(Enclose 30c Stamps)

MICROWAVE UNADILLA/REYCO DIVISION (Dept. HRH)
FC COMPANY INC.
8743 KINNE STREET EAST SYRACUSE, NY 13210, 1987

DEALERS WANTED - OVER 300 WORLD-WIDE



model sw-5 heavy duty -
REMOTE CONTROLLED ANTENNA SWITCH - \$135.00 plus \$3 shipping
• order direct or write for brochure •

ANTENNA MART

515-292-7114

box 1010, i.s.u. station, ames, iowa 50010

*our little boxes
replace a lot of cable!*

- select any of five antennas at the turn of a knob, with just one feedline and a control cable to the remote switching unit.
- saves coax, simplifies station layout.
- handles 4 kw p.e.p.
- other models to nine positions.
- full one-year warranty.

ERICKSON'S MOVED!

Come in and see our new,
bigger, and better store.
Just a few blocks south of
our old location.

YOU'LL FIND the best from

- AEA • Ameco • ASP • Atlas
- Belden • Bencher • Bird
- CDE • CIR • CES • Cushcraft
- DenTron • Drake • Hy-Gain
- Icom • KLM • Kenwood
- Larsen • MFJ • Midland
- Mosley • NPC • Newtronics
- Nye • Palomar • Regency
- Shure • Swan • Standard
- Tempo • Ten-Tec • Tonna
- Transcom • Wilson • Yaesu

NEAR CHICAGO?

COME IN AND SEE US!



Tim WB8SBL and Mike WN9ANF
serving you!



CALL TOLL FREE
FOR THE ERICKSON PRICE!

ILLINOIS, OUTSIDE 312: (800) 972-5841
OUTSIDE ILLINOIS: (800) 621-5802



Hours:

9:30-5:30 Mon., Tues., Wed. & Fri.

9:30-9:00 Thursday

9:00-3:00 Saturday



ERICKSON
COMMUNICATIONS, INC.

5456 N. MILWAUKEE AVE.
CHICAGO, IL 60630 (312) 631-5181

HRH LOCATOR

TO HELP YOU FIND YOUR LOCAL AMATEUR RADIO DEALER

Arizona

POWER COMMUNICATIONS
6012 N. 27 AVENUE
PHOENIX, AZ 85017
602-242-6030
Arizona's #1 "Ham" Store,
Kenwood, Drake, Icom & more.

California

C & A ELECTRONIC ENTERPRISES
22010 S. WILMINGTON AVE.
SUITE 105
P. O. BOX 5232
CARSON, CA 90745
800-421-2258
213-834-5868 - Calif. Res.
Not the biggest, but the best —
since 1962.

JUN'S ELECTRONICS
11656 W. PICO BLVD.
LOS ANGELES, CA 90064
213-477-1824 Trades
714-282-8682 San Diego
The Home of the One Year
Warranty — Full Service.

SANT ELECTRONICS CO.
8106 S. SORENSEN
SANTA FE SPRINGS, CA 90670
213-698-1388
Amateur Sales and Service.
See Rick WB6EWE or Gary WD6FWQ.

SHAVER RADIO
3550 LOCHINVAR AVE.
SANTA CLARA, CA 95051
408-247-4220
Atlas, Kenwood, Yaesu, KDK,
Icom, Tempo, Wilson, Ten-Tec.

Connecticut

THOMAS COMMUNICATIONS
95 KITTS LANE
NEWINGTON, CT 06111
800-243-7765
203-667-0811 - Conn. Res.
Call Us Toll Free —
See Our Full Page Ad in this Issue.

Delaware

DELAWARE AMATEUR SUPPLY
71 MEADOW ROAD
NEW CASTLE, DE 19720
302-328-7728
Delaware's Largest Stock of
Amateur Radio Equipment
& Accessories.

Florida

AGL ELECTRONICS, INC.
1800-B DREW STREET
CLEARWATER, FL 33515
813-461-HAMS
West Coast's Only Full Service
Amateur Radio Store

AMATEUR RADIO CENTER, INC.
2805 N.E. 2ND AVENUE
MIAMI, FL 33137
305-573-8383
The Place For Great Dependable
Names in Ham Radio

RAY'S AMATEUR RADIO
1590 US HWY. 19 SOUTH
CLEARWATER, FL 33516
813-535-1416
West Coast's only dealer: Drake,
ICOM, Cushcraft, Hustler.

Illinois

AUREUS ELECTRONICS INC.
1415 N. EAGLE STREET
NAPERVILLE, IL 60540
312-420-8629
"Amateur Excellence"

ERICKSON COMMUNICATIONS, INC.
5456 NORTH MILWAUKEE AVE.
CHICAGO, IL 60630
312-631-5181
Illinois (Outside 312)
800-972-5841
Outside Illinois 800-621-5802
Hours 9:30-5:30 Mon., Tues., Wed.,
Fri.; 9:30-9:00 Thurs.; 9:00-3:00 Sat.

KLAUS RADIO, INC.
8400 NO. PIONEER PARKWAY
PEORIA, IL 61614
309-691-4840
Let Us Quote Your Amateur Needs.

SPECTRONICS, INC.
1009 GARFIELD STREET
OAK PARK, IL 60304
312-848-6777
One of America's Largest
Amateur and SWL Stores

Iowa

BOB SMITH ELECTRONICS
RFD #3, HIGHWAY 169 & 7
FORT DODGE, IA 50501
515-576-3886
For an EZ Deal on New
or Used Equipment.

Kansas

ASSOCIATED RADIO
8012 CONSER, P. O. B. 4327
OVERLAND PARK, KS 66204
913-381-5901
Amateur Radio's top dealer.
Buy — Sell — Trade.

Maryland

THE COMM CENTER INC.
9624 FT. MEADE ROAD
LAUREL PLAZA RT. 198
LAUREL, MD 20810
800-638-4486
R. L. Drake, Ten-Tec, ICOM, Swan,
Tempo, Wilson, DenTron, Mosley.

Massachusetts

TEL-COM, INC.
675 GREAT RD., RT. 119
LITTLETON, MA 01460
617-486-3040
The Ham Store of New England
You Can Rely On.

TUFTS ELECTRONICS
209 MYSTIC AVENUE
MEDFORD, MA 02155
617-395-8280
New England's Friendliest
Ham Store.

Michigan

ELECTRONIC DISTRIBUTORS
1960 PECK STREET
MUSKEGON, MI 49441
616-726-3196
Dealer for all major amateur
radio product lines.

RSE HAM SHACK
1207 W. 14 MILE
CLAWSON, MI 48017
313-435-5660
Complete Amateur Supplies.

Minnesota

PAL ELECTRONICS INC.
3452 FREMONT AVE. NO.
MINNEAPOLIS, MN 55412
612-521-4662
Midwest's Fastest Growing Ham
Store. Where Service Counts.

Nebraska

COMMUNICATIONS CENTER, INC.
443 N. 48 STREET
LINCOLN, NE 68504
800-228-4097
Kenwood, Yaesu, Drake and More
at Discount Prices.

Nevada

COMMUNICATIONS CENTER WEST
1072 RANCHO DRIVE
LAS VEGAS, NV 89106
800-634-6227
Kenwood, Yaesu, Drake and More
at Discount Prices.

New Hampshire

EVANS RADIO, INC.
BOX 893, RT. 3A BOW JUNCTION
CONCORD, NH 03301
603-224-9961
Icom, DenTron, Yaesu, Drake.
We service what we sell.

New Jersey

ATKINSON & SMITH, INC.
17 LEWIS STREET
EATONTOWN, NJ 07724
201-542-2447
Ham supplies since "55".

METUCHEN RADIO
216 MAIN STREET
METUCHEN, NJ 08840
201-494-8350
New and Used Ham Equipment.
WA2AET "T" Bruno

RADIOS UNLIMITED
P. O. BOX 347
1760 EASTON AVENUE
SOMERSET, NJ 08873
201-469-4599
New Jersey's Fastest
Growing Ham Store.

New York

ADIRONDACK RADIO SUPPLY, INC.
185 WEST MAIN STREET
AMSTERDAM, NY 12010
518-842-8350
Yaesu and Kenwood dealer
for the Northeast.

AM-COM ELECTRONICS INC.
RT. 5
NORTH UTICA SHOPPING CTR.
UTICA, NY 13502
315-732-3656
The Mohawk Valley's Newest and
Largest Electronics Supermarket.

HAM-BONE RADIO
(Div. Stereo Repair Shop)
3206 ERIE BOULEVARD, EAST
SYRACUSE, NY 13214
315-446-2266
We Deal, We Trade,
We Discount, We Please!

HARRISON RADIO CORP.
20 SMITH STREET
FARMINGDALE, NY 11735
516-293-7990
"Ham Headquarters USA®"
since 1925.
Call toll free 800-645-9187.

RADIO WORLD
ONEIDA COUNTY AIRPORT
TERMINAL BLDG.
ORISKANY, NY 13424
800-448-7914
315-337-2622 } NY
315-337-0203 } Res.
New & Used Ham Equipment. See
Warren K2IXN or Bob WA2MSH

Ohio

**AMATEUR RADIO
SALES & SERVICE INC.**
2187 E. LIVINGSTON AVE.
COLUMBUS, OH 43209
614-236-1625
Antennas for all services.

COMMUNICATIONS WORLD, INC.
4788 STATE ROAD
CLEVELAND, OH 44109
216-398-6363
Repairs on all HF Gear
regardless of age.

Pennsylvania

ARTCO ELECTRONICS
302 WYOMING AVENUE
KINGSTON, PA 18704
717-288-8585
The largest variety of semiconduc-
tors in Northeastern Pennsylvania

ELECTRONIC EXCHANGE
136 N. MAIN STREET
SOUDERTON, PA 18964
215-723-1200
Demonstrations, Sales, Service.
New/Used Amateur Radio Equip.

**HAMTRONICS, DIV. OF
TREVISE ELECT.**
4033 BROWNSVILLE RD.
TREVISE, PA 19047
215-357-1400
Same Location for
More Than 30 Years.

LaRUE ELECTRONICS
1112 GRANDVIEW STREET
SCRANTON, PENNSYLVANIA 18509
717-343-2124
ICOM, Bird, Cushcraft, CDE,
Ham-Keys, VHF Engineering,
Antenna Specialists.

South Dakota

**BURGHARDT
AMATEUR CENTER, INC.**
P. O. BOX 73
WATERTOWN, SD 57201
605-886-7314
"America's Most Reliable
Amateur Radio Dealer".

Texas

HARDIN ELECTRONICS
5635 EAST ROSEDALE
FORT WORTH, TX 76112
817-461-9761
You Bet Fort Worth
Has A Ham Store!

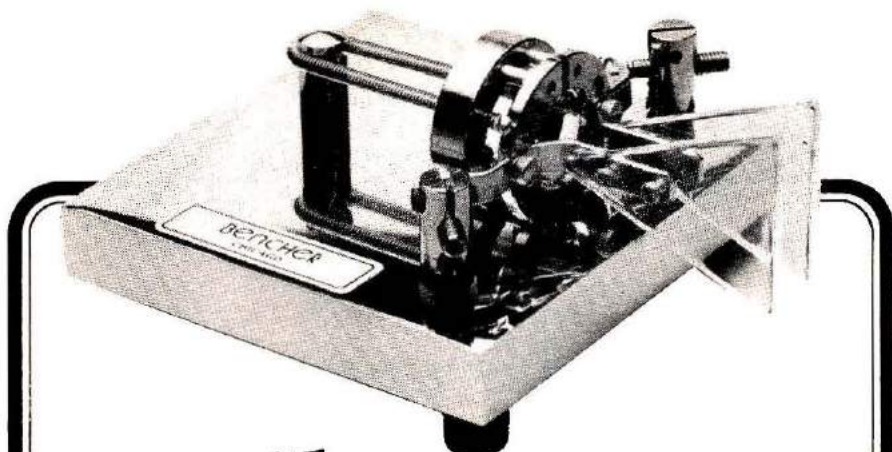

the Ultimate IAMBIC PADDLE

WRITE FOR LITERATURE

BENCHER, INC.

333 W. Lake Street, Dept. A
Chicago, Illinois 60606 • (312) 263-1808

- Full range of adjustment in tension and contact spacing.
- Self-adjusting nylon and steel needle bearings.
- Solid silver contact points.
- Polished lucite paddles.
- Precision-machined, chrome plated brass frames.
- Standard model has black, textured finish base; deluxe model is chrome plated.
- Heavy steel base; non-skid feet.

Available at selected dealers or send \$39.95 (\$49.95 for chrome model) plus \$2.00 shipping and handling. Overseas amateurs invited to request quotation for air parcel post shipment.

NEWCOMER OR OLD PRO . . .

ALPHA POWER

IS YOUR KEY TO A
BIG SIGNAL



ALPHA/VOMAX can boost the "talk power" of any rig up to ten times or more. The new SBP-4 split band speech processor uses the only system more effective than rf clipping — AND distortion is extremely

low so your voice sounds natural. Under tough conditions VOMAX can help as much as most linears. Combine VOMAX with a good linear and WOW! It's simple to install and operate with any rig.



ALPHA 76A is a heavy-duty "rock crusher" . . . a full kilowatt (2+KW PEP), No Time Limit, all-band desk top linear amplifier . . . a no-compromise ALPHA with a TWO YEAR FACTORY WARRANTY.

Other superb ALPHA's include the "ULTIMATE LINEAR" ALPHA 77Dx and two new models that require NO TUNE UP at all to deliver maximum legal power, with No Time Limit, on all bands. Call or write your dealer or ETO direct for detailed literature on all ALPHA products.



EHRHORN TECHNOLOGICAL
OPERATIONS, INC.
P.O. BOX 708, CANON CITY, CO 81212
(303) 275-1613

ALL BAND TRAP ANTENNAS!



PRETUNED - COMPLETELY ASSEMBLED - ONLY ONE NEAT SMALL ANTENNA FOR UP TO 6 BANDS! EXCELLENT FOR CONGESTED HOUSING AREAS - APARTMENTS LIGHT - STRONG - ALMOST INVISIBLE!

FOR ALL MAKES & MODELS OF AMATEUR TRANSCEIVERS - TRANSMITTERS - GUARANTEED FOR 2000 WATTS SSB 1000 WATTS CW. FOR NOVICE AND ALL CLASS AMATEURS!

COMPLETE AS SHOWN with 90 ft. RG58U-52 ohm feedline, and PL259 connector, insulators, 30 ft. 300 lb. test dacron and supports, center connector with built in lightning arrester and static discharge - molded, sealed, weatherproof, resonant traps "X6" - you just switch to band desired for excellent worldwide operation - transmitting and receiving! WT. LESS THAN 5 LBS.

160-80-40-20-15-10 bands 2 trap -- 149 ft. with 90 ft. RG58U - connector - Model 777BU . . . \$54.95
80-40-20-15-10 bands 2 trap -- 102 ft. with 90 ft. RG58U - connector - Model 998BU . . . \$49.95
40-20-15-10 bands 2 trap -- 54 ft. with 90 ft. RG58U coax - connector - Model 1001BU . . . \$48.95
20-15-10 bands 2 trap -- 26 ft. with 90 ft. RG58U coax - connector - Model 1007BU . . . \$47.95

SEND FULL PRICE FOR POST PAID INSURED DEL. IN USA. (Canada is \$5.00 extra for postage - clerical - customs - etc.) or order using VISA Bank Americard - MASTER CHARGE - AMER. EXPRESS. Give number and ex. date. Ph 1-308-236-5333 9AM - 6PM week days. We ship in 2-3 days. PRICES MAY INCREASE SO - ORDER NOW AND SAVE! All antennas guaranteed for 1 year. Money back trial! Made in USA. FREE INFO. AVAILABLE ONLY FROM.

WESTERN ELECTRONICS

Dept. AH-4

Kearney, Nebraska, 68847

FREE BOOK CATALOG

Whether you're interested in Amateur Radio, Electronics, Microprocessing, Microcomputer, Radio Astronomy, Old-Time Radio, VHF, SSB or just novels that involve Amateur Radio — you'll find a large selection of these books and more! Vast inventory of over 200 titles. Send your name and address to:

HAM RADIO'S BOOKSTORE

Greenville, NH 03048

NEW! ATLAS 110 LINE ATLAS RX-110

A high performance Ham Band Receiver at a fantastic low price.

- Frequency Coverage: 3500-4000 kHz, 7000-7500 kHz, 14,000-14,500 kHz, 21,000-21,500 kHz, 28,000-29,000 kHz.
- All Solid State, High Performance Design. Excellent Sensitivity, Selectivity, and Dynamic Range. Superior to Most Receivers currently on the market.
- Receives CW and normal SSB. Lower Sideband on 3.5 and 7 MHz bands. Upper Sideband on 14, 21, and 28 MHz bands.
- Built-in AC supply and loud speaker.
- EXCITING NEW FEATURE: The RX-110 converts to a 110-X Transceiver by plugging in the TX-110 Transmitter Module. The two units may be attached with brackets, if desired.

List Price \$229.00

This exciting new equipment is NOW IN STOCK! Order today with confidence. We are an authorized Atlas dealer and the East Coast Service Center for Atlas. Pennsylvania residents please add 6% Sales Tax.



mic not included.

TX-110 TRANSMIT MODULE

Note: New and used Atlas 210s and 215s IN STOCK!

Add the TX-110 Module to the RX-110 and PRESTO! A Complete Ham Band Transceiver.

A REAL BREAKTHROUGH IN VERSATILE LOW COST AMATEUR EQUIPMENT!

- Provides CW and SSB communications.
- All solid state.
- Full band coverage on 15 through 80 meters, 28 to 29 MHz on 10 meters.
- Choice of 15 watts input or 200 watts input, with power amplifier.

TX-110L (15 watts) \$159.00 List



WA3UCS — Steve
WA3UCR — Bill

SPECIALTY COMMUNICATIONS

2523 PEACH ST.
ERIE, PA 16502 814-455-7674



RATES Regular classified is available at 50¢ per word. Display classified (1 inch deep x 2 1/4 inches wide) is \$65, or at the 12x rate is \$50. All Ad Scan payable in advance. No cash discounts or agency commissions allowed.

HAMFESTS Sponsored by non-profit organizations receive one free regular classified ad (subject to our editing). Repeat insertions of hamfest ads pay the standard rate.

COPY No special layout or arrangements available. Material should be typewritten or clearly printed (not all capitals) and must include full name and address. We reserve the right to reject unsuitable copy. *HORIZONS* cannot check each advertiser and thus cannot be held responsible for claims made. Liability for correctness of material limited to corrected ad in next available issue.

DEADLINE 15th of third preceding month.

SEND MATERIAL TO: Ad Scan, Ham Radio Horizons, Greenville, N. H. 03048.

CUSTOM EMBROIDERED EMBLEMS — Your design, low minimum. Informational booklet. Emblems, Dept 65, Littleton, New Hampshire 03561.

CLUB CALL PINS — 3 lines 1 1/4 x 3 1/4 \$1.55 each call, first name and club. Colors black, blue or red with white letters. (catalog) Arnold Linzner, 2041 Linden Street, Ridgewood, N. Y. 11227.

CANADIAN HAMS: Help me help our kids learn about Amateur Radio. If you're willing to take a portable rig to school or have some youngsters visit your shack to talk to a ham in another province, send me your QSL card. On the blank side of the card list bands and modes you use. Our Ministry of Education school-to-school coordinator seems interested in helping me match up classes and hams. Bob Hulme, VE3DNG, Box 430, Temagami, Ontario P0H 2H0.

QSL's — TOP QUALITY — Samples 50¢ — Includes Rubber Stamp Info — Ebbert Graphics, Dept. 5H, Box 70, Westerville, Ohio 43081.

EZ DEALS are hard to beat. Try me and see for new or used ICOM, Cushcraft, KLM, Yaesu, Drake, Wilson, VHF Eng., Ten-Tec, Swan, Den-Tron, CDE, Hustler, Larsen, and more. W0EZ, Bob Smith Electronics, RFD 3, Fort Dodge, Iowa 50501. (515) 576-3886.

MOBILE IGNITION SHIELDING provides more range with no noise. Bonding strap sale less than 50¢ each. Literature. Estes Engineering, 930 Marine Drive, Port Angeles, Wash. 98362.

WANT UP-TO-DATE INFORMATION? "Radio-Hobbyist Newsletter" issued every two weeks. Only \$5.00 per year! Guaranteed! ARC; Box 1171-G; Garland, Texas 75040.

REPAIRS BY N2MB, NEW YORK AREA, First Class Commercial license, Amateur extra, in business 20 years — Radio Clinic, N2MB (formerly WA2BIT). 212-327-4952.

ANTENNA HOMEBREWERS: Complete line of aluminum, fiberglass, and stainless-steel antenna hardware. We will custom-design for you or supply to your design at prices you can't beat! GL Enterprises, Route 1, Box 10G, Brownsville, Wisconsin 53006. (414) 583-4001.

QSLs with class! Unbeatable quality, reasonable price. Samples: 50¢ refundable. QSLs Unlimited, 1472 SW 13th Street, Boca Raton, FL 33432.

SYNERTEK SYM, KTM, etc., now in stock at Alltronics, Phone (408) 371-3053 same day shipment. VISA/MC.

CUSTOM Printed and photo QSL's, very economical; free samples, stamp appreciated. Stu, K2RPZ, Box 412, Rocky Point, N. Y. 11778. (516) 744-6260.

FREQUENCY ALLOCATION CHART. See how the entire radio spectrum is used. 2 kHz to 200 GHz. Send \$3.00. Collins Chart Co., Box 935, Coronado, CA 92118.

QSL CARDS 500/\$10. 400 illustrations, sample. BOWMAN Printing, Dept. HRH, 743 Harvard, St. Louis, MO 63130.

NAMETAGS — 1 1/2" x 2 1/2" — One line \$2.50. Each additional line \$0.50. 12 colors. Tag-it Co., Box 2062, Indianapolis, IN 46206.

MICHIGAN: ARROW Repeater Association annual Swap and Shop Sunday, May 13, 1979 at the Saline Michigan Fairgrounds. Prizes, covered area for trunk sales, and indoor tables. Admission, including parking on the fairgrounds \$2.00 at door, \$1.50 advanced. Free admission for wives. Food service available. Talk-in on 146.37/97, 223.18/224.78 and 448.5/443.5 MHz. For details write ARROW, P.O. Box 1572, Ann Arbor, Michigan 48106 or call George Raub, AD8X, (313) 485-3562.

QSO PARTY: NEW ZEALAND; ZL3 Canterbury Chapter of the International 10/10 Net. From 0000 GMT Saturday, March 31, 1979 to 1200 GMT Sunday, April 1, 1979 (36 hours). Contact each station only once, on the ten meter band only; exchange call sign, name, QTH, 10X number, if any, Canterbury Chapter number (if held) and your own local Chapter name and number, if any. Awards include trophy to highest scorer overall, and a pennant to the highest scorer in each U.S., Canadian, Australian, Japanese and New Zealand call area; to each Central and South American country; to each European, Asian, and African country; and in three Pacific Ocean zones. Logs must be received no later than May 15, 1979. Please write clearly, show name, call, address and 10X number. Send logs to ZL3ME — C.J. Bramley, 198 Greers Road, Christchurch 5, New Zealand.

CODE got you stumped?

RELAX and worry not! Learn international Morse Code the EASY, Rus Farnsworth way. No books, no gimmicks, just listen & learn. Using the word method, based on modern psychological techniques, you can zoom past 13 w.p.m. in less than half the time! Available in cassettes @ \$10.95 and LP records at \$9.95 — you get over two hours of instruction!

EPSILON RECORDS

P.O. Box 626, San Jacinto, CA 92383

ELECTRONIC BARGAINS, CLOSEOUTS, SURPLUS! Parts, equipment, stereo, industrial, educational. Amazing values! Fascinating items unavailable in stores or catalogs anywhere. Unusual FREE catalog. ETCO-059, Box 762, Plattsburgh, N.Y. 12901.

CODE PRACTICE OSCILLATORS, hand keys, electronics keyers, other products. Free catalog. Globalman (W6PHA) Products, Box 388-HO, El Toro, CA 92630. 714-533-4400.

TEXAS: "Luckenbach DXpedition", 0800 CDT May 12, 1979 to 1200 CDT May 13, 1979, continuous. Call W5TEX. CW: 7.110 MHz and 21.110 MHz (± 5 kHz); FM: 52.525 MHz, 29.6 MHz, and 146.52 MHz; SSB: 3.9, 7.235, 14.285, 21.360, 28.625, 50.110 and 144.200 MHz; (± 5 kHz). Luckenbach sits nestled between two small rivers in the heart of the Texas hill country. Virtually untouched by modern civilization, this 1870's cowtown got its first pay telephone only last year. Luckenbach's general store/saloon/postoffice combination serves as a community center and gathering place for citizens to watch for the annual return of the mud dauber — a red hornet. Don't miss the fun of our "DXpedition". Send all logs and inquiries to Bob Schneider, AI5Q, 7206 Gumtree, San Antonio, Texas 78238.

STOP LOOKING for a good deal on amateur radio equipment — you've found it here — at your amateur radio headquarters in the heart of the Midwest. We may not have a toll free number but we'll save you more in the long run! We are factory-authorized dealers for Kenwood, Drake, Yaesu, Collins, Wilson, Ten-Tec, Atlas, ICOM, DenTron, MFJ, Tempo, Regency, Hy-Gain, Mosley, Alpha, Cushcraft, Swan, and many more. Write or call us today for our low quote and try our personal and friendly Hoosier service. HOOSIER ELECTRONICS, P.O. Box 2001, Terre Haute, Indiana 47802. (812) 238-1456.

MINNESOTA: Rochester Area Hamfest, Saturday, April 7, 1979 sponsored by the Rochester A.R.C. and Rochester Repeater Society. Doors open 8:30 AM at St. John's School gymnasium, 490 West Center Street, Rochester, MN. Large indoor flea market, prize raffles, refreshments, free parking. Talk-in on 146.22/82. For more information write RARC c/o K0TS, 2514 N.W. 4th Avenue, Rochester, Minnesota 55901.

WANT QSLs FAST? Send \$9.95 for 100 multicolored sent return mail! (\$4.00 each additional hundred!) Satisfaction guaranteed! ARC; Box #1171; Garland, Texas 75040.

OHIO: 10th Annual FM B*A*S*H*, 8 PM until midnight, Friday, April 27, 1979, at the Dayton Convention Center, Main at Fifth Street. Admission FREE to all hams and their friends. Food and C.O.D. bar available. Super floor show and drawings for fabulous prizes. For more information contact the Miami Valley F.M. Association, P.O. Box 263, Dayton, Ohio 45401.

NEW CONCEPT — Novice instructional package, theory tape & study material. Complete license study package, \$17.95. General study package, \$19.95. MARI, 1320 Canary Drive, West Columbia, SC 29169.

COMPUTER GENERATED CODE TAPES

New FCC type code test format with over 25 different Ham QSO's on each cassette! **General/Advanced** — 15 WPM, 80 minutes of actual copy. **Extra Class** — 22.5 WPM, 80 minutes of actual copy. \$5.95 postpaid or both tapes \$9.95 postpaid. Free printout of copy included to check your copy. Write COMPU-CODE, 113 Starlite Dr., Plano, TX 75074.

Reliability Service Experience

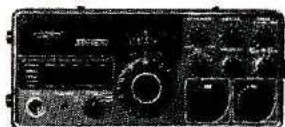

WANTED: Any working ham radio transceiver, with manual! **REWARD:** \$250 to be credited toward the purchase of a new **KENWOOD TS-600**. (Example: TS-600 \$759, less trade in of Drake TR-22 @ \$250. Your balance \$509.)



KENWOOD TR-7600 plus STACO RPS-8 six amp power supply (\$59.95 retail) all for **\$375**

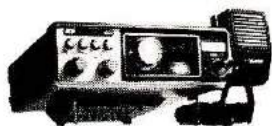

YAESU FT-227RA plus STACO RPS-8 six amp power supply all for **\$399**



KENWOOD TS-820S, list \$1299
RSE price **\$1049**

KENWOOD R-820, list \$1099
RSE price **\$929**

KENWOOD TL-922A, list \$1199
RSE price **\$1024**



Quantities limited. Michigan residents add 4% sales tax. Please include your area code and telephone number with any correspondence.



RSE HAM SHACK

NOW AT TWO LOCATIONS
31155 PLYMOUTH, LIVONIA, MI 48150
(313) 522-4232
1207 W. 14 MILE, CLAWSON, MI 48017
(313) 435-5660

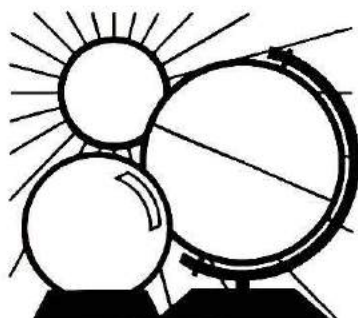

DX FORECASTER

A last-minute peek in the crystal ball shows April to be an excellent DX month with virtually all bands from 160 through 10 meters producing outstanding results for the DX chasers. A period between April 3rd and 10th is likely to be disturbed, with the days of the 7th, 8th, and 9th most likely to be involved in the ionospheric and geomagnetic "fireworks." Once again, a period between April 16th and 23rd may show some upsets — particularly around the 23rd, which is also the date of the full moon. For moonbouncers, perigee is also April 23rd. The rest of the month, with the possible exception of the 28th and 29th should be good for combing the bands of your choice. On these two days, keep an ear tuned to WWV for the solar-flux and geomagnetic-index information.

Band-by-band Propagation

As in March, 10 meters will be open much of the time every day, as will 15 and 20 meters, with the latter bands remaining open after local sunset and into the evening. Thunderstorm activity in April really makes 40 and 80 meters an uncomfortable, noisy place to listen, but on clear days and nights you will hear some long-skip signals coming through. The 160-meter band will be usable after dark, but is just about all through for any serious work until next fall. Local and short-skip stations will be workable however, depending on static levels.

Vhfers will like the 6-meter openings, which will be frequent as the muf moves ever upward in pace with the increasing sunspot activity. There will also be openings on 2 meters from a variety of possible sources such as storm-front propagation, and ionization of the E layer; a mixed bag of goodies that should make everyone happy to be licensed and operating.

Pay particular attention to the charts to tell you where to point your beam antennas for the best DX openings at various hours during each day. The highest usable bands will be shown, and the asterisk (*) means to look at the next *higher* band for possible openings along the path indicated.

HRH

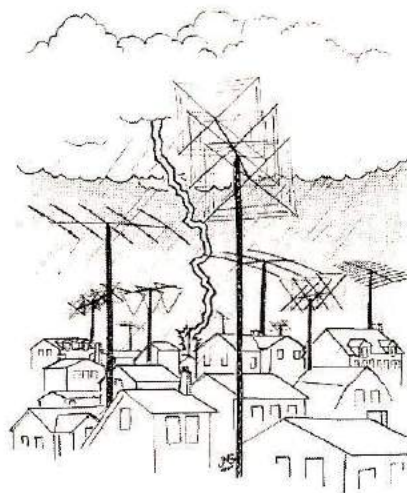

There is no justice ...

WESTERN USA

MID USA

EASTERN USA

GMT	WESTERN USA										MID USA										EASTERN USA									
	PST	CENTRAL ASIA	EUROPE	S. AFRICA	S. AMERICA	ANTARCTICA	NEW ZEALAND	W. AUSTRALIA	OCEANIA	FAR EAST	CENTRAL ASIA	EUROPE	S. AFRICA	S. AMERICA	ANTARCTICA	NEW ZEALAND	W. AUSTRALIA	OCEANIA	FAR EAST	CENTRAL ASIA	EUROPE	S. AFRICA	S. AMERICA	ANTARCTICA	NEW ZEALAND	W. AUSTRALIA	OCEANIA	FAR EAST		
0000	4:00	15	—	15*	10	20	10	15	10	15	10	15	10	15	10	15	10	15	10	15	10	15	10	15	10	15	10	15	10	
0100	5:00	15	—	15	10	20	10	15	10	15	10	15	10	15	10	15	10	15	10	15	10	15	10	15	10	15	10	15	10	
0200	6:00	15	—	15	15	20	10	15	10	15	15*	15	15	15	15*	15	15	15	15	15	15	15	15	15	15	15	15	15	15	
0300	7:00	15	—	20	15	—	10	15	15	15	15	15	15	15	15	15	15	15	15	15	15	15	15	15	15	15	15	15	15	
0400	8:00	15	—	20	15	—	10	15	15	15	15	15	15	15	15	15	15	15	15	15	15	15	15	15	15	15	15	15	15	
0500	9:00	20	—	—	15	—	15	15	20	20	20	20	20	20	20	20	20	20	20	20	20	20	20	20	20	20	20	20	20	
0600	10:00	20	—	—	15	—	15	15	20	20	20	20	20	20	20	20	20	20	20	20	20	20	20	20	20	20	20	20	20	
0700	11:00	20	20	—	20	—	15	15	20	20	20	20	20	20	20	20	20	20	20	20	20	20	20	20	20	20	20	20	20	
0800	12:00	—	—	—	20	—	15	20	20	20	20	20	20	20	20	20	20	20	20	20	20	20	20	20	20	20	20	20	20	
0900	1:00	—	—	—	—	—	20	20	—	—	—	—	—	—	—	—	—	—	—	—	—	—	—	—	—	—	—	—	—	
1000	2:00	—	—	—	—	—	20	20	—	—	—	—	—	—	—	—	—	—	—	—	—	—	—	—	—	—	—	—	—	
1100	3:00	—	—	—	—	—	20	20	—	—	—	—	—	—	—	—	—	—	—	—	—	—	—	—	—	—	—	—	—	
1200	4:00	—	—	—	20	—	20	20	—	—	—	—	—	—	—	—	—	—	—	—	—	—	—	—	—	—	—	—	—	
1300	5:00	—	—	—	20	20*	15	15	20	20	20*	15	15	20	20	20	20	20	20	20	20	20	20	20	20	20	20	20	20	
1400	6:00	20	20	15	15	—	—	—	—	—	—	—	—	—	—	—	—	—	—	—	—	—	—	—	—	—	—	—	—	
1500	7:00	15	15	15*	15*	—	15	20	—	—	—	15	20	—	—	—	—	—	—	—	—	—	—	—	—	—	—	—	—	
1600	8:00	15	10	10	10	—	20	15	—	—	—	15	10	10	10	10	10	10	10	10	10	10	10	10	10	10	10	10	10	
1700	9:00	15	10	10	10	—	20	15	—	—	—	15	10	10	10	10	10	10	10	10	10	10	10	10	10	10	10	10	10	
1800	10:00	20	10	10	10	—	20	15	—	—	—	15	10	10	10	10	10	10	10	10	10	10	10	10	10	10	10	10	10	
1900	11:00	20	15	10	10	—	20	15	—	—	—	15	10	10	10	10	10	10	10	10	10	10	10	10	10	10	10	10	10	
2000	12:00	20	20	10	10	—	15	15*	15	15	15	15	15	15	15	15	15	15	15	15	15	15	15	15	15	15	15	15	15	
2100	1:00	20*	20	10	10	—	15*	10	15*	10	15	10	10	10	10	10	10	10	10	10	10	10	10	10	10	10	10	10	10	
2200	2:00	20*	20	10	10	15	10	10	10	10	10	10	10	10	10	10	10	10	10	10	10	10	10	10	10	10	10	10	10	
2300	3:00	20*	—	10	10	20	10	15	10	10	10	10	10	10	10	10	10	10	10	10	10	10	10	10	10	10	10	10	10	

APRIL

SUNDAY	MONDAY	TUESDAY	WEDNESDAY	THURSDAY	FRIDAY	SATURDAY
<p>Old Natchez ARC Hamfest — Natchez Convention Center — Natchez, MS Perry W. Hess Association Tradesfest '79 — 1106 Charles Miller — 30334, TX Bechtold Room — Fairfest-His — PA 15030</p>	<p>FLORIDA HAM NEWS — SWAP NET By the Broward ARC 146 31 91 at 7:30PM BLEEMHURST RADIO SOCIETY Transmits Amateur Radio News — 222 86/224 26 MHz via WR2APG and 21 400 MHz USB WEST COAST BULLETIN Edited & Transmitted by W6ZP 8PM PST 3540 kHz A-1 22 WPM</p>	<p>ANKSAT Eastcoast Net 3850 kHz 8PM EST - 10:00Z Wednesday Morning ANKSAT Mid-Continent Net 3850 kHz — 8PM CST 10:00Z Wednesday Morning ANKSAT Westcoast Net 3850 kHz 7PM PST - 10:00Z Wednesday Morning</p>	<p>West Coast Qualifying Run</p>			<p>ARRL Hamfest — Columbia, MO ARRL — Dares — CO Party — CO — 17-8 Repeater ARC Repeater Society Hamfest — St. John's School Gymnasium, 100 W. Center Street — Hopkinsville, MO Walesley ARS Auction — Walesley High School — Walesley, MA — MA1YVY</p>
1	2	3	4	5	6	7
<p>Madison Area Repeater Association Swadfest — Dave Co Expo Center Forum Building, Madison, WI</p>	<p>FLORIDA HAM NEWS — SWAP NET By the Broward ARC 146 31 91 at 7:30PM BLEEMHURST RADIO SOCIETY Transmits Amateur Radio News — 222 86/224 26 MHz via WR2APG and 21 400 MHz USB</p>	<p>ANKSAT Eastcoast Net 3850 kHz 8PM EST - 10:00Z Wednesday Morning ANKSAT Mid-Continent Net 3850 kHz — 8PM CST 10:00Z Wednesday Morning ANKSAT Westcoast Net 3850 kHz 7PM PST - 10:00Z Wednesday Morning</p>	<p>W1AW Qualifying Run</p>			
8	9	10	11	12	13	14
<p>See April 5, 4, 7 12, 17</p> 	<p>FLORIDA HAM NEWS — SWAP NET By the Broward ARC 146 31 91 at 7:30PM BLEEMHURST RADIO SOCIETY Transmits Amateur Radio News — 222 86/224 26 MHz via WR2APG and 21 400 MHz USB WEST COAST BULLETIN Edited & Transmitted by W6ZP 8PM PST 3540 kHz A-1 22 WPM</p>	<p>ANKSAT Eastcoast Net 3850 kHz 8PM EST - 10:00Z Wednesday Morning ANKSAT Mid-Continent Net 3850 kHz — 8PM CST 10:00Z Wednesday Morning ANKSAT Westcoast Net 3850 kHz 7PM PST - 10:00Z Wednesday Morning</p>				<p>ARRL "Open" CD Party — Phone — 21-22 EME Contest #11 — 21-22 Jackson ARC Hamfest — Kalamoon Academy Gymnasium — Jackson, MS 21-22 P-D Day Hamfest — 4900B City, Eagle View, located at the Kansas City Downtown Plaza — Kansas City, MO — 21-22 Fenton Computer Festival — Fenton State College — Fenton, NJ — 21-22</p>
15	16	17	18	19	20	21
<p>Delaware Valley Radio Assoc. Lawrencetown Amateur Repeater Group Hamfest — New Jersey National Guard 112th Field Artillery Armory — Trenton, NJ Rock River Rd Hamfest — Lee County 4-H Center, South of Oaken, IL, near east of Route 52 and 30</p>	<p>FLORIDA HAM NEWS — SWAP NET By the Broward ARC 146 31 91 at 7:30PM BLEEMHURST RADIO SOCIETY Transmits Amateur Radio News — 222 86/224 26 MHz via WR2APG and 21 400 MHz USB</p>	<p>ANKSAT Eastcoast Net 3850 kHz 8PM EST - 10:00Z Wednesday Morning ANKSAT Mid-Continent Net 3850 kHz — 8PM CST 10:00Z Wednesday Morning ANKSAT Westcoast Net 3850 kHz 7PM PST - 10:00Z Wednesday Morning</p>			<p>Central Massachusetts ARS Auction, Fairmarket, Near South American, English Post 341 — Worcester, MA — WATLEP Continues 28A**</p>	<p>DAYTON HAMVENTION</p>
22	23	24	25	26	27	28
<p>Delaware Valley Radio Assoc. Lawrencetown Amateur Repeater Group Hamfest — New Jersey National Guard 112th Field Artillery Armory — Trenton, NJ Rock River Rd Hamfest — Lee County 4-H Center, South of Oaken, IL, near east of Route 52 and 30</p>	<p>FLORIDA HAM NEWS — SWAP NET By the Broward ARC 146 31 91 at 7:30PM BLEEMHURST RADIO SOCIETY Transmits Amateur Radio News — 222 86/224 26 MHz via WR2APG and 21 400 MHz USB</p>	<p>ANKSAT Eastcoast Net 3850 kHz 8PM EST - 10:00Z Wednesday Morning ANKSAT Mid-Continent Net 3850 kHz — 8PM CST 10:00Z Wednesday Morning ANKSAT Westcoast Net 3850 kHz 7PM PST - 10:00Z Wednesday Morning</p>				<p>DAYTON HAMVENTION</p>
29	30					
<p>Dayton Hamvention W1AW Qualifying Run</p>	<p>FLORIDA HAM NEWS — SWAP NET By the Broward ARC 146 31 91 at 7:30PM BLEEMHURST RADIO SOCIETY Transmits Amateur Radio News — 222 86/224 26 MHz via WR2APG and 21 400 MHz USB</p>					<p>**DAYTON HAMVENTION — Dayton, OH — 27-29 2M BBS — Dayton Convention Center — Main & 5th Streets — Dayton, OH — 27-29 2M BBS — Dayton Convention Center — Main & 5th Streets — Dayton, OH — 27-29 2M BBS — Dayton Convention Center — Main & 5th Streets — Dayton, OH — 27-29 2M BBS — Dayton Convention Center — Main & 5th Streets — Dayton, OH — 27-29</p>

NOVICE DELIGHT



Make a Good Start. Begin your ham career with a HF transceiver you can really enjoy now. Get up to 250 watts dc input on 80 and 40, and 200 watts on 15 meters with the Alda 103A.

Enjoy the frequency flexibility of a rock-solid VFO. The convenience of semi break-in keying.

Use the receiver-incremental-tuning (RIT) feature to reduce adjacent-channel interference on CW or SSB. And monitor your own keying easily with the built-in sidetone.

Change bands without the hassle of final-amplifier tuning. The solid-state PA is totally broadband.

A Rig to Grow With. After you've upgraded to General, plug in the mic and work the world on SSB. For even more fun, go mobile.

You'll need a mobile mount available at your dealer, or direct from the factory. And while you're at it, order a noise blanker. A big help in copying through ignition noise.

Power for the Alda 103A. The transceiver requires a nominal 13.8 volts dc input at 20 amps. When you operate mobile, just connect the transceiver directly to the battery.

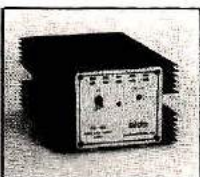

The PS-130 delivers 30 amps regulated and requires 117v or 220v, 50/60 Hz input.

For base station operation, you'll need an ac power supply. The Alda

PS-130 will give you full rated power on SSB and CW. The PS-115 will give you full power on SSB and 75% of full power on CW.

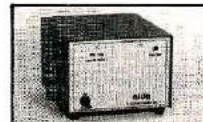

The PS-115 delivers 18 amps unregulated and requires 117v or 220v, 50/60 Hz input.

Summary Specifications.

Frequency Coverage . . . 80, 40 and 15 meters

Input Power

With power from car or Alda

PS-130 . . . 250 watts PEP or dc on 80 and 40 meters, 200 watts PEP or dc on 15 meters

With power from Alda

PS-115 . . . 250 watts PEP/200 watts dc on 80 and 40 meters, 200 watts PEP/175 watts dc on 15 meters

Dimensions . . . 3 1/4 inches (82 mm) high, 9 inches (228 mm) wide, 12 1/2 inches (317 mm) deep

Weight 8 1/4 lbs. (3.66 kg)

Only \$495 Base Price. See your dealer or write to us directly for ordering information. Our address is Alda Communications, Inc., 215 Via El Centro, Oceanside, CA 92054. Phone (714) 433-6123.

Here are the prices of optional accessories which you can buy now or later.

Model HM-1 Microphone . . .	\$ 14.95
Model MM-1 Mobile mount . . .	3.95
Model PC-701 Noise Blanker	39.95
Model PC-801 Dual xtal calibrator, 100 kHz and 25 kHz	19.95
Model PS-115 Power supply	84.95
Model PS-130 Power supply	149.95

alDa 103A
We're proud it's built in the U.S.A.

AD CHECK

... for literature, in a hurry — we'll rush your name to the companies whose names you check.

Place your check mark in the space between name and number. Example: HRH 150.

ALDA ___ 625	Long's ___ 468
Amateur Radio Rochester ___ 752	MFJ ___ 082
Antenna Mart ___ 009	Madison *
Astatic ___ 484	Microwave Filter ___ 637
Atlas ___ 198	J.W. Miller ___ 745
Barker & Williamson ___ 765	Oak Hill Acad. A. R. S. *
Bencher ___ 629	P.C. Elect. ___ 766
Chemtronics ___ 706	Palomar Eng. *
Cohoon ___ 559	Pathcom ___ 705
Comm. Center ___ 534	Portland Radio ___ 719
Cover Craft ___ 685	RF Power Comp. ___ 542
Cushcraft *	RSE Ham Shack ___ 607
DSI ___ 656	Callbook ___ 100
Dayton Hamvention *	Constructor ___ 586
Daytronics ___ 612	Radio World *
Drake *	S-F A. R. S. ___ 640
Edsyn ___ 759	Specialty Comm. ___ 739
E.T.O. *	Swan ___ 111
EICO ___ 285	Taylor ___ 674
Erickson *	Telrex ___ 377
Fox-Tango ___ 657	Ten-Tec *
Hal *	Thomas Comm. ___ 730
H.R.B. ___ 150	Tri-Ex ___ 116
Horizons ___ 150	Universal Mfg. ___ 684
Henry ___ 062	Webster Assoc. ___ 423
Icom ___ 065	Western *
Int. Crystal ___ 066	Wilson ___ 123
Kantronics *	
Kenwood *	
Klaus ___ 430	
Larsen ___ 078	

*Please contact this advertiser directly.

Limit 15 inquiries per request.

APRIL 1979

Please use before May 31, 1979

Tear off and mail to
HAM RADIO HORIZONS — "Ad Check"
Greenville, N. H. 03048

NAME _____

CALL _____

STREET _____

CITY _____

STATE _____ ZIP _____

MADISON APRIL SHOWERS



% WRITE IN
YOUR
BEST QUOTE
FROM THE
"800 GANG."

NOW, LIST THE EQUIPMENT YOU WANT IN THE SPACES PROVIDED BELOW, CUT OUT THIS AD, AND SEND IT TO US WITH YOUR NAME, ADDRESS AND TELEPHONE NUMBER. WE WILL WRITE OR CALL (CHECK ONE) YOU BACK AS SOON AS POSSIBLE WITH THE **MADISON QUOTE**.

(HINT: DON'T GO BELOW OUR COST).

WE HAVE AN IN-DEPTH STOCK AND LARGE INVENTORY OF MAJOR LINES AND ACCESSORIES.

PLEASE QUOTE ON:

1. _____	NAME _____
2. _____	ADDRESS _____
3. _____	TELEPHONE _____
4. _____	ZIP _____

TERMS: ALL PRICES FOB HOUSTON. PRICES SUBJECT TO CHANGE WITHOUT NOTICE. ALL ITEMS GUARANTEED. SOME ITEMS SUBJECT TO PRIOR SALE. SEND LETTERHEAD FOR AMATEUR DEALER'S PRICE LIST. TEXAS RESIDENTS ADD 6% TAX. PLEASE ADD POSTAGE ESTIMATE.

MADISON ELECTRONICS SUPPLY, INC.

1508-D MCKINNEY HOUSTON, TEXAS 77002
713/658-0268 NITES 713/497-5683

AD INDEX

ALDA Communications	77
Amateur Radio of Rochester, Inc.	49
Antenna Mart	69
Atlas Radio Company	Cover IV
Barker & Williamson, Inc.	67
Bencher, Inc.	72
Cohoon Amateur Supply	53
Communications Center	55
Cover Craft	79
Cushcraft	40, 41
DSI Instruments	4
Dayton Hamvention	48
Drake Co., R. L.	Cover IV, 63
Ehrhorn Technological Operations	72
Erickson Communications	69
Hal Communications Corp.	9
Ham Radio's Bookstore	58, 59, 72
Ham Radio Horizons	68
Henry Radio Stores	66
Icom	7
International Crystal	21
Kantronics	68
Trio-Kenwood Communications Inc.	Cover III
Klaus Radio Inc.	65
Larsen Antennas	67
Long's Electronics	1
MFJ Enterprises	3
Madison Electronic Supply	68, 78
Microwave Filter, Inc.	69
Oak Hill Academy Amateur Radio Session	48
Palomar Engineers	57
Pathcom, Inc.	49
Portland Radio Supply Co.	79
RF Power Components	67
RSE Ham Shack	74
Radio Amateur Callbook	46
Radio & Electronics Constructor	48
Radio World	48
S-F Amateur Radio Services	66
Specialty Communications	72
Swan Electronics	47
Taylor Radio Company, Inc.	79
Telrex Laboratories	69
Ten-Tec	29
Thomas Communications	80
Tri-Ex Tower Corp.	61
Universal Manufacturing Corp.	64
Webster Associates	68
Western Electronics	72
Wilson Electronics	10

Foreign Subscription Agents for Ham Radio HORIZONS

Ham Radio Austria
Karin Ueber
Postfach 2454
D-7850 Loerrach
West Germany

Ham Radio Holland
MRL Electronics
Postbus 88
NL-2204 Delft
Holland

Ham Radio Belgium
Stereohouse
Brusselsesteenweg 416
B-9218 Gent
Belgium

Ham Radio Italy
STE, Via Maniaco 15
I-20134 Milano
Italy

Ham Radio Canada
Box 114, Goderich
Ontario, Canada N7A 3Y5

Ham Radio Switzerland
Karin Ueber
Postfach 2454
D-7850 Loerrach
West Germany

Ham Radio Europe
Box 444
S-194 04 Uplands Vasby
Sweden

Ham Radio France
Christiane Michel
F-89117 Parly
France

Ham Radio UK
P. O. Box 63, Harrow
Middlesex HA3 6HS,
England

Ham Radio Germany
Karin Ueber
Postfach 2454
D-7850 Loerrach
West Germany

Holland Radio
143 Greenway
Greenside, Johannesburg
Republic of South Africa

SINCE 1932

Portland Radio Supply Co.

DAH-DIT-DAH-DIT DAH-DAH-DIT-DAH

OREGON RESIDENTS — CALL TOLL FREE

800-452-0908

TO ORDER DESK — PORTLAND STORE



- ALLIANCE • ATLAS
- CDE • CIR
- COLLINS • DRAKE
- ICOM • KENWOOD
- REGENCY • SWAN • TEN-TEC
- YAESU • COVER CRAFT • CUSHCRAFT
- HY-GAIN • KLM • MOSLEY • NYE • NEW-TRONICS • LARSEN • ROHN • TRI-EX • TRISTAO
- UNADILLA (W2AU) • PLUS A COMPLETE LINE OF PARTS FOR YOUR NEEDS.

SALES & SERVICE AT TWO LOCATIONS IN OREGON

1133 SOUTH RIVERSIDE AVE.
MEDFORD, ORE. 97501
503-773-5815

1234 S.W. STARK ST.
PORTLAND, ORE. 97205
503-228-8647

RAVE REVIEWS

"I want to express my thanks for a beautiful job. They fit just fine and I am very well pleased."
Norm Howard, W1JBV

"The workmanship and quality are excellent. Well worth the money."
Gene Amara

"Thanks for the 'expedite' on the covers! As usual, they fit fine!"
Keith Baker, WD8CMU

"Again, thank you for the covers. They fit perfectly as have the other covers I've ordered from your company in the past."
Phil Wilson, WA4MCP



And "Thank you, Folks," for your kind words.

Cover Craft Dust Covers are available at more than 90 Amateur retailers.

Why wait any longer?

COVER CRAFT
P.O. Box 555, Amherst, NH 03031
Telephone (603) 673-8592

2MPC

COLINEAR 2 METERS

- 2Mtr. Phased Collinear
- +6.5 db Gain
- +Phased Collinear Design
- +Impervious to Wx
- +52 ohm Feed
- +Mount Accomodates up to 1 1/4" Dia.
- +Simple Field Adjustment
- +Adjustable Matching
- +Very Low VSWR
- +Stainless Clamps
- +500 Watt Rating
- +90mph Wind Survival
- +Gain Measures over 1/4 Wave

**2M-PC
Amateur Net
\$34.95**

**6.5 db
Over
1/4 wave**



TAYLOR RADIO COMPANY, INC.
3305 Commerce Drive-North Leg Industrial Park
Augusta, Georgia 30909 - Phone 404-736-3336

Call Toll Free 1-800-243-7765

FREE

• Retail Price Catalog • Monthly
Computerized Used Equipment List



KENWOOD TS-820S



YAESU FT-901

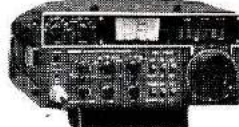

ICOM IC-701



KDK 2015R



IC-701

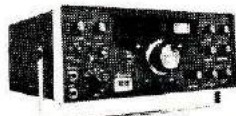

TEN TEC OMNI-D

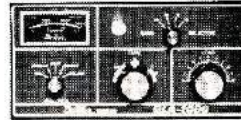

GLA-1000

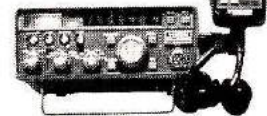

CPU 2500 R/K

OVER 50 BRANDS IN STOCK

- KENWOOD • SWAN • KDK • DENTRON •
- MOSLEY • WILSON • YAESU • DRAKE •
- LARSEN • BENCHER • PIPO • BEARCAT •
- B & W • DATONG • ICOM • PANASONIC •
- ARRL PUBLICATIONS • ALLIANCE • MFJ •
- CUSHCRAFT • TRAC • MICROLOG • CDE •
- FINCO • DSI • DAYBURN INSULATORS •
- BIRD • ASTATIC • HAM KEY • REGENCY •
- HUSTLER • SAXTON • TEN TEC • AMECO •
- AMCOMM • CALL BOOK • KLM • TEMPO •
- ROHN • BUTTERNUT • Plus Many More! •

★ NEW AND USED EQUIPMENT

"Get on our used equipment mailing list"

★ TRADES WELCOME

"The best allowances anywhere"

"We buy good used SSB gear"

★ FREE CATALOG

"Prices of all major manufacturers"

★ SAME DAY U.P.S. SHIPPING

"Just a phone call away"

★ COMPLETE RADIO SERVICE SHOP

"Mail Order Repair Service"

- Fast Efficient Service • We Repair All Brands
- All Work Guaranteed • Amateur Extra/First Class Licenses • Send Us Your Defective Equipment U.P.S. Collect • Free Shipping Both Ways If Work Is Done
- Most Repairs Done and Shipped Within 7 Days

OUR FINE REPUTATION SPEAKS FOR ITSELF

"YOU SHIP IT

WE FIX IT"

THOMAS COMMUNICATIONS

Call
or Write
for your
super quote
today!

95 Kitts Lane, Newington, Conn. 06111

"Near ARRL Headquarters"

Connecticut Residents Call:

(203) 667-0811



OPEN MON.-FRI. 10-6 • THURS. 10-8 P.M. • SAT. 10-4

EASY DIRECTIONS: Rt. 15 South — 2 blocks past McDonald's
(Berlin Turnpike)

The DXer's Choice.

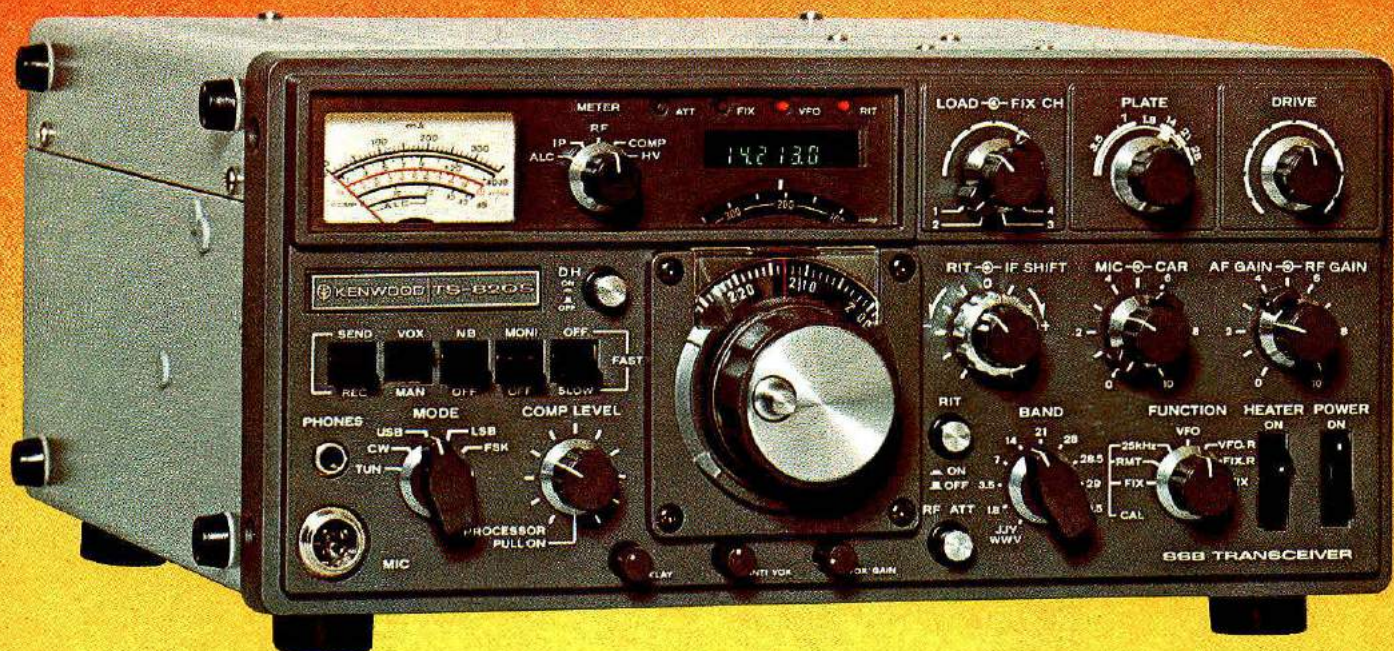

Kenwood's TS-820S has everything the Amateur Operator could want in a quality rig.

Time proven over thousands of hours of operating time, the Kenwood TS-820S has become the preferred rig for those individuals interested in high reliability. And, the TS-820S has every feature any Amateur could want for operating enjoyment, on any band, from 160 through all of 10 meters... plus an RF speech processor in the transmitter, IF shift and sharp filters in the receiver. All combine to give optimum performance under all conditions.

You can always tell who's running a TS-820S. Its superb quality stands out from all the other rigs on the band... and when the QRM gets heavy the TS-820S's adjustable RF speech processor,

utilizing a 455-kHz circuit to provide quick-time-constant compression, will get the message through. RF negative feedback is applied from the final to the driver to improve linearity, and third-order products are at least -35 dB. Harmonic spurious emissions are less than -40 dB and other spurs are less than -60 dB.

RF input power is 200 W PEP on SSB, 160 W DC on CW, and 100 W DC on FSK. Receiver sensitivity is better than $0.25 \mu\text{V}$ for 10 dB S/N.

The TS-820S from Kenwood! See it today at your nearest Authorized Kenwood Dealer.



KENWOOD

... pacesetter in amateur radio

TRIO-KENWOOD COMMUNICATIONS INC.
1111 WEST WALNUT/COMPTON, CA 90220

Introducing the first price breakthrough in amateur radio equipment in a decade!



\$388

ATLAS 110 TRANSCEIVER

- Self-contained power supply and speaker
- All solid state
- Covers 10-80 meters
- 20 watt input power
(250 watt model available)
- SSB and semi-break-in CW with sidetone

True, it doesn't have all the bells and whistles, but it does two things extremely well:

It does an excellent job of receiving.

It does an excellent job of transmitting.

On both SSB and CW.

Compare the performance of the Atlas 110 with any other equipment on the market, and see for yourself: it is truly a high performance transceiver in every respect.

And it costs only \$388.

Also available is the Model 110 Special, which includes RIT, CW Filter, and RF Gain Control.

Both the 110 Standard and the 110 Special transceivers are available with either 20 watt or 250 watt power

input rating. (250 watt model requires a separate AC power supply.)

The receive portion of the 110 transceiver is also available separately, as the Atlas RX-110 receiver. The TX-110 transmit module may be added later.

20 W MODEL 110 STANDARD TRANSCEIVER... **\$388**

20 W MODEL 110 SPECIAL* TRANSCEIVER... **\$428**
(illustrated above)

250 W MODEL 110 STANDARD TRANSCEIVER... **\$478**

250 W MODEL 110 SPECIAL* TRANSCEIVER... **\$518**

PS-110H AC POWER SUPPLY... **\$ 89**

(required with 250 watt transceiver)

*Includes RIT, CW filter, RF Gain Control.

For complete details see your Atlas dealer or drop us a card and we'll mail you a brochure with dealer list.

 **ATLAS**
RADIO INC.
417 Via Del Monte, Oceanside, CA 92054
Phone (714) 433-1983