

JANUARY 1978 / \$1.25

AM RADIO HORIZONS

PC

40 *
**

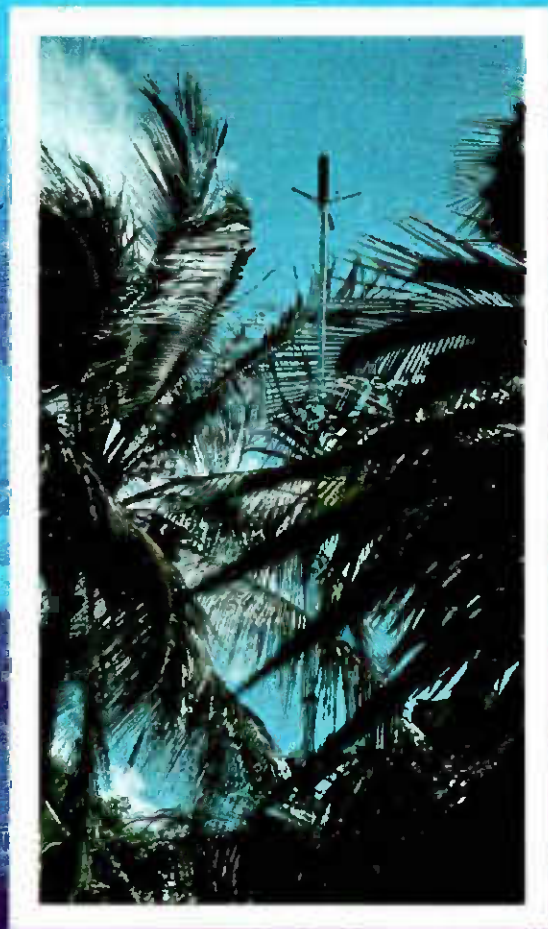

DXpedition to the Caribbean

DX-ing

on an island so small that
the only things resembling coconuts
are the traps on your beams—

You'll be glad you're using a Drake C-Line...

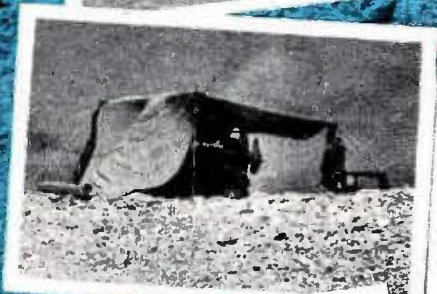

R.L. Drake Company
Miamisburg, Ohio

1977 DXpedition Group
Palmyra / Kingman Reef

A DXpedition to Kingman Reef requires the operators to have an uncommon amount of faith in their equipment. For this reason we chose the Drake C-Line.

- Our two C-Lines were subjected to what we feel were some of the most adverse conditions possible:
1. Temperatures were 150° plus in the engine room of our chartered boat for 17 days.
 2. Generator voltage was low due to running 1kW amplifiers. (Typically 100 volts)
 3. AC-4 power supplies were sitting in water on several occasions due to severe rains.
 4. During one rain storm, water was actually coming out of the R-4C headphone jack.
 5. Numerous small lizards and spiders were crawling in and out of the C-Lines.

Despite all these adversities, the two Drake C-Lines were in operation for over 145 hours; the only "off time" was during the six hour trip from Palmyra Island to Kingman Reef. A total of over 16,000 contacts were made from KP6AL Palmyra and KP6BD Kingman Reef without a single transmitter or receiver failure.

I know that customer satisfaction has been the cornerstone of R.L. Drake Co. for 34 years. Let me say that as far as we are concerned, that cornerstone is firmly in place.

Thank you for making a very reliable product.

Barry J. Fairfax

Barry J. Fairfax WB9KTA,
operator: KP6AL Palmyra Island
KP6BD Kingman Reef

Received 7/15/77 by:

R. L. DRAKE COMPANY



DRAKE

540 Richard St., Miamisburg, Ohio 45342 • Phone: (513) 866-2421 • Telex: 288-017

Western Sales and Service Center, 2020 Western Street, Las Vegas, Nevada 89102 • 702/382-9470



CALL TOLL FREE! 1-800-633-3410 and save big on Drake!

In some cases save up to \$100.00! Offer is good while supplies last.

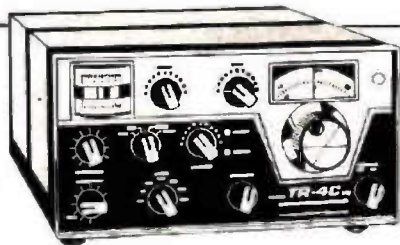

DRAKE TR-4CW transceiver

TR-4CW covers 80 thru 10 meters
• Modes: SSB, AM, CW • 300 watts
PEP input: SSB, 260 watts AM & CW
• Has RIT • Transceive or separate
PTO • Wide range receiving AGC
• Solid-state VFO • CW semi-break-in
• VOX or PTT • Shifted-carrier CW
• Constant calibration mode to mode.

699.00 List price: 799.00

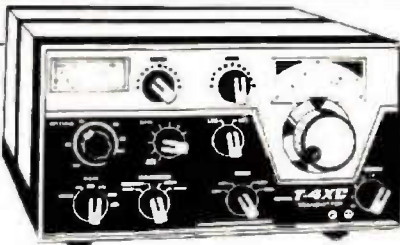

DRAKE T-4XC transmitter

T-4XC features: 80 thru 10 meter
coverage with crystals furnished
• Covers 160 meters with accessory
crystal (optional) • 200 watts PEP in-
put on SSB and CW • Controlled
carrier modulation for AM • VOX or
PTT on SSB or AM is built-in
• USB/LSB/AM/CW on all bands
• Built-in CW sidetone.

599.00 List price: 699.00

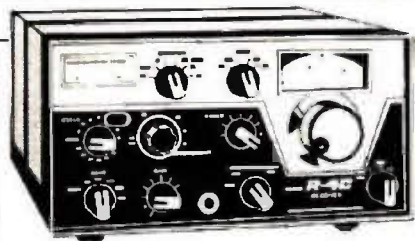

DRAKE R-4C receiver

The R-4C features: • 80 thru 10 meter
coverage with crystals furnished
• Covers 160 with accessory crystal
(optional) • Linear permeability-tuned
VFO • Modes of operation:
SSB/CW/AM/RTTY/SSTB • 3 AGC
release times • Crystal lattice filter
• Dial calibration: 0 to 500 KHz in 1 KHz
increments.

599.00 List price: 699.00



DRAKE L-4B linear amplifier

The L-4B features: • 2000 watts PEP on
SSB, 1000 watts DC on CW, AM, &
RTTY • High efficiency Class B
grounded grid circuit • Transmitting
AGC • Broadband tuned input
• Directional watt meter • RF neg.
feedback • 2 taut-band suspension
meters • Solid-state power supply.

895.00 List price: 995.00



DRAKE MS-4 matching speaker

The Drake MS-4 matching speaker is
designed for use with the Drake R-4C,
R-4B, R-4A, and R-4 receivers. It has
space inside to house the Drake AC-4
power supply or the AC-3 power supply.
The 8-ohm speaker will always
come through loud and clear.

30.00 Long's price. Call today.

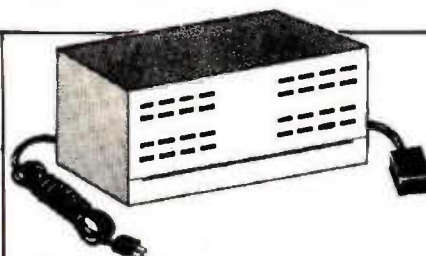

DRAKE AC-4 power supply

The AC-4 power supply works with all
Drake 4-line transceivers and
transmitters. Fits inside the MS-4
speaker cabinet. • Input: 120 or 240
VAC • Output: 650 VDC at 300 mA
average, 500 mA peak, also: 12.6 VAC
at 5.5 amps. Just what you need to
complete your Drake station.

120.00 List price: 150.00

Remember, you can call TOLL-FREE: 1-800-633-3410 in U.S.A. or call 1-800-292-8668 in Alabama for our low price quote. Store hours: 9:00 AM til 5:30 PM, Monday thru Friday.



Long's Electronics



MAIL ORDERS: P.O. BOX 11347 BIRMINGHAM, AL 35202 • STREET ADDRESS: 2808 7TH AVENUE SOUTH BIRMINGHAM, ALABAMA 35233

THIS MONTHS

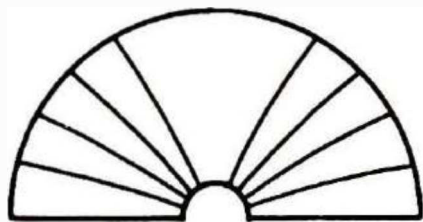

HORIZONS

West Indies Adventure

Did you ever dream of being on the receiving end of a pileup throughout a contest? How about being able to change from one sought-after country to another with a minimum of travel and bother? Then add exotic sights, friendly people, helpful local amateurs, and you have the makings of a most memorable vacation. K1DG tells you how he and his friends worked out the plan and then carried it through. The line for tickets forms on the right.

Simple Dipole Antennas

Of the many antenna designs which are available to amateurs, the half-wavelength dipole or doublet is hard to beat. It has much to offer: simplicity, low cost, easy installation, and good performance; all contribute to its great popularity. In this article W1HR shows you how to build dipole antennas, discusses what you can expect in way of performance, and tells you how you can extend coverage up to five bands with one simple antenna.

CB Happiness

If you are a Citizens-Band operator and are thinking of something better in radio communications, here's real food for thought. WB2HJD interviewed many CBers who were disenchanting with what's happening on CB and who wanted something better. Most didn't want to

abandon CB entirely in favor of ham radio. The testimonials included here indicate that many CBers would like the best of both worlds.

In true reporting style, WB2HJD obtained written permission to use their pictures from all persons whose photos appear in this article.

Looks like more converts every day to amateur radio! So be it.

Learning Morse Code

It's an inescapable fact. You must be able to receive and send Morse at various speeds to pass examinations for amateur operator licenses. There's really no easy way to get over this hurdle. Many ads in the amateur magazines offer all kinds of methods for learning the code. Some are okay; some are questionable. It all boils down to one basic fact: To be proficient, you *must practice*. There's no other way.

In this article, editor W6NIF has provided some ideas for learning the code; once learned, these ideas can be used for increasing proficiency in receiving and sending.

Earthquake

Certainly you remember the devastating quake that struck Guatemala in early 1976. Some of the pictures accompanying this article aren't very pretty — but, as the story shows, man is ever ready to help man. We at *Ham Radio Horizons* are proud to present this account of how amateur radio operators reached out to help others in distress.

How To Speak "Ham"

Abbreviations and *Q signals* are used to save time without losing essential information in the transmission and reception of radio messages. To be an efficient operator, you'll need to know what abbreviations mean, as well as how and when to use them correctly. Correct use of

these time-honored signals helps you lose your Novice "dialect."

Your Power Supply

Power supplies probably cause more problems in electronic equipment than any other circuit. To be sure, you may find a piece of equipment in which some other circuit is more often the cause of problems, but that's the exception rather than the rule. Here we'll explore the operation of a simple power supply and examine the voltage waveforms produced on an oscilloscope.

Questions? And Answers!

This part of the series gets to the end of Operating Procedures, talks about the why and how of amateur operation during emergencies, and then finishes up the section on Emission Characteristics. You'll find out what the A and F designations mean, as in A0, A1, or F3. Parasitic oscillations and harmonic output are undesirable emissions, but they are not alone in that category.

The Cover

What ham can resist the dream of antennas in the midst of a tropical vacation scene? The dream became reality for K1DG on more than one island in the West Indies. Just to compound the thrill, he combined the antenna location with a good DX spot, and checked it out during a DX contest.

HAM RADIO HORIZONS January, 1978, Volume 2, No. 1. Published monthly by Communications Technology, Inc., Greenville, New Hampshire 03048. One-year subscription rate, \$10.00; three-year subscription rate, \$24.00. Second-class postage paid at Greenville, New Hampshire 03048 and additional offices.

Call toll-free 800-647-8660

for products by MFJ ENTERPRISES



\$59⁹⁵



MFJ-901 Versa Tuner
 This NEW MFJ Versa Tuner matches everything from 160 thru 10 Meters: dipoles, inverted vees, long wires, verticals, mobile whips, beams, balance lines, coax lines. Up to 200 watts RF OUTPUT. Built-in balun, tool New efficient air wound coil for more watts out!
 Only MFJ uses an efficient air wound inductor in this class of tuners for more watts out and far less losses than a high permeability toroid core!



\$39⁹⁵

MFJ-16010 Antenna Tuner
 Now you can operate all bands — 160 thru 10 Meters — with a single random wire and run your full transmitter power output — up to 200 watts RF power OUTPUT.
 • Small enough to carry in your hip pocket, 2-3/16 x 3-1/4 x 4 inches • Matches low and high impedance by interchanging input and output • SO-239 coaxial connectors • 12 position tapped inductor. Stacked toroid cores • At 1.8 MHz tuner matches 25 to 200 ohms.



\$29⁹⁵

CWF-2BX Super CW Filter
 This MFJ Super CW Filter gives you 60 Hz bandwidth, and extremely steep skirts with no ringing for razor sharp selectivity that lets you pull signals out of heavy QRM. Plugs between receiver and phones or connect between audio stage for speaker operation.
 • Selectable BW: 80, 110, 180 Hz • 60 dB down one octave from center frequency of 750 Hz for 80 Hz BW • Reduces noises 15 dB • 9 V battery • 2-3/16 x 3-1/4 x 4 inches • CWF-2PC, wired PC board, \$19.95.



\$69⁹⁵

MFJ-8043 IC Deluxe Electronic Keyer
 This NEW MFJ Deluxe Keyer gives you more features per dollar than any other keyer available.
 • Uses Curtis-8043 keyer chip • Sends iambic, automatic, semi-automatic, manual • Use squeeze, single lover, or straight key • Dot memory, self-completing dots and dashes, jam proof spacing, instant start • RF proof • Solid state keying ±300 V max • Weight, tone, volume, speed controls • Uses 4 C-cells; external power jack • 6 x 6 x 2 inches • Sidetone and speaker • Optional squeeze key. \$29.95



\$54⁹⁵

CMOS-8043 Electronic Keyer
 State of the art design uses CURTIS-8043 Keyer-on-a-chip.
 • Built-in Key • Dot memory • Iambic operation with external squeeze key • 8 to 50 WPM • Sidetone and speaker • Speed, volume, tone, weight controls • Ultra reliable solid state keying ±300 volts max. • 4 position switch for TUNE, OFF, ON, SIDETONE OFF • Uses 4 penlight cells • 2-3/16 x 3-1/4 x 4 inches



\$59⁹⁵

LSP-520BX II Log Speech Processor
 Up to 400% more RF power. Plugs between your microphone and transmitter.
 • Gives your audio punch power to slice through QRM • 30 dB IC log amp and 3 active filters • RF protected • 9 V battery • Two Mic jacks: 1/4" phone jacks, uncommitted 4 pin jack • Output cable • 2-1/8 x 3-5/8 x 5-9/16 inches • LSP-520BX, in standard MFJ enclosure, electronically identical, \$49.95.



\$29⁹⁵

SBF-2BX SSB Filter
 Dramatically improves readability.
 • Optimizes your audio to reduce sideband splatter, remove low and high pitched QRM, hiss, static crashes, background noise, 60 and 120 Hz hum • Reduces fatigue during contest, DX, and ragchewing • Plugs between phones and receiver or connect between audio stage for speaker operation • Selectable bandwidth IC active audio filter • Uses 9 volt battery • 2-3/16 x 3-1/4 x 4 inches



\$29⁹⁵

MFJ-200BX Frequency Standard
 Provides strong, precise markers every 100, 50, or 25 KHz well into VHF region.
 • Exclusive circuitry suppresses all unwanted markers • Markers are gated for positive identification. CMOS IC's with transistor output. • No direct connection necessary • Uses 9 volt battery • Adjustable trimmer for zero beating to WWV • Switch selects 100, 50, 25 KHz or OFF • 2-3/16 x 3-1/4 x 4 inches



\$49⁹⁵

MFJ-1030BX Receiver Preselector
 Clearly copy weak unreadable signals (Increases signal 3 to 5 "S" units).
 • More than 20 dB low noise gain • Separate input and output tuning controls give maximum gain and RF selectivity to significantly reject out-of-band signals and reduce image responses • Dual gate MOS FET for low noise, strong signal handling abilities • Completely stable • Optimized for 10 thru 30 MHz • 9 V battery • 2-1/8 x 3-5/8 x 5-9/16 inches



\$29⁹⁵

MFJ-40T QRP Transmitter
 Work the world with 5 watts on 40 Meter CW.
 • No tuning • Matches 50 ohm load • Clean output with low harmonic content • Power amplifier transistor protected against burnout • Switch selects 3 crystals or VFO input • 12 VDC • 2-3/16 x 3-1/4 x 4 inches
 MFJ-40V, Companion VFO \$29.95
 MFJ-120C, IC Regulated Power Supply, 1 amp, 12 VDC \$29.95



\$49⁹⁵



MFJ-202 RF Noise Bridge
 This MFJ RF Noise Bridge lets you adjust your antenna quickly for maximum performance. Measure resonant frequency, radiation resistance and reactance. Exclusive range extender and expanded capacitance range gives you much extended measuring range.
 • Tells whether to shorten or lengthen antenna for min SWR • Range extender and expanded cap. range (±150 pf) for wide imp measurements • 1 to 100 MHz



\$19⁹⁵

C-500 Digital Alarm Clock
 This digital alarm clock is also an ID Timer. Assembled, too!
 • Gives ID buzz every 9 minutes automatically, or after tapping ID/doze button • Pressing ID/doze button displays seconds • Large 63 inch digits • Easy zero to WWV • AM and PM LED indicators • Power out indicator • Fast set, slow set buttons • 110 VAC, 60 Hz • 3-1/8 x 3-3/4 x 3-3/8 inches • One year warranty by Fairchild

Order any product from MFJ and try it. If not delighted, return within 30 days for a prompt refund (less shipping).
 Order today. Money back if not delighted. One year unconditional guarantee. Add \$2.00 shipping/handling.
 Order By Mail or Call TOLL FREE 800-647-8660 and Charge It On

MFJ ENTERPRISES P. O. BOX 494
 MISSISSIPPI STATE, MISSISSIPPI 39762
 In Europe contact: ING I. STERN, Lohkoppelstrasse 27, 2000 Hamburg 76, West Germany. Tel.: (040) 299-6110, Telex: 2161808 STEX D

ATB-34

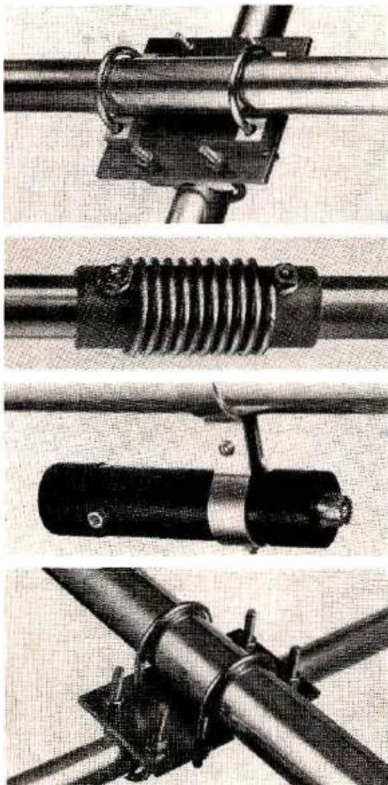
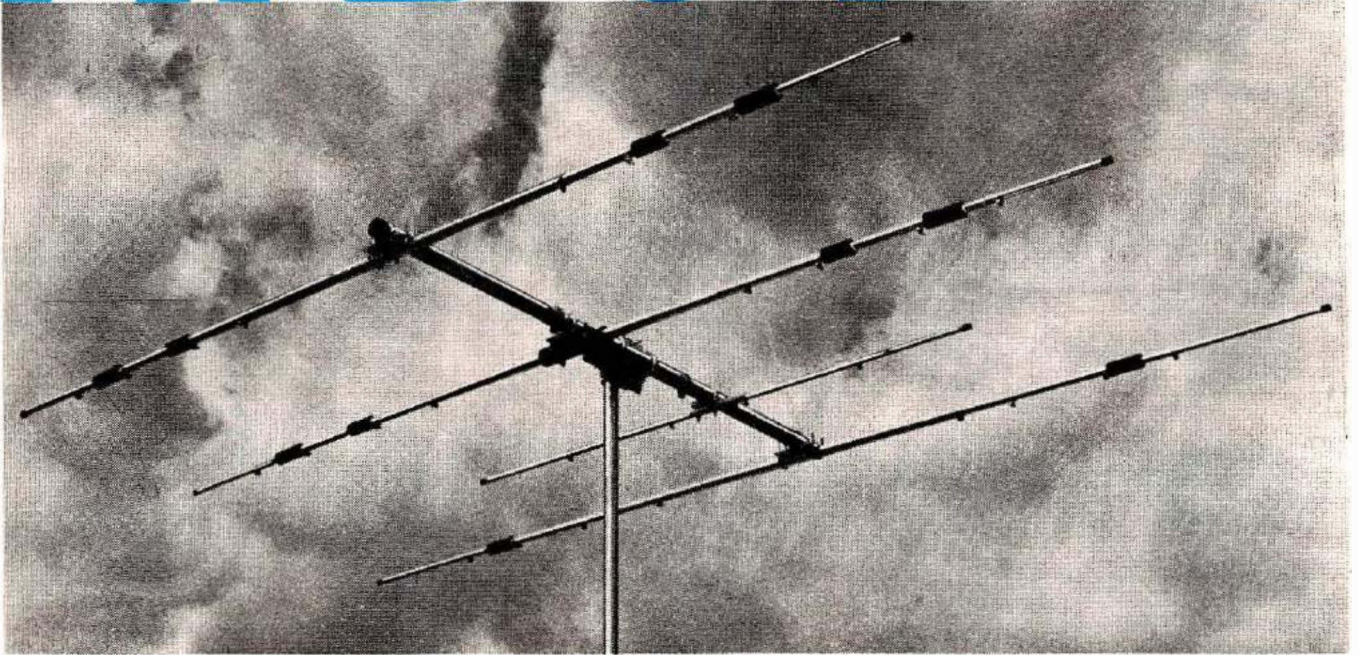

4 ELEMENT-3 BAND 10-15-20 METER BEAM

Cushcraft engineers have incorporated more than 30 years of design experience into the best 3 band HF beam available today. **ATB-34** has superb performance with three active elements on each band, the convenience of easy assembly and modest dimensions. Value through heavy duty all aluminum construction and a price complete with 1-1 balun.

Enjoy a new world of DX communications with ATB-34!

SPECIFICATIONS

FORWARD GAIN -	7.5 dBd	WIND SFC -	5.4 Sq.Ft.
F/B RATIO -	30 dB	WEIGHT -	42 Lbs.
VSWR -	1.5-1	WIND SURVIVAL -	90 MPH.
POWER HANDLING -	2000 WATTS PEP		
BOOM LENGTH/DIA. -	18' x 2 1/8"		
LONGEST ELEMENT -	32'8"		
TURNING RADIUS -	18'9"		

\$239.95

COMPLETE
NO EXTRAS TO BUY

UPS SHIPPABLE

IN STOCK WITH DISTRIBUTORS WORLDWIDE



cushcraft

CORPORATION

BOX 4680, MANCHESTER, N.H. 03108

January, 1978
Volume 2, Number 1

HAM RADIO HORIZONS

T.H. Tenney, Jr., W1NLB
Publisher

James R. Fisk, W1HR
Editor-in-Chief

Editorial Staff

Thomas F. McMullen, Jr., W1SL
Managing Editor

Patricia A. Hawes, WA1WPM
Executive Editor

Charles J. Carroll, K1XX
Alfred Wilson, W6NIF
Assistant Editors

Publishing Staff

C. Edward Buffington, WB1AMU
Assistant Publisher

Fred D. Moller, Jr., WA1USO
Advertising Manager

James H. Gray, W1XU
Assistant Advertising Manager

Therese R. Bourgault
Circulation Manager

Ham Radio Horizons
is published monthly by
Communications Technology, Inc
Greenville, New Hampshire 03048
Telephone 603-878-1441

Subscription rates are
\$10.00 per year, worldwide

Copyright 1977 by Communications
Technology, Inc. Title registered
at U.S. Patent Office

Microfilm copies
are available from
University Microfilms, International
Ann Arbor, Michigan 48103

Cassette tapes of selected articles
from *Ham Radio Horizons* are available to
the blind and physically handicapped
from Recorded Periodicals
919 Walnut Street, 8th Floor
Philadelphia, Pennsylvania 19107

CONTENTS

West Indies DX Adventure 12
Norman D. Grant, K1DG

Dipole Antennas 18
James R. Fisk, W1HR

CBers Become Hams 28
Charlene Babb Knadle, WB2HJD

Some Ideas for Learning the Code 32
Alfred Wilson, W6NIF

**Guatemalan Earthquake — Amateur
Communications Helps the Victims 36**
Robert C. Reiley, WB2FHN

Speak the "Ham" Language 42
James H. Gray, W1XU

Power Supply Basics 50
Joseph J. Carr, K4IPV

Questions? and Answers! Part 6 58
Thomas F. McMullen, W1SL

Activities Calendar 76

Ad Check 78

Ad Scan 73

Advertiser's Index 78

Benchmarks 66

DX Forecaster 74

Focus and Comment 8

Horizons Locator 68

Newsline 11

Product Showcase 70

Propagation Chart 75

Publisher's Log 6

Station of the Month 64

This Month's Horizons 2



The Second Year of *Ham Radio Horizons*! It seems hard to believe that nearly twelve months have passed since we put the final touches on that all-important first issue and then waited to see just how our reception would go.

It's all history now, and exciting history at that. *Horizons* has been very well accepted, and both our magazine and amateur radio have continued to grow at a very brisk pace; we like to feel that these two events go hand in hand. *Ham Radio Horizons* continues to introduce amateur radio to many potential newcomers, while the tens of thousands who have been licensed in recent months have provided us with an ever-growing, eager, group of new subscribers.

We would particularly like to extend a welcome to several thousand subscribers who have joined us in the past month or so from sources outside the ranks of amateur radio. Your new readership is both an honor and a responsibility to all of us here at *Ham Radio Horizons*, and we promise to do our very best to show you just what ham radio is all about, and how to start getting in on all the fun the rest of us are having with this fascinating hobby.

We have some good plans for *Ham Radio Horizons* in 1978, and you should find each issue even more useful and exciting than ever before. You'll find a new column, "Benchmarks," which will focus on those small ideas and gadgets which can make the maintenance and operation of an amateur station so much more enjoyable. For many, these pages may well become one of the most valuable aspects of their electronics library.

Many excellent, new, feature articles are in the works, including both a new Novice transmitter and receiver that have been designed specifically with the newcomer in mind. They'll be easy to build, and perhaps of even more significance, all of the required components will be easy to find. You can look for the first of them by mid-year, with the other not too far behind. There will be some excellent articles on the important part that clubs play in amateur radio. You'll learn about the good features (and some bad features) of many clubs, and also what your organization can do to stress the positive side of things.

We'll be growing in 1978: as more and more advertisers learn of the unique advertising opportunities that *Ham Radio Horizons* offers we will be able to bring you larger issues with even more good ideas and projects. We'll also be doing a lot of hard work to line up a lot more new readers (we hope to at least double our circulation this year), and, hopefully, reach out to many real good candidates for the amateur ranks.

As you can see, we are all planning for a busy and exciting year at *Ham Radio Horizons*. Stay tuned along with us and join in on all the fun.

Skip Tenney, W1NLB
Publisher

ICOM wants you to

Begin with the Best

As you develop your skills, increase your participation in Ham Radio activities, and add hardware for ever-increasing flexibility of operations, you'll come to know ICOM. Just ask any old Ham. ICOM is the quality name in VHF/UHF Amateur Radio equipment because it is simply the best. ICOM is the line you'll want to move up to for unequaled quality and features.

But you needn't wait until you can trade in a truck load of equipment to reach up to ICOM. You can begin building your Amateur Radio operations with reasonably priced ICOM units that have flexible add-on features when you purchase your very first voice transceiver. And when you are installing ICOM's top-of-the-line fixed station unit, the ICOM equipment you began with will probably still be an important integral part of your active hardware.

Don't delay in moving up to ICOM: begin with the best.



Clockwise from lower left: IC-211 4MHz, 2 meter, All Mode Transceiver; IC-245 Mobile 2 meter Transceiver; IC-229 Mobile VHF FM Transceiver; IC-502 Portable 50 MHz SSB Transceiver; IC-215 Portable 2 meter FM Transceiver; IC-30A Mobile UHF FM Transceiver.

Ask your dealer for ICOM's complete product line catalog, or mail your request to an address below.

VHF/UHF AMATEUR AND MARINE COMMUNICATION EQUIPMENT

Distributed by:



ICOM

ICOM WEST, INC.
Suite 3
13256 Northrup Way
Bellevue, Wash. 98005
(206) 747-9020

ICOM EAST, INC.
Suite 307
3331 Towerwood Drive
Dallas, Texas 75234
(214) 620-2780

ICOM CANADA
7087 Victoria Drive
Vancouver B.C. V5P 3Y9
Canada
(604) 321-1833



FOCUS & COMMENT

In the first issue of *Horizons*, March, 1977, we had a letter from a reader asking how to get started in putting a ham station together. Some of the articles we have printed since then have been aimed at providing this information, notably "Your Station From the Ground Up," in April, "Be Proud of Your Hamshack," in September, and "Amateur Station Accessories," in November. Then, too, there was "Get On the Air On A Budget," in the same first issue that saw the letter published in the *Postbox* section.

An idea was put forth in the Editor's answer to that letter — how about some readers sending in photographs and descriptions of their stations so we could show the uninitiated what amateur stations look like.

I'm glad to say that response to the idea has been good, and that we are starting 1978 in the proper manner by presenting a *Station of the Month* in this, the January issue.

There are several important areas to consider when the *Station of the Month* is being selected, and the two that are foremost in our minds are that the station depicted must be meaningful to a beginner, and the accompanying photograph must be of sufficient quality to withstand the rigors of magazine reproduction; the greatest station layout in the world will be meaningless if the photograph is fuzzy, dark, pale, streaked, or if the composition is poor.

There are no restrictions as to cost, amount of equipment, shack size, mode(s) of operation, or whatever. Photographs that have the operator visible are fine, of course, as long as the perspective doesn't cause him (or her) to hide a major portion of the equipment from view. After all, we are interested in showing other hams some ideas about setting up their own stations.

We are also trying to show people that a good, working, hamshack is an achievable goal — therefore a photograph that shows a roomfull of equipment costing kilobucks does not guarantee that it will be selected; but, neither does it automatically get ruled out because of cost. I guess the word I am looking for is "relevant."

Each station that is selected and published will receive a suitable gift from our Ham Radio's Communications Bookstore. We'll start out with Alice Clink Schumacher's excellent book, *Hiram Percy Maxim*. It's an enthralling story of the man acclaimed "father of amateur radio," who had the vision and perseverance to take steps to secure the existence of our great hobby — a book that should be read by every amateur and would-be amateur.

At year's end, we will look over all of the stations selected, and see if there is any way to choose the best of the lot (without getting our ears roasted in the process). The one selected will receive a three-year subscription to *Ham Radio Horizons*.

You'll find suggestions about photographs and written material on page 64, where we present our first selection as *Station of the Month*. Dust off your camera, put a new ribbon in the typewriter, and let us know about your station if you feel that it has something to offer a beginner who wants to know, "but what will my station look like?"

Tom McMullen, W1SL
Managing Editor

SPECIAL TRIPLE BONUS DEAL on KENWOOD TS-820S

**SERVING
HAMS
BETTER!**

*North ... south ...
east ... west*

All leading brands ...
in-depth stocks ...
new/used gear.



The deal:

- 1)—Send us 1048.00* (in the form of check, M/O, BankAmericard, VISA, Master Charge)
- 2)—We'll ship you immediately, a beautiful brand-spanking-new, peerless performing **KENWOOD TS-820S TRANSCEIVER!**
- 3)—PLUS a **BIRD Model 43 wattmeter** (a 120.00 retail value). **OR . . . De luxe Remote VFO** (for TS-820S)
- 4)—PLUS prepaid shipment of both items (UPS Brown)

* (Calif. residents add 6% sales tax)

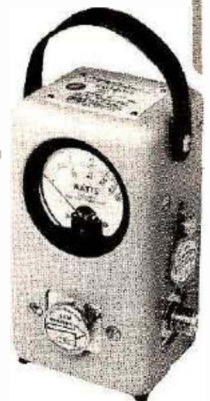

BIRD ELEMENTS
(Not supplied with BIRD wattmeter)
2-30MHz . . . 42.00
25-1000MHz . . . 36.00

RFE-100 DIGITAL READOUT
(for Drake R-4C receiver) **169.95**

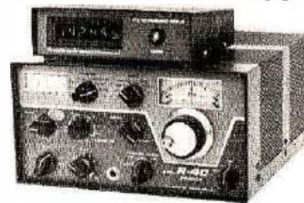

DRAKE R-4C RECEIVER
A limited number
at old price of **599.00**

HY-GAIN TH6DXX

De Luxe, 6 element Hy-Gain Thunderbird, covers 10, 15, 20 meters. Separate low loss traps for each band. Hy-Gain Beta match for low VSWR with 50 ohm line.

Longest element: 31.1 ft.
Boom: 24 ft.
Turning radius: 20 ft.
Wind load: (80 mph): 156 lbs.
Max. wind survival: 100 mph.
Surface area: 6.1 sq. ft.
Net weight: 57 lbs.

TRI-EX W-51 TOWER

Our "package" deals can't be beat!
The "package" antenna, tower, rotator
Inquire

Every-day special
**CDE HAM III
rotator**
129.95

shipped prepaid (UPS Brown)

**SHURE
33.95
444**



← shipped prepaid (UPS Brown) →



**ICOM IC-22S
VHF transceiver**
249.00

OVER THE COUNTER (Mon. thru Sat. 10AM to 5:30PM). PHONE, WRITE. SAME DAY SHIPMENT MOST ITEMS.

HAM RADIO OUTLET

SOUTH

Anaheim, Calif. 92801

2620 W. La Palma, (714) 761-3033

1 mile east Knott's Berry Farm (213) 860-2040

NORTH

Burlingame, Calif. 94010

999 Howard Ave., (415) 342-5757

5 miles south on 101 from S.F. Airport.

SOUTH

Van Nuys, Calif. 91401

13754 Victory Blvd., (213) 988-2212

Dealer inquiries invited.



**Bob Ferrero,
K6AHV/W6RJ,
Jim Rafferty, N6RJ,**
other well known hams,
give you courteous,
personalized service.



• ATLAS • BIRD • CDE • COLLINS • CUSHCRAFT • CURTIS • DENTRON • DRAKE • EIMAC • HUSTLER
• HY-GAIN • ICOM • KENWOOD • KLM • MOSLEY • SWAN • TEMPO • TEN TEC • TRI-EX • YAESU • more.

Wilson's

System One

TRIBANDER ANTENNA IS HERE...

System One

FOR 20, 15 and 10 METERS
Monoband performance
with 4 elements on 20 meters
on a 26' boom

NEW! 100% TRIBANDER
ANTENNA SHOWN HERE
WITH THE WR 500 ROTOR
AND 550' BUSHY BARK 87
WIRE - 50' P
(System not shown)

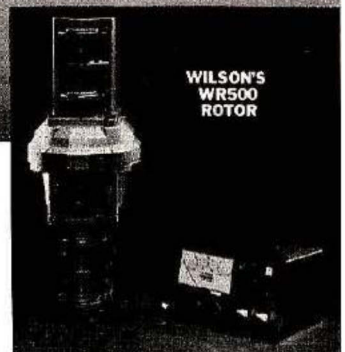

WILSON'S
WR500
ROTOR

The new standard of performance for Tribanders is the Wilson System One!!! A DX'er's delight operating 20 meters on a full 26' boom with 4 elements, 4 operational elements on 20-15-10, plus separate reflector element on 10 meters for correct monoband spacing. Featured are the large diameter High-Q Traps, Beta matching system, heavy duty Taper Swaged Elements, rugged Boom to Element mounting . . . and value priced at \$259.95. Additional features: • 10 dB Gain • 20-25 dB Front-to-Back Ratio • SWR less than 1.5 to 1 on all bands.

MODEL SY-1 SPECIFICATIONS:

Matching Method:	Beta	F/B Ratio	20-25 dB	Mast Diameter	2" O.D.
Band MHz:	14-21-28	Boom Length	26'	Boom Diameter	2" O.D.
Maximum Power Input:	Legal Limit		[2" O.D.]	Surface Area	7.3 sq. ft.
Gain	10 dB	No. of Elements	5	Windload Area	146 lbs.
VSWR (at Resonance)	1.5 to 1	Longest Element	26' 7"	Shipping Weight	50 lbs.
Impedance	50 ohms	Turning Radius	18' 6"		

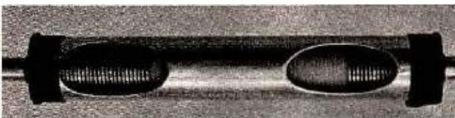
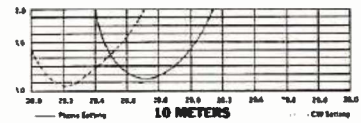
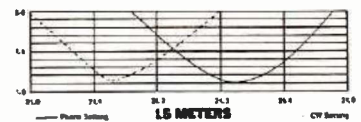
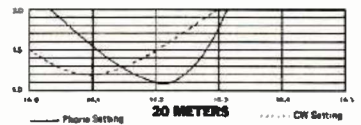

ADVANCED DESIGN LARGE DIAMETER HIGH-Q TRAPS FOR MINIMUM LOSS AND MAXIMUM POWER CAPACITY

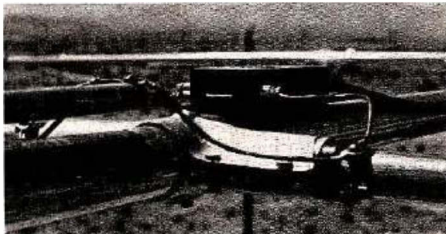

INSULATED DRIVEN ELEMENT WITH PRECISION BETA MATCH AND HEAVY DUTY ELEMENT MOUNTS

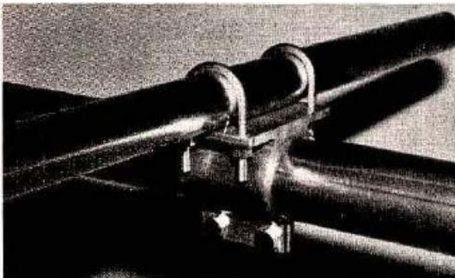

HEAVY DUTY BOOM TO ELEMENT EXTRUSION

AMATEUR PRODUCTS DEALERSHIPS FOR MANY AREAS ARE AVAILABLE!!!
If you are interested in the profits you can make as a Wilson Dealer, contact us.

For complete specifications on the above products or a copy of our new Amateur Products Buyers Guide, write: Consumer Products Division

Wilson Electronics Corp.
P.O. BOX 19000 • LAS VEGAS • NEVADA • 89119 • (702) 739-1931 • TELEX 684-522

NEWSLINE

FCC'S DROPPING OF DOCKET 19759, the proposal that the 220-MHz Amateur band provide a home for a new CB service, doesn't mean that the band won't still become the new CB home. It does remove the immediate threat to the band, however, and many opinions have it that the longer the decision on where CB should go is delayed, the less likely 220 becomes as a choice.

In Announcing Its Termination of Docket 19759 the Commission pointed out that so many changes in related circumstances have occurred since several thousand comments were filed on it back in 1973, those comments are now obsolete. However, the question of new CB frequencies is still very much alive, and 220 will undoubtedly be one of the options when the Commission considers the issue again in a future rulemaking.

THE LARGEST NON-EMERGENCY AMATEUR RADIO net operation ever organized provided total communications for the October, 1977, New York City Marathon, in which over 5000 runners from all 50 states and 38 foreign countries participated. 221 New York and New Jersey Amateurs, coordinated by the Tri-State Amateur Radio Council, provided communications for the 26-mile, 385-yard race through all five New York City boroughs. Long Island Mobile Amateur Radio Club alone provided 65 operators for the event, which used repeaters WR2 ACD, ACH, and AFE plus simplex.

Fine Amateur Radio PR resulted, with over a million and a half spectators seeing and hearing Amateur Radio at work during the 12-hour event. Congratulations to Coordinator WA2DHF.

AMATEUR LICENSING IRREGULARITIES will receive a full-fledged investigation run by an FCC Administrative Law Judge. The decision to go all-out on such a probe was reached at a closed meeting of the Commission last October, when information was presented that some of the same abuses may have occurred without payment; and that some amateur callsigns have been issued inconsistent with normal FCC procedures.

Such An Inquiry is a very formal proceeding including subpoena powers and the ability to require witnesses to testify. Though it will undoubtedly be Washington based, it's entirely possible that sessions will also be held in other cities. It has been considered likely for some time that a full-bore probe would be forthcoming, with as many as several hundred amateurs involved. When the story broke back in August, 1976, one of the investigators was quoted as saying they had uncovered "just the tip of the iceberg."

A PIRATE 220-MHZ REPEATER operating in Chicago as a "commercial telephone service" was shut down in early November by the FCC's Chicago Field Office after a two-week-long investigation. No Amateur Callsigns were ever heard and it's probable that most of the "subscribers" (including a tire wholesaler and a medical clinic) thought they were perfectly legal.

NEW MANAGER OF AMSAT QSL BUREAU is Ross Forbes, WB6GFJ, P.O. Box 1, Los Altos, California 94022. Former manager, WALEHF, is stepping down after 4½ years at the helm. Ross is well qualified, having spent 1969-1972 as manager of the ARRL W6 QSL Bureau, which handles over 90,000 cards per month!

Donations From Clubs and Individuals to the solar cell and battery funds have brought in nearly \$18,000, proving the effectiveness of AMSAT's recent-heavy publicity campaign.

Several Donations of \$1000 Each have resulted in the names and callsigns of the donors being inscribed on a plaque to be carried into space aboard the first Phase Three satellite.

A New Satellite Bandplan is going into effect January 1, which will place CW only on the bottom third of the satellite downlink, mixed CW and sideband in the center third, and ssb only on the top third — just the reverse of current practice.

Arthur C. Clark, The noted science-fiction writer, has been made an honorary AMSAT member in ceremonies attended by most of the AMSAT brass — Clark's honor came in recognition of his predictions of communications satellites and synchronous satellites in a 1945 Wireless World article.

FCC'S NEW CHAIRMAN, Charles D. Ferris, was sworn in October 17 by Vice President Mondale at White House ceremonies. Chairman Ferris has a B.S. in Physics and a law degree, and until his appointment to the Commission was general counsel to House of Representatives Speaker Thomas O'Neill.

FCC Safety and Special Services Chief Charley Higginbotham, in a banquet speech at the November SAROC Hawaii hamfest, warned that autopatch abuses continue to jeopardize interconnect abilities for the Amateur Service. "It's your decision!" he said, and if we don't clean up our act we'll end up with formal Commission proceedings that will severely curtail, if not eliminate, amateur freedom to tie into the telephone system.

CB AND TV ANTENNAS will both require warning labels, and detailed safety instructions for proper installation must be included with each antenna, under the terms of a proposal just issued by the Consumer Product Safety Commission. In its brief announcement of the new proposal, no mention of Amateur Radio antennas was made.

DXpedition to the Caribbean

*Puerto Rico
KP4*

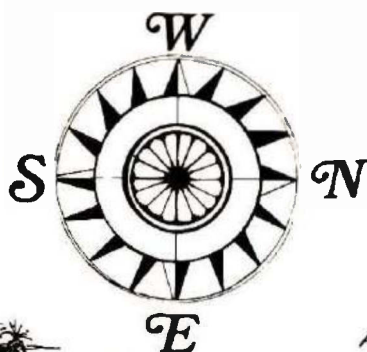

*FG7
Guadeloupe*



Martinique FM7

BY DOUG GRANT, K1DG

It all began while we were still in high school. Bill, WA1JKJ, and I planned a dream vacation to almost every island in the West Indies. Air fares and hotel rates were computed and every minute accounted for. We decided that we'd need one or two other people with us, and the plans were shelved until an appropriate college semester break rolled around.

Unfortunately, finding two other people proved as difficult as finding enough money, and our trip didn't happen — then.

Most people consider the Caribbean to be a playground for the jet set — a land of perfect tans in the winter and a place to unwind and relax. There's an added perspective

for the radio amateur: many of the islands in the West Indies are considered separate countries for DXCC award purposes. Additionally, very few active ham operators are on these islands. Thus, when a visitor brings a radio along on his vacation, strings up a few antennas, and begins to operate, it isn't long before he's deluged with stations calling him. It's every ham's dream to be on the other end of a pileup for once. Add that to the everyday charm of the area, and it becomes a true dream vacation!

Bill graduated from college a year ahead of me and took a trip to the French island of St. Pierre in March 1975. St. Pierre

is, unfortunately, not in the West Indies; rather it is in the North Atlantic, not far from the Canadian Maritime provinces. The weather was terribly cold, but Bill had a chance to experience operating from a semi-rare country and was hooked. Two months later, I finished school and started to work. With a cash flow, it appeared that our trip south might actually take place. After a few false starts, we obtained licenses to operate on the French island of Guadeloupe and were on our way.

**First stop:
San Juan, Puerto Rico**

It was a typical October morning in Boston —

temperature about 45F (7C) and overcast. We were both unprepared for the 90F (32C) heat and high humidity in San Juan, Puerto Rico, that afternoon. Since we had several hours before our next flight, we shed our sweaters, stored our luggage in a locker at the airport, and took a taxi downtown.

The taxi driver turned out to be a Boston Red Sox fan. When he learned we were from Boston, he agreed to show us around San Juan for a while. We then decided to explore Fort Morro on foot, then went down to the "old city." After all the walking around, we started looking for someplace to eat. We found a cab and asked the driver to take us to McDonald's. He didn't speak any English. Bill explained in Spanish that we wanted hamburgers from a restaurant with golden arches; the driver took us to Burger King. Close enough.

When we got back to the airport, the first order of business was to check in at the Air France counter for our flight to Guadeloupe. We had

no problems and went to the gate area to wait. As we approached, one of the other waiting passengers spotted the radio in Bill's hand and introduced himself as Austin Regal, K4YFQ. Austin was on his way to Sint Maarten, a Dutch possession in the Caribbean, which was an intermediate stop on our flight. We compared plans, swapped stories, and marveled at the coincidence of meeting. We arrived in Guadeloupe at 10:30 PM, found a hotel, checked in, and fell asleep.

Adventure in Guadeloupe — a contest

The next morning we took stock of our situation. We had a license, a rig, several spools of wire, and several hanks of rope. Our hotel was surrounded by other buildings and wasn't in a good radio location. We clearly needed some place more suited to our particular needs. We then consulted our *Callbook* and set out to visit some of the local amateurs.

Hams are pretty easy to find. We climbed to the top of a tall building and looked for a



Yvon, FG7AK, and Jack, FG7TD, get together for a visit in Gosier.

house with antennas on it. After we spotted one, we walked toward it, and rang the bell. And, as luck would have it, Jean Wegimont, FG7XT, answered the door. We introduced ourselves as American hams on vacation, and he received us with open arms. Jean is in the import/export business and was at one time an underwater photographer. He's a long-time friend of Jacques Cousteau and a most interesting fellow to talk with. His radio station is very impressive, equipped for all bands, including OSCAR, and all modes including slow-scan television and radio-teletype. Jean is probably the most active ham on the island and is nearing completion of 5BWAS — all on teletype!

After several Cognacs we asked Jean if he could recommend a hotel where we could operate. He said that there was a hotel nearby, which was on a hill near the water (and managed by a ham, no less). A few phone calls later, we were on our way there.

Au Grande Corsaire is a restaurant located in the resort village of Gosier. Nearby are six bungalows under the same management and available for a modest charge. As we pulled up in front of the restaurant, we noticed first the triband antenna on the roof, and second, a fellow rushing out to greet us, who turned out to be



Bill, K1MM, and Don, W1MIW/FP0DB, aboard FP8AP's boat *Atta Boy* for the March, 1975 FP0MM operation. If the operators look cold, it's because it is; about -20°F (-28°C). That's enough to drive you to a warmer climate, and it did.

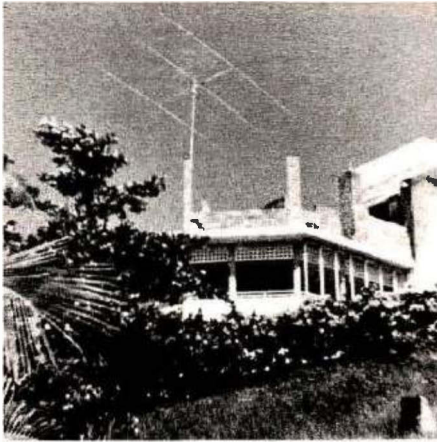

Au Grand Corsaire in 1975. The first FG0MM operation took place from the room at right, atop the building.

the manager, Yvon Kerguen, FG7AK. Yvon welcomed us, brought us drinks, and then excused himself, explaining that he was needed in the kitchen. As we found out, Yvon is also the master Chef of the restaurant. After dinner, we were shown to our bungalow, where we collapsed, exhausted but encouraged by our good fortune thus far.

Next morning we explained to Yvon that we would like to operate his station during a contest weekend. He cooperated with us to the point of letting us take over his room at the restaurant while he moved into a vacant bungalow. Thus, we were able to use his antennas rather than our own. Yvon didn't have an 80-meter antenna, however, so we strung up a wire between two palm trees as a temporary solution. During the day, Jack Deckmyn, FG7TD, came over to visit. Jack is a priest in Gosier and we had a chance to visit his station several days later. He noticed we didn't have either a wattmeter or an antenna switch and returned later with one of each to loan us. They were quite useful for adjusting antennas and made operation in the contest much more effective.

Our main objective in going to Guadeloupe was to operate in a contest. Contests are sponsored by several

organizations with the intent of developing operating skills in a competitive atmosphere. Scores are calculated on the basis of number of stations contacted as well as the number of different states, countries, or geographical zones contacted, depending on the contest. Obviously, the fellow in a rare country becomes popular, because he's everybody's only chance to talk to that country. A little research showed that there hadn't been any contest activity from Guadeloupe in several years, and that's why we went there. We had obtained the call sign FG0MM, and when the contest began at 7 PM Friday we were ready.

The next 48 hours were a chaotic mixture of operating, sleeping, eating, and taking some breaks to go swimming or sunbathing. When the contest was over we'd amassed over 4700 contacts and sufficient countries for a score of over 3 million points — good enough for fifth place worldwide! After a bottle of champagne to celebrate our success, we began planning the next trip, and Yvon assured us we'd be welcome.

We spent the next few days touring Guadeloupe and on our last night there, we dined

at Yvon's restaurant with a National Geographic Society officer, who was vacationing in the islands. Yvon prepared a special dinner for us, which was a culinary triumph. After dinner, he asked us to sign his guest book, which included signatures from visiting royalty, most of the *National Geographic* staff, and about a dozen other hams from several countries. We signed it and promised to return.

Further adventures — St. Martin and Martinique

Mark Pride, WA1ABV, offered his assistance by designing and building a full-size, 3-element 15-meter beam antenna that was lightweight and would easily knock down to fit a 4-foot-long (1.2m) case. Also, we brought along several telescoping sections of tubing for use as a vertical antenna as well as pre-cut wire dipoles for each band and plenty of rope. We were much better prepared this time than on our first trip.

Our first stop was French St. Martin. French St. Martin occupies the northern part of an island in the Netherlands Antilles, which is about 50 miles (80km) east of Puerto Rico. The southern part of St. Martin is administered by the

Au Grand Corsaire, 1976 — the view to the east includes the portable 15-meter Yagi on top of our bungalow.

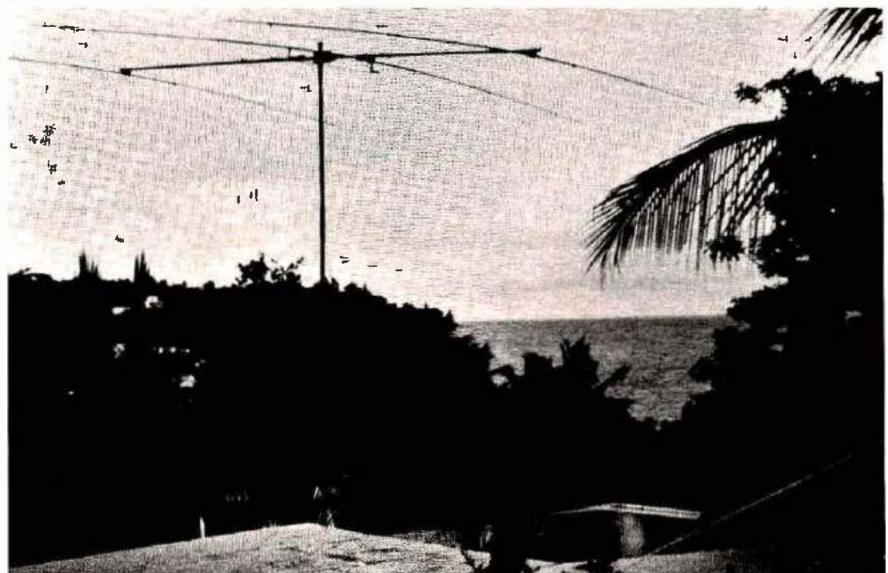

Netherlands and is known as Sint Maarten. We'd been informed beforehand that the management of Le Pirate, a small hotel in Marigot, had no objection to visiting amateurs stringing antennas on the grounds. Clearly, this was the place to stay. Upon our arrival, the desk clerk assigned us to room 6, where, he said, "all the hams stay." When we got to the room we took stock of our situation. We knew that all our checked baggage had missed the connection in San Juan and wouldn't arrive until the following day. Our clothes and personal items were in Puerto Rico, but we had the important things on hand (the transceiver, microphone, keyer, and the wire antennas), so we immediately put up a 40-meter dipole and began to operate.

When we took a break for dinner, we decided to give Alain Rochemont, FG7AR/FS7, a call on the telephone. Alain informed us that we weren't the only American hams on the island, since Terry, W4GSM, was also visiting. Terry and Alain dropped by Le Pirate that evening, and the four of us sat around talking until nearly midnight. Alain, the only active ham on the French half of the island, works at the power

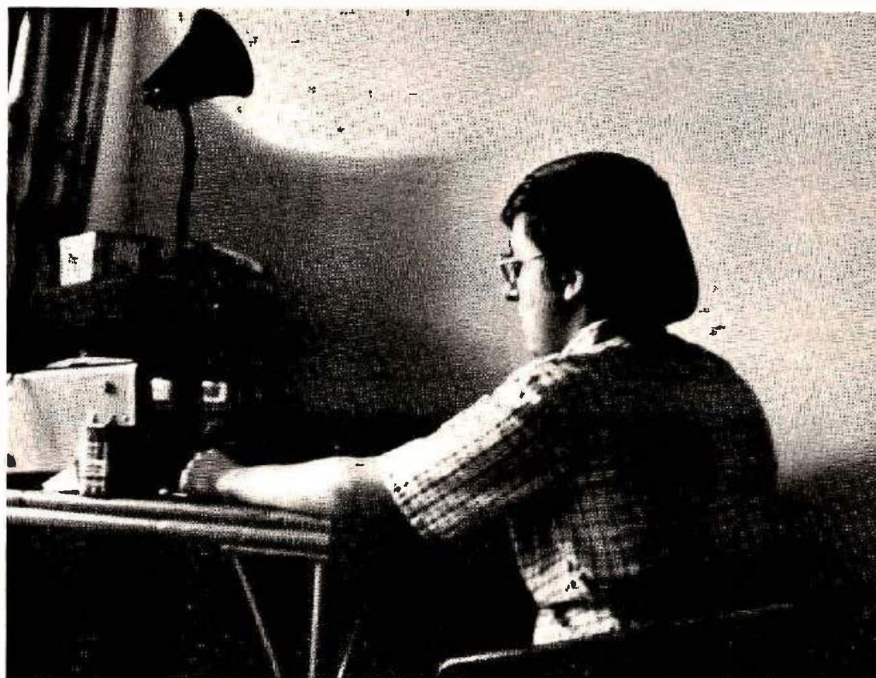

Room 6 at Le Pirate — K1DG operating FG0MM/FS7 on 40 meter CW as a warm-up exercise for the contest.

company. He came over several times to visit and answered our questions about the island. Terry was preparing for the contest the following weekend. He's a veteran island-hopping ham and had some good advice to offer on the subject.

During the next few days, we managed to recover our lost suitcases, put up a few antennas, see some of the sights on the island, and make

about 2000 contacts in all 50 states and 65 countries. Several of the hams we contacted asked us if we were at Le Pirate in room 6 — where they had stayed! The desk clerk wasn't kidding after all!

We visited Terry again just before we left. He'd been joined by Jim, W4PRO, and Don, WA4DUS, at Le Grand St. Martin, a hotel on the north side of Marigot. Terry had brought a 60-foot (18m) aluminum tower with him as well as several antennas more elaborate than our wires. They used Jim's call sign, FG0CXV/FS7, for about three weeks including the contest weekend. Between their operation and ours, French Saint Martin became a little less rare.

Back to Guadeloupe

Our next stop was familiar Guadeloupe. Yvon was no longer manager of the restaurant on the hill, having taken over a smaller place on the beach. His triband antenna was still on the roof of the building on the hill, and our makeshift 80-meter wire was still in the air. We never

Some of the antennas used at FG0MM in October, 1976, are visible here — including a tribander and various wire antennas.

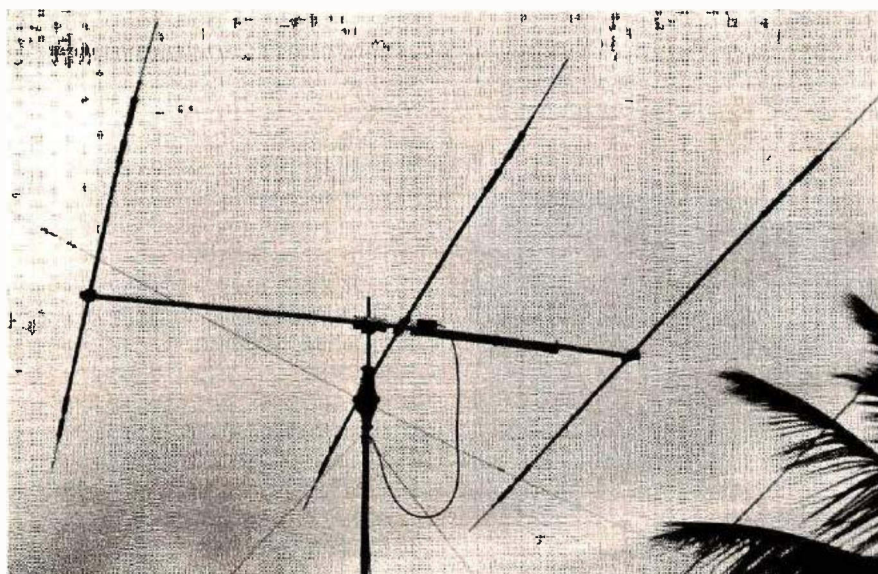

expected it to last that long! Since Yvon's new location was not suitable for the contest, we opted to set up the station in a bungalow about half way up the hill.

We removed his tribander and installed it at the bungalow, strung up some wires, and were on the air. We borrowed some pipe from a neighbor and put up the 15-meter antenna. Mark's design worked fine — it took only about a half hour to install, starting with the antenna in pieces on the ground, and finishing with the whole thing in the air and in use.

A few vertical antennas were also erected for standby use and we were ready to go. Unfortunately, the air conditioner in the bungalow failed the day before the contest, and the torrential downpours of the week before created oppressive humidity, which sapped our strength during the contest. We did manage slightly under 4000 contacts and enough multipliers to top our previous score by ten per cent or so. Our biggest problem was the triband beam — the traps were full of water and the antenna wouldn't work on 20 meters. But considering the 2000 stations we contacted on 15 meters, we were satisfied. In fact, we were able to sustain rates of 200-250 contacts per hour for several hours each day. It really is a switch, operating from the DX end. During the contest, we ran

across FG7AS on the air, a relative newcomer to Guadeloupe. Sam and his brother Jude, FG7XA, are both very active and came over several times to visit during the contest and afterwards to dine with us at Yvon's restaurant. We've talked to both Sam and Jude (who prefers CW) several times since returning to the United States, and expect to see Sam again when he visits the Boston area next winter. We visited Jean Wegimont, FG7XT, once again and borrowed some of his equipment for use in the contest. It's amazing how helpful the local amateurs have been every place we have operated. We've been welcomed with open arms and have always been offered equipment, antennas, advice, and assistance in finding places to stay and putting a station together. Ham radio truly is an international brotherhood.

On to Martinique

After our stay of a week or so on Guadeloupe, we bade our friends good-bye and headed further south. Our destination this time was Martinique and the call sign FM0MM. Martinique was the first of the islands to actively promote tourism as an industry in contrast to Guadeloupe, which is still not fully geared to tourists. In Trois-Ilets, across the bay from Fort-de-France, luxury tourist hotels abound. There isn't a similar area on St.

Martin (although the Dutch side is tourist oriented), and the resort hotels on Guadeloupe aren't all in the same area. Upon arriving at Trois-Ilets, we looked at a few hotels and finally settled on the Frantel, since it had a high roofline, a large lawn, and was right on the water.

We strung up a few wires, erected the vertical, and handed out 500 or so contacts in our two-day stay. Much of our time was devoted to sunbathing, since we had been too busy beforehand to really get tanned. We also had an opportunity to visit a small fishing village on the east coast of the island which, except for the cars, looked much the same as it must have for a hundred years. We found Fort-de-France to be an interesting city, which seemed to have been transplanted intact from Europe with all the stores and shops typical of a small city in France. We spent more time playing tourist on Martinique than we did playing ham radio, but enjoyed ourselves just as much.

In retrospect

All in all, our trip netted over 6000 contacts from the three countries in which we operated. We worked several stations from all three countries, including Austin, K4YFQ. You'll recall he was the ham we met in San Juan on our first trip to Guadeloupe in 1975. He had originally planned to come with us in 1976, but was unable to arrange the trip. However, he was with us on the air everywhere we went, keeping tabs on us. In fact, we run into each other often on the air and have become good friends. I'm amazed at how much has happened, and how many new friends Bill and I have made as a result of our afternoon musings about a vacation in the Caribbean — and bringing some ham gear along. It's been a truly unforgettable experience.

HRH

Verticals, beams, and wires at FG0MM in 1976.

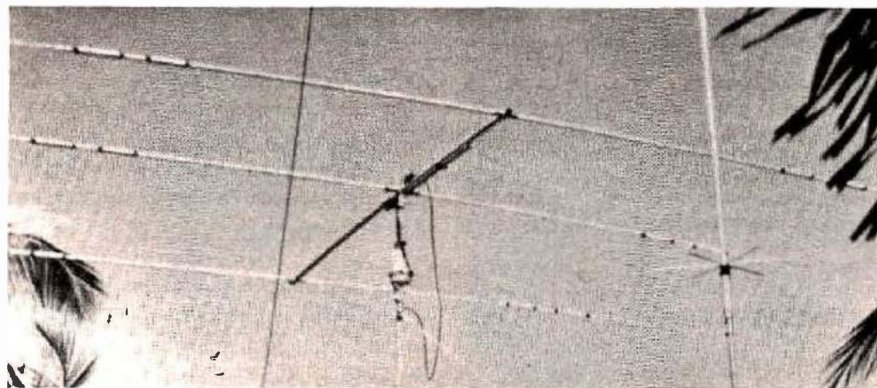

For Performance, Value and Reliability...

There's more for the Ham at Heath!



\$669⁹⁵
KIT

The new, Improved SB-104A: An Advanced Concept

From front panel to rear apron this solid-state 80 through 10 meter transceiver is packed with the superior features and performance that set Heath's SB series apart. Featuring digital frequency display, all new front end board, sensitivity less than 0.5 μ v, broadband design, and a solid 100 watts out, you'll agree the SB-104A is the ultimate experience in Amateur Radio. Only 669.95 Kit

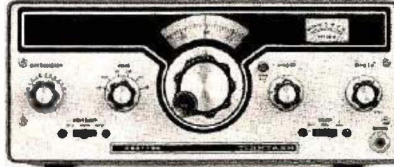

\$199⁹⁵
KIT

HR-1680: The Perfect Choice for your first Receiver

One look and you'll know... this is one outstanding receiver! The HR-1680 covers 80, 40, 20, 15, and the lower 1 MHz of 10 meters and features solid state design, pre-selector tuned dual-conversion MOSFET front end, excellent sensitivity, 4-pole crystal IF filter for razor sharp selectivity, active audio filtering, and a price that's unbeatable. Only 199.95 Kit

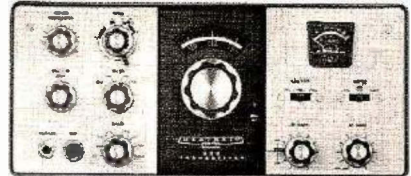

\$339⁹⁵
KIT

HW-101: Amateur Radio's unbeatable value

If you're looking, search no further, because there isn't a better performance value than the Heathkit HW-101. This 80 through 10 meter transceiver features LSB, USB and CW operation, 180 watts PEP in on phone, sensitivity less than 0.35 microvolts, open chassis layout, easy circuit board assembly, incredible performance and a price that's rock bottom! Only 339.95 Kit



\$269⁹⁵
KIT

HW-2036: The New Industry Leader

This is the transceiver that's made 2-meter history and with specifications like these it's easy to see why! 15 dB quieting with 0.5 μ v in; a solid 10 watts out; choose simplex or \pm 600 kHz offsets, top it off with full frequency synthesis, add excellent audio, built in sub-audible tone encoding... the list just keeps going and at this price the HW-2036 is unbeatable! Only 269.95 Kit (with standard microphone)

Heathkit accessories to make your shack a showplace



- 1 Fully assembled desk mike. Hi-Z dynamic, grip-to-talk, VOX and PTT with cables. HDP-121A 39.95
- 2 "Cantenna" dummy load. 1 kW max. input; 1.5-300 MHz range with SWR 1.5:1 or less. Oil not included. Kit HN-31 14.95
- 3 Hybrid phone patch. Has VU meter, 30 dB isolation, matches 3-16 Ω speakers & hi-Z or 600 ohm inputs. Kit HD-15 37.95

- 4 Coax switch for multiple antennas. SWR 1.1:1 max, 2 kW PEP rating. Kit HD-1234 10.95
- 5 VHF wattmeter. 1-25 and 10-250 W ranges. Built-in SWR bridge. Kit HM-2102 37.95

- 6 Hi Z ceramic mobile mike. PTT or PTT and VOX operation. Fully assembled. GH-12A 12.95
- 7 HF wattmeter/SWR bridge. 1.8-30 MHz range handles up to 2000 watts. Kit HM-102 37.95
- 8 Solid-state dip meter. Covers 1.8 through 250 MHz. Battery powered. Batt. not included. Kit HD-1250 59.95

Look over the complete Amateur Radio line in the new Winter '78 Catalog. Contains complete descriptions and specifications for nearly 400 unique electronic products... all in money saving kit form!



You can get a FREE retail catalog by redeeming this coupon in person at any of the 50 Heathkit Electronic Centers (Units of Schlumberger Products Corporation) in major markets coast-to-coast, where Heathkit products are sold, displayed, and serviced. (Retail prices on some products may be slightly higher.)

(Check the white pages of your telephone book.)

FREE

The new Heathkit Catalog... chock full of Radio, Hobby, Home Entertainment, Service and Instrument electronics. Send for yours Today!

HEATH
Schlumberger

Heath Company, Dept. 348-380
Benton Harbor, MI 49022

Please send me my free Heathkit catalog.
I am not on your mailing list

Name _____

Address _____

City _____ State _____

AM-359 _____ Zip _____

simple dipole antennas

BY JIM FISK, W1HR

One band, two bands, three bands, more ...

Of the many types of antennas which are described in the amateur magazines, the most popular single-band antenna for 80 and 40 meters is the half-wavelength dipole, fed in the center with low-loss coaxial transmission line. The same type of antenna also provides excellent performance on 20, 15, and 10 meters. The dipole's popularity is not without reason — among its many advantages are low cost, easy installation, and simplicity. Unless you make a poor solder connection, or use old, deteriorated coaxial cable, it's pretty hard to build a dipole that doesn't work right the first time you connect your transmitter to it and call CQ.

The length of the basic half-wavelength dipole antenna shown in Fig. 1 is given by the simple formula

$$\text{Dipole length (feet)} = \frac{468}{f_{\text{MHz}}}$$

$$\text{Dipole length (meters)} = \frac{142.5}{f_{\text{MHz}}}$$

where f_{MHz} is the chosen operating frequency in MHz. Calculated half-wave dipole lengths for various frequencies on 80 through 10 meters are given in Table 1. Although the method of fastening the insulators, and the antenna's closeness to other objects, will have some effect on the dipole's resonant frequency,

it's surprising how close a carefully measured and built antenna will resonate to the design frequency.

Antenna height

For daylight operation on 40 and 80 meters, and for close-in work on the higher amateur bands, antennas that are only 20 to 25 feet (6-8 meters) high work nearly as well as dipoles installed at greater heights. Over longer distances, however, the performance improves almost linearly with heights up to about 50 feet (15 meters), and more slowly for greater heights. If you don't have a couple of 60-foot (18-meter) trees in your backyard to support your dipole, don't worry about it; a low antenna outperforms a high one often enough to make it interesting, especially over distances up to 100 miles (160 km) or so.

Dipole radiation resistance

Theoretically, in *free space*, the radiation resistance or antenna feedpoint impedance of a half-wavelength dipole of small diameter wire is close to 72 ohms. When the half-wave dipole is installed over perfectly conducting ground, however, the radiation resistance varies with height, as shown in Fig. 2. Unfortunately, you're not going to come anywhere close to a perfect ground unless you have your hamshack on a houseboat anchored in saltwater. Since the ground under your antenna isn't perfect, the radiation resistance won't be exactly that shown in Fig. 2, but this graph should give you an idea of the range of values to expect. In practical terms, half-wavelength dipoles which are installed at reasonable heights over average ground provide an excellent match to 50- or 75-ohm coaxial cable, and that's what is important!

Antenna resonance

Every antenna, including the simple half-wavelength dipole, is really a complex electronic circuit consisting of resistance, capacitance, and inductance. At a certain frequency the effects of capacitance and inductance cancel out, and at this point the antenna is said to be resonant.

Below resonance the

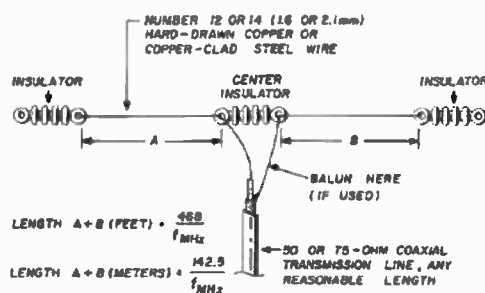

Fig. 1. Construction of the basic half-wavelength dipole antenna. Lengths for various frequencies on the high-frequency amateur bands are listed in Table 1.

antenna looks capacitive, and above resonance it looks inductive. This is important because it means the antenna is resonant at only *one* frequency; since amateurs don't limit their activities to a single, spot frequency, their

antennas are seldom used at resonance. This has practically no effect on how well the antenna radiates, but it does affect the feedpoint impedance, the standing-wave ratio (swr), and ultimately, transmitter output power.

Swr itself is usually not a problem, but the output matching networks in most modern amateur transmitters (and transceivers) are designed for a maximum swr of 2:1. If the swr is greater than 2:1, the matching network in the transmitter simply can't compensate for the impedance mismatch, so the transmitter can't be loaded to full power input. In some solid-state

Glossary of Terms

Antenna tuner or antenna matching unit is a device which uses a combination of variable capacitors and inductors to provide a means of matching the low output impedance of your transmitter to the unequal (usually much higher) impedance of the transmission line to the antenna. Also called a Transmatch.

Balun is a device that will provide a transition between an unbalanced (to ground) feedline such as coaxial cable, and a balanced line or antenna such as twin-lead or a dipole. The term is derived from *Balanced-to-unbalanced*.

Dipole is literally *two* poles, an antenna that has two poles or "arms" which are separated by an insulator and connected to each other through the transmission line. The dipole is sometimes called a doublet antenna.

Dummy load is a device which accepts rf power and dissipates it as heat. A dummy load should always be used when tuning up a transmitter to eliminate unnecessary transmissions and interference.

Feedline or transmission line is one or more electrical conductors that conduct radio-frequency energy from your radio to the antenna. The most popular feedline used by amateurs is coaxial cable, often called *co-ax*.

Impedance is the apparent resistance of a load in an ac or rf circuit that opposes current into that load. It consists of the ohmic resistance plus the effects of inductance or capacitance in the circuit.

Insulators for antennas are often egg-shaped or cylindrical,

are made from ceramic, glass, or plastic, and have small holes at each end; one for attaching the antenna wire, and the other for the supporting line or *halyard*.

Mismatch is short for impedance mismatch, for example, when the impedance of the feedline doesn't match the feedpoint impedance of the antenna. For best efficiency the impedances should be closely matched. The amount of impedance mismatch is defined by the SWR or standing wave ratio (for a perfect match the SWR = 1:1).

SWR is an acronym for **standing-wave ratio** which is the ratio of a voltage maxima to the voltage minima along a feedline. **VSWR** or **voltage standing wave ratio** is the more proper term for the same thing. The ideal situation is to have a *flat* feedline — a VSWR of 1:1. The VSWR on the feedline can be changed *only* by changing the impedance at the load (antenna) end of the line.

SWR Bridge is more correctly an SWR Meter because few instruments of this type are true bridge-type units. The SWR Meter samples both the rf energy going toward the antenna (load) and the energy reflected back because of an impedance mismatch. The indicator may be calibrated so either a direct comparison of power levels or their ratio is possible.

Transmatch is a popular type of antenna tuner first described by W1ICP in QST and later sold commercially by the James Millen Company. The term is now commonly used to describe all types of antenna tuners and antenna matching units.

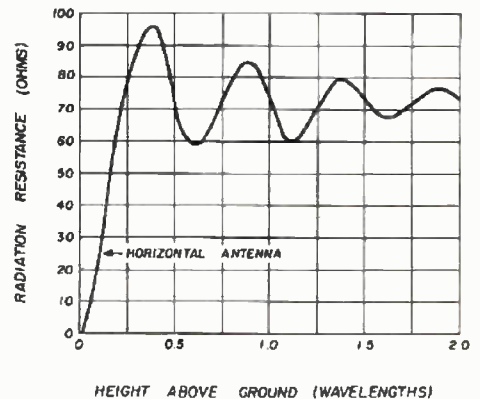

Fig. 2. Radiation resistance or feedpoint impedance of a horizontal half-wavelength dipole varies with height above a perfectly conducting ground. The earth under your antenna is not a perfect conductor, but this graph will give you an idea of the range of values to expect. A half-wave dipole, installed at a reasonable height over average ground, provides an excellent match to 50- or 75-ohm coax.

transmitters the manufacturers even build in a circuit that shuts down the transmitter if the swr exceeds 2:1.

Amateur radio is unique among the radio services in that amateur operators can move at will from one frequency to another. There are exceptions, of course, but professional antenna engineers are accustomed to designing antenna systems for operation on a single frequency. Therefore, there is very little published experimental data on the performance of a half-wavelength dipole over a whole band of frequencies; the information which is available is difficult to translate into practical terms unless you have a degree in advanced

Table 1. Length of half-wavelength dipole antennas for various frequencies in the high-frequency amateur bands.

Band	Frequency (MHz)	Use	Half Wavelength	
			(feet, inches)	(meters)
160	1.825	General	256' 5¼"	78.2
160	1.875	General	249' 7¼"	76.1
80	3.600	CW	130' 0"	39.6
80	3.725	Novice	125' 7½"	38.3
80	3.750	General	124' 9½"	38.0
75	3.800	Phone	123' 2"	37.5
40	7.100	CW	65' 11"	20.1
40	7.150	General	65' 5½"	19.9
40	7.175	Novice	65' 3"	19.8
40	7.250	Phone	64' 6½"	19.7
20	14.050	CW	33' 3¾"	10.15
20	14.150	General	33' 1"	10.08
20	14.200	Phone	32' 11½"	10.05
20	14.275	Phone	32' 9½"	10.00
15	21.100	CW	22' 2"	6.76
15	21.175	Novice	22' 1¼"	6.72
15	21.225	General	22' ½"	6.72
15	21.350	Phone	21' 11"	6.68
10	28.050	CW	16' 8¼"	5.09
10	28.150	Novice	16' 7½"	5.07
10	28.510	Phone	16' 5"	5.00
10	29.475	Oscar	15' 10½"	4.84

mathematics — and time to correlate the theory with measured results.*

There's another problem with the published information: it is based on an antenna in free space. When a dipole is installed near ground — even several wavelengths above ground — the antenna behaves differently than it would out in free space. This is further complicated by the fact that the earth under your antenna has different electrical characteristics from every other antenna site, even one at a different spot in your own backyard! Nevertheless, it's possible to come up with some reasonable *guesstimates* of

*Formulas and graphs for the evaluation of dipole antennas operated off resonance are given by R. W. P. King in *Theory of Linear Antennas* (Harvard University Press, Cambridge, Massachusetts, 1956), but this book is not recommended unless you have a solid engineering background. A somewhat simplified discussion of the same material is presented in *Transmission Lines, Antennas, and Waveguides* (Dover Books, New York, 1965), but even here you must be prepared to deal with complex mathematical concepts. *Editor*

what to expect from real-life, small diameter, half-wavelength dipole antennas.†

The graph in Fig. 3 shows the swr, with a 50-ohm transmission line, of a half-wavelength dipole in free space, compared to one installed near ground. The swr you can expect from a half-wave dipole installed in your own backyard will probably

fall somewhere between the limits of these two curves. The horizontal axis is marked off in per cent deviation from the center resonant frequency, f_c , so the chart may be used for any of the high-frequency amateur bands. Note that this graph is only for 50-ohm transmission lines. If you use 75-ohm coaxial cable the shape of the curves will change somewhat, but will not be drastically different from those shown.

If you study this graph for a minute, you'll see that to maintain an swr of 2:1 or less, you have to limit your operation to within about 2 per cent above or below the center frequency. Except on 80 meters this is not as serious as it looks because the 40-, 20-, 15-, and 10-meter bands all fall between the 2 per cent limits as shown in Fig. 4 (the entire 10-meter band, 28.0 to 29.7 MHz, is nearly ± 3 per cent of the center frequency, but most amateur operation takes place between 28.0 and 29.0 MHz, which is well within

†Small diameter in terms of wavelength. On 80 meters this includes wire or tubing up to about ½ inch (12 mm); at 28 MHz a wire size of no. 14 AWG (1.6 mm) or smaller is considered a small diameter for the purposes of this discussion.

The DenTron Jr. Monitor antenna tuner is designed for use with antennas fed with coaxial cable, balanced feedline, or a random length of wire. Power capability is 300 watts (photo courtesy DenTron).



the 2 per cent limits).

The 80-meter band presents some problems, however, because each of the band edges is nearly 7 per cent from the center frequency; to maintain a 2:1 swr on 80 meters, you must limit your operation to about 150 kHz of the band. If a half-wavelength dipole resonates at 3.75 MHz, the swr at 3.5 MHz will fall in the range between about 5:1 and 8:1; at 4 MHz the swr will be between 4:1 and 7:1. In both cases the swr is well outside the 2:1 swr limits recommended for amateur transmitters. One solution on 80 meters is to use an antenna tuner or *Transmatch* at the transmitter end of the line as shown in Fig. 5. With an antenna tuner in the line, it can be adjusted so the swr seen by the transmitter will be less than 2:1 from one end of 80 meters to the other.

Dipole length vs frequency

If you use the formula to calculate the length of a dipole for your chosen operating frequency, and carefully cut your antenna to the correct length, it should resonate very close to the desired frequency. However, nearby objects (including ground) may slightly move the resonant frequency away from the desired point.

If you want to resonate your dipole on a precise frequency, cut it slightly longer than the calculated length and put it up. Then install an *accurate* swr bridge in the transmission line and measure the swr at different frequencies near the desired center frequency. If you plot the swr values on graph paper, you should end up with a graph similar to that shown in Fig. 3; the point of minimum swr is the resonant frequency.

Since the dipole was cut slightly longer than the calculated length, the point of minimum swr should be *below* the desired operating frequency. To move the

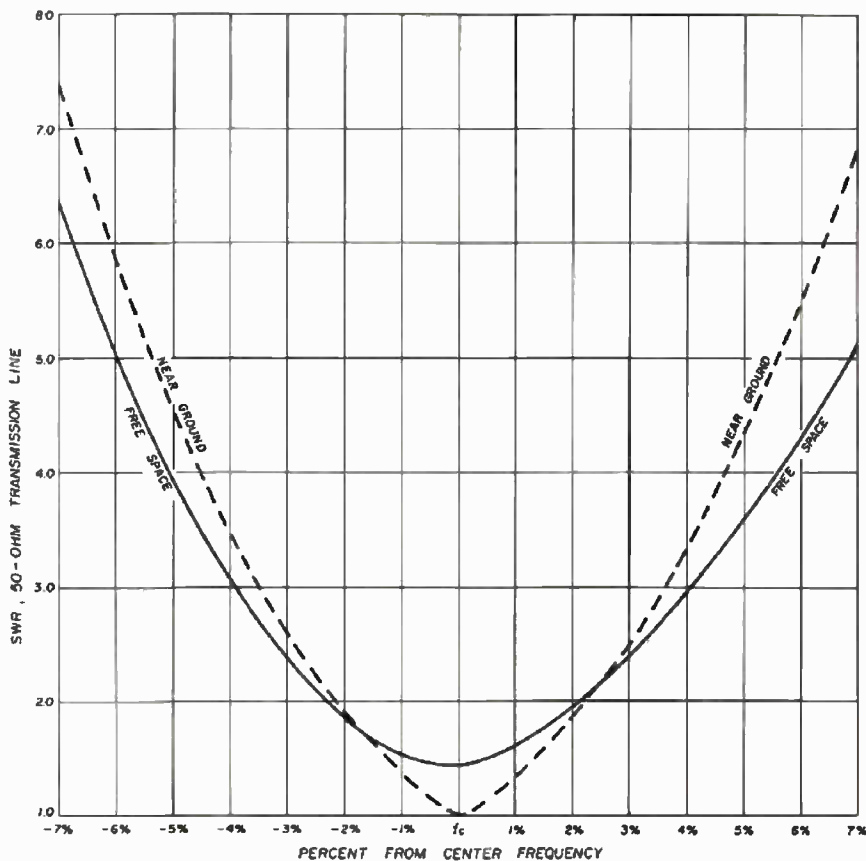

Fig. 3. Swr performance of a horizontal half-wavelength dipole fed with 50-ohm coaxial transmission line in terms of per cent deviation from the design center frequency, F_c . The swr curves of dipoles in free space and near ground are plotted — practical amateur antennas should fall between the limits of these two curves. Operation must be limited to within about 2 per cent of the center frequency for an swr of less than 2:1. Note that the swr increases more rapidly on the low side of resonance than it does on the high side.

minimum swr point up to the desired spot, you simply have to shorten the antenna by a small amount. On the 80-meter band, the resonant frequency of a half-wave horizontal dipole changes approximately 2.5 kHz per inch (1 kHz per cm) — slightly less near 3.5 MHz, and slightly more near 4.0 MHz. On the other high-frequency amateur bands the variation with length is greater, as detailed below:

40 meters	9 kHz/inch	4 kHz/cm
20 meters	36 kHz/inch	14 kHz/cm
15 meters	80 kHz/inch	31 kHz/cm
10 meters	142 kHz/inch	56 kHz/cm

Suppose you want your dipole to resonate at 3.725 MHz, the center of the 80-meter Novice band. The calculated length for a half-wavelength dipole at 3.725

MHz is 125 feet, 7½ inches (38.29 meters). If you cut the antenna about 12 inches (30 cm) longer than the calculated length and put it up, the point of minimum swr will be lower in the band, say at 3705 kHz, 20 kHz below the desired frequency. Since the resonant frequency changes by about 2.5 kHz per inch (1 kHz per cm), if you shorten the antenna by about 8 inches (20 cm), the antenna should resonate very close to 3.725 MHz. (Be sure to shorten the antenna equally at both ends — in this case, 4 inches or 10 cm from each end of the dipole).

Simple multiband antennas

There's no doubt that the most efficient (and simplest) multiband antenna is a half-wavelength dipole, cut to



Typical antenna tuner construction. This is the popular Transmatch circuit described by W1ICP in *QST*. Many manufacturers build similar units around the same basic design, and many amateurs have built their own (photo courtesy the James Millen Company).

resonate at the lowest operating frequency, center fed with open-wire transmission line through an antenna tuner. The only real problem with this arrangement is that the open-wire feedline should be installed well away from any metal objects, with no sharp bends. The transmission line may be either transmitting type twinlead, TV ladder line, or a pair of no. 12 or 14 AWG (1.6 to 2.1 mm) wires spaced 2 to 4 inches (5 to 10 cm) apart.

Many amateurs shy away from antennas fed with open-wire feeders because they don't like antenna tuners, but if you want efficient, all-band operation with a single antenna, this is the only way to go. Every other multiband antenna is a compromise.

Multi-dipole antennas

Another simple multiband antenna is the multiple-dipole shown in Fig. 6. On the lower frequency band the longer pair of wires acts as a conventional

half-wavelength dipole, and the shorter wires have negligible effect on operation. On the higher band the short dipole radiates and the long one goes along for the ride.

If the two dipoles are on

harmonically related frequencies — say 3.525 MHz and 7.050 MHz — this arrangement works quite well, but if the resonant frequencies are not harmonically related, the swr on the higher band may be greater than expected. For example, assume the low frequency dipole is resonant at 3.725 MHz, and the high-frequency dipole is tuned to 7.125 MHz. At 3.725 MHz the antenna will perform as advertised, but at 7.125 the swr will be higher than expected.

If you run a curve of swr vs frequency, you'll find that minimum swr will occur near 7.450 MHz, the second harmonic of the frequency to which the longer dipole is cut. This happens because at 7.450 MHz, the 3.725 MHz dipole appears as a simple high resistance of several thousand ohms across the transmission line. Below 7.450 MHz, however, it looks like an inductor and the resulting inductive reactance drives up the swr.

The solution to the problem is both simple and effective: just increase the length of the higher frequency dipole (lowering the resonant frequency) so it looks slightly capacitive. This will cancel

The Collins 637T multiband dipole is used primarily in military applications, and consists of two spring-loaded reels of wire. To use the antenna you simply unreel the wire to the proper length (indicated by the calibrated dial on the end plate). This dipole can be used on any frequency between 3.3 and 30 MHz, but you have to re-adjust the length for each band (photo courtesy Collins Radio Company).

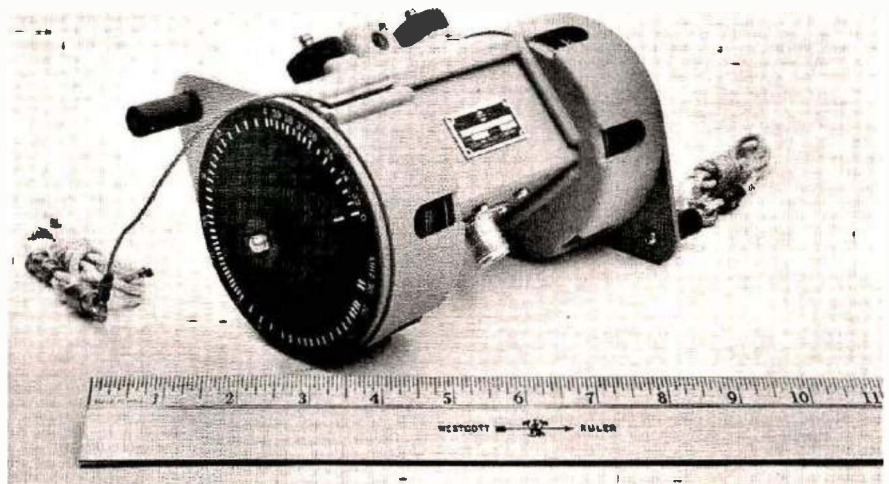

out the inductance presented by the lower frequency antenna.

Assuming the minimum swr occurs at 7.450 MHz and you want minimum swr at 7.125 MHz — a difference of 325 kHz — then the higher frequency dipole should be lengthened approximately 3 feet (90 cm) for minimum swr on 7.125 MHz. This is based on the fact that the resonant frequency of a 40-meter dipole changes approximately 9 kHz per inch (4 kHz per cm).

When installing multiple-dipole antennas be sure to space the ends of the two dipoles several feet (1 meter) apart. If the antennas are spaced closer than this, slight changes in spacing between the two dipoles when the wind blows will cause large variations in the swr.

This same type of multiple-dipole arrangement can be used on more than two amateur bands, but the secret to success is to cut each dipole somewhat longer than the calculated length. Then, starting at the lowest operating frequency, trim each one for minimum swr. This may require raising and lowering the antenna several times, but the final results will be worth it.

Trap dipoles

One popular multiband antenna that has found widespread use on the high-frequency amateur bands is the *trap* dipole shown in Fig. 7A. The traps are tuned circuits which are used to electrically connect or disconnect the outer sections of the dipole as

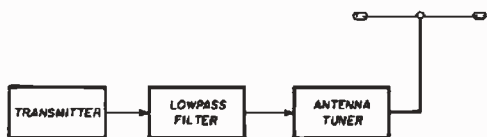

Fig. 5. Using an antenna tuner to provide a good match to your transmitter when using a half-wavelength dipole on 80 meters. If line loss is low, the swr on the line between the tuner and the antenna is of little importance. The lowpass filter behaves as it should only when it's terminated in a matched load, so it should be placed between the transmitter and the antenna tuner.

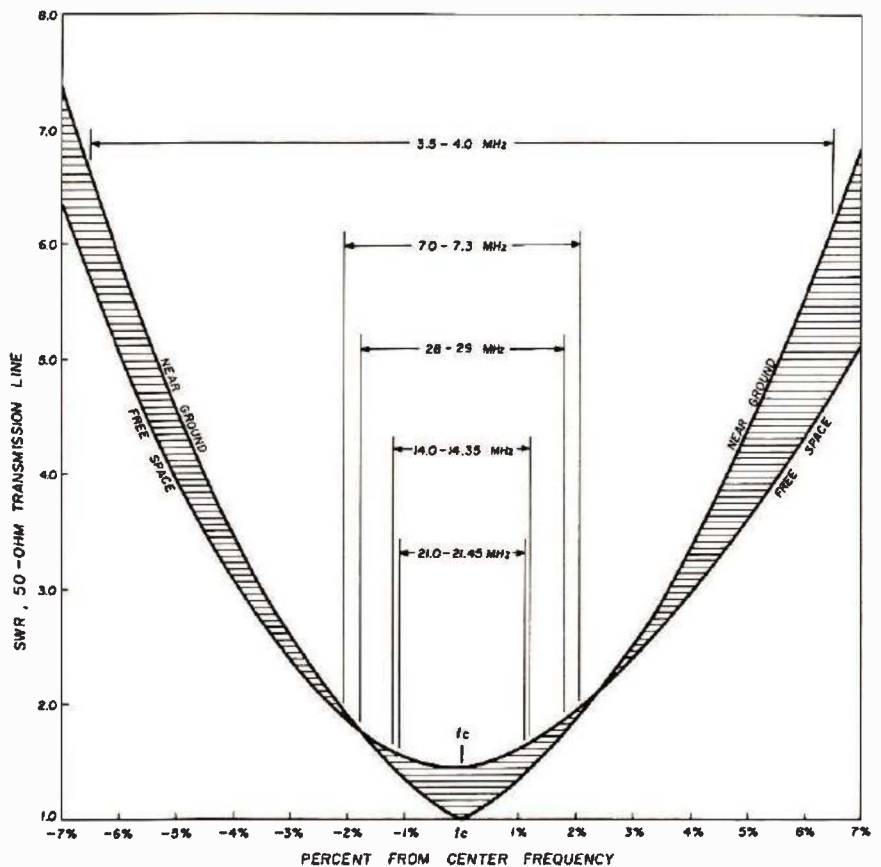

Fig. 4. Percentage bandwidth of the high-frequency amateur bands and how they compare with the swr curves of Fig. 3. Dipoles cut at the center of 40, 20, 15, and 10 meters are within the 2% bandwidth required for a 2:1 swr; on 80 meters the 2:1 swr bandwidth is about 150 kHz. One solution for operation to the 80-meter band edges with a single dipole is to use an antenna tuner, as discussed in the text.

you change bands. At the lowest operating frequency the traps look like small inductors in series with the antenna wire so the dipole appears essentially as a continuous piece of wire (Fig. 7B). On the higher frequency bands where the tuned circuits are resonant, the traps exhibit a very high resistance and look like insulators (Fig. 7C); this effectively divorces the ends of the antenna from the center section.

Purists often point out that the efficiency of the trap dipole is lower than individual dipoles for each of the bands because traps are not perfect insulators. Theoretically this is true, but in practice an accurately tuned multiband dipole with high-Q traps compares favorably with separate full-size dipoles so far as bandwidth and operating

efficiency are concerned.

Shown in Fig. 8A is a trap dipole for the 15- and 20-meter amateur bands. Since these two bands aren't harmonically related, it isn't practical to use the parallel dipoles of Fig. 6. The trap dipole, however, provides excellent performance. As shown in Fig. 8A, the center section of the antenna is resonant at about 21.15 MHz; this length is very close to that given in Table 1. The overall antenna is resonant at about 14.15 MHz. If you compare this length with that given in Table 1 for the same frequency, you'll see that the trap dipole is about 3½ feet (1 meter) shorter. This shortening is due to the small loading inductance contributed by the traps. Note that each of the traps is about 4 inches (10 cm) long; this dimension must be included in the overall

length. A similar arrangement for 10 and 15 meters is shown in Fig. 8B.

If you want to operate on three amateur bands, an additional set of traps can be installed in the dipole as shown in Fig. 9; this trap dipole is designed for the 10-, 15-, and 20-meter bands. In this antenna the center, 10-meter, section is the normal length while the 15- and 20-meter lengths are shortened slightly by the loading of the traps. The use of two traps decreases the bandwidth over which you can operate with an swr less than 2:1, but this three-band

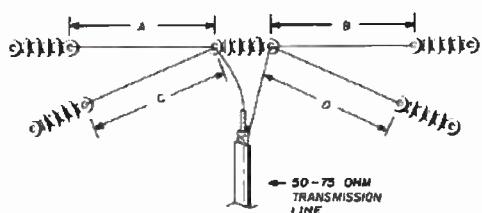

$$A + B \text{ (LOWER FREQUENCY)} = \frac{468}{f_{\text{MHz}}} \text{ (FEET)} = \frac{143}{f_{\text{MHz}}} \text{ (METERS)}$$

$$C + D \text{ (HIGHER FREQUENCY)} = \frac{468}{f_{\text{MHz}}} + \text{CORRECTION FACTOR (FEET)}$$

$$= \frac{143}{f_{\text{MHz}}} + \text{CORRECTION FACTOR (METERS)}$$

Fig. 6. Multiple dipole antennas can be used for operation on two amateur bands, but if the center frequencies are not harmonically related, the higher frequency antenna must be lengthened slightly for low swr as discussed in the text. Multiple dipoles are usually built with no. 12 or 14 AWG (1.6-2.1mm) hard-drawn copper or copper-clad steel wire.

dipole can be used from 28.0 to 28.6 MHz, and over the entire 15- and 20-meter bands with swr less than 2:1. (Remember that height above ground affects swr, so in some cases you may have to prune the antenna length slightly to obtain best performance.)

Trap construction

In most cases the traps are built around antenna strain insulators as shown in Fig. 10. The inductor is a short section

*B&W coil stock, Centralab ceramic capacitors, and antenna insulators are available from G. R. Whitehouse, 15 Newbury Drive, Amherst, New Hampshire 03031.

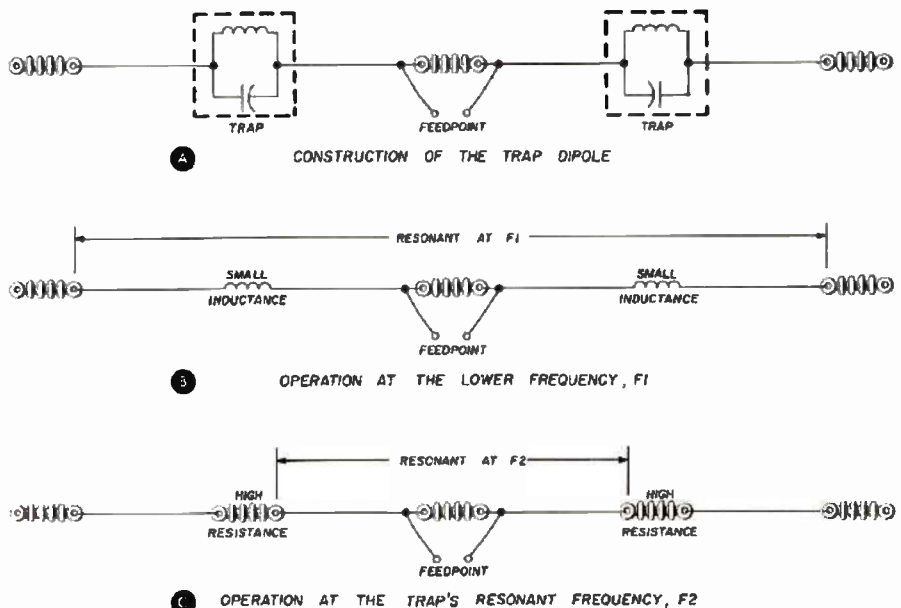

Fig. 7. Basic construction and operation of the two-band trap dipole antenna. At the lower frequency, F_1 , the traps appear as small inductors in series with the antenna, B. At the higher frequency, F_2 , the traps exhibit very high resistance and the traps look essentially like insulators, C.

of air-wound coil stock such as that manufactured by B&W.* The capacitor is a high-voltage ceramic capacitor such as the Centralab 850S series; these capacitors will handle up to 2000 watts PEP in this application. For power levels below 500 watts the Centralab 850A series of capacitors, rated at 3000 volts, is satisfactory. One of the best

ways to connect the trap to the antenna wire is to use small electrical service connectors like the Burndy KS90 Servits which are available from electrical supply stores.

After the traps have been built, they have to be adjusted to the correct frequency. This is most easily done with a grid-dip oscillator (use your receiver to make sure the dipper is

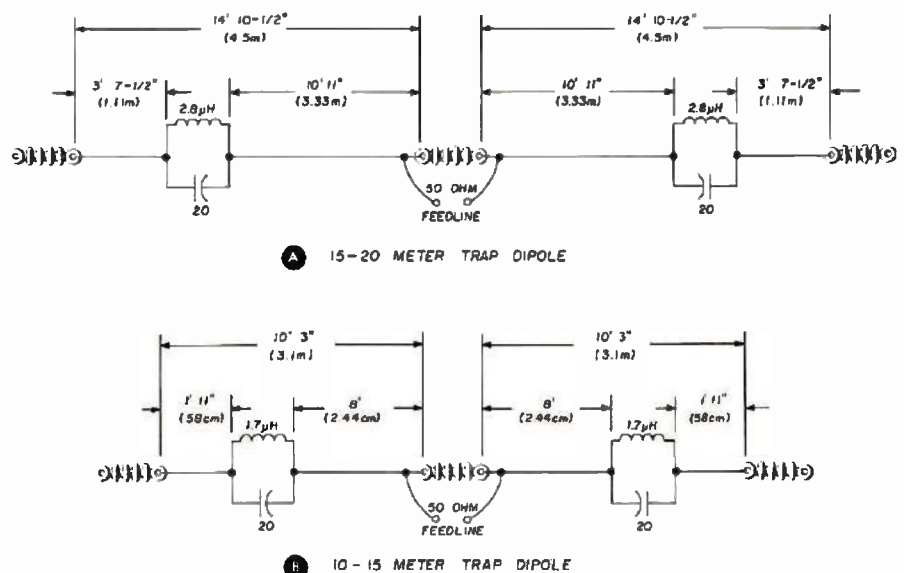

Fig. 8. Two-band trap dipoles for 15 and 20 meters, A; and 10 and 15 meters, B. The capacitors should be high-voltage ceramic units such as the Centralab 853A series. The inductors are made from sections of B&W coil stock. For the 15-20 dipole use 8 turns of B&W 3025 coil stock; for the 10-15 dipole use 6 turns of B&W 3025 coil stock.

tuned to the right frequency).

Place the assembled trap in a clear space away from any metal objects and loosely couple it to the dipper. For best results the traps should be tuned slightly *below* the operating frequency — this gives maximum bandwidth. The traps will also work if they are tuned to the center of the operating band, but the 2:1 swr bandwidth won't be as great. Adjusting the traps so they dip about 50 to 100 kHz below the band edge seems to give the best results. For coarse frequency tuning adjustments slightly prune off turns from the coil about one-quarter turn at a time; for fine adjustments simply expand or compress the outer turns.

5-band trap antenna

If you build a trap dipole for 40 and 80 meters and analyze its operation on the higher amateur bands, you'll find that the traps appear as small capacitors in series with the antenna wire at the higher frequencies. These capacitors have the effect of increasing the resonant frequency as compared to a simple dipole of the same overall length. By carefully choosing the inductance-capacitance ratio in the traps, it's possible to design a trap dipole that will provide a good match to 75-

in parallel with a 10 μH inductor built from 15 to 17 turns of B&W 3905-1 coil stock. The traps are tuned to 7.1 MHz.

If you don't have enough room in your backyard to put up the 106-foot (32.3 meter) "5-Band Cape Antenna," shown in Fig. 12 is a four-band trap dipole that covers 40 through 10 meters; the overall length of this antenna is only about 55 feet (16.8 meters). Each of the traps consists of a 25 pF capacitor in parallel with a 5.1 μH inductor built from commercial coil stock. For best results the traps should be tuned to 14.1 MHz with a grid dipper.

Waterproofing the traps

There are several methods for protecting the traps from the ravages of rain and snow. One of the neatest is to use short sections of 4-inch (10 cm) PVC drain pipe available at plumbing supply houses.* The trap is placed inside a section of plastic pipe and end caps are cemented on with PVC solvent (do this outdoors or in a well-ventilated area). Holes are drilled in the end caps for the antenna wire to pass through; after the antenna wire is installed, seal the hole with RTV or bathtub caulking to keep the moisture out.

Another method of waterproofing the traps is to

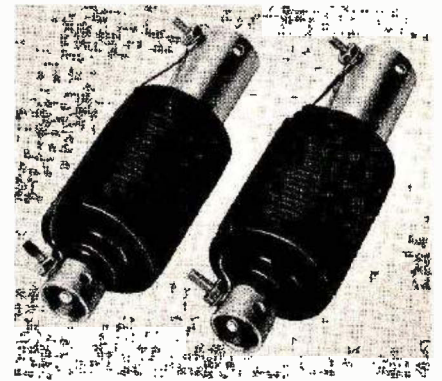

Commercial multi-band antenna coils manufactured by the Microwave Filter Company, 6743 Kinne Street, East Syracuse, New York 13057. Several models are available including the KW-40 trap for 40 meters, and the KW-10, KW-15, and KW-20 for 10, 15, and 20 meters. The KW-40 can be used by itself to build a five-band dipole, but operation is a compromise on 20 through 10. For lower swr performance on the higher bands, the other traps should be used as well. Total length of a five-band dipole using all eight traps is about 100 feet (30 meters). The traps are completely waterproof and will handle up to 1000 watts.

mindful, you might consider using the round, flexible, plastic "squeeze" bottles that contain various household products. Cut the bottom off the bottle, insert the trap and antenna wire, and cement the bottom back on with bathtub caulking or RTV.

Baluns

Simple, center-fed dipoles first became popular with the

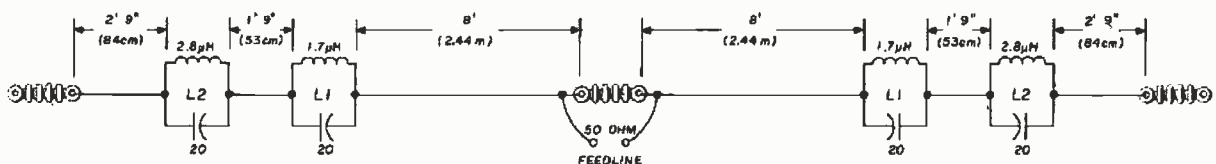

Fig. 9. Three band trap dipole for 10, 15, and 20 meters. The capacitors are high-voltage transmitting ceramics such as the Centralab 853A series. The inductor in the 10-meter trap (L1) is 6 turns of B&W 3025 coil stock; inductor L2 in the 15-meter trap is 8 turns of B&W 3025 coil stock. For best performance and greatest bandwidth the 10-meter trap should be tuned to 27.8 MHz; the 15-meter trap is resonated at 21.85 MHz.

ohm transmission line on 80 through 10 meters.

Just such an antenna is shown in Fig. 11. This five-band antenna was designed by engineers at Cape Kennedy and is known as the "5-Band Cape Antenna." Each of the traps consists of a 50 pF ceramic capacitor (Centralab 850S-50Z)

use a short section of large-diameter Lucite tubing with large corks that are meant for Thermos bottles.

If you're really budget

*PVC drain pipe is also available from Sears. The catalog number for the 4-inch (10 cm) pipe is 42G23131N; the matching end caps are catalog number 42G23119.

development of efficient, flexible, low-impedance twin-lead transmission lines which matched the dipole's nominal 72-ohm center impedance. Even after amateur transmitters with unbalanced pi-network output circuits became standard, many amateurs continued to use twin-lead to feed their

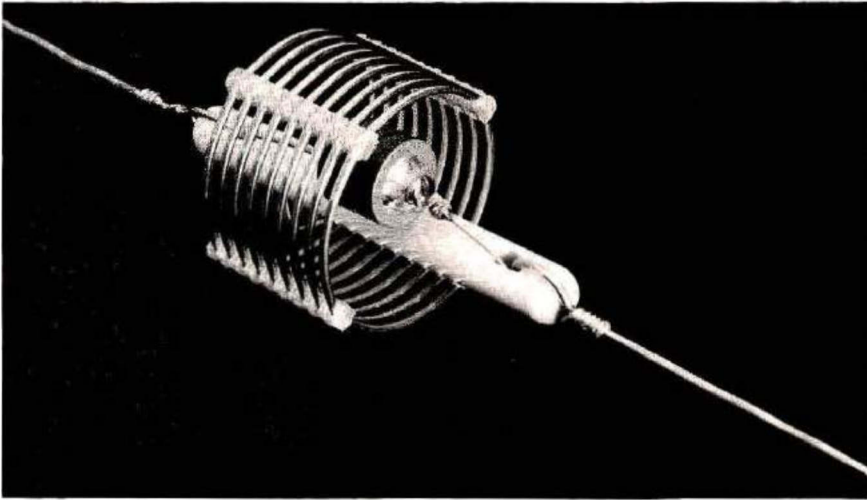

Fig. 10. Method of building the traps for multiband dipole antennas. The coil stock is air wound with no. 12 AWG (2.1mm) on a 2-inch (50mm) diameter form, 6 turns per inch (B&W 3025 or equivalent). The capacitor is a 7500-volt ceramic transmitting type (Centralab 850S series or similar). This design will handle the amateur power limits of 2000 watts PEP. For power levels up to 500 watts, the coil may be built from smaller diameter coil stock, and the capacitor may be the smaller 5000-volt Centralab 853A series.

dipoles by grounding one conductor of the twin-lead and connecting the other lead to the center pin of the transmitter's coaxial output connector.

This arrangement seemed to

fine, just as they apparently did with the twin-lead. Then the purists came up with the edict that you couldn't feed a balanced antenna like the dipole with unbalanced coaxial feedline unless you put a

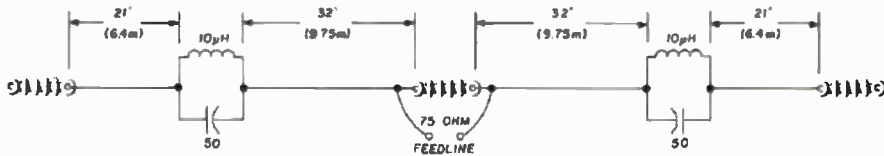

Fig. 11. Five-Band Cape Antenna for 80 through 10 meters which was designed by engineers at Cape Kennedy. The inductor is 15 to 17 turns of B&W 3905-1 coil stock (2½" 6.4cm diameter, no. 12 AWG 2.1mm wire, wound 6 turns per inch). The capacitor is a ceramic Centralab 850S-50Z. The traps should be tuned to 7.1 MHz by carefully pruning one end of the coil a little at a time.

work just fine, but the word gradually got around that you couldn't feed a balanced transmission line with the unbalanced pi network.* Most amateurs dutifully switched from twin-lead to coaxial cable — and the antennas worked

balancing device such as a balun between the feedline and the antenna. Many amateurs quickly installed the required baluns, but noticed very little difference in antenna operation.

Admittedly, there is some

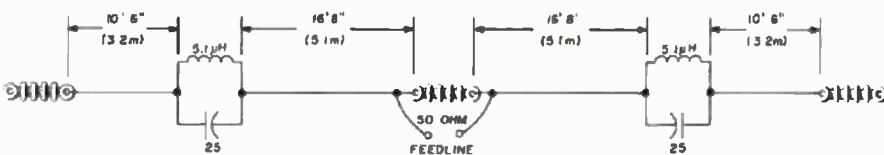

Fig. 12. Four-band trap antenna for 40, 20, 15, and 10 meters. The overall length is only 55 feet (16.8 meters), 10 feet (3 meters) shorter than a normal single-band dipole for 40 meters. The inductors are 9 turns of B&W 3905-1 coil stock (2½" 6.4cm diameter, no. 12 AWG 2.1mm wire, wound 6 turns per inch). The capacitor is a high-voltage transmitting type. The traps should be carefully tuned to 14.1 MHz.

skewing of the dipole's radiation pattern when it's fed directly with coaxial cable, but for the average installation, where the antenna is less than 50 feet (15 meters) above the ground, the pattern is so distorted by nearby objects that the skewing goes unnoticed. With a balun installed, however, you'll notice poorer reception of local vertically polarized signals. This is important because most man-made noise is vertically polarized, so a dipole with a balun *may* be somewhat quieter than a dipole without one.

If you are using a high-gain beam which is designed for balanced feedline, the use of a balun is much more important because pattern skewing can be very noticeable without the balun. Amateurs who use simple balanced antennas such as dipoles, however, are about equally split on their use of baluns. If you want to install one on your dipole, it certainly won't do any harm, and it will probably reduce the amount of man-made noise your receiver hears.

Harmonic radiation

Some amateurs avoid multiband antennas because they're afraid of excessive harmonic radiation. Fortunately this is not a problem with modern transmitters and transceivers because they have sufficient harmonic suppression built into the design. If you carefully tune your transmitter into a dummy load before you go on the air, and operate with a swr of 2:1 or less, you should have no problems with unwanted harmonics. **HRH**

*Unbalanced to ground; the output of the pi network is "hot" with respect to ground. A balanced line such as twin-lead must have equal magnitude, opposite polarity rf currents flowing on each of the two conductors to prevent rf radiation. When twin-lead is connected to a pi network, the currents in the conductors are not balanced, so the line acts like a radiator; this may lead to problems with television and hi-fi interference.

SST T-1 RANDOM WIRE ANTENNA TUNER

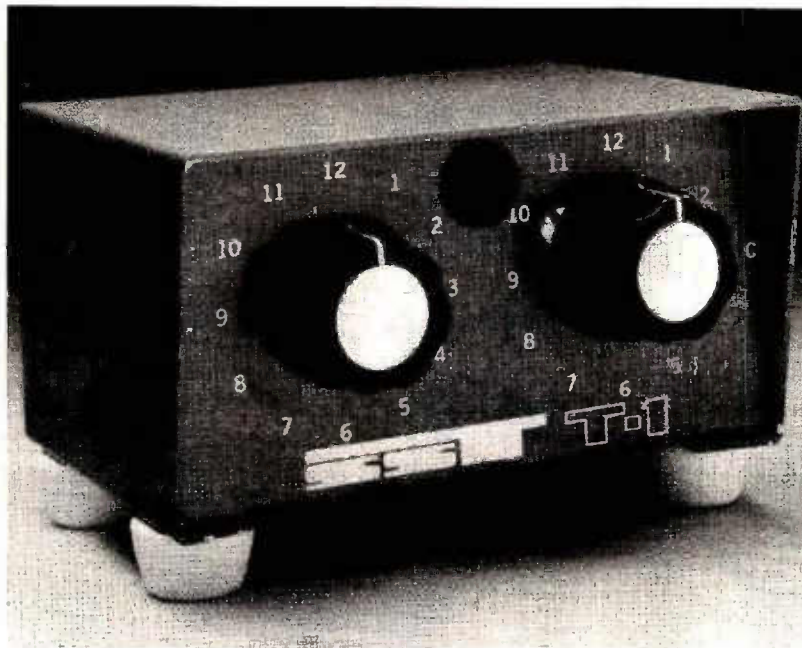

All band operation (160-10 meters) with any random length of wire. 200 watt **output** power capability—will work with virtually any transceiver. Ideal for portable or home operation. Great for apartments and hotel rooms—simply run a wire inside, out a window, or anyplace available. Toroid inductor for small size: 4-1/4" X 2-3/8" X 3." Built-in neon tune-up indicator. SO-239 connector. Attractive bronze finished enclosure.

only **\$29.95**

sst t-2 ULTRA TUNER

Tunes out SWR on any coax fed antenna as well as random wires. Works great on all bands (160-10 meters) with any transceiver running up to 200 watts power output.

Increases usable bandwidth of any antenna. Tunes out SWR on mobile whips from inside your car.

Uses toroid inductor and specially made capacitors for small size: 5 1/4" x 2 1/4" x 2 1/2." Rugged, yet compact. Attractive bronze finished enclosure. SO-239 coax connectors are used for transmitter input and coax fed antennas. Convenient binding posts are provided for random wire and ground connections.

only **\$49.95**



sst t-3 IMPEDANCE TRANSFORMER

Matches 52 ohm coax to the lower impedance of a mobile whip or vertical. 12 position switch with taps spread between 3 and 52 ohms. Broadband from 1-30 MHz. Will work with virtually any transceiver—300 watt output power capability. SO-239 connectors. Toroid inductor for small size: 2-3/4" X 2" X 2-1/4." Attractive bronze finish.

only **\$19.95**



GUARANTEE

All SST products are guaranteed for 1 year. In addition, they may be returned within 10 days for a full refund (less shipping) if

you are not satisfied for any reason. Please add \$2 for shipping and handling. Calif. residents, please add sales tax. COD orders OK by phone.



ELECTRONICS
P.O. BOX 1 LAWNSDALE, CALIF.
90260 • (213) 376-5887 S10

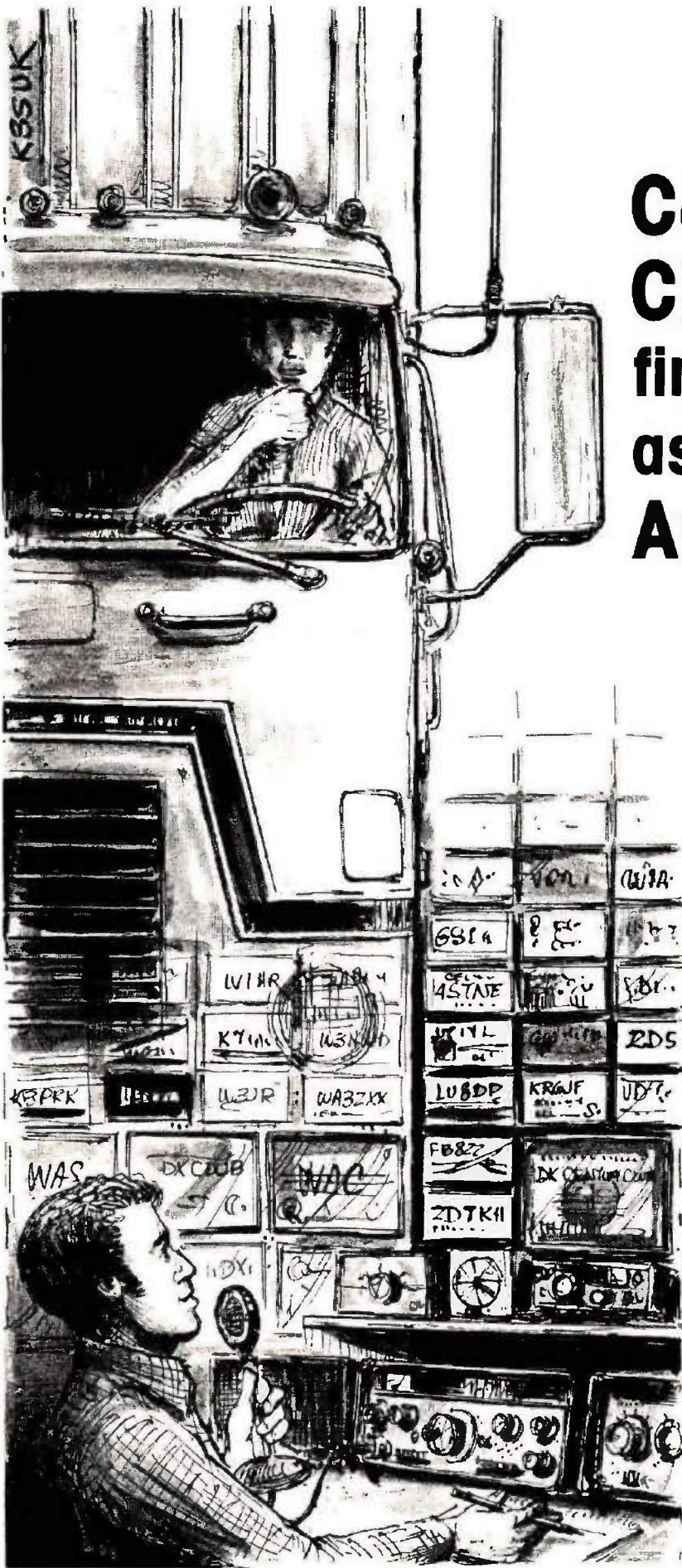

Can a CBer find happiness as an Amateur?



Kevin Fitzpatrick
"CB's too crowded . . ."



John Fosso
"I met most of my school friends (through CB)"



Ralph Flint
"Now seems like the time . . ."



Cynthia Donato
"I don't want to be left out of anything new . . ."



Constantine (Dino) Pahoulis
"Hams are more helpful"



Above: Ted Trostle
"CB keeps everyone together"



Left: Matthew D'Azzo
"Two meters is like super CB"

BY CHARLENE KNADLE, WB2HJD

Constantine (Dino) Pahoulis says, "CB just isn't enough of a challenge." Both Dino and Ted Trostle have a desire to get into the "nuts and bolts" of their rigs, partly by learning from fellow hobbyists. "But CBers know zilch about their rigs," says Dino. "Hams, on the other hand, are more helpful. They're interested in what you're doing and are capable and willing to give help if you need it."

Is DX your bag?

John Rosso and Franklin Donato cite greater distance as their strongest motivation for getting into amateur radio. Matthew D'Azzo agrees. "Back in 1960, when I first became a CBer," Matthew says, "CB was new and uncrowded. Once I even got 35 miles on a 5-watt a-m transmitter. CB was a ham station to me, then. But now the noise, the crowding, and the shorter possible distances discourage me. Now it's terrible — unless you leave the New York area."

Crowded conditions on CB bothered almost everyone. "I've seen this problem even at 4 AM," says Dino. "You can't have a conversation — just, 'Where are you?' 'Meet you at such-and-such a place.' Then you go *there* to talk."

Ragchewing

Ability to have reasonably long, uninterrupted conversations on the air was a popular reason for getting into amateur radio. Cynthia Donato wants mainly to be able to talk to her husband, Franklin, when she's in the house and he's in the car. Matthew D'Azzo, also, hopes to be able to communicate with his wife at home. Ralph Flint, however, does not have a problem between house and car: "I'm on sideband (single sideband) on CB," he says. "It's less crowded."

But on a-m, where most

CBers operate, crowding remains a problem. For Kevin Fitzpatrick, it's enough to leave him undecided about continuing with CB after he gets his amateur-radio license. "I'm discouraged," he says. "CB's too crowded. People even curse each other."

The case for CB

Most others, on the other hand, planned to remain CBers even after becoming hams. Franklin Donato values CB for traffic and weather reports. "I will use both (CB and amateur radio)," he says. "I can listen to two rigs at once." Ted Trostle plans to use CB, as he has before, for Boy-Scout trips. "We usually have a 7-car convoy," he says. "CB keeps everyone together." And Dino Pahoulis will use it for help on the road "in case I get stuck." Not all CBers are entirely happy with CB radio, even though they still derive some satisfaction from it. But their frustration with CB in no way diminishes their interest in radio communications. What are they doing about this dilemma? Some of them are planning to become radio amateurs.

I recently visited a class for prospective radio amateurs at Stony Brook University. The class, taught by Arnold Benton, a physicist and radio amateur (WA2AHB), is designed to prepare one to pass the FCC exam for an amateur radio Novice-class license (a follow-up class will lead to preparation for the General-class license). The class is sponsored by the Suffolk County Radio Club, some of whose members volunteer their time to assist Arnold with the class. Of the 50 or so people who had signed up for the class, the majority were CBers. I wondered why, and decided to find out.

Testimonials

After talking with some of the CBers, I could see that

their main goal was to get more of what CB radio had promised but had not fully delivered. Listen to Franklin Donato, who had once seen what radio communications could be:

"For about six years I was employed as a deputy sheriff at a county sheriff's office," says Franklin. "Our cars were equipped with Motorola sets, which operated in the 39-MHz band. The combination of that frequency, high power, and a clear channel, always gave us a powerful radio clout. I got involved with CB communications in 1964 in an effort to have a personal two-way communications system in my own car that might resemble the capability of the police radio. I found the CB set to be a poor substitute. Amateur radio now affords additional capabilities. It allows more range, a broader frequency spectrum, and the capability for phone-patch communications. It's a tremendous additional aid for community service and travel."

But almost everyone when asked why they would remain with CB included one word in their answer; friends. "I met most of my school friends that way," says John Rosso. Dino Pahoulis has had lots of delightful experiences with the friendliness of CBers. He says, for example, "When my wife and I were expecting a baby, I mentioned it over the air, and when the baby was born, I naturally told everyone. A bunch of CBers showed up with gifts. I hadn't expected that." And when he moved into his new house, Dino was delighted to find that the other new house, across the street, had been bought by a CBer he knew.

The transition to amateur radio

How do people, including CBers, learn about amateur radio? Mostly by word of mouth. John Rosso, Dino Pahoulis, and Matthew D'Azzo



Tropical Hamboree

ARRL Southeastern
Division
CONVENTION

**FLAGLER
DOG TRACK**

(37th Ave. at N.W. 7th St.)

MIAMI, FLA.

**Jan. 21-22,
1978**

FREE PARKING INCLUDING
OVERNIGHT SPACE FOR
COMPLETELY
SELF-CONTAINED RV's

**Pre-
Registration
\$2.50**

FOR SPECIAL HOTEL RATES
AND FURTHER INFORMATION
WRITE:

**P.O. BOX 350045
RIVERSIDE STA.
MIAMI, FLA. 33135**

all had neighbors who were hams. In addition, John's father is a former ham, who still occasionally turns on his receiver and listens. (It's illegal to transmit without a license, but perfectly legal to listen.) Kevin Fitzpatrick's first exposure to radio also came from his father, whose hobby was listening to international shortwave broadcasts. Franklin Donato says, "After I got my CB rig, an old friend who is a ham talked with me about (amateur) radio."

Ralph Flint says he's been interested in radio ever since World War II, when he was denied training as a radio operator because the class was filled. "Now seems like the time to go ahead and do it," he says. "I made that decision after I gave up my airplane and needed a new interest. One thing at a time!" Ted Trostle, too, has had a long-standing interest in radio. He says, "I've been putting it off since 25 years ago, when a high-school friend who was a ham got me interested. But an easy opportunity was never presented until now. An associate of my wife's, who is a ham, knew about this class. So I called Arnold (the teacher)."

Goals

Now that they're close to getting their amateur-radio licenses, what do these CBers expect from amateur radio? "Fun," says Ted Trostle, "I want to operate long distances — maybe around the world." Matthew D'Azzo agrees. "It's exciting to think of contacting Alaska, Europe, Australia, Africa." Franklin Donato adds, "I'd like to make new friends, and maybe even promote

*Amateur-radio autopatch works this way: A touch-tone equipped transceiver in the car contacts a repeater station hooked to telephone-company lines (an autopatched repeater). Hams making calls from their cars still pay for the calls.

international good will through amateur radio."

In this country, Ralph Flint and Kevin Fitzpatrick both have relatives "everywhere," whom they would like to be able to contact, either directly or through phone patch.

Ted Trostle looks forward to being able to use Morse code, as does Cynthia Donato. "I don't want to be left out of anything new that's going on," Cynthia says, "but I don't feel comfortable talking to strangers over a microphone. I think I could do it with code."

Some CBers hope amateur radio can fulfill their technical interests. "I'm an antenna nut," says Ted Trostle. "I've just been trying a new 5/8 wavelength CB mobile antenna. Maybe I'll experiment like that with mobile amateur radio." And Ralph Flint plans eventually to add computers to his amateur-radio setup.

Franklin Donato wants to put an autopatch in his motor home so he can make regular phone calls while on the road.* But he's not interested in the technical aspects. "I don't plan to service my own rig," he says. "I won't get into the electronics. The parts would be all over the house."

Mostly, CBers expect better mobile operation from amateur radio. Franklin Donato looks forward to greater distance through the use of amateur-radio repeaters. And he wants to use fm, which is mostly static-free. "I want to be able to hold a long conversation in an intelligible way," he says. "Two-meters is like super CB," Matthew D'Azzo says. "Crystal clear. You get 100-200 mile range."

"I expect more courtesy," says Dino Pahoulis. "Hams are more law-abiding, and more helpful with radio."

But Matthew D'Azzo summed up what seemed to be everybody's feelings: "What do you expect from amateur radio?" I asked. His answer: "A whole new world." **HRH**

**don't let
the low
price fool
you...**



**the Tempo ONE is much more
than just an inexpensive transceiver**

The Tempo ONE is a highly reliable, excellent quality HF transceiver. It has proven itself in worldwide use by thousands of General and Advanced Class amateurs for more than six years. And now under the new FCC regulations the Tempo ONE has become the ideal rig for the Novice and Technician Class also. Study its specifications, talk to any of the thousands of owners, compare the Tempo ONE with other transceivers . . . and we know you can't beat the price. We're sure the Tempo ONE will prove itself to be the "value leader" for you also.

Frequency Range: 80 through 10 meters (28.5-29.0 10M. xtal supplied)
Modes of Operation: SSB upper and lower sideband, CW and AM.
Solid State VFO: Very stable Colpitts circuit
Receiver Offset Tuning (Clarifier): Provides -5 khz variation of receiver tuning when switched ON.

Frequency Stability: Less than 100 cycles after warm-up, and less than 100 cycles for plus or minus 10% line voltage change.
Input Power: 300 watts PEP, 240 watts CW.
AF Bandwidth: 300-2700 cps
Receiver Sensitivity: 1/2 μ v input S/N 10dB
AGC: Fast attack slow decay for SSB and CW.
Selectivity 2.3 khz. (-6 dB), 4 khz. (-60 dB)
Image Rejection: More than 50 dB.
Audio Output: 1 watt at 10% distortion.
Audio Output Impedance: 8 ohms and 600 ohms
Tubes and Semiconductors: 16 tubes, 15 diodes, 7 transistors
Antenna Impedance: 50-75 ohms
Carrier Suppression: -40 dB or better
Sideband Suppression: 50 dB at 1000 CPS
Third Order Intermodulation Products: -30 dB (PEP)

TEMPO "ONE" TRANSCEIVER	\$399.00
AC/ONE POWER SUPPLY	\$99.00
DC/1-A POWER SUPPLY 12 volts DC	\$120.00
TEMPO VF/ONE External VFO	\$109.00

AVAILABLE AT SELECT DEALERS THROUGHOUT THE U.S.

Henry Radio

11240 W. Olympic Blvd., Los Angeles, Calif. 90064 213/477-6701
931 N. Euclid, Anaheim, Calif. 92801 714/772-9200
Butler, Missouri 64730 816/679-3127

LEARNING MORSE CODE: SOME IDEAS

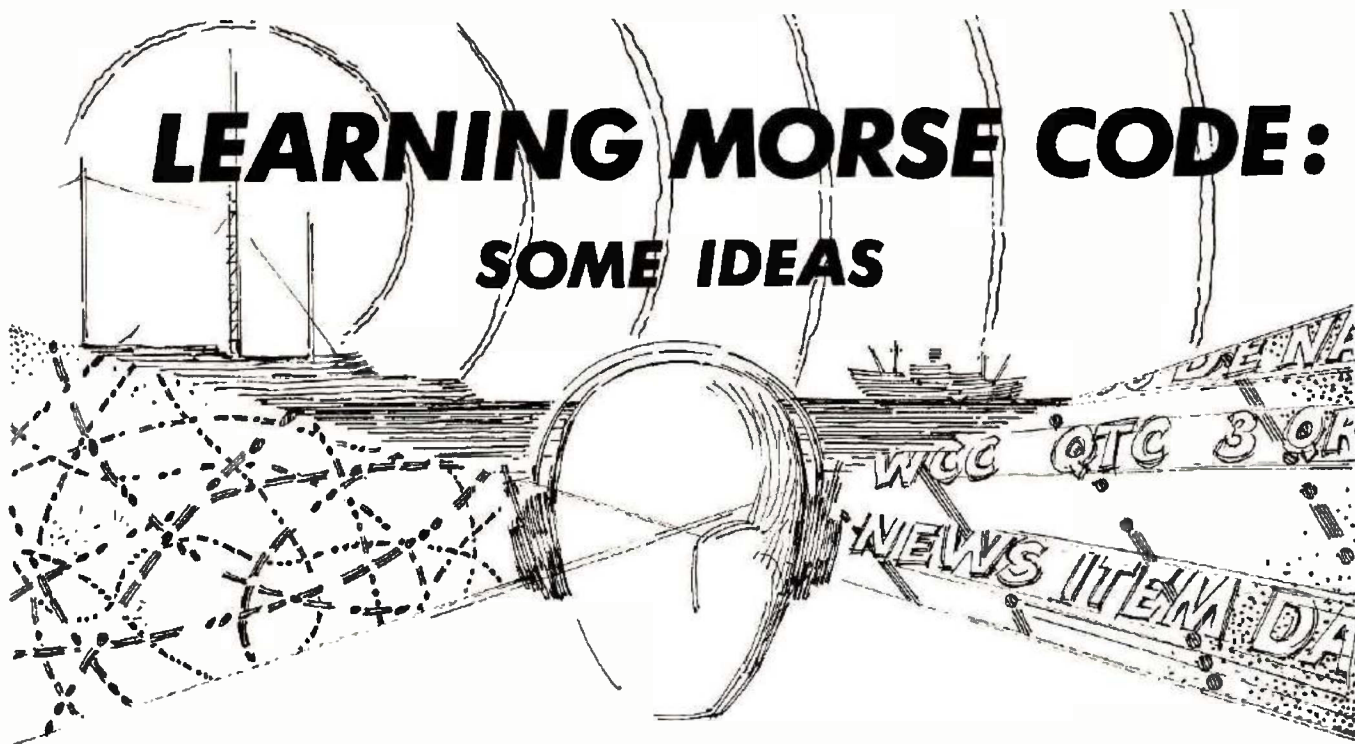

BY ALFRED WILSON, W6NIF

Receiving and sending Morse code seems to be the major hangup in passing amateur radio license exams. Here's one approach to the problem — it worked for me

Learning to copy and send Morse is much like learning to touch type. When you first start a class in touch typing, the instructor usually gives you a copy of the typewriter keyboard with a diagram that shows what fingers are to be used to type each character. The row of keys on the machine starting with the letter A and ending with @ is called the "home row." You are then instructed to learn the typewriter keyboard by first typing ASD with your left hand and JKL with your right hand. You do this over and over and over again until you instinctively type these letters *without looking at the keyboard*. The remaining portion of the typewriter keyboard is learned similarly. Eventually, after hours of practice, you can sit down at any standard typewriter

keyboard and type copy without looking at the keyboard.

This article, of course, isn't a lesson in learning to touch type, but rather a way to learn Morse code based on the repetitive principles used to learn how to handle the typewriter keyboard. The key (no pun intended) is *practice*. Many, many hours are required for some; for others, perhaps just a few hours.

Preliminary steps

You've heard that Morse is learned by sound rather than sight. You don't learn the Morse alphabet by memorizing "dot dash" for the letter A or "dash dot dot dot" for B, and so on. You must translate the Morse characters for each letter, number, and punctuation mark into sounds: "dit-dah" for A, "dah dit dit dit" for B,

and so on through the alphabet.

In keeping with the repetitive principles of learning to touch type, start by learning the first three letters of the alphabet. Mentally sound out these three letters over and over again until you can irrevocably recognize each letter, however slowly. After sufficient practice you'll be able to have someone sound out these first three letters and you'll be able to write them down in any combination, without error, and without hesitation.

The next step, again in keeping with touch-typing principles of repetitive learning, is to get acquainted with the next three letters of the alphabet. (You've learned how to recognize ABC in all three combinations by now, and you'll never forget them —

providing you've practiced sufficiently.)

Work with *D*, *E*, and *F* in the same way. Try copying various combinations, over and over again, until you can recognize each Morse character for these letters *without having to think about it*. Your brain and motor

Table 1. Where to find commercial ship and coastal radiotelegraph stations in the medium- and high-frequency shortwave spectrum.

Ship stations (frequency, MHz)	Coastal stations (frequency, MHz)
4.160 - 4.177	
4.187 - 4.238	4.238 - 4.368
6.240 - 6.265	
6.281 - 6.357	6.357 - 6.525
8.320 - 8.354	
8.374 - 8.476	8.476 - 8.745
12.471 - 12.531	
12.561 - 12.714	12.714 - 13.130
16.622 - 16.706	
16.748 - 16.952	16.952 - 17.290
22.148 - 22.220	
22.270 - 22.400	22.400 - 22.650

nerves will then be conditioned to operate as a system. Once learned, you'll never forget.

How to practice

One method I used to gain code proficiency proved quite helpful. It was many years ago when I was a youngster going to high school. I'd learned all the letters, numbers, and punctuation using the repetitive learning approach mentioned above. But my code speed was slow, slow, slow! Perhaps 5 words per minute.

On the trolley car to school, I read all the billboard ads and mentally sent the words to myself in Morse. I'd look at a billboard, send the message to myself mentally, and wait for the next billboard. After about two weeks of this I was able to mentally recognize words, numbers, and punctuation without hesitation. With this new-found ability, the next step was to increase speed.

I didn't have any buddies to send Morse to me so I could increase my code speed. I did, however, have a general-

coverage shortwave receiver. In those early days there were no code-practice transmissions by ARRL station W1AW. So I tried to build up my code speed by copying fellows on the 40-meter band. Sounds like a reasonable approach, but it didn't work — at least not for me. Too many guys with lead (I mean lead as in lead pipe) fists, too much interference (the band is even worse today), and unpredictable propagation conditions.

Then, one evening, I tuned my receiver upward in frequency past the 40-meter band and started listening to marine radio-telegraph stations, which operate between about 8.0 and 8.8 MHz. What a difference! I started copying ship stations sending messages to each other and to stations on the coastal shores of the U.S. No real problems with fading or interference!

The marine coastal stations are in business to make money, of course, so they operate on clear channels with substantial power and are manned by operators who are real pros. These fellows don't horse around, believe me. They send Morse code, perfectly and impeccably, and gear their

sending to prevailing conditions.

All in all, I recommend using coastal and ship stations, operating in the CW commercial bands, as sources for code practice. You can hear all sorts of stuff from the coastal stations that should provide code practice for whatever level your code speed is. You'll find newspress items (generally sent at speeds around 20-25 wpm); weather transmissions (between 15 and 25 wpm); messages to ships at speeds ranging from 5 to 35 wpm, depending on conditions. Some of the coastal stations ops use electronic keyers, some use the dash side of a bug, some sound as if they're using a heavy foot pushing a trapdoor. But in every case, the Morse is generally perfect. Characters are formed so that there's no doubt as to the letter or number being sent. If propagation conditions are not good, the coastal station operators repeat words or sentences.

After you gain a little proficiency in handling code, listening to the stations on the marine radio telegraph short-wave bands can be a lot of fun.

Table 2. Selected list of coastal marine radiotelegraph stations operating in the 8-MHz band. These stations will be found just above the 40-meter Novice amateur band on a general-coverage shortwave receiver.

Station	Frequency (kHz)	Power (kW)	Location
WMH	8502	0.75	Baltimore
WSL	8514	2.5	New York
WAX	8526	3.0	Ojus, Florida
WPA	8550	3.0	Port Arthur, Texas
KFS	8558	10.0	San Francisco
WNU	8570	2.0	New Orleans
KLB	8582	2.5	Seattle
WCC	8586		Chatham, Massachusetts
KOK	8690	10.0	Los Angeles
WSC	8610	20.0	Tuckerton, New Jersey
KPH	8618	10.0	San Francisco
WCC	8630		Chatham, Massachusetts
KPH	8642		San Francisco
WSL	8658	10.0	New York
KBL	8658	2.5	Seattle
KLC	8666	2.0	Bremerton, Washington
WSC	8686	2.0	Tuckerton, New Jersey
WMH	8686	0.75	Baltimore

This is easy- anyone can solder- WITH KESTER SOLDER

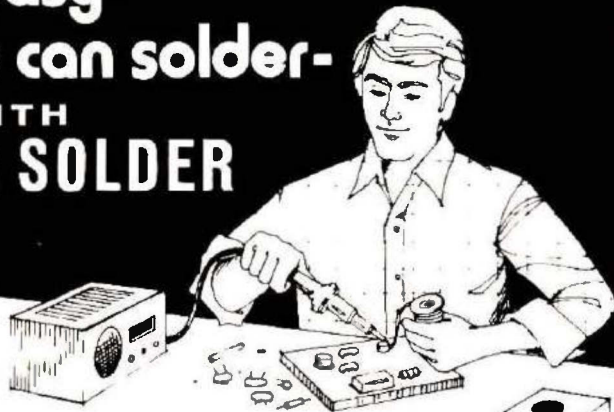

Handymen! Hobbyists! DO-IT-YOURSELFERS!



Let Kester Solder aid you in your home repairs or hobbies. For that household item that needs repairing — a radio, TV, model train, jewelry, appliances, minor electrical repairs, plumbing, etc. — Save money — repair it yourself. Soldering with Kester is a simple, inexpensive way to permanently join two metals.

When you Solder go "First Class" — use Kester Solder.

For valuable soldering information send self-addressed stamped envelope to Kester for a FREE Copy of "Soldering Simplified".



KESTER SOLDER

Litton 4201 WRIGHTWOOD AVENUE/CHICAGO, ILLINOIS 60639

For example, the other day I was listening to a west-coast coastal station trying to work a foreign-ship station. Seems that the ship's operator was having problems receiving the coastal station. After about ten minutes the foreign-ship operator said, "Mucho QRM, OM. Tomorrow is another day, OK?"

Where to find them

The accompanying tables will help you find the marine stations on your general-coverage receiver. **Table 1** lists frequencies of ship and coastal stations in the shortwave marine bands. In **Table 2** you'll find information on commercial coastal stations and their locations. Most of the latter stations run a lot of power, so you should be able to find them without any trouble, even if you use a wet noodle for an antenna.

Closing remarks

Learning to achieve proficiency in receiving and sending code is a matter of perseverance and much practice. This means listening and copying what you can, bit by bit, until you achieve your goal. It may take weeks, months, or years. Eventually you'll make it. If I made it, so can you.

HRH



502-886-4534



YAESU — TEN-TEC — TEMPO — DENTRON

- WE HAVE FULL SERVICE ON WARRANTY AND NON-WARRANTY RADIOS.
- ALL NEW DIGITAL MODELS ARE NOW IN STOCK.
- CALL US SOON FOR PERSONAL SERVICE.



TEN-TEC
544 DIGITAL



TRENTON, KY. 42286

COHOON
AMATEUR SUPPLY





**CALL TOLL FREE
1-800-535-9598**

LA. RESIDENTS CALL COLLECT

AUTHORIZED DEALER FOR...



DRAKE



ICOM

YAESU!



MOTOROLA HOBBY COMPUTERS

ATLAS • BIRD • CDE • DENTRON

ETO • HUSTLER • HY-GAIN

KLM • LARSEN • MOSLEY

ROHN FOLD OVER TOWERS

SWAN • TEMPO • TEN-TEC

TRI-EX • WILSON • CUSHCRAFT

- Prompt phone and mail service
- Liberal trade ins
- Large inventory
- Same day shipment made cut before noon
- Visa and Master Charge accepted

**NEW!
KENWOOD
DEALER**

DIGITAL ELECTRONICS INC.

1201 ANNUNCIATION ST.

P.O. BOX 30566

NEW ORLEANS, LA. 70190

PHONE 504-568-9879

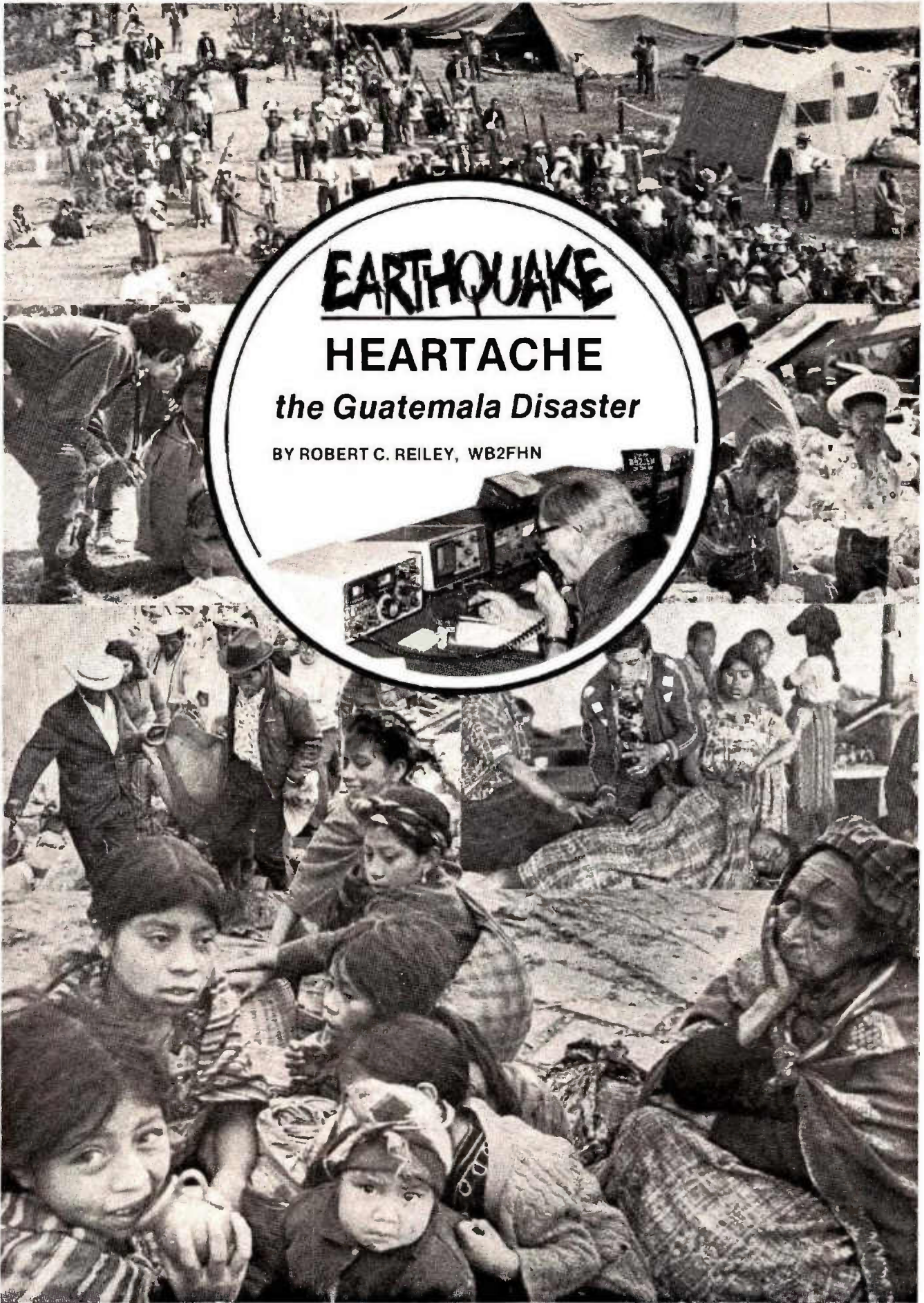

EARTHQUAKE

HEARTACHE

the Guatemala Disaster

BY ROBERT C. REILEY, WB2FHN

It was early in the morning; the sun wouldn't be coming up for several hours. People were asleep in their small mud-walled houses. It was February 4th, 1976, and each day now the sun moved farther north bringing warmer days. The dogs in the village lay outside the doors of the houses as always; but this night they were restless, skittish — something just wasn't right.

Then it happened — like the crack of a whip, only deafening, no warning, instantaneous. The earth shook, rumbled, and groaned. Earthquake! The small country of Guatemala was ripped from one end to the other by disaster. In the next few days more rumblings were to come. Walls cracked, roofs fell in, buildings twisted, roads buckled, lights went out. Then silence — but not for long.

Now the people ran into the streets, bewildered, some injured, screaming. Calmer heads quickly gathered in small groups, who feverishly clawed at the collapsed homes to help trapped people to safety.

Maria was only seven years old. She was dead under the fallen roof of her home when they reached her.

Frederico had spent his life developing his small factory. Now it was only rubble. All his workers' homes were gone, but Frederico was thankful because none of his workers had been killed.

Word of the disaster flashed around the world as relief teams went into action. Disaster crews were inside the collapsed buildings removing the injured; first aid stations went up. The missionaries, the Maryknolls, the Red Cross, the police, the army — all quickly

went to the aid of the victims. Supplies were needed. Power and telephone lines were out. The few emergency radio communications sets with the disaster units were overwhelmed and could only be used for local communications.

But Guatemala is one of the countries that has encouraged its citizens to become amateur radio operators. These amateur operators own and operate their radio stations from their homes, and many have emergency gasoline-engine-driven generator sets to provide power when the local power source is inoperative. The Guatemalan amateurs quickly put their stations on the air and established a communications network throughout the country.

Overseas help

As thousands of amateur operators in many other countries received the disaster news, they too went on the air, checking into emergency nets

and offering their services. The airwaves were full of emergency traffic, and soon amateur-radio operators had some urgently needed medical supplies on the way from Cleveland, Ohio; building-repair materials from Texas; and many other supplies from all parts of the country.

In New York City thousands of people have families or friends in Guatemala. As the New Yorkers learned of the quake, they tried to place telephone calls to the stricken area — but without success. They overwhelmed the telephones at the New York Red Cross headquarters, the Guatemalan consulate, the Guatemalan desk at the State Department, and even at the United Nations headquarters. All to no avail.

Emergency radio networks

It is well known that in times of disaster, amateur radio operators traditionally establish nets quickly between the

John Gorman, WA2ROF, of the Hall of Science Radio Club, New York City, talks on amateur radio with an operator in Guatemala City during an emergency traffic call to the earthquake-stricken city. Standing by is the Carlos Jimenez family, formerly of Guatemala City, and now living in New York. They contacted relatives in Guatemala City to find out how they were. They discovered, through amateur radio, that the family sustained no injuries but that the family home had been destroyed in the quake. The radio-amateur emergency station was set up and operated in Flushing, New York, in the Meadow Park Hall of Science.



The montage on the facing page was assembled from photographs supplied by Associated Press of their news coverage of the Guatemalan disaster. Inset photograph by WA2VOS.



Darkened section of map shows extent of area affected by a massive earthquake, which rolled through three Central American countries and Mexico. The quake epicenter was estimated to be southwest of Guatemala City, Guatemala, which was severely damaged (AP).

stricken community and the outside world. More than 300,000 licensed amateurs are in the United States.

In New York City, the Hall of Science, (a science and technology museum) operates amateur radio station WB2JSM as an exhibit, demonstrating to the public and permitting many visitors to talk to people in

foreign countries as well as in the fifty contiguous United States. Millions of people have visited the Hall of Science and have seen WB2JSM on the air.

On receiving news of the disaster, WB2JSM checked into the emergency traffic nets and offered its services in the New York area. Guatemalan Nationals and people with

family and friends in Guatemala came to the station, seeking information on their loved ones. Hundreds of others called the Hall of Science, asking for the help of the radio station.

Newspapers and television stations learned of the dramatic developments at the Hall of Science and ran stories

and programs, bringing more inquiries. The Hall of Science placed three telephone operators at its switchboard just to handle these calls and take information. Station WB2JSM was placed on a 24-hour-per-day schedule. It was manned by volunteers from the Hall of Science Radio Club. The story of tragedy and joy of people learning bad and good news from Guatemala was seen by hundreds of thousands of Americans on nationwide television.

WB2JSM contains equipment capable of the maximum power permitted by the Federal Communications Commission to amateurs and could easily contact Guatemalan stations directly on a sustained basis. The station made contact with several missionary amateur radio stations and with members of the Radio Amateur Club of Guatemala City. In the ten days following the quake, WB2JSM handled over three-thousand messages to Guatemala.

Sidelights

A woman in the Bronx called the Hall of Science pleading for information on her family; seven-year-old Maria was her niece. A man in Brooklyn called about his brother; his brother, Frederico, was safe. The Guatemalan amateurs furnished information about hundreds of families when there was no other way to learn of their fate. Dozens of other stations, such as WB2JSM, operated from all over the United States with similar results. Emergency traffic handled by amateur radio operators resulted in expediting shipment of tons of urgently needed supplies, aiding in saving the lives of hundreds and alleviating the suffering of thousands.

In 1979 there will be a meeting of communications officials from many countries, (WARC), who will review the uses of the various frequencies



Ron Greene, WA2PCY, of the Hall of Science Radio Club, operates station WB2JSM during the Guatemala earthquake emergency, while Leon Weiner, WA2PFY, accepts traffic from Guatemalan Nationals and explains communications progress with the stricken country (WA2VOS photo).

in the radio spectrum. Many National organizations from police departments, armies and navies, commercial communications services, and radio hobbyists will be seeking to gain more radio-spectrum space, or at least to protect what they presently have.

Some countries don't approve of their citizens having radio stations in their homes with which they can communicate with others in foreign countries. The few radio bands now available to amateur radio operators worldwide will be under attack at the 1979 conference.

Much of the technology that has made modern radio, television, and home entertainment devices possible has been developed by amateurs. Their role in times of disaster has been well established.

There's a cooperative understanding between the American Red Cross and the

American Radio Relay League, the National organization of amateur radio operators, which states: "The American Red Cross recognizes that the amateur radio service, because of its excellent geographical station coverage, can render valuable aid in maintaining continuity of communications during disasters and emergencies when normal communications are disrupted or overloaded."

Every day, somewhere in the United States, this cooperative understanding becomes a living reality when disaster strikes, as amateur radio operators play their volunteer role as part of the Red Cross Disaster Service. Communications officials representing their countries at the 1979 World Administrative Radio Conference (WARC) would be well advised to ensure that these important services to their citizens will be available in times of disaster, as this example shows. HRH

REFLECTIONS of FR

DenTron antenna tuners give you the freedom to experiment with antennas. Whether you're using a beam or a vertical, a piece of wire or the gutters on your motel room; our tuners provide continuous tuning 1.8 - 30 MHz.

Let DenTron amplifiers give you the power to stand out in a crowd and be heard around the world. The MLA-1200 and MLA-2500 are an exceptional source of power, offering understated luxury exemplifying pride in design and workmanship.



A The MT-3000A \$349.50. The MT-3000A is a professionalizing his station. It is a... It has built-in dual watt meters, and (a) enables you to by-pass the tuner systems.

B NEW! The MT-2000A 3KW PEP \$199.50. The MT-2000A is a... on the amateur market. It includes... protection grounding switch, and the feedline.

C NEW! MLA-1200 \$399.50, external... shares many fine features with its... distinctive features of its own. It emp... 1KW DC. It incorporates the same b... 1200 watt linear amplifier on the ma...

D MLA-2500 \$799.50. The MLA-2500... amateur amplifiers. It was designed... ates precision plus power. Coast al... watts DC input on CW, RTTY, or S... contained power supply, and it feat...

FREEDOM and POWER

Dentron

Radio Co., Inc.
2100 Enterprise Parkway
Twinsburg, Ohio 44087
Phone (216) 425-3173



MLA-1200 was designed for the serious ham interested in a rugged antenna tuner that easily handles 3KW PEP. It has a built-in dummy load. The antenna selector switch: (a) direct; (b) select the dummy load or 5 other antenna

MLA-2500. The MT-2000A is the most versatile, basic tuner with front panel coax bypass switching, front panel lightning protection, and ability to match coax, random wire, and balanced

AC supply, \$159.50, DC supply \$199.50. The MLA-1200 is the smallest of the big brothers, the MLA-2500, but also has a few features: built-in ALC as the 2500. The MLA-1200 is the smallest and most rugged, great for your mobile home, boat or car!

One of the world's finest high performance military grade amplifiers for the discriminating buyer who knows and appreciates quality. The heart of the MLA-2500 is a heavy duty, self cooling 2 Eimac 8875's.



How to Speak "Ham"

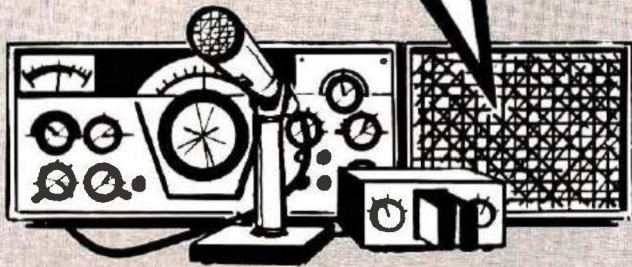

Hams use a somewhat different language for their contacts on the air — a combination of abbreviations and Q signals — that sound like gibberish if you don't understand them; and you need a key to break the code

BY JIM GRAY, W1XU

The lamp sheds a soft glow on the polished surface of your operating desk, illuminating a clean sheet of tablet paper and sharpened pencil that seems to be waiting for your hand. The station clock indicates 0000 GMT — 7 PM Eastern Standard Time — and the mute faces of the silent radio equipment lined up along the back of the desk invite you to reach over and bring it to life. You sit down, lean forward, and begin the now-familiar routine of switching things on. Antenna: *Ungrounded*; Receiver: *On*; and — for the first time, "for real" — Transmitter: *On*. Your faithful hand key is positioned

a comfortable forearm's length in front of you at the operating position and slightly in from the right-hand edge of the desk. It beckons irresistably.

This all began about six weeks ago when you passed the Novice code test and your buddy, a "General", gave you the written exam. You worried about passing in spite of all the studying. Looking back, you remembered some questions you might have answered differently. Then, when you came home this afternoon, an envelope marked *FCC* was waiting in your mail. Instant butterflies! License or invitation to re-take the test? Your

hands shook a bit trying to tear open the envelope and you thought, "Did I or didn't I?" Hot dog, you did, you really did!

Now, a couple of hours later, things look good on 80 meters as you spin the dial of your receiver to the Novice part of the band. It had been set on W1AW's frequency where you still practice the ten wpm "runs," hoping to reach the magic "13." Wow! On 3730 kHz you hear a CQ. You've already checked the transmitter tune-up procedure for the tenth time on the dummy load. All is well and the meters point where they should. You "zero beat" the caller's frequency with the transmitter vfo and check the tuning for a brief second on the antenna. All okay. Switching to receive again, you find that the CQer is just signing. Your palms are a bit sweaty and your hand trembles slightly on the key. The "moment of truth" is at hand, and a thousand things run through your mind. "Will he hear me? How many times should I call him? Can I understand him if he returns my call? What signal report should I give him? What abbreviations should I use? How about Q signals — can I remember the right ones?"

The second milestone of your amateur radio career is about to take place (the first was getting your license), and you're naturally a bit tense because you want everything to be right the first time.

Have you been in this situation? Does it sound familiar? If not, either you haven't received your license yet, or you are Mr. Cool in person!

There is one way to help yourself prepare for this milestone — first QSO — in addition to the obvious one of being able to copy the code. You already know you can hack plain text, but what about not-so-plain text? Aha! Thought so. You did have trouble understanding what you put on paper, and thought you had copied wrong, when you listened to that Novice contact

the other night. That wasn't the first time, either, was it? You copied only a few words "solid" with lots of missing letters, and you found letter combinations that didn't make any sense at all, right? Okay, read on.

The CW dialect

Way back in the early days of radio, commercial messages were sent by CW only. Time was money; the faster you "passed traffic" (handled messages), the more money you made for the company. High speed operators developed short cuts; they abbreviated common words that were ordinarily lengthy, they cut sentences down to only a few words, they adopted number codes for the most frequently sent messages, and they used *Q signals* — internationally accepted by shipboard operators — to replace frequently asked questions and corresponding answers. All of these traffic procedures reduced transmission time considerably and speeded up the flow of traffic. Just like yesterday's news, there was — and still is — nothing staler than undelivered messages. In addition, there are times when message-handling is literally a life-or-death proposition, and speed is of the essence.

As a ham, you are not expected to be a commercial operator, and in most cases an easy and leisurely flow of send

and receive will be most enjoyable. But, as your operating skills improve, you'll find yourself becoming impatient with dragging conversation. After all, the idea is to communicate, not spend time with punctuation and laborious spelling of entire words.

Ham abbreviations were borrowed from commercial traffic handlers, from shipboard operators and — a surprising number — from other hams who manned the greatest message-handling network of all time: The American Radio Relay League. Just as you use slang expressions to add flavor, interest, and speed to conversation, the radio operator adopts his own ham slang for the same reasons. It becomes a dialect or accent, and is instantly recognizable to

experienced operators. They all use it, and so will you.

Abbreviations are time savers

Perhaps the first thing that ought to be said is that you don't *have* to use abbreviations at all, but you'll find that most Amateurs *do* use them and — sooner or later — you'll probably use them too. The following list is not complete, but it does give you the most popular abbreviations and the original word from which they were taken. Notice another thing as you read them; sometimes just one letter is replaced, usually by a letter having a shorter Morse Code Character. For example, in the word *any* — or *ani* in abbreviated form — *i* replaces *y*; two *dits* instead of a *dit* and three *dahs*.

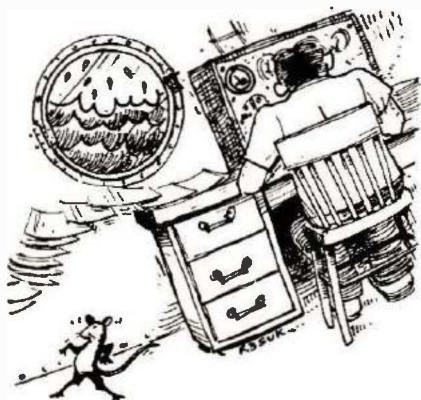

On land and ships traffic-handling short-cuts were developed.

ABT	about	DE	from
AGN	again	DIF	difference
ANI	any	DLR	deliver, dealer
ANT	antenna	DN	down
AR	end of message	DNT	don't
AS	wait a moment	DR	dear, doctor
B4	before	DSNT	does not
BALUN	balanced-to-unbalanced	DUNNO	don't know
BC	broadcast	DX	distance or rare station
BCNU	be seeing you	ER	?
BFO	beat frequency oscillator	EL	element
BGN	begin	EM	them
BK, BKG	break, breaking	ENI	any
BK, BKG	back, backing	ERE	here
BKR	breaker	ES	and (from Morse &)
BN	been, between	ETA	estimated time of arrival
BT	dash, long break	FB	fine business
C	yes (correct)	FD	field day
CUD	could	FER	for
CUDNT	could not	FLO	field, filed
CFM	confirm	FLR	floor
CK	check	FM	from, frequency modulation
CKT	circuit	FND	friend, find, found
CL	close (closing station)	FNI	funny
CLG	calling	FREQ, FQ	frequency
CLIX	clicks	FWD	forward
CLR	clear	GA	go ahead, good afternoon
CNDX	conditions	GB	good bye
COZ, CUZ	because	GD	good, good day
CPI	copy	GESS	guess
CQ	general call to any station	GG	going
CUAGN	see you again	GL	good luck
CUL	see you later	GLD	glad
CUM	come	GN	gone, good night
CUPLA	couple of	GNG	going
CW	continuous wave (telegraphy)	GND	ground
DBL	double	GOTTA	must
DA	day	GP	group, ground plane
		GUD	good

GV	give	NG	no good	SVC	service
GVG	giving	NR	near, number	SW	switch, short wave
HD	had	NW	now	SX	\$ (dollar sign)
HRD	hard, heard	NVR	never	T	zero
HDG	heading	OB	old boy	TRBL	trouble
HI	high, laughter	OC	old chap	TBL	trouble
HPE	hope	OM	old man	TFC	traffic, messages
HPG	hoping	OT	old timer	THR	there
HPI	happy	OP	operator	TMW	tomorrow
HPN	happen	OPTR	operator	TNG	thing, tuning
HQ	headquarters	PA	power amplifier	TNK	think
HR	here	PD	period, paid	TNKS, TNX	thanks
HRD	heard	PKG	package	TT	that
HRG	hearing	PSE	please	TU	thank you
HV	have	PSD	pleased	TV, TVI	television, television
HVNT	have not	PLS	please		interference
HVG	having	PSN	position	TX	transmitter
HVI	heavy	PT	part, point, plate	TWR	tower
HW	how	PWR	power	U	you
INFO	information	R	received, roger, ok, yes	UR, URS	your, yours
K	go ahead (please answer)	RCD	received	UT, UTC	universal time, GMT, (See "zulu" or "zebra" time)
KA	attention	RCVR, RX	receiver		
KLIX	clicks	RDI	ready	VA	signing off (same as SK)
KN	go ahead, but only the station called	RDO	radio	VERT	vertical
KNW	know	RE	concerning	VFB	very fine business
LK	look, like	REG(S)	regulation(s)	VFO	var. freq. osc.
LKG	looking	RM	room	VOX	voice operated switch
LL	land line (telephone)	RNG	running	VY	very
LNG	long	RIG	equipment, station	W, WT	watt
LOTSA	lots of, many	ROCK	crystal	WAT	what
LP	long path	RPT	repeat, report	WATSA	what say
LSN	listen	RST	Readability, Strength, Tone	WD	word
LTR	letter	SA	say	WID	with
LUV	love	SAE	self-addressed envelope	WK, WKG	weak, work, working
LV	leaving	SASE	self-addressed stamped envelope	WX	weather
LW	long wire, low	SB, SSB	single sideband	XTAL	crystal
MAG	magazine	SG	sign, signature	XMTR	transmitter
MGR	manager	SGD	signed	XYL	ex-young lady (wife)
MI	my	SHUD	should	YL	young lady
MIL	milliampere	SIG(S)	signal(s)	YF	wife
MILL	typewriter	SKED	schedule	YR	your
MIN	minute, minimum	SN	soon	Z	"zebra" or "zulu"
MK	make, mark	SRI	sorry		time UT, GMT
MIC, MIKE	microphone	SEZ	says	ZILCH, ZIP	nothing
MNG	morning, meaning	SK	signing off (see VA)		
MNI	many	SS	sweepstakes		
MSG	message	STN	station		
N	no, nine	SU	(I'll) see you		
NIL	nothing	SUM	some		
ND	nothing doing				

You will occasionally see two letters with a bar over them, such as **AS**, **SK**, and the like. The bar means that the two letters are sent as one letter; that is, the Morse characters are run together. These symbols have special meanings of their own, as indicated in the list.

It is obvious that abbreviations are used almost exclusively for CW communication and are seldom used in voice transmission. It is ridiculous to hear someone

say **SK** when he means "I'm leaving the air."

Q signals — CW only.

These have meanings of their own, and usually stand for an entire sentence in the form of a question (when followed by a question mark) or a statement. You will need to know some basic ones for everyday use, and some others for occasional use. When you begin operating on the voice (phone) bands, the habit of using Q signals is very hard to break, but please try.

Use equivalent words — not the Q signal spoken aloud. Note: each may be followed by a question mark to indicate a question.

QRG	your (my) frequency is
QRK	readability of your (my) signals
QRL	busy
QRM	interference
QRN	static
QRO	increase power
QRP	decrease power
QRQ	send faster
QRS	send more slowly
QRT	stop sending

QRV	ready (to copy traffic)
QRX	delay, wait
QRZ	who is calling
QSA	signal strength
QSB	fading
QSK	full break-in capability
QSL	acknowledgement
QSO	contact, communication
QSV	send series of Vs
QSY	change frequency
QSZ	send each word twice
QTH	position, location
QTR	correct time

Some 'silly' Q signals have come into commonplace use in a kidding manner. Here are some, together with their usual meanings:

QLF	send with your left foot
QLZ	lazy operator
QMT	mail your traffic
QQQ	clean your antenna

Still others have been adopted by certain groups or organizations as special signals, for example:

QST	calling all Amateurs; adopted by the ARRL (also magazine)
QN —	used by traffic nets. The blank is replaced by appropriate letter. Example: QNZ — zero beat net control.

Abbreviations and Q signals in Practice

Now, let's take a look at a typical message and see how it might be deciphered. First, the code version:

W2EUQ DE WB1AEA R TNX FR
CLG ES GA —
UR SIGS FB HR — RST 579
QTH PETERBOROUGH, NH —
MI NM JIM —

WX HR CLR ES SUNI BUT CLD — HPE
UR WX GUD —
RIG HR TX 150W — WID LW ANT —
RX DRAKE 2B — HW CPI OM? AR
W2EUQ DE WB1AEA K

You will notice that very little punctuation is used. Questions, sentences, comments, and thoughts are spaced apart by long-break dashes; *i.e.* BT. If the message were formal, another style would be used, and proper punctuation supplied. Now for the plain text translation: "W2EUQ from WB1AEA. Roger, thank you for

calling and good afternoon. Your signals are fine business here: readability 5, strength 7, and tone 9. My location is Peterborough, New Hampshire and my name is Jim. The weather here is clear and sunny but cold. I hope your weather is good. Equipment here is a 150-watt transmitter connected to a long wire antenna, and the receiver is a Drake 2B. How do you copy old man? End of message. W2EUQ from WB1AEA. Invitation to answer."



"QLZ"

It is obvious, of course, that a lot of time and space has been saved. You will also find right away that this kind of abbreviation is easier to take down on paper without getting writer's cramp. Eventually, you will use it only to make notes while you copy most conversations "in your head", that is, without putting them down on paper.

Although you probably can't believe it now, the day will come when you hear words and whole sentences, and won't even be conscious of hearing letters. The translation in your brain becomes automatic, and CW becomes almost like conversation.

Ham Jargon

Unfortunately, there is also a lot of jargon in common use on the Amateur bands. Some of it is acceptable — barely — and a lot is pure nonsense, adopted

to give the talker a kind of *mystique*. You won't find much of it on CW, but you probably have heard a great deal on the Amateur phone bands and on CB.

It is using a lot of words that don't really mean anything — a kind of "ratchetjawing" just to hear yourself talk. Examples? There are plenty. Here's one: "By golly, OM, that ol' rig of yours is sure knockin' the top off my receiver and bendin' the meter against the peg, an' its been a wonderful cue-so, but the XYL is beatin' the gong for chow, an' if I don't QSY to the ol' kitchen, she'll be a-throwin' it to the hawks, hi, hi, hi, hi. So by golly, OM, it's shore been a great cue-so an' that signal of yours has been real great. May see you on later if I don't QSY to the mahogany knot hole, you know the ol' modulated milk bottle, the ol' boob toob. So best seventy-threes and eighty-eights, yessir by golly. Sure has been real great hearin' that big signal of yours . . . blah . . . blah . . ." and so on for another ten minutes. This, of course is an exaggeration, but it is intended to show that very little real information has been passed. The "meat" of the conversation could have been transmitted in one sentence. Remember that the other Amateur probably won't hate you if you are brief and to the point. In fact, he may even want to talk to you again!

There's another type of abbreviation that should be routine, but seldom is: economy of words. You don't have to repeat everything twice or three times. Have you heard another Amateur send everything two or three times, even when the signals are loud and there is no interference? Sure, we have all heard that unnecessary redundancy, and it's not necessary; not even desirable, *unless* the other station asks for a repeat! Send each bit of information clearly and slowly — *once*. That's usually enough, and if it isn't, you'll be told.

Don't show off your Novice

FM YOUR GONSET

Or your Clegg 22'er, Ameco TX-62, Polycom 2 or PC-62, Johnson 6N2, Heath Seneca VHF-1, or Hallicrafters SR-34.

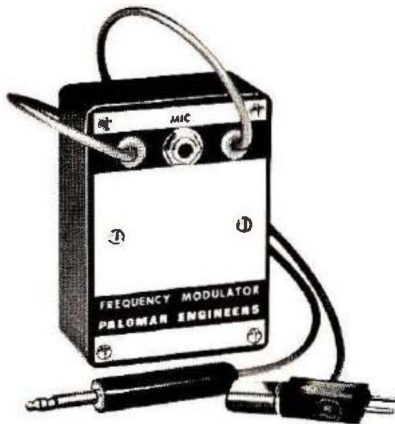

Why throw away that old AM 2-meter rig? Why spend \$300 for a new FM transceiver when you have a working AM rig gathering dust? The Palomar Engineers FM'er plugs in (no rewiring or modification required) and puts your old AM transmitter on FM.

The adapter contains a preamp, clipper, filter, driver and modulator to give clear, crisp FM. Sounds as good or better than a brand new transmitter. Frequency adjust for netting is built in. Receive by slope detection.

Works with the Gonset Communicator I (Goosy Bird), II, III, IV, GC-105 and other rigs listed. For 2-meter band only. Requires HC-6/U crystal and 9-v transistor battery (not supplied).

Get on FM at a tenth the cost of a new rig. Use the plug in Palomar Engineers FM'er that has been proven in daily use by MARS and Civil Defense nets nationwide. Send for free brochure.

Order direct. \$37.50 postpaid U.S. and Canada. Specify transmitter model. California residents add sales tax.

PALOMAR ENGINEERS

BOX 455, ESCONDIDO, CA 92025
Phone: (714) 747-3343

"accent" by sending K twice when you invite the other station to answer, and — for goodness' sake — don't send KN when you mean K. If you send KN following a CQ, it's meaningless at worst; at best, it means you don't want anyone to answer!



A lot of jargon is pure nonsense.

Another mistake is sending your call two or three times after you have established contact with another station. If the other Amateur didn't get it right, then of course you should repeat it, but otherwise not.

If he got it right the first time, then he *knows* your call, and it's a waste of time to send it more than once on each transmission. Certainly he knows *his* call, so you don't have to send it twice or three times, either.

These common, but unfortunate and inefficient, practices betray your inexperience and lack of confidence. Sure, it takes time to build confidence, but don't do it by improper operating procedure. Your "fist" is your signature — and you'll be recognized by your "accent" so do it right.

Another common mistake is *too frequent* identification of your station by sending your call sign more often than necessary. FCC regulations state that you must identify your station once every ten minutes. Typically, you send the *other station's* call sign followed by your own at the

beginning and at the end of the contact. In between, you send your call sign once every ten minutes, and the other station sends his every ten minutes. For example, all that's necessary is to send

"... DE WB1AEA,"

or whatever your call may be, each time you identify. You don't have to send *both* calls each time. Almost everyone does, but it's *not* necessary.

Oh, yes, another much misused abbreviation that appears at the end of a closing transmission or message — 73. These numbers mean "best regards" just by themselves, but you often hear 73s, both on CW and voice (and sometimes in print). The translation of this would come out as "best regardses," which is silly at best. Remember, when you send 73 you are sending "best regards;" when you send 73s, you are sending the other guy a collection of magazines!

If you enjoy conversational CW, make it easy for yourself and the other Amateur. Most stations today have *break-in*, or modified break-in capability. Basically, this means that you hear the signals from your receiver as soon as you release the key; your station's transmit-receive function is automatic. This is a beautiful and smooth way to operate, especially if you use the right procedure. BK means *break*. When you send it, pause a few seconds and the other station should immediately respond by sending BK and then continue with his answer to your question, or with a comment about something you've just said. Notice that no call is required, no identification, as long as the ten minutes are not up. This easy and pleasant procedure makes CW communication as enjoyable as any two-way conversation, whether it be by telephone or radio. Use it, be brief, employ abbreviations and Q signals properly, and have the time of your life.

HRH

ME-3 microminiature tone encoder

Compatible with all sub-audible tone systems such as: Private Line, Channel Guard, Quiet Channel, etc.

- Powered by 6-16vdc, unregulated
- Microminiature in size to fit inside all mobile units and most portable units
- Field replaceable, plug-in, frequency determining elements
- Excellent frequency accuracy and temperature stability
- Output level adjustment potentiometer
- Low distortion sinewave output
- Available in all EIA tone frequencies, 67.0 Hz-203.5 Hz
- Complete immunity to RF
- Reverse polarity protection built-in

\$29.95 each

Wired and tested, complete with K-1 element

communications specialists

P. O. BOX 153
BREA, CALIFORNIA 92621
(714) 998-3021



K-1 FIELD REPLACEABLE,
PLUG-IN, FREQUENCY
DETERMINING ELEMENTS

\$3.00 each

ORLANDO HAMCATION 78 ORLANDO HAMCATION 78 ORLANDO HAMCATION 78 ORLANDO HAMCATION 78 ORLANDO HAMCATION 78

OH!

.....Have you been thinking about a wonderful Florida vacation, to places such as Disney World, Cypress Gardens, Sea World, the famous East and West coast beaches, and many of our other near by attractions???.....
.....NOW, think about combining that vacation with one of the South's greatest Hamfest.....

ORLANDO'S HAMCATION '78' and the FLORIDA STATE A R R L CONVENTION

AT THE SHERATON'S TWIN TOWERS HOTEL & CONVENTION CENTER, ON S-435
NEAR THE CROSSROADS OF THE FLORIDA TURNPIKE AND I-4 INTERCHANGE.

FEBRUARY 17-18-19, 1978

DOORS OPEN.....*6PM FRI. the 17th (Swapfest area only),
7AM SAT.the 18th, 8AM SUN. the 19th.

●
A R R L
FORUMS

**ADMISSION, \$3 Advance, \$4 At the door.
Ladies FREE, Children 14 and under FREE!!!**

●
TECHNICAL
FORUMS

THOSE ADMITTED FREE MUST BE IN THE COMPANY OF A REGISTERED TICKET HOLDER AT THE DOOR.

● MANY DOOR AWARDS ●

GIGANTIC SWAPFEST AREA

25,000 SQ.FT. OF AIR CONDITIONED INDOOR COMFORT.
SWAPFEST TABLES \$5 PER TABLE PER DAY

●
LARGE
COMMERCIAL
EXHIBIT AREA

SATURDAY NIGHT BANQUET

\$8 per person - Great speaker lineup.

●
LADIES'
ACTIVITIES

RESERVE BANQUET TICKETS IN ADVANCE, LIMITED QUANTITY AVAILABLE.

FOR ADVANCE REGISTRATION, SWAPFEST AND BANQUET TICKETS

SEND CHECK PAYABLE TO : THE ORLANDO AMATEUR RADIO CLUB, INC.

HAMCATION CHAIRMAN, WB4HAK
6 CAMELLIA DRIVE
De BARY, FLORIDA 32713

All advance ticket sales will be confirmed by return mail. Last postmark for advance sales will be Feb. 12th 1978.

FOR SHERATON TWIN TOWERS HOTEL RESERVATIONS, WRITE DIRECTLY TO:
The Sheraton Towers, 5780 Major Blvd. Orlando, Fla. 32805. Sing. \$28, Doub. \$36 per day.
Call toll free 1-800-325-3535. Mention that you are attending Hamfest Convention.

Sorry!!! City ordinance prohibits overnight camping (Rec. vehicles, etc.) on parking lots.

All in the family.

Feather Touch Keyer

\$69.95

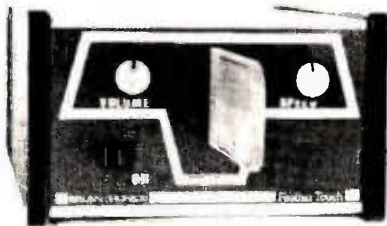

No moving parts! The **Kantronics Feather Touch Keyer** responds to the lightest touch. No more slapping or slushing! No moving parts also means the end of adjusting and readjusting before each QSO.

The **Feather Touch** sends self completing dots and dashes, adjustable from 7½ WPM, and gives you a great fist on the air. Attractive design and compact size make the **Feather Touch** a professional addition to the sharpest ham station. Design features keep the keyer from creeping away as you send.

This **battery powered** unit is great for portable use or home operation with the aid of any DC power supply from 5-15 volts. Pick up a motionless keyer today!

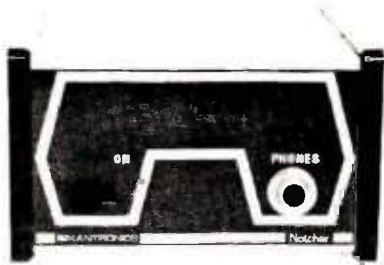

Notcher CW Filter \$34.95

Make your CW receiver selectivity razor sharp with the **Kantronics Notcher Audio CW Filter**. This filter makes sense out of the biggest pileups! The **Notcher** funnels down to 150 Hz @ -3dB to separate signals that appeared to be on top of each other before.

Your **Notcher** will operate portable with a 9 volt internal battery, or from your 5-15 volt DC power supply.

Designed to look sharp too, the Notcher is one in a growing family of **Kantronics** quality products. Our quality is more than skin deep. One look inside will tell you the **Notcher** is built to perform!

The Standard Frequency Calibrator

\$39.95

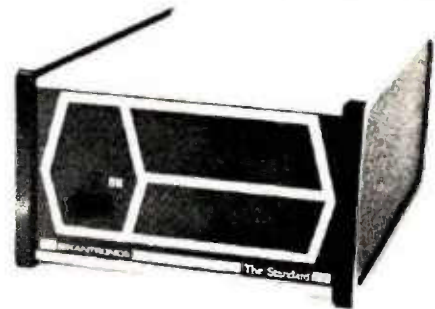

Kantronics frequency calibrator is **The Standard**. Advanced CMOS circuitry checks your frequency with crystal controlled accuracy. Zero beat your transceiver to **The Standard** at 50 KHz intervals.

No direct connections are needed, the unit transmits to your receiver. Internal jumpers adjust **The Standard** for a choice of 25 KHz, 50 KHz or 100 KHz intervals.

Powered by battery for portable operation, or 5-15 volt DC power supply. **The Standard** is a handsome station accessory that looks sharp inside and out.

Be confident of your frequency.

Magnetic Mount



The **Kantronics Mobile 2 Antenna** offers a reasonable alternative to the high priced VHF antenna! The **Mobile 2** is a high-quality, quarter-wavelength antenna that is quickly installed.

Choose between **magnetic or trunk mounting** bases. Both include 18 feet of RG-58/U coax cable and standard PL-259 connector. Specify 147 MHz or 220 MHz whip and coil assembly.

All these features . . . for a low, low price!



Trunk Mount

The **Kantronics Code Speed-Building Kit** offers perfect **computer generated** code. Code is sent to exact Morse specifications as used by the FCC. Choose 5, 7½, 10, 13, 16 or 20 words per minute tapes. Oscillator and brass key included.



KANTRONICS The Lightweight Champs.

1202 East 23rd Street Lawrence, Kansas 66044

Name		
Address		
City	State	Zip
Card No.	Expires	
<input type="checkbox"/> Code Kit with _____ WPM tape - \$19.95 <input type="checkbox"/> Notcher - \$34.95 <input type="checkbox"/> Feather Touch - \$69.95 <input type="checkbox"/> Mobile 2 Trunk - \$6.95 <input type="checkbox"/> The Standard - \$39.95 <input type="checkbox"/> Mobile 2 Magnetic - \$14.95 <input type="checkbox"/> Whip and Coil - \$4.95 _____ 147 _____ 220		
KS & MO add 3% sales tax		
Master Charge, Visa, check or money orders only!		



(913) 842-7745

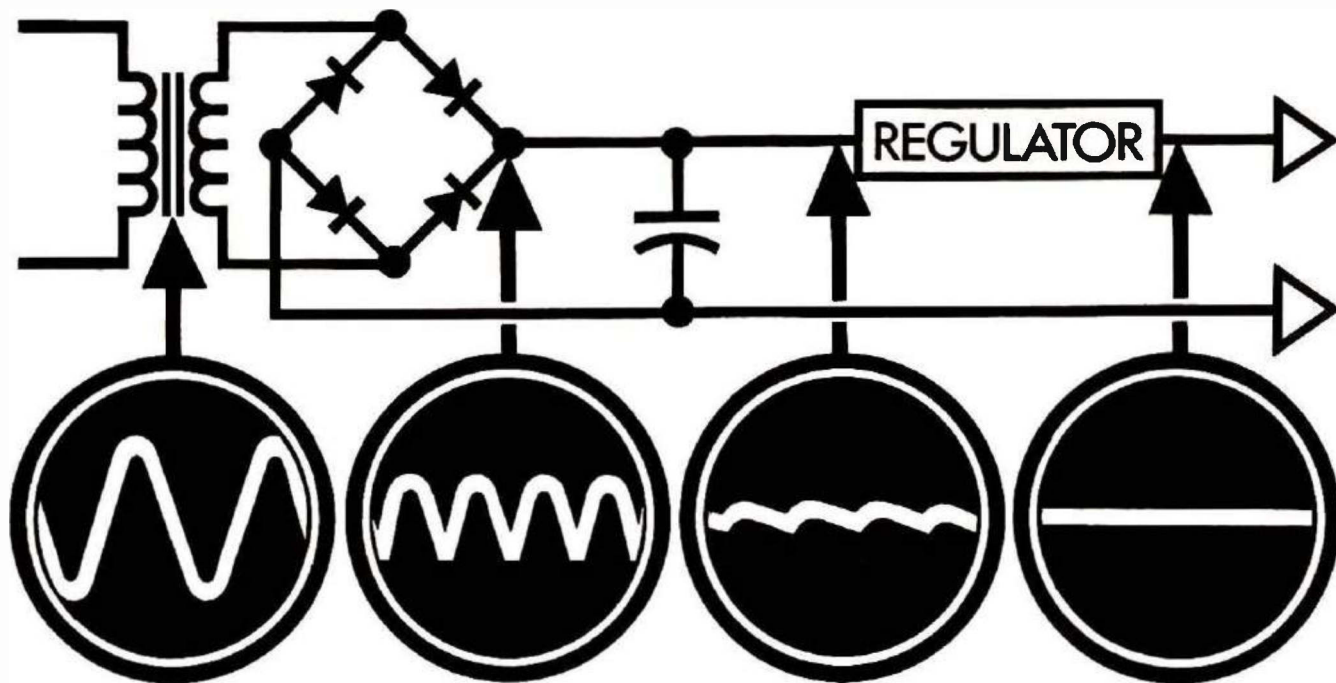

Your POWER SUPPLY-- What the 'Scope will show

BY JOSEPH CARR, K4IPV

A power supply can be said to provide the fuel that your electronic circuits run on. Most power supplies are so basic in design that it is surprising that they cause much trouble, and even more surprising that so many people have trouble understanding what the problem is. A few minutes spent with some elementary theory and following the current flow through some typical power-supply circuits will save much more time when trouble strikes. I'll start right at the beginning of a typical supply and tell you how it all fits together. So you'll be able to look for any problems, or build your own supply.

Some basics

The dc power supply converts the alternating current from the wall outlet to the direct current required by most

electronic circuits. The heart of the supply is a rectifier, which may be either a vacuum tube or solid-state device. In recent equipment, of course, the latter is used. The rectifier has an important property: it allows current to pass in only *one* direction. The symbol for a diode rectifier is shown in Fig. 1. When the rectifier anode is positive with respect to the cathode the diode will be *forward-biased* and will pass current. When the diode's anode is negative with respect to the cathode, however, the diode will be *reverse-biased*,

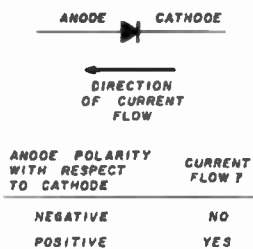

Fig. 1. The basic diode rectifier symbol.

and won't pass current.

An ac waveform is shown in Fig. 2. This waveform is called a sine wave. Positive-going peaks in this waveform represent current flow in one direction, while negative-going peaks represent current flow in the opposite direction. When this waveform is applied to a diode, only the positive half can forward-bias the diode and thus will appear at the cathode.

Figs. 3 and 4 show two common power supplies. Fig. 3 is a full wave supply, while Fig. 4 shows a full wave bridge circuit. Let's first consider the operation of these circuits as if the filter capacitor (C1 in both cases) were not there.

The power supply of Fig. 3 uses a center-tapped transformer and two rectifier diodes (typically of the 1N4000 series). On the positive half of the ac input alternation, the top of the transformer will be negative with respect to the

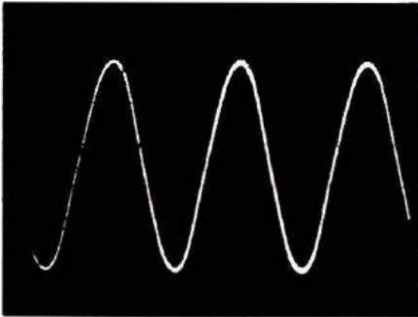

Fig. 2. Ac input waveform applied to the rectifier.

bottom. Of course, because of the operation of an inductor, we know that each turn will be slightly more positive than the turn immediately above it if we measure the potential on a turn-for-turn basis starting at the top. This means that the center-tap will be positive with respect to the top end but negative with respect to the bottom end of the transformer secondary. Since it is a center-tap, the voltages appearing across the top and bottom halves will be equal. When the bottom half is positive, diode CR2 will be forward biased and diode CR1 will be reverse biased. This means that current will flow from the center tap through load resistor R1 then through CR2 back to the transformer. On the second alternation of the ac cycle the polarities will reverse, making the top of the transformer secondary winding positive with respect to the bottom. In this case, current flows out of the center tap, through R1 in the same direction as before, and back to the transformer secondary winding through diode CR1. The key to the success of the full wave supply is that *current in the resistor flows in the*

same direction on both halves of the ac input cycle.

The bridge rectifier circuit of Fig. 4 doesn't require a center-tapped secondary on the transformer. If the same transformer used in Fig. 3 were used in Fig. 4, you'd obtain twice the output voltage but at one-half the current rating. When the top of the secondary of T1 is negative with respect to the bottom, diodes CR1 and CR3 will be forward-biased and CR2/CR4 reverse biased. Current will flow from the top of the transformer secondary through CR1, and load resistor R1, through CR3, then back to the opposite end of the

same on both halves of the ac input waveform. This action produces a waveform across R1 (assuming C1 is out of the circuit!) as in Fig. 5.

This waveform is still not pure enough for most electronic circuits. If it were a receiver power supply a loud hum would be heard in the output.

If the supply were for a transmitter you'd receive hum reports from other amateur stations, ARRL *Official Observers*, and maybe the FCC if you're unlucky. Adding C1 (Figs. 3 and 4) to the circuit will help reduce the bumpiness, or "ripple component" and make

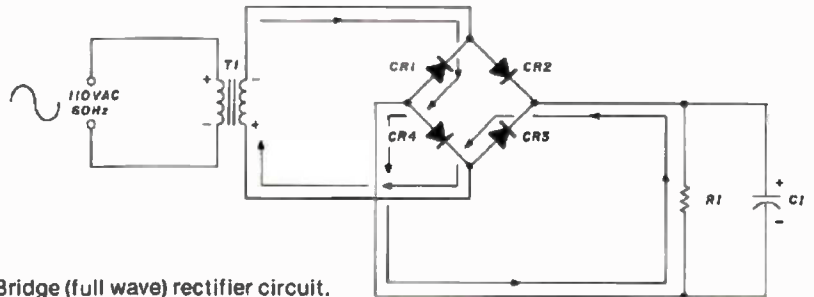

Fig. 4. Bridge (full wave) rectifier circuit.

transformer secondary. On the second half of the input ac waveform the situation will reverse, making the top of the secondary positive with respect to the bottom and forward-biasing diodes CR2 and CR4. Of course, CR1/CR3 will then be reverse-biased. Current will flow from the bottom of the transformer secondary through CR4 and load resistor R1 in the same direction as before, through CR2, and then to the top of the transformer secondary.

Since both Figs. 3 and 4 are full wave supplies, the current flowing through R1 will be the

the dc output more like pure dc, as obtained from batteries.

Fig. 6 shows the waveforms associated with a full wave supply with a single filter capacitor to smooth the direct current. This is typical of most modern solid-state equipment, especially if critical stages such as the VFO, crystal oscillator, or local oscillator are fed from a regulated power-supply circuit. The waveform in Fig. 6A is the ac sine wave delivered by the transformer. If you placed the input of your oscilloscope across the secondary of T1 in either power-supply circuit you'd see this shape. The waveform in Fig. 6B is the full wave rectified voltage applied across the resistor (R1).

But since capacitor C1 is in both circuits, we find a slightly different situation, as represented in Fig. 6C. During

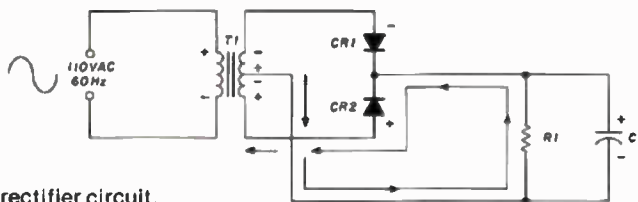

Fig. 3. Simple full wave rectifier circuit.

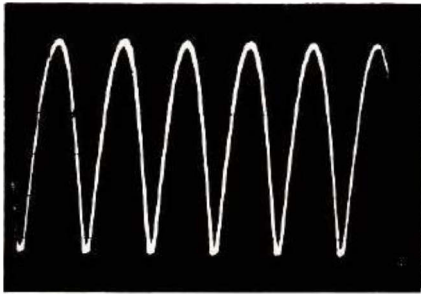

Fig. 5. Waveform across R1 if C1 is disconnected.

each hump or peak in the Fig. 6B waveform, capacitor C1 will charge on the upward excursion but discharges during the downward excursions. So when the rectifier voltage is increasing in amplitude, a charge will be stored in C1; but as the rectified voltage passes its peak and begins to fall, the charge from the capacitor is dumped back into the circuit. This action tends to fill in the spaces between peaks, as shown in the waveform of Fig. 6C. Of course, if an oscilloscope were placed across the power supply output, we'd not see the rectifier peaks but rather a ripple component riding on a dc level, as in Fig. 6D.

Some faults

Fig. 7A shows the waveform photographed on a scope. The waveform was at the output of a bridge-rectified power supply such as shown in Fig. 4. The oscilloscope horizontal sweep was set so that two cycles of the 120-Hz output saw-tooth were visible. But when either diode CR1 and CR4 opens up, you'd see the waveform in Fig. 7B. Because only one diode is operating, the ripple frequency will be half that normally expected. (In any operating full wave supply, the ripple frequency is twice that of the ac mains frequency; in the 60-Hz systems used in the U.S. it will be 120 Hz.) In this case, the

ripple component is only 60 Hz, indicating that one or more (of the same pair!) of diodes is open-circuited.

Although it may seem unlikely that a diode rectifier would *open*, it's fairly common in bridge circuits. With molded bridge-rectifier stacks, especially the low cost "bargain" variety, an internal connection may be broken. But in all bridges — and that includes those with four discrete rectifier diodes handwired — very often one of the diodes to the negative output line (CR1/CR4) will open if one of the other diodes becomes shorted.

Unfortunately this becomes an occult problem, because the shorted diode will cause all kinds of pyrotechnics including blown fuses. It seems that all of the initial and most obvious symptoms will occur from that shorted diode. No loud whistles will occur when CR1 or CR4 opens, but you'll find

minor things like improper tuning; a loud hum (the filters were designed to work with 120 Hz, so are less effective); or off-calibration. In one case, I used the "bridge with a known good one" test to check the capacitor. When the extra capacitance was added to the circuit, the hum level decreased, so I erroneously labeled the existing filter as "bad" and replaced it . . . guess what — the hum was still there! The problem was caused by an open bridge rectifier and not by an open filter capacitor.

Replacement of solid-state rectifier diodes is one area where many amateurs go wrong. Most fail to appreciate the voltage at which the diode must operate. Let's take, for example, the common +750-1000-volt power supply used with transmitters and transceivers in the 100-200-watt class. The diode-voltage rating is the *peak reverse voltage* (PRV) or *peak inverse voltage*

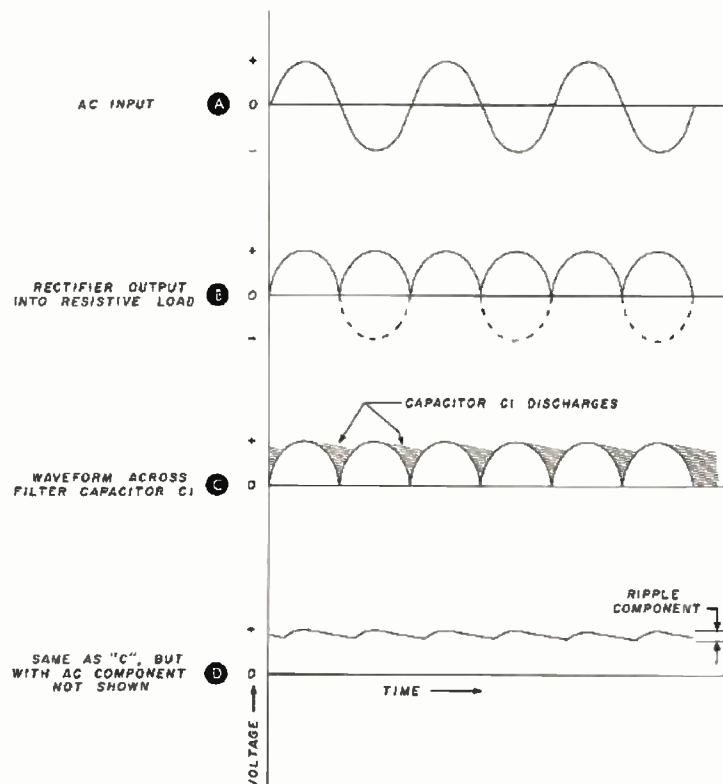

Fig. 6. Waveforms associated with either Fig. 3 or 4 showing action of filter capacitor C1.

KENWOOD



**Adirondack
has it!**

ADIRONDACK Radio Supply
Amateur Headquarters for the Northeast
185-191 West Main Street • P.O. Box 88
Amsterdam, N.Y. 12010 Tel. (518) 842-8350
Just 5 minutes from N.Y. Thruway - Exit 27

**NEW VISUAL CODE READER
AND ELECTRONIC KEYS**

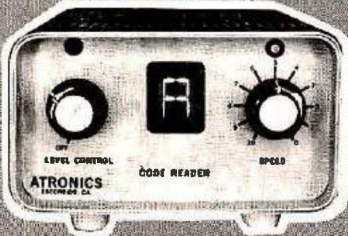

Works with any
keyer, including
squeeze keyer in
speeds from 7
WPM to 40
WPM. Both in a
single unit.
Model CR101EK
\$249

from **ATRONICS**

- Display letters, numbers, and commonly used punctuation visually as Morse Code signal is received.
- Operating speed 5 to 50 WPM at selected speeds.
- All Solid State.
- Makes code learning faster and easier.
- A single connection to your receiver or transceiver speaker puts it into operation.
- Hard copy read-out of CW available with TU-102 TTY interface Module accessory.

Our popular, lowest priced CODE READER KIT
Model KCR101 \$149
Ready made CODE READER Model CR101 \$225

**BUY FACTORY DIRECT & SAVE! SEND FOR FREE LITERATURE.
USE YOUR BANKAMERICARD OR MASTER CHARGE**

BOX 2946 LAGUNA HILLS, CA 92653 (714) 830-8428

Atronic

More details? Ad Check page 78.

the famous
HAM KEYS

The keys that are easy
to put your fingers on!



JUST DIAL
1-800-325-3636
TOLL FREE

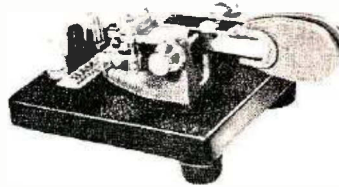

Model HK-1
• Dual-level squeeze paddle
• Use with HK-5 or any electronic keyer
• Heavy base with non-slip rubber feet
• Paddles reversible for wide- or close-finger spacing
\$29⁹⁵

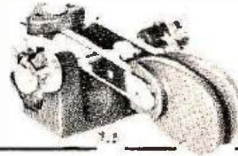

Model HK-2
• Same as HK-1. In its base for incorporation in other keyer
\$19⁹⁵

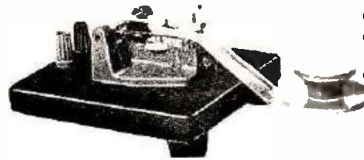

Model HK-3
• Deluxe straight key
• Heavy base - no need to attach to desk
• Velvet smooth action
\$16⁹⁵

Model HK-3A
• Same as above, less base \$9.95

Navy type knob only \$2.75

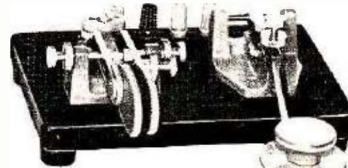

Model HK-4
• Combination of HK-1 and HK-3 on same base
\$44⁹⁵

• Base only with rubber feet \$12.00
Terminals, red or black \$.75 each

NEW AND IMPROVED



**Model HK-5A
Electronic Keyer**
• New Cabinet Colored-Keyed to Match most modern radio equipment
• Iambic Circuit for squeeze keying
• Self-completing dots and dashes
• Dot memory
• Battery operated with provision for external power
• Built-in side-tone monitor
• Grid block or direct keying

- Speed, volume, tone and weight controls all mounted on front panel
- For use with external paddle such as HK-1 or HK-4
- Can be used as Code practice oscillator with straight-key, such as HK-3

\$69⁹⁵

Same day shipment... PREPAID

We welcome the use of your



HAM RADIO CENTER, INC.

8340-42 Olive Blvd • P.O. Box 28271 • St. Louis, MO 63132

(PIV) (both the same). This voltage is the maximum reverse bias the diode can handle without being destroyed. If the 750-1000-volt supply is built as in Fig. 3 the transformer will have a 750-0-750-volt secondary. This means that the voltage applied to the diode will be $1.41 \times 750 = 1060$ volts. The factor 1.41 is needed because the 750-volt rating is root-mean-square (*rms*) and we want *peak* volts.

A commonly available TV replacement rectifier is rated at 1000-volts PIV, so two in series can be used, right? Wrong! To be sure, the PIV rating of the combination will be 2000 volts, which is greater than 1060 volts — so what's the problem? If capacitor C1 (Fig. 3) were not used, then the PIV and forward voltages would be the same — but recall that capacitor C1 charges also to the peak voltage. The actual PIV presented to the diode will be $2 \times 1060 = 2120$ volts. Clearly, 2000 volts of PIV rating is not good enough, because there will be 120 volts *more* on one half of each cycle! Fig. 8 shows the full wave supply of Fig. 3, which has been redrawn and simplified to illustrate this problem. In this case, the reverse voltage applied to the diode is $2 \times 1.41 \times$ the transformer rms. The correct PIV rating of the replacement diode is *not less than* $E_{rms} \times 2.82$. Most professional servicers, who back their work, prefer to use a factor of 3 for safety and so will select a

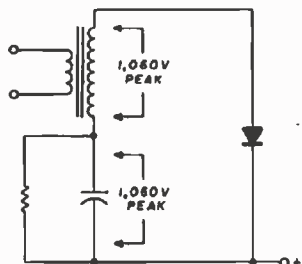

Fig. 8. Redrawn and simplified version of Fig. 3 showing how the diode PIV is actually $2.82 \times E_{rms}$.

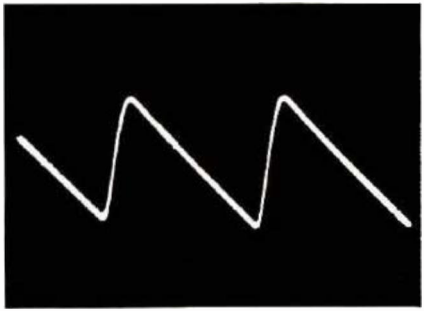
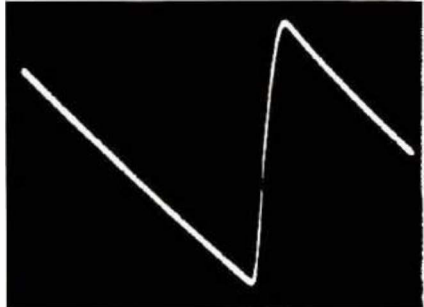

Fig. 7. Above, normal 120-Hz sawtooth from Figs. 3 and 4. Below, 60-Hz sawtooth if CR1 or CR4 is open.



diode that is $3 \times E_{rms}$. Of course, we may still use those low-cost TV-replacement diodes, but we must adapt them as in Fig. 9. Each diode is a 1000-volt PIV TV replacement type. These diodes are available in the 1N4007 series at 1-ampere forward-current rating and up to 2.5 amperes in certain "house brand" types. Be a little wary of certain types apparently rated at 1 ampere, especially those of the imported variety, or when found in certain blister-pack offerings. Many of these diodes are substandard and will only withstand their rated current if the leads remain at full length to act as heat sinks.

You think I'm kidding? Ask a number of TV servicers about that! A lot of those diodes were sold to the service industry awhile back, and the sets that received them wouldn't make it through the 90-day warranty on the repair! There are no bargains, in general, so be prepared to pay a little bit for the diodes. Good 1N4007 diodes from reputable sources

(see some of the advertisements in this magazine) cost only a little more than the off brands but will most likely behave themselves. It's an extreme case of penny wise and pound foolish to use less than top-grade replacement parts on that transceiver, which probably cost you almost a thousand bucks!

The resistors in Fig. 9 balance the voltage drops across the respective diodes. It's usually satisfactory to use a value for R that is 100-ohms/volt peak applied to the stack. For full rating of the diodes, 1000 volts \times 100 ohms/volt results in a value of 100 kilohms or more. Less resistance would make the circuit think that there is no diode and little in the way of rectification would occur. Some sources also recommend that a $0.001 \mu\text{F}$ capacitor be placed across each diode.

Fig. 10 shows the waveform to expect in another kind of problem. Fig. 10A was from a bridge rectifier circuit such as Fig. 4. In both cases, the problem was the same: a B+ fuse placed at the rectifier output failed. Note that the waveform in each case is the rectifier output as if no filtering were present. The fuse in each case was used to protect the rectifiers in case a filter capacitor, final output tube, or other circuit element shorted to ground. The fuse was located right at the rectifier, between the load and the filters.

The waveform photos were taken at the (+) terminal of the rectifiers. An initial voltmeter check would lead you astray if made across the filters, at the

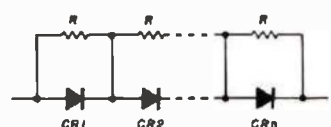

Fig. 9. TV-replacement rectifiers can be stacked to gain a higher PIV rating that might be needed in a transmitter.

transmitter final amplifier (rf choke), or other point beyond the fuse. One might say "Aha! A bad power supply!" and spend a great deal of time trying to figure out why the supply is no good. The real culprit, however, might be external to the power supply.

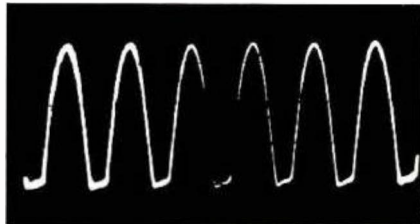
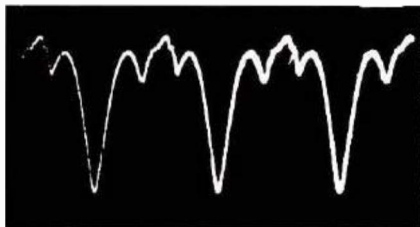

Fig. 10. Waveforms at the output of full-wave rectifier, above, and bridge rectifier, below, if a rectifier fuse is blown (see text).



For example, in many transmitters, if the oscillator or a buffer stage fails the final amplifier tubes will be unbiased and will run red hot. This means that an overload current is being dragged out of the power supply, so a fuse might blow — if you're lucky.

B+ fuses often seem to be located on the chassis rather than be accessible from the outside; I don't know why but it's a fact. So look for a fuse either in a chassis (open) fuse holder, or a pigtail fuse wired into the circuit. At the risk of repeating myself from earlier articles, let me point out once more that a fuse doesn't cause trouble, it *indicates* trouble! If a serviceman charges you beaucoup bucks for repairs that could have been simple, except that you installed an oversized fuse to stop the "blowing" problem, then you're up for *fair game!* **HRH**



hallicrafters

IS BACK — BIGGER and BETTER THAN EVER — and "HAM" BUERGER HAS IT!



H2M-1000
Frequency synthesized 800-channel (5 kHz steps) all-mode CW/AM/FM/SSB 144-148 MHz Transceiver with PLL digital frequency readout, 12 watts output, 117 VAC, 13.8 VDC and VXO, SSB, VOX noise blanker and repeater offset.

H2M-500
Frequency synthesized 800-channel (5 kHz steps) 144-148 MHz FM Mobile Transceiver with PLL digital frequency readout, 1W or 25W output, 13.8 VDC and repeater capability.

H2M-1000.....\$749⁰⁰

H2M-500.....\$389⁰⁰

Call or write TODAY for our very best deal on: Antenna Specialists, Astatic, Drake, Hallicrafters, Hy-Gain, Mosley, Regency, Rohn, Telex, Ten-Tec, and Wilson. REMEMBER: We pay shipping charges on all prepaid orders!

"HAM" BUERGER, INC.

ELECTRONIC EQUIPMENT DISTRIBUTOR

WA3ZID-Bob
WB3BPJ-Bob
WB3GXP-Dave
WB3HOF-Jeff

68 NORTH YORK RD.
WILLOW GROVE, PA
19090
(215) 659-5900



GILFER



"NORTH AMERICA'S SHORTWAVE MAIL ORDER PLACE"

One-Stop Armchair Shopping For All SWL Needs

- * Receivers — Drake, Yaesu — special mods for better performance
- * Frequency Readouts
- * Receiving Antennas
- * Antenna Tuners
- * Frequency Calibrators
- * Log Books
- * FM or TV Guides
- * QSL Albums
- * AM Pattern Maps
- * ITU Publications
- * QSL Address Books
- * Confidential Frequency List
- * Clocks
- * All SWL Books

The New 1978 32nd Edition **WORLD RADIO TV HANDBOOK** Is Ready!



Listen to the world with this comprehensive directory of stations at your side. Best there is! Only \$11.95 ppd.

FREE SWL MINI-CATALOG GILFER SHORTWAVE

Dept. H R H - 1, Box 239, Park Ridge NJ 07656



Oak Hill Academy Amateur Radio Session

19th Year — July 29 thru August 11, 1978

We have moved our location just 15 miles from our previous site to the Oak Hill Academy, Mouth of Wilson, Virginia.

Our accommodations are now the finest one could hope for, suites in a beautiful Dorm with bath for each four students. Lovely spacious lobby and fine recreation room in the lower level of the dorm.

Oak Hill Academy in the Appalachian Mountains of Virginia offers an intensive two week Radio Session in code and theory starting at your level.

Expert instructors, some of whom have been on the staff for the past 18 years are the same. Only the location has been changed. Close association with fellow amateurs offers an opportunity for Saturation Learning that has been very successful since its conception. Novices upgrade to General, Techs to General & Advanced, and Advanced become Extras. Golf privileges, canoeing on the New River & many other recreation activities are offered. Make your vacation a "Vacation with a Purpose" and upgrade your license at a beautiful school in the cool mountains of Virginia. Formerly Glade Valley School Radio Session

C. L. PETERS, K4DNJ, Director
Oak Hill Academy Amateur Radio Session
Mouth of Wilson, Virginia 24363

Name _____ Call _____
Address _____
City/State/Zip _____

YOU... AND AMSAT PHASE III

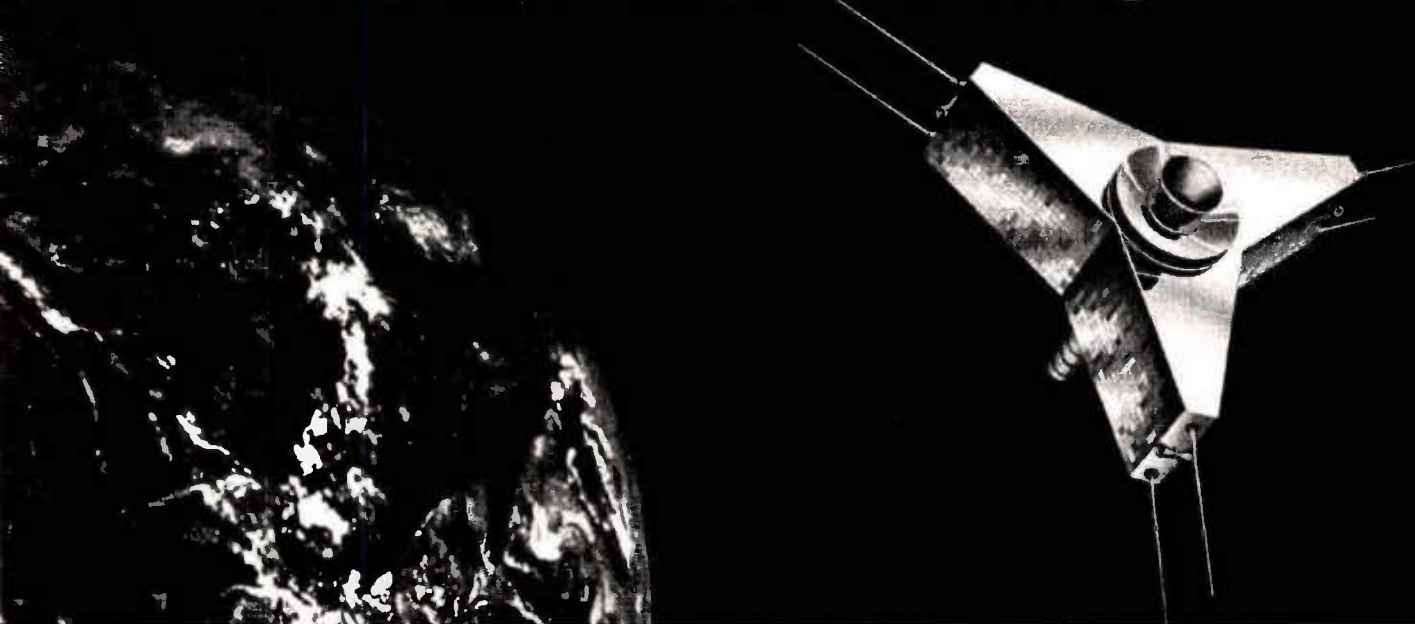

An exciting new era in amateur radio is about to begin... the era of AMSAT PHASE III OSCAR satellites.

Many of you are familiar with the benefits of the AMSAT OSCAR satellites, notably OSCAR 6 and 7. These satellites, with a combined total of over 8 years in orbit, have provided communications between amateurs throughout the world. They have also provided a capability for an educational program in space sciences and many interesting experiments.

AMSAT, with members and contributing groups worldwide, and headquarters in Washington, D.C., has been responsible for our current satellite program. Many people feel that perhaps the greatest value of the amateur satellite program is the dramatic demonstration of amateur resourcefulness and technical capability to radio spectrum policy makers around the world.

The value of this aspect of amateur radio as we prepare for the 1979 World Administrative Radio Conference (WARC) is enormous.

The AMSAT PHASE III satellite program promises a continuing demonstration that amateur radio is at the forefront of modern technology. PHASE III satellites will routinely provide reliable communications over paths of up to 11,000 miles (17,600 km) for 17 hours each day. You can think of them as a resource equivalent to a new band.

The cost of these PHASE III satellites is a projected \$250,000. Commercial satellites of similar performance would cost nearly \$10,000,000.

Your help is needed to put these PHASE III OSCAR satellites in orbit.

Your valued, tax-deductible contribution can be as small as one of the 5000+ solar cells needed. A handsome certificate will acknowledge the numbered cells you sponsor for \$10 each. Larger components of the satellites may also be sponsored with contribution acknowledgements ranging to a plaque carrying your name aboard the satellites. Call or write us for the opportunities available.

Your membership in AMSAT is important to the satellite program, and will give AMSAT a stronger voice in regulatory matters concerned with satellites. At \$10 per year or \$100 for life, you will be making a most significant contribution to the satellite program and the future of amateur radio. You will also receive the quarterly AMSAT newsletter.

Clip the AMSAT PHASE III coupon below and send your support today, or call 202-488-8649 and charge your contribution to your BankAmericard (VISA) or Master Charge card.

	AMSAT PHASE III	HRH
	Radio Amateur Satellite Corporation Box 27, Washington, D.C. 20044 202-488-8649	
YES, I want to support AMSAT PHASE III OSCAR satellites. Enclosed is:		
<input type="checkbox"/> \$_____ in sponsorship of _____ solar cells (@ \$10 each)		
<input type="checkbox"/> \$10 Annual membership <input type="checkbox"/> \$100 Life membership		
<input type="checkbox"/> Send information on sponsoring larger satellite components.		
Name _____	Call _____	AMSAT Member? _____
Street _____		
City _____	State _____	Zip _____
The publisher has donated this space to AMSAT in support of AMSAT and the PHASE III program.		

AMATEUR PRODUCTS GALORE!

YAESU

FT-301D all solid-state transceiver; 160-10 meters; AM, CW, SSB, FSK; 200 watts PEP input on SSB, 200 watts DC input on CW, and 50 watts DC input on AM or FSK; features 100-Hz frequency stability, 6-digit LED frequency display; tailored audio response, 0.25 μ sensitivity, variable selectivity from 0.6 to 12 kHz, requires only 13.5-volts DC power source; matching AC supply and speaker available.*



FT-301D TRANSCEIVER
ALL SOLID STATE

Famous YAESU quality, reliability, and versatility, and now all solid state! Conserves energy too.

* We will include FREE AC power supply with every purchase of a new FT-301D. You can't beat this offer, so order now.

Call or visit with us today for assistance in selecting the Amateur product that is the most likely to meet your operating requirements.

KENWOOD

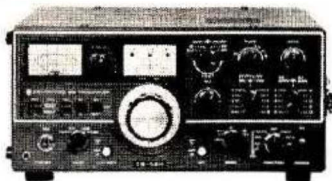

TS-520S
160-10M TRANSCEIVER

Ask around about Kenwood's TS-520. It's in constant use around the globe and has a record of reliability that is universally admired. USB, LSB, CW, operates AC, WWV receiver, RIT, VOX and noise blanker are some features that make the TS-520 a very welcome companion in your shack.

Also, come in and ask about the NEW Kenwood TS-820 that has all of the great features found in the TS-520 plus so many truly unique operating advantages that it is the Pacesetter of the industry.

KENWOOD

TR-7400A two-meter FM transceiver covers 144-148 MHz in 5-kHz steps, selectable simplex and 600-kHz offset; PLL circuitry with unlock protection; LED digital frequency display; CTCSS encode-decode, plus tone-burst; MOSFET with helical resonators, plus 2-pole 10.7-kHz crystal IF filter for superior sensitivity and selectivity, and much more. Write today for details and price.



RSE HAM SHACK

1207 W. 14 MILE, CLAWSON, MICHIGAN 48017
313-435-5660



2 METER FM

and HF too ...
SATELLITE
HEADQUARTERS

See Erickson
for all your
Amateur Radio
needs!



**WB9EBP, WB9JKT,
WB9VIK serving you
with ...**

- Ameco • ASP • Atlas
- Belden • Bird • CDE
- CES • Collins • Cushcraft
- Dentron • Drake • HAL
- Hy-Gain • Icom • KLM
- Kenwood • Larsen • MFJ
- Midland • Mosley • NPC
- Newtronics • Nye
- Regency • Shure • Swan
- Standard • TPL • Tempo
- Ten-Tec • Wilson • Yaesu

REMOTE CONTROLLED ANTENNA SWITCH

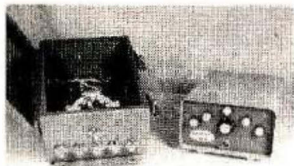

- The SW-5 is a heavy-duty remote controlled RF switch. Handles 4 kW PEP with negligible insertion loss and SWR below 30 MHz. Housed in rugged, weather-proof enclosure.
- Safe, low-voltage operation from 26 VDC supply in control unit.
- Indicator lights show at a glance which antenna is in use.
- Requires six-wire control cable. Ham-M cable satisfactory to 150 feet.
- Models from 3 to 9 positions. Optional connectors and special switching systems are available.
- Five position Model SW-5 \$120.00 (Shipping \$3.00 in USA — IA res. add 3%)

ANTENNA MART

Box 1010 ISU Station
Ames, IA 50010
Phone: 515-292-7114

FOR THE HAM

A BELT BUCKLE



From The COLORADO SILVER CO
Cast in SOLID BRONZE
ENGRAVED WITH CARE

This fine personalized belt buckle can be yours for only \$12.50, plus \$1.00 for postage and handling.

OR SEND FOR FREE DESCRIPTIVE BROCHURE.

COLORADO SILVER CO

P. O. BOX 1755
ASPEN, COLO. 81611



COLO. RES. INCLUDE 3% SALES TAX



Hours: 9:30-9 Mon. & Thurs.
9:30-5:30 Tues, Wed. & Fri.
9-3 Sat.

ERICKSON COMMUNICATIONS
5935 N. Milwaukee Ave.
Chicago, IL 60646
(312) 631-5181



QUESTIONS & ANSWERS

*Public Service, Networks, Emergencies;
Key Clicks and Spurious Emissions*

BY THOMAS McMULLEN, W1SL

We're almost through with the Operating Procedures portion of the Question and Answer series; there's one more category to talk about — Public Service Operation. After that, I'll talk about the signals that are sent out by your transmitter, which is a subject that comes under the heading of Emission Characteristics.

Public service operation

If there is any part of amateur radio that you can be proud to show off to the general public, this is it. The usual man-on-the-street will not be overly enthused about your prowess at putting up antennas, at building an eleven-transistor widget, or in scoring 9-million points in a contest, but when you call him up to deliver a message from his son in Antarctica, or to assure him that his brother survived an earthquake in Nicaragua, then he is impressed.

There is no rule that says you have to "serve time" in traffic nets, learning to send messages in their proper form. Or, you are not required to earn points toward advancement by serving during an emergency situation; however, the requirement that amateurs *should be ready* to provide emergency communications is

right there, in black and white, in the Basis and Purpose part of the Rules and Regulations. Just in case you missed the issue of *Ham Radio Horizons* that it was in, I'll give it to you again:

97.1 Basis and Purpose

The rules and regulations in this part are designed to provide an amateur radio service having a fundamental purpose as expressed in the following principles:

(a) Recognition and enhancement of the value of the amateur service to the public as a voluntary noncommercial communication service, particularly with respect to providing emergency communications.

By and large, amateurs have fulfilled this obligation very well. They have done a commendable job in large disasters, such as floods, fires, or earthquakes, on the high-frequency bands. Since the use of vhf repeaters has become widespread, the chances for an individual to lend a helping hand in more localized trouble have increased many fold.

As a beginner, restricted to CW operation in portions of the amateur bands, you can participate in some good training for the time when you need to be an efficient emergency operator. There are many slow-speed nets that tailor their activities to the beginner's abilities. You can

eavesdrop on them until you know their style and procedure, and, when your courage is up to it, join in. Don't worry if you goof — they're patient types or they wouldn't be there.

You don't have to feel tied down to a lifetime of handling messages if you don't want to (although many amateurs enjoy great pleasure in doing just that), but you should definitely get enough practice to feel at ease in any network that you join.

Network operation

Amateur traffic (message-handling) networks spend a lot of time sending messages back and forth, and many of these messages are of no great consequence. Most are friendly greetings from one person to another, just to demonstrate a method of communication. However, all of these nets have one important function — they are keeping the operators' skills sharpened in readiness for troubled times. Their procedures were developed from long practice and experience in what works and what is most efficient in passing information.

Here are a few simple ground rules to remember when you join a traffic net:

1. The Net Control Station (NCS) is the boss. Follow his instructions at all times.
2. Don't break into the net except at the times when the NCS asks for more stations to check in (QNI).
3. Learn the Q-signals that apply to network operation, and use them properly. (Most QN-signals apply to network situations).
4. Wherever possible, put all of the information in formal message form, complete with addresses, telephone numbers, word count, time, and name of sender. This makes it easier for operators to assure that all the information gets through.

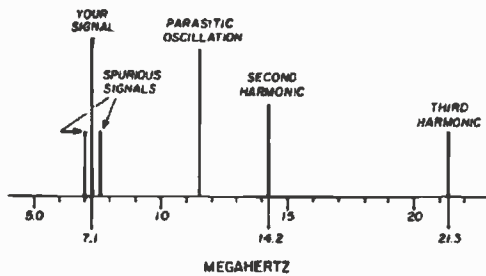

Fig. 1. Your transmitter could send out a spectrum of signals such as that represented here. Eliminating the harmonics and the two spurious signals near your main signal is a matter of good transmitter design and, perhaps, a filter in the output line. The parasitic oscillation is usually an indication of something gone wrong, especially in a transmitter that was once working well. Any signal other than the main one is a spurious signal which will usually cause trouble.

5. Do not send a message faster than the other guy can write it down. (Once, slow and accurate, is better than twice as fast with errors).

These rules are designed to apply to messages sent by Morse Code, but the same principles work just as well with voice. When you advance to a higher class of license, and can use voice for passing along messages, you'll find that some networks adhere to this more formal style of operation, and some do not. Also, if you are using the local repeater to talk to a Police or Fire dispatcher about some emergency, he will be completely unfamiliar with formal messages of this type, so you should not use formal message procedures. However, the general idea remains the same — be brief, be thorough, and stay calm; your early training in an 80-meter traffic net will give you a good deal of self-confidence and skill at making yourself understood.

Disaster operation

In the event that you become involved in handling communications during any widespread emergency or disaster such as flood, hurricane, or earthquake, there

are some things to remember so that you will be helping, rather than causing more problems. An important procedure is to listen on and near the frequency where the emergency network is handling messages. You'll find that they usually keep several spots clear for calling frequencies, so a station in the disaster area can quickly reach the net control station. Other stations are shunted to nearby channels to pass the messages along. One or more stations may make announcements from time to time in an effort to prevent unsuspecting operators from interfering with the network. If the emergency is severe enough, the FCC may declare some frequencies as reserved for emergency work only. Listen carefully for bulletin stations in time of disaster — they may be transmitting important information about the frequencies that you should avoid unless you are needed.

Only the stations involved in the immediate area of a disaster need to be in constant touch with the net control station. If you are not one of those, spend most of your time listening and taking notes. If the net control station needs help, he'll ask for it, stating specifically what the nature of the problem is, for example: "This is Net Control, WD7XXX, with traffic for the Fire Department in Highvillage. Can anyone relay?" If you are in a position to help with his request, then go to it. Identify yourself and state how you can help him out. Again, this is where your previous exposure to message handling techniques in a network can save time and make you feel more at ease when the real thing comes along.

Emission characteristics

This section concerns the energy that is transmitted by your rig — its emissions. The term covers any type of energy that your transmitter sends

forth, and it can include both desired and undesired emissions. Obviously, the Morse Code (or voice, or Teletype, or whatever) is the desired emission, but some transmitters will emit other energy too. Sometimes this is caused by poor design, sometimes by operator error, and occasionally something will go wrong in the rig to cause it to transmit signals other than what you intended. These unwanted signals are called *spurious emissions*.

A very common type of spurious emission is a harmonic. All non-linear electronic circuits produce harmonic energy, but a transmitter of good design will have circuitry that tends to suppress these harmonics. A harmonic is simply a multiple of the fundamental frequency — second, third, fourth, and so on. If you were operating at 7105 kHz, your second harmonic would be at 14210, third at 21315, fourth at 28420; see Fig. 1. Circuit losses at higher frequencies become so great that the harmonic energy cannot be developed, but it is possible to have troublesome harmonics as high as the 10th, 12th, or 15th.

Other types of spurious emissions include parasitic oscillation, which is sometimes caused by a defective component or poor design. This can cause your transmitter to send out a signal at a frequency near the desired one, but not necessarily within the confines of the amateur band. If these signals interfere with commercial or military stations, it can be very serious. Another type of spurious signal could be the product of a mixing action somewhere within the transmitter. In short, any type of signal that your transmitter puts out, other than the one you intend to use for communications, is a spurious one.

A key-click is another undesirable characteristic of a

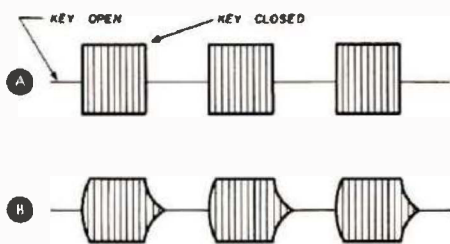

Fig. 2. A quick rise-time when you close your key looks nice on paper, A, but the sudden transition from rising to the steady "on" condition is similar to a square wave, which is full of harmonic energy and causes key clicks near your signal. A small amount of delay in the turn-on and turn-off, B, will soften the transition, and eliminate the clicks. If you go too far in softening the waveform, the code will run together and be impossible to copy.

transmitted signal. A click is caused by turning a signal (or other form of energy) on or off too rapidly. A Morse code element (dot or dash) should not be a nicely squared segment of rf energy, but rather should have the corners slightly rounded. The leading edge (start) should rise quickly, but with just enough time lag to prevent a sharp transition from one state to another (see Fig. 2). The end of the character (trailing edge) should have a similar soft decay. Some transmitters have built-in circuits that will provide this desirable characteristic; others require that you add the circuit at your key. A key-click suppressor is usually a capacitor and resistor in series, hooked across the key or the circuit to be keyed.

A chirp is a different matter — it almost always must be cured in the transmitter. If your transmitted frequency moves when you close the key, your signal has a chirp. It is caused by an unstable oscillator, poor power supply regulation, or by too much energy being drawn from the oscillator (heavy loading by the next stage). This is not the same thing as frequency drift. Although a chirp is noticeable as a slight change in frequency each time you close the key, the basic

frequency remains the same throughout your transmission. If your frequency changes gradually while you are sending, so that the receiving station must keep retuning to hear you, then you have a frequency *drift*. This is often caused by too much heat in or near the oscillator circuit.

Types of emission

As a Novice licensee, you will be concerned with just one type of emission — A1. Generally speaking, emissions can be classed as amplitude modulated (A0, A1, A2, A3), or frequency modulated (F1, F2, F3). don't let the modulation part of the term mislead you. To modulate means to modify, to impress one form of information upon another. When you turn a carrier on or off by means of a key, you are changing its amplitude from zero to maximum, thereby *modulating* it with information in the form of Morse code. A0 is a steady carrier, without any form of modulation such as tone, code, or voice. It is applied most often in amateur radio as a means of controlling model planes, boats, or cars. This type of emission cannot be used by amateurs below 51 MHz. Table 1 gives the emission designations for the most common modes used by amateurs. Don't worry too much about any of them except A1, which is what you use when you send code (CW).

Now, there's another term that you may wonder about — CW. The letters stand for *continuous wave*. The natural (and often asked) question is: "How can it be continuous when you are turning it on and off with a key?" In order to answer that question, I'll have to take you back a few years to the beginning of radio communications.

Early transmitters were of the spark variety — that is, they sent information by making and breaking a circuit that caused a spark to jump

across a gap. The energy that flowed through this circuit and spark-gap was coupled to an antenna, to be radiated and eventually received as a keyed buzz or tone. Energy that discharges through a spark in this fashion has a characteristic called a damped wave — each succeeding repetition of the waveform is smaller in amplitude until it dies out completely; Fig. 3A. Several of these characteristic wave-trains could occur during a single "dit" while the key was closed, depending upon how frequently the spark was made to jump.

The reason the waves were damped — decreasing in amplitude — was that no more energy could be supplied during the time that the spark was jumping. You had to wait for the spark to stop before the capacitors and inductors could have their energy restored, ready for the next spark to discharge them.

Well, along came vacuum tubes, invented as a means of controlling current flow, and used mainly to amplify audio

Table 1. Emission types and designations for the Amateur Radio Service are as follows:

A0	— steady, unmodulated pure carrier.
A1	— telegraphy on pure continuous waves.
A2	— amplitude tone-modulated telegraphy.
A3	— a-m telephony including single and double sideband, with full, reduced or suppressed carrier.
A4	— facsimile.
A5	— television.
F0	— steady, unmodulated pure carrier.
F1	— carrier-shift telegraphy.
F2	— audio frequency-shift telegraphy.
F3	— frequency- or phase-modulated telephony.
F4	— fm facsimile.
F5	— fm television.
P	— pulse emissions.

THE GREAT BASICS



UPDATE THIS YEAR! The 1978 CALLBOOKS

New size — 8½ x 11"! All calls in boldface, easier to read and now more useful than ever! All of this at last year's prices!

US EDITION

Over 350,000 listings — 15% bigger than last year — thousands of new hams and new 1 x 2 calls with all the Callbook references you've come to depend on — included in US and its possessions.

Order CB-US Only \$14.95*

DX EDITION

Over 280,000 entries — a must for every active DX'er! Complete those QSL's accurately with the latest concise information in this volume.

Order CB-F Just \$13.95*

*Please include \$1.50 for shipping and handling with each Callbook order. Give full street address (no box numbers) so we can ship UPS to expedite delivery.

A VITAL REFERENCE The Radio Amateur's Handbook for 1978 by ARRL Staff

The world's best selling technical handbook ever published — THE standard reference for Radio Amateurs. The '78 Edition is a giant 700 pages containing virtually every fact and figure for Amateur or experimenter needs.



Holidays, Birthdays, any occasion — the ideal gift.
Order AR-HB (Softbound) \$8.50
Order AR-BB (Hardbound) \$13.50
(available early January)

Ham Radio's
Communications Bookstore
Greenville, NH 03048

Update my editions of
these Great Basics.

- US CALLBOOK DX CALLBOOK
 1978 ARRL HANDBOOK

Paper Cloth

Check or Money Order enclosed

- VISA MASTERCARD

Account # _____ Exp. date _____

Name _____

Address _____

City _____

State _____ Zip _____

... at last -
your shack
organized!

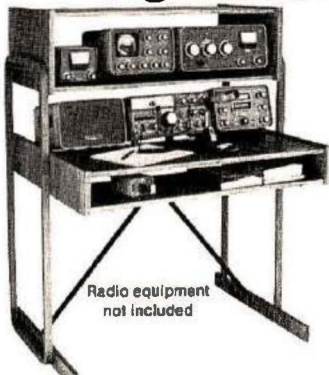

Radio equipment
not included

\$13995 S-F RADIO DESK

A beautiful piece of furniture
— your XYL will love it!

Deluxe - Ready to Assemble

Floor Space: 39" Wide 30" Deep

Designed with angled rear shelf for your viewing comfort and ease of operation.

FINISHES: Walnut or Teak Stain.

Also available in Unfinished Birch, \$124.95.

Additional Information on Request.

Checks, Money Orders, BankAmericard
and Master Charge Accepted.

F.O.B. Culver City. (In Calif. Add 6% Sales Tax.)

S-F AMATEUR RADIO SERVICES

4384 KEYSTONE AVENUE • CULVER CITY, CALIF.
90230

PHONE (213) 837-4870

RADIO & ELECTRONICS CONSTRUCTOR

Here is an interesting general electronics hobby magazine. It's loaded with lots of interesting simple circuits and ideas, not only about radio, but in all phases of electronics including test gear, audio, remote control and security electronics.

We are sure that you will find a number of worthwhile projects in this British magazine.

1 Year (12 issues) \$11.00

Radio & Electronics
Constructor
Greenville, NH 03048

MADISON

SUPER STATION BUYS

NEW

OMNI-J 2-meter mobile or portable antenna. ¾" thread, 5-dB gain (1.5-dB gain over conventional ¾-wave mobile whip antenna). \$29.95; 220-MHz \$27.95. Guaranteed results.

PREMAX 4-foot ground rod plus clamp \$4.50

MIDLAND 23-136 dual meter reads SWR and relative power. Handles 1 kW from 3-150 MHz. \$21.95

YAESU FT-101EE + Hy-Gain 18AVT/WB vertical antenna \$649.00

YAESU FT-101EX + Hy-Gain 18AVT/WB vertical antenna \$589.00

HY GAIN 18AVT/WB + 100 feet RG8 coax \$100.00

HY GAIN 18V vertical \$19.95

Model 214 2m Yagi \$21.50

Hy-Gain 2BDQ Dipole \$39.95

VHF SPECIALS: Kenwood TS700S List... \$679 Call for quote

KLM: Antennas, Linears, Accessories All In Stock

FREE balun w/2 meter base antenna.

JANEL PREAMPS: In Stock. Technical Books (ARRL, Sams, Tab, RCA, T.I., etc.)

HAM X ROTOR (New Model) Turns 28 sq. ft. of antenna. List \$325. In Stock. Order Now. Your Price \$249

CDE HAM-III \$129.00

BIRD 43 WATTMETERS plus slugs in stock.

SWAN METERS: WM 6200 VHF Wattmeter \$49.95; SWR 1A \$21.95

TELEX HEADSETS: In Stock

CETRON 572B \$24.95 ea.

ADEL nibbling tool, \$6.45; punch \$3.50

CABLE 5/32", 6-strand, soft-drawn guy cable. For mast or light tower, 3¢ foot.

BELDEN COAX CABLE: B237 RG8 19¢ ft., B214 RG8 foam 23¢ ft., 8448 8-wire rotor cable 14¢ ft., B210 72 ohm kw twinlead \$19/100 ft., 8235 300 ohm kw twinlead \$12/100 ft., Amphenol PL-259 59¢, UG175 adapter 19¢, PL-258 dbf female \$1.00. BNC female, chassis mount 61¢ ea; MICRO RG-8/U same size as RG-59, 2 KW PEP @ 30 MHz 16¢/ft.

NYLON CORD 5000 ft. + per roll \$15.00

BELDEN 14 gauge copper stranded antenna wire. \$5.00/100 ft.

RG8 foam Xtra-Flex coax, 100% Braid coverage, 23¢ ft.

22 gauge plastic covered ant. wire for long wire, radials. \$3.50/1000 ft.

KESTER SOLDER 1 lb. 60/40, .062 \$6.50

Leader — Amateur Test Equip. — 10% off list.

Mallory 2.5A/1000PIV epoxy diode 19¢ ea.

.001 MFD 20KV CAP. \$1.95

CALL FOR QUOTES ON:
YAESU FT301D, FT301, KENWOOD TS520S, TS820S, TS600A, TR7400A, TR7500A, FT101E & ETO-ALPHA. ALL IN SEALED CARTONS. CALL FOR QUOTES ON ITEMS NOT LISTED.

CALL FOR FAST QUOTE, OR WRITE AND INCLUDE TELEPHONE NUMBER. IF WE HAVE YOUR BARGAIN, WE'LL CALL YOU PREPAID.

TERMS: All prices FOB Houston. Prices subject to change without notice. All Items Guaranteed. Some items subject to prior sale. Send letterhead for Amateur dealers price list. Texas residents add 5% tax Please add postage estimate.

MADISON

ELECTRONICS SUPPLY, INC.

1508 MCKINNEY HOUSTON, TEXAS 77002
713/658-0268 Nites 713/497-5683

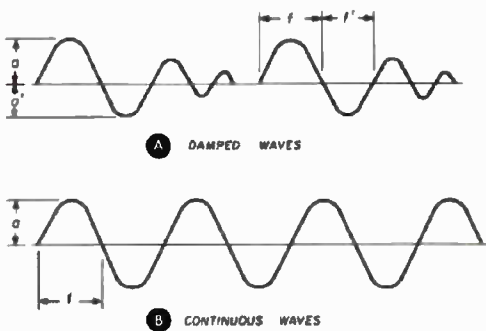

Fig. 3. Spark transmitters put forth a damped wave, as in A. Note that the amplitude, a , a' , changes, as does the frequency, f , f' , when the energy in the circuit dissipates. In modern oscillator circuits that use tubes or transistors, the energy is replenished so that the amplitude and frequency remain constant — or continuous, B. Therefore, it is called a *continuous wave*, even though you are keying the transmitter in a dot or dash sequence.

signals. Then circuits were developed for radio-frequency amplifiers or oscillators. Because a tube allows energy to flow through it in one direction, it could supply energy to a tuned circuit — thus sustaining oscillation — but it would not discharge the energy in that circuit as would a resistor or capacitor or transformer. This meant that each succeeding cycle of oscillation would be sustained at the same amplitude as the one before it — a continuous wave; Fig. 3B. (Yes, it was sometimes referred to as an “undamped wave” in the early days). So, CW is a continuous wave, even though you are breaking it up into dits and dahs with your key.

Keying, stability, and monitoring

The spot in your transmitter circuit to which the key is connected can have a lot to do with the quality of your signal. It generally is not a good idea to key the oscillator in simple transmitters, because many of them are not designed to accept the change from off to on without creating a chirp, which is undesirable. A buffer stage (medium-powered amplifier) is a good place to

key a transmitter, if it has one; a frequency multiplier will also work well as a keyed stage, and many transmitters are arranged to key the final amplifier. Some transmitters have two or three stages keyed at once.

Sometimes, you might hear a weak signal from a station when his key is open, between characters or words; this is called a *back wave*. A back wave is caused by the signal from the oscillator (which is on continuously) leaking through the following stages even though they are not keyed. Transmitting a back wave is unnecessary and often annoying. It is usually caused by poor design or a malfunction in the multiplier or amplifier stages; the bias may not be sufficient to make the amplifier “turn off” when the key is up, or one or more of the stages may need neutralizing or shielding.

Amplifiers that use tubes are generally keyed by one of two methods: cathode keyed or grid-block keyed. A cathode-keyed transmitter has the key in series with one or more of the cathodes, and when you close the key you complete the circuit to ground, turning it on. Grid-bias keying involves applying a high negative voltage to a grid of a tube, through a resistor of several thousand ohms. When you close the key, you short out the bias, allowing the tube to conduct. Because of the series resistor, only a small amount of current will flow through your key contacts, which prevents overheating the bias supply.

Transistorized equipment can be keyed in much the same manner, but of course the names of the elements are different. You can place a key in series with the emitter circuit, which will have the same function as cathode keying. You can also place a bias on the base circuit, and then short it out with your key to make the stage work.

Additionally, a stage can be self-biased so that it is not conducting, and you can apply a small forward bias through your key to make the transistor turn on. It gets a bit tricky here because of the different device and voltage polarities (NPN or PNP transistors), but the principle involved is the same.

Direct keying of the voltage applied to a transmitter is seldom done — in fact, it is usually downright dangerous. Tube transmitters normally require hundreds of volts for operation, which means that you would have high voltage on your key, waiting to zap you if your finger slipped. The low voltage required for transistorized equipment is not safe either; a short circuit could allow a high current to flow through some relatively small wires, which might get hot enough to start a fire, in addition to damaging the power supply or transmitter.

I’ve already pointed out that chirp can be caused by too much loading of the oscillator by the next stage, or by keying the oscillator. The obvious cure is to decrease the coupling to the next stage, or to key a buffer or multiplier or amplifier.

Frequency drift is usually a matter of too much heat somewhere in the oscillator circuit. Better ventilation might be the cure, or reduce the voltage to the oscillator to the minimum value that will allow it to operate properly. Less power consumed in that stage means less of it will be dissipated in heat, therefore less chance of frequency drift.

Good power-supply regulation is also a means of achieving frequency stability, for both chirp and drift problems. Another, often unsuspected, cause of poor frequency stability is rf from the output stage getting back into the oscillator of the transmitter. A severe mismatch at the antenna can allow

reflected rf energy to get back into the oscillator or power supply, perhaps through the 117-volt ac wiring; a poor ground system could cause the same type of problem. This effect is especially noticeable with some solid-state rigs; even a fraction of a volt of rf can change the operating characteristics of some transistors.

Monitoring the quality of your transmitted signal can be done in many ways, but you'll have to choose one that fits your particular transmitting and receiving arrangement. If you are using a transceiver, it is impossible to hear your transmitted signal because the receiver portion of the unit is turned off when the key is closed. You may hear a tone, but it is usually just a keyed audio tone that is not related to the *quality* of your signal at all. To check on the quality of a transceiver's output, you must use a separate receiver that is tuned to your frequency. Some of the surplus frequency meters will do the job, too, by providing a heterodyne between the signal from the frequency generator and the one from your transmitter. You should check your transmitter quality periodically (several times a year) and after any changes have been made to your transceiver. If you do not own a separate receiver or a frequency meter, borrow one from a local ham or club, or ask someone for a critical on-the-air check.

Separate transmitter and receiver arrangements allow you to hear your own transmitter, but to be sure that you are not overloading the receiver, it should be isolated as much as possible from the transmitter. If too much rf gets into the front end of a receiver, it can overload the high-gain circuits, causing them to make your signal sound strange. In extreme cases of receiver overload, you may have to hook your transmitter

to a dummy load, turn the rf gain control of the receiver all the way down, and perhaps even place a low-value resistor (simulating the load of the feedline and antenna) across the receiver input terminals.

Here's a sample question about emissions, taken right from the FCC study guide:

- The symbol A1 designates
- the purity of an emission
 - the readability of a signal
 - the power level of an emission
 - the stability of an emission
 - the type of emission

The correct answer is (e), of course. Remember, A = Amplitude, 1 = Morse code (telegraphy, or CW).

That's the end of this section from the Study Guide. In the next part of this series the subject is Electrical Principles. Now, things are going to get very interesting. You'll find out what goes on inside all those circuits, and what some of those funny sounding names (Hertz, Ohm, Farad, Henry) are all about. Stick with me, and you can unravel the mysteries of electronics.

HRH



"Some people get very indignant when you tell them that the letters 'SOS' don't stand for anything..."

TOROID CORES



- ✓ All the popular sizes and mixes.
- ✓ Fast Service. Same day shipment via first class mail or air.
- ✓ No minimum order.

IRON POWDER TOROIDS:

CORE SIZE	MIX 2 8-30 MHz u = 10	MIX 6 10-90 MHz u = 8.5	MIX 12 80-200 MHz u = 4	SIZE OD (in.)	PRICE USA \$
T-200	120			2.00	3.25
T-106	135			1.06	1.50
T-80	55	45		.80	.80
T-68	57	47	21	.88	.85
T-50	51	40	18	.50	.55
T-25	34	27	12	.25	.40

RF FERRITE TOROIDS:

CORE SIZE	MIX Q1 u = 125 .1-70 MHz	MIX Q2 u = 40 10-150 MHz	SIZE OD (in.)	PRICE USA \$
F-240	1300	400	2.40	6.00
F-125	900	300	1.25	3.00
F-87	600	190	.87	2.05
F-50	500	190	.50	1.25
F-37	400	140	.37	1.25
F-23	190	60	.23	1.10

Chart shows uH per 100 turns.

FERRITE BEADS:



\$2.00 DOZEN

WIDE BAND CHOKES

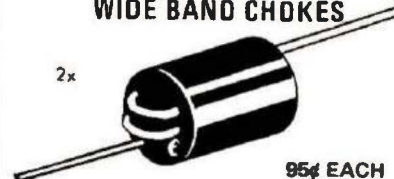

TO ORDER: Specify both core size and mix for toroids. Packing and shipping 50 cents per order USA and Canada. Californians add 6% sales tax.

Fast service. Free brochure and winding chart on request.

PALOMAR ENGINEERS

BOX 455, ESCONDIDO, CA 92025

Phone: (714) 747-3343

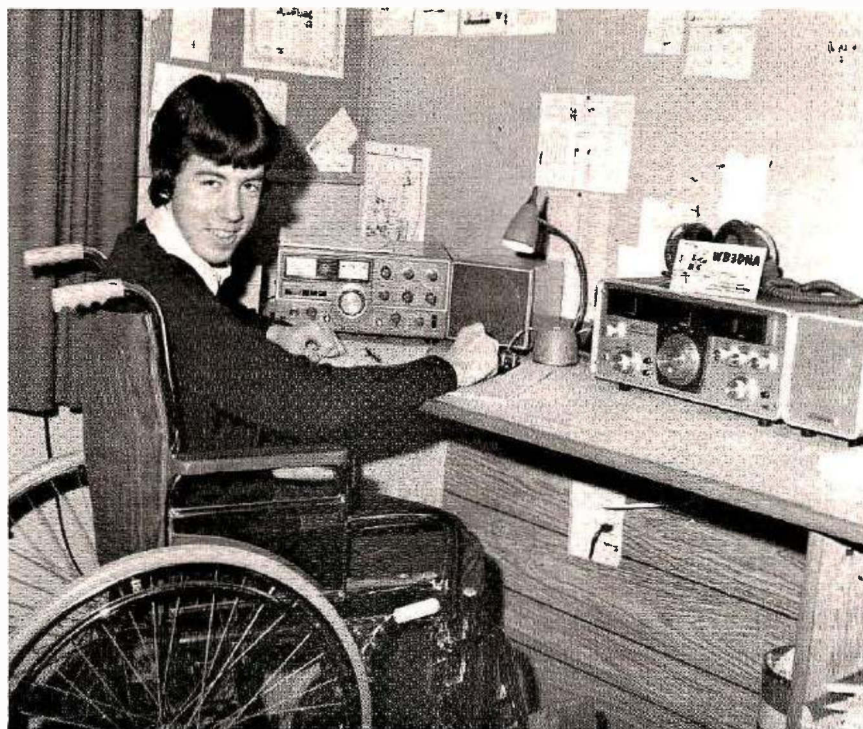
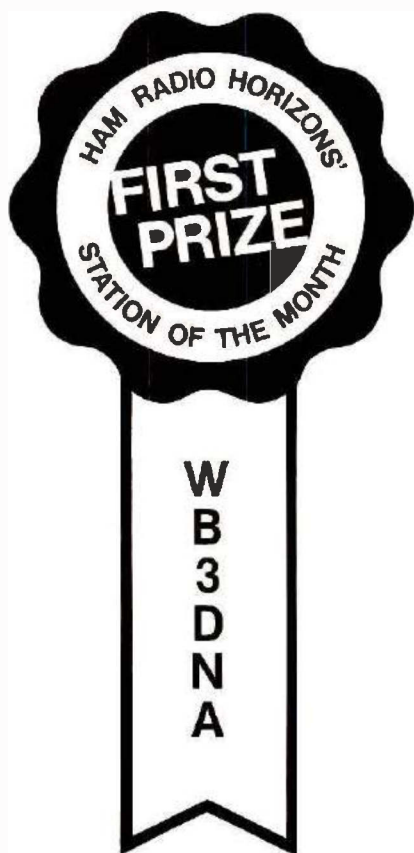

Our Station of the Month feature is intended to show newcomers to amateur radio what some of the stations at the other end of the QSO are like. Some are simple and inexpensive, some are very complex with a large assortment of gear, but others are modest installations for only a single amateur band. Whatever their style, their purpose is to communicate with fellow amateurs. Perhaps some of you will recognize a station you have worked, or maybe these station layouts will suggest a way to start your own hamshack.

Our first selection as Station of the Month is from Timothy Fanus, WB3DNA. Tim is 17, and resides on Chambers Hill Road, Harrisburg, Pennsylvania. Tim says . . . "I got interested in ham radio while I was in 10th grade at Central Dauphin High School in Harrisburg, where I

am now a Senior. My chemistry teacher, Ronald Funk, K3ZYT, started a radio club which kept my interest and led me to my ticket. I received my novice license in August, 1976.

On my first QSO, using the school rig, I worked WA4REE in Tennessee. The pleasure and excitement of this contact convinced me it was well worth investing my savings to buy a good rig. My first piece of equipment was an Allied AX190 receiver with which I practiced copying code along with a Heath-kit oscillator and key I built.

In December, 1976, I purchased a Kenwood TS520, and went on the air the same day. It was very exciting to make contacts on my own rig. To date I have worked 49 states, including Hawaii, plus Canada and 15 European countries. My antenna is a simple 40- and 15-meter dipole on sloping land giving it a height from 15 to 40 feet (8-12m). My shack consists of a bench with a bulletin board behind it. The bulletin board is

getting covered with QSL cards because I like to QSL, whether local or DX.

I am in a wheelchair and am limited in my activities, but since I became a ham-radio operator, my life has changed. My parents had a phone put in my shack because I get many phone calls from other amateur radio operators. I have many visitors and many invitations to visit other hams at home. Hams are great people.

I enjoy *Ham Radio Horizons* because it's on my level of understanding. Keep up the good work with all the interesting articles." **HRH**

Any of our readers who would like to submit an entry for our Station of the Month feature are welcome to do so. Photographs should be black-and-white glossy prints, either 8x10 or 5x7 size. A good negative will be considered if it is of good quality. Sharp focus and good lighting tone are essential to proper reproduction. A one- or two-page typewritten description of the station, including type of operating you engage in, and biographical background, should accompany your entry.

THE BIG STEAL

★ starring ★

The Touch. by Regency.



NOW SHOWING AT:

The Touch by Regency. The first fully synthesized 16 channel scanner to put over 15,000 frequencies at the command of a fingertip.

Now that's not just a new scanner. It's a revolution in scanning.

Alan, check out these reviews

"TRULY AMAZING!" The Montrose Gazette
 "MAGNIFICENT!" The Salida Post Tribune
 "...HUH?" The Cotopaxi Chronic Bugler
 "ATSA MY BOY." Mrs. Capone

Frequency Coverage (MHz)

30-50
 146-148
 146-174
 440-450
 450-512

Reg. \$329 Now

\$269

Offer good to licensed hams only.
 Include call with order.



1401 Blake Street
 Denver, Co. 80202



electronics
 303-893-5525



This NEW MFJ Versa Tuner . . .

matches everything from 160 thru 10 Meters: dipoles, inverted vees, random wires, verticals, mobile whips, beams, balance lines, coax lines. Up to 200 watts RF OUTPUT. Built-in balun, too! NEW EFFICIENT air wound coil for more watts out!

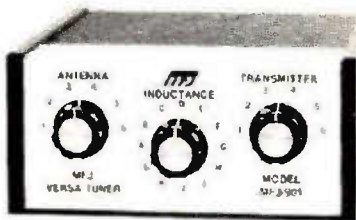

\$59⁹⁵

With the NEW MFJ-901 Versa Tuner you can run your full transceiver power output — up to 200 watts RF power output — and match your transmitter to any feedline from 160 thru 10 Meters whether you have coax cable, balance line, or random wire.

You can tune out the SWR on your dipole, inverted vee, random wire, vertical, mobile whip, beam, quad, or whatever you have.

You can even operate all bands with just one existing antenna. No need to put up separate antennas for each band.

Increase the usable bandwidth of your mobile whip by tuning out the SWR from inside your car. Works great with all solid state rigs (like the Atlas) and with all tube type rigs.

It travels well, too. Its ultra compact size 5x2x6

inches fits easily in a small corner of your suitcase.

Only MFJ uses an efficient air wound inductor in this class of tuners to give you more watts out and far less losses than a high permeability toroid core. Wide range 12 position inductor. Quality capacitors manufactured for MFJ. Built in 1:4 balun for balanced lines.

This beautiful little tuner is housed in a deluxe eggshell white Ten-Tec enclosure with walnut grain sides.

SO-239 coax connectors are provided for transmitter input and coax fed antennas. Quality five way binding posts are used for the balance line inputs (2), random wire input (1), and ground (1).

Order from MFJ and try it — no obligation. If not delighted, return it within 30 days for a refund (less shipping). This tuner is unconditionally guaranteed for one year.

ranteed for one year.

To order, simply call us toll-free 800-647-8660 and charge it on your VISA or Master Charge or mail us an order with a check or money order for \$59.95 plus \$2.00 shipping/handling for the MFJ-901 Versa Tuner.

Don't wait any longer to tune out that SWR and enjoy solid OSO's. Order today.

MFJ ENTERPRISES

P. O. BOX 494

MISSISSIPPI STATE, MS. 39762

CALL TOLL FREE . . . 800-647-8660

For technical information, order and repair status, and in Mississippi, call 601-323-5869.

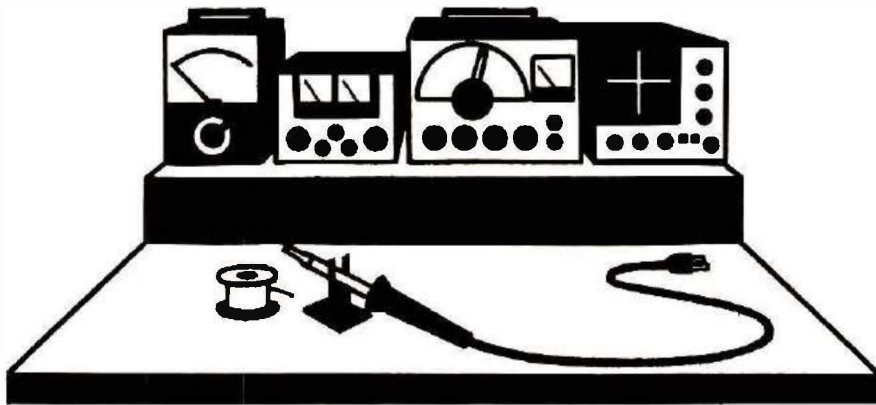

BENCHMARKS

Removable mount for vertical antennas

Hams were never meant to live on city lots! Or is it that city lots were never meant to have hams? Whatever the case, limited space for antennas always creates a problem. The vertical ground-plane antenna is, however, a good DX antenna, and can be used with limited ground area. My small backyard must be shared between antennas and what seems to be a never-ending supply of children. This never seems to be much of a problem in the winter months when they are in school or playing

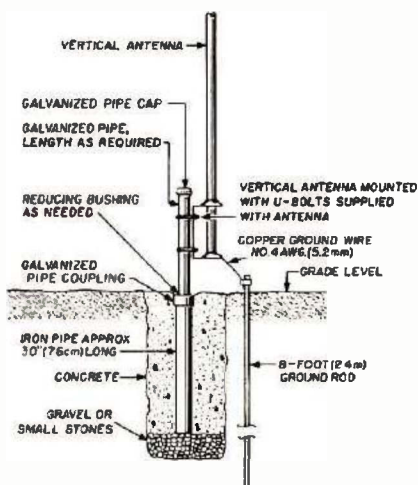

Fig. 1. This mount for a vertical antenna can be removed for safety when your operating season is finished. The buried section of pipe should be closed with a plug to keep water out of it when not in use.

indoors. A ground-mounted antenna in the summer, however, represents a real safety hazard to running children. Because of very limited high-frequency operation during the summer months, you can remove the vertical antenna and not create a hardship.

Shown in **Fig. 1** is a method which I have been using for several years to mount my vertical antenna so I can remove it every spring and reinstall it every fall, with a minimum of effort. A section of standard (heavy-wall) iron pipe, with a coupling attached, is set in concrete into the ground approximately 30 inches (75cm). The top of the coupling should be slightly below ground level. In the fall another section of pipe is screwed into the coupling, fitted with a reducing bushing if necessary, to accommodate the vertical antenna's mounting bracket, and U-bolts.

Removing the antenna in the spring is easily done by unscrewing the top pipe and inserting a pipe plug of the right size to mate with the coupling. If all mating threads are well greased at assembly time, removal will be easily done. Since mechanical strength is no real problem, pipe sizes may be varied to use scrap pieces on hand and accept the size

of the antenna clamp.

Removal of the ground rod is also easily done by using the bracket shown in **Fig. 2**. Simply slip the hole in the steel angle over the ground rod. Next, hook an automotive bumper jack through the U-bolt and begin jacking the ground rod out of the ground. The bracket binds against the ground rod and pulls it upward. When the jack

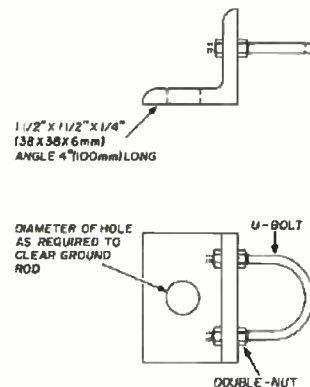

Fig. 2. A fixture to help pull the ground rod can be made from a small piece of angle stock and a U-bolt. A bumper jack supplies the lifting power.

has been extended to its maximum height, slide the bracket lower on the ground rod, lower the jack, and begin raising it again. Continue this procedure until the rod is completely removed.

With the ground rod removed and the pipe coupling plugged and below grade, there is nothing to interfere with the lawn mower, and you don't have to worry about children falling on any exposed hardware.

F. Neil Urban, W8CD

Cable feedthrough idea

After breaking a wood bit in a solid window sill, breaking the sash by easy drilling with carbide bits lubricated in kerosene, and finally, running out of places to drill holes in the cellar window frames for the entry (or is it exit?) of coaxial and rotator-control cable, I was finally tipped off to

a simple and readily available solution to my problem: a clothes-dryer vent kit. It works!

These vent kits are available from discount stores, hardware stores, and appliance sales outlets for under ten dollars. You can install a 3 or 4 inch (7.6 or 10cm) vent in the cellar wall and then add, subtract, remove, and replace cables to your heart's content — quickly and easily. I stuff insulation or old rags around the cables to fill up the interior of the vent housing to prevent cold drafts and mice or other creatures from entering my shack.

The natural trap in the vent housing makes a perfect drip loop to prevent water from following the cables into your shack. My present installation includes five RG-8/U coaxial cables, three RG-58/U coaxial cables, two rotator-control cables, and a piece of solid-dielectric twinlead for my TV antenna. Believe it or not, there's room to spare, and it is a simple matter to snake them in or out.

I did not use the flexible hose that comes with the kit, but you may want to use it in your installation as a conduit to guide your cables under, over, through, or whatever.

So do it the easy way — add a dryer vent and be ready for the inevitable changes to your antenna farm without the necessity for making new holes each time you add or change a cable. I'd like to thank Rennie, WA1DHM, who first suggested the idea to me, although he disclaims originality. In any case, a good idea is a good idea, no matter where it comes from. My only problem is that it took me so long to find out about it.

Curtis Heuberger, WA1IUR

Two-meter receiver alignment

A good emergency signal source for the alignment of your 2-meter fm receiver's front end is an a-m/fm/PSB (public-

service band) radio that can be found in many homes and shops.

I have two types of these multiband radios. One has a band that covers 108 to 174 MHz, and its oscillator operates 10.7 MHz above the input frequency. When tuning this radio near 136 MHz, I can receive its oscillator quite well on my 2-meter unit. To get a weak signal I move the radio to another room or even into the garage. The signal it puts out is very stable, and when the receiver is set for a discriminator zero, it will stay on frequency for 5 to 10 minutes.

The other radio I have has only a 148 to 174 MHz band, but its oscillator signal is 10.7 MHz below the tuned frequency. This one I tune to about 158 MHz and use it in the same way as the first radio.

I have also used one of these radios to check my 2-meter directional antennas. To do this I locate my mobile unit in a clear area and tune the PSB radio's oscillator to the 2-meter frequency I'm using. Then I set the PSB radio 100 yards (91m) away and make my antenna test. My better antennas can pinpoint the PSB radio's location.

Duane J. Meyer, K9PVY

Feeder Spreader

I guess I'm just an experimenter at heart, but antennas have always fascinated me. Over the years I've had my share of them, too, but the open-wire-feeder type antenna such as the Zepp was always a favorite.

Nowadays it is difficult to find open-wire feedlines such as we used to make years ago, although for a short period of time, at the beginning of the TV-and-outdoor antenna-boom, *ladder line* of 450-ohm impedance was available. Now, even that is scarce, and most hams who want open-wire feedlines are out of luck unless

they can homebrew something. This is where my other hobby comes in.

For sometime now my wife has been using an XL-70 Polaroid camera, mostly for indoor flash exposures. One day, as I was about to throw one of the used flash bars away, the plastic holder caught my attention. Hmmm . . . looked just like a spreader for an open-wire feedline.

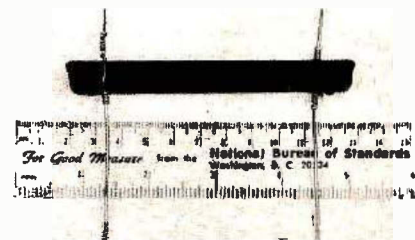

The plastic holder from a flashbar can be used to make spreaders for open-wire transmission line.

Tearing the flashbar apart, I quickly and easily isolated the base portion which looked like it would do the trick. It's about 4-3/16 inch (10.6cm) long, 5/16 inches (8mm) wide, and 5/16 inches (8mm) high, and weighs only a few grams. The best part is that it already has two 2mm (.080 inch) diameter holes spaced 3-1/8 inches (8cm) apart. Since discovering the new spacer stock, I've been encouraging my wife to take as many indoor pictures as she wants (what am I saying!) and soon I'll have enough to build that 66-foot (20 meter) Zepp feedline that I've needed for the past year. I figure the spacing will give me a characteristic impedance of about 500 ohms.

Oh yes, before I forget, ask for General Electric Flashbar no. 10. I suppose other manufacturers make them, but these are the ones that my wife always seems to buy. Pretty soon we'll own a large block of film and flashbar stock, and I've had spots before my eyes for nearly a year now, but that's all right because my Zepp will be up in the spring.

Phil Ingraham, W2OSY

HRH LOCATOR

TO HELP YOU FIND YOUR LOCAL AMATEUR RADIO DEALER

Alabama

LONG'S ELECTRONICS
2808 7TH AVENUE SOUTH
BIRMINGHAM, AL 35202
800-633-3410
Call Us Toll-Free
To Place Your Order.

Arizona

POWER COMMUNICATIONS
6012 N. 27 AVENUE
PHOENIX, AZ 85017
602-242-6030
Arizona's #1 "Ham" Store,
Kenwood, Drake, Icom & more.

California

C & A ELECTRONIC ENTERPRISES
2529 EAST CARSON STREET
P. O. BOX 5232
CARSON, CA 90745
213-834-5868
Not the biggest, but the best —
since 1962.

TOWER ELECTRONICS CORP.
24001 ALICIA PARKWAY
MISSION VIEJO, CA 92675
714-768-8900
Authorized Yaesu Sales & Service.
Mail Orders A Specialty.

Connecticut

ARCOMM ELECTRONICS
2865 MAIN STREET
BRIDGEPORT, CT 06606
Come On In, Tues. thru Sat.
10:00 - 6:00

Florida

LAFAYETTE RADIO ELECTRONICS
(Assoc. Store)
1811 N. HIGHWAY 17-92
MAITLAND, FL 32751
305-831-2271
The Electronics Emporium

Illinois

SPECTRONICS, INC.
1009 GARFIELD STREET
OAK PARK, IL 60304
312-848-6777
Chicagoland's Amateur Radio
leader.

Indiana

HOOSIER ELECTRONICS, INC.
P. O. BOX 2001
(43B Meadows Shopping Center)
TERRE HAUTE, IN 47802
812-238-1456
Communications Headquarters
of the U.S.A.

Iowa

BOB SMITH ELECTRONICS
12 SOUTH 21ST STREET
FORT DODGE, IA 50501
515-576-3886
For an EZ Deal on New
or Used Equipment.

Maryland

THE COMM CENTER, INC.
LAUREL PLAZA - RTE. 198
LAUREL, MD 20810
301-792-0600
Drake, Hy-Gain, Mosley, Tempo,
Ten-Tec, Wilson.

Massachusetts

TUFTS ELECTRONICS
209 MYSTIC AVENUE
MEDFORD, MA 02155
617-395-8280
New England's Friendliest
Ham Store.

Michigan

RSE HAM SHACK
1207 W. 14 MILE
CLAWSON, MI 48017
313-435-5660
Complete Amateur Supplies.

Minnesota

PAL ELECTRONICS INC.
3452 FREMONT AVE. NO.
MINNEAPOLIS, MN 55412
612-521-4662
The Midwest's fastest growing
ham dealer.

Nebraska

COMMUNICATIONS CENTER, INC.
443 N. 48 STREET
LINCOLN, NE 68503
402-466-8402
Call Toll Free for Low
Prices! 800-228-4097

New Hampshire

EVANS RADIO, INC.
BOX 893, RT. 3A BOW JUNCTION
CONCORD, NH 03301
603-224-9961
Icom, Dentron & Yaesu dealer.
We service what we sell.

New York

HAM-BONE RADIO
(Div. Stereo Repair Shop)
3206 ERIE BOULEVARD, EAST
SYRACUSE, NY 13214
315-446-2266
We Deal, We Trade,
We Discount, We Please!

HARRISON RADIO CORP.
20 SMITH STREET
FARMINGDALE, NY 11735
516-293-7990
"Ham Headquarters USA®"
since 1925.
Call toll free 800-645-9187.

Ohio

UNIVERSAL AMATEUR RADIO
1280 AIDA DRIVE
REYNOLDSBURG (Columbus)
OH 43068
614-866-HAMS
Drake, Yaesu, Ten-Tec, KDK, Wilson.
All Lines In Stock.

Pennsylvania

ELECTRONIC EXCHANGE
136 N. MAIN STREET
SOUDERTON, PA 18964
215-723-1200
Personal attention to Newcomer
and Oldtimer.

Texas

HARDIN ELECTRONICS
5635 EAST ROSEDALE
FORT WORTH, TX 76112
817-461-9761
You Bet Fort Worth
Has A Ham Store!

THE BIG SIGNAL

UNADILLA
"W2AU" BALUN

S/S HARDWARE

\$1495

HANG-UP
HOOK

SILVER PLATED
SO-239



BUILT-IN
LIGHTNING
ARRESTER

FULLY
ENCLOSED

UNADILLA ORIGINATED!

World Famous Among Hams,
Armed Forces, Communica-
tions Industry. Why?

- Each BALUN 2KW PEP tested
- Lightning Arrester
- 500+ Pull - No Insulator Needed

- Only 7 oz. and 6" x 1 3/4" diameter
- Reduces TVI
- Improves F/B ratios
- Weatherproof
- Complete Instructions
- Antenna Length Table

THE OLD RELIABLE

REYCO
"W2VS" ANTENNA COILS

\$2195

pair

ALUM/POLY
CAPACITOR

WEATHERIZED
COIL

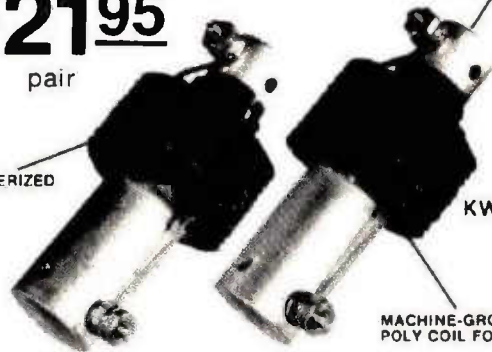

KW - 40
- 20
- 15
- 10

MACHINE-GROOVED
POLY COIL FORM

FREQUENCY-MATCHED PAIRS!

Turns Your Antenna into A
Multi-Band! Professionals
Demand Reyco! Why?

- Precision Machined
- Frequency-Matched Pairs
- Only 6 oz. and 5 1/2 x 1 3/4" diameter

- Rugged - Over 300# Pull
- Weatherized
- Models for 10, 15, 20, 40 Meters
- Complete Instructions
- Multi-Band Length/Tuning Data

DEALERS WANTED - NOW OVER 200 WORLD-WIDE

AT YOUR HAM DEALER - If not, order direct (Add \$1)
Need the name of your nearest dealer, technical help, literature?
ROGER!

Call us TOLL-FREE and ask for Hugh Gunnison, WA2ZOT
NYS 1-800-962-7965 OTHER STATES 1-800-448-1666
TWX: 710-541-0493 CABLE: MICROFILCO

UNADILLA/REYCO DIVISION, Microwave Filter Company, Inc., 6743 Kinne Street, East Syracuse, New York 13057

ENERGY CRISIS SOLVED!

Personal energy crisis? Get precious
RF on DX target with World Record
Breaking antenna that won W6TYP the
QRP ARC 1,000,000 miles/watt award.

THE JOYSTICK VFA

(Variable freq. ant) gives low angle,
omnidirectional, harmonic free radiation
on all bands 160 thru 10 (- MARS and
receive on all BC & SW).

1000's of glowing reports in our files of
the VFA in use, often in poor QTH and/or
under QRP, contests, etc.

SYSTEM 'A' \$75.00

250W P.E.P. &/or Receiving Only

SYSTEM 'J' \$99.00

500WP E.P. &/or Improved Q Factor Receive
Air Mail cost included. (Each system
3 sections easily assembled to make
unit 7' 6" long. Matching ATU). Not only
will you save space but you will save
\$\$\$ at present low exch. rate and by
buying direct UK manuf. Rush your
order - Mastercharge or check, or
ask for brochure.

**PARTRIDGE (HH)
ELECTRONICS LTD.**

Broadstairs, Kent, England
Tel. Thanet 62535

G3CED

G3VFA

★ FREE! ★



NEW CATALOG OF HARD-TO-FIND PRECISION TOOLS

Jensen's new 144-page catalog is jam-
packed with more than 3000 quality
items. Your single source for hard-to-
find precision tools used by electronic
technicians, scientists, engineers, in-
strument mechanics, schools, labora-
tories and government agencies. This
popular catalog also contains Jensen's
world-famous line of more than 40 tool
kits. Plus 10 pages of useful "Tool Tips"
to aid in tool selection. Send for your
free copy today!

JENSEN TOOLS & ALLOYS
1230 SOUTH PRIEST DRIVE - TEMPE, AZ 85281

A BOST & LAUGHIN COMPANY

NEW HAM STATION OR ANTENNA SYSTEM IN THE WORKS?

SSB - FM - AM - CW
SSTV - RTTY - EME
OR . . . ?

Let us HELP you

As we have helped thousands
of others, the world over,
for the past 39 years!

WE CARRY EVERY
TOP BRAND OF HAM
AND COMMUNICATIONS GEAR.

ELECTRONIC DISTRIBUTORS, Inc.

Communication Specialists
1960 Peck St., Muskegon, Mich. 49441
Tel. (616) 726-3196 Telex 22-8411

PRODUCT SHOWCASE

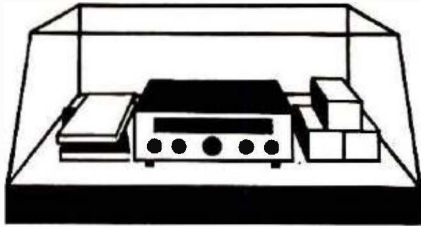

Kenwood TS-700S and VFO-700S



Kenwood has announced the new TS-700S, an all-mode, 2-meter transceiver. Based on the popular TS-700A, the TS-700S incorporates several new features such as a digital readout with "Kenwood Blue" digits, high-gain receiver pre-amp, a 1-watt low-power switch, built in vox, and CW Sidetone. It operates all modes: upper and lower sideband, fm, am and CW. The completely solid-state circuitry provides stable, long-lasting, trouble-free operation. You can operate the rig from your car or boat on 12-V dc, or as a home station with its built-in power supply. Frequency coverage is 144 to 148 MHz. The TS-700S automatically moves its transmit frequency 600 kHz for repeater operation; simply dial in your receive frequency and the radio does the rest for simplex, repeater, or reverse modes. Or, select your frequency by plugging a single crystal into one of the 11 crystal positions for your favorite channel. You'll have transmit/receive capability on 44 channels with 11 crystals.

The VFO-700S is a handsomely styled companion to the TS-700S. This unit provides you with the extra versatility and luxury of having a second vfo in your vhf shack, which is great for split-frequency operation and for tuning off frequency to

check the band. The function switch on the VFO-700S selects the vfo in use, and the appropriate frequency is displayed on the digital readout in the TS-700S. In addition, a momentary-contact "frequency-check" switch allows you to spot check the frequency of the other vfo.

List price of the TS-700S is \$679, and the VFO-700S lists at \$119. Both units are available from authorized Trio-Kenwood dealers throughout the United States. For a list of authorized dealers and more information on the TS-700S and VFO-700S, write: Trio-Kenwood Communications, Inc., 1111 West Walnut Street, Compton, California 90220; or use *ad check* on page 78.

Hiram Percy Maxim — a Biography

Probably Hiram Percy Maxim has contributed more to amateur radio than any other single person. Historically, he founded *QST Magazine*, the American Radio Relay League, and the International Amateur Radio Union. He pleaded the amateur's cause very successfully before American and international forums bent on abolishing the hobby, and he held one of the most famous ham callsigns of all time: W1AW. Taken together, he organized, nurtured, defended, and disciplined the hobby in its critical formative years; amateur radio still bears the distinctive stamp of his gentlemanly personality.

Maxim is best known outside the world of amateur radio for his inventions and pioneering work in the development of the automobile and noise-control devices. A holder of 49 patents, he was also a pioneer in aviation, air conditioning, motion pictures, and radio astronomy. He was an accomplished international diplomat, screen writer, urban ecologist, and nationally-syndicated newspaper columnist. In short, he was a true Renaissance man; the embodiment of the line from *The Ama-*

teur's Code, "an amateur is balanced."

This is the only available biography of a great and unique American character. It is a fascinating and painstakingly well researched account that brings his personality to life. The author, Alice Clink Schumacher, avoids dull scholarship and makes the reader feel that he is overhearing a collection of treasured family anecdotes told by close friends and relatives.

The book provides a unique insight into one man's life and an era of unprecedented technological progress in dozens of fields. Perhaps the feature which most commends this book to every amateur's library is the lengthy excerpting from Maxim's incomparable series of "The Old Man" editorials. Printed anonymously in early issues of *QST*, they are amusing, humorous yet thought-provoking caricatures of radio amateurs and their foibles. They are still amazingly accurate today.

Certainly few men were as well-liked and respected, nor did as much to make amateur radio the most gentlemanly of hobbies, than The Old Man — Hiram Percy Maxim.

Softcover, 153 pages, \$4.50 postpaid Ham Radio's Communications Bookstore, Greenville, New Hampshire 03048. Order catalog HR-HPM.

Antenna Disconnect

Gold Line, of Norwalk, Connecticut, has introduced an antenna "Quick Disconnect" fitting that should make life easier for any user of mobile radio equipment. It is the model 1116 *Antenna Quick Disconnect*, which operates on the press-and-twist principle for attachment of the whip antenna to its base. This allows easy removal of the antenna for safety when having the car washed, for service in garages, or for storage of the antenna.

The adaptor has threads of 3/8-24, which is standard with

many of the whips in use throughout industry. It measures 2-1/2 inches high and 5/8 inch (63x16mm) diameter.

Gold Line produces other accessories for mobile or fixed station use, including matching devices, filters, meters, and several adaptors and connectors for antennas and feedlines. For more information write to Gold Line, 25 Van Zant Street, East Norwalk, Connecticut 06855; or use *ad check* on page 78.

Magsat — Communications for the Deaf

Magsat is a small five-pound (2.3kg) portable alphanumeric readout unit designed to interface with an ordinary telephone and provide communications for the deaf. Basically, this is the way it works: Suppose you can't hear well enough to use the telephone, but have to communicate with someone. You plug Magsat into an ordinary household current receptacle, slide the switch to ON, and place the telephone handset into the cradle at the top of the Magsat unit. The display light (dial tone) will glow steadily, telling you that the line is open and ready for your call. Next, you dial the number you want, and the display light flashes each time the telephone rings. If the line is busy, the light flashes rapidly.

The person receiving your call places their telephone handset on their own Magsat unit, and answers you by typing a message. The message appears as a lighted display on your Magsat; for example, MARY HERE GA. You and your party now type to each other, and the message will be simultaneously displayed on both screens. Each letter appears at the right side of the screen and moves left as the words are formed. When the conversation is over, replace the handset on the telephone, and slide the switch to off. That's all there is to it!

Here are some of the other

features that make the unit desirable: Large, easy-to-read letters in the electronic display; a single key for carriage return and line feed; keyboard speed that can exceed the fastest typist; every unit is equipped to accept a tape recorder; and the unit is easily carried in a matching attache-type case. It is vir-

tually silent in operation, and velvety-smooth — being electronic rather than mechanical.

Magsat employs a five-level Baudot code, making it compatible with ordinary *Teletype* units for use on radio circuits. For example, each letter key is converted by means of a built-in converter to an audio tone,

We Don't Claim That Your ALPHA Linear Will Run A Kilowatt Key-Down FOREVER . . .



. . . But We Don't Put A Time Limit On It, Either.

YOU'LL PROBABLY NEVER SET A BRICK ON YOUR KEY FOR 26,000 MINUTES, BUT WE DID IT TO ILLUSTRATE WHAT ETO'S NO TIME LIMIT [NTL] CONTINUOUS DUTY RATINGS REALLY MEAN TO EVERY ALPHA AMPLIFIER OWNER.

April 7th: A standard ALPHA 76 was taken from production, loaded up to a full 1000 watts key-down dc input, and left operating with a brick on the key.

April 25th: The '76 was still operating completely normally, delivering about 675 watts of continuous rf carrier output into a very hot dummy load — after 18 days — 435 hours — some 26,000 consecutive minutes key-down at a full kilowatt. You may have seen the same unit running key-down all day long the following week-end at the Dayton Hamvention. It's still as good as new — a fact which will surprise no one who knows how all ALPHA's are built. You'd expect no less.

The point is, every ALPHA linear amplifier — including the power- and value-packed ALPHA 76 and the exclusive NO-TUNE-UP ALPHA 374 — is meticulously engineered and built to handle continuous operation IN ANY MODE AT MAXIMUM LEGAL POWER [NTL] . . . No Time Limit. And ETO's warranty on every ALPHA amplifier protects you FOR EIGHTEEN MONTHS — FIVE TIMES LONGER than most amateur equipment warranties!

ALPHA: SURE YOU CAN BUY A CHEAPER LINEAR . . . BUT IS THAT REALLY WHAT YOU WANT?

A LINEAR AMPLIFIER IS A BIG INVESTMENT . . . MAKE IT WISELY. For an enlightening glimpse at what goes into the design of every ALPHA by ETO's power professionals, or to aid you in comparing one linear with another, call or write for our brief guide entitled, "EVERYTHING YOU ALWAYS WANTED TO KNOW ABOUT (COMPARING) LINEARS . . . BUT DIDN'T KNOW WHOM TO ASK." We'll also send you fully detailed and illustrated literature describing the entire ETO line of superb ALPHA power amplifiers and ALPHA/VOMAX — the new split-band speech processor that's your key to rf clipper type "talk power" combined with easy mike-line installation and low-distortion, practically foolproof operation.



EHRHORN TECHNOLOGICAL OPERATIONS, INC.
P.O. BOX 708 — INDUSTRIAL PARK
CANON CITY, CO. 81212 PHONE (303) 275-1613

which may be transmitted by radio or telephone line. Radio amateurs will find Magsat ideal for a tiny RTTY terminal, and perhaps other uses.

Each Magsat unit is unconditionally guaranteed by the manufacturer to be free from defects in materials and workmanship for a period of one year from date of purchase. Magsat will

make all repairs, and will even make out-of-warranty repairs at cost.

Magsat Corporation also offers a complete line of accessories, including a useful telephone flasher adapter that tells you when your phone is ringing.

The Magsat unit represents a five-year design and development program by a talented en-

gineer who has made a long study of deaf persons' needs, and decided that, "there must be a better way."

The Magsat retails for only \$695. Further details may be obtained from Magsat Corporation, 56 Arbor Street, Hartford, Connecticut 06106, or use *ad check* on page 78.

Hamtronics Test Probe Kits

Hamtronics recently added a line of test probe kits as accessories for your vtm, fet vm, oscilloscope, and frequency counter. The kits are complete with probes, cable, all components, and instructions. They feature a handy spring-hook-type probe and ground clip for easy connection to even the smallest components. You will appreciate the convenience of the probe and the flexible cable after working with alligator clips and stiff cable for so long. The line of probes includes the following six types:

- TE-3 RF Probe — detects rf for vtm or scope
- TE-4 Direct Probe — for ac and ohms measurements with vtm
- TE-5 DC Probe — for dc measurements with 11-megohm vtm or fet vm
- TE-6 Blocking Probe — series capacitor for signal generator or frequency counter
- TE-7 Wideband Detector Probe — for video i-f circuit monitoring with scope
- TE-8 Low Capacitance/High Impedance Probe — compensated probe for accurate waveform indications with scope

Kits are \$7.95 each. For a complete catalog, including the line of vhf and uhf fm receiver, transmitter, and preamp kits, send a self addressed stamped envelope to Hamtronics, Inc., 182 Belmont Road, Rochester, New York 14612, or use *ad check* on page 78.

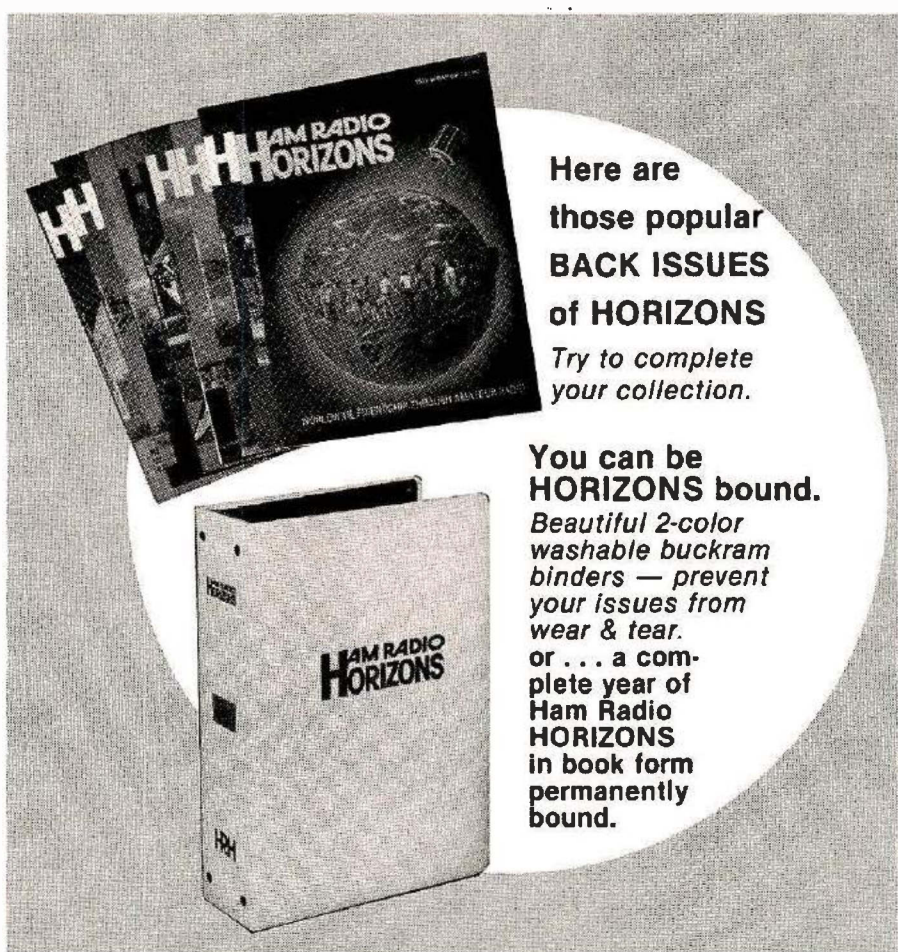

BACK ISSUES . . . \$2.00 ea. — 3 for \$4.95 (Check the issues desired)

- HORIZONS' BINDERS \$6.95 ea. — 3 for \$17.95
- HORIZONS' BOUND VOLUME \$24.95 ea.

- March 1977 September 1977
- May 1977 October 1977
- June 1977 November 1977
- July 1977 December 1977
- August 1977 Wrap-Up 1977

HAM RADIO HORIZONS

Greenville, N.H. 03048

Check or Money Order Enclosed

VISA MASTERCHARGE

Account # _____ Exp. date _____

Name _____

Address _____

City _____

State _____ Zip _____

HORIZONS ad-scan

RATES Regular classified is available at 50¢ per word. Display classified (1 inch deep x 2 1/4 inches wide) is \$50, or at the 12x rate is \$35. All Ad Scan payable in advance. No cash discounts or agency commissions allowed.

HAMFESTS Sponsored by non-profit organizations receive one free regular classified ad (subject to our editing). Repeat insertions of hamfest ads pay the standard rate.

COPY No special layout or arrangements available. Material should be typewritten or clearly printed (not all capitals) and must include full name and address. We reserve the right to reject unsuitable copy. *HORIZONS* cannot check each advertiser and thus cannot be held responsible for claims made. Liability for correctness of material limited to corrected ad in next available issue.

DEADLINE 15th of third preceding month.

SEND MATERIAL TO: Ad Scan, Ham Radio Horizons, Greenville, N. H. 03048.

GOVERNMENT SURPLUS Ham Band Gear. Send S.A.S.E. to Gordon, 10925 Morris Avenue South, Bloomington, Minnesota 55437.

"THE CADILLAC" of QSL's! — New! Samples: \$1.00 (Refundable) — MAC'S SHACK, Box #1171-G, Garland, Texas 75040.

FREE LICENSING CLASSES in Flushing, NY area. Send Inquiries to FRATS (Flushing Radio Amateur Technical Society), 62026 Boelsen Crescent, Rego Park, NY 11374.

SECOND ANNUAL WELLESLEY AMATEUR RADIO Society QSO Party from 0100Z November 19th to 1900Z November 20th. Exchange RS(T) and ARRL Section or Country with W1TKZ on 3.950, 7.250, 14.310, 21.400, 28.600, and 146.52 (phone) or 3.720, 7.120, 21.120, and 28.120 (CW). QSL and long SASE to W.A.R.S., 324 Washington St., Wellesley, MA 02181.

SST T-1 RANDOM WIRE ANTENNA TUNER

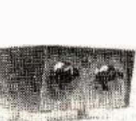

All band operation (160-10 meters) with most any random length wire, 200 watt output power capability, ideal for portable or home operation. Toroid inductor for small size 3 x 4-1/4 x 2-3/8. Built-in neon turn-step indicator. SO-239 coax connector. Guaranteed for 1 yr., 30-day trial. Complete — easy to use, only \$29.95 postpaid. (Add Sales Tax in Calif.) (213) 376-5887

SST ELECTRONICS, P.O. BOX 1, LAWDALE, CA 90260

ANTENNA all ham bands 80 thru 10 No Traps \$25.00 postpaid. (Ca. residents add \$1.50 sales tax). Rudy Plak, P.O. Box 966, San Marcos, Ca. 92069.

QSL's with class! Unbeatable quality, reasonable price. Samples, 25¢. QSL's Unlimited, Box 27553H, Atlanta, GA 30327.

Free **solitrex** Literature *****
ELECTRONIC VOLTAGE REGULATORS
FOR CAR ALTERNATORS
• Operating Range: -50°C to +85°C
• Full Warranty For 5 Years (€ 7,30)
• Available For Most Cars, Send \$ 14.95 to
SOLIO STATE DEVELOPMENT COMPANY
P.O. Box 106, Clarkson Postal Station,
Mississauga, Ontario, CANADA, L5L 3X8

ANNUAL FORT WAYNE WINTER HAMFEST. Shiloh Hall, January 22, 1978 from 8AM until 4PM local time. Early parking available. Talk in on 28/88 and 52/52. Admission \$2 at the door. Table space available at \$1.50 per half table (about 4 feet). For information or table reservations (held until 9:30AM) write Hamfest Chairman, AC/ARTS, P.O. Box 342, Fort Wayne, Indiana 46801

1978 CLASSIC RADIO EXCHANGE 2000 UTC January 29 to 0300 UTC January 30, 1978. Exchange name, RST, state/province/country, receiver and transmitter type (homebrew — send P.A. tube). Same station may be worked with different equipment combinations, on each mode, each band. CW call CQ CX, phone call CQ EXCHANGE. Frequencies: CW up 60 kHz from low edge of band; Phone 3910, 7280, 14280, 21380, 28580; Novice/tech 3720, 7120, 21120, 28120. Listen to 20 meters on half hour for coast-to-coast DX. Logs to Stu Stephens, K8SJ, 2386 Queenston Road, Cleveland Heights, OH 44118. S.A.S.E. for newsletter & results.

NORTH CAROLINA QSO PARTY — from 1900Z Dec. 2 through 0100Z Dec. 4. Suggested frequencies are plus/minus 10 kHz: cw, 3560 7060 14080 21080 28060; Novice, 3720 7120 21120 28120; ssb, 3900 7270 14290 21390 28590. Out-of-state stations transmit RS(T) and state, province or country. NC stations send RS(T) and NC county. Logs must be postmarked no later than Jan. 10, 1978 and sent to: Alamance ARC Inc., 2822 Westchester Dr., Burlington, NC 27215. For additional information write K4EG.

CODE PRACTICE OSCILLATORS, hand keys, electronics keyers, other products. Free catalog. Globalman Products, Box 246, El Toro, CA 92630. 714-533-4400.

MOBILE IGNITION SHIELDING provides more range with no noise. Bonding strap sale less than 50¢ each. Literature. Estes Engineering, 930 Marine Drive, Port Angeles, Wash. 98362.

PHOTOGRAPHERS: I am a retired broadcast engineer who would like to meet active hams, on the air, who are interested in the historical processes of photography such as carbonyl, oil, bromoil, etc., for the purpose of exchanging data on the air with the hope of working together to preserve the knowledge of these beautiful processes for future generations of ham-photographers. I work all bands, 2 through 160 meters, am or ssb. For sked info please contact Tracy Diers, W2OQK, 58-14-84th Street, Elmhurst, N.Y. 11373.

WEAR YOUR CALL LETTERS proudly at the next hamfest or get-together: 1 x 3" badge-custom engraved w/ur call & name in red, blue, green, black, white, yellow, orange, silver, gold, woodgrain. \$1.75 ppd. The Elbridge Engraver, Elbridge, NY 13060.

AWARD CERTIFICATES
Award for Public Service or Emergency Communications Award. Send 2.00 each, event, name and address. FREE information. 49'er RADIO CLUB, Box 1400-HH, Downey, Calif. 90240.

CUSTOM ENGRAVING for the Ham and Ham-shack. 1 x 3" Namebadge with name and call \$2.50. 2 x 8" Nameplate w/acrylic base \$5.25. All colors. Send check or money order to Ed's Engraving, Box 644, Westfield, MA 01085.

WEST COAST BULLETIN edited and transmitted by W6ZF, 9 PM PDT (8 PM PST) (0400 UTC) 3450 kHz, A-1, 22 WPM, FIRST AND THIRD MONDAYS each month. Ten to fifteen items of latest current events of interest to Amateurs, with final few minutes at 25 WPM to help build code speed.

LaPORTE ARC'S WINTER HAMFEST. Sunday, February 26, 1978 at the LaPorte Civic Auditorium, 50 miles southeast of Chicago. Plenty of room, free tables, good food. Donation \$2 at gate. Talk in on 01/61 and 52 simplex. LPARC, Box 30, LaPorte, IN 46350.

ENGRAVED NAMETAGS-1 1/2" x 2 1/2" — \$3.00. QTH added-\$0.50. Black, blue, red, green, walnut. White letters. Beveled. Locking pin. Other colors available. Tag-It Co., Box 2062, Indianapolis, In. 46206.

STOLEN AMATEUR RADIO EQUIPMENT: Anyone desiring to list stolen amateur radio equipment please send information to Colorado Council of Amateur Radio Clubs, c/o Charles E. Meyers, W0RNT, 1120 Yosemite Drive, Colorado Springs, Colorado 80910. Include as much information as possible. FREE distribution will be made to all Amateur Radio magazines and Colorado Amateur Radio Clubs. Funds for postage and printing will be greatly appreciated.

TRIPOLE MULTI-BAND

All-band antenna 80 to 8 meters plus 160-5 SWR. Guaranteed 2000-1000000 Hz. 2 KW PEP rating. No swamping. 100% trap change. 80 to 120 ft. mounted. 40 or horizontal. Available in 4 forms or assembled. ON TOLL-FREE \$54.95 cash PPD in USA. Free literature and 1/2" x 1/2" x 1/2" card for information on the HRL antenna. Call 1-800-451-1910

STOLEN, FIRST OF OCTOBER FROM MY HOME: 1- Atlas 350XL with DD6-XL digital dial. Serial Number 877025; 1- AC power supply for the Atlas, Serial Number 877104PS. Jay Leonard, W5TSM, Route 1, Box 32A, Pottsville, Arkansas 72858.

WANTED: Heath Company VFO, Model HG-10 or HG-10B. WB1DBY, Larry Krainson, 153 Brookwood Drive, Longmeadow, Massachusetts 01106; Telephone (413) 567-0064.

CASH for your clean ham gear. Beacon Communications — used equipment specialists, 879 Beacon St., Boaton, Mass. 02215. 617-267-1975.

R-X NOISE BRIDGE

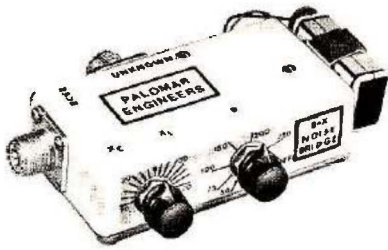

- ✓ Learn the truth about your antenna.
- ✓ Find its resonant frequency.
- ✓ Adjust it to your operating frequency quickly and easily.

If there is one place in your station where you cannot risk uncertain results it is in your antenna.

The Palomar Engineers R-X Noise Bridge tells you if your antenna is resonant or not and, if it is not, whether it is too long or too short. All this in one measurement reading. And it works just as well with ham-band-only receivers as with general coverage equipment because it gives perfect null readings even when the antenna is not resonant. It gives resistance and reactance readings on dipoles, inverted Vees, quads, beams, multiband trap dipoles and verticals. No station is complete without this up-to-date instrument.

Why work in the dark? Your SWR meter or your resistance noise bridge tells only half the story. Get the instrument that really works, the Palomar Engineers R-X Noise Bridge. Use it to check your antennas from 1 to 100 MHz. And use it in your shack to adjust resonant frequencies of both series and parallel tuned circuits. Works better than a dip meter and costs a lot less. Send for our free brochure.

The price is \$49.95 and we deliver postpaid anywhere in U.S. and Canada. California residents add sales tax.

Italy write i2VTT, P.O. Box 37, 22063 Cantu. Elsewhere send \$52.00 (U.S.) for air parcel post delivery worldwide.

Fully guaranteed by the originator of the R-X Noise Bridge. ORDER YOURS NOW!

PALOMAR ENGINEERS

BOX 455, ESCONDIDO, CA 92025

Phone: (714) 747-3343

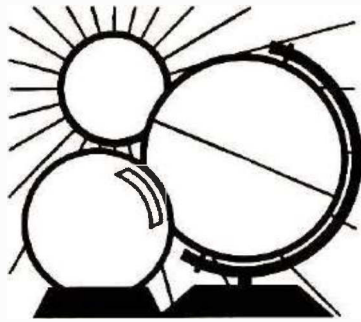

DX FORECASTER

Propagation conditions for January should be markedly improved over those of only one year ago, with considerable solar activity boosting MUFs into very usable regions for much of the month. You may expect some ionospheric disturbances of a noticeable, but not severe, nature during the week or so between New Year's Day and January 10th; and again between the 13th and 18th. A very pronounced disturbance may be expected during the third week of this month, particularly between the 21st and 27th, and it could also be accompanied, or shortly followed, by unusual atmospheric conditions here and abroad. Keep your receiver tuned to WWV at 18 minutes after each hour and listen for the propagation data — particularly the A and K index information. Sharp increases in the K index mark geomagnetic disturbances, and you may be sure that band conditions will respond rapidly.

20 meters will continue to be the top DX band, but you will notice that 15 meters is beginning to share the honors, with many good openings to all parts of the world. Be sure to check the next higher band whenever you hear good signals coming through. The bands marked with an asterisk (*) indicate when the next higher band is likely to be open to the area shown. Naturally, with the winter sun low in the sky, ionization will not be as great as during the fall and spring months. This means that the 10, 20, and 15-meter bands will close soon after dark, with the higher frequencies leading the way.

40, 80, and 160 meters will be very good this month, and much DX will be available from late afternoon through midnight until the early morning hours. As always, there will be a difference as to times of band opening, depending upon the frequency and your location. The chart will be most helpful in this respect. Twilight-zone propagation is a very good mode for working DX along the sunset-sunrise terminator. Try sunrise and sunset $\pm 1/2$ hour or so. In general, the bands below 40 meters will begin to be very active after dark — just about the time that the bands above 40 meters have thrown in the towel for the day. Solar Cycle 21 is coming along nicely, with very noticeable increases in the monthly smoothed sunspot number, centered on mid 1976. This means that the 160-meter band may not be quite as good as last year, but will still be great for DXing.

Moon bouncers will like January 8th because the moon is at perigee — closest to the earth on that day. VHFers will find occasional openings during the passage of major storm fronts, and again during sporadic-E conditions — relatively rare in January. The Quadrantid meteor shower on January 8th will offer some meteor-burst propagation, but you'll need to be quick on the trigger to make a solid two-way QSO. Also, look for some vhf openings at times of ionospheric disturbance, particularly during the third week of the month. 50, 144, and even 220 MHz might provide some fun.

WESTERN USA



MID USA

EASTERN USA

GMT	WESTERN USA										MID USA										EASTERN USA									
	N	NE	E	SE	S	SW	W	NW	N	NE	E	SE	S	SW	W	NW	N	NE	E	SE	S	SW	W	NW						
0000	15	20	15	15	15	15	15	15	40	40	20	15	20	20	15	15	40	40	20	40	40	20	20	20						
0100	15	20	15	20	15	15	15	15	40	40	20	20	20	20	20	15	80	80	40	80	40	40	40	40						
0200	15	20	15	20	15	15	15	15	80*	80	40	40	40	40	20	20	80	80	40	80	40	40	40	40						
0300	20*	20	15	20	15	15	15	15	40*	40	20	20	20	20	20	20	80	80	40	80	40	40	40	40						
0400	20	20	15	20	15	15	15	15	20	20	40	40	40	40	20	20	80	80	40	80	40	40	40	40						
0500	20	20	15	20	15	15	15	15	80*	80	40	80*	80	40	20	20	80	80	40	80	40	40	40	40						
0600	20	20	15	20	15	15	15	15	80*	80	40	80*	80	40	20	20	80	80	40	80	40	40	40	40						
0700	20	20	15	20	15	15	15	15	40	40	20	80*	80	40	20	20	80	80	40	80	40	40	40	40						
0800	20	20	15	20	15	15	15	15	40	40	20	80*	80	40	20	20	80	80	40	80	40	40	40	40						
0900	20	20	15	20	15	15	15	15	40	40	20	80*	80	40	20	20	80	80	40	80	40	40	40	40						
1000	20	20	15	20	15	15	15	15	40	40	20	80*	80	40	20	20	80	80	40	80	40	40	40	40						
1100	20	20	15	20	15	15	15	15	40	40	20	80*	80	40	20	20	80	80	40	80	40	40	40	40						
1200	20	20	15	20	15	15	15	15	40	40	20	80*	80	40	20	20	80	80	40	80	40	40	40	40						
1300	20	20	15	20	15	15	15	15	40	40	20	80*	80	40	20	20	80	80	40	80	40	40	40	40						
1400	20	20	15	20	15	15	15	15	40	40	20	80*	80	40	20	20	80	80	40	80	40	40	40	40						
1500	20	20	15	20	15	15	15	15	40	40	20	80*	80	40	20	20	80	80	40	80	40	40	40	40						
1600	20	20	15	20	15	15	15	15	40	40	20	80*	80	40	20	20	80	80	40	80	40	40	40	40						
1700	20	20	15	20	15	15	15	15	40	40	20	80*	80	40	20	20	80	80	40	80	40	40	40	40						
1800	20	20	15	20	15	15	15	15	40	40	20	80*	80	40	20	20	80	80	40	80	40	40	40	40						
1900	20	20	15	20	15	15	15	15	40	40	20	80*	80	40	20	20	80	80	40	80	40	40	40	40						
2000	20	20	15	20	15	15	15	15	40	40	20	80*	80	40	20	20	80	80	40	80	40	40	40	40						
2100	20	20	15	20	15	15	15	15	40	40	20	80*	80	40	20	20	80	80	40	80	40	40	40	40						
2200	20	20	15	20	15	15	15	15	40	40	20	80*	80	40	20	20	80	80	40	80	40	40	40	40						
2300	20	20	15	20	15	15	15	15	40	40	20	80*	80	40	20	20	80	80	40	80	40	40	40	40						

HAM CALENDAR

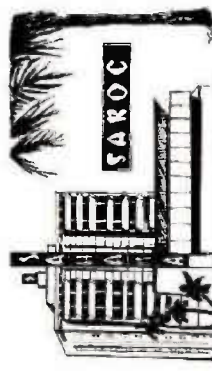
January 1978

SUNDAY	MONDAY	TUESDAY	WEDNESDAY	THURSDAY	FRIDAY	SATURDAY
<p>Straight Key Night Begins midnight New Year's Eve — Full 20U Period</p>  <p>Happy New Year</p>	<p>FLORIDA HAM NEWS — SWAP NET By the Broward ARC — Ft Lauderdale, FL — 146.31.91 at 7:30PM</p> <p>WEST COAST BULLETIN Edited & Transmitted by W6ZF 5PM PST 3540 MHz, A-1, 22 WPH</p>	<p>AMSAT Eastcoast Net 3850 kHz 8PM EST (0100Z) Wednesday Morning</p> <p>AMSAT Midcontinent Net 3850 kHz 8PM CST (0200Z Wednesday Morning)</p> <p>AMSAT Westcoast Net 3850 kHz 7PM PST (0300Z) Wednesday Morning</p>	<p>West Coast Qualifying Run</p>	<p>SAROC Convention — Santa Inge Las Vegas, NV 5-8 Personal Communications Show (PC 70) made with 1975 Winner Consumer Electronics Show — Las Vegas Convention Center — Las Vegas, NV — 5-8</p>		 <p>Ohio Area Regener Chancel Meeting — Delaware County Historical Society — Delaware, Oh</p>
<p>Hamfest & Swap & Shop — New Century Center — South Bend, IN — K9XU</p>	<p>FLORIDA HAM NEWS — SWAP NET By the Broward ARC — Ft Lauderdale, FL — 146.31.91 at 7:30PM</p> <p>WEST COAST BULLETIN Edited & Transmitted by W6ZF 5PM PST 3540 MHz, A-1, 22 WPH</p>	<p>AMSAT Eastcoast Net 3850 kHz 8PM EST (0100Z) Wednesday Morning</p> <p>AMSAT Midcontinent Net 3850 kHz 8PM CST (0200Z Wednesday Morning)</p> <p>AMSAT Westcoast Net 3850 kHz 7PM PST (0300Z) Wednesday Morning</p>	<p>11</p>	<p>12</p>	<p>13</p>	 <p>ARRL Southeastern Div. Convention — Miami, FL — 21-22 ARRL VHF Sweepstakes — 21-22</p>
<p>8</p>  <p>Sat Jan 1, 4, 14, 17 Sun Jan 21, 27, 28</p>	<p>FLORIDA HAM NEWS — SWAP NET By the Broward ARC — Ft Lauderdale, FL — 146.31.91 at 7:30PM</p> <p>WEST COAST BULLETIN Edited & Transmitted by W6ZF 5PM PST 3540 MHz, A-1, 22 WPH</p>	<p>AMSAT Eastcoast Net 3850 kHz 8PM EST (0100Z) Wednesday Morning</p> <p>AMSAT Midcontinent Net 3850 kHz 8PM CST (0200Z Wednesday Morning)</p> <p>AMSAT Westcoast Net 3850 kHz 7PM PST (0300Z) Wednesday Morning</p> <p>WIAM Qualifying Run</p>	<p>18</p>	<p>19</p>	<p>20</p>	<p>21</p>
<p>15</p> <p>Fort Wayne Winter Hamfest — By the Allen County AR Technical Society — Shiob Hall — North of Fort Wayne, IN — W4SCED</p>	<p>FLORIDA HAM NEWS — SWAP NET By the Broward ARC — Ft Lauderdale, FL — 146.31.91 at 7:30PM</p>	<p>AMSAT Eastcoast Net 3850 kHz 8PM EST (0100Z) Wednesday Morning</p> <p>AMSAT Midcontinent Net 3850 kHz 8PM CST (0200Z Wednesday Morning)</p> <p>AMSAT Westcoast Net 3850 kHz 7PM PST (0300Z) Wednesday Morning</p>	<p>25</p>	<p>26</p>	<p>27</p>	<p>28</p>
<p>22</p> <p>Classic Radio Exchange — By the Southeast ARC of Cleveland, OH — 2000Z 1179 - 0300Z 1/20:</p>	<p>FLORIDA HAM NEWS — SWAP NET By the Broward ARC — Ft Lauderdale, FL — 146.31.91 at 7:30PM</p>	<p>AMSAT Eastcoast Net 3850 kHz 8PM EST (0100Z) Wednesday Morning</p> <p>AMSAT Midcontinent Net 3850 kHz 8PM CST (0200Z Wednesday Morning)</p> <p>AMSAT Westcoast Net 3850 kHz 7PM PST (0300Z) Wednesday Morning</p>	<p>*An international events such as contests are shown on the GMT days on which they take place with the jth they may actually begin on the following day in the preceding GMT Mean America.</p>	<p>**During the week of January 14-22 special Event Station KM1CC will be celebrating the 75th Anniversary of the first two way radio telegraph transmission between the United States and Europe by Guglielmo Marconi in 1900. The station will be operating from the original Marconi station location in South Weymouth, Massachusetts. The sponsor of the station is the Town of Barnstable Radio Club of Cape Cod, Massachusetts. Operation will be on 160 MHz, 2000 kHz, 2000 kHz, 2000 kHz, 2000 kHz, 2000 kHz, 2000 kHz, 2000 kHz, SSB during the 1500-1800 MHz. The FCC has granted special approval for the use of A2, A3, A1, A1, A1, A1, A1, A1, A1, A1, A1, A1, A1, A1, A1, A1, A1, A1, A1, A1, at 14 Pine Street, Southwick, Massachusetts 02563 USA.</p>	<p>WIAM Qualifying Run CONTEST — CW — 21-29</p>	<p>Simulated Emergency Test — 28-29</p>
<p>29</p>	<p>30</p>	<p>31</p>				

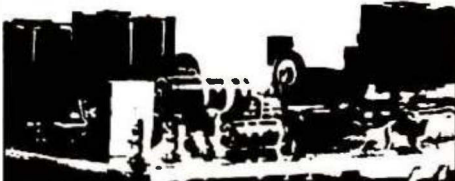

the Audio Amateur

THE AUDIO AMATEUR is a quarterly for the enthusiast who enjoys hands-on work in building or customizing his audio equipment, or technical savvy about his hi fi gear.

TYPICAL ARTICLES: Octave equalizers, Transmission line loudspeakers with 8" to 24" drivers, Electrostatic speakers with a 900 Watt direct drive amplifier, Mixers, preamps, parametric equalizers, stock equipment modifications for Heath and many Dynaco units. Completely tested circuits, construction aids, etched circuit boards, parts sources.

READERS SAY: "A hit here at WLWT Television...provided several useful ideas for our engineers" "...Cannot praise you enough for your understanding of just what it is audio enthusiasts with limited know-how yearn to do." "As an audio technician I have found TAA one of the best sources for technical help in the audio field..." *Craig Stark of Stereo Review says: "Those interests of the 'home constructor' The Audio Amateur serves are...absolutely top quality. The magazine is. I think, the only American publication devoted to the really serious audiophile constructor."*

DEPT. H
P. O. BOX 176,
PETERBOROUGH
N.H. 03458 U.S.A.

Audio Amateur

- Check here for free prospectus.
 I enclose \$9.00 for 4 quarterly issues.
 I enclose \$25.00 for twelve issues.

NAME _____

ADDRESS _____

CITY _____ STATE _____

ZIP CODE _____

Please allow six weeks for delivery. Rates above are for the U.S.A. only. Rates for other areas available on request.

PARTS PANIC!

Having parts problems such as Minimum Orders, Unanswered Letters, Uninterested Suppliers, Too Much Time at Flea Markets?

Let G. R. Whitehouse & Co., the New Parts Specialists solve your problems.

NOW IN STOCK

Transmitting Variables
 Roller Inductors — Counter Dials
 Air Wound Coils — Couplings
 Knobs — Receiving Variables
 Toroids — R.F. Chokes
 Coil Forms and more

From

Millen - E. F. Johnson
 Barker & Williamson
 JW Miller - Hammarlund

Send First Class Stamp for Flyer

G. R. WHITEHOUSE & CO.
 15 Newbury Drive, Amherst, N. H. 03031

MAXI TUNER

SOLVES ANTENNA PROBLEMS!



THE FINEST ANTENNA TUNER AVAILABLE

- Presents 50-75 Ohm Resistive Load to Your Transmitter Using Virtually Any Antenna System
- Improved Ultimate Transmatch Circuit Matches Coax, Random Wire and Balanced Antennas
- Continuous 1.7-30 MHz Coverage
- 229-203 Rotary Inductor (28 μH)
- Rugged Cast Aluminum Turns Counter
- Handles 3 KW PEP
- Mismatch SWR Circuit
- Heavy Duty Balun
- Velvet-Smooth 6 to 1 Vernier Tuning
- 0-100 Logging Scale on Capacitors
- Available in Kit Form or Assembled
- One Year Factory Warranty
- Available without SWR for use with your present SWR meter or wattmeter.
- Custom Vacuum Capacitor Designs and Individual Components Available

Call or Write for Pricing, Spec Sheet, and FREE Amateur Market Antenna Tuner Comparison Chart That Tells It Like It Is! Dealer Inquiries Invited.

RF POWER COMPONENTS
 P. O. Box 11
 Ladysmith, WI 54848
 (715) 532-3971

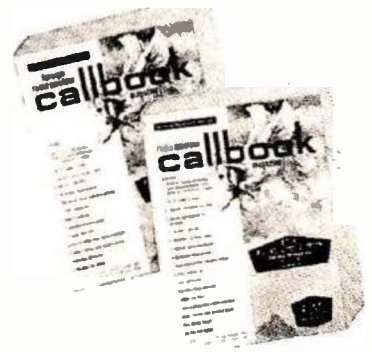

There's nothing like it !

RADIO AMATEUR **callbook**

Respected worldwide as the only complete authority for radio amateur QSL and QTH information.

The U. S. Callbook has over 300,000 W & K listings. It lists calls, license classes, names and addresses plus the many valuable back-up charts and references you come to expect from the Callbook.

Specialize in DX? Then you're looking for the Foreign Callbook with almost 300,000 calls, names and addresses of amateurs outside of the USA.

U.S. Callbook \$14.95

Foreign Callbook \$13.95

Order from your favorite electronics dealer or direct from the publisher. All direct orders add \$1.50 for shipping. Illinois residents add 5% Sales Tax.

RADIO AMATEUR **callbook** INC.
 Dept. E 925 Sherwood Drive
 Lake Bluff, Ill. 60044

AD CHECK

... for literature, in a hurry — we'll rush your name to the companies whose names you check.

Place your check mark in the space between name and number. Example: HRR 150.

Adirondack Radio <input type="checkbox"/> 000	Henry <input type="checkbox"/> 062
Amsat <input type="checkbox"/> 220	Icom <input type="checkbox"/> 065
Antenna Mart <input type="checkbox"/> 009	Jensen <input type="checkbox"/> 293
Atlas <input type="checkbox"/> 198	Kantronics <input type="checkbox"/> 605
Atrionics <input type="checkbox"/> 382	Kenwood <input type="checkbox"/>
Audio Amateur <input type="checkbox"/> 564	Kester <input type="checkbox"/>
CW Elect. <input type="checkbox"/> 533	Logitronics <input type="checkbox"/> 643
Cohoon <input type="checkbox"/> 559	Long's <input type="checkbox"/> 468
Colorado Silver <input type="checkbox"/> 630	MFJ <input type="checkbox"/> 082
Comm. Center <input type="checkbox"/> 534	Madison <input type="checkbox"/>
Comm. Spec. <input type="checkbox"/> 330	Magsat <input type="checkbox"/> 642
Cushcraft <input type="checkbox"/> 035	Matric <input type="checkbox"/> 084
DenTron <input type="checkbox"/> 259	Microwave Filt. <input type="checkbox"/> 637
Digital Elect. <input type="checkbox"/> 631	Oak Hill Acad. A. R. S. <input type="checkbox"/> 213
Drake <input type="checkbox"/> 039	Orlando Hamcation <input type="checkbox"/>
E. T. O. <input type="checkbox"/>	Palomar <input type="checkbox"/> 093
Elect. Dist. <input type="checkbox"/> 044	Partridge <input type="checkbox"/> 439
Erickson <input type="checkbox"/> 047	RF Power Com. <input type="checkbox"/> 542
Gold Line <input type="checkbox"/> 641	RSE Ham Shack <input type="checkbox"/> 607
"Ham" Buerger <input type="checkbox"/>	Callbook <input type="checkbox"/> 100
Ham Center <input type="checkbox"/> 491	Radio Constructor <input type="checkbox"/> 586
H. R. C. B. <input type="checkbox"/> 150	S-F Radio Am. Serv. <input type="checkbox"/> 640
Ham Outlet <input type="checkbox"/> 595	SST <input type="checkbox"/> 375
Hamtronics <input type="checkbox"/> 246	Trop. Hamboree <input type="checkbox"/>
Heath <input type="checkbox"/> 060	Whitehouse <input type="checkbox"/> 378
	Wilson <input type="checkbox"/> 123

*Please contact this advertiser directly. Limit 15 inquiries per request.

JANUARY, 1978

Please use before February 28, 1978

Tear off and mail to
HAM RADIO HORIZONS — "Ad Check"
 Greenville, N. H. 03048

NAME _____

CALL _____

STREET _____

CITY _____

STATE _____ ZIP _____

CALL TOLL FREE 800-228-4097

for prices on Yaesu, Tempo, Swan, Ten-Tec, Icom, MFJ, Nye-Viking, Drake, Hy-Gain, Dentron, Midland, and CDE.

DRAKE

TR4-CW (RIT) 80-10m hf trans. with CW filter	reg. \$699.00	Now \$629.00
34PNB Noise blanker for TR-4C	reg. \$100.00	Now \$90.00
RV-4C Remote VFO/speaker	reg. \$150.00	Now \$134.95
AC-4 AC power supply for TR-4C & T-4XC	reg. \$120.00	Now \$109.00
DC-4 DC power supply	reg. \$135.00	Now \$124.00
L4B Linear amplifier	reg. \$895.00	Now \$789.00
SSR-1 Gen. coverage rcvr, 5.30 MHz	reg. \$350.00	Now \$279.00
R-4C 80-10m receiver	reg. \$599.95	Now \$539.95
4-NB Noise blanker for R-4C	reg. \$70.00	Now \$64.00
T-4XC 80-10m transmitter	reg. \$599.95	Now \$539.95
TV-3300LP Low pass filter	reg. \$26.60	Now \$19.95
MN-2000 Antenna Tuner	reg. \$240.00	Now \$219.95
MN-4 Antenna Tuner	reg. \$120.00	Now \$109.95
1525 Encoder Microphone	reg. \$49.95	Now \$45.95
TR-33C, 2m Portable Xcvr	reg. \$229.95	Now \$209.95

HY-GAIN

TH6DX 6 element super Thunderbird	reg. \$249.95	Now \$209.95
TH3-MK3 3 element tri-band	reg. \$199.95	Now \$169.95
204BA 4 element 20m beam	reg. \$189.95	Now \$159.95
Hy-Quad, 2 el. Quad, 10-20 meters	reg. \$219.95	Now \$189.95
TH3JR 3 element tri-band	reg. \$144.50	Now \$129.95
TH2MK3, 2 element tri-band	reg. \$139.95	Now \$124.95
402BA 2 element, 40m	reg. \$199.95	Now \$169.95
203BA 3 element 20m	reg. \$129.95	Now \$109.95
153BA 3 element 15m	reg. \$79.95	Now \$69.95
103BA 3 element 10m	reg. \$54.95	Now \$49.95
DB10-15A 3 element 10, 15m	reg. \$149.95	Now \$134.95
18HT Hy-Tower, reg. \$279.95	Now \$239.95	
2BDQ Trap Doublet 40, 80m	reg. \$49.95	Now \$44.95
5BDQ Trap Doublet 10 thru 80m	reg. \$79.95	Now \$69.95
12AVQ 10-20m vertical	reg. \$37.95	Now \$33.95
14AVQ/WB 10-40m vertical	reg. \$67.00	Now \$57.00
18AVT/WB 10-80m vertical	reg. \$97.00	Now \$84.95
LA-1 Lightning Arrestor	reg. \$44.95	Now \$39.95
BN-86 Ferrite Balun	reg. \$15.95	Now \$14.95
203 3 el 2m beam	\$12.95	
205 5 el 2m beam	\$16.95	
208 8 el 2m beam	\$19.95	
214 14 el 2m beam	\$26.95	
273 4 el J-Pole	\$49.95	
3806 2m Handheld	reg. \$189.00	Now \$169.00
3750 Transceiver	reg. \$1895.00	Now \$1695.00

CALL FOR DAILY SPECIALS
OPEN 7 DAYS A WEEK

Talk to Bob, WB0RQZ, Joe, WA0WRI, Don, WB0YEZ, Roy, WB0WWA, Bill, WB0YHJ, or Ken WD0EMR.

800-228-4097

Nebr. residents call
402-466-3733 collect

Communications Center

2226 North 48th Street
Lincoln, NE 68504

AD INDEX

Adirondack Radio Supply	53
Amsat	56
Antenna Mart	57
Atlas Radio Company	Cover IV
Atrionics	53
Audio Amateur	77
CW Electronic Sales Co.	65
Cohoon Amateur Supply	34
Colorado Silver Co.	57
Communications Center	78
Communications Specialists	47
Cushcraft	4, 80
DenTron Radio Company	40, 41
Digital Electronics, Inc.	35
Drake Co., R.L.	Cover II
Ehrhorn Technological Operations	71
Electronic Distributors Inc.	69
Erickson Communications	57
"Ham" Buerger	55
Ham Radio Center	53, 79
Ham Radio's Communications Bookstore	55, 61
Ham Radio Outlet	9
Heath Company	17
Henry Radio Stores	31
Icom	7
Jensen Tools & Alloys	69
Kantronics	49
Trio-Kenwood Corporation	Cover III
Kester Solder	34
Logitronics	72
Long's Electronics	1
MFJ Enterprises	3, 65
Madison Electronic Supply	61
Matric	79
Microwave Filter, Inc.	69
Oak Hill Academy Amateur Radio Session	55
Orlando Hamcation	48
Palomar Engineers	46, 63, 74
Partridge Electronics Ltd.	69
RF Power Components	77
RSE Ham Shack	57
Radio Amateur Callbook	77
Radio & Electronics Constructor	61
S-F Radio Amateur Services	61
SST Electronics	27
Tropical Hamboree	30
G. R. Whitehouse & Co.	77
Wilson Electronics	10

Foreign Subscription Agents for Ham Radio HORIZONS

Ham Radio Austria Karin Ueber Postfach 2454 D-7850 Loerrach West Germany	Ham Radio Holland MRL Electronics Postbus 88 NL 2204 Delft Holland
Ham Radio Belgium Stereohouse Brusselaesteeweg 418 B-9218 Gent Belgium	Ham Radio Italy STE. Via Mantago 15 I-20134 Milano Italy
Ham Radio Canada Box 114, Goderich Ontario, Canada N7A 3Y5	Ham Radio Switzerland Karin Ueber Postfach 2454 D-7850 Loerrach West Germany
Ham Radio Europe Box 444 S-194 04 Upplands Vasby Sweden	Ham Radio UK P.O. Box 63, Harrow Middlesex HA3 6HS, England
Ham Radio France Christiane Michel F-89117 Parly France	Ham Radio Germany Karin Ueber Postfach 2454 D-7850 Loerrach West Germany
	Holland Radio 143 Greenway Greenside, Johannesburg Republic of South Africa

Joy to the World...

And the angel said unto her, Fear not, Mary: for thou hast found favor with God. And, behold, thou shalt conceive in thy womb, and bring forth a son, and shalt call His name Jesus. Luke 1: 30,31 KJV

Then said Mary unto the angel, How shall this be, seeing I know not a man? And the angel answered and said unto her, The Holy Ghost shall come upon thee, and the power of the Highest shall overshadow thee; therefore also that holy thing which shall be born of thee shall be called the Son of God. Luke 1: 34,35 KJV

And she brought forth her firstborn son, and wrapped him in swaddling clothes, and laid him in a manger; because there was no room for them in the inn. Luke 2:7 KJV

For God so loved the world, that he gave his only begotten Son, that whosoever believeth in him should not perish, but have everlasting life. John 3:16 KJV

Nearly 2000 years ago, God reached out and touched the world with his love. He is still reaching out today seeking the lost.

Let his love reach into your heart this Christmas season. Become a member of God's family by turning from your way, and trusting in God's way today.

May you and your family reach out and accept the joy he has for you this Christmas.

Joy to the World...

Lee, Andy, Denny, Don, Bill, Denny, Linda, Lydia, Billie, Kim, Lee, Rick, Jane, Deb, Barb, Les, Merrill, and Paul.



RD 1 • BOX 185A • FRANKLIN, PA 16323

1-800-432-1234 ? 1-800-233-0250 ? 1-800-527-4634 ? 1-800-645-9187 ? 1-800-432-1234 ? 1-800-233-0250 ? 1-800-432-1234 ? 1-800-233-0250 ? 1-800-527-4634 ? 1-800-645-9187 ? 1-800-228-4097 ? 1-800-647-8660 ? 1-800-645-9187 ? 1-800-527-4634 ? 1-800-228-4097 ?

Don't play the numbers!

Just call us ... Toll Free!

1-800-325-3636

<p>FOR NEW OR USED AMATEUR RADIO GEAR ... we're specialists and carry <i>in stock</i> most of the famous-brand lines. Or, we will talk trade.</p>	<p>FOR FAST, DOOR-STEP DELIVERY ... give us a call. You'll be amazed; for we guarantee we'll ship your equipment the same day. Plus, most shipments are PRE-PAID.</p>	<p>TO SAVE MONEY ... join thousands of our satisfied customers who buy from us as easily as from their local supplier. So, remember your call is <i>Toll Free</i>.</p>
--	---	---

We welcome your Master Charge or VISA/BankAmericard.

HAM RADIO CENTER, INC.

8340-42 Olive Blvd. P.O. Box 28271 St. Louis, MO 63132



VHF DX

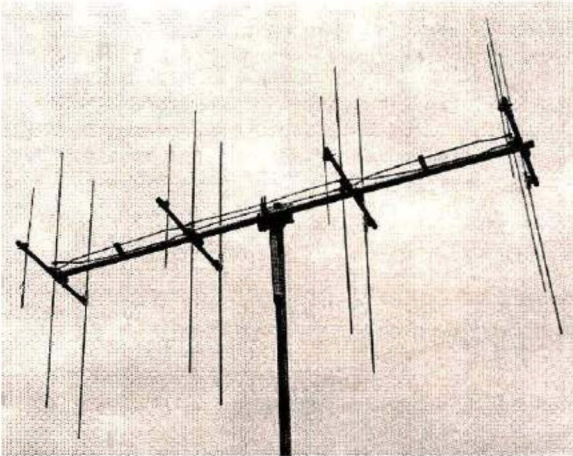

FM —

Enjoy the thrill of dependable long distance contacts on simplex or thru remote repeaters. The 20 element co-linear DX-Array offers a precise pattern with large capture area. This vertically polarized, horizontally stacked array provides a narrow beamwidth for the discriminating FM user. Wide impedance and gain bandwidths make the DX-Array a natural choice for the serious FM'er. A vertical polarization bracket, model DX-VPB, is required (support boom and mast not supplied). Seek out new horizons with DX-Array!

SSB/CW —

Discover reliability in long-haul communications with VHF SSB and CW. The Cush Craft DX-Array also gives low angle, high gain performance for many exotic propagation modes — tropo, aurora, sporadic-E, and meteor scatter. Horizontally polarized DX-Arrays may be used singly or combined in pairs (twice Effective Radiated Power) or quads (4 x ERP). Each DXK stacking kit is complete with stacking frame and phasing harness (vertical mast not supplied). This year has seen some spectacular VHF band openings — Don't miss the next one!

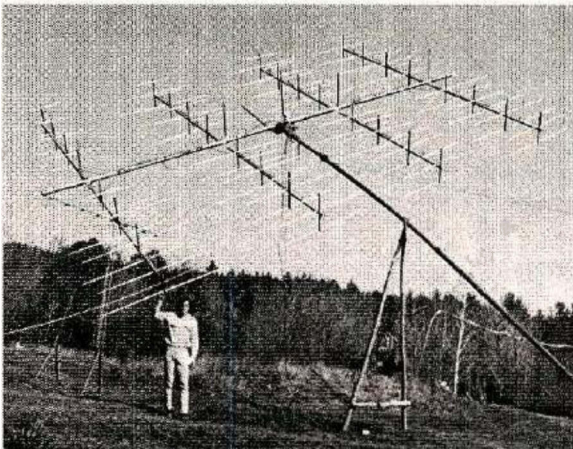
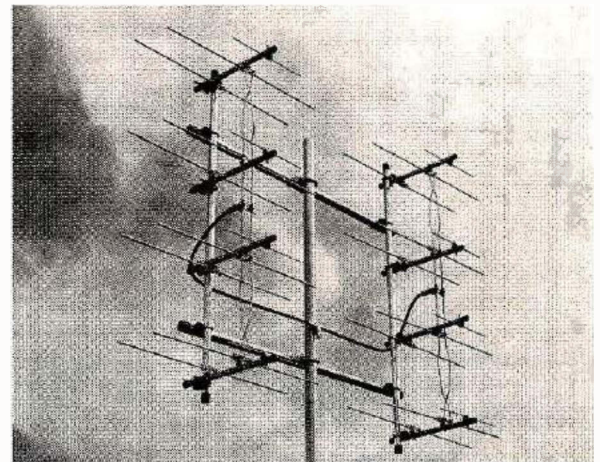

Dave Olean, K1WHS, with his 160 Element DX-Array and Polar Mount EME System

EME —

Many VHF experimenters have found excitement in conquering the formidable Earth-Moon-Earth (EME) path. 2-meter moonbouncers have achieved outstanding success using eight stacked DX-Arrays. Impedance and gain characteristics of this antenna permit stacking without the critical detuning problems inherent in large arrays of Yagis. Enlarging system size will yield a more uniform gain increase with DX-Arrays than with many other large antennas. The physical configuration alleviates mounting and phasing/tuning problems. EME enthusiasts are setting new records — So can you!

DX-ARRAY LEADS THE WAY!

Description:	144 MHz.		220 MHz.		432 MHz.	
	Model:	Price:	Model:	Price:	Model:	Price:
20 Element DX-Array	DX-120	\$42.95	DX-220	\$37.95	DX-420	\$32.95
Frame & Harness (40 E.)	DXK-140	\$59.95	DXK-240	\$54.95	DXK-440	\$39.95
Frame & Harness (80 E.)	DXK-180	\$109.95	DXK-280	\$89.95	DXK-480	\$79.95
1-1 52-ohm Balun	DX-1BN	\$12.95	DX-2BN	\$12.95	DX-4BN	\$12.95
Vert. Pol. Bracket (20 E.)	DX-VPB	\$9.95	DX-VPB	\$9.95	DX-VPB	\$9.95

IN STOCK WITH DISTRIBUTORS WORLDWIDE

cushcraft
THE ANTENNA COMPANY
P.O. BOX 4680, MANCHESTER, N.H. 03108



KENWOOD AND ALL OF OUR AUTHORIZED DEALERS WHO SELL KENWOOD PRODUCTS WOULD LIKE TO TAKE THIS OPPORTUNITY TO WISH OUR FELLOW HAMS THE MERRIEST CHRISTMAS AND A NEW YEAR OF FANTASTIC QSO'S. AND FOR THOSE CONTEMPLATING THE PURCHASE OF AMATEUR RADIO GEAR OR ACCESSORIES, WE CORDIALLY INVITE YOU TO VISIT OR CONTACT ANY OF THE FINE DEALERS LISTED BELOW.

REMEMBER, WHEN YOU BUY YOUR KENWOOD PRODUCT FROM AN AUTHORIZED KENWOOD DEALER YOU'RE BUYING CONFIDENCE ALONG WITH YOUR HAM GEAR.

FOLLOWING IS A LIST OF AUTHORIZED DEALERS.

As of Dec. 1, 1977

ALABAMA

Long's Electronics
3521 10th Ave. North
Birmingham, AL 35234

ARIZONA

Power Communications*
6012 North 27th Ave.
Phoenix, AZ 85017

CALIFORNIA

Gary Radio
8199 Clairemont Mesa Blvd
San Diego, CA 92112

Ham Radio Outlet
999 Howard Ave.
Burlingame, CA 94010

Ham Radio Outlet
13754 Victory Blvd.
Van Nuys, CA 91401

Henry Radio, Inc.
11240 West Olympic Blvd.
Los Angeles, CA 90064

Henry Radio, Inc.
931 North Euclid
Anaheim, CA 92801

Webster Radio
2802 East Ashlan
Fresno, CA 93726

COLORADO

CW Electronics
1401 Blake St.
Denver, CO 80202

CONNECTICUT

Audiotronics*
18 Isaac Street
Norwalk, CT 06850

FLORIDA

Amateur Electronic Supply
621 Commonwealth
Orlando, FL 32803

Amateur Radio Center

2805 N.E. Second Ave.
Miami, FL 33137

Grice Electronics
320 East Gregory St.
Pensacola, FL 32501

HAWAII

Lafayette Radio Company
1111 Mc Cully St.
Honolulu, HI 96814

ILLINOIS

Erickson Communications
5935 North Milwaukee Ave.
Chicago, IL 60646

Klaus Radio, Inc.
8400 North Pioneer Parkway
Peoria, IL 61614

INDIANA

Graham Electronics
133 South Pennsylvania
Indianapolis, IN 46240

Hoosier Electronics
438 Meadows Shopping Center
Terre Haute, IN 47802

IOWA

HI, Inc.
1601 Avenue "D"
Council Bluffs, IA 51501

KANSAS

Associated Radio Comm.
8012 Conser
Overland Park, KS 66204

LOUISIANA

Digital Electronics, Inc.*
1201 Annunciation Street
New Orleans, LA 70190

MAINE

Craig Radio Company
Route 1 By-Pass South
Kittery, ME 03904

MARYLAND

Electronic International Service
11305 Elkin St.
Wheaton, MD 20902

Professional Electronics
1710 Joan St.
Baltimore, MO 21204

MASSACHUSETTS

Tufts Electronics*
209 Mystic Avenue
Medford, MA 02155

MICHIGAN

Electronic Distributors
1960 Peck St.
Muskegon MI 49441

Radio Supply & Engineering
1207 W. 14 Mile Rd.
Clawson, MI 48017

MINNESOTA

Electronic Center
127 Third Ave. North
Minneapolis, MN 55401

MISSOURI

Ham Radio Center
8342 Olive Blvd.
St. Louis, MO 63132

Henry Radio Company
211 North Main St.
Butler, MO 64730

Midcom Electronics, Inc.
2506 South Brentwood Blvd.
St. Louis, MO 63144

MONTANA

Conley Radio Supply
318 North 16th St.
Billings, MT 59101

NEBRASKA

Communications Center*
2226 North 48th Street
Lincoln, NB 68504

NEW MEXICO

Electronic Module
601 North Turner
Hobbs, NM 88240

NEW YORK

Adirondack Radio Supply
186 West Main St.
Amsterdam, NY 12012

Harrison Radio Corporation
20 Smith St.
Farmingdale, L.I., NY 11735

NORTH CAROLINA

Freck Radio Supply
252 Patton Ave.
Asheville, NC 28801

Vickers Electronics
500 East Main St.
Durham, NC 27702

OHIO

Amateur Electronic Supply
17929 Euclid Ave.
Cleveland, OH 44112

Srepco Electronics
314 Leo St.
Dayton, OH 45404

OKLAHOMA

Derrick Electronics
714 West Kenosha
Broken Arrow, OK 74012

Radio Inc.
1000 South Main
Tulsa, OK 74119

OREGON

Portland Radio Supply
1234 S.W. Stark St.
Portland, OR 97205

PENNSYLVANIA

Electronic Exchange
136 Main St.
Souderton, PA 18964

Hamtronics
4033 Brownsville Rd.
Trevose, PA 19047

JRS Distributors
646 West Market St.
York, PA 17404

SOUTH CAROLINA

Accutek, Inc.
420 Laurens Rd.
Greenville, SC 29607

SOUTH DAKOTA

Burghardt Amateur Center
124 First Ave. N.W.
Watertown, SD 57201

TENNESSEE

Sere-Rose & Spencer Elec.
1465 Wells Station Rd.
Memphis, TN 38108

TEXAS

AGL Electronics
3068 Forest Lane #309
Dallas, TX 75234

Oouglas Electronics
1118 South Staples
Corpus Christi, TX 78404

Electronics Center
2929 North Haskell
Dallas, TX 75204

Madison Electronics
1508 McKinney Ave.
Houston, TX 77002

UTAH

Manwill Supply Company
2780 South Main St.
Salt Lake City, UT 84115

WASHINGTON

ABC Communications
17541 15th Ave. N.E.
Seattle, WA 98155

Amateur Radio Supply Company
6213 - 13th Ave. South
Seattle, WA 98108

WISCONSIN

Amateur Electronic Supply
4828 West Fond Du Lac Ave.
Milwaukee, WI 53216

*Pending



