

OCTOBER 1989 / \$2.95

# NEW **HAM RADIO**



*An Exclusive First Look at Kenwood's TS-950S*

*Computerizing Smith Chart Network Analysis*

*Variable Gain 160-Meter Preamp*

# NEW TECHNOLOGY AND SOPHISTICATION IN ONE SMALL PACKAGE

ICOM

IC-726 HF Transceiver

ALL HF PLUS  
SIX METERS!

ICOM does it again by combining top performance on all HF bands with deluxe six-meter operation in an ultra-compact and easy-to-operate transceiver! Six-meter DXing is terrific and the IC-726 is your key to great all mode action fixed, mobile or portable.

### UNCOMPROMISING FEATURES

- All mode operation from 160 through six-meters • Shortwave reception from 500KHz to 33MHz plus 46.2 to 61.1MHz • 100 watts SSB and CW • 10Hz digital frequency display • 26 memories tune full range and reprogram independent of VFO use • Three scan modes • Noise blanker

**ADVANCED CIRCUIT DESIGNS** Feature: • Direct digital synthesizer (DDS) • Dual VFOs • Band stacking registers • Sensitive 105db dynamic range receiver • Panel-selectable RF preamp and attenuator • Built-in controller for optional AH-3 remote antenna tuner for HF operation.

The outstanding IC-726 puts all the exciting DX action of sunspot cycle 22 right at your fingertips, and it is confidently backed with ICOM's no-compromise one year warranty. See this amazing unit at your local ICOM dealer.



ICOM  
First in Communications

ICOM America, Inc. 2300-116th Ave. N.E., Bellevue, WA 98004 Customer Service Hotline (206) 454-7519  
3150 Premier Drive, Suite 126, Irving, TX 75063 / 1777 Phoenix Parkway, Suite 201, Atlanta, GA 30349  
ICOM CANADA, A Division of ICOM America, Inc., 3071 - 85 Road, Unit 9, Richmond, B.C. V6X 2T4 Canada

All stated specifications are subject to change without notice or obligation. All ICOM radios significantly exceed FCC regulations limiting spurious emissions. 726893

# AT-300<sup>tm</sup> Antenna Tuner

An affordable antenna tuner from a name you can trust  
The AT-300<sup>tm</sup> from AEA



## Low Pass Design

The low-pass design of the AT-300 is what you would expect from a company where Engineering Makes the Difference. The low-pass design of this AEA tuner means harmonic attenuation for lower TVI potential. This design also allows matching a much wider range of antenna impedances than the common high-pass designs.

## Larger Size

One look at the AT-300 lets you know this tuner is different, it's bigger. While some manufacturers promote the small size of their tuners, AEA knows that performance is most important. The simple reason for the larger size is that smaller sizes degrade the inductors' Q (Quality factor), which results in less efficiency. Less efficiency means that for a given power output from your transmitter, less power will actually get to your antenna.

## Easy Operation

The AT-300 tuner features a precision frequency compensated dual-movement SWR meter for ease of tuning. The high and low power front panel switch selects the proper range for the SWR meter. The AT-300 is rated for 300 watt operation. The internal balun and front panel selector switch allows for balanced and unbalanced outputs.

Get maximum performance from your transceiver and antenna by using the AT-300 antenna tuner from AEA. See your local AEA dealer today or contact:

## Advanced Electronic Applications, Inc.

P.O. Box C-2160  
Lynnwood, WA 98036  
206-775-7373

**AEA Retail \$249.95**  
**Amateur Net \$219.95**

# KENWOOD

...pacesetter in Amateur Radio

**DX-celence!**

## #1 Rated HF!



### TS-940S Competition class HF transceiver

TS-940S—the standard of performance by which all other transceivers are judged. Pushing the state-of-the-art in HF transceiver design and construction, no one has been able to match the TS-940S in performance, value and reliability. The product reviews glow with superlatives, and the field-proven performance shows that the TS-940S is "The Number One Rated HF Transceiver!"

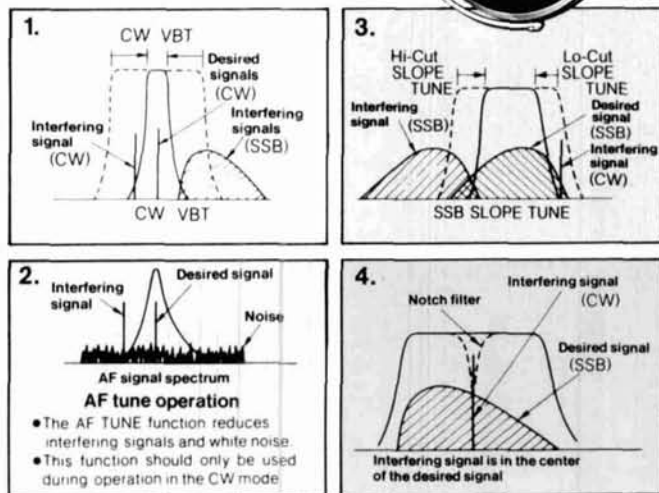
- 100% duty cycle transmitter. Kenwood specifies transmit duty cycle **time**. The TS-940S is guaranteed to operate at full power output for periods **exceeding one hour**. (14.250 MHz, CW, 110 watts.) Perfect for RTTY, SSTV, and other long-duration modes.
- First with a full one-year limited warranty.
- Extremely stable phase locked loop (PLL) VFO. Reference frequency accuracy is measured in **parts per million!**

#### Optional accessories:

- AT-940 full range (160-10m) automatic antenna tuner
- SP-940 external speaker with audio filtering
- YG-455C-1 (500 Hz), YG-455CN-1 (250 Hz), YK-88C-1 (500 Hz) CW filters
- YK-88A-1 (6 kHz) AM filter
- VS-1 voice synthesizer
- SO-1 temperature compensated

- crystal oscillator
- MC-43S UP/DOWN hand mic.
- MC-60A, MC-80, MC-85 deluxe base station mics.
- PC-1A phone patch
- TL-922A linear amplifier
- SM-220 station monitor
- BS-8 pan display
- IF-232C/IF-10B computer interface.

Complete service manuals are available for all Kenwood transceivers and most accessories. Specifications, features, and prices are subject to change without notice or obligation.



**1) CW Variable Bandwidth Tuning.** Vary the passband width continuously in the CW, FSK, and AM modes, without affecting the center frequency. This effectively minimizes DRM from nearby SSB and CW signals.

**2) AF Tune.** Enabled with the push of a button, this CW interference fighter inserts a tunable, three-pole active filter between the SSB/CW demodulator and the audio amplifier. During CW OSOs, this control can be used to reduce interfering signals and noise, and peaks audio frequency response for optimum CW performance.

**3) SSB Slope Tuning.** Operating in the LSB and USB modes, this front panel control allows independent, continuously variable adjustment of the high or low frequency slopes of the IF passband. The LCD sub display illustrates the filtering position.

**4) IF Notch Filter.** The tunable notch filter sharply attenuates interfering signals by as much as 40 dB. As shown here, the interfering signal is reduced, while the desired signal remains unaffected. The notch filter works in all modes except FM.

- Complete all band, all mode transceiver with general coverage receiver. Receiver covers 150 kHz-30 MHz. All modes built-in: AM, FM, CW, FSK, LSB, USB.
- Superb, human engineered front panel layout for the DX-minded or contesting ham. Large fluorescent tube main display with dimmer; direct keyboard input of frequency; flywheel type main tuning knob with optical encoder mechanism all combine to make the TS-940S a joy to operate.
- One-touch frequency check (T-F SET) during split operations.
- Unique LCD sub display indicates VFO, graphic indication of VBT and SSB Slope tuning, and time.
- Simple one step mode changing with CW announcement.
- Other vital operating functions. Selectable semi or full break-in CW (OSK), RIT/XIT, all mode squelch, RF attenuator, filter select switch, selectable AGC, CW variable pitch control, speech processor, and RF power output control, programmable band scan or 40 channel memory scan.

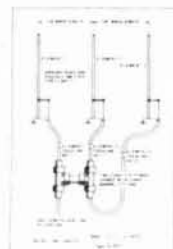
## KENWOOD

KENWOOD U.S.A. CORPORATION  
2201 E. Dominguez St., Long Beach, CA 90810  
P.O. Box 22745, Long Beach, CA 90801-5745

# HAM RADIO



WB5IRI, page 22



NU1N, page 30

OCTOBER 1989  
Volume 22, Number 10

Publisher & Editor-in-Chief:  
T.H. TENNEY, JR., W1NLB

## EDITORIAL STAFF

**Editor:**  
TERRY NORTHUP, KA1STC

**Technical Editor:**  
Marty Durham, NB1H

**Consulting Editor:**  
Robert D. Wilson, WA1TKH

**Associate Editors:**  
Tom McMullen, W1SL  
Joseph J. Schroeder, W9JUV  
Alfred Wilson, W6NIF

**Production Editor:** Susan Shorrock  
**Copy Editor:** Peggy Tenney, KA1QDG  
**Editorial Assistant:** Beth McCormack

## Editorial Review Board:

Peter Bertini, K1ZJH  
Forrest Gehrke, K2BT  
Michael Gruchalla, P.E.  
Bob Lewis, W2EBS  
Mason Logan, K4MT  
Vern Riportella, WA2LOQ  
Ed Wetherhold, W3NQX

## PUBLISHING STAFF

**Assistant Publisher:**  
J. CRAIG CLARK, JR., NX1G

**Director of Advertising Sales:**  
Henry S. Gallup, N1GCF

**Advertising Production Manager:**  
Dorothy Sargent, KA1ZK

**Circulation Manager:** Susan Shorrock

**Circulation:** Therese Bourgault

**Traffic Manager:** Phil Alix, N1FPX

**Book Store:** Priscilla Gauvin

**Cover photo:** *Ham Radio* takes an exclusive first look at Kenwood's TS-950S transceiver. See page 28 for features and preliminary specifications. Photo courtesy of Kenwood USA Corporation.

## FEATURES

- |   |           |
|---|-----------|
| <b>COMPUTERIZING SMITH CHART NETWORK ANALYSIS</b>                       | <b>10</b> |
| <i>Richard A. Gardner, N1AYW</i>  |           |
| <b>The Weekender: THREE ELEMENT VERTICAL DRIVEN ARRAY FOR 10 METERS</b> | <b>22</b> |
| <i>Douglas Rowlett, Ph.D., WB5IRI</i>                                   |           |
| <b>AN EXCLUSIVE LOOK AT KENWOOD'S TS-950S</b>                           | <b>28</b> |
| <i>J. Craig Clark, Jr., NX1G</i>  |           |
| <b>ARTIFICIAL INTELLIGENCE APPLICATIONS IN AMATEUR RADIO</b>            | <b>30</b> |
| <i>Bryan Bergeron, NU1N</i>   |           |
| <b>Ham Radio Techniques: INTERESTING ANTENNA FEED SYSTEMS</b>           | <b>39</b> |
| <i>Bill Orr, W6SAI</i>  |           |
| <b>VARIABLE GAIN 160-METER PREAMP</b>                                   | <b>46</b> |
| <i>Gary R. Nichols, KD9SV</i>   |           |
| <b>THE BATTLE OF THE BEAMS — PART 3</b>                                 | <b>53</b> |
| <i>D.V. Pritchard, G4GVO</i>  |           |
| <b>THE PV-4 ON YOUR COMMODORE</b>                                       | <b>64</b> |
| <i>Alan Hoffmaster, WA3EKL</i>  |           |
| <b>DIGI-KEYER</b>   | <b>68</b> |
| <i>Ronald D. King, AB4DP</i>  |           |
| <b>The Weekender: EXTEND YOUR DVM'S MEASUREMENT CAPABILITIES</b>        | <b>72</b> |
| <i>Ralph H. Fowler, N6YC</i>  |           |
| <b>PEP WATTMETER</b>  | <b>76</b> |
| <i>Thomas V. Cefalo, Jr., WA1SPI</i>                                    |           |
| <b>Practically Speaking: VERTICALLY POLARIZED HF ANTENNAS — PART 3</b>  | <b>81</b> |
| <i>Joseph J. Carr, K4IPV</i>  |           |
| <b>Elmer's Notebook: TEST EQUIPMENT — EASY AND USEFUL</b>               | <b>86</b> |
| <i>Tom McMullen, W1SL</i>   |           |

## DEPARTMENTS

<b>HENRY GALLUP, N1GCF</b>	<b>4</b>	<b>HAM MART</b>	<b>92</b>
<b>BACKSCATTER</b>	<b>6</b>	<b>FLEA MARKET</b>	<b>94</b>
<b>COMMENTS</b>	<b>9</b>	<b>DX FORECASTER</b>	<b>96</b>
<b>NEW PRODUCTS</b>	<b>52,84,90</b>	<b>ADVERTISER'S INDEX</b>	<b>98</b>
<b>HAM NOTEBOOK</b>	<b>62</b>	<b>READER SERVICE</b>	<b>98</b>
<b>PUBLISHER'S LOG</b>	<b>71</b>		

**HAM RADIO** Magazine (ISSN 0148-5989) is published monthly by Communications Technology, Inc. Greenville, New Hampshire 03048-0498 Telephone: 603-878-1441 **Subscription Rates:** United States: one year, \$22.95; two years, \$38.95; three years, \$49.95; Canada and Mexico: one year, \$31.00; two years, \$55.00; three years, \$74.00. *All other countries:* one year, \$35.00 via surface mail only. All subscription orders payable in U.S. funds, via international postal money order or check drawn on U.S. bank. **International Subscription Agents:** page 74.

Microfilm copies are available from Buckmaster Publishing Mineral, Virginia 23117. Cassette tapes of selected articles from **HAM RADIO** are available to the blind and physically handicapped from Recorded Periodicals, 919 Walnut Street, Philadelphia, Pennsylvania 19107.

Copyright 1989 by Communications Technology, Inc. Title registered at U.S. Patent Office.

Second-class postage paid at Greenville, New Hampshire 03048-0498 and at additional mailing offices. *Send change of address to HAM RADIO, Greenville, New Hampshire 03048-0498.*



Photo courtesy of the Keene Sentinel.

**Henry Gallup**  
1940 – 1989

## **Farewell to a Friend**

One of the hardest things one has to do as a writer is to compose the obituary of a friend. I remember my first year in journalism school. The "obit" was simply another piece of specialty writing you had to learn. There was a formula to it. A way to handle the family. A way to get facts from funeral directors — something beyond the standard phrase "he died after a long/short illness." As I sit here tonight, I find the formulas mean nothing to me any longer. My friend has died and the what, when, where, why, and how doesn't matter — just the who.

Late in the afternoon on August 22nd, I received word that Henry Gallup, N1GCF, *Ham Radio's* Director of Advertising Sales, had died suddenly, and most unexpectedly. He was only 48. He leaves behind his family — all of whom he loved very much. He was a responsible man who took his work seriously.

Henry's death was a great shock to all of us here at *Ham Radio*. He was a part of our lives for a short year and a half, but he gave us a great deal. Henry always had a ready smile, or a joke. I found he was always there when I needed to talk. He was a man of great caring and compassion. I truly believe that he accepted each person just the way he was, unconditionally, without judgment. If I was having a problem, I could always count on Henry to give me some perspective.

Many of you only knew Henry as a voice on the phone, looking for this month's ad or trying to sell you a little more space. Others met him at Amateur Radio shows. You may not have gotten to know the Henry I knew, but I'm sure you warmed to his wit and his charm.

How do you say goodbye to a friend? You reminisce, remember the last time you saw him, the funny things he used to say, the things he did that drove you crazy. You replay them over and over in your mind until they're worn and threadbare. And then, you finally say goodbye.

Goodbye Henry. I'll miss you. All of us will.

**Terry Northup, KA1STC**

# KENWOOD

...pacesetter in Amateur Radio

# NEW!

## Affordable DX-ing!

### TS-140S

HF transceiver with general coverage receiver.

Compact, easy-to-use, full of operating enhancements, and feature packed. These words describe the new TS-140S HF transceiver. Setting the pace once again, Kenwood introduces new innovations in the world of "look-alike" transceivers!

- **Covers all HF Amateur bands with 100 W output.** General coverage receiver tunes from 50 kHz to 35 MHz. (Receiver specifications guaranteed from 500 kHz to 30 MHz.) Modifiable for HF MARS operation. (Permit required)
- **All modes built-in.** LSB, USB, CW, FM and AM.
- **Superior receiver dynamic range** Kenwood DynaMix™ high sensitivity direct mixing system ensures true 102 dB receiver dynamic range.



- **New Feature! Programmable band marker.** Useful for staying within the limits of your ham license. For contesters, program in the suggested frequencies to prevent QRM to non-participants.
- **Famous Kenwood interference reducing circuits.** IF shift, dual noise blankers, RIT, RF attenuator, selectable AGC, and FM squelch.

- **M. CH/VFO CH sub-dial.** 10 kHz step tuning for quick QSY at VFO mode, and UP/DOWN memory channel for easy operation.
- **Selectable full (QSK) or semi break-in CW.**
- **31 memory channels.** Store frequency, mode and CW wide/narrow selection. Split frequencies may be stored in 10 channels for repeater operation.
- **RF power output control.**
- **AMTOR/PACKET compatible!**
- **Built-in VOX circuit.**
- **MC-43S UP/DOWN mic. included.**

#### Optional Accessories:

- **AT-130** compact antenna tuner • **AT-250** automatic antenna tuner • **HS-5/HS-6/HS-7** headphones • **IF-232C/IF-10C** computer interface
- **MA-5/VP-1** HF mobile antenna (5 bands)
- **MB-430** mobile bracket • **MC-43S** extra UP/DOWN hand mic • **MC-55** (8-pin) goose neck mobile mic • **MC-60A/MC-80/MC-85** desk mics.
- **PG-2S** extra DC cable • **PS-430** power supply
- **SP-41/SP-50B** mobile speakers • **SP-430** external speaker • **TL-922A** 2 kW PEP linear amplifier (not for CW QSK) • **TU-8** CTCSS tone unit
- **YG-455C-1** 500 Hz deluxe CW filter, **YK-455C-1** New 500 Hz CW filter.



### TS-680S

All-mode multi-bander

- 6m (50-54 MHz) 10 W output plus all HF Amateur bands (100 W output).
- Extended 6m receiver frequency range 45 MHz to 60 MHz. Specs. guaranteed from 50 to 54 MHz.
- Same functions of the TS-140S except optional VOX (VOX-4 required for VOX operation).
- Preamplifier for 6 and 10 meter band.

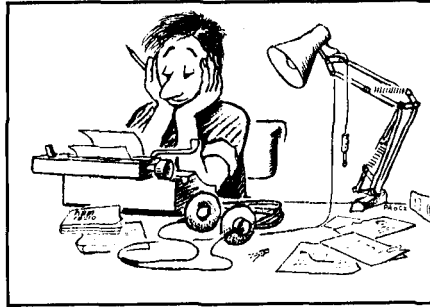


Complete service manuals are available for all Kenwood transceivers and most accessories. Specifications, features, and prices are subject to change without notice or obligation.

# KENWOOD

KENWOOD U.S.A. CORPORATION  
2201 E. Dominguez St., Long Beach, CA 90810  
P.O. Box 22745, Long Beach, CA 90801-5745

# Backscatter



## Amateur Radio Licensing Fees — the “Non-Tax” Tax

*On July 13th the House Energy and Commerce Committee voted to levy fees on Amateur Radio licenses and several commercial ventures. They did this to reduce the Federal budget deficit by means of a “tax that isn’t called a tax.” That, frankly, is a bunch of baloney. The deficit is in the billions; this proposal will raise an estimated 50 million dollars at most. I originally wrote this editorial several months ago and find it rather remarkable that the House “picked up” on my thoughts. But don’t blame me for their action. My idea has merit and, if not limited by statute, would be worth further consideration.*

**W**e live in an era of government deregulation. Over the last ten years, the government’s grip on regulation has slowly loosened in almost all areas of our lives, from airline travel to telecommunications services. AT&T no longer has a monopoly on long distance telephone service. New technology, spurred by deregulation, is coming online daily.

In the Amateur service, we no longer need to keep daily logs. Nor do we have to send a letter to the FCC Engineer-in-Charge when we operate portable. The FCC is no longer directly involved in the testing of new Amateurs. Who would have thought any of this possible twenty years ago?

However, deregulation does have a downside. Great concern has been voiced in the Amateur ranks about rules enforcement. Hams everywhere wonder what can be done to improve this situation. The FCC has neither the staff nor money to enforce rules the way they used to. The FCC budget, the whole thing, is about the same as one Pentagon weapons system procurement budget. An ex-FCC staff member stated that the Commission is using “mirrors and illusion” to keep programs running. Staff reductions due to budget cuts don’t allow a lot of extra fat.

Another source of funding is needed if the FCC is ever to return to monitoring the airwaves and enforcing Amateur rules and regulations. I’m talking about the principle of “TANSTAAFL;” there ain’t no such thing as a free lunch. Perhaps the time has come to institute a system of user fees to support the FCC’s licensing and enforcement activities. This was proposed in the past and was met with a storm of protest. But if we could institute a system where all fees were put into the FCC’s budget, as opposed to the General Fund, perhaps we could have many of the activities we’d like. It would take judicious planning. Funding for monitoring and enforcement could be expanded to allow the FCC to act on bad operating habits and illegal activities.

I would be more than willing to pay for the privilege of my Extra class license. What is it worth to me? At least \$20 per year — maybe more. Would I write a check for \$200 for my 10-year renewal? Yes, if I knew that the money was going to go to the FCC and not into the Federal Government’s General Fund. I would propose a sliding scale of rates based upon the license class. Extras would pay the largest fee; beginners would pay a relatively nominal amount, perhaps nothing at all.

Unfortunately, there’s more than one problem with this proposal. In the sixties, the imposition of FCC fees was one of the biggest reasons for the lack of growth (and even a decline) in Amateur numbers. When you look at the FCC numbers from that era, you can see the dramatic result of fees on licensing. Hams and potential hams simply didn’t want to pay a fee to get their Amateur ticket. Based upon past experience, one would expect history to repeat itself. Reimposition of user fees could have a serious affect on the growth of the Amateur service. Secondly, by statute, user fees are put into the government’s General Fund instead of going to support the collecting agency. In other words, the user fees become nothing more than an additional tax, though the “politicos” don’t have to label it as such.

So, we are caught in a dilemma. There’s little chance of an increase in the FCC budget. Yet the last time user fees were implemented, there was a downturn in Amateur licensing numbers. Amateurs want more from the FCC. What’s to be done?

I wish I had the answer. This question is full of traps and pitfalls. While the Energy and Commerce Committee’s idea has merit, Amateur Radio will derive little or no benefit if the monies simply go into the General Fund. Should the Committee’s recommendations go any further, I strongly suggest that you write to your local representatives and express your feelings on the matter. For myself, if Congress could arrange for the fees collected to go to the FCC — fine; I’m in favor of the proposal. However, if the fees go into the General Fund — sorry, no. My taxes are high enough as it is now. Don’t try to flim-flam us with a “non-tax” tax. Hams are not stupid, and we don’t forget when it comes time for re-election.

**Craig Clark, NX1G**

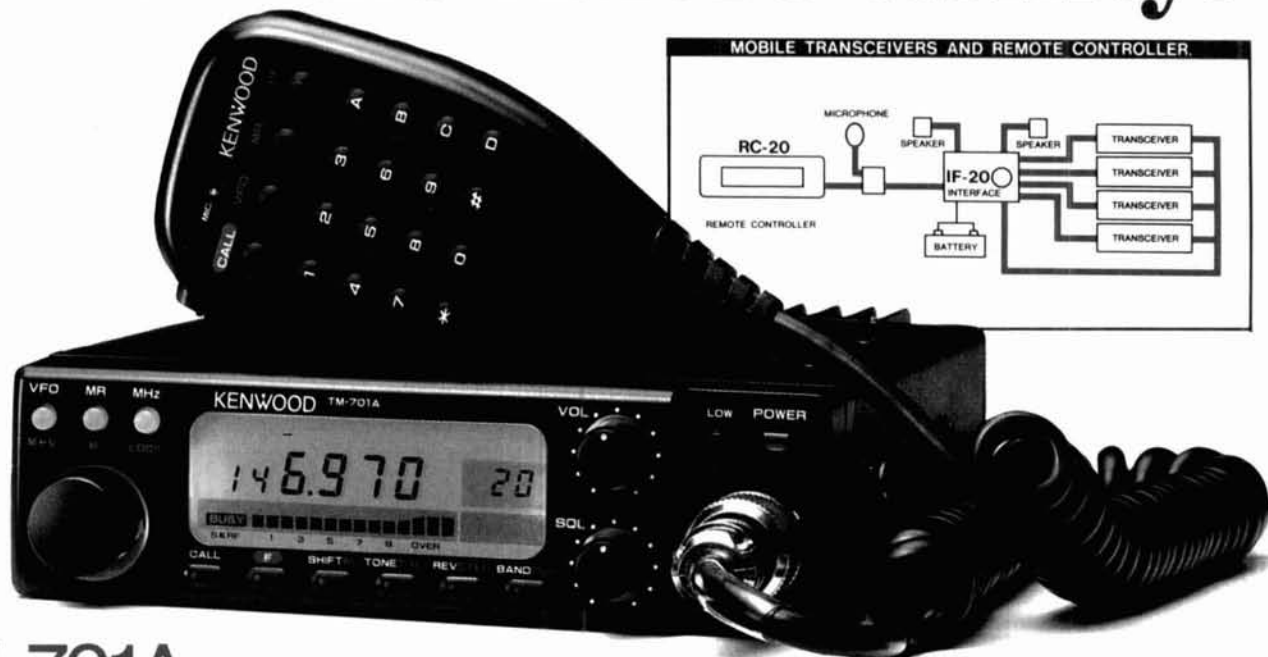


# KENWOOD

...pacesetter in Amateur Radio

Affordable  
Breakthrough!

## Dual Band Afford-ability!



### TM-701A

#### Dual Bander

The TM-701A combines two radios into one compact package. You get 25 watts on 2 meters and 70cm, 20 memory channels, tone encoder built-in, multiple scanning, auto repeater offset selection on 2 meters, and a host of additional features!

- **20 multi-function memory channels.** 20 memory channels allow storage of frequency, repeater offset, CTCSS frequency, frequency step, and Tone On/Off status, CTCSS and REV, providing quick and easy access during mobile operation.
- **25W on 2m and 70cm.**
- **Selectable full duplex-cross band (Telephone style) operation.**
- **Easy-to-operate front panel layout.**
- **Multi-function DTMF mic. supplied.** Controls are provided on the microphone for CALL (Call Channel), VFO, MR (Memory Call or to change the memory channel) and a programmable function key. The programmable key can be used to control one of the following functions on the radio: MHz, T.ALT, TONE, REV, BAND, or LOW power.
- **Easy-to-operate illuminated keys.** A functionally designed control panel with individually backlit keys increases the convenience and ease of operation during night-time use.

- **Optional full-function remote controller (RC-20).**

A full-function remote controller using the Kenwood bus line may be easily connected to the TM-701A and mounted in any convenient location. The new controller is capable of operating all front panel functions.

- **Built-in dual digital VFO's.**

a) Frequency step selection (5, 10, 15, 20, 12.5, 25kHz)

b) Programmable VFO

The user friendly programmable VFOs allow the operator to select and program variable tuning ranges in 1MHz band increments.

- **Programmable call channel function.**

The call channel key allows instant recall of your most commonly used frequency data.

- **Programmable tone encoder built-in.**

- **Tone alert system—for true quiet monitoring.**

When activated this function will cause a distinct beeper tone to be emitted from the transceiver for approximately 10 seconds to signal the presence of an incoming signal.

- **Easy-to-operate multi-mode scanning.**

a) VFO scan

Band scan, Programmable band scan.

b) Memory scan plus programmable memory channel lock-out

c) Dual scan

Dual call channel scan

Dual memory scan

Dual VFO scan

d) Scan stop modes

Time operated scan (TO)

Carrier operated scan (CO)

- e) Scan direction
- f) Alert

When the AL switch is depressed memory channel 1 is scanned for activity at approximately 5 second intervals.

- MHz switch.
- Lock function.
- Repeater reverse switch.

#### Optional Accessories

- RC-20 Full-function remote controller
- RC-10 Multi-function remote controller
- IF-20 Interface unit handset
- MC-44 Multi-function hand mic.
- MC-44DM Multi-function hand mic. with auto-patch
- MC-48B 16-key DTMF hand mic.
- MC-55 8-pin mobile mic.
- MC-60A/80/85 Desk-top mics.
- MA-700 Dual band (2m/70cm) mobile antenna (mount not supplied)
- SP-41 Compact mobile speaker
- SP-50B Mobile speaker
- PS-430 Power supply
- PS-50 Heavy-duty power supply
- MB-201 Mobile mount
- PG-2N Power cable
- PG-3B DC line noise filter
- PG-4H Interface connecting cable
- PG-4J Extension cable kit
- TSU-6 CTCSS unit

## KENWOOD

KENWOOD U.S.A. CORPORATION  
COMMUNICATIONS & TEST EQUIPMENT GROUP  
P.O. BOX 22745, 2201 E. Dominguez Street  
Long Beach, CA 90801-5745  
KENWOOD ELECTRONICS CANADA INC.  
P.O. BOX 1075, 959 Gana Court  
Mississauga, Ontario, Canada L4T 4C2

# MFJ's Deluxe 300 Watt Tuner

... gives you **full** 1.8-30 MHz coverage, a **peak reading** (and average) Cross-Needle meter, built-in **dummy load**, antenna switch and balun ... all covered by a **full one year unconditional guarantee** ... for only \$149.95

MFJ-949D

\$ **149<sup>95</sup>**

Made in U.S.A.

- **Peak reading meter**
- **Built-in dummy load**
- **Covers 1.8 to 30 MHz**
- **1 full year guarantee**



You won't find all these useful features in any other 300 watt tuner -- not even at twice the price.

## New peak reading meter

The new **peak** and average reading Cross-Needle meter in the MFJ-949D shows you SWR, forward and reflected power -- all in a single glance.

Without a **peak reading** wattmeter you just won't be able to tell if your rig is putting out all the peak SSB power it's designed for. Don't be without one if you want top performance.

## Built-in dummy load

A built-in 300 watt 50 ohm dummy load makes tuning up your rig sooo easy. How do you tune up your rig without one?

An external dummy load will cost you about \$30 more -- plus it takes up valuable space at your operating position and requires another cable.

## Full 1.8 to 30 MHz coverage

The MFJ-949D gives you **full** 1.8-30 MHz coverage.

**Make** sure the tuner you're considering covers *all* the HF bands.

**Don't** get a tuner that keeps you from operating all the frequencies you've worked for -- now or in the future.

## Plus more . . .

You get a versatile 6-position antenna switch and a 4:1 balun for balanced lines.

You can run up to 300 watts PEP and tune out SWR on coax, balanced lines or random wires.

## Unconditional Guarantee

You get a **full one year unconditional guarantee**. That means we will repair or replace your MFJ tuner (at our option) *no matter what* for a full year.

**Others** give you a 90 day *limited* warranty. What do you do *after* 90 days? Or *before* 90 days when they say, "Sorry, it's your fault"?

## What's really important? precise control for minimum SWR

What's really important is your tuner's ability to get your SWR down to a minimum -- and the MFJ-949D gives you more precise control over SWR than *any* tuner that uses two tapped inductors.

**Why?** Because the two *continuously* variable capacitors in the MFJ-949D give you *infinitely* more positions than the *limited* number on two switched coils.

**This** gives you the precise control you need to get minimum SWR and maximum

power into your antenna.

**After** all, isn't that why you need a tuner?

## High efficiency and a compact size: performance is most important

The MFJ-949D uses a *single* airwound coil. Using only one inductor takes up a minimum of space and there's no mutual coupling problems.

The excellent form factor of the short fat coil gives you highest Q. Plus you get plenty of inductance that gives you a much wider matching range than other designs.

**This** results in a highly efficient tuner that puts maximum power into your antenna *and* a compact 10 x 3 x 7 inch size that complements your rig and fits right into your station.

**Competing** tuners using *two* tapped coils require a large cabinet -- not just to house the coils but also to help reduce detrimental coupling between the inductors. The result? A tuner that's **bigger** than your radio.

## Your very best value

The MFJ-949D gives you your very best value, first-rate performance, proven reliability and the best guarantee in ham radio . . . all from the *most trusted* name in antenna tuners. Don't settle for less. Get yours today!

## MFJ's 1500 Watt Tuner



For a few extra dollars the MFJ-962C lets you use your barefoot rig now and have the capacity to add a 1.5 KW PEP linear amplifier later. It covers 1.8 to 30 MHz.

You get MFJ's new **peak** and average reading Cross-Needle SWR/Wattmeter.

You also get a 6-position antenna switch and a teflon wound balun with ceramic feed-thru insulators for balanced lines. Measures just 10 $\frac{3}{4}$ x4 $\frac{1}{2}$ x14 7/8 inches.

## How can an American manufacturer like MFJ give you more tuner for your money than clearing houses for foreign competition?

MFJ tuners are made in America. **Here's** how MFJ gives you more tuner for your money than *any* clearing house for foreign competition.

MFJ builds every tuner cabinet from scratch using the latest high-speed

computer controlled punch presses.

MFJ manufactures, assembles and tests every PC board that goes into MFJ tuners.

**Instruction** manuals and other materials are printed in MFJ's print shop.

MFJ tuners go directly from our factory to your dealer. We're not just an importer adding profits, tariffs and import charges.

**With** MFJ's efficient in-house manufacturing and straight to your dealer distribution you get the most tuner for your money.

## WHY CHOOSE AN MFJ TUNER?

**Hard-earned Reputation:** There's just no shortcut. *MFJ is a name you can trust* -- more hams trust MFJ tuners throughout the world than all other tuners combined.

**Proven Reliability:** *MFJ has made more tuners for more years than anyone else* -- with MFJ tuners you get a highly-developed product with proven reliability.

**First-rate Performance:** MFJ tuners have earned their reputation for being able to match just about anything -- *anywhere*.

**One full year unconditional guarantee:** That means we will repair or replace your tuner (at our option) *no matter what* for a full year.

**Continuing Service:** MFJ Customer Service Technicians are available to help you keep your MFJ tuner performing flawlessly -- no matter how long you have it -- just call 601-323-5869.

**Your very best value:** MFJ tuners give you the most for your money. Not only do you get a *proven* tuner at the lowest cost -- you also get a one year *unconditional* guarantee and *continuing* service. That's how MFJ became the world's leading tuner manufacturer -- by giving you your very best value.

**Choose** your MFJ tuner with confidence! You're getting proven performance and reliability from the most trusted name in antenna tuners. Don't settle for less.

**Call** or write for a *free* full-line MFJ catalog with all 10 of our tuners and tons of ham radio accessories!

Copyright © 1989 by MFJ Enterprises, Inc.

**MFJ**

MFJ ENTERPRISES, INC.  
P.O. Box 494, Mississippi State, MS 39762  
601-323-5869; TELEX 534590 MFJSTKV  
Nearest Dealer/Orders: 800-647-1800  
Include shipping and handling

MFJ ... making quality affordable

# Comments



## Packet radio made simple

Dear HR

Congrats to Tom McMullen, W1SL, on his article, "Packet Radio for the First-timer." Clearly, Tom has found a way to present his material in an understandable manner to neophyte packet ops like me. After reading his article several times, I feel confident to attempt my first QSO via packet radio. Frankly, after reading the operations manual provided with my TNC, I became more confused as to what to do first. My question is: why can't TNC manufacturers write their manual in a simple form similar to the style that Tom's article is written? I feel that my manual is completely unsuitable for someone just getting started in packet radio. Tom's work was indeed a sight for sore eyes, and I would like to see additional articles on packet written in the same manner.

**Walt Bilous, WA2QDB,  
Linden, New Jersey**

## Code/No Code Choice

Dear HR

Must we always see things as either black or white?

For those who believe in the no-code license, simply taking out the code part would make the tests too easy. In short, it would be the equivalent of opening the ham bands to the same general public who ruined CB with illegal practices and lack of consideration for others. Also, there are pre-teen hams on the air — surely those having a genuine interest in becoming a ham have a better excuse than "the code is the primary obstacle to obtaining my license."

Many of those in favor of the pro-code exams have the "I had to take it so you should too" mentality. This isn't a legitimate reason for maintaining the pro-code test but a childish one.

I propose a compromise to the code/no-code debate. Applicants should be given a choice of taking either the standard code-and-theory test, or a substantially harder theory but no-code test. An applicant who opts for the more difficult theory but no-code test may not be able (or want) to communicate in Morse, but at least she/he might have a technical edge over the ham who opts for the current theory-and-code test, and doesn't really know how to design or construct a working antenna/radio system.

With either choice of test, the key ingredient in obtaining the license is still dedication. If we are to maintain the feeling of pride and responsibility in having and using a ham radio license, we have to keep it a challenge to earn one.

**Richard Stuart, WF7A,  
Lynwood, Washington**

## Many benefits along the way to a career

Dear HR

To me, Amateur Radio is an intriguing hobby that led to a professional career as a consultant in electromagnetic interference and RF circuit design. Licensed as WN6RHM in 1952, I remember discovering by the direct experience method that the 6L6 oscillator/transmitter described in "How to Become Radio Amateur" (ARRL publication of that era) radiated

equally well on all bands 80-10 at the same time. I remember to this day the excitement of working WN6UJX in Van Nuys, California as my first contact.

I am still in frequent contact with Wil Claus, K6DKA, whom I met in junior high school in the seventh grade. So amongst other things, Amateur Radio holds forth as a source of lifelong friends that I doubt could be obtained by other means.

Some of the technical insights gained by the hands-on experience of trial and error of those younger days give emphasis to the theories of electromagnetic and electronic effects learned since. In that regard, I think it must be said that Amateur Radio is a resource in addition to a service and/or a hobby. For it is from that resource that many of tomorrow's engineers and scientists will come. The importance of exposing today's youth to this hobby *cannot* be overemphasized. For some, as it did for me, it may grow into an avocation yielding life long friends as a by-product along the way.

As to the issue of how much spectrum is enough for the hams, I doubt that any of us will resolve that issue. I will say however that as both a professional and an "Amateur" in the field of communications, there is little doubt that Amateur Radio could use some sprucing up in the image department when it comes to the nature of the use of the spectrum. For example, some VHF repeaters here in Southern California are simply an embarrassment to the sport of radio communication, and its public image.

However, the future of Amateur Radio lies with the youthful licensees of today. Some of them will no doubt gain from this hobby and therefore be in a position later to return something not only to the hobby, but to society as a whole. Let us hope that the practices of the detractors and abusers of the privileges associated with Amateur Radio do not result in the complete loss of spectrum space.

**Steve Jensen, W6RHM,  
Running Springs, California**

# COMPUTERIZING SMITH CHART NETWORK ANALYSIS

## Network calculations made easy

By Richard A. Gardner, N1AYW, 49 Notre Dame Road, Bedford, Massachusetts 01730

**T**he Smith Chart is a versatile, time-saving tool useful for solving many Amateur Radio circuit and network design problems. It addresses network equations graphically, eliminating the need to wade through the math. Even so, using the paper Smith Chart can be a time-consuming process — especially if many network element changes are involved. Having used paper Smith Charts, I knew how useful they were but I wanted a more efficient approach. I have developed a BASIC computer program for the Smith Chart that is easier, faster, and more accurate than the paper chart.

I first used the Smith Chart when trying to understand the effect of a matching network on a triband beam. The antenna and matching network had an SWR much higher than acceptable, so I needed to isolate the problem to either the antenna or matching network. Because I made the antenna system impedance measurement from my shack, I used the Smith Chart to separate the effect of the 100-foot coax feedline from the antenna system measurement.

The second time I needed to use Smith Chart calculations was when I decided to use my antenna tuner as a measurement instrument. Because the Smith Chart can handle not only transmission line problems but also circuit networks made up of lumped components, capacitors, inductors, and resistors, I reasoned that I should be able to use the chart to work backwards from 50 ohms to find the conjugate antenna impedance. All I needed to do was calibrate and model the antenna tuner capacitors and variable inductor accurately. However, when I was working on the right side of the Smith Chart, small positional changes represented significant changes in component values, and it was extremely difficult to come up with an accurate measurement. What I needed was a computer-aided chart to provide computational accuracy.

These two tasks gave me some incentive to explore a computerized Smith Chart. The basic ideas for this program

came from two excellent articles by Lynn Gerig.<sup>1,2</sup> I've corrected some errors, added features (like modular computation structure), included additional network elements, incorporated hyperbolic functions into transmission line equations to account for line losses, provided for recall of prestored user-defined loads, and rewritten the program for use on IBM PCs and compatibles. I found that these additional features made the original program even more useful.

Since improving the computerized Smith Chart, I have found many uses for it — including the design of matching networks for amplifiers, antennas, and oscillators, and determining transmission line effects on antennas and filters. The computerized version is faster and provides a more precise output than is possible with the paper chart. The program structure and equations have been developed to address the specific capabilities I needed in a computerized Smith Chart. I've made many changes to the program as my needs have changed. I expect other users may also want to make changes; the modular structure makes customization straightforward.

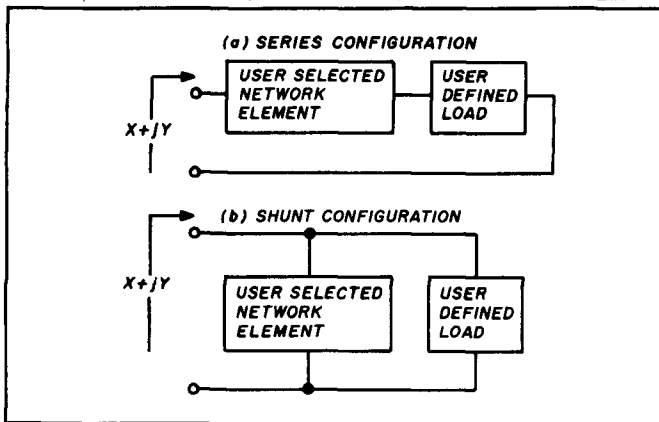
### What does the program do?

The Smith Chart Network Analysis program calculates the resultant impedance of user-selected network elements in series or shunt, with a user-defined load. The two network configurations are shown in **Figure 1A** and **1B**. The resultant impedance is then plotted on a Smith Chart, which is reproduced on the screen. The user-selected network elements can be either lumped components or transmission line sections.

A subprogram, which calculates component values for series and parallel resonant circuits, is included with the Smith Chart Network Analysis program. It can also be used alone. I've found it's very helpful when used in conjunction with the Smith Chart, while solving resonant network problems.

As shown in **Figure 2**, complex numbers are used to describe the various impedances with  $R + jI$  representing the user-defined load,  $A + jB$  representing the user-selected network elements, and  $X + jY$  denoting the resultant impedance. The user-defined load must be described as a series resistance and reactance at each frequency of interest. If you have a load in mind which is described as

FIGURE 1



User Selected Network Element and User Defined Load connections for series and shunt configurations.

FIGURE 2

User-defined load	$R+jI$
User-selected network element	$A+jB$
Resultant impedance	$X+jY$
<b>Resultant impedance for series combination</b>	
$X+jY = (A+R) + j(B+I)$	
<b>Resultant impedance for shunt combination</b>	
$X+jY = \frac{A(I^2 + R^2) + R(A^2 + B^2)}{(A + R)^2 + (B + I)^2} + \frac{B(I^2 + R^2) + I(A^2 + B^2)}{(A + R)^2 + (B + I)^2}$	

Complex notation for User Selected Network Elements, User Defined Loads, and resultant impedances. The equations are for the series and shunt configurations.

a parallel combination of elements, you can find the series equivalent using the Smith Chart program. Appendix A describes how to do this. The essential calculations performed by the program are those which compute numerical values for the user-selected network element and for the resultant impedance. The resultant impedance is displayed in complex notation and also plotted on the Smith Chart as shown in Figure 7.

Figure 3 illustrates the 24 network elements contained in the program. Some of them are redundant, but are included for convenience. For example, the series RLC element could be formed by selecting (in turn) a series R, a series L, and a series C; however, it's rather slow and cumbersome. You can generate your own network elements by expressing the network element's impedance in complex form and using it to replace an existing network element in the program.

You can select five transmission line configurations: a transmission line in series with the load, an open or shorted stub in parallel with the load, or an open or shorted stub in series with the load. Transmission line computations take line attenuation into account. The attenuation for six common coax cable types is calculated automatically at the fre-

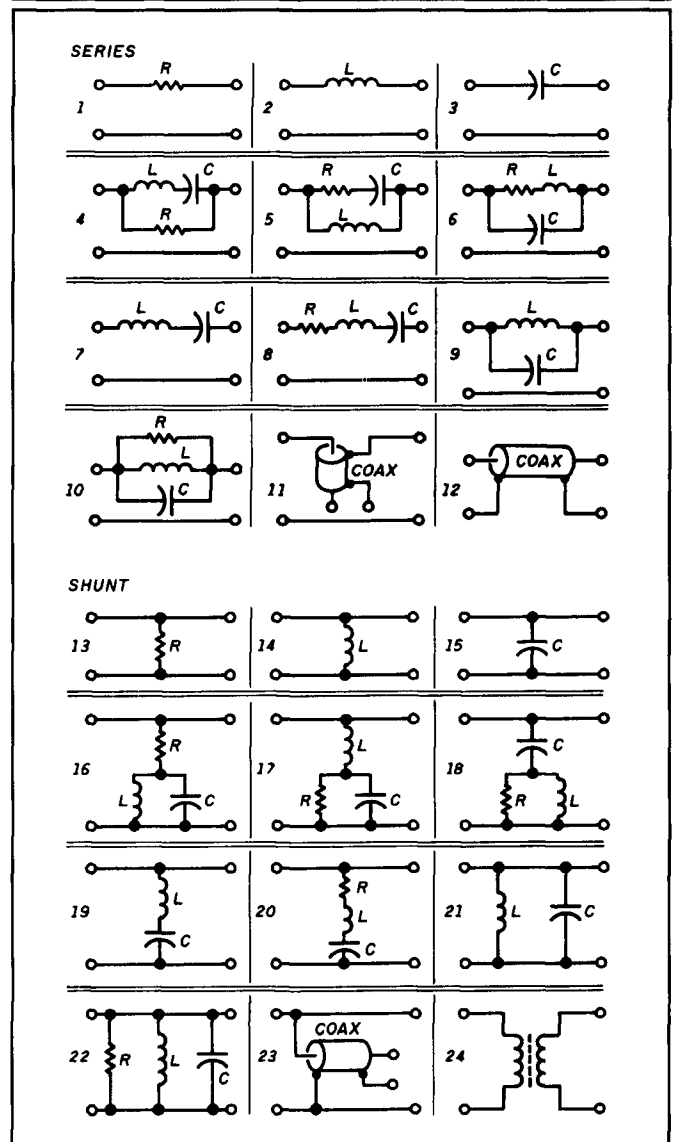
quencies of interest. The attenuation equations are based upon attenuation curves in Reference 3. The program will also accept a single user-supplied attenuation value if one of the six cable options isn't selected.

You can select a step-up or step-down transformer for insertion in series with the load. The transformer is assumed to be ideal; however, transformer leakage and magnetizing inductances and stray capacitances can be simulated by using the appropriate network elements, along with the transformer element.

### Sample problem

Here's a simple design to clarify what I've described so far. (Those not familiar with the Smith Chart may want to read Appendix B for some help in using a Smith Chart before proceeding.) Say you want to use a 40-meter antenna on 30 meters. To obtain an acceptable SWR, you'll need some kind of matching network. You'll need the

FIGURE 3



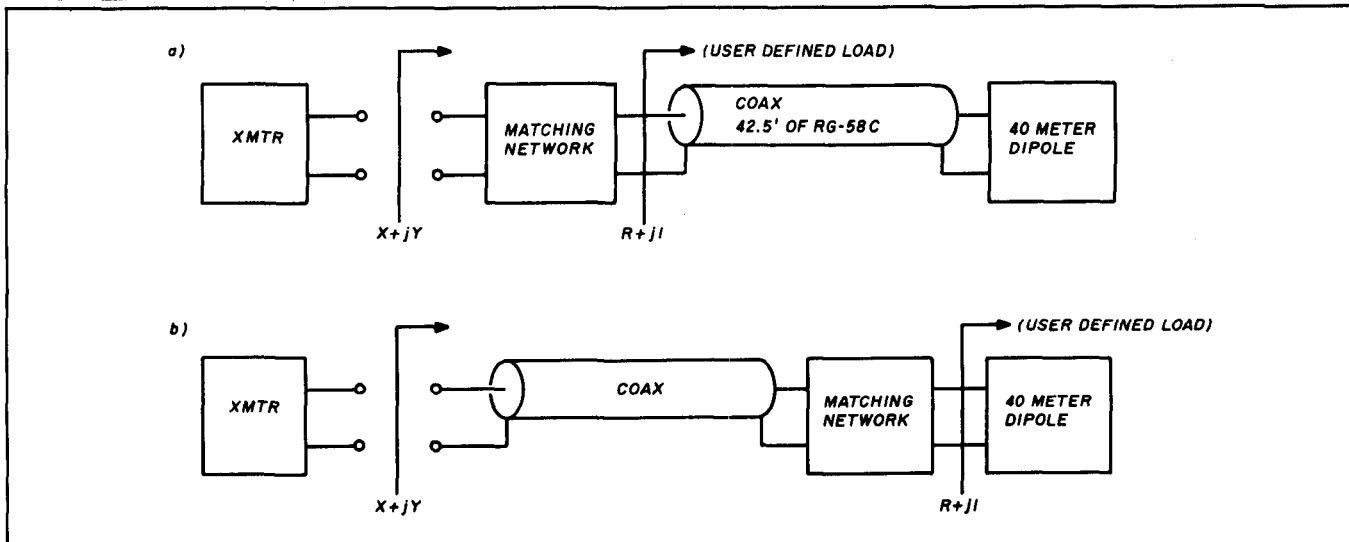
Network Elements that can be selected to form matching network designs.

impedance of the 40-meter antenna system measured at 30 meters to begin the design. Using a noise bridge, measure the combined dipole and feedline impedance at 30 meters. **Table 1** shows the measured load values,  $R + jI$ , of my 40-meter dipole at the frequencies of interest, and this data will be entered into the program when requested. The user-defined load in this case is the 40-meter dipole/feedline shown in **Figure 4A**. If this load were driven without a matching network, it would present the SWRs shown in **Table 1** — values that are calculated by the program.

There are two possible places to insert a matching network: one is down in the shack (see **Figure 4A**), and the other is up at the antenna (see **Figure 4B**). The first design example, shown in **Figure 4A**, will describe a matching net-

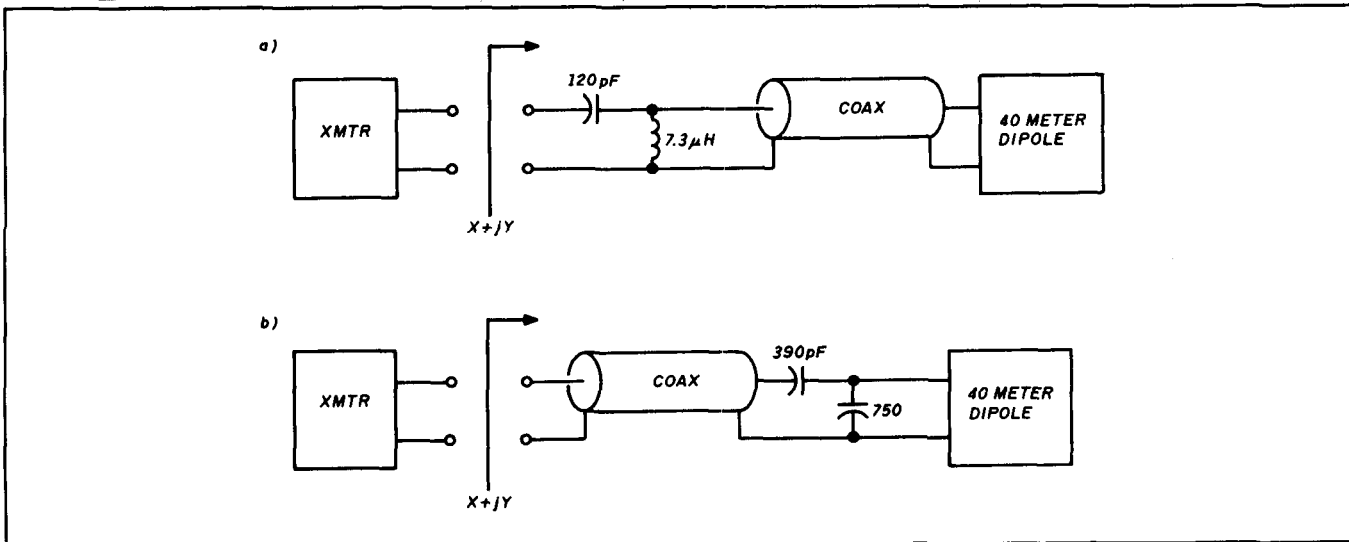
work connected at the transmitter end of the coax. This matching network will be made up of a combination of shunt and series network elements. Although there are literally an infinite number of matching network configurations that could theoretically satisfy the requirements, I chose a simple L-network for this demonstration. (Once you're familiar with the Smith Chart, the network configurations that can perform the match become readily apparent.) This simple L-network consists of a shunt L and series C, as shown in **Figure 5**. Note that the order in which the network elements are used is important. The shunt inductor must be adjacent to the load followed by the series capacitor. Placing the components in the opposite order will generally result in a different impedance.

**FIGURE 4**



Diagrams showing the matching network and user defined load configuration for the sample problem described in the text. **Figure 4A** shows a matching network located at the transmitter end of the coax. **Figure 4B** shows a matching network located at the antenna end of the coax.

**FIGURE 5**



Sample problem matching network solution and component values.



## If You Want the Most Advanced TNC Today...

**I**n 26 countries around the world, tens of thousands of amateurs know that Kantronics is the leader in bringing tomorrow's technology to their stations today. They also know they will always be among the first to incorporate just-introduced features and modes with Kantronics software and firmware updates.

And, they know that Kantronics is unique in its ability to seek out, develop and incorporate the most advanced features into each of five different TNC models before anyone else. Why? Because every program Kantronics writes, and every unit Kantronics designs and produces are born right here at the factory in the U.S.A.

### Meet Your Mailman

**I**n this age of telco LANS, E-mail and FAX,



*PBBS is just one of the firsts Kantronics delivered.*

you will know you have mail in your **Personal Packet Mailbox™** when your KAM "STA" LED is blinking. New firmware level 2.85 has also added a handy automatic mailbox user-

connect. So save your computer and monitor life by turning them off when you are away, and never miss a beat on the airwaves.

Version 2.85 KAMs have increased Packet Cluster™ compatibility, **KA-NODE™** path preservation, KA-NODE recognition of the "NET" nodes and HF baud rates from 50 through 300! And there are three new mailbox commands: *List Mine, Read Mine* and *Kill Mine*.

## and Tomorrow...

### Will the Real Dual-Port Please Stand Up?

**R**ead our lips. The **KAM™** is the only true dual-port when it comes to packet. Your Personal Packet Mailbox™ is accessible from both HF and VHF! Version 2.85 has dual-port compatibility with RLI/MBL boards and KISS mode for both ports. You can monitor HF and VHF packet operations at the same time. Users can even gateway from HF to VHF (or in reverse) through your KAM.

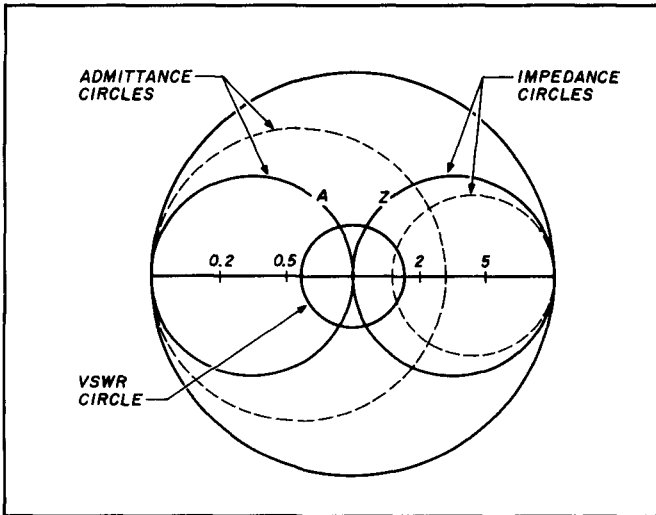
Kantronics All-Mode™ (KAM) has Packet, WEFAX, ARQ, FEC, RTTY and CW reception. But we have five models to suit your particular taste. **Ask your dealer for the best choice today...and tomorrow.**

**Kantronics**  
RF Data Communications Specialists

1202 E. 23rd Street Lawrence, Kansas 66046  
(913) 842-7745

Packet Cluster™ is the copyrighted software of Pavilion Software  
KAM™, All-Mode™, KA-NODE™, and Personal Packet Mailbox™  
are trademarks of Kantronics Company, Inc.

**FIGURE 6**



**Smith Chart showing two admittance and two impedance circles. The solid admittance and impedance circles pass through the chart's center, 50 ohms.**

In this example, the matching network consists of two user-selectable network elements — a shunt inductor and a series capacitance. Values for these components will be determined later, but first be sure you understand that the *user-defined load* is the 40-meter dipole and feedline characterized at 30 meters. In this case the matching network consists of two user-selected network elements, a shunt inductor, and a series capacitor.

The design objective is to obtain an acceptable match at the frequencies listed in **Table 1**. Do this by looking at the plotted load points on the Smith Chart, and by trial and error. Select a shunt inductor value which drives the resultant impedance ( $X + jY$ ) to the circle labeled Z in **Figure 6**. If you try an inductor value of  $7.3 \mu\text{H}$ , the new resultant impedance points will be located roughly on the Z circle perimeter. Note that the real part of the impedance is now very close to 50 ohms. Now, select a value of series capacitor which will move these points down toward the center of the chart — the 50-ohm point. Trial and error shows that 120 pF is an acceptable capacitor value (see **Figure 5A**).

The second design approach assumes that the matching network will be placed at the antenna, as shown in **Figure 4B**. Again, start with the measured data in **Table 1**. In this case the 40-meter dipole is the desired user-defined load, but in order to determine its impedance the feedline effect must first be removed from the impedance measurement made in the shack. If you were using a paper Smith Chart, you could calculate the feedline length in fractions of a wavelength and then rotate the impedance points in the correct direction to determine the dipole's impedance. Removing the feedline's effect is much simpler with the Smith Chart program. Simply choose a negative value for the feedline length when the program requests the line's length. Cable length is entered in inches, and since the cable length is 42.5 feet, enter  $-510$  inches as the feedline length. **Table 2** shows the dipole's calculated impedance or user-defined load for this example. As in the previous example, there are many possible matching network configurations that will satisfy the requirement. For this

**TABLE 1**

40-meter dipole plus feedline impedance on 30-meter band.

Frequency	R	jI	SWR
10.100	95.0	+j161	7.75
10.125	95.6	+j171	8.43
10.150	96.9	+j181	9.11

**TABLE 2**

40-meter dipole impedance on 30-meter band.

Frequency	R	jI	SWR
10.1	4.1	+j17.1	13.8
10.125	3.4	+j17.1	16.4
10.15	2.8	+j17	19.7

**TABLE 3**

40-meter dipole with matching network.

Frequency	R	jI	SWR
10.1	56.8	-j7.1	1.2
10.125	55.7	+j2.8	1.13
10.15	53	+j12.0	1.29

**TABLE 4**

Impedance seen by transmitter.

Frequency	R	jI	SWR
10.1	47.3	-j0.2	1.06
10.125	54.6	-j2.8	1.11
10.15	62.8	-j6.6	1.29

example, select a simple matching network that consists of a shunt capacitor followed by a series capacitor. Using the Smith Chart Network Analysis program and selecting values of 750 pF and 390 pF, respectively, will result in an impedance close to 50 ohms. The actual impedance values are shown in **Table 3**. These impedance values represent the combination antenna and matching network impedance. This load impedance will be connected to the transmitter through the feedline coax. To find the load seen by the transmitter, select the series transmission line network element. Since 42.5 feet of RG-58A coax is being added back into the system, select  $+510$  inches when prompted for coax length. The computer will then calculate the transmitter load shown in **Table 4**.

From the SWRs shown in **Tables 3** and **4**, you can see that the matching network design has been successful.

### Program description

The program is menu driven and contains enough direction to be used with minimal help, provided you have a basic understanding of Smith Charts. For those readers who are unfamiliar with them, I recommend **References 4** and **5**. I've included a very brief description of Smith Chart operation in **Appendix B** to get you started.



# ICOM

# IC-765 HF Transceiver



## MAKE YOUR DREAMS A REALITY!

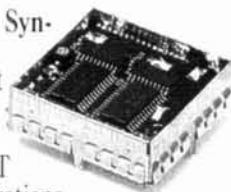
ICOM incorporated your most requested features with modern technology's best designs to produce the remarkable IC-765 dream rig. Its combination of excellent performance and superb reliability truly open a new dimension in HF operating enjoyment.

### THE HF FOR TODAY'S ACTIVE AMATEUR.

Includes: **\*Band Stacking Registers.** Each band's VFO's retain the last selected frequency, mode and filter choice when changing bands. Produces the equivalent of 20 VFO's; two per band. Great for multiband DX'ing! **\*99 Fully Tunable Memories.** Store frequency, mode and filter selections. Each one can be returned and/or reprogrammed independent of VFO operations. Memories 90-99 also store split Tx/Rx frequencies. **\*10Hz Readout.** Perfect on-the-dot frequency selection for nets, DX skeds and data communication modes. **\*Full QSK Break-in.** For super CW operations!

### \*Direct Digital Synthesizer (DDS).

Assures ultra-fast PLL switching and lock-in for excellent PACKET and AMTOR operations.



**\*Maximum Operation Flexibility!** The three step attenuator cuts multi-station overloads. **\*Built-in AC Supply.** The IC-765 is 100 percent duty cycle rated for cool operation and superb performance on all modes! **\*Fully Automatic Antenna Tuner.** With built-in CPU and memory for extremely fast tuning and one-touch operation. Wide tuning range. **\*CW Pitch Control.** Total operating comfort and convenience for successful contesting and DX'ing. An iambic keyer with adjustable speed and weight is also built into the IC-765! ICOM also included **\*Narrow 500Hz CW**

**Filters.** The FL-32A and FL-52A deliver razor sharp selectivity. A serious DX'er's delight! 250Hz FL-53A and FL-101 optional.

The IC-765 **General Coverage Receiver** covers all bands, all modes and is backed by ICOM's full one-year warranty at any one of our four North American Service Centers. The IC-765 turns your dreams into reality!

# ICOM

First in Communications

ICOM America, Inc. 2380-116th Ave. N.E. Bellevue, WA 98004  
Customer Service Hotline (206) 454-7619  
3150 Premier Drive, Suite 126, Irving, TX 75063  
1777 Phoenix Parkway, Suite 201, Atlanta, GA 30349  
ICOM CANADA, A Division of ICOM America, Inc., 3071 -  
#5 Road, Unit 9, Richmond, B.C. V6X 2T4 Canada  
All stated specifications are subject to change without notice or obligation. All ICOM  
radios significantly exceed FCC regulations, limiting spurious emissions. 765489

**H**uge pileups, big city QRN, no spare parts, and a long way to anywhere. You probably couldn't find a better test of the new SB-1400 All-Mode Transceiver than Heath's expedition to Taipei in the Republic of China.

When working DX, you need sensitivity to dig for the weak ones, but still need dynamic range so the guy down the block doesn't clobber you in the middle of a QSO. Sure, the SB-1400 worked the S9 + 30 signals, but out of the pileups it also worked a number of stateside stations running 5 watts or less! And that's not bad for a short path distance of 7600 miles!

### SB-1400

#### A proven transceiver.

The technology that worked the world can work for you, too, in your own ham shack. The SB-1400 is a fully assembled all-band, all-mode (FM optional), continuous duty, 100-watt transceiver. It incorporates an impressive general coverage receiver with dual VFOs for split operation and 20 memories to store your favorite frequencies. The unit includes standard SSB filter plus a narrowband 500 Hz CW filter and wideband AM filter. It also

features clarifier (RIT), front panel AGC, noise blanker, all mode squelch, 20 dB attenuator, computer interface, and a clean, "operator preferred" front panel layout.

The transmitter's PA is cooled by a quiet, thermostatically controlled internal fan and is enclosed in its own diecast aluminum heat-sink chamber, which allows for full power operation in CW, SSB, FM and RTTY, AMTOR, SSTV, and Packet.

**"Thanks for  
the new  
country  
(Taiwan)!  
Your Heath  
gear sounds  
great!"**

*K3YGU, Maryland*

### Heath offers you more.

In addition to the SB-1400, Heath offers a full line of pre-assembled or build-it-yourself amateur radio equipment to completely outfit your ham shack or upgrade your system.

You can also prepare for your next exam (Novice, Technician, General, Advanced or Extra class) with Heath study courses.

Finally, as a Heath-equipped ham, you can get answers to your technical questions from our tech consultants, who are licensed ham operators, on the Heath Tech Assistance line.

For more information on the SB-1400 or Heath's complete line of amateur radio equipment, call for a FREE catalog: **1-800-44-HEATH**  
(1-800-444-3284)

Best to start with.  
Best to stay with.

### Heath Company

Benton Harbor, Michigan 49022

©1989, Heath Company.  
A subsidiary of  
Zenith Electronics Corporation.



The program is designed to use default values if you offer no input. Default values are either the initialization values, entered automatically at program start, or the last value you enter. When the program prompts for a new value, the default value is displayed followed by a ?. If you wish to use the default value, simply hit the Enter key.

When you're asked a question requiring a simple yes or no answer, hit the Y or N key as appropriate to carry out your action. When entering "letter" answers, you can use either upper or lower case.

The program starts out with a four-item menu.

- \* CHOOSE AN OPERATION \*
- START A NEW NETWORK = 25
- RESONANT CALCULATIONS = 26
- CLEAN UP CHART = 27
- REVIEW NETWORK = 28

The default selection is 25, "Start a New Network." This is the way you'd normally start a design. An alternative starting point is the "Resonant Calculations" selection. This selects a subprogram which permits the calculation of series or parallel resonant circuit parameters like Q; resonant frequency; or R, L, and C values. When you've completed resonant circuit calculations, you'll exit back to the main Smith Chart program. Don't select operations 27 and 28 initially; they are useful only after a network design has started.

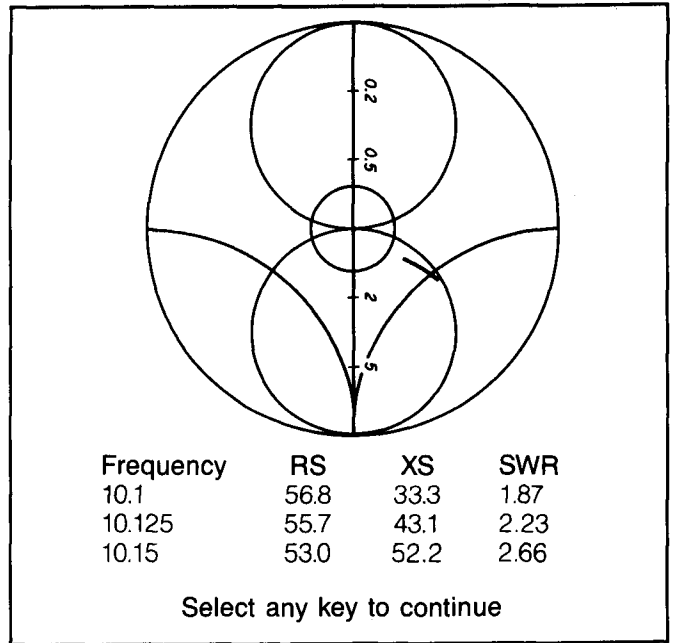
Once you've selected the Start a New Network operation, the program enters the setup mode. During setup, program constants are assigned, variables are initialized, and user-selectable parameters are established. The first setup parameter requested is the SWR circle radius. A circle will be drawn on the Smith Chart and all plotted points that fall within this circle will have a SWR less than the value you specify. A default value of 1.5 is used if you don't offer a value. The program goes on to request the Smith Chart impedance. This impedance defines the chart's center impedance. For example, if you wish to match a load to a 72-ohm system, you would select 72 ohms as the chart impedance. Because I work most often with 50-ohm systems, the default value is set at 50 ohms.

Next, you'll be asked if you want to recall prestored load data. (The prestored load data currently listed describe my antennas, and are probably not of use to most of you.) You may want to enter the impedance of your antennas or other selected loads into the data statements. It's particularly useful for those user-selected loads that are used repeatedly. Prestored load data begins at program line 4430. **Appendix C** discusses how to modify the prestored load data.

If you don't select the prestored load data, the program will ask: "How many frequencies?" (For how many frequencies do you wish to calculate the resultant impedance?) Initially, you might select two or three frequencies across the ham band of interest, until you get an idea of how the program works. You can enter up to ten frequencies.

The program now requests the frequency in MHz and the load impedance at each frequency. It will continue to request this information until you've entered all frequencies and load impedances. When all data have been entered, the program will give you an opportunity to check the data and make changes. It will ask: "Are you satisfied?" Simply enter Y if the displayed data are correct, or N if not. If you answer no, the computer gives you another opportunity to load prestored data. If you answer no to that choice, you'll be given a chance to repeat the data entry process, cor-

FIGURE 7



**Impedance and Smith Chart as displayed by the program. The resultant impedance,  $X+Yj$ , is displayed and plotted on the Smith Chart as shown. Note that the notation  $X+Yj$  is used in the BASIC program, but the resultant impedance is displayed as  $R_s$  and  $X_s$  on the screen.  $R_s = X$ , the series resistance, and  $Y = X_s$ , the series reactance.**

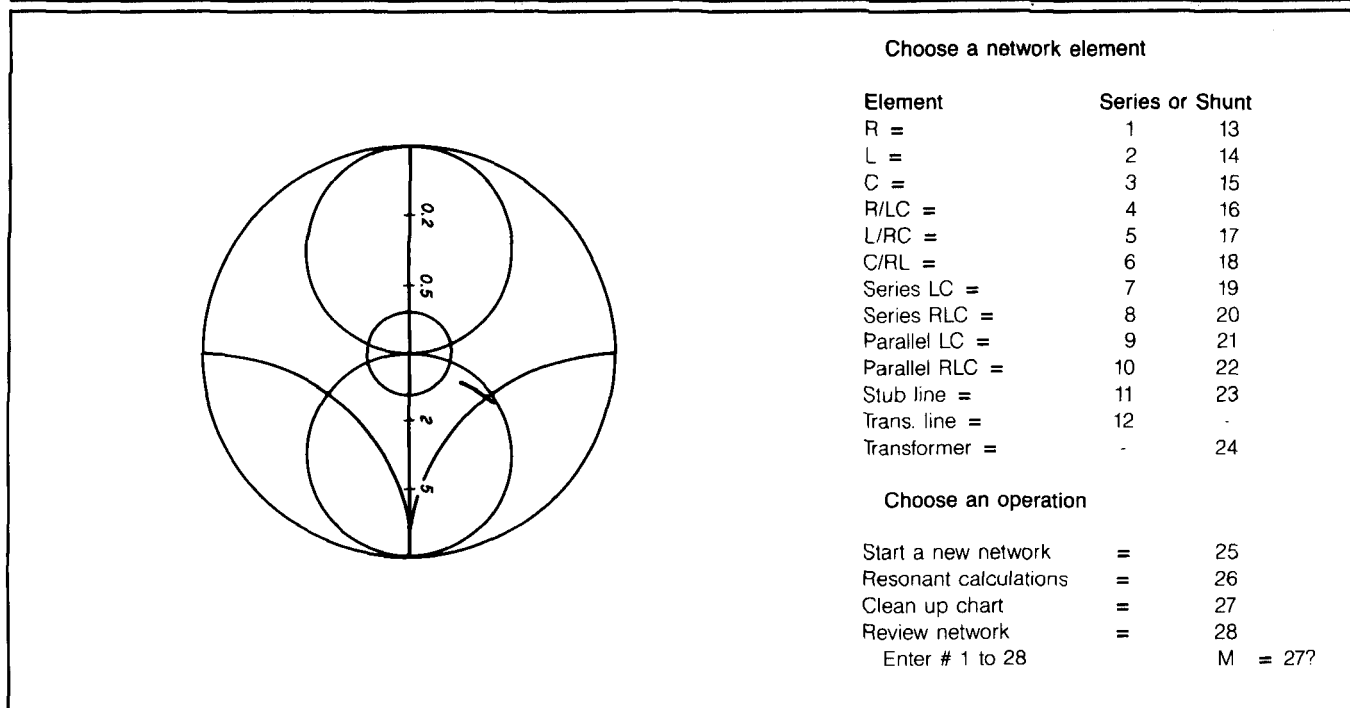
recting the errors as you go. Because previously entered data will now be the default data you need, enter only the corrections. When all data are correctly entered, you'll be given the option of printing the user-defined load data. *Do not elect to print unless a printer is connected, or the computer will hang up.* If that happens, you'll have to reboot the system and you'll lose all the network values you've entered.

The program now plots your load data on the screen along with a simplified Smith Chart, as shown in **Figure 7**. Note that the frequencies are plotted in the order in which they were entered. The first frequency is plotted with a small circle, the second with a medium circle, and the third with a large circle. The sequence begins again with the fourth frequency. This display permits an unambiguous identification of each frequency — a feature which will be helpful as your design proceeds.

As shown in **Figure 8**, a menu which lets you select either series or shunt networks elements is displayed beside the Smith Chart. After you enter an element number, the computer prompts for component values. After they've been entered, the new resultant impedance is displayed on the Smith Chart, along with the real and imaginary numerical values. At this point the program asks: "Do you want to accept this run?" Select N if the resultant values aren't acceptable, and you'll be given an opportunity to select new component values. If the values were acceptable, the program will display your design configuration to this point.

For users with a poor short term memory (like me), there's a recall feature that permits review of the elements

FIGURE 8



Smith Chart Network Analysis program menu display.

"accepted" during the current design session. This is helpful in recalling the order and the component values selected for the final design solution. You can obtain a hard copy by using the "PrtSc" key.

After you have selected elements within a design, the Smith Chart becomes a bit messy. I've included a feature to clean up the chart, which clears out all intermediate impedance plots, and replots the Smith Chart with only the latest design values.

### Getting started

Try the sample problem while following the procedure outlined in Appendix B. Experimenting with each of the network elements in Figure 3 will help you understand how series and shunt components transform impedances. I'm sure you'll find designing with the Smith Chart an enjoyable and efficient process.

If you'd like to type in the program, you can obtain a copy from *Ham Radio* by sending a business sized SASE. For those who don't like to type, I'll provide a copy of the program on disk to anyone who sends me their mailing address and \$5 to cover postage and mailing materials.

I've written the program in BASICA and configured it to operate on an IBM XT or AT equipped with an EGAWondercard. Although I haven't tried, I believe it will also run with an IBM EGA card. The program has been run using HBASIC (used with the Hercules graphics card), Microsoft QuickBASIC, and GWBASIC. When you run with the EGAWondercard, you should select the option 2 or 3 display mode before entering the BASIC interpreter or compiler. I have also run it on an AT and XT equipped with the Hercules graphic card and on the Toshiba TS1100 and Zenith ZWL-183-92 lap top computers.

### Appendix A

#### Converting a parallel network to a series equivalent

Assume you have a load that is a parallel RLC network and you want to generate the series equivalent,  $R + jI$ , at frequency  $f_1$ . First select one component of the RLC network to be the user-defined load; it doesn't matter which one. Then use the program to add the other two components in parallel with the first one selected. The program calculates the resultant combination, and displays the result in the series form,  $R + jI$ .

For example: take a RLC network whose individual values are known to be  $R = 300$  ohms,  $L = 4 \mu\text{H}$  and  $C = 240$  pF. Select the 300-ohm resistor as the user-defined load and, when the program requests it, enter the load parameters  $R = 300$  ohms and  $I = 0$  at the frequency of interest. (You can choose more than one frequency if you wish. Just enter the other frequencies when requested, but enter the same load,  $R = 300$  and  $I = 0$ .) Next, choose a parallel LC from the network elements, number 21, to be put in shunt with the 300-ohm load. The LC values for this example will be  $4 \mu\text{H}$  and 240 pF, respectively. The result calculated by the program for  $f_1 = 7.2$  MHz is  $84.3 - j134.9$ . This is equivalent to a resistor of 84.3 ohms in series with a capacitor of 163.9 pf. Remember that this equivalence is valid only at 7.2 MHz.

### Appendix B

#### How to use a Smith Chart for impedance matching

I strongly recommend that those who enjoy RF circuit

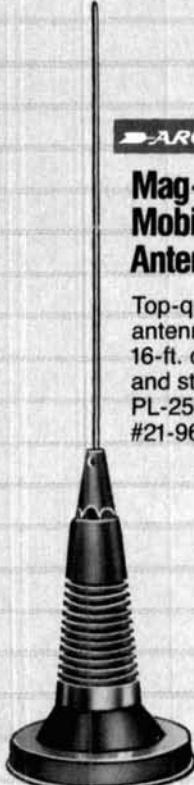
# The Best Buys in Ham Radio Are at Radio Shack Now!



**REALISTIC**  
10-Meter Mobile  
SSB/CW Transceiver

Winning praise from hams everywhere, novice to extra class! HTX-100 has a 10-frequency memory, mike-mounted up/down tuning, 5 or 25-watt output, digital VFO with selectable steps, and CW sidetone. FB value at only 259.95

You must have a valid FCC Amateur Radio License to legally transmit with the HTX-100



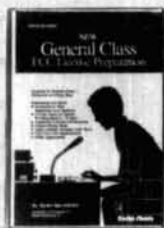
**ARCHER**  
Mag-Mount  
Mobile  
Antenna

Top-quality antenna with 16-ft. cable and standard PL-259 plug.  
#21-960, 37.95




**REALISTIC**  
WWV & WX  
Receiver

Crystal-controlled radio receives WWV on 5, 10 or 15 MHz plus local VHF weather.  
#12-148, 39.95



**Radio Shack**  
General Class  
Study Pack

Everything you need to upgrade: Exam manual and speed-building code cassettes.  
#62-2404, 19.95



**ARCHER**  
High-Grade  
Coax Cable

Type	Cat. No.	Per Foot
RG-8	278-1323	42¢
RG-8M	278-1328	25¢
RG-58	278-1326	20¢
RG-59	278-1327	20¢



**REALISTIC**  
Extension  
Speaker

Better audio for HTs and mobiles! Has 4" speaker, 10-ft. cord and 1/8" plug.  
#21-549, 13.95

Exclusively at  
**Radio Shack**  
The Technology Store<sup>SM</sup>  
A DIVISION OF TANDY CORPORATION

FREE 184-Page Radio Shack Catalog! Write Dept. 062-02, 300 One Tandy Center, Fort Worth, TX 76102

Prices apply at participating Radio Shack stores and dealers

# HITACHI SCOPES AT DISCOUNT PRICES



**V-212**  
**\$425**

List \$595  
Save \$170

## 20MHz Dual Trace Oscilloscope

All Hitachi scopes include probes, schematics and Hitachi's 3 year warranty on parts and labor. Many accessories available for all scopes.



**V-425**  
List \$1,070 **\$849**

- DC to 40MHz
- Dual Channel
- CRT Readout
- Cursor Meas
- DC Offset
- Alt Magnifier
- Compact Size



**V-1060**  
List \$1595 **\$1,359**

- DC to 100MHz
- Dual Channel
- Delayed Sweep
- CRT Readout
- Sweep Time
- Autoranging
- Trigger Lock
- 2mV Sensitivity

V-223	20MHz	D.T., 1mV sens, Delayed Sweep, DC Offset, Vert Mode Trigger
V-422	40MHz	D.T., 1mV sens, DC Offset Vert Mode Trigger, Alt Mag
V-423	40MHz	D.T., 1mV sens, Delayed Sweep, DC Offset, Alt Mag
V-660	60MHz	D.T., 2mV sens, Delayed Sweep, CRT Readout
V-1065	100MHz	D.T., 2mV sens, Delayed Sweep, CRT Readout, Cursor Meas
V-1100A	100MHz	Q.T., 1mV sens, Delayed Sweep, CRT Readout, DVM, Counter
V-1150	150MHz	Q.T., 1mV sens, Delayed Sweep, Cursor Meas, DVM, Counter

LIST	PRICE	SAVE
\$825	\$725	\$100
\$940	\$740	\$200
\$1,025	\$825	\$200
\$1,295	\$1,145	\$150
\$1,895	\$1,670	\$225
\$2,450	\$2,095	\$355
\$3,100	\$2,565	\$535

# ELENCO PRODUCTS AT DISCOUNT PRICES

## 20MHz Dual Trace Oscilloscope



**\$375**  
**MO-1251**

- 6" CRT
- Built in component tester
- TV Sync

## FREE DMM

with purchase of  
MO-1251/1252 Scope

### SCOPE PROBES

P-1 65MHz, 1x, 10x	\$19.95
P-2 100MHz, 1x, 10x	\$23.95

## 35MHz Dual Trace Oscilloscope



**\$495**  
**MO-1252**

- High luminance 6" CRT
- 1mV Sensitivity
- 6KV Acceleration Voltage
- 10ns Rise Time
- X-Y Operation • Z Axis
- Delayed Triggering Sweep

Top quality scopes at a very reasonable price. Contains all desired features. Two 1x, 10x probes, diagrams and manual. Two year guarantee.

## PRICE BREAKTHRU on Auto Ranging DMMs



3 to choose from:  
**MDM-1180** \$24.95  
**MDM-1181** \$27.95  
**MDM-1182** \$29.95

- 3 1/2 LCD Display
- 27 Functions
- Auto/Manual Ranges
- Audible Continuity
- Data Hold (MDM-1182)
- .1% Accuracy (MDM-1181)

## True RMS 4 1/2 Digit Multimeter



**\$135** **M-7000**  
.05% DC Accuracy  
.1% Resistance with Freq. Counter and deluxe case

## Multimeter with Capacitance and Transistor Tester



**\$55** **CM-1500A**  
Reads Volts, Ohms, Current, Capacitors, Transistors and Diodes with case

## Digital Capacitance Meter



**\$58.95** **CM-1550**  
9 Ranges  
.1pf-20,000ufd  
.5% basic accy  
Zero control with case

## Digital LCR Meter



**\$125** **LC-1800**  
Measures Coils 1uH-200H  
Caps .1pf-200uf  
Res .01-20M

## Bench DMMs



**\$125** **M-3500** 3 1/2 digit 1% accy  
**\$175** **M-4500** 4 1/2 digit .05% accy

## SOLDERING STATION Temperature Controlled



**\$99** **SL-30**  
Digital display  
Temp range: 300F-900F  
Grounded tip  
Overheat protect

## Solderless Breadboards



9430 1,100 pins \$15  
9434 2,170 pins \$25  
9436 2,860 pins \$35  
All have color coded posts

## AC Clamp-On Current Adapter



**\$25** **ST-265**  
0-1000A AC  
Works with most DMM

## Wide Band Signal Generators



**\$129** **SG-9000**  
RF Freq 100K-450MHz  
AM Modulation of 1KHz  
Variable RF output

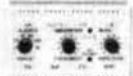
**\$249** **SG-9500 with Digital Display and 150MHz built-in Freq Ctr**

## 3 1/2 Digit Probe Type DMM



**\$39** **M-1900**  
Convenient one hand operation  
Measures DCV, ACV, Ohms  
Audible continuity check, Data hold  
with batteries and case

## Function Generator



**\$28.95** **Blox #9600**  
Provides sine, tri, squ wave from 1Hz to 1MHz  
AM or FM capability

## Decade Blox



**\$18.95**  
#9610 Resistor Blox  
47 ohm to 1M & 100K pot  
#9620 Capacitor Blox  
47pf to 10MFD

## Digital Triple Power Supply



**\$249** **XP-765**  
0-20V at 1A  
0-20V at 1A  
5V at 5A

Fully Regulated, Short circuit protected with 2 Limit Cont., 3 Separate supplies  
**\$175** **XP-660 with Analog Meters**

## Quad Power Supply



**\$59.95** **XP-580**  
2-20V at 2A  
12V at 1A  
5V at 3A  
-5V at 5A

Fully regulated and short circuit protected  
**\$39.95** **XP-575 without meters**

## 10Mhz XT 100% IBM® Compatible



**\$595** **MODEL PC-1000**  
5 Year Warranty

- 150W Power Supply
- 256K RAM
- Expandable to 640K
- Monochrome Monitor
- Monographic Video Card
- Parallel Printer Port

**FREE spreadsheet and word processor**  
3.XXMS DOS and GW Basic add 75.00

## Four-Function Frequency Counters



**\$179** **F-100 120MHz**  
**\$259** **F-1000 1.2GHz**

Frequency, Period, Totalize, Self Check with High Stabilized Crystal Oven Oscillator, 8 digit LED display

## GF-8016 Function Generator with Freq. Counter



**\$249**  
Sine, Square, Triangle Pulse, Ramp, .2 to 2MHz  
Freq Counter .1 - 10MHz

**\$179** **GF-8015 without Freq. Meter**

## WE WILL NOT BE UNDERSOLD!

UPS Shipping: 48 States 5%  
(\$10 Max) IL Res., 7% Tax



## C & S SALES INC.

1245 Rosewood, Deerfield, IL 60015  
(800) 292-7711 (312) 541-0710

## 15 Day Money Back Guarantee

2 Year Warranty Prices subject to change

WRITE FOR FREE CATALOG

design learn how to use the Smith Chart. A description of some basic procedures necessary to design a simple matching network follows. To gain a thorough understanding, check out references 4, 5, 6, and 7.

Although network problems could be solved with a set of simultaneous equations, the Smith Chart does the calculation for you while providing a graphic insight into the problem. It also provides potential solutions that the equations don't supply, and does away with many tedious calculations.

There are three circles within the Smith Chart circle (see **Figure 6**). The circle tangent to the left side of the Smith Chart is an admittance circle; the one tangent to the right side is an impedance circle. There are other admittance and impedance circles that can be drawn; however, these two are especially important because they pass through the chart's center. You can choose any value you wish for the chart's center impedance; for this discussion assume it is 50 ohms. The middle circle is the SWR circle and will be discussed later.

Other larger and smaller diameter admittance and impedance circles can be drawn, but they must be tangent to the left or right of the Smith Chart, respectively. (These other circles aren't shown in the computer display because I wanted to keep the chart relatively simple.) Reactive components (capacitors or inductors), placed in series or parallel with a load, will cause the load impedance to shift along these circles or paths. Shunt components cause shifts along the admittance circles and series components cause shifts along impedance circles. Capacitors cause shifts toward the bottom of the chart and inductors cause shifts toward the top. With these basic rules, you can design a simple matching network.

Enter the arbitrary load impedance, the frequencies of interest, and the desired SWR into the program. The program will draw a Smith chart on the screen, along with the points which represent your arbitrarily selected load. The "matching network game" objective is to select network elements which will move the load toward the 50-ohm point — the center of the Smith chart. However, the rules constrain you to move only along impedance or admittance circles to reach the center. Any impedance or admittance circle can be used as part of the path to reach any other circle on the way to the center.

Because the match doesn't have to be exactly 50 ohms to work properly, a matching performance criteria or SWR is used. A SWR of 1.5 or less is selected for this example, and when all load impedance points fall within this circle, the desired match will have been achieved.

Using **Table 1** data which are plotted in **Figure 6**, you can see that the user-defined load falls inside the impedance circle labeled Z. There are several design solutions available, but two very straightforward approaches involve moving the load impedance to the Z circle. Do this by moving the load impedance either up or down along an "invisible" admittance circle. Moving up along an admittance circle implies using a shunt inductor; moving down implies using a shunt capacitor as the first element in the matching network. Once you've moved the load impedance to the Z circle, you must move it to the center of the chart. If you first used a shunt capacitor to move the load to the Z circle, you have to select a series component to move it along the Z circle. Because the impedance must be

moved upward, a series inductor is required. If you used a shunt inductor to get the Z circle, you'll need to use a series capacitor to move down the impedance circle toward the Smith Chart's center.

I've been shown that two component combinations can move the initial impedance toward the 50-ohm point. Choose a combination for this design and determine the component values by selecting trial values and letting the program calculate and display the new resultant impedance.

Use the Smith Chart Network Analysis program to determine the component values which move the load the proper amount. Try a few values to see how the load impedance is moved on the chart. After entering the load values from **Table 1**, select a shunt capacitor from the menu for the first component. When prompted for a value, make a guess based on your experience, or from the capacitor values available in your junkbox. You'll find that if you try a value of 100 pF, the load doesn't move downward far enough, but appears to move about half the distance. A value of 170 pF will cause the three load points to straddle the Z circle line. For the series inductor, a little experimenting will lead to a value of 2.2  $\mu$ H. All three points now fall within the SWR circle of 1.5, with the displayed numerical values showing a maximum SWR of 1.21.

## Appendix C

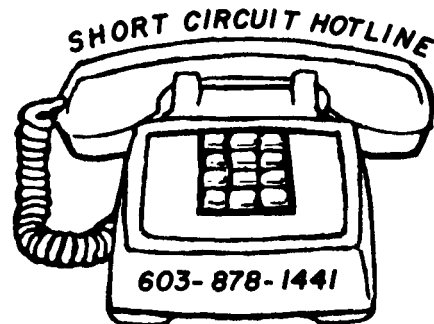
### Changing prestored load data

Prestored load data are contained in data statements at the end of the program starting at line 4430. The data must be entered in a specific format in order to be interpreted correctly by the Smith Chart Network Analysis program. Data are entered with frequency in MHz first, the real part (R) of the load impedance second, followed by the load impedance's imaginary part (jI). For example, if the load had an impedance of  $27 + j34$  at 14.2 MHz, and  $29 + j38$  at 14.3 MHz, the data statement would be:

```
DATA 14.2,27,34,14.3,29,38
```

#### REFERENCES

1. L. Gerig, "Computer Interface for Smith Chart Calculations," *RF Design* January/February, 1982.
2. L. Gerig, "Smith Chart Impedance Matching On Your Commodore 64," *Ham Radio*, October 1984.
3. *The ARRL Handbook for the Radio Amateur*, ARRL, 1985.
4. *The ARRL Antenna Book*, Thirteenth Edition.
5. "HF Transistor Amplifier Design," *RF Design*, September/October, 1981.
6. P. Smith, "Transmission Line Calculator," *Electronics*, January 1939.
7. P. Smith, "An Improved Transmission Line Calculator," *Electronics*, January 1944.



# THREE-ELEMENT VERTICAL DRIVEN ARRAY FOR 10 METERS

By Douglas Rowlett, Ph.D., WB5IRI, 2603 North  
Brompton, Pearland, Texas 77584

**T**en meters is wide open to Europe and Africa in the mornings, and to Japan and Australia in the evenings. But you just can't seem to break through the pileups — all the guys with their kilowatts and six-element monobanders at 70 feet grab the DX before you can even hit the microphone switch. Your barefoot transceiver and trap dipole just don't cut the mustard. Sure, you make a few contacts overseas — but your signal reports are always low, and no one wants to ragchew the way they do with those who are putting in better signals. Even if you had the money, your neighborhood's deed restrictions make a tower and rotatable beam out of the question, and an amplifier would only cause more TVI.

Sounds familiar? Well, why not try a vertical driven array? A three-element array for 10 meters is only 8 feet tall by 17 feet long, and should fit in the smallest backyard. The antenna in **Figure 1** is an end-fire array with elements 2 and 3 fed 90 and 180 degrees out of phase, respectively, relative to element 1. The array provides about 4.5-dB gain over a single quarter-wavelength vertical, has a front-to-back ratio of 15 to 20 dB, costs less than \$30 to build (even if you buy everything new), and can be erected in a single weekend. Separate gamma matching for each element simplifies adjustment and provides a low VSWR. Its low height makes this array unobtrusive, and if you mount the elements in your backyard the neighbors won't even know it exists. The major lobe is fairly broad, and the beam heading can be switched 180 degrees by swapping the phasing lines to elements 1 and 3.

## Construction

The elements are made of 3/4-inch diameter EMT conduit, which sells in hardware stores for under \$3 a 10-foot section. The gamma-matching rods are made from 1/2-inch

diameter EMT conduit, which runs about \$2 per 10-foot section. The shorting bar, clamps, and coax-connector support are made from the U-shaped two-hole straps commonly sold as wall fasteners for 3/4-inch conduit (see **Figure 2**). These usually sell for about \$1.25 per dozen. Radials for each element are quarter-wavelength sections of whatever size wire you happen to have on hand. It doesn't matter whether the radial wires are solid or stranded, and insulation on the radials makes no difference in performance.

## Element lengths

Antenna elements constructed of tubing should be slightly shorter than quarter-wavelength elements made of wire. The formula  $230/F_{\text{MHz}}$  results in element lengths of 8 feet at 28.5 MHz, which will provide a reasonably low VSWR over the entire 10-meter band. After the elements have been cut, deburr the cut ends with a file and drill four evenly spaced 3/32-inch holes around the circumference and 1/4 to 1/2 inch from one end of each element. You'll attach the radials and coax connectors at these points later with no. 6 self-tapping sheet metal screws.

## Gamma rods

The gamma rod and variable gamma capacitor for each element consists of a 20-inch piece of 1/2-inch conduit, an 18-inch piece of RG-8 foam dielectric coaxial cable, four conduit straps, and an SO-239 female coaxial cable connector. Cut and deburr the piece of conduit, then strip 1.5 inches of insulation from one end of the piece of RG-8 foam coax. Fold back the braid and remove 1 inch of the center dielectric; then solder the braid to the center conductor. Tape and seal the other end of the cable to prevent moisture contamination. Next, flatten two of the conduit



FIGURE 1

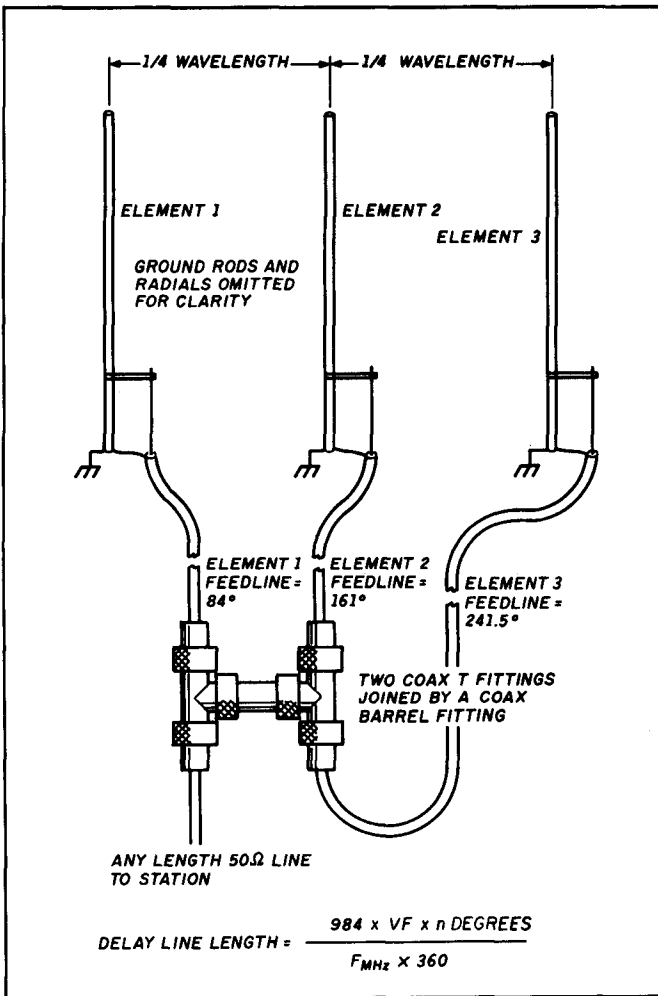
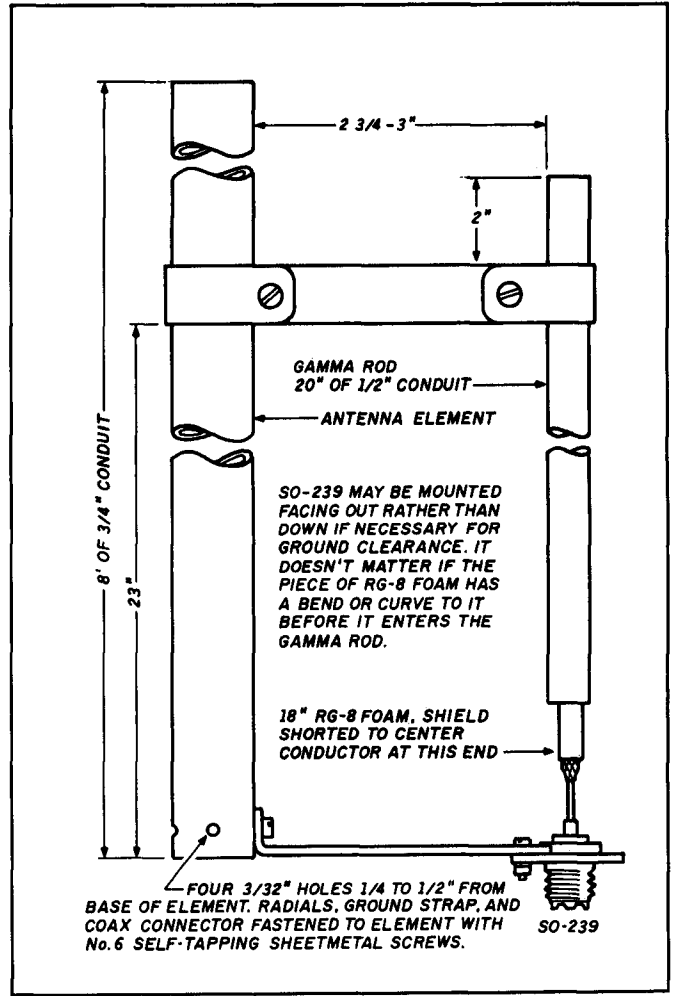


FIGURE 2



Three-element driven array for 28 MHz. Phasing lines are cut according to formula in text.

Assembling gamma rod and antenna element.

straps (a hammer works fine for this). File a notch in the end of one strap so the hole in the strap will mate with one of the holes on the SO-239's mounting flange. Fasten the strap to the connector with a 4-40 screw, lockwasher, and nut as shown in Figure 3. Bend the other end of this strap as indicated, and fasten it to the bottom of one element with a no. 6 self-tapping sheet metal screw.

### Gamma assembly

Make the shorting bar clamps by straightening the "ears" on the two remaining straps. Slip one modified strap onto the element, slide the other onto the gamma rod, place the remaining previously flattened strap between them (see Figure 3), and fasten tightly with machine screws, lockwashers, and nuts. Tighten the screws to form the clamps; they can be loosened for adjustment. Slip the already prepared section of coaxial cable into the gamma rod (don't worry about the sloppy fit — it won't make any difference in performance) and solder the shorted end of the cable to the center conductor of the SO-239.

The gamma rod with the cable inside makes an adjustable tubular capacitor of about 100 pF, which eliminates the expense of finding a suitable transmitting-type variable capacitor and the hassle of building some sort of weather-

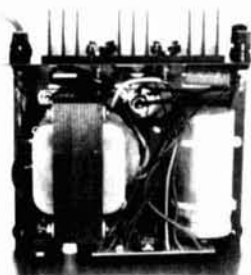
proof enclosure for each element. Loosen the clamps on the shorting bar and set the top edge of the gamma rod clamp 2 inches from the top of the rod and the bottom edge of the element clamp 23 inches from the base of the element. These dimensions will be your starting points during adjustment and tuneup. Tighten the clamps, set the element aside, and prepare identical matching sections for elements 2 and 3. It should take only a couple of hours to build all three elements.

### Element mounting

The elements should be spaced a quarter wavelength apart using the formula  $246/F_{MHz}$  (8 feet, 7 inches at 28.5 MHz), and mounted so they are in line with the compass bearing you wish to favor. I put mine on a wooden picket fence running due east and west; this gives me good coverage of Europe and Africa in one direction, and Australia and Japan in the other. As the main lobe is fairly broad, precise aiming isn't necessary with this array. The elements are fastened to the fence with conduit straps and wood screws. If you don't have a handy wooden fence running in the right direction, you can fasten the elements to wooden posts set deep enough to ensure that they won't topple over if disturbed.

## ASTRON POWER SUPPLIES

• HEAVY DUTY • HIGH QUALITY • RUGGED • RELIABLE •



INSIDE VIEW — RS-12A

### SPECIAL FEATURES

- SOLID STATE ELECTRONICALLY REGULATED
- FOLD-BACK CURRENT LIMITING Protects Power Supply from excessive current & continuous shorted output
- CROWBAR OVER VOLTAGE PROTECTION on all Models except RS-3A, RS-4A, RS-5A.
- MAINTAIN REGULATION & LOW RIPPLE at low line input Voltage
- HEAVY DUTY HEAT SINK • CHASSIS MOUNT FUSE
- THREE CONDUCTOR POWER CORD
- ONE YEAR WARRANTY • MADE IN U.S.A.

### PERFORMANCE SPECIFICATIONS

- INPUT VOLTAGE: 105-125 VAC
- OUTPUT VOLTAGE: 13.8 VDC  $\pm$  0.05 volts (Internally Adjustable: 11-15 VDC)
- RIPPLE Less than 5mv peak to peak (full load & low line)
- Also available with 220 VAC input voltage



MODEL RS-50A



MODEL RS-50M



MODEL VS-50M

### RM SERIES



MODEL RM-35M

### 19" x 5 1/4" RACK MOUNT POWER SUPPLIES

MODEL	Continuous Duty (Amps)	ICS* (Amps)	Size (IN) H x W x D	Shipping Wt. (lbs.)
RM-12A	9	12	5 1/4 x 19 x 8 1/4	16
RM-35A	25	35	5 1/4 x 19 x 12 1/2	38
RM-50A	37	50	5 1/4 x 19 x 12 1/2	50
• Separate Volt and Amp Meters				
RM-12M	9	12	5 1/4 x 19 x 8 1/4	16
RM-35M	25	35	5 1/4 x 19 x 12 1/2	38
RM-50M	37	50	5 1/4 x 19 x 12 1/2	50

### RS-A SERIES



MODEL RS-7A

MODEL	Continuous Duty (Amps)	ICS* (Amps)	Size (IN) H x W x D	Shipping Wt. (lbs.)
RS-3A	2.5	3	3 x 4 1/4 x 5 1/4	4
RS-4A	3	4	3 1/4 x 6 1/2 x 9	5
RS-5A	4	5	3 1/2 x 6 1/2 x 7 1/4	7
RS-7A	5	7	3 3/4 x 6 1/2 x 9	9
RS-7B	5	7	4 x 7 1/2 x 10 3/4	10
RS-10A	7.5	10	4 x 7 1/2 x 10 3/4	11
RS-12A	9	12	4 1/2 x 8 x 9	13
RS-12B	9	12	4 x 7 1/2 x 10 3/4	13
RS-20A	16	20	5 x 9 x 10 1/2	18
RS-35A	25	35	5 x 11 x 11	27
RS-50A	37	50	6 x 13 1/4 x 11	46

### RS-M SERIES



MODEL RS-35M

MODEL	Continuous Duty (Amps)	ICS* (Amps)	Size (IN) H x W x D	Shipping Wt. (lbs.)
• Switchable volt and Amp meter				
RS-12M	9	12	4 1/2 x 8 x 9	13
• Separate volt and Amp meters				
RS-20M	16	20	5 x 9 x 10 1/2	18
RS-35M	25	35	5 x 11 x 11	27
RS-50M	37	50	6 x 13 1/4 x 11	46

### VS-M AND VRM-M SERIES



MODEL VS-35M

- Separate Volt and Amp Meters • Output Voltage adjustable from 2-15 volts • Current limit adjustable from 1.5 amps to Full Load

MODEL	Continuous Duty (Amps)			ICS* (Amps)	Size (IN) H x W x D	Shipping Wt. (lbs.)
	@13.8VDC	@10VDC	@5VDC	@13.8V		
VS-12M	9	5	2	12	4 1/2 x 8 x 9	13
VS-20M	16	9	4	20	5 x 9 x 10 1/2	20
VS-35M	25	15	7	35	5 x 11 x 11	29
VS-50M	37	22	10	50	6 x 13 1/4 x 11	46
• Variable rack mount power supplies						
VRM-35M	25	15	7	35	5 1/4 x 19 x 12 1/2	38
VRM-50M	37	22	10	50	5 1/4 x 19 x 12 1/2	50

### RS-S SERIES



MODEL RS-12S

- Built in speaker

MODEL	Continuous Duty (Amps)	ICS* (Amps)	Size (IN) H x W x D	Shipping Wt. (lbs.)
RS-7S	5	7	4 x 7 1/2 x 10 3/4	10
RS-10S	7.5	10	4 x 7 1/2 x 10 3/4	12
RS-12S	9	12	4 1/2 x 8 x 9	13
RS-20S	16	20	5 x 9 x 10 1/2	18

## The importance of a good ground system

I can't overemphasize the importance of a good ground system for this or any other type of ground-mounted vertical array. Remember, the efficiency of a grounded vertical antenna is directly related to the quality of its ground system. This array *will* radiate with no ground system at all (although it will be difficult to tune) and will still provide about 4.5 dB of gain, but that gain is referenced to a single *similar* element. The efficiency of a quarter-wavelength vertical over poor ground may be 25 percent or less, which means that a poorly grounded array of this type would barely achieve the efficiency of a single horizontal dipole.

## Ground losses

The *ARRL Antenna Book* lists the loss resistance for a quarter-wavelength vertical with only four radials as 29 ohms! Because loss resistance is added in series to radiation resistance, four radials on a vertical is equivalent to putting a 30-ohm resistor in series with your feedline. Eight radials drops the loss resistance to 18 ohms, while 16 radials lowers it to only 9 ohms. While this isn't ideal, it's a figure most of us can live with.

An ideal ground system would consist of 120 or more quarter-wavelength radials fanned out equally around the base of each element, but a reasonable compromise can be achieved using a ground rod and 16 quarter-wavelength radials for each element. Obviously, the more radials the better, with 16 per element as a minimum starting figure. However, if you decide to install more than 16 radials, remember that you'll need to double the number of radials *per element* to achieve any appreciable reduction in ground loss. The next step up from 16 would be 32 radials, and the step after that would be 64 — that's a total of 192 radials!

## The ground screen

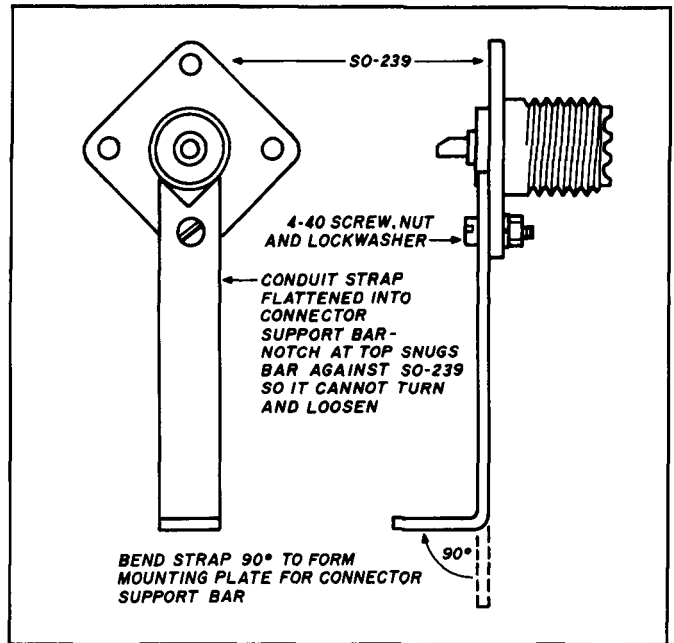
An alternative to installing a radial system is to use metal screening or hardware cloth. As long as all the joints are bonded together electrically, you can lay the metal mesh directly on the ground, secure it, and let the grass grow up through it. Eventually you won't even be able to tell it's there. Such a ground screen should cover the area immediately under the array and extend a quarter wavelength from the sides and ends. Individual strips of screening material must be soldered or welded to adjoining strips every few inches. That much hardware cloth (nearly 700 square feet) would be pretty expensive, which is why I used radials. But if you happen to have enough screen on hand, give it a try. It will make a nearly perfect ground for your array, and cut ground losses to nearly zero.

## Ground rod and radial construction

Each element in my array has its own ground rod made from 4-foot pieces of steel reinforcing rod (rebar), hammered into the ground at the base of the element until only the top 2 inches stick out. Perhaps copper ground rods would be better, but rebar is cheap, durable, and readily available in my area. You could also use 4-foot sections of conduit in place of the rebar. Longer ground rods might be better, but 4-foot rods are difficult enough to drive into the soil. Bond the ground rod to the base of the element with a short piece of heavy wire or braid.

The quarter-wavelength radials are cut to the formula

FIGURE 3



Connector support bar is fashioned from conduit strap.

$234/F_{\text{MHz}}$ , which makes them 8 feet, 2-1/2 inches long at 28.5 MHz. I used inexpensive four-conductor telephone hookup wire because I had it on hand, cut four sections for each element to the proper length, separated the four wires in each section from their outer covering, and fastened them to the bottoms of the elements with ring connectors and sheet metal screws. Any wire of any size will do, as long as the radials are close to the right length. Ideally, the radials should be fanned out around the base of each element evenly; however, if you don't have the space, don't worry too much about it. There will be some pattern skewing in the direction of the greatest number of radials, but the array will still function just fine. Some people like to bury their radials; I use U-shaped pieces of stiff wire (ordinary bobby pins work well) to peg the radials to the ground at approximately 1-foot intervals, so people won't trip over them.

## Phasing lines

As shown in Figure 1, the phasing or delay lines for this array are brought to a common point and connected together by a "plumber's delight" arrangement of two coaxial T fittings joined by a coaxial barrel connector. One feedline of any length of 50-ohm coax goes to the station. I recommend Belden 9913, RG-8 Foam, RG-8, or RG-8X for long runs. Stay away from RG-58 unless the transmission line going to your shack is shorter than about 50 feet. Cut the remaining three feedlines to the elements so that element 2 is 90 degrees out of phase with element 1, and element 3 is 180 degrees out of phase with element 1. Cut the phasing lines according to the formula:

$$\frac{984 \times VF \times n \text{ degrees}}{F_{\text{MHz}} \times 360} \quad (1)$$

where VF = the velocity factor of the coaxial cable used.

This gives you the *electrical* length of a piece of coaxial cable  $n$  degrees long. Thus, element 1 is fed with a 90-degree (quarter wavelength) section of coaxial cable; element 2, if it is to be 90 degrees out of phase with element 1, requires a 180-degree section (half wavelength); and element 3, which you want to be 180 degrees out of phase with element 1, takes a 270-degree section (three-quarter wavelength). However, since there's mutual coupling among the elements in the array, the line lengths must be adjusted from these values somewhat to provide a proper feed. The line to element 1 should be 84 degrees long, the line to element 2 should be 161 degrees, and the line to element 3 should be 241.5 degrees long. I used RG-8X coaxial cable, which has a velocity factor of 0.75, to construct my delay lines. The feedline for element 1 is 6 feet, for element 2 it's 11.5 feet, and for element 3 it's 17 feet 4 inches. These lengths include the coaxial connectors at the ends of each feedline. If you use a different type of coaxial cable, with a different velocity factor, you'll have to refigure the feedline lengths. Chapter 24 of *The ARRL Antenna Book* lists the velocity factors of popular coaxial cables.

## Adjustment

Before you connect the phasing lines to the elements, you must first tune each element to resonance. Without a feedline attached to either element 2 or 3, but with all three elements mounted in place, connect a VSWR bridge to the base of element 1 directly through a short piece of 50-ohm coax, and connect the meter to your transceiver through the feedline you'll use to drive the array. Adjust the position of the clamps on the element and gamma rod for lowest VSWR (making sure the transmitter is off while you work on the antenna, of course).

## Obtaining lowest VSWR

First move the shorting bar up and down both the element and the gamma rod in small increments, until you reach the point of lowest VSWR. Then move the gamma rod only up and down in its clamp (this adjusts the variable capacitor) to bring the VSWR down further. By alternating these adjustments — first the shorting bar, and then the gamma capacitor, you should be able to find a point where the VSWR is nearly 1:1. Once you've found this point, tighten the clamps securely, and repeat the procedure for each of the other two elements. Go back and check that element 1 is still in tune. (Remember, there's mutual coupling among the elements and all adjustments are somewhat interdependent.) Repeat these adjustments until each element's VSWR is as close to 1 as possible.

Now connect the three delay lines to the elements, and their opposite ends to the main feedline, as shown in **Figure 1**. Apply power to the array. The VSWR at the station should be around 1.5:1. If it isn't, and all the elements are close to 1:1 at their feedpoints when tuned individually, you can feed the array through a matching network located at the transmitter end of the feedline to make your transistorized finals happy. Tuning will differ from one installation to another, depending upon ground losses, proximity to nearby conducting objects, and the number of radials attached to each element.

That's all there is to it. The direction of maximum radiation or reception will be in line with the array from element

1 to element 3. To switch the direction of the array, simply connect the feedline of element 1 to element 3, and the feedline of element 3 to element 1.


## Performance

I don't have an antenna range, but on-the-air tests comparing the array with a 10-meter dipole at 35 feet indicate that the array beats the dipole by a minimum of 1 to 2 S-units — and sometimes (especially if the other station is using vertical polarization) by as much as 4 to 5 S-units. The low angle of radiation presented by vertical antennas helps on those long DX contacts, and the vertical array seems less susceptible to atmospheric noise than the dipole — although it is more susceptible to manmade noise. Stations off the back of the array are typically 4 to 6 S-units weaker than with the dipole, which helps when you're trying to pull a weak one through QRM.

## Adding more elements

I like a three-element design for this array because of its broad main lobe, and because it simplifies beam pattern switching. I just have to swap the feedlines to elements 1 and 3 to "turn" the beam 180 degrees. However, if you wish to work in one direction only, or if you don't mind changing several different feedlines, there's no reason why you can't add more elements to this array. The theoretical gain of an array of this type is  $10 \log(N)$ , where  $N$  equals the number of elements. Thus, maintaining quarter-wavelength spacing between elements, an array with four elements would have a gain of 6 dB, five elements would give you 7 dB, and six elements would give 7.8 dB over a single similar element. Actual gain figures will, of course, be slightly lower, depending upon ground losses, feedline losses, and proximity to nearby objects. Remember that adding elements will narrow the beamwidth, which will make aiming the beam more critical.

The effects of mutual impedance among the elements become more critical as the number of elements increases; so do delay line losses. You'll want to use only high quality, low loss coax for your delay lines, and you'll probably want to use the current-forcing method of feeding multi-element arrays described in Chapter 8 of *The ARRL Antenna Book*. However, the math and measurements involved in using the current-forcing method are quite cumbersome. If you're in the mood to experiment, you might try delay line lengths of 322 degrees for element 4, 402.5 degrees for element 5, and 483 degrees for element 6.

I'd be interested in hearing from others who build this array — especially from those who adapt it to other bands, or add additional elements. 

### Invitation to Authors

*ham radio* welcomes manuscripts from readers. If you have an idea for an article you'd like to have considered for publication, send for a free copy of the *ham radio* Author's Guide. Address your request to *ham radio*, Greenville, New Hampshire 03048 (SASE appreciated).

# If you plan to buy an amplifier this year...

# do yourself a favor!



You wouldn't buy a car from a dealer who offers only one model. . .so why buy an amplifier that way?

Henry Radio offers the widest choice of amplifiers in the world. We design and produce amplifiers to fit different needs and different budgets. We feel we offer the best equipment and there are a lot of amateurs who obviously agree. That's why we've sold over 40,000 amplifiers during the last 25 years. If you plan to buy an amplifier, do yourself a big favor. . .call, write, FAX, or come in. But make sure you have our new information packet in your hands before you make a decision. You owe it to yourself. Read it through, compare the specs, compare prices, compare VALUE.

And, of course, when you buy from Henry Radio you're buying factory direct.



Henry Radio. . .  
the amplifier specialists

Our present HF amplifier line includes the following models:

2KD STANDARD	Single 3-500Z Desk SSB Amp	3K CLASSIC MKII	Domestic Console
2KD CLASSIC	Desk Model Linear Amplifier	3K CLASSIC MKII	Export Console
2K CLASSIC	Console Amplifier	3K CLASSIC RF	RF Deck only
2K CLASSIC X	Domestic Console	5K CLASSIC	Export Console
2K CLASSIC X	Export Console	5K CLASSIC RF	RF Deck only
2K CLASSIC X RF	RF Deck only	3K PREMIER	Console Amp. with 160 meters
3KD CLASSIC	Single 3CX1200A7 Desk Amp	3KD PREMIER	Desk Amp. with 160 meters



## Henry Radio

2050 S. BUNDY DR. LOS ANGELES, CA 90025 (213) 820-1234  
Toll free order number: (800) 877-7979 TELEX: 67-3625(Henradio) FAX: (213) 826-7790

# AN EXCLUSIVE LOOK AT KENWOOD'S TS-950S

J. Craig Clark, NX1G, Assistant Publisher, *Ham Radio Magazine*

One of the best parts of Amateur Radio publishing is getting a chance to go behind the scenes of new product development and marketing. Recently I was offered a good look at Kenwood's new addition to their HF line — their just-announced TS-950S. Here's a preview of the features and preliminary specifications of this new transceiver.

## The basics

The engineers at Kenwood have really worked overtime (and then some) to design this new radio. The TS-950S is a 10 through 160-meter Amateur transceiver plus a general coverage receiver from 100 KHz to 30 MHz. The transmitter section is rated at 150 watts output on all Amateur bands. The TS-950S has dual receive capability and incorporates the latest digital filtering techniques in both its transmitter and receiver.

Kenwood called a short time ago and gave me some exclusive information on the new TS-950S transceiver. You can imagine the excitement it created here at *Ham Radio* as we conjured up all kinds of design ideas and operational capabilities over a lunch of burgers and fries.

Then Kenwood faxed us the preliminary technical specifications, operational capabilities, and other design features. We pored over the "top secret" material anxiously to see how close we had come to predicting what the TS-950S could do and how it compared with other radios. We certainly weren't disappointed.

## New features

One of the radio's most interesting new features is Kenwood's Digital Signal Processor (DSP). The DSP is designed to take advantage of the latest state-of-the-art signal processing techniques. Kenwood's new DSP technology allows the following ratings for the TS-950S: spurious response less than 50 dB, unwanted sideband suppression less than 60 dB, and carrier suppression of greater than 50 dB. These numbers are 10 dB better than can normally be achieved with analog signal processing. This should be a major step forward in reducing unwanted clutter and noise on the Amateur bands.

The DSP also allows flat and clean transmit audio over four user-selectable ranges. Emphasis can be either added or subtracted, based on operator preferences and individual voice characteristics. Digital tailoring, as opposed to brute force analog processing, is expected to result in a much cleaner transmitted audio signal. This can be the margin of difference in intelligibility under crowded bands conditions.



Code operators should find the CW waveform quite pure and free of any spurious signals. The waveform rise time is user selectable in either fast or slow modes. Finally, the DSP gives you a digital AF filter. The AF filter is synchronized with the SSB IF slope-tuning controls to improve slope-tuning filter response characteristics.

Another neat TS-950S feature is its dual receive capability. The TS-950S lets you listen on two separate frequencies (within 500 KHz of each other) simultaneously.

A separate IF circuit for the subreceiver minimizes problems even under the most adverse operating conditions. Frequency selection is separate from the main receiver and is available in either 10 or 100-Hz steps. The subreceiver also has a noise blanker control that's independent of the main receiver settings. The audio level is continuously variable and the subreceiver has a florescent tube display of its own.

Kenwood has also redesigned the final amplifier circuit to take advantage of high output, 50-volt, low noise RF transistors. Consequently, you should never find yourself running short of sufficient drive for any amplifier you may have. The final deck is mounted on a large aluminum heat sink and has a thermally switched fan.

The automatic antenna tuner is a nice little extra. It's controlled by its own microprocessor and preprogrammed with band settings to reduce tuning time.

In addition to using digital signal processing, the receiver section has a redesigned front end with a cascode amplifier circuit (or source floor circuit). The signal is fed into the first of two double balanced mixer circuits. This technique is used to reduce the noise floor substantially and improve two-tone characteristics. The IMD is claimed to be less than -37 dB with an intercept point of +20 dBm, a dynamic range of +105 dB, and a noise floor of -140 dBm.

The TS-950S's filtering is very similar to the earlier Kenwood HF radios with SSB IF slope tuning, CW VBT, AF tune audio filter, and an IF notch filter. In CW and RTTY modes

## TS-950S preliminary engineering specifications

### General

Transmitter frequency range.....	160-meter band 1.8 to 2.0 MHz 80-meter band 3.5 to 4.0 MHz 40-meter band 7.0 to 7.3 MHz 30-meter band 10.1 to 10.15 MHz 17-meter band 18.068 to 18.168 MHz 15-meter band 21.0 to 21.45 MHz 12-meter band 24.89 to 24.99 MHz 10-meter band 28.0 to 29.7 MHz
Receiver frequency range.....	100 kHz to 30 MHz
Mode.....	J3E(SSB), A1A(CW), F1B(FSK), F3E(FM), A3E(AM)
Temperature range.....	14°F to 122°F
Frequency stability.....	$\pm 0.5 \times 10^{-6}$
Frequency accuracy.....	$\pm 10 \times 10^{-6}$ (at normal temperatures)
Antenna impedance.....	50 ohms
Power requirements.....	120/220/240 volts AC, 50/60 Hz
Power consumption.....	Maximum transmit 700 watts. Receive (no signal) 80 watts
Dimensions.....	15.83" W x 5.55" H x 15.75" D (projections not included)
Weight.....	40.78 pounds (approximately)

### Transmitter

Final power output.....	SSB/CW/FSK/FM = 150 watts PEP, 10 meters: 110 watts
Modulation.....	SSB = balanced modulation, FM = reactance modulation, AM = low level modulation
FM maximum:	
Frequency deviation.....	$\pm 5$ kHz
FSK shift width.....	170 Hz
Carrier suppression.....	Less than -50 dB
Spurious response.....	Less than -40 dB (CW)
Unwanted sideband	
Suppression.....	Better than 60 dB (modulation frequency—1.5 kHz)
Third Harmonic	
Intermodulation distortion.....	Better than -37 dB (at 14.2 MHz) (based on single tone output)
Microphone impedance.....	500 to 50 k ohms
Frequency response (SSB).....	200 to 3100 Hz

the AF VBT lets you tune the audio passband away from interfering signals.

An interesting new feature gives you the ability to select second or third IF filter combinations independently, based upon conditions, and save them in memory with the operating frequency. This conserves time when changing bands or modes.

## Visit to Kenwood

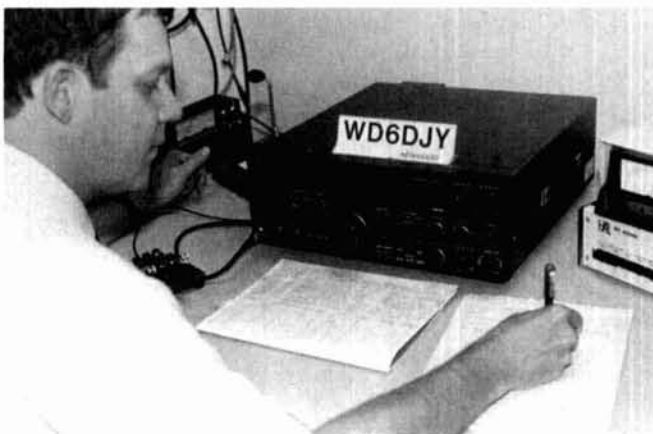
Several days after receiving the preliminary specifications on the TS-950S from Kenwood, I was in Los Angeles and had an opportunity to sit down and spend a few hours operating this new radio.

The basic layout of knobs, buttons, switches, and other controls is very similar to earlier Kenwood models. It took me just a few minutes with the user's manual to learn how to operate the TS-950S. However, I quickly found that it would take a little extra time to become acquainted with some of

### Receiver

Circuitry.....	Quadruple conversion system
Intermediate frequency.....	1st IF—73.05 MHz 2nd IF—8.83 MHz 3rd IF—455 kHz 4th IF—100 kHz (except FM)
Sensitivity.....	SSB,CW,FSK: Less than 2.5 $\mu$ V (100 to 150 kHz) (at 10 dB S/N) 1 $\mu$ V (150 to 500 kHz) 4 $\mu$ V (500 kHz to 1.62 MHz) 0.2 $\mu$ V (1.62 to 30 MHz) AM: Less than 25 $\mu$ (100 to 150 kHz) (at 10 dB S/N) 10 $\mu$ V (150 to 500 kHz) 32 $\mu$ V (500 kHz to 1.62 MHz) 2 $\mu$ V (1.62 to 30 MHz) FM: 12-dB SINAD less than 0.5 $\mu$ V (28 to 30 MHz)
Squelch sensitivity.....	SSB,CW,FSK, AM: Less than 6.2 $\mu$ V (100 to 150 kHz) 2.5 $\mu$ V (150 to 500 kHz) 10 $\mu$ V (500 kHz to 1.62 MHz) 0.5 $\mu$ V (1.62 to 30 MHz) FM: Less than 0.32 $\mu$ V (28 to 30 MHz)
Image ratio.....	More than 80 dB (1.8 to 30 MHz)
IF rejection.....	More than 70 dB (1.8 to 30 MHz)
Selectivity.....	SSB,CW,FSK: 2.4 kHz (-6 dB) 3.8 kHz (-60 dB) AM: 6 kHz (-6 dB) 15 kHz (-60 dB) FM: 12 kHz (-6 dB) 24 kHz (-60 dB)
Variable frequency range..	SSB slope tuning (with SSB filter) High cut = more than 1500 Hz Low cut = more than 700 Hz CW VBT (without optional filter) 600 Hz to 2.4 kHz (continuous)
RIT/XIT variable range.....	$\pm 999$ kHz
Notch filter attenuation.....	More than 45 dB
Audio output power.....	1.5 watt (8 ohms at 10 percent distortion)

Specifications are subject to change on production radios without notice.



the new features and ascertain the radio's true power.

One of the first things I noticed is that Kenwood has gone to a bar graph readout, as opposed to the analog meter movement found in other radios. The indicator shows signal strength, final current, SWR, compression, ALC level, and power output.

The filter selection readouts are located next to the bar graph. The first IF (8.83 MHz) filter lights are on the left; the

(continued on page 80.)

# ARTIFICIAL INTELLIGENCE APPLICATIONS IN AMATEUR RADIO

## Make your computer think for you!

By Bryan Bergeron, NU1N, 30 Gardner Road,  
Apt. 1G, Brookline, Massachusetts 02146

**S**ince their introduction a little over a decade ago, microcomputers have been applied to virtually all phases of Amateur Radio — from modeling the ionosphere to predict HF propagation; calculating antenna radiation patterns; generating and interpreting CW, RTTY, and SSTV; to satellite tracking and circuit design. In general, these and other Amateur Radio applications use complete, step-by-step algorithms for problem solving. For example, when you know the DC voltage and resistance, you can calculate the current using Ohm's Law,  $I=E/R$ .

However, there are problems in Amateur Radio that don't lend themselves to simple algorithmic solutions; they are non-numeric and ill defined. For instance, if your receiver suddenly exhibits reduced audio output, what's the most likely point of failure? Is it the power supply? Perhaps it's the RF amplifier? Suppose you have both vertical and dipole antennas, and you want to contact Canada. Assuming the same working frequency, which antenna should you use? What if there's snow on the ground? What if it's summer...or winter? Diagnosing transceiver and antenna failures, and complex propagation predictions are but a few of the problems in Amateur Radio that defy simple numerical analysis. I'd like to tell you about expert systems — a class of "Artificial Intelligence" (A.I.) software tools developed expressly for non-numeric problems — and their Amateur Radio applications.

### Some expert system basics

A.I. is a branch of computer science devoted to investigating robotics, vision, speech recognition, and machine intelligence. Expert systems are one of the more commercially viable offshoots of the last decade of A.I. research. Current expert system research is concerned with replacing scarce, expensive human experts with readily available, inexpensive computer "clones," which possess the problem-

solving abilities of the human experts. These expert systems are appealing because they provide instantaneous advice. The system asks only for the data it deems necessary to solve the particular problem it's presented.

You can think of an expert system as a program composed of two major interdependent modules. First, it's an inference engine or rule interpreter for defining rules specific to the problem area. The inference engine is also responsible for informing the user of the conclusions that have been reached. Second, it's a knowledge base, which usually takes the form of rules. An example of a rule from a knowledge base dealing with power supply diagnosis might read:

**IF the output voltage is zero, AND there is a strong odor like burning tar, THEN the power transformer is suspect.**

Notice that, for the most part, this rule isn't numerical. Rules are typically composed of simple, English-like statements. The premise (the IF and AND parts of a rule) is always followed by a conclusion (the THEN part of a rule).

The rules in a knowledge base are generally constructed by interviewing a human expert and determining what heuristics (rules of thumb) he or she uses in solving specific problems. Capturing the human expert's heuristics is the point of expert system programming. Consider, for example, how a novice technician might go about troubleshooting a particular power supply. He first checks the fuses, then the transformer, and so on, in some sort of systematic fashion. The expert technician, with years of experience repairing the same model power supply, checks the rectifier bridge immediately. Based on past experience, the expert knows that on power supplies of this design, the rectifier bridge is the most likely point of failure. Now, if the novice technician works long enough with the expert, he, too, will learn the rules of thumb for each piece of equipment. Unfor-



MAGGIORE ELECTRONIC LAB.

Manufacturers of Quality Communications Equipment

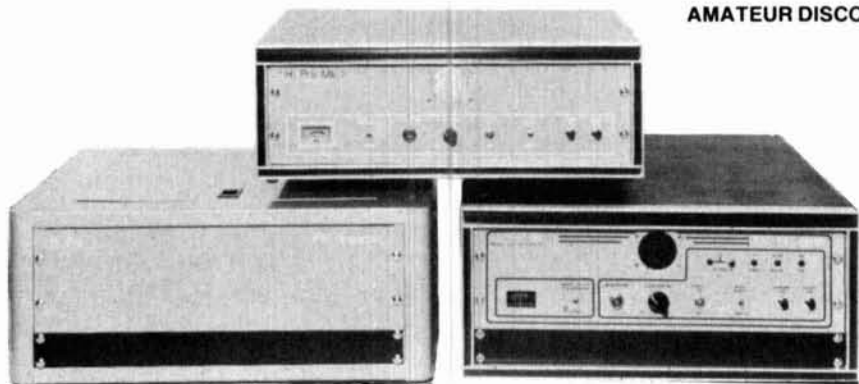
# Hi PRO

## VHF-UHF REPEATERS

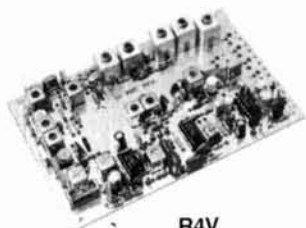
SUPERIOR RECEIVER AND TRANSMITTER SPECIFICALLY DESIGNED FOR REPEATER SERVICE.

ADJUSTABLE TRANSMITTER POWER, FROM 1 TO 25 WATTS MINIMUM OUTPUT WITH EXTREMELY COOL OPERATION.—  
 AUTOMATIC BATTERY BACK UP SYSTEM CAPABILITY WITH BATTERY CHARGING AND REVERSE POLARITY PROTECTION.—  
 NOW WITH A FULL COMPLIMENT OF INDICATORS AND STATUS LIGHTS.—100% DUTY CYCLE—ADVANCED REPEATER SQUELCH  
**NO CHOPPING, POPPING, OR ANNOYING REPEATER KEY UPS DURING LIGHTNING STORMS.**—DIE CAST ALUMINUM R.F.  
 ENCLOSURES —SMALL SIZE 5 1/4 x 19 x 13 " —HIGH QUALITY LONG LIFE DESIGN.

**AMATEUR DISCOUNTS AVAILABLE**



### Hi Pro Receivers

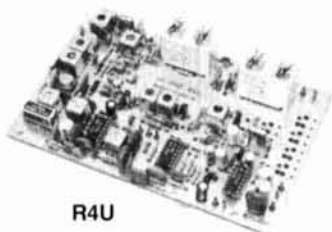


R4V

The **Hi Pro Receiver** is the heart of the Hi Pro Repeater specifically designed to commercial specifications for Repeater service, and boasts high Q multi tuned circuits in both the rf and oscillator stages to insure low desense intermod and spurious along with choice of varying degrees of if selectivity. Superior squelch action, a necessity for Repeater service, extreme sensitivity, frequency and thermal stability. This receiver not only can be used as initial receiver, but also to replace that troublesome receiver in your present repeater. Easily adapts to any system. The small size, allows for easy mounting, even where space is at a premium. The excellent front end rejection with wide dynamic range guarantees excellent desense, intermod, and spurious response rejection. Advanced squelch circuitry to produce min. squelch chopping, even with weak signals of high deviation, such as weak mobile or rapid fading signals, and also high electrical noise rejection, such as electrical storms, ignition pulses, etc.

**FEATURES:**

- High sensitivity
- Superior rejection
- Double sided mil spec G-10 fiberglass boards
- Extremely stable operation
- Excellent adjacent channel rejection
- Squelch circuit designed for critical repeater use
- Small size
- Choice of passbands
- Wide selection of frequency ranges
- Separate open collector C.O.R. output
- Separate tone control squelch input
- Separate tone control output
- Discriminator meter output
- Signal level meter output
- Multi channel capability. Up to 6 channels
- Multiple Voltage Regulation
- Available with precision grade high stability crystal.
- Selectable C.O.S. high or low output
- 1 year warranty



R4U

**SPECIFICATIONS:**

- Sensitivity:**  
 12 dB Sinad (EIA Method) 0.25 uv,  
 20 db quieting method 0.30 uv
- Selectivity:**  
 EIA two signal method  
 Standard ± 15 kHz -80 dB  
                   ± 30 kHz -130 dB  
 Optional Narrow ± 15 kHz -100 dB  
                           ± 30 kHz -130 dB
- Spurious Response:** -85 dB
- Intermodulation:** -70 dB
- Modulation Acceptance:** Standard ± 6.0 kHz  
   Narrow ± 5.0 kHz
- Squelch Sensitivity:** 0.10 to 0.20 uv
- Frequency Response:** +2 to -3 dB of 6 dB/Octave  
 de-emphasis from 300-3000 Hz, 1000 Hz reference.
- Audio Output:** (to 8 ohm speaker) 2.0 watts max.  
   5% distortion at 1.5 watts max.
- Rf input impedance:** 50 ohms
- Frequency Range:**  
 V.H.F. 130-150 MHz, 144-175 MHz, 220-250 MHz.  
 U.H.F. 406-450 MHz, 450-490 MHz
- Operating Voltage:** +11 to +14.5 V.D.C.  
                                   +13.8 V.D.C. nominal
- Current:** 90 mA nominal squelched
- Size:** 3 1/8" W x 6 1/8" L x 1 1/8" H.
- Duty Cycle:** 100% at 60° C
- Operating Temp. Range:** -30° C to +60° C
- Meets or Exceeds All Published Specifications.*



ASK ABOUT OUR COMPUTER CONTROL SYSTEM, AND MICROCONTROL AUTO PATCH, AND REPEATER KITS.

**Maggiore Electronic Laboratory**

600 WESTTOWN RD., WEST CHESTER, PA 19382  
 PHONE: 215-436-6051   TELEX: 499-0741-MELCO   FAX: 215-436-6268

**WRITE OR CALL FOR OUR COMPLETE CATALOG**

# NYE

Takes the fear out of full power antenna tuners, and the guesswork out of PEP measurement with these two MUST SEE PRODUCTS!!

## MB-V-A



Discover this durably built, feature packed MB-V-A Antenna tuner. You'll find operating conveniences that make antenna tuning a snap and value engineered to do the job over wide operating ranges. Compare quality, features and the NYE VIKING TWO YEAR WARRANTY.

## RFM-003



Get correct easy to read measurements of PEP for SSB, AM, and Pulse along with full time completely automatic SWR display with this unique Power Monitor System. Two models to choose from: The RFM-003 for 3KW indication and The RFM-005 for 5KW.

### CHECK THE FEATURES:

- **PI Network.** Low Pass PI Network tuning 1.8-30 MHz. Heavy duty silver plated continuously variable inductor with 25:1 vernier dial. 7000 volt variable capacitor and 10,000v switch selected fixed capacitors on output side. Tunes 40-2000 ohms loads. Good Harmonic suppression!
- **Automatic SWR.** Hands free metering of SWR. No reset or calibration needed. Separate power meter—300 or 3000 w f.s. automatically switched. Easy to read 2.5" recessed and back-lighted taut band meters.
- **Antenna Switch.** PUSH-BUTTON antenna switching to (4) antennas (2 coax, single wire and twin lead). Coax bypassed on first coax output. We designed this switch to take the power. Rated at 10KV and 20 amps.
- **3 KW Balun.** Trifler wound triple core torroid gives balanced output to twin feeder from 200 to 1000 ohms and unbalanced output down to 20 ohms.
- **Maximum Power Transfer.** Match your transmitter output impedance to almost any antenna system for maximum power transfer. Amplifiers only run at their designed Q when properly matched.
- **Model Options.** MB-IV-A1 includes all MB-V-A features less antenna switch and balun. MB-IV-A2 is identical to MB-IV-A1 with the addition of a triple core balun.
  - 1.8 MHz will not tune on some antennas.
- **(3) Modes** — Peak Average and Peak and Hold with a unique non-drift Sample & Hold Analog memory circuit.
- **(2) Ranges** — Automatically switched power scales to 5 KW.
- **Fully Automatic SWR** — Full time meter displays ratios directly without drift.
- **Built-in ALO** — Protect your amplifier tube investment with this fast acting lockout.
- **Remote Couplers** — Six feet remotes the interchangeable calibrated couplers.
- **True RMS Conversion** — H.F. couplers use forward biased full wave detection.
- **Rugged Construction** — Heavy gauge aluminum construction. Top quality glass epoxy PCB. This meter is built to last.
- **Accuracy** — Guaranteed to  $\pm 5\%$  F.S.
- **Warranty** — TWO FULL YEARS
- **Added Features** — Switchable reverse power all mode metering — Full status LED Display — Adjustable ALO is switchable SWR/REFL power — Heavy duty Nicad batteries charged by the applied RF for the field and a charger is supplied for fast charging and backlighting of the taut band meters for the ham shack.

### OTHER NYE VIKING PRODUCTS

Phone Patches — Electronic and Memory Keyers — Squeeze Keys — Straight Keys — Code Practice Sets — SWR Wattmeter for the blind — Low Pass Filters — All Band Antennas and more ...  
ASK FOR A FREE FULL LINE CATALOG.

### TO ORDER, CALL YOUR FAVORITE DEALER

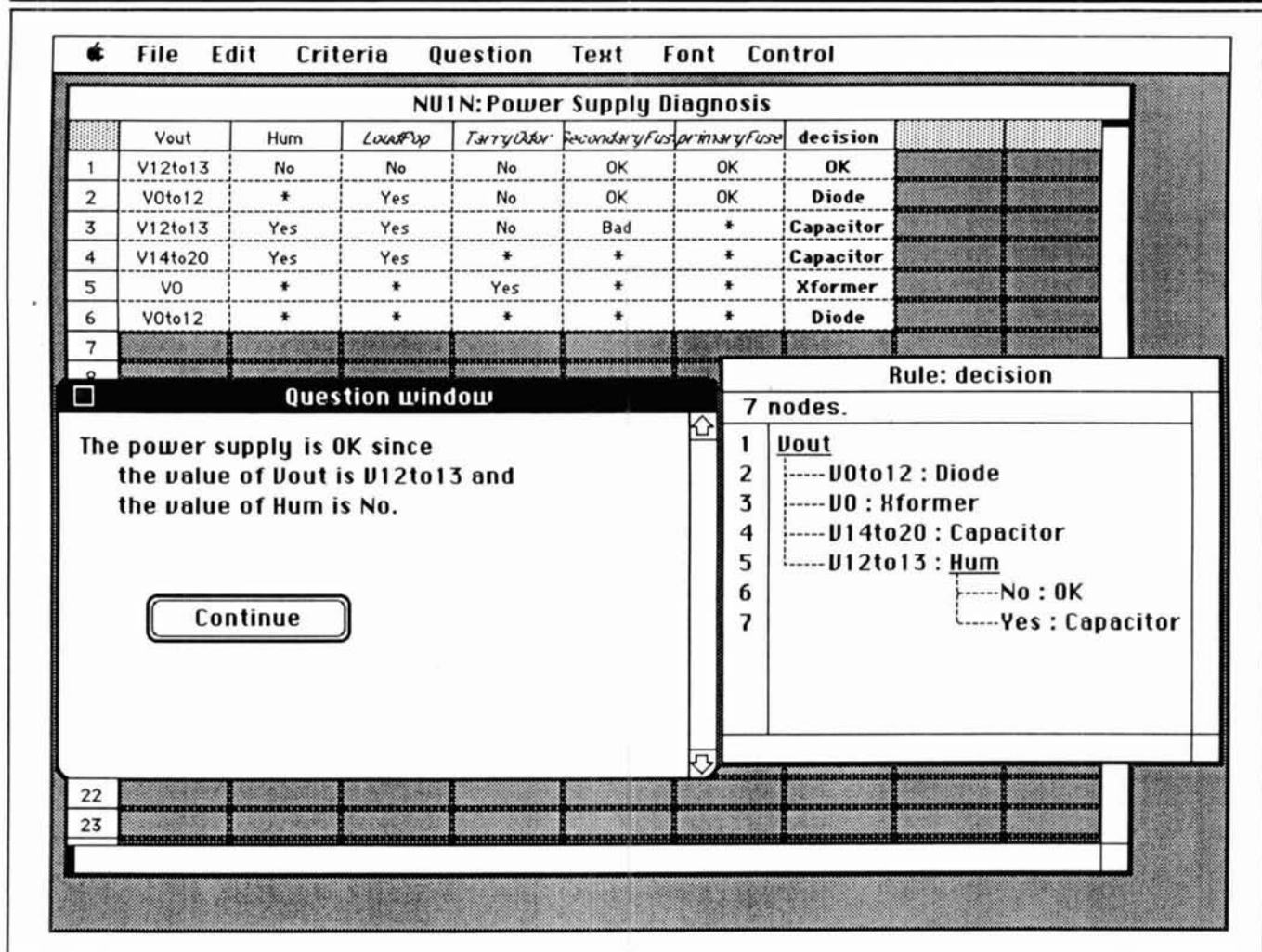
Amateur Electronic Supply  
Ham Radio Outlet  
Henry Radio  
Madison Electronics  
EGE  
R&L Electronics  
rf enterprises  
Barry Electronics

C-Comm  
Ross Distributing  
Quement Electronics  
LaCue Communications  
Ham Station  
  
In Europe: Kneisner & Doering,  
Braunschweig, W-Germany



**Wm. M. Nye Co. Inc.**  
1614 130th Ave. N.E.  
Bellevue, WA 98005  
TEL: (206) 454-4524  
FAX: (206) 453-5704

FIGURE 1



An expert system shell programmed for power supply diagnosis. The "source code" for this greatly over-simplified expert system takes the form of examples in the spreadsheet-like window (background, center). The decision rules to be used by the expert system during a consultation (right, foreground) are derived automatically from programmer-supplied examples. The Question Window, the only window normally seen by the user, currently displays the results of a previous consultation (left, foreground).

Unfortunately, not all of us have the opportunity or time to work with experts in every field. Hence the beauty of expert systems!

### Expert system development alternatives

How do you go about developing an expert system? You can start with a traditional, procedural language like BASIC or PASCAL, a nonprocedural "A.I. language" like LISP (LIST Processing), or with an expert system shell. Although it's possible to create suitable inference engines with BASIC or PASCAL, it requires a great deal of time and experience with A.I. techniques like recursion (when a routine repeatedly calls itself). Handling lists of text and implementing recursion are almost trivial in LISP, but you must learn to program in LISP or some other A.I. language. Unless your goal is to learn A.I. techniques, an expert system shell is the way to go.

Shells provide the quickest and easiest means of creating an expert system. These shells are available for virtu-

ally all microcomputers, at prices ranging from \$49 to over \$5000. There are at least half a dozen shells available for the Commodore-64, Apple II, IBM PC, and Macintosh computers for less than \$200. My favorite shell for the IBM PC is VP-Expert™ from Paperback Software, at less than \$100. For the Macintosh, I use SuperExpert™ from Softsync, at about \$150.

Expert system shells provide a programming environment that includes everything you need to create an expert system, with the exception of a knowledge base. Shells typically provide not only the inference engine, but also an editor for entering rules, some sort of end-user interface, and software tools for maintaining the knowledge base. If you can write simple IF/THEN rules, like the ones in my example, you can program an expert system shell. It's that simple!

If you have trouble writing simple rules, or the rules aren't readily apparent, or there are simply too many rules to keep track of, there's still hope. So called "case-based" expert

# AMATEUR TELEVISION

## SMILE! YOU'RE ON TV



Only  
\$329

Designed and built in the USA  
Value + Quality from over 25 years in ATV...W6ORG

With our all in one box TC70-1, 70cm ATV Transceiver, you can easily transmit and receive live action color and sound video just like broadcast TV. Use any home TV camera or VCR by plugging the composite video and audio into the front VHS 10 pin or rear phono jacks. Add 70cm antenna, coax, 13.8 Vdc and TV set and you are on the air...it's that easy! TC70-1 has >1 watt p.e.p. with one xtal on 439.25, 434.0 or 426.25 MHz & properly matches Mirage D15, D24, D100 amps for 15, 50, or 70 watts. Hot GaAsfet downconverter varicap tunes whole 420-450 MHz band to your TV ch3. Shielded cabinet 7x7x2.5". Req. 13.8 VDC @ .5A Transmitters sold only to licensed amateurs, for legal purposes, verified in the latest Callbook or send copy of new license. Call or write now for our complete ATV catalog including downconverters, transmitters, linear amps, and antennas for the 70, 33, & 23cm bands.

(818) 447-4565 m-f 8am-5:30pm pst.

Visa, MC, COD

**P.C. ELECTRONICS**

Tom (W6ORG)  
Maryann (WB6YSS)

2522 Paxson Ln Arcadia CA 91006

✓ 115

## UNADILLA ANTENNA MANUFACTURING CO.

PO Box 4215 BV•Andover•MA•01810  
(508) 475-7831 9am-5pm EST•(508) 474-8949 24HR FAX

### THE BIG SIGNAL

#### Amateur Antenna Baluns

For over 20 years, preferred by Amateur, Military and Commercial Operators. Assembled with all stainless steel hardware and a built-in lightning arrester minimizes your TVI, maximizes your power.

#### Transformer Baluns

For medium power (1000 watts RF minimum) and broadband operation 3-40 MHz.

**W2AU 1:1**

50/50 or 75/75Ω

Dipoles, V's

Beam Models, Quads

**W2AU 4:1**

200/50 or 300/75Ω

Hi-Impedance Antennas

(ie: Folded Dipoles)

#### Non-Transformer Baluns

**W2DU-HF**

1.8-30 MHz

3000-9000W

1500-5000W



w/1:1 SWR

w/2:1 SWR

**W2DU-VHF**

30-300 MHz

2000-4000W

1200-2400W

#### Contact Your Local Ham Dealer Today!!!

Call or write direct for our informational brochure on our other fine products

Trape-Antenna Kits-Filters-Center Insulators-ENDulators™-Coaxial Relays  
All products come with a 30 Day Warranty

-NOTICE-

We are the **NEW** manufacturers of the original

**JAMES MILLEN™** Products  
(508) 475-7831 9am-5pm EST

shells are available (see Figure 1). These shells take files of expert decisions and derive executable rules from these examples through a process called induction.<sup>1</sup> Expert system shells that make use of case-based programming (sometimes called "programming by examples") have the potential to make an important contribution to Amateur Radio. Expert systems developed using this programming approach are already being used in law, medicine, and military science.

## Some expert system applications

Expert systems have been developed by the military to help diagnose problems in electronic circuitry,<sup>2</sup> by NASA to help shuttle pilots land,<sup>3</sup> and by physicians to help diagnose patients.<sup>4</sup> What can you, as an Amateur Radio operator, do with expert system technology? As an explorer of this exciting, new frontier, you are limited mainly by your imagination. Here are two systems that I've developed out of necessity and curiosity. Each system took me less than a day to create with the aid of a shell. You'll no doubt see ways to improve upon these systems, or devise even more sophisticated ones to suit your own needs.

## Transceiver diagnosis

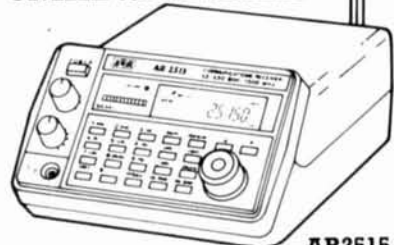
My wife, KA1SSL, doesn't have my background in electronics or 20 years experience in Amateur Radio. However, she's very active and is learning all aspects of the hobby — including equipment repair. To give her a hand while I'm away on business trips, I created an expert system (using the programming by examples shell SuperExpert on the Macintosh) to aid in diagnosing our SWAN-500 transceiver. Using the case-based approach, I created a knowledge base that included the most likely points of failure (antenna down, bad coax, blown finals, faulty power supply, keyer defective) and methods of remedying them. My wife thinks the system is great! You might consider a similar project if your husband, wife, or children are new to Amateur Radio equipment diagnosis.

## Antenna selection

Like a number of Amateurs, I'm not fortunate enough to have the real estate required to erect a seven-element Yagi. Instead, I make do with a multiband vertical and a dual band dipole. I've come to realize that the performance of each antenna varies considerably, depending on the season, weather, and location of the received station. The dipole, for example, performs poorly in the rain (not surprising in retrospect, since it is run between closely grouped trees), whereas the vertical performs superbly (perhaps because of the increased efficiency of the ground system). Again, using a case-based expert system shell, I managed in just a few hours to create a useful expert system to aid in antenna selection. For the most part, I took the cases I used to program the shell directly from my logbook, where I record the time, frequency, weather conditions, QTH, signal strength, and antenna used for each contact. Patterns that may not be obvious from casual observation of logbook data (e.g., when there's snow on the ground, and my objective is to work Europe, the dipole is the better choice), may be revealed by a case-based expert system. Your logbook is likely harboring similar surprises!

# New from AOR

**2000 Channels  
5MHz to 2000MHz**



**AR2515**

- Covers 5MHz to 2000MHz in AM/FM/Wide FM modes. Continuous coverage.
- 2000 Channel Memory. 1984 Scan Frequencies & 16 Search Groups.
- Scan/Search speeds up to 36 channels or increments per second.
- Built in RS 232 computer interface.
- 25 Day Satisfaction Guarantee. Full Refund if not Satisfied.
- Size: 3 1/2" H x 5 1/4" W x 7 1/4" D. Wt. 2 lb. 10 oz.
- Supplied with AC & DC power cords. Telescopic antenna.

Total Price: Freight Prepaid (Express Shipping Optional)  
\*Upgrades of AR2022's to AR2515 specs Available

**\$695.00**



COMMUNICATIONS

10707 E. 106th St. Indpls., IN 46256

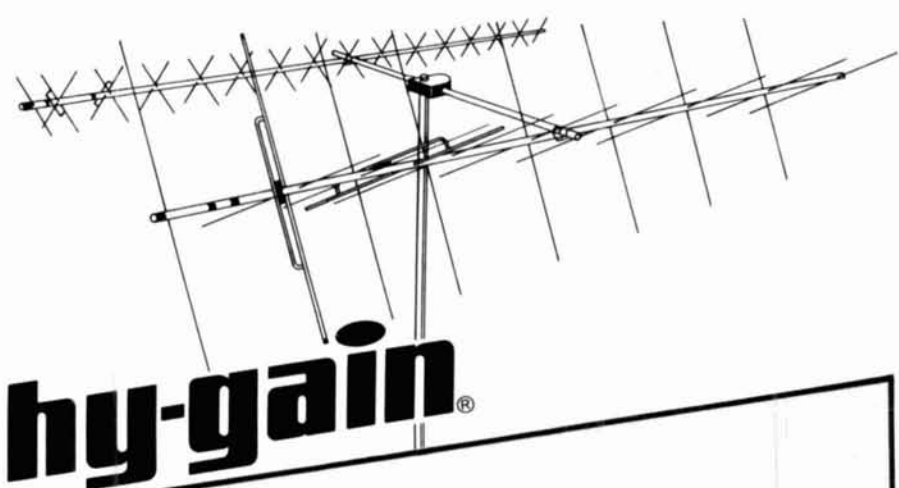
Toll Free 800-445-7717

Visa and MasterCard

(COD slightly higher)

In Indiana 317-849-2570 Collect FAX (317) 849-8794

117



# hy-gain®

## Link up with OSCAR

The new OSCAR system is modular so you can pick and choose the antenna you want. Each comes complete with the necessary phasing lines, relays and hardware:

### 435 ANTENNA • 145.9 ANTENNA

Of course, your best choice is the complete system, matched and balanced for superior performance.

- The flexible design with switchable up/down link antennas is suitable for worldwide application. Includes left and right circularity switching to reduce fading (less than 3 dB ellipticity).
- High efficiency "T" matched driven element.
- True RF switching relays are rated at 200 watts and improve the VSWR for higher efficiency.
- Weather-protected, encapsulated feed points for long life. The 2 meter antenna has a S0-239 connector. The 70 cm antenna has a Type N connector.
- The heavy-walled fiberglass cross boom maintains the integrity of the circularity pattern and eliminates the interaction problems so common with metal booms.
- MIL-spec coax balun with Teflon dielectric and outer covering. A silver plated braid shield and center conductor assure minimum attenuation and long life.
- The 70 cm antenna is based on 4.2 wave length NBS design (NBS Tech Note 688).
- The 2 meter antenna has logarithmic element spacing for high attenuation of side lobes.
- For years of maintenance-free operation, the elements come with stainless steel positive locking rings and UV stabilized insulators.
- The mechanically well balanced antennas require only a small turning radius and exert minimal stress on the elevation rotator.

Hy-Gain, with the quality you've come to rely on, is now ready to "LINK UP WITH OSCAR". Complete data available at your amateur radio dealer or write Amateur Radio Department, Telex/Hy-Gain, 9600 Aldrich Avenue South, Minneapolis, MN 55420.

Or call us toll-free at

**1-800-328-3771**

(In Minnesota call 612-887-5528)

**TELEX hy-gain**

TELEX COMMUNICATIONS, INC.

118

## NEW SUPER LONG PLAY TAPE RECORDERS

12 Hour Model — \$119.00\*  
USES D-120 TAPE

Modified Panasonic Slimline, high quality, AC-DC Recorders provide 6+ continuous hours of quality recording & playback on each side of cassette for a total of 12 hours. Built-in features include: Voice level control, Digital counter, etc. TDK DC 120 Cassette Furnished.



### PHONE RECORDING ADAPTER

Records calls automatically. All Solid state connects to your telephone jack and tape recorder. Starts recording when phone is lifted. Stops when you hang up.



**\$28.50\***

FCC APPROVED

### VOX VOICE ACTIVATED CONTROL SWITCH

Solid state. Self contained. Adjustable sensitivity. Voices or other sounds automatically activate and control recorder. Uses either recorder or remote mike.



**\$28.50\***

\*Add for ship & hdg. Phone Adapter & Vox \$1.50 ea. Recorders \$4.00 ea. Cal. Res. add tax. Mail order, VISA, M/C, COD's OK. Money Back Guarantee. Qty. disc. avail. Dealer Inquiries Invited. Free data.

AMC SALES INC. Dept. 9335 Lubec St., Box 928, Downey, CA 90241 Phone (213) 869-8519

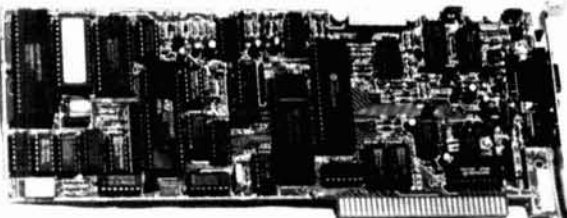
119



# PacComm

- Advanced Technology
- Enduring Value

## New! PC-320 / TNC-320 PACKET CONTROLLERS



### PC-320 features . . .

- Dual modems for optimal VHF and HF operation.
- Appears as regular PC serial port (COM 1-4) - operates with any terminal program just like an external TNC.
- Dual Powered - operates from PC or external power. Continues complete operation even when the PC is turned off!
- Personal Message System - the most advanced personal mailbox available... included at no extra charge.
- Displays on-screen HF tuning indicator and simulated LEDs.

### Announcing the next generation of packet controllers for the serious operator!

The new inboard PC-320 (shown), is designed to work with all PC/XT, PC/AT, and Tandy 1000 series computers. The TNC-320 outboard controller offers many of the same high quality features!

PC-320

## \$209<sup>95</sup>

TNC-320... \$194.95

(Wired & Tested / 1 Year Warranty)

For complete info & specifications

Call (813) 874-2980 / To Order, Call

Toll Free: 1-800-223-3511

Major Credit Cards Accepted!

PacComm • 3652 West Cypress Street • Tampa, Florida 33607

Please send  PC-320  TNC-320  More Information  FREE Catalog

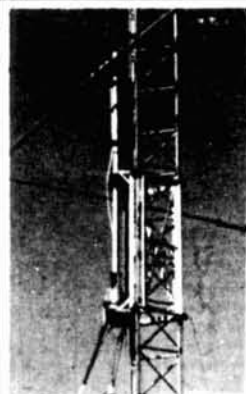
Name \_\_\_\_\_ Call \_\_\_\_\_

Address \_\_\_\_\_

State \_\_\_\_\_ Zip \_\_\_\_\_ Card# \_\_\_\_\_ Exp. Date \_\_\_\_\_

**MONEY BACK GUARANTEE!** Add \$4.00 shipping/handling per order. FL residents add 6% sales tax. Major Credit Card give number, expiration and signature. FAX: 813-872-8696

✓ 125



## MARTIN TOWERS and THE HAZER

### Bring things down for safety and convenience.

Never climb again with this tower and elevator system. MARTIN TOWERS are made of aluminum and specifically engineered for use with the HAZER. Two sizes of tower: M-13 (13" wide) and M-18 (18" wide.) All bolted construction, no welds. Easy to install hinge base, walk up erection, next plumb with leveling bolts in base. Mount antennas and rotor on HAZER in vertical upright position, then winch to top of tower for normal operating position. Guy wires fasten to HAZER or above HAZER at top of tower. Safety lock system operates while raising or lowering. Never can fall. Photo above shows HAZER midway on tower.

Complete tower UPS or motor freight shippable. Pre-assembled or kit form.

Send for free details of HAZER kits for Rohn 20, 25G, 45, 55 and other towers.

Special tower price: 50' M-13, hinged base, concrete footing section, HAZER kit - \$1269.60. Includes all hardware, winch, cable etc. FOB Boonville, MO.

Masts, rotors, thrust bearings, guy wire, turnbuckles also available.

Satisfaction guaranteed. Call today and charge to Visa, MasterCard or mail check or money order.

GLEN MARTIN ENGINEERING, INC.

Rte 3, Box 322

Boonville, MO 65223

(816) 882-2734 FAX 816-882-7200



✓ 124

## EVERY ISSUE of HAM RADIO

now available on microfiche!

The entire run of *Ham Radio Magazine* (March, 1968 thru last year) is ready to ship to you in one, easy to use format.

Our 24x microfiche is easy to read and very compact. We offer a hand held reader for \$75, and a desk model for \$200. Libraries have these readers.

As a bonus, you will receive *Ham Radio Horizons* (3/77 thru 12/80) free.

Everything is included, front cover to back - ads too!

Annual updates will be offered for \$10.

Send \$185 payment (visa/mc accepted) to:

## BUCKMASTER

BUCKMASTER PUBLISHING

Route 3, Box 56

Mineral, Virginia 23117

703/894-5777 visa/mc 800/282-5628

✓ 125

## antenneX<sup>o</sup>

"The Magazine About Antennas"  
IF YOU -

- Have a lousy mobile signal on all bands?
- Need an inexpensive beam for 10 meters?
- Unsure about using vert vs horiz antenna?
- Need a low noise antenna for 160 meters?
- Want to design an antenna just for you?
- Need a program for design and plotting?
- Need to solve a unique problem?
- Know the best antenna for hamsats, etc.?
- Need a disguised mobile antenna?
- Want a cheap automatic coupler system?
- Just want to learn more about antennas?

THEN SUBSCRIBE TO - antenneX<sup>o</sup>  
12 MONTHLY ISSUES is only \$15.97 for USA and possessions. \$19.97 foreign.

## antenneX<sup>o</sup>

P.O. Box 8995 Dept. 19  
Corpus Christi, TX 78412

✓ 120

## Amplifier Repair

Alpha - Ameritron - AMP - Henry Dentron - Heathkit - TenTec - Etc.

35 Years Experience as the Service Manager with a major manufacturer

Authorized TenTec Dealer

## K4BWC



## OMEGA

Visa & Master Card

## ELECTRONICS

4209 Live Oak Road  
Raleigh, NC 27604  
919-832-1025

✓ 121



## Sparky J Antennas

Balanced J-pole antennas that roll up small enough for your pocket or briefcase, yet have the punch of a full size half-wave radiator. A great answer for apartment dwellers or as a super emergency antenna. Don't leave home without one, because nobody beats these J's—nobody!

20 M - \$49.95  
15 M - \$43.95  
10 M - \$39.95  
6 M - \$32.95  
2 M - \$29.95  
7 M - \$24.95  
Add \$5 S & H

\*Ant here is a Sparky J\*

Sparrow Hawk Communications

450-H Westfield Rd Alpine, UT 84004


Order direct from the factory (801) 756-7842



✓ 123

# SAY YOU SAW IT IN ham radio!

## The future

What does the future hold for expert system technology and Amateur Radio? I'd like to see expert systems available — either as shareware or at a nominal fee — to aid in the construction, diagnosis, and use of all Amateur equipment. Diagnosis of antenna failures and problems with power supplies, today's ultra-complex transceivers, and keyers could all be much less time consuming if expert systems were readily available. How about a system to select toroids for your next project? And wouldn't it be great to have a system that, if given the desired noise characteristics and frequency range of a preamplifier, could tell you which field effect transistors you should use? Imagine the impact on Amateur Radio if, in each Amateur Radio club, the gurus got together and created expert systems for the other members. It's up to you. Amateur Radio is about communications and sharing. Expert systems seem to be a natural extension of our desire to explore and communicate. 

### REFERENCES

1. B. Thompson and W. Thompson, "Finding Rules in Data," *Byte*, 1986, pages 149-158.
2. R. Davis and D.G. Bobrow, Editors, "Diagnostic Reasoning Based on Structure and Behavior," *Qualitative Reasoning About Physical Systems*, Cambridge: MIT Press, 1985, pages 347-410.
3. *The Autoland Expert System*, GHG Corporation of Texas.
4. R. Miller, F.E. Masarie, and J.D. Meyers, "Quick Medical Reference (QMR) for Diagnostic Assistance," *MD Computing*, 1986, 3: 34-48.

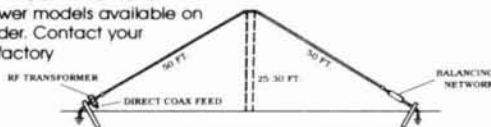
## CONTINUOUS COVERAGE ANTENNAS FOR COMMERCIAL & AMATEUR SERVICE

### Model AC 1.8-30

1.8 to 30 MHz

- SWR Max 2:1, 1.4:1 average from 1.8 to 30 MHz
- Can be installed in approximately 80 ft. space
- Ideal for commercial services for multi frequency operation without the need for antenna tuners or additional antennas
- Handles 1 KW, 2 KW PEP ICAS
- Higher power models available on special order. Contact your dealer or factory

**\$175.00**  
SHIPPING & HANDLING  
ADD \$4.00



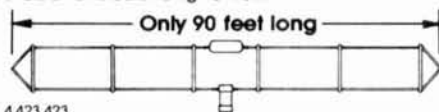
U.S. Patent No. 4,511,898

### Model AC 3.5-30

3.5 to 30 MHz

- SWR less than 2:1 from 3.5 to 30 MHz
- Complete assembled. Balun terminated with standard SO-239 connector
- Power capability 1 KW - 2 KW PEP ICAS. Higher power model is available on special order.
- Designed for 50 ohm feedline
- Weather proof balun and balancing network

**\$184.50**  
SHIPPING & HANDLING  
ADD \$4.00



U.S. Patent No. 4,423,423

ALL OUR PRODUCTS MADE IN USA



**BARKER & WILLIAMSON**

Quality Communication Products Since 1932  
At your Distributors. Write or Call.  
10 Canal Street, Bristol, PA 19007  
**(215) 788-5581**



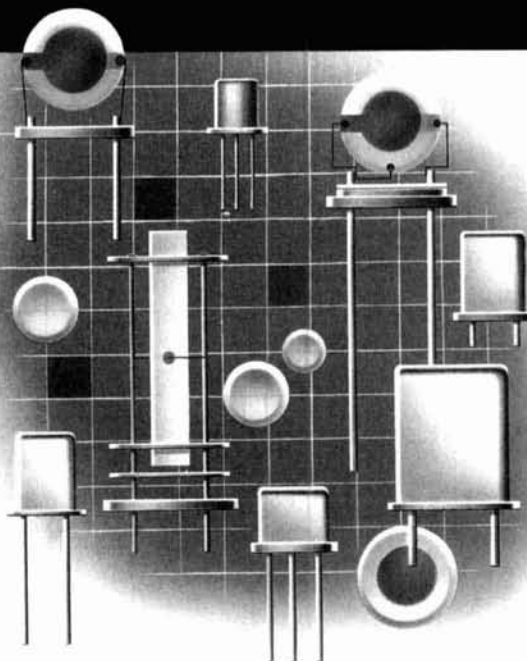
# CUSTOM CRYSTALS

## Crystals for many applications

For over 37 years, ICM has manufactured the finest in quartz crystals for every conceivable purpose.

A wide selection of holders are available to fit most any requirement. Our computer database contains crystal parameters for thousands of equipment types.

Need crystals for communications, telemetry, industrial, or scientific applications? Let ICM's sales department assist you to determine which type of crystal is best for you.



## Can we solve your crystal problem?

For special purpose crystals, special holders, special sizes, call our crystal sales department. We will be pleased to provide recommended data.



**International Crystal Manufacturing Co., Inc.**

P.O. Box 26330, 701 W. Sheridan,  
Oklahoma City, OK 73126-0330  
Phone (405) 236-3741  
Telex 747-147  
Facsimile (405) 235-1904

# High Performance vhf/uhf preamps



Receive Only	Freq. Range (MHz)	N.F. (dB)	Gain (dB)	1 dB Comp. (dBm)	Device Type	Price
P28VD	28-30	<1.1	15	0	DGFET	\$29.95
P50VD	50-54	<1.3	15	0	DGFET	\$29.95
P50VDG	50-54	<0.5	24	+12	GaAsFET	\$79.95
P144VD	144-148	<1.5	15	0	DGFET	\$29.95
P144VDA	144-148	<1.0	15	0	DGFET	\$37.95
P144VDG	144-148	<0.5	24	+12	GaAsFET	\$79.95
P220VD	220-225	<1.8	15	0	DGFET	\$29.95
P220VDA	220-225	<1.2	15	0	DGFET	\$37.95
P220VDG	220-225	<0.5	20	+12	GaAsFET	\$79.95
P432VD	420-450	<1.8	15	-20	Bipolar	\$32.95
P432VDA	420-450	<1.1	17	-20	Bipolar	\$49.95
P432VDG	420-450	<0.5	16	+12	GaAsFET	\$79.95

Inline (rf switched)	Freq. Range (MHz)	N.F. (dB)	Gain (dB)	1 dB Comp. (dBm)	Device Type	Price
SP28VD	28-30	<1.2	15	0	DGFET	\$59.95
SP50VD	50-54	<1.4	15	0	DGFET	\$59.95
SP50VDG	50-54	<0.55	24	+12	GaAsFET	\$109.95
SP144VD	144-148	<1.6	15	0	DGFET	\$59.95
SP144VDA	144-148	<1.1	15	0	DGFET	\$67.95
SP144VDG	144-148	<0.55	24	+12	GaAsFET	\$109.95
SP220VD	220-225	<1.9	15	0	DGFET	\$59.95
SP220VDA	220-225	<1.3	15	0	DGFET	\$67.95
SP220VDG	220-225	<0.55	20	+12	GaAsFET	\$109.95
SP432VD	420-450	<1.9	15	-20	Bipolar	\$62.95
SP432VDA	420-450	<1.2	17	-20	Bipolar	\$79.95
SP432VDG	420-450	<0.55	16	+12	GaAsFET	\$109.95

Every preamplifier is precision aligned on ARR's Hewlett Packard HP8970A/HP346A state-of-the-art noise figure meter. RX only preamplifiers are for receive applications only. Inline preamplifiers are rf switched (for use with transceivers) and handle 25 watts transmitter power. Mount inline preamplifiers between transceiver and power amplifier for high power applications. Other amateur, commercial and special preamplifiers available in the 1-1000 MHz range. Please include \$2 shipping in U.S. and Canada. Connecticut residents add 7-1/2% sales tax. C.O.D. orders add \$2. Air mail to foreign countries add 10%. Order your ARR Rx only or inline preamplifier today and start hearing like never before!

## Advanced Receiver Research

Box 1242 • Burlington, CT 06013 • 203 582-9409



✓ 126

## THE RF CONNECTION

"SPECIALIST IN RF CONNECTORS AND COAX"

Part No.	Description	Price
321-11064-3	BNC 2 PST 28 volt coaxial relay, Amphenol Insertion loss: 0 to 0.75GHz, 0.10dB Power rating: 0 to 0.5GHz, 100 watts CW, 2 kw peak Isolation: 0.1 GHz/45dB, 0.2 GHz/40dB, 0.4 GHz/35dB	\$25 used tested
83-822	PL-259 Teflon, Amphenol	1.75
PL-259/ST	UHF Male Silver Teflon, USA	1.50
UG-21D/U	N Male RG-8, 213, 214, Amphenol	3.25
UG-21B/U	N Male RG-8, 213, 214, Kings	4.00
9913/PIN	N Male Pin for 9913, 9086, 8214 fits UG-21D/U & UG-21B/U N's	1.50
UG-21D/9913	N Male for RG-8 with 9913 Pin	3.95
UG-21B/9913	N Male for RG-8 with 9913 Pin	5.75
UG-146A/U	N Male to SO-239, Teflon USA	6.00
UG-83A/U	N Female to SO-239, Teflon USA	6.00

"THIS LIST REPRESENTS ONLY A FRACTION OF OUR HUGE INVENTORY"

**THE R.F. CONNECTION**  
213 North Frederick Ave. #11  
Gaithersburg, MD 20877

(301) 840-5477

VISA/MASTERCARD: Add 4%  
Prices Do Not Include Shipping

✓ 128

## VHF-UHF POWER DIVIDERS



RF power dividers provides the best way to feed in-phase 2 and 4 antenna arrays to maximize system gain and at the same time reduce losses to a minimum. Covering 144 thru 1296 MHz, this series of VHF/UHF power dividers are premier RF devices designed for a long service life with low SWR and broad operating bandwidth.

Extruded aluminum body with a durable enamel finish in addition to silicon sealing at connector flanges results in a ruggedized unit for all array installations. Available with N-type connectors only, these units are unconditionally guaranteed for 2 years.

MODEL	CONFIG.	PRICE
144-2P	(2 ports)	\$54.00
144-4P	(4 ports)	\$61.00
220-2P	(2 ports)	\$53.00
220-4P	(4 ports)	\$60.00
430-2P	(2 ports)	\$51.00
430-4P	(4 ports)	\$59.00
902-2P	(2 ports)	\$51.00
902-4P	(4 ports)	\$59.00
1296-2P	(2 ports)	\$52.00
1296-4P	(4 ports)	\$60.00

SHIPPING NOT INCLUDED

STRIDSBERG ENGINEERING, CO.

P.O. Box 7973 • Shreveport, LA 71107 • USA  
Phone: (318) 865-0523

✓ 129

## 2 METER AMPLIFIERS • ATV CONVERTERS

DISCOVER THE WORLD OF FAST SCAN TELEVISION:



AMATEUR TELEVISION CONVERTERS	Price
ATV-2 420-450 MHz	\$ 44.95 Kit
ATV-3 420-450 MHz GaAs-Fet	\$ 49.95 Kit
ATV-4 902-928 MHz GaAs-Fet	\$ 59.95 Kit

Available in Kit or Assembled/Tested  
Add \$ 2.00 For Shipping and Handling

### RF Amplifiers Per Motorola Bulletins

Complete Parts list for:  
140 Watt or 300 Watt HF Amplifiers per Motorola Bulletins  
AN-758, AN-762, EB-27A, EB-63

COMMON RF CHOKES  
0.15 uh, 0.22 uh, 0.33 uh  
4.7 uh, 10.0 uh \$ 1.20

MIXERS  
SBL-1 DBL Bal Mixer \$ 6.50  
SBL-1X DBL Bal Mixer \$ 7.95

FERROXUBE DEVICE  
VK700-20/4B RF Choke \$ 1.20  
56-590-65-3B Ferrite Bead \$ 2.20

POWER SPLITTER/COMBINER  
2-30 MHz, 600 Watts (2 Port or 4 Port)



BROADBAND TRANSFORMERS PER MOTOROLA BULLETINS

We Also Stock Hard-To-Find Parts

KEMET CHIP CAPACITORS  
METALCLAD MICA CAPACITORS  
SEMICONDUCTORS  
RF POWER TRANSISTORS

For detailed information, please call or write for our free catalog



**CCI** Communication Concepts Inc.

121 Brown Street • Dayton, Ohio 45402 • (513) 220-9677



✓ 130

✓ 127



# Ham Radio Techniques

Bill Orr, W6SAI

## INTERESTING ANTENNA FEED SYSTEMS

In my August column, I discussed the gamma match — a convenient and easily adjustable device for matching a coax line to the driven element of a Yagi beam. Many commercial beams use this system.

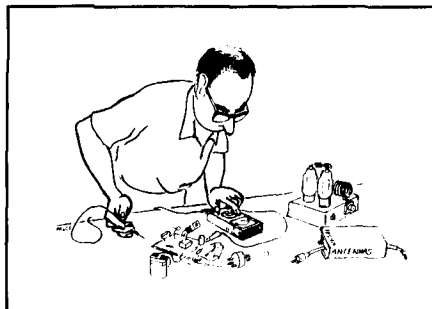
Other interesting but less well-known matching systems exist; I'll cover a few that the homebrewer can use. Some of the matches will function with a multi-band antenna, while others are single band devices. All of them deserve consideration for your next antenna project.

### The W6GKM matching system

Back in 1950 Dale Frink, W6GKM, devised a match for his 10-meter beam.<sup>1</sup> The arrangement is shown in **Figure 1**. The driven element is split with a 2-inch gap at the center, and excited by a length of 50-ohm coax. The inner and outer conductors are shorted together at each end of the coax, and the shield braid is broken and fed with the transmission line at the center. The "matching coax" is about one-quarter wavelength long.

Dale taped the matching coax to the driven element, taking care that the ends of the coax didn't short to the driven element. He found the SWR was low over the entire 10-meter band. Dale told me that he'd also placed the matching coax inside the driven element, instead of taping it to the outside. It seemed to work equally well either way.

How does this device function? The driven element is split and there are no electrical connections to either half. The simplest explanation is that the capacitance between the matching coax and the dipole halves does the job.



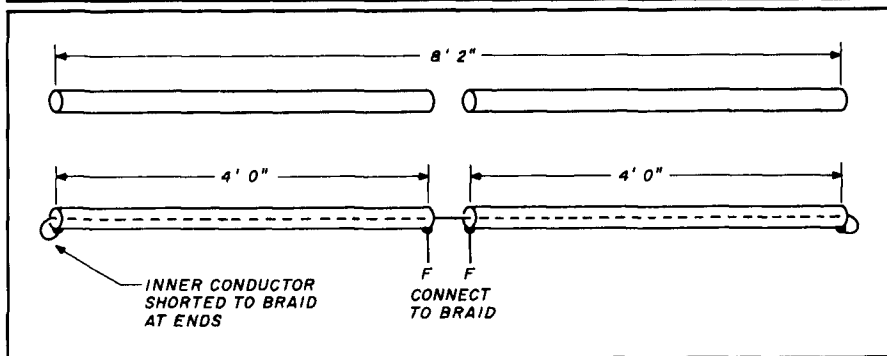
### The Mosley "Classic" match system

The Mosley "Classic" series of antennas use a similar matching scheme.<sup>2</sup> This device is shown in **Figure 2**. The Mosley advertisement calls it a "balanced capacitive match." The Classic match resembles the system used in W6GKM's design. Even though Dale uses coax in his match, the only meaningful part of the match is the outer shield of the coax — the inner conductor contributes nothing.

By substituting a single insulated wire for the coax, you have the Classic system instead of the W6GKM match.

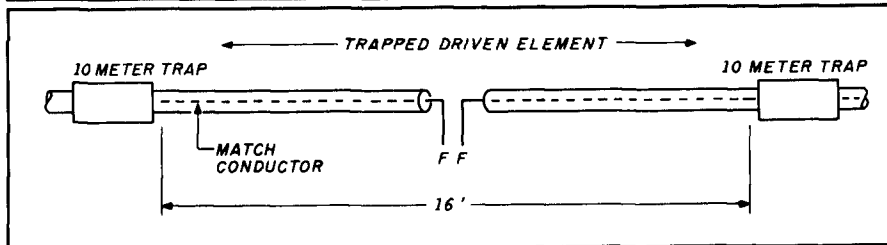
With the Classic-33 tribander, the match conductor is about a quarter wave long on 20 meters. It's placed inside the split driven element. I'll accept that; but how does the match function on the 15 and 10-meter bands, where the match wire is longer than a quarter wavelength? Is the length of the match wire unimportant, or does it bear a specific relationship to the operating frequency? I know the match works because I have a Classic-33 beam. It has a good front-to-back ratio, a good operating bandwidth, and exhibits a low SWR value at resonance on each of the three HF bands (10, 15, and 20 meters). Those are the principal attributes of a good match-

FIGURE 1



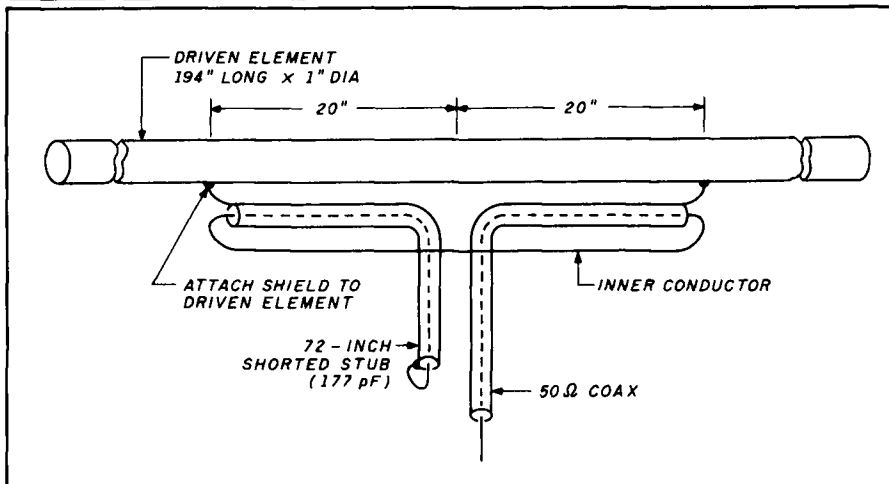
W6GKM feed system. Matching coax is taped to element. Feedline is connected to braid at F-F.

FIGURE 2



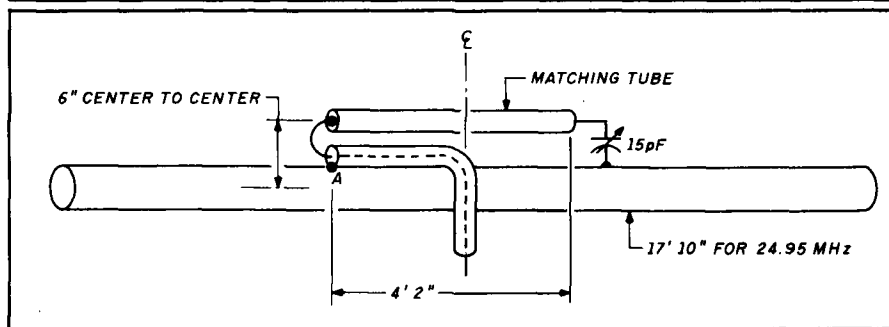
"Classic" feed system consists of coaxial wire placed in each half of trapped driven element.

FIGURE 3



"Clemens match" for 29 MHz. Two gamma matches back-to-back?

FIGURE 4



ZL2ANT version of Clemens match. Coax is taped to driven element. Shield is attached to driven element at A and center conductor is attached to matching tube. Tony says system works best when both tubes are the same diameter.

ing system. Is it purely a capacitive match, or do the match wire and the split element form some kind of a coaxial matching transformer?

### The Clemens match

In 1951 John Clemens, W9ERN, published a novel match system he had adapted from a television antenna matching scheme.<sup>3,4</sup> He applied the match to a three-element 10-meter beam (Figure 3). This wild-looking device taps the outer conductor of the coax feedline on the driven element at a point that provides a good match to the line. The inner conductor is brought back along the driven element to an equivalent point on the opposite side of the element. It's connected to the element at this point through a series capacitor. The capacitance is made up

of a section of coax line. The tap points and capacitance value are varied until unity SWR is obtained at the design frequency.

If you use your imagination, you can think of this device as two back-to-back gamma matches. The gamma capacitor is moved from the base of one gamma to the antenna end of the gamma conductor. The gamma "rod" is the 40-inch length of coax conductor running from one tap point to the other. What an interesting idea!

The Clemens match sank into oblivion for decades. I forgot about it completely until I worked Tony, ZL2ANT, a few days ago. He had taken the 1951 design and modernized it (Figure 4). Tony jettisoned the coax and substituted an aluminum tube. He fed the tube and one side of the driven ele-

ment with the coax feedline taped along the driven element. With the dimensions shown, his series capacitor was 15 pF, as opposed to the 177 pF of the W9ERN design. He feels the 6-inch separation between the matching tube and the driven element accounts for this difference. Tony says the match is very broad and he can work the dipole on both the 10 and 12-meter bands, with low SWR on each band.

All of these designs show the promise of multiband operation. In fact, multiband operation is proven with the Mosley Classic match. Perhaps one of these ideas is the one for you!

### The Weinschel matching system

In 1972 QST published a triband beam that uses a trapped 20/15 meter driven element connected in parallel with a 10-meter element placed about 18 inches away (Figure 5).<sup>5</sup> The elements are connected by double wires, and the combination is fed at the center of the 10-meter element. The product review reported very low SWR on all bands, and the antenna exhibited good front-to-back ratio. I don't know of anyone who has tried this multiband matching system. I'm eagerly awaiting a missive that will inform me of the actual operating results achieved with this simple design.

### The open sleeve dipole system

An unusual dual frequency antenna was developed at Stanford Research Institute in 1950. Its operation was described in a paper by H. B. Barkley.<sup>6,7</sup> Roger Cox, WB0GDF, gives a good description of the device in Amateur terms in CQ magazine.<sup>8</sup>

The device is called an "open sleeve dipole." It consists of a conventional center-fed dipole with two parasitic elements spaced close together on each side. The parasitics are cut to a half-wavelength at some higher frequency (Figure 6). The ratio of high to low frequency can't exceed 2:1.

You can make a practical open sleeve dipole for 20/17, 20/15, 15/12, 20/10 meters, or other combinations of frequencies between 14 and 29.7 MHz. The drawing gives dimensions for a 20/10 dipole.

This scheme looks like a quick and painless way to add second band capability to an existing beam. In addi-

# ACCURACY DIGIMAX PERFORMANCE



10 MHz Oven Oscillator 9 X 8 1/2 X 3 1/4  
10 Hz to 1.2 GHz .1 PPM ACCURACY



50 Hz to 512 MHz  
1 PPM ACCURACY  
TCXO  
5 1/4 X 5 X 1 1/4

ALL MODELS HAVE 1 YEAR WARRANTY

Optional factory installed rechargeable battery pack available



FOR DEALER LOCATIONS

OR PHONE ORDERS  
800-854-1566

8560 Production Avenue  
San Diego, CA 92121

California Call 619-578-7171

Telex #697120-DATAMAX-103

## DIGIMAX INSTRUMENTS CORP.

MODEL	PRICE	FREQUENCY RANGE	ACCURACY OVER TEMPERATURE	READ OUTS	SENSITIVITY TYP.		POWER REQ.
					50 Hz-25 MHz	25 MHz-450 MHz	
D500	\$149.95	50 Hz-512 MHz	1 PPM 17°-35°C TCXO	8	15 to 50 MV	20 to 50 MV to 450 MHz	8-15 VDC 300 MA
D610	\$179.95	50 Hz-1.0 GHz	TIME BASE			50 to 100 MV to 1 GHz	AC-12 REQ. FOR
D612	\$259.95	50 Hz-1.2 GHz	0.1 PPM 20°-40°C PROPORTIONAL 10 MHz OVEN	9	15 to 50 MV	2 to 20 MV to 450 MHz	110 VAC
D1200	\$299.95	10 Hz-1.2 GHz			15 to 50 MV	20 to 30 MV to 1 GHz	8-15 VDC 500 MA

AC-12 AC-ADAPTER \$8.95

T-1200 BNC-BASE 21" ANT. \$8.95

BAC12 \$34.95

BACS \$29.95

EXPORT AGENT: MAGNUS

3500 Devon Avenue

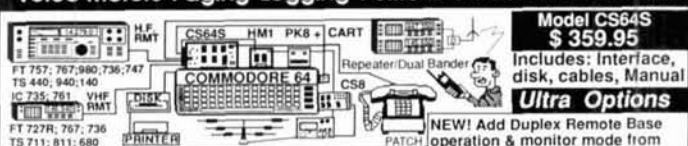
Chicago, IL 60659

312-679-6070

Telex #253503 MAGNUS CGO

142

Engineering Consulting's computer controlled Ham Shack  
See system variables, control & reprogram all via packet!  
**Ultra Comshack 64 Repeater Controller**  
HF & VHF Remote Base\* Autopatch\* CW Practice\* Rotor Control  
\*Voice Meters\* Paging\* Logging\* Polite ID's\* Packet Voice B.B.S.



**Model CS64S \$359.95**  
Includes: Interface, disk, cables, Manual  
**Ultra Options**

NEW! Add Duplex Remote Base operation & monitor mode from any telephone .....TLCN.....\$159.95  
External relays: 3 DPDT relays +5 Open Col. Trans. Sw.....CS 8...\$89.95  
\*Rotor control D.C. to digital display & Voice; for all rotors.....HM1...\$59.95  
\*Packet & BBS: Voice Meters & Alarm Inputs; 8 On/Off. PK8.\$159.95  
\*Slave Packet interface & cable Links PK8 to 2nd C64...PK1...\$89.95  
\*EPROM Autoboot CART, custom with your system.....CART...\$109.95  
\*C64 & 1541 12V. Switching supply crystal controlled...DCPS...\$129.95  
\*Manual(REFUNDED) MN1...\$20.00

**Controller Features**  
\*Change variables remotely from touchtones or Packet  
\*Unlimited voice vocabulary!  
\*Alarm Clock, auto execute  
\*Individual 4 digit user codes  
\*Disk & Printer logging of users, tel #'s, lapsed time  
\*18 Rotating Polite ID's  
\*16 External relay controls  
\*2-tone & sub tone Paging  
\*CW Practice with voice  
\*Security mode, T.tone mute  
\*Voice announces each user call sign when logging on

**Autopatch & Reverse**  
\*1000 (18 digit) tel #'s stored  
\*Quick dial & quick answer  
\*Directed, general page  
\*Selected restricted patch  
\*Telephone control input  
**Dual Combined Remotes**  
\*18 Macro/Scan memories  
\*Scan up/down; 100Hz steps  
\*Monitor & lock modes  
\*Operate splits, combine HF & VHF radios as Dual VFO's  
\*Automatic mode selection  
\*Talking S Meter; Voltmeter  
\*Voice Beacon rotating msc

**Computer Control YAESU FT-727R**

**Mini Cat**  
Allows H.T. to scan 100 Channels & programs  
H.T. for field use! Digital "S" Meter; comment fields; auto resume & delay; Scan Lock-outs; Loads FT727 in 15 sec.  
Hardware, cables, & disk included for C64 or IBM

**Model 727 \$49.95**

**Touchtone Decoder**  
4 digit sequence; & QUAD expansion 4 relay option

**2"x3" TSDQ**  
8/20 V & audio in; Field Program 50,000 Codes; Mom. & Latching; DPDT Relay; Wrong digit reset; LED for digit valid & latch; inc. 24 Pin connector  
**QUAD** option adds: four 2 Amp. relays; 5 digit master on/off control for each relay.

**TSDQ \$89.95 QUAD \$99.95**

**Decode-A-Pad**  
Touchtone to RS232 300 Baud Interface

Use with all computers  
Decodes 16 touchtones  
Includes Basic program  
**DAP \$99.95**  
**12 Volt C64 SWITCHER**  
Crystal 60Hz  
9VAC 5V. 2A.  
C64 & 1541  
**DCPS \$129.95**

**AUDIO BLASTER** IC02;04;2AT;FT-727R 411;209;470;73;23;U16

**AB15** ← Miniature Audio Amp  
Module installs inside all H.T.'s  
1 watt audio amp! When it needs to be loud! Installs in 15 Min. Used by police, fire!  
**Model AB15 \$24.95**

**ENGINEERING CONSULTING**  
593 CANDLEWOOD ST.  
BREA, CA. 92621  
TELEPHONE: 714-671-2009  
FAX: 714-255-9984

**New C64 "Packet Talker"**

TNC COMMODORE 64 TX/RX  
disk PACKET TO VOICE  
Stores messages on disk for up to 300 users; touchtone commands recall & speak your stored messages on repeater or packet freq. Works with all Packet TNC's; Converts all packet messages to VOICE!  
Inc. disk & Interface **PKTA \$189.95**

Make the most of your general coverage transceiver with **Monitoring Times!**

Every month Monitoring Times brings everything you need to make the most of your general coverage transceiver: the latest information on international broadcasting schedules, frequency listings, international DX reports, propagation charts, and tips on how to hear the rare stations. Monitoring Times also keeps you up to date on government, military, police and fire networks, as well as tips on monitoring everything from air-to-ground and ship-to-shore signals to radioteletype, facsimile and space communications.

**ORDER YOUR SUBSCRIPTION TODAY** before another issue goes by. In the U.S., 1 year, \$18; foreign and Canada, 1 year, \$26. For a sample issue, send \$2 (foreign, send 5 IRCs). For MC/VISA orders (\$15 minimum), call 1-704-837-9200.

## MONITORING TIMES

Your authoritative source, every month.

P.O. Box 98 A  
Brasstown, N.C. 28902

159

tion to the "sleeves," you can interlace the parasitic elements for the higher band between the existing elements. It's worth a try!

### The Telex/Hy-gain para-sleeve matching system

Here's a triband antenna which uses the open sleeve dipole concept. A product review<sup>9</sup> says the driven element of the "Explorer 14" beam consists of three elements insulated from the boom. The longer element is trapped for 20 and 15-meter operation. The two short sections spaced close to the driven element act as an open sleeve dipole for 10 meters. The short elements are optimized to provide the best SWR across the 10-meter band. The 15/20 meter element is fed with a "hairpin match," balun, and 50-ohm line. According to the product review, the SWR is quite low at design resonance and the front-to-back ratio is good on each band.

### The Telex/Hy-gain TH7DX drive system

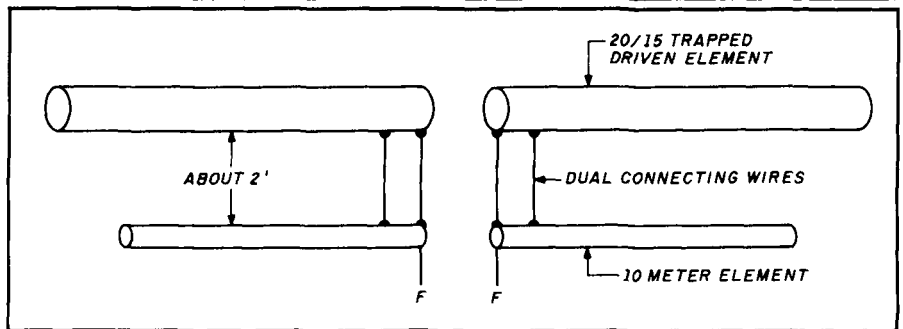
This top-of-the-line triband beam has two trapped, driven elements for 20, 15, and 10 meters. Figure 7 shows the feed arrangement. The elements are cross connected at the centers and the rear element is fed with a hairpin match, balun, and 50-ohm line. The TH7DX drive system also has very low SWR and good front-to-back ratio at design resonance on each band.

This matching idea resembles the Weinschel system, but uses a cross-over connection instead of a parallel connection between the elements. I wonder about the significance of this difference in connections. The cross-over scheme reminds me of the feed system used on a log-periodic array. Hopefully, someone will come up with a computer program that analyzes these interesting matching systems.

### The Log-Yagi design

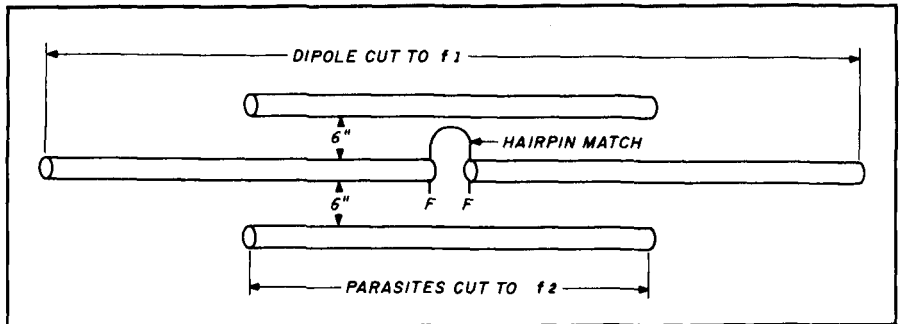
The matching systems I've discussed work on one or more Amateur bands, but it doesn't look as if any of them will cover the five bands between 14 and 29.7 MHz. The log-periodic antenna is the only device that will do this in an acceptable manner. This design trades power gain for bandwidth, and you must put a lot of log-periodic aluminum up in the air to provide equivalent Yagi performance over a wide bandwidth.

FIGURE 5



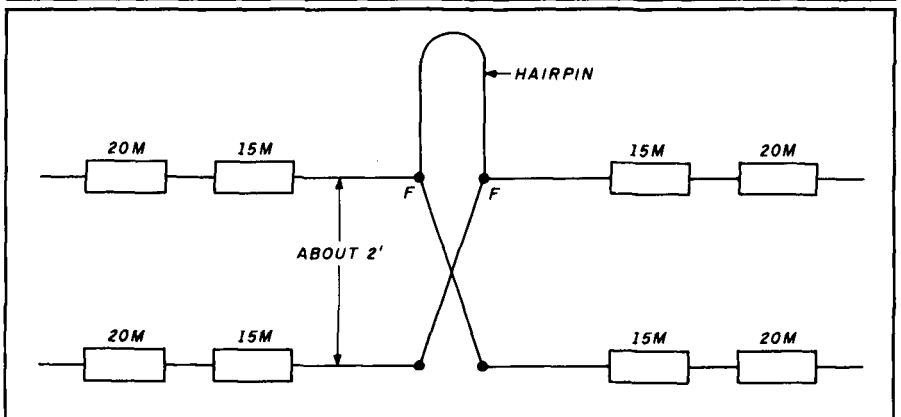
The Weinschel match. Coax balun is used at F-F. Later model beam used "hairpin" match at feedpoint in addition to balun.

FIGURE 6



"Open-sleeve" two-frequency dipole. Spacing between driven element and parasitic element is about six inches.

FIGURE 7



Telex/Hy-gain triband match system using two trapped elements.

There's an interesting derivation of the log-periodic antenna that provides good gain over a single Amateur band when used in combination with Yagi-type parasitic elements. This idea uses a single band log-periodic "cell" of three or four elements, with extra parasitic elements. The technique has been used with single channel TV antennas and is now gaining popularity in Amateur Radio's HF and VHF circles. I discussed this interesting antenna concept in last month's column.

Next month (if I don't forget), I'll review the hairpin (inductance) matching technique. It's another way of matching the coax line to the driven element of an array.

### The Dead Band Quiz

I thought I had you confounded with the April Quiz about the coax line sections, but a lot of you realized the answer was "zero ohms:" N1EVN, AB1K, K1REC, WA2DWV, KC2KB, WB2KHE, W2LYH, WB2NTQ,

# PLUG INTO PACKET!

## Simple and Easy.

Here's the easiest packet radio yet, you don't even have to buy a TNC to join the digital revolution. Just let your PC do the work. Plug a PC Packet Adapter into any expansion slot and get on the air in minutes, just like an expert. And you'll still be able to use the PC for other work! The complete VHF system is only \$139.95!

## Sophisticated, Too.

When you've mastered the basics, use the PC\*Packet Adapter for simultaneous dual-band HF/VHF, multiconnect, BBS, TCP/IP, DXer's PacketCluster, 2400 baud (and higher). Even use the Developer's Package to write your own packet application.

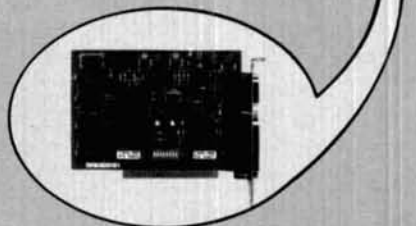
## Software Included.

Unlike others, DRSI includes all the software you need. The THS terminal package has split screen, file save/send, binary file transfer, print, scroll, review and more.

## 2400 BAUD

Many areas are upgrading their packet nets to this higher speed. DRSI's M-24 modem for 2400 baud connects simply with no modifications to your rig and lets you operate both 1200 and 2400 simultaneously with your present radio. Step up to this new speed for just \$79.95, today!

**Call or Write**  
for complete  
**Product Catalog**



**DRSI**

2065 Range Road  
Clearwater, FL 34625  
**ORDERS: 1-800-999-0204**

## WHAT'S THE BIGGEST ISSUE IN HAM TV TODAY?

## THE NEXT ISSUE OF AMATEUR TELEVISION QUARTERLY

- ACCURATE reporting
- TECHNICAL information
- VALUABLE content
- QUALITY production

### SUBSCRIPTIONS:

1 Year \$15 U.S., \$20 Canada, \$25 Elsewhere

1545 Lee Street, Suite 73  
Des Plaines, Illinois 60018  
(312) 298-2269

132

## Employment opportunities at Cushcraft Corporation

### Antenna Design Engineers

3 to 1000 MHz Range

Enthusiastic experienced Yagi, Omni, and mobile antenna design engineer wanted to lead our design team.

We are also seeking entry level BSEE to join the team.

This is your opportunity to make a difference.

### Landmobile Antenna Salesperson

Excellent opportunity for experienced salesperson with two-way radio familiarity. Market our state-of-the-art Voice and Data Transmission Antennas to the growing Landmobile industry. Business-to-Business sales. Established territory. Commission.

Excellent benefits.

Call Now —

**Cushcraft/Signals**  
48 Perimeter Road  
Manchester, NH 03103  
603-627-7877

# BATTERIES "R" US...

You've bought our replacement batteries before...  
**NOW YOU CAN BUY DIRECT FROM US, THE MANUFACTURER!**



**ICOM**  
 CM2, PB2 7.2v @ 500MAH  
 CM5, PB5 10.8v @ 500MAH  
**SUPER**  
 7S 13.2v @ 1200 MAH \$63.95  
 8S 9.6V @ 1200 MAH \$59.95  
 (base charge only-1" longer)  
 ICOM CHARGERS AVAILABLE SOON

## NEW PRICING

**ICOM**  
 7S (1200 MAH) \$63.95  
 8S (1200 MAH) \$59.95

**ICOM INSERT**  
 PB-3 \$17.45

**YAESU**  
 FNB-2 \$20.95  
 P4W \$20.95

**Replacement batteries for cordless telephones.**

**Look for new catalog coming soon!**



**YAESU/MAXON**  
 FNB-10 7.2v @ 600MAH  
 FNB-12 12v @ 500MAH  
 FNB-10(S) 7.2v @ 1000MAH  
**NEW**  
 FNB-12 12v @ 500MAH  
 FNB-12(S) 12v @ 600MAH  
 the above is equivalent to FNB-11 (1/2" shorter)  
 \*same size case as FNB-12  
**NOW**  
 P4W 11V @ 500MAH - \$20.95  
 FNB-2 11v @ 500MAH - \$20.95



**CUSTOM MADE BATTERY PACKS & INSERTS**  
 Made to your specifications.  
**Introductory Offer!**  
**KENWOOD INSERTS**  
 PB-21-\$13.75, PB-25-\$20.00,  
 PB-26-\$20.00  
**ICOM INSERTS**  
 BP-5-\$23.00, BP-3-\$17.45  
 BP-7, BP-8



MasterCard and Visa cards accepted. NYS residents add 8 1/4% sales tax. Add \$3.50 for postage and handling.



**SOURCE FOR ALL YOUR COMMUNICATION BATTERY REPLACEMENT NEEDS.**

## W & W ASSOCIATES

29-11 Parsons Boulevard, Flushing, N.Y. 11354

WORLD WIDE DISTRIBUTORSHIPS AVAILABLE. PLEASE INQUIRE.

In U.S. & Canada Call Toll Free (800) 221-0732 • IN NYS (718) 961-2103 • Telex: 51060 16795 • FAX: (718) 461-1978

**MADE IN THE USA**

Send for free catalog & price list!

✓ 133

## SYNTHESIZED SIGNAL GENERATOR

MADE IN USA



**MODEL SG-100F**  
**\$429.95 delivered**

- Covers 100 MHz to 199.999 MHz in 1 kHz steps with thumbwheel dial
- Accuracy +/- 1 part per 10 million at all frequencies
- Internal FM adjustable from 0 to 100 kHz at a 1 kHz rate
- External FM input accepts tones or voice
- Spurs and noise at least 60 dB below carrier
- Output adjustable from 5-500 mV at 50 Ohms
- Operates on 12 Vdc @ 1/2 Amp
- Available for immediate delivery • \$429.95 delivered
- Add-on accessories available to extend freq range, add infinite resolution, AM, and a precision 120 dB attenuator
- Call or write for details • Phone in your order for fast COD shipment.

### VANGUARD LABS

196-23 Jamaica Ave., Hollis, NY 11423  
 Phone: (718) 468-2720 Mon. thru Thu.

✓ 134

## 5-1000 MHz PREAMPLIFIERS

	NF	G	P(1 dB)	\$
WLA20M*	2dB	15dB	0dBm	73
WLA21M	3	13	8	57
WLA22M	4	11	12	61
WLA23M	4	22	12	87
WLA24M	3	23	18	109
WLA25M	5	11	20	82
WLA26M	6	21	24	199

Add \$4 for S&H; \*BW 1-500 MHz



WILAM TECHNOLOGY, Div. of

### WI-COMM ELECTRONICS INC.

P.O. Box 5174, MASSENA, N.Y. 13662  
 (315) 769-8334

✓ 135

## HAM LICENSE PREPARATION

### WRITTEN TEST STUDY GUIDES

All word-for-word questions, multiple choices... answers. Choose Novice, Technician, General, Advanced or Extra Class Answer explanations supplied!

**\$4.95 Each version + \$1.50 shipping.**

**All five manuals: \$22.95 postpaid.**

### HAM RADIO Q & A MANUAL

All 1,932 questions, multiple choices and answers found in every ham license exam, Novice through Extra Class.

**\$9.95 Shipped postpaid.**

### MORSE CODE TEST PREPARATION

Set contains two 2-hr. cassette tapes  
 Code Teacher, 0-5 WPM \$9.95  
 General Code, 3-15 WPM \$9.95  
 Extra Code, 12-21 WPM \$9.95

**Plus \$1.50 shipping per set.**

**All Manuals/Code Tapes: \$49.95**  
**New \$Part 97 Ham Rules: \$ 2.95**

Order shipped same day received!  
 Credit card phone orders: 10 a.m. - 2 p.m.

### W5YI MARKETING

P. O. Box #565101 - Dallas, TX 75356  
 Tel: (817) 461-6443 - 24 hours


✓ 136

W2RJW, N3GDE, NK3Z, WX4D, N4DX, W4EIN, WB4HFX, W5DS, K5ESV, K5GV, KA5MXX, W5PEK, K5RA, WB6AWM/7, W6BDN, WB6BYU, WD6DUD, KJ6GR, W6HDO, W6KEZ, ND6M, W6NTX, WA6ZOU, K7FC, W7FSP, WD8KBW, WA8KNE, W8YFB, W9BTI, N9HWC, KS9J/0, W9NGP, AA0B, K0LSJ, G0FAH, G4TDJ, VE4KZ.

Congratulations to all!

## A thought about the "no-code" license

The May 1989 issue of *The Old Timer's Bulletin* (a publication of the Antique Wireless Association, Inc.) had an interesting comment on the no-code licensing proposal. Bruce Kelley, W2ICE, quotes a reader's suggestion. He makes the argument that the FCC and the ARRL are going about the license enhancement in the wrong way — the code requirement should be retained but the theory should be eliminated! The great majority of hams use

factory-made equipment and wouldn't dare touch it if something was wrong for fear of voiding the warranty! They send it back to the maintenance center, and let factory-trained technicians repair it. So why is there a need for technical know-how? Take a look at the February 1988 *Ham Radio* cover, and you'll know what Bruce is talking about! 

### REFERENCES

1. Dale Frink, "Something New in Matching Devices," *QST*, April 1950, page 64
2. Mosley Electronics, Inc. advertisement, *QST*, August 1969, front inside cover
3. John Clemens, "The Clemens Match," *QST*, February 1951, page 26-28
4. John Clemens, "A Coaxial Feed System for Antennas," *Electronics*, October 1950, page 154-55
5. "Recent Equipment: The Weinschel System 1 Triband Yagi," *QST*, December 1942, page 41-42
6. H. Barkley, "The Open Sleeve as a Broadband Antenna," U.S. Naval Postgraduate School, Monterey, California
7. H. King, "Experimental Antenna Development at the Aerospace Corporation," *IEEE Antennas and Propagation Newsletter*, Vol. 24, No. 2, April 1982, page 5-8
8. R. Cox, "The Open Sleeve Antenna," *CQ*, August 1983, page 13-18
9. J. Schultz, "The Telex/Hy-gain Explorer 14 Triband Beam," *CQ*, April 1985, page 18-21



## LOW BAND DX-ING COMPUTER PROGRAMS

by John Devoldere, ON4UN, for Apple IIe/c, MS-DOS, Commodore C-128 Apple Macintosh and Kaypro CPM Computers

Here's a collection of 30 super programs written by ON4UN. Just about every interest or need is covered—from antenna design and optimization to general operating programs. Antenna programs include: shunt and series input L network design, feedline transformer, shunt network design, SWR calculation, plus 11 more! General Ham programs include: sunrise/sunset, great circle distances, grayline, vertical antenna design program, sunrise calendar plus 9 more! Phew. When you sit down to use these programs you'll be amazed at what you have. The best value in computer software available today. © 1986.

- UN-Apple IIe/IIc \$39.95 ea.
- UN-MS (MS-DOS) \$39.95 ea.
- UN-CPM/Kaypro \$39.95 ea.
- UN-C-128 (COMMODORE) \$39.95 ea.
- UN-MAC (MACINTOSH) \$49.95

## LOW BAND DX'ING by John Devoldere ON4UN

Now Available! The new, 2nd edition of the definitive book on Low Band DX'ing. Based upon years of practical on-the-air experience, learn the secrets of how ON4UN has been so successful on the low bands. Extensive coverage is given to transmit and receive antennas with clear concise explanations and plenty of illustrations—dipoles, inverted V's, slopers, phased arrays and Beverages—they're all in this book. Also covered: propagation, transmitters, receivers, operating, software and an extensive Low Band bibliography. Going to be a best seller! Get yours today. © 1987 2nd Edition 200 pages

AR-UN Softbound \$9.95

## BUY 'EM BOTH SPECIAL OFFER

Book & Software Reg. \$49.90  
(\$59.90 for Mac)

Just \$44.90 (\$54.90 for Mac)

- UN-SO (specify computer) \$44.90
- UN-MSO Macintosh Special \$54.90

## SAVE \$5

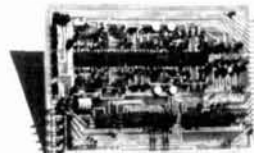
Please enclose \$3.75 shipping & handling

# HAM BOOKSTORE RADIO

ham radio

GREENVILLE, NH 03048 603-878-1441

## THE MULTIPLE RECEIVER SOLUTION



### 4 Channel Signal-to-Noise Voter

- Expandable to 32 Channel by Just Adding Cards
- Continuous Voting
- LED Indicators of COR and Voted Signals
- Built in Calibrator
- Remote Voted Indicators Pinned Out
- 4 1/2 x 6 Double Sided Gold Plated 44 Pin Card
- Remote Disable Inputs
- MORE

Built, tested and calibrated with manual

**\$350.00**

Telephone interface now available  
For more information call or write:

**DOUG HALL ELECTRONICS**  
Voter Department  
815 E. Hudson Street  
Columbus, Ohio 43211  
(614) 261-8871

✓ 137

## PC Slow Scan \$149.95

A complete slow scan television station for your IBM PC or compatible. Send and receive images in up to 10 shades of gray depending upon your graphics card and printer.

### Includes:

Demodulator Modulator 75 Page Manual  
Software Tutorial Cassette

### Requires:

Ham transceiver PC with 640K Parallel Port  
Graphics Card Tape Recorder Serial port  
Slow Scan Formats: 8, 12, 17, 23, 34, 36, 48, 72 sec.



Software Systems Consulting  
1303 S. Ola Vista  
San Clemente, CA 92672  
(714) 498-5784

✓ 138

### NEW!

The classic "Antenna Bible"  
now in a thoroughly-revised, much-enlarged  
edition

## ANTENNAS

2nd edition

by John Kraus, W8JK  
Ohio State University

Covers both theory and its applications to practical systems. With design formulas, tables and references. Over 1000 illustrations.

"Modern, complete, a classic", *Microwave Journal*.

917 pages, hardcover. \$51.95

Add \$2.50 per book for shipping and handling U.S., \$5.00 elsewhere.

CYGNUS-QUASAR BOOKS  
P.O. Box 85, Powell, Ohio 43065  
Tel. 614-548-7895

✓ 139

# VARIABLE GAIN 160-METER PREAMP

## Tuned input and output offer increased performance

By Gary R. Nichols, KD9SV, 4100 Fahlsing Road,  
Woodburn, Indiana 46797

**A**fter buying a new rig and getting on 160 meters with a shunt-fed tower for my antenna, I soon found myself in the position of most newcomers to top band; I was definitely an "alligator," all mouth and no ears. The shunt-fed tower is great for transmitting, but leaves a lot to be desired for receiving. Quiet is not one of the benefits of a vertical.

Beverage antennas were pretty much out of the question because I live on a fairly small lot (100' x 300'), so I tried the next best things — small shielded loops, snakes, and short low wires. I had quite a bit of success with the 6' shielded loop made of 1/2" hardline and a less than desirable preamp, still managing to work 75 DX countries my first season on the band.

As I looked over the problems I had with a lack of signal when using the loops and intermod on the other antennas, it seemed I needed a good bandpass filter with gain — in other words, a preamp with tuned input and output. After I tried four or five different preamp designs and found them to be lacking either in gain or selectivity, I decided to create my own.

I started with two high Q tuned circuits, matched them for 50 ohms, and then looked for an FET to supply the needed gain. Chuck, N8BYI, had some 3SK88 devices and suggested I try one of them. This device worked very well, producing high gain and a good noise figure.

### Circuit description

The circuit (see Figure 1) is very basic, except for its unusual bias arrangement. This amplifier's gain is 27 dB typical, and the gain control covers the full range (or more) because of the bias. The 750-k resistor from gate 1 to gate 2 helps to increase the maximum gain. The resistor from gate 1 to the junction of the gain control pot and the 10-k resistor pull gate 1 up above the source slightly at minimum gain setting; this allows the minimum gain setting to be unity (gain of zero) or below, depending on the value of this resistor. Typical values are from 1 to 3 megs.

This arrangement is most beneficial when there are many

strong signals present (like during a contest) and you don't want any preamplification. Placing the amp in the circuit at low or minimum gain adds two high Q tuned circuits, which help selectivity and reduce or eliminate any intermod from broadcast stations or nearby hams.

The amplifier has back-to-back diodes to protect the input during transmit. My own transmit signal hasn't caused me any trouble with receiving antennas as close as 75 feet from my vertical. Tune the trimmers for "your" portion of the band; the bandwidth won't cover the full 200 kHz without swamp-ing the tuned circuits at the expense of gain and selectivity. I tune mine for maximum at 1850 and can use it anywhere in the band with somewhat reduced gain at the high end, where I seldom operate.

This year I have five 800' Beverages, thanks to a friendly farmer and a 1-1/2" plastic pipe I had put under the road to gain access to 40 acres east of my QTH. I don't normally need the preamp with these antennas — except when signals are very weak. But there are times when the band is noisy, and the shielded loop and preamp "hears" better than the Beverages.

### Construction

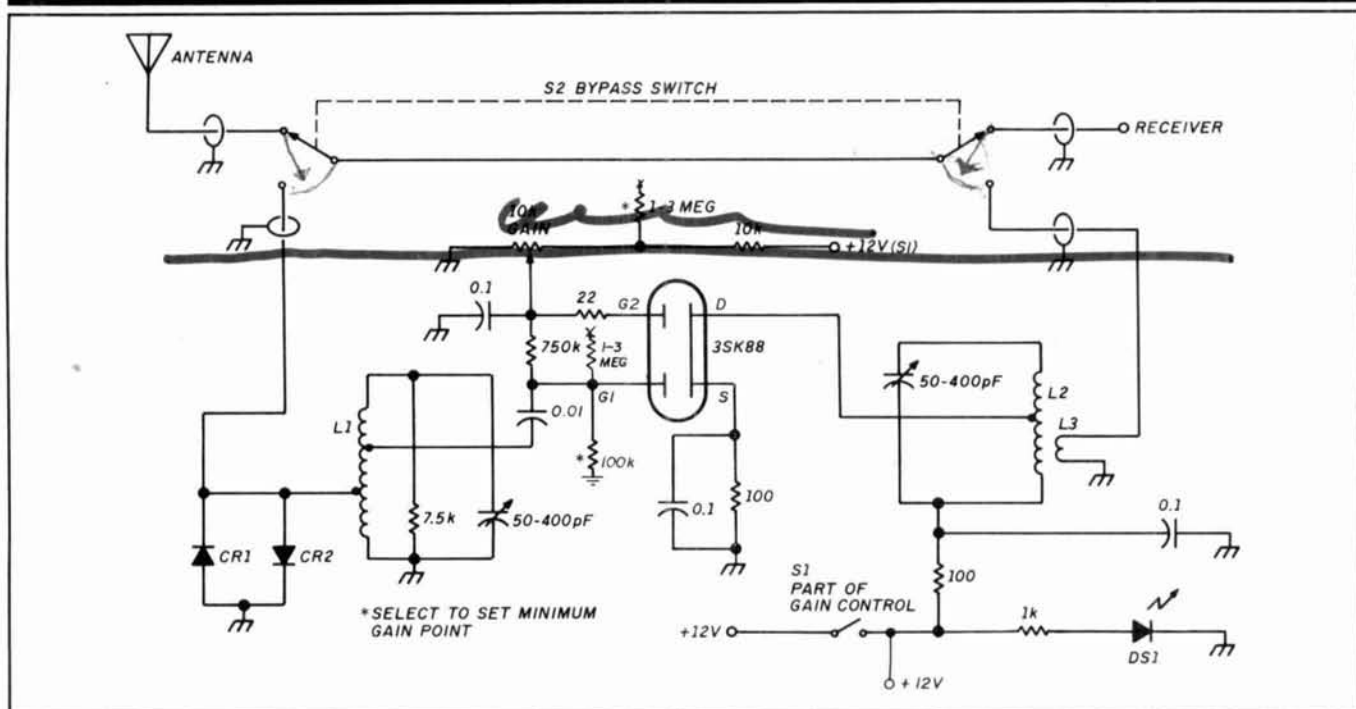
I built the preamp in a homebrew chassis 4 x 5 x 1-1/2 inches and painted it to match my Ten-Tec Corsair II transceiver. See Figures 2 and 3 for foil pattern and component placement guide.\* I used miniature coax on the bypass

### PARTS LIST

C1,C2	Arco 429 compression trimmer
CR1,CR2	Silicon signal diodes or hot carrier for input protection (The 3SK88 already has built in protection, but this provides added safety.)
L1,L2	FT50-61 toroid core (Amidon, Micro-metals) L1, 22 turns tap at 11, 2 L2, 22 turns tap at 11 L3, 2 turns over L2
Q1	Nec 3SK88 or equivalent (ECG455)
R1	10-k pot with switch, Radio Shack 271-215A. All other resistors, 1/4-watt carbon composition; capacitors are 0.1- $\mu$ F ceramic disc.
S2	DPDT miniature toggle switch for bypass (switch around)
DS1	LED to indicate power on RCA phono jack for power in
Misc	Two connectors (your choice) for input and output

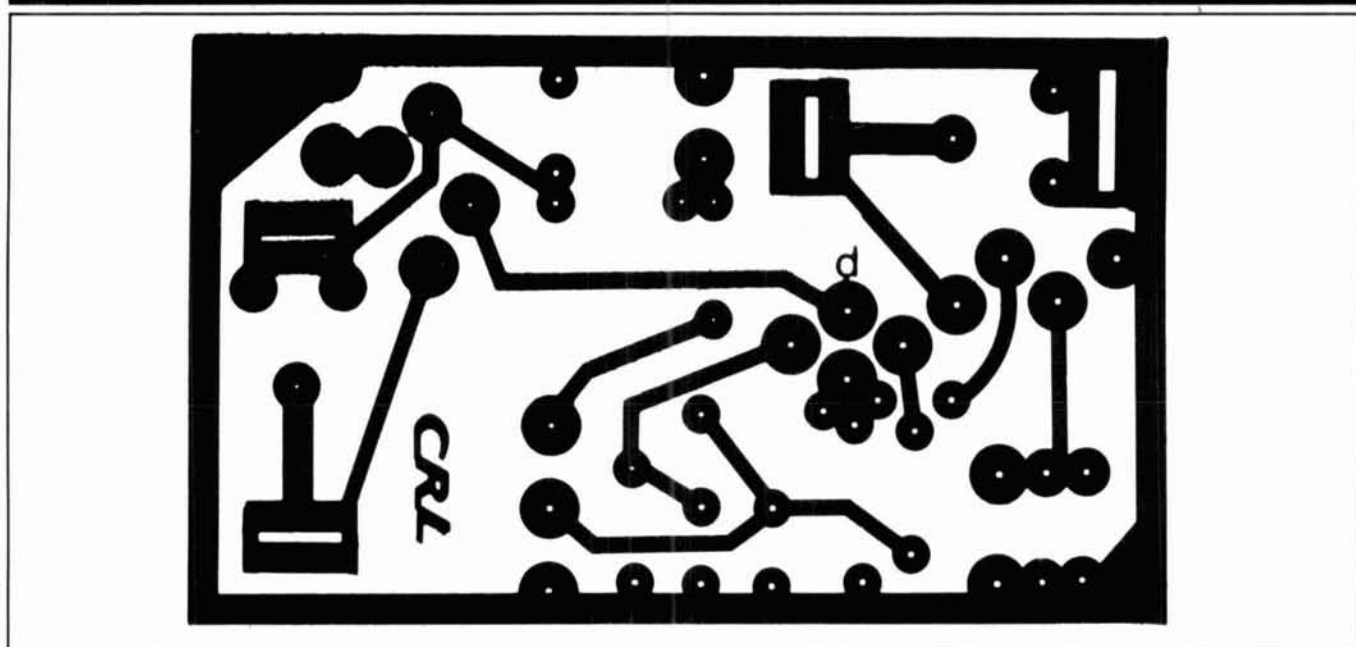


FIGURE 1



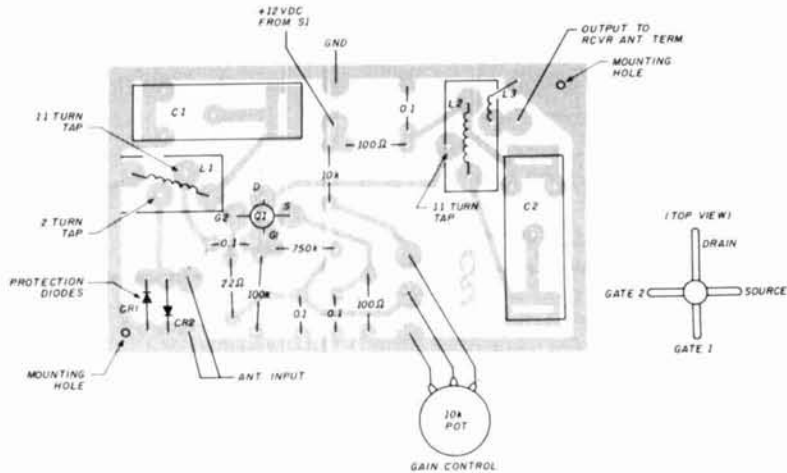
Schematic of the 160-meter pre-amp.

FIGURE 2



PC board foil pattern.

FIGURE 3



**Component placement guide.**

switch. Although the bypass isn't necessary, it's a feature I wouldn't leave out. The circuit board is mounted on two small threaded standoffs. Stick-on rubber feet and rub-on transfer decals give the project a "professional" appearance. The LED indicating power on is also nice, but not necessary.

Chuck Lewis, N8BYI, has kits available for \$29.95 plus \$2 shipping and handling. For more information, contact N8BYI at 4925 Vermont Lane, Fort Wayne, Indiana 46815; phone (219)749-2324. 

*Editor's Note:* Those who want an 80-meter pre-amplifier should substitute either an FT50-63 or T50-3 core. Use the same number of windings as for the 160-meter pre-amp. \*Although a 7.5-k resistor is shown across the input tank circuit, it is not on the pc board artwork. This resistor was added to the circuit to broaden the bandwidth and provide a more constant 50-ohm match at the input. The circuit will work without the 7.5-k resistor with only slightly reduced bandwidth. Ed

**KD9SV Preamp User's Notes**

Whether it's a bigger transmitting antenna, full legal power, or a way to improve my Beverage array, I'm always looking for an edge over my competition on 160 meters. Late last fall, KD9SV sent us a prototype 160-meter preamplifier to try out before he completed this article.

There are several important parameters that need to be examined when evaluating a preamp: is it prone to self-oscillation, can it handle both in and out-of-band strong signals, and does it induce any great amount of noise to the receiver?

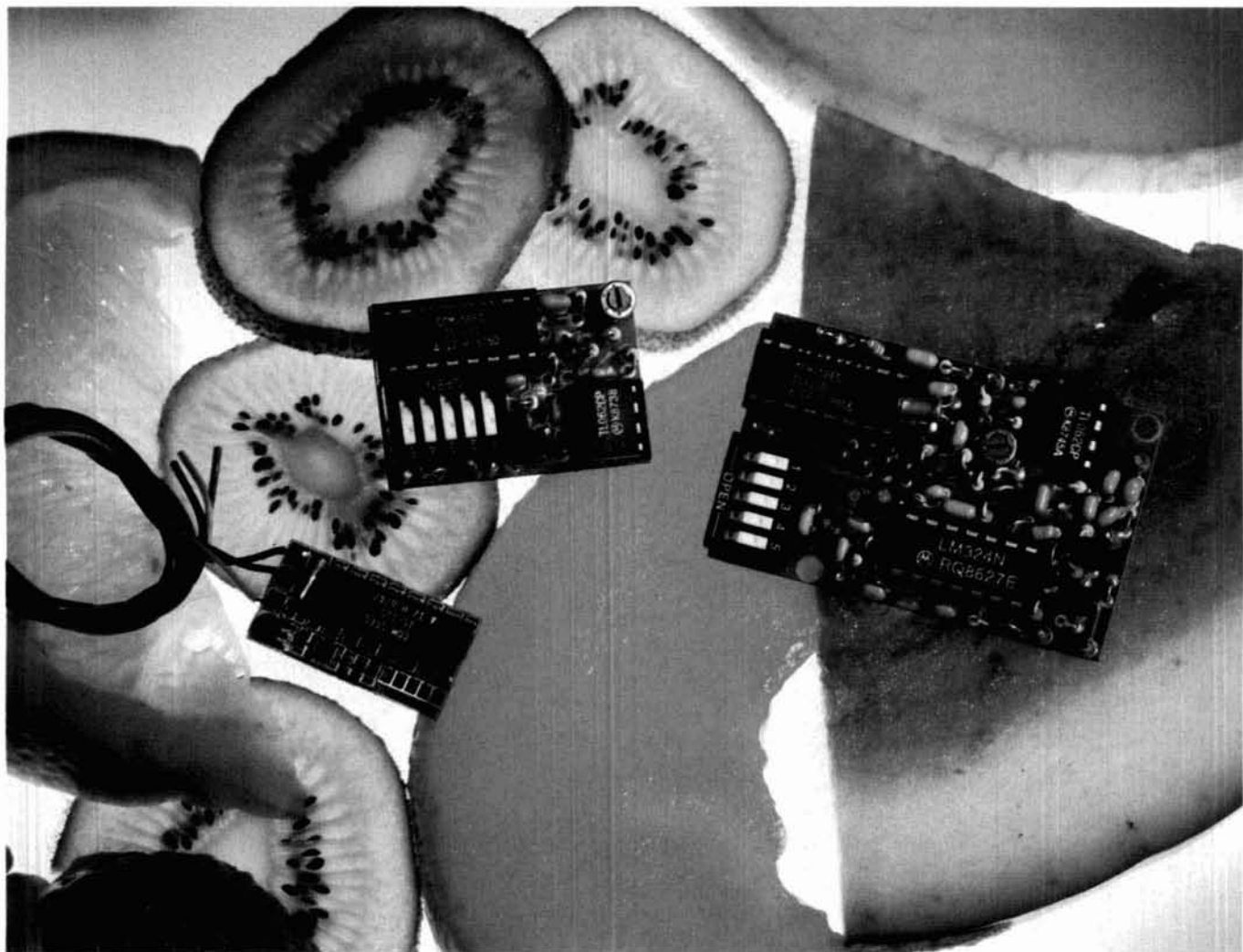
One of the toughest tests you can give any piece of equipment is to use it during a major DX contest. I put KD9SV's preamp on line just before the CQWW® CW, and ARRL 160-meter contests and it performed without fault. The circuit is well designed and isn't prone to self-oscillation. It never "folded up" in the presence of strong adjacent in-band signals. The tuned front end effectively eliminates any

problem with out-of-band stations. (KD9SV lives close to several AM broadcast stations and operates without problems.)

In casual operation after the contest, I did A-B comparisons with my other preamp to evaluate performance from a "known" standard. This design induces little additional noise in the circuit. The variable gain control is also a nice addition that lets you maximize gain without adding too much noise to the receiver.

The acid test was trying to dig out weak signals. This preamp performed extremely well in all cases. Stations that were barely audible on the vertical or unamplified Beverages were perfectly Q-5 when I turned on the preamp. The only gripe I have about this preamp is that it's a single band unit. However, the overall improvement in operation is worth the minor inconvenience. I suspect I'll build another preamp for 80 meters sometime this summer.

**de NX1G**



## Choice Selection.

Now you can have it all! Take all the qualities you've come to depend on in our programmable CTCSS tone equipment: Astonishing Accuracy, Instant Programming, Unequaled Reliability; and add full spectrum tone versatility, multi-tone capability without diodes, a reprogrammable memory... It's our new harvest of CTCSS tone equipment.

The choice is yours! If standard CTCSS EIA tones do not suit your taste, select any 32 tones of your liking from 15.0Hz to 255.0Hz. And if you change your mind, no problem; the memory can be changed in your shop with our HHP-1 programmer, or at our factory for free. Your working tone is accessed by a simple DIP switch, so there's no fussing with counters or other test equipment.

Call today toll-free and find out more about this fresh new flexibility in tone signalling, and don't forget to ask about multi-tone switching without cumbersome diode networks or binary switches.

It's all brought to market by the people who introduce the freshest ideas in tone signalling, and of course our customary same day shipping and one year warranty apply.

**TS-32P CTCSS ENCODER-DECODER** Based on the time proven TS-32, the industry standard for over a decade. The TS-32P gives you the added versatility of a custom, changeable memory base. A low price of \$57.95 makes it an even sweeter deal.

**SS-32P ENCODER** Based on the equally popular SS-32 encoder. Available for CTCSS, or audible burst tones up to 6550.0Hz. Price is \$28.95.

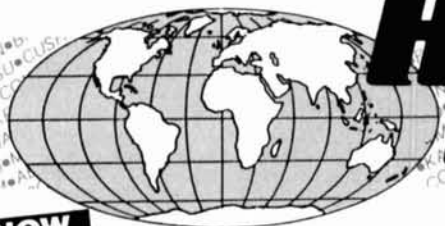
**SS-32SMP SUB-MINIATURE ENCODER** Our smallest encoder for handheld applications. Now you can satisfy that customer that needs to access multiple repeater sites with a radio that has precious little space inside. At \$27.95, the price is small too.

**HHP-1 HANDHELD PROGRAMMER** For programming the 32 memory locations in any of our new programmable products, including our SD-1000 Two-Tone Sequential decoder. The HHP-1 is battery operated for field use, and will program ANY 32 tones from 15.0 to 6550.0Hz in .1Hz. increments. Price is \$199.95.



**COMMUNICATIONS SPECIALISTS, INC.**  
426 West Taft Avenue • Orange, CA 92665-4296  
Local (714) 998-3021 • FAX (714) 974-3420 • **Entire U.S.A. 1-800-854-0547**

For A HRO 72 Page  
Communication Equipment Catalog  
Send \$1.00 to any HRO Store



# HAM RADIO OUTLET

LARGEST HAM OUTLET IN THE WORLD

NOW

## 9 STORE BUYING POWER



**GEOCHRON**  
GLOBAL  
TIME  
INDICATOR

**SALE!**

- Detailed illuminated map shows time, time zone, sun position and day of the week at a glance for any place in the world.
- Continuously moving - areas of day and night change as you watch.
- Mounts easily on a wall. Size: 34 1/2" x 22 1/2".

~~\$1295~~ **\$1159.95 DELIVERED IN U.S.**

**A3** DX THAT STANDS OUT FROM THE CROWD

10, 15, 20  
Meters

**cushcraft**

Whether busting pileups, rag chewing or hunting rare DX, the A3 stands out from the crowd with the perfect combination of easy assembly, the right size, rugged durability and great performance.

- Boom Length 14 ft., Weight 27 lbs.
- Wind Surface Area 4.36 ft.

Most not included

REG. 399.00

SALE 269.95  
Plus Shipping

**SALE!**

**concept**

VHF/UHF  
SOLIDSTATE  
AMPLIFIERS



Contemporary design, quality and a 5 year warranty on parts and labor.  
6 months on the RF Final transistors.  
All amplifiers have GaAsFET receive pre-amps and high SWR shutdown protection.



**MA-40**

40' TUBULAR TOWER

~~\$899~~ **SALE! \$629**

**MA-550**

55' TUBULAR TOWER

~~\$1369~~ **SALE! \$999**

- Handles 10 sq. ft. at 50 mph
- Pleases neighbors with tubular streamlined look

**TX-455 SALE! \$1389**

55' FREESTANDING  
CRANK-UP

- Handles 18 sq. ft. at 50 mph
- No guying required
- Extra-strength Construction
- Can add raising and motor drive accessories

Shown with optional MARK rotor base

TOWERS RATED TO EIA SPECIFICATIONS  
OTHER MODELS AT GREAT PRICES  
IN STOCK FOR QUICK DELIVERY

**TEN-TEC**

**MADE IN U.S.A.**



**OMNI-V**

- Optimized for reduced Phase Noise
- Dual VFO's, 100 W Output
- All bands 160-10



**TITAN 425**

- Pair 3CX800A7 • External Power Supply
- Performance at legal limit
- 3 MS OSK, 1.6 to 22 MHz • Assures "Loaf Along"
- With authorized modification through 29.999 MHz

IN STOCK NOW! FREE SHIPMENT!



Advanced  
Electronic  
Applications

**PK-232 Multi-mode  
Data Controller**



- NEW IBM Fax Screen Display Program Available
- Transmit/Receive on Six Modes
- CW/RTTY/ASCII/AMTOR/Packet/FAX
- IBM and Commodore terminal programs available
- Radio Ports for HF and VHF

In Stock for Quick Delivery  
Free Shipment

**Kantronics/KAM**



True dual port - simultaneous HF/VHF packet operation

- Personal Bulletin Board
- RTTY/ASCII/AMTOR/CW/Weather Fax
- Programmable MARK and SPACE tones
- Terminal programs for PC compatibles and Commodore
- WEFAX programs for PC, Commodore, and Macintosh

One-year Warranty  
CALL FOR LOW, LOW PRICE

**FREE SHIPMENT**  
Most items over \$100  
UPS surface

# All Major Brands in Stock Now!

Call any of our 800 numbers coast to coast from most parts of the country.

**CALL TOLL FREE**  
IN CALIFORNIA CALL STORE NEAREST YOU

MID-WEST/WEST  
ANAHEIM, 9 to 5:30 PST  
**1-800-854-6046**

SOUTHEAST  
ATLANTA, 9 to 5:30 EST  
**1-800-444-7927**

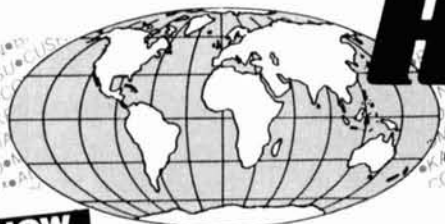
MID-ATLANTIC  
WOODBRIIDGE, 9 to 5:30 EST  
**1-800-444-4799**

NEW ENGLAND  
SALEM, 9 to 5:30 EST  
**1-800-444-0047**



Toll free including Hawaii. Phone Hrs: 7:00 am to 5:30 p.m. Pacific Time. California, Arizona and Georgia customers call or visit nearest store. California, Arizona, Georgia and Virginia residents please add sales tax. Prices, specifications, descriptions subject to change without notice.

For A HRO 72 Page  
Communication Equipment Catalog  
Send \$1.00 to any HRO Store



# HAM RADIO OUTLET

LARGEST HAM OUTLET IN THE WORLD

NOW

## 9 STORE BUYING POWER

### ICOM IC-765



100W GENERAL COVERAGE RECEIVER  
HF ALL BAND TRANSCEIVER  
Maximum Operation Flexibility

**SALE! CALL FOR PRICE**

### ICOM IC-781



THE ULTIMATE  
150 W, ALL BAND  
HF TRANSCEIVER

**GREAT PRICE!**

### ICOM IC-900 MULTI-BAND MOBILE



CLOSEOUT  
PRICES  
TOO LOW  
TO PRINT

YOU CAN OPERATE SIX BANDS  
WITH ONE CONTROLLER!  
2 MTR 25/45W, 440 MHz 10 MTR, 6 MTR,  
220 MHz & 1.2 GHz 10 MEMORIES  
**ARE YOU READY FOR  
1.2 GHz OPERATION?**

ICOM A Models 25 WATTS  
H Models 100 WATTS  
**IC-275A/275H, 138-174 MHz**  
**IC-375A, 220 MHz**  
**IC-475A/475H, 430-450 MHz**



**LOW PRICE!**

### HAM RADIO OUTLET NATIONWIDE TEAM



**COAST TO COAST**  
**RAPID DELIVERIES  
FROM STORE NEAREST YOU**

### ICOM HAND-HELD VHF/UHF



MICRO  
SIZE

**IC-32AT** Dual Band Hand Held  
**IC-2GAT** 2 Meter HT 7 WATT  
**IC-2SAT, 2MTR**  
**IC-3SAT, 220 MHz**  
**IC-4SAT, 440 MHz**

### ICOM IC-2400A 2m, 440 MHz

NEW



VHF/UHF DUAL BAND  
FM TRANSCEIVER

### ICOM IC-228A/H 2 METER MOBILES IC-448A 440 MHz MOBILE



FM TRANSCEIVER  
20 Memories with Memory  
Channel Lock-Out.

### ICOM IC-725



100W GENERAL COVERAGE RECEIVER  
HF ALL BAND COMPACT TRANSCEIVER  
**GREAT PRICE**



## All Major Brands in Stock Now!

**FREE SHIPMENT**  
Most items over \$100  
UPS surface

**Bob Ferrero W6RJ**  
President/Owner  
**Jim Rafferty N6RJ**  
VP-National  
Sales Manager

**ANAHEIM, CA 92801**  
2620 W. La Palma  
(714) 761-3033, (213) 860-2040  
Between Disneyland &  
Knotts Berry Farm

**BURLINGAME, CA 94010**  
999 Howard Ave.  
(415) 342-5757  
George, Mgr. WB6DSV  
5 miles south on 101 from SFO

**PHOENIX, AZ 85015**  
1702 W. Camelback Rd.  
(602) 242-3515  
Gary WB7SLY, Mgr.  
East of Hwy. 17

**SAN DIEGO, CA 92123**  
5375 Kearny Villa Rd.  
(619) 560-4900  
Tom, Mgr. KM6K  
Hwy 163 & Claremont Mesa Blvd.

**ATLANTA, GA 30340**  
6071 Buford Hwy.  
(404) 263-0700  
Larry, Mgr. WD4AGW  
Doraville, 1 mi. north of I-285

**OAKLAND, CA 94606**  
2210 Livingston St.  
(415) 534-5757  
Rich, Mgr. WA9WYB  
IS-880 at 23rd Ave. Ramp

**SALEM, NH 03079**  
224 N. Broadway  
1-800-444-0047  
Curtis, Mgr. WB4KZL  
28 miles north of Boston exit 1 I-93

**WOODBIDGE, VA 22191**  
14803 Build America Drive  
(703) 643-1063 1-800-444-4799  
Linda KB4ZYT, Mgr.  
Exit 54, I-95 South to US RT 1

STORE HOURS 10 AM-5:30 PM  
CLOSED SUNDAYS

**VAN NUYS, CA 91411**  
6265 Sepulveda Blvd.  
(818) 988-2212  
Al, Mgr. K6YRA  
San Diego Fwy. at Victory Blvd

**CALL TOLL FREE**  
IN CALIFORNIA CALL STORE NEAREST YOU

Call any of our 800 numbers coast to coast from most parts of the country.  
**1-800-854-6046** MID-WEST/WEST ANAHEIM, 9 to 5:30 PST  
**1-800-444-7927** SOUTHEAST ATLANTA, 9 to 5:30 EST  
**1-800-444-4799** MID-ATLANTIC WOODBRIDGE, 9 to 5:30 EST  
**1-800-444-0047** NEW ENGLAND SALEM, 9 to 5:30 EST



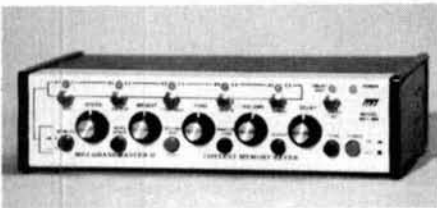
Toll free including Hawaii. Phone Hrs: 7:00 am to 5:30 p.m. Pacific Time. California, Arizona and Georgia customers call or visit nearest store. California, Arizona, Georgia and Virginia residents please add sales tax. Prices, specifications, descriptions subject to change without notice.

# NEW PRODUCTS

## Easy-To-Use MFJ-486 Grandmaster Memory Keyer

The MFJ-486 Grandmaster Memory Keyer™ gives you the power and versatility of a microprocessor memory keyer with knobs and buttons instead of a keypad. It comes with the new MFJ CW Word Processor™ that lets you change a message without having to rekey it. CW Word Processor Function keys let you move around within any message, insert, delete, and change your message. You also get the MFJ Custom-Speed™ control and a three-step built-in CW Course.

Other features include: 8000 characters of soft-partitioned memory in 10 memory banks, lithium battery backup, automatic incrementing serial numbering, message repeat and beaoning delay (1 second to 3 minutes), instant start from memory, manual or automatic work spacing, speaker, earphone/speaker jack, easy-to-use front panel controls for speed, weight, volume, tone and delay. There's also tune-up, A or B type iambic keying, Z-80 microprocessor, and more. Use 12 to 15 volts DC or 110 volts AC with MFJ-1312, 12.95.



A wired remote control, MFJ-77 for \$19.95, lets you control memories and CW Word Processor function keys at your paddle.

It comes with MFJ's new One Full Year No Matter What™ Guarantee.

For more information contact any MFJ dealer or MFJ Enterprises, Inc., P.O. Box 494, Mississippi State, Mississippi 39762, or call (601)323-5869, FAX, (601)323-6551, or order toll free at 800-647-1800.

Circle #303 on Reader Service Card.

## New TM-231A Series VHF Transceivers

The new Kenwood TM-231A 2-meter FM transceiver has 20 memory channels, a DTMF microphone with control functions, a remote control head accessory, and a bright amber LCD display. It includes extended 2-meter frequency coverage (136 to 174 MHz receive) for MARS and CAP, and modifiable transmit range (permits required for modification information).



Models available for other bands include: TM-431A for 450 MHz, TM-531A for 1200 MHz, and coming soon the TM-331A for 220 MHz.

See your authorized Kenwood Amateur Radio dealer for more details or write: Kenwood USA Corporation, PO 22745, 2201 E. Dominguez Street, Long Beach, California, 90801-5745. Suggested retail prices: TM-231A: \$459.95, TM-431A: \$469.95, TM-531A: \$569.95.

Circle #000 on Reader Service Card.

## SG-9500 Signal Generator/Counter

The Elenco SG-9500 signal generator/counter combines a generator able to generate RF frequencies from 100 kHz to 150 MHz and a built-in frequency counter switchable to measure external frequencies up to 150 MHz in one unit.

The SG-9500A features include:

- Accuracy  $\pm$ count  $\pm$ 1 digit
- RF output 100 mV RMS (up to 35 MHz)
- Output control 0 dB/20 dB switch with fine adjustment control
- 1-kHz internal modulation
- Crystal oscillator HC-6/V holder
- Input voltage less than 50 mV
- Gate times selector 0.1 sec and 1 sec
- Input impedance HF 1 ohm VHF 50 ohms



The price is \$349.95. For more information contact Elenco Electronics, 150 W. Carpenter Avenue, Wheeling, Illinois 60090.

Circle #304 on Reader Service Card.

## SSTV and FAX System for Commodore Amiga

Advanced Electronic Applications, in agreement with Black Belt Systems, now offers the Commodore Amiga Video Terminal (AVT) "Master" system.

Developed by Ben Blish, N4EJI, and Dr. Anne Williams, N7LWZ, the AVT Master uses Amiga's graphics capabilities to transmit and receive high resolution facsimile and slow-scan television images. Received images can be printed on any Amiga printer or saved on a disk file. The AVT Master can manage your logbook, slow-scan TV (SSTV) system, packet bulletin board, and more.

The AVT mode features 400-Hz bandwidth. All video information is crystal-locked at both the transmitting and receiving stations at the start of each frame. The AVT Master can send high speed color images over the telephone lines to similarly equipped AVT Master stations. It also has telephone ring detect and auto answer.

The AVT Master system's suggested retail price is \$299.95. For more details contact AEA, P.O. Box C-2160, Lynnwood, Washington 98036, Telephone (206)775-7373.

Circle #305 on Reader Service Card.

## SCR7000X VHF/UHF Repeater

Spectrum Communications Corp. has released its new SCR7000X VHF/UHF repeater with a built-in microprocessor controller. All functions can be controlled remotely through either touch-tone or computer commands. Advanced panel controls include digital metering and a full complement of system status LEDs. Also available are a number of state-of-the-art options to tailor the SCR7000X to your specific operating requirements. For more information, contact: Spectrum Communications, 1055 Germantown Pike, Norristown, Pennsylvania 19403.

Circle #308 on Reader Service Card.

## OR-2300 Antenna Rotator

The new Orion OR-2300 antenna rotator uses a worm gear drive method and is rated at 35 square feet. The special compact design allows mounting in most popular crank-up and stacked towers. The control box has a large, easy-to-read direction indicator with variable speed.

Rugged mast clamps incorporating a self-centering guide accept mast diameters from 1-3/4 to 3-1/8". A flex mount clamping method self-corrects for misaligned masts and absorbs windload. Built-in thrust and double bronze bear-

(continued on page 84.)

# THE BATTLE OF THE BEAMS

## PART 3

*Ever since 1939, Dr. Plendl of the German Aeronautical Research Establishment entertained doubts about the effectiveness of X-Gerät in the face of strong jamming; accordingly, schemes for a new system were put in hand at that time. D. V. Pritchard Dip Ed, G4GVO, concludes this most interesting story.*

*By D. V. Pritchard, G4GVO, 55 Walker Dr., Leigh on Sea, Essex SS9 3QT, England*

Ideally, such a system would have only one director beam for the guidance of the bomber, and another for a range measurement system which would enable ground control to drop the bombs accurately. Clearly improved accuracy would be needed, and it was possible that owing to the nature of the system the number of aircraft on the beam at any one time would be necessarily low.

### Early experiments

Since the only aircraft receiver available was the FuG 17 (42 to 48 MHz), a multibeam beacon was designed for it by a Dr. Herzog of the Gotz Company and given the code name *Wotan 2*. A system similar to X-Gerät was also built which used the *Bertha 1/2* television transmitter, with similar pulsing and modulation having a dot/dash ratio of 1:7 modulated at 2000 Hz. Plendl's analyzer was also employed; this system was envisaged as the director beam for the aircraft's flight path.

For range measurement, another special "dash system" was developed at Rechlin. A transmitter tunable between 42 and 48 MHz was modulated for 10 seconds at 300 Hz; its signal was received in the aircraft on a later mark of Herzog's receiver — now the FuG 17 E and on the German production line. Its output was fed through a tone filter and the resulting note modulated an airborne transmitter, which returned the signal to the ground on another frequency in the 42 to 48-MHz range. There the returned modulation note was compared with the original one sent from the ground and the phase difference, after deduction of the time lag in the aircraft's equipment, gave a direct measure of the range between the ground transmitter and the aircraft.

### Different ideas

In fact several systems were tried for the early Y-System, but the one chiefly employed was the "Y-Range Measuring System Mechanical" developed by Dr. H. J. Schmidtman at Rechlin and Dr. Jenns of Siemens (see **Figure 1**). Two tone frequencies of 300 Hz (corresponding to 500 km, the "coarse measuring range") and 3000 Hz (equaling 50 km, the "fine tuning range") were transmitted. Rectifiers loosely coupled to the transmitting antennas fed both frequencies via separate filters and phase converters to two small c.r.t.s, which were also fed the filtered frequencies from the receiver tuned to the aircraft's return signal. Tuning the phase converter resulted in diagonal strokes appearing on the screens which served as null-point indicators; range was read from a scale marked in kilometers.

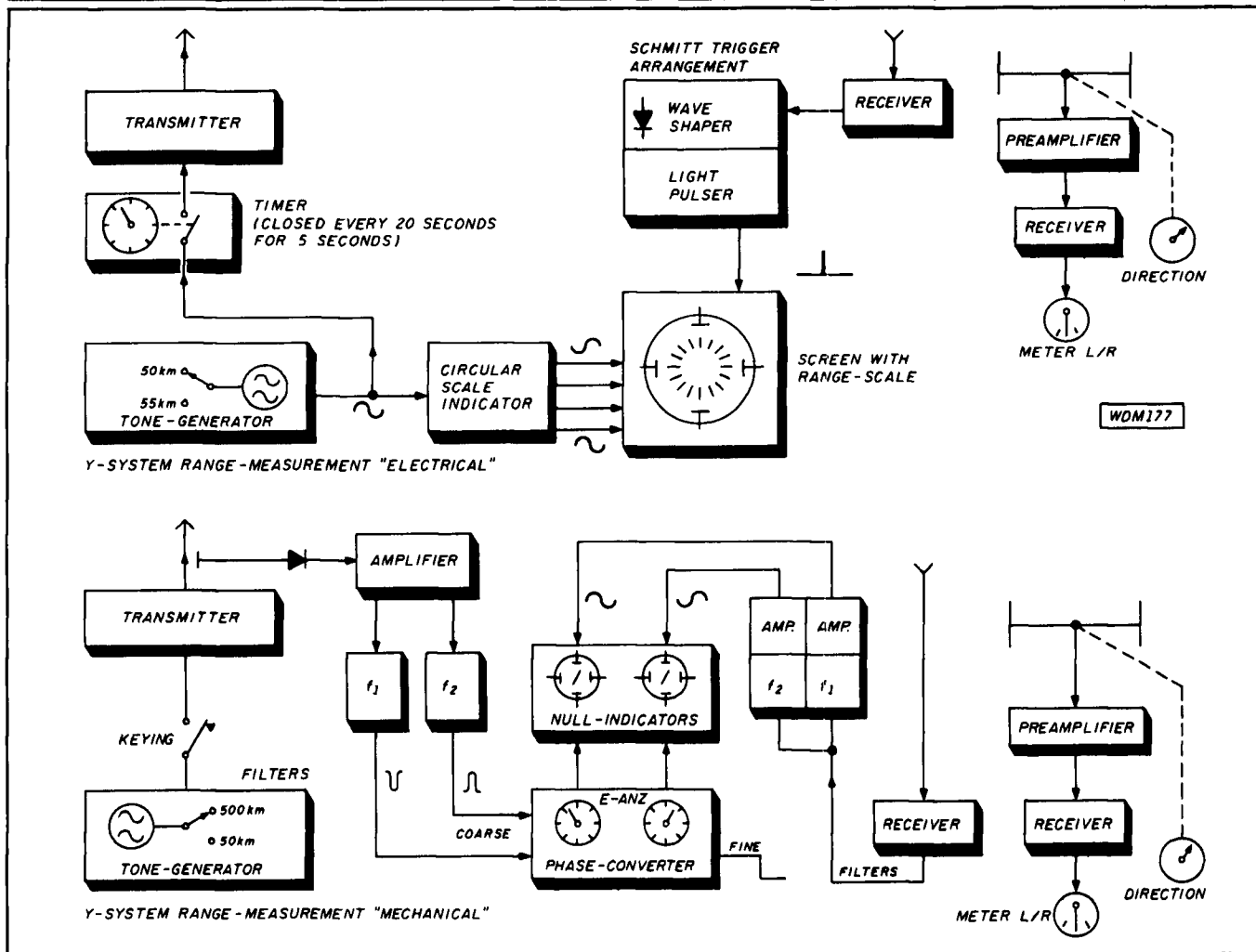
Siemens also produced a range measurement known as the *Electrical Notebook*, which recorded the ultimate range of five simultaneously measured aircraft. This incorporated a fine-measuring system devised by a Dr. Bekker that used a larger c.r.t. with a circular range scale showing a range from 0 to 20 km. A transmitted tone of 7500 Hz generated a "dark pulse" circular time zone calibrated against a further circular "bright zone." The phase-converted voltage from the receiver was then transformed into a pulse which the electron beam converted into light points, so that a change in range could be observed directly. This system was somewhat unreliable in that a 5-km variation in range was sometimes observed, but nevertheless it was of some help when enemy jamming was strong.

Later, Dr. Bekker introduced another device known as the "Y-System Measuring Electrical" which was produced by the Graetz Company. A modulation note of 300 Hz corresponded to 50 km, but it could also be used for an indication at, say, 20 km. Switching to a frequency 10 percent higher extended the range to 32 km, and so on. Little more, unfortunately, is known about this method.

### First trials

These systems were, however, only useful for random location at first. Only an all-round representation of an aircraft was given. For example, the aircraft flew to a given point by standard navigational methods and its range was then measured by these various electronic systems. Its approach to the point was ascertained by coupling the system to an ultra-shortwave Adcock direction finder, code named *Heinrich*. Variants of the earlier X-Gerät system were often incorporated wherein a director beam was used. But

FIGURE 1



Block diagram of the Y-system range-measurement systems, electrical and mechanical.

the place where the old cross beams would have been employed, instead of the X-Uhr combined clock/calculator, would indicate the precise timing according to range measurement from the ground. On approaching the bomb release point the X-Uhr received a 9-second Morse signal. The bombs were released on the last dot.

**Final form**

In 1940, under the direction of Dr. Plendl, a development was devised from this method by Dr. Herzog. This new system retained the code name *Wotan 2*. Its full title was the "Y-Double-Beam Beacon System" and it included parts of the multibeam system already described (see Figures 2 and 3).

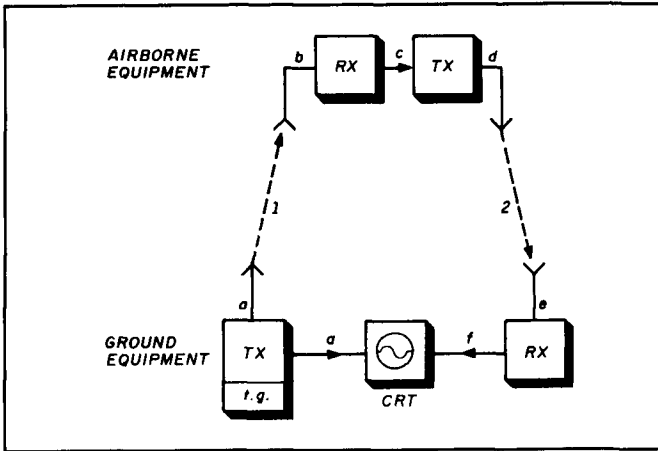
Although the same rotating installation with transmitter and operating cabin was used, new antennas were introduced with seven parallel dipoles and reflectors, which generated a long club-shaped lobe with smaller side lobes. At a half wavelength in front of these were two further dipoles spaced at a wavelength apart which, on an opposite phase, produced a "washed out" cardioid pattern. Thus two sets of beams were sent out — one for the flight path to the target, and the other for the aircraft's return. (Refer to Figure 4.)

Keying the system was originally effected by mercury switches or vacuum relays, but as they gave rise to key clicks, they were replaced by the so-called "capacitive mill" designed by a Dr. Escherich. This was a motor-driven differential capacitor which used a light bulb to take the transmitter load between the pauses in transmission. The long lobed directional antennas were keyed at 176 pulses per minute followed by the cardioid-shaped dipoles. This resulted in a slower dot/dash pulse with much shorter gaps at a ratio of 8.8:1, and was acoustically more acceptable.

In addition, a new receiver based upon Herzog's FuG 17 E was developed by Dr. H. Donn and Dr. W. Hepper; it was designated the FuG 28a and manufactured by the Heliowatt Company. This was combined into one unit with Plendl's improved AW 28 analyzer. The latter contained a motor driving a cam making 180 contacts per minute, which conducted the receiver output to two series-connected capacitors. Their differential voltages then biased the grids of two valves so that one was bridge switched. A balance existed if the field strength of the two pulses from either transmitter was the same; that is, if the aircraft was found on one of the two beams. Variation to left or right gave opposing bridge currents, with corresponding responses on the indicating meters.



FIGURE 2



General layout of the Y-system. (1) Outward beam. (2) Return beam. t.g.- tone generator, TX—transmitter. RX - receiver.

additional winding on the relay delivered sufficient voltage to release the relay.

The Y-System could probably have been the most effective (if not dangerous) system of all the German beams had it not been for one small item the Germans, in spite of their customary thoroughness, had somehow overlooked.

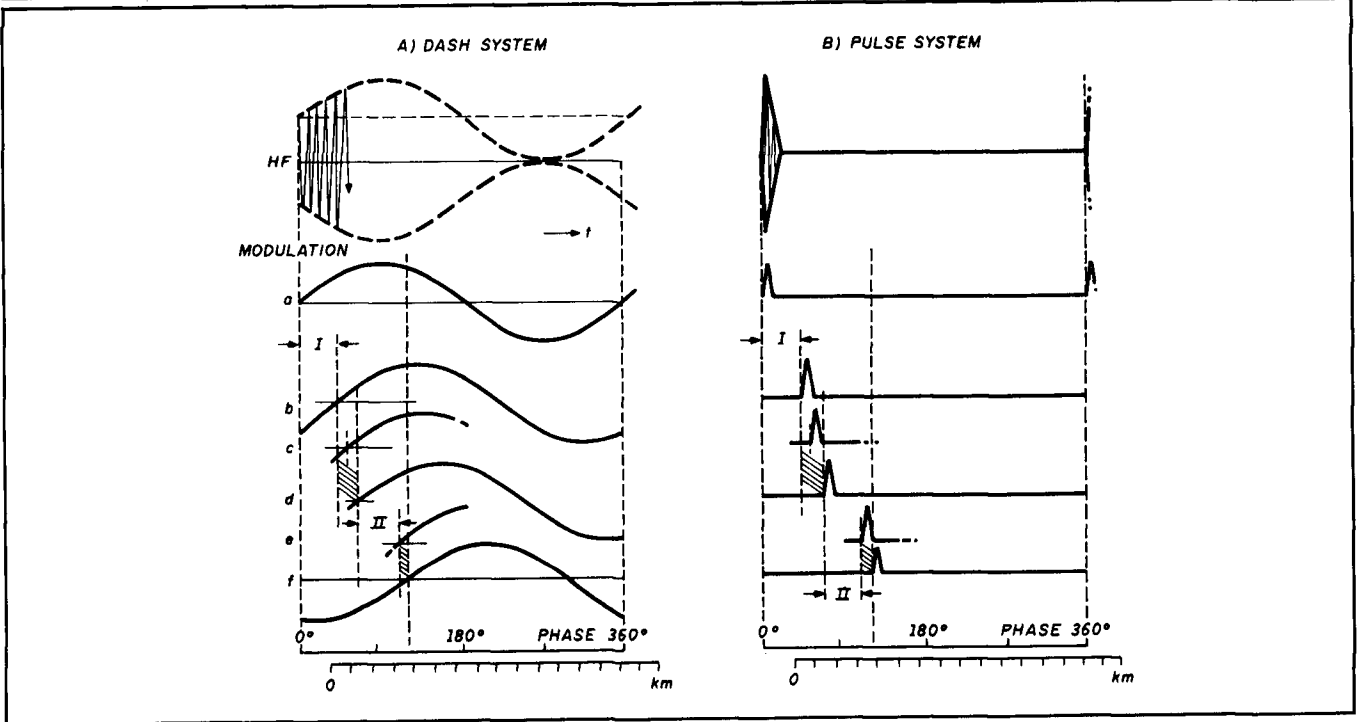
### Norse mythology — the giveaway

As early as June 1940, when Dr. R. V. Jones had final proof of the existence of Knickebein, he received an Enigma decode from Bletchley Park. *It is proposed to set up Knickebein and Wotan installations near Cherbourg and Brest.*

Wotan was certainly something new, but what did it mean? He knew that Wotan was the greatest of the German gods, but was there anything unusual about him? What attributes did he possess that moved the Germans to use his name as a code word?

Jones phoned his friend Frederick "Bimbo" Norman,

FIGURE 3



Graphs of range, modulation, and timing of the Y-system. The running time inside the equipment is shown on the shadowed parts of the graphs. The range scale is therefore displaced by this value on the right-hand graph (B).

The gap between transmissions in each case caused a magnetic coupling between the motor and the switch to drop, and to be reinstated only when the next cycle of transmissions commenced. In this way a positive synchronization between the ground station and the aircraft was established. To position himself on the correct beam, the pilot switched on his equipment — which also incorporated a sensitive, heavy-duty relay with an extra winding. The relay operated according to course variations by switching over the polarity for left and right directions. Thus the motor would be in the correct rotation sense when switched on, until a potentiometer connected between the motor and the

Professor of German at King's College, London, then one of the cryptographers at Bletchley Park. "Bimbo" was renowned for his lightning-fast mind and at once gave proof of it.

"Yes, Wotan was the chief German god. Wait a moment...he had only one eye. One eye, one beam! Can you think of a system that would use only one beam?"

Dr. Jones could, in principle; but it was not until the end of 1940, when X-Gerät was finally mastered, that he and his assistant Dr. F. C. Frank suspected that another German beam system might be making its appearance. Could this be the Wotan they were looking for? The new system

seemed to involve a director beam plus a means for ranging. Jones's suspicions were aroused when on October 6 an Enigma transmission to what appeared to be a station called "Wotan 2" northwest of Cherbourg read, *Target no. 1 for "Y" coordinates 50°41'49.2" north, 2°14'21.2" west.*

Study of a map revealed these to be the coordinates of an army depot at Bovington in Dorset. They showed a great difference from the X-Gerät system in which a number of beam directions were always sent out, each station having to set its beam in the required direction. With this new method, however, the position of the target was given to a single station, which suggested that the station had the entire means of directing the bomber to its target. This seemed to be confirmed when Bovington was attacked a few days later by two aircraft with results which, though somewhat inaccurate in direction, were good as regards the range.

## Frequencies and cyphers

Signals Intelligence and our monitoring services soon began to report the existence of beams on frequencies between 40 and 50 MHz which had very different characteristics from Knickebein and X-Gerät. Instead of the left and right transmissions being modulated with dots and dashes, the emissions were of equal duration — except for a short pause in transmission when one signal, for example the left, came directly after the pause and the other signal followed in a sequence thus: pause — left, right, pause — left, and so on.

Dr. Robert Cockburn and his assistants at the Telecommunications Research Establishment put the signal on an oscilloscope, and immediately observed its principle. The beam emitted three directional transmissions per second and seemed to have been designed to operate a beam flying indicator in the aircraft. As things turned out, more surprising developments were to be revealed.

Jones discovered that the aircraft using the new system were not from K.Gr.100 but from the Third Group of KG 26. He also learned that the scientist who had developed the system was none other than Dr. Plendl who had devised X-Gerät. Plendl was the German equivalent of T. L. Eckersley, our leading radio propagation expert. When Jones asked Eckersley what he thought of Plendl he replied, "He's not much good, he bases his theory on experiment!" (*Amateurs please note!*)

On January 19, 1941, an aircraft of KG 26 was shot down and, though it was badly damaged, it could be seen that it carried equipment similar, though not identical, to X-Gerät. But of greater significance was the radio operator's charred notebook:

Loge	244	142	10
Schmalstigel	454	149	11
Bruder	372	120	11
Suden	272	117	11
Bild	405	137	11

## Rückflug

Knowing that KG 26's base was at Poix, southwest of Amiens, and that "Loge" was the German code name for

London, Jones and Charles Frank were able to make the following interpretation:

Objective	Distance to Poix	Rhumb bearing to Poix	Magnetic variation
London	244 km	142°	10°
Sheffield	454 km	149°	11°
Bristol	372 km	120°	11°
Southampton	272 km	117°	11°
Birmingham	405 km	137°	11°

## Homeward flight

The second table in the notebook gave:

Hinflug	
294	10
318	11
283	11
274	11
302	11

By assuming that these entries referred to the same cities as those in the first table, and that they were bearings, the intersection point appeared to be at Cassel in north France, which gave them:

## Outward flight

Objective	Approach bearing from Cassel	Magnetic variation
London	294°	10°
Sheffield	318°	11°
Bristol	283°	11°
Southampton	274°	11°
Birmingham	302°	11°

Jones could therefore deduce that:

(a) the aircraft approached its target from the direction of Cassel; (b) the pilot was not concerned with distance calculations, which would be consistent with the distance being determined by a distant ground station; and (c) after the plane had reached its target, the pilot intended to return directly to an airfield near Poix. And since he was navigating on his own, he needed to know the distance from the target back to Poix — as well as the direction.

A third table in the notebook contained the frequencies for both the beam itself and the ranging system. Typically, the station radiated a sinusoidally modulated signal to the aircraft on 42.5 MHz and its modulated note was then detected, amplified, and used to modulate a transmitter in the aircraft, which sent a signal on 46.9 MHz back to the ground station. The distance of the aircraft was determined by the delay in the return signal. As we know, an analyzer was used.

## The delicious leg pull!

From a security viewpoint it is remarkable that the Germans failed to ensure that notebooks and tables giving important information were not taken aboard aircraft. It would have been a simple matter to memorize these things for a single operation. On the other hand, it could be said that the Germans were completely unaware that we had broken their Enigma signal system, which gave away so much more vital information. At all events, these matters added up to British intelligence being able to glean much information which the enemy confidently believed to be secure.

Dr. Jones immediately spotted a "delicious" method of

**LIMITED  
SUPPLY**

**ICOM 228H**

Call for  
special price!

MA. ★

# TEL-COM ★

*Electronic Communications*

NEW ENGLAND'S FACTORY-  
AUTHORIZED SALES & SERVICE  
FOR

**KENWOOD**  **ICOM**

Also displaying the popular accessories needed to complete a HAM STATION . . .

- ARRL PUBLICATIONS • AEA PRODUCTS • AMPHENOL
- ALPHA DELTA • ASTRON • AUSTIN ANTENNAS • AVANTI
- BELDEN • BENCHER • B & W • DAIWA • ALINCO
- HUSTLER • KLM • LARSEN • MIRAGE • ROHN
- TELEX/HY-GAIN • TOKYO HY-POWER LABS
- TRAC KEYERS • VIBROPLEX • WELZ • ETC.

OPEN SIX DAYS A WEEK   WELCOMED

**Telephone 508/486-3400, 3040**

675 Great Rd., (Rte. 119) Littleton, MA 01460

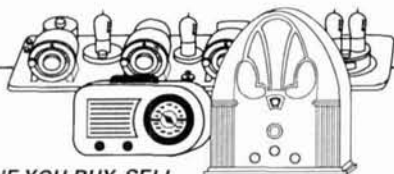
1/4 miles from Rte. 495 (Exit 31) toward Groton, Mass.

**LIMITED  
SUPPLY!**

**Kenwood  
TH 25 AT**

Call for  
Special Price

✓ 142



IF YOU BUY, SELL  
OR COLLECT OLD RADIOS, YOU NEED...

## ANTIQUE RADIO CLASSIFIED

FREE SAMPLE COPY!

Antique Radio's Largest Monthly Magazine  
Classifieds - Ads for Parts & Services

Articles - Auction Prices-Flea Market Info.

Also: Early TV, Ham Equip., Books, Telegraph,

Art Deco, 40's & 50's Radios & more...

Free 20-word ad each month. Don't miss out!

6-Month Trial - \$11.

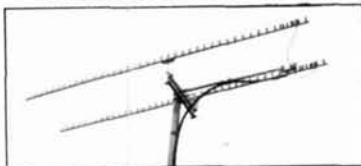
1-Year: \$20 (\$30 by 1st Class)

Foreign by air - Canada: \$32; Mexico: \$30; Other: \$60.

A.R.C., P.O. Box 802-A5, Carlisle, MA 01741

✓ 143

### DOWN EAST MICROWAVE



#### MICROWAVE ANTENNAS AND EQUIPMENT

- Loop Yagis • Power Dividers • Linear Amplifiers • Complete Arrays • Microwave Transverters • GaAs FET Preamps
- TROPO • EME • Weak Signal • OSCAR • 902 • 1269 • 1296 • 2304 • 2400 • 3456 MHz

2345 LY	45el	loop Yagi	1296 MHz	20dBi	\$99
1345 LY	45el	loop Yagi	2304 MHz	20dBi	\$80
3333 LY	33el	loop Yagi	902 MHz	18.5dBi	\$99

Above antennas assembled and tested. Kits available.

Add \$8 UPS S/H. \$11 West of the Mississippi

#### MICROWAVE LINEAR AMPLIFIERS SSB, ATV, REPEATER, OSCAR

2316 PA	1w in 18w out	1240-1300 MHz	13.8V	\$265
2335 PA	10w in 35w out	1240-1300 MHz	13.8V	\$315
3318 PA	1w in 20w out	900-930 MHz	13.8V	\$265
3335 PA	10w in 40w out	900-930 MHz	13.8V	\$320
231NA preamp	0.7dB N.F.	1296 MHz	\$ 90	
331NA preamp	0.9dB N.F.	902 MHz	\$ 90	

Add \$5 shipping UPS/48

SHF systems transverters and kits available.

Write for free catalog



**DOWN EAST MICROWAVE**

Bill Olson, W3HQT

Box 2310, RR 1, Troy, ME 04987

(207) 948-3741



✓ 144

### ALL AMATEUR WIRE AND CABLE from the

## WIREMAN

#### CERTIFIED QUALITY

The only wire and cable designed by amateurs for amateurs.

#### featuring:

- CQ-4XL IIA ..... The top of the "POOR MAN'S HARDLINE" type, with the most braid and non-contaminating jacket.
- CQ-FLEXI 4XL ..... Brand new!! As above—same super low loss (1.3db/100' @ 2 meters), but now flexible enough for rotors, tip overs, etc. No more sumpers!!
- CQ-213/U ..... An enhanced version of MIL SPEC, with 24 more braid wires, better flex characteristics, MIL SPEC IIA jacket
- CQ-8X ..... The old standby mini-8, with silver-gray reflective jacket.
- CQ-8XIIA ..... As above, plus silky black MIL SPEC IIA non-contaminating jacket
- CQ-8X/M ..... New, heavy duty mini-8, temp. low corrosion, crush resistant, IIA jacket for marine and mobile use.
- CQ-COPPERCLAD ..... Designed for antennas (there is a difference) in 18, 16, 14, 13 awg, solid, stranded, multistranded, insulated, etc.
- CQ-TWIN LEAD ..... 450, 300, 72 ohm transmission line.
- CQ-ROTOR ..... 12 Standard and custom rotor cables.

Also hard line, guy wire, shielded audio, magnet, buss, ground, braid, ground rods, buss bars, connectors, wire antennas, baluns, kits, antenna accessories...

Wholesale and retail — any amount — Dealers OK

Catalog \$1 refundable w/order

1-800-727-WIRE (9473)

803-895-4195 (tech help and ragchew)

803-895-5811 (FAX)

CERTIFIED COMMUNICATIONS ("THE WIREMAN")

261 Pittman Road, Landrum, SC 29356

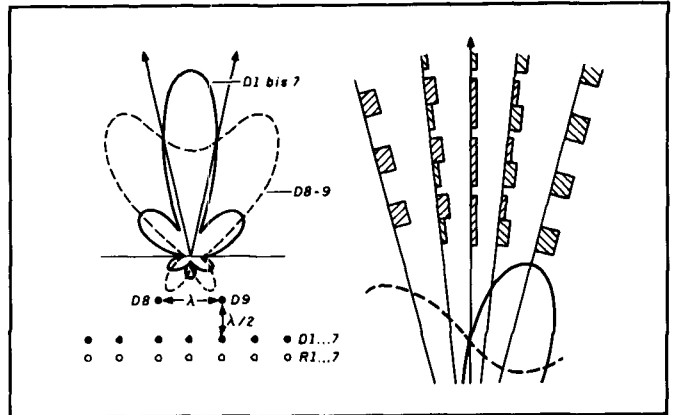
✓ 145

upsetting the Y-System, as shown in Figure 5. (Doubtless his prowess in practical joking came to his assistance here. After all, if disguised as a telephone engineer he had been able to persuade an Oxford physicist to plunge a telephone into a bucket of water, finding a way to bamboozle the enemy was likely to come quite readily to mind.) We in England could receive the 46.9-MHz signal from enemy aircraft even better than their ground station could, and so we could re-radiate the already re-radiated signal back to the aircraft on 42.5 MHz, the frequency used by the ground station. As Dr. Jones pointed out, "This would therefore be fed into the aircraft receiver, along with the signal coming in from the ground station, and in turn be fed back to the ground station again. The effect would be rather like that which occurs in public address systems where the noise from the loudspeakers impinges on the original microphone, and is therefore picked up and relayed back to the speakers again. It would appear to the ground station that the aircraft was at a false distance, because the returning waves would have traveled round an extra loop between the aircraft and our own station before getting back to their original base; and if we used a powerful transmitter ourselves, the whole system would ring just as a public address system squeals if the gain of the amplifier is made too high."

The BBC television transmitter at Alexandra Palace was just right for the task because it operated in the right frequency band. Dr. Cockburn immediately requisitioned it for the purpose and it transpired that this countermeasure, code named *Domino*, was first put to use the very night that KG 26 took over from K.Gr.100 — because we had now successfully jammed X-Gerät.

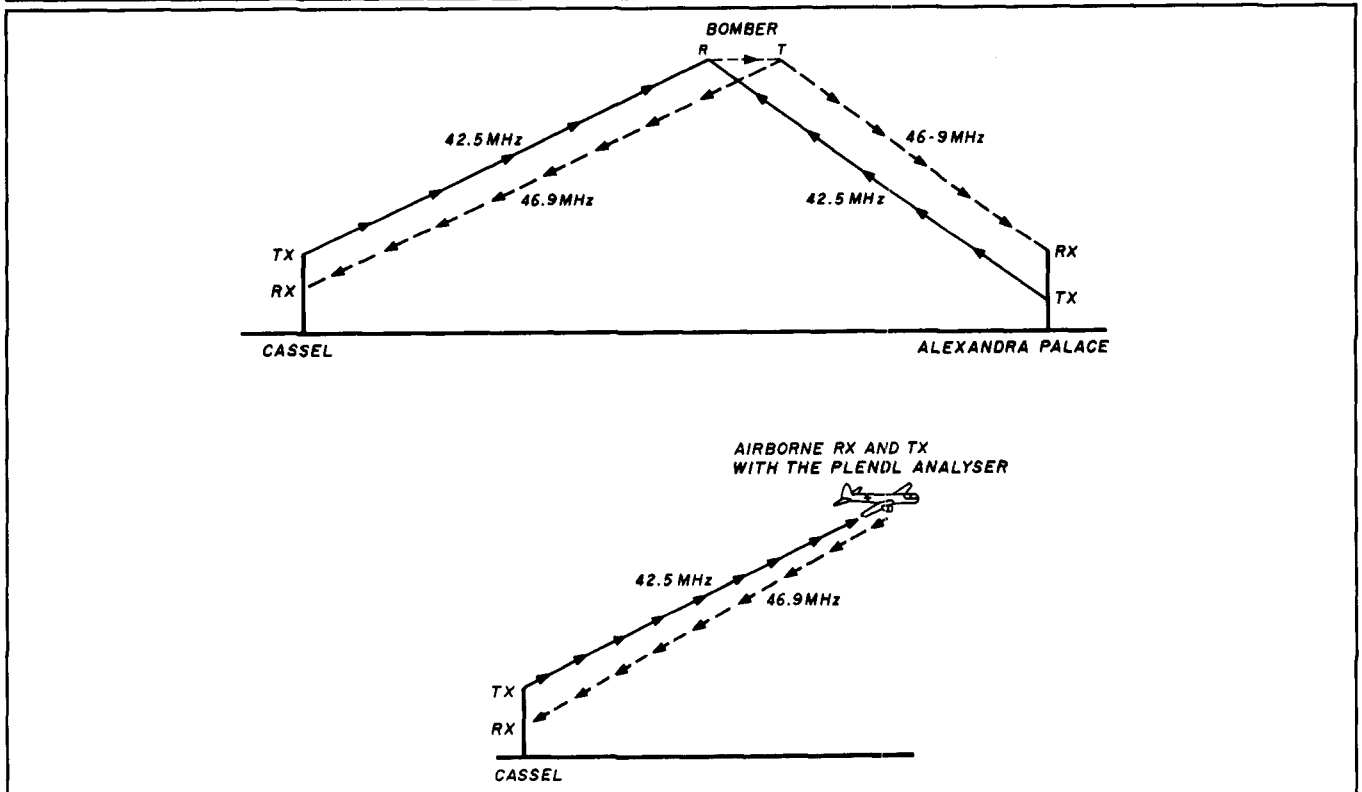
Jones advised that for the first few nights only a minimum of power should be used, just enough to inject a small signal into the Y-System to give the Germans a false range without arousing their suspicions (a process of "acclimatization" by slow change). The first results were not only successful, but afforded a source of innocent merriment. One aircraft became involved in an acrimonious exchange with the ground station, who suggested he must have a loose wire in his receiver and that he should abandon the attack

FIGURE 4



Official German diagrams of antenna patterns for (left) return path and (right) directional pulsed beam.

FIGURE 5



The method of interfering with the Y-beam system and the ranging principle of the Y-system.

# INTRODUCING OUR NEW COMPUTER-CONTROLLED REP-200 REPEATER

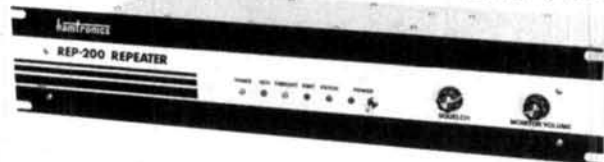
If you always thought a computer-controlled repeater had to be expensive, LOOK AGAIN! You could easily spend this much just for a controller.

As always, Hamtronics strives to give *superb performance at modest cost!* In this case, a premium repeater with versatile computer control, autopatch, and many dtmf control features at *less than many charge for a bare-bones repeater!*

We don't skimp on rf modules, either! Check the features on R144 Receiver, for instance. GaAs FET front-end, helical resonators, sharp crystal filters, hysteresis squelch.

We completely re-thought the whole idea of what a repeater should be, to give the *best features at the lowest cost.*

ONLY \$1295!



- Available for the 10M, 6M, 2M, 220MHz, 440MHz, 902MHz ham bands. FCC type accepted models also available for vhf and uhf commercial bands.
- Rugged exciter and PA, designed for continuous duty.
- Power output 15-18W (25W option) on 2M or hi-band; 10W on uhf or 902MHz.
- Accessory add-on PA's available with power levels up to 100W.
- Five courtesy beep types, including a pleasant multi-tone sequence.
- AUTOPATCH: either open or closed access, toll-call restrict, auto-disconnect.
- Reverse Autopatch, two types: auto-answer or ring tone on the air.
- DTMF CONTROL: over 45 functions can be controlled by touch-tone. Separate 4-digit control code for each function, plus extra 4-digit owner password.
- Owner can inhibit autopatch or repeater, enable either open- or closed-access for repeater or autopatch, and enable toll calls, reverse patch, kerchunk filter, site alarm, aux rcvr, and other options, including two auxiliary external circuits.
- The cwid message, dtmf command codes, and owner-specified default parameters for cor and cwid timers and tones are burned into the eeprom at the factory.
- Cw speed and tone, courtesy beep and tail timers, and courtesy beep type can all be changed at any time by owner-password-protected dtmf commands.
- Many built-in diagnostic & testing functions using microprocessor.
- Color coded led's indicate status of all major functions.
- Welded partitions for exciter, pa, receiver, and controller. PEM nuts for covers.
- 3-1/2 inch aluminum rack panel, finished in eggshell white and black.
- Auxiliary receiver input for independent control or cross linking repeaters.

There are many other features, too numerous to mention. Request catalog for full details.

## HIGH PERFORMANCE XMTRS & RCVRs FOR REPEATERS, AF & DIGITAL LINKS, TELEMETRY, ETC.

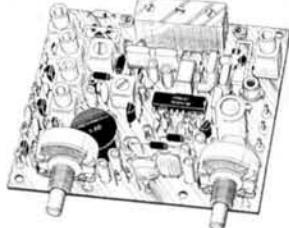
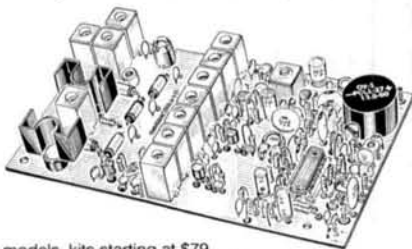
**FM EXCITERS:** kits \$99, w/t \$169. 2W continuous duty. TCXO & xtal oven options available. FCC type accepted for com'l uhf & hi bands.

- TA51 for 10M, 6M, 2M, 150-174, 220MHz.
- TA451 for uhf.
- TA901 for 902-928MHz, 0.5W out (w/t only, \$169).
- VHF & UHF AMPLIFIERS.

For fm, ssb, atv. Output from 10W to 100W. Several models, kits starting at \$79.

**FM RECEIVERS:** kits \$139, w/t \$189.

- R144/R220 FM RECEIVERS for 2M, 150-174, or 220MHz. GaAs FET front end, 0.15uV sensitivity! Both crystal & ceramic if filters plus helical resonator front end for exceptional selectivity: >100dB at ±12kHz (best available anywhere!) Flutter-proof hysteresis squelch; afc tracks drift.
- R451 UHF FM RCVR, similar to above.
- R901 902-928MHz FM RCVR. Triple-conversion, GaAs FET front end.
- R76 ECONOMY FM RCVR for 10M, 6M, 2M, 220MHz, w/o helical res. or afc. Kits \$129.
- Weather satellite & AM aircraft rcvrs also available.



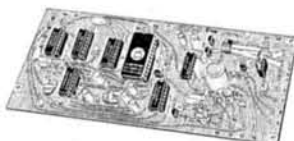
If you prefer a plain-vanilla or kit repeater, you couldn't find a better value than our original REP-100 REPEATER

Same fine rf modules as REP-200 but with COR-4 Controller. Can add autopatch, dtmf decoder, CTCSS, either now or later. Kit only \$675, w/t \$975.

## ACCESSORIES

**COR-3 REPEATER CONTROLLER kit.** Features adjustable tail & time-out timers, solid-state relay, courtesy beep, and local speaker amplifier .....\$49

**CWID kit.** Diode programmed any time in the field, adjustable tone, speed, and timer, to go with COR-3 .....\$59

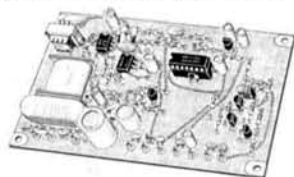


**NEW COR-4 kit.** Complete COR and CWID all on one board for easy construction. CMOS logic for low power consumption. Many new features. EPROM programmed; specify call ..\$99



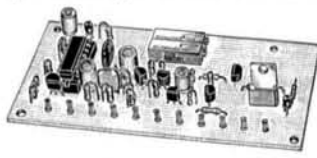
**NEW TD-3 SUBAUDIBLE TONE DECODER/ENCODER kit.** Adjustable for any tone. Designed especially for repeaters, with remote control activate/deactivate provisions .....\$24

**TD-2 TOUCH-TONE DECODER/CONTROLLER kit.** Full 16 digits, with toll-call restrictor, programmable. Can turn 5 functions on/off. Great for selective calling, too! .....\$79



**AP-3 AUTOPATCH kit.** Use with above for repeater autopatch. Reverse patch & phone line remote control are std. \$79

**AP-2 SIMPLEX AUTOPATCH Timing Board kit.** Use with above for simplex operation using a transceiver .....\$39



**MO-202 FSK DATA MODULATOR kit.** Run up to 1200 baud digital signals through any fm transmitter with full handshakes. Radio link computers, telemetry gear, etc. ....\$39

**DE-202 FSK DEMODULATOR kit.** For receive end of link. ....\$39

**9600 BAUD DIGITAL RF LINKS.** Low-cost packet networking system, consisting of new MO-96 Modem and special versions of our 220 or 450 MHz FM Transmitters and Receivers. Interface directly with most TNC's. Fast, diode-switched PA's output 15 or 50W. Call for more info on the right system for your application!

## GaAs FET PREAMPS at a fraction of the cost of comparable units!

LNG-(\*)

ONLY \$59  
wired/tested



FEATURES:

- Very low noise: 0.7dB vhf, 0.8dB uhf
- High gain: 13-20dB, depends on freq.
- Wide dynamic range - resist overload
- Stable: low-feedback dual-gate FET

\*Specify tuning range: 26-30, 46-56, 137-150, 150-172, 210-230, 400-470, or 800-960 MHz.

## LNW-(\*) MINIATURE GaAs FET PREAMP

ONLY \$24/kit, \$39 wired/tested

- GaAs FET Preamp similar to LNG, except designed for low cost & small size. Only 5/8"W x 1-5/8"L x 3/4"H. Easily mounts in many radios.
- \*Specify tuning range: 25-35, 35-55, 55-90, 90-120, 120-150, 150-200, 200-270, or 400-500 MHz.

## LNS-(\*) IN-LINE PREAMP

ONLY \$79/kit, \$99 wired/tested

- GaAs FET Preamp with features similar to LNG series, except automatically switches out of line during transmit. Use with base or mobile transceivers up to 25W. Tower mounting brackets incl.
- \*Specify tuning range: 120-175, 200-240, or 400-500 MHz.

## HELICAL RESONATOR PREAMPS

- Preamps with 3 or 4 section helical resonators reduce intermod & cross-band interference in critical applications. MODEL HRA-(\*) \$49 vhf, \$94 uhf.
- \*Specify tuning range: 142-150, 150-162, 162-174, 213-233, 420-450, 450-470.



## RECEIVING CONVERTERS

Low noise converters to receive vhf and uhf bands on a 10M receiver. Choice of kit with case & BNC jacks, kit with pcb only, or w/t unit in a case. Other models available for other in/out ranges & atv. Request catalog for complete listings.

**VHF input ranges avail:** 136-138, 144-146, 145-147, 146-148, 220-222, 222-224; kit less case \$39, kit w/case \$59, w/t in case \$89.

**UHF input ranges avail:** 432-434, 435-437; kit less case \$49, kit w/case \$69, w/t in case \$99.

902-928 MHz converts down to 422-448 or 430-450 range. Same price as uhf.

## TRANSMITTING CONVERTERS

XV2 for vhf and XV4 for uhf. Models to convert 10M ssb, cw, fm, etc. to 6M, 2M, 220, 432, 435, and for atv. 1W output. Kit only \$79. PA's up to 45W available. Request catalog for complete listings.

OUR 27TH YEAR!

# hamtronics, inc.

65 MOUL RD. - HILTON NY 14468-9535  
Phone: 716-392-9430 -- FAX: 716-392-9420

Hamtronics is a registered trademark. Copyright 1990, Hamtronics, Inc. All rights reserved.

- For complete info, call or write for FREE 40-page catalog. Send \$2 for overseas air mail. For casual interest, check reader service; allow 3-4 weeks.
- Order by mail, fax, or phone (answering machine off hrs).
- Min. \$3 S&H charge for first pound plus add'l weight & ins.
- Use VISA, Mastercard, check, or UPS C.O.D. (\$3 fee).

here is the next generation Repeater  
2 meters - 220 - 440

## MARK 4CR

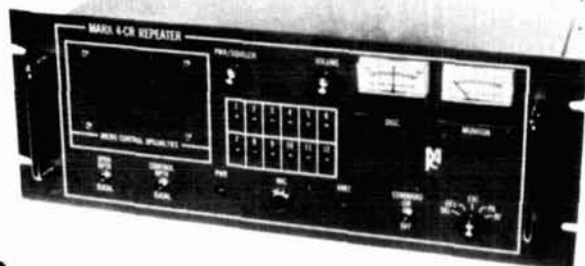
The **only** repeaters and controllers  
with REAL SPEECH!

No other repeaters or controllers match Mark 4 in capability and features. That's why Mark 4 is the performance leader at amateur and commercial repeater sites around the world. Only Mark 4 gives you Message Master™ real speech • voice readout of received signal strength, deviation, and frequency error • 4-channel receiver voting • clock time announcements and function control • 7-helical filter receiver • extensive phone patch functions. Unlike others, Mark 4 even includes power supply and a handsome cabinet.

### NEW OPTION

RS-232 for Repeater Control  
using MODEM or Packet TNC

Create messages just by talking. Speak any phrases or words in any languages or dialect and *your own voice* is stored instantly in solid-state memory. Perfect for emergency warnings, club news bulletins, and DX alerts. Create unique ID and tail messages, and the ultimate in a real speech user mailbox — only with a Mark 4.



Call or write for specifications on the  
repeater, controller, and receiver winners.



### MICRO CONTROL SPECIALTIES

Division of Kendecom Inc.  
23 Elm Park, Groveland, MA 01834 (508) 372-3442

FAX 508-373-7304

✓ 147

# NUTS & VOLTS MAGAZINE

P.O. Box 1111-H  
PLACENTIA, CA 92670  
714-632-7721



Ham Radio  
Computer Hardware  
Computer Software  
Plans-Kits  
Schematics  
Test Equipment  
CB Gear  
Satellite TV  
Video  
Components  
Antique Electronics  
Cable TV  
Publications  
Repairs-Services  
New Products  
Events Calendar

**IF YOU ARE INTO ELECTRONICS AND SAVING MONEY IS IMPORTANT TO YOU, THEN YOU OWE IT TO YOURSELF TO TRY NUTS & VOLTS MAGAZINE. DISCOVER WHY THOUSANDS OF SMART PEOPLE NATIONWIDE TURN TO NUTS & VOLTS EACH MONTH TO MEET THEIR ELECTRONIC NEEDS. WHETHER YOU'RE BUYING, SELLING, OR JUST TRYING TO LOCATE THOSE UNIQUE OR HARD-TO-FIND ITEMS, FIND OUT HOW NUTS & VOLTS CAN HELP!**

### SUBSCRIBE TODAY!

CHECK  MONEY ORDER  VISA  MC

Name \_\_\_\_\_

Address \_\_\_\_\_

City \_\_\_\_\_

State \_\_\_\_\_ Zip \_\_\_\_\_

Card No. \_\_\_\_\_ Exp. Date \_\_\_\_\_

CALL FOR ADVERTISING INFORMATION  
DISTRIBUTOR INQUIRIES INVITED

### Subscription Rates

U.S. FUNDS REQUIRED

#### 3rd Class Mail - USA

One Year . . . . . \$12.00

Two Years . . . . . \$21.00

Lifetime . . . . . \$60.00

#### 1st Class Mail

One Year - USA . . . \$20.00

Canada & Mexico . . \$22.00

#### Air Mail

Foreign - 1 Year . . . \$55.00

Includes one FREE 40-word  
Classified Ad

**A National Publication For The Buying And Selling Of Electronic Equipment**

✓ 16

for that night. Over the following nights Alexandra Palace gradually increased its power and the Germans woke up to the fact that we were now successfully jamming the system, whereupon they abandoned it.

Dr. Jones's original aims were that, since he was not entirely sure for how long the Germans had successfully used the system, he should break their confidence by making them think that we had been interfering with it in a way that had remained undetected for considerable time. This policy reaped further (and at times hilarious) bonuses because once the Germans suspected we were interfering with the system other alarms entered their heads. "Since the aircraft had to be instructed by the ground station when to release its bombs, it had to be monitored all the time during its bombing run, and the ground station could handle only one aircraft at a time. The aircraft would therefore fly to a convenient area from which it could be ordered onto the beam by the ground station, and so commence its bombing run. In principle, all we needed to do was transmit false orders to the aircraft. In fact we did not do this, but it seemed such an easy countermeasure that the German crews thought we might, and they therefore began to be suspicious about the instructions they received."

Substance was added to this later when an aircraft was ordered by the ground station to steer due west (possibly because it was east of the beam) to bring it onto the start of its bombing run. Failing to hear further ground station orders, the aircraft flew a considerable distance west, then returned to base to complain that the British had given false orders. On other occasions, when the power of Alexandra Palace had been increased, aircraft became confused and were ordered back to their bases after being told, again, that a wire was probably loose somewhere in the equipment. "What with our real countermeasures and those imagined by air crews, Y-operations became a fiasco and the system was withdrawn; we had restored our moral ascendancy for the rest of the winter."

Only later did Dr. Jones learn that the Y-System was really *Wotan 2*, and X-Gerät was *Wotan 1*. "And so, while *Wotan* may have had one eye for 'Y', he could not have crossed eyes for 'X'..." In fact the Y-System was nicknamed "Benito" because Mussolini was considered to be the one-eyed end of the Axis!

So ends the battle of the beams. I hope that some interest may have been aroused in you to study this aspect of scientific warfare further, and to live again those momentous days of the 1940s in the company of such distinguished (if then secret) servants who unraveled the enemy beam systems.

But to one man, above all, must go the highest recognition: R. V. Jones, the young scientist who defied the experts, confounded officialdom, and quietly saved the country from a terrible disaster — yet inexplicably, is still denied the knighthood he so richly deserves. The man who, to repeat Churchill's words, "broke the bloody beams."

## Acknowledgments

I am grateful to Professor R. V. Jones, Emeritus Professor in the Department of Natural Philosophy, University of Aberdeen, for his kind help and advice, and also for his permission to use extracts from his book *Most Secret War*, published by Hamish Hamilton. My thanks must also go to AEG (formerly Telefunken) for their permission to use extracts from *Die deutschen Funkverfahren bis 1945*,

and especially to Dr. Colin Hamilton, manager of the Airborne Early Warning Department, for his kind assistance and advice. I am also grateful for the help received from some old and respected opponents, notably Herr Fritz Trenkle, author of *Die deutschen Funk-Navigations und Funk-Führungsverfahren bis 1945*; Dr. Rudolph Kühnhold, designer of the *Freya* and *Seetakt* radars; the late Professor Dr. Wilhelm T. Runge, designer of the *Mannheim*, *Darmstadt*, *Würzburg* and *Lichtenstein* series of radars, who was able to give valuable help regarding Telefunken's work in the field of beam systems; and Dr. Herbert Kummritz, Dr. B. Röde and Dr. Gotthardt Müller.

## Further reading

*Most Secret War* by R. V. Jones. Published by Hamish Hamilton.


*The Bruneval Raid* by George Millar. Published by The Bodley Head.

*The Ultra Secret* by F. W. Winterbotham. Published by Nicolson.

*The Rise of the Boffins* by Clark.

*Instruments of Darkness* by Alfred Price.

For our German speaking readers:

*Die deutschen Funk-Navigations und Funk-Führungsverfahren bis 1945* by Fritz Trenkle. Published by Motorbuch Verlag. 

Reprinted with permission from *Practical Wireless*, PW Publishing Ltd., March 1988. *Ed.*

# W6SAI BOOKS

published by Bill Orr, W6SAI and Stu Cowan, W2LX

## BEAM ANTENNA HANDBOOK

Completely revised and updated with the latest computer generated information on Beam Antenna design. Covers HF and Yagi's and 10, 18 and 24 MHz WARC bands. Everything you need to know. 204 illustrations. 268 pages. ©1985. Revised 1st edition. RP-BA **Softbound \$11.95**

## ALL ABOUT VERTICAL ANTENNAS


Theory, design, construction, operation—are fully covered. Here's what this exciting book covers: Horizontal vrs vertical—which is best? Top loaded and helical antennas, 5 high efficiency Marconi antennas for 80 and 160, verticals and TVI—is there a problem? The effects of ground on vertical antennas and a how to make an effective ground system, the Bobtail beam, construction data for 25 different antennas, matching circuits of all descriptions—which is best, plus P-L-E-N-T-Y more! 1st edition, 192 pages © 1986 RP-VA **Softbound \$10.95**

## RADIO HANDBOOK 23rd Edition

Here are some of the highlights of this exciting new edition: New easy-to-use charts for Chebyshev and elliptic filter configurations, new data on power MOS-FETS, how to use state-of-the-art OP-AMPS, and home computer RTTY—to name just a few examples. New projects include: GaAsFET preamps for 902 and 1296 MHz, easy-to-build audio CW filter, Economy two 3-500Z, 160 meter amplifier, multiband amp using two 3CX800A7's, and a deluxe amplifier with the 3CX1200A7 tube. New antenna projects include: efficient Marconi design for 160 and 80 meters, computer generated dimensions for HF-Yagis, and a 2 meter slot beam. Get your copy today. 23 edition © 1986 22424 (Reg. \$29.95) **Hardbound \$26.95**

## THE RADIO AMATEUR ANTENNA HANDBOOK

A wealth of projects that covers verticals, long wires, beams as well as plenty of other interesting designs. It includes an honest judgement of gain figures, how to site your antenna for the best performance, a look at the Yagi-Quad controversy, baluns, slopers, and delta loops. Practical antenna projects that work! 190 pages. ©1978. 1st edition. RP-AH **Softbound \$11.95**

Please enclose \$3.75 for shipping and handling. 

**HAM  
RADIO**  
GREENVILLE, NH 03048

**BOOKSTORE**  
(603) 878-1441

## A Remote Control Switching System

Because I had up to four HF antennas in use, I decided to control each antenna remotely by feeding them to a relay box, using a single coaxial line to the operating position.

The relay box contains two DPDT relays and five SO239 sockets. At the operating position there's a box with a three-pole four-position wafer switch and four LEDs to indicate the antenna in use. A two-conductor cable, in conjunction with the shielded outer braid of the main coax, feeds 13.8 volts, taken from the transceiver power supply to the relays. The details are shown in Figure 1, the circuit diagram.

### Operation details

Switch position 1 — both relays are passive connecting antenna A.

Switch position 2 — relay no. 1 energized connecting antenna B.

Switch position 3 — relay no. 2 energized connecting antenna C.



## Transistor Lead Identification with a DVM

You don't always have a drawing showing which leads of a junction transistor are which when you're connecting the transistor in a circuit. But you can tell which lead is the emitter, which is the base, and which is the collector, and also identify the transistor as a PNP or an NPN type by using the ohmmeter of a digital voltmeter. First turn the ohmmeter to a scale that will forward bias a diode (these scales often have a diode symbol beside them), and leave it on this scale for all of the following measurements. Connect the ohmmeter to all possible pairs of the transistor's leads, using both polarities. If the transistor is good, only two of the six combinations possible will show conduction. The two leads having the higher indicated resistance on the ohmmeter are the base and the emitter; the remaining lead is the collector. Only one of these two leads will show resistance when the collector is

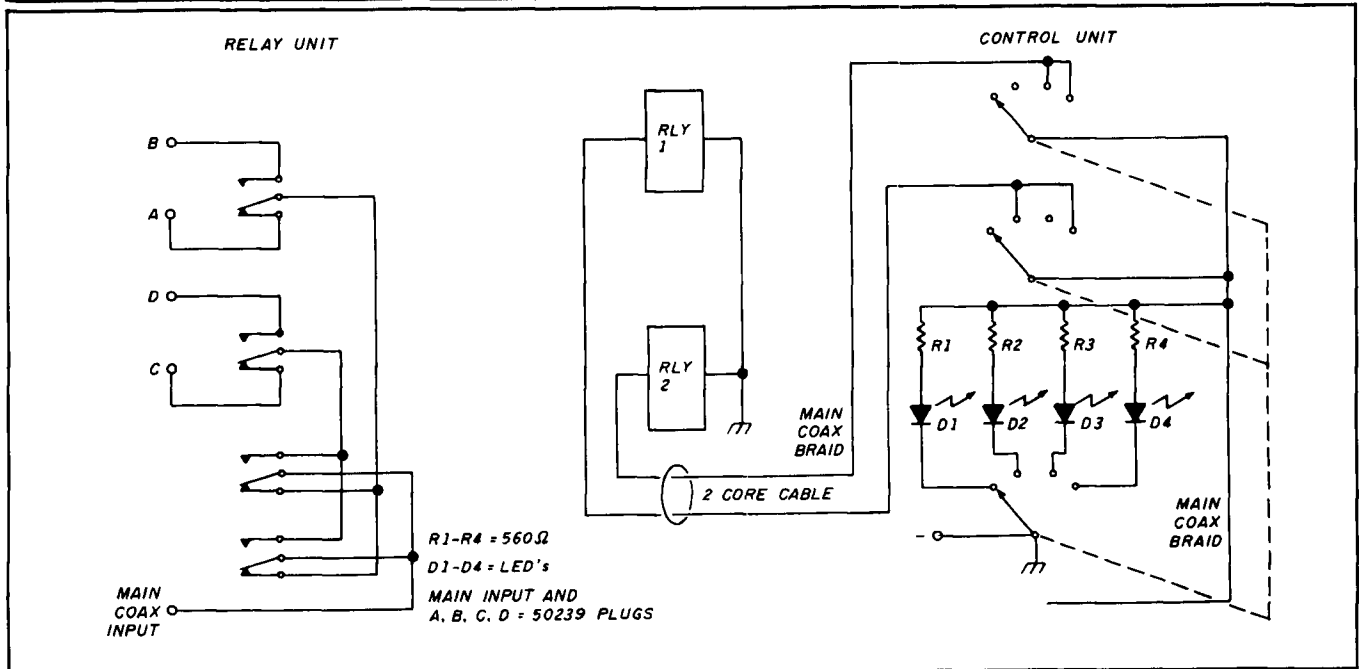
Switch position 4 — both relays energized connecting antenna D.

The relays are Archer catalog no. 275-2188. The system has been in use for over 12 months on frequencies from 28 to 3.7 MHz with entirely satisfactory results.

**Bill Duke, VK2WD**

\*Reprinted with permission from *Amateur Radio*, Wireless Institute of Australia, September 1988, page 26.

FIGURE 1



Circuit diagram for remote control antenna switching system.



one of the leads connected to the ohmmeter. This lead is the base. Since you've identified both the base and collector leads, the remaining lead must be the emitter.

To identify the transistor as NPN (the most common) or PNP, connect the ohmmeter to two of the leads so conduction is indicated. If the positive ohmmeter lead is connected to the base, the transistor is NPN — otherwise, it's PNP. This method works because the emitter (which has the same type of doping as the collector) is always doped more heavily than the collector. When a given current is forced through the emitter-base junction, a higher voltage is required to overcome the greater built-in voltage of the space charge region than is needed for the more lightly doped collector-base junction. All DVM ohmmeters work by forcing a current through the leads and indicating the voltage that results (calibrated as a resistance). A given current amplitude "reads" as a higher resistance when forced through the emitter-base junction than it does when it's forced through the collector-base junction.

**Bob Henderson, K0GSS**

**"ONLINE" U.S. CALL DIRECTORY**

Hamcall service gives you all hams via your computer & modem. Updated each month! Only \$29.95 per year. Unlimited use - you pay for phone call.

**BUCKMASTER PUBLISHING**

Route 3, Box 56  
Mineral, Virginia 23117  
703/894-5777 visa/mc 800/282-5628

✓ 122



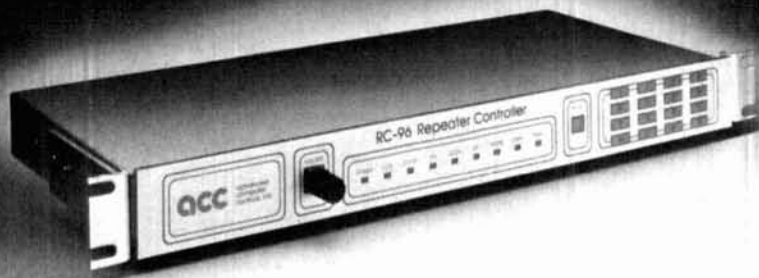
Get your 192 page catalog filled with hard-to-find Amateur Products!!!

Send \$2 to:

**DICK SMITH ELECTRONICS**

Jo Folger  
Catalog Subscriptions  
P.O. Box 468  
Greenwood IN 46142  
(317) 888-7265

**"Become Enlightened, Not Lightning'd!"**



**Flash! The RC-96 Repeater Controller two year warranty now includes lightning coverage.**

The '96 is tough. A three-terminal gas discharge tube across the phone line and transient suppressors on each input and output signal stop lightning from taking your system down. The '96 is so well protected that its proven performance in the field allows us to offer two year warranty coverage which includes damage caused by lightning!

You'll hear thunderous applause when you install a '96 controller on your repeater. Remote programming will let you easily make changes to your repeater from anywhere without a trip to the hill. Change codes, autodial numbers, ID and tail messages and more, with reliable storage in E<sup>2</sup>PROM memory.

Your users will be thunderstruck by the outstanding patch and autodialer, with room for 200 phone numbers. The talking S-meter will let them check their signal strength into the repeater. Remote base support for up to six bands allows linking your repeater to others. Plus support for pocket papers and a bulletin board.

Your technical crew will light up when they see the built-in keypad and indicators. And the ease of hookup with shielded DIN cables. With pots and DIP switches easily accessible at the rear of the unit.

Rugged, capable, easy to hook up. The RC-96 Repeater Controller - an enlightening experience for your repeater.

**acc**

advanced computer controls, inc.

2356 Walsh Avenue, Santa Clara, CA 95051 (408) 727-3330

✓ 151



**ICOM**



**VHF COMMUNICATIONS**

9:00 am - 5:30 pm weekdays

Weekends and evenings by appointment.



280 Tiffany Avenue  
Jamestown, New York 14701

Weston New York's finest... amateur radio dealer!  
PH. (716) 664-6345

✓ 154

# THE PV-4 ON YOUR COMMODORE

## Designing high performance Yagi antennas

By Alan Hoffmaster, WA3EKL, 929 Andrews Road,  
Glen Burnie, Maryland 21061

**T**he following program is an upgraded version of one published in *Ham Radio* in June 1985.<sup>1</sup> The program lets you duplicate the performance characteristics of the PV-4 accurately without having to build a PV-4 clone.

### PV-4 background

Jim Lawson, W2PV, never published the PV-4.\* It was a custom design for a number of New England area contesters, who make good use of it today — along with W3LPL and myself. This particular array defied Jim's original findings of equal spacing and directors all of equal length. It also makes use of an odd boom length, 0.57 wavelength. The reflector, driven element, and first director are all bunched down at one end of the boom and the second director is the other end of the boom, making the array mechanically unbalanced at the center. However its performance characteristics are exceptionally good. The Yagi maintains a high gain (10 dB) over the whole band and at least 20-dB front-to-back ratio, with a very high peak (40 dB) at the central design frequency. The central design frequency should be chosen in the middle of the phone band, because the performance characteristics tend to deteriorate rapidly as frequency is increased. A beam designed this way will still perform very well in the CW portion of the band; however, the reverse is not true.

With the aid of a rather large computer, Lawson explored numerous combinations of Yagi element spacings and resonant lengths. He chose a combination that yielded a high gain and front-to-back ratio over a 3-percent bandwidth, which covers most Amateur bands. His original designs<sup>2</sup> used equal element spacing and a  $5.26 \times 10^{-4}$  wavelength average diameter. Using these criteria, he established a chart<sup>2</sup> of resonant element lengths of constant diameter for two, three, four, five, and six-element Yagis. I call the chart "The Magic Numbers."

### Design parameters

Jim left us with a set of mathematical formulas as important tools to design high performance antennas.

#### Tool A

The ability to determine accurately the magic numbers for any average diameter chosen.

#### Tool B

The ability to determine accurately the resonant electrical length of a tapered element at any frequency.

#### Tool C

The ability to scale, or shift, the antenna resonant frequency to anyplace in the desired band and have the scaled model perform in exactly the same way as the original.

Because I've received many queries about my original program (and this one is very similar), I'll explain it in more detail. Those of you who've already typed in the original program should have no trouble modifying it — even if your computer isn't a Commodore.

### Program notes

As the PV-4 began to appear, none of the articles gave the magic numbers and the average diameter associated with them, until K1GQ published them in 1986.<sup>3</sup> Before K1GQ's article appeared, I tried to extrapolate the magic numbers from the various designs in the literature, but couldn't get consistent accuracy. My challenge was to convert K1GQ's magic numbers, based on a 0.001 wavelength average diameter, to  $5.26 \times 10^{-4}$  wavelength average diameter, which is what my programs run on. The program does this for you. After it computes the average diameter of the element you've input (lines 720 through 740), it checks to see if the average diameter is 0.875, which corresponds to a  $5.26 \times 10^{-4}$  wavelength on line 1450. If the average diameter isn't 0.875, then lines 1430 to 1530 calculate a new set of magic numbers for the average diameter of the input element. To prove that the new magic numbers are correct, I wrote the following program from lines 1480 through 1560 of the main program.

#### Proof program

```
70 DIM A(4), B(4)
80 FOR H=0 TO 3
90 A(H)=0:B(H)=0
100 NEXT H
110 A(0)=0.49528: A(1)=0.48028: A(2)=0.44811:
A(3)=0.44811
120 RA=0.000526
130 RB=0.001
140 KA=1/RA
150 KB=1/RB
160 FOR J=0 TO 3
170 F1=(1-((10.7575*(LOG(KA)/LOG(10))))-8^J-1)/(2*A(J))
180 XX=((215.15*(LOG(KA)/LOG(10)))-160)*((1/F1)-F1)
190 AA=XX/((215.15*(LOG(KB)/LOG(10)))-160)
200 F2=(-AA+((AA^2)+4)^0.5)/2
210 B(J)=(1-((10.7575*(LOG(KB)/LOG(10))))-8^J-1)/(2*F2)
220 NEXT J
230 ? B(0)
```

\*Jim Lawson, W2PV, is known for his many articles on Yagi antennas published in *Ham Radio*. He is now a silent key. Ed.

## Electronic Repair Center

Servicing

Amateur

Commercial Radio

The most complete repair facility on the East Coast.

Large parts inventory and factory authorized warranty service for Kenwood, Icom and Yaesu.

### SEND US YOUR PROBLEMS

Servicing "Hams" for 30 years, no rig too old or new for us.

## HAMTRONICS, INC.

4033 Brownsville Road

Treose, Pa. 19047

215-357-1400



When performance & price really count...



# CRYSTEK CRYSTALS

The pulse of dependable communications

### QUARTZ CRYSTALS FOR Industrial Equipment/Instrumentation

- Micro-processor control
- Computers/Modems
- Test/Measurement
- Medical

### General Communications

- Channel element Service (VHF/UHF)
- Land Mobile 2-way
- Marine
- Aircraft
- Telemetry
- Monitors/Scanners/Pagers

### Amateurs/2-Meter/General Coverage CB/Hobbyist/Experimenter

For Optimum Stability and Reliability in Frequency Management

Custom Made Crystal Catalog

### The Pulse of Dependable Communications...

Crystek Crystals offers their new 16 page FREE catalog of crystals and oscillators. Offering state of the art crystal components manufactured

by the latest automated technology. Custom designed or "off the shelf," Crystek meets the need, worldwide. Write or call today!

CRYSTEK CORPORATION  
DIVISION OF WHITEHALL CORPORATION



2351/2371 Crystal Drive • Ft. Myers, FL 33907  
P.O. Box 06135 • Ft. Myers, FL 33906-6135

TOLL FREE 1-800-237-3061

PH 813-936-2109/TWX 510-951-7448/FAX 813-939-4226  
TOLL FREE IN THE U.S.A. EXCEPT FLORIDA, ALASKA, HAWAII

## BLACK DACRON® POLYESTER ANTENNA ROPE

- UV-PROTECTED
- HIGH ABRASION RESISTANCE
- REQUIRES NO EXPENSIVE POTTING HEADS
- EASY TO TIE & UNTIE KNOTS
- EASY TO CUT WITH OUR HOT KNIFE
- SIZES: 3/32" 3/16" 5/16"
- SATISFIED CUSTOMERS DECLARE EXCELLENCE THROUGHOUT U.S.A.

LET US INTRODUCE OUR DACRON® ROPE TO YOU • SEND YOUR NAME AND ADDRESS AND WE'LL SEND YOU FREE SAMPLES OF EACH SIZE AND COMPLETE ORDERING INFORMATION.

Dealer Inquiries Invited

MANUFACTURED BY  
**synthetic**  
textiles, inc. 2472 EASTMAN AVE. BUILDING 21  
VENTURA, CALIFORNIA 93003  
(805) 658-7903

✓ 148

## G5RV MultiBand Antenna

10 thru 160 Meter  
Factory Wired & Tested

Introductory Price  
\$39.95 Plus \$4 Shipping

Authorized  
TenTec  
Dealer

K4BWC



## OMEGA ELECTRONICS

4209 Live Oak Road  
Raleigh, NC 27604  
919-832-1025

Visa & Master Card

✓ 149

## NEMAL ELECTRONICS

- Complete Cable Assembly facilities MIL-STD-45208
- Commercial Accounts welcome- Quantity pricing • Same day shipping most orders
- Factory authorized distributor for Alpha, Amphenol, Belden, Kings, Times Fiber

Call NEMAL for computer cable, CATV cable, Flat cable, semi-rigid cable, telephone cable, crimping tools, D-sub connectors, heat shrink, cable ties, high voltage connectors.

### HARDLINE 50 OHM

FXA12 1/2" Aluminum Black Jacket.....	89/ft
FLC12 1/2" Cablewave corr. copper blk jkt .....	1.69/ft
FLC78 7/8" Cablewave corr.copper blk jkt .....	4.25/ft
NM12CC N conn 1/2" corr copper m/1 .....	25.00
NM78CC N conn 7/8" corr copper m/1 .....	54.00

### COAXIAL CABLES (per ft)

1180 BELDEN 9913 very low loss .....	55
1102 RG8/U 95% shield low loss foam 11ga.....	36
1110 RG8X 95% shield (mini B) .....	17
1130 RG213/U 95% shield mil spec MCV jkt.....	39
1140 RG214/U dbl silver shld mil spec.....	1.85
1705 RG142B/U dbl silver shld, teflon ins .....	1.50
1310 RG217/U 50 ohm 5000 watt dbl shld .....	98
1450 RG174/U 50 ohm .100" od mil spec .....	14

### ROTOR CABLE-8 CONDUCTOR

8C1822 2-18ga and 6-22ga .....	25
8C1820 2-18ga and 6-20ga .....	39

### CONNECTORS-MADE IN USA

NET20 Type N plug for Belden 9913 .....	\$3.95
NET23 Type N jack for Belden 9913.....	4.95
PL259AM Amphenol PL259 .....	.89
PL259TS PL259 teflon ins/silver plated.....	1.59
PL258AM Amphenol female-female (barrel).....	1.65
UG175/UG176 reducer for RG58/59 (specify).....	.22
UG21DS N plug for RG8,213,214 Silver.....	3.35
UG83B N jack to PL259 adapter, teflon .....	6.50
UG146A SO239 to N plug adapter, teflon .....	6.50
UG255 SO239 to BNC plug adapter, Amphenol.....	4.29
SO239AM UHF chassis mt receptacle,Amphenol.....	.89
UG88C BNC plug RG58, 223, 142 .....	1.45

### GROUND STRAP-GROUND WIRE (per ft.)

GS38 3/8" tinned copper braid .....	40
GS12 1/2" tinned copper braid .....	50
GS200 1-1/2" heavy tinned copper braid .....	2.00
HW06 6ga insulated stranded wire .....	39
AW14 14ga stranded Antenna wire CCS .....	14

Prices do not include shipping, \$3 minimum, Visa/Mastercard \$30 min, COD add \$3.00  
Call or write for complete price list. NEMAL's new 40 page CABLE AND CONNECTOR SELECTION GUIDE is available at no charge with orders of \$50 or more, or at a cost of \$4 with credit against next qualifying order.

NEMAL ELECTRONICS, INC. 12240 NE 14th Ave. N. Miami, FL 33161  
(305) 893-3924 Telex 6975377 24hr FAX (305)895-8178

SAY YOU SAW IT  
IN  
HAM RADIO

# COMET

ANTENNAS FOR THE PROFESSIONAL AMATEUR

## "NEW" DUAL & TRI BAND SUPER "LINEAR" ANTENNAS

MODEL	FREQUENCY	GAIN	POWER	LENGTH	USE
CA-2X4Z	146 MHz 446 MHz	8.2dB 11.5dB	200W	15' 4"	BASE/REPEATER
CA-2X4FX	146 MHz 446 MHz	4.5dB 7.2dB	200W	5' 11"	BASE/REPEATER
CA-2X4M	140-155 MHz 440-460 MHz	4.5dB 7.0dB	150W	5'	MOBILE
CA-2X4SR	146 MHz 446 MHz	3.8dB 6.2dB	150W	3' 4"	MOBILE
CX-901	146 MHz 446 MHz 1.2 GHz	3.0dB 6.0dB 8.4dB	150W	3' 6"	BASE/REPEATER
CX-801	146 MHz 446 MHz 1.2 GHz	3.0dB 6.8dB 9.6dB	100W	3' 3"	MOBILE
CA-630TN	146 MHz 446 MHz 1.2 GHz	2.15dB 2.15dB 5.5dB	150W 50W	1' 5"	MOBILE

## NEW! ULTRA COMPACT SWR/POWER METERS



CM-200 144-150 MHz  
CM-300 200-250 MHz  
CM-400 420-460 MHz  
CM-420 140-460 MHz  
CM-900 850-950 MHz  
CM-1200 1250-1350 MHz

DEALERS INQUIRIES WELCOME

## CALL YOUR DEALER



1275 N. Grove St.  
Anaheim, CA 92806  
(714) 630-4541  
FAX (714) 630-7024

## GILFER — first in Shortwave



### Try JRC's new HF transceiver JST-135 at Gilfer's store.

• Gen. coverage triple conversion receiver, 100 kHz-30MHz, microprocessor controlled, direct digital synth. IC • Low distortion adjustable power amp. 10-150W out • Pass-band shift, Notch, Blanking, Processor, Dual VFO's, 200 ch memory, VOX, AGC, RIT, Squelch, Full/Semi Break-in.

### VISIT GILFER'S STORE

Easy to find, accessible from New York City. Take Garden State Parkway (NE portion of N.J.), Exit 172. Gilfer is in the center of Park Ridge, opposite the Borough Hall. Store hours: M-F 10am-5pm, Sat. 10am-3pm.



Order operators: 1-800-GILFER-1 (1-800-445-3371) NJ 201/391-7887

## GILFER SHORTWAVE

52 Park Ave. • Park Ridge, NJ 07656



P.O. Box 6522  
220 N. Fulton Ave.  
Evansville, IN 47719-0522

Store Hours  
MON-FRI: 9AM - 6 PM  
SAT: 9AM - 3 PM  
CENTRAL TIME

SEND A SELF ADDRESSED STAMPED (50¢) ENVELOPE (SASE) FOR NEW AND USED EQUIPMENT SHEETS.

WARRANTY SERVICE CENTER FOR:  
ICOM, YAESU, TEN-TEC

FOR SERVICE INFORMATION CALL  
(812) 422-0252  
FAX 812-465-4449  
MONDAY - FRIDAY  
9:00 AM - 12:00 NOON

### TERMS:

Prices Do Not Include Shipping.  
Price and Availability Subject to  
Change Without Notice  
Most Orders Shipped The Same Day  
COD's Welcome (\$3.50 + shipping)



ORDERS &  
PRICE CHECKS

# 800-729-4373

NATIONWIDE & CANADA

LOCAL  
INFORMATION

# 812-422-0231

## YAESU



### FT-747GX

- 100 Watts of Economical Performance
- Dual VFO's, 20 Memories
- Receives from 100 kHz - 30 MHz
- Built-In CW Filter + More

### FT-470

COMPACT 2M/70CM DUAL BAND FM

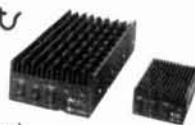


- Simultaneous Reception on Both Bands
- Up to 5 Watts Output
- 21 Memories on Each Band
- Built-in 10 Memory DTMF Auto Dialer
- Built-in CTCSS PLUS MORE!

## concept

### VHF/UHF AMPS

- High VSWR and Overdrive Protection
- 5 Year Warranty, 6 Months on RF Transistors
- All Units have GaAsFET Receive Pre-amps



## ICOM

### IC-32AT

- New Dual Band HT
- RX-138-174 MHz 440-450 MHz
- TX-140-150 MHz 440-450 MHz
- 5 Watts Output on Both Bands
- Full Duplex & 20 Memories



### IC-2SAT

- NEW 2 Meter Handheld
- Ultra Small HT with up to 5 Watts Output
- VFO Scan & Memory Scan
- 48 Programmable Memories
- Covers 140-150 MHz



## ALINCO

### DR-110T

- NEW 2 Meter Mobile
- 45 Watts Output
- 14 Memories with Standard Encode/Decode Subaudible Tones
- CAP and MARS Modifiable



## Heath

### SB-1000

HF Linear Amp (kit)

- 1000W Output on SSB, 850 on CW, 500 W on RTTY
- Covers 160-15 Meters
- 1,3-500Z Tube
- QSK with Optional Board



## MFJ



### 989-C ROLLER INDUCTOR ANTENNA TUNER

- Cross-Needle SWR/Wattmeter
- Handles 3 kW Power
- Matches 1.8-30 MHz

## TEN-TEC

### OMNI V



- New U/LSB, QSK, CW, FSK HF Rig
- Dual VFO's, 100 W Output
- Allbands 160-10
- Superior "Phase Noise"
- Made in USA

240 ? B(1)  
250 ? B(2)  
260 ? B(3)  
270 END

If you plug in the numbers from Jim's chart<sup>2</sup> on line 110, and use a 0.001 or 0.008-average diameter on line 130, you'll get an accurate set of all of his figures. When you insert K1GQ's magic numbers on line 110, 0.001 average diameter on line 120, and  $5.26 \times 10^{-4}$  on line 130, the preceding program calculates a new set of magic numbers based on a  $5.26 \times 10^{-4}$  average diameter. You'll find it on line 1400 of the main program. I used the same procedure to prove the rest of the program. The original program was written on my Atari computer. It took my wife (N3DPB, an excellent program debugger) and me four hours of debugging this one little subroutine before we could consistently reproduce Jim's figures. After that, it took another three hours on the phone with WA3HQX, who converted the subroutine to the Commodore format.

## Program explanation

Lines 100 to 400 are a brief history and list of recommendations. Lines 400 through 780 store the user input information in the various arrays and variables with a subroutine, and lines 1750 to 1810 print the information to the screen. Line 750 takes you to a subroutine (lines 1360 through 1640) which calculates the normalized element half lengths for whatever average diameter element you input, and then stores the data in other variables. Next, in line 760, you gosub again to lines 1650 to 1720, which print the normalized lengths to the screen. Lines 790 through 1050 calculate the actual electrical resonant element half length (called the "total equivalent length") per the data you've input, and prints it to the screen. Program line 1050 asks if you want to change a segment length. The object is to adjust your segment lengths until the total equivalent length is equal, or very close to, the "normalized length" for the element you're working on. Lines 1050 to 1140 let you do this. Finally, lines 1150 through 1350 print all of the data to the screen.\*

## Avoiding stumbling blocks

This program, as is, will run on an Atari computer. With a few modifications it will probably run on most others. The only difference between the Atari and Commodore programs is the way in which each computer calculates the common logarithm. This was a major hangup for WA3HQX and me in trying to get from Atari to Commodore. For instance, if you say LOG5 in Commodore language, the computer takes the natural log of 5 (or log to the base e of 5). This program and Jim's formulas use the common log or log to the base 10. To convert from the natural log to the common log in Commodore language, you must divide the natural log by the natural log of 10. For example: LOG5/LOG10 = common log of 5 in Commodore language. In Atari language, you simply say CLOG5 to get the common log of 5. Check your computer's BASIC language book to see how it calculates the common log, and make the appropriate changes to lines 910, 1510, 1520, 1530, and 1550.

## Hints for Atari users

For Atari users who want to make the program run a little faster, and also make it a little easier to type in, change the aforementioned lines to the following:

910 M=((43.03\*CLOG(K2))-32)/((43.03\*CLOG(K1))-32)

1510 F1=(1-((10.7575\*CLOG(KA))-8) $\lambda$ -1)/(2\*A(J))

1520 XX=((215.15\*CLOG(KA))-160)\*(1/F1)-F1

1530 AA=XX/((215.15\*CLOG(KB))-160)

1550 B(J)=(1-((10.7575\*CLOG(KB))-8) $\lambda$ -1)/(2\*F2)


I hope this explanation helps you understand how the program runs. The rest of the program is straightforward, simple, and basic. All the formulas can be found in Jim Lawson's original articles.

It was Jim's desire that the Amateur community build, evaluate, and report to each other how his monoband Yagis performed. I have built Jim's three-element design on a 0.3 wavelength, and his four-element design on a 0.75-wavelength boom. W3LPL has built Jim's six-element design on a 0.75-wavelength boom. Both W3LPL and I have built Jim's specialized four-element design on a 0.57-wavelength boom.

## Results

I built the three-element version for 10, 15, and 20 meters. They work unbelievably well. I could hold my own very easily in a contest with the big guns. W3LPL's six-element versions on a 0.75-wavelength boom played extremely well, according to all the operators who worked his station during the DX contests. I also built a four-element, 10-meter version on a 0.75-wavelength boom. No matter what I did to it, including placing it on different towers at different heights (56 and 67 feet) and retuning the elements, it wouldn't play. The gain seemed very low and the front-to-back ratio was bad. I recommend that you don't build the four-element version on a 0.75-wavelength boom. However, the four-element version you can design on a 0.57-wavelength boom using this program is an entirely different story. During the summer of 1987, W3LPL built a four-element, 20-meter version. Even though my three-element, 10 and 15-meter antennas worked great, I changed them to four-element versions with this program.

After completing the 1987-88 contest season under the call K3ZZ, I could honestly say that the results were indescribable. To quote some of the operators at the 10 and 15-meter positions, "It was like shooting a cannon at the DX." While I still had the three-element versions up, we were able to achieve third place in one of the ARRL DX phone contests, multi-multi category. That's quite an achievement; we had just two towers in an area 63 feet wide and 140 feet deep, and our highest antenna was a three-element, 20-meter monobander at 76 feet!

I'm a believer in Jim Lawson's designs, and so are the contesters who operate my station under the call K3ZZ. When you hear WA3EKL or K3ZZ during a contest, you'll know what we're using. I hope this article encourages you to build this superior four-element monoband Yagi. Good luck and good DX! 

## REFERENCES

1. Alan Hoffmaster, WA3EKL, "Designing Yagis with the Commodore 64," *Ham Radio*, June 1985, page 59.
2. James L. Lawson, W2PV, "Yagi Antennas Practical Designs," *Ham Radio*, December 1980
3. Bill Myers, K1GQ, "The W2PV Four-Element Yagi," *QST*, October 1986, page 15.

\*WA3EKL's program is available from *Ham Radio* upon receipt of a self-addressed, large, stamped envelope. Ed.

# DIGI-KEYER

## An easy-to-build TTL design

By Ronald D. King, AB4DP, 569 Croley Drive,  
Nashville, Tennessee 37209

**W**e live in a high tech world. This might lead you to think that, with all the advancement in communications technology, hams would abandon the old low tech modes. But a quick scan of the CW bands tells us that's just not so; they're packed with activity!

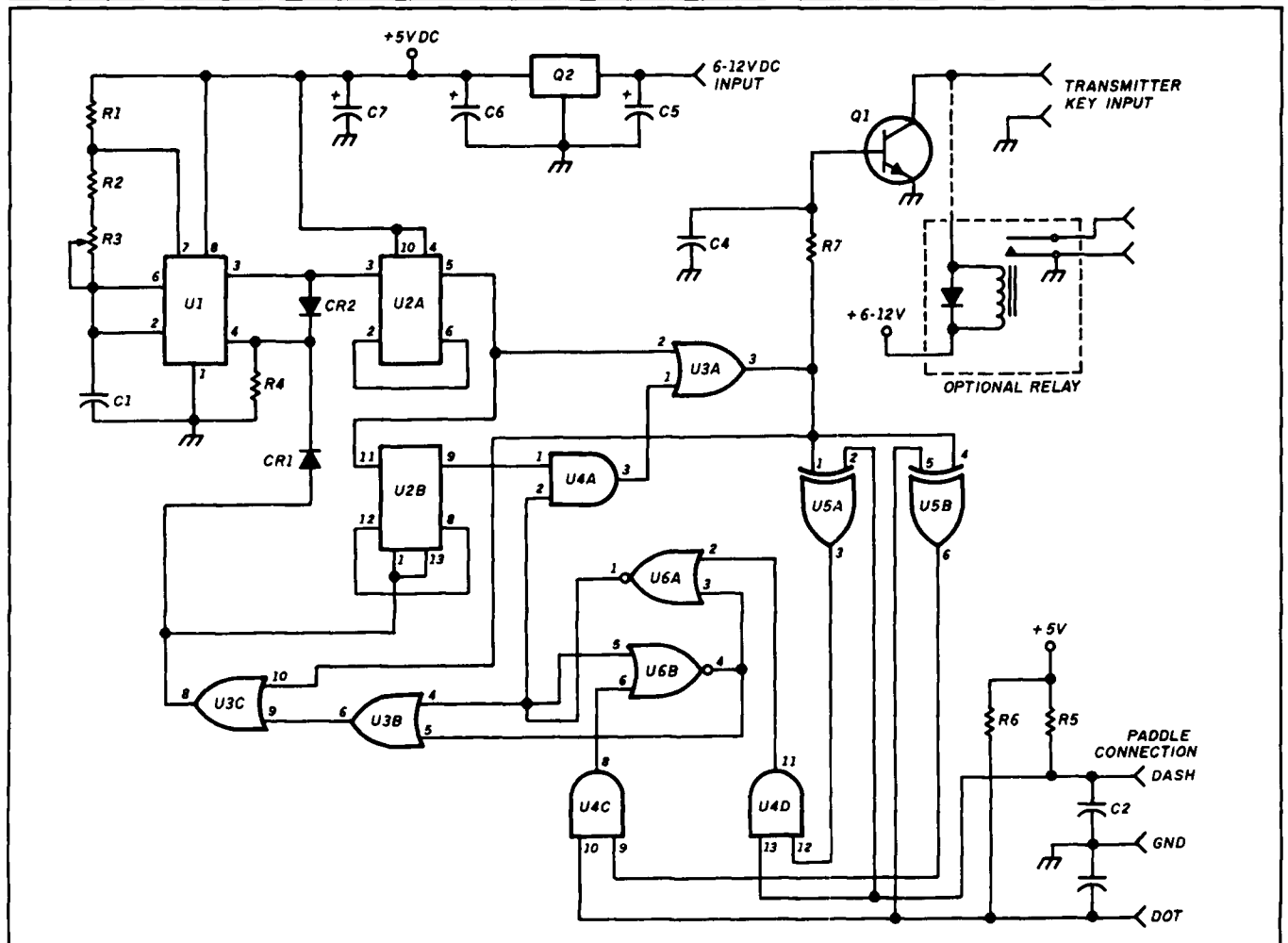
I was in grade school when I became a ham. I couldn't afford phone gear, so I spent a lot of time "pounding brass."

Even though I now use a state-of-the-art, micro-controlled all band transceiver, you'll still find me down in the CW segments of the bands.

I wanted the feel of an electronic keyer, but money was a consideration when I thought of purchasing one. Instead, I designed one myself and called it the "Digi-Keyer." It uses inexpensive and dependable TTL 7400 series digital ICs.

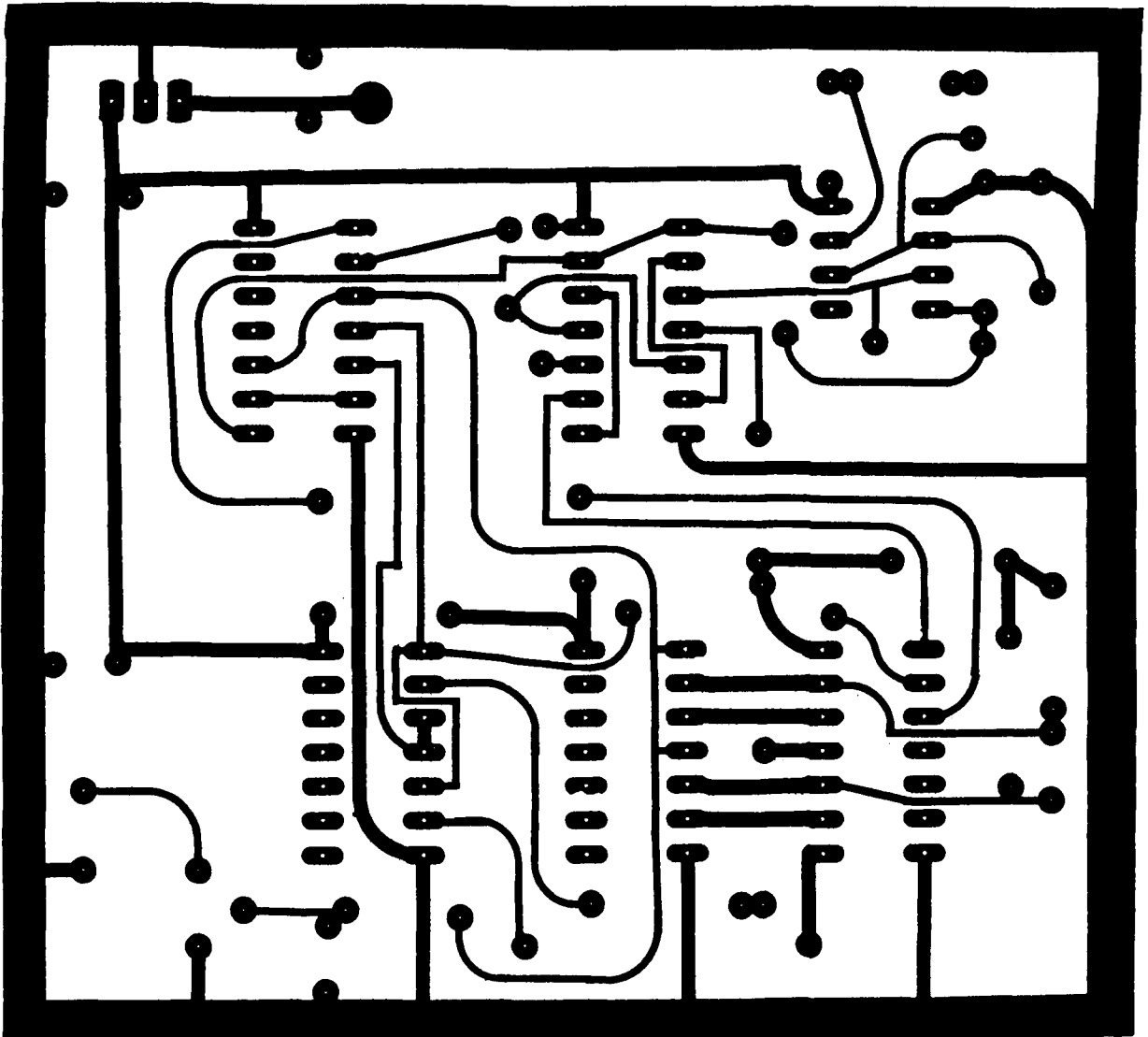
The Digi-Keyer is a no-frills, self-completing dot/dash keyer. It's not iambic, but you'll find it very straightforward. Think of it as an electronic "bug." You press the paddle in one direction for a string of dots and go the other way for a string of dashes. Sorry, there's no squeeze technique here, but it's easy to build and fun to use!

FIGURE 1



Schematic of the Digi-Keyer.

FIGURE 2



PC board layout.

### How it works

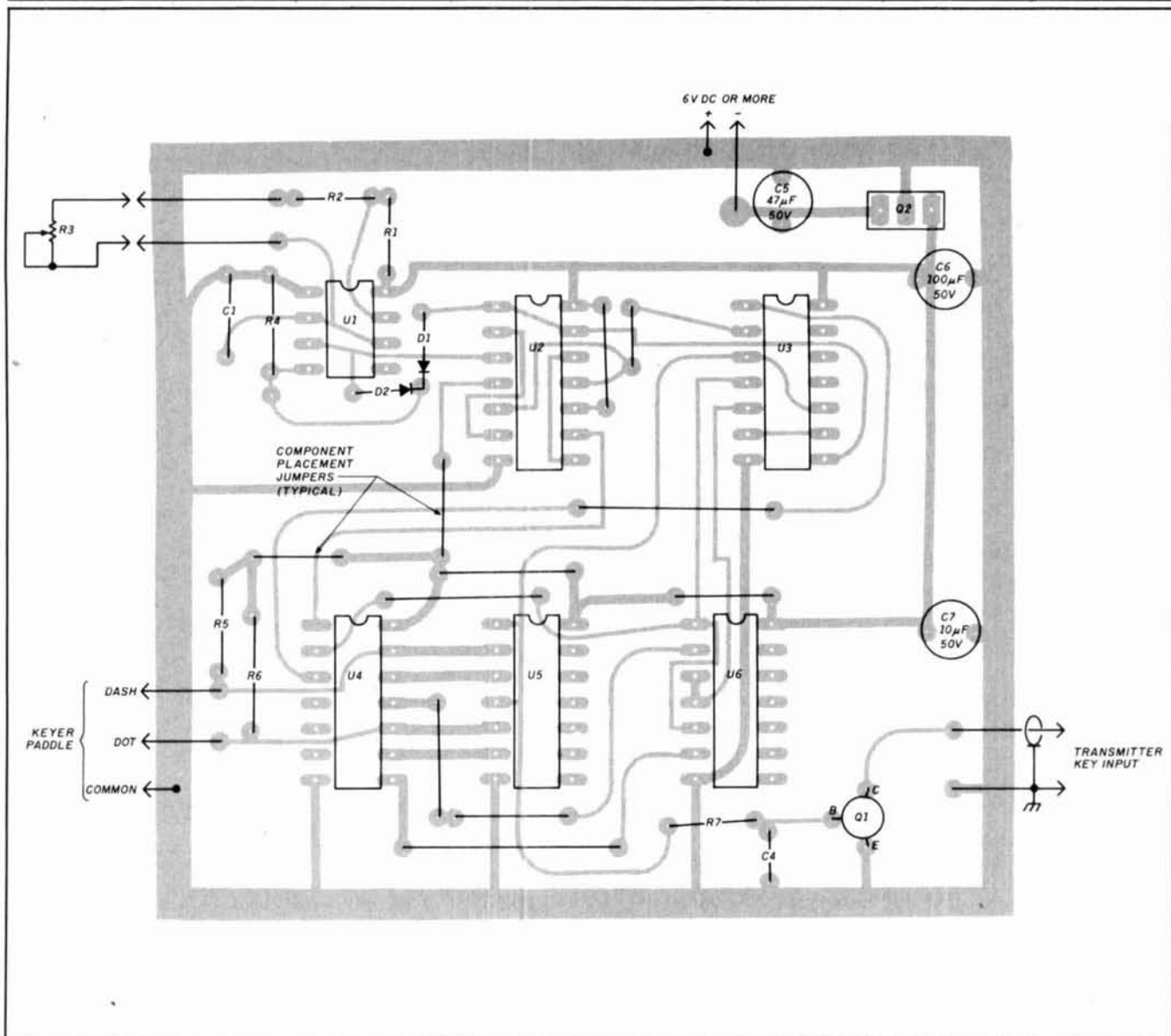
First, let's analyze the circuit in its idle state to explain its operation. (See Figure 1.) U1 is a basic 555 astable oscillator gated by its reset input, pin 4. When this input is low, U1 is in an off condition; when it's high, the timer is free running anywhere from 12 to 42 Hz. When neither paddle is being pressed, both inputs to U4c and U4d are high. One input is high via pull-up resistors R5 and R6; the other is high via gates U5a and U5b, which are also high because of the pull-up resistors (the output of U3a is low at this time). The two highs from U4c and U4d hold the outputs of U6a and U6b low. Because there isn't a high level gated to the reset input of U1 (the astable oscillator), it remains in an off state. The same low level that keeps U1 off, also keeps the two D flip-flops U2a and U2b cleared.

The keyer is in a settled state.

Now press the dot paddle. The output of gate U4c goes low, and causes the output of U6b to go high. This high is detected on one input of U6a, causing it to remain low during the dot cycle. It locks out the dash cycle effectively by holding one of U4a's inputs low. The high from U6a is also gated to the clear inputs of U2 and the reset input of U1 via U3b, U3c, and CR1. U1 begins its timing cycle and the output, pin 3, goes high.

This positive-going level reaches the clock input of U2a. The  $\bar{Q}$  output is high because U2 was previously in a clear state; this output is presented to the D input of U2a. The high level is clocked through U2a, gated to the output of U3a, and routed back to U1's reset input via U3c — allowing U1 to time out the complete dot cycle.

FIGURE 3



Component placement guide.

**PARTS LIST**

Capacitors		Semiconductors	
C1	1 $\mu$ F (see text)	Q1	2N2222
C2,C3	0.1 $\mu$ F	Q2	7805 (5-volt regulator)
C4	0.01 $\mu$ F	U1	555
C5	47 $\mu$ F/50 volt electrolytic	U2	7474
C6	100 $\mu$ F/50 volt electrolytic	U3	7432
C7	10 $\mu$ F/50 volt electrolytic	U4	7408
		U5	7486
		U6	7402
Diodes			
CR1,CR2	1N914		
Resistors			
R1	1 k		
R2	22-27 k (see text)		
R3	50 k potentiometer		
R4	4.7 k		
R5,R6	10 k		
R7	4.7 k (see text)		

Let's say you release the dot paddle before the dot is completed. Because you now have two highs at the inputs of U5b, the output of this "exclusive-or" gate goes low, holding U4c low. This keeps U6a low via the U6b latch arrangement, allowing the dot to be completed. When the dot is completed, U3a goes low, causing U1 to stop and U2a and U2b to clear — unless you're holding the paddle, letting the circuit time out and form another dot.

The dash circuit operates in a similar fashion. The exception is that U6a goes high to U4a, causing U4a to gate the output of the second flip-flop (U2b) into U3a. When U2a is clocked by the first pulse of U1, its positive-going output also clocks U2b, placing a high at the latter's output. That high remains for a complete cycle of U2a — the equivalent of two dots. As U2a is going high a second time, U2b is clocked low, but the pulse from U2a is added to the pulse of U2b by way of U3a to create a pulse that's three dots long — or a dash! As with the dot circuit, this cycle will repeat itself if you hold the



dash paddle, or will time out after the completed dash if you release the paddle.

Diodes CR1 and CR2 are essentially gating diodes. I used them because of the overriding function of the reset input of the 555 chip, U1. When the reset goes low, it forces the output low — no matter where it is in the timing cycle. Sometimes a “slap” on one of the keyer paddles produces a pulse that’s short enough to prevent the 555 from timing out because of the delay time from reset to output (typically around 0.5  $\mu$ s). Reset goes low before a pulse can propagate through the circuit. If you use CR1 and CR2, once the output of U1 goes high CR2 will hold the reset input high and CR1 will be forward biased. But if U3c goes low before the output pulse can gate back through to U1, CR1 will become reverse biased, isolating the output of U3c, and allowing the timer to continue its timing cycle long enough for the output to be gated back through U3c. R4 is a pull-down resistor which prevents accidental triggering of U1 when its output is low and the output of U3c is also low. R7 and Q1 are the keying circuit that activates your transmitter.

All Digi-Keyer parts are inexpensive and readily available. If you order from one of the many mail order parts houses, you’ll have no problem getting them. The total cost of the parts, if you purchase them through one of these firms, should be under \$5.00, minus the pc board, case, and power supply. (See **Figures 2** and **3** for PC board layout and component placement guide.) I use an AC adapter-type power supply that outputs anywhere between 6 and 12 volts DC, with a current rating of 500 mA or more. Use a 7805 three-pin regulator chip to obtain the 5 volts you’ll need for the Digi-Keyer. Unfortunately, TTL uses a lot of current, so batteries won’t last long.

You can build the Digi-Keyer by mounting the sockets on a perfboard and wire wrapping the circuit. There’s nothing critical about the layout. If you decide to use my pc board layout, you won’t need the sockets.


R7 is normally a 4.7-k resistor. But if you plan to use a keying relay, lowering R7’s resistance will give you more current to pull in the relay contacts. A 47-ohm resistor works quite well for most small relays.

You can vary R2 from 22 to 27 k, depending on the speed range you prefer. For example, a 22 k will give you a speed range from about 10 to 30 wpm. A 27 k gives you a speed range from about 5 to 25 wpm. Be sure that R3 is a linear-taper potentiometer. C1 can be any type of 1- $\mu$ F capacitor. I tried several kinds, from polystyrene to nonpolarized electrolytics.

I didn’t include a space for a keying relay on the pc board layout. A small piece of perfboard, not much larger than the relay itself, will be sufficient to outboard the relay close to the board.

I have found that, in some instances, the keying voltage of some transmitters may be too high for Q1 to handle. Sometimes RF gets into the keyer through Q1, causing the latter to lock on. For either of these problems, I suggest using a keying relay between Q1’s collector and the power supply positive. Use a relay whose coil is rated at the voltage of the power supply you’ve selected to use for the keyer. In worst case situations, place the keyer board in a small metal box (Bud no. CU-234) and ground it to your transmitter chassis.

As I said before, Digi-Keyer operation is simple, straightforward, and fun!

I’d like to thank Ralph Easley, N4UTW, who helped me with the pc board, and Marcus Harton, KC4HVG, for his help editing this article. 



## Congratulations Terry; apologies Dick

One of the fun parts of managing any business enterprise is to be able to announce the promotion of a valuable team member. If you take a look at this month’s masthead you will find that Terry Northup, KA1STC, is now the editor of *Ham Radio Magazine*.

In the two years that she has been with us, Terry has made a most enviable track record for herself. She took on the assignment of refocusing our editorial product to make it more useful to our existing readers and at the same time to make it more appealing to Amateurs who were not already subscribers. The magazine was also to be given a bold new look which would reinforce the message that it was not just business as usual here in New Hampshire.

There was a tremendous amount of work to be done, as no part of the production process was left untouched. The whole *Ham Radio* staff became involved in the many changes that had to be made and everyone certainly deserves a lot of credit. However, it was Terry who had to keep the whole project on track and on schedule.

The results speak for themselves. The magazine you are holding in your hands is a more lively and timely product than ever before. Your many letters and comments have been virtually all in approval. The real proof is that our readership is up over 25 percent in just one year’s time, and this growth shows no signs of slowing.

You’ve earned your new desk, Terry. Thanks both from your teammates and from your many thousands of loyal readers.

On another subject, Dick Ross, K2MGA, my counterpart at CQ Magazine called the other day to point out that the name of their magazine and of The CQ World-Wide DX Contest are trademarked and should have been indicated as such in the article published in our August issue. Our apologies, Dick; it won’t happen again. All DX editors, please take note.

**Skip Tenney, W1NLB**

# EXTEND YOUR DVM'S MEASUREMENT CAPABILITIES

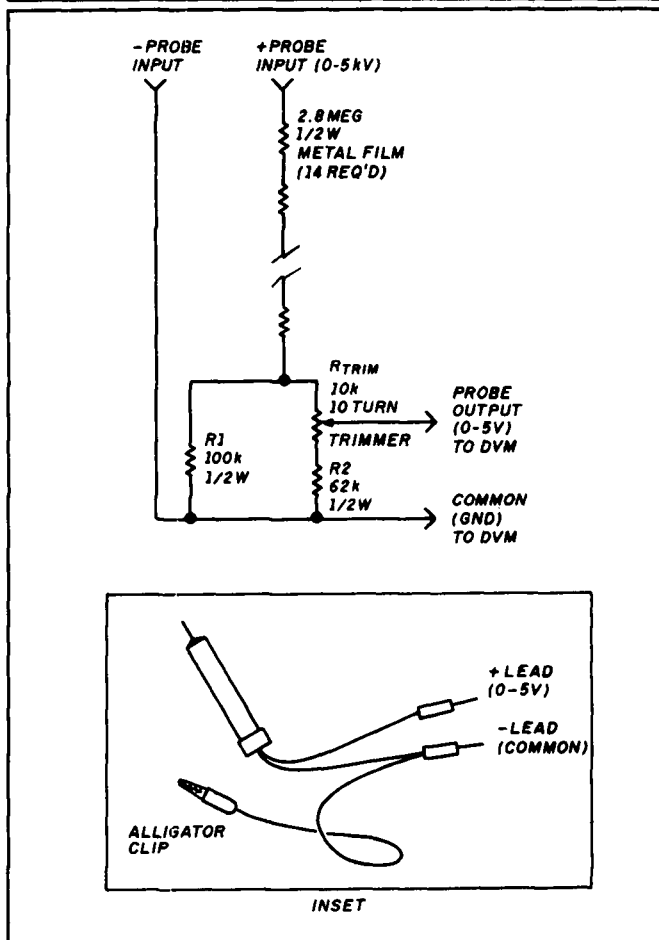
By Ralph H. Fowler, N6YC, Rt. 1 Box 253R, Pearl River, Louisiana 70452

**M**ost of the DVMs offered by today's manufacturers lack the ability to measure voltages higher than approximately 1 kV. Perhaps this is why the old, reliable Simpsons are still so popular. It's as if manufacturers forgot that some people still troubleshoot high voltage equipment like linear amplifiers, tube-type transceivers, and high voltage power supplies. In an attempt to fill this void, I'll show you how to construct a simple, easy to build high voltage probe capable of measuring 5 kV, or more. You can use this probe with any DVM capable of measuring 0 to 5 volts. Almost any reasonable DVM input impedance is allowable, and the basic accuracy of your DVM is preserved after the probe is calibrated.

The schematic of the probe is shown in Figure 1. It's essentially a 40-meg string of resistors shunting the measurement voltage, with an adjustable tap near the ground end. When connected to the tap, your DVM will read the voltage out in kVDC, with a scale factor of 1,000. Thus, 3100 volts DC from your linear's power supply will be read out as 3.100 volts DC.

The resistor string in my version is composed of fourteen 2.8-meg 1/2-watt metal film resistors. Metal or film resistors are preferred over composition types because the latter have poorer stability, and the accuracy of readings is apt to degrade over time — requiring recalibration. With an input of 5 kV, each resistor sees less than 360 volts, which is well within the manufacturers' ratings. Manufacturers typically rate 1/2-watt carbon composition resistors at 350 volts continuous, and metal film resistors at up to 900 volts. Power dissipated with 5 kV applied is less than 0.64 watts total, a very conservative condition. You need not duplicate my particular resistor values, nor do all the resistor values have to be the same. More importantly, the voltage (across EACH resistor, calculated individually if the values are not all the same), dissipation, and stability factors should be consid-

FIGURE 1



Schematic of the 0 to 5 kV high voltage probe.

ered. Don't run the risk of subjecting your sensitive DVM to the ravages of high voltage.

One feature worth incorporating is the redundancy of the paralleled resistors near the ground end of the string, R1, R2, and Rtrim in **Figure 1**. Note that should any one of these resistors open, for whatever reason, the voltage presented to the DVM will not soar up to 1kV (with 5 kV applied to the input) and cause meter breakdown. Though it probably wouldn't damage most DVMs with typical protective circuitry, why tempt fate?

This probe works with meters of various input impedances because the tap is at a fairly low impedance point on the string. The shunting action presented by meters with 1 meg or higher impedance is negligible. I chose the values used here for a 10-meg input impedance, although this circuit will accommodate anything above approximately 1 meg. To accommodate significantly lower impedances, it may be necessary to change the string and/or tap position on the string. In any case, Rtrim allows exact calibration for your particular DVM.

## Construction

The probe is built on a 5-1/2" by 5/8" piece of perfboard, as shown in **Figure 2**. Do not use prototype pc boards, or any other noninsulating board. The high voltage may lead to breakdown. The perfboard is housed in a 7" length of 3/4" rigid PVC pipe with a cap (uncemented) on the lead exit end. The probe end has a probe tip cemented in place with epoxy. After the components are in place inside the housing, stuff a tuft of fiber glass insulation or other non-flammable insulator around the probe tip and approximately 1/2" inside the probe housing. Backfill the remaining 1/2" void around the probe with epoxy or urethane cement to secure the tip in place. To provide some strain relief for the cable/perfboard connection point at the lead exit end, anchor the leads to the end plug with tape or cement. Two leads exit from the rear of the probe housing. One is connected to the tap on Rtrim, and goes to the "+" input of the DVM. The other is the common lead, which connects to the "-" input of the DVM. I used miniature coax to reduce the tangle of cables. A third lead originates from the "-" plug, which attaches to the common (ground) point in the circuit you are probing. This is shown in the **Figure 1** inset.

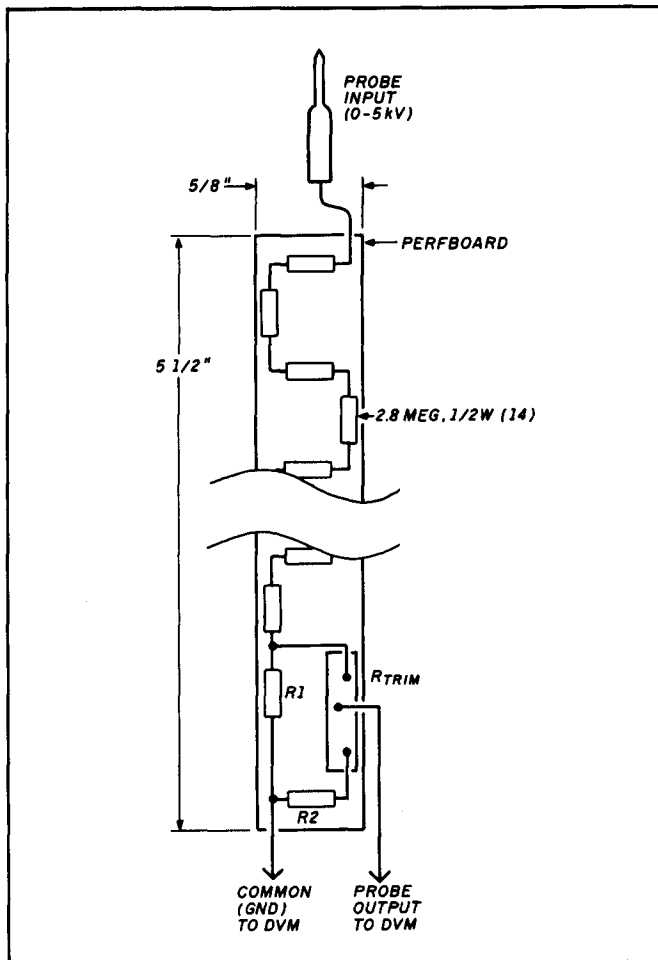
I found that the "zigzag" pattern of resistor mounting shown allows for reasonable parts placement with a minimum of probe length. The tubing I used for my probe is 0.185 inch thick and marked "suitable for drinking." Since rigid PVC has an advertised dielectric strength of 350 volts per mil thickness\*, it will (theoretically) withstand about 32 kV with 100 percent safety factor. This is at DC or low, non-RF frequencies, however, so don't use this probe with RF present at an appreciable power level (like at tube anodes).

## Calibration

Calibration is simple and can be done in either of two ways.

**Method 1:** If possible use a second, accurate meter capable of reading, say 1 kV, as a reference. Simply adjust Rtrim so your probe/DVM reads the same as the reference meter when connected to a suitable high voltage source. Remove

FIGURE 2



Suggested parts layout on the perfboard.

the end cap and use an **INSULATED** tweaking tool to do the Rtrim adjustment.

**Method 2:** The second method requires only one meter capable of measuring a few volts accurately. It can be the meter you plan on using with the probe.

First, determine the resistance of the R1, R2, Rtrim series/parallel combination by measuring from point A to ground (see **Figure 3**). If you use precision resistors, calculate their resultant value. My resistor configuration measured 41.860 k.

Next, obtain a stable, low voltage source (like a 1.5-volt cell) whose voltage is known, or can be measured accurately. I used a D cell with a measured voltage of 1.555 volts DC, open circuit.

Finally, refer to **Figure 3**. Notice that if 1.555 volts DC from the source is applied between point A and ground, by Ohm's law a current of 37.15  $\mu$ A will flow through 41.860 k. Note that the same current would also flow if 1458 volts DC were applied to the probe input. By applying 1.555 volts DC between point A and ground (with the probe output connected to your DVM), you simply adjust Rtrim to get a 1.458-volt reading on the DVM, corresponding to an equivalent of 1458 volts at the probe input. **Figure 3** shows this calibration setup.

One operational note remains. Some meters have differ-

\*According to ARRL Handbook, 1986 Edition, page 35.

### SMART REPEATER & LINK CONTROLLER

- DTMF MUTING
- INTELLIGENT ID'ER
- AUXILIARY OUTPUTS
- EASY TO INTERFACE
- REPEATER & LINK COURTESY TONES
- LOW POWER, 22ma @ 12V
- TELEMETRY RESPONSE TONES
- ALARM MONITOR INPUT
- SYNTHESIZED LINK/ REMOTE BASE CAPABILITY WITH OPTIONAL PI-10/S SYNTHESIZER BOARD

SRC-10 — \$149.00/PI-10/S — \$39.00

### REPEATER/LINK AUDIO MIXER INTERFACE

- FIVE AUDIO INPUTS
- THREE ADJUSTABLE AUDIO OUTPUTS
- CTCSS DECODER ON UAI-20 ONLY
- CONTROLLED DTMF ROUTING
- LOW POWER, 19ma @ 12V
- EASY TO INTERFACE
- LINK MONITOR-MIX/MONITOR MUTE CONTROL

UAI-10 — \$44.00/UAI-20 — \$89.00

ASSEMBLED & TESTED  
ONE YEAR WARRANTY

### CREATIVE CONTROL PRODUCTS

3185 Bunting Avenue  
Grand Junction, CO 81504  
(303) 434-9405



✓ 161

## CATALOGS

### HAM

- ▶ Transceivers
- ▶ HF-VHF-UHF
- ▶ Antennas
- ▶ RTTY-Packet
- ▶ Receivers
- ▶ Books & Accs.

Only \$1 Postpaid

### SWL

- ▶ Receivers
- ▶ Antennas
- ▶ Tuners
- ▶ Headphones
- ▶ RTTY-FAX
- ▶ Books & Accs.

Only \$1 Postpaid

Send  
to:

**Universal Radio**  
1280 Alda Drive Dept. HR  
Reynoldsburg, OH 43068

✓ 162

### HI-PERFORMANCE DIPOLES

Model	Frequency Range	Description	Price
MPD-5*	80-40-20-15-10M	max-performance dipole 87' long	\$105ppd
MPD-2	80-40M	max-performance dipole, 85' long	\$62
HPD-3*	160-80-40M	hi-performance dipole 113' long	\$79 ppd
SSD-8*	160-80-40-20-15-10M	space saver dipole 71' long	\$125 ppd
SSD-5*	80-40-20-15-10M	space saver dipole-specify L, 42', \$105; 52', \$108 ppd	
SSD-4*	80-40-20-15M	space-saver dipole-specify L, 46', \$93; 60', \$96 ppd	

\*9-bands with wide-matching-range tuner.

SASE for catalogue of 30 dipoles, slopers, and space-saving, unique antennas

312-394-3414 BOX 393 W9INN ANTENNAS MT. PROSPECT, IL 60056

✓ 162

### N6KW QSL Cards

The finest QSL Cards at reasonable prices. Basic Cards, map cards, cartoon cards, photo cards and more. Your idea converted to ink or use standard designs. 747 ink colors, any card stock. Photos b/w or beautiful color. Have cards that fit your style. FREE SAMPLES - postage appreciated.

KW Litho - Dept. HR P.O. Box 17390  
(817)332-3658 Ft. Worth, TX 76102

**NEW OSCAR**

**BRIDGES HAMISPHERE**

- Coming soon to a shack near you.
- Signals from space.
- Catch some free.
- We know how.
- You can too!
- Join AMSAT
- Free brochure for SASE

**AMSAT**  
PO BOX 27  
WASHINGTON, DC 20044

✓ 160

**TEXPRO**

**snap-on-choke**

**ELIMINATES RF INTERFERENCE IN:** TV sets, Radios, HI-FI, PA systems, Telephones, VCRs, Test equipment, Burglar and Fire alarms, Modems, Monitors, Computers, Radio and TV stations, etc.

**EASY TO USE:** fits over and snaps onto small, large and ribbon cables. No need to rewire connectors. Unique, split ferrite core design fits up to RG8U coax cables.

**WORKS IN "COMMON MODE"**, filters current induced in the braid of shielded cables and ground wires!

**Special ferrite material effective 0.5 - 200 MHz.**  
**DOES NOT VOID EQUIPMENT WARRANTY**

Available from your dealer or order direct from:

**computeradio**  
Box 282, Pine Brook, NJ 07058  
Tel: (201) 227-0712

Package of 4 chokes with inst. instructions  
**\$12.99**  
+ \$2.00 shipping

Send personal check with order, we ship same day First Class. 30-day money back warranty. Quantity discounts.

✓ 157

### 1989 U.S. CALL DIRECTORY (on microfiche)

Call Directory - by callsign .....\$8  
Name Index - by last name .....\$8  
Geographic Index - by state/city .....\$8  
All three - \$20

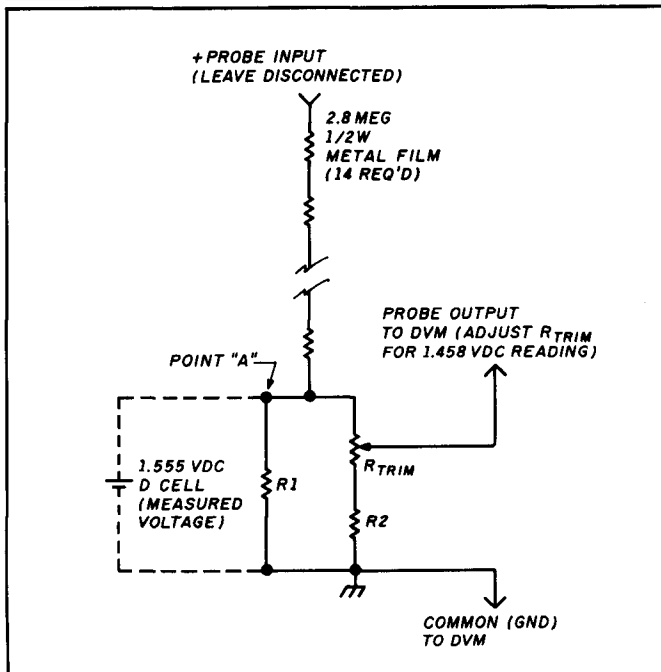
\$3 shipping per order

### BUCKMASTER PUBLISHING

Route 3, Box 56  
Mineral, Virginia 23117  
703/894-5777 visa/mc 800/282-5628

✓ 158


FIGURE 3



Simple setup for calibrating the probe.

ent DC and AC input impedances. Ten-meg DC and 1-meg AC input impedances are sometimes specified. In this case, if you calibrate with a DC voltage on the DC scale, AC voltages will be approximately 3.6 percent too low as a result of changing impedances. I think most of us can live with this; but if you're a perfectionist, you can calculate the error in volts and add this number to your reading.

A final safety note: While a HV probe increases your measurement capability, remember it also increases your risk of lethal shock. **ALWAYS** exercise **EXTREME** caution while working around high voltages.

And there you have it. A cheap, simple and accurate HV probe. Happy measurements! 

### Foreign Subscription Agents for Ham Radio Magazine

Ham Radio France  
SM Electronic  
20 bis, Ave des Clarions  
F-89000 Auxerre  
France

Ham Radio Canada  
C.A.R.F.  
P.O. Box 356  
Kingston, ON  
Canada K7L 4W2  
Prices in Canadian funds  
1 yr. \$38.00, 2 yrs. \$67.00  
3 yrs. \$90.00

Ham Radio Japan  
Katsumi Electronic Co., Ltd.  
27-5 Ikegami  
4 Chome, Ota-Ku  
Tokyo 146, Japan  
Telephone (03) 753-2405

Ham Radio England  
c/o R.S.G.B.  
Lambda House  
Cranborne Road  
Potters Bar  
Herts EN6 3JW  
England

# NEW BOOKS & SOFTWARE

## WA9GFR COMMUNICATIONS ENGINEERING version 3.1

by Lynn Gerig, WA9GFR

Interesting program that will allow you to predict communications ranges based upon your station's operational capabilities. Useful from 3.5 to 3.5 GHz. Also includes helpful Smith chart program for any type of matching network. Provides impedance results in both tabular and high resolution Smith chart graphics. Great value at a low price.

- GFR-DOS (MS-DOS) \$19.95
- GFR-C64 (Commodore C-64) \$19.95

## MICROSMITH Smith Chart Utility Program MS-DOS

by Wes Hayward, W7ZOI

MicroSmith is a working Smith chart that has been optimized for impedance matching applications. The user can modify all variables to meet specific matching goals. Includes a clear and concise tutorial that all levels of interest will find helpful. Complete text explanations with graphs aid full comprehension of the material.

- WH-MS (MS-DOS) \$29.00

## SPACE ALMANAC

by Tony Curtis, K3RXX

Complete database almanac is an unbelievable value! 955 pages jammed full of just about every bit of information you could want on including: space stations, shuttles, un-manned satellites, rockets, astronauts to name just a few areas covered. Also includes plenty of reference tables, charts, maps, diagrams, drawings photos and much more. 35+ pages on Ham Radio in space. 1989

- AS-SA \$19.95

## W2GGE CONTEST PROGRAMS (MS-DOS)

by Jack Schultz, W2GGE

Great contest logging programs! Written in machine language for maximum flexibility and speed. Compatible with most MS-DOS PCs. Shows log, countries worked, all band score on screen. Super fast dupe checking. Prints out log, checklist, and QSLs.

- GGE-CQ CQ WW Contest (6000 QSO's per band) \$39.95
- GGE-AR ARRL DX Contest (6000 QSO's per contest) \$39.95
- GGE-WPX CQ Prefix Contest (5000 QSO's per band) \$39.95

## ARIES-1 for Kantronics KAM & AEA PK-232 and MS-DOS computers

by Thom Ashton, NY2I

This fully featured program acts as a controller for your computer compatible radio, multi-mode terminal unit and MS-DOS computer. In fact, this program does so much, it is hard to fully describe! It will log and dupe check for you. It prints QSL cards. Automatically inserts date, time, frequency, and mode. Works with a mouse or function keys. Will do log searches and much more! Hard to describe but extremely useful program.

- ARIES (MS-DOS Computers) \$89.95

## ANTENNA IMPEDANCE MATCHING

by ARRL

One of the most comprehensive books ever written on the use of Smith charts in solving impedance matching problems. Written for the advanced Amateur, technician or engineering professional. 224 pages full of helpful information and solutions to tricky matching problems. c 1989

- AR-IMP Hardbound \$14.95

## PACKET PICTURE TRANSFER PROGRAM from MFJ

This new program is designed to allow you to pass picture to packet stations anywhere. Written to be compatible will all multi-function TNCs. Will convert most other formatted graphics into a compatible format for transmission. Allows you to set up your own Picture BBS. Prints to screen and saves to disk on receiving end.

- MFJ-PIX INTRODUCTORY SPECIAL \$9.95

## CONTEST PROGRAMS (MS-DOS)

by John Berg, KA1HYU and Clint Wise, W1XN

If you haven't yet done a contest with a computer, you're missing one of life's true pleasures! No more dupe or log sheets strewn around your operating table. Instantaneous scoring eliminates hours of work at the end of the contest. Print out the dupe sheets and log, fill out the entry and mail to the contest committee. The following contest logs are available (ALL MS-DOS):

- BW-DX ARRL DX Contest \$39.95
- BW-CQ CQ WW Contest \$39.95
- BW-WPX CQ Prefix Contest \$39.95
- BW-A60 ARRL 160 Contest \$39.95
- BW-C60 CQ 160 Contest \$39.95
- BW-A10 ARRL 10 Meter Contest \$39.95



# HAM RADIO'S BOOKSTORE



Greenville, NH 03048 • (603) 878-1441

# PEP WATTMETER

By Thomas V. Cefalo, Jr., WA1SPI, 29 Oak Street, Winchester, Massachusetts 01890

**P**eak envelope power (PEP) can't be measured easily with an analog meter. This meter doesn't respond well to the dynamic variations in the human voice. As an alternative to the analog meter, you can use an LED bar display to monitor output power. The LED indicates actual peak power, eliminating the problems you'd experience with the analog meter. This article describes a PEP wattmeter designed for use with a transceiver or linear amplifier with an LED display having power ranges of 30 to 160 and 300 to 1600 watts.

## Sampling power

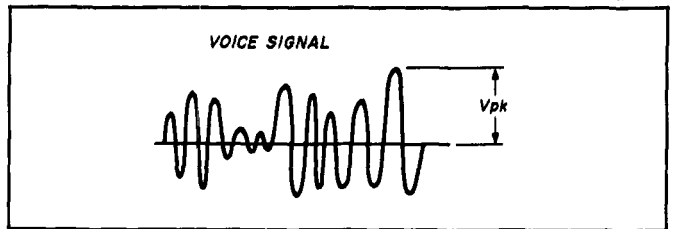
PEP is probably one of the most misunderstood terms in Amateur Radio. A modulated signal composed of two or more tones results in a complex sinusoidal wave. However, the variation from cycle to cycle is small, so you can use sine wave measurement techniques (see Figure 1). The actual PEP is the rms power contained in a signal at the peak of the modulation envelope. Calculate PEP using Equation 1.

$$PEP = \frac{(0.707 \cdot V_{pk})^2}{RL} \quad (1)$$

The problem lies in determining how to sample a small percentage of power from a transmission line. One approach is to simply tap off the transmission line with a resistive divider. This itself presents two major problems. First, the impedance of a carbon resistor isn't constant over frequency. A model of a carbon resistor is shown in Figure 2. The inductance is caused by lead length. If you have short leads, you can ignore this inductance in the HF spectrum. The main contributor of reactance is capacitive in the one-half watt and larger wattage resistors. This is because of the capacitance formed between the carbon granules. For example, I measured the series resistance and parallel capacitance of a 10-k, 1-watt carbon resistor over frequency on a Hewlett Packard RF impedance analyzer model 4191A and plotted it in Figure 3. The graph indicates that the resistive divider is a poor way to sample power.

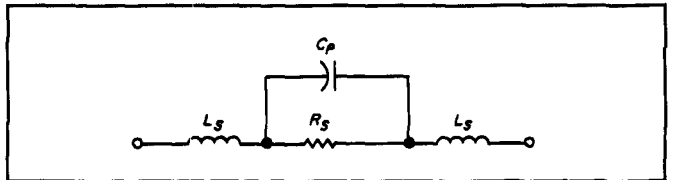
The second problem that occurs with a resistive divider has to do with isolation. There's no isolation between the forward and reflected wave. This means that any VSWR on the transmission line causes the forward power to add with the reflected power, giving a false power reading. To obtain an accurate power reading, the VSWR on the transmission line must be less than or equal to 1.1:1.

FIGURE 1



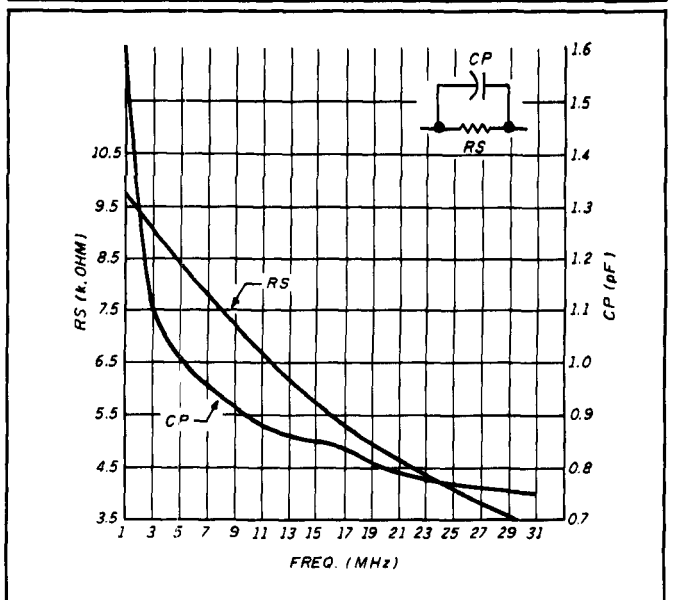
Signal sample showing voice peaks.

FIGURE 2



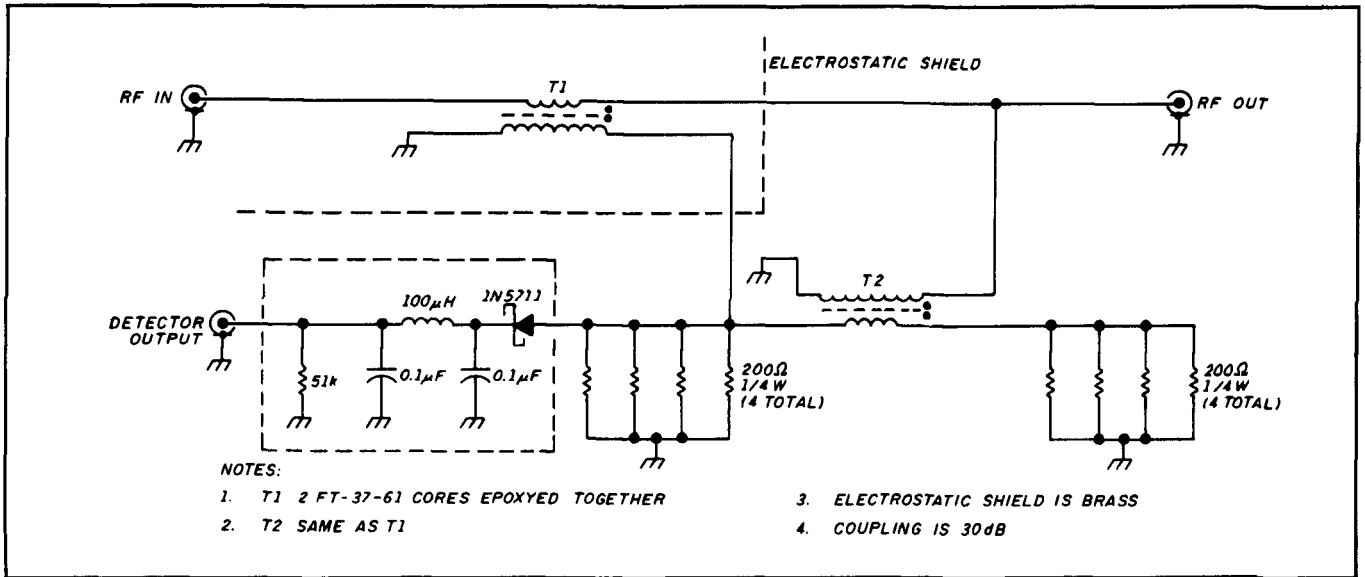
Carbon resistor equivalent circuit.

FIGURE 3



Graph showing series resistance and parallel capacitance variations versus frequency.

FIGURE 4



Schematic of the dual directional coupler.

PARTS LIST

Dual directional coupler	
<b>Capacitors</b>	
2	0.1 µF
<b>Inductors</b>	
1	100 µH
<b>Resistors</b>	
8	200 ohm, 1/4 watt
<b>Semiconductors</b>	
1	1N5711

A dual directional coupler eliminates all the ailments of the resistive divider. The coupler is a device that samples the forward power, but is insensitive to reflected power. This is referred to as the directivity, which is the isolation between the forward and reflected ports. The variation of coupling is flat when used over the specified bandwidth (unlike the resistive divider). Because the insertion loss is very small, a coupler can be connected directly in series with a transmission line. A single directional coupler would be sensitive to VSWR because of inadequate isolation.

30-dB dual directional coupler

The dual directional coupler used with the PEP wattmeter is a modified version of one that appeared in *Ham Radio*.<sup>1</sup> Because the coupler can be used with a 2-kW linear amplifier, 1/1000 of the RF power is sampled — so I chose a 30-dB coupler. To increase the power-handling capability, I epoxied two cores together. I used Amidon FT-37-61 toroidal cores with a permeability of 125. Core dimensions are 0.125" thick, 0.187" ID, and 0.375" OD. The primary of each transformer is a 1-inch piece of 0.141" OD semi-rigid coax cable passed through the center of the core. Only one side of the shield is soldered to ground. The secondary of each transformer has 31 turns of no. 30 AWG enameled wire

evenly spaced and epoxied to the core upon completion of the coupler. Remember that you make a turn each time the wire passes through the center of the core. For more information on dual directional couplers see **References 2 and 3.**

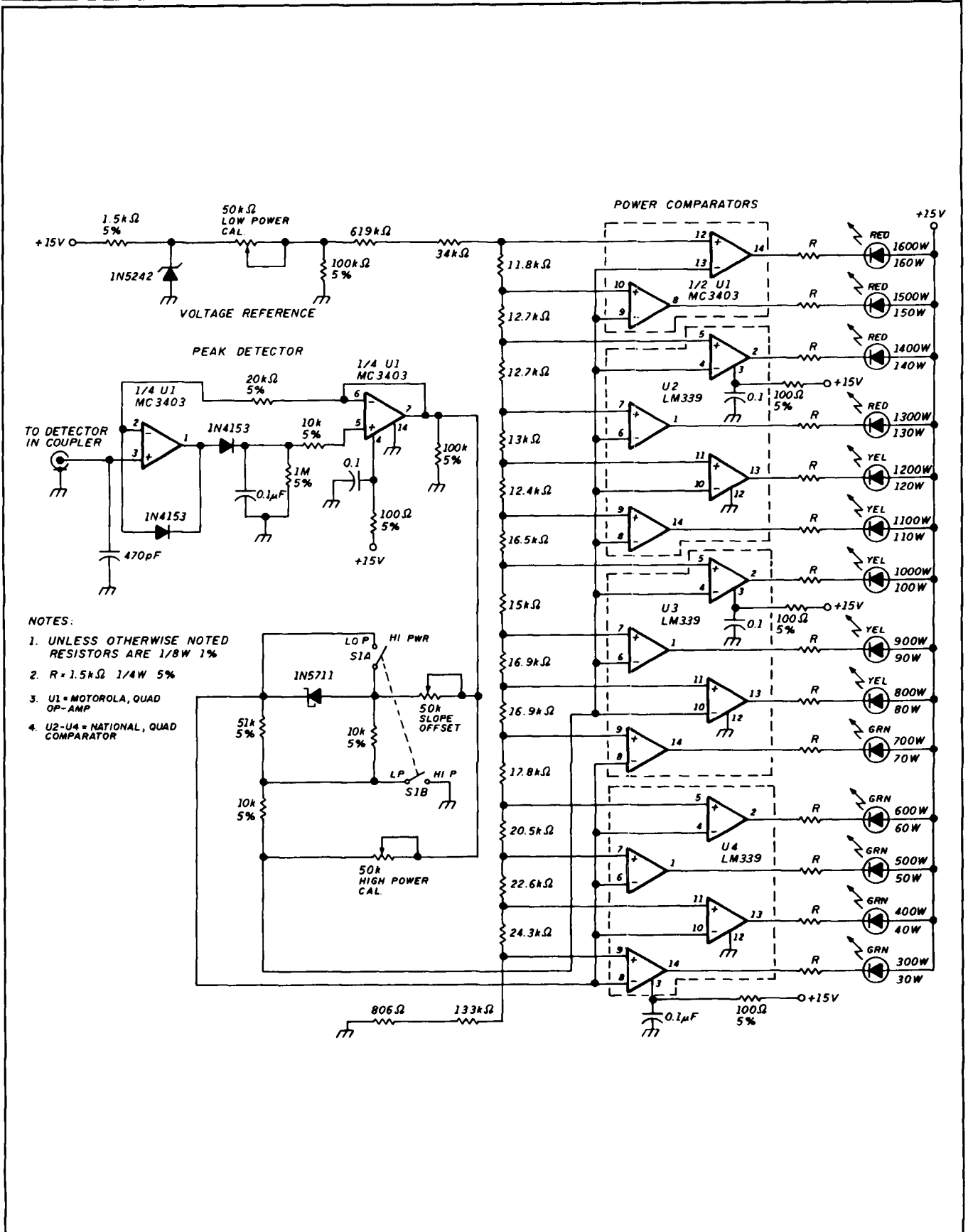
The actual coupling is 29.9 dB ± 0.1 dB from 1 to 30 MHz; the 3 dB point is at 55 MHz. I measured the self-resonant frequency at 77 MHz. Directivity is 35 dB at 1 MHz and rolls off to 20 dB at 30 MHz. The insertion loss is 0.06 dB. **Figure 4** shows the directional coupler and detector.

Theory of operation

The coupler samples a signal from the transmission line and the diode detects the positive peaks. I chose a Schottky diode because it's more sensitive and stable than a germanium. The RF is filtered and the video portion is applied to the input of a peak detector. As the detected voltage slope rises, the op amp drives the series diode on, and the capacitor is charged to the peak of the input voltage. When the detected voltage reverses its slope, the capacitor is left in a charged state. The discharge time is determined by the resistor in parallel with the capacitor. On the negative-going slope, the op amp switches the series diode off and the peak voltage across the capacitor is applied to the input of a buffer. The buffer also provides input bias current for the op amp. With no signal applied to the peak detector, the feedback loop opens. In this state, the resistor in the feedback loop allows the op amp to be clamped in the off state by the diode connected at the inverting terminal. This leads to a faster recovery and prevents op amp saturation.

The buffer output is fed to a voltage divider network. In the low position, the diode is shorted and the divider network is switched above ground. Because the comparators have high input impedance, the series resistors in the divider won't attenuate the signal in the low power position. In the high power position, the diode is switched in and the resistors in the network are grounded. The signal is now divided down to the low power voltages. To increase accuracy below 800 watts on the high power scale, a diode

FIGURE 5



- NOTES:
1. UNLESS OTHERWISE NOTED RESISTORS ARE 1/8W 1%
  2. R = 1.5kΩ 1/4W 5%
  3. U1 = MOTOROLA, QUAD OP-AMP
  4. U2-U4 = NATIONAL, QUAD COMPARATOR

Schematic of PEP Wattmeter.



## PARTS LIST

### PEP wattmeter

#### Capacitors

5	0.1 $\mu$ F
1	470 pF

#### Resistors

4	100 ohm, 5 percent
15	1.5 k, 5 percent
3	10 k, 5 percent
1	20 k, 5 percent
1	51 k, 5 percent
3	50-k potentiometer
2	100 k, 5 percent
1	1 meg, 5 percent
1	11.8 k
2	12.7 k
1	13 k
1	15 k
1	16.5 k
2	16.9 k
1	17.8 k
1	20.5 k
1	22.6 k
1	24.3 k
1	34 k
1	133 k
1	619 k
1	806 k

#### LEDs

5	green
5	yellow
4	red

#### Semiconductors

1	1N5242 zener
2	1N4153
1	1N5711 Schottky
1	MC3403
3	LM339

is used to reproduce the same slope as the low power scale. The output of the divider network is applied to the inverting inputs of the comparators.

The reference voltages are derived from a ladder network composed of 1-percent resistors. The tap point voltages take the voltage drop in the detector diode into account. Each tap is connected to a noninverting input of a comparator. When the output voltage of the peak detector is greater than the reference voltage, the output of that comparator switches to an active low. The LED is now forward biased and turned on, indicating the PEP being transmitted. The wattmeter is shown in Figure 5.

## Construction

The directional coupler is constructed on a  $2 \times 2 \times 0.062$ " double-sided piece of G10 board. I cut square holes in the board for toroid clearance so the semi-rigid coax could lie flat on the board. Each center conductor of the semi-rigid was soldered to small standoff terminals. I enclosed the board in a  $4 \times 2\text{-}1/2 \times 1\text{-}5/8$ " CU-2102-B Bud minibox with panel mount SO-239 connectors on each side. You should use RG/8U (or any type of 50-ohm coax cable that will handle the high power levels) between the coupler board and the SO-239 connectors.

The detector is built into a small enclosure made from brass and placed within the minibox to shield it from the RF. The coupler and detector are placed in a separate enclosure so they can be connected remotely from the watt-

# SATELLITE ESSENTIALS

Satellite TV is still full of the wonderment that made it so popular in the early '80s. The tinkerers are there, the programming is there, and never has the cost of becoming a dish owner been so low.

So, how do you find out about this exciting entertainment?

Through publications devoted specifically to satellite TV, that's how!



## America's Weekly Guide To Satellite TV

OnSat is unsurpassed for the most up-to-date listings of satellite programming. Dr. Dish, Mailbag, and the Transponder Service Watch are all geared to help you make the best use of your satellite TV system. A sample issue can be obtained for only \$1.



## The Complete Monthly Guide To Satellite TV

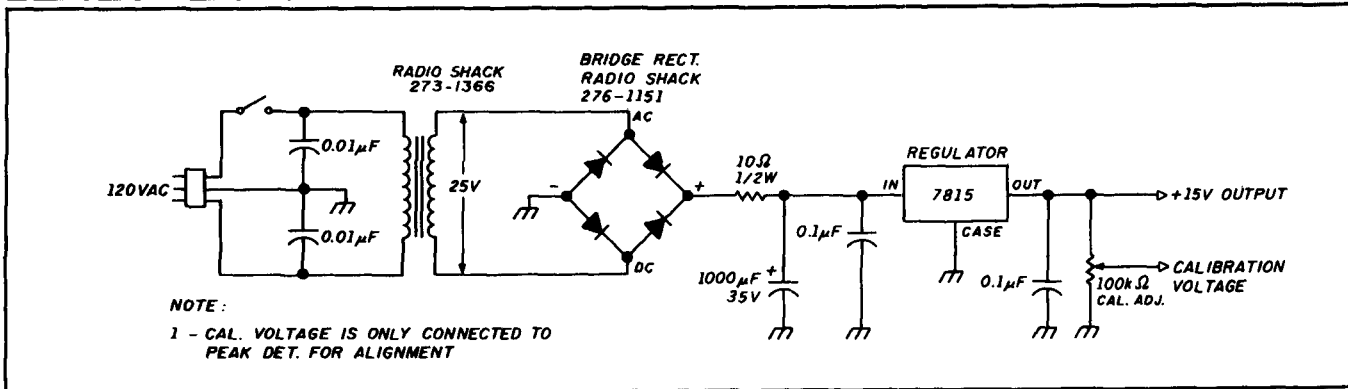
STV Guide contains over 300 pages of programming information, product reviews, home troubleshooting, and information about satellite TV. A sample issue can be obtained for only \$2.

Both OnSat and STV Guide contain listings for over 120 channels and Prime Time Grids for over 50 channels. Subscribe to either the weekly OnSat or the monthly STV Guide for only \$48 per year.

To start receiving the best in satellite TV guides and information, call toll-free (800) 234-0021. VISA® and MasterCard® accepted.


STV Guide/OnSat  
PO Box 2384 • Shelby, NC 28151-2384

FIGURE 6



Schematic of power supply.

### Conclusion

I tried different time constants to produce a fast attack and slow decay. A 1-second time constant gave the best results. This let the LEDs stay on long enough for me to see, and still let them track the response of the human voice. I used the wattmeter with a 2-kW linear amplifier; the coupler cores showed no evidence of overheating. I checked the calibration using a Hewlett Packard model 436A wattmeter. The maximum error for the low and high power scales was 2 percent. 


### REFERENCES

1. Henry Perras, K1ZDI, "Broadband Power-Tracking VSWR Bridge," *Ham Radio*, August 1979.
2. John Grebenkemper, KA3BLO, "The Tandem Match — An Accurate Directional Wattmeter," *QST*, January 1987.
3. Robert S. McDonald, WB7CLV, "Low Cost, Wideband Dual Directional Coupler," *RF Design*, May/June 1982.

### TS-950S (continued from page 29.)

second IF (455 kHz) filter indicators are on the right. You can select a number of different filter combinations by pressing the appropriate buttons just below the indicator lights. For example, I tried the 500-Hz first IF filter in conjunction with the 250-Hz second IF filter. This combination let me copy a weak DXpedition through a relatively unruly pileup without much trouble. I then switched to 2.7-kHz filters in both IFs to scan around the band for other stations. This is a nice feature, and I'm glad to see it added to the TS-950S.

Another feature I really liked is the subreceiver. I left it tuned to the pileup I had been monitoring while I listened up and down the band with the main receiver. In a contest you can run stations on VFO A and, at the same time, search for new multipliers on the subreceiver. When you find one, enter the frequency into VFO B and give the station a call. After working him, select VFO A again and continue to run stations. The subreceiver must operate within 500 kHz of the main receiver. While this means you can't monitor two bands simultaneously, this isn't a major limitation for most operators. The subreceiver uses a fixed 2.7-kHz bandpass filter.

Getting a preview of a new radio is fun. Getting to operate it before it reaches the marketplace is a special treat. Kenwood estimates delivery of the TS-950S to dealers within a few months. The list price is currently unavailable. Stay in touch with your favorite Kenwood dealer for final pricing and availability. 

### PARTS LIST

#### Power supply

#### Capacitors

- 2 0.1  $\mu$ F
- 2 0.01  $\mu$ F
- 1 1000  $\mu$ F, 35-volt electrolytic

#### Resistors

- 1 10 ohm, 1/2 watt
- 1 100-k potentiometer

#### Semiconductors

- 1 Bridge rectifier (Radio Shack P/N 276-1151)
- 1 15-volt regulator (7815)

meter. The separate enclosure also achieves greater isolation.

The wattmeter is housed in Radio Shack enclosure no. 270-272. Its dimensions are 1-15/16 x 8-1/4 x 6-1/2". I built the peak detector and comparator circuits on a vector pc board. Because the signals of this circuit are low frequency, I used point-to-point wiring. The LEDs are mounted in a straight row across the front panel. The power supply was built on a pc board using small standoff terminals. The power supply schematic is shown in Figure 6.

### Alignment

Calibrate the wattmeter with the DC power supply and a voltmeter. First remove the coupler and connect the output of the calibrator to the input of the peak detector. Connect a voltmeter to pin 7 of the MC3403 and switch the wattmeter to low power. Increase the calibration voltage until the voltmeter indicates 2.711 volts. Adjust the low power pot so the 100-watt LED just comes on. Now switch to high power and increase the calibration voltage until the voltmeter indicates 7.673 volts. Next adjust the slope offset pot until the 700-watt LED just comes on. Finally, increase the calibration voltage so the voltmeter indicates 9.27 volts and adjust the high power pot until the 1000-watt LED just comes on. You can also align the wattmeter by applying a CW signal to the coupler. Using the same power levels, adjust the power calibration pots in the same sequence you used for the DC alignment.

# Practically Speaking

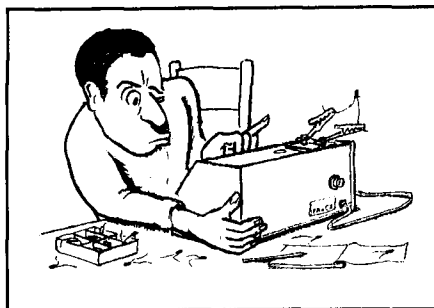
By Joe Carr, K4IPV

## VERTICALLY POLARIZED HF ANTENNAS: PART 3

In the first part of this three-part series, I examined the basic theory of vertical antennas. In part 2, I developed the theme further by looking at the construction, mounting, and grounding of verticals. In this third and final part, I'll look at the 5/8-wavelength vertical (including shunt-feed alternatives to the series feed normally used on vertical antennas) and a safety issue.

### Five-eighth wavelength verticals

Figure 1 shows the configuration for the 5/8-wavelength vertical antenna. Such an antenna generally gives a lower angle of radiation than the more common 1/4-wavelength radiator, so,



presumably, it's better for long distance work.

The radiator of this antenna is made from 1/2 to 2-inch aluminum tubing. (Remember that adjacent sizes fit together snugly to form longer sections.) The physical length of the 5/8-wavelength radiator is found from:

$$L(\text{ft}) = \frac{585}{F(\text{in MHz})} \quad (1)$$

The radials are the usual quarter wavelength, made of no. 12 or no. 14 cop-

per wire. This length is found from:

$$L(\text{ft}) = \frac{246}{F(\text{in MHz})} \quad (2)$$

The feedpoint impedance of the 5/8-wavelength antenna isn't a good match for the ordinary coaxial cables routinely available on the Amateur market. You'll need some form of impedance matching.

One option is to use a broadbanded RF transformer like the Palomar Engineers, Inc. models shown in part 1. These transformers will work throughout the HF spectrum, and match a wide variety of impedances to the 50-ohm standard system impedance.

Another option, especially for a single band antenna, is to use a coaxial cable impedance transformer like the one shown in Figure 1. The transformer consists of two sections of coaxial cable joined together. These sections appear as L1 and L2 in Figure 1. The length is found from:

$$L1 = \frac{122}{F(\text{in MHz})} \text{ feet} \quad (3)$$

and,

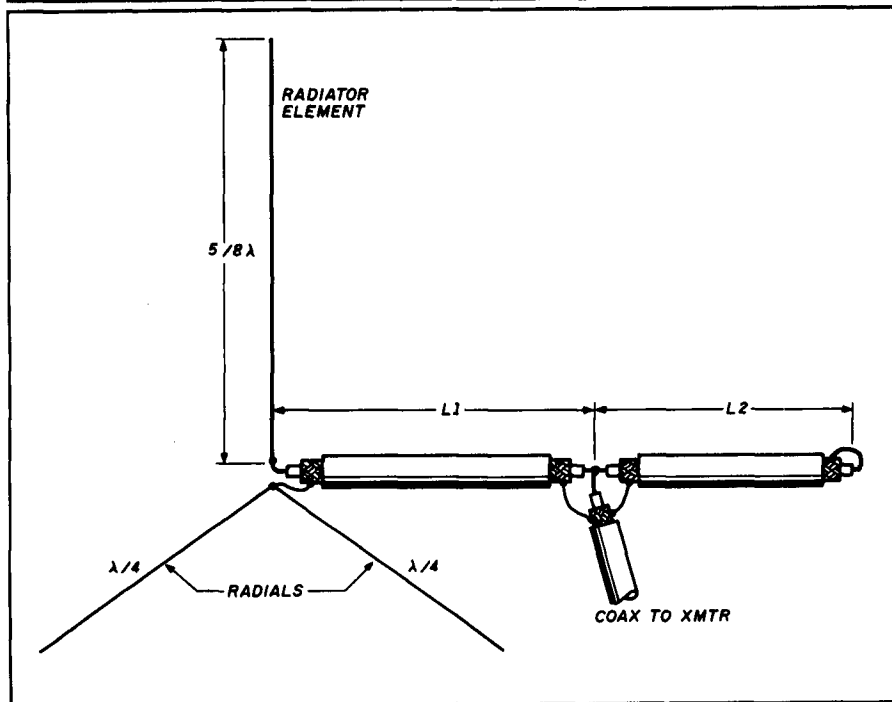
$$L2 = \frac{30}{F(\text{in MHz})} \text{ feet} \quad (4)$$

### Grounded vertical antennas

The vertical antennas I've presented in this series so far are called *series-fed verticals* because the generator is essentially in series with the radiator element. Such antennas must be insulated from ground. The other class of vertical is the *shunt-fed vertical*, which is grounded at one end (see Figure 2). There are three methods of shunt feeding a grounded vertical antenna: *delta*, *gamma*, and *omega*. All three matching systems have exactly the same function. They form an impedance transformation between the antenna radiation resistance at the feedpoint and the coaxial cable characteristic impedance, and cancel any reactance in the system.

The delta feed system is shown in

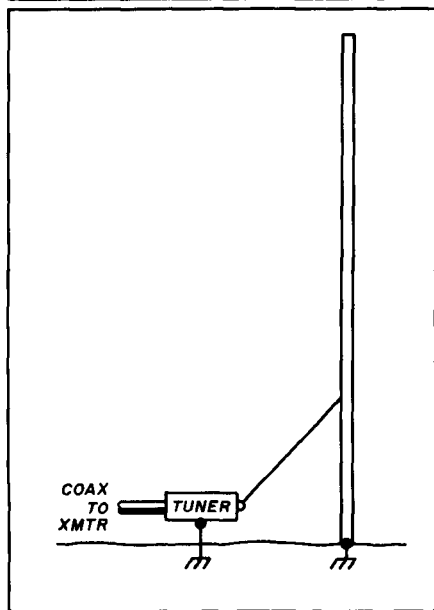
FIGURE 1



Basic configuration for a 5/8-wavelength vertical antenna.

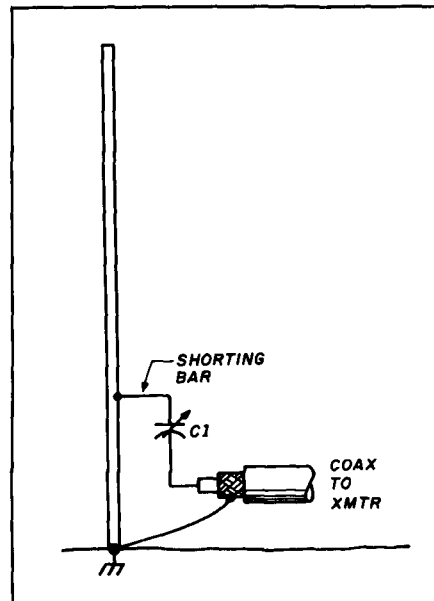
**Figure 2.** A taut feed wire is connected between a point on the antenna, which represents a specific impedance, and an antenna tuner. This feed method is common on AM broadcast antennas (usually, or perhaps always, verticals). Although you'd think that the sloping feed wire would distort the pattern, that's not the case. The distortion of the pattern, if any, is very minimal and negligible.

**FIGURE 2**



**Shunt-fed vertical using the Delta match.**

**FIGURE 3**



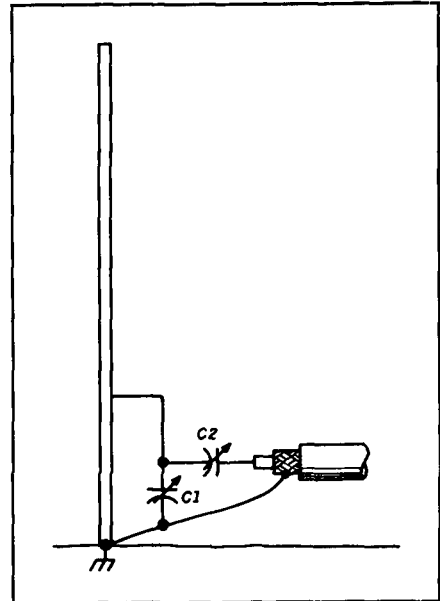
**Shunt-fed vertical using the Gamma match.**

The gamma feed system is shown in **Figure 3.** Since Amateurs commonly use this method to feed Yagi beam antennas, it's a familiar one to most of us. The feed system consists of a variable capacitor to tune the system, and a matching rod that parallels the antenna radiator element. It's important that the rod not be anywhere near a quarter wavelength, or it will become a vertical antenna in its own right. In fact, it would resemble the so-called J-pole antenna. The omega feed shown in **Figure 4** is similar to the gamma match, except that you use a series-shunt capacitor network.

**Safety first!**

Rarely does a year go by that we don't hear of an Amateur killed by ill-advised antenna installations. There are always stories (fortunately, not always regarding fatalities) about how inept antenna installations cause property damage or, worse yet, serious injury. There are several issues involved. A standard HF vertical is 18 to 27 feet high. When installed on a mast, the total antenna height may be 50 to 60 feet. Having antennas this tall can lead to serious problems. *Before erecting your antenna, be sure that it won't fall onto power lines if it gets away from you.* Also, be aware of windows and other objects the antenna may damage if it falls, and make plans to avoid that problem.

**FIGURE 4**



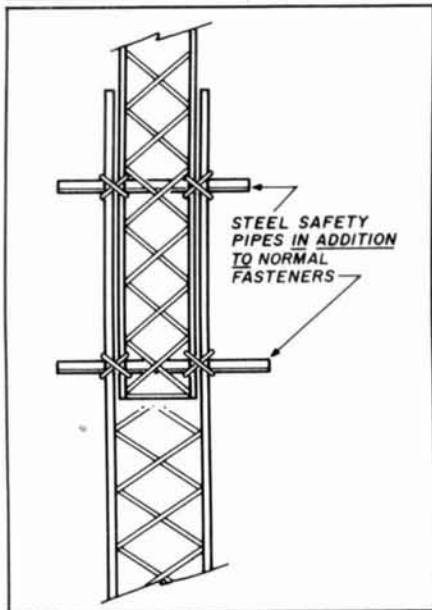
**Shunt-fed vertical using the Omega match.**

There's a no-nonsense, common sense, two-person rule that you should follow when erecting antennas: *Always use two or more physically fit people when installing a vertical antenna.* These antennas aren't terribly heavy on the ground, so you might get the false impression that handling one is going to be easy. But try holding onto the lower end of a 20-foot high aluminum "wind sail" while standing on a ladder; even the slightest breeze can become terribly dangerous! You'll also find that normal antenna motions ("wiggle") become serious when amplified by a 20-foot lever arm. I made that foolish mistake one Thanksgiving day, and I'm thankful that my father-in-law showed up in the nick of time to help steady a 37-foot high vertical, plus mast.

Another safety issue is illustrated in **Figure 5.** Although it doesn't pertain to vertical antennas exactly, it's nonetheless an antenna safety issue. My friend from Novice days, Doug (now EI2CN), has a slip-up tower from his beam. He told me about something called the "guillotine effect." I didn't think much about this problem until, on one of my business trips, I read about a professional tower rigger for a two-way radio company who'd had an arm amputated after it was crushed while he was climbing a slip-up tower. Apparently he failed to use the safety stops provided on the tower, and it collapsed while he was on it. The center section came slicing down, crushing his arm so badly that the surgeons couldn't save it.

A slip-up tower lets you do your maintenance closer to the ground. So why would you be at risk of being crushed? There are two reasons. First, even if your tower is collapsed completely, it's possible for the antenna to shift downward a couple of inches — especially if a physical failure is present. Second, it's easier to do some types of work on the tower while it's in an upright position. For example, repairing a coaxial line or damaged gamma match is easier with the tower in place. Sometimes, it simply seems like too much trouble to release the guys and crank down the tower. Some Amateurs also ignore the manufacturer's directions and climb the tower. Those who insist on tackling this type of job by climbing the tower are better off double rigging it for safety. But you'll need more than the mechanisms provided by the manufacturer.

FIGURE 5



A means of providing additional safety precautions when working with a slip-up tower.

Figure 5 shows a tower that's safety rigged to protect against failures. A pair of heavy wall steel pipes are inserted across the tower, impeding the center section. These pipes can be bolted or tied securely in place, and should be used in addition to any fasteners or safety features provided by the tower manufacturer. Do not defeat the builder's safety features.

Wear two leather safety belts, not one. Always make sure one of the belts is connected; don't depend on your own physical strength to stay on the tower.

I can be reached at POB 1099, Falls Church, Virginia 22041; I'd like to have your comments and suggestions for this column.



I SAY AGAIN, YOUR KITE ANTENNA CAME DOWN IN MY YARD AND YOU CAN PICK IT UP AT...

**WE SHIP WORLDWIDE**  
**Barry Electronics Corp.**  
 WORLD WIDE AMATEUR RADIO SINCE 1950  
 Your one source for all Radio Equipment!

**KITTY SAYS: WE ARE NOW OPEN 7 DAYS A WEEK. Saturday & Sunday 10 to 5 P.M. Monday-Friday 9 to 6:30 PM Thurs. to 8 PM**  
 Come to Barry's for the best buys in town.

**ONV Safety belts-in stock**

**ICOM**  
 IC-R71A, 751A, 781, 28AH, 38A, 48A, Micro2II, R-7000, IC-765, IC-375A, 275AH, 3210A, 475AH, 735, IC-901, IC-228H, IC725, IC-2400A

**SMART PATCH**  
 CES Simplex Autopatch 510-5A, VHF Patch FM Transceiver To Your Telephone Great For Telephone Calls From Mobile To Base. Simple To Use. \$105A/SDH-50

**TUNERS STOCKED: NYE MBV-A 3 Killowatt Tuner**

**MFJ-989C**

**SHORTWAVE RECEIVERS STOCKED**

**Ten-Tec Tuner 238**

**COMET ANTENNAS STOCKED**

**HEIL EQUIPMENT IN STOCK**

**SANGEAN Portable Shortwave Radios**

**Hy-Gain Towers & Antennas, and Flators will be shipped direct to you FREE of shipping cost.**

**IX Towers, Antennas, Mobile Radio mounts, stocked call.**

**AMERITRON AUTHORIZED DEALER**

**MAIL ALL ORDERS TO: BARRY ELECTRONICS CORP., 512 BROADWAY, NEW YORK CITY, NY 10012 (FOUR BLOCKS NORTH OF CANAL ST.)**

**New York City's LARGEST STOCKING HAM DEALER COMPLETE REPAIR LAB ON PREMISES**

**"Aqui Se Habla Espanol!"**  
 BARRY INTERNATIONAL TELEX 12-7670  
 MERCHANDISE TAKEN ON CONSIGNMENT FOR TOP PRICES  
 Monday-Friday 9 A.M. to 6:30 P.M. Thursday to 8 P.M.  
 Saturday & Sunday 10 A.M. to 5 P.M. (Free Parking)  
 IRT/LEX: "Spring St. Station" Subways: BMT-  
 "Prince St. Station" IND-"F" Train-Buy Station  
 Bus: Broadway #6 to Spring St. Path-9th St./6th Ave. Station.

**COMMERCIAL RADIOS STOCKED:** ICOM, Motorola, MAXON, Standard, Yaesu. We serve municipalities, businesses, Civil Defense, etc. Portables, mobiles, bases, repeaters.

**ALL SALES FINAL**

We Stock: AEA, ARRL, Alnico, Ameco, Ameritron, Antenna Specialists, Asatic, Astron, B&K, B&W, Benchner, Bird, Butterfield, CDE, CES, Cushcraft, Davies, Eimac, Henry, Heil, Hustler, Hy-Gain, Icom, KLM, Kantronics, Larsen, MJF, J.W. Miller, Mirage, Nya, Palomar, RF Products, Saxton, Shure, Tempo, Ten-Tec, TUBES, Yaesu, Vibroplex, Duplexers, Repeater, Scanners, Radio Publications, Usden, Kenwood, Maxon, RFC.

**WE NOW STOCK COMMERCIAL COMMUNICATIONS SYSTEMS**  
 HAM DEALER INQUIRES INVITED. PHONE IN YOUR ORDER & BE REIMBURSED  
**COMMERCIAL RADIOS STOCKED & serviced on premise.**  
 Amateur Radio Courses Given on Our Premises, Call  
**Export Orders Shipped Immediately. TELEX 12-7670**

**FAX: 212-925-7001**

## SERVICE MONITOR MEASUREMENTS MODEL FM 110

- Covers all business channels from 30MHz to 512MHz
- Monitor: 2uV, frequency error display, scope deviation display
- Generator: Calibrated output up to 10mV, Sinad display
- Built-in Tone Generator

AMAZINGLY LOW PRICE OF ONLY

**\$2450.00**

FOB - BATESBURG, SC

WE ACCEPT VISA, MASTERCARD & AMERICAN EXPRESS

**AIE CORPORATION — MEASUREMENTS DIVISION**  
 PO BOX 70, BATESBURG, SOUTH CAROLINA 29006 (803)532-9256



# NEW PRODUCTS

(continued from page 52.)

ings decrease friction and load transfer to the gear set. The OR-2300 is available through dealers. The suggested retail price is \$859.

For details contact Orion Business International, Inc., PO Box 9577, Canoga Park, California 91309. Phone: (818)888-4927.

Circle #000 on Reader Service Card.

## Handheld Programmer

Communications Specialists, Inc. has announced the HHP-1, a new handheld programmer. This device is designed for custom programming of tones into memory in the Communications Specialists IC-110 custom microcircuit.

The IC-110 microcircuit allows complete flexibility of tone choice and offers accuracy and stability.



The working frequency for these tone products is programmed via a DIP switch on the tone board. With a changeable memory you can choose any nonstandard tone frequency. When you customize the arrangement of the tones, multiple tone switching with one tone unit can be done without diode network circuitry.

The HHP-1 operates on a 9-volt battery (supplied), and measures only 4 x 7-1/2 x 1-3/4 inches. A plug-in socket is provided for external power. The HHP-1 is priced at \$199.95. Communications Specialists' standard one-year warranty applies.

For further information, contact: Communications Specialists, Inc., 426 West Taft Avenue, Orange, California 92665-4296. Telephone: (800)854-0547 or (714)998-3021 (local). FAX (714)974-3420.

Circle #307 on Reader Service Card.

## Carolina Windom/2

The CAROLINA WINDOM/2<sup>©</sup> is a half-size 40-10 meter version of the CAROLINA WINDOM<sup>©</sup>. It covers seven HF bands, including all of the WARC bands. Performance equals the full-size CAROLINA WINDOM on all of the bands covered.

The CAROLINA WINDOM/2 is fed with 50-ohm coaxial cable. A transmatch is required on all bands. Each antenna comes assembled and complete with special dedicated matching unit.



vertical radiator section, high power transmission "Line Isolator<sup>©</sup>," no. 14 stranded antenna wire, and glass-filled insulators. The CAROLINA WINDOM package comes with CoaxSeal<sup>®</sup> and illustrated manual. It lists for \$69.95.

For more information, or a copy of the RADIO WORKS 56 page "Discovery" catalog, call or write the RADIO WORKS, Box 6159, Portsmouth, Virginia 23703. Phone: (804)484-0140.

Circle #306 on Reader Service Card.

## B-3030-G RF Amplifier

The Mirage B-3030-G is the next generation of Power Amplifiers for 144 to 148 MHz. Features include automatic shut-down circuitry for protection against high antenna VSWR, high temperature, and excessive RF power input. A GaAs-FET receive pre-amp provides high gain and low noise amplification for weak signal applications. The pre-amp includes an attenuator to reduce signal output level. Provision is made for auto-

matic or remote (external) keying, and for remote control of all front panel functions using the Mirage/KLM RC-1 Remote Control Unit. The Mirage B-3030-G is capable of FM, SSB, and CW operational modes. Contact Mirage/KLM Communications Equipment, Inc., PO Box 1000, Morgan Hill, California 95037, Telephone (408)779-7363.

Circle #302 on Reader Service Card.

## YO Yagi Optimizer Software

The new YO program for IBM PC and compatible computers will automatically adjust the element lengths and spacings of a Yagi-Uda design to maximize forward gain, optimize pattern, and minimize SWR. Radiation patterns at the center and edges of a band, and a scale drawing of the antenna, are plotted on CGA, EGA, or HGC graphics screens during optimization. Hard copies of the plots may be made on dot-matrix printers. YO will compute several trial designs per second for small Yagis, with a math coprocessor chip installed (not required). Yagis having up to 50 elements may be modeled. The YO design package includes models for gamma and hairpin matching networks, element tapering, mounting plates, and frequency scaling. A library of Yagi files and documentation is included. YO is \$90 postpaid (\$95 California and foreign), and is available from Brian Beezley, K6STI, 507-1/2 Taylor Street, Vista, California 92084.

Circle #000 on Reader Service Card.

## AEA Fast-Scan TV Transceiver

AEA's new FSTV-430 fast-scan TV transceiver lets you add live color transmission to your Amateur Radio communications.

The FSTV-430 transceiver connects to the video output of a video camera so you can transmit and receive live or taped videos. A second video camera can be used for studio-like "shooting" from other angles.



(continued on page 90.)

# ICOM

# KENWOOD YAESU



IC-781

HF Equipment	List	Jun's
IC-781 Super Deluxe HF Rig	\$5995.00	Call \$
IC-765 New, Loaded with Features	3,149.00	Call \$
IC-735 Gen. Cvg Xcvr	1099.00	Call \$
IC-751A Gen. Cvg. Xcvr	1699.00	Call \$
IC-725 New Ultra-Compact Xcvr	949.00	Call \$
IC-575A 10m/6m Xcvr	1399.00	Call \$
IC-726 HF/50 MHz All Mode	1299.00	Call \$
<b>Receivers</b>		
IC-R9000 100 kHz to 1999.8 MHz	5459.00	Call \$
IC-R7000 25-1300 + MHz Rcvr	1199.00	Call \$
IC-R71A 100 kHz-30 MHz Rcvr	999.00	Call \$
<b>VHF</b>		
IC-228A/H New 25/45w Mobiles	509/539.	Call \$
IC-275A/H 50/100w All Mode Base	1299/1399.	Call \$
IC-28A/H 25/45w, FM Mobiles	469/499.	Call \$
IC-2GAT, New 7w HT	429.95	Call \$
IC-2SAT Micro Sized HT	439.00	Call \$
IC-901 Remote Mount Six Band Mobile	TBA	Call \$
<b>UHF</b>		
IC-475A/H 25/75w All Modes	1399/1599.	Call \$
IC-48A FM Mobile 25w	509.00	Call \$
IC-4SAT Micro Sized HT	449.00	Call \$
IC-4GAT, New 6w HT	449.95	Call \$
IC-04AT FM HT	449.00	Call \$
IC-32AT Dual Band Handheld	629.95	Call \$
IC-3210 Dual Band Mobile	739.00	Call \$
IC-2500A FM, 440/1.2 GHz Mobile	999.00	Call \$
IC-2400 144/440 FM	899.00	Call \$
<b>220 MHz</b>		
IC-3SAT Micro Sized HT	449.99	Call \$
IC-375A All-Mode, 25w, Base Sta.	1399.00	Call \$
IC-38A 25w FM Xcvr	489.00	Call \$
1.2 GHz		
IC-12GAT Super HT	529.95	Call \$



TS-940S

HF Equipment	List	Jun's
TS-940S/AT Gen. Cvg Xcvr	\$2499.95	Call \$
TS-440S/AT Gen. Cvg Xcvr	1449.95	Call \$
TS-140S Compact, Gen. Cvg Xcvr	949.95	Call \$
TS-680S HF Plus 6m Xcvr	1149.95	Call \$
TL-922A HF Amp	1749.95	Call \$
<b>Receivers</b>		
R-5000 100 kHz-30 MHz	1049.95	Call \$
R-2000 150 kHz-30 MHz	799.95	Call \$
RZ-1 Compact Scanning Rcvr.	599.95	Call \$
<b>VHF</b>		
TS-711A All Mode Base 25w	1059.95	Call \$
TR-751A All Mode Mobile 25w	669.95	Call \$
TM-231A Mobile 50w FM	459.95	Call \$
TH-215A, 2m HT Has It All	399.95	Call \$
TH-25AT 5w Pocket HT NEW	369.95	Call \$
TM-731A 2m/70cm, FM, Mobile	749.95	Call \$
TM-621 2m/220, FM, Mobile	729.95	Call \$
TM-701A 25w, 2m/440 Mobile	599.95	Call \$
TH-75A 2m/70cm HT	TBA	Call \$
<b>UHF</b>		
TS-811A All Mode Base 25w	1,265.95	Call \$
TR-851A 25w SSB/FM	771.95	Call \$
TM-431A Compact FM 35w Mobile	469.95	Call \$
TH-45AT 5w Pocket HT NEW	389.95	Call \$
TH-55 AT 1.2 GHz HT	524.95	Call \$
TM-531A Compact 1.2 GHz Mobile	569.95	Call \$
<b>220 MHz</b>		
TM-3530A FM 220 MHz 25w	519.95	Call \$
TM-321A Compact 25w Mobile	469.95	Call \$
TH-315A Full Featured 2.5w HT	419.95	Call \$



FT-767GX

HF Equipment	List	Jun's
FT-747 GX New Economical Performer	\$889.00	Call \$
FT-757 GX II Gen. Cvg Xcvr	1280.00	Call \$
FT-767 4 Band New	2299.00	Call \$
FL-7000 15m-160m Solid State Amp	2279.00	Call \$
<b>Receivers</b>		
FRG-8800 150 kHz- 30 MHz	784.00	Call \$
FRG-9600 60-905 MHz	808.00	Call \$
<b>VHF</b>		
FT-411 New 2m "Loaded" HT	406.00	Call \$
FT-212RH New 2m, 45w Mobile	499.00	Call \$
FT-290R All Mode Portable	610.00	Call \$
FT-23 R/TT Mini HT	351.00	Call \$
FT-33R/TT 220 MHz HT	373.00	Call \$
FT-73R/TT 70cm HT	355.00	Call \$
<b>UHF</b>		
FT-712RH, 70cm, 35w Mobile	536.00	Call \$
FT-811 70cm built-in DTMF HT	410.00	Call \$
FT-790 R/II 6m/25w Mobile	681.00	Call \$
<b>VHF/UHF Full Duplex</b>		
FT-736R, New All Mode, 2m/70cm	2025.00	Call \$
FEX-736-50 6m, 10w Module	294.00	Call \$
FEX-736-220 220 MHz, 25w Module	322.00	Call \$
FEX-736-1.2 1.2 GHz, 10w Module	589.00	Call \$
FT-690R MKII, 6m, All Mode, port.	752.00	Call \$
<b>Dual Bander</b>		
FT-4700RH, 2m/440 Mobile	996.00	Call \$
FT-470 Compact 2m/70cm Mobile	576.00	Call \$
FT-690 R/II 6m/10w Mobile	497.00	Call \$
<b>Repeaters</b>		
FTR-2410 2m Repeaters	1154.00	Call \$
FTR-5410 70cm Repeaters	1154.00	Call \$
<b>Rotators</b>		
G-400RC light/med. duty 11 sq. ft.	242.00	Call \$
G-800SDX med./hvy. duty 20 sq. ft.	300.00	Call \$
G-800S same/G-800SDX w/o presets	322.00	Call \$

ALINCO ASTRON Kantronics MFJ concepts MIRAGE/KLM TE SYSTEMS

INSTANT CREDIT WITH ICOM PREFERRED CUSTOMER CARD



FAX 213-390-4393

## JUN'S BARGAIN BOX (Limited Quantities)



IC-28H  
2 Meter, FM, 45W  
Mobile Transceiver

LIST \$499.00 **SALE \$399.95**



IC-228H  
2 Meter, FM, 45W  
Mobile Transceiver

LIST \$539.00 **SALE \$409.95**

**SPECIAL ICOM MONTH LEFT OVER SALE!**

SE HABLA ESPAÑOL  
FREE U.P.S. CASH ORDER  
(MOST ITEMS, MOST PLACES)

**(213) 390-8003**

3919 Sepulveda Blvd.  
Culver City, CA 90230

## INDUSTRIAL QUALITY REPLACEMENT BATTERIES FOR COMMUNICATIONS

Nickel-Cadmium, Alkaline, Lithium, etc.

Repair Packs For  
ICOM®, KENWOOD, YAESU,  
SANTEC, AZDEN, TEMPO,  
CORDLESS PHONES...AND MORE!

**NEW! I.C.E. PACK \$49.95**



**E.H. YOST & CO.**  
EVERETT H. YOST KB9XI  
7344 TETIVA RD.  
SAUK CITY, WI 53583  
ASK FOR OUR CATALOG  
**(608) 643-3194**

166

## TOWERS by ALUMA

TELESCOPING CRANK UP  
GUYED STACK-UP  
TILT-OVERS

Easy to install. Low Prices. Crank-ups to 100 feet.

Over 36 types aluminum towers made—specials designed and manufactured—write for details.

EXCELLENT FOR AMATEUR COMMUNICATIONS

Mobile Trailer Type

Roof Top Aluminum Type

SPECIAL Four Section 50 Ft Van Mounted Crank-Up Alumina Tower

**ALUMA TOWER CO.**  
BOX 2806HR  
VERO BEACH, FL 32961-2806  
(407) 567-3423 FAX 407-567-3432

167

## RFI KIT

Use ferrite beads to keep RF out of your TV, stereo, telephone, etc. Kit includes one dozen beads, one dozen toroids 1/2" to 1 1/4" diameter, three "split beads" and our helpful RFI tip sheet. Everything needed to fix most RFI problems. **\$15 + \$3 shipping U.S. and Canada. 7% in CA.**

Free catalog and RFI tip sheet on request.

**PALOMAR ENGINEERS**  
Box 455, Escondido, CA 92025  
Phone: (619) 747-3343

168

# Elmer's Notebook

Tom McMullen, W1SL

## TEST EQUIPMENT—EASY AND USEFUL

In these modern days of high-tech gadgets and equipment, we sometimes tend to forget that the test equipment we use to build, check, and maintain our Amateur stations can be quite simple. While digital readouts and touch-pad programmed meters are certainly attractive and a joy to own, there's a lot to be said for some of the basic instruments you can build. They can be extremely useful around the shack. Because they are so simple, very little can go wrong.

Here's a gadget that I've used for years to check and monitor everything from old vacuum-tube equipment (would you believe a 6L6 oscillator driving a pair of 807s?) for 80-meter CW use, to a UHF Yagi.

### The meter

I've always referred to this device as "the meter," as in, "let's get the meter and check it out." "It" was whatever project I was working on at the moment. The meter is basically a microammeter mounted in a metal box along with a diode RF detector (see **Figure 1**). Almost any sensitive meter will do; a metal enclosure is recommended. The size of the box isn't important, as long as the meter and other parts will fit inside. You'll find plenty of suitable meters and enclosures at most radio flea markets, or you can go to your local Radio Shack and browse through their racks of bagged goodies.

**Figure 1** shows a basic "no frills" detector and meter. A more versatile version is shown in **Figure 2**. A switch and some resistors have been added to let you change the sensitivity for different signal strengths.

Construction isn't critical, with the exception of the diode leads and the leads of the  $0.001 \mu\text{F}$  capacitors. Keep these as short as practical. Don't cut the diode leads too short or you'll over-heat the diode when you solder it.

The first meter I built had an SO-239



coaxial fitting for J1. I later put in a BNC type, which made it easier to change whatever was plugged into it. Use whichever type fitting you prefer. You can use insulated stand offs or tie points to connect the capacitor, diode, and meter leads together. The capacitors can be plain disc-ceramic units with a voltage rating of 50 or higher.

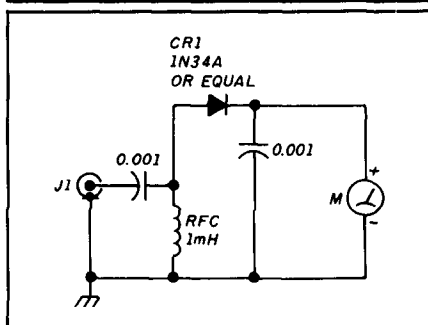
The switch can be any rotary or push-button type, as long as it fits in the box you're using. If you don't have a switch with four positions, just connect resistors to whatever you have. The one shown in **Figure 2** just hap-

pened to be in my junkbox, so that's what went into the meter.

The resistors aren't critical either. The idea is to put more resistance in the circuit with each switch position. When whatever you're measuring provides a full-scale reading, switch to the next position and continue. Any value close to those shown will work.

The meter itself is critical in current capacity only, but there's a lot of room to experiment. I use a 0 to  $100 \mu\text{A}$  meter obtained from a "bargain box" sale at Radio Shack. Anything from 0-50 to 0-500  $\mu\text{A}$  should work okay; the physical size is your choice. I once used a 12-inch wide meter (from an old battery-charging panel) in an antenna-checking version of the meter. It had a 50-mA movement (originally used with shunt resistors and calibrated to 500 A) and a huge pointer that could be seen from several hundred feet away. Before I retired it, I used this meter to tune up several UHF antennas.

FIGURE 1



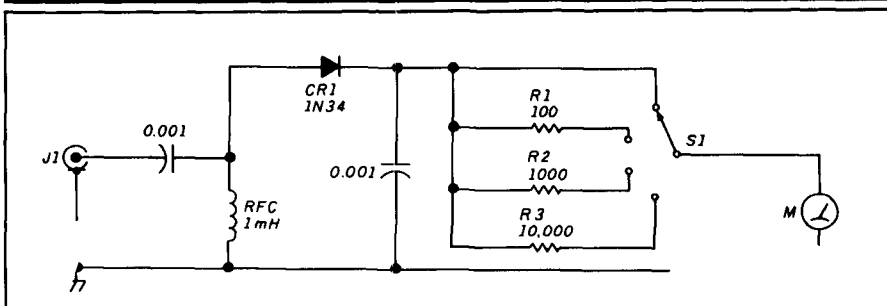
The meter is basically a microammeter with a diode detector, mounted in a metal box along with a coaxial connector.

### Accessories

So far, I've discussed a basic RF detector (the diode and C1), and a meter that will display the current produced by the diode. Now, I'll look at some input devices.

The unit that's most often connected to my meter is a telescoping antenna which is approximately 14 inches long when extended (see **Figure 3A**). You'll find them for sale at low prices at flea markets or hamfests. You can also purchase them inexpensively from Radio Shack or by mail order. Some come

FIGURE 2



Adding a selector switch and resistors to the basic meter makes the device more versatile in handling different signal strengths.



# HAM RADIO MAGAZINE

# Great Magazine At a Special Price.

## The Perfect Holiday Gift!

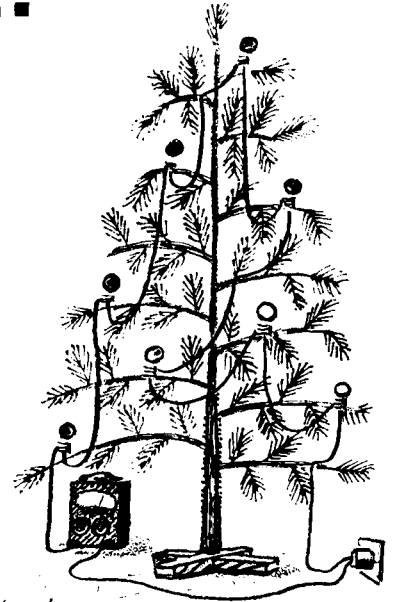
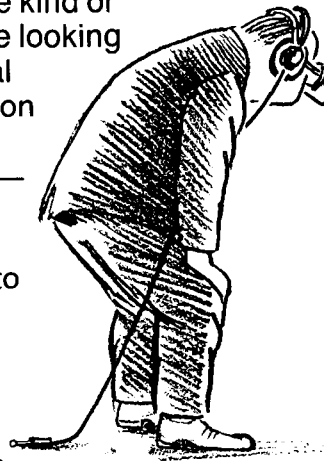
HAM RADIO Magazine is the perfect gift for the hard-to-buy-for Ham friend or for yourself! If you act now, you can take advantage of these special low Holiday rates.

Each monthly issue is stuffed full of the kind of construction articles and projects you are looking for. In addition, you get four super special issues. January is the Annual Construction Issue — full of projects for all levels of Amateur interest. May means antennas — from DC to daylight. Summer doldrums are relieved with July's VHF/UHF issue. In November, the Receiver issue brings to you the latest in state-of-the-art design and construction techniques for winter projects.

HAM RADIO Magazine is growing by leaps and bounds. Reader satisfaction is at an all time high and thousands have joined the HR ranks in the last year alone!

Send a gift to that special Ham friend or renew your subscription today. Take advantage of these special low Holiday rates before they expire January 1, 1990.

**An attractive gift card will be sent  
if your order is received before December 5, 1989**



*Ken Keel PA6CX*

Please enter my one year gift/renewal subscription(s) to HAM RADIO Magazine as follows:

**First gift/renewal \$19.95 SAVE \$3**  
**Two or more \$15.95 SAVE \$7**

**FIRST SAVE \$3** Name \_\_\_\_\_ Call \_\_\_\_\_  
Address \_\_\_\_\_  
City \_\_\_\_\_ State \_\_\_\_\_ Zip \_\_\_\_\_

**SECOND SAVE \$7** Name \_\_\_\_\_ Call \_\_\_\_\_  
Address \_\_\_\_\_  
City \_\_\_\_\_ State \_\_\_\_\_ Zip \_\_\_\_\_  
 NEW  RENEWAL

**THIRD SAVE \$7** Name \_\_\_\_\_ Call \_\_\_\_\_  
Address \_\_\_\_\_  
City \_\_\_\_\_ State \_\_\_\_\_ Zip \_\_\_\_\_  
 NEW  RENEWAL

Start  Renew my Subscription to HR  
 Enclosed is a check or money order  
Charge:  Mastercard  VISA

Card # \_\_\_\_\_ Expires \_\_\_\_\_  
My Name \_\_\_\_\_  
Address \_\_\_\_\_  
City \_\_\_\_\_ State \_\_\_\_\_ Zip \_\_\_\_\_

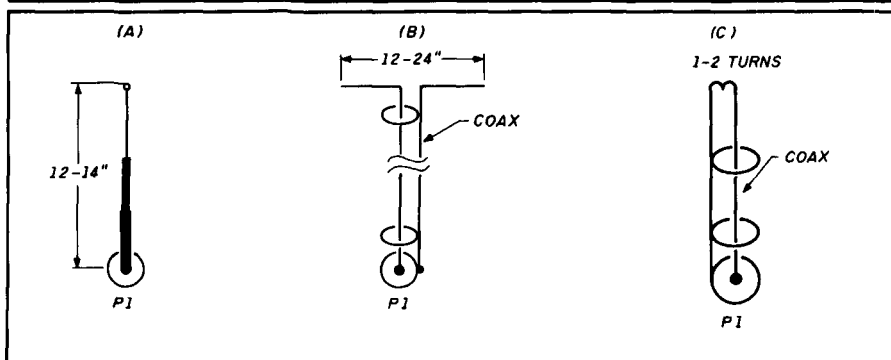
**HAM  
RADIO  
MAGAZINE**  
GREENVILLE, NH 03048

CALL TOLL FREE  
**800-341-1522**  
M-F: 8-9 EST. • Sat: 9-5  
**DATATEL 800™**  
ORDERS ONLY

FOR EXTRA FAST SERVICE, CALL TOLL FREE  
TO ORDER YOUR GIFT SUBSCRIPTIONS OR BOOKS

Prices U.S. only. Foreign prices upon request.

**FIGURE 3**



**RF pickup devices for the meter.** Shown at **A** is a simple telescoping whip mounted on a coaxial fitting. A dipole and length of coax, **B**, serves as a remote pick-up antenna. The two-turn loop and short piece of coax, **C**, is used to "sniff" out RF on power leads, house wiring, and TV antenna leads.

with a BNC fitting on the base already, but it's not hard to connect one if there's no fitting. I prefer a whip that has a swivel joint at the base — it can be tilted for best signal pickup.

If you don't have a telescoping antenna, you can use a 12 to 14-inch length of stiff copper wire as a general RF pickup device. Any RF in the area will provide a meter reading if the field is strong enough.

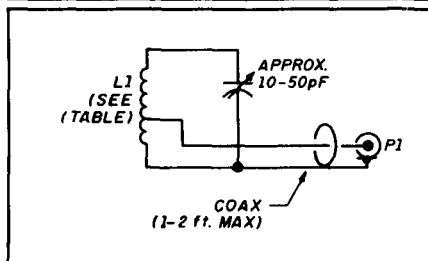
A dipole antenna with a short (6 to 10 foot) length of coaxial cable between it and the BNC connector is another useful input device (Figure 3B). The dipole isn't critical, a 12 to 24 inch length tip to tip is fine. I used a couple of pieces of brass brazing rod stuck into a piece of plastic rod that served as a center insulator. My favorite use for this is as a very rough check of antenna radiation pattern or strength. Just tape it to a wooden pole or broom handle and stand it up several feet away from the antenna you're working on.

The next device is an RF "sniffer." It's just a 2-turn loop of no. 16 enameled wire, approximately an inch in diameter, connected to the end of a couple of feet of RG-58A/U coaxial cable, as shown in Figure 3C. This sniffer is very useful for finding RF that's sneaking along the outside of coaxial feedlines, house wiring, or whatever.

Figure 4 shows a device I've used to tune up many oscillator/mixer/multiplier circuits. The loop in Figure 3C will pick up RF from a tuned circuit, but won't tell you the frequency. The tuned circuit in Figure 4 will. It's a "wavemeter" device that you can place near a circuit that contains RF energy. As the

wavemeter is tuned to the frequency of the RF in an oscillator, for example, the meter will show a reading. Admittedly, it's not as accurate as a frequency counter, but I've found it very

**FIGURE 4**



**A tuned circuit can act as a wavemeter when connected to the meter via a short length of coax.** See Table 1 for some suggested values of L1, or look in the theory section of most Amateur Radio handbooks for ideas on other combinations and frequency ranges. C1 can be any small variable capacitor with a range of approximately 10 to 50 or 10 to 75 pF. The coil form can be mounted on a long screw or a stand-off insulator for support.

**TABLE 1**

Table 1. Suggested coil data for the wavemeter attachment. The frequencies listed are approximate. You can tailor them to your needs by adding or removing turns.

Frequency, MHz	Turns	Tap	Wire Size
3.5 to 8	35	11	No. 30 enameled
7 to 15	22	8	No. 20 enameled
14 to 30	10	3	No. 20 enameled
30 to 100	4	1	No. 20 enameled
75 to 200	hairpin, 1/2" wide, 2" long, tap 1" from ground. No. 14 enameled or bare wire.		

All coils except the hairpin can be wound on a 1" diameter plastic form for support. Windings are close to each other except for the 30 to 100-MHz range, which is spaced to be approximately 1" long.

useful in determining quickly that a crystal oscillator wasn't working on the correct overtone, that a doubler circuit was really tripling, that the output of a mixer was F1+F2 instead of F1-F2, and so on.

### Wavemeter calibration

Calibrating a wavemeter like this one may be puzzling to some. It's not hard to do. Visit a friend who has a multi-band transmitter and put the coil near the antenna (keep the transmitter on low power, of course). Vary the capacitor for a maximum reading. By marking the position of the knob for the frequencies you find, you can make a good estimate of any that fall between Amateur bands. Most dip meters will produce enough RF to cause a small meter indication when tuned in, and you can use this method to make a useful calibrated scale.

Another method involves connecting the tuned circuit in parallel with your receiver antenna input. Just put a "T" fitting in the coax near your receiver input jack, connect the tuned circuit to one leg of the T, and listen to a signal as you tune the capacitor. When the circuit is resonant at the signal's frequency, the signal will decrease markedly, and may even disappear. A general-coverage receiver will provide many calibration points; a ham-bands only rig will give you several frequencies at important parts of the range.


I hope you'll find the meter as useful as I have. Many times, it's the first thing I grab to look at the basics of what's happening in a circuit or antenna. At one time, when my residence was in the midst of acres of trees instead of a housing development, I had the little dipole mounted on a 20-foot wood pole at the end of

500 feet of surplus coaxial cable. Because it was located exactly north of my 2-meter beam antenna, I always had a way to check antenna-rotator position and relative beam-antenna performance.

### Precautions

As much as I miss the "good ole days" and their simplicity of life, there are other things that I'm glad to have learned. For example, I no longer work on antennas with 5, 10, or 20 watts of power being fed to them. When I do "tweak" an antenna with power being fed to it, the power is limited to a few milliwatts. Even then, I stay away from the front of any directive beam like a dish reflector or large Yagi. (I don't know how much RF is harmful, but why push my luck!)

Another "gotcha" is the pick-up antenna — especially the dipole. Don't leave it connected to the meter when you're not using it to measure or check something. It's nice to have a constant monitor of how your antenna is radiating or how your transmitter is putting out, but that diode in the box is a great harmonic generator. Where are the harmonics going to go? Right back up the coax and out of the antenna to your neighbor's TV set, of course. To avoid problems, disconnect the whip or dipole from the meter unless you're actually checking something. The sniffer loop and the tuned circuit will pick up RF fields at several inches from most transmitter tuned circuits, and most transistorized circuits don't have more than 10 or 12 volts of DC that you can contact. However, for vacuum-tube final amplifier stages and some high-powered solid-state circuits, caution is the important word. Not only is the DC in a plate circuit bad for your health, but the RF will cause severe burns if you get careless. However, with a sensitive device like the meter, you'll be able to pick up enough RF for an indication long before you get close to the danger point. You can even locate some RF leaking out of metal enclosures on most high-powered amplifiers. It's surprising what you can find out about shielding and bypassing with the sniffer loop.

In my next column, I'll look at an RF output measuring device that you can connect to your transmitter or use as a test instrument. Some of you may have seen one before, but I'll refresh your memory and show everyone else how easy it is to build. 



Published  
Bi-Monthly

Read All About Your  
Favorite Modes Of  
Digital Communications!

★ **Subscribe Today!** ★

**Digital Digest**  
4063 N. Goldenrod Road  
Winter Park, FL 32792

**\$16.00 Per Year**  
U.S. \$22.00 Elsewhere

Payable in U.S. Funds Only / Check or M.O. Preferred



Factory Authorized Dealer & Service For

**KENWOOD  
YAESU  
ICOM**

Call Us For  
Great Prices & Great Service

TOLL FREE ORDER LINE 1-800-344-3144  
Continental U.S. & Texas

RECMM, INC. THE HAM CENTER  
SALES AMATEUR RADIO SERVICE

5707A Mobud San Antonio, Texas 78238 (512) 680-6110  
FAX (512) 647-8007

✓ 173

### MOVING?

Let circulation know  
60 days in advance.

Ham Radio  
Greenville, NH 03048-0498  
603-878-1441

## WRITE FOR FREE BOOK CATALOG

Ham Radio's Bookstore  
Greenville, NH 03048



### R-7000 Widespan Panadaptor

Panadaptor especially designed for the R-7000 receiver. For use with a standard scope. Variable span width from 1 to 10 Mhz. Uncover unknown elusive signals. Complete with all cables, & 90 day warranty. \$349.95 Shipped. Pa. res. add 6%.

### GTI Electronics

RD 1 BOX 272  
Leighton, Pa. 18235  
717-386-4032

✓ 171

THE  
**ASOTRON**  
COMPACT ANTENNAS FROM 160-10 METERS

NO TUNERS!  
NO RADIALS!  
NO RESISTORS!  
NO COMPROMISE!

FOUR EXCELLENT REVIEWS JUST  
DON'T HAPPEN BY CHANCE.  
CALL US FOR A FREE CATALOGUE.

\*See review in Oct. 73, 1984 \*Sept. 73, 1985  
\*March 73, 1986 \*Dec. 88, CQ

### BILAL COMPANY

137 Manchester Dr.  
Florissant, Colo. 80816  
(719) 687-0650

✓ 172

# NEW PRODUCTS

(continued from page 84.)

If you own a video camera, you can set up an ATV station by adding a FSTV-430 transceiver and a 430-MHz antenna like AEA's 430-16. You only need a Technician or higher Amateur Radio license.

The FSTV-430 available from AEA authorized dealers. The suggested retail price is \$499.95.

For more information contact AEA, P.O. Box C-2160, Lynnwood, Washington 98036, telephone (206)775-7373.

Circle #309 on Reader Service Card.

## IC-901 Fiber Optic Multi-Band Transceiver

ICOM has introduced the IC-901 Fiber Optic Remote Mount Multi-Band Transceiver.

- ICOM's IC-901 comes standard as a dual band FM transceiver (2 meter and 440 MHz). Users can add band units to complete their system. The following band units from the IC-900 can be installed on the new IC-901:

UX-19A 10 meter 10 watt  
UX-39A 220 MHz 25 watt  
UX-59A 6 meter 10 watt  
UX-129A 1.2 GHz 10 watt

Other optional band units will include the UX-S92 144 MHz SSB Module that will allow for USB, LSB, and CW operation.

- The band units and interface box can be installed in a car trunk and the control head can be mounted on the dash via fiber optic cable. The control head can be installed directly to the interface box for a compact transceiver, or it can be connected to the interface box via the control cable.
- Other features include a multicolor LCD that displays squelch and volume settings and an HM14 touch tone microphone.
- The IC-901 also has DTMF ANI. The operator can set a code and give it out selectively. When the transceiver receives a signal preceded by this code, squelch will automatically open for the transmission — no other noise will be heard.

For more information, please contact ICOM at (206)454-8155 or write ICOM America, Inc., PO Box C-90029, 2380 116th Avenue NE, Bellevue, Washington, 98009-9029.

Circle #301 on Reader Service Card.

## Programmable Miniature Two-tone Sequential Encoder

Communications Specialists, Inc. offers a new PE-2P DIP switch programmable Two-tone Sequential Encoder. The PE-2P is designed to be mounted inside a radio or other housing, and lets you send a single two-tone sequential paging call. The PE-2P has standard 1 second—3 second timing. It's compatible with Communications Specialists SD-1000 Two-tone Decoder and other systems like the Motorola Quick-Call II, 1+1, and GE Type 99. The timing may be changed to match other two-tone formats.

Both tone A and tone B are DIP switch programmed from a 32 tone memory base that is specified when ordering. This allows over 1000 possible combinations from a single PE-2P. With some additional circuitry, the PE-2P may be wired to send multiple calls.

The PE-2P measures 1.25" x 2" x 0.4" to allow installation into most mobile radios and is powered by +10 to 16 volts DC. The selected call is activated by a momentary ground. A 150-mA output is provided to key PTT.

The PE-2P is priced at \$54.95. Communications Specialists' standard one year warranty applies.

For more information, contact: Communications Specialists, Inc. 426 West Taft Avenue, Orange, California 92665-4296. Telephone (800)854-0547 or (714)998-3021 (local). FAX (714)974-3420.

Circle #312 on Reader Service Card.

## Warranty Expansion to Cover Lightning Damage

Advanced Computer Controls, Inc. has expanded its two-year warranty for the RC-96 Repeater Controller to cover lightning damage.



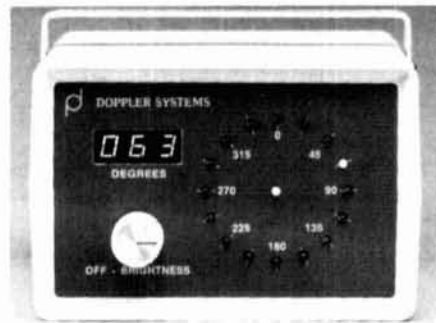
ACC manufactures microcomputer-based control systems for Amateur, commercial and government radio users. For additional information, contact Advanced Computer Controls, Inc., 2356 Walsh Avenue, Santa Clara, California 95051. Phone (408)727-3330.

Circle #311 on Reader Service Card.

## New Expanded Line of Radio Direction Finding Systems

Doppler Systems offers an expanded line of radio direction finding systems covering frequencies up to 1 GHz. The new 5000 series provides improved accuracy as well as a wider frequency range using a remote RF summing circuit. Typical accuracy is  $\pm 5$  degrees. A wide range of antennas is offered to cover frequencies between 108 and 1000 MHz.

There are four processor/display models. DDF5001 displays the bearing with 16 high intensity LEDs arranged in a circle. The DDF5002 has a three-digit display for 1 degree resolution. Models DDF5003 and 5004 provide an RS232 serial interface and synthesized speech. The RF summer DDF5050 is available in a variety of cable lengths for mast mounting. The mobile version is DDF5060.



Mast-mounted antennas include frame-mounted dipoles DDF5051 and 5052 for coverage of the 108 to 136-MHz and 136 to 180-MHz bands. Monopole antennas with groundplanes are used for 350 to 500 MHz (DDF5055) and 700 to 1000 MHz (DDF5057). Magnetic-mounted mobile antennas are also available. DDF5061 covers 108 to 136 MHz, and DDF5062 spans the 136 to 500-MHz range. Frequencies between 700 and 1000 MHz are covered with the DDF5067.

For further information, contact Doppler Systems Inc., PO Box 31819, Phoenix, Arizona 85046. Telephone (602)488-9755. FAX (602)488-1295.

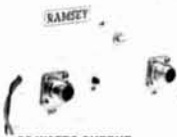
Circle #310 on Reader Service Card.

# ★ ALL NEW KITS ★

## 2 MTR & 220 BOOSTER AMP

Here's a great booster for any 2 meter or 220 MHz hand-held unit. These power boosters deliver over 30 watts of output allowing you to hit the repeaters full quieting while the low noise preamp remarkably improves reception. Ramsey Electronics has sold thousands of 2 mtr amp kits but now we offer completely wired and tested 2 mtr as well 220 MHz units. Both have all the features of the high priced boosters at a fraction of the cost.

**PA-10 2 MTR POWER BOOSTER** (10 X power gain)  
Fully wired & tested ..... \$69.95  
**PA-20 220 MHz POWER BOOSTER** (8 X power gain)  
Fully wired & tested ..... \$69.95



- 30 WATTS OUTPUT
- LOW NOISE PREAMP
- LOW COST
- RUGGED CAST ALUMINUM CASE
- ONE YEAR WARRANTY



## PERSONAL SPEED RADAR

Complete kit \$89.95  
New low cost microwave doppler radar kit. clocks cars, planes, boats, horses, bikers, baseballs, runners or virtually anything that moves. Operates at 2.4 GHz with over 1/4 mile range. LED digital readout displays speeds in miles per hour, kilometers per hour or feet per second. Earphone output permits listening to actual doppler shift (uses two 1 lb coffee cans for antenna not included and runs on 12 VDC). Easy to build - all microwave circuitry is PC striping. Kit includes deluxe ABS plastic case with speed graphics for a professional look. A very useful and full-of-fun kit.

## RADIOS

### 20, 40 & 80 METERS HAM RECEIVERS

Sensitive all mode AM CW SSB receivers for 3.5-4.0 or 70-75 MHz. Direct conversion design using NI 602 IC as featured in QST and ARRL handbooks. Less than 1 µV sensitivity varactor diode tuned. 50 mw audio output. Runs on 9VDC, has RF gain control. This kit is very easy to build. Lots of fun and educational - ideal for the beginner or the old pro. The optional matching case kit features a rugged ABS plastic case with screened graphics. Included are machined aluminum knobs for a well finished professional look.

20 MTR receiver kit HR-4 ..... \$24.95  
40 MTR receiver kit HR-6 ..... \$24.95  
80 MTR receiver kit HR-8 ..... \$24.95  
Receiver case CR-1 ..... \$12.95

### QRP TRANSMITTER KITS, 20, 40 & 80 METERS

Operate a min ham shack. These little QRP rigs are ideal mates to our 40 and 80 meter receivers. Features include smooth variable tuning, one watt output and excellent keying characteristics. Runs on 12 VDC and is VSWR protected. See how far you can stretch your signal with one of these min rigs. Optional ABS cases are available.

20 MTR QRP kit QRP-20 ..... \$29.95  
40 MTR QRP kit QRP-40 ..... \$29.95  
80 MTR QRP kit QRP-80 ..... \$29.95  
Case CRP ..... \$12.95

### AIRCRAFT RECEIVER KIT

Hear exciting aircraft communications - picks up planes up to 100 miles away. Receives 110-130 MHz AM air band. varactor tuned superhet design with AGC, ceramic filter and adjustable squelch. Runs on 9V battery. 50 mw audio output. 1 µV sensitivity. Optional matching ABS plastic case lets you take it anywhere. Features screened graphics and machined aluminum knobs for a real professional look. Compact - great for airshows or for just plain hanging around the airport.

Complete kit AR-1 ..... \$24.95  
Receiver case kit CAR-1 ..... \$12.95

### SHORTWAVE RECEIVER KIT

A fantastic receiver that captures the world with just a 12' antenna. Receives 4-11 MHz in 2 MHz bands. varactor tuned superhet design with AGC, RF gain control and 50 mw audio output. Uses new Synchroplex mixer chip for less than a microvolt sensitivity. Runs on 9V battery. This is a fascinating, exciting and fun project. And it will provide hours of fun even to the most seasoned DX'er. Add the optional case kit and you have a real nice looking shortwave set.

Complete kit SR-1 ..... \$24.95  
Receiver case kit CSR-1 ..... \$12.95

### PACKET RADIO

Communicate G4-128 packet radio interface. Uses famous German Digicom software. Features 2.8K Baud chip set for reliable operation - runs HF or VHF. Includes FREE disc software, PC board, all necessary parts and full documentation.

Complete kit PC-1 ..... \$49.95

### FM COMMUNICATIONS/ 2 MTR, 10 MTR & 220 RECEIVERS

Sensitive superhet FM receiver tunes any 5 MHz segment of band. Listen to ham operations, high band police calls, weather or mobile phone calls! Easy to build receiver features varactor tuning, IC mixer stage, ceramic IF filters and dual conversion design with adjustable squelch. Less than 1 µV sensitivity, runs on 9V battery, with 50 mw audio output. Optional ABS case with screened graphics and machined aluminum knobs provide a nice professional look.

2 MTR kit FR-10 ..... \$29.95  
10 MTR kit FR-10 ..... \$29.95  
220 MHz kit FR-10 ..... \$29.95  
Receiver case kit CFR-7 ..... \$12.95

## NEW MINIKITS—NEW MINIKITS

### BROADBAND PREAMP

A sensitive all purpose preamp ideal for scanners, TV sets, VHF, UHF rigs, counters, etc. Features low noise, 4 db, NF, 20 db gain, 100 KHz to 1 GHz operation. Runs on 9-12 VDC. 50 ohm input.

Complete kit SA-7 ..... \$14.95

### LIGHT BEAM COMMUNICATORS

Transmits modulated infrared light up to 30 feet without lenses, up to 1/4 mile using mirrors. Uses 30 KHz carrier for beam free operation. Transmits thru windows, etc. Ideal for bugs or listening to RR remote control transmitter has sensitive mike input, receiver uses PIN detector and drives speaker output. Limits operates on 9-12 VDC.

Transmitter kit LB-1 ..... \$8.95  
Receiver kit LB-1 ..... \$9.95

### HIGH POWER FM WIRELESS MIKE

A high power unit that will transmit up to 1/2 mile to any FM broadcast radio. Sensitive input accepts any type of mike, will pick up normal voices 10 feet away using the available mini-electric mike cartridge. Operates on 9-12 VDC.

FM 4 kit ..... \$12.95  
Sensitive microphone cartridge ..... \$2.95

# RAMSEY ELECTRONICS

Quality Test Gear & Electronic Kits for Professionals and Hobbyists



### PR-2 COUNTER PREAMP

The PR-2 is ideal for measuring weak signals from 10 to 1,000 MHz. Flat 20 db gain. BNC connectors. Great for snuffing RF. Ideal receiver TV preamp. 1.3 db NF.

\$49.95

wired includes AC adapter  
PR-2 kit \$39.95



### PS-2 AUDIO MULTIPLIER

The PS-2 is handy for high resolution audio resolution measurements. Multiplies up in frequency. Great for PL tone measurements. Multiplies by 10 or 100. 0.01 Hz resolution. Built-in signal preamp/conditioner.

\$69.95

wired PS-2 kit \$49.95



### PS-10B 1.5 GHz PRESCALER

Extends the range of your present counter to 1.5 GHz. 2 stage preamp. Divides by 1000 circuitry. Super sensitive (50 mV typical). BNC connectors. 1.5 GHz in 1.5 MHz out. Drives any counter.

\$89.95

wired includes AC adapter

## COM-3



**\$2795.00** THE COMMUNICATIONS SERVICE MONITOR THAT WORKS HARDER FOR LESS.

Introducing COM-3... the new service monitor designed by service technicians for service technicians. It works harder for less, giving you advanced testing capabilities at a very affordable price. FEATURES: Direct entry keyboard with programmable memory. Audio & transmitter frequency counter. LED bar graph frequency error deviation display. 0.1-10,000 µV output levels. High receive sensitivity. Less than 5 µV. 100 KHz to 999,999.5 MHz. Continuous frequency coverage. Transmits protection, up to 100 watts. CTS tone encoder. 1 KHz and external modulation.

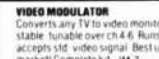
## MINI KITS—EASY TO ASSEMBLE—FUN TO USE



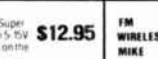
**TONE DECODER**  
A complete tone decoder on a single PC Board. Features: 400-5000 Hz adjustable range via 20 turn pot. touch tone regulation. 56T IC. Useful for four-tone burst detection. FSK, etc. Can also be used as a stable tone encoder. Runs on 5 to 12 volts.  
Complete kit TD-1 ..... \$5.95



**COLOR ORGAN**  
See music come alive! 3 different lights flicker with music. One light each for high, mid-range and low. Each individually adjustable and drives up to 300 W runs on 120VAC.  
ML-1 kit ..... \$8.95



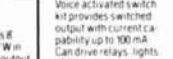
**VIDEO MODULATOR**  
Converts any TV to video monitor. Super stable, tunable over ch 4-6. Runs on 5-9V. accepts std. video signal. Best unit on the market! Complete kit JM-7 ..... \$12.95



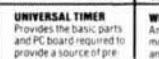
**FM WIRELESS MIKE**  
Transmits up to 300 yd. any FM broadcast radio uses any type of mike. Runs on 3 to 9V. Type FM 2 has added sensitive mike preamp stage.  
FM-1 kit ..... \$5.95  
FM-2 kit ..... \$7.95



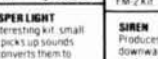
**40 WATT 2 mtr PWR AMP**  
Simple Class C power amp. Features 8 times power gain! 1 W in for 8.0 W out. For 15 out 5 W in for 40 W out. Max output of 50 W. Incredible value. Complete with all parts. Less case and 1 R relay.  
PA-1, 40 W pwr amp kit ..... \$27.95  
TR-1, RF shielded 1 R relay kit ..... 6.95



**VOICE ACTIVATED SWITCH**  
Voice activated switch kit provides switched output with current capability up to 100 mA. Can drive relays, lights, LED or even a tape recorder motor. Runs on 9VDC.  
VS-1 kit ..... \$6.95



**LED BLINKY KIT**  
Attractive flashes 2 jumbo LEDs. Use for name badges, buttons, warning panel lights. Runs on 3 to 5 volts.  
BL-1 kit ..... \$3.95



**MAD BLASTER**  
Produces LOUD ear-shattering and attention getting siren like sound. Can supply up to 15 watts of obnoxious audio! Runs on 6-15 VDC.  
MB-1 kit ..... \$4.95



**SIREN**  
Produces upward and downward wail. 5 W peak audio output. Runs on 3-5 volts. Uses 3.45 ohm speaker.  
Complete kit SM-3 ..... \$3.95



**SUPER SLEUTH**  
A super sensitive amplifier which will pick up a pen drop! 15 Volt Gain! for monitoring baby's room or as general purpose amplifier. Full 2 W rms output! runs on 6 to 15 volts, uses 8-45 ohm speaker.  
BN-9 kit ..... \$5.95



**TELEPHONE TRANSMITTER**  
Low cost with professional performance. Features include: self phone line powered, tuneable from 76 to 100 MHz. polarity insensitive (compact size), 1 x 1" easily installs anywhere on the phone line or inside the instrument itself.  
PB-1 kit ..... \$14.95  
TB-6 kit ..... \$5.50  
TB-6 Ass'y ..... \$9.95



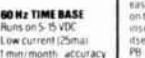
**FM RECEIVER**  
For built-in applications or hobby experiments. Full featured super-heterodyne receiver. microvolt sensitivity. 10.7 MHz IC. Integrated Circuit detector. 50 mw audio amplifier. 9V external power source, operation on standard FM broadcast band as well as large portions on each side. Compact 16 square for bug detection or reception.  
FR-1 kit ..... \$14.95



**FM MINI MIKE**  
A super high performance FM wireless mike kit. Transmits a stable signal up to 300 yards with exceptional audio quality by means of its built-in electrical mike. Kit includes case, mike, on-off switch, antenna battery and super instructions. This is the finest unit available.  
FM-3 kit ..... \$16.95  
FM-3 Wired and tested ..... 19.95



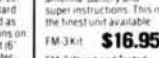
**SPEECH SCRAMBLER**  
Communicate in total privacy over your telephone or radio. This scrambler kit features full duplex operation, using frequency inversion. Runs on a 9-volt battery. Both mike and line or speaker output inputs. Easy to connect to any radio-telephone use requires no direct connection! Easy to build, uses IC, DDM circuitry. Can also be used to descramble most com. scramblers.  
Complete kit SS-7 ..... \$29.95  
Case kit CS-7 ..... 12.95



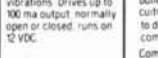
**90 HZ TIME BASE**  
Runs 5-15 VDC.  
Low current (20mA).  
1 min/month accuracy.  
TB-6 kit ..... \$5.50  
TB-6 Ass'y ..... \$9.95



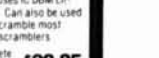
**CT-70 7 DIGIT 525 MHz**  
\$139.95  
WIRED INCLUDES AC ADAPTER



**CT-90 9 DIGIT 600 MHz**  
\$169.95  
WIRED INCLUDES AC ADAPTER



**CT-50 8 DIGIT 600 MHz**  
\$189.95  
WIRED INCLUDES AC ADAPTER



**CT-125 9 DIGIT 1.2 GHz**  
\$189.95  
WIRED INCLUDES AC ADAPTER

## FREQUENCY COUNTERS

Ramsey Electronics has been manufacturing electronic test gear for over 10 years and is recognized for its lab quality products at breakthrough prices. All of our counters carry a full one year warranty on parts and labor. We take great pride in being the largest manufacturer of low cost counters in the entire USA. Compare specifications. Our counters are full featured, from audio to UHF, with FET high impedance input, proper wave shaping circuitry and durable high quality epoxy glass, plated thru PCB board construction. All units are 100% manufactured in the USA.

### ACCESSORIES FOR COUNTERS

Telescopic whip antenna-BNC plug ..... \$ 8.95  
High impedance probe, light loading ..... 18.95  
Low pass probe, audio use ..... 18.95  
Direct probe, general purpose use ..... 13.95  
Trit ball for CT-70, 90 & 125 ..... 3.95  
Nicaid pack for CT-70, 90 & 125 ..... 8.95

MODEL	FREQ RANGE	SENSITIVITY	ACCURACY	DIGITS	RESOLUTION	PRICE
CT-70	20 Hz-550 MHz	< 50 mV to 150 MHz	1 PPM	7	1 Hz, 10 Hz, 100 Hz	139.95
CT-90	10 Hz-600 MHz	< 10mV to 150 MHz < 150mV to 600 MHz	1 PPM	9	0.1 Hz, 10 Hz, 100 Hz	169.95
CT-50	5 Hz-600 MHz	LESS THAN 25 mV	1 PPM	8	1 Hz, 10 Hz	189.95
CT-125	10 Hz-1.25 GHz	< 25mV @ 50 MHz < 50mV @ 500 MHz < 100mV @ 600 MHz	1 PPM	9	0.1 Hz, 1 Hz, 10 Hz	189.95
CT-90 WITH OPT-1	10 Hz-600 MHz	< 10mV to 150 MHz < 150mV to 600 MHz	0.1 PPM	9	0.1 Hz, 1 Hz, 10 Hz	229.95

TERMS: \* satisfaction guaranteed \* examine for 10 days, if not pleased, return in original form for refund + add 6% for shipping and insurance for a maximum of \$10.00 \* bargain add 15% for surface mail \* CDD add \$2.25 (CDD in USA only) \* orders under \$50.00 add \$1.50 \* NY residents add 7% sales tax \* 90 days parts warranty on all kits \* 1 year parts & labor warranty on all wired units.



**PHONE ORDERS CALL 716-924-4560**  
FAX 716-924-4555  
RAMSEY ELECTRONICS, INC. 793 Canning Parkway, Victor, NY 14564

# HAM MART

*Ham Radio's guide to help you find your local Amateur Radio Dealer*

## CALIFORNIA

A-TECH ELECTRONICS  
1033 Hollywood Way  
Burbank, CA 91505  
(818) 845-9203  
New Ham Store and Ready to Make a Deal!

JUN'S ELECTRONICS  
3919 Sepulveda Blvd.  
Culver City, CA 90230  
(213) 390-8003  
(800) 882-1343 Trades  
Habla Espanol

## COLORADO

ALLIED APPLIANCE & RADIO  
4253 South Broadway  
Englewood, CO 80110  
(303) 761-7305  
1 (800) 321-7305 (Orders only)  
Rocky Mts Amateur/Shortwave Specialists,  
Ten-Tec, Yaesu, JRC-NRD, Sony, MFJ,  
KLM, and other fine gear. New and used.  
Visa/MC. Antennas, books, discount prices  
too!

COLORADO COMM CENTER  
525 East 70th Ave.  
Suite One West  
Denver, CO 80229  
(303) 288-7373  
(800) 227-7373  
Stocking all major lines  
Kenwood Yaesu, Encomm, ICOM

## CONNECTICUT

HATRY ELECTRONICS  
500 Ledyard St. (South)  
Hartford, CT 06114  
(203) 527-1881  
Call today. Friendly one-stop shopping  
at prices you can afford.

## DELAWARE

AMATEUR & ADVANCED  
COMMUNICATIONS  
3208 Concord Pike  
Wilmington, DE 19803  
(302) 478-2757  
Delaware's Friendliest Ham Store.

DELAWARE AMATEUR SUPPLY  
71 Meadow Road  
New Castle, DE 19720  
(302) 328-7728  
(800) 441-7008  
Icom, Ten-Tec, Microlog, Yaesu, Kenwood,  
Santec, KDK, and more. One mile off I-95,  
no sales tax.

## FLORIDA

AMATEUR ELECTRONIC SUPPLY  
1898 Drew Street  
Clearwater, FL 33575  
(813) 461-4267  
Clearwater Branch  
West Coast's only full service  
Amateur Radio Store.  
Hours Mon.-Fri. 9-5:30, Sat. 9-3

AMATEUR ELECTRONIC SUPPLY  
621 Commonwealth Ave.  
Orlando, FL 32803  
(305) 894-3238  
Fla. Wats: 1 (800) 432-9424  
Outside Fla: 1 (800) 327-1917  
Hours Mon.-Fri. 9-5:30, Sat. 9-3

## HAWAII

HONOLULU ELECTRONICS  
819 Keeaumoku Street  
Honolulu, HI 96814  
(808) 949-5564  
Kenwood, ICOM, Yaesu, Hy-Gain, Cush-  
craft, AEA, KLM, Tri-Ex Towers, Fluke,  
Belden, Astron, etc.

## IDAHO

ROSS DISTRIBUTING COMPANY  
78 South State Street  
P.O. Box 234  
Preston, ID 83263  
(208) 852-0830  
Mon. 9-2; Tues.-Fri. 9-6; Sat. 9-2  
Stock All Major Brands  
Over 7000 Ham Related Items on Hand

## ILLINOIS

ERICKSON COMMUNICATIONS, INC.  
5456 N. Milwaukee Avenue  
Chicago, IL 60630  
(312) 631-5181  
Hours: Mon. - Fri. 9-5:30, Sat. 9-3

## INDIANA

THE HAM STATION  
220 N. Fulton Avenue  
Evansville, IN 47710  
(800) 523-7731  
(812) 422-0231  
ICOM, Yaesu, Ten-Tec, Cushcraft, Hy-Gain,  
AEA & others.

## MARYLAND

MARYLAND RADIO CENTER  
8576 Laureldale Drive  
Laurel, MD 20707  
(301) 725-1212  
(800) 447-7489  
Kenwood, ICOM, Ten-Tec, Kantronics. Full  
service dealer.  
Mon.-Fri. 10-8, Sat. 9-5

## MASSACHUSETTS

TEL-COM, INC.  
675 Great Road, Rte. 119  
Littleton, MA 01460  
(508) 486-3400  
(508) 486-3040  
The Ham Store of New England  
You Can Rely On.

## MISSOURI

MISSOURI RADIO CENTER  
102 NW Business Park Lane  
Kansas City, MO 64150  
(800) 821-7323  
Missouri: (816) 741-8118  
ICOM, Kenwood, Yaesu  
Same day service, low prices.

## NEVADA

AMATEUR ELECTRONIC SUPPLY  
1072 N. Rancho Drive  
Las Vegas, NV 89106  
(702) 647-3114  
Dale Porray "Squeak," AD7K  
Outside Nev: 1 (800) 634-6227  
Hours M-F 9-5:30, Sat. 9-3

## NEW HAMPSHIRE

RIVENDELL ELECTRONICS  
8 Londonderry Road  
Derry, N. H. 03038  
(603) 434-5371  
Hours Mon.-Sat. 10-5; Thurs. 10-7  
Closed Sun/Holidays

## NEW JERSEY

ABARIS SYSTEMS  
276 Oriental Place  
Lyndhurst, NJ 07071  
(201) 939-0015  
Don WB2GPU  
ARRL, Astatic, Astron, B&W, Belden,  
Bencher, Hustler, Kenwood, Larsen, RF  
Concepts, Tonna and much, much more!  
Tues.-Fri. 10AM-7:30PM  
Thurs. 10AM-9:00PM  
Sat. 10AM-4:00PM  
Visa/MC

KJI ELECTRONICS  
66 Skytop Road  
Cedar Grove, NJ 07009  
(201) 239-4389  
Gene K2KJI  
Maryann K2RVH  
Distributor of: KLM, Mirage, ICOM, Larsen,  
Lunar, Astron. Wholesale - retail.

# HAM MART

## NEW YORK

**BARRY ELECTRONICS**  
512 Broadway  
New York, NY 10012  
(212) 925-7000  
New York City's Largest Full Service Ham  
and Commercial Radio Store.

**VHF COMMUNICATIONS**  
280 Tiffany Avenue  
Jamestown, NY 14701  
(716) 664-6345  
Open 8:00 AM till 5:30 PM  
Evenings, Saturday and Sunday by appoint-  
ment. Western New York's finest Amateur  
dealer. Featuring ICOM "The World System."

## OHIO

**AMATEUR ELECTRONIC SUPPLY**  
28940 Euclid Avenue  
Wickliffe, OH 44092 (Cleveland Area)  
(216) 585-7388  
Ohio Wats: 1 (800) 362-0290  
Outside Ohio: 1 (800) 321-3594  
Hours Mon.-Fri. 9-5:30, Sat. 9-3

**DEBCO ELECTRONICS, INC.**  
3931 Edwards Road  
Cincinnati, OH 45209  
(513) 531-4499  
Mon.-Sat. 10AM-9PM, Sun. 12Noon-6PM  
We buy and sell all types of electronic parts.

**UNIVERSAL AMATEUR RADIO, INC.**  
1280 Aida Drive  
Reynoldsburg (Columbus), OH  
43068  
(614) 866-4267  
Featuring Kenwood, Yaesu, Icom,  
and other fine gear. Factory author-  
ized sales and service. Shortwave  
specialists. Near I-270 and airport.

## PENNSYLVANIA

**HAMTRONICS,**  
Div. of Trevoe Electronics  
4033 Brownsville Road  
Trevose, PA 19047  
(215) 357-1400  
Same Location for over 30 Years

## TEXAS

**K COMM dba THE HAM STORE**  
5707A Mobud  
San Antonio, TX 78238  
(512) 680-6110  
(800) 344-3144  
Stocking all major lines. San Antonio's Ham  
Store. Great Prices — Great Service. Factory  
authorized sales and service.  
Hours: Mon.-Fri. 10-6, Sat. 9-3

**MADISON ELECTRONICS SUPPLY**  
3621 Fannin  
Houston, TX 77004  
(713) 520-7300  
Christmas?? Now??

**MISSION COMMUNICATIONS**  
11903 Aleif Clodine  
Suite 500 (Corner Harwin & Kirkwood)  
Houston, Texas 77082  
(713) 879-7764  
Now in Southwest Houston—full line of  
equipment. All the essentials and extras for  
the "ham."

## WISCONSIN

**AMATEUR ELECTRONIC SUPPLY**  
4828 W. Fond du Lac Avenue  
Milwaukee, WI 53216  
(414) 442-4200  
Wisc. Wats: 1 (800) 242-5195  
Outside Wisc: 1 (800) 558-0411  
Mon.-Fri. 9-5:30, Sat. 9-3

### Dealers:

YOU SHOULD BE HERE TOO!  
Contact Ham Radio now for  
complete details.

## ANTENNA SOFTWARE New Releases

**MN 2.00** analyzes free-space antennas 2-3 times faster than before, with twice as many analysis segments available. New plotting features enhance pattern shape and detail. Better plot printouts. Analyze almost any antenna made of wire or tubing, in free space or over realistically-modeled earth. Compute forward gain, F/B, beamwidth, sidelobes, current, impedance, SWR, take-off angle, and patterns. Compute the interaction among several nearby antennas. MN includes libraries of antenna and plot files, a file editor, and extensive documentation. \$75.

**YO 2.00** features a powerful new gain-F/B-SWR tradeoff mechanism, optimization across a frequency band, control of all sidelobes, and full EGA color. Better designs, nicer plots. YO optimizes Yagi designs by automatically adjusting element lengths & spacings for maximum forward gain, maximum F/B, and minimum SWR. YO is extremely fast, and can compute several trial designs per second. YO includes models for gamma, T, hairpin, and beta matches, element tapering, mounting plates, and frequency scaling. A Yagi library, file editor, and extensive documentation are included. \$90.

Upgrade from previous versions for \$50 & \$60. Add 6% for California & foreign orders. For IBM-PC.

Send check or international money order to:  
Brian Beezley, G6ST1, 507-1/2 Taylor, Vista, CA 92084

## THE K1FO 16 ELEMENT 220 MHz YAGI

Model FO-16-220



**ELECTRICAL SPECIFICATIONS:**  
Measured gain 14 dBd  
E-Plane beamwidth 26 deg  
H-Plane beamwidth 32 deg  
Sidelobe attenuation  
1st E-Plane -18 dB  
1st H-Plane -16.5 dB  
SWR 1.12 (typical)  
F/B ratio 22.5 dB  
Impedance 50 ohm

**MECHANICAL SPECIFICATIONS:**  
Length 17ft 4in  
Boom 1.375" 6061 T-6 Aluminum  
Elements 3/16" Aluminum rod  
Wind survival 120+ MPH  
Mast up to 2" diameter  
Element Insulators Black Delrin  
Stainless Steel hardware  
(except U-bolts)  
Coax connector N type

### ALSO AVAILABLE

FO-12-144, FO-22-432, FO-25-432, FO-33-432, FO-11-440

POWER DIVIDERS STACKING FRAMES

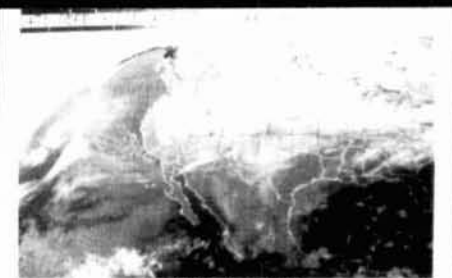
We supply those hard to find parts for the home builder  
3/16" Delrin insulators \$12/100. Stainless keepers \$10/100  
Add \$5 UPS SH for each antenna  
\$7 west of Mississippi  
PA residents add 6% state sales tax

## RUTLAND ARRAYS

1703 Warren Street • New Cumberland, PA 17070  
(717) 774-5298 7-10 P.M. EST

Dealer inquiries are invited

## PC HF FACSIMILE 4.0 \$99



Actual VGA Screen Photo

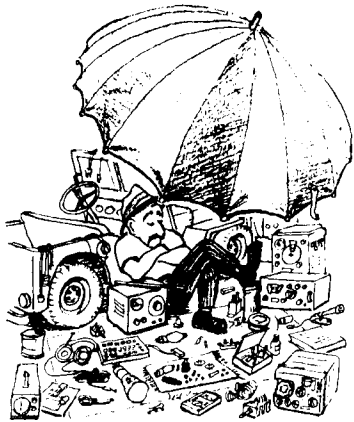
The best computer FAX system just got better!

A complete facsimile reception system for the IBM PC or Compatible. Receives up to 16 intensity levels.

**Includes:**  
Demodulator Software  
Frequency List  
80 Page Manual  
Tutorial Cassette  
Interpretation Guide

**Features:**  
Print on Epson, or HP Laser Jet  
Disk Save, Zooming, Image processing  
Unattended Image Capture and much more

**Software Systems Consulting**  
1303 S. Ola Vista, San Clemente, CA. 92672  
**(714)-498-5784**



# FLEA MARKET

**RATES** Noncommercial ads 10¢ per word; commercial ads 60¢ per word **both payable in advance**. No cash discounts or agency commissions allowed.

**HAMFESTS** Sponsored by non-profit organizations receive one free Flea Market ad (subject to our editing) on a space available basis only. Repeat insertions of hamfest ads pay the non-commercial rate.

**COPY** No special layout or arrangements available. Material should be typewritten or clearly printed (not all capitals) and must include full name and address. We reserve the right to reject unsuitable copy. **Ham Radio** cannot check each advertiser and thus cannot be held responsible for claims made. Liability for correctness of material limited to corrected ad in next available issue.

**DEADLINE** 15th of second preceding month.

**SEND MATERIAL TO:** Flea Market, Ham Radio, Greenville, N. H. 03048.

**BEGINNER'S RADIO CLEARINGHOUSE.** On a space available basis, we are going to offer you, OUR SUBSCRIBER, free of charge, a chance to find a home for your used equipment with a new Ham. Please send us a short description of what you want to sell along with price, name, address and phone number. We'll run it once in a special section of the classified ads under the heading of BEGINNER'S RADIO CLEARINGHOUSE. Please limit your ad to 20 words or less.

**CUSTOM MADE EMBROIDERED PATCHES.** Any size, shape, colors. Five patch minimum. Free sample, prices and ordering information. HEIN SPECIALTIES, Inc., 7960 SW Manitou Trail, Glen Arbor, MI 49636. (616) 334-4385.

**IBM-PC SOFTWARE FOR PK-232.** New CompRtty II is the complete RTTY/CW program for IBM-PC's and compatibles. Now with larger buffers, better support for packet units, pictures, much more. Virtually any speed ASCII, BAUDOT, CW. Text entry via built-in screen editor! Adjustable split screen display. Instant mode/speed change. Hardcopy, diskcopy, break-in buffer, select calling, text file transfer, customizable full screen logging, 24 programmable 1000 character messages. Ideal for MARS and traffic handling. Requires 256k PC or AT compatible, serial port, RS-232C TU. \$65. Send call letters (including MARS) with order. David A. Rice, KC2HO, 144 N. Putt Corners Rd, New Paltz, NY 12561.

**FOR SALE:** ICOM-781 transceiver, new, with warrantee. W2KQI, (914) 452-1130.

**WANTED:** CW, SSB, AM crystal filters for Heathkit SB300 series, Drake R4C, also SB series or R4C for parts. N5LB, 13 Traminer Drive, Kenner, LA 70065. (504) 466-9318.

**ENGINEERING/RADIO TECHNICIAN WANTED.** Responsible for design and construction of 220 MHz equipment for medical research. Please send resume to: Vicki Chestnut, NIM Inc, 3401 Market Street, #330, Philadelphia, PA 19104.

**COMPUTER SOFTWARE:** (IBM Shareware). Free Catalog. MCV/Visa accepted. Save on Software, Box 2637, Wilkes Barre, PA 18703.

**SHORTWAVE ENGINEER.** Immediate openings at WSHB, WCSN, and KYOI — international shortwave radio stations of The Christian Science Monitor. One site in South Carolina, one in Maine, one in Northern Mariana Islands of western Pacific. Engineer is primarily responsible for operating, maintaining, and repairing high power radio broadcast equipment. Current FCC, SBE, or NARTE certification and 5 years transmitter maintenance experience required. High power experience preferred. Salary and benefit package highly competitive. Please specify sites of interest. EOE. Send resume to: Human Resources Administrator, The Christian Science Monitor Syndicate, Inc., 1680 Soldiers Field Road, Boston, MA 02135. Fax: (617) 787-8853.

**ICOM, KENWOOD & YAesu OWNERS:** Informative separate Newsletters. 10th year. USA bulk (\$10.50) F.C. (\$12.50) Canada (\$13.00). Elsewhere (\$14.00 & \$18.00). Free catalog. Send 45-cent SASE. International Radio Computers, Inc., 751 South Macedo Blvd, Port St. Lucie, FL 34983. Tel (407) 873-6868.

**FREQUENCY METER/COUNTER.** 5Hz—100MHz. Data precision. Mint. \$135 ppd. Matt Garey, 24771 Kay Avenue, Hayward, CA 94545.

**COLLINS KWM/HF380** Repairs and discount accessories. Kirby, K7WOC (713) 320-2324.

**CCTV VIDEO CAMERAS:** Color Sanyo VCC3700 \$395.00, Panasonic B&W \$219.00, others. Digital Vision PC B&W Video Digitizer \$249.00, Color \$399.00. Sampson Engineering, PO Box 550363, Dallas, TX 75355-0363. (214) 328-2730.

**WANT TO KNOW** the latest FCC news, operating tips, tech talk, free ads? Get America's #1 club publication monthly, lowest dues figure in U.S. for 61 services and benefits. Join the Triple States Radio Amateur Club. Send \$3.50 for six months to: TSRAC, Box 240, RD 1, Dept HR, Adena, OH 43901.

**FLOOD YOUR MAILBOX!** You get 100's of radio & electronic & computer specialty catalogs. Send \$10 with your name & address to: Electronic List Service, PO Box 1683, Brookline, MA 02146.

**R-390A Parts List SASE.** CPRC-26 Infantry Manpack Radio, component, 6 meter FM, receiver/transmitter sections, case, antenna, crystal, handset: \$22.50/ piece complete; \$39.50/pair. Patrol Seismic Intrusion Device ("PSID") TRC-3: \$42.50/ piece, \$147.50/set of four. Military-spec TS-352 voltmeter/multimeter, leads, information: \$12.50. Add \$4.50/piece shipping, \$9 maximum. Baytronics, Box 591, Sandusky, OH 44870.

**HAM LICENSES SUPEREASY.** Cut studytime 50%. All classifications. Free catalog. SASE. Bahr, 1196-H1 Citrus, Palm-bay, FL 32905.

**HT-CLONE BATTERIES:** ICOM BP-3S double BP3 "Wall Chargeable" \$43.95, BP5 \$42.95, Yaesu FNB2 \$21.95, Sun-tek 142/442/1200 (3 pin) \$22.95 "Rebuilding: Send-U-Pack" ICOM BP3 \$20, BPS \$28, BP7/B8 \$34, BP70 \$30, Yaesu FNB4/4A \$37, Kenwood PB21 \$18, PB25/H/26 \$25, T-2 T991 \$28. "LI-DO-IT REPAIR INSERTS" ICOM BP2 \$18.95, BP3 \$16.95, BP5 \$22.95, BP7/BP8 \$28.95, Kenwood PB21 \$12.95, PB24/25/26 \$19.95, Azden COO \$19.95, Yaesu FNB4/4A \$32.95, Tempo S1, 2, 4, 5, 15/450 \$22.95, 12V/5Ahr PORTA-PAC w/hchr \$49.95. "ANTENNAS" 2mr 5/8-Tel/BNC \$14.95. "TELEPHONE / Pager & commercial packs" "FREE CATALOG" \$3 shipping/order. PA plus 6%. VISA/MC plus \$2. (814) 623-7000. CUNARD ASSOCIATES, Dept H, RD 6, Box 104, Bedford, PA 15522.

**LET THE GOVERNMENT FINANCE** your small business. Grants/loans to \$500,000 yearly. Free recorded message: 707-448-0270. (KH5).

**DIGITAL AUTOMATIC DISPLAYS.** Any Radio. Be specific. Large 45 cent SASE. GRAND SYSTEMS, POB 2171, Blaine, WA 98230.

**DIGITAL INDUCTANCE/CAPACITANCE** meter as featured in July 1988 Radio Electronics Magazine. Inductance from 0.01 uhy to 10 mhy, capacitance from 0.10 pf to 0.10 ufd. Automatic range, automatic zero, accuracy +1.3%. Assembled \$149.95, kit \$129.95 (digital frequency counter needed during calibration). Add \$5.00 shipping. SASE for detailed specification. Almost All Digital Electronics, 5211—117th Avenue SE, Bellevue, WA 98006.

**LASER COMPONENTS!** Surplus tubes, power supplies, optics. Build a working LASER for under \$75.00. Free plans with order. \$1.00 (refundable) brings list. FundServ, 1546D Peaceful Lane, Clearwater, FL 34616.

**AVANTEK ATF10135,** \$12.00, MIMIC's, P.C. board, SASE: WAS3IAC, 7148 Montague St, Philadelphia, PA 19135.

**WANTED:** URR 390/Alpha all band rec. Must be in good condition. Call W6BPV (408) 438-4467 collect.

**100 QSL CARDS \$8.** \$3 thereafter. Grid square printed free. Shipped postpaid. Guaranteed correct! Free samples. Shell Printing, K09KW, Box 50B, Rockton, IL 61072.

**"HAMLOG" COMPUTER PROGRAM.** Full features, 17 modules. Auto-logs, 7-band WAS/DXCC. Apple \$19.95. IBM, CP/M, KAYPRO, Tandy, C128 \$24.95. HR-KA1AWH, POB 2015, Peabody, MA 01960.

**REPEATER JAMMERS?** Pinpoint them with our "Hand-Finder" — attaches to HT. Kits: \$24.95, or less! Club project discounts! NOARD. 29460-H Lorain, Cleveland, OH 44370. (216) 777-9460.

**10 YEAR CLEANOUT SALE.** Shack overloaded. Must vacate 2000 cu/ft area of test equipment, microwave, radios, antiques, parts, variacs, temp. controls, very interesting collection. Send stamp for complete list. Joseph Cohen, WA1HDD, 200 Woodside, Winthrop, MA 02152. (617) 846-6312.

**FREE Ham Gospel Tracts.** SASE, Steve Forst, N3FTT, 5133 Gramercy, Clifton Heights, PA 19018.

**WANTED:** Ham equipment and other property. The Radio Club of Junior High School 22 NYC, Inc. is a nonprofit organization, granted 501(c)(3) status by the IRS, incorporated with the goal of using the theme of Ham Radio to further and enhance the education of young people nationwide. Your property donation or financial support would be greatly appreciated and acknowledged with a receipt for your tax deductible contribution. Meet us in person at the Lima, Ohio Hamfest, October 15 and learn all about the most exciting and beneficial application of Ham Radio today. Please write us at: PO Box 1052, New York, NY 10002. Round the clock hotline: (516) 674-4072. Thank you!

**YAGI BUILDERS.** 6061-T6 tube traps. Good for 1500 PEP. SASE for details. No collect calls. Brown Engineering, Inc, 5501 SW 25th Court, Hollywood, FL 33023. (305) 989-4658.

**AMIGA/COMMODORE CHIPS:** F. Agnus—\$61.50, Denise—\$56.95, Paula—\$56.95, 8520A1—\$17.95, 6526—\$12.95, 6567—\$17.95. PLA—\$12.95 and many others. Heavy duty power supply for C64 \$22.50. New, version II of the Commodore Diagnostian just out. Fantastic way to diagnose and fix all Commodore computers and 1541 drives. \$6.95 postpaid. Ask for our complete catalog on drums, diagnostics, and other exclusive products. Dealer pricing available, we ship worldwide. MCV/ISA. GRAPEVINE GROUP INC, 35 Charlotte Drive, Wesley Hills, NY 10977. 1-800-292-7445.

**INTERESTED IN PUBLIC SERVICE?** Join your local Radio Emergency Associated Communications Team. In Pennsylvania call 717-938-6943 or write REACT, 1160 Old Trail Rd, Eilers, PA 17319.

**WANTED:** All types of Electron Tubes. Call toll free 1-800-421-9397 or 1-612-429-9397. C & N Electronics, Harold Bramstedt, 6104 Egg Lake Road, Hugo, MN 55038.

**HANDICAPPED NOVICE** needs HF equipment donated—anything please. KA3OJUE, (412) 531-7443 anytime

**IMRA** International Mission Radio Association helps missionaries. Equipment loaned. Weekday net, 14.280 MHz, 1-3 PM Eastern. Nine hundred Amateurs in 40 countries. Rev. Thomas Sable, S. J., University of Scranton, Scranton, PA 18510.

**WANT:** 300T and 500T tubes. KF6WM, 45300 Royal, King City, CA 93930.

**INTERESTED IN QRP?** \$1 brings 8-page information brochure plus sample of The QRP Quarterly. Joe Sullivan, WA1WLU, 267 Sutton St, North Andover, MA 01845.

**ANALOG AND RF CONSULTING** for the San Francisco Bay area. Commercial and military circuits and systems. James Long, Ph.D., N6YB (408) 733-8329.

**SALE:** Ham Station Swan 350, power supply, mike, vert ant. 10-75m, ant. tuner \$350.00 Schelter, 3126 SE 26 Street, Okeechobee, FL 34974. (813) 467-2511.

**RTTY JOURNAL**—Now in our 36th year. Read about RTTY, AMTOR, PACKET, MOS'S, RTTY CONTESTING, RTTY DX and much more. Year's subscription to RTTY JOURNAL \$10.00, foreign slightly higher. Order from: RTTY JOURNAL, 9085 La Casita Ave., Fountain Valley, CA 92708.

**RUBBER STAMPS:** 3 lines \$5.00 PPD. Send check or MO to G. L. Pierce, 5521 Birkdale Way, San Diego, CA 92117. SASE brings information.

**ELECTRON TUBES:** Receiving, transmitting, microwave... all types available. Large stock. Next day delivery, most cases. DAILY ELECTRONICS, PO Box 5029, Compton, CA 90224. (213) 774-1255.

**RECONDITIONED TEST EQUIPMENT** \$1.25 for catalog. Walter, 2697 Nickel, San Pablo, CA 94806.

## COMING EVENTS

Activities — "Places to go . . ."

**SPECIAL REQUEST TO ALL AMATEUR RADIO PUBLICITY COORDINATORS:** PLEASE INDICATE IN YOUR ANNOUNCEMENTS WHETHER OR NOT YOUR HAMFEST LOCATION, CLASSES, EXAMS, MEETINGS, FLEA MARKETS, ETC. ARE WHEELCHAIR ACCESSIBLE. THIS INFORMATION WOULD BE GREATLY APPRECIATED BY OUR BROTHER/SISTER HAMS WITH LIMITED PHYSICAL ABILITY.

**NEW YORK:** October 1. Ham Fair sponsored by the Yonkers ARC, Yonkers Municipal Parking Garage, Corner Nepperhan and Main St. 9 AM to 3 PM. Buyers \$4 admission. Under 12 free. Auction 2 PM. Talk in 146.865/R, 440.150/R; 146.52. For information YARC, PO Box 378, Centuck Station, Yonkers, NY 10710. Phone (914) 963-1021.  
**WEST VIRGINIA:** October 7. The Tri-State ARA (TARA) Hamfest & Computer Fair, West Hall, Huntington Civic Center, Huntington, 9 AM to 4:30 PM. Admission \$5/door. Under 12 free. Talk in 146.167/79 W8VA. For further information write TARA, c/o Charley Shumaker, PO Box 4120, Huntington, WV 25729.

**PENNSYLVANIA:** October 7. 13th annual Mid-Atlantic VHF Conference, Warrington Motor Lodge, Rt 611, Warrington and the 18th annual Hamatama, Sunday, October 8, Bucks County Drive-In Theater, Rt 611, Warrington. Sponsored by the MI. Airy VHF ARC. Advance registration for conference and hamfest \$5, \$6/door. Send to Hamarama 89, PO Box 311, Southampton, PA 18966. Admission to flea market \$5; \$7 per carload. Gates open 6 AM. Rain or shine. Contact Pat Cawthorne. WB3DNI. (215) 672-5289.

**INDIANA:** October 8. Huntington Hamfest sponsored by the Huntington County ARS, P.A.L. Club, 2099 Riverside Drive, Huntington. 8 AM to 3 PM. Vendor setup 6 AM. Tickets \$3.50/advance; \$4/door. 8' table \$5. For tickets or tables Jim Covey, KC9GX, 1752 Kocher Street, Huntington, IN 46750.

**NEW JERSEY:** October 8. The Bergen Amateur Radio Association (B.A.R.A.) will sponsor its annual Fall Hamfest, rain or shine, Bergen Community College, 400 Paramus Rd, Paramus. 8 AM to 3 PM. Buyers free admission. Sellers \$5 per space. For additional information contact Jim Joyce, K2ZD, 286 Ridgewood Blvd, No. Westwood, NJ 07675. (201) 664-6725.

**OHIO:** October 8. The Northwest Ohio ARC will hold their annual Hamfest, Allen County Fairgrounds, Rt 309, E. Lima. Admission \$3.50/advance and \$4/door. All areas handi accessible.



**NEW YORK:** October 14. The Radio Amateurs of Greater Syracuse will hold their 34th Hamfest, New York State Fairgrounds, Rt 690. 9 AM to 5 PM. Admission \$4 prior to October 1: \$5/gate. 16 and under free. For information call Ed Swiatkowski, WA1URK (315) 487-3417 or Viv Douglas, WA2PUU (315) 469-0590.

**TENNESSEE:** October 14-15. Mem-Fest '89 sponsored by the Mid-South Area, Mid-South Fairgrounds, Memphis. Sat 9-5; Sun 9-2. Admission \$5/person; \$7/family. Flea Market info Clayton Elam, K4FZJ, 20 So. Cooper, Memphis, TN 38104. Exhibitors Nita Wofford, N4DON, 2966 Cordell, Memphis, TN 38118.

**FLORIDA:** October 14-15. Palm Beach County Hamfest sponsored by the Palm Beach Repeater Association, West Palm Beach Fairgrounds, 9 to 5 Sat. 9 to 3 Sunday. Tickets \$4/advance; \$5/door. For information write Hamfest, PO Box 461, Lake Worth, FL 33460.

**OHIO:** October 15. The Northwest Ohio ARC will hold their annual Hamfest, Allen County Fairgrounds, Rt 309, E. Lima. Admission \$3.50 advance; \$4/door. Talk in on 146.07/87, 147.63/03, 444.925, 449.925. All areas are handi accessible.

**MARYLAND:** October 15. The CARA Hamfest sponsored by the Columbia ARA, Howard County (MD) Fairgrounds. Doors open 8 AM. Admission \$4. Spouse and kids free. Free parking.

**NEW JERSEY:** October 15. Shore Area Ham Radio & Computer Fest sponsored by Garden State ARA, Jersey Shore ARC, Neptune ARC & Ocean-Monmouth ARC. Allaire Expo Center, Allaire Airport (formerly Monmouth County Airport) 8 AM to 3 PM. Admission \$4/advance; \$5/door. Children under 12 and XYL free. Talk in on 145.110-600. Contact Al Jackson, NK2O, PO Box 635, Eatontown, NJ 07724. (201) 922-8121.

**QUEENS, NEW YORK:** October 15 (rain date October 22). The Hall of Science ARC Hamfest, New York Hall of Science Parking Lot, Flushing Meadow Park, 47-01-111 Street, Queens. Doors open 9 AM. Buyers \$3. Sellers \$5/space. For information call evening events Greenbaum, WB2KDG (718) 898-5599 or Phil Kubert, N2HYE (212) 777-8648. For VE info contact Anne Fanelli, W1ZG (718) 847-0155.

**NORTH CAROLINA:** October 21. The Triangle Area Amateur Radio Association's First Hamfest, Smithfield Moose Lodge, I-95 and Hwy 70-A interchange. Admission \$4. For information SASE to PO Box 255, Smithfield, NC 27577 or call W2AC (919) 553-4309 days or KK4YP (919) 965-9577 evenings 5:30-9:30.

**TENNESSEE:** October 21. The ninth annual Tri-Cities Hamfest, sponsored by the Kingsport, Bristol and Johnson City Radio Clubs, Appalachian Fairgrounds, off I-81, Gray. Admission \$5. Large indoor/outdoor flea market. RV hookups. Mail inquiries to PO Box 3682 CRS, Johnson City, TN 37602.

**PENNSYLVANIA:** October 22. Tradefest '89 sponsored by the Penn Wireless Association, Yezzi Field, Rt 513, Bensalem, 7 AM to 2 PM. Rain or shine. Admission \$3 each or \$7/carload. Kids 12 and under free. For information contact Steve (215) 752-1202. For advance tickets send SASE with checks to PWA Tradefest '89, PO Box L-734, Langhorne, PA 19047.

**MICHIGAN:** October 22. 7th annual Kalamazoo Hamfest sponsored by the Southwest Michigan Amateur Radio Team and Kalamazoo ARC, Kalamazoo Central High School, 2431 N. Drake Rd. Sellers 6 AM. Doors open 8 AM. Admission \$3/door, \$2/advance. Talk in on 147.64/04 SMART repeater.

**TENNESSEE:** October 28-29. The 11th annual Hamfest Chattanooga Amateur Radio and Computer Convention, South Hall of the Chattanooga-Hamilton County Convention and Trade Center. For information write Hamfest Chattanooga, PO Box 3377, Chattanooga, TN 37404.

**MINNESOTA:** October 28. Hamfest Minnesota & Computer Expo, sponsored by the Twin Cities FM Club, Hennepin Technical College, 9000 Brooklyn Blvd, Brooklyn Park. 7:30 AM to 3 PM. Tickets \$4/advance, \$5/door. Talk in on 146.167.76. For information SASE to Hamfest Minnesota & Computer Expo, PO Box 5598, Hopkins, MN 55343. (612) 474-1529.

**OHIO:** October 29. The 15th annual Heart of Ohio Hamfest sponsored by the Marion ARC, Marion County Fairgrounds Coliseum. 8 AM to 3 PM. Tickets \$3/advance, \$4/door. Check in on 146.52 simplex or 147.90/30 repeater. For information, tickets or tables contact Ed Margraf, KD8OC, 1989 Weiss Avenue, Marion, OH 43302. (614) 382-2608.

**GEORGIA:** November 4-5. Ham Radio and Computer Expo '89 sponsored by the Alford Memorial Radio Club, Gwinnett County Fairground, Lawrenceville. W4BOC repeater 146.76, 444.250. For information Alford Memorial Radio Club, PO Box 1282, Stone Mountain, GA 30086.

**CONNECTICUT:** November 12. SCARA Indoor Ham Radio and Computer Flea Market, North Haven Park and Recreation Center, 7 Linsley Street, North Haven. Sellers admitted at 7 AM. Buyers 9 AM to 3 PM. Tables \$12/advance; \$15/door. General admission \$3 per person. Talk in on 146.01/61. Reservations for tables must be received with check by November 2, 1989 and no reservations by phone. For information or reservations SASE to: SCARA Flea Market, PO Box 81, North Haven, CT 06473 or call between 7 PM and 10 PM Brad at (203) 265-6478.

## OPERATING EVENTS

"Things to do . . ."

**October 7:** The Billy the Kid Chapter of Ten-Ten International will run special event station W5M5Q from the Whole Enchilada Fiesta in Las Cruces, NM. 1500 UTC to 2200 UTC. SSB, CW, VHF packet. Freq: 28.365 MHz. QSL plus \$1 to Billy the Kid Chapter of Ten-Ten International, PO Box 274, Fairacres, NM 88033 or call Joe Mayfield, KADYOS at (505) 523-8958 evenings.

**October 7-8.** Columbus, Ohio. The Columbus Amateur Radio Association will conduct the 6th annual Columbus Day Special Event in conjunction with the Columbus USA Festival which salutes the City of Columbus and the explorer, Christopher Columbus. Sugg. Freqs: 7.240, 14.340, 21.375, 28.500. Listen for WB10.

**MICHIGAN:** October 8. HamFair '89 sponsored by the Central Michigan ARC and Lansing CD Repeater Association, Lansing Civic Arena, 2 blocks SW of capitol building. 8 AM to 3 PM. Admission \$3.50. Talk in on 146.94. Contact Rowena Erod, KA8OBS, 111 Lancelot Place, Lansing, MI 48906. (517) 482-9650.

**October 8-14:** The Carroll County ARC will operate K3PZN to celebrate Fire Prevention Week in honor of the all-volunteer fire service in that county. Freq: 25-30 kHz from bottom of general phone bands 80-15 and Novice/Tech portion of 10 phone. For certificate send QSL card, contact number and SASE to the Carroll County ARC, PO Box 2099, Westminster, MD 21157.

**October 14:** The Elkhorn Valley ARC will operate special event station KE0JL from 1500Z to 0300Z to celebrate "Amateur Radio Sell Nebraska Day" by proclamation of Governor of Nebraska, Kay A. Orr. 10-80 and 6m. For a beautiful certificate send QSL and 9x12 SASE to Roy Barkhuff, KE0JL, 1701 Skyline Drive, Norfolk, NE 68701.

**October 14-15:** The South Texas Amateur Repeater Society (STARS) is sponsoring the commemorative station, N5CAF, to celebrate the Confederate Air Force's annual Air Show in Harlingen, Texas. Listen for operation from a B-29, B-17, B-25, P-51, P-40, etc. 1500Z to 0000Z on SSB 14260, 21360 and 28460. For a special photo QSL, send QSL and SASE to Dr. David Woolweaver, K5RAV, 2210 S. 77 Sunshine Strip, Harlingen, TX 78550.

**October 15:** The Kaw Valley ARC will operate W0CET from Kansas, The Land of OZ, 1400Z to 2300Z, to celebrate the 50th anniversary of the Movie, "The Wizard of Oz". Freq: General portion of 20 and 75m and Novice/Tech portion of 10m. For a special QSL send your QSL and SASE to KA6BNL, Sherry Langstron, 1919 Adams #62, Topeka, KS 66607.

**October 18:** The Providence Radio Association, W1OP, will celebrate its 70th anniversary with on-the-air activities through December. On Oct 18 from 0000-0400Z, W1OP will operate on 14.040 CW. For a certificate SASE to PRA, W1OP, 1 Ludlow St. Johnston, RI 02919.

**October 21:** The Laurel Maryland ARC will operate K3IOG from the US Department of Agriculture's Beltsville Agricultural Research Center, 1300-2100Z, to celebrate the many achievements of the Center in farm life and agricultural productivity. Freq: Phone 7.240, 14.240, 21.340, 28.340, 147.540. CW 14.055. For special photo certificate send QSL and No. 10 SASE to Laurel ARC, Box 3039, Laurel, MD 20708.

**October 27-Nov 3.** Special event station ON4CLM (Canadian Liberation Movement) will once again be on the air from the Cultural Center "Scharpoord" in Knokke, Belgium to commemorate the 1944 liberation of the town of Knokke by Canadian troops after a long and exhausting battle. For more information write: Radio ON4CLM, PO Box 110, 8300 Knokke, Belgium.

**YOUTH LINK NET.** Open to all Hams under age 18. Saturdays at 2000 UTC, 28.425 MHz. For more information contact Net Control, George Manning, WB5NMH, 602 Glendale St. Burkburnett, TX 76354.

**FREE 1989-90 Florida** two meter repeater directories are currently being distributed by the Hernando County Amateur Radio Assn. of Brooksville, FL. Ask for one at any official Florida Welcome Center or SASE to Repeater Directory, Hernando County ARA, POB 1721, Brooksville, FL 34605-1721.

**LICENSE EXAMS:** Middlesex Amateur Radio Society (MARS) has scheduled the following exams: October 10 and December 12: United Methodist Church, 381 Main Street, Portland, CT. 6:45 to 9 PM. November 18—Portland Public Library, 20 Freestone Avenue, Portland, CT. 1 to 5 PM. To pre-register call Ed Kerns, KN9Y (203) 342-3400. Walkins allowed. The Middlesex ARS meets every Tuesday evening at 7 PM at the United Methodist Church. All are welcome.

**LAUREL ARC** monthly (except December) Amateur exam sessions for all license classes. No fee is charged. Pre-registration is required. Call (301) 725-1212, Maryland Radio Center, 8576 Laureldale Drive, Laurel, MD 20707.

**NORTH COAST ARC 1989 LICENSE EXAMS.** 12:30 PM, Saturdays October 14, December 9. N. Olmsted Community Cabin, S of Lorain on W. Park. Novice thru Extra. Walkins allowed. Talk in 145.29 repeater. For information Dan Sarama, KB8A, 15591 Rademaker Blvd, Brookpark, Ohio 44142. 267-5083 or Pauline Wells, KA8FOE, Rick Wells, K8SCI, 777-9460/779-8999.

**AMATEUR RADIO CLASSES:** For those people interested in obtaining a Novice (basic level) Ham license or upgrading to Tech/General, the Chelsea Civil Defense, in cooperation with QRA Radio Club, will sponsor Amateur Radio Communications classes evenings at Chelsea High School starting MARCH 7, 1989. For more information write Frank Masucci, K1BPN, 136 Grove Street, Chelsea, MA 02150. Please enclose your telephone number.

**THE MIT UHF REPEATER ASSOCIATION** and the MIT Radio Society offer monthly HAM EXAMS. All classes Novice to Extra. Wednesday, OCTOBER 18, 7 PM, MIT Room 1-150, 77 Mass Avenue, Cambridge, MA. Reservations requested 2 days in advance. Contact Ron Hoffmann at (617) 484-2098. Exam fee \$4.50. Bring a copy of your current license (if any), two forms of picture ID, and a completed form 610 available from the FCC in Quincy, MA (617) 770-4023.

# MADISON SHOPPER

**CALL FOR ORDERS**  
**1 (800) 231-3057**  
**1 (713) 520-7300 OR 1 (713) 520-0550**  
**TEXAS ORDERS CALL COLLECT**  
**FAX 1 (713) 771-7759**  
**ALL ITEMS ARE GUARANTEED OR**  
**SALES PRICE REFUNDED**



New Icom IC 781  
Kenwood TH215A, TH25AT  
TS440 S/AT

Trades wanted  
Trade in your old HT  
Call



Kenwood TS 140S  
New Kenwood TM 721A, mobile  
ICOM 228H/T1TM

Call for trade  
Call  
449.00



TS 790A Superior 2 Meter 70 cm Rig, 1.2 GHz Option Available	Call
Icom 765	2695.00
Kenwood MC-60A + Heil HC-5 cartridge inst.	150.00
Icom IC 725	799.00
NYE MB5A Tuner	569.00
Alpha Delta Transitrapp HV	33.00
CSI Private Patch V	489.00
Armedco PT 3 Pre Amp	99.00
Larsen 2 meter on glass	49.95
Anteco 2M 5/8" Mag Mount, Comp	25.00
Van Gordon Window WA2	44.00
Bird 43 elements/stock	Call
Thousands of panel meters	3.95 up CALL
Beiden 9913, 8267, 8214 Stock	Call
MICA Capacitors	Call
Ampire VHF, UHF GaAsFET preamps	Call
831SP-PL259 Silverplate (Amphenol)	1.50
82-61 N Male (Amphenol)	3.50
82-202 1006 N Male (9913)	3.50
Double Female UHF	1.00
UG176 RGBX	each 40
Surplus Elbow PL259-SO239	each \$1
Receiving tubes 50-90% off list price	Call
STUPH	
RF Amp Meters	\$15 to \$30 each
25 pf/10KV Doorknob Cap	5.00
Throat Mike (new mil. surplus)	5.00
ANBH-1 600 Ohm Headphones (new mil. surplus)	5.00
New Demo Units for Sale	
Kenwood R-5000	849.00

### USED EQUIPMENT

All equipment, used, clean, with 90 day warranty and 30 day trial. Six months full trade against new equipment. Sale price refunded if not satisfied.

(800) 231-3057

### POLICIES

Minimum order \$10.00. Mastercard, VISA, or C O D. All prices FOB Houston, except as noted. Prices subject to change without notice. Items subject to prior sale. Call anytime to check the status of your order. Texas residents add sales tax. All items full factory warranty plus Madison warranty.

**Bird and Beiden products in stock. Call today.**

# MADISON

## Electronics Supply

3621 FANNIN  
HOUSTON, TEXAS 77004



# DX Forecaster

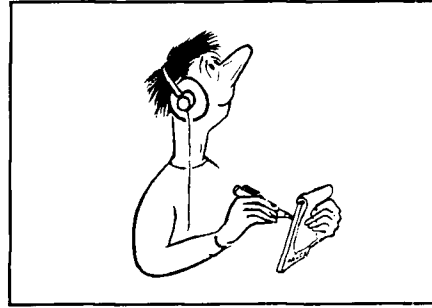
Garth Stonehocker, KØRYW

## MORE ON EQUINOX PROPAGATION

Last month's discussion of equinoctial propagation, changing daylight conditions, and solar initiated events is also pertinent to October because the equinox occurs late in September. The spring of 1989 gave us an example of events during a typical equinox (though actually they may have been worse than usual). This month I'd like to consider these geophysical events and their signal strengths and midlatitude day and night ionospheric usable frequency changes affecting propagation.

The small geomagnetic disturbances on March 3rd and 5th decreased the daytime ionospheric density vertical reflections by 11 and 18 percent, respectively. They decreased by twice that at night. The big solar flare on the 10th at 1922 UTC induced a sudden ionospheric disturbance (SID) which had maximum D region signal absorption affecting propagating signals at the equator below the central United States (Denver), and then had stronger signals east to 30 degrees and west to Samoa. During the flare (related to flux burst and shape intensity), the amount of signal loss and its length (maximum of several hours) depend on frequency! The polar cap signal absorption (PCA) started soon after, affecting polar path signals during daylight hours for three days. Meanwhile, the geomagnetic disturbance started on the 12th. The disturbance increased the midlatitude ionosphere by 15 percent initially, then decreased it on the 13th by 65 percent. The ionosphere recovered to median values by the 17th. Signals were gone completely on most midlatitude and higher paths for most of the 14th, and then very QSB while recovering.

The next large flare on the 23rd at 1959 caused a large, but not as lengthy, SID in the same area as the one on the 10th. The PCA lasted 12 hours on polar paths. The geomag-



netic disturbance began on the 27th at 1342 UTC, decreasing the ionospheric density 19 percent. The disturbance continued until April 5th and kept the ionosphere down from 14 to 47 percent, the latter percentage occurring on March 31st.

In April, the first large solar flare and its accompanying flux burst took place on the 9th at 0105 UTC. A large SID, which lasted over an hour with its maximum D region signal absorption (sub solar point), was on the equator above New Zealand. It covered the region from India to Denver with signals of increasing strength in directions away from the subsolar point. No geomagnetic-ionospheric disturbances of importance resulted from this flare. The next flare was on April 23rd at 2155 UTC. No SID was reported, even though this was an x-ray flare of over an hour's duration. Its maximum effect should have been on the equator south of Hawaii, extending across the United States to the east and Australia to the west. A geomagnetically disturbed ionosphere started on the 25th at 1859 UTC with a drop in electron density of 25 percent which decreased the next day, but continued off and on until the 29th around 1000 UTC. This is representative of a "typical" propagation summary through a spring equinox season near sunspot cycle maximum.

### Last-minute forecast

The first two weeks of the month are expected to have a high solar flux producing increased MUFs. However, these MUFs should be above our 10-meter band. The hours of openings should be longer, but the signal strengths will fall on the 10 to 30-meter


bands. Look for good transequatorial openings to be more plentiful in the late evenings. In particular, look for enhancement around the 4th, 12th, and 21st because of a higher probability of geomagnetic-ionospheric disturbance. The lower bands, usually better for night-time DX, should be good the 2nd and 3rd weeks of the month. During the disturbed periods, look for unusual DX locations to be heard in the weak and fluttery signals to the east and west.

The Orionids meteor shower will be visible from the 15th to 24th of October, with a maximum rate of between 10 and 20 per hour on the 20th to 21st of the month. The moon is full on the 14th, and perigee occurs on the 15th.

### Band-by-band summary

Ten, 12, 15, 17, and 20 meters will be open from morning to early evening almost every day to most areas of the world. The openings on the higher of these bands will be shorter and occur closer to local noon. Transequatorial propagation on these bands will most likely occur toward evening during conditions of higher solar flux and a disturbed geomagnetic field.

Thirty and 40 meters will be poor during the day. Nighttime DX will be good, except after days of high MUF conditions and geomagnetic disturbances. Look for DX from unusual places on eastern, northern, and western paths during this time. The usable distance is expected to be somewhat less than that on 20 meters in daytime and greater than that on 80 meters at night.

Eighty and 160 meters will be opening for DX at dusk. These bands follow the darkness path, opening to the east just before your sunset, swinging more to the south near midnight, and ending up in the Pacific areas during the hour or so before dawn. The 160-meter band opens later and ends earlier than 80. 

### REFERENCES

1. Bill Orr, W6SAJ, "Ham Radio Techniques: Have You Met SID?" *Ham Radio Magazine*, page 31.

**WESTERN USA**

GMT	PDT	Directional Indicators							
		N	NE	E	SE	S	SW	W	NW
0000	5:00	12	30	12	10	10	10	10	10
0100	6:00	12	30	15	10	10	10	10	12
0200	7:00	15	30	15	10	10	10	10	12
0300	8:00	17	30	17	10	10	10	10	15
0400	9:00	20	30	30	12	10	10	10	20
0500	10:00	20	30	17	12	10	10	10	20
0600	11:00	30	30	17	15	12	12	12	20
0700	12:00	30	30	17	15	15	12	12	30
0800	1:00	30	30	17	15	17	15	15	30
0900	2:00	30	30	30	17	17	15	15	30
1000	3:00	30	30	30	17	17	15	15	30
1100	4:00	30	30	30	17	20	17	15	30
1200	5:00	30	20	10	17	20	17	17	30
1300	6:00	30	15	10	10	20	17	17	30
1400	7:00	20	15	10	10	15	17	17	30
1500	8:00	30	12	10	10	10	17	17	30
1600	9:00	30	12	10	10	10	17	12	30
1700	10:00	30	15	10	10	10	12	12	30
1800	11:00	30	15	10	10	10	12	15	30
1900	12:00	30	17	10	10	10	10	12	17
2000	1:00	30	20	10	10	10	10	12	12
2100	2:00	30	20	10	10	10	10	10	12
2200	3:00	30	30	10	10	10	10	10	10
2300	4:00	17	30	10	10	10	10	10	10

**OCTOBER**

**MID USA**

GMT	MDT	Directional Indicators							
		N	NE	E	SE	S	SW	W	NW
0000	6:00	12	30	12	10	10	10	10	12
0100	7:00	15	30	15	10	10	10	10	15
0200	8:00	17	30	15	10	10	10	10	15
0300	9:00	20	30	15	10	10	10	10	20
0400	10:00	20	30	17	12	10	12	12	20
0500	11:00	30	30	30	12	12	12	12	20
0600	12:00	30	30	30	15	15	15	15	30
0700	1:00	30	30	30	15	15	15	15	30
0800	2:00	30	30	30	17	17	17	15	30
0900	3:00	30	30	20	17	17	17	17	30
1000	4:00	30	20	17	17	20	17	17	30
1100	5:00	30	17	15	15	20	17	17	30
1200	6:00	20	15	10	12	20	17	17	30
1300	7:00	30	15	10	10	15	17	17	30
1400	8:00	30	12	10	10	12	15	17	30
1500	9:00	30	12	10	10	10	12	12	30
1600	10:00	30	12	10	10	10	17	15	30
1700	11:00	30	15	10	10	10	12	17	30
1800	12:00	30	15	10	10	10	12	12	17
1900	1:00	30	17	10	10	10	10	12	15
2000	2:00	30	20	10	10	10	10	12	12
2100	3:00	30	20	10	10	10	10	10	12
2200	4:00	30	30	10	10	10	10	10	12
2300	5:00	17	30	10	10	10	10	10	10

**EASTERN USA**

GMT	EDT	Directional Indicators							
		N	NE	E	SE	S	SW	W	NW
0000	8:00	30	30	12	10	10	10	10	20
0100	9:00	30	30	15	10	10	10	12	20
0200	10:00	30	30	15	10	10	10	12	20
0300	11:00	30	30	15	12	10	15	15	30
0400	12:00	30	30	20	12	12	15	15	30
0500	1:00	30	30	17	15	15	15	15	30
0600	2:00	30	30	17	15	15	17	17	30
0700	3:00	30	30	17	15	17	17	17	30
0800	4:00	30	30	17	17	20	17	17	30
0900	5:00	30	17	15	17	20	17	17	30
1000	6:00	17	15	10	12	17	17	17	30
1100	7:00	15	15	10	10	15	15	12	30
1200	8:00	12	15	10	10	15	15	12	30
1300	9:00	17	12	10	10	12	15	12	30
1400	10:00	20	12	10	10	10	15	15	30
1500	11:00	20	12	10	10	10	17	15	30
1600	12:00	30	12	10	10	10	12	15	30
1700	1:00	30	15	10	10	10	12	17	30
1800	2:00	30	15	10	10	10	10	12	30
1900	3:00	30	17	10	10	10	10	12	20
2000	4:00	30	20	10	10	10	10	10	15
2100	5:00	30	30	10	10	10	10	10	12
2200	6:00	30	30	10	10	10	10	10	12
2300	7:00	30	30	12	10	10	10	10	12



**ORDER  
TOLL-FREE  
1-800-821-7323**

**Dependable Service  
At The Right Price . . . Everytime**

MasterCard—VISA—Discover

# Missouri Radio Center

**KENWOOD**



**TS-940 "DX-CELLENCE"**

- All Band, All Mode Transceiver
- Direct Keyboard Entry
- Engineered for the DX-Minded and Contesting Ham
- Its Got It All!

**YAESU**



**FT-767GX**

HF/VHF/UHF  
BASE STATION

- Add Optional 6m, 2m & 70cm Modules
- Dual VFO's
- Full CW Break-in
- Lots More Features

**ICOM** **NEW!**



**IC-765** NEW HF TRANSCEIVER

- Built-in Automatic Antenna Tuner and Power Supply
- 99 Memories • 100 W Output
- 160-10M/General Coverage Receiver
- Band Stacking Registers

**uniden**



**HR-2600**

- Mobile 10 Meter Transceiver
- SSB/AM/FM/CW
- 25 Watts PEP
- New FM Offsets & PL

**KENWOOD**



**TS-140S** AFFORDABLE DX-ing!

- HF Transceiver With General Coverage Receiver
- All HF Amateur Bands
- 100 W Output
- Compact, Lots of Features

**YAESU**



**FT-736R** VHF-UHF BASE STATION

- SSB, CW, FM on 2 Meters and 70 cm
- Optional 50 MHz, 220 MHz or 1.2 GHz
- 25 Watts Output on 2 Meters, 220 and 70 cm
- 10 Watts Output on 6 Meters and 1.2 GHz • 100 Memories

**ICOM** **NEW!**



**IC-725** NEW ULTRA-COMPACT HF TRANSCEIVER

- USB/LSB/CW, AM Receive
- Optional Module for AM Transmit and FM TX/RX
- 160-10M Operation • 100 W Output
- Receive 30 kHz to 33 MHz
- 26 Memories with Band Stacking Registers

**ASA** **CP-100**



Complete Terminal Unit for Morse, Baudot, ASCII, AMTOR

**NOW 1/2 PRICE  
CLOSEOUT SPECIAL  
ONLY \$169. DELIVERED**

Software Available  
Call Now—Don't Delay

**KENWOOD**



**TM-231A**

2 METER FM MOBILE

- 50 Watts Output
- 20 Multi-Function Memories
- Selectable CTCSS Tone Built-in
- Operate 4 Mobile Rigs with Optional IF-20 Interface and RC-20 Controller

**Kantronics**



**KT-Series Mono-Band Radios**

10-15-20-30-40-80M MODELS

**SAVE BIG \$\$**

Best Price and Complete Selection  
Call Today!

**ICOM**

**IC-2GAT  
IC-4GAT**

2 Meter & 440  
Handhelds

- IC-2GAT  
RX 138-174 MHz  
TX 140-150 MHz  
7 Watts
- IC-4GAT  
440-450 MHz  
6 Watts



**ASTRON**



- RS7A . . . \$51 • RS35M . . . \$167
- RS12A . . . \$75 • VS35M . . . \$179
- RS20A . . . \$92 • RS50A . . . \$209
- RS20M . . . \$112 • RM50M . . . \$235
- VS20M . . . \$129 • RM50M . . . \$259
- RS35A . . . \$149 • VS50M . . . \$245

**KENWOOD**

**SALE!** **TH-25AT**  
POCKET-SIZED  
AND POWERFUL



- Frequency Coverage: 141-163 MHz (Rx), 144-148 MHz (Tx)
- Front Panel DTMF Pad
- 5 Watts Output
- 14 Memories
- TH-45AT Available for 440 MHz

**ALINCO**  
**SUPER SALE**

**ALD-24T**  
2m/70cm  
Dual Band  
Mobile



**\$449.00** Delivered  
25W, 21 Memories, Dual VFO's  
At an Unbeatable Price!

**ICOM**

**IC-32AT**  
SUPER DUALBAND  
FM HANDHELD

- 5 Watts on Both Bands
- Receive 138-174 MHz  
440-450 MHz
- Stores Standard and Odd Offsets



**MFJ SALE MFJ**

LARGEST STOCK OF ALL  
YOUR MFJ FAVORITE  
ACCESSORIES  
CALL TODAY FOR  
BEST PRICE



Extra Savings on the **MFJ-1278**  
Multi-Mode Data Controller

102 N.W. Business Park Lane Kansas City, MO 64150  
Send SASE For Used List

Call Toll Free—9am - 6pm Mon.-Fri. 9am - 2pm Sat.  
In Missouri Call—816-741-8118

**MOST ORDERS SHIPPED SAME DAY**

• DAIWA • HUSTLER

HYGAIN • ICOM •

KANTRONICS • KENWOOD • MFJ • LARSEN • MIRROR/KLM • NYE VIKING • RF CONCEPTS • UNIDEN • YAESU

# OPTOELECTRONICS



## You Have Counted on Us for 15 Years

You have counted on OPTOELECTRONICS Hand Held Frequency Counters to be the best quality, to be affordable and reliable. We have been there for you with Frequency Counters that are compact and ultra sensitive.

And more and more of you are counting on us, technicians, engineers, law enforcement officers, private investigators, two-way radio operators, scanner hobbyists, and amateur radio operators, just to name a few.

### Hand Held Series Frequency Counters and Instruments

MODEL	2210	1300H/A	2400H	CCA	CCB
<b>RANGE: FROM TO</b>	10 Hz 2.2 GHz	1 MHz 1.3 GHz	10 MHz 2.4 GHz	10 MHz 550 MHz	10 MHz 1.8 GHz
<b>APPLICATIONS</b>	General Purpose Audio-Microwave	RF	Microwave	Security	Security
<b>PRICE</b>	\$219	\$169	\$189	\$299	\$99
<b>SENSITIVITY</b>					
1 KHz	< 5 mv	NA	NA	NA	NA
100 MHz	< 3 mv	< 1 mv	< 3 mv	< .5 mv	< 5 mv
450 MHz	< 3 mv	< 5 mv	< 3 mv	< 1 mv	< 5 mv
850 MHz	< 3 mv	< 20 mv	< 5 mv	NA	< 5 mv
1.3 GHz	< 7 mv	< 100 mv	< 7 mv	NA	< 10 mv
2.2 GHz	< 30 mv	NA	< 30 mv	NA	< 30 mv

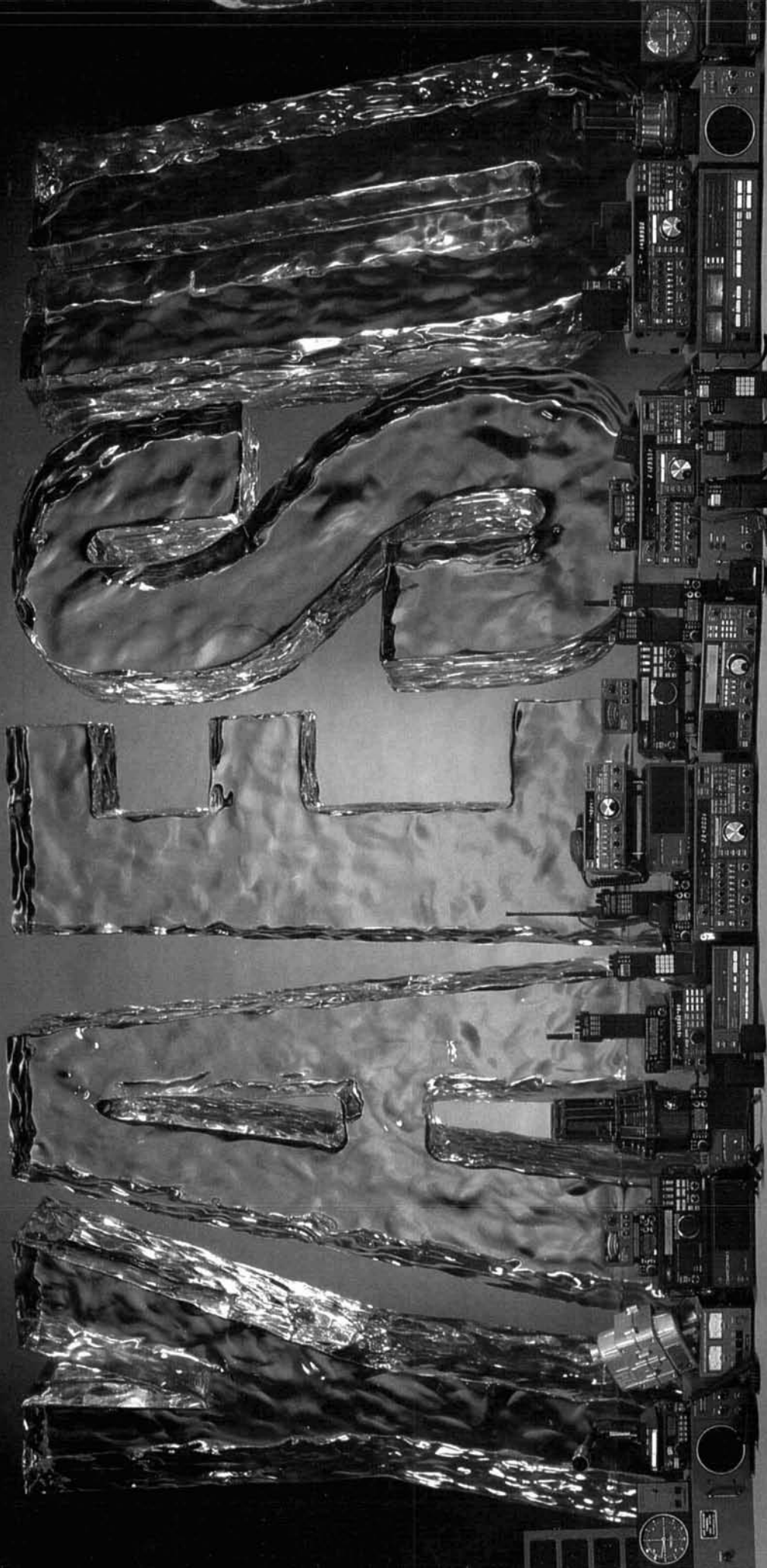
ACCURACY ALL HAVE +/- 1 PPM TCXO TIME BASE.

All counters have 8 digit red .28" LED displays. Aluminum cabinet is 3.9" H x 3.5" x 1". Internal Ni-Cad batteries provide 2-5 hour portable operation with continuous operation from AC line charger/power supply supplied. Model CCB uses a 9 volt alkaline battery. One year parts and labor guarantee. A full line of probes, antennas, and accessories is available. Orders to U.S. and Canada add 5% to total (\$2 min, \$10 max). Florida residents, add 6% sales tax. COD fee \$3. Foreign orders add 15%. MasterCard and VISA accepted.

Orders to U.S. and Canada add 5% to total (\$2 min, \$10 max). Florida residents, add 6% sales tax. COD fee \$3. Foreign orders add 15%. MasterCard and VISA accepted.

### OPTOELECTRONICS INC.

5821 N.E. 14th Avenue • Fort Lauderdale, Florida 33334  
1-800-327-5912 FL (305) 771-2050 FAX (305) 771-2052



\* For More Information, call 1 800-999-2070

# KENWOOD

...pacesetter in Amateur Radio

All-mode  
tri-bander!

## Warp Drive!



## TS-790A Satellite Transceiver

The new Kenwood TS-790A VHF/UHF all-mode tri-band transceiver is designed for the VHF/UHF and satellite "power user." The new TS-790A is an all-mode 144/450/1200 MHz transceiver with many special enhancements such as automatic uplink/downlink tracking. Other features include dual receive, automatic mode selection, automatic repeater offset selection for FM repeater use, VFO or quick step channel tuning, direct keyboard frequency entry, 59 memory channels (10 channels for separate receive and transmit frequency storage), multiple scanning and multiple scan stop modes. The Automatic Lock Tuning (ALT) on 1200 MHz eliminates frequency drift. Power output is 45 watts on 144 MHz, 40 watts on 450 MHz, and 10 watts on 1200 MHz. (The 1200 MHz section is an optional module.)

- High stability VFO. The dual digital VFOs feature rock-stable TCXO (temperature compensated crystal oscillator) circuitry, with frequency stability of  $\pm 3$  ppm.
- Operates on 13.8 VDC. Perfect for mountain-top DXpeditions!
- The mode switches confirm USB, LSB, CW, or FM selection with Morse Code.
- Dual Watch allows reception of two bands at the same time.
- Automatic mode and automatic repeater offset selection.
- Direct keyboard frequency entry.
- 59 multi-function memory channels. Store frequency, mode, tone information, offset, and quick step function. Ten memory channels for "odd split".
- CTCSS encoder built-in. Optional TSU-5 enables sub-tone decode.
- Memory scroll function. This feature allows you to check memory contents without changing the VFO frequency.
- Multiple scanning functions. Memory channel lock-out is also provided.
- ALT—Automatic Lock Tuning—on 1200 MHz eliminates drift!
- 500 Hz CW filter built-in.
- Packet radio connector.
- Interference reduction controls: 10 dB RF attenuator on 2m, noise blanker, IF shift, selectable AGC, all mode squelch.
- Other useful controls: RF power output control, speech processor, dual muting, frequency lock switch, RIT.
- Voice synthesizer option.
- Computer control option.

**Optional Accessories:**  
• PS-31 Power supply • SP-31 External speaker  
• UT-10 1200 MHz module • VS-2 Voice synthesizer unit  
• TSU-5 Programmable CTCSS decoder  
• IF-232C Computer interface • MC-60A/MC-80/MC-85 Desk mics • HS-5/HS-6 Headphones  
• MC-43S Hand mic • PG-2S Extra DC cable

## KENWOOD

KENWOOD U.S.A. CORPORATION  
COMMUNICATIONS & TEST EQUIPMENT GROUP  
P.O. BOX 22745, 2201 E. Dominguez Street  
Long Beach, CA 90801-5745  
KENWOOD ELECTRONICS CANADA INC.  
P.O. BOX 1075, 959 Gana Court  
Mississauga, Ontario, Canada L4T 4C2

Complete service manuals are available for all Kenwood transceivers and most accessories. Specifications, features, and prices are subject to change without notice or obligation.

