

JULY 1988 / \$2.50

ham radio • July 1988

# ham radio

magazine



**hr**  
focus  
on  
communications  
technology

annual VHF/UHF issue

Hand built PA CX



# HOW DO YOU PACK 7 WATTS, 20 MEMORIES AND SCANNING INTO A HANDHELD?

**IC-2GAT: 7 Watts** Rx 138-174MHz, Tx 140-150MHz

**IC-4GAT: 6 Watts** 440-450MHz

**IC-32AT: 5 Watts** Rx 138-174MHz/440-450MHz,  
Tx 140-150MHz/440-450MHz

**A New Generation of Powerful, Versatile Handhelds.**

*Select a new "G Series" or dual band ICOM transceiver and enjoy full base station luxury in a portable unit designed especially for you!*

- **Maximum Frequency Coverage.** The IC-2GAT receives 138-174MHz, including NOAA, and transmits 140-150MHz to include CAP and MARS frequencies. The IC-4GAT operates 440-450MHz, and the IC-32AT receives 138-174MHz and operates 140-150MHz/440-450MHz.
- **Most Powerful Handheld!** The IC-2GAT delivers seven watts! The IC-4GAT is six watts and the IC-32AT is five watts! One watt level selectable for local QSO's.
- **20 Memories.** Store any frequency, Tx offset and subaudible tone in any memory. Total flexibility!
- **Programmable Scanning** of band and memories plus easy lockout and instant memory recall.
- **Additional Features.** Battery saver, call channel, all subaudible tones, multi-function LCD readout and DTMF pad.
- **Compatible Accessories.** All ICOM IC-2AT/02AT series battery packs, headsets and speaker mics are interchangeable.
- **Optional UT-40 Beeper** silently monitors a busy channel for your calls. When the pre-programmed subaudible tone is received, the unit beeps and the LCD flashes.



**IC-32AT**  
2 Meters and  
440MHz

**IC-2GAT**  
2 Meters

**IC-4GAT**  
440MHz



**First in Communications**

ICOM America, Inc., 2380-116th Ave. N.E., Bellevue, WA 98004  
**Customer Service Hotline (206) 454-7619**  
 3150 Premier Drive, Suite 126, Irving, TX 75063  
 1777 Phoenix Parkway, Suite 201, Atlanta, GA 30349  
 ICOM CANADA, A Division of ICOM America, Inc., 3071 - #5 Road, Unit 9,  
 Richmond, B.C. V6X 2T4 Canada  
All stated specifications are subject to change without notice or obligation. All ICOM radios significantly exceed FCC regulations limiting spurious emissions. 1H4488

# THE ALL NEW PRIVATE PATCH IV BY CSI HAS MORE COMMUNICATIONS POWER THAN EVER BEFORE

- Initiate phone calls from your HT or mobile
- Receive incoming phone calls

NEW!

- Telephone initiated control . . .

- ✓ Operate your base station with complete control from any telephone
- ✓ Change frequencies from the controlling telephone
- ✓ Selectively call mobiles using regenerated DTMF from any telephone
- ✓ Eavesdrop the channel from any telephone
- ✓ Use as a wire remote using ordinary dial up lines and a speaker phone as a control head.

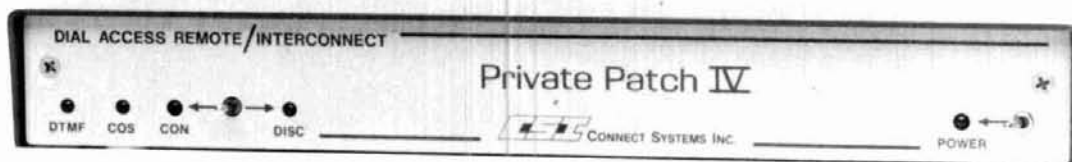

The new telephone initiated control capabilities are awesome. Imagine having full use and full control of your base station radio operating straight simplex or through any repeater *from any telephone!* From your desk at the office, from a pay phone, from a hotel room, etc. You can even change the operating channel from the touchpad!

Our digital VOX processor flips your conversation back and forth fully automatically. There are no buttons to press as in phone remote devices. And you are in full control 100% of the time!

The new digital dialtone detector will automatically disconnect Private Patch IV if you forget to send # (to remotely disconnect) before hanging up. This powerful feature will prevent embarrassing lock-ups.

The importance of telephone initiated control for emergency or disaster communications cannot be overstated. Private Patch IV gives you full use of the radio system from any telephone. And of course you have full use of the telephone system from any mobile or HT!

To get the complete story on the powerful new Private Patch IV contact your dealer or CSI to receive your free four page brochure.

Private Patch IV will be your most important investment in communications.

✓ = NEW FEATURE

- ✓ \* /# or multi-digit connect/disconnect
- ✓ Fully regenerated tone dialing
- Pulse dialing
- Toll protection
- Secret toll override code
- Busy signal disconnect
- ✓ Dialtone disconnect
- CW identification
- Activity timer
- Timeout timer
- ✓ Telephone initiated control
- ✓ Regenerated DTMF selective calling
- Ringout
- ✓ Ringout or Auto Answer on 1-8 rings
- Busy channel ringout inhibit
- ✓ Status messages
- ✓ Internally squelched audio
- MOV lightning protection
- ✓ Front panel status led's
- ✓ Separate CW ID level control
- ✓ 24 dip switches make all features user programmable/selectable.

- Connects to MIC and ext. speaker jack on *any* radio. Or connect internally if desired.
- Can be connected to any HT. (Even those with a two wire interface.)
- Can be operated simplex, through a repeater from a base station or connected directly to a repeater for semi-duplex operation.
- 20 minutes typical connect time
- Made in U.S.A.

## OPTIONS

1. ½ second electronic voice delay
2. FCC registered coupler
3. CW ID chip



**CONNECT SYSTEMS INC.**  
23731 Madison St.  
Torrance CA 90505  
Phone: (213) 373-6803

**AMATEUR ELECTRONIC SUPPLY**  
Milwaukee WI, Wickliffe OH,  
Orlando FL, Clearwater FL,  
Las Vegas NV  
**BARRY ELECTRONICS CORP.**  
New York NY  
**EGE, Inc.**  
Woodbridge VA  
**ERICKSON COMMUNICATIONS**  
Chicago IL  
**HAM RADIO OUTLET**  
Anaheim CA, Burlingame CA,  
Oakland CA, Phoenix AZ,  
San Diego CA, Van Nuys CA,  
Atlanta GA

**HENRY RADIO**  
Los Angeles CA  
**INTERNATIONAL RADIO SYSTEMS**  
Miami FL  
**JUNS ELECTRONICS**  
Culver City CA  
**MADISON ELECTRONICS SUPPLY**  
Houston TX  
**MIAMI RADIO CENTER CORP.**  
Miami FL  
**MIKES ELECTRONICS**  
Ft. Lauderdale, Miami FL  
**N&G DISTRIBUTING CORP.**  
Miami FL

**OMNI ELECTRONICS**  
Laredo TX  
**PACE ENGINEERING**  
Tucson AZ  
**THE HAM STATION**  
Evansville IN  
**WESTCOM**  
San Marcos CA  
**CANADA:**  
**CARTEL ELECTRONIC**  
**DISTRIBUTORS**  
Surrey B.C.  
**COM-WEST RADIO SYSTEMS, LTD.**  
Vancouver B.C.

# KENWOOD

...pacesetter in Amateur Radio

THE FIRST  
144/220 MHz  
Dual Bander!

## Double Take!



ACTUAL SIZE FRONT PANEL

### TM-621A/721A 144/220 and 144/450 MHz FM Dual Banders

Once again, Kenwood brings you another Dual Bander First! The **TM-621A** is the first 144/220 MHz FM Dual Bander. The **Kenwood TM-621A** and **TM-721A** (144/450 MHz) re-defines the original Kenwood "Dual Bander" concept. The wide range of innovative features includes a dual channel watch function, selectable full duplex operation, 30 memory channels, extended frequency coverage, large multi-color dual digital LCD displays, programmable scanning, and more!

- Extended receiver range (138,000-173,995 MHz) on 2 m; 70 cm coverage is 438,000-449,995 MHz; 1-1/4 m coverage is 215-229,995 MHz. (Specifications guaranteed on Amateur bands only. Two meter transmit range is 144-148 MHz. Modifiable for MARS/CAP. Permits required.)
- Separate frequency display for "main" and "sub-band"
- Call channel function. A special memory channel for each band stores frequency, offset, and sub-tone of your favorite channel. Simply press the CALL key, and your favorite channel is selected!

- 30 multi-function memory channels. 14 memory channels and one call channel for each band store frequency, repeater offset, CTCSS, and reverse. Channels "A" and "b" establish upper and lower limits for programmable band scan. Channels "C" and "d" store transmit and receive frequencies independently for "odd splits".
- 45 Watts on 2 m, 35 watts on 70 cm. 25 watts on 1-1/4 m. Approx. 5 watts low power.
- Automatic Band Change (A.B.C.) Automatically changes between main and sub-band when a signal is present.
- Dual watch function allows VHF and UHF receive simultaneously.
- Programmable memory and band scanning, with memory channel lock-out and priority watch function.
- Balance control and separate squelch controls for each band.

- Dual antenna ports.
- TM-621A has auto offset.
- Full duplex operation.
- CTCSS encode/decode selectable from front panel or UP/DWN keys on microphone. (Encode built-in, optional TSU-6 needed for decode.)
- Each function key has a unique tone for positive feedback.
- Illuminated front panel controls and keys.
- 16 key DTMF mic. included.
- Handset/remotè control option (RC-10).
- Frequency (dial) lock.
- Supplied accessories: 16-key DTMF hand mic., mounting bracket, DC cable.

Complete service manuals are available for all Kenwood transceivers and most accessories. Specifications, features and prices are subject to change without notice or obligation



TM-721A shown with optional RC-10

#### Optional Accessories:

- **RC-10** Multi-function handset/remotè controller • **PS-430** Power supply • **TSU-6** CTCSS decode unit • **SW-100B** Compact SWR/power/volt meter • **SW-200B** Deluxe SWR/power meter • **SWT-1** 2 m antenna tuner • **SWT-2** 70 cm antenna tuner • **SP-40** Compact mobile speaker • **SP-50B** Deluxe

- mobile speaker • **PG-2N** DC cable • **PG-3B** DC line noise filter • **MC-60A, MC-80, MC-85** Base station mics. • **MA-4000** Dual band 2 m/70 cm mobile antenna (mount not supplied) • **MB-11** Mobile bracket • **MC-43S** UP/DWN hand mic. • **MC-48B** 16-key DTMF hand mic.

## KENWOOD

KENWOOD U.S.A. CORPORATION  
2201 E. Dominguez St., Long Beach, CA 90810  
P.O. Box 22745, Long Beach, CA 90801-5745



# ham radio

magazine

**JULY 1988**

**volume 21, number 7**

**T. H. Tenney, Jr., W1NLB**  
publisher  
and editor-in-chief

Terry Northup  
managing editor

Marty Durham, NB1H  
technical editor

Robert D. Wilson, WA1TKH  
consulting editor

Tom McMullen, W1SL  
Joseph J. Schroeder, W9JUV  
Alfred Wilson, W6NIF  
associate editors

Susan Shorrock  
production editor

Peggy Tenney, KA1QDG  
copy editor

Beth McCormack  
editorial assistant

#### editorial review board

Peter Bertini, K1ZJH  
Forrest Gehlke, K2BT  
Michael Gruchalla, P. E.  
Bob Lewis, W2EBS  
Mason Logan, K4MT  
Vern Riportella, WA2LQQ  
Ed Wetheroid, W3NQN

#### publishing staff

**J. Craig Clark, Jr., N1ACH**  
assistant publisher

Rally Dennis, KA1JWF  
director of advertising sales

Henry S. Gallup, KA1RYG  
advertising sales manager

Dorothy Sargent, KA1ZK  
advertising production manager

Susan Shorrock  
circulation manager

Therese Bourgault  
circulation

Phil Alix, KA1IDP  
traffic manager

Hans Evers, PA0CX  
cover

ham radio magazine is published monthly by  
Communications Technology, Inc.  
Greenville, New Hampshire 03048-0498  
Telephone: 603 878-1441

#### subscription rates

United States:  
one year, \$22.95, two years, \$38.95, three years, \$49.95  
Europe (via KLM air mail), \$40.00  
Canada, Japan, South Africa and other countries (via surface mail),  
one year, \$31.00, two years, \$55.00, three years, \$74.00

All subscription orders payable in U.S. funds, via international  
postal money order or check drawn on U.S. bank

#### international subscription agents: page 89

Microfilm copies are available from  
University Microfilms, International  
Ann Arbor, Michigan 48106  
Order publication number 3076

Cassette tapes of selected articles from ham radio  
are available to the blind and physically handicapped  
from Recorded Periodicals,  
919 Walnut Street, Philadelphia, Pennsylvania 19107

Copyright 1988 by Communications Technology, Inc.  
Title registered at U.S. Patent Office

Second class postage paid  
at Greenville, New Hampshire 03048-0498  
and at additional mailing offices  
ISSN 0148-5989

Send change of address to ham radio  
Greenville, New Hampshire 03048-0498



## contents

### 10 sporadic E and 50-MHz transatlantic propagation during 1987

Geoffrey H. Grayer, G3NAQ

### 38 VHF/UHF world: propagation update — part 3

Joe Reisert, W1JR

### 56 cheap and dirty 6-meter beam

Glen E. Zook, W5UOJ

### 60 ham radio techniques: line voltage and power tube life

Bill Orr, W6SAI

### 64 2-meter monitor

Rodney A. Kreuter, WA3ENK

### 72 practically speaking: non-ideal linear IC amplifiers typical problems and how to solve them

Joe Carr, K4IPV

### 78 a simple low-cost comb generator frequency calibrator

Larry Martin

### 90 Elmer's notebook: ten-meter skyware

Tom McMullen, W1SL

The Quad Antenna: part 3 by W4MB will appear  
in our August issue.

98 advertisers index

9 comments

83 DX forecaster

96 flea market

88 ham mart

71 new products

98 reader service

4 reflections

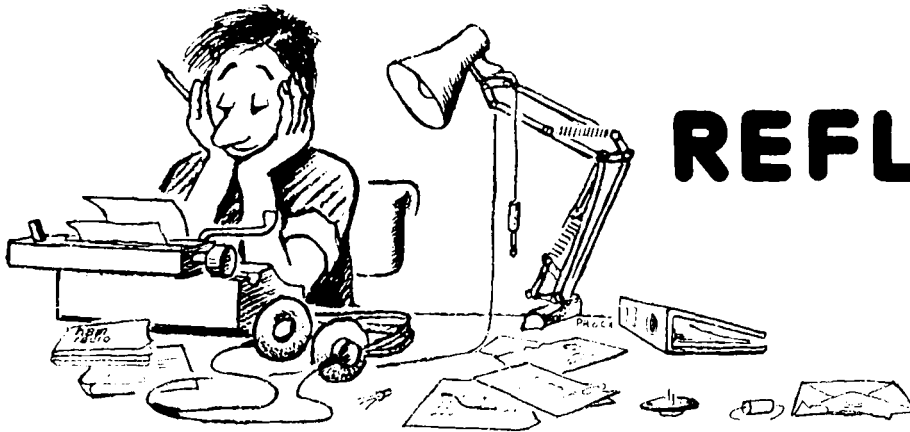

# REFLECTIONS

**No doubt about it folks** — we've got a mess on our hands.

Recent events in the repeater coordination area would lead a casual observer to believe that chaos is but one small step away. While it may be stretching a point, the reality may not be too far from chaos.

In several regions of the United States, groups who are dissatisfied with current coordinators have formed coordinating bodies of their own. The goals of these new groups may be either well placed or highly questionable, but the confusion they are creating is threatening irreparable harm to the hobby.

Because the events leading up to this situation have already been well reported, I won't go into specifics. I will say, however, that blame needs to be assigned to many. Some would call for the FCC to step in and solve the problem once and for all; in this era of government de-regulation it isn't going to happen. The FCC has neither the budget nor the manpower to step in. Anyway, remember what happened in the '70s when the FCC clamped down on repeaters with all kinds of new regulations and rules. Not too many of us were happy with that situation.

Who else could step in and help solve the problem? The ARRL.

After extensive discussion and planning, Steve Mendelson, WA2DHF, ARRL Hudson Division Director, made a suggestion to the FCC at the Dayton Hamvention FCC Forum that makes the most sense I've heard in a long time. Simply put, this suggestion is for the ARRL to conduct a national referendum of repeater trustees to ascertain which coordination group they support. The referendum results would then be certified to the FCC as a clear mandate of who the preferred regional coordinator is for the majority of repeater trustees. The FCC would then "certify" that group as the sole regional authority for frequency coordination.

I have talked to Mendelson at length and feel that his suggestion has tremendous merit. Mendelson has years of experience in the field of repeaters. He is an ex-president of the New York City Area Coordinating Group and has been actively involved in FM communications for many years.

There are a couple of hurdles that need to be cleared before this plan can be implemented. First, the plan is not a League plan — it is Mendelson's and needs to be proposed to the Board of Directors for their approval at the July Board meeting. Second, the proposal needs to be endorsed by the FCC. Without FCC approval, little will be done to solve the problem. In fact, because of the feelings of some of the participants in this struggle, it could further inflame the situation to the point of complete spectrum anarchy.

If ever there was a reasonable and intelligent suggestion to solve a very serious problem, this is it! I urge you to contact your League Director today and discuss this proposal with him. Notes to ARRL President Larry Price and Dave Sumner wouldn't hurt either. There are currently no alternative ideas; Mendelson's plan is well thought out and offers a good chance to solve the problem before it reaches crisis proportions.

Hopefully, the Board of Directors will agree. We can't afford to wait much longer.

**Craig Clark, N1ACH**  
Assistant Publisher

# KENWOOD

...pacesetter in Amateur Radio

All New  
Compact HF!

## “DX-citing!”

### TS-440S Compact high performance HF transceiver with general coverage receiver

**Kenwood's advanced digital know-how brings Amateurs world-wide "big-rig" performance in a compact package. We call it "Digital DX-citement"—that special feeling you get every time you turn the power on!**

• **Covers All Amateur bands**

General coverage receiver tunes from 100 kHz—30 MHz. Easily modified for HF MARS operation.

• **Direct keyboard entry of frequency**

All modes built-in USB, LSB, CW, AM, FM, and AFSK. Mode selection is verified in Morse Code.

• **Built-in automatic antenna tuner (optional)**

Covers 80-10 meters.

• **VS-1 voice synthesizer (optional)**

• **Superior receiver dynamic range**

Kenwood DynaMix™ high sensitivity direct mixing system ensures true 102 dB receiver dynamic range. (500Hz bandwidth on 20m)

• **100% duty cycle transmitter**

Super efficient cooling permits continuous key-down for periods exceeding one hour. RF input power is rated at 200 W PEP on SSB, 200 W DC on CW, AFSK, FM, and 110 W DC AM. (The PS-50 power supply is needed for continuous duty.)

• **Adjustable dial torque**

• **100 memory channels**

Frequency and mode may be stored in 10 groups of 10 channels each. Split frequencies may be stored in 10 channels for repeater operation.

• **TU-8 CTCSS unit (optional)**

• **Superb interference reduction**

IF shift, tuneable notch filter, noise blanker, all-mode squelch, RF attenuator, RIT/XIT, and optional filters fight QRM.

• **MC-43S UP/DOWN mic. included**

• **Computer interface port**

• **5 IF filter functions**

• **Dual SSB IF filtering**

A built-in SSB filter is standard. When an optional SSB filter (YK-88S or YK-88SN) is installed, **dual** filtering is provided.

• **VOX, full or semi break-in CW**

• **AMTOR compatible**



**Optional accessories:**

- AT-440 internal auto. antenna tuner (80 m—10 m)
- AT-250 external auto. tuner (160 m—10 m)
- AT-130 compact mobile antenna tuner (160 m—10 m)
- IF-232C/IC-10 level translator and modem IC kit
- PS-50 heavy duty power supply
- PS-430/PS-30 DC power supply
- SP-430 external speaker
- MB-430 mobile mounting bracket
- YK-88C/88CN 500 Hz/270 Hz CW filters
- YK-88S/88SN 2.4 kHz/1.8 kHz SSB filters
- MC-60A/80/85 desk microphones
- MC-55 (8P) mobile microphone
- HS-5/6/7 headphones
- SP-40/50B mobile speakers
- MA-5/VP-1 HF 5 band mobile helical antenna and bumper mount
- TL-922A 2 kw PEP linear amplifier
- SM-220 station monitor
- VS-1 voice synthesizer
- SW-100A/200A/2000 SWR/power meters
- TU-8 CTCSS tone unit
- PG-2S extra DC cable.

**Kenwood takes you from HF to OSCAR!**



Complete service manuals are available for all Kenwood transceivers and most accessories. Specifications and prices are subject to change without notice or obligation.

# KENWOOD

KENWOOD U.S.A. CORPORATION  
2201 E. Dominguez St., Long Beach, CA 90810  
P.O. Box 22745, Long Beach, CA 90801-5745



# Join the fun at th

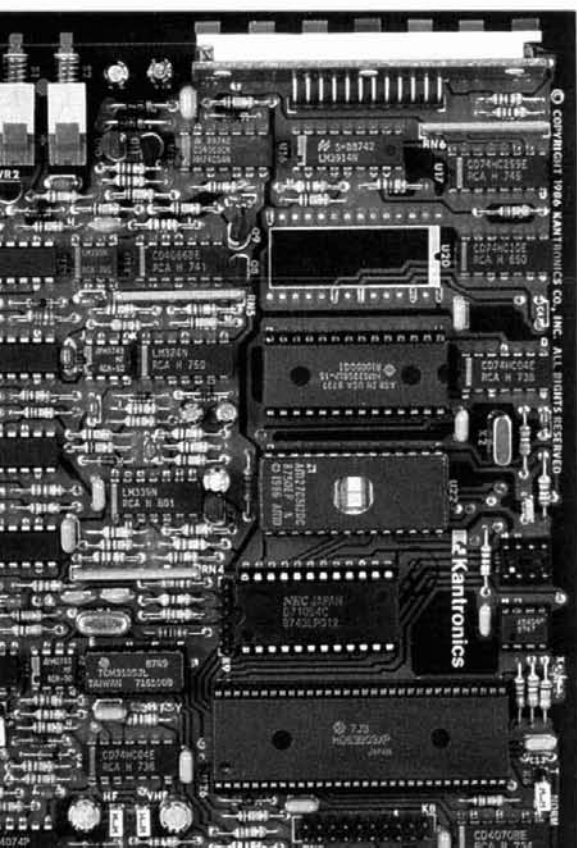

Whatever your interest, you'll find the Kantronics All Mode™ at the top of the pack. CW, Radioteletype, AMTOR, ASCII, WEFAX and Packet, "KAM handles them all." HF and VHF simultaneous operation? You bet! The KAM can operate RTTY or AMTOR on HF while communicating Packet on VHF. Believe it. It's the only true dual-port on the market.

## World-Class

Swedish and German hams have noticed KAM's

engineering and are some of our biggest fans. The Japanese scrutinized our features and gave us ideas for extras like a subject field for the Personal Packet Mailbox™, listings of digipeater paths and more CW characters and functions. We are shipping KAM around the world.

## Fun for Everyone

You'll be the envy of the airwaves with all the modes and features KAM brings to your fingertips. In addition to Packet, ASCII, AMTOR,





# At the top of the pack!

WEFAX, CW and Radioteletype, you'll have Dual-Port Operation (the only TNC offering this feature), Personal Packet Mailbox™, KA-NODE™, gateway, and digipeater operation.

You can operate non-packet modes on HF while maintaining a packet station at the same time on VHF. Or run an HF/VHF accessible personal mailbox or pc-based BBS totally dedicated to packet. Configure your KAM as an HF to VHF digipeater (gateway) or

KA-NODE. Or open your LAN to the world. All these modes and more features are waiting to be discovered. Increase your station abilities to the most advanced available.

## Today and Tomorrow

KAM is packed with all the latest features of today with Kantronics-written firmware. And since we write and copyright our own firmware, we're in a position to lead you into the exciting modes of tomorrow first. We have a

history of keeping our customers current. Proof is in our firmware updates (2.7 in 1987 and 2.83 in 1988) offered at a fraction of the cost of a new purchase.

**So join the fun, join the Top of the Pack.**

**Kantronics**  
RF Data Communications Specialists  
1202 E. 23 St Lawrence, Kansas 66046 (913) 842-7745

Kantronics All-Mode, KAM, Personal Packet Mailbox, and KA-NODE are trademarks of Kantronics Company, Inc.

# MFJ multi-mode data controller

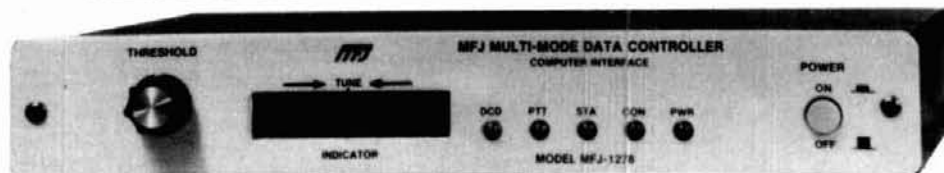

**MFJ shatters the 6 mode barrier and the price barrier with the MFJ-1278 and gives you . . . Packet, RTTY, ASCII, CW, WEFAX, SSTV and Contest Memory Keyer . . . 7 digital modes . . . for an affordable \$249.95**

Amateur radio's newest multi-mode data controller -- the MFJ-1278 -- lets you join the fun on Packet, RTTY, ASCII, CW, Weather FAX, SSTV and gives you a full featured Contest Memory Keyer mode . . . you get 7 modes . . . for an affordable \$249.95.

Plus you get high performance HF/VHF/CW modems, software selectable dual radio ports, precision tuning indicator, 32K RAM, AC power supply and more.

You'll find it the most user friendly of all multi-modes. It's menu driven for ease of use and command driven for speed.

A high resolution 20 LED tuning indicator lets you tune in signals fast in any mode. All you have to do is to center a single LED and you're precisely tuned in to within 10 Hz -- and it shows you which way to tune!

All you need to join the fun is an MFJ-1278, your rig and any computer with a serial port and terminal program.

You can use the MFJ Starter Pack to get on the air instantly. It includes computer interfacing cable, terminal software and friendly instructions . . . everything you need to get on the air fast. Order MFJ-1282 (disk)/MFJ-1283 (tape) for the C-64/128 and VIC-20 or MFJ-1284 for the IBM or compatible, \$19.95 each.

## Packet

Packet gives you the fastest and most reliable error-free communications of any amateur digital mode.

With MFJ's super clone of the industry standard -- the TAPR TNC-2 -- you get genuine TAPR software/hardware plus more -- not a "work-a-like" imitation.

Extensive tests published in *Packet Radio Magazine* ("HF Modem Performance Comparisons") prove the TAPR designed modem used in the MFJ-1278 gives better copy with proper DCD operation under all tested conditions than the other modems tested.

Hardware DCD gives you more QSOs because you get reliable carrier detection under busy, noisy or weak conditions.

A hardware HDLC gives you full duplex operation for satellite work or for use as a full duplex digipeater. And, it makes possible speeds in excess of 56K baud with a suitable external modem.

Good news for SYSOPs! New software lets the MFJ-1278 perform flawlessly as a WORLI/WA7MBL bulletin board TNC.

## Baudot RTTY

You can copy all shifts and all standard speeds including 170, 425 and 800 Hz shifts and speeds from 45 to 300

baud. You can copy not only amateur RTTY but also press, weather and other exciting traffic.

A high performance modem lets you copy both mark and space for greatly improved copy under adverse conditions. It even tracks slightly drifting signals.

You can transmit both narrow and wide shifts. The wide shift is a standard 850 Hz shift with mark/space tones of 2125/2975 Hz. This lets you operate MARS and standard VHF FM RTTY.

You get both the American Western Union and the international CCITT character sets. Autostart for unattended reception and selectable "Diddle".

A receive Normal/Reverse software switch eliminates retuning and Unshift-On-Space reduces errors under poor receiving conditions.

## ASCII

You can transmit and receive 7 bit ASCII using the same shifts and speeds as in the RTTY mode and using the same high performance modem. You also get Autostart and selectable "Diddle".

## CW

You get a Super Morse Keyboard mode that lets you send perfect CW effortlessly from 5 to 99 WPM, including all prosigns -- it's tailor-made for traffic handlers.

A huge type ahead buffer lets you send smooth CW even if you "hunt and peck".

You can store entire QSOs in the message memories, if you wanted to! You can link and repeat any messages for automatic CQs and beaconing. Memories also work in RTTY and ASCII modes.

A tone Modulated CW mode turns your VHF FM rig into a CW transceiver for a new fun mode. It's perfect for transmitting code practice over VHF FM.

An AFSK CW mode lets you ID in CW.

The CW receive mode lets you copy from 1 to 99 WPM. Even with sloppy fists you'll be surprised at the copy you'll get with its powerful built-in software.

You also get a random code generator that'll help you copy CW faster.

## Weather FAX

You'll be fascinated as you watch WEFAX signals blossom into full

fledged weather maps on your printer. Other interesting FAX pictures can also be printed -- such as some news photographs from wire services.

Any Epson compatible printer will print a wealth of interesting pictures and maps.

Automatic sync and stop lets you set it and leave it for no hassle printing.

You can save FAX pictures and WEFAX maps to disk if your terminal program lets you save ASCII files to disk.

Pictures and maps can be printed to screen in real time or from disk on IBM and compatibles with the MFJ-1284 Starter Pack.

You can transmit FAX pictures right off disk and have fun exchanging and collecting them.

## Slow Scan TV

The MFJ-1278 lets you exchange pictures with thousands of SSTVers all-over-the-world.

You'll not only see what your ham buddies look like but you can send your own pictures to them, too.

You can print slow scan TV pictures on an Epson compatible printer. If you have an IBM PC or compatible you can print to screen in near real time or from disk with the MFJ-1284 Starter Pack.

You can transmit slow scan pictures right off disk -- there's no need to set up lights and a camera for a casual contact.

You can save slow scan pictures on disk from over-the-air QSOs, audio tapes and other sources if your terminal program lets you save ASCII files.

The MFJ-1278 transmits and receives 8.5, 12, 24, and 36 second black and white format SSTV pictures using two levels.

## Contest Memory Keyer

Nothing beats the quick response of a memory keyer during a heated contest.

You'll score valuable contest points by completing QSOs so fast you'll leave your competition behind. And you can snag rare DX by slipping in so quickly you'll catch everyone by surprise.

You get iambic operation with dot-dash memories, self-completing dots and dashes and jamproof spacing.

Message memories let you store contest RST, QTH, call, rig info -- everything you used to repeat over and over. You'll save precious time and work more QSOs.

You get automatic incrementing serial numbering. In a contest it can make the difference between winning and losing.

A weight control lets you penetrate QRM with a distinctive signal or lets your transmitter send perfect sounding CW.

## More Features

Turn on your MFJ-1278 and it sets itself to match your computer baud rate. Select your operating mode and the correct modem is automatically selected.

Plus . . . printing in all modes, threshold control for varying band conditions, tune-up command, lithium battery backup, RS-232 and TTL level serial ports, watch dog timer, FSK and AFSK outputs, output level control, speaker jack for both radio ports, test and calibration software, Z-80 at 4.9 MHz, 32K EPROM, and socketed ICs. FCC approved. 9x1 1/2 x 9 1/2 in. 12VDC or 110VAC.

Get yours today and join the fun crowd!

**FOR YOUR NEAREST DEALER**  
or to order call toll free  
**800-647-1800**

One Year Unconditional Guarantee

**MFJ ENTERPRISES, INC.**

Box 494, Miss. State, MS 39762  
601-323-5869 Telex: 53-4590 MFJSTKV

**MFJ . . . making quality affordable**

# comments comments

## carrier complaint

Dear HR:

I finally got around to thoroughly digging into my copy of your March issue.

Your "Reflections" column hit a very, very sore spot with me (if I may be excused for that old, old cliché). I agree with you that all lids who throw carriers on an occupied frequency should be hung by their thumbs (sorry Bob and Ray). I too have experienced trying to copy a weak DX station with the headset in place on my ears and the audio gain turned way up when some idiot sends me rolling off my chair in pain with an S-9 carrier.

I guess I'm not an aggressive DXer, but I do like to do some of it now and again when the bands are open. More often though, you'll find me chatting with some of my friends about our latest antenna experiments or other projects. It is on many of these occasions when I have had that famous urge-to-kill a few of your DXing friends. It's absolutely infuriating to have some lid, working split with a European on 40 meters, start screaming right on our frequency. Of course we can't inform this dumbbell that he is wiping us out because he is listening down below 7100 kHz. Did he ever think to check the frequency he intended to transmit on and/or ask if it was busy? Not on your life. More than once my friends and I have given serious consideration to dropping down on the DX station's transmitting frequency and start up a CW QSO. But we haven't gotten that mad yet...not yet. What is that old saying, "two wrongs never make a right?" So, my DXer friend, next time you get your eardrums blown out by some thoughtless tuner-upper...stop and think. Did

you have the same kind of consideration for the guys on 7.229 MHz when you were trying to make a contact with that EA5 operating split the other night?

Next time you get so frustrated you feel compelled to write an editorial on behalf of all of your DXing buddies, slip the shoe on the other foot and see if it fits.

Incidentally, I have prepared charts of settings for both my transmatch and my amplifier. These are kept handy at my operating position, and 99 percent of the time I can go on the air with transmatch and amp without any preliminary tuneup. If there happens to be a little error and the SWR is higher than I would like, I just touch it up while I'm transmitting my side of the QSO. Those amplifier settings were arrived at by tuning into a dummy load, and the transmatch settings were developed by transmitting low power into my antenna on bands which were closed during that part of the day. Once these settings are recorded and stuck on the wall behind my desk I never have to put a carrier on the bands again.

Hell of a fine publication. Enjoy every issue cover to cover. I admit a good many of the articles are over my head but then I would never learn anything if I read only that which I already knew and understood, would I?

**Harold P. (Phil) Morgan, WD0P,  
ex KAØRUM, Lake Lotawana,  
Missouri 64063**

## remedy for RFI

Dear HR:

Last week one of our local hams, WB6MBT, came to me for help on an RFI problem. Every time he keyed his transmitter, significant amounts of rf appeared at all of his ac outlets. TV reception was impossible. I loaned him a dummy load and suggested he determine if the radiation from his antenna was being coupled into the house wiring. My second suggestion was to check that the neutral ground wire was not connected to his radio chassis.

Finally, I suggested that he wind his line cord on a ferrite rod.

Today I received my March copy of *ham radio* and Bill Orr's column fully endorsed my approach.

I will include some comments on this subject extracted from articles in my RFI file.

"Ground Systems," I.L. McNally, *ham radio*, May 1970:

"Do not use the electric utility ground bus as that common impedance will introduce the noise and interference on that ground wire."

"Solving the Problems of RFI," John Labaj, W2YW, *ham radio*, September 1984:

"Better keep all grounds, especially ac and rf grounds separate. The feed-through of rf power to the ac line will be much greater from a common junction than the ac line would pick up from direct radiation."

"Power Line Grounding: Friend or Foe," WØTHM, *QST*, February 1985:

WØTHM discusses in detail the problems of unbalanced loads in the three wire distribution system. This results in high currents in the neutral wire and an induction field that penetrates throughout the house. Power line transients and power line hash cause serious interference to radio reception if the third wire neutral is connected to the radio chassis.

The first step toward noise reduction is a good earth ground (*ham radio*, May 1980). The second step is to remove the third wire neutral ground connection from the radio chassis. Third, use a good surge and RFI filters in the line supply using a separate earth ground.

The current article on "Radio Grounds" by Bill Orr in the March *ham radio* discusses the use of ferrite rod line filters to reduce the coupling of rf into the house wiring.

It appears that close attention to all of the remedies covered in these articles should go a long way in reducing noise coupling and rf coupling associated with the primary power distribution system.

**I.L. McNally, K6WX  
Sun City, California 92381**

# sporadic E and 50-MHz transatlantic propagation during 1987

Examines  
transatlantic openings  
on 50 MHz

**This article examines** transatlantic openings during 1987 from the United Kingdom on the new 50-MHz (6 meter) Amateur band. Data from ionospheric vertical sounders (ionosondes) on both sides of the Atlantic and a correlation with European DX on the same day supports conjecture that propagation is due to multi-hop sporadic E ( $E_s$ ). The geographical distribution of stations is consistent with the geometry of multiple hops at E layer height and the land distribution. The time behavior of transatlantic openings can be derived from that of European long distance contacts, which in turn is shown to be consistent with  $E_s$  on other bands. Thus  $E_s$  is now firmly established as being partly or completely responsible for transatlantic propagation on this frequency during solar minimum years.

## introduction

In February 1983 the 50-MHz band was released to a number of selected Radio Amateurs in Great Britain, following the termination of Band 1 television transmissions. Since then the band has been made available to both classes of licensees in the United Kingdom (with severe ERP restrictions), and also in certain other European countries. In addition, many Amateurs in countries which still do not allow transmission now have receiving equipment for cross-band contacts. Although the 50-MHz band was available in

pre-war Europe, the band has produced many surprises, perhaps due to advances in equipment and an increased number of stations. Recently there has been much discussion about the propagation mechanism responsible for the transatlantic openings which have been unexpectedly frequent during the present minimum in the solar cycle. It was obvious from the reported strength of the signals that propagation was due to a reflection (or more properly, refraction) mode rather than a scatter mode. Transatlantic openings coincided with the months during which intense ionization of the E layer is common and, together with other evidence, this suggested that multiple reflections from  $E_s$  were the most likely mechanism. I decided to study a few of these events in detail to see which characteristics could be understood using known  $E_s$  phenomenology. Apart from reports by operators of 50-MHz Amateur contacts or reception, data are included from ionosondes at a few MHz, and from observations of Amateur beacons on 28 MHz (10 meter) and of 144-MHz (2 meter)  $E_s$  events. A consistent picture is found throughout the spectrum making it possible to predict, simply but accurately, the time of day when a particular long distance path is likely to be open.

## $E_s$ : an overview

Sporadic E is the name given to a form of ionization which occurs at E layer heights (100-130 km, occasionally up to 170 km) and exhibits rapid changes in density, position, and height<sup>1</sup>. The characteristics of  $E_s$  in the equatorial region, and  $E_s$  connected with

**By Geoffrey H. Grayer, G3NAQ, "Bagatelle",  
3 Southend, Brightwalton, Newbury, Berks RG16  
0BE, England**



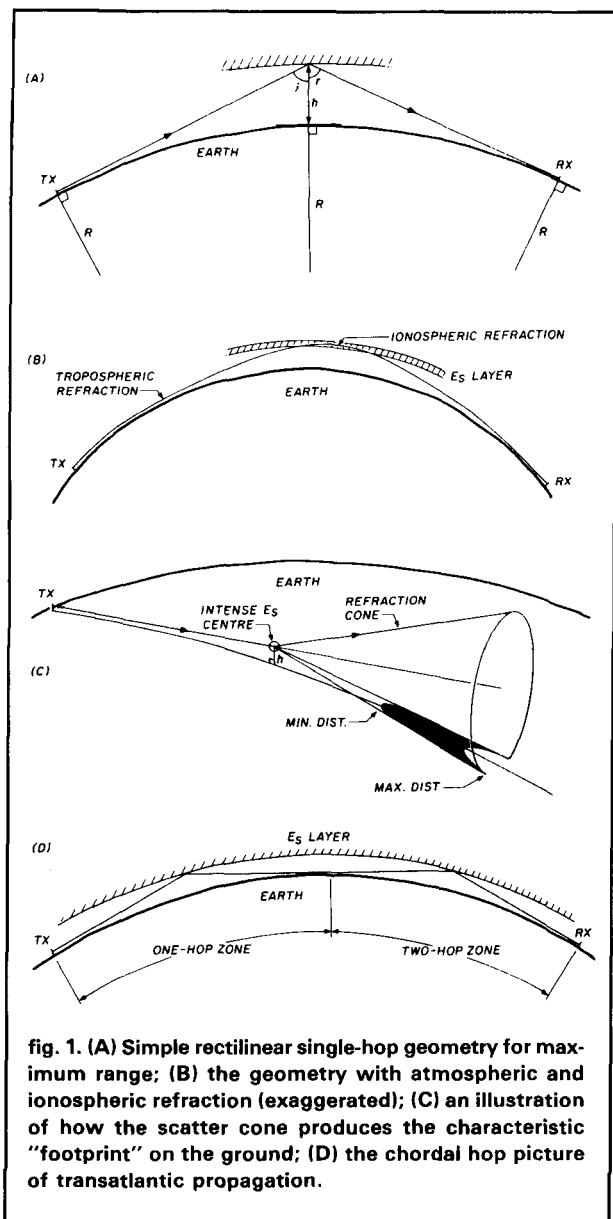

fig. 1. (A) Simple rectilinear single-hop geometry for maximum range; (B) the geometry with atmospheric and ionospheric refraction (exaggerated); (C) an illustration of how the scatter cone produces the characteristic "footprint" on the ground; (D) the chordal hop picture of transatlantic propagation.

auroral activity, differ from temperate zone  $E_s$  which is the type referred to here. A temperate zone sporadic E "layer" is characterized by being rather thin in depth (estimates range from a few km to less than 1 km)<sup>2</sup> and uneven in density.<sup>3,4</sup> It is often transparent enough for higher (normal E and F) ionospheric layers to be observed through it by ionosondes probing at vertical incidence. The frequency below which no penetration occurs is known as the *blanketing frequency*,  $f_b E_s$ . The lowest frequency which penetrates the  $E_s$  layer without any reflection is referred to as the *critical frequency*,  $f_o E_s$ . (The suffix "o" refers to the so-called "ordinary" component of the wave.)

The ionization density of the  $E_s$  layer is never great enough for the frequency  $f_o$  of waves reflected back at vertical incidence to reach 50 MHz. However, as

the angle of radio waves meeting the  $E_s$  layer moves away from the perpendicular (as is the case for point-to-point contacts) the upper frequency of waves which may be returned to earth increases. The highest reflected frequency  $f_{max}$  is normally related to  $f_o$  by  $f_{max} = f_o / \cos i = f_o \sec i$ , where  $i$  is the angle between the ray and the normal to the refracting layer (fig. 1). This relation, sometimes referred to as the *secant law*, is true for a boundary where there is a sudden change of electron density, and is also valid under certain conditions for a horizontally stratified layer<sup>5</sup>. The highest frequencies are reflected when  $\cos i$  is minimum and  $i$  is maximum, corresponding to reflection from an  $E_s$  layer on the horizon. In this case the range is near the maximum possible for the height of the reflecting layer; this range is evaluated later. Only if the layer is completely regular will the wave emerging from the layer be at the same angle to the normal — that is,  $r = i$ . As mentioned above, the layer is in fact usually very uneven in density, and the secant law also implies that regions where the ionization is most concentrated propagate the highest frequencies. These regions can be very small<sup>6</sup>, resulting in extremely narrow "beams" of propagation.

Let us imagine what the  $E_s$  layer looks like if we could see radio waves at any frequency we chose. At  $f < f_b$  (typically a few MHz) we would see the sky covered by a shiny, irregular reflecting surface. Propagation is general over a large area, and multiple hops are possible over the extent of the layer. As  $f$  increases through  $f_b$  to  $f_o$  and above, the patch overhead becomes translucent and then transparent, while the rest becomes increasingly lumpy in appearance. This transparent patch increases in size as the frequency is raised until it spreads to the horizon, but the "sky" remains hazy, as the irregular patches of ionization still scatter some of the waves.

Finally, only a few shiny clouds remain on the horizon. At the highest frequencies where there is still evidence of  $E_s$  (rarely above 200 MHz), only one or two very small concentrations with an ionization density sufficient to refract the radio wave back to earth will be visible. The  $E_s$  no longer looks like a layer, but rather a few small clouds. The waves undergoing maximum deflection from these concentrations of ions form the surface of a cone, filled with waves that are refracted less as they miss the core of ionization. The intersection of this narrow cone with the ground forms the long, narrow wedge-shaped zone of propagation (fig. 1C). The width of this track on the ground must subtend less than the cone vertex angle, and in the case of minimum angle to reach ground, it reduces to a line. In practice the refracting clouds are unlikely to be regular in shape, so the "cone" will also be rather irregular. Rays are refracted into a very small solid angle rather than being widely scattered, so signal

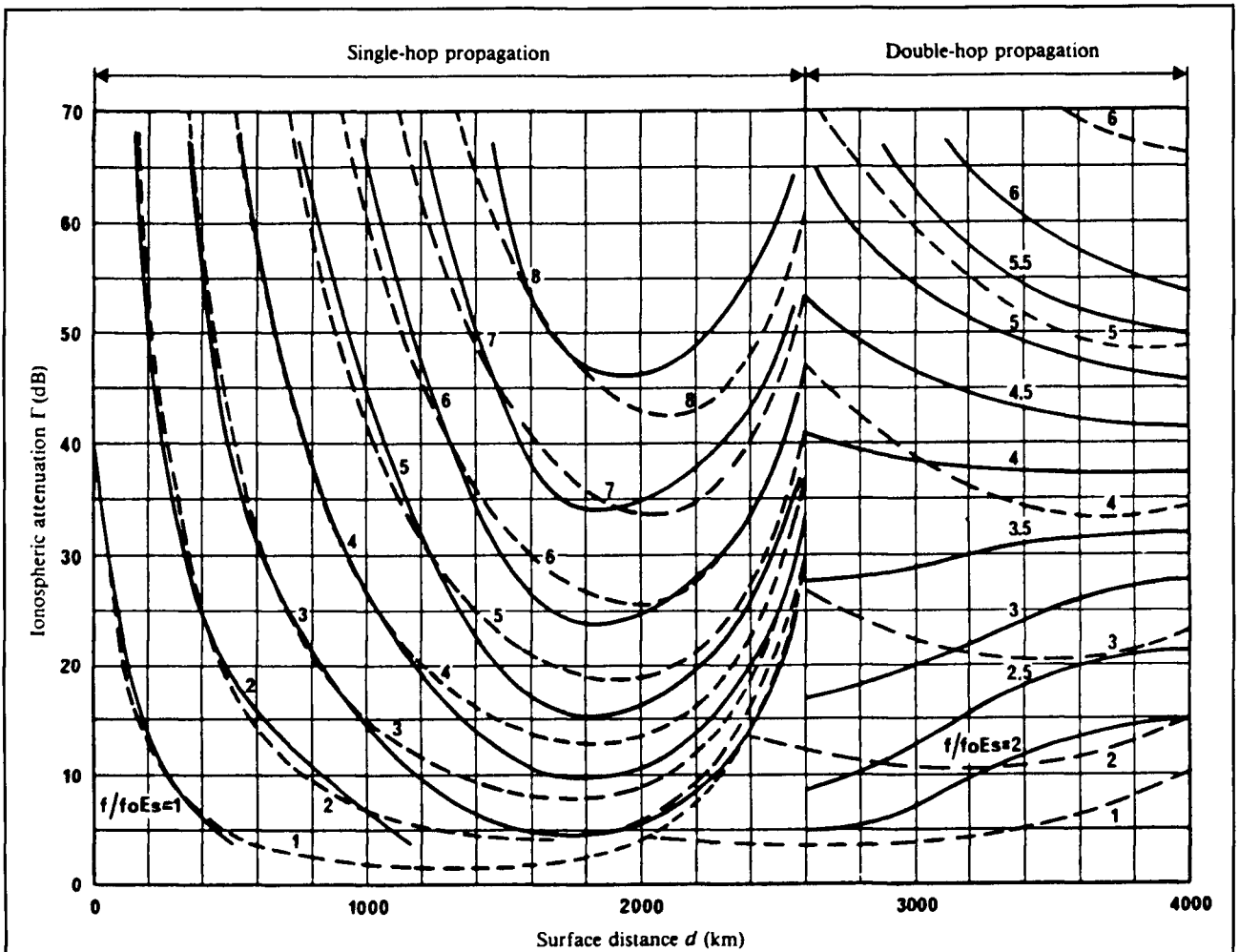

fig. 2. Path loss for  $E_s$  propagation as a function of distance with  $f/f_0$  as parameter. Continuous lines are observed values, dotted lines are from an empirical formula<sup>a</sup> (reproduced by permission of ITU).

reduction will be small. Because the grazing angle with the earth is very shallow, a small increase in bending angle will illuminate a long strip on the ground. Since the  $E_s$  clouds are not stationary, the area covered on the ground will also move, increasing the extent of the opening. This pattern is typical of the upper end of the  $E_s$  spectrum — for example, 144 MHz.

At lower frequencies like 50 MHz this situation will occur more frequently, and sometimes ionization densities will reach levels where the refracted cone grows quite large and skip distance shorter, so that the ground area covered is extensive. The rays in the cone which do not quite reach the ground can go on to encounter another  $E_s$  cloud. At 50 MHz there is still a sufficiently high probability of ionization reaching the necessary density for reflection, so an occasional second or third encounter should come as no great surprise. This can be deduced from the pattern of stations heard during suitable  $E_s$  conditions throughout the

frequency spectrum. The references already quoted also support this scenario.

Now let's consider the maximum critical frequency necessary for  $E_s$  propagation, using the simple rectilinear geometry shown in fig. 1A. The value of the angle  $i$  at maximum range (elevation angle at antennas being zero) is given by

$$i = \sin^{-1} \left( \frac{R_o}{R_o + h} \right) \quad (1)$$

where  $R_o$  is the radius of the earth, and  $h$  is the height of the reflecting layer. At a typical  $E_s$  layer height of 115 km, the resulting value of  $i$  is 79.2°. The secant law  $f_o = f_{max} \cos i$  gives 9.35 MHz as the critical frequency which must be exceeded for 50 MHz to be returned to ground. Because of the irregularity of the  $E_s$  layer described above, the secant law is only approximately true in its simple form. Weak propagation does take place by scatter mode above  $f_{max}$ , but



# JDR INSTRUMENTS™

Complete customer satisfaction... superior service... friendly, knowledgeable personnel... quality merchandise... providing the best values in leading edge technology.

## 35 MHz OSCILLOSCOPE

A remarkable value

# \$499<sup>95</sup>

Wide bandwidth and exceptional 1mV/DIV sensitivity make the Model 3500 a powerful diagnostic tool for engineers or technicians at a remarkable price. Delayed triggering allows any portion of a waveform to be isolated and expanded for closer inspection. Variable Holdoff allows stable viewing of complex waveforms.

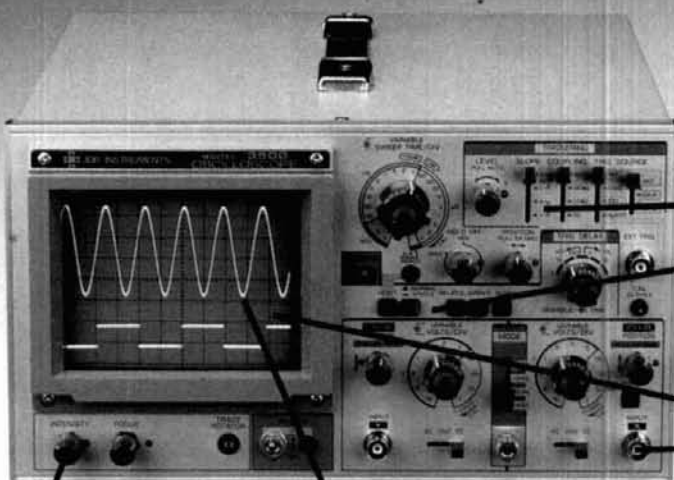

TV SYNC FILTER

DELAYED AND SINGLE SWEEP MODES

EXCEPTIONALLY BRIGHT 5" CRT

X-Y OPERATION

Z AXIS INTENSITY MODULATION

FAST 10NS RISE TIME

### DMM-300

\$79.95

3.5 DIGIT DMM/MULTITESTER

This full function 3.5 digit DMM offers highly accurate performance and a host of added features like audible continuity, capacitance, transistor, temperature, and conductance to help you do the job—fast. Temperature probe, test leads and battery included.

- Basic DC accuracy: plus/minus 0.25%
- DC voltage: 200mV–1000V, 5 ranges
- AC voltage: 200mV–750V, 5 ranges
- Resistance: 200 ohms–20M ohms, 6 ranges
- Capacitance: 2000pF–20  $\mu$ F, 3 ranges
- Transistor Tester: 0–2000 $^{\circ}$ F
- Conductance: 200ns
- Fully overload protected
- Input impedance: 10M ohm.

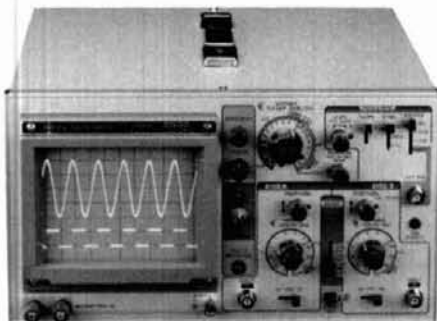

### MODEL 2000

\$389.95

20 MHz DUAL TRACE OSCILLOSCOPE

Model 2000 makes frequency calculation and phase measurement quick and easy. The component tester aids in fast troubleshooting. Service technicians appreciate the TV Sync circuits for viewing TV-V and TV-H and accurate synchronization of the video signal, Blanking, VITS, and V/H sync pulses.

- Exceptionally bright 5" CRT
- Built-in component tester
- TV Sync filter
- X-Y operation \*110/220 volts

### DMM-100

\$29.95

3.5 DIGIT POCKET SIZE DMM

Perfect for the field service technician. Shirt pocket size without compromising features or accuracy. Large, easy to read 1/2" LCD display. Fully overload protected for safety. 2000 hour battery life with standard 9v cell. Probes and battery included.

- Basic DC accuracy: plus/minus 0.5%
- DC voltage: 2V–1000V, 4 ranges
- AC voltage: 200V–750V, 2 ranges
- Resistance: 2k ohms–2M ohms, 4 ranges
- DC current: 2mA–2A, 4 ranges
- Input impedance: 10M ohm
- Fully overload protected
- Approx. 5" x 3" x 1". Under 7 ozs.



### DMM-200

\$49.95

3.5 DIGIT FULL FUNCTION DMM

Get highly accurate performance at a very affordable price. Rugged construction, 20 amp current capability and 22 ranges make it a perfect choice for serious field or bench work. Low battery indicator and tilt-stand. Probes and 2000 hour battery included.

- Basic DC accuracy: plus or minus 0.25%
- DC voltage: 200mV–1000V, 5 ranges
- AC voltage: 200mV–750V, 5 ranges
- Resistance: 200 ohms–20M ohms, 6 ranges
- AC/DC current: 200 $\mu$ A–20A, 6 ranges
- Input impedance: 10M ohm
- Fully overload protected
- Approx. 7" x 3 1/2" x 1 1/2". Wt. 11 ozs.

### DPM-1000

\$54.95

3.5 DIGIT PROBE TYPE DMM

Custom 80 pin LSI chip provides accuracy and reliability in such a compact size. Autoranging, audible continuity and data hold feature help you pinpoint the problem quickly. Case and batteries included.

- Basic DC accuracy: plus/minus 1%
- DC voltage: 2V–500V, autoranging
- AC voltage: 2V–500V, autoranging
- Resistance: 2k ohms–2M ohms, autoranging
- Fully overload protected
- Input impedance: 11M ohm
- Approx 6 1/2" x 1" x 3/4". Under 3 ozs.



- ★ 2 YEAR REPLACEMENT WARRANTY
- ★ 30 DAY MONEY BACK GUARANTEE
- ★ TOLL FREE TECHNICAL SUPPORT
- ★ NEXT DAY AIR SHIP AVAILABLE

COPYRIGHT 1987 JDR MICRODEVICES



JDR INSTRUMENTS, 110 KNOWLES DRIVE, LOS GATOS, CA 95030  
RETAIL STORE: 1256 SOUTH BASCOM AVE, SAN JOSE, CA (408) 947-8881

# ORDER TOLL FREE 800-538-5000

**GUARANTEED  
QUALITY  
AT COMPETITIVE PRICES**



# HAM RADIO OUTLET

LARGEST HAM OUTLET IN THE WORLD

## 7 STORE BUYING POWER



**GEOCHRON**  
GLOBAL  
TIME  
INDICATOR

- Detailed illuminated map shows time, time zone, sun position and day of the week at a glance for any place in the world.
- Continuously moving - areas of day and night change as you watch.
- Mounts easily on a wall. Size: 34" x 22 1/2".

**\$1295 DELIVERED IN U.S.**

Gordon West's

### 21 DAY NOVICE

**\$19.95**



CODE TAPES • 112 PAGE BOOK • BANDS CHART  
ALL FCC FORMS • SAMPLE TESTS • PLUS MORE!

- \$70 in equipment certificates from ICOM, KENWOOD, & YAESU.
  - Ham radio equipment "Wish Books".
  - ARRL membership forms.
  - Hotline for student questions.
  - Course completion certificate.
- PLUS  
ADDITIONAL  
ITEMS

**concept**



Contemporary design,  
quality and a 5 year warranty  
on parts and labor.

6 months on the RF Final transistors.

All amplifiers have GaAsFET receive  
pre-amps and high SWR shutdown protection.



**MA-40**

40' TUBULAR TOWER

~~\$609~~ **SALE! \$629**

**MA-550**

55' TUBULAR TOWER

~~\$1369~~ **SALE! \$999**

- Handles 10 sq. ft. at 50 mph
- Pleases neighbors with tubular streamlined look

**TX-455**

55' FREESTANDING  
CRANK-UP

- Handles 18 sq. ft. at 50 mph
- No guying required
- Extra-strength Construction
- Can add raising and motor drive accessories

Shown with optional  
MARB rotor base

TOWERS RATED TO EIA SPECIFICATIONS  
OTHER MODELS AT GREAT PRICES  
IN STOCK FOR QUICK DELIVERY



Advanced  
Electronic  
Applications

### PK-232 Multi-mode Data Controller



- NEW IBM Fax Screen Display Program Available
- Transmit/Receive on Six Modes
- CW/RTTY/ASCII/AMTOR/Packet/FAX
- IBM and Commodore terminal programs available
- Radio Ports for HF and VHF

**In Stock for Quick Delivery**

**Free Shipment**

## KENWOOD

**TM-721A DUAL BANDER**

2 MTR / 70 cm

45 w 35 w

EXTENDED RECEIVING  
RANGE (2 m)



**TM-621A DUAL BANDER**

2 MTR / 220 MHz

45 w 25 w

AUTOMATIC OFFSET

**CALL FOR LOW, LOW PRICE**

**A3** DX THAT  
STANDS OUT  
FROM THE CROWD

**10, 15, 20  
Meters**

Whether busting pileups,  
rag chewing or hunting  
rare DX, the A3 stands  
out from the crowd with  
the perfect combination  
of easy assembly, the  
right size, rugged durabil-  
ity and great  
performance.

- Boom Length 14 ft.,  
Weight 27 lbs.
- Wind Surface Area  
4.36 ft.

Must  
not  
included

**REG.  
\$319.95**

**SALE  
\$259.95**  
Plus Shipping

**FREE  
SHIPMENT**  
Most items UPS  
surface

**All Major Brands in Stock Now!**

**CALL TOLL FREE (800) 854-6046**



Toll free including Hawaii. Phone Hrs: 7:00 am to 5:30 p.m. Pacific Time. California, Arizona and Georgia customers call or visit nearest store.  
California, Arizona and Georgia residents please add sales tax. Prices, specifications, descriptions subject to change without notice.





WORLDWIDE DISTRIBUTION



# HAM RADIO OUTLET

LARGEST HAM OUTLET IN THE WORLD

FREE SHIPMENT  
MOST ITEMS UPS SURFACE

## 7 STORE BUYING POWER

ICOM IC-761



HF SUPERIOR GRADE  
TRANSCEIVER

SALE! CALL FOR PRICE

ICOM IC-781



THE ULTIMATE  
150 W, ALL BAND  
HF TRANSCEIVER

GREAT PRICE!

ICOM IC-900  
MULTI-BAND  
MOBILE



YOU CAN OPERATE SIX BANDS  
WITH ONE CONTROLLER!  
2 MTR 25/45W, 440 MHz 10 MTR, 6 MTR,  
220 MHz & 1.2 GHz 10 MEMORIES  
ARE YOU READY FOR  
1.2 GHz OPERATION?

ICOM A Models 25W,  
H Models 100 W

IC-275A/275H, 138-174 MHz  
IC-375A, 220 MHz  
IC-475A/475H, 430-450 MHz



LOW PRICE!

NOW! RAPID DELIVERIES

COAST  
TO COAST

FROM STORE NEAREST YOU

ICOM HAND-HELD  
VHF/UHF

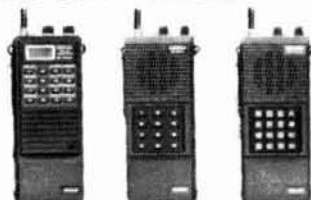

IC-02AT IC-2AT 2MTR  
IC-03AT IC-3AT 220 MHz  
IC-04AT IC-4AT 440 MHz

ICOM IC-735



100 W, 100 KHz-30 MHz  
Dual VFO Receiver

CALL FOR LOW, LOW PRICE

ICOM IC-R7000



25 MHz-1300 MHz  
SCANNING RECEIVER

GREAT PRICE!

ICOM IC-u4AT/u2AT  
440 MHz, 2MTR

Mini  
Hand-Held  
AT Model  
w/ TT Pad

GREAT  
PRICE!



## All Major Brands in Stock Now!



Bob Ferrero W6RJ  
President  
Jim Rafferty N6RJ  
VP So. Calif. Div.  
Anaheim Mgr.

ANAHEIM, CA 92801  
2620 W. La Palma  
(714) 761-3033, (213) 860-2040  
Between Disneyland &  
Knotts Berry Farm

ATLANTA, GA 30340  
6071 Buford Hwy  
(404) 263-0700  
Larry, Mgr. WD4AGW  
Doraville, 1 mi. north of I-285

BURLINGAME, CA 94010  
999 Howard Ave.  
(415) 342-5757  
George, Mgr. WB6DSV  
5 miles south on 101 from SFO

OAKLAND, CA 94606  
2210 Livingston St.  
(415) 534-5757  
Al, Mgr. WA6SYK  
17N-5th Ave. / 17S-16th Ave.

PHOENIX, AZ 85015  
1702 W. Camelback Rd.  
(602) 242-3515  
Bob, Mgr. K7RDH  
East of Hwy 17

SAN DIEGO, CA 92123  
5375 Kearny Villa Rd.  
(619) 560-4900  
Tom, Mgr. KM6K  
Hwy 163 & Claremont Mesa Blvd.

VAN NUYS, CA 91411  
6265 Sepulveda Blvd.  
(818) 988-2212  
Al, Mgr. K6YRA  
San Diego Fwy  
at Victory Blvd

STORE HOURS  
10 AM-5:30 PM  
CLOSED SUNDAYS



# CALL TOLL FREE (800) 854-6046



Toll free including Hawaii. Phone Hrs: 7:00 am to 5:30 p.m. Pacific Time. California, Arizona and Georgia customers call or visit nearest store. California, Arizona and Georgia residents please add sales tax. Prices, specifications, descriptions subject to change without notice.



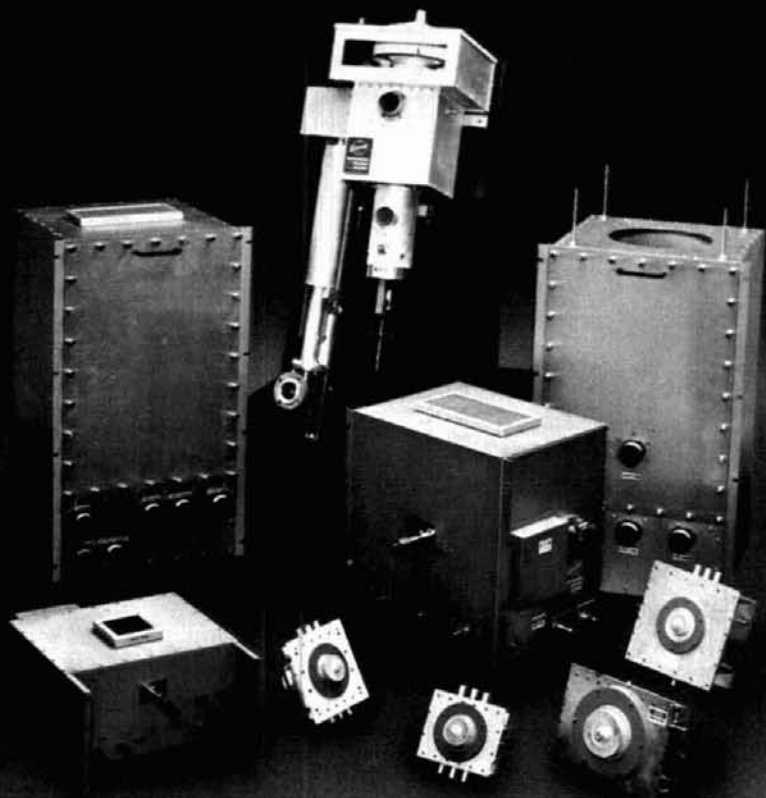

## EIMAC cavities cover 54 to 970 MHz at power levels to 30 kW —our design or yours

Varian EIMAC has complete cavity design and production capability. We make sure that tube and cavity are compatible. If it isn't an off-the-shelf-item, we have the designers and engineers for any specific job.

EIMAC has expertise in all disciplines including pulse, CW, FM, and TV. We match tube, power,

bandwidth and operating mode to achieve optimum performance.

More information on EIMAC cavities and tubes is available in our Cavity Capability brochure from Varian EIMAC. Or for prompt consideration of your special design requirements, contact Product Manager, Var-

ian EIMAC, or the nearest Varian Electron Device Group sales office. Call or write today.

**Electron Device Group  
Varian EIMAC  
301 Industrial Way  
San Carlos, California 94070  
415-592-1221**

**Varian A.G.  
Steinhauserstrasse  
CH-6300 Zug, Switzerland  
Tel: (042) 23 25 75  
Telex: 78 841**

EIMAC Cavity	Matching EIMAC Tube	Tuning Range (MHz)	Power Output
CV-2200	4CX20,000A	86-108	30 kW
CV-2220	3CX1500A7	86-108	1.5 kW
CV-2225	4CX3500A	86-108	5 kW
CV-2240	3CX10,000U7	54-88	10 kW†
CV-2250	3CX10,000U7	170-227	10 kW†
CV-2400	8874	420-450	300/1250 W*
CV-2800	3CX400U7	850-970	225 W
CV-2810	3CX400U7	910-970	190 W

\*pulsed power

†peak sync, or 2.5 kW combined in translator service



there is a rapid increase in signal strength near this frequency<sup>6</sup>. It has been found<sup>7</sup> that a better approximation is  $f_{max} = \epsilon f_o \sec i$ , where  $\epsilon$  normally lies between 1.2 and 1.3. For 50-MHz propagation it is probably sufficient that  $f_o$  exceeds 7.2 to 7.8 MHz, and the corresponding  $f_o$  for 144 MHz is 21 to 22.5 MHz. The observed path loss for sporadic E has been fitted<sup>8</sup> to an empirical formula as a function of  $f/f_o$  and distance, see fig. 2.

Next consider the maximum theoretical range. From fig. 1A, this is given by

$$D_{max} = 2 R_o \cos^{-1} \left( \frac{R_o}{R_o + h} \right) \quad (2)$$

This expression is a simpler form of that given by Kimbell<sup>9</sup>, and predicts the same maximum range of about 2400 km for reflection at a height of 115 km. The calculation assumes: no atmospheric refraction, a point reflection at a sharp ionospheric boundary, and both stations at zero height above ground. Corrections for each of these points will tend to extend the available range, as I will now describe.

In a "standard" troposphere at these frequencies the apparent horizon is 4/3 the distance of the visible horizon. In addition, forward scattering will increase the over-horizon range. In practice, on 144 MHz during summer conditions, a well-equipped station typically has a ground range exceeding 300 km, and low-angle rays go on to hit the ionosphere at some extended point. You would have to trace the ray through the actual atmosphere to find the increase of range obtained in each particular case. Note that the wave will be bent towards a more grazing angle of incidence, hence  $f_o$  does not need to be so high for reflection to occur. It is, however, a fact that tropospheric effects are less on 50 MHz than the higher frequency bands.

There is a second effect which tends to extend the range. The ray is returned to earth by refraction in an electron gradient rather than reflection at a surface, and this curved path itself extends the range by the distance

$$d = a \sin i \frac{f}{f_o} \ln \left( \frac{f_o + f \cos i}{f_o - f \cos i} \right) \quad (3)$$

where  $a$  is the "half thickness" of the ionized layer assuming a parabolic distribution of electrons<sup>5</sup>, the other quantities having been defined above. Similar penetration effects occur with vertical incidence ionosondes. It can be shown that with some assumptions<sup>10</sup> this extra distance is included in the recilinear model of fig. 1A if one uses the observed or "virtual" height  $h' = ct/2$ , where  $t$  is the time delay measured by the ionosonde and  $c$  is the velocity of light. This effect is such that if the true height  $h = 115$  km and the virtual height  $h' = 125$  km, the range is increased by 100 km.

# KEEP IT INSIDE



- Frequency Range - 13 MHz to 30 MHz
- Power Limit - 1500 Watts P.E.P.
- Diameter - 39 inches
- Wind Survival - 70 + MPH
- Surface Area - < .89 Sq. Ft.
- Antenna Finish - Heat Shrink Tubing
- Coax Connector - PL-259
- Antenna Weight - 4 lbs.
- Magnetic Design Maximum Efficiency
- 100% Copper One Piece Construction
- Military Spec Vacuum Variable Capacitor Rated at 35,000 Volts
- Hi-Q Harmonic Suppression
- All Locations - Indoors or Outdoors
- Bi-Directional at 0-20 Degrees TOA
- Omni-Directional at 25-90 Degrees TOA
- High Signal to Noise Ratio
- Direction Feed 52 OHM Coax SWR < 1.5:1
- No Matching Unit, Pretuned Coax, Ground Screen or Radial System

## WA2VMO A BELIEVER

WHEN YOU'RE TOLD YOU CAN'T — THE DMQ-5588 SAYS YOU CAN

**OPERATION:** Apply power to DMQ-5588 and adjust vacuum variable for lowest SWR.

**INSTALLATION:** DMQ-5588 inside ground floor apartment brick building 100W.

**DX CONTACTS MADE BETWEEN 3/88 TO 5/88:** 524 P43 PA0 TK9 DJ8 GWO CP5 YS9 ZS6 J37 ZDB HP9 WP4 IK4 HK6 GM4 IS EA5 JH1 C6 HK6 IK2 GD4 PJ2 HP4 CE1 524 ST5 KP4 U74 SP3 CP3 F9 IK3 N91 UA6, UR2 UP1 Y2 UB5 IV3 EA5 TG9 GJ5 ON7 YU1 VO1 DL6 J73 PY8 T12 LZ1 PY5 OE4 GI0 G4 WP4 KL7

Become a Believer! For more information about this exciting new antenna, call or write DMQ today! Limited time intro offer: \$349.50 + Shipping.

221 Slater Boulevard  
Staten Island, NY 10305  
(718) 979-3505



TECHNOLOGY

114

## COMMANDER II VHF LINEAR POWER AMPLIFIER



### SPECIFICATIONS

Frequency Range—144-148 MHz	Output Impedance—50 OHMS Nominal
Modes—USB, LSB, RTTY, FM	Antenna Load—2:1 Maximum
Power Requirements—117/234VAC with 234VAC recommended	Harmonic Suppression Down 60DB @ Rated Output
RF Drive Power—10-15 Watts Nominal 25 Watts Maximum	Intermodulation Distortion Down 30 DB Minimum
RF Output—15+ DB Gain or over 650 Watts	Weight—56 lbs.
Input Impedance—50 OHMS	Cabinet Size—14 1/4" x 14 1/4" x 6"
	Tube—3CX800A7 Ceramic/Metal Triode
	Pressurized Chassis Forced Air Cooling

### FEATURES

Reduced Ratio (6 to 1) on all Tuning Controls for Smooth and Easy Tuneup.  
Front Panel Input Tuning Control Allowing a Higher Circuit "Q" for Excellent Linearity and a Very Low Input VSWR all Across the 2 Meter Band.  
A Switched Multimeter for Monitoring Plate Voltage, Plate Current, and Grid Current.  
External Coaxial Relay or Sequencer Needed for Transceiver Operation.  
UPS Shippable.

MADE IN U.S.A. BY HAMS FOR HAMS  
Direct from Manufacturer

**\$988.00** (Coaxial Relay Extra)

Ohio Residents Add Sales Tax. VISA and Mastercards accepted. Prices or specifications subject to change without notice.

**COMMAND TECHNOLOGIES, INC.**  
1117 West High Street, Bryan, Ohio 43306 (419) 636-2721



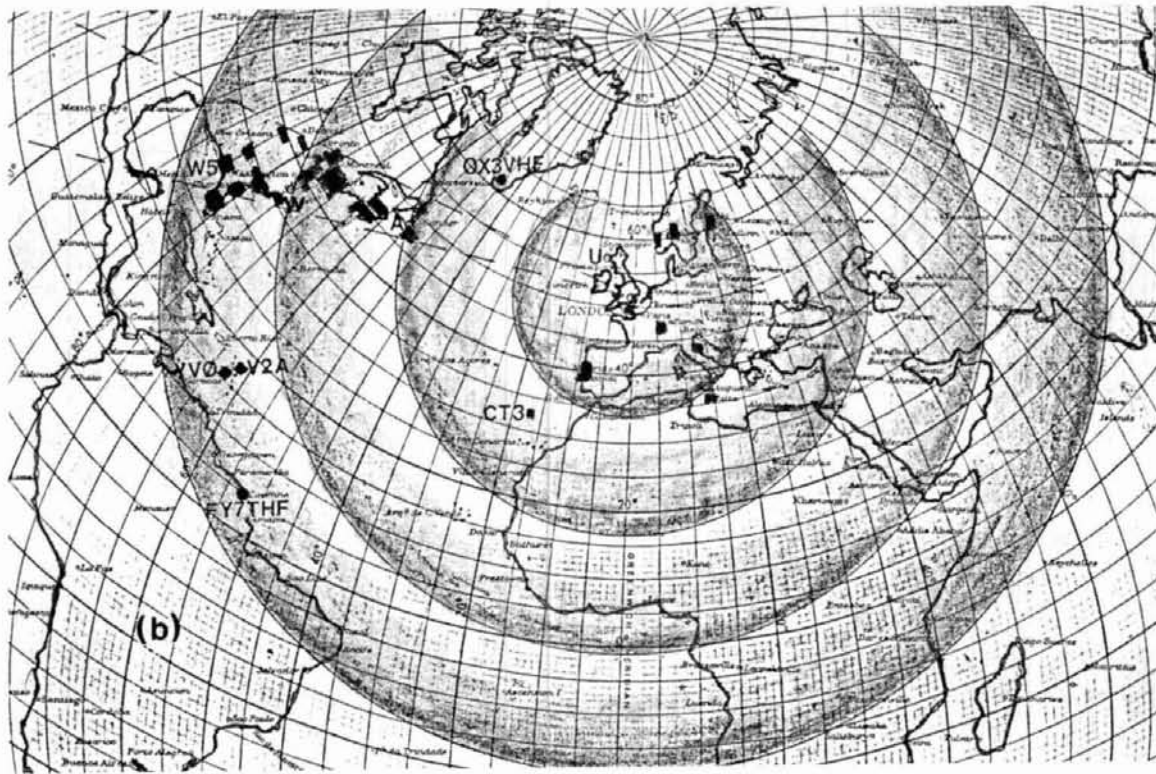
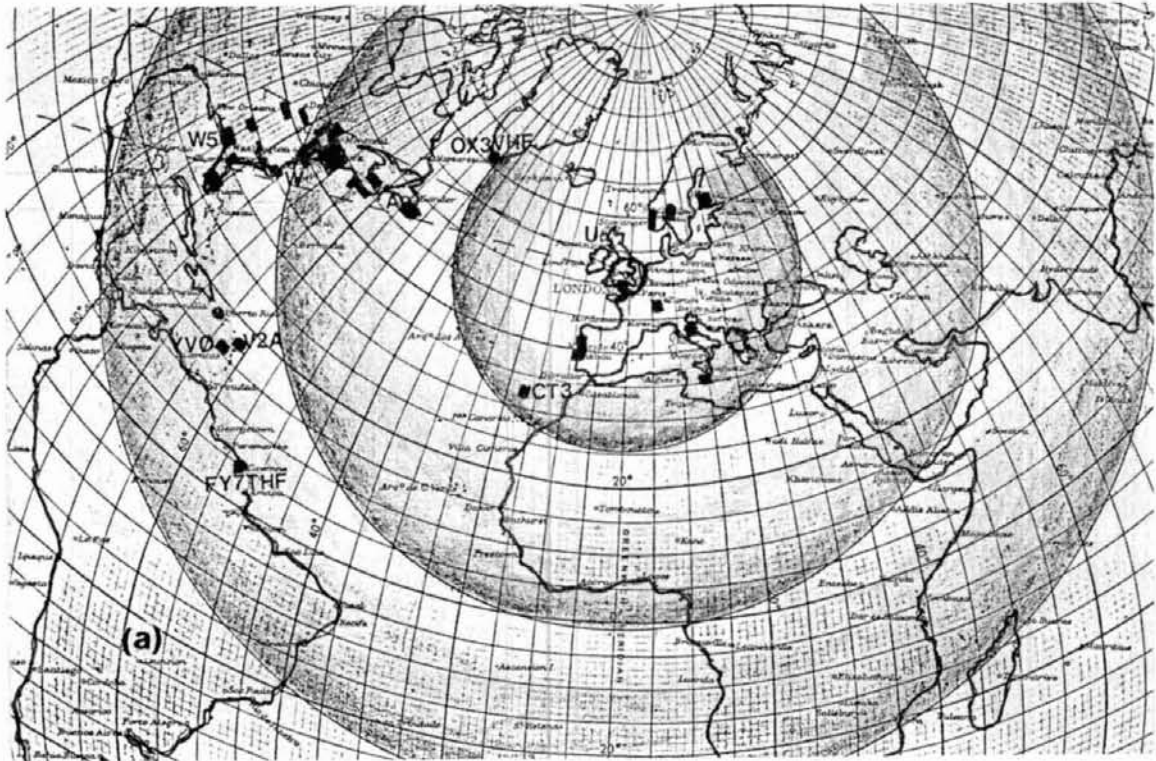

fig. 3. Distribution of 50-MHz propagation from England and Wales (black areas) during 1987 plotted on a Great Circle projection centered on Greenwich. The 50-MHz beacons OX3VHF and FY7THF are indicated, also the ionosondes on Wallops Island (W), Argentina (A), South Uist (U), and Slough (S). The shading shows the areas with highest probability of contact assuming: (a) Double hop transatlantic  $E_s$  propagation, (b) Triple hop transatlantic  $E_s$  propagation.

**Table 1. Summary of principal 50-MHz openings<sup>11</sup> during 1987 used in fig. 3. Callsigns and prefixes are in bold. †IARU World Locator System<sup>12</sup>.**

Date	Start	End	Locators† worked/heard
May 25	1605	1830	IN80, JN36
to	2012	2048	<b>FY7THF</b>
May 26	2220	0037	EN90, EM74, EM90, FM09, FM18, FM19, FM25, FN31, FN32, FN42, FN43, FN44, FN53, GN37
Jun 7	1253	1552	FN43, FN44, IN61, JM75, JN53, JN64, JO45, JO65, JO67, KM64
Jun 15	1643	2041	FK97( <b>V2A</b> ), IN53, IN60, IN61, JN02, KM64, KP01, JN36, JN87
Jun 15	2328	2343	EM94, FM04, FM15
Jun 17	2136	0042	EM70, EM79, FM09, FM18, FM19, FM29, FN20, FN31, FN32, FN42, FN43, FN44, FN53, GN37
Jun 18	1155	1211	EL96, EL97
	1610	1940	IO54, IP62, JN11, JN47, JN58, JN64, JO43, JO45, JO55, JO65, JO67
	2006	2040	FN44, FN74, GP60( <b>OX3VHF</b> )
	2134		<b>FY7THF</b>
Jun 19	1725		EN86, FM18, FM29, FN20, FN21, FN24, FN25, FN31, FN32, FN34, FN42, FN43, FN44, FN74,
		2002	GN37, <b>FY7THF</b>
Jun 21	1714		FM28, FM29, FN12, FN20, FN21, FN24, FN25, FN31, FN32, FN34,
		2200	FN41, FN42, FN43, FN44, FN74, FN84
Jun 24	1451		JM75
	1714	1830	FK85( <b>YV0</b> )
	1917	2034	IM59, JN11, JN12
Jul 10	1908	2116	GP60( <b>OX3VHF</b> ), JP61, KP01
Jul 17	1815		EN81, FN91, FM19, FM29, FN13, FN20, FN21, FN24, FN25, FN29, FN31, FN32,
		2200	FN41, FN42, FN43, FN44, FN51, FN53, FN84, FN86, JO67, JP61
Jul 19	0715	2010	IM12( <b>CT3</b> ), IM59, JN69, JO28, JO29, JO53, JO59, JO65, JP61
Jul 21	1645	1731	JN13, JN33, JP61
	1829	2250	FM15, FM28, FN20, FN31, FN32, FN41, FN42, FN43, FN44, FN53, FN74, FN84, GN37

Thirdly, stations at both ends of the path will in general have an advantage in height compared with the simple model, which assumes both stations at sea level, and thus a horizon at zero distance! For a height of 100 m, this geometric horizon becomes 35 km, increasing to 50 km at 200 m height. If stations on either end were situated at 200 m ASL with their horizon at sea level, their range (ignoring refraction effects) would be increased by 100 km. There is an effect counteracting this, however; ground reflection inclines the principal antenna lobes upwards by an angle depending on the radiation pattern, the antenna height, and the nature of the surrounding land.

To summarize, in the situation in **fig. 1B**, it should not be surprising if the maximum observed skip distances exceed that derived from the simple approach of Kimbell<sup>9</sup> by some hundreds of km.

### multiple hop $E_s$

The locations of long distance stations heard or worked in the United Kingdom on 50 MHz during 1987 (**table 1**) are plotted on maps (**figs. 3A** and **3B**) centered on Greenwich, using a projection in which directions and distances are true globally along great circle paths measured from the central region (circled). The locations of the North American stations are shown separately and on a larger scale for a few major openings on **fig. 4**. Note that all times quoted in this article are UTC.

**Table 1** and **fig. 4** show that the majority of openings to the United States in 1987 had a similar pattern, most of the stations contacted being in a rather limited area. This is also one of the characteristics of  $E_s$  openings on the higher frequencies. The northerly limit is given by the region in which midlatitude  $E_s$  is normally found (**fig. 6**), and the southern extent is bounded by the sea. It is assumed that the most distant stations contacted correspond to the limiting case in terms of chordal hops, which do not quite touch the earth between  $E_s$  reflections (**fig. 1D**). As many authors<sup>13</sup> have noted, there is no need to invoke a reflection off the sea between ionospheric reflections; this would only decrease range and signal strength.

The outer limits of the zones shown in **fig. 3** are meant to indicate the maximum range normally found from  $E_s$  propagation. Obtainable range extends towards the observer with increasing ionization density, but the probability falls rapidly at the same time (indicated by the shading). Unusually intense ionization at one or more of the reflection points will fill in the intermediate areas, but its occurrence will be rarer. Maximum range is statistically the most probable, and chordal hops can occur at densities below that needed for ground-to-ground liaison. The outer zone limits represent the points of nearest approach to the earth for maximum range chordal hops. This does not mean to imply that multi-hop propagation has an intermediate ground reflection.



The HF4B "Butterfly"<sup>TM</sup>  
A Compact Beam  
for 20-15-12-10 Meters

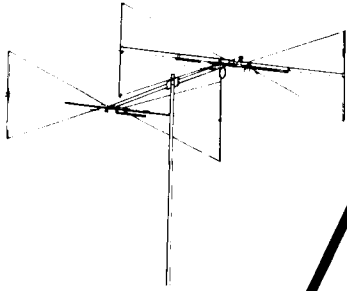

- Unique design reduces size but **not** performance.
- No lossy traps, full element radiates on all bands.
- Retrofit kit for 17 meters coming soon.
- Turns with TV rotor
- Only 17 lbs.

HF ANTENNAS FROM BUTTERNUT

### Butternut Verticals

Butternut's HF verticals use highest-Q tuning circuits (not lossy traps!) to outperform all multiband designs of comparable size!

#### Model HF6V

- 80 40 30 20 15 and 10 meters automatic bandswitching.
- Add-on kit for 17 and 12 meters available now
- 26 ft tall

#### Model HF2V

- Designed for the low-band DXer
- Automatic bandswitching on 80 and 40 meters
- Add-on units for 160 and 30 or 20 meters
- 32 feet tall - may be top loaded for additional bandwidth

For more information see your dealer or write for a free brochure



BUTTERNUT ELECTRONICS CO.

405 East Market Lockhart, Texas 78644

## SPECIALISTS IN FAST TURN P.C. BOARDS

PROTO TYPE P.C. BOARDS  
**AS LOW AS \$25.00**

- SINGLE & DOUBLE SIDED
- PLATE THROUGH HOLES
- TEFLON AVAILABLE
- P.C. DESIGN SERVICES

FOR MORE INFORMATION \_\_\_\_\_

**Midland Technologies**

34374 EAST FRONTAGE ROAD  
BOZEMAN, MT 59715 (406) 586-1190

✓ 116

## KENNEDY ASSOCIATES

Stocking all major lines. San Antonio's Ham Store. Great Prices—Great Service. Factory authorized sales and service. Hours: M-F 10-6; SAT 9-3

## KENWOOD

YAESU



ICOM

Amateur Radio Division  
5707A Mobud  
San Antonio, TX 78238  
Telephone: 512-680-6110



✓ 117

## NEMAL ELECTRONICS

- \*Complete Cable Assembly facilities MIL-STD-45208
- \*Commercial Accounts welcome- Quantity pricing \* Same day shipping most orders
- \*Factory authorized distributor for Alpha, Amphenol, Belden, Kings, Times Fiber

Call NEMAL for computer cable, CATV cable, Flat cable, semi-rigid cable, telephone cable, crimping tools, D-sub connectors, heat shrink, cable ties, high voltage connectors.

### HARDLINE 50 OHM

FXA12 1/2" Aluminum Black Jacket.....	89/ft
FLC12 1/2" Cablewave corr. copper blk jkt .....	1.59/ft
FLC78 7/8" Cablewave corr.copper blk jkt .....	3.92/ft
NM12CC N conn 1/2" corr copper m/f .....	23.00
NM78CC N conn 7/8" corr copper m/f .....	54.00

### CONNECTORS-MADE IN USA

NE720 Type N plug for Belden 9913 .....	\$3.95
NE723 Type N jack for Belden 9913 .....	4.95
PL259 standard UHF plug for RG8,213.....	65
PL259AM Amphenol PL259 .....	.89
PL259TS PL259 teflon ins/silver plated.....	1.59
PL259AM Amphenol female-female (barrel).....	1.45
UG175/UG178 reducer for RG8/59 (specify).....	22
UG21DS N plug for RG8,213,214 Silver .....	3.35
UG83B N jack to PL259 adapter, teflon .....	6.50
UG148A SO239 to N plug adapter, teflon .....	6.50
UG255 SO239 to BNC plug adapter, Amphenol.....	3.29
SO239AM UHF chassis mt receptacle,Amphenol.....	.89

### COAXIAL CABLES (per ft)

1180 BELDEN 9913 very low loss .....	
1102 RG8/U 95% shield low loss foam 11ga.....	C
1110 RG8X 95% shield (mini 8) .....	A
1130 RG213/U 95% shield mil spec NCV jkt.....	L
1140 RG214/U dbl silver shld mil spec.....	L
1705 RG142B/U dbl silver shld, teflon ins .....	L
1310 RG217/U 50 ohm 5000 watt dbl shld .....	L
1450 RG174/U 50 ohm .100" od mil spec .....	L

### ROTOR CABLE-8 CONDUCTOR

8C1822 2-18ga and 8-22ga .....	CALL
8C1820 2-18ga and 8-20ga .....	

\*Shipping: Cable \$3/100, Connectors \$3.00, Visa/Mastercard \$30 min, COD add \$2.00  
Call or write for complete price list. NEMAL's new 38 page CABLE AND CONNECTOR SELECTION GUIDE is available at no charge with orders of \$50 or more, or at a cost of \$4 with credit against next qualifying order.

NEMAL ELECTRONICS, INC. 12240 NE 14th Ave. N. Miami, FL 33161  
(305) 893-3924 Telex 6975377 24hr FAX (305)895-8178

## Multiband QRV Dipole/V/Sloper

Ready to Use	Tough	Full Legal Power
Fastest Install	Flexible	No Lossy Traps
Coax Feed	Kink-Proof	Low Noise
2500 V Insul		Never Corrodes

QRV - \$49.95 30-10 51 ft. long  
QRV - \$59.95 160-10 102 ft. long  
Includes 51 page Tech Manual. Add \$5 Post & Handling.

Infopack \$1 by 1st class mail.  
Dept H, Provo, UT 84603-1144

AntennasWest  
(801) 373-8425

✓ 118

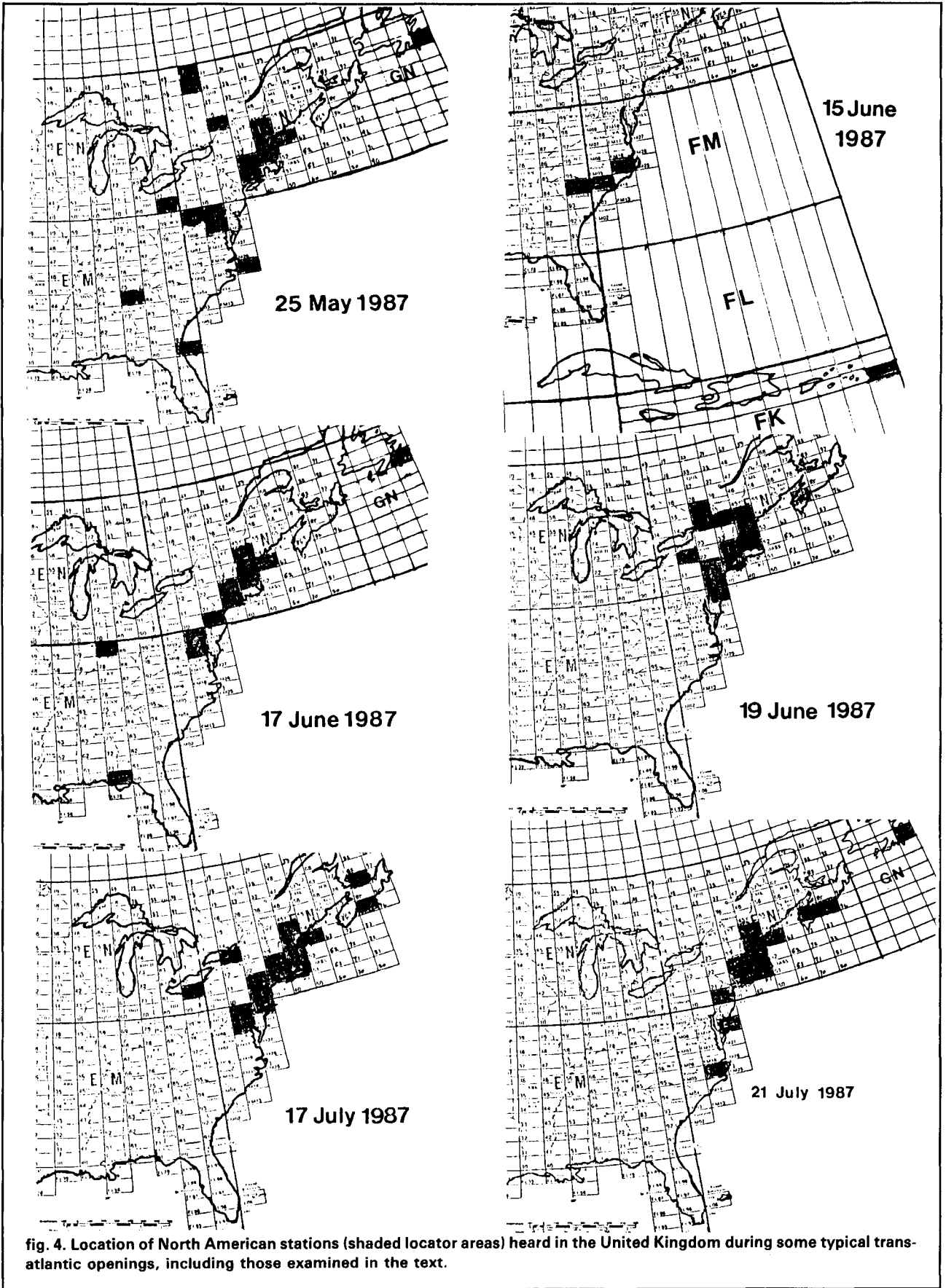

fig. 4. Location of North American stations (shaded locator areas) heard in the United Kingdom during some typical transatlantic openings, including those examined in the text.

**Figure 3A** illustrates two-hop propagation to the main area of North America, corresponding to a maximum skip distance of about 3000 km and a minimum of 2000 km, distances which are credible in view of the preceding discussion. Bands corresponding to one, two, and three hops have been drawn using these limits.  $E_s$  contacts at these distances on 144 MHz are very rare; contacts in the 1500 to 2000 km range are more common. The record distance for an  $E_s$  contact from the United Kingdom on 144 MHz is about 3475 km to Cyprus, while the world record  $E_s$  distance on 144 MHz is 3865 km from Lebanon to Portugal. These distances seem excessive to be single hop, even taking into consideration the previous arguments, but are consistent with twice the common-hop distance. Note that in each case the countries involved lie in a zone of high incidence of  $E_s$  (**fig. 6**), and double-hop propagation becomes more likely. In **fig. 3B** bands are shown corresponding to triple-hop propagation to North America, each hop being between 1350 and 2000 km which match the 144 MHz data well. **Figure 2** shows a minimum in this distance range for  $f/f_o < 7$  — that is, refractive propagation. The European 50-MHz contacts shown in **fig. 3** are also typically within this range.

No firm conclusion can be drawn at this stage as to whether **fig. 3A** or **fig. 3B** is the correct picture, but on balance the evidence suggests the latter. Although the reduced probability of finding a triple rather than a double coincidence of suitable  $E_s$  supports the two-hop case, it will be seen below that there are several instances of contacts indicating two hops between 1150 and 1500 km. It should be possible to infer the normal skip distance for multi-hop paths by examining logs of Amateurs in North America, where there are stations along the transcontinental east-west path, unlike across the Atlantic!

### estimate of probability

The principal objection to multiple hop  $E_s$  being accepted as the mechanism for transatlantic openings may be that the probability of suitable  $E_s$  "clouds" correctly positioned is too small. In Europe, this view seems to be based on experience of  $E_s$  at 144 MHz, forgetting the much more common propagation on 28 MHz. However, the time for which  $f_{max}$  exceeds a certain value decreases very rapidly with frequency. This is illustrated in **fig. 5** — a plot of the number of days during 1976 when a particular value of  $f_oE$  was exceeded at the Wallops Island ionosonde. These data were chosen for 1976 (one period previous in the solar cycle) because of the 15-minute sampling rate throughout the year; comparable data for 1987 was unavailable. Two lines are drawn in **fig. 5** showing the relation of  $f_o$  to  $f_{max}$ , assuming the secant law with

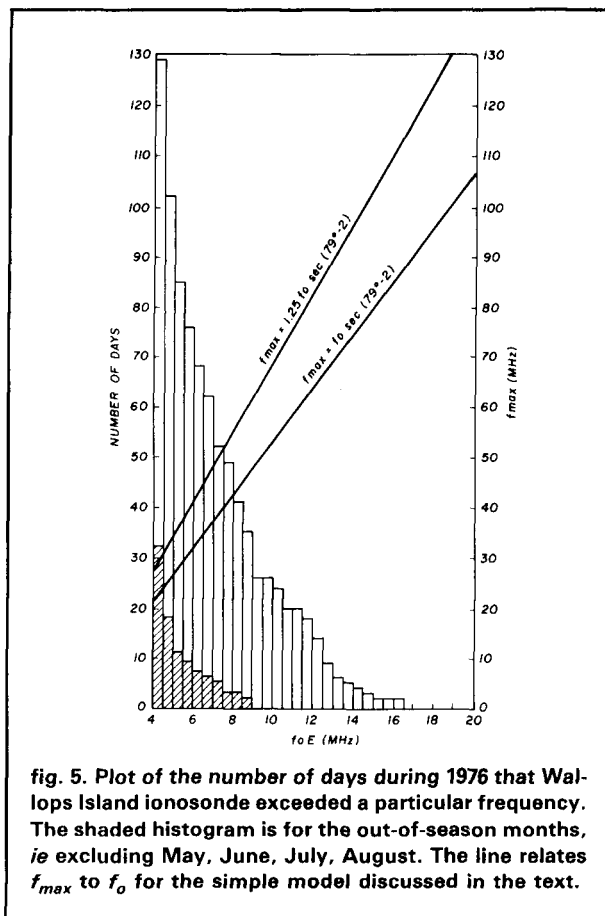

and without the correction factor  $\epsilon = 1.25$ . Note that  $f_{max} = 50$  MHz is exceeded on 52(26) days, compared with 128(76) days when  $f_{max} > 30$  MHz (uncorrected values are given in parentheses). Thus  $E_s$  is present at 50 MHz for 35 to 40 percent of the time it is found on 30 MHz.

I must point out the errors in using vertical ionosonde data in this way. A factor has already been introduced to correct the secant law. This factor was justified on account of the irregular nature of the  $E_s$  layer. The highest concentrations of ionization seem to be very small in extent, as is evidenced by the extremely limited areas of propagation on 144 MHz, and also by radar observations<sup>4</sup>. If the dimensions (in particular in the vertical direction, which is normally the minimum) become comparable with the wavelength (25 meters at 12 MHz), then an incident wave will be scattered rather than reflected, however concentrated the ionization. These patches may never be detected by ionosondes, providing a good justification for studies of point-to-point communication. In addition, the periods when the highest frequencies are propagated are very fleeting; at a sampling rate of 15 minutes, there is a good probability that these extreme excursions will be missed, either in time or in space.

# Radio Shack—The Technology Store®

## STATION ACCESSORIES AT OUR STORE NEAR YOU

### Versatile FET VOM

49<sup>95</sup>

10-Megohm Input—Works Like Solid-State VTVM



Quality! Rugged, with jumbo 5" meter scale. 28 ranges including handy 10 amps DC and 0-1 VDC. Continuity beeper. With leads, manual. #22-220

### Scientific Calc

27<sup>95</sup>

Folding Support For Easy Viewing



Advanced features and 68 functions—makes ticket upgrade math a snap. Handles complex numbers and up to 15 levels of parentheses. Auto shutoff. #65-989

### Complete Novice Study Package

19<sup>95</sup>

By Fred Maia, W5YI and Gordon West, WB6NOA

- Code Practice Cassettes
- Exam Questions and Answers



Attention Elmers! Here's everything a newcomer needs to prepare for the Novice test. Includes two quality cassettes for self-paced code learning, plus a study guide containing practice questions and answers. Durable foldup binder, too. #62-2402

### Spike Protectors

Guard Your Equipment!

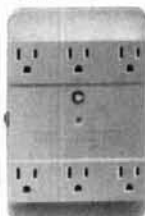

(1) (2)



- (1) Six-Outlet. Just plug in to convert one grounded outlet to six with MOV protection. Built-in breaker, noise filter, LED status light. 13A. #61-2786 . . . . . 24.95
- (2) Heavy-Duty Single Outlet. Featuring dual MOV protection and LED status light. 15A/120VAC. #61-2792 . . . . . 9.95

### Archerrotor®

59<sup>95</sup>



Why pay more? Radio Shack's reliable, UL listed rotator is just right for many VHF and small loaded HF beams. Cable extra. #15-1225

100' 3-Wire Cable. #15-1150, 7.95

### Extension Speaker



Superior to most built-ins! Improves tone quality of mobile or home rigs. Rugged 4" speaker has adjustable bracket, 10-ft. cord with 1/8" plug. #21-549 . . . . . 13.95

### WWV and Weather Monitor



Crystal Control

DXer's and storm spotter's best friend! Receives WWV time signals and solar info on 5, 10 and 15 MHz. Also receives local weather station on 162.4, 162.475 or 162.55 MHz. Battery extra. #12-148 . . . . . 39.95

### Soldering Helpers

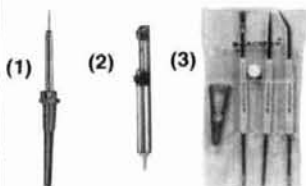

- (1) 12VDC, 30-Watt Soldering Iron. For on the spot repairs. 12-foot cord with cigarette lighter plug. #64-2105 . . . 4.99
- (2) Vacuum Desoldering Tool. Easy one-hand operation. #64-2098 . . . 4.95
- (3) 4-Piece Tool Set. Heat sink, brush/scrapper, probes. #64-2227 . . . . . 2.99

### Power Values



- (1) Plug-In 12VDC Adapter. Includes four AdaptaPlugs. #273-1652 . . . 10.95
- (2) Computer/Printer AC Line Cord. 10-ft. with grounded plug and CEE-type connector. #278-1257 . . . . . 3.99
- (3) Regulated Supply. Use VHF/UHF mobile at home. #22-120 . . . . . 39.95

### Solder-Type D-Sub



Description	Cat. No.	Each
9-Position Male	276-1537	1.49
9-Pos. Female	276-1538	2.49
Hood for Above	276-1539	1.19
25-Pos. Male	276-1547	1.99
25-Pos. Female	276-1548	2.49
Hood for Above	276-1549	1.29

### RS-232C Items

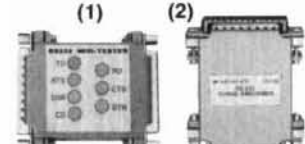

Connect Inline

- (1) RS-232 Mini Tester. Diagnose interface problems! Dual-color LEDs indicate status of D, RTS, DSR, CD, CTS and DTR lines. #276-1401 . . . . . 14.95
- (2) RS-232 Spike Protector. AC line protection is not enough! Use at each EIA port to stop spikes cold. Shielded. #276-1402 . . . . . 16.95

### Coax Fittings

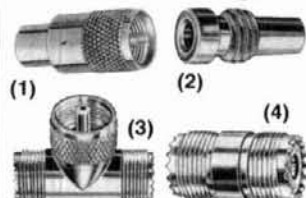

Fig.	Description	Cat. No.	Price
1	PL-259	278-205	2/1.99
2	Reducer for RG8M, RG59	278-204	2/ .99
2	RG58 Reducer	278-206	2/ .99
3	T Coupler	278-198	3.49
4	Double Female	278-1369	1.69

### Coax and Sealant



New Improved RG8 has 95% Shielding for Lower Loss



Cable	Cat. No.	Per Foot
RG8	278-1323	.40
RG8M	278-1328	.25
RG58	278-1326	.20
RG59	278-1327	.18

Sealant Tape. Keeps outdoor fittings dry and clean. #278-1645 . . . . . 2.49

### Audio Adapters



- (1) 8-Pin Mike Plug. #274-025 . . . 2.19
- (2) Headphone Adapter. Accepts 1/8" stereo plug and plugs into 1/4" monaural jack. Use lightweight "mini" phones with your Ham equipment. #274-348 . . . 1.99
- (3) Plug Adapter. As above, but accepts 1/8" mono plug. #274-325 . . . 1.59
- (4) H-T Adapter. Accepts 1/8" plug, plugs into 1/2" jack. #274-381 . . . 1.99

### Parts "Hotline"



Fast Service!

Your Radio Shack store manager can special-order many parts and accessories not listed in our catalog—tubes, ICs, semis, crystals and more. No minimum order. No postage charge.

Over 1000 items in stock! Binding Posts, Books, Breadboards, Buzzers, Capacitors, Chokes, Clips, Coax, Connectors, Fuses, Hardware, ICs, Jacks, Knobs, Lamps, Multimeters, PC Boards, Plugs, Rectifiers, Resistors, Switches, Tools, Transformers, Transistors, Wire, Zeners, More!

Prices apply at participating Radio Shack stores and dealers

**Radio Shack**  
The Technology Store™

A DIVISION OF TANDY CORPORATION

# Gunnplexers & accessories 10 & 24 GHz



A. Microwave Associates 10 GHz Gunnplexer. Two of these transceivers can form the heart of a 10 GHz communication system for voice, mcw, video or data transmission, not to mention mountaintop DXing! MA87141-1 (pair of 10 mW transceivers) \$251.95. Higher power units (up to 200 mW) available. B. Microwave Associates 24 GHz Gunnplexer. Similar characteristics to 10 GHz unit. MA87820-4 (pair of 20 mW transceivers) \$739.20. C. This support module is designed for use with the MA87141 and MA87820 and provides all of the circuitry for a full duplex audio transceiver system. The board contains a low-noise, 30-MHz fm receiver, modulators for voice and mcw operation, Gunn diode regulator and varactor supply. Meter outputs are provided for monitoring received signal levels, discriminator output and varactor tuning voltage. RXMR30VD assembled and tested \$119.95. D. Complete, ready to use communication system for voice or mcw operation. Ideal for repeater linking. A power supply capable of delivering 13 volts dc at 250 mA (for a 10 mW version), microphone, and headphone and/or loudspeaker are the only additional items needed for operation. The Gunnplexer can be removed for remote mounting to a tower or 2 or 4 foot parabolic antenna. TR10GA (10 GHz, 10 mW) \$399.95. Higher power units available. TR24GA (24 GHz, 20 mW) \$639.95. Also available: horn, 2 and 4 foot parabolic antennas, Gunn, varactor and detector diodes, search and lock systems, oscillator modules, waveguide, flanges, etc. Call or write for additional information. Let ARR take you higher with quality 10 and 24 GHz equipment!

## Advanced Receiver Research

Box 1242 • Burlington CT 06013 • 203 582-9409



## WORLD'S SMALLEST WEATHER STATION



THE TW-2 MICRO WEATHER STATION INCLUDES A COMPUTER MODULE, THE AN-2 ANEMOMETER, AND 40' OF LEAD IN CABLE. FOR ONLY \$159.95.

WIND SPEED	AUTO SCAN
WIND DIRECTION	METRIC / STANDARD
WIND CHILL	FOUR WAY POWER
WIND GUST RECORD	NICAD READY
TEMPERATURE	MOUNTING OPTIONS
H/L/LOW TEMP RECORD	ONE YEAR WARRANTY

\*\* SATISFACTION GUARANTEED \*\*

MAGNAPHASE INDUSTRIES, INC.

MADE IN U.S.A. 1502 PIKE STREET N.W. AUBURN, WA 98001

ORDERS ONLY: 800-322-1502

INFORMATION: 206-735-0374 FAX: 206-735-9044

✓ 121

## "NEW" SUPER LINEAR ANTENNA SYSTEM

MODEL	FREQUENCY	GAIN	POWER	LENGTH	USE	PRICE
CA-2x4z	146 MHz 446 MHz	8.2dB 11.5dB	200 W	15'4"	Base	\$192.85
CA-1243E	446 MHz 1.2GHZ	8.5dB 10.1dB	100 W	4'8"	Base	\$ 85.95
CA-901	146/446/1.26GHZ	3/6/8.4dB	150 W	3'5"	Base	\$ 91.55
CFC-771	900-930MHZ	7.14dB	50 W	4'5"	Base	\$ 97.40
CA-1221S	1260/1300	15.5dB	100 W	7'8"	Base	\$151.90
CA-2422S	2400/2450	15.3dB	100 W	4'8"	Base	\$173.55

### NEW! SWR Power Minimizers

CM	200 —	144 - 150 MHZ	\$ 62.50
CM	300 —	200 - 230 MHZ	\$ 62.50
CM	400 —	420 - 460 MHZ	\$ 62.50
CM	900 —	900 - 930 MHZ	\$ 93.50
CM	1200 —	1200 - 1300 MHZ	\$ 93.50

DUAL & TRI BAND MOBILE ANTENNA'S DUPLEXERS - TRI PLEXERS

Dealer inquiries welcomes.



(714) 630-4541  
1275 N. Grove St., Anaheim, CA 92806

Specifications and prices subject to change without notice or obligation.

✓ 119

## NEW SUPER LONG PLAY TAPE RECORDERS

12 Hour Model — \$105.00\*  
USES D-120 TAPE

Modified Panasonic Slimline. high quality, AC-DC Recorders provide 6 continuous hours of quality recording & playback on each side of cassette for a total of 12 hours. Built-in features include:  
• Voice level control • Digital counter, etc. TDK DC 120 Cassette Furnished.



### PHONE RECORDING ADAPTER

Records calls automatically. All Solid state connects to your telephone jack and tape recorder. Starts recording when phone is lifted. Stops when you hang up. \$24.50\*  
FCC APPROVED



### VOX VOICE ACTIVATED CONTROL SWITCH

Solid state. Self contained. Adjustable sensitivity. Voices or other sounds automatically activate and control recorder. Uses either recorder or remote mike. \$24.95\*  
\*Add for ship & hdlg. Phone Adapter & Vox \$1.50 ea. Recorders \$4.00 ea. Cal. Res. add tax. Mail order, VISA, M/C, COD's OK. Money Back Guarantee. Qty. disc. avail., Dealer Inquiries invited, Free data. ©



AMC SALES INC. Dept# 9335 Lube  
St., Box 928, Downey, CA  
90241 Phone (213) 869-8519

✓ 122



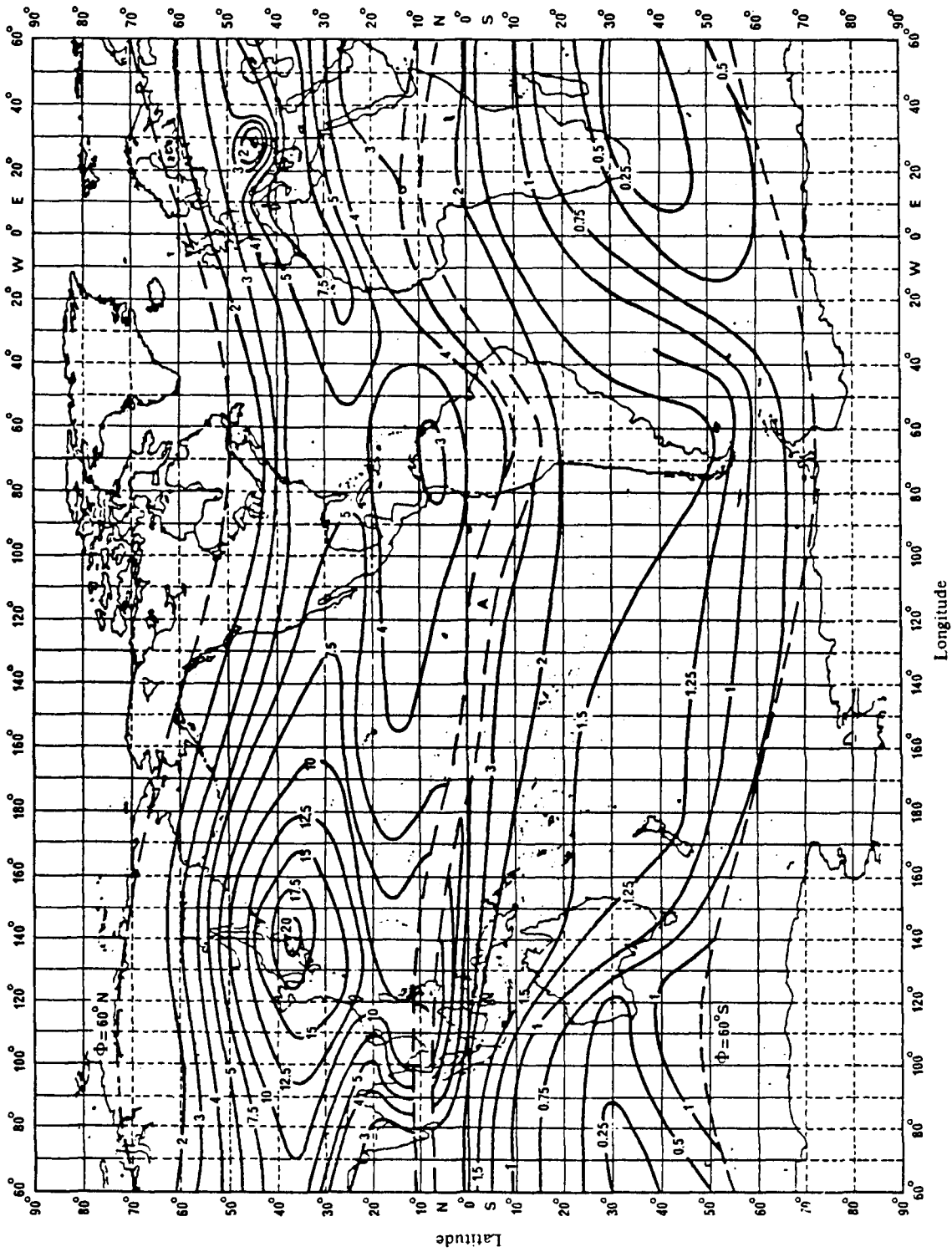

fig. 6. Map showing the percentage of time  $f_oE_s$  exceeds 7 MHz in the temperate zones between May and August (Northern Hemisphere) and between November and February (Southern Hemisphere)<sup>1</sup> (reproduced by permission of ITU).

So while the figures above are likely to be good estimates, the data cannot be extrapolated to 144 MHz, where **fig. 5** shows that an  $f_{max}$  of 144 MHz was never reached! The lack of appreciation of these factors has led a number of commentators in the past to disbelieve Amateur reports of 144 MHz  $E_s$ !

**Figure 5** was used to estimate the number of days on which 50-MHz propagation by  $E_s$  was possible. An estimate of the total time this was possible can be made from a CCIR document<sup>9</sup>. This gives for Region A (Europe and North Africa)  $f_oE_s$  exceeding 7.5 MHz, corresponding to  $f_{max} > 50$  MHz using  $\epsilon = 1.25$  for 2.5 percent of the time, or about 46 hours, in the period 0800 to 2300 UTC from May through August. The equivalent value for Region B (North America) is 3.5 percent, or 65 hours. Split between the 52 days on which  $f_{max} > 50$  MHz at Wallops Island, as evaluated above, this implies an average opening of more than one hour. From **table 1** it seems that the days when transatlantic communication occurred were those in which the  $E_s$  lasted much longer. These graphs unfortunately do not extend beyond  $f_oE_s = 12$  MHz, probably for reasons similar to those listed above, so again estimates cannot be made for 144 MHz.

### correlation between European and transatlantic propagation

There is no dispute that  $E_s$  is the propagation mechanism of 50-MHz contacts made over distances of 1000 to 2000 km during the summer months. From the United Kingdom, these were reported on no less than 40 days out of the 61 in June and July (66 percent). Compare this with the 52 days during 1976 when Wallops island ionosonde suggested that 50-MHz propagation was possible, estimated above from  $f_o$ . Transatlantic propagation was reported on 8 of these days (13 percent). The probability of both occurring on the same day if their origins are unrelated (that is, due to different mechanisms) is 66 percent  $\times$  13 percent = 8.6 percent, or 5.2 days. In fact, 7 (11 percent) out of 8 of the days when North American stations were heard had earlier produced European contacts. Although the difference of 2 days is hardly significant in a statistical sense, it could become so if this test were extended to months during which  $E_s$  occurred less frequently.

### ionosonde data at the time of 50-MHz openings

If  $E_s$  can be shown to be present on both sides of the Atlantic during transatlantic openings, this would constitute very strong circumstantial evidence for this mode of propagation. Unfortunately the current distribution of active ionosondes is significantly reduced compared with the IGY era. The four active and relevant to this investigation are shown in **fig. 3**. They are

located at Slough, southern England; South Uist, Outer Hebrides, Scotland; Argentia near St. John's, Newfoundland; and Wallops Island off the coast of Maryland, United States. A number of openings of special interest are described next.

### July 10, 1987

First consider the evidence for  $E_s$  propagation into the nearer zones of **fig. 3**. The Greenland 50-MHz beacon OX3VHF, situated just above 60 degrees North in latitude, is above the zone where  $E_s$  is prevalent (see **fig. 6**). But on July 10, 1987, this beacon was audible throughout the United Kingdom between 1945 and 2115 UTC (**table 1**), at distances between 2500 and 3000 km. At 2000 UTC the South Uist ionosonde, located near the great circle path (**fig. 3**), shows  $E_s$  with  $f_o = 10.2$  MHz, amply exceeding the minimum  $f_o$  for 50-MHz propagation. An hour earlier it had reached the highest value of  $f_oE_s$  recorded at this sta-

**Table 2.** Ionosonde data for July 10, 1987. The  $f_oE_s$  in brackets are the monthly median values for that time of day.

UTC	Slough		South Uist	
	$f_oE_s$ MHz	h' km	$f_oE_s$ MHz	h' km
1600	3.4(4.7)	110	3.2	105
1700	3.5(4.4)	110	3.2	105
1800	3.0(4.4)	110	3.8	125
1900	3.0(4.3)	115	12.1	120
2000	3.1(4.4)	110	10.2	110
2100	3.7(3.7)	105	8.4	110
2200	3.8(3.8)	110	2.5	120
2300	2.9(3.4)	115		

tion during the year, 12.1 MHz (**table 2**). This intense  $E_s$  to the north also gave short-skip  $E_s$  contacts into Norway and Finland (1140 to 1600 km). Considering the high values of  $f_o$  observed, the propagation of OX3VHF is consistent with two rather short hops of 1250 to 1500 km, or one of 2500 to 3000 km (**fig. 3B**).

### July 19, 1987

At the southerly end of this arc (there is only sea in between) on July 19, 1987, several stations contacted Madeira (marked CT3 in **fig. 3**) between 1600 and 1836 UTC at distances of 2300 to 2600 km. At the same time many stations were contacted in Portugal, ranging between 800 and 1500 km, so it seems highly probable that two hops of 1150 to 1300 km were responsible. At around 1800 UTC a contact between Norway and Madeira took place, a distance of 2600 km. Since Norwegian stations were audible in the southern United Kingdom at the time, it is possible this was a triple-hop contact. Both the Slough and South Uist ionosondes show  $E_s$  present during this

RUTHERFORD APPLETON LABS. REMOTE YY DDD HMM OUTPUT FRQUY CAB XLZT NRW HEIG PP  
 #051 SLOUGH, U.K. DIGISONDE 256 1987 170 1759 124410001A15 CCE 4151 324 8208 C1  
 H(KM) 100 150 200 250 300 350 400 450 500 550 600 650

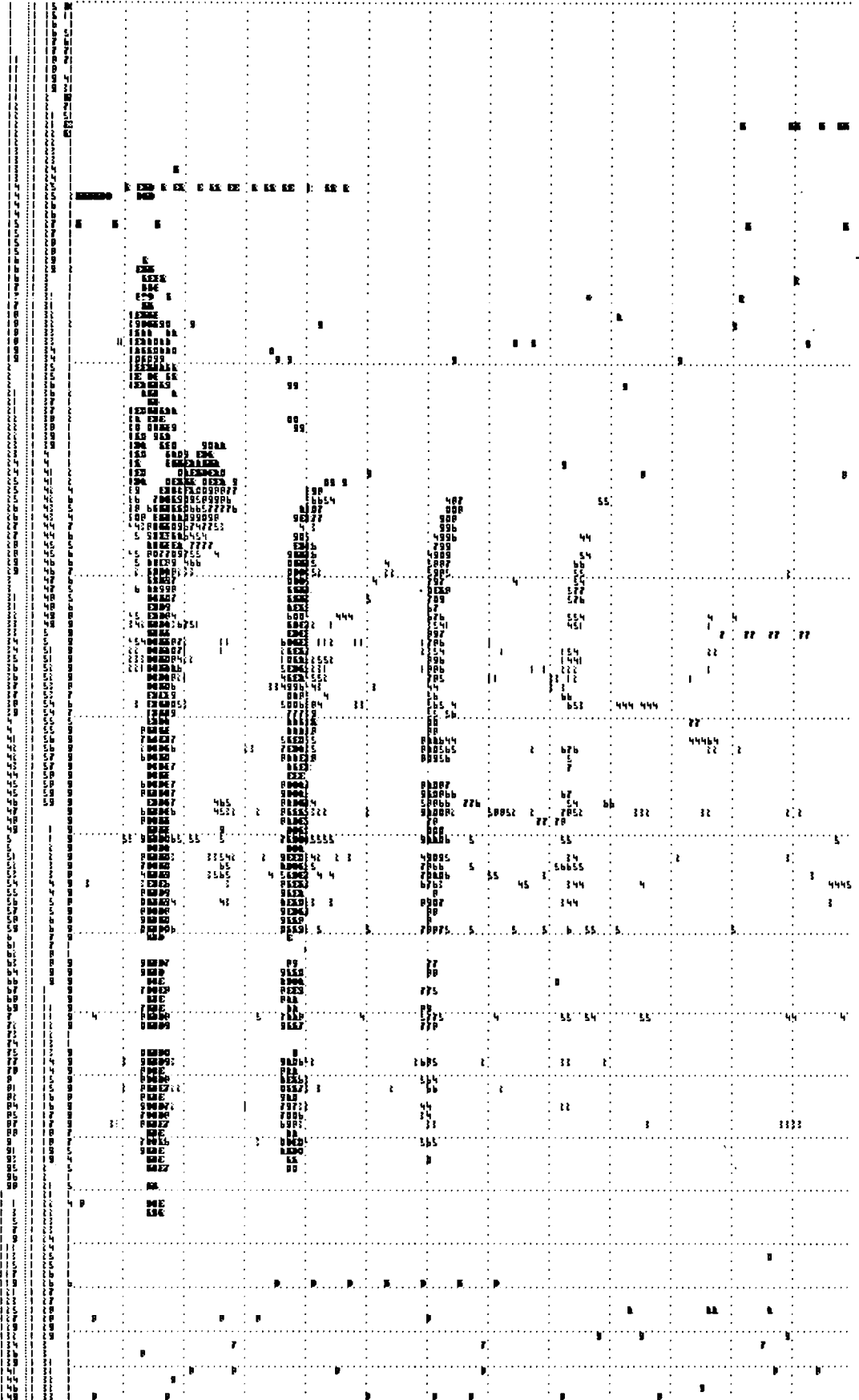

fig. 7. The ionogram recorded at Slough on June 19, 1987 at 1800 UTC. It shows at least four reflections from a blanketing  $E_s$  layer at a virtual height of 130 km.

**Table 3. Ionosonde data for July 19, 1987.**

UTC	Slough		South Uist	
	$f_oE_s$ MHz	$h' km$	$f_oE_s$ MHz	$h' km$
1500	5.5(5.0)	120	none	
1600	8.5(4.7)	115	4.7	130
1700	5.5(4.4)	120	3.2	105
1800	4.0(4.3)	120	4.5	105
1900	2.8(4.3)	125	3.5	135
2000	5.7(4.4)	115	2.65	180

time (table 3), though only one value (that for Slough at 1600 UTC) exceeds the  $f_o$  required for this skip at 50 MHz. Because the ionosonde samples only a very limited area once an hour, small high density clouds may not be observed. Transatlantic propagation was not recorded on either this or the next day, but July 21st produced a long list of North American stations heard in the United Kingdom.

### June 19, 1987

Now let's look at the transatlantic opening of June 19, 1987 occurring between approximately 1725 and 2000 UTC (table 1). The areas heard in central and southern England and Wales shown in fig. 4 are typical of other openings shown in the figure. The Slough ionosonde (table 4) shows  $E_s$  increasing from 1600 UTC, and  $f_o$  exceeding 7.5 MHz sometime between 1700 and 1800 UTC. Figure 7 shows the appearance of the ionosonde trace at 1800 UTC. The lowest trace represents the first reflection of the  $E_s$  layer; the simi-

**Table 4. Ionosonde data for June 19, 1987.**

UTC	Slough		South Uist	
	$f_oE_s$ MHz	$h' km$	$f_oE_s$ MHz	$h' km$
1500	5.9(4.0)	120		
1600	3.6(4.1)	150	3.9	165
1700	6.7(5.0)	125	4.0	145
1800	9.9(4.0)	115	5.2	130
1900	10.1(5.0)	115	5.3	125
2000	8.7(3.3)	115	4.6	120
2100	1.6(3.2)	-	8.7	110

lar ones above are the second, third, and fourth reflections, with an intermediate ground reflection between each one. The apparent heights of these layers were  $2h'$ ,  $3h'$ , and  $4h'$ . There was no sign of an F layer, so the  $E_s$  layer blanketed up to the highest frequency. By 2000 UTC the  $E_s$  was less dense, and had almost disappeared by 2100 UTC. This behavior correlates with the times that transatlantic signals were recorded. Because the first ionospheric reflection takes place in a northerly region of low  $E_s$  probability, it might be

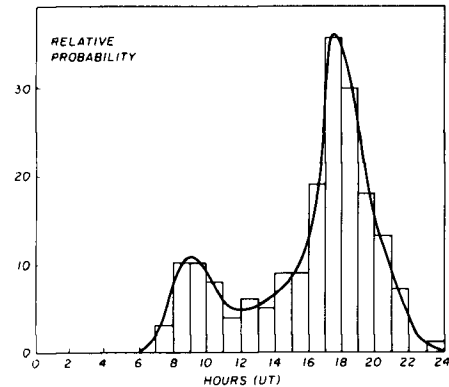

**fig. 8. Hours during which European  $E_s$  signals were reported on 50 MHz during summer of 1987. The curve is a freehand smoothing.**

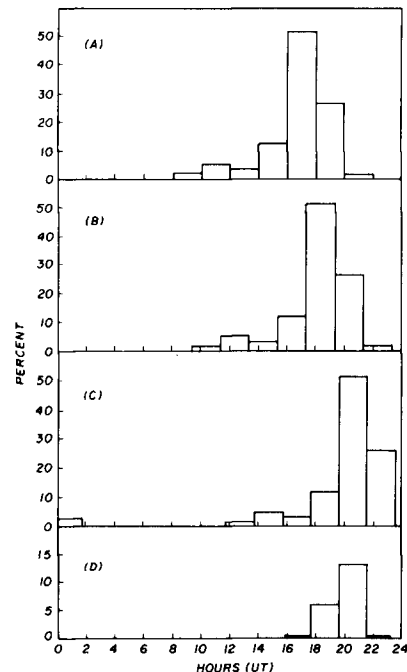
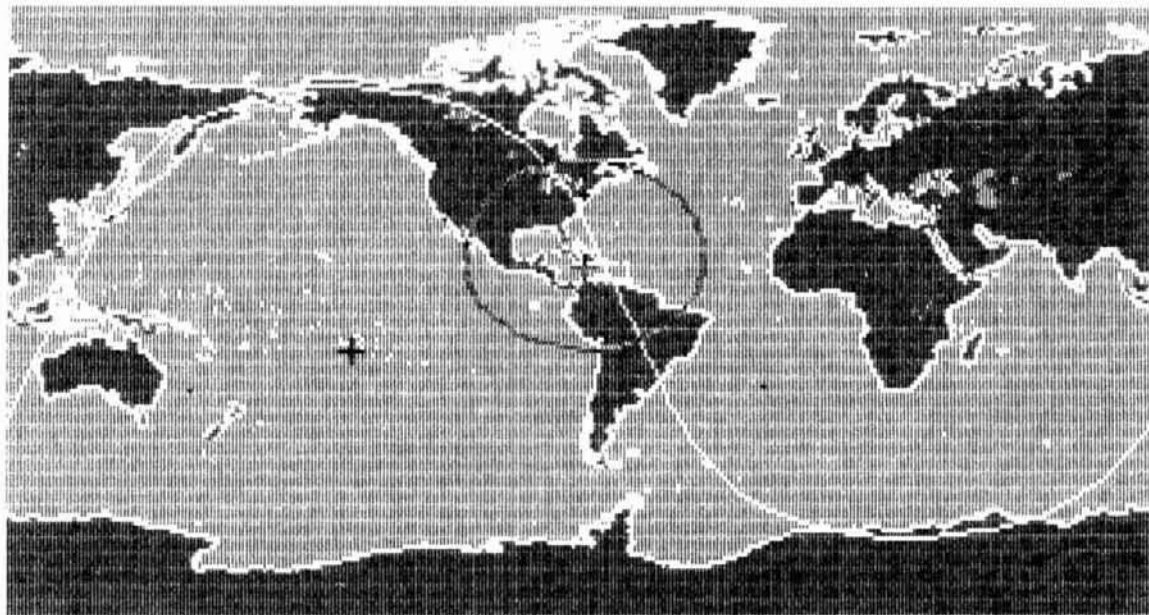

**fig. 9. (A) Distribution of 144-MHz  $E_s$  openings throughout the day binned in 2-hour intervals<sup>18</sup>; (B) and (C) the same distribution shifted to the position of the two ionospheric reflections on a transatlantic path; (D) the product of (B) and (C).**

expected that the presence of  $E_s$  in this region determines the path. The ionosonde at Slough, some 1200 km to the east, is the nearest. Unfortunately, the ionosonde at Argentia, Newfoundland, situated near the great circle path, was not operational at this time. But the Wallops Island ionosonde, some 2000 km to the southwest, does show the presence of  $E_s$ , though

# Satellite Tracking

with your PC and the Kansas City Tracker & Tuner



The **Kansas City Tracker** is a hardware and software package that connects between your rotor controller and an IBM XT, AT, or clone. It controls your antenna array, letting your PC track any satellite or orbital body.

The **Kansas City Tuner** is a companion product that is used in satellite work to provide automatic doppler-shift compensation. It interfaces to your radio through its serial computer control port (RS232) or "mike click" interface to update the receive and/or transmit frequencies once a second. It can be used in digital or analog modes. The **Tuner** is compatible with most rigs including the Yaesu 726 & 736, the ICOM 271/471, 275/475, and R-7000. Call regarding your specific rig.

The **Kansas City Tracker** and **Tuner** have several advantages over other products available today. They do not use your computer's COMM ports or hardware interrupts. The software runs in your computer's "spare time," letting you run other programs at the same time. Several Kansas City products can be installed in one PC, letting you control up to 16 separate antenna arrays at the same time.

The **Kansas City Tracker** consists of an interface card that can be plugged into a PC short-card slot, a Terminate-And-Stay-Resident (TSR) rotor control program, and a TSR status "pop-up" program. The **Kansas City Tracker** can be connected directly to a Yaesu/Kenpro 5400/5600 rotor controller, or to any other rotor on the market today using our Rotor Interface Option.

The rotor driver and status programs are TSR programs that attach themselves to DOS and "disappear." You can run other DOS programs while your antenna tracks its target under computer control at the same time. This unique feature is especially useful for satellite and land digital work, as communications programs like PROCOMM can be run while the PC aims the rotors at the same time. The status "pop-up" allows the user to view and change the current antenna position and upcoming pass information. The **Kansas City Tracker** is compatible with DOS 2.00 or higher, and will run under DESQ-VIEW.

## Satellite and EME Work

The **Kansas City Tracker** and **Kansas City Tuner** are fully compatible with AMSAT's QUIKTRAK (3.2) and with Silicon Solution's GRAFTRAK (2.0). These programs can be used to load the **Kansas City Tracker's** tables with more than 50 satellite passes. We also supply assembled & tested TAPR PSK modems with cases and 110v power supplies.

## DX, Contests, and Nets

Working DX or contests and need three hands? Use the **Kansas City Tracker** pop-up to work your antenna rotor for you. The **Kansas City Tracker** is compatible with all DX logging programs. A special callsign aiming program is included for working nets.

## Packet BBS

The **Kansas City Tracker** comes complete with special control programs that allow the packet BBS user or control-op to perform automated antenna aiming over an hour, a day, or a week. Your BBS or packet station can be programmed to automatically solicit mail from remote packet sites.

## Vision-Impaired Hams

The **Kansas City Tracker** has a special morse-code sender section that will announce the rotor position and status automatically or on request. The speed and spacing of the code are adjustable.

The **Kansas City Tracker** and **Tuner** packages includes the PC interface card, interface connector, software diskette, and instructions. Each Kansas City unit carries a one year warranty.

- KS Tracker package for the Yaesu/Kenpro 5400/5600 controller ..... \$169
- Interface cable for Yaesu/Kenpro 5400/5600 ..... \$ 19
- KC Tracker with Rotor Interface Option (to connect to ANY rotors) ..... \$199
- KC-Tracker and Tuner combination: Add to the price of the TRACKER version you need Mike-Click version .... \$ 59
- RS232-Interface version ..... \$ 79
- Assembled & Tested TAPR PSK modem with case & 110v power supply ..... \$199
- AMSAT QUIKTRAK software ..... \$ 75

Visa and MasterCard accepted.  
Shipping and handling: \$5, \$10 for 2nd day air, \$15 for international shipments. Prices subject to change without notice.

**L. L. Grace**

Communications Products

41 Acadia Drive • Voorhees, NJ 08043

Call (609) 751-1018 evenings & weekends (EST) for more info



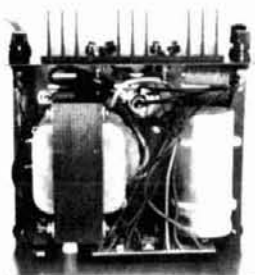

INSIDE VIEW — RS-12A

## ASTRON POWER SUPPLIES

• HEAVY DUTY • HIGH QUALITY • RUGGED • RELIABLE •

### SPECIAL FEATURES

- SOLID STATE ELECTRONICALLY REGULATED
- FOLD-BACK CURRENT LIMITING Protects Power Supply from excessive current & continuous shorted output
- CROWBAR OVER VOLTAGE PROTECTION on all Models except RS-3A, RS-4A, RS-5A.
- MAINTAIN REGULATION & LOW RIPPLE at low line input Voltage
- HEAVY DUTY HEAT SINK • CHASSIS MOUNT FUSE
- THREE CONDUCTOR POWER CORD
- ONE YEAR WARRANTY • MADE IN U.S.A.

### PERFORMANCE SPECIFICATIONS

- INPUT VOLTAGE: 105-125 VAC
- OUTPUT VOLTAGE: 13.8 VDC  $\pm$  0.05 volts (Internally Adjustable: 11-15 VDC)
- RIPPLE Less than 5mv peak to peak (full load & low line)
- Also available with 220 VAC input voltage



MODEL RS-50A



MODEL RS-50M



MODEL VS-50M

### RM SERIES



MODEL RM-35M

### 19" x 5 1/4" RACK MOUNT POWER SUPPLIES

MODEL	Continuous Duty (Amps)	ICS* (Amps)	Size (IN) H x W x D	Shipping Wt. (lbs.)
RM-12A	9	12	5 1/4 x 19 x 8 1/4	16
RM-35A	25	35	5 1/4 x 19 x 12 1/2	38
RM-50A	37	50	5 1/4 x 19 x 12 1/2	50
• Separate Volt and Amp Meters				
RM-12M	9	12	5 1/4 x 19 x 8 1/4	16
RM-35M	25	35	5 1/4 x 19 x 12 1/2	38
RM-50M	37	50	5 1/4 x 19 x 12 1/2	50

### RS-A SERIES



MODEL RS-7A

MODEL	Continuous Duty (Amps)	ICS* (Amps)	Size (IN) H x W x D	Shipping Wt. (lbs.)
RS-3A	2.5	3	3 x 4 1/4 x 5 1/4	4
RS-4A	3	4	3 1/4 x 6 1/2 x 9	5
RS-5A	4	5	3 1/2 x 6 1/2 x 7 1/4	7
RS-7A	5	7	3 3/4 x 6 1/2 x 9	9
RS-7B	5	7	4 x 7 1/2 x 10 1/4	10
RS-10A	7.5	10	4 x 7 1/2 x 10 1/4	11
RS-12A	9	12	4 1/2 x 8 x 9	13
RS-12B	9	12	4 x 7 1/2 x 10 1/4	13
RS-20A	16	20	5 x 9 x 10 1/2	18
RS-35A	25	35	5 x 11 x 11	27
RS-50A	37	50	6 x 13 3/4 x 11	46

### RS-M SERIES



MODEL RS-35M

MODEL	Continuous Duty (Amps)	ICS* (Amps)	Size (IN) H x W x D	Shipping Wt. (lbs.)
• Switchable volt and Amp meter				
RS-12M	9	12	4 1/2 x 8 x 9	13
• Separate volt and Amp meters				
RS-20M	16	20	5 x 9 x 10 1/2	18
RS-35M	25	35	5 x 11 x 11	27
RS-50M	37	50	6 x 13 3/4 x 11	46

### VS-M AND VRM-M SERIES



MODEL VS-35M

- Separate Volt and Amp Meters • Output Voltage adjustable from 2-15 volts • Current limit adjustable from 1.5 amps to Full Load

MODEL	Continuous Duty (Amps)			ICS* (Amps)	Size (IN) H x W x D	Shipping Wt. (lbs.)
	@13.8VDC	@10VDC	@5VDC	@13.8V		
VS-12M	9	5	2	12	4 1/2 x 8 x 9	13
VS-20M	16	9	4	20	5 x 9 x 10 1/2	20
VS-35M	25	15	7	35	5 x 11 x 11	29
VS-50M	37	22	10	50	6 x 13 3/4 x 11	46
• Variable rack mount power supplies						
VRM-35M	25	15	7	35	5 1/4 x 19 x 12 1/2	38
VRM-50M	37	22	10	50	5 1/4 x 19 x 12 1/2	50

### RS-S SERIES



MODEL RS-12S

- Built in speaker

MODEL	Continuous Duty (Amps)	ICS* (Amps)	Size (IN) H x W x D	Shipping Wt. (lbs.)
RS-7S	5	7	4 x 7 1/2 x 10 1/4	10
RS-10S	7.5	10	4 x 7 1/2 x 10 1/4	12
RS-12S	9	12	4 1/2 x 8 x 9	13
RS-20S	16	20	5 x 9 x 10 1/2	18

not reaching particularly high values of  $f_o$  during the opening (table 4).

### July 17, 1987

The distribution of contacts on July 17, 1987 is much the same (fig. 4). This time all three ionosondes show a sporadic E layer at the time of the opening, and the  $E_s$  trace again disappears from the Slough data about the time the opening terminated (table 5). The critical frequencies recorded are not very high, but see the comments made for July 19th. Note that this opening finished two hours later than that of June 19th, and that the F2 layer was also evident on the ionograms at both Slough and Argentina. This is unlikely to be material for two reasons: the  $f_oF2$  was too low (5.7 MHz at 2200 UTC) and the F2 layer does not show the inhomogeneous structure of  $E_s$ , and the area of propagation is similar to the other events. For the F layer to span the range of stations contacted during this opening in a single skip would require (using

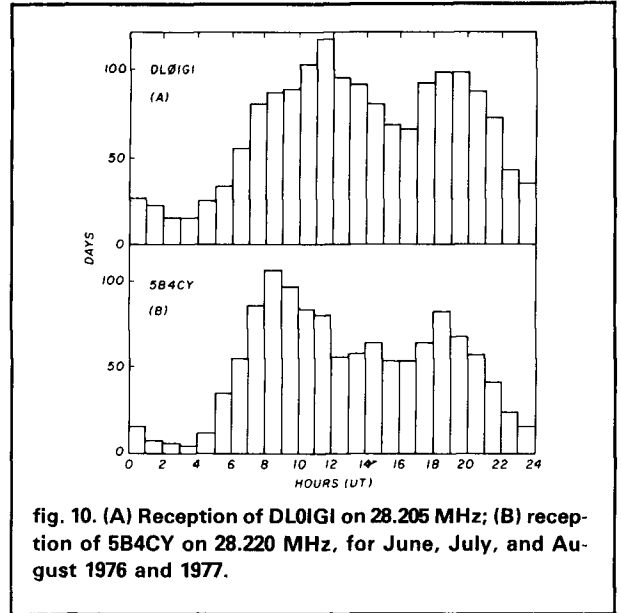

fig. 10. (A) Reception of DLØIGI on 28.205 MHz; (B) reception of 5B4CY on 28.220 MHz, for June, July, and August 1976 and 1977.

Table 5. Ionosonde data for July 17, 1987.

UT	Slough		Argentina		Wallops Is.	
	$f_oE_s$ MHz	h' km	$f_oE_s$ MHz	h' km	$f_oE_s$ MHz	h' km
1500	none					
1600	5.8	120				
1700	4.4	120				
1800	3.3	120				
1900	2.8	130				
2000	3.1	135	5.1	130	5.4	110
2100	2.8	120	4.2	120	4.2	110
2200	none		4.8	120	5.1	110
2300	none		3.7	120	6.1	110

the formula derived from fig. 1A) heights between about 350 and 800 km, and critical frequencies between 15 and 23 MHz — conditions certainly not observed on the ionograms!

### diurnal pattern of transatlantic contacts

It has been noted that the daily time distribution for 50-MHz transatlantic  $E_s$  contacts looks very different from that of typical European  $E_s$  openings<sup>9</sup>. I will show that the two are in fact strongly related. Figure 8 shows the hourly distribution of 50-MHz European DX during the summer of 1987.

This histogram was constructed by making an entry for each hour during which 6-meter continental European stations were logged by the stations contributing to table 1. This means that the same hour can appear several times in the histogram, making calibration in terms of probability difficult. The distribution obtained is typical of that found for  $E_s$ . A comparable plot for 144 MHz  $E_s$  given by Pasteur<sup>15</sup> is shown

in fig. 9A. Agreement with fig. 8 is good for the afternoon peak, while the morning peak occurs earlier on 50 MHz.

This double time structure is also found on the hf bands. Figures 10A and 10B show, for each hour of the day, the number of days that two 28-MHz beacons were observed at Keele, central England<sup>16</sup> during the months of June, July, and August 1976 and 1977, at a similar point in the solar cycle. Continuous observations were made using an automatic recorder. The distances imply that this propagation was either due to  $E_s$  or was exceptionally auroral; the latter was excluded on the basis of signal characteristics. Here the morning peak was the dominant one, and occurs somewhat earlier than on the higher bands. Now DLØIGI<sup>17</sup> at 3450 km must be double-hop propagation with the reflection taking place at around 13° and 24° E. Assuming that the pattern of occurrence moves with the sun, you can see that the peaks are shifted about the correct amount and in the correct direction (15° longitude is equivalent to 1 hour). Note also that

# Affordable Packet



**TINY-2** is our new low-cost high-performance standard for packet controllers. Thousands already in use, worldwide. A perfect beginner's unit.

Complete, wired **\$119.95** and tested, only

**BENEFITS and features of both units:**

- Conveniently portable size, 5x7" at only 18 oz.!
- Tiny enough for briefcase/portable, yet large enough for easy experimentation or repair.
- 1-year limited warranty, excellent customer support.
- RS-232 and TTL compatible—all connectors supplied.
- Latest AX.25 software, TCP/IP (KISS) module included.



**MICROPOWER-2** is our remarkably compact, 18-ounce unit using upgraded TAPR TNC-2 technology that requires less than 40 milliamps! For very portable operation, solar or battery, you need not pay more for a TNC that's about the size of your HT! Was \$179.95, **\$159.95** now at a low

- Fully compatible with ROSE & NET/ROM EPROMS.
- 32K RAM, 32K ROM, 4.9 MHz CPU.
- Xtal controlled modem, compatible with use on 10m HF/VHF/UHF

**TO ORDER**, toll-free with major charge card, call: **1-800-223-3511**

Technical support line: **813-874-2980**

## Pac-Comm

3652 West Cypress St., Tampa FL 33607

Please send:  Tiny 2  MicroPower-2  TNC-220 info  FREE Packet Catalog

Name _____	Call _____
Address _____	City _____
State _____	Zip _____
Card Number _____	Exp. Date _____

**Money Back Guarantee.** Add \$3. shipping/handling per order, FL addresses add 6%. Major Credit Card: give number, expiration and signature. FAX: 813-872-8696

## GOT SOMETHING TO SELL?

Try a classified ad in Amateur Radio's #1 magazine, *ham radio*.

Non-commercial ads \$.10 per word. Commercial ads \$.60 per word. No agency discounts allowed. 15% discount allowed for ads run 6 consecutive months without change. 33% discount allowed for ads run 12 months without change. Payable in advance. Deadline 15th of 2nd prior month.

From something simple to something exotic, *ham radio* readers are interested. And results prove that they BUY!

Send your ad in today. Send payment with order or give us your MasterCard or VISA and we'll charge your account for you.

Name \_\_\_\_\_  
 Address \_\_\_\_\_  
 City \_\_\_\_\_  
 State \_\_\_\_\_ Zip \_\_\_\_\_  
 Card Number \_\_\_\_\_  
 MasterCard VISA  
 Expires \_\_\_\_\_

**HAM RADIO MAGAZINE**  
 Greenville, NH 03048

## Look at our MOBILE MARK™

### "ON WINDOW" Line

PATENTED

#### VHF (140-175)

- No Hole
- Easy to Mount
- Rugged
- Superior Performance
- Radiator Snaps On and Off
- Competitively Priced

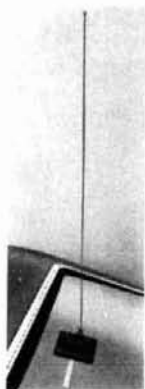

#### UHF (420-520)

- 3 db gain
- No Hole
- Easy to Mount
- Rugged
- Superior Performance
- Radiator Snaps On and Off
- Competitively Priced

○ **220 MHz NOW Available!** ○

**MOBILE MARK, INC.**  
 COMMUNICATIONS ANTENNAS

9001 Exchange Ave • Franklin Park, IL 60131 • 312-671-6690

*brings imagination and innovation to antennas ..... and has been since 1948 !!*

125

INTERNATIONAL MONTHLY MAGAZINE BY AND FOR ACTIVE RADIOAMATEURS

## Radiosporting

THIS IS IT! - FOR BIG GUNS & LITTLE PISTOLS

A magazine dedicated to quality and sportsmanship in amateur radio operating. Fresh, timely, practical and down to earth reading for little pistols and big guns. Written by the world's best in their fields: ON4UN, SM0AGD, LZ2CJ, VE3BMV, KH6BZF, DJ9ZB, ZS6BRZ, W1WY, N2SS, K7GCO, K4ZN, W4GF, VE3JTO, WB4ZNH, WB9TBU, KQ2M, NS6X, W2XQ, W3FG, KA3B, K1PLR, N3IK, N7CKD, VE3XN, ABØX, JE1CKA and others.

Includes DX News, QSL Info, 160m, 80m, 10m, 6m columns, DXpeditioning, Propagation, Awards, Contest Rules and Results, Traffic - Emergency, FCC News, New Products, Antennas, Technical News and articles, Equipment Reviews and Modifications, Computer Programs, Radio Funnies, Club Life, SWL, RTTY, VHF/UHF, Mail Box, Classified Ads and much more in a magazine format with the speed of a bulletin. **RADIOSPORTING** sponsors DX Centurion Award, Contest Hall of Fame and World Radio Championship contest.

"Your publication is superb! Keep it up!" Joe Reisert, W1JR  
 "Your W2PV articles are priceless. Your magazine is super!"  
 Rush Drake, W7RM

"Let me congratulate you on a very impressive magazine. Just what I've been looking for as a DXer and Contester!" Dick Moen, N7RO  
 "RADIOSPORTING, once received, cannot be tossed aside until it is read from cover to cover. Then reviewed again and again."  
 Chas Browning, W4PKA

"I take every ham magazine and can say without reservation that **RADIOSPORTING** is the first one read each month."  
 Joe Rudi, NK7U, "Oakland A's"

Subscription rates: 1 year USA \$18, Canada CDN\$28, Overseas US\$25; 2 years \$33, \$50, \$44 respectively. Single issue \$2.  
 USA First Class Mail add \$10/year, DX Air Mail add \$20/year.

**TRY US! SUBSCRIBE OR SEND \$1 FOR YOUR SAMPLE COPY.** VISA, MASTERCARD accepted.  
**RADIOSPORTING Magazine**  
 PO Box 282, Pine Brook, NJ 07058, USA Tel. (201) 227-0712

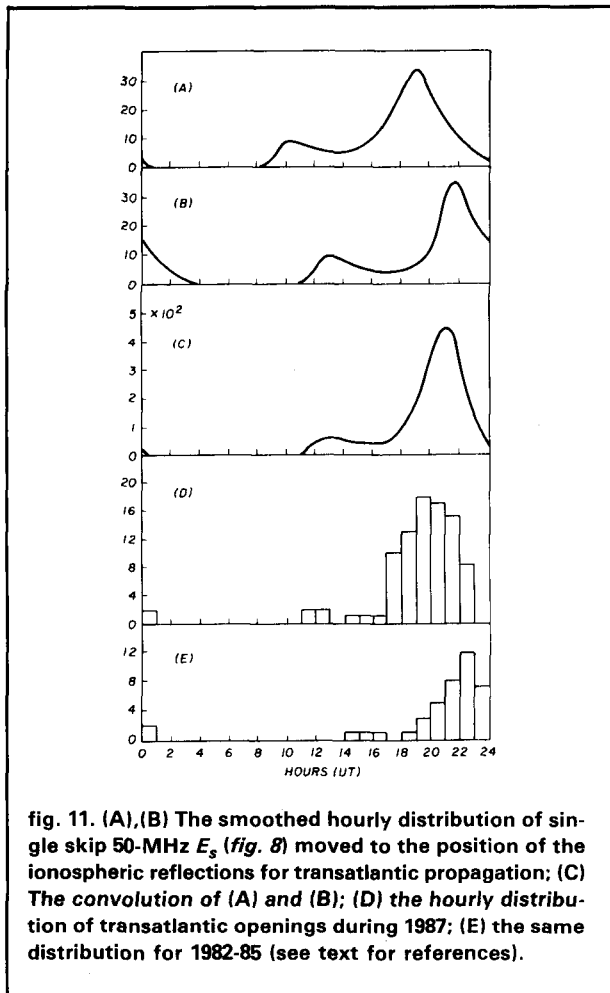

fig. 11. (A),(B) The smoothed hourly distribution of single skip 50-MHz  $E_s$  (fig. 8) moved to the position of the ionospheric reflections for transatlantic propagation; (C) The convolution of (A) and (B); (D) the hourly distribution of transatlantic openings during 1987; (E) the same distribution for 1982-85 (see text for references).

the single-hop beacon was audible for 1592 hours out of a total of 4416 hours, or 36 percent of the time, while the double-hop beacon was audible for 1222 hours, or 28 percent of the time. If the probability of the second reflection was equal to that of the first, the expected fraction of time when it would be audible is  $0.36^2 \times 100\% = 13\%$ . Obviously the occurrence of  $E_s$  at the two points of reflection was highly correlated, implying that the conditions for producing  $E_s$  on a certain day act over a considerable area. This has already been suggested from the correlation between European and transatlantic propagation on 50 MHz.

Returning now to the 50-MHz daily pattern — made up largely of contacts in the NNE and SSW directions to Norway and Portugal (as rather few other European countries are able to use this band) — it is assumed that the distribution correctly describes the relative probability of occurrence of 50-MHz  $E_s$  at the longitude of the United Kingdom. The following treatment assumes two-hop transatlantic propagation (fig. 3A), but the results are almost identical for three hops (fig. 3B) apart from lower probability introduced by requiring an extra reflection. Figure 11A shows the distri-

bution of fig. 8 corrected to the region of the first ionospheric reflection at about  $20^\circ$  W, a delay of 1 hour 40 minutes, and fig. 11B at the second around  $56^\circ$  W, a delay of 3 hours 45 minutes. The hourly pattern for the occurrence of simultaneous hops should then be the two distributions multiplied together hour by hour; this is shown in fig. 11C. Figure 11D shows the *actual* hourly distribution of transatlantic contacts, using the same observers to eliminate (as far as possible) personal bias. The agreement is remarkably good, except for a slight excess of late events. This distribution peaked significantly earlier (2 to 3 hours) compared with transatlantic openings<sup>9</sup> which occurred during 1982-1985 (see fig. 11E). It appears that during that period, following the solar maximum, transatlantic events could have originated from a different mechanism (possibly involving F layer propagation).

It can be assumed from the information above that the *short term* probability of  $E_s$  at the two locations is uncorrelated and the *daily* occurrence is highly correlated. The fact that the treatment works supports this assumption. This could give a clue to the originating mechanism of  $E_s$ .

A similar exercise was performed with the data of the reception of the 50-MHz beacon in French Guiana, FY7THF. This is located in the triple-hop zone of fig. 3A, but as the direction is more southerly the reflection points are at about  $14^\circ$  W (+1 hour),  $33^\circ$  W (+2 hours 12 minutes) and  $47^\circ$  W (+3 hours 8 minutes). Because they are close together in time there is a bigger overlap than for the North American path, which must compensate somewhat for the requirement of an additional reflection. Furthermore, fig. 6 shows that this path traverses a zone of much higher incidence of  $E_s$ . The three overlapping curves are shown in fig. 12A and their product in fig. 12B. The actual distribution<sup>9</sup> of reports of reception in Europe during the months of May, June, and July in the years 1979-1985 is reproduced in fig. 12C; again, agreement is very good. The few available reports of reception during 1987 are also consistent.

You should now be able to estimate, with the aid of fig. 6 and the construction of diagrams like fig. 12, the likelihood of a particular path "working", and the best time of day to try. Openings southward employing one or two hops to north and mid-Africa should be fairly frequent considering that they lie in the same time zone, have maximum overlap, and they traverse a zone of frequent  $E_s$ . Paths from the United Kingdom eastward towards Asia also look very favorable due to the high incidence of  $E_s$  over the European continent (fig. 6), although high ground reduces the effective skip distance. For example, the two-hop path to Bahrein reaches grazing incidence over the Black Sea, and a similar time analysis shows a good overlap around 1600 hours UTC (fig. 13).

The same treatment was applied to the transatlantic path using the hourly distribution of 144-MHz  $E_s$  (figs. 9A-D). An overlap is found between about 2030 and 2200 UTC, showing that transatlantic  $E_s$  contacts on 144 MHz may well be possible even if very infrequent. So, after a big  $E_s$  opening in Europe on 144 MHz, operators in Europe shouldn't just turn off and celebrate, but turn their beams west. If 50 MHz is open, try to set up a transatlantic contact on 2 meters!

### comments on the causes of $E_s$

The wind shear theory has become generally accepted as the explanation for the concentration of ions in a thin layer. The annual regularity and daily unpredictability of  $E_s$  remain as inexplicable as ever. On one day intense  $E_s$  can occur anywhere from central Europe to the mid-United States, indicating that whatever mechanism concentrates the ionizable material acts over a considerable fraction of the globe. For this reason thunderstorms, essentially local phenomena, can't play a major role as some have suggested. Indeed, the worldwide distribution of thunderstorms shows no correlation with the occurrence of  $E_s$ . Likewise stratospheric "jet streams" producing localized "plaques" of  $E_s$  do not seem consistent with the widespread simultaneous occurrence of  $E_s$  on a hemispheric scale. The annual pattern of meteor showers is very much like that of the occurrence of  $E_s$  in the Northern Hemisphere, peaking with many showers in the May to July period and a smaller peak from December to January. Meteors may originate the metallic material making up the  $E_s$  layer, but they can have no immediate influence. The peak  $E_s$  season occurs during the summer in the Southern Hemisphere, while maximum global meteor activity happens during the winter. From the success of the path time predictions, it can be seen that the sun clearly plays a decisive (though perhaps not unique) role in ionization. There are indications that the solar wind also plays some part, but this is a subject for another article!

### conclusion

The evidence indicates that the origin of the majority of 50-MHz openings listed in table 1 is multi-hop sporadic E reflections. The rarity of double-hop  $E_s$  on higher frequencies (144 MHz) can be explained by the very rapid fall-off of probability as the frequency increases, and also by the lack of suitably equipped and active stations in accessible regions. At the same time, I do not want to discount reports that lack an obvious explanation: apparent one-way propagation, long distance stations which don't appear on great circle beam headings, and the presence or absence of backscatter during these openings.

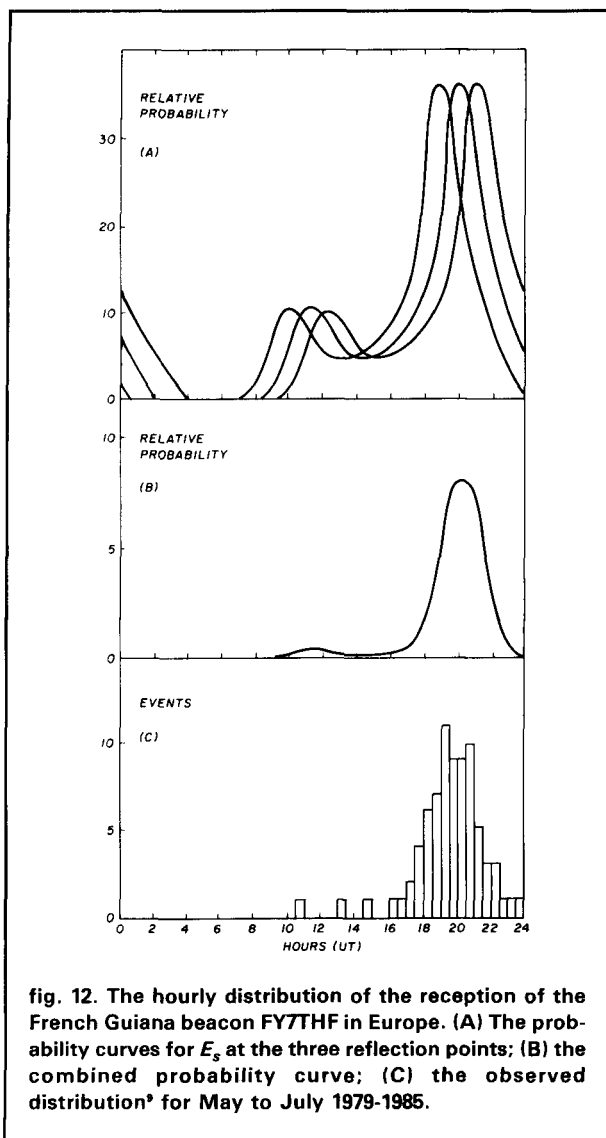

fig. 12. The hourly distribution of the reception of the French Guiana beacon FY7THF in Europe. (A) The probability curves for  $E_s$  at the three reflection points; (B) the combined probability curve; (C) the observed distribution<sup>9</sup> for May to July 1979-1985.

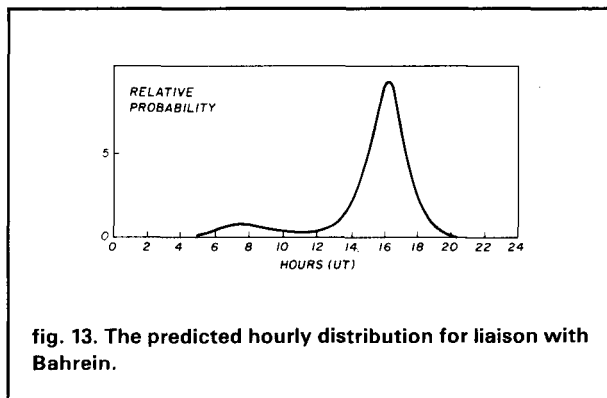

fig. 13. The predicted hourly distribution for liaison with Bahrain.

The localized directional properties of  $E_s$  make observations very difficult. Amateur service can be valuable for this kind of study; the 50-MHz band is very suitable for studying and collecting information on  $E_s$ .





"The amateur world knows us well"

**For more than 60 years we've been a world leader in amateur radio. . .selling the finest equipment at a fair price. We manufacture a quality line of high power linear amplifiers and we stand behind what we sell. That's why thousands of amateurs keep coming back.**

★ Featuring a large inventory of fine equipment from the world's leading manufacturers ★ A knowledgeable staff dedicated to amateur radio ★ A complete line of accessories ★ A well stocked repair shop staffed by experienced technicians ★ We take trade-ins and sell used equipment ★ Generous discounts on cash purchases ★ We accept Visa, Mastercard and Discover and carry our own term financing

Some of the names we stock include: HENRY • TEMPO • KENWOOD • ICOM • YAESU • ACE • ADVANCED RECEIVER RESEARCH • AEA • ALINCO • AMECO • AOR • AMPHENOL • ANTRONIC • ARRL • ASTRON • B&K • B&W • BEARCAT • BECKMAN • BENCHER • BIRD • BUTTERNUT • CES • CETRON • CENTURIAN • COMM SPEC • CONNECT SYSTEMS • CUSHCRAFT • DAIWA • DIGIMAX • DOWKEY • EIMAC • FANON • GE • GRUNDIG • HAL • HUSTLER • HY GAIN • JABRO • JIL • KENPRO • LANDWEHR • LARSEN • LUNAR • MFJ • MICRO • NYE • PALOMAR • PIPO • SANGEAN • SIMPSON • SWITCHCRAFT • TRIEX • TRIPPLITE • TX/RX • UNADILLA • VIBROPLEX • WINEGARD •



**Henry Radio**

2050 S. Bundy Dr., Los Angeles, CA 90025 (213) 820-1234  
Butler, Missouri 64730 (816) 679-3127

TOLL FREE ORDER NUMBER: (800) 421-6631

For all states except California. Calif. residents please call collect on our regular numbers.

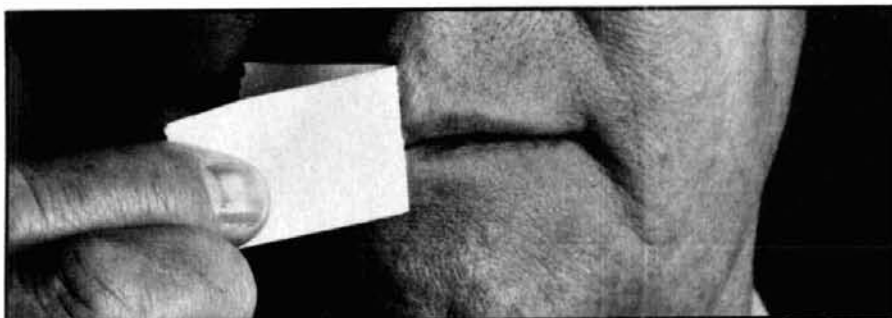

## Now that you can speak, talk to Larsen.

Novice Enhancement opens up a whole new way for novices to communicate. To make the most of it, talk to Larsen Electronics.

We'll tell you how Larsen antennas can greatly improve your powers of communication. We'll also explain how Larsen 220 and 1296 MHz antennas are designed to give you the best performance.

Talk to your Larsen amateur dealer today, and see if Larsen performance doesn't speak for itself.



## Larsen Antennas The Amateur's Professional™

See your favorite amateur dealer or write for a free amateur catalog.

IN USA: Larsen Electronics, Inc., 11611 N.E. 50th Ave., P.O. Box 1799, Vancouver, WA 98668. 206-573-2722.  
IN CANADA: Canadian Larsen Electronics, Ltd., 149 West 6th Avenue, Vancouver, B.C. V5Y 1K3. 604-872-8517.



✓ 129

## Iron Powder and Ferrite TOROIDAL CORES

Shielding Beads, Shielded Coil Forms  
Ferrite Rods, Pot Cores, Baluns, Etc.

Small Orders Welcome  
Free 'Tech-Data' Flyer

**AMIDON**  
*Associates* Since 1963

12033 Otsego Street, North Hollywood, Calif. 91607



✓ 130

## Six Function DTMF Controller

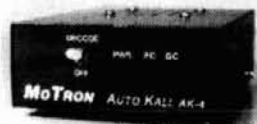

*Auto-Kall*  
**AK-4**

- Outputs: 2 or 3 latched, 1 or 2 momentary, 1 timed and 1 manually reset group-call latched for remote alarm
- Different codes for turning outputs on/off **NOT** toggle on/off like most others! • Wrong number - reset
- 4-digit access code - can use \* up # down
- Multiple group-call response • On-board 1-amp relay



AK-4K (board/kit) . . . . . \$69.95

AK-4W (wired/tested board) . . . \$89.95

**MoTron**



**Electronics**

695 W. 21st Ave.  
Eugene, OR 97405

AK-4C (Complete unit in metal enclosure with in/out jacks, built-in speaker, etc) . . . . . \$139.95

Plus \$3.00 shipping & handling

Call Toll Free 1-800-338-9058 or (503) 687-2118

✓ 133

## VHF-UHF POWER DIVIDERS



RF power dividers provides the best way to feed in-phase 2 and 4 antenna arrays to maximize system gain and at the same time reduce losses to a minimum. Covering 144 thru 1296 MHz, this series of VHF/UHF power dividers are premier RF devices designed for a long service life with low SWR and broad operating bandwidth.

Extruded aluminum body with a durable enamel finish in addition to silicon sealing at connector flanges results in a ruggedized unit for all array installations. Available with N-type connectors only, these units are unconditionally guaranteed for 2 years.

MODEL	CONFIG.	PRICE
144-2P	(2 ports)	\$54.00
144-4P	(4 ports)	\$61.00
220-2P	(2 ports)	\$53.00
220-4P	(4 ports)	\$60.00
430-2P	(2 ports)	\$51.00
430-4P	(4 ports)	\$59.00
902-2P	(2 ports)	\$51.00
902-4P	(4 ports)	\$59.00
1296-2P	(2 ports)	\$52.00
1296-4P	(4 ports)	\$60.00

SHIPPING NOT INCLUDED

STRIDSBERG ENGINEERING, CO.

P.O. Box 7973 • Shreveport, LA 71107 • USA  
Phone: (318) 865-0523

✓ 132

## 1988 CALL DIRECTORY

(on microfiche)

Call Directory \$8  
Name Index \$8  
Geographic Index \$8

All three — \$20 Shipping per order \$3

**BUCKMASTER PUBLISHING**

Mineral, Virginia 23117  
703-894-5777  
800-282-5628

✓ 131

propagation. If a few interested Amateurs calibrate their equipment to give approximate signal field strengths and accurate beam headings, the results could lead to a greater understanding of  $E_s$  phenomena.

## acknowledgments

I wish to thank Dr. Mike Hapgood and Rita Blake of the World Data Centre for Solar-terrestrial Physics, Rutherford Appleton Laboratory, for help with the ionosonde data; Ian White, G3SEK, Steve Cherry, G3SJK, and Jon Eastment, GW4LXO, for discussions; the Rutherford Appleton Laboratory for permission to reproduce the ionosonde data; and Radio Amateurs whose logs extracts have been included.

## references

1. N. Wakai, H. Ohya, and T. Koizumi, *Manual of Ionogram Scaling (Revised Edition)*, July 1986, page 28.
2. E.K. Smith and S. Matsushita (eds.), *Ionospheric Sporadic E*, Pergamon, 1962, pages 257, 323.
3. E.K. Smith and S. Matsushita (eds.), *ibid*, pages 151, 235, et seq.
4. K.L. Miller and L.G. Smith, "Horizontal structure of midlatitude sporadic E layers observed by incoherent scatter radar", *Radio Science* 10, no. 3, March 1975, pages 271-276.
5. K.G. Budden, *The propagation of radio waves*, Cambridge University Press, 1985 \$12.7, page 344.
6. E.K. Smith and S. Matsushita (eds.), *ibid*, pages 253-255.
7. "VHF propagation by regular layers, sporadic E, or other anomalous ionization", *Recommendations and reports of the CCIR, 1986*, vol. VI, Rep. 259-6, pages 258-266.
8. "Method for calculating sporadic-E field strength", *Recommendations and reports of the CCIR, 1986*, vol. VI, Rec. 534-2, pages 271-294.
9. G.F. Kimball, G3TCT, "Transatlantic propagation by sporadic E at 50 MHz", *Radio Communication* 62 no. 7, July 1986, pages 491-494.
10. K. G. Budden, *ibid*, §12.8, pages 345-347.
11. *VHF/UHF Newsletter*, Radio Society of Great Britain, October 1987. Log extracts were provided by G3SEK, GW4LXO, G4VXE, and G0DAZ.
12. J. Morris, GM4ANB, "The New Locator System", *Radio Communication* 60 no. 10, October 1984, pages 862-865; also F. Rosvall, *The Radio Amateur's World Atlas*, October 1986.
13. *Radio Communication* 60 no. 4, April 1984, pages 315-316.
14. E.K. Smith and S. Matsushita (eds.), *ibid*, pages 103-107.
15. P. Pasteur, HB9QQ, "VHF UHF Funkverfahren und Betriebstechnik", Aerolit-Verlag Hans G. Auer, Zurich 1982, page 100.
16. The plots were constructed from observations recorded and made available to the author by Prof. M. Harrison, G3USF, at 53° 0' N. 2° 17' W.
17. DL0IGI is located on Predigtstuhl Mountain, South Germany at 47° 42' N. 12° 53' E.
18. 5B4CY is located at Zyyi, Cyprus at 34° 45' N. 33° 19' E.

ham radio

### about the author

Geoffrey H. Grayer, BSc, PhD, is an experimental physicist and was engaged in particle physics until 1986. His last experiment was the Nobel Prize winning UA1 at Cern, Geneva, where he was the senior resident physicist working on the experiment trigger. Dr. Grayer was the discoverer of the intermediate vector boson particles W and Z. For the last 18 months he has been involved in satellite experiments investigating lower energy particles found in solar wind. He has been published by the RSGB and works for Rutherford Appleton Laboratory in England. He has been involved in Amateur Radio since 1958.

## AMATEUR TELEVISION

### NOVICES: NOW YOU CAN TRANSMIT VIDEO WITH OUR NEW TX23-1

Did you know that you as well as all classes of licensed amateurs can easily transmit live action color and sound video just like broadcast TV with our TX23-1 transmitter. Use any home TV camera and/or VCR, computer, etc. by plugging the composite video and audio into the front 10 pin or rear phono jacks. Call or write now for our complete ATV catalog including downconverters, transceivers, linear amps, and antennas for the 70, 33, & 23cm bands.



Only  
\$299

TX23-1 one watt ATV transmitter crystalized for 1289.25 MHz runs on 12-14 Vdc @ .5A. PTL T/R switching. 7x7x2.5". Transmitters sold only to licensed amateurs for legal purposes verified in the latest Callbook or with copy of license sent with order.

(818) 447-4565 m-f 8am-5:30pm pst.

P.C. ELECTRONICS  
2522 Paxson Ln Arcadia CA 91006

Tom (W6ORG)  
Maryann (WB6YSS)

## HIGH PERFORMANCE PRESELECTOR-PREAMP

The solution to most interference, intermod, and desense problems in AMATEUR and COMMERCIAL systems.



- 40 to 1000 Mhz - tuned to your frequency
- 5 large helical resonators
- Low noise - High overload resistance
- 8 dB gain - ultimate rejection > 80 dB
- 10 to 15 volts DC operation
- Size - 1.6 x 2.6 x 4.75" exc. connectors
- **FANTASTIC REJECTION!**

Typical rejection:  
± 600 Khz@144 Mhz: -28dB  
± 1.6 Mhz@220 Mhz: -40dB  
± 5 Mhz@450 Mhz: -50dB

Price - CALL bipolar w/RCA jacks  
Connector options: BCN \$5, UHF \$6, N \$10  
**SUPER HOT!** GaAs Fet option \$20

## AUTOMATIC IDENTIFIERS

ID-1

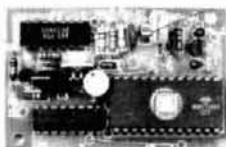

ID-2



- For transceivers and repeaters - AMATEUR and COMMERCIAL
- Automatic operation - adjustable speed and amplitude
- Small size - easy installation - 7 to 15 volts DC
- 8 selectable, reprogrammable messages - each up to 2 min. long
- Wired, tested, and programmed with your message(s)

Model ID-1 - \$54.95 Model ID-2 w/2 to 10 minute timer - \$79.95

We offer a complete line of transmitter and receiver strips and synthesizers for amateur and commercial use.

Request our free catalog.

Mastercard and VISA welcome

**GLB ELECTRONICS, INC.**

Dept H, 151 Commerce Pkwy., Buffalo, NY 14224  
716-675-6740 9 to 4

# VHF/UHF WORLD

Joe Reisert, W1JR

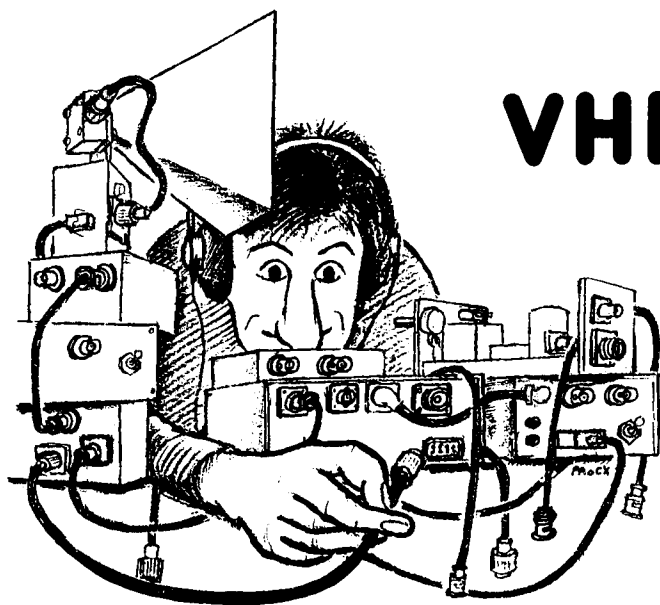

## propagation update- part 3

In June we reviewed the latest VHF/UHF/Microwave DX records.<sup>1</sup> We also discussed the upcoming solar cycle and what effect it may have on some of the ionospheric modes of radio propagation like F2 and FAI. This month we'll discuss some of the other ionospheric modes; then we'll update tropo, EME, and other types of microwave and millimeter-wave propagation.

### midlatitude sporadic E

Sporadic E propagation, often referred to as "E skip" by VHFers, is truly the workhorse mode for 6-meter DX. Band openings can occur at any time of the day or year. In North America openings are most common and intense between mid-May and mid-August, with a minor peak  $\pm 1$  month around the winter solstice (December 22). They occur most often in the late morning or the late afternoon to early evening (local time).

Radio sonde observations show that the ionized cloud responsible for E skip is typically 0.6 to 2.5 miles (1-4 km) thick and is usually located at an altitude of 62 to 75 miles (100-120 km). Therefore, the typical propagation distance varies between about 500 and 1300 miles (800-2100 km), although distances as short as 300 miles (500 km) sometimes occur when there is very intense ionization. Multiple-hop sporadic E openings are most common during the summer, permitting North American stations to work coast to coast as well as CONUS to Hawaii and Europe.

It has long been known that sporadic E propagation was usable through 225 MHz, although openings on 2 meters and above are few and far between.<sup>2,3</sup> While studies have been conducted to see if there is any link between solar activity and sporadic E propagation, no definitive correlation has been proven. In fact, there seems to be a feeling that there may be some inverse relationship, because some of

the most intense openings have occurred during years when sunspot activity is low!

There is some possibility that a relationship does exist between sporadic E openings and the position of coronal holes on the surface of the sun. Research conducted by Sid Lieberman, WA2FXB, shows that most North American 6-meter sporadic E openings during June and July occur about 4 or 5 days after the occurrence of an MSB (magnetic sector boundary) crossing.<sup>4</sup>

For many years Amateurs have noticed the presence of lightning storms when sporadic E propagation is present. Sid's research also shows that meteorologists have noted an increase in lightning storms 4 or 5 days after an MSB crossing.

The MSB crossing can be determined from solar data available from WWV propagation reports at 18 minutes after each hour, or from the PRF (Preliminary Report and Forecast of Solar Geophysical Data) available from NOAA (National Oceanic and Atmospheric Administration).<sup>\*</sup> The MSB crossing tends to occur when the "K"

\*The PRF is published weekly and is available from NOAA, Space Environment Services Center, 325 Broadway, R/E/SE2, Boulder, Colorado 80303-328. Effective June 30, 1988, there is a \$26 per year charge to cover the actual cost of publication.



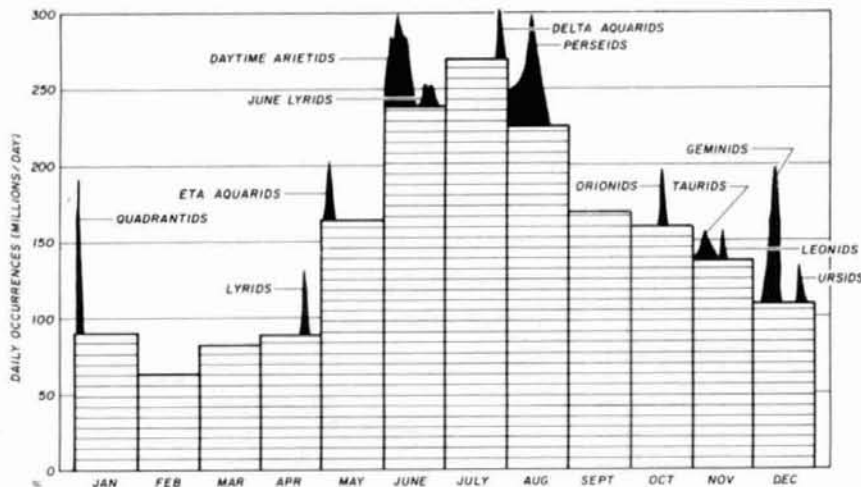

fig. 1. This chart shows the daily occurrence of random meteors. Superimposed on the tops are the major meteor showers at the approximate dates they occur.

index (a measure of magnetic activity) drops to a minimum for at least a few hours.

Dick Bolt, W1DGA, has taken up where Sid left off and studied many years of data on 6 and 2-meter openings. He noticed an increase in sporadic E openings 3 to 5 days after a coronal hole crosses the central meridian, the point on the sun's surface directly opposite the earth. However, he points out that because the surface of the sun is not solid, the rotational period is different between the sun's equator and its poles. Those coronal holes near the sun's equator tend to rotate on about a 25-day basis, while those at 45 degrees latitude take 28 or 29 days per revolution. The typical sporadic E openings will repeat statistically on an approximate 25-29 day basis, depending on the latitude of the coronal hole.

Unfortunately, Dick has not been able to pinpoint the place on the earth where the opening will occur but he's still trying. Stay tuned. This study may bear fruit in the not too distant future.

As has been widely reported in the literature and in references 2 and 3, one probable cause of sporadic E propagation is wind shear — a break in the vertical profile of the horizontal winds. The cause is still under speculation but lightning is definitely suspect. Lightning is most prevalent at the same time

of year that sporadic E propagation peaks.

It seems to me that meteors can also have a definite effect on sporadic E propagation. Looking at fig. 1 you'll see that the occurrence of random meteors tends to peak over 250,000,000 per day between June and August, the same time period when sporadic E propagation peaks. The minimum amount of random meteors occurs between mid-January and mid-April when sporadic E propagation is low.

Figure 1 shows that about half of the major yearly meteor showers occur during the same random meteor peak season. Another significant point about this time of year is that several of these same meteor showers occur during the daytime hours when sporadic E propagation is typically most prevalent. Also, the very dense Geminids and Quadrantids as well as the weaker Ursides showers occur near the winter sporadic E peak.

Finally, Swedish scientists have reported that the number of meteors tended to increase during sunspot minimums by up to a factor of 2 during 1963, as compared with the peak of solar cycle 19 in 1956-59.<sup>3</sup> The terminal point of meteors likewise was higher during these same minimum sunspot years.

Throughout the summer of 1987

800-882-1343

ICOM



HF Equipment	IC-735	List	JUN's
<b>ICOM</b>			
IC-781 New Deluxe HF Rig		\$5995	Call \$
IC-761 Loaded with Extras		2699	Call \$
IC-735 Gen. Cvg Xcvr		1099	Call \$
IC-751A Gen. Cvg Xcvr		1699	Call \$
<b>Receivers</b>			
IC-R7000 25-1300 <sup>+</sup> MHz Rcvr		1199	Call \$
IC-R71A 100 kHz-30 MHz Rcvr		999	Call \$
<b>VHF</b>			
IC-28A/H FM Mobile 25w/45w		469/499	Call \$
IC-02AT FM HT		409.95	Call \$
IC-u2AT Micro HT		329	Call \$
IC-900 Six Band Mobile		639	Call \$
<b>UHF</b>			
IC-48A FM Mobile 25w		509	Call \$
IC-04AT FM HT		449	Call \$
IC-12AT 1.2 GHz HT		473	Call \$
<b>220 MHz</b>			
IC-38A 25w FM Xcvr		489	Call \$
IC-37A FM Mobile 25w		499	Call \$

KENWOOD

HF Equipment	List	Call \$
<b>KENWOOD</b>		
<b>HF Equipment</b>		
TS-940S/AT Gen. Cvg Xcvr	2449.95	Call \$
TS-440S/AT Gen. Cvg Xcvr	1379.95	Call \$
TS-140S Compact Gen. Cvg Xcvr	929.95	Call \$
<b>VHF</b>		
TS-711A All Mode Base 25w	1029.95	Call \$
TR-751A All Mode Mobile 25w	649.95	Call \$
TM-2530A FM Mobile 25w	479.95	Call \$
TM-2550A FM Mobile 45w	499.95	Call \$
TM-2570A FM Mobile 70w	599.95	Call \$
TH-215A 2m HT Has It All	379.95	Call \$
TH-25AT 5w Pocket HT NEW	349.95	Call \$
TM-721A 2m/70cm FM Mobile	649.95	Call \$
<b>UHF</b>		
TH-415A 2.5w 440 HT	399.95	Call \$
TH-45AT 5w Pocket HT NEW	369.95	Call \$
<b>220 MHz</b>		
TM-3530A FM 220 MHz 25w	499.95	Call \$
TH-31BT FM 220 MHz HT	299.95	Call \$
TH-315A Full Featured 2.5w HT	399.95	Call \$

YAESU

HF Equipment	List	Call \$
<b>YAESU</b>		
<b>HF Equipment</b>		
FT-767 GX Gen. Cvg Xcvr	1929.95	Call \$
FT-757 GX II Gen. Cvg Xcvr	1129.95	Call \$
FT-747 GX New Economical Performer	889.95	Call \$
FL-7000 15m-160m AMP	1995.00	Call \$
<b>VHF</b>		
FT-212RH NEW 2m 45w	459.95	Call \$
FT-211RH FM Mobile 45w	389.95	Call \$
FT-712RH 70cm 35W	499.95	Call \$
FT-290R All Mode Portable	599.95	Call \$
FT-23 R/TT Mini HT	344.95	Call \$
FT-209RH FM Handheld 5w	389.95	Call \$
<b>VHF/UHF Full Duplex</b>		
FT-736R, New All Mode 2m/70cm	1749.95	Call \$
<b>Dual Bander</b>		
FT-727R 2m/70cm HT	439.95	Call \$
FT-109RH New HT	399.95	Call \$



3919 Sepulveda Blvd.  
Culver City, CA 90230  
213-390-8003



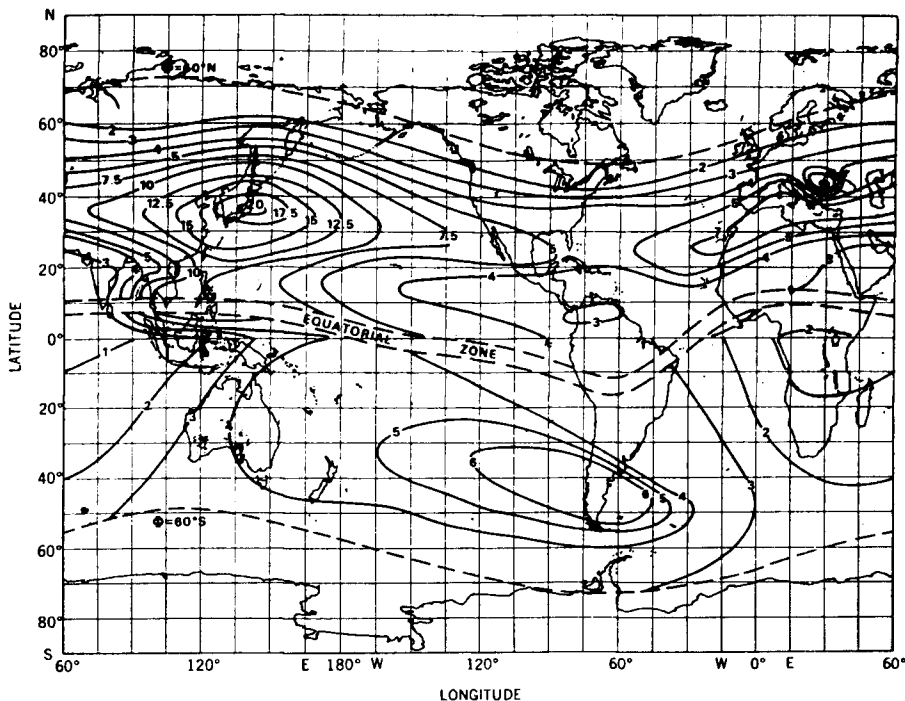

fig. 2. This map shows the percentage of time during the summer months when sporadic E ( $F_oE_s$ ) exceeds 7 MHz at vertical incidence. This corresponds roughly with the time when 6-meter sporadic E propagation is present.

sporadic E openings were reported almost daily somewhere in North America. Did meteor activity enhance this terrific sporadic E season in 1987 when the solar cycle was near its minimum?

Let's review some of the telltale signs of sporadic E propagation. It is most easily detected at hf by vertical-incidence ionosondes (ionospheric sounding stations). Typical sporadic E critical frequency, or  $F_oE_s$  as it is sometimes called, is first detected in the 5-10 MHz region but can go as high as 15-18 MHz when a very intense event is taking place. The higher the frequency of the vertical return, the higher the VHF MUF.

Probably the most interesting data to Amateurs is the  $F_oE_s$  summer months worldwide map assembled by Ernest K. Smith, N6HQK, and shown in fig. 2. These data are taken from ionosondes when the  $F_oE_s$  was about 7 MHz, a typical value to yield 6-meter and higher sporadic E propagation.<sup>5</sup>

Note in fig. 2 that the highest incidence of summertime sporadic E propagation is in the region around

Japan, Indonesia, and near the Mediterranean Sea. South Africa and the northern part of North America have much less. The southern portion of the United States will have about two to three times more openings than the northern states and southern Canada.

We've been discussing 6-meter sporadic E. As mentioned earlier and in reference 2, sporadic E propagation can extend beyond the 135-cm (220 MHz) Amateur band.

Most 2-meter openings occur when the skip distance on 6 meters drops well below 500-600 miles (800-950 km) or when there is noticeable backscatter on 6 meters.<sup>1</sup> The longest worldwide documented two-way sporadic E contact on 144 MHz took place on July 7, 1983 over a distance of 2402 miles (3865 km) between EA8XS (IL28GA) and HG0HO (KN07RU). The complementary North American record took place on June 14, 1987 at a distance of 1980 miles (3186 km) between KD4WF (EM92LA) and NW70/7 (DM25GV).<sup>1,6</sup>

Both contacts were probably dou-

ble hops where at least two E clouds were linked, presumably with a mid-path reflection from the earth as shown in fig. 3. Based on North American geography, coast to coast 2-meter contacts may be possible. However, the proper conditions will most likely favor stations in the southern United States and only take place if two clouds are very close to the optimum geometry (fig. 3).

## 2-meter and higher sporadic E

What does it take for 2-meter or 135-cm sporadic E propagation? This question involves much speculation. Obviously the E cloud must have a tremendous refractive index and be very smooth. Propagation on 6 meters should be "super" and some very short paths might be accessible.

Backscatter on 6 meters would probably also be present, along with evidence of co-channel interference on television channel 7 (174-180 MHz or higher). The conditions on 2 meters should be very good before attempting 135-cm contacts.

These conditions were present when the first 135-cm two-way sporadic E contact took place between K5UGM (EM12MS) and W5HUQ/4 (EM90GC) on June 14, 1987 over a

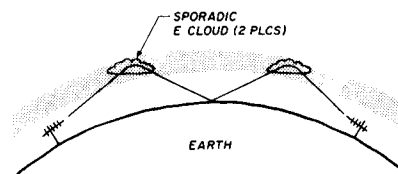

fig. 3. This sketch shows the approximate geometry required for "double hop" sporadic E propagation.

932-mile (1499 km) path.<sup>1,7</sup> Virtually the entire United States was experiencing 6-meter E skip. Some triple hop (and possibly quadruple hop) was noted as stations as far apart as Georgia to Hawaii and Europe to the central United States were making contacts! Numerous stations from coast to coast were making 2-meter contacts, some in both easterly and westerly directions at the same time.

# Introducing the only mobiles that double as answering machines.

220 MHz  
Model FT-312RM  
Now Available

Now you can stay in touch—even when you're away from your radio.

With Yaesu's 2-meter FT-212RH and 70-cm FT-712RH, an optional, internal digital voice recorder serves as a convenient answering machine for you and your friends. And that's just the beginning!

## High performance mobiles.

The FT-212RH features wideband receive coverage of 140-174 MHz (144-148 MHz Tx), while the FT-712RH covers 430-450 MHz. An oversize amber display includes an innovative photo-sensor which increases the display brightness during the day. The function buttons are arranged in a chromatic musical scale—ideal for visually-impaired operators. You get 45 watts output on 2 meters, 35 watts on 70 cm.

An autodialer DTMF microphone with 10 memories, each ready to store telephone numbers up to 22 digits long.

And, like our FT-211RH Series mobiles, you'll enjoy surprisingly simple controls, yet highly sophisticated microprocessor-based flexibility. Including 18 memories that store frequency, offset, PL tone, and PL mode (CTCSS unit optional). Band or memory scanning. Offset tuning from any memory channel. Memory channel lockout for scanning. High-low power switch.

All in an amazingly small package, shown actual size below.

## Digital voice recorder option.

Only Yaesu brings you the advanced technology found in our digital voice recorder option.

You can store messages or your call sign—in your own voice, not a synthesized replica—or give your friends a private code for leaving messages on your radio. All they need is a DTMF microphone! Then you can play back your messages either in-person, or remotely by using another radio with a DTMF microphone. And you've always got security because you can command your radio to respond only to in-person playback requests.

## Visit your Yaesu dealer today.

And test drive Yaesu's FT-212RH and FT-712RH mobiles. The only radios with the power to keep you in touch. Always.

# YAESU



Yaesu USA 17210 Edwards Road, Cerritos, CA 90701 (213) 404-2700. Repair Service: (213) 404-4884. Parts: (213) 404-4847.

Prices and specifications subject to change without notice. PL is a registered trademark of Motorola, Inc.

One normally expected sporadic E phenomenon was not present — the shortening of the 2-meter path distance. It had been widely speculated that the 2-meter distance would have to shorten significantly and that different Amateur bands would experience different optimum distances. In fact, the stations completing the first 135-cm contact were in contact on 2 meters at virtually the same time, and no real short distance 2-meter contacts were reported.

Is some rethinking necessary? Perhaps too much emphasis has been placed on the shortened path on the next lower band. If 2 meters is open, give 135 cm a whirl! The higher frequency path requirements are more precise; don't give up.

During the next few years we'll experience the peak of solar cycle 22. Sporadic E openings will probably be somewhat enhanced for the more northern stations as the upper air winds and weather change slightly. Increased interest in solar as well as lightning connections will be studied. The higher the altitude of the lightning strikes, the better the chance for a 2-meter or higher frequency sporadic E propagation opening.<sup>2,3</sup> In North America this tends to happen toward the end of July.

More 6-meter DX will be worked because the number of countries with 50-MHz operating privileges has been greatly expanded, especially in Europe and Africa. There is always a possibility of a 2-meter contact between the United States and Europe, but if it does happen it will probably be between the Azores and a lucky Amateur in the fourth call area (see fig. 2).

### sporadic F propagation?

Sporadic F propagation was recently broached in *Radio Communications*.<sup>8</sup> The discussion came about because some of the United Kingdom to United States openings were too long in duration, and the distances don't always match the typical sporadic E path distances across the continents.

The article references scientific data that verifies the presence of ionized regions up to 93 miles (150 km) above ground level in the normal F layer, and much higher than the typical sporadic E explained earlier in this column. These F layer ionized patches tend to drift slowly downward over a period of several hours until they settle in and dissipate around 65 miles above the earth, the typical height of sporadic E clouds. This is an interesting theory; advanced rockets should make a study possible. Does anyone have any further supporting data?

### aurora update

As the solar cycle heats up, so do the number of occurrences of auroral propagation. This mode of propaga-

1988 is particularly interesting. Even though only about one-quarter of 1988 is included, the number of aurora observed so far this year is already well ahead of the last two years. It looks as if there will be some very exciting auroral openings in the next year or two.

Although auroral propagation tends to favor stations in the northern latitudes, some of the strongest auroral occurrences have favored stations further south. The reasons for this are simple.

Lower latitude stations have a better reflection angle and can fully use their lower angle of radiation to direct most, if not all, of their signal directly at the aurora. Northern stations often "see" the aurora well above the maximum radiation angle of their antennas.

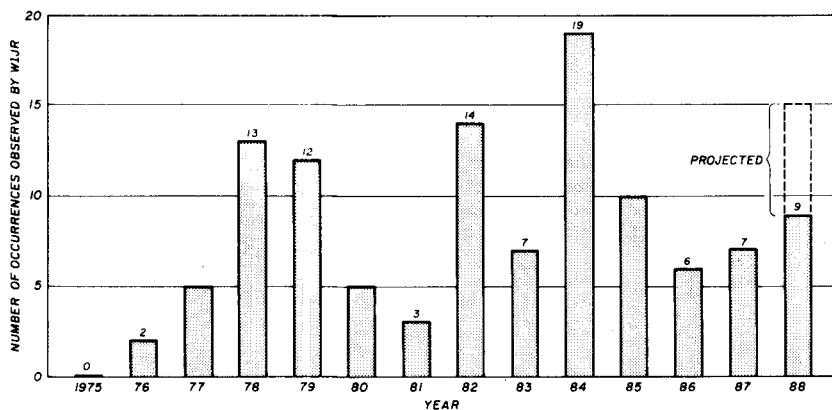

fig. 4. This histogram shows the number of times auroral propagation was observed at W1JR (FN42HN) since 1975. See text for further explanation.

tion should be very common in the next couple of years. While it will virtually wipe out hf propagation, it can yield some great VHF and UHF DX.

Reference 3 illustrates how auroral propagation tends to follow the rise and fall of each solar cycle. However, it's not too common near the solar minimum or at the peak of the solar cycle. To re-emphasize this point, I have updated the information in reference 3 to include the more recent auroras that I have observed here in New England.

Figure 4 clearly shows the trend of auroras just mentioned; the data for

To illustrate this point, stations in the northern United States had the auroral curtain directly over their heads during the now-famous aurora of February 7 and 8, 1986. During that same aurora the North American DX record was extended on both 144 and 432 MHz and equaled on 220 MHz.<sup>1</sup> In all but one case, one or both of the stations involved were below the 40th parallel.

Don't forget that auroras can occur at any time of the day. I've noted several recently that were in progress in the mornings (8-11 A.M. local) but were not productive because there

# From The Creative Minds at HAL Communications Packet Radio Made Easy ...

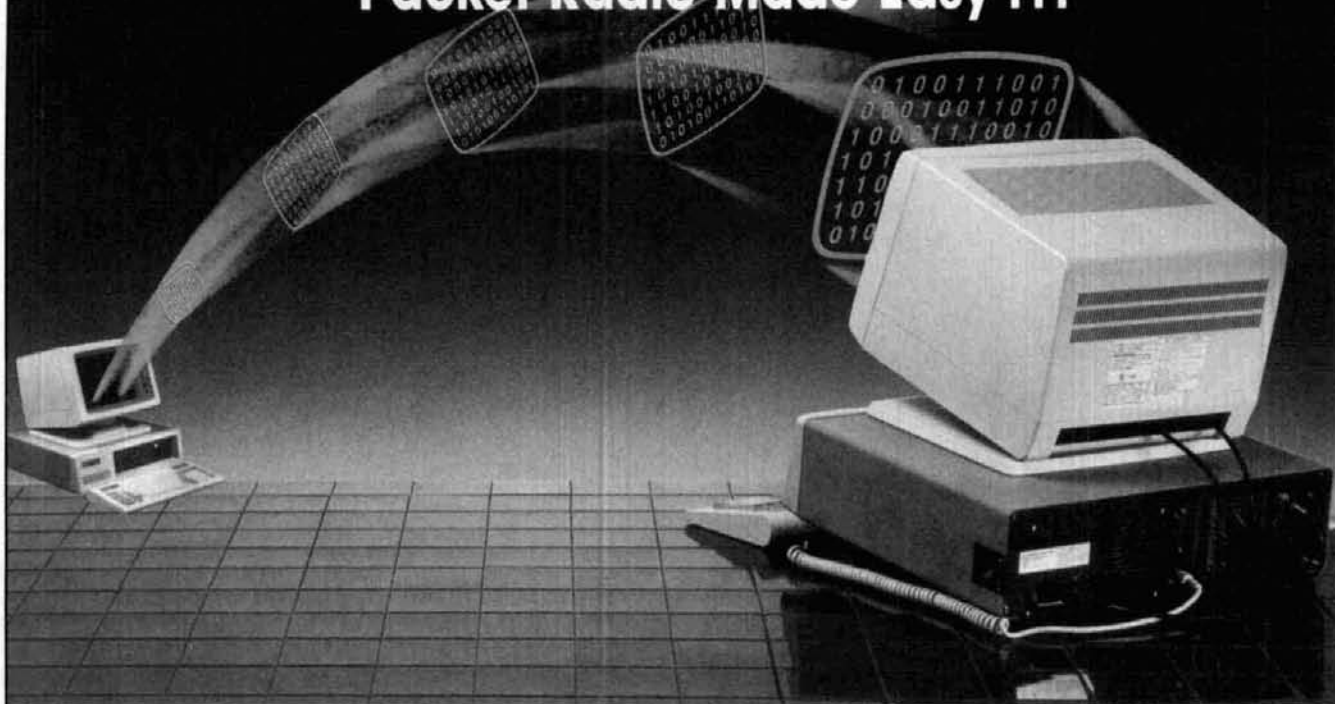

## THE RPC-2000

### TWO-CHANNEL RADIO PACKET CONTROLLER

- Menu driven – No commands to memorize
- Works on VHF or HF
- Built-in Modem and RS-232C I/O
- Exclusive HAL CALLpath programmable directory
- Software included

The RPC-2000 is a two-channel radio packet controller that adds fast, error-free data communications to radio links. It plugs into an expansion slot of the HAL DS-3200 Radio Data Communications Terminal or any fully compatible PC, PC-Xt, or PC-AT computer. The RPC-2000 uses Packet Radio protocol based on AX.25 to provide data communications at rates from 45 to 4800 BPS.

The standard configuration of the RPC-

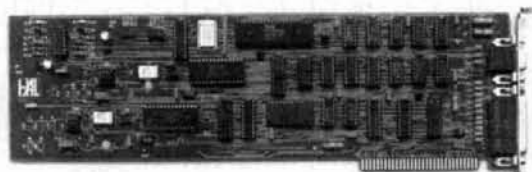

2000 uses an RS-232C I/O port (Channel A) for an external HF modem (such as the HAL ST-8000) and a 7910 modem for a VHF link (Channel B). The M2-RPC option converts Channel A to a second 7910 modem.

The RPC-2000 is driven entirely from disk-based software that provides on-screen menus to choose all features and modes, eliminating the need to memorize complicated commands and procedures.

DISCOVER HOW EASY PACKET RADIO CAN BE. CALL OR WRITE US FOR MORE SPECIFICATIONS.



**HAL COMMUNICATIONS CORP.**  
P.O. BOX 365  
URBANA, IL 61801  
Phone 217-367-7373



# Eureka!

We just struck gold with a miniature, high quality and very reliable DTMF decoder at a rock bottom price of \$59.95. Our DTD-1 will decode 5040, 4 digit codes with the security of wrong digit reset. It contains a crystal controlled, single chip DTMF decoder that works great in bad signal to noise environments and provides latched and momentary outputs. Why carry that heavy gear when its size is only 1.25 x 2.0 x .4 inches and it comes with our etched in stone, legendary, one year warranty.

Instead of sifting through the field...searching, use our super quick one day delivery and cash in on a rare find.

✓ 140

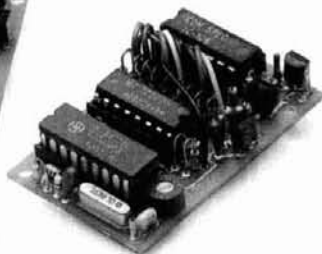

**\$59.95 each**

**COMMUNICATIONS  
SPECIALISTS**

426 W. Taft Ave., Orange, CA 92665-4296  
Local (714) 998-3021 • FAX (714) 974-3420  
Entire U.S.A. 1-800-854-0547





was "no one around to talk to."

How was I sure that there was aurora present? There was a pronounced flutter noted on hf Amateur signals. I also heard the familiar "buzz" on some of the 6-meter Amateur beacons as well as television video carriers. If you hear these telltale signs, aim your antenna north and put out a call. You may get a surprise.

Most auroral openings occur in the spring and fall, and typically start in the late afternoon or early evening. Remember, the highest usable frequency during an aurora opening tends to occur shortly after the commencement of aurora. If you want to make 135 or 70-cm contacts, move up there quickly after discovering the presence of aurora on the lower VHF bands before the MUF drops too low. Don't give up if the aurora goes away. It often returns in an hour or so.

Knowing when an aurora is expected is not as difficult as predicting sporadic E propagation! Besides the clues noted above, the propagation bulletin on radio station WWV is a great indicator of aurora.

Auroras almost always occur within 30-48 hours after a major solar flare. Listen to WWV at 18 minutes past the hour for word of flares. Expect an aurora imminently whenever the K index announced on the station (it is updated every 3 hours) goes to 4 or higher. The higher the better!

Don't forget that auroras often repeat in 26 to 30 days. This can be ascertained ahead of time by checking the forecasted K index in the NOAA PRF, as mentioned earlier.

Reference 2 notes that aurora propagation is possible beyond 2500 MHz, although Amateurs haven't had any documented success above 450 MHz. However, as you go higher in frequency, the "hot spot" gets very narrow and lots of ERP (effective radiated power) is necessary. These are incompatible requirements since antenna gain will have to be high, making the beam width narrow and increasing the problem of locating the common reflection point.

For these reasons 1296 MHz may be

very difficult to conquer on aurora propagation. The signal will be very spread out in frequency and the doppler shift could reach 5 to 10 kHz! For this reason the new 903-MHz band offers some very interesting possibilities. I've tried 903-MHz schedules several times when 432 MHz was usable, but no success to date.

Finally, the doppler shift on aurora propagation is often greater than most Amateurs expect. For instance, I've seen shifts approaching 3-5 kHz at 432 MHz. If you use a transceiver, tune around only with RIT after you call a CQ. Don't forget that a station responding to your CQ doesn't expect you to shift frequency. Also check the range of your RIT. Many of the modern transceivers don't have sufficient tuning range to match the maximum doppler present.

Aurora propagation is a fun mode and a great way to work DX on a band when normal propagation modes won't support extended DX. The present claimed North American DX record on 2 meters is 1347 miles, with 1145 and 1182 miles on 220 and 432 MHz, respectively.<sup>1</sup> A recent claim in Europe would extend the worldwide 2-meter aurora record out to 1439 miles. That's real DX!

### auroral E<sub>s</sub>

Reference 2 mentioned this interesting form of radio propagation on 6 meters. Basically it resembles sporadic E and takes place a few hours after an auroral opening has faded away.

The problem with catching auroral E openings is that they tend to occur during the very early hours of the morning. They are most often discovered over weekends when someone strolls home from a late evening cocktail party!

Several W1 to W7 auroral E type openings were observed during the descending years of solar cycle 21 (1982-1986). Likewise, openings from Alaska to the lower 48 states and Canada have been reported. With the return of auroras, this could be a good way to increase your DX and VUCC grids.

### meteor scatter update

Interest is still high in meteor scatter communications, especially during the major showers like the Perseids and Geminids. Meteor scatter offers 800-1000 mile contacts up through 432 MHz (more on this shortly), and with a little luck out to 1400 miles.

Nowadays 2 and 6-meter meteor scatter contacts are sort of routine. They can be made almost daily using random meteors that typically peak between 5 and 8 A.M. local time. Use fig. 1 to determine the most optimum time of the year. Meteor showers offer more flexibility on schedule time, better reliability, and greater distances.

European Amateurs have been running meteor scatter schedules since the early 1960s and achieving success daily, even during the daytime on random meteors. What's their secret? They transmit for long periods, typically 1 to 5 minutes, at very high speed CW, usually 100-200 words or 500-1000 letters per minute! This way they only need a very short burst (not much longer than a ping!) to obtain an entire set of calls or reports.

You ask, "Who can copy CW at that speed?" The answer is "no one!" The Europeans' secret to success is to record the output of their receiver at a fast speed, and at the end of the receiving period slow down their tape and replay any recorded bursts at an easy to copy 15-25 words per minute<sup>9</sup>.

The European meteor scatter procedure is, in effect, a form of packet communication. Some Amateurs in North America would say this isn't a valid contact, but technology marches on! We now have an abundance of VHF packet communications on 2 and 6 meters. Just tune up to 145.010 MHz some evening and listen to all the strange sounds.

Can this technology be used to VHFer's advantage? The answer is a qualified yes. One problem is that present packeteers are using bandwidths of 15 kHz, 5 to 6 times that of normal 2-meter SSB communications. Using NBFM creates an additional 10 dB disadvantage in the signal strength

required for adequate detection signal to noise ratio.

If you run a packet system with typical antenna gains of 12-14 dBi, at least 500 watts, and the packet protocols presently in use, you incur about a 15-20 dB disadvantage over SSB. But many meteor bursts on 2 and 6 meters, especially during showers, are at least 30-40 dB out of the noise. Therefore, packet meteor scatter even using NBFM is definitely feasible.

The implementation of packet radio for DXing would be a big step forward and probably will be the next technology step. A great enhancement would be to implement one of the hf packet protocols at a lower baud rate (300 baud), using narrow receiver bandwidths that enhance signal to noise ratio. Packet meteor scatter DXing is a wide-open opportunity for DXing VHFers.

Meteor scatter contacts on 135 cm are still rather difficult even with high power and high gain antennas, and are almost entirely confined to the better meteor showers. Contacts on 70 cm, despite some push in the 1970s, are almost nonexistent in North America due to the extremely poor success rate and the apparently poorer results on the Perseids meteor shower of late. Europeans have had several successes on 70-cm meteor scatter lately, but they are all using the CW high-speed system. It looks as if 70-cm operators will have to wait until the Leonids peak in the late 1990s or discover new operating techniques!

Meteor scatter techniques and how to pinpoint shower peaks are discussed in detail in reference 10. Reference 11 stresses the importance of the scheduling time to attain proper meteor shower geometry along with recommended software. Reference 12 discusses the optimum times as well as the peak of the shower. For those interested in optimizing the shower peak, I'd suggest that you obtain a copy of the latest *Astronomical Calendar 1988*.\*

\* *Astronomical Calendar 1988* is available from Astronomical Workshop, Furman University, Greenville, South Carolina 29613 at \$12 plus \$3 for postage and handling.

## EME update

In the early days of EME communications, contacts were rare and usually involved large groups. Amateurs often used the latest and best equipment available, whether it be homebrew or borrowed from a commercial company. That has all changed. EME operation is now a proven communications technique used daily on 144 and 432 MHz. Two-way contacts have now been made on every Amateur band between 50 and 5760 MHz, as shown on **tables 1 and 3** in reference 1.

Six-meter EME is picking up. There are about five stations now active and many more in the advanced building stages. It still requires large antenna arrays and 1,000 watts, but receiver and feedline problems are minimal. Look for an increase in 6-meter EME to fill in the gap until F2 returns.

Most of the worldwide EME activity is concentrated on 2 meters. One station alone has contacted over 800 different stations but it has a gigantic antenna system capable of working anyone with at least 2,000 watts of ERP! Nowadays you can be an appliance operator and still join in on the fun. Everything you need to use is available commercially.<sup>13,14</sup>

EME activity on 135 cm is now very slow, due in part to the small number of stations with the required equipment. It hasn't been helped by recent attacks by commercial companies on the 220-222 MHz frequency spectrum. However, this is still an excellent band and requires an antenna system with much less physical size than 2 meters. So 135-cm EME really deserves more consideration. Typical equipment is described in reference 15.

EME activity on 70 cm is quite prevalent, with several stations having contacted well over 200 different stations. About 45 DXCC countries have been represented, as well as all continents and 50 states. Portable 70-cm EME operation is also popular using 20-foot dishes or arrays of four to eight long Yagis. Typical equipment requirements are described in reference 16.

Our newest UHF band, 33 cm (903 MHz), is just getting started on EME.

For a starter antenna a dish with a diameter of at least 12 feet should be sufficient, as long as you run at least 100-150 watts and a feed-mounted low-noise preamplifier. This band looks very exciting for EME in the near future, since only a modest setup is required.

Two-way EME got its start on 23 cm (1296 MHz) in 1960. It does require a more elaborate setup, but many stations with dishes as small as 8-12 feet in diameter are making contacts. Power is a problem and most operators now use two to six 2C39/7289 tubes in a cavity. Circular polarization is standard operating practice, so Faraday is no longer a problem! Many operators use SSB and contacts are now routine. The W2NFA/W2IMU notes are a good guide.\*

EME activity on 2304/2320, 3456, and 5760 MHz is much more specialized and beyond the scope of this month's column. Those who are active are using state-of-the-art antennas, and in most cases antenna-mounted preamplifiers as well as power amplifiers. It appears that 10.368 GHz EME will soon be a reality.<sup>1</sup> One of the biggest problems so far is antenna aiming and tracking the moon. Another problem, antenna cost, is being helped by the use of TVRO-type dishes. EME operation is alive and well, so stay tuned.

## other propagation modes

A lot of microwave activity is springing up, especially on 3 cm (10.368 GHz) with the commercial availability of solid-state transverters. The difference between a GunnPlexer® running 20 milliwatts and a low-noise transverter operating on CW or SSB with 200 milliwatts (both are typical equipment specifications) is over 36 dB, or an equivalent of 63 times improvement in DX! I'll bet some really serious record attempts will take place shortly on the 13-cm (2304 MHz) through 3-cm bands.

There are many propagation modes and developments and I try to include

\*Write Dick Turrin, W2IMU, Box 65, Colts Neck, New Jersey 07722 for further information.

**KLM** **Cushcraft CORPORATION** **TELEX** **hy-gain**  
**KENWOOD** **Beckman** **Larsen** **TOKYO HY-POWER**  
**Heathkit** **ALLIANCE** **METRON** **HUSTLER**  
**Phillystron** **MIRAGE** **ASTRON CORPORATION**  
**Beacon** **DAIWA**  
**Amplifier** **Mosley**

## Our Antenna & Tower Discounts Are Tops

Hy-Gain, Cushcraft, Rohn, Tri-Ex, and Alliance Package Specials Available

Call and Compare Our Prices



### KENWOOD



**NEW TM-721A**  
 2m/440 MHz dual-band mobile with deluxe features.

### YAESU



**NEW FT-212**  
 Mini 2m mobile with 45 Watts

### ICOM



**IC-27A SPECIAL**  
 25-Watt Mobile with UT-16 speech synthesizer already installed.  
**\$349<sup>95</sup>**

Offer good while they last. Limited quantity subject to prior sale.

**Orders & Quotes Toll Free 800-444-4799**

**ege inc**  
 1988 Buyer's Guide/Catalog Available - Send \$1

**EGE VIRGINIA**  
 14803 Build America Drive, Bldg. B Woodbridge, Virginia 22191  
 Information: (703) 643-1063  
 Service Dept: (703) 494-8750  
 Fax: (703) 494-3679  
 Store Hours: M-F: 10-6; Sat: 10-4  
 Order Hours: M-F 9-7; Sat: 10-4

**EGE NEW ENGLAND**  
 8 Stiles Road Salem, New Hampshire 03079  
**New England (NH included) Toll Free: 800-444-0047**  
 Info & Service: (603) 898-3750  
 Store Hours: MTuWF: 10-5  
 Th: 12-8; Sat: 10-4

**VISA** **MasterCard** **DISCOVER**  
 Our associate store: Lacombe Distributors Davis & Jackson Road P.O. Box 293 Lacombe, Louisiana 70445 Phone: (504) 882-5355

BENCHE  
 VAN GORDE  
 UNIDER  
 SON  
 SMILEY  
 CES

**TE SYSTEMS**

**TEN-TEC** **Unarco-Rohn**  
**Amphenol** **YAESU**  
**Kantronics** **DIAMOND**  
**AMERITRON**

**Table 1. This quick reference table lists the most common types of North American VHF/UHF and above propagation. They are in no particular order. Optimum frequencies and a short summary of the typical characteristics are included.**

Propagation Mode	Frequencies	Remarks
1. Line of sight	50 MHz and up	Unobstructed path plus some bending extension.
2. F2	50 MHz	Requires high sunspot number, typically above 100 (solar flux > 150). Fall is best season.
3. Backscatter	50 MHz	Present during high sunspot activity like F2 or during an intense sporadic E opening.
4. Midlatitude sporadic E	50-225 MHz	Peaks between mid-May and mid-August and again between mid-November and mid-January. Best times are 0900-1200 and 1700-2000 local.
5. TE	50 MHz	Best at equinoxes $\pm 2$ weeks. Especially good when sunspot count is high. Optimum time is in late afternoon and early evening.
6. Equatorial FAI	50-450 MHz	Requires high number of sunspots. Should be located $\pm 10$ to 15 degrees of the geomagnetic equator. Other characteristics are same as TE.
7. Ionospheric scatter	50-150 MHz	Good from 800-1300 miles at midday in summer. Especially good during years with high sunspot activity. Path loss about 90 dB over free space at 6 meters and 115 dB at 2 meters. Requires high power.
8. Aurora	50-3000 MHz	Often occurs 24-48 hours after a solar disturbance. WWV K $\geq 4$ . Aim antenna to northerly direction.
9. Artificial aurora	50-450 MHz	Manmade ionospheric heating. Best when located near one of the heater installations. Very similar to aurora.
10. Auroral E	50 MHz	Similar to sporadic E. Usually occurs a few hours after an aurora has faded out.
11. Meteor scatter	50-450 MHz	Best on 2 and 6 meters for random meteors between 5-8 A.M. local time or at optimum direction and time during meteor showers. Above 225 MHz is very difficult.
12. FAI	50-450 MHz	Usually follows a sporadic E opening. Aim antenna slightly north of direct path. Has characteristics similar to aurora.
13. EME	50 MHz and up	High path loss (250-280 dB typical) depending on frequency. Requires very low noise figure receiver, high transmitter power, and high antenna gain (>20 dB).
14. Tropospheric scatter	50 MHz-20 GHz	Good up to 800 miles between stations having equipment similar to EME.
15. Tropospheric bending and super refraction	144 MHz and up	Best in spring and early fall, especially when there's a slow moving high barometric pressure (>30.0") and when a weather front is approaching somewhere along the path.
16. Tropospheric ducting	50 MHz and up	Similar to tropospheric bending. Best over water and flat land. Antenna elevation is important so you can couple into the duct.
17. Lightning scatter	144 and up	Sporadic. Both stations must aim into storm cell. Characteristics similar to meteor scatter.
18. Aircraft scatter	144 MHz up	Best when a large aircraft is at a high elevation and midway between stations. Usable up to about 500 miles.
19. Knife edge diffraction	1 GHz up	Best over a sharp edge such as a mountain peak especially when it is near one end of the path.
20. Obstacle gain	400 MHz up	Both stations must aim at obstacle such as a large building or mountain. Best when obstacle is near mid-point of path.
21. Rain scatter	5-25 GHz	Aim antenna into storm cell especially if it is elevated. Lots of signal distortion.

the latest record-breaking contacts at the end of each month's column. For those interested in microwave and millimeter-wave propagation, see references 17 and 18 which appeared in "VHF/UHF World" two years ago.

## how to find openings

By now you're probably wondering how to discover and use all this super propagation. To take full advantage you must understand the propagation modes available on all bands of interest and know when they are usable. **Table 1** shows most of the major propagation modes, the frequencies where they are most prevalent, and a few

words on their characteristics. It provides a quick reference guide.

There are many ways to find openings and just as many ways to miss them. For instance, there will always be a major opening when you least expect it or when you're "out of town!" It is surely a fact that we miss more openings than we catch. But this is rapidly changing with the increased use of calling frequencies (see **table 2**) and greater activity.

There is a problem with the 6-meter calling frequency (50.110 MHz) that has been used for many years. For the last decade it has been recommended as the DX calling frequency, with

50.200 MHz recommended for domestic operation. The latter never caught on. The popular 50.110 MHz is now so totally congested, especially during VHF contests, that DX can't break through the QRM. It has been suggested that all contest and routine activity on 6 meters take place above 50.125 MHz to allow room for the weaker DX near 50.110 MHz.

Another good way to detect openings is to monitor Amateur propagation beacons. They are most prevalent between 50-50.1, 144.05-144.06, and 432.07-432.08 MHz, with some scattered throughout the UHF and microwave bands.

# A Great New ARRL Antenna Book

Twice the size of the previous edition

Over 700 pages

987 figures

Edited by Gerald L. Hall, K1TD

QST Associate  
Technical Editor

Available in August

The 15th Edition of *The ARRL Antenna Book* has been dramatically expanded in a similar fashion to recent editions of the *ARRL Handbook* and the *ARRL Operating Manual*. We've drawn on material produced by the ARRL Technical Department and from 16 well-known outside authors who have done much to contribute to the state-of-the-art in antenna and transmission line design. Available in softcover only for \$18 at your dealer or directly from ARRL (shipping and handling: \$2.50, \$3.50 for UPS)

#### CHAPTER LINEUP:

The number of pages appears in parentheses after the chapter title. Page counts may vary slightly. Safety First (18), Antenna Fundamentals (42), *The Effects of the Earth* (14), Selecting Your Antenna System (30), Loop-Antennas (16), Multielement Arrays (42), Broadband Antennas (12), Log Periodic Arrays (24), Yagi Arrays (26), Quad Arrays (14), Long Wire and Traveling Wave Antennas (18), Direction Finding Antennas (26), Portable Antennas (10), Mobile and Maritime Antennas (30), Repeater Antenna Systems (20), VHF and UHF Antenna Systems (44), Antennas for Space Communications (32), Spacecraft Antennas (8), Antenna Materials and Accessories (20), Antenna Supports (22), Radio Wave Propagation (26), Transmission Lines (26), Coupling the Transmitter to the Line (18), Coupling the Line to the Antenna (28), Antenna and Transmission-Line Measurements (36), Smith Chart Calculations (16), Topical Bibliography on Antennas (32), Glossary and Abbreviations (4), Contents, Index, etc (16).

ARRL 225 MAIN ST., NEWINGTON, CT 06111

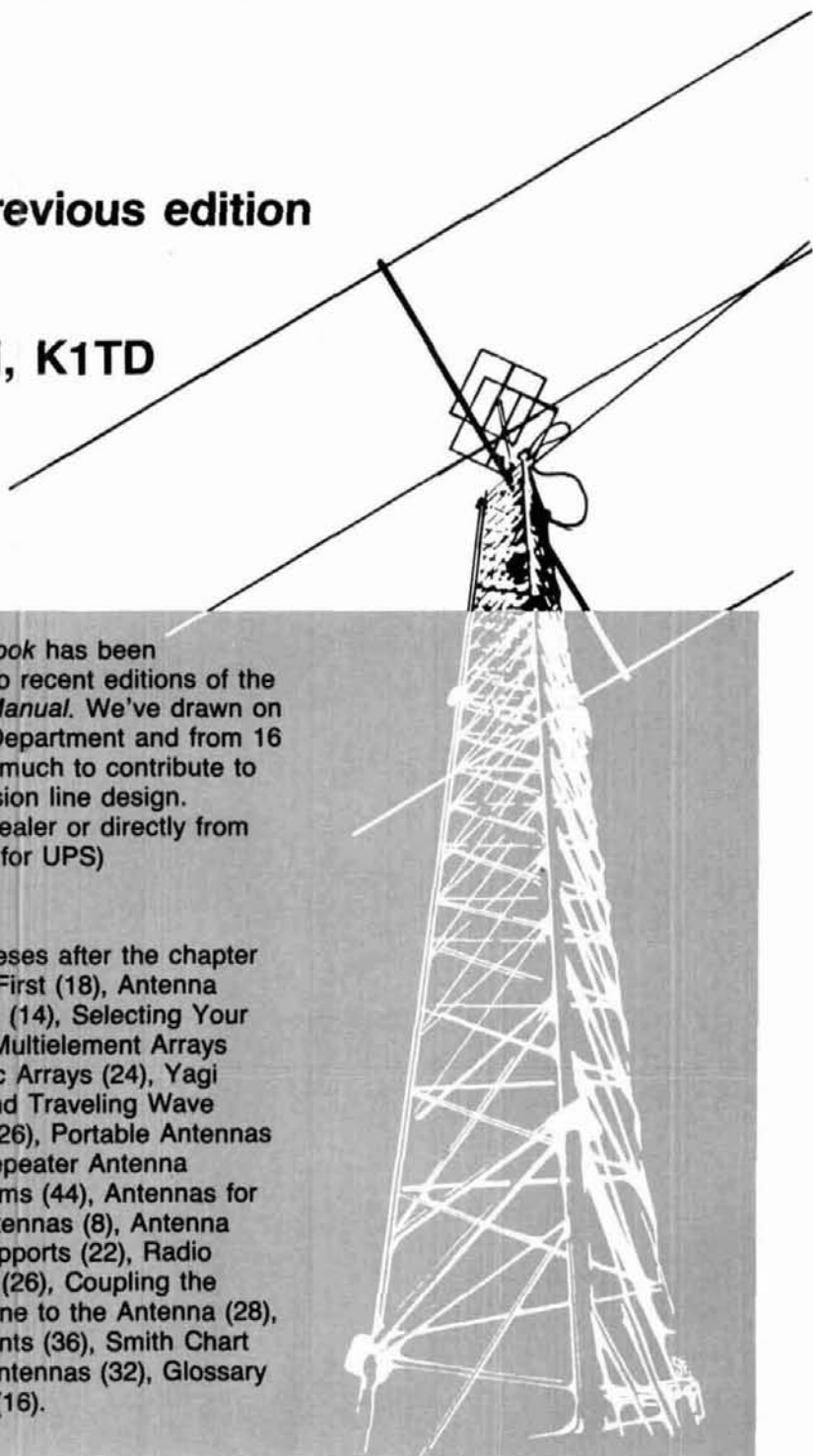



# ICOM.....FIRST IN

**FIRST IN QUALITY.** Spectacular performance, smooth operation and incomparable dependability are confirmation of ICOM equipment's top-line quality. These superb characteristics are built into every ICOM handheld, mobile, base unit and accessory. They assure your maximum operating pleasure anywhere, anytime. Move into the winner's circle with ICOM and enjoy a commitment to excellence that extends from HF to microwave!

**FIRST IN TECHNOLOGY.** Pacesetter designs and innovative circuitry are synonymous with the ICOM nameplate. This technical leadership spans from the early inclusion of microprocessor tuning concepts through continuing development of today's most advanced designs and full communications systems. *Some* ICOM-pioneered features are now available in competitive units, but *only* ICOM equipment delivers the "full package!"



# COMMUNICATIONS



**FIRST IN SERVICE.** ICOM is on your side with the best customer support program in amateur radio. That includes a full one year warranty on all HF units, a direct service hotline, and four North American service centers. ICOM strives for a repair turnaround time of less than five days. Your total enjoyment of quality and technically advanced ICOM equipment is fully guaranteed!

142

# ICOM

ICOM America, Inc., 2380-116th Ave. N.E., Bellevue, WA 98004  
Customer Service Hotline (206) 454-7619  
3150 Premier Drive, Suite 126, Irving, TX 75063  
1777 Phoenix Parkway, Suite 201, Atlanta, GA 30349  
ICOM CANADA, A Division of ICOM America, Inc., 3071 - #5 Road,  
Unit 9, Richmond, B.C. V6X 2T4 Canada



## CONTINUOUS COVERAGE ANTENNAS FOR COMMERCIAL & AMATEUR SERVICE

### Model AC 1.8-30

1.8 to 30 MHz

- SWR Max 2:1, 1.4:1 average from 1.8 to 30 MHz
- Can be installed in approximately 80 ft. space
- Ideal for commercial services for multi frequency operation without the need for antenna tuners or additional antennas
- Handles 1 KW, 2 KW PEP ICAS
- Higher power models available on special order. Contact your dealer or factory

**\$175.00**  
SHIPPING & HANDLING  
ADD \$4.00

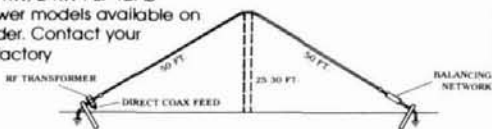

U.S. Patent No. 4,511,898

### Model AC 3.5-30

3.5 to 30 MHz

- SWR less than 2:1 from 3.5 to 30 MHz
- Complete assembled. Balun terminated with standard SO-239 connector
- Power capability 1 KW - 2 KW PEP ICAS. Higher power model is available on special order.
- Designed for 50 ohm feedline
- Weather proof balun and balancing network

**\$184.50**  
SHIPPING & HANDLING  
ADD \$4.00

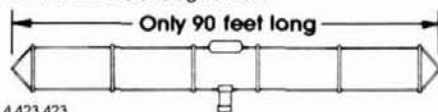

U.S. Patent No. 4,423,423

ALL OUR PRODUCTS MADE IN USA



**BARKER & WILLIAMSON**

Quality Communication Products Since 1932

At your Distributors. Write or Call  
10 Canal Street, Bristol, PA 19007

(215) 788-5581



# OnSat

## "America's Weekly Guide to Satellite TV"



The best in satellite programming! Featuring: ★ Over 120 Channels listed ★ Weekly, Updated Listings ★ Magazine Format ★ Complete Alphabetical Movie Listings ★ Sports Specials ★ Prime Time Grids ★ Specials ★ Programming Updates!

- Only \$45.00 per year (52 weekly issues)
- 2 Years \$79.00 (104 weekly issues)
- \$1.00 for sample copy

\*NC Residents must add 5% Sales Tax

**Subscribe Today!**

call toll free 1-800-234-0021

Visa® and MasterCard® accepted

OnSat PO Box 2347 Shelby, NC 28151-2347



## W6SAI BOOKS

published by Bill Orr, W6SAI and Stu Cowan, W2LX

### BEAM ANTENNA HANDBOOK

Completely revised and updated with the latest computer generated information on BEAM Antenna design. Covers HF and VHF Yagis and 10, 18 and 24 MHz WARC bands. Everything you need to know. 204 illustrations. 268 pages. ©1985. Revised 1st edition.

□RP-BA

Softbound \$11.95

### SIMPLE LOW-COST WIRE ANTENNAS

Primer on how-to-build simple low cost wire antennas. Includes invisible designs for apartment dwellers. Full of diagrams and schematics. 192 pages. ©1972 2nd edition

□RP-WA

Softbound \$11.95

### ALL ABOUT CUBICAL QUAD ANTENNAS

Simple to build, lightweight, and high performance make the Quad at DX'ers delight. Everything from the single element to a multi-element monster. A wealth of information on construction, feeding, tuning and installing the quad antenna. 112 pages. ©1982. 3rd edition.

□RP-CQ

Softbound \$9.95

### THE RADIO AMATEUR ANTENNA HANDBOOK

A wealth of projects that covers verticals, long wires, beams as well as plenty of other interesting designs. It includes an honest judgement of gain figures, how to site your antenna for the best performance, a look at the Yagi-Quad controversy, baluns, slopers, and delta loops. Practical antenna projects that work! 190 pages. ©1978. 1st edition.

□RP-AH

Softbound \$11.95

Please enclose \$3.50 for shipping and handling.



**ham radio** magazine **BOOKSTORE**  
GREENVILLE, NH 03048 (603) 878-1441

# STV GUIDE

The new **STV Guide** contains valuable information on zoning regulations, scrambling, plus technical tips for installing or updating a satellite system—and now a precise monthly guide to satellite TV with the latest program listings for over 90 channels!



All this in each complete issue of **STV Guide!**

- Only \$48.00 per year (12 monthly issues)
- \$2.00 for a sample copy

\*NC Residents must add 5% sales tax

**Subscribe Today!**

Call toll free 1-800-234-0021

Visa® and MasterCard® accepted



STV Guide PO Box 2384 Shelby, NC 28151-2384



The FCC regulates all automatic beacons (the most common types) on all frequencies below 450 MHz. In recent years, partially because of increased Amateur activity, beacons have sometimes caused interference with EME and other weak signal propagation. As a result, the ARRL VUAC is now soliciting comments on moving all beacons on 2 meters and higher to roughly 75-300 kHz above the present weak signal calling frequencies (rather than below, as is current practice). A note to the ARRL Membership Services Committee with your comments might help. Only after a consensus is found will the FCC be petitioned to approve any frequency changes for automatic beacons on the frequencies below 450 MHz.

The thousands of beacons outside the Amateur bands are rich sources of propagation indicators. Commercial stations like FM, television, and aircraft beacons are a few. Prime beacons to monitor for possible 6-meter openings to Europe are the video carriers of European television at 48.25 and 49.75 MHz.

Other good indicators of possible openings on 6 meters are the Amateur beacons between 28.2-28.3 MHz. Don't overlook above average and out-of-area Amateur activity between 28.3-28.5 MHz, the new Novice phone band.

**Table 2. This table shows the recommended weak signal calling frequencies on the VHF/UHF bands.**

Band	Frequency
6 meters	50.110 MHz DX *
	50.200 MHz Domestic *
2 meters	144.2 MHz
135 cm	220.1 MHz
70 cm	432.1 MHz
33 cm	903.1 MHz
23 cm	1296.1 MHz
13 cm	2304.1 MHz
9 cm	3456.1 MHz
6 cm	5760.1 MHz
3 cm	10.368 GHz

\* See text for explanation.

There are also clubs and publications. KA3B now publishes a North American 50-MHz SSB Directory and beacon list and a 6-meter repeater

# AR501 BACK TO BASICS... But far more advanced...



Model AR501 Telegraph Terminal  
**\$229.00**  
(California res. add \$13.74 tax.)

Visa and MasterCard orders are welcomed. Price includes shipping & handling. Purchase orders accepted from Government agencies

**AR-501** covered by One Year Limited Warranty. Extended warranty service available at the following rates:  
**\$25.00 - 3 Years \$15.00 - 2 Years**

**AR501** is a compact triple mode CW terminal in a small package (4.5" x 6.25" x 2.25") but a powerful gear to practice and play with. As a CW decoder, it detects morse code between 5 to 30 WPM. **For practice?**, it activates and displays the code. **More?**, it operates as an electronic keyer both standard and iambic. **More yet?**, How about a print-out function? The **AR501** does just that. We offer a stand alone thermal printer as an option.

**APE communications, inc.** TOLL FREE 1-800-523-6366  
22511 Aspan St., Lake Forest, CA 92630-6321 (714) 581-4900 • Telex 29-7385 • Fax (714) 768-4410

✓ 144

## COMPUTERIZE YOUR SHACK

YAESU 747, 757GX, 757GXII, 767, 9600.  
KENWOOD TS 440, TS 940,  
ICOM R71A, R7000, 735, 751A.  
DRIVERS FOR RADIOS ARE MODULAR.  
JRC NRD 525.

COMPLETE PROGRAM ENVIRONMENT  
MENU DRIVEN AND DESIGNED FOR EASE  
OF USE.  
SCAN FUNCTION ADDED TO RADIOS THAT DO  
NOT SUPPORT IT.

### MENUS FOR THE FOLLOWING:

AMATEUR HF—AMATEUR VHF—  
AMATEUR UHF  
AM BROADCAST—FM BROADCAST—  
TELEVISION BROADCAST  
SHORT WAVE BROADCAST  
AVIATION HF(SSB)—AVIATION VHF—  
AVIATION UHF  
HIGH SEAS MARINE—VHF MARINE  
MISCELLANEOUS HF, VHF, UHF  
MOST POPULAR FREQUENCIES ALREADY  
STORED  
ADDITIONAL LIBRARIES AVAILABLE  
COMPLETE LOGGING FACILITY  
ALL FREQUENCY FILES MAY BE ADDED TO,  
EDITED OR DELETED

AVAILABLE FOR IBM PC, XT, AT, 80386 256K RAM  
1 SERIAL PORT AND 1 FLOPPY MINIMUM

PROGRAM WITH INITIAL LIBRARIES **99.95**  
RS—232 TO TTL INTERFACE ONLY  
NEEDED IF DON'T HAVE MANUFACTURERS  
INTERFACE ALLOWS 4 RADIOS **99.95**  
SPECTRUM ANALYZER MODULE (CALL FOR PRICE)

### DATACOM, INT.

8081 W. 21ST. LANE ✓ 195  
HIALEAH, FL 33016  
AREA CODE (305) 822-6028

## CIE Cleveland Institute of Electronics

1776 East 17th St., Cleveland, Ohio 44114

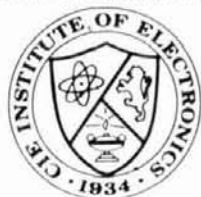

✓ 145

Accredited Member National Home Study Council

CIE is the world's largest independent study electronics school. We offer ten courses covering basic electronics to advanced digital and microprocessor technology. An Associate in Applied Science in Electronics Engineering Technology is also offered.

Study at home — no classes. Programs accredited and eligible for VA benefits.

CIE Cleveland Institute of Electronics  
1776 East 17th St., Cleveland, Ohio 44114  
YES! I want to get started. Send me my CIE school catalog including details about the Associate Degree program.

Print Name \_\_\_\_\_  
Address \_\_\_\_\_ Apt. \_\_\_\_\_  
City \_\_\_\_\_ State \_\_\_\_\_ Zip \_\_\_\_\_  
Age \_\_\_\_\_ Area Code/Phone No. \_\_\_\_\_  
Check box for G.I. Bulletin on Educational Benefits  
 Veteran  Active Duty MAIL TODAY!  
AHR-03

**★ QUALITY PARTS ★ DISCOUNT PRICES ★ FAST SHIPPING**

# ALL ELECTRONICS CORP.

FREE CATALOG PAGE

### OPTO SENSORS

TRW OPB15  
U shaped  
opto emitter  
and sensor unit  
CAT# OSU-3  
2 for \$1.00

Clairex#  
CL800W  
U shaped unit  
with flange  
mount.  
CAT# OSU-2  
75¢ each

Opto emitter  
and sensor on  
opposite sides  
of slotted  
opening. P.C. mount  
CAT# ILED-U  
2 for \$1.00

### PHOTO TRANSISTOR

TIL-99  
TO-18 CASE  
CAT# TIL-99  
2 FOR \$1.50

### PHOTO DIODE

Similar to  
ClairexCLD42  
Sealed TO-18 case  
CAT# PD-1  
75¢ each

### PHOTO RESISTOR ASSEMBLY

Center-tapped  
photo resistor  
mounted in  
plastic case  
(can be easily  
removed). 700  
ohms light, 36K dark.  
1/4" diameter.  
CAT# PR-4 \$1.00 each  
10 for \$8.50

### FLASHING L.E.D. KIT

Two L.E.D.'s  
flash in  
unison when  
a 9 volt  
battery is  
attached.  
Requires easy assembly,  
you solder the parts to  
the circuit board.  
CAT# LEDKIT  
\$1.50 each

### WE STOCK OVER 4000 ITEMS CALL OR WRITE FOR OUR FREE CATALOG OF PARTS!

RESISTORS • CAPACITORS • DIODES • CABLES •  
BRIDGE RECTIFIERS • CHOKES COILS • CIRCUIT  
CONNECTORS • SUB MINIATURE D CONNECTORS •  
CRYSTALS • LAMPS • HEAT SINKS • I.C.'S  
• TRANSISTORS • MOTORS • PHOTO BOARDS •  
POTENTIOMETERS • POWER SUPPLIES • JACKS  
• PLUGS • SWITCHES • PERF BOARD • FANS •  
FUSES • SHRINK TUBING • TIE WRAPS •  
KEYPADS • VIDEO ACCESSORIES • TOOLS •  
• TRANSFORMERS • TELEPHONE ACCESSORIES •  
• S.C.R.'S • RELAYS • WIRE • I.C. SOCKETS  
• RIBBON CABLE • CRYSTALS • CIRCUIT  
BREAKERS • TRANSUCERS • VOLTAGE  
REGULATORS • AND MANY OTHER ITEMS...

### SWITCHING POWER SUPPLY

Compact, well regulated  
switching power supply  
designed to power Texas In-  
strument computer equipment.  
INPUT: 14-25 Vac @ 1 Amp  
OUTPUT: +5 Vdc @ 1.2 Amp, -5 Vdc @ 200 ma., 12  
Vdc @ 350 ma. SIZE: 4 3/4" square. Includes 18 Vac  
@ 1 Amp wall transformer designed to operate this  
power supply. CAT# PS-TX \$5.00 each  
10 for \$45.00

### WALL TRANSFORMERS

ALL PLUG  
DIRECTLY  
INTO  
120 VAC  
OUTLET  
6 Vdc @ 200 ma. \$2.25  
CAT# DCTX-620  
6 Vdc @ 750 ma. \$3.50  
CAT# DCTX-675  
9 Vdc @ 250 ma. \$2.50  
CAT# DCTX-925  
12 Vdc @ 900 ma. \$3.50  
CAT# ACTX-1293  
18 Vac @ 1 Amp. \$3.50  
CAT# ACTX-1685

### PROTO BOARD

Large enough to  
design most  
experimental circuits.  
This proto board  
measures  
8 3/4" X 2 1/2".  
Contains main board  
and two power buss  
strips.  
CAT# PB-101  
\$11.00 each

### XENON FLASH TUBES

3/4" long X 1/8" diameter  
CAT# FLT-1 2 for \$1.00

### FULL WAVE BRIDGE RECTIFIERS

10 AMP  
200 P.I.V.  
5/8" SQUARE  
CAT# FWB-1020  
\$1.50 each - 10 for \$9.00

### 25 AMP RATING

1 1/8" SQUARE  
metal epoxy filled case  
200 P.I.V. \$2.50 each  
CAT# FWB-251  
400 P.I.V. \$3.00 each  
CAT# FWB-254  
600 P.I.V. \$3.50 each

### TRANSISTORS

PART	TYPE	CASE	PRICE
2N2222	NPN	TO-18	5 for 75¢
2N2904	PNP	TO-18	3 for \$1.00
2N2950	PNP	TO-18	3 for 75¢
2N2957	PNP	TO-18	3 for 75¢
2N3055	NPN	TO-18	\$1.00 each
2N3548	NPN	TO-18	5 for 50¢
2N3954	NPN	TO-18	5 for 75¢
2N3998	PNP	TO-18	5 for 75¢
2N4400	NPN	TO-18	5 for 75¢
2N4402	NPN	TO-18	5 for 75¢
2N4403	NPN	TO-18	5 for 75¢
2N4404	NPN	TO-18	5 for 75¢
2N4405	NPN	TO-18	5 for 75¢
2N4406	NPN	TO-18	5 for 75¢
2N4407	NPN	TO-18	5 for 75¢
2N4408	NPN	TO-18	5 for 75¢
2N4409	NPN	TO-18	5 for 75¢
2N4410	NPN	TO-18	5 for 75¢
2N4411	NPN	TO-18	5 for 75¢
2N4412	NPN	TO-18	5 for 75¢
2N4413	NPN	TO-18	5 for 75¢
2N4414	NPN	TO-18	5 for 75¢
2N4415	NPN	TO-18	5 for 75¢
2N4416	NPN	TO-18	5 for 75¢
2N4417	NPN	TO-18	5 for 75¢
2N4418	NPN	TO-18	5 for 75¢
2N4419	NPN	TO-18	5 for 75¢
2N4420	NPN	TO-18	5 for 75¢
2N4421	NPN	TO-18	5 for 75¢
2N4422	NPN	TO-18	5 for 75¢
2N4423	NPN	TO-18	5 for 75¢
2N4424	NPN	TO-18	5 for 75¢
2N4425	NPN	TO-18	5 for 75¢
2N4426	NPN	TO-18	5 for 75¢
2N4427	NPN	TO-18	5 for 75¢
2N4428	NPN	TO-18	5 for 75¢
2N4429	NPN	TO-18	5 for 75¢
2N4430	NPN	TO-18	5 for 75¢
2N4431	NPN	TO-18	5 for 75¢
2N4432	NPN	TO-18	5 for 75¢
2N4433	NPN	TO-18	5 for 75¢
2N4434	NPN	TO-18	5 for 75¢
2N4435	NPN	TO-18	5 for 75¢
2N4436	NPN	TO-18	5 for 75¢
2N4437	NPN	TO-18	5 for 75¢
2N4438	NPN	TO-18	5 for 75¢
2N4439	NPN	TO-18	5 for 75¢
2N4440	NPN	TO-18	5 for 75¢
2N4441	NPN	TO-18	5 for 75¢
2N4442	NPN	TO-18	5 for 75¢
2N4443	NPN	TO-18	5 for 75¢
2N4444	NPN	TO-18	5 for 75¢
2N4445	NPN	TO-18	5 for 75¢
2N4446	NPN	TO-18	5 for 75¢
2N4447	NPN	TO-18	5 for 75¢
2N4448	NPN	TO-18	5 for 75¢
2N4449	NPN	TO-18	5 for 75¢
2N4450	NPN	TO-18	5 for 75¢
2N4451	NPN	TO-18	5 for 75¢
2N4452	NPN	TO-18	5 for 75¢
2N4453	NPN	TO-18	5 for 75¢
2N4454	NPN	TO-18	5 for 75¢
2N4455	NPN	TO-18	5 for 75¢
2N4456	NPN	TO-18	5 for 75¢
2N4457	NPN	TO-18	5 for 75¢
2N4458	NPN	TO-18	5 for 75¢
2N4459	NPN	TO-18	5 for 75¢
2N4460	NPN	TO-18	5 for 75¢
2N4461	NPN	TO-18	5 for 75¢
2N4462	NPN	TO-18	5 for 75¢
2N4463	NPN	TO-18	5 for 75¢
2N4464	NPN	TO-18	5 for 75¢
2N4465	NPN	TO-18	5 for 75¢
2N4466	NPN	TO-18	5 for 75¢
2N4467	NPN	TO-18	5 for 75¢
2N4468	NPN	TO-18	5 for 75¢
2N4469	NPN	TO-18	5 for 75¢
2N4470	NPN	TO-18	5 for 75¢
2N4471	NPN	TO-18	5 for 75¢
2N4472	NPN	TO-18	5 for 75¢
2N4473	NPN	TO-18	5 for 75¢
2N4474	NPN	TO-18	5 for 75¢
2N4475	NPN	TO-18	5 for 75¢
2N4476	NPN	TO-18	5 for 75¢
2N4477	NPN	TO-18	5 for 75¢
2N4478	NPN	TO-18	5 for 75¢
2N4479	NPN	TO-18	5 for 75¢
2N4480	NPN	TO-18	5 for 75¢
2N4481	NPN	TO-18	5 for 75¢
2N4482	NPN	TO-18	5 for 75¢
2N4483	NPN	TO-18	5 for 75¢
2N4484	NPN	TO-18	5 for 75¢
2N4485	NPN	TO-18	5 for 75¢
2N4486	NPN	TO-18	5 for 75¢
2N4487	NPN	TO-18	5 for 75¢
2N4488	NPN	TO-18	5 for 75¢
2N4489	NPN	TO-18	5 for 75¢
2N4490	NPN	TO-18	5 for 75¢
2N4491	NPN	TO-18	5 for 75¢
2N4492	NPN	TO-18	5 for 75¢
2N4493	NPN	TO-18	5 for 75¢
2N4494	NPN	TO-18	5 for 75¢
2N4495	NPN	TO-18	5 for 75¢
2N4496	NPN	TO-18	5 for 75¢
2N4497	NPN	TO-18	5 for 75¢
2N4498	NPN	TO-18	5 for 75¢
2N4499	NPN	TO-18	5 for 75¢
2N4500	NPN	TO-18	5 for 75¢

### 10 AMP SOLID STATE RELAYS

ELECTROL# S2181  
CONTROL  
Rated 5.5 to 10 Vdc  
will operate on 3-32 Vdc  
LOAD:  
10 Amp @ 240 Vac  
2 1/4" X 1 3/4" X 7/8"  
CAT# SRR1Y-10B  
\$9.50 each  
10 for \$85.00 each  
QUANTITY DISCOUNT!  
25 for \$7.00 each  
50 for \$6.00 each  
100 for \$5.00 each

### MINIATURE TOGGLE SWITCHES

all rated 5 Amp

S.P.D.T. (on-on)  
Solder lug terminals  
CAT# MTS-4  
\$1.00 each  
10 for \$9.00

S.P.D.T. (on-on)  
Non threaded bushing  
P.C. mount  
CAT# MTS-40PC  
75¢ each  
10 for \$7.00

D.P.D.T. (on-on)  
Solder lug terminals  
Gray rectangular key cap  
CAT# MTS-8  
\$2.00 each  
10 for \$19.00

### MINI PUSH BUTTON

S.P.S.T. mounting  
threaded bushing  
Red button  
CAT# MPB-1  
35¢ each  
10 for \$3.25

### ITT PUSH BUTTON

ITT MDPL series. 3/4" X 1/2"  
gray rectangular key cap  
S.P.S.T. N.O. Push to close  
RATED:  
0.1 amp  
switching  
0.25 amp  
carry current. P.C. mount  
CAT# PB-8 65¢ each  
10 for \$6.00 - 100 for \$50.00

### HALL EFFECT SWITCH

MICROSWITCH #4B3  
Shielded keyboard  
switch with hall  
effect sensor  
Snaps into 5/8"  
square chassis  
hole. Hall effect  
sensor slides easily from  
switch and can be used in  
other applications.  
CAT# HESW-4 for \$1.00  
100 for \$15.00

### NICKEL-CAD (RECHARGEABLE) BATTERIES

AA SIZE \$2.00 each  
1.25 volts 500 mAh  
CAT# NCB-AA  
AA SIZE \$2.20 each  
with SOLDER TABS  
CAT# NCB-SAA  
C SIZE \$4.25 each  
1.2 volts 1200 mAh  
CAT# NCB-C  
D SIZE \$4.25 each  
1.2 volts 1200 mAh  
CAT# NCB-D

### 10 AMP SOLID STATE RELAYS

ELECTROL# S2181  
CONTROL  
Rated 5.5 to 10 Vdc  
will operate on 3-32 Vdc  
LOAD:  
10 Amp @ 240 Vac  
2 1/4" X 1 3/4" X 7/8"  
CAT# SRR1Y-10B  
\$9.50 each  
10 for \$85.00 each  
QUANTITY DISCOUNT!  
25 for \$7.00 each  
50 for \$6.00 each  
100 for \$5.00 each

### SOUND ACTIVATED SWITCH

This circuit is designed to react to  
high pitched sounds. Each board  
contains many useful parts including  
a condenser mic. Operates on  
6 Vdc. CAT# SAB \$5.00 each

### SOUND & VIDEO MODULATOR

THE LM1381-1  
Designed for use  
with T.I. compul-  
ers. Can be used  
with video cam-  
eras, games, or  
other audio/  
video sources.  
Built in AB  
switch enables  
user to switch  
from T.V. antenna without dis-  
connection. Operates on chan-  
nel 3 or 4. Requires 12 Vdc.  
Hook up program included.  
CAT# AVMOO \$5.00 each

### GRAB BAGS

\$1.00 each

50 ASSORTED  
DISC CAPS.  
Cut leads. Many common  
values, some 500 volts.  
CAT# GRABC

ASSORTED  
1/4 WATT  
RESISTORS  
Approximately 200  
pieces of assorted values,  
some cut leads.  
CAT# GRABR

ASSORTED  
PARTS  
Strip of 100 assorted  
parts. Each strip contains  
an assortment of resis-  
tors, capacitors, diodes,  
coils etc. 100 parts.  
CAT# GRABTR

15 VALUES OF  
ELECTROLYTICS  
Assortment contains 15  
values from 1 Mfd up.  
Some with cut leads.  
CAT# GRABCP

### 600 / 600 OHM COUPLING TRANSFORMER

600 ohm  
c.t.  
P.C. mount  
on mounting tabs.  
1" X 3/4" X 7/8"  
CAT# CPTX  
\$1.25 each  
10 for \$11.00

STORES:  
LOS ANGELES  
909 S. VERMONT AVE.  
LOS ANGELES, CA 90004  
(813)288-4620

VAN NUYS  
8229 REPUBLICA BLVD.  
VAN NUYS, CA 91411  
(818)887-1826

MAIL ORDERS TO:  
ALL ELECTRONICS  
P.O. BOX 567  
VAN NUYS, CA  
91408

TELEX: TWB-21018144  
ALL ELECTRONICS  
ORDER CATALOG \$2.00 \$1.50  
POSTAGE FREE WITH CATALOG

TOLL FREE  
800-826-5432  
INFO: (818)904-0524  
FAX: (818)781-2653

MEMBER UNDER THE  
ELECTRONIC INDUSTRY  
ASSOCIATION (EIA)  
ELECTRONIC INDUSTRY  
ASSOCIATION (EIA)  
ELECTRONIC INDUSTRY  
ASSOCIATION (EIA)

directory. \* Other VHF publications are of interest and many are listed in reference 19. (I hope to publish a club list soon.)

There are net frequencies and special VHF activity frequencies on the hf bands that often help spot VHF openings. An example is 3818 kHz, the frequency of the Central States VHF Society net which is often used as an evening gathering place for VHFers, especially during meteor showers. EMEers meet on Saturdays and Sundays from 1600 to approximately 1900 UTC on 14.345 MHz. The 6-meter activity frequency is 28.885 MHz, which is often busy when 6-meter openings or crossband activity is expected.

How about a dedicated packet net for exchanging VHF/UHF information, activity, band openings, and beacon frequencies? Dxers in W1/W2/W6 (and perhaps other places) have such nets and bulletin boards near 144.95 MHz. These nets broadcast rare DX activity as well as WWW solar activity. They also allow interconnects between linked stations over a wide coverage area. This could be an invaluable source of information exchange for VHF and above enthusiasts. Imagine seeing a flash that ZD8MB is being heard in the states on 50.110 MHz or KH6HME is being heard in California on 1296 MHz! Why not give it a thought. Maybe the DXers would let us jump on their net until we can establish our own systems.

### summary

I hope this month's column has brought you up to date on all the latest propagation happenings on the frequencies above 50 MHz. Reviewing the references listed should help you understand the propagation opportunities available on these bands. Table 1 can be your mini propagation guide. Good luck on your search for new DX.

### notes

Per Amateur Satellite Report (AM-SAT newsletter), bulletin no. 171, March 21, 1988: Dr. Patrick MacIntosh, the Director of Solar Physics

\*Harry Schools, KA3B, 1606 S. Newkirk Street, Philadelphia, Pennsylvania 19145, \$8 for each directory.

# ICOM

**915 North Main Street  
Jamestown, New York 14701**

INTRODUCING  
W2DRZ VHF/UHF MODULES.  
NOW AVAILABLE.

ICOM, AEA, LARSEN, VAN GORDEN,  
VIBROPLEX, NYE-VIKING, FALCON  
COMM, LEADING EDGE, ARRL PUBLI-  
CATIONS, KAGLO, HAMTRONICS,  
PROWRITER, ELEPHANT DISKS,  
DEBCO, TRIONYX

Western New York's finest... amateur radio dealer!

PH. (716)664-6345



Research at NOAA's Space Environment Laboratory, Boulder, Colorado, reports that the peak of solar cycle 22 may be a lot higher and earlier than originally predicted. Let's hope he's right. Check WWV and the PRF.

Just a reminder. The latest accepted ARRL VUAC Band Plan as shown in the ARRL Repeater Directory lists the 33-cm calling frequency as 903.1 MHz with EME activity between 903.0 and 903.05 MHz. Using these frequencies will help reduce QRM from other services and bring interested parties together so they won't miss openings by being spread out in frequency.

### new records

On March 22, 1988 at 1300 UTC Gene Monk, W4ODW, Niceville, Florida (EM60SM) worked Al Ward, WB5LUA, McKinney, Texas (EM13QC) for a new extension of the 33-cm (902-928 MHz) tropo DX record. Gene was running only 10 watts on 903.1 MHz SSB while Al was running 150 watts to a single 47-element loop Yagi. Tropo was reported between the Florida Panhandle and Texas for a few days and signals were quite strong. The distance was 623 miles (1003 km). **Table 1** from last month's column is already obsolete! Congratulations to Gene and Al.

### acknowledgments

I would particularly like to thank Dr. Ernest K. Smith for sending me the copy of his  $F_0E_s$  maps article.<sup>5</sup> Thanks also to those who took the time to write with comments and suggestions for future columns.

### important VHF/UHF events

July 1	$\pm 1$ month. Look for USA to Europe openings on 6 meters
July 2	EME perigee
July 13	New moon
July 16-17	CQ VHF WPX Contest
July 20	$\pm 3$ weeks. Look for 2-meter sporadic E openings
July 21-24	Central States VHF Conference, Lincoln, Nebraska (contact WD0DGF)

July 28	Predicted peak of the Delta Aquarids meteor shower at 2100 UTC
July 30	EME perigee
Aug 6-7	ARRL UHF Contest
August 11	Predicted peak of the Perseids meteor shower at 1900 UTC
August 12	New moon
August 20-21	ARRL 10 GHz Cumulative Contest, first weekend
August 25-28	Microwave Update 1988 Conference Estes Park, Colorado (contact W0PW)
August 27	EME perigee

### references

1. Joe Reiser, W1JR, "VHF/UHF World: Propagation Update-part 2," *ham radio*, June 1988, page 38.
2. Joe Reiser, W1JR, "VHF/UHF World: The VHF/UHF Primer: An Introduction to Propagation," *ham radio*, July 1984, page 14.
3. Joe Reiser, W1JR, "VHF/UHF World-Propagation Update," *ham radio*, July 1985, page 86.
4. S. J. Lieberman, WA2FXB, "Chasing the Elusive E Skip on 2 Meters," Copyright 1985. Copies available from WA2FXB.
5. Ernest K. Smith, "Temperate Zone Sporadic-E Maps ( $F_0E_s > 7$  MHz)," *Radio Science* Vol. 13, number 3, pages 571-575, May-June 1978.
6. Joe Reiser, W1JR, "VHF/UHF World: Low-Noise Receiver Update-part 1," *ham radio*, November 1987, page 77.
7. Joe Reiser, W1JR, "VHF/UHF World: Impedance-Matching Techniques," *ham radio*, October 1987, page 27.
8. Pat Hawker, G3VA, "Technical Topics," *Radio Communications*, RSGB, October 1987, page 749.
9. Ken Willis, G8VR, "Meteor Scatter-European Style," *QST*, November, 1986, page 35.
10. Joe Reiser, W1JR, "VHF/UHF World: Improving Meteor Scatter Communications," *ham radio*, June 1984, page 82.
11. Joe Reiser, W1JR, "VHF/UHF World: Meteor Scatter Communications," *ham radio*, June 1986, page 68.
12. Joe Reiser, W1JR, "VHF/UHF World: Loose Ends," *ham radio*, February 1988, page 82.
13. Joe Reiser, W1JR, "VHF/UHF World: Minimum Requirements for 2-Meter EME-part 1," *ham radio*, August 1987, page 39.
14. Joe Reiser, W1JR, "VHF/UHF World: Minimum Requirements for 2-Meter EME-part 2," *ham radio*, September 1987, page 65.
15. Joe Reiser, W1JR, "VHF/UHF World: 220 MHz EME Requirements," *ham radio*, September 1984, page 45.
16. Joe Reiser, W1JR, "Requirements and Recommendations for 70-cm EME," *ham radio*, June 1982, page 12.
17. Joe Reiser, W1JR, "VHF/UHF World: Microwave and Millimeter-wave Propagation-part 1," *ham radio*, July 1986, page 82.
18. Joe Reiser, W1JR, "VHF/UHF World: Microwave and Millimeter-wave Propagation-part 2," *ham radio*, August 1986, page 69.
19. Joe Reiser, W1JR, "VHF/UHF World: Keeping VHF/UHFers up-to-date," *ham radio*, March 1985, page 126.

ham radio

## GORDON WEST'S RADIO SCHOOL

### 21 DAY NOVICE



- 2 code tapes
- 112 page book
- World maps
- Frequency charts
- Course certificate
- Free magazine coupon
- 50 piece literature set!

\$70 in equipment certificates from ICOM, KENWOOD, and YAESU **\$19.95**

**COMPLETE NOVICE COURSE \$49.95**  
4 code tapes, 2 theory tapes, 2 text books, code oscillator set, examiner test packet, and \$70 discount coupons.

**NOVICE TEXTBOOK \$4.95**  
Written by Gordon West, this 112 page book contains all Novice questions and answers.

**NOVICE CODE COURSE \$39.95**  
6 tape stereo code course for learning the code from scratch. Includes certificates.

**TECHNICIAN THEORY COURSE \$19.95**  
2 theory tapes & 2 textbooks.

**GENERAL THEORY COURSE \$19.95**  
2 theory tapes & 2 textbooks.

**TECHNICIAN/GENERAL COURSE \$19.95**  
Combined tech & general course with 4 tapes and 1 book.

**THE COMPLETE GENERAL \$49.95**  
4 tapes & 2 books for theory plus 6 tape stereo code set for CW speed building.

**GENERAL CODE COURSE \$39.95**  
6 tape stereo code course for CW speed building from 5 wpm to 13 wpm.

**THE COMPLETE ADVANCED \$49.95**  
4 tapes & 2 books for theory plus 6 tape stereo general or extra class code course. (Specify which CW tapes you want.)

**ADVANCED THEORY CLASS \$19.95**  
4 tape stereo theory course plus fully illustrated theory book.

**THE COMPLETE EXTRA \$49.95**  
4 tapes & 2 books for theory plus 6 tape stereo code set for CW speed building 13 wpm to 22 wpm+.

**EXTRA CODE COURSE \$39.95**  
6 tape stereo code course for CW speed building from 13 wpm to 22 wpm+.

**EXTRA THEORY CLASS \$19.95**  
4 tape stereo theory plus fully illustrated theory book.

**GORDON WEST ELECTRONICS BOOK**  
200 page marine electronics book plus marine mobile antenna hints. **\$19.95**

**COMMERCIAL TEST PREP BOOK \$29.95**

**BRASS CODE KEY & OSCILLATOR \$19.95**

**PLASTIC CODE KEY & OSCILLATOR \$14.95**

**COOPER GROUND FOIL 60¢ FOOT**

### SINGLE CODE TAPES

\$9.95 EACH • BUY 2, GET 3rd ONE FREE

- 5 wpm Novice Tests • 5 wpm Random Code
- 5-7 Speed Build • 7-10 Speed Build • 10 Hump Jump
- 10-12 Speed Build • 12-15 Coils & Numbers
- 13 Random • 13 Test Prep • 5-15 General Quiz
- 13 Cor Code • 13-15 Speed Build • 15-17 Speed Build
- 17-19 Speed Build • 20 Random • 20 Test Prep
- 20 Cor Code • 10-24 Extra Quiz

Pass any upgrade & receive \$25 Kenwood rebate  
• plus a license holder & wall certificate FREE! ••

Slow code uses 13 wpm character speed. Same day service. Add \$3.00 UPS for courses, or \$1.00 for single tapes. 100% return policy.

### GORDON WEST RADIO SCHOOL

2414 COLLEGE DR., COSTA MESA, CA 92626

Mon.-Fri. 10-4pm (714) 549-5000

# cheap and dirty 6-meter beam

For over 40 years the Amateur Radio fraternity has used an antenna construction technique known as "plumber's delight". This method, based on the fact that the center of a half-wave antenna lies at a 0-voltage point, allows the center of the element to be grounded to the boom material and can make for easier rotary beam construction.

Many different ways of attaching elements to the boom have been tried over the years. Some have been as simple as a single "U" bolt with holes drilled in the element; others have been much more complicated. The beam construction method described here is simple and inexpensive. It cost me less than a dollar!

Several years ago, the local Amateur Radio club needed a 6-meter beam for Field Day operation. Not wishing to expend much in the way of funds, we made a quick search of the antenna graveyard. We found various pieces of aluminum but no way to attach the elements. Then it hit me; just use simple E.M.T. clamps (photo A)!

These clamps, often made of galvanized iron, are available from any well-stocked hardware store for as little as 7 cents apiece. Drill the element material to pass a No. 10 bolt and the clamp easily attaches to the element. Next, drill two 1/8-inch holes into the boom, through the clamp, to pass a No. 8 sheet metal screw. Viola! A "cheap and dirty" way to attach the elements to the boom.

This antenna worked great for Field Day, but was relegated to the antenna graveyard soon after. Over the next several years, the boom and other pieces found their way into other antenna projects and soon only the elements remained. I finally decided to resurrect the antenna, and the "Cheap and Dirty 6-meter Beam" was the result.

The beam consists of four elements on a 10-foot boom (antenna dimensions shown in fig. 1). The material used for the boom is two sections of Radio Shack heavy-duty mast that telescopes approximately 6

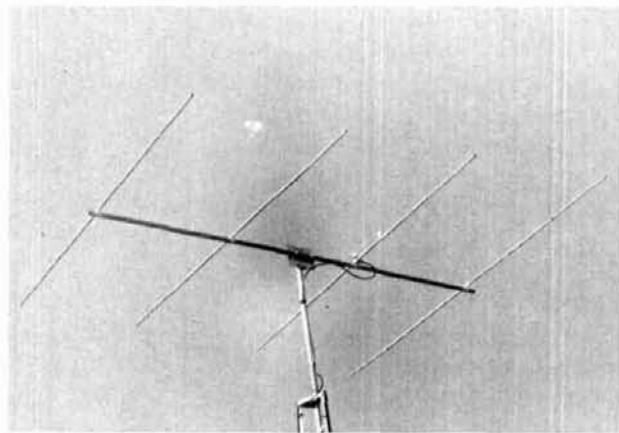

## Inexpensive way to attach elements

inches. The elements are made from 5/8-inch 6061-T3 aluminum, and the gamma match from 3/16-inch rod. You could probably use Radio Shack light-duty mast for the boom material, but the difference in cost is minor.

To build the antenna, cut the elements to length, drill them to attach to the E.M.T. clamps, and attach them to the boom. To attach the boom to the mast, drill a sheet of aluminum about 12 x 6 inches to accept "U" bolts. The model built at W5UOJ (see lead photo) uses Radio Shack TV-type "U" bolts for both the boom and mast. However, the actual "U" bolts used depend on the size of the mast and boom material.

The gamma match, shown in fig. 2, is straightforward; it's a piece of 3/16-inch rod approximately 14 inches long. Make a movable strap from a small piece of aluminum and attach it near the end of the material. A second strap attaches the rod to the variable capacitor. A small plastic enclosure can be used for weatherproofing; I didn't use one.

Instead of a plastic enclosure, the variable capacitor was set, then wrapped with a plastic bag and black plastic tape. This appears to work; the capacitor has

Glen E. Zook, W5UOJ, 410 Lawndale Drive,  
Richardson, Texas 75080

Others May Try to Imitate, But...

# Only One Can Be The Best



**Morse Code - Baudot - ASCII - AMTOR - Packet - Facsimile - Navtex**

Amateur Net Price \$319.95

It's a lesson you learn very early in life. Many can be good, some may be better, but only one can be the best. The PK-232 is the best multi-mode data controller you can buy.

## 1 Versatility

The PK-232 should be listed in the amateur radio dictionary under the word Versatile. One data controller that can transmit and receive in six digital modes, and can be used with almost every computer or data terminal. You can even monitor Navtex, the new marine weather and navigational system. Don't forget two radio ports for both VHF and HF, and a no compromise VHF/HF/CW internal modem with an eight pole bandpass filter followed by a limiter discriminator with automatic threshold control.

The internal decoding program (SIAM<sup>tm</sup>) feature can even identify different types of signals for you, including some simple types of RTTY encryption. The only software your computer needs is a terminal program.



PC Pakratt Packet TX/RX Display



Facsimile Screen Display

## 2 Software Support

While you can use most modem or communications programs with the PK-232, AEA has two very special packages available exclusively for the PK-232....PC Pakratt with Fax for IBM PC and compatible computers, and Com Pakratt with Fax for the Commodore 64 and 128.

Each package includes a terminal program with split screen display, QSO buffer, disk storage of received data, and printer operation, and a second program for transmission/reception and screen display of facsimile signals. The IBM programs are on 5-1/4" disk and the Commodore programs are plug-in ROM cartridges.

## 3 Proven Winner

No matter what computer or terminal you plan to use, the PK-232 is the best choice for a multi-mode data controller. Over 20,000 amateurs around the world have on-air tested the PK-232 for you. They, along with most major U.S. amateur magazines, have reviewed the PK-232 and found it to be a good value and excellent addition to the ham station.

No other multi-mode controller offers the features and performance of the PK-232. Don't be fooled by imitations. Ask your friends, or call the local amateur radio store. We're confident the PK-232 reputation will convince you that it's time to order your very own PK-232.

Call an authorized AEA dealer today. You deserve the best you can buy, you deserve the PK-232.

**Advanced Electronic Applications, Inc.**

P.O. Box C-2160  
Lynnwood, WA 98036  
206-775-7373

**AEA** Brings you the Breakthrough!

made it through two separate ice storms so far. But, if in doubt, use a small plastic box.

You don't need stand-off insulators in the gamma match assembly — the gamma rod isn't long enough to need any and the aluminum strap gives enough support. By the way, the gamma capacitor used at W5UOJ was an old "APC" type, but you can use any variable with an appropriate value.

There are two methods of adjusting the gamma match for best SWR. The first is to mount the antenna directly on a tower, mast, or other suitable point and make the necessary adjustments. A simpler method is to take a wooden stepladder, prop the antenna on it pointing upward, and make your adjustments to the gamma match.

You don't have to use 6061-T3 for the elements; almost any aluminum tubing from 1/2 to 5/8 inch will work. The lengths are such that any droop is insignificant. The gamma rod can be made from aluminum ground wire, like the kind available from Radio Shack, but probably will have to be a couple of inches longer for the best match.

You'll probably have to use bolts about 1/2 to 1 inch longer than necessary when attaching the E.M.T. clamps to the elements because the clamps are a bit too short. But the bending that results from tightening the bolts firmly secures the elements to the boom.

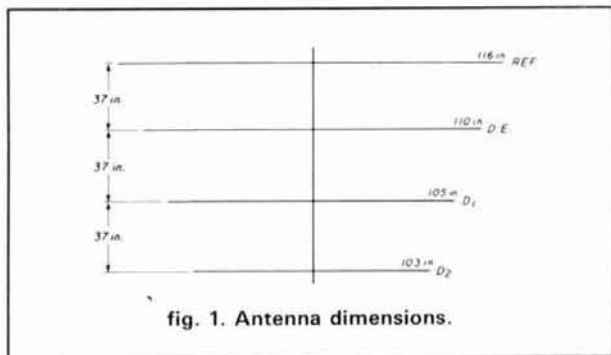

fig. 1. Antenna dimensions.

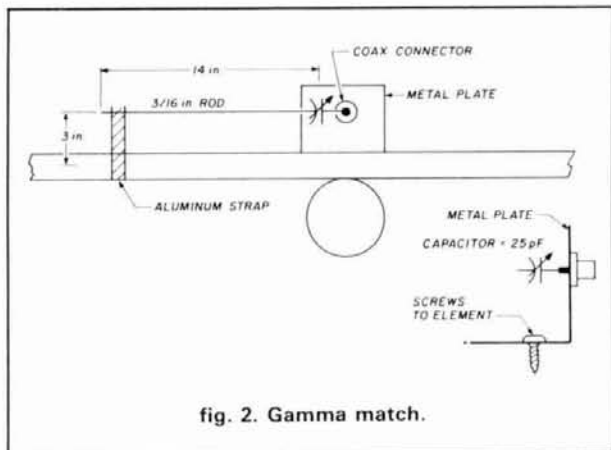

fig. 2. Gamma match.

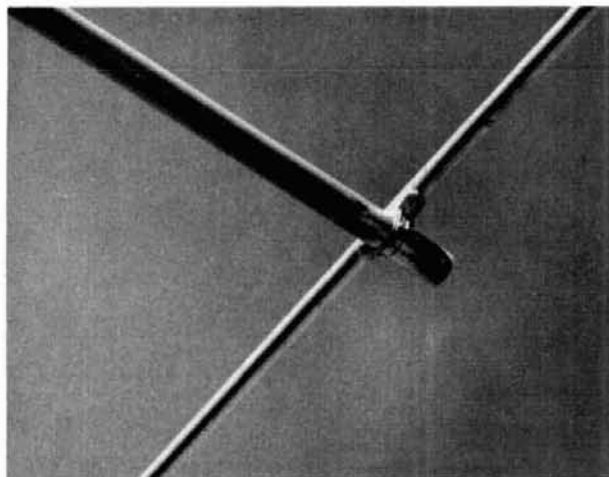

photo A. An E.M.T. clamp makes an excellent method of connecting the elements to the boom.

The extra bolt length can be cut off with a pair of sidecutters. Next, drill the clamp on each side and secure it to the boom with sheet metal screws.

The clamps used with the 1-1/4 inch boom material are for 1-inch E.M.T. For a 1-1/2 inch boom, use clamps for 1-1/4 inch E.M.T. Antennas built for higher frequency operation can use smaller clamps. Boom material 1-1/2 inches in diameter results in a stronger beam.

If you use Radio Shack boom material, make sure that the two boom halves do not turn. Put the two sections together and drill a 1/8-inch hole. Then, secure the boom material with a No. 8 sheet metal screw.

The same technique was also applied to a three-element 10-meter beam used for OSCAR 6 and 7 work. Here, however, I used boom material 1-1/2 inches in diameter along with the heavier clamps to secure the elements to the boom.

Obviously, there are other ways to secure elements to the boom in a "plumber's delight" Yagi. But I doubt you'll find any as inexpensive. Although I haven't tried it, there's no reason why E.M.T. clamps can't be used for 6-meter antennas with more than four elements, or smaller clamps for 2 meters and up.

While the actual performance of this antenna has not been checked on an antenna range, it compares favorably with commercially made four- and five-element beams used in this area. The total cost was less than \$15; the aluminum and the variable capacitor were surplus. You'll spend approximately \$25 to \$30 on this antenna if you buy all the parts. But, it's still cheaper than buying a beam and takes only a few hours to build.

ham radio



here is the next generation Repeater  
2 meters - 220 - 440

# MARK 4CR

The **only** repeaters and controllers  
with REAL SPEECH!

No other repeaters or controllers match Mark 4 in capability and features. That's why Mark 4 is the performance leader at amateur and commercial repeater sites around the world. Only Mark 4 gives you Message Master™ real speech • voice readout of received signal strength, deviation, and frequency error • 4-channel receiver voting • clock time announcements and function control • 7-helical filter receiver • extensive phone patch functions. Unlike others, Mark 4 even includes power supply and a handsome cabinet.

Call or write for specifications on the repeater, controller, and receiver winners.

Create messages just by talking. Speak any phrases or words in any languages or dialect and *your own voice* is stored instantly in solid-state memory. Perfect for emergency warnings, club news bulletins, and DX alerts. Create unique ID and tail messages, and the ultimate in a real speech user mailbox — only with a Mark 4.



## MICRO CONTROL SPECIALTIES

Division of Kendecom Inc.  
23 Elm Park, Groveland, MA 01834 (508) 372-3442

TELEX 4932256 Kendecom

FAX 508-373-7304

✓ 150



SAY  
YOU SAW **ham**  
IT IN **radio** magazine



### DOWN EAST MICROWAVE

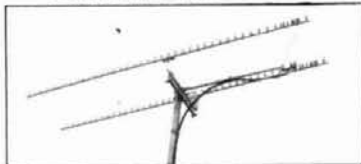

#### MICROWAVE ANTENNAS AND EQUIPMENT

• Loop Yagis • Power Dividers • Linear Amplifiers • Complete Arrays • Microwave Transverters • GaAs FET Preamps • TROPO • EME • Weak Signal • OSCAR • 902 • 1269 • 1296 • 2304 • 2400 • 3456 MHz

2345 LY 45el loop Yagi 1296 MHz 20dBI \$97  
1345 LY 45el loop Yagi 2304 MHz 20dBI \$84  
3333 LY 33el loop Yagi 902 MHz 18.5dBI \$97

Above antennas assembled and tested. Kits available.

Add \$8 UPS S/H. \$11 West of the Mississippi

#### MICROWAVE LINEAR AMPLIFIERS SSB, ATV, REPEATER, OSCAR

2316 PA	1w in 18w out	1240-1300 MHz	13.8V	\$255
2335 PA	10w in 35w out	1240-1300 MHz	13.8V	\$305
3318 PA	1w in 20w out	900-930 MHz	13.8V	\$255
3335 PA	10w in 40w out	900-930 MHz	13.8V	\$305
23LNA	preamp 0.7dB N.F.	1296 MHz		\$ 80
33LNA	preamp 0.9dB N.F.	902 MHz		\$ 80

Add \$5 shipping UPS/48

LMW 1206 & 2304 MHz transverter kits in stock

Write for free catalog



DOWN EAST MICROWAVE

Bill Olson, W3HQT  
Box 2310, RR 1, Troy, ME 04987  
(207) 948-3741



### THE RF CONNECTION

"SPECIALIST IN RF CONNECTORS AND COAX"

Part No.	Description	Price
321-11064-3	BNC 2 PST 28 volt coaxial relay, Amphenol Insertion loss: 0 to 0.75GHz, 0.10dB Power rating: 0 to 0.5GHz, 100 watts CW, 2 kw peak Isolation: 0.1 GHz: 45dB, 0.2 GHz: 40dB, 0.4 GHz: 35dB	\$25 used tested
83-822	PL-259 Teflon, Amphenol	1.50
PL-259/ST	UHF Male Silver Teflon, USA	1.50
UG-21D/U	N Male RG-8, 213, 214, Amphenol	2.95
UG-21B/U	N Male RG-8, 213, 214, Kings	4.00
9913/PIN	N Male Pin for 9913: 9086, 8214 fits UG-21D/U & UG-21B/U N's	1.50
UG-21D/9913	N Male for RG-8 with 9913 Pin	3.95
UG-21B/9913	N Male for RG-8 with 9913 Pin	4.75
UG-146/U	N Male to SO-239, Teflon USA	5.00
UG-83/U	Female to SO-239, Teflon USA	5.00

"THIS LIST REPRESENTS ONLY A FRACTION OF OUR HUGE INVENTORY"

THE R.F. CONNECTION  
213 North Frederick Ave. #11  
Gaithersburg, MD 20877

(301) 840-5477

VISA/MASTERCARD: Add 4%  
Prices Do Not Include Shipping

Think you've seen it all?  
TAKE A LOOK AT THIS!



Send check or money order to:  
(US Funds only, Incl. \$2 S/H)



MORLAN SOFTWARE

P.O. Box 2400  
EAST LIVERPOOL, OH 43920-0400  
THANK DAYTON

✓ 151

✓ 152

✓ 153



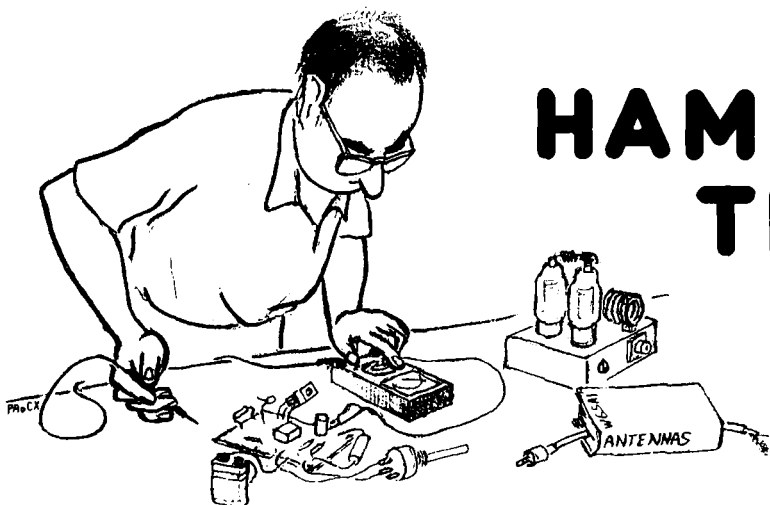

# HAM RADIO TECHNIQUES

Bill Orr, W6SAI

## line voltage and power tube life

Have you checked the cost of a replacement power tube recently? Just like the cost of automobiles, houses, and other items, it has gone up over the years. Taking good care of the tubes in your linear amplifier will put money in your pocket in the long run.

Control of filament voltage is a main factor in determining vacuum tube life. Most power tubes specify filament voltage excursion limits — in most cases,  $\pm 5$  percent of a nominal value. The popular 3-500Z high- $\mu$  power triodes have a nominal filament voltage of 5.0 with limits of 4.75 and 5.25 volts.

Undervolting the filament will seriously limit the electron emission and the maximum plate current level; overvolting the filament will reduce the emission life of the tube. The voltage limits specified by the tube manufacturer strike an economical compromise between emission and filament life.

During World War II the 6C21 pulse tube was developed. It was a 450TH triode whose 7.5-volt filament was uprated to 8.2 volts. The tube had very high pulse emission for its size, but the

guaranteed tube life was derated to 200 hours.

## measuring filament voltage

Measure filament voltage at the tube socket so that the resistance of filament wiring or chokes does not degrade the reading's accuracy. Use a digital voltmeter or an iron-vane, d'Arsonval type rms-responding analog instrument. The latter can be identified by the nonlinear ac scale which is highly compressed at the low-voltage end. The old Weston model 476, 3-1/2 inch meter with a 0 to 8-volt scale is ideal for 5-volt tubes. It can often be found for a few dollars at a flea market. You can have the calibration checked at the electrical laboratory at a local college, or at a meter repair shop.

The popular digital voltmeter used for ac measurements is a peak-reading device, calibrated for an rms reading. It's acceptable, but accuracy is not as good as the iron-vane analog meter in cases where the power line harmonics are particularly high. In any case, both instrument types are satisfactory for general Amateur use.

The common volt-ohmmeter is not recommended for accurate filament voltage measurement. It has a dc meter movement with a series rectifier added for ac measurement. Calibration can change quickly if the rectifier is accidentally overloaded or slowly as the rectifier ages. In addition, any substantial harmonic content of the power line casts doubt on the indicated reading, even if the meter is accurately calibrated for 60 Hz use.

## meter accuracy

The accuracy of many small meters is  $\pm 2$  percent of the full scale reading. This doesn't leave much margin for error when you're trying to ascertain voltage limits of  $\pm 5$  percent. The solution is to have the meter calibrated as described earlier. My filament voltmeter was accurately calibrated at the 5-volt scale marking. I take good care of the meter and keep it in a safe place, away from bumps and jars.

## line voltage limitations

As the filament voltage limitations of the 3-500Z are  $\pm 5$  percent, the primary line voltage must be held within these

limits. In the thirties the nominal line voltage in the United States and Canada was 110 volts; in the forties it was raised to 115, and then to 117 just after World War II. By the late fifties the nominal line voltage was about 120 volts. Now, it may run as high as 125 volts in certain parts of the country.

Line voltage limits are set by the Public Utility Commission in each state. In California, the voltage limits are 115 and 125 volts, centered about 120 volts. This amounts to a plus or minus tolerance of about 4.5 percent, which is within the 5-percent voltage tolerance established for the 3-500Z. So, if the manufacturer of the amplifier using the 3-500Z designs his transformer to deliver the required filament voltage and current at a primary voltage of 120 volts, the filament voltage will remain within limits even if the line voltage varies within the proscribed excursions.

Most imported linear amplifiers are manufactured with a power transformer designed for the line voltage of the country where the amplifier will be used. Unfortunately, many of the amplifiers are designed around a 115-volt primary requirement, because this is a common line voltage in many countries. When such an amplifier is run on a nominal 120-volt line, the filament voltage often exceeds the upper limit specified by the manufacturer.

I have a popular imported amplifier using a pair of 3-500Z tubes. The instruction manual specifies a power source of either 120 or 240 volts. However, when checked with accurate meters, it was found that a line voltage of 120 resulted in a filament voltage of 5.22 volts at the tube socket — dangerously close to the upper limit of filament voltage excursion. Using a variable voltage transformer, I determined that a primary voltage of 115 provided the correct filament voltage. I then checked the results under the 240-volt condition and found that a line voltage of 230 provided the correct filament voltage.

Obviously, the power transformer of the amplifier had been designed for a 115/230-volt primary source. When

run on a 120/240-volt source, the amplifier requires an auxiliary primary circuit step-down transformer to achieve the correct nominal filament voltage (fig. 1).

### the correction transformer

Because I wanted to run the amplifier from the nominal 240-volt circuit, I had to reduce the primary voltage by 10 volts. Checking line voltage over a

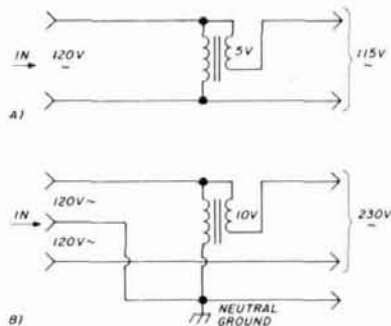

fig. 1. (A) 5-volt transformer "bucks" line voltage. Depending upon polarity of secondary, the transformer either boosts or reduces line voltage. (B) 115/120 volt transformer can be used as 240-volt circuit with primary connected between one side of line and neutral. Notes: Neutral ground is attached to chassis ground in most amateur equipment. Transformer secondary must carry full primary current of amplifier.

period of days showed that the average value ran close to 244 volts. This meant that a 14 volt, rather than a 10 volt, step-down transformer was required. According to the operating manual, the maximum primary current of the amplifier was about 14 amperes, so the transformer has to deliver 14 volts at about 14 amperes. An oddball!

Looking for a transformer like this in a catalog may be a waste of time. Even if you find one, it will be very expensive. A suitable transformer can often be purchased at a flea market. If the current capacity is OK, you may be able to run it from a variable-voltage transformer (like a Variac™ or Powerstat™) in order to hit the required voltage "on the nose" (fig. 2). The transformer can have either a 120 or 240-volt primary. Various hookups are shown in the illustration.

# GILFER SHORTWAVE

*"First in Shortwave, first in service to the world's SWLers"*



## Datong Multi-Mode Filter

It separates the signals you want from those you don't — with multi functions. Fully automatic notch filter removes heterodynes and other steady tone interference. Independent low and high pass filters stop "monkey chatter" and other off-tune interference, tuning 200-3500 Hz. Second notch filter manually tunes 200-3500 Hz. For speech, all filters work independently for flexibility. A special mode for CW and RTTY combines the filters into a 12-pole filter with super skirt selectivity and non-interacting controls. Works with any receiver, easy to install. Features 29 ICs with latest switched capacitor filter technology.

FL-3 ..... \$229.95 (+\$4)

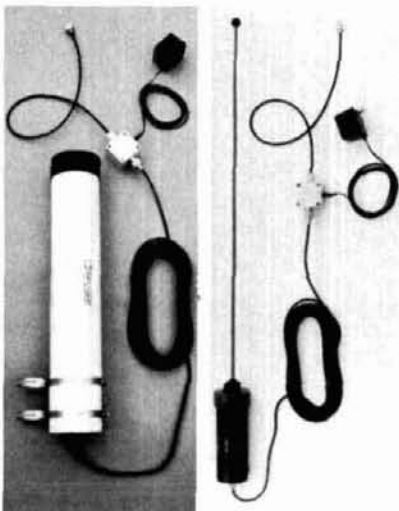

## Dressler Active Antennas

Model ara 30 ..... \$159.95 (+\$8)  
For HF use up to 30 MHz and more. Features low noise field effect transistor acting as an impedance transformer together with a high linear CATV transistor. A push-pull amplifier with noiseless negative feedback produces high linearity for low noise. Installs vertically, outdoors or in. Includes 26' cable, interface, and AC adaptor.

Model ara 900 ..... \$189.95 (+\$8)  
For VHF-UHF and Scanners. Range 50-900MHz and more. Has low noise high gain 2-stage amp. With 1 GHz bandwidth. Gain is 15-16dB. Mounts indoors or out. Includes 26' cable, interface, and AC adaptor.

ORDER PHONE: 1-800-GILFER-1

Prices subject to change w/o notice

**GILFER SHORTWAVE**

52 PARK AVE. PARK RIDGE, NJ 07656

Ph 201/391-7887

**NEW OSCAR**

**BRIDGES HAMISPHERE**

- Coming soon to a shack near you.
- Signals from space.
- Catch some free.
- We know how.
- You can too!
- Join AMSAT
- Free brochure for SASE

**AMSAT**  
PO BOX 27  
WASHINGTON, DC 20044

## keeping track of filament voltage

In most cases it is not practical to attach a permanent filament voltmeter to the amplifier. An iron-vane meter connected across the primary circuit is helpful. I have one mounted in a small box that sits next to the SWR meter on my operating table. It didn't cost much and doesn't take up much space. But I feel very comfortable with it, especially when I contemplate the cost of replacement tubes for my amplifier!

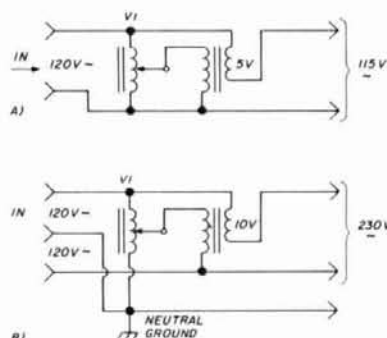

fig. 2. (A) Variable voltage transformer (V1) used on 120-volt circuit to adjust line voltage. (B) Variable voltage transformer (V1) on 240-volt circuit. Capacity of variable voltage transformer is equal to line current drawn by amplifier times difference in input and output voltages. For 2-kw condition ( $i = 14A$ ) capacity is  $14 \times 10 = 140$  watts.

## a "cheap and dirty" antenna current indicator

Remember those good old thermocouple rf meters of yesteryear? Just the thing for measuring antenna current! You can occasionally find one at a flea market, but if you can't, Jack Sobel, W0SVM, has a satisfactory substitute for all except nitpickers (fig. 3). Jack shunts a No. 47 pilot lamp with a 33-ohm, 1-watt resistor. This little assembly has copper alligator clips on it and he snaps it across a few inches of his feedline at his antenna tuner. He uses two of these gadgets for a two-wire line. Vary the tap spacing to accommodate your power level.

## the helix antenna revisited

The helix dipole seems to generate

156

**1500 + WATT TRANSMATCH KIT \$169.95**      **OTHER KITS**

**BASIC KIT: INDIVIDUAL ITEMS**

- 1 - rotary inductor 28 $\mu$ h.....\$59.00
- 2 - 6:1 ball drives.....\$9.00 ea.
- 1 - 0-100 turns counter.....\$65.75
- 2 - variable capacitors
- 25-245 pf 4500 v.....\$44.00 ea.

**OPTIONS—**

- enclosure (pictured in Sept. 86 CQ).....\$64.00
- 4:1 balun kit.....\$22.50
- dials, terminals, chassis, ceramic standoffs, hardware, toroids, amp components, B&W coil stock, etc.

**Factory Wired**

- Article Reprints (refundable).....\$1.50
- G3RUH, PSK Packet Modem, Satl./Terrestrial\$99.00
- PC Board for above only, delivered.....\$27.99
- Ten-Tec Designer Cabinet for above.....\$12.00
- K9CW Memory Contest Keyer.....\$109.00
- Yaesu FRG-9600, .1 to 60 MHz Converter.....\$94.95
- 20m CW, 15w Transceiver (H.R. 6/87).....\$159.95
- 50W 75M SSB XCVR.....\$199.95
- Nel-Tech DVK-100A (New Model).....\$269.00
- B & W PT-2500A Amp.....\$1,670.00
- B & W VS1500A Tuner.....\$388.00
- Amp Supply/Ameritron Linears.....CALL

**Shipping Extra Unless Noted**  
Catalog \$1.00

**RADIOKIT • P.O. Box 973-H**  
Pelham, NH 03076 • (603) 635-2235

157

more heat than light. A lot of hams don't like them, but some who have used them are very happy with them. Bruce Muscolino, W6TOY, has used helix-wound antennas for some years.

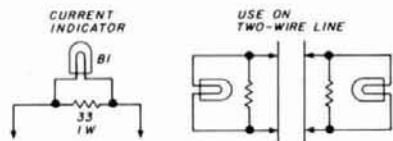

fig. 3. Inexpensive antenna current indicator. Clips are placed across a few inches at one feed wire. Vary resistance value to match line circuit. (Design shown is for two-wire line.)

One arrangement he found satisfactory was two HY-gain helically wound fiber glass CB antennas which he used back-to-back as a helical dipole, hung in his small attic. A hand-wound center coil resonated them to 20 meters with the aid of a dip meter. He fed the antenna with ribbon line and an antenna tuner. Running 100 watts, he made WAC over a period of several weeks. For those Amateurs who have landlord problems, a simple antenna like this may be the only compromise which permits them to get on the air!

### what to do when the band is dead

What do you do when the band is dead? Many times I hunker down with a good book and forget Amateur Radio. I have favorites that I have read repeatedly over the years. I bet you do too! Just to see how smart my readers are, I'm going to give you a quotation from one of my favorite books and see how many can identify it. No prizes, but I'll give the name and call in this column of the readers who send their QSL card to me (Box 7508, Menlo Park, California 94025) with the name of the book and the correct identification of the quote. Choice of the "winner" will be arbitrary-HI. OK? Here's the quote: "You have been in Afghanistan, I perceive."

(That was easy, wasn't it?)

ham radio

# Barry Electronics Corp.

WORLD WIDE AMATEUR RADIO SINCE 1950  
Your one source for all Radio Equipment!

For the best buys in town call:  
212-925-7000  
Los Precios Mas Bajos en Nueva York

**KITTY SAYS: WE ARE NOW OPEN 7 DAYS A WEEK Saturday & Sunday 10 to 5 P.M.**  
Monday-Friday 9 to 6:30 PM Thurs. to 8 PM  
Come to Barry's for the best buys in town.

**WE GIVE YOU THE BEST IN AMATEUR AND COMMERCIAL RADIOS... Call Us. It's Low!**  
W2BIE, Kitty WA2BAP, and Jan KB2RV

**ONV Safety belts-in stock**

**ICOM**  
IC-R71A, 751A, 761, 26AH, 36A, 48A, Micro214, R-7000, IC-761, IC-375A, 275AH, 300SA, 475A, H-725, IC-900, IC-781

**YAESU**  
FT-767GX, FT-757GXII, FT-311 RM, FRG-8800, FT-736, FRG-9600, FT-211/711RH, FT-2700RH, FT 212/712RH.

**KENWOOD**  
Antennas: FT-237/33/727R, FT-211-709RH, FT-1902/1123, KTH-2006-7005

**Land Mobile HiT Midland/Standard Wilson Maxon**  
YAESU FT-122, FT-132, IC-142, IC-142U16

**BUDDIG ANT PRODUCTS**  
NELTECH DWR-150 Digital Voice Keyer  
FLUKE 77 Multimeter

**VoCom/Mirage/Alinco**  
Tokyo Hy-Power/TE SYSTEMS Amplifiers & 518xHT Gain Antennas IN STOCK

**AMERITRON AMPLIFIER AUTHORIZED DEALER**  
ALINCO ALD-24T

**Computer Interfaces**  
Stocked: MFJ-1270B, MFJ-1274, MFJ-1224, AEA PK-87, MFJ-1278, PK-232 W/FAX.

**Complete Butternut Antenna Inventory In Stock!**  
DIGITAL FREQUENCY COUNTERS  
Trinityx, Model TR 1000 0-600 MHz  
AMP SUPPLY STOCKED  
Long range Wireless Telephone for export in stock

**BENCHER PADDLES, BALUNS, LOW PASS FILTERS IN STOCK**

**MIRAGE AMPLIFIERS ASTRON POWER SUPPLIES**  
Saxon Wire & Cable, Int'l Wire

**NEW TEN TEC**  
Corsair II, PARAGON, Argosy II

**HEIL EQUIPMENT IN STOCK**  
Tri-Ex Towers  
Hi-Gain Towers  
Antennas and Rotors will be shipped direct to you FREE of shipping cost!

**MAIL ALL ORDERS TO BARRY ELECTRONICS CORP., 512 BROADWAY, NEW YORK CITY, NY 10012 (FOUR BLOCKS NORTH OF CANAL ST.)**

**New York City's LARGEST STOCKING HAM DEALER COMPLETE REPAIR LAB ON PREMISES**

**"Aqui Se Habla Espanol!"**  
BARRY INTERNATIONAL TELEX 12-7670  
MERCHANDISE TAKEN ON CONSIGNMENT FOR TOP PRICES  
Monday-Friday 9 A.M. to 6:30 P.M. Thursday to 8 P.M.  
Saturday & Sunday 10 A.M. to 5 P.M. (Free Parking)  
AUTHORIZED DIST. MCKAY DYMEK FOR SHORTWAVE ANTENNAS & RECEIVERS  
INTLEX-Spring St. Station  
Subways: BMT-Prince St. Station  
IND-F Train Bwy. Station  
Bus: Broadway #6 to Spring St.  
Path-9th St. 8th Ave. Station

Commercial Equipment Stocked: ICOM, MAXON, Midland, Standard, Wilson, Yaesu. We serve municipalities, business, Civil Defense, etc. Portables, mobiles, bases, repeaters.  
Wanted: Full time Technicians

**WE NOW STOCK COMMERCIAL COMMUNICATIONS SYSTEMS**  
HAM DEALER INQUIRES INVITED. PHONE IN YOUR ORDER & BE REIMBURSED.  
COMMERCIAL RADIOS stocked & serviced on premises.  
Amateur Radio Courses Given On Our Premises, Call  
Export Orders Shipped Immediately. TELEX 12-7670  
ALL SALES FINAL

Barry Electronics Commercial Radio Dept. offers the Best in two-way communications for Businesses, Municipalities, Civil Defense, Broadcasting Companies, Hospitals, etc. Sales and Service for all brands: Maxon, Yaesu, Icom, Tad, Octagon, Regency/Wilson, Midland, Standard, Uniden, Shinway, Fujitus, Seas, Spillsbury, Neutec, etc. Call or write for information. 212-925-7000.

## INTERFERENCE?

- ★ Interference Location
- ★ Stuck Microphones
- ★ Cable TV Leaks
- ★ Security Monitoring
- ★ VHF and UHF Coverage
- ★ Computer Interface
- ★ Speech Synthesizer
- ★ 12 VDC Operation

**New Technology** (patent pending) converts any VHF or UHF FM receiver into an advanced Doppler shift radio direction finder. Simply plug into receiver's antenna and external speaker jacks. Uses four omnidirectional antennas. Low noise, high sensitivity for weak signal detection. Call or write for full details and prices.

**DOPLER SYSTEMS, INC.** P.O. Box 31819  
Phoenix, AZ 85046 (602) 488-9755



# 2-meter monitor

## A simple receiver project

**Are you looking** for a simple club project? How about a spare 2-meter receiver? A receiver to take backpacking? A scanning receiver for those times on the road? A digital data link? Radio control receiver? Direction finding receiver? Here's one that's hard to beat for simplicity and performance. One or two evenings and a little searching in the old junk box is all it takes.

When's the last time you fired up the old soldering iron? A friend of mine once said, "Rosin is the grease paint of our industry and every now and then you've got to get out to the bench and remember what it is to smell some solder."

Thanks to a new product line from Motorola, which includes narrowband fm transmitters and receivers, this dual conversion tunable receiver is about as simple as a receiver can get.

### MC3362

The receiver is built around the new Motorola MC3362. Although there have been a few "receivers on a chip" (like the CA3089) for a few years, none comes close to the MC3362. Until now most ICs have included the i-f amplifiers, detectors (or discriminators), and audio pre-drive circuits. The MC3362 is a dual conversion receiver that starts at the antenna and ends at the audio output.

A basic block diagram of a dual conversion receiver is shown in **fig. 1**. Notice that the antenna feeds directly into the first mixer with no rf stage. This technique is more common than most people realize. RF amplifiers are included only in high performance rigs. If you

have a fully synthesized 2-meter rig it probably has one, but the difference in performance with or without an rf stage is minor. (Please, no letters from DX hounds with liquid nitrogen-cooled front ends!) Tests on the unit I built showed a sensitivity of about 1.5 microvolts — not fantastic but not bad either.

Except for the i-f filters, the crystal, the audio driver, some resistors, capacitors, inductors, and the speaker, the MC3362 has all of the circuitry shown in **fig. 1**. The MC3362 specifications are listed in **table 1**.

A functional block diagram and pinouts of the MC3362 are shown in **fig. 2**. Let's take a look at it block by block.

### first mixer

The first mixer has two inputs in case you want to use a balanced drive from a transformer. Motorola says this mixer is good to about 470 MHz. Input required at 49.7 MHz (the IC was built for the cordless telephone market) is typically 0.7 microvolt for an (S + N)/N of 20 dB. Gain is about 18 dB; Motorola says this increases to about 2 microvolts at 470 MHz.

### first LO

The first local oscillator can use an LC tank or crystal as its frequency determining element, or an external source. In the case of an LC tank, a varicap diode is included so that tuning can be accomplished by using a variable control voltage instead of a variable capacitor. If you need a wide tuning range, use a large inductor and small capacitor in your tank so that the varicap has more effect (the varicap range is about 10 to 20 pF). Coarse tuning can be accomplished by tuning the capacitor in the tank (pins 21, 22), fine tuning

**By Rodney A. Kreuter, WA3ENK, 319 McBath Street, State College, Pennsylvania 16801**



# Easiest Packet Radio Ever!

DRSI's PC\*Packet Adapter plugs right into your IBM® PC/XT/AT or compatible. One port connects to your VHF rig and gets you on the air in minutes. Our one-page Quick Start takes you through it step by step. Splitscreen terminal software (included) runs on the PC and turns it into a dual-port TNC with cross-band digipeating. The software can run in background, letting you continue to use the PC for other work. The accessory HF\*Modem gets you on low band packet at the lowest cost ever. Ask your dealer for more info.

	Amateur List	Intro (to 7/1)
PC*Packet	\$139.95	\$119.95
HF*Modem	\$ 79.95	\$ 59.95

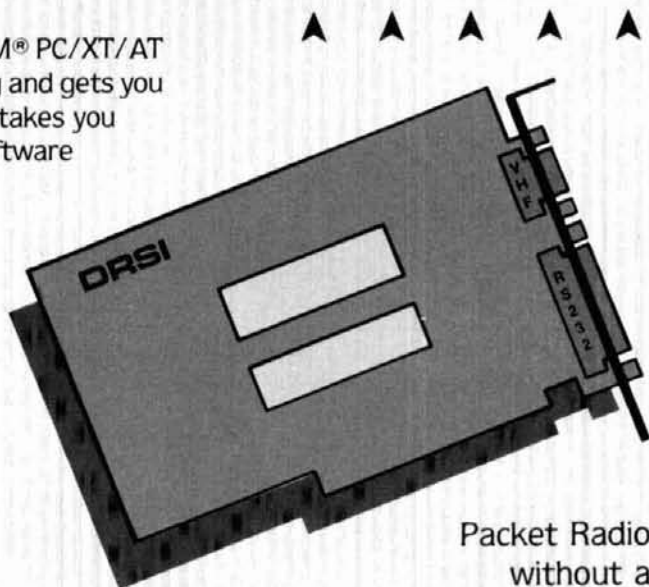

Packet Radio  
without a  
Packet Radio TNC

**DRSI**

**Digital Radio Systems, Inc.**

2065 Range Rd. ▲ Clearwater, FL 34625 ▲ (800) 999-0204 (813) 461-0204

✓ 158

## SYNTHESIZED SIGNAL GENERATOR

MADE IN  
USA



MODEL  
SG-100F  
\$429.95  
delivered

- Covers 100 MHz to 199.999 MHz in 1 kHz steps with thumbwheel dial
- Accuracy +/- 1 part per 10 million at all frequencies
- Internal FM adjustable from 0 to 100 kHz at a 1 kHz rate
- External FM input accepts tones or voice
- Spurs and noise at least 60 dB below carrier
- Output adjustable from 5-500 mV at 50 Ohms
- Operates on 12 Vdc @ 1/2 Amp
- Available for immediate delivery • \$429.95 delivered
- Add-on accessories available to extend freq range, add infinite resolution, AM, and a precision 120 dB attenuator
- Call or write for details • Phone in your order for fast COD shipment.

### VANGUARD LABS

196-23 Jamaica Ave., Hollis, NY 11423  
Phone: (718) 468-2720 Mon. thru Thu.

✓ 159

## FREE CATALOG!

Features Hard-to-Find Tools  
and Test Equipment



Jensen's new catalog features hard-to-find precision tools, tool kits, tool cases and test equipment used by ham radio operators, hobbyists, scientists, engineers, laboratories and government agencies. Call or write for your free copy today.

**JENSEN®  
TOOLS INC.**

Dept. HR  
7815 S. 46th Street  
Phoenix, AZ. 85044  
(602) 968-6231

✓ 160

## The Finest 432 MHz Yagis EME - Tropo - Weak Signal The FO-22

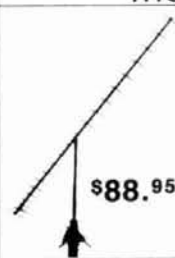

\$88.95

**ELECTRICAL SPECIFICATIONS:**  
Measured gain 15.8 dBd  
E Plane beamwidth 2 x 11.5 deg  
H Plane beamwidth 2 x 12 deg  
Sidelobe attenuation  
1st E Plane sidelobe -17.5 dB  
1st H Plane sidelobe -15.5 dB  
F1R ratio 22 dB

**MECHANICAL SPECIFICATIONS:**  
Length 14 ft  
Wind survival 90+ MPH  
Wind Surface Area .78 sq ft  
Coax connector N-type  
Mast up to 1.5" diameter  
Element insulators U.V. resistant  
black Delrin  
Stainless steel hardware  
(except plated keepers and U-bolt)

All stainless option for FO-22 (keepers and U-bolt) \$10.78

**ALSO AVAILABLE**  
**The incomparable FO-25 and FO-33**  
STACKING FRAMES POWER DIVIDERS

We supply those hard to find parts for the home builder  
Delrin insulators \$12/100 Plated keepers \$4/100, Stainless \$10/100  
A-14 \$6 UPS. SH for single or pair of Antennas.  
\$8 west of Mississippi  
PA residents add 6% state sales tax

### RUTLAND ARRAYS

1703 Warren St. • New Cumberland, PA 17070  
(717) 774-5298 7-10 PM EST

✓ 161

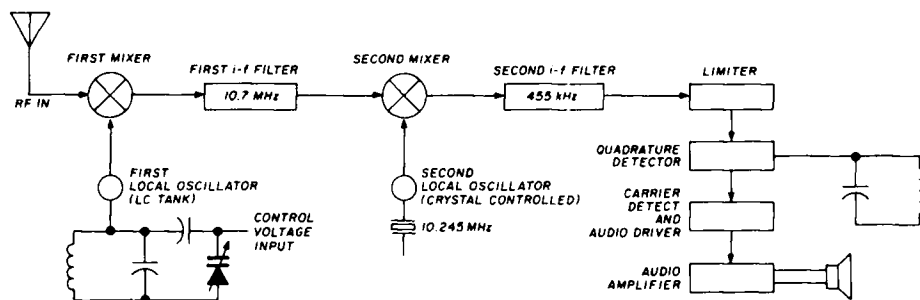

fig. 1. Block diagram of a typical dual conversion FM receiver.

Table 1. MC3362 specifications

First i-f	10.7 MHz
Second i-f	455 kHz
Power Supply	2 to 7 volts (regulated)
Current Consumption	4 mA
Sensitivity	0.7 microvolts (50 MHz)
Maximum Frequency	180 MHz (with internal LO) 470 MHz (with external LO)
First Mixer Input	690 ohms in parallel with 7.5 pF
Cost	\$1.86 in 100-piece quantity (Sept. 1987)

by using the varicap. Keep the control voltage between 1.2 volts and  $V_{CC}$ , the supply voltage. The oscillator quits below about 1.2 volts. If you don't use the varicap, tie pin 23 to  $V_{CC}$ .

Maximum frequency is about 180 MHz. Use a larger  $V_{CC}$  for higher frequency operation.

A buffered output is provided for this LO (pin 20), in case you want to phase lock it to an external source. *Be careful not to ground this pin* because it is the emitter of an emitter follower with no collector resistance.

### first i-f

The first i-f filter is external to the MC3362. A 10.7-MHz ceramic filter is recommended. The muRata filter that Radio Shack used to carry is satisfactory. Note that many different filters will work here: the main considerations are bandwidth, insertion loss, and cost. Be careful — some 10.7-MHz filters are not 10.7 MHz, but more like 10.63 MHz. Impedance should be 330 ohms. Typical parts are the muRata SFE10.7MA and Toko SK107M3-AO-10.

### second mixer

The second mixer also has two inputs, perhaps to accommodate a fancy 455-kHz crystal filter that requires transformer matching. The gain is about 21 dB; response is good to about 20 MHz.

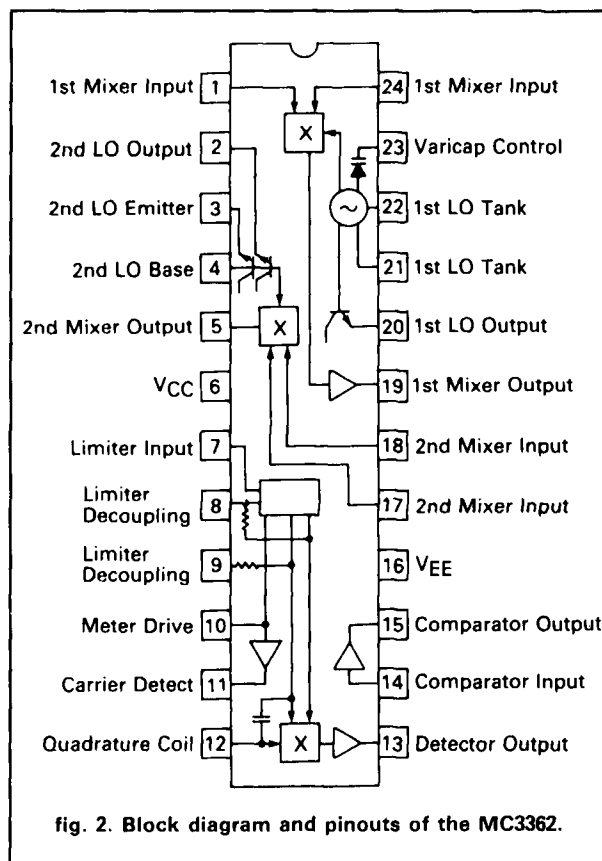

fig. 2. Block diagram and pinouts of the MC3362.

### second LO

The second local oscillator is designed to be crystal controlled at 10.245 MHz (10.7 MHz — 455 kHz). The crystal should be a fundamental type cut for a load capacitance of 32 to 40 pF. A buffered output is provided (pin 2).

### second i-f

The second i-f filter is external to the MC3362. A 455-kHz ceramic filter is recommended. The printed

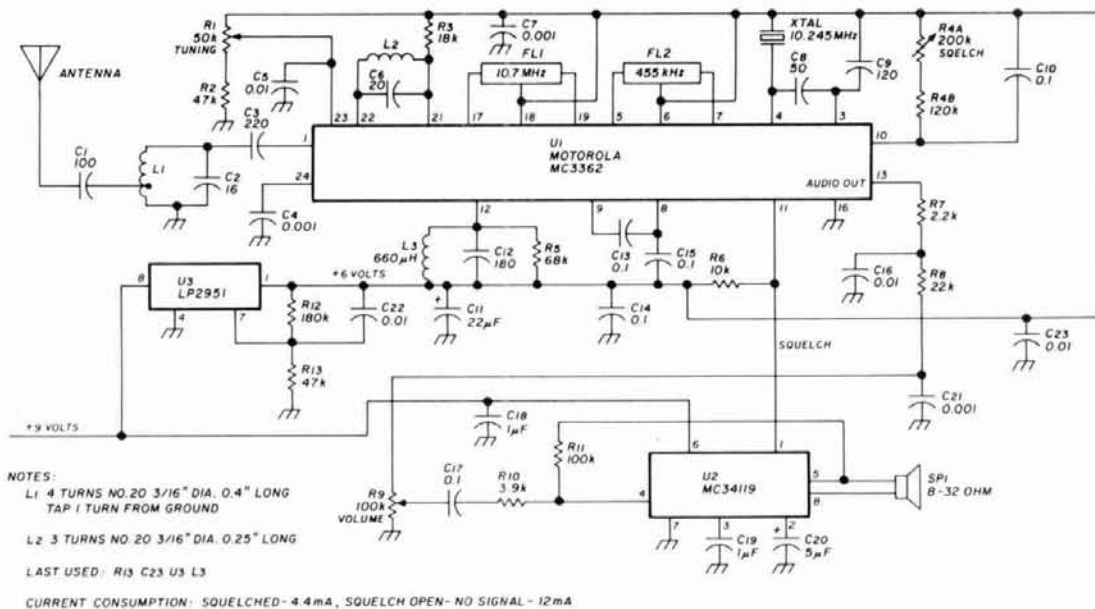

fig. 3. Motorola MC3362 IC is foundation for 2-meter receiver.

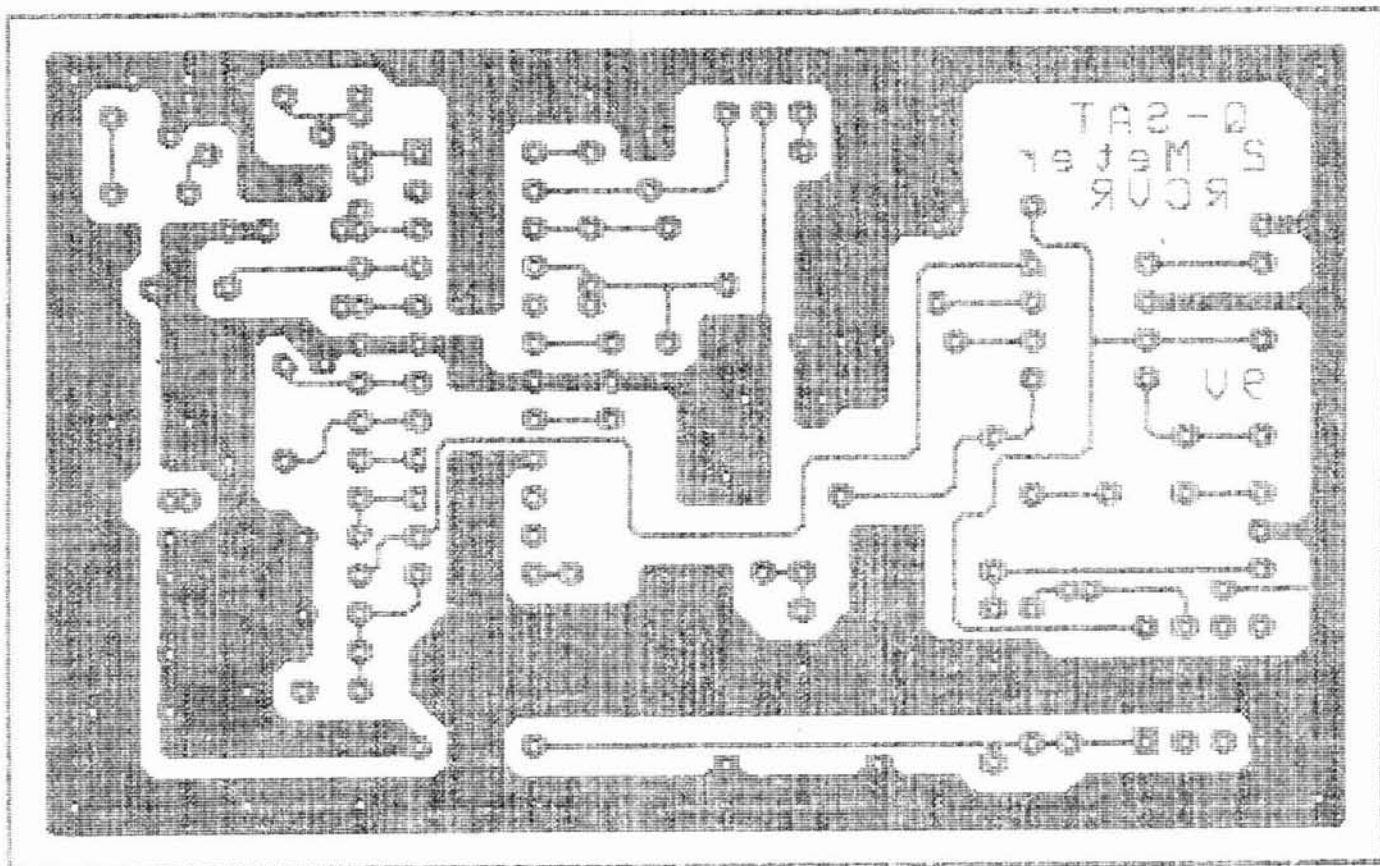

fig. 4. Printed circuit artwork; 2X size. Top view looking through the board.

parts list

C1	100 pF
C2	16 pF NPO or dipped silver mica (see text)
C3	220 pF
C4,C7,C21	0.001 $\mu$ F
C5,C16,C22,C23	0.01 $\mu$ F
C6	22 pF NPO or dipped silver mica (see text)
C8	47 or 50 pF
C9	120 pF
C10,C13,C14, C15,C17	0.1 $\mu$ F
C11	10 to 22 $\mu$ F, 10 volts
C12*	180 pF or RMC2A6597HK (see text)
C18,C19	1 $\mu$ F
C20	5 $\mu$ F, 15 volts
FL1*	10.7-MHz filter—SFE10.7MA (see text)
FL2*	455-kHz filter—SFU455A (see text)
L1	3/16 inches diameter 4 turns spaced to 0.4 inches tapped 1 turn from ground No. 20 wire
L2	3/16 inches diameter 3 turns spaced to 0.25 inches No. 20 wire
L3*	660 $\mu$ H or RMC2A6597HK (see text)
R1	50-k pot
R2	47 k (see text)
R3	18 k
R4	(see text)
R5	68 k
R6	10 k
R7	2.2 k
R8	22 k
R9	100-k pot (audio taper)
R10	3.9 k
R11	100 k
R12	180 k
R13	47 k
U1*	Motorola MC3362P
U2*	Motorola MC34119P
U3*	National LP2951CN
Crystal*	10.245 MHz (HC-18U style)
Printed Circuit Board*	

All capacitors should be as small as possible.

All resistors 1/4 watt.

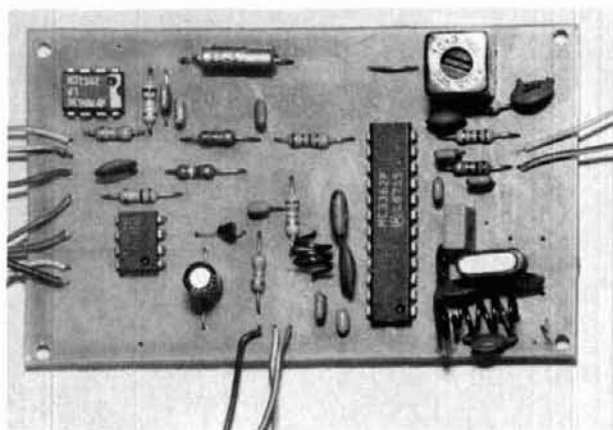

fig. 5. Closeup of 2-meter receiver showing parts placement.

circuit board is laid out to accept two different pinouts. The 455-kHz filters once sold by Radio Shack will work. As in the case of the 10.7-MHz filter, consider bandwidth, loss, and cost. Impedance should be 1.5 to 2 k. Typical parts are the muRata CFU455D and SFU455A, and the Toko LFC-455I.

A limiter is used to remove any a-m component from the signal. The limiter response is good to about 1 MHz.

A quadrature detector is provided to detect the fm signal. Output is dependent on the carrier "swing". Figure about 250 microvolts for narrowband fm.

A meter drive and a squelch circuit are provided.

Data detect is a comparator which is designed to detect zero crossings of FSK modulation data rates of 2000 to 35000 baud.

## construction

The basic receiver circuit is from a Motorola application note. It was so new that it didn't have an application note number. The schematic (modified from the application note) is shown in fig. 3.

Since the receiver is operating at 147 MHz, it is advisable to build the circuit on a pc board (fig. 4). Perfboard with a ground plane and some copper tape can be used; my original prototype was built on a Radio Shack board — the type with a ground plane on top.

If you duplicate the pc board presented here, please note that some capacitors have more than two mounting holes. Don't worry about the extra holes; just find the best fit (fig. 5). Be careful — it's crowded around L<sub>1</sub>!

Some things about this circuit may seem a little strange. For example, if you've ever used ceramic filters, you probably connected the middle lead to ground instead of to the V<sub>CC</sub> plane. Actually, at 150 MHz and with proper power supply bypassing, the V<sub>CC</sub> plane and the ground plane are both at the same ac potential, so it doesn't really make any difference. Also many components that you would normally see connected between the IC and ground are really connected to the V<sub>CC</sub> plane.

The voltage regulator (a National LP2951) used in this design is also a little different; it's a low dropout adjustable regulator. Believe me, I agonized over using this part because many people will have a hard time obtaining it. Why not just stick to a 7805? Most regulators require an input voltage at least 2 volts higher than the output. For example, imagine a standard 5-volt 7805 operating from a 9-volt NiCd battery. In the first place, a 9-volt NiCd is really 8.4 volts. Since the 7805 requires about 2 volts more than the output, this circuit will work until the battery output falls to about 7 volts. With the LP2951, the circuit will work until the battery falls to about 5.5 volts. (Battery life is extended by using the LP2951.)

The output may be trimmed to suit your power supply. Because Motorola suggests a slightly higher voltage for operation at 150 MHz, an adjustable regulator is recommended. The temperature performance of this particular part is better than almost anything else on the market. You probably can delete it (jumper pin 1 to pin 8) and get away with four AA batteries for a power supply, but I suggest a 9-volt NiCd and a regulator. Motorola warns that the first LO will drift with any change of the power supply.

The audio amplifier is a bit different, too. I've used

### Directory of component manufacturers

muRata-Erie 1148 Franklin Rd, S.E. Marietta, Georgia 30067	(404) 436-1300 coils, crystals, ceramic filters, crystal filters
Toko America Inc. 1250 Feehanville Drive Mount Prospect, Illinois 60056	(312) 297-0070 coils, ceramic filters, crystal filters, quadrature coils
Coilcraft 1102 Silver Lake Road Cary, Illinois 60013	(312) 639-6400 coils
Fox Electronics PO Box 1078 Cape Coral, Florida 33910	(813) 482-7212 crystals
GTE Sylvania Electronic Components Division 2401 Reach Road Williamsport, Pennsylvania 17701	(717) 326-6591 crystals
International Crystals P.O. Box 26330 Oklahoma City, Oklahoma 73126	(405) 236-3741 crystals
JAN Crystals P.O. Box 06017 Ft. Myers, Florida 33906	(813) 936-2397 crystals
Comtec 3300 East Sparrow Ave. Flagstaff, Arizona 86004	(602) 526-4123 crystals
Standard Crystal Corp. 9940 E. Baldwin Pl. El Monte, California 91731	(818) 443-2121 (800) 423-4578 crystals
Digi-Key Corp. P.O. Box 677 Thief River Falls, Minnesota 56701	(800) 344-4539 Toko coils and filters

For the National Semiconductor and Motorola parts, I suggest you contact your nearest sales office or try the following distributors: Hamilton—Avnet, Hallmark, Schewber, or Mil-Gray.

the LM386 in this type of application for quite a while, but I hate finding room for a 100- or 250- $\mu$ F output coupling capacitor. The MC34119 with a differential output and an enable pin is hard to beat.

Notice resistors  $R_{4A}$  and  $R_{4B}$ . If you want an adjustable squelch, use them both ( $R_{4A} = 200$  k;  $R_{4B} = 1$  k). If you'd rather have a fixed level, replace  $R_{4A}$  with a jumper and make  $R_{4B}$  about 120 k. The pc layout is set up for either configuration.

Inductor  $L_3$  and capacitor  $C_{12}$  can both be replaced by a Toko LC tank part number RMC2A6597HK (highly recommended). If the tank doesn't seem to want to go down far enough in frequency, put about 18 pF in parallel with it.

If you can't find nonpolarized capacitors for  $C_{18}$  and  $C_{19}$ , use polarized caps. In both cases the negative side will go to ground.

The only critical thing about this circuit is that you enjoy building it!

### tune-up

I suggest that you omit  $C_2$  and  $C_8$  at the start. In my first prototype I calculated the coils precisely and

allowed for input capacitance, strays, and the varicap. They weren't even close (10 MHz off). As an alternative, tack solder a trimmer (10-60 pF) temporarily to the bottom of the board. Tweak the tank using the trimmer; then take the tank out and measure it. Substitute the closest cap you can find.

Your tune-up can be done in a number of different ways. Some signal source will be necessary. A signal generator is best, but you can use a grid dip meter or an on-the-air signal like a busy local repeater. Start with the first LO tank ( $L_2$ ,  $C_6$ ). For now, you can tack a trimmer capacitor in place of  $C_6$ , or squeeze and stretch the coil until the oscillator is around 136 MHz. The buffered output and a frequency counter would be ideal. After you have trimmed the oscillator tank, you can tune the input coupling tank ( $L_1$ ,  $C_2$ ) using the same method. Now tune the quadrature coil  $L_3$ . Don't forget the tuning control  $R_1$  during all this. By the way, increasing  $R_2$  will give a smaller, less critical tuning range. Just don't go below 10 k or the control voltage will drop below 1.2 volts. A practical upper limit is probably about 100 k.

My prototype tuned 4.5 MHz (143.75 to 148.25



**NETWORK**  
SERIES 1000

The Original Ringrotor

**NEW FROM TIC General**

Here's a fantastic new idea in antenna rotators? Instead of rotating one antenna per tower, with the Network 1000, you can mount several antennas on a tower and rotate each one either together in a phased array, or independently of each other.

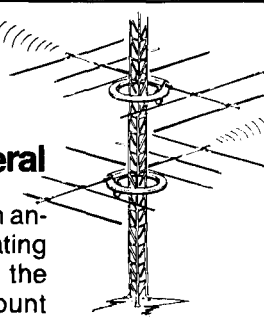

Uses high strength steel gear drive, super strong I-beam ring construction and has been fully field tested. You can also aim the antenna to 1 degree of accuracy. TIC also has a digital control box available.

For more information about this exciting new antenna rotator, call TIC today.

(800) 423-6417 nationwide, (800) 542-5009 MN or (218) 681-1291 or write TIC General, P.O. Box 1 Thief River Falls, MN 56701.

*Be the envy of your club when you demonstrate your new TIC Network 1000!*

✓ 162

MHz) with the parts called for in the parts list. For fine tuning add a 5-k pot between R<sub>1</sub> and R<sub>2</sub>, connected as a variable resistor; or better yet use a ten-turn pot for R<sub>1</sub>.

**modifications**

There is no reason that this receiver must work on 2 meters. Motorola doesn't specify the lower operating frequency, but I suspect it will go all the way down to the a-m broadcast band. Of course, a narrowband fm receiver isn't much good below 28 MHz. It was designed to operate on 49 MHz, and 6 meters should be no problem. (My prototype is also a good weather receiver on 162 MHz.)

Because tuning can be done using a control voltage, a scanner seems to be a natural. A ramp generator or even a counter with a D/A can be connected to pin 23. The squelch can be used to stop the scan. Remember not to allow the control voltage to go too low.

With a fixed crystal instead of an LC tank for the first LO, you could operate on the 75-MHz radio control band — if fm is allowed on that band. Motorola's data sheet covers operation with a fixed crystal oscillator, although it's a bit sketchy.

**more Motorola parts**

In addition to the MC3362, Motorola has three more ICs which should be of interest to hams. One is the MC3363 narrowband fm receiver. This receiver is much like the MC3362 but has an extra NPN transistor and an op-amp. It's available only in a 28-pin surface mount package.

The MC2831A, a low-power fm transmitter, includes a microphone preamp, fm modulator, rf buffer good to 30 MHz, a tone oscillator, and a low battery detector.

The MC2833 fm transmitter is the same as the MC2831A, but has no tone oscillator or low battery detector. It does have two undedicated NPN transistors which can be used as rf amplifiers or doublers/triplers. (24 MHz multiplied by 6M1 puts it on 2 meters.) It might make a nice transceiver with the MC3362.

**obtaining parts**

Parts seem to be a problem these days. The people at Motorola were nice enough to provide me with the lists of parts suppliers.

You can obtain a printed circuit board for \$6 plus \$1 postage and handling. A kit of "hard to find" parts (marked with an \* on the parts list) is also available for \$23 plus \$2 postage and handling from: Q-Sat, PO Box 110, Boalsburg, Pennsylvania 16827. (Pennsylvania residents please add 6 percent sales tax.)

ham radio

**\*\*\* Super Comshack 64 \*\*\***  
**Programmable Repeater Controller/HF & VHF Remotes/Autopatch**  
 Rotor Control/Voice Meters/Paging/User Logging/Unlimited Vocabulary/BBS

REMOTE #1 CS64S \* HM1 \* CART \* CSB \* BASE TX/RX  
 FT57/767/980 TS440/940/IC735  
 REMOTE #2 FT27R/767; TS711/B11

Set up your own personal repeater with any Dual band radio from your home or club site. Operate cross-band for instant full duplex operation. You can have your own system! We will help you get your system operational! Hundreds of systems now in operation throughout the U.S. Join the fun today!

**REPEATER CONTROLLER**  
 \*Change all variables remotely  
 \*Synthesized voice adj. pitch/speed  
 \*Program mail box or select ID tail mess. with touchtones from HT  
 \*Alarm clock & auto excute mode  
 \*Macro commands/user logging  
 \*Individual user access codes  
 \*Code practice & voice readback  
 \*Multifunction voice alarm clock  
**H.F. REMOTE #1**  
 \*20 Macro mem/ auto mode sel  
 \*Scan up/down sel. rate or step  
 \*Voice ack all control commands

**AUTOPATCH & REVERSE PATCH**  
 \*1000 (18 digit) Tel. #'s stored  
 \*300 users/CTCSS & 2 tone paging  
 \*50 enable/disable tel #'s  
 \*Directed/general & reverse page  
 \*User programs Tel. answer message  
 \*Full or Half duplex (level cont.)  
 \*Security mode/TT readback on/off  
 \*Store MCI/Sprint tel. #'s  
 \*Reverse Patch active all modes  
 \*Call waiting/quick dial & reset  
**V.H.F. REMOTE #2**  
 \*Dual VFO's/Rev/Split/COR detect  
 \*Set Scan inc. & offset/var. resume

**Super Comshack CS64S \$349.95**  
 \* \$4.00 ship USA; incl. computer interface, disk, cables & manual (simplex version inc. on request)

**SYSTEM OPTIONS**  
 \*External Relay Control 3 DPDT relays + 5 open collector outputs. CS-8879.95  
 \*Beam control, speaks bearing and rotates beam .1 degree incre. HM1 \$49.95  
 \*2 Voice Meter & Alarm inputs/8 Ext. On/off controls/Package BBS. PK8 \$149.95  
 \*EPROM Auto boot Cartridge customized with your system. CART \$99.95  
 \*Manual (Refunded) MNI \$15.00

**MINI (BEAR CAT) COMPUTER CONTROL FT-727R**  
 Programs and Scans 100 ch. In Mem/General coverage. Converts HF into a powerful 100 ch. scanner & programs all for field use!  
 \*Digital "S" meter, stops scan from S(1-9), Auto resume  
 \*Loads & programs all FT-727R parameters in less than 15 secs  
 \*Includes hardware & disk for C64 or IBM PC MODEL 727S \$39.95

**12V C64 SWITCHER**  
 \*Draws 1.1A @12v  
 \*70kHz 75% efficient  
 \*Outputs 5v @2 amps and 9 vac 60Hz  
 \*Crystal time base  
 \*Plugs into C64 power  
 MODEL DCPS.....\$119.95 NEW

**Touchtone 4 Digit Decoder & on/off latch with all 16 Digits**  
 Expendable Repeater on/off control

**Touchtone to RS-232 (300 baud inter face)**  
 Program your computer. In basic to decode multidigit "strings", sound alarms, observe codes, includes basic program for C64 VIC20/C128, works on all computers! MODEL DAP \$89.95

**\*Audio Blaster\* IC02/04; 2AT; 016; FT209/727; 23/73R**  
 Module installs inside the radio in 15 min. Boost audio to 1 watt! Low standby drain/Corrects low audio/1000's of happy users. Miniature audio amplifier! → HEARD!  
 Used by Police, fire, Emergency, when it needs to be HEARD!  
 WOW! that's loud now!!! You can hear everything!  
 NOW FROM FT76/228 QWBK MODEL AB1-B \$22.95  
 MODEL AB1-B \$19.95 \*Model TSD \$59.95

**ENGINEERING CONSULTING - 583 CANDLEWOOD ST. - BREA, CA. 92621**  
 MASTERCARD - VISA - CHECK - M.O. - CA. RES. ADD 6% TEL: 714-671-2009



# NEW products

## all-new TM-721A FM dual bander

Kenwood's new FM Dual Bander includes a dual channel watch function, selectable full duplex operation, 30 multifunction memory channels, extended frequency coverage, large multicolor digital LCD displays, programmable scanning, with 45 watts of output on VHF and 35 watts on UHF.

Other features include:

- Extended receiver range (138.000-173.995 MHz) on 2 meters; 70 cm coverage is 438.000-449.995 MHz. (Specifications guaranteed on Amateur bands only. Two-meter transmit range is 144-148 MHz. Modifiable for MARS/CAP. Permits required.)
- Fourteen memory channels and one call channel for each band store frequency, repeater offset, CTCSS, and reverse. Channels "A" and "B" set upper and lower limits for programmable band scan. Channels "C" and "D" store transmit and receive frequencies independently for "odd splits".



- Dual frequency display for "main" and "sub-band."
- Automatic Band Change (A.B.C) changes between main and sub-band when a signal is present.
- Dual watch function allows VHF and UHF receive simultaneously.
- Handset/remote control option (RC-10).
- Dual antenna ports.
- Programmable memory and band scanning, with memory channel lock-out and priority watch function.
- Supplied accessories: 16-key DTMF hand microphone, microphone hook, mounting bracket, and dc cable.

The suggested retail price is \$649.95. For details see your Kenwood dealer or write Kenwood USA Corporation, Communications and Test Equipment Group, 2201 E. Dominguez Street, Long Beach, California 90810.

## new edition listeners catalog

Universal Shortwave has released a new edition of their listeners catalog. Catalog 88-03 has a full line of portable and communications receivers, antennas, headphones, books, and accessories. As always, a large section of the catalog is devoted to radioteletype and facsimile equipment.

Universal's Amateur Radio division has just published its first ham radio catalog. Catalog 88-02 features a full spectrum of Amateur equipment, representing all major manufacturers.

Both catalogs are now available for \$1 each (refundable) or free with any purchase from: Universal Radio, 1280 Aida Drive, Reynoldsburg, Ohio 43068.

Circle #301 on Reader Service Card.

## Kantronics Watchdog and Morse Tutor

Kantronics announces the Watchdog circuit that can be installed inside the KPC-1, KPC-2, and the KPC-400. The circuit monitors the push-to-talk line of the TNC. If the P.T.T. has been active for two minutes, the Watchdog will activate and the attached radio will un-key preventing a local area network from being disabled due to a "hung-up" TNC. After the circuit has been activated, a power on/off will restore the KPC to normal operation.

The Watchdog circuit retails for \$10, plus \$2.50 for shipping in the U.S. and Canada. International shipping is \$7.50.

The new Kantronics Morse Tutor for IBM compatible computers provides practice, quiz, and general information functions. It has alternate learning sequences and variable character speeds to sound like hand-sent code. No memorization of commands is required to operate.

The Morse Tutor is priced at \$19.95, plus \$2.50 for shipping in the U.S. and Canada. International shipping is \$7.50.

For more information contact Kantronics, Inc., 1202 East 23rd Street, Lawrence, Kansas 66046.

Circle #302 on Reader Service Card.

## satellite tracking, propagation software

Randy Stegemeyer, W7HR, has developed a new satellite tracking software package for Macintosh computers with at least 512K RAM and an 800K drive. MacTrak offers tabular data output for tracking and scheduling, and "windows" to selected locations. Graphics capabilities include world map, polar, and great circle

displays. A view mode presents the earth as seen at any time from the satellite. The real-time mode displays data as it changes and, when used with the KLM/Mirage Tracking Interface, follows satellites as they pass within range. The program also tracks the sun and moon and would be useful for EME applications.

A propagation prediction package is included which provides an estimate of Maximum Usable Frequency (MUF) to any point, calculates sunrise and sunset times, bearings and distances, and displays the "gray line".

The program is priced at \$49.95. For complete details contact the author at PO Box 1590, Port Orchard, Washington 98366.

## new version 4.4 software for CS64S

Engineering Consulting has introduced new 4.4 software for the Super Comshack 64 Model CS64S for the ham shack or hilltop repeaters.

Each user may be assigned a unique access code which the Super Comshack 64 recognizes. The control operator can then allocate access privileges on various levels of system control. The Super Comshack system "speaks" the call-sign of each station requesting access to a function such as autopatch, remotes, or system commands.

The new version 4.4 software supports up to 300 users and up to 1,020 18-digit telephone numbers which can be assigned to individuals in banks. New users may be added to the system at any time. The system can be reprogrammed remotely to switch over to nine sets of parameter files, each containing unlimited system variables. A complete printout of user assignments and all parameters can be made at any time.

The control operator can adjust the speed and pitch of the voice synthesizer. The new software has the capability to pronounce all words in the English language. Verbal messages can be entered from the parameter files or from touchtones; emergency messages can be created from touchtone strings which represent letters.

The version 4.4 software can be used with any REV 4 CS64S board. It is available from Engineering Consulting, 583 Candlewood Street, Brea, California 92621 for \$59.95, which includes the manual and 90-day free revision upgrades.

**SAY YOU SAW IT  
IN  
HAM RADIO**

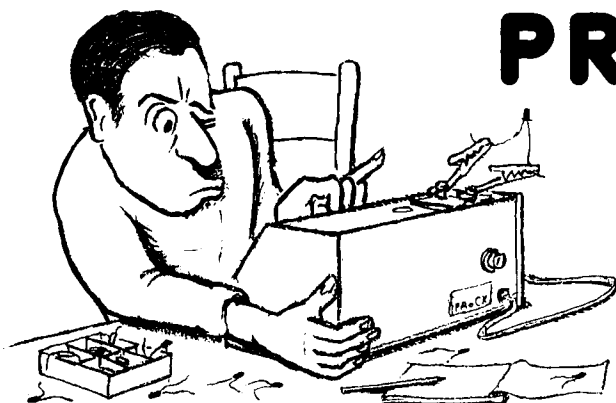

# PRACTICALLY SPEAKING

Joe Carr, K4IPV

## non-ideal linear IC amplifiers typical problems and how to solve them

**Operational amplifiers** and other linear IC devices are widely used in communications equipment; this includes Amateur equipment. Unfortunately, the textbook circuits are based on ideal devices — amplifiers that are perfect in every way. That little ploy makes the equations work, but is somewhat naive for the real world. When you go to the electronics parts store (or mail-order catalog), the kind of op-amps you'll find fall short of the ideal type in the textbooks. Here's a dose of reality — and the medicine needed to correct the problems that these amplifiers exhibit.

We'll consider two major problems. The first is dc offsets on the output resulting from any of several defects, the different forms of offset, and several means for eliminating them. Second, we'll discuss the problem of frequency response. This problem is twofold, involving gain bandwidth product (which affects the maximum frequency response of the circuit) and excess frequency response. The latter can lead to oscillation and ringing in the output circuit.

### dc offset problems

A dc output offset is a dc voltage

that appears on the output terminal, but not in response to any input signal. It's an output voltage that exists when it shouldn't (i.e., when  $V_{in} = 0$ ). There are several sources of output offset voltage in real-world op-amps.

**Input Offset Current.** One cause of the output offset voltage is input offset currents. **Figure 1** shows the typical input stage used in bipolar op-

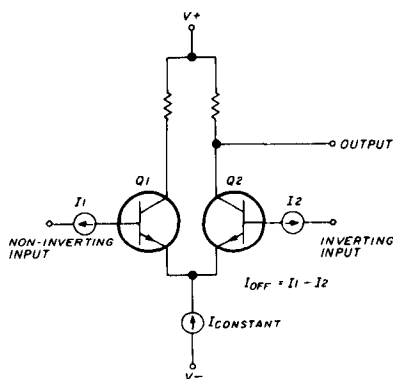

fig. 1. Differential amplifier input stage.

amps. Transistors Q1 and Q2 form an NPN differential pair. The inputs of ideal op-amps neither sink nor source current, but real op-amp inputs are transistors — and transistors need to be biased. If this were an ideal world the two currents would be equal and cancel out. But real op-amps use transistors that are mismatched ever so slightly. The differential input bias current forms an input offset current:

$$I_{off} = I_1 - I_2 \quad (1)$$

The offset current ( $I_{off}$ ) can produce an output voltage offset equal to the product of the current and the gain of the op-amp. While a low-gain op-amp circuit may not exhibit a large output offset from the input offset current, high-gain circuits almost invariably suffer such problems.

The severity of the problem depends in part upon the design of the op-amp. While certain old-fashioned types (like the 741) have rather significant offset currents, certain new types have the current reduced to a point where it is all but negligible. Especially low-input bias currents are found in op-amps that use either MOSFET or JFET transistors for input transistors Q1 and Q2 (fig. 1). These devices are called BiMOS and BiFET op-amps, respectively.

One problem with input offset currents occurs when a feedback network is used to set the gain of the op-amp (including both inverting and noninverting followers). The current flows in both input resistor (R1) and feedback resistor (R2), and produces an input offset voltage equal to the product of the current and the parallel combination of R1 and R2. By Ohm's law, this voltage is equal to:

$$V = \frac{(I_{BI} \cdot R1 \cdot R2)}{(R1 + R2)} \quad (2)$$

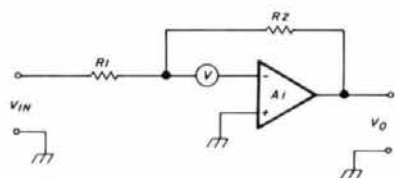

fig. 2. Input offset voltage.

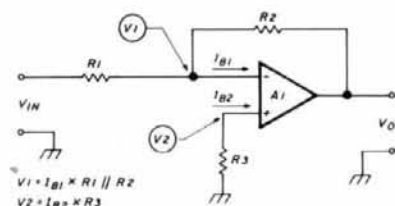

fig. 3. Use of compensation resistor.

A method to cancel this voltage in practical circuits by using a compensation resistor in series with the other (noninverting) input follows.

**Input Offset Voltage.** The ideal op-amp has no voltage sources in series with either input, except those external sources that supply signal. Real op-amps, however, have an internal voltage source in series with one or both inputs. The input offset voltage **fig. 2** is defined as the voltage required to force the output voltage to zero when the input signal voltages are zero. There are usually independent voltages in series with each input, but unless they are exactly equal (in which case they cancel each other), we can model the input offset voltage as a single voltage source in series with one of the two differential inputs. The output voltage offset produced by the input offset voltage is given by:

$$V_{out} = \frac{(V)(R1 + R2)}{R1} \quad (3)$$

Where:

- $V_{out}$  is the output offset voltage at  $V_o$  in **fig. 2**
- $V$  is the input offset voltage
- $R1$  is the input resistance
- $R2$  is the feedback resistance

### corrections for dc offset problems

Both input offset current and input offset voltage produce an output off-

set voltage that can adversely affect amplifier operation. There are several ways to eliminate the output offset voltage.

**Figure 3** shows an inverting follower circuit that uses a compensation resistor ( $R3$ ) to eliminate the output offset voltage caused by the input offset current. The input bias current flowing from the inverting input ( $IB1$ ) will create a voltage drop ( $V1$ ) across  $R1$  and  $R2$ . This voltage was defined in **eqn. 2**. Voltage  $V1$  is seen by the op-amp as a valid dc signal voltage. If the value of  $R3$  is equal to the parallel combination of  $R1$  and  $R2$ , then the voltage drop across it ( $V2$ ) will be the same as the voltage applied to the inverting input. In other words,  $V1 = V2$ . This situation occurs because the two bias currents are almost equal in the majority of op-amps. The value of  $R3$  is the parallel combination of  $R1$  and  $R2$ , or:

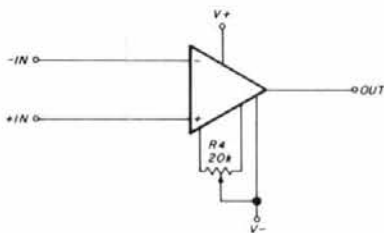
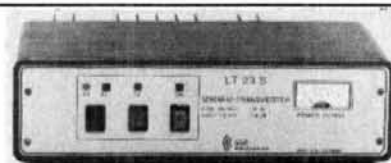

fig. 4. Use of offset null terminals on some op-amps.

$$R3 = \frac{R1 \cdot R2}{R1 + R2} \quad (4)$$

**Figure 4** shows the use of built-in offset null terminals found on some op-amps (typically pins 1 and 5, or 1 and 8). This circuit can eliminate output offset voltages from any source. The offset null potentiometer is connected between the offset null terminals, while the potentiometer wiper is connected to the negative dc power supply ( $V-$ ). This method is preferable where the offset voltage is within the normal range of the offset null terminals.

The variant circuit in **fig. 5** is used on the LM-101, LM-201 and LM-301 op-amps. In this circuit the potentiom-



### SSB ELECTRONICS TRANSVERTERS

LT6S	50/28 MHz, 20W, GaAs-Fet, DBM	\$529
LT2S	144/28 MHz, 20W, GaAs-Fet, DBM	529
LT70S	432/28 MHz, 20W, GaAs-Fet, DBM	549
LT33S	902/144 MHz, 20W, GaAs-Fet	549
LT23SO	1269/144 MHz, 10W, OSCAR	549
LT23S	1296/144 MHz, 10W, GaAs-Fet	549

### MASTMOUNTED RF SWITCHED GaAs-Fet PREAMPLIFIERS

SP-2	144 MHz, 0.8DB NF, 25 DB Gain	199
SP-70	432 MHz, 1.0DB NF, 25 DB Gain	199

### RF SWITCHED GaAs-Fet PREAMPLIFIERS

MX-2	144 MHz, 0.8DB NF, 25 DB Gain	89
MX-70	432 MHz, 1.0DB NF, 25 DB Gain	99

### MISCELLANEOUS ITEMS

UEK-3	901 Or 1296 LO/RX Conv. Kit	119
USM-3	902 OR 1296 TX Mixer, 1.5W	129

### EME ELECTRONIC

HF400	High Power Relay, 2KW at 144 MHz	129
HF2000/6	High Power Relay to 6 GHz	199

### TRANSVERTERS UNLIMITED

T144/28	Transverter, 25W, GaAs-Fet	229
T220/28	Transverter, 15W, GaAs-Fet	249
PA23200	1296 2 Tube Water Cooled PA	299

\* SALE ITEMS—END OF LINE—USED—DEMOS ETC

### EME ELECTRONIC

PA33200	902 MHz 2 Tube PA, 200W Out	429
PA23150	1296 MHz 2 Tube PA, 150W Out	379
PA1325	2304 MHz 1 Tube PA, 25W Out	359

### MICROWAVE MODULES

MMT144/28R	Transverter, GaAs-Fet, DBM	329
MMT1296/144	Transverter, 2W	249
MMC432/28S	Converter	69
MMS-1	Morse Talker	120

### MUTEK MASTMOUNTED GaAs-Fet PREAMPLIFIERS

GMFA144E	144 MHz 0.5 DB NF Sequencer	\$99
GLNA432E	432 MHz 0.6 DB NF Sequencer	\$99

### SSB ELECTRONIC TRANSVERTERS

LT33SL	902/144 MHz, 6W, GaAs-Fet	399
--------	---------------------------	-----

### MASTMOUNTED GaAs-Fet PREAMPLIFIERS

MV144S01	144 MHz, 5 DB NF, 25 DB Gain	159
MV902S	902 MHz, 9 DB NF, 18 DB Gain	169
DCW15A	Sequence Controller for MV144	55
DCW15A-23	Sequence Controller for MV902	65

### GaAs-Fet PREAMPLIFIERS

DX144	144 MHz 0.4 DB NF, 25 DB Gain	109
DX220	220 MHz 0.5 DB NF, 25 DB Gain	109
DX432	432 MHz 0.3 DB NF, 20 DB Gain	159
DX902	902 MHz 0.5 DB NF, 23 DB Gain	159
DX1296	1296 MHz 0.5 DB NF, 23 DB Gain	159

### MISCELLANEOUS

PA2310	1296 MHz PA, 1W in 10W Out	189
PM1300A	Terminating Power Meter 20 MW-20W	199
TPM-4	Wattmeter DC-12 GHz .3MW-.1W	299
K7001	432/144 Receive Converter, DBM	109
TV28-144	144 MHz Transverter Kit, 100mw	149
TV28-432	432 MHz Transverter Kit, 100mw	149

### TRANSVERTERS UNLIMITED

BOX 6286 STATION A	1900-2300 EDT
TORONTO, ONTARIO	MONDAY-THURSDAY
CANADA M5W 1P3	VISA
(416) 759-5562	

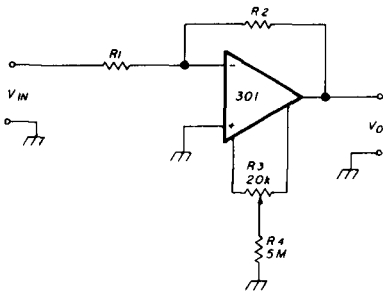

fig. 5. LM-101/LM-301 offset null terminals.

eter is connected across the offset null terminals as before, but the potentiometer wiper is connected to ground through a 5-megohm resistance (R4).

You should select a ten to twenty-turn trimmer potentiometer for any of these offset null circuits. This type of part allows maximum adjustability. The usual offset potentiometer is screwdriver operated, but if you use a shaft operated type you can use the same control as a position control for oscilloscopes, strip chart recorders, and other purposes where an offset is intentionally selected.

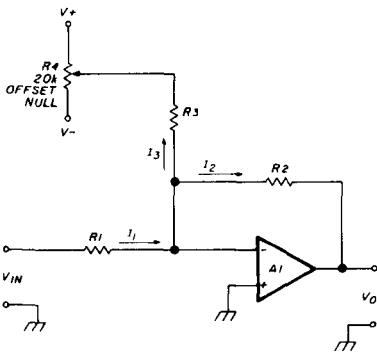

fig. 6. "Universal" offset null circuit.

Figures 6 through 9 show offset null circuits that can be used with any op-amp whether or not it possesses offset null terminals. The method shown in fig. 6 is, perhaps, the most commonly seen. In this case, cancel the output offset voltage by inserting a counter current (I3) into the summing junction. When V1 is the voltage at the wiper of the offset null potentiometer the output voltage, due to the adjustment of R4, is:

$$V_o = V_1 \cdot \frac{-R_2}{R_3} \quad (5)$$

The idea is to adjust potentiometer R4 to obtain an output voltage that exactly cancels the output offset. For example, if the output offset potential is +1.5 volts, select a value of V1 that makes eqn. 5 equal to -1.5 volts. In many cases, this involves making R3 = R2, so the voltage at the wiper of potentiometer R4 (i.e., V1) should be equal to the output offset voltage that it cancels.

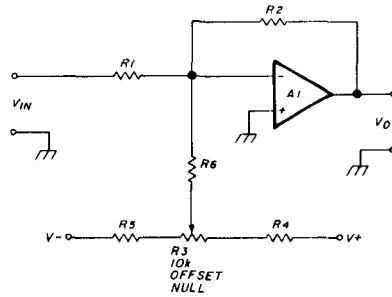

fig. 7. High resolution offset null circuit.

Figures 7 and 8 are variations on the same theme that permit better resolution adjustments of the offset voltage. These circuits are often used in high-gain amplifier circuits with small signals. Those applications typically have very low level signal inputs. The version in fig. 7 places two resistors in series with the arms of the potentiometer (R4 and R5). The value of R3 is usually smaller than the combined values of R4 and R5, and also R4 = R5. The fig. 8 version uses a pair of

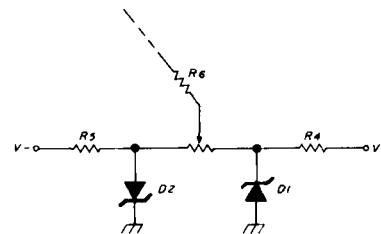

fig. 8. Alternate high resolution offset null circuit.

zener diodes to place the ends of the potentiometer at lower potentials than the V- and V+ voltages that operate the amplifier. In most cases the zener potentials of D1 and D2 are equal, giv-

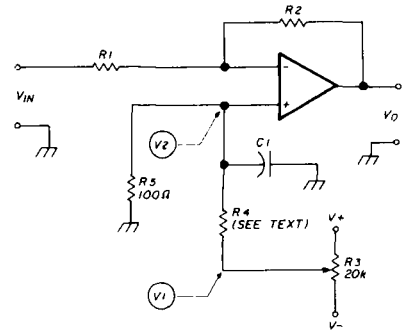

fig. 9. "Zero null" circuit.

ing a symmetrical range of offset voltages that can be canceled. There is no reason why different values can't be used if that is the situation of the specific circuit.

Figure 9 shows a final offset null circuit. In this case, apply the counter-voltage to the noninverting input rather than the inverting input. A small value resistor (R5) is connected between the noninverting input and ground. A resistor from the potentiometer wiper (R4) acts with R5 to form a resistor voltage divider. The voltage applied to the noninverting input (V2) is:

$$V_2 = \frac{V_1 \cdot R_5}{R_4 + R_5} \quad (6)$$

or, given the value of R5:

$$V_2 = \frac{100 \cdot V_1}{R_4 + 100} \quad (7)$$

The output voltage produced by V2 acting on the op-amp's noninverting input is:

$$V_o = V_2 \frac{R_2}{R_1} + 1 \quad (8)$$

Because of the gain of the circuit, make V2 a very small value. Use the equations above to select the values for V1 and R4 required to cancel out the offset voltage.

The capacitor used between the inverting input and ground is optional in most cases. C1 sets the noninverting input at ground potential for ac signals, while keeping it at a non-zero value of V2 for dc. The value of C1 is such that it has a capacitive reactance of 10 ohms at the lowest frequency of oper-



ation. This capacitor can be used only in relatively low gain circuits because capacitors to ground from inputs increase the noise output from the circuit. In low-gain circuits, however, the benefits may outweigh the noise problems.

## frequency compensation problems

Ideal amplifiers of any type have an infinite bandwidth, so they will amplify all signals accurately and cleanly. Real amplifiers have frequency response limitations; for op-amps these limitations can be quite severe. There are two problems to consider with regard to frequency response: the bandwidth and stability of the system. The frequency response problem requires us to understand the gain bandwidth product of the amplifier.

The gain bandwidth product (GBP) is the product of the voltage gain and the maximum bandwidth of the device. GBP is specified as the frequency in MHz or kHz at which the

tion amplifiers are examples where gain and wide bandwidth frequency response go hand in hand. These examples also illustrate the problems of GBP most distinctly. Suppose you need a voltage gain of 40 dB (a gain of 100) and a frequency response of 10 kHz (10,000 Hz). The gain bandwidth product required of the op-amp is:

$$\text{GBP} = A_v \times F \quad (9)$$

$$\text{GBP} = (100) (10,000 \text{ Hz}) \quad (10)$$

$$\text{GBP} = 1,000,000 \text{ Hz} = 1 \text{ MHz} \quad (11)$$

Stability is always an issue whenever op-amps are used. Almost invariably, when breadboarding a new circuit with wideband op-amps, the first attempt will result in an unwanted oscillation. One solution is to use a frequency compensated op-amp like the 741 (if the application permits). These devices are unconditionally stable — a condition that occurs at the expense of gain bandwidth product. Such an op-amp will work as an ac amplifier only to frequencies of a few kHz.

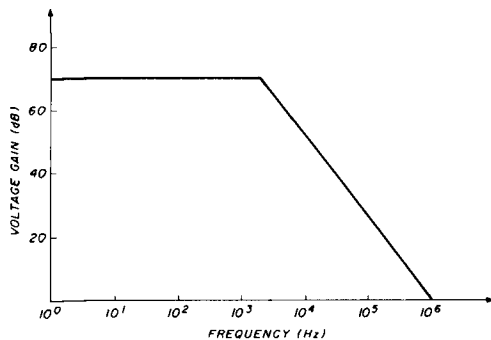

fig. 10. Gain-Bandwidth plot for a typical op-amp.

gain of the op-amp drops to unity (i.e., 1). **Figure 10** plots the voltage gain against the frequency response of an amplifier. The gain remains relatively constant over a certain frequency range, but begins to fall above a certain point. At some frequency (1,000,000 Hz in this case), the gain drops to unity.

You'll run into GBP when you try to obtain high gain and wide frequency response in the same amplifier. A cassette tape preamplifier, a microphone preamplifier, and certain instrumenta-

These difficulties can be created from any of several problems. Layout, for example, can create oscillation. If the stray capacitances and inductances create a resonant situation at a frequency lower than the unity gain frequency, then the circuit will oscillate. Similarly, if the dc power supply is not properly decoupled, problems can occur. This latter problem occurs especially in multistage circuits where one stage can affect the other. Be careful of disc ceramic capacitors — some of those components have very

significant stray inductances and can form resonant circuits that do not bypass very well at one frequency. If that resonant frequency is below the GBP frequency, oscillation may occur.

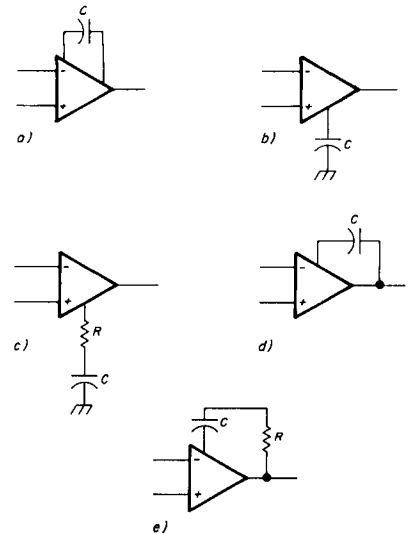

fig. 11. Frequency compensation capacitor circuits.

Grounding problems in the circuit can also create obstacles. One cause of oscillations here is an impedance in the ground circuit common to both input and output circuits. Because output signal flowing in that impedance is also in series with the input circuit, feedback automatically exists.

If any combination of feedback and phase shift occurs between output and input, at a frequency that is less than the unity gain GBP frequency, oscillation can occur. Several ploys are used to reduce the gain at frequencies less than GBP to prevent oscillation. Some of these methods are shown in **fig. 11**. Note the use of a capacitor (**fig. 11A**) across the frequency compensation terminals found on some op-amps. The manufacturer typically specifies a capacitance in the data sheet for the device. Values in the 30-to-100 pF range are common. Standard practice is to make this capacitance the value for the noninverting unity gain follower configuration. For all other configurations with gain, the value of the capacitance required is the noninverting unity gain value multiplied by the feedback factor, B:

## BLACK DACRON® POLYESTER ANTENNA ROPE

- UV-PROTECTED
- HIGH ABRASION RESISTANCE
- REQUIRES NO EXPENSIVE POTTING HEADS
- EASY TO TIE & UNTIE KNOTS
- EASY TO CUT WITH OUR HOT KNIFE
- SIZES: 3/32" 3/16" 5/16"
- SATISFIED CUSTOMERS DECLARE EXCELLENCE THROUGHOUT U.S.A.

LET US INTRODUCE OUR DACRON® ROPE TO YOU • SEND YOUR NAME AND ADDRESS AND WE'LL SEND YOU FREE SAMPLES OF EACH SIZE AND COMPLETE ORDERING INFORMATION.

Dealer Inquiries Invited



MANUFACTURED BY  
**synthetic textiles, inc.** 2472 EASTMAN AVE., BUILDING 21  
VENTURA, CALIFORNIA 93003  
(805) 658-7903

✓ 164



### R-7000 Widespan Panadaptor

Panadaptor especially designed for the R-7000 receiver. For use with a standard scope. Variable span width from 1 to 10 Mhz. Uncover unknown elusive signals. Complete with all cables, & 90 day warranty. \$349.95 Shipped. Pa. res. add 6%.

### GTI Electronics

RD 1 BOX 272  
Leighton, Pa. 18235  
717-386-4032

✓ 165

## NEW SUPER FAST C-64 LOGGING PROGRAM

from WAØLIB and Charlie Stone

A revolutionary new contest program for the C-64 computer designed and tested by active contesters. Can be used in CQWW, ARRL Sweeps, Field Day, ARRL DX Test or any other Contest. Can be used with ONE OR TWO DISKDRIVES. Superfast dupechecker with real time clock ON or OFF. 3,000 QSOs stored per band on your data disk. Special print and formatting routines plus much more. Easy-to-use and user friendly. Worth twice the price.

**Just \$39.95 plus \$3.50 shipping and handling**

### Also available QSL CARD FILE DATA BASE.

Organize your QSLs on computer for fast and easy retrieval of information. Each file has 28 fields which can be filled in or edited at any time. Each data disk will accept 400 complete records. Includes special print routine.

**Just \$19.95 plus \$3.50 shipping and handling.**

**BUY BOTH SPECIAL  
Contest Logger @ \$39.95 plus  
QSL Data Base @ \$19.95  
Regular \$59.90**

**SPECIAL SALE PRICE JUST \$49.90  
Save \$10! plus \$3.50 shipping & handling**

We accept VISA/MASTERCARD-PERSONAL CHECKS.

**RIEBSTONE SOFTWARE CO.**  
P.O. Box 13532  
St. Louis, Missouri 63137

✓ 167

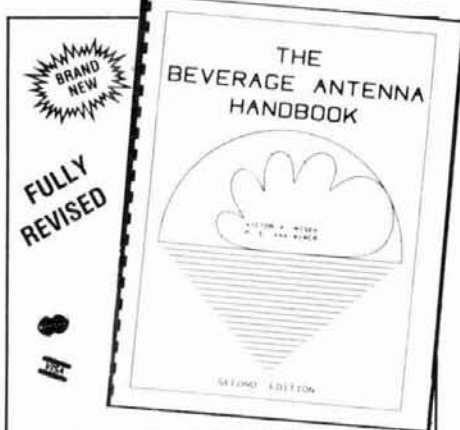

## BEVERAGE ANTENNA HANDBOOK

by Vic Misesk, W1WCR New Edition

W1WCR has spent countless hours developing new antenna ideas and optimizing the SWA (Steerable wave antenna.) Misesk delves deep into the secrets of the single wire Beverage with helpful hints and tips on how to maximize performance based upon wire size, height above ground, overall length and impedance matching. Also includes information on center fed Beverages constructed out of several wire types. **SMALL LOT OWNERS** — Beverage for you too! Called the Micro-SWA, it is just 60 ft long. You get excellent directivity and null steering capabilities. Transformer design information for both termination and feedline matching is completely revised. © 1987 80 pages

1 VM-BAH Softbound \$14.95

Please enclose \$3.50 shipping & handling

**ham radio BOOKSTORE**  
GREENVILLE, NH 03048 603-878-1441

$$C_{req} = C \times B \quad (12)$$

Where:

$C_{req}$  is the required capacitance

C is the specified capacitance for noninverting unity gain

B is the feedback factor

Factor B is merely the transfer function of the feedback network. In the usual circuit with a resistor feedback network, the value of B is:

$$B = \frac{R1}{R1 + R2} \quad (13)$$

Where:

B is the feedback factor

R1 is the input resistor

R2 is the feedback resistor

For example, let's suppose that an inverting amplifier with a gain of 10 has a rated compensation capacitance of 30 pF for the unity gain configuration. Assume the feedback resistor (R2) is 100k, and the input resistor (R1) is 10k. The value of B is:

$$B = \frac{10k}{10k + 100k} \quad (14)$$

$$B = 10/110 = 0.091$$

The value of the capacitance required to stabilize this amplifier is:

$$C_{req} = C \times B \quad (15)$$

$$C_{req} = (30 \text{ pF}) (0.091) \quad (16)$$

$$C_{req} = 2.7 \text{ pF} \quad (17)$$

Figures 11B through 11E show variations. The values of the components are taken from charts or graphs in the specifications sheet for the particular op-amp being used.

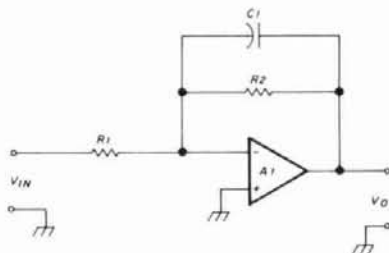

fig. 12. Feedback capacitor controls frequency response.

## HI-PERFORMANCE DIPOLES

ANTENNAS THAT WORK! CUSTOM ASSEMBLED TO YOUR CENTER FREQ. EA. BAND - ADVISE RT. OF CENTER AND EACH END - MARK AS INVERTED "V" - HORIZONTAL - VERT DIPOLE, SLOPING DIPOLE - COMMERCIAL QUALITY - STAINLESS HARDWARE - LEGAL POWER - NO-TRAP, HIGH-EFFICIENCY DESIGN. PERSONAL CHECK, MO, OR C.O.D. (1987)

WFD-5*	80-40-20-15-10M	MAX PERFORMANCE DIPOLE 87' LONG	.....\$105ppd
WFD-2	80-40M	MAX PERFORMANCE DIPOLE, 85' LONG	.....\$97-965ppd
WFD-3*	160-80-40M	HI PERFORMANCE DIPOLE 113' LONG	.....\$78ppd
SSD-4*	160-80-40-20-15-10M	SPACE SAVER DIPOLE 113' LONG	.....\$125ppd
SSD-5*	80-40-20-15-10M	SPACE SAVER DIPOLE-SPECIFY L, 44', 4 93, 60', 4 96ppd	.....\$108ppd
SSD-4*	80-40-20-15M	SPACE SAVER DIPOLE-SPECIFY L, 44', 4 93, 60', 4 96ppd	.....\$108ppd

\*1/2-BANDS WITH WIDE MATCHING-RANGE TUBES.  
PAGE FOR CATALOGUE OF 30 DIPOLES, SLOPERS, & SPACE-SAVING, UNIQUE ANTENNAS

**W9INN ANTENNAS** 312-394-3414  
BOX 393 MT. PROSPECT, IL 60056

✓ 166

**Input Capacitance Compensation.** Figure 12 shows the method for compensating for stray input capacitance. The circuit shown here is an inverting follower with a capacitance shunting the feedback resistor. From dc to a given frequency, F1, the gain of the amplifier is given by the equation:

$$A_v = -R_2/R_1 \quad (18)$$

At frequency F1, the gain begins to drop off at a rate of -6 dB per octave. The breakpoint frequency (F1) at which this happens is:

$$F1 = \frac{1,000,000}{2 \pi R_2 \cdot C1} \quad (19)$$

Where:

F1 is the frequency in Hz

R2 is in ohms

C1 is in microfarads

The input resistance and the input capacitance (which consists mostly of stray capacitances) form a phase shift at certain frequencies defined by  $1/2\pi R1C$ , where C is the stray input capacitance. If that frequency is below the unity gain frequency, then it is possible for the phase shift that occurs at this frequency to add to the op-amp's ordinary phase shift (180 degrees  $\pm$  error for inverting followers) to form a 360-degree phase shift, which is the criterion for oscillation. To compensate for this stray capacitance, select a value of C1 (fig. 12) that has a capacitive reactance of approximately one-tenth the resistance of R2.

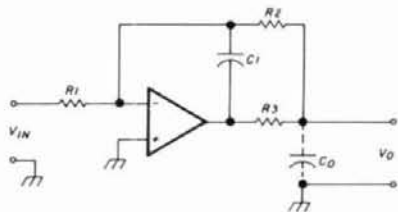

fig. 13. Alternate feedback capacitor circuit.

Figure 13 shows the method for compensating for high output load capacitances. This situation occurs, for example, when the op-amp drives a coaxial cable or twisted pair transmission line. Capacitor C1 is selected to have a capacitive reactance of one-tenth R2, while R3 is selected to have a value of several hundred ohms.

### conclusion

The linear IC, especially the operational amplifier, is a powerful tool for communications circuit designers. Although the practical IC device doesn't measure up to the textbook version, it is useful because its problems are easily solved.

### for further reading

Joseph J. Carr, *IC User's Casebook*, Howard W. Sams & Company, Inc., No. 22488, \$12.95.

Joe Carr, K4IPV, can be contacted at POB 1099, Falls Church, Virginia 22041. He welcomes your questions, comments, and criticisms.

ham radio

**QRZ Contest!**<sup>™</sup>  
VHF Contest Software  
for PC Compatibles  
\$39.95 postage paid

- + Covers all VHF and UHF contests
- + Includes the 70 MHz European band
- + Menu driven and user friendly
- + Color and options user configured
- + Grids worked display on-line!
- + Full dupe checking
- + Complete log editor included
- + Handles 4000 contacts with 512K
- + Demo-version \$5.00 (refundable with purchase of full program)
- + HF version to be available soon!

ATFAB Computers and Electronics  
PO Box 4766, Maineville, OH 45039  
(513)683-2042  
VISA and Master Card Accepted

✓ 168

## R-4C Enhancements

Custom AGC / Filter Switch Available

Custom AF / RF Knob Set Available

Plug-in Filters for Every Mode and Bandwidth

CF-1.7K/8, Sharp SSB. Better than FL-1500.

CF-1.0K/8, Wide CW. Super scanning filter.

CF-500/8, Standard bandwidth CW.

CF-250/8, Narrow bandwidth CW.

Switchable First I-F Filter Solutions

CF-2K/8, Sharp filter pair for Contests and DX.

CF-5K/8, First I-F Replacement.

CF-600/6, The Ultimate CW Upgrade.

## Sherwood Engineering Inc.

1268 South Ogden Street, Denver, CO 80210

(303) 722-2257 Monday - Friday 9 A.M. - 5 P.M.

Full Installation Dealers:

Design Electronics Ohio, KN8Z

(614) 836-5711 Days, (614) 836-3376 Evenings

LTA Industries, K3LR (412) 528-9302

## A RACE ON THE EDGE OF TIME

Radar — The Decisive Weapon of WW II

by David E. Fisher

*A Race On The Edge Of Time* reads like a thriller but is based upon painstaking and comprehensive research by the author. In fact, Fisher argues rather convincingly that radar was the crucial factor that allowed the allies to win the war and that radar has played the same important role in our current military and political environment. Filled with fascinating twists and turns of history that could have changed the war's outcome, anecdotes about the personalities involved in the development of radar and other military insights. Also includes radar development post WW II and how it will influence future battles. Illustrated with rare vintage photographs and diagrams.

☐ MH-21088

Hardbound \$19.95

Please enclose \$3.50 shipping and handling.

ham radio BOOKSTORE

GREENVILLE, NH 03048

603-878-1441

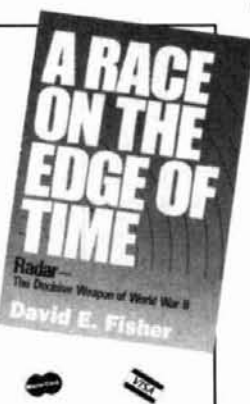

## Multiband QRV 160-10 Emergency Pack

Field Day Winner

Fastest Antenna in the West

The Emergency Pack contains QRV 160-10 All Band kink-proof weather sealed antenna, Quick Launch kit, 70' RG-8x feedline, 160 meter adapter, all band counterpoise, 200' rotproof line. Complete and QRV. One person installs in 15 minutes.

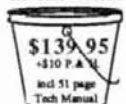

Infopack \$1 by 1st class mail.  
Dept. H, Provo, UT 84603-1144

AntennasWest  
(801) 373-8425

✓ 118

# a simple low-cost comb generator frequency calibrator

Produces pulses  
for test equipment  
calibration

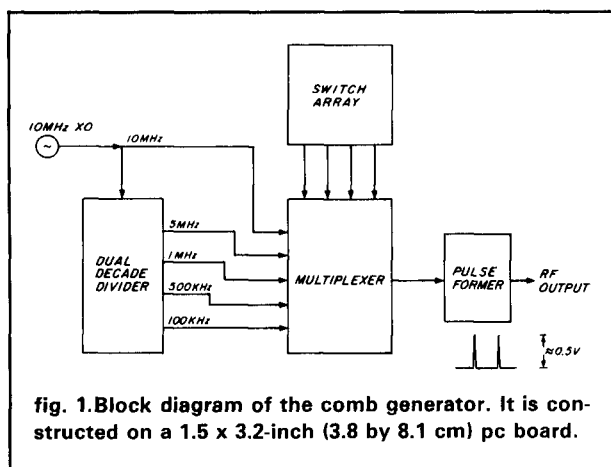

Here's the construction and theory behind a simple digital comb generator\* that produces accurate (crystal-controlled) pulses and can be used to calibrate a wide variety of test equipment. One possible application is the calibration of a spectrum analyzer (like the "Low-cost Spectrum Analyzer with Kilobuck Features," *ham radio*, September 1986, pages 82-90). It can also be used to align receivers, and to provide a stable comparison for calibrating various kinds of signal sources. A bandpass filter can be used to select any *tooth* of the comb to provide a single, pure signal.

A block diagram is shown in fig. 1. The heart of the generator is a crystal-controlled 10-MHz clock oscillator. Although a clock with moderate accuracy ( $\pm 0.05$  percent) is used in this model, more accurate

\*It is called a comb generator because when its output is viewed in the frequency domain, as with a spectrum analyzer, the pattern resembles a comb.

oscillators are available in the same package style if you want higher stabilities. The oscillator's output is then divided down in frequency by a digital divider to a minimum frequency of 100 kHz. A multiplexer is used to select one of the signals from the divider chain or the 10-MHz signal. The multiplexer output drives the clock input of a high-speed CMOS D-type flip-flop, connected so that when a clock pulse is applied it tries to reset itself. This causes a narrow pulse about 6 nanoseconds wide to appear at its output. The repetition rate of this pulse train is the same as the applied input signal to the flip-flop, and when viewed in the frequency domain appears as a series of teeth separated in frequency by the repetition rate of the pulses. The schematic for the comb generator is shown in fig. 2; a parts list is provided.

The crystal oscillator, U3, can be purchased as a component in a DIP style package with a wide variety of specifications in terms of output levels and frequency accuracy. You'll need a part with either a CMOS or TTL compatible output for this application. The accuracy of the oscillator used in this comb generator is specified as  $\pm 0.05$  percent (about  $\pm 72$  kHz at 2 meters). Oscillator output is applied to both a frequency divider, U1, and one input of an eight-input multiplexer, U2. The frequency divider is a 74LS390 dual decade counter. It is hooked up so that its outputs furnish pulse repetition rates of 5, 1, 0.5, and 0.1 MHz simultaneously. All these outputs are then connected to the multiplexer inputs.

A quad DIP switch is used to select one of the five signals which appear at the output of the multiplexer, U2 (a 74LS151). DIP switch coding for the various output frequencies is shown in table 1. The multiplexer output is connected to the clock input of a high-speed CMOS D-type 74AC74 flip-flop, U4. The D input of the flip-flop is always wired high, so the flip-flop will set when the rising edge of a clock pulse occurs. The Q complement is wired to the flip-flop's reset pin; as

By Larry Martin, PO Box 997, Sebastopol, California 95472

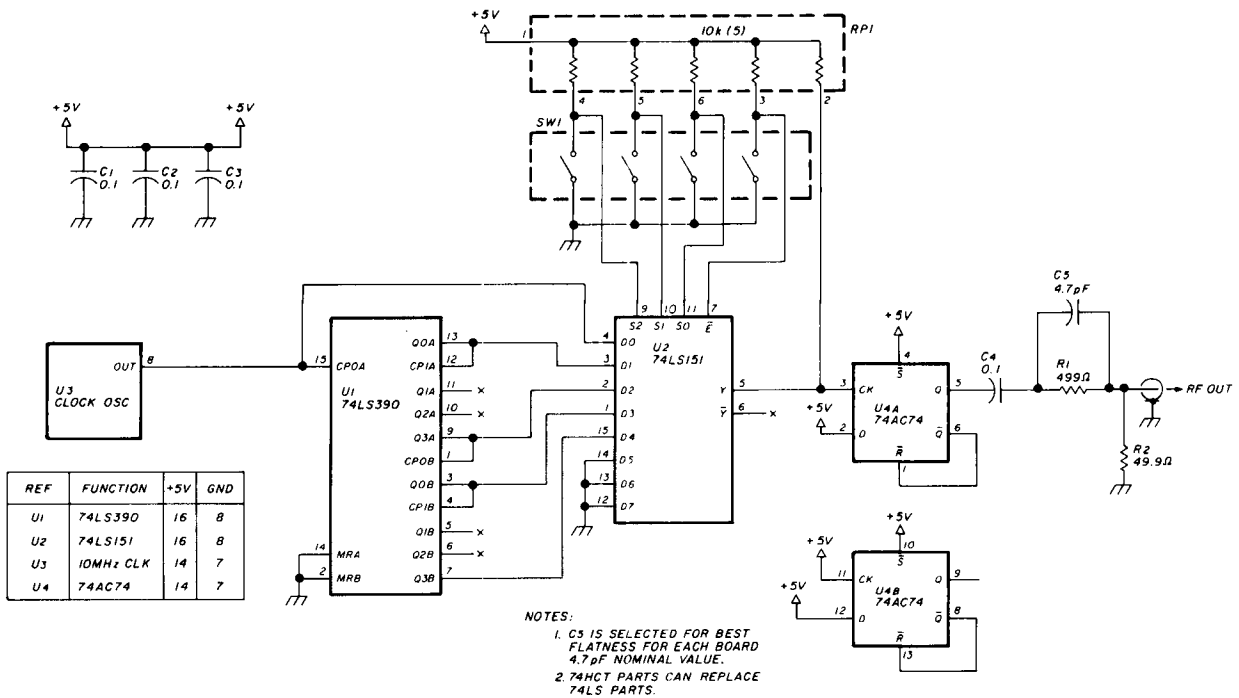

fig. 2. Detailed schematic of the comb generator. It uses four integrated circuits and a few other passive components.

Table 1. Output Frequency Coding

DIP Switch Code	Output Pulse Repetition Rate
0000	Output is disabled
0001	Output is disabled
0010	Output is disabled
0011	Output is disabled
0100	Output is disabled
0101	Output is disabled
0110	Output is disabled
0111	Output is disabled
1000	Output is disabled
1001	Output is disabled
1010	Output is disabled
1011	100-kHz rate
1100	500-kHz rate
1101	1-MHz rate
1110	5-MHz rate
1111	10-MHz rate

soon as the flip-flop is set (its output rises to 1), the complement output goes low, and the flip-flop is forced to reset. Its output is a narrow pulse whose width is limited only by the time delays through the internal logic of the flip-flop and the wiring delays associated with the pc board. This pulse, shown in fig. 3, is typically 6 nanoseconds wide.

This pulse train, when viewed in the frequency domain, looks like a comb (see footnote) as shown in

Ref. Desig.	Part Description	Manf'r	Qty.
C1	0.1 uF 50 V CK05 Capacitor	AVX	4
C2	0.1 uF 50 V CK05 Capacitor	—	—
C3	0.1 uF 50 V CK05 Capacitor	—	—
C4	0.1 uF 50 V CK05 Capacitor	—	—
C5	4.7 pF nominal value, CK05 Capacitor (Set at test)	AVX	1
J1	BNC PC Mount Jack	AMP	1
R1	499 ohm 1% 0.1 W resistor	Corning	1
R2	49.9 ohm 1% 0.1 W resistor	Corning	1
RP1	6 pin 5 resistor 10K ohm SIP	Bourns	1
SW1	4 position DIP switch	Grayhill	1
U1	74LS390N Dual Decade Counter	TI	1
U2	74LS151N Multiplexer	TI	1
U3	10 MHz Clock Oscillator	Dale	1
U4	74AC74PC Dual D Flip-flop	Fairchild	1
X1	Printed Circuit Board	LMCA	1

figs. 4 and 5 for a 10-MHz pulse repetition rate. Figure 4 shows the output of the comb generator with a 10-MHz repetition rate from 0 to 100 MHz, while fig. 5 shows the output spectrum of the same waveform from 0 to 1000 MHz. These figures show that the typical output is flat to within  $\pm 1$  dB from 0 to 100 MHz (careful adjustment of C5 can reduce the flatness to less than  $\pm 0.6$  dB) and that the comb generator is useful to above 1000 MHz.

The comb generator can be used as a very stable, pure tone generated by filtering one of the output teeth. The spectral purity of the 100-MHz tooth of the comb generator is seen in fig. 6, which shows the noise within a 1-kHz frequency span (with a 10-Hz resolution bandwidth). Note that the line-related sidebands are over 70 dB down.

Figures 7, 8, 9, and 10 show the output spectrum



## LET THE SUN DO THE WORK

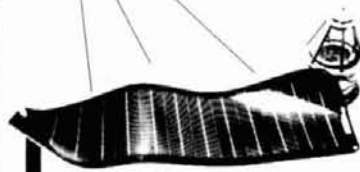

Electricity  
from the  
Sun with

**SOVONICS**  
Solar Systems

- Charge batteries on stored machinery
- Light your tent
- Run fans
- Run remote transmitters
- Light signs
- Pump water for your animals
- Power for your motor home
- Run your radio without batteries
- Light your home
- Yard lights
- Charge flashlight batteries
- Light your cabin
- Run electric fences
- Charge your boat battery
- Run appliances in your home
- Charge hand held radio batteries
- Fish shanty lights
- Charge your Camcorder battery pack

ALSO: OUTSTANDING PRICES ON IBM XT COMPATIBLE SYSTEMS!

SHIPPING INFORMATION: PLEASE INCLUDE 10% OF ORDER FOR SHIPPING AND HANDLING CHARGES (MINIMUM \$2.50, MAXIMUM \$10). CANADIAN ORDERS, ADD \$7.50 IN US FUNDS. MICHIGAN RESIDENTS ADD 4% SALES TAX. FOR FREE FLYER, SEND 22¢ STAMP OR SASE.

HAL-TRONIX, INC. (313) 281-7773

12671 Dix-Toledo Hwy  
P.O. Box 1101  
Southgate, MI 48195

Hours  
12:00 - 6:00 EST Mon-Sat

"HAL" HAROLD C. NOWLAND  
W8ZXH

169

# CTM SALE CTM

## Going-out-of-Business

CTM had too many readers and not enough subscribers to make a profit. Too many people copying CTM and passing it around to their friends month after month after month!

### A sure way to kill a magazine!

In an effort to help those who had to have their subscription returned, we will sell back issues for only **\$2.00 each plus \$2.00 S&H each order** as long as they last. **U.S. ONLY!** Canadians \$3.00 ea. Other Countries \$7.00 each. Some issues in short supply. We were your best and largest source of **Packet Radio information**. We had 65 articles in 1987 and, 32 in 1988.

A SPECIAL THANKS to our fine writers who made CTM the GREAT magazine it was!

Send your Ck, M.O., (M/C, Visa +5%) to:

Chet Lambert, W4WDR  
1704 Sam Drive  
Birmingham, AL 35235  
(205) 854-0271

196

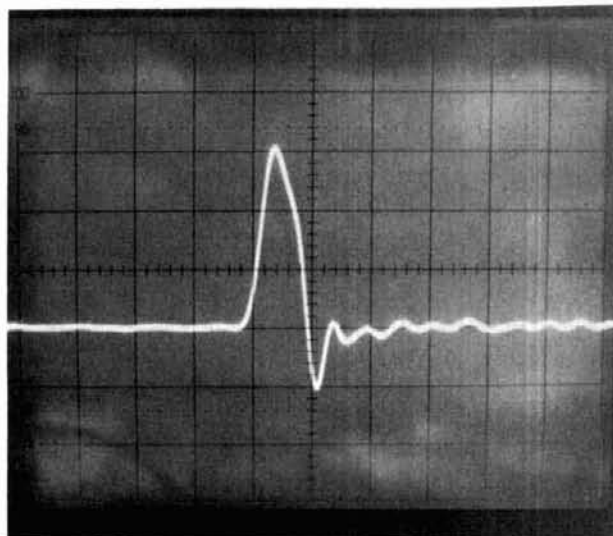

fig. 3. Output pulse of the comb generator. The horizontal scale is 10 nSec/div and the vertical scale is 0.2 V/div. The repetition rate of the pulses depends on the switch settings.

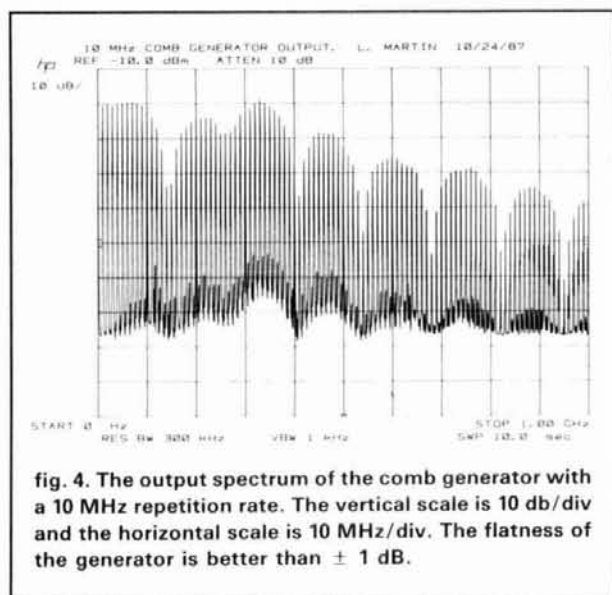

fig. 4. The output spectrum of the comb generator with a 10 MHz repetition rate. The vertical scale is 10 dB/div and the horizontal scale is 10 MHz/div. The flatness of the generator is better than  $\pm 1$  dB.

for a 5-MHz repetition rate, a 1-MHz repetition rate, a 500-kHz repetition rate, and a 100-kHz repetition rate, respectively. Note that the amplitude of each tooth is reduced by the ratio of the repetition rates. This is because the energy in each pulse is spread into many more comb teeth, reducing the amplitude of each tooth when the repetition rate is reduced. **Figure 11** shows the output of the 100-kHz repetition rate signal over the 20 to 30-MHz frequency range and gives an indication of the flatness of the comb generator in the hf frequency bands.

The comb generator is constructed on a double-sided pc board with plated through holes. All compo-

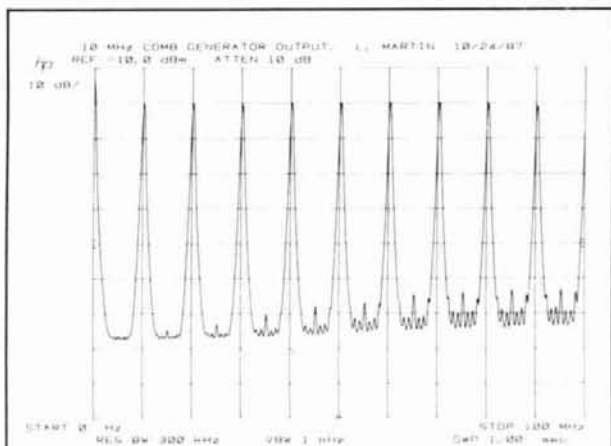

fig. 5. A broadband view of the comb generator output. The vertical scale is 10 dB/div and the horizontal scale is 100 MHz/div. This shows that the comb generator has useful outputs up into the low microwave range.

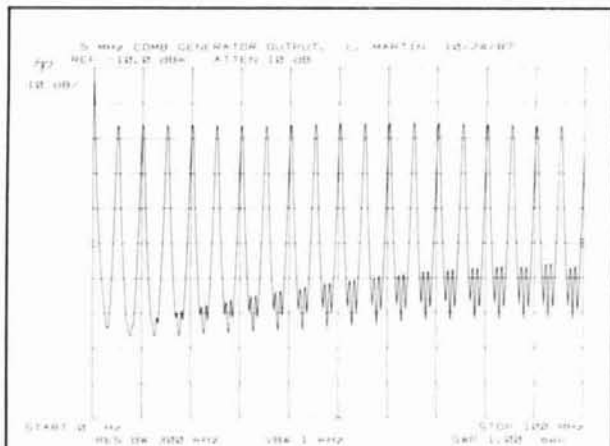

fig. 7. The output of the comb generator with a 5-MHz repetition rate. The horizontal scale is 10 MHz/div and the vertical scale is 10 dB/div.

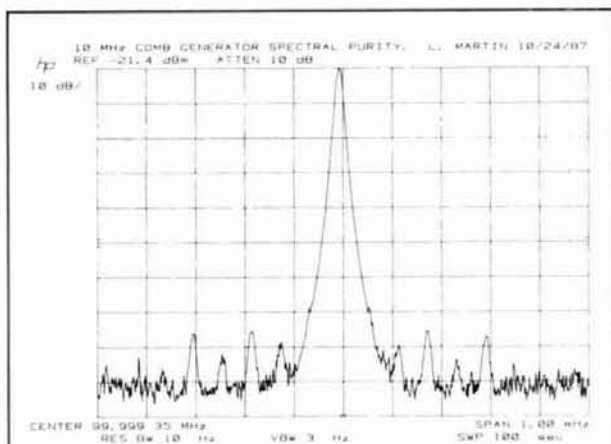

fig. 6. The close in spectral purity of the 100-MHz tooth of the comb generator when set to a 10 MHz-repetition rate. The horizontal scale is 100 Hz/div and the vertical is 10 dB/div. The spurious sidebands are multiples of 60 Hz.

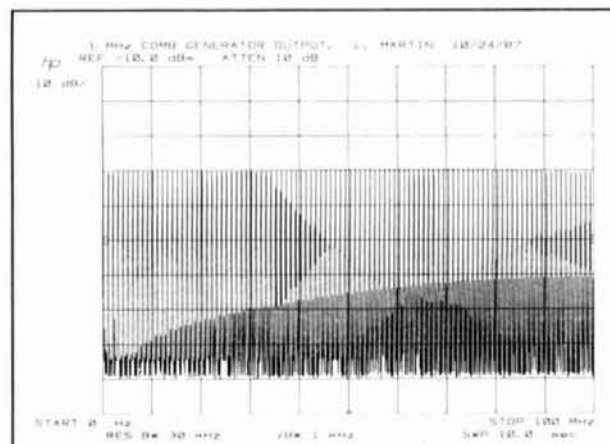

fig. 8. The output of the comb generator with a 1-MHz repetition rate. The horizontal scale is 10 MHz/div and the vertical is 10 dB/div. Note that the amplitudes of each of the teeth has decreased as their quantity has increased.

nents are soldered to the board without sockets to minimize component lead lengths and reduce any switching spikes which could upset the output pulse waveshape. The generator uses 65 mA from a +5 volt supply.

A major use of the comb generator is calibration of test equipment — for example, a typical spectrum analyzer. The tunable oscillator in most rf spectrum analyzers is a varactor-tuned oscillator. This oscillator has an inherently nonlinear tuning curve, so when an unknown signal is measured, the analyzer must be calibrated to determine its frequency. The comb generator allows this calibration to be done efficiently.

First connect the unknown signal to the spectrum

analyzer, set the analyzer to a wide frequency span (0 to 100 MHz), and note the position of the signal on the screen. Disconnect the signal and connect the comb generator to the spectrum analyzer. Set the comb repetition rate of the generator to 10 MHz, and count the number of comb teeth to the unknown signal to the nearest 10 MHz. Next, set the comb generator to 5 MHz and repeat the process; this sets the frequency of the unknown signal to 5 MHz. Then retune the analyzer so the unknown signal is on the screen and bracketed by two visible comb teeth (whose exact frequencies are known). Reconnect the unknown signal to the spectrum analyzer and note its new position. Repeat the above procedure, with

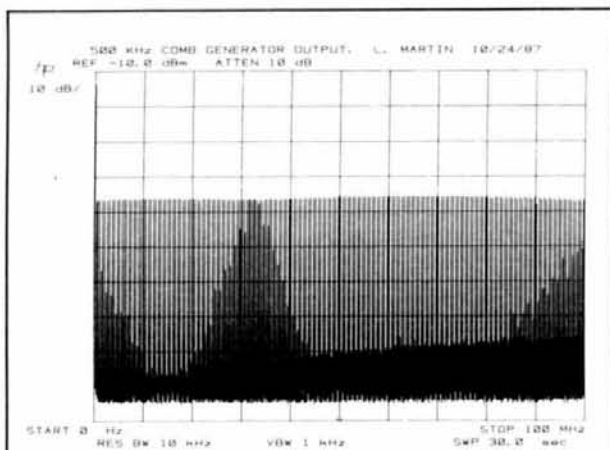

fig. 9. The output of the comb generator when set to a 500-kHz repetition rate. The vertical scale is 10 dB/div and the horizontal is 10 MHz/div.

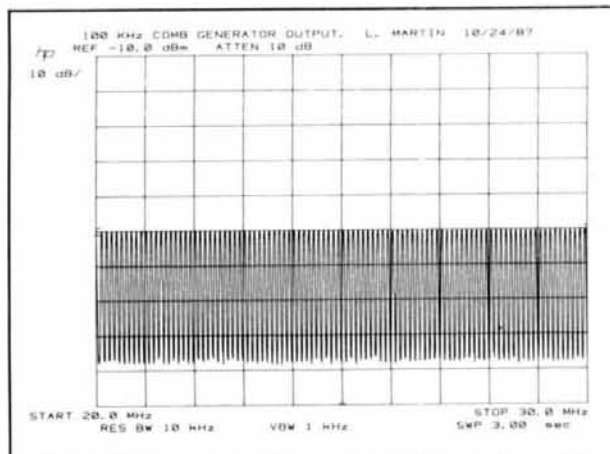

fig. 11. A closer look at the output of the comb generator with a 100-kHz repetition rate. The vertical scale is 10 dB/div and the horizontal scale is 1 MHz/div centered at 25 MHz.

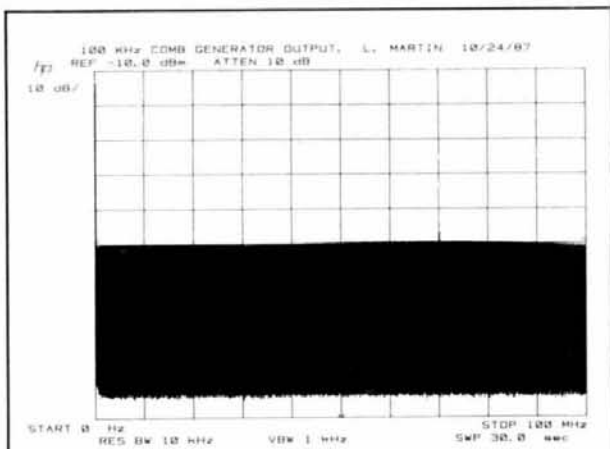

fig. 10. The output of the comb generator with a 100-kHz repetition rate. The vertical scale is 10 dB/div and the horizontal is 10 MHz/div.

smaller and smaller steps between the comb teeth, until the frequency of the unknown signal is estimated by interpolation between the nearest two 100-kHz comb teeth. You will be able to determine the frequency of the unknown signal to about 1 or 2 kHz resolution because most oscillators are relatively linear over very small tuning ranges. The absolute accuracy of the crystal oscillator sets the absolute accuracy to which the unknown frequency can be measured. The above accuracy specification means that a 100-MHz comb tooth will have an accuracy of 50 kHz — much poorer than the measurement capability of the newly calibrated spectrum analyzer.

Many low-cost receivers are not frequency synthesized. The comb generator can also be used to calibrate receiver dials in steps as fine as 100 kHz with an iterative procedure similar to that used for spectrum analyzer calibration.

ham radio

**CADDELL COIL CORP.**

35 Main Street  
Poultney, VT 05764  
802-287-4055

**BALUNS**

Get POWER to your antenna! Our Baluns are already wound and ready for installation in your transmatch or you may enclose them in a weatherproof box and connect them directly at the antenna. They are designed for 3-30 MHz operation. (See ARRL Handbook pages 19-9 or 6-20 for construction details.)

100 Watt (4:1, 6:1, 9:1, or 1:1 Impedance—select one)	\$10.50
Universal Transmatch 1 KW (4:1 Impedance)	14.50
Universal Transmatch 2 KW (4:1 Impedance)	17.00
Universal Transmatch 1 KW (6:1, 9:1, or 1:1—select one)	16.00
Universal Transmatch 2 KW (6:1, 9:1, or 1:1—select one)	18.50

Please send large SASE for info.

**ALL BAND DIPOLE TRAP ANTENNAS!**

PRE-TUNED-ASSEMBLED ONLY ONE NEAT SMALL ANTENNA FOR ALL BANDS! EXCELLENT FOR APARTMENTS! IMPROVED DESIGN!

FOR ALL MAKES AMATEUR TRANSCEIVERS! GUARANTEED FOR 2000 WATTS SSB INPUT FOR NOVICE AND ALL CLASS AMATEURS! CW-AM-FM

COMPLETE with 90 ft. RG58U-52 ohm feedline, and PL259 connector, insulators, 30 ft. 300 lb. test dacron end supports, center connector with built in lightning arrester and static discharge, sealed, weatherproof, traps - 1"X5" wt 3 oz. Low SWR over all bands. Tuners usually NOT NEEDED! Can be used as inverted V's - slopers - in attics, on building tops or narrow lots. WORKS ON NEW WARC BANDS! THE ONLY ANTENNA YOU WILL EVER NEED FOR ALL BANDS! NO BALUNS NEEDED!

160-80-40-20-15-10 -- 4 trap - 169 ft.	No. 1060E	\$134.95
80-40-20-15-10 -- 2 trap - 104 ft.	No. 998E	\$99.95
40-20-15-10 -- 2 trap - 64 ft.	No. 1001E	\$99.95
20-15-10 meter - 2 trap - 26 ft.	No. 1007E	\$97.95

SEND FULL PRICE FOR PP DEL. IN USA. (Canada is \$5.00 extra for postage etc.) order using VISA - MASTER CARD - AMER. EXPRESS. Ph. 1-308-236-5333 week days. We ship in 2-3 days. (Per Ck's 14 days). All antennas guaranteed for 1 year. 10 day money back trial if returned in new condition! Made in USA. FREE INFO. AVAILABLE ONLY FROM WESTERN ELECTRONICS

Dept. AH Kearney, Nebraska, 68847

**AMATEUR RADIO MAIL LISTS**  
Self-stick 1x3 labels

\*\*\* NEWLY LICENCED HAMS \*\*\*  
\*\*\* ALL NEW UPGRADES \*\*\*  
\*\*\* UPDATED EACH WEEK \*\*\*

Total List = 462,728 (ZIP sorted)  
Price is 2.5 cents each (4-up Cheshire)

**BUCKMASTER PUBLISHING**  
Mineral, Virginia 23117  
703-894-5777  
800-282-5628

✓ 171



# DX FORECASTER

Garth Stonehocker, KØRYW

## summer thunderstorm noise

**At any given moment** an estimated 3600 thunderstorms are in progress around the world. They can be classified as air mass, frontal, or orographic, depending on how they're formed. The main source of summertime QRN is the air mass thunderstorm, which builds up from the sun heating the ground and the air above it.

The process works as follows. The sun heats the ground; as the heat from the ground rises, it warms the air above and causes it to rise. As this heated air meets the colder air above, its moisture condenses, forming clouds. The clouds — some of which may be seized by the winds and carried into the jet stream to form the characteristic anvil-shaped top of a thunderhead at 30 to 40,000 feet — continue to rise until their condensed moisture forms drops heavy enough to fall as rain. Some drops are taken further upward and freeze into hail. This fast up-and-down motion generates static electricity strong enough to cause the air to break down between a cloud and the earth or between one cloud and another. As the lightning stroke releases this energy it produces sound and electromagnetic pulses.

Our receivers pick up the hf radio frequency pulse we call "noise." Most air mass storms form on afternoons when the humidity is above 50 percent, and last into the night before cooling off enough to dissipate. Air mass thunderstorms linger for several days until rain releases their moisture or they slowly move on.

During the evening DXing hours, air mass thunderstorm QRN may limit the usefulness of low-band signals to local ragchewing, and for the most part, rule out weak-signal DX. The QRN, propagated from the equatorial land regions, or closer, increases the overall average noise level on the 80- and 160-meter bands. This is because the tropical areas get closer to those of us in the Northern Hemisphere in the summer as the sun comes up to 23°N. A hop or two is cut off from the propagation distance adding a few dB to the noise. Several areas which develop many air mass thunderstorms are even closer — Florida and the eastern side of the Rocky Mountains in Colorado and Nebraska, followed by the southeastern part of the United States are the top producers.

How can you communicate with DX stations on these bands? Directional antennas may help if the thunderstorm activity is in the opposite direction from the DX stations. If you can avoid pointing your beam at these areas, you can help minimize noise pickup. In fact, if you can get the back of the antenna pointed in that direction, you can use the front-to-back ratio (typi-

cally 15 dB) to further decrease noise pickup. This may mean working a DX country over the long path or over the Pole. If the ionosphere will support propagation in that direction and no geomagnetic field disturbance is occurring, you may find this the solution to some of the summer noise problems.

## last-minute forecast

Expect DX conditions for the higher frequency bands to be best during the middle of the month because of increased solar flux with its higher MUFs. Transequatorial one-long-hop skip is nil this month but sporadic E short skip and regular long skip should fill in well. The lower frequency signal strengths decrease during daylight hours when the flux is high, and because of noise this month, conditions really suffer. Nighttime signals will be best the first and last weeks of the month. Look for sunrise and sunset enhancement from sporadic E short skip to help signals get through the noise. Try those early morning operating hours.

## band-by-band summary

Six-meter sporadic E short-skip conditions on some days will last anywhere from 30 minutes to a couple of hours around local noon. Expect about 1000 miles per hop.

Ten, 12, and 15 meters will have quite a few short-skip E<sub>s</sub> openings and some long-skip openings during the 27-day solar flux peaks to southern areas of the world during daylight hours. Fifteen meters will be best for only an hour or two as the maximum usable frequency decreases during the late afternoon.

Twenty, 30, and 40 meters will be

### WESTERN USA

GMIT	PDT	Directional Indicators							
		N	NE	E	SE	S	SW	W	NW
0000	5:00	20	20	20	12	15	10	10	15
01:00	6:00	15	30	20	12	15	10	10	15
02:00	7:00	15	30	20	15	20	10	10	12
03:00	8:00	15	30	20	15	20	10	10	12
04:00	9:00	15	30	20	20	20	10	10	15
05:00	10:00	20	20	20	20	30	12	12	15
06:00	11:00	20	20	15	20	30	12	12	15
07:00	12:00	20	20	15	20	30	12	15	20
08:00	1:00	20	30	15	20	30	15	20	20
09:00	2:00	20	30	20	20	30	15	20	20
10:00	3:00	30	20	20	20	30	20	20	20
11:00	4:00	30	20	20	30	30	20	20	20
12:00	5:00	20	20	15	20	30	20	20	30
13:00	6:00	20	20	12	20	30	20	20	30
14:00	7:00	20	20	12	15	30	20	20	20
15:00	8:00	20	15	10	12	30	20	20	20
16:00	9:00	20	15	10	12	30	20	20	30
17:00	10:00	20	15	10	12	30	20	20	30
18:00	11:00	20	12	12*	10	20	15	30	20
19:00	12:00	30	15	12	10	20	12	20	20
20:00	1:00	30	15	15	10	15	12	12	20
21:00	2:00	20	20	15	10	15	12	12	20
22:00	3:00	20	20	20	10	15	10	10	20
23:00	4:00	20	20	20	10	15	10	10	15

### MID USA

MIDT	PDT	Directional Indicators							
		N	NE	E	SE	S	SW	W	NW
6:00	6:00	20	20	20	12	20*	10	10	15
7:00	7:00	20	30	20	12	20	10	10	15
8:00	8:00	15	30	20	15	20	10	10	12
9:00	9:00	15	30	20	15	20	10	10	15
10:00	10:00	20	30	20	20	30	12	10	15
11:00	11:00	20	20	20	20	30	12	12	15
12:00	12:00	20	20	20	20	30	15	12	20
1:00	1:00	20	30	20	20	30	15	15	20
2:00	2:00	20	30	20	20	30	20	20	20
3:00	3:00	30	20	20	20	30	20	20	20
4:00	4:00	30	20	20	30	30	20	20	30
5:00	5:00	20	20	15	20	30	20	20	30
6:00	6:00	20	20	15	20	30	20	20	20
7:00	7:00	20	20	12	15	30	20	20	20
8:00	8:00	20*	15	12	12	30	20	20	20
9:00	9:00	20*	15	10	12	30	20	20	20
10:00	10:00	20	15	10	12	30	20	20	20
11:00	11:00	20	15	10	10	20	15	30	20
12:00	12:00	20	15	10	10	20	15	30	20
1:00	1:00	20	20	12	10	20*	12	15	20
2:00	2:00	30	20	12	10	20	12	12	20
3:00	3:00	30	20	15	10	15	12	12	20
4:00	4:00	20	20	20	10	15	10	10	15
5:00	5:00	20	20	20	10	10	10	10	15

### EASTERN USA

EDT	PDT	Directional Indicators							
		N	NE	E	SE	S	SW	W	NW
8:00	8:00	20	20	20	12	20	10	10	15
9:00	9:00	20	20	20	12	20	10	10	15
10:00	10:00	20	30	20	15	20	10	10	15
11:00	11:00	20	30	20	15	30	10	10	20
12:00	12:00	20	30	20	20	30	12	12	20
1:00	1:00	20	30*	20	20	30	12	12	20
2:00	2:00	30	30	20	20	30	15	15	20
3:00	3:00	30	30	20	20	30	15	15	20
4:00	4:00	20	20	20	20	30	20	20	30
5:00	5:00	20	20	20	30	30	20	20	20
6:00	6:00	20	20	15	20	30	20	30	20
7:00	7:00	20	20	15	20	30	20	20	20
8:00	8:00	20	20	12	15	30	20	20	20
9:00	9:00	20*	20	12	12	30	20	20	20
10:00	10:00	15	15	10	12	30	20	20	20
11:00	11:00	20*	15	10	12	30	20	30	20
12:00	12:00	20	15	10	12	30	20	30	30
1:00	1:00	20	15	10	10	20	15	30	20
2:00	2:00	20	15	12	10	20	15	30	20
3:00	3:00	20	20	12	10	20	12	15	20
4:00	4:00	30	20	15	10	20	12	12	20
5:00	5:00	30	20	15	10	20	12	10	20
6:00	6:00	20	20	20	10	20	10	10	15
7:00	7:00	20	20	20	10	20	10	10	15

The italicized numbers signify the bands to try during the transition and early morning hours, while the standard type provides MUF during "normal" hours.  
 \*Look at next higher band for possible openings.



# HITACHI SCOPES AT DISCOUNT PRICES!

## \$100 Price Reduction



**V-212**  
**NOW \$379**  
was \$475  
List \$560

Plus 'Free' 9600 Function Generator

All Hitachi scopes include two 1x, 10x probes and have a 3 year warranty on parts and labor



40MHz **V-425** List 995  
CRT readout **\$835**



60MHz **V-660** List 1,195  
Delayed sweep **\$949**



100MHz **V-1060** List 1,595  
Delayed sweep **\$1,285**

	List	Our Price	Save
V-223 20MHz D.T. 2mV Sens. Delayed Sweep	770	695	75
V-422 40MHz D.T. 1mV Sens. DC offset	875	695	180
V-423 40MHz D.T. 1mV Sens. Delayed Sweep DC offset	955	795	160
V-1065 100MHz D.T. 2mV Sens. Delayed Sweep	1,895	1,575	320
V-1100 100MHz Q.T. 1mV Sens. Cursor meas. DVM counter	2,295	1,995	300
V-1150 150MHz Q.T. 1mV Sens. Cursor meas. DVM counter	3,100	2,565	535

# ELENCO PRODUCTS AT DISCOUNT PRICES!



**\$349**  
**MO-1251**

- 6" CRT
- Built in component tester
- TV Sync
- Much More

20MHz Dual Trace Oscilloscope

## Scope Probes

- P-1 65MHz, 1x, 10x **\$19.95**
- P-2 100MHz, 1x, 10x **\$23.95**
- with 5 accessories
- 10 meg ohms input impedance
- Fits most scopes
- TL-3 BNC Minigrabber **\$3.49**



**\$498**  
**MO-1252**

- High Luminance 6" CRT
- 1mV Sensitivity
- 6KV Acceleration Voltage
- 10ns Rise Time
- X-Y Operation • Z Axis
- Delayed Triggering Sweep
- Much More

35MHz Dual Trace Oscilloscope

Top quality scopes at a very reasonable price. Contains all desired features. Two 1x, 10x probes, diagrams and manual.



**True RMS 4 1/2 Digit Multimeter**  
**\$135 M-7000**

- .05% DC Accuracy
- .1% Resistance with Freq. Counter & Deluxe Case

## 10MHz Oscilloscope



**\$-3000**  
**\$239**

- 10MHz DC or AC Triggered Sweep
- Calibrated Vert & Hor
- Reads Volts & Freq

## Decade Blox

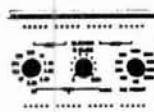

9610 or 9620  
**\$14.95**

- #9610 Resistor Blox: 47 to 1M ohm
- #9620 Capacitor Blox: 47pF to 10MFD
- Both interconnectable w/ #9600 or #9550

**Low Cost Multimeter**  
**M-1600**  
**\$25**

- 3 1/2 Digit LCD
- 1% DC Accuracy
- 10A Scale
- Auto zero/polarity

**Digital LCR Meter**  
**LC-1800**  
**\$138**

- Measures Coils (1uH-200H)
- Caps (.1pF-200uF)
- Resistors (.1 ohm-20M ohms)

## Breadboard

9436 Shown



- 9430 1,100 pins \$15
- 9434 2,170 pins \$25
- 9436 2,860 pins \$35

**Multimeter with Capacitance and Transistor Tester**  
**\$55 CM-1500A**

- Reads Volts, Ohms
- Current, Capacitors, Transistors and Diodes w/case

**Digital Capacitance Meter**  
**CM-1550**  
**\$58.95**



- 9 Ranges
- .1pF-20,000uF
- .5% basic accuracy
- Zero control w/case

**Analog Multimeter**  
**M-1100**  
**\$19.95**



- 19 ranges
- High Accuracy
- 10A reading
- Mirrored scale
- Kit 17.50

**3 1/2 Digit Meter**  
**Auto and Manual Ranging**  
**28 Functions**  
**Fully Protected**



- M-1180 .7% Ac \$36.95
- M-1181 .1% Ac \$42.95
- M-1182 .25%Ac \$39.95

## Function Generator Blox

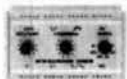

#9600  
**\$24.95**

- Provides sine, tri, squ wave
- From 1Hz to 1MHz
- AM or FM capability

## Solderless Breadblox



550 tie pts including 2 power bus lines  
**#9550**  
**\$7.50**

## IC Test Clips



- 16 pin \$5.95
- 20 pin \$8.25
- 24 pin \$10.75
- 28 pin \$11.75
- 40 pin \$18.50

All are gold plated to assure trouble free contact

## Temperature Probe



**M-110CF**  
**\$29.95**  
Semiconductor type  
Range -58F-302F  
Fits most digital multimeters

## 50MHz Logic Probe



**LP-700**  
**\$23**

**Logic Pulser LP-600 \$23**

## Digital 3 Amp Power Supply



**XP-750**  
**\$175**

- 0-40V @ 1.5A
- 0-2V @ 3A

**XP-650 with Analog Meters \$129.50**

## Regulated P.S. Breadboard



**\$99.95 XK-400**

- Fully regulated
- Short circuit protection
- 3550 test points
- 3 power supplies

• 5V @ 2A, 12V @ .3A, -12V @ .3A

## GF-8016 Function Generator



**with Freq. Counter**  
**\$239**

- Sine, Square, Triangle
- Pulse, Ramp, .2 to 2MHz
- Frequency .1 thru 10MHz

**GF-8015 without Freq. Meter \$179**

## Digital Triple Power Supply



**XP-765**  
**\$239**

- 0-20V @ 1A
- 0-20V @ 1A
- 5V @ 5A

Fully Regulated, Short Circuit Protected with 2 Limit Cont. 3 Separate Supplies

**XP-660 with Analog Meters \$169.50**

## Quad Power Supply



**XP-580**  
**\$59.95**

Fully regulated and short circuit protected

**XP-575 without meters \$44.95**

## Four-Function Frequency Counters



**F-1000 \$259**  
**1.2GH**

**F-100 \$179**  
**120MH**

Frequency, Period, Totalize, Self Check with High-Stabilized Crystal Oven Oscillator, 8 Digit LED Display

**WE WILL NOT BE UNDERSOLD!**



**C & S SALES INC.**  
1245 Rosewood, Deerfield, IL 60015  
Add 5% for Postage (\$10 Max) IL Res., 7% Tax

(800) 292-7711  
(312) 541-0710

**15 Day Money Back Guarantee**  
**2 Year Warranty**

**ASK FOR FREE CATALOG**

## RELY ON JAN FOR 3-WAY HELP:

1. TECHNICALLY CORRECT CRYSTALS TO YOUR SPECS.
2. QUICK TURNAROUND WITH HUGE INVENTORY, PROMPT SERVICE, AND OUR EMERGENCY ORDER PLAN.
3. LOW PRICES. ✓ 173

QUARTZ CRYSTALS FOR  
TWO-WAY — INDUSTRY  
MARINE — AMATEURS  
SCANNERS — CBs  
MICROPROCESSORS



FOR FREE CATALOG,  
CALL OR WRITE:  
**JAN CRYSTALS**  
P.O. BOX 06017  
FORT MYERS, FL 33906  
(813) 936-2397

SINCE  
1965



**TOLL-FREE: 1-800-237-3063**

IN FLORIDA: 1-800-226-XTAL  
FAX ORDERS: 1-813-936-3750

This publication is  
available in microform  
from **University  
Microfilms  
International.**



Please send information about these titles:

\_\_\_\_\_

Name \_\_\_\_\_

Company/Institution \_\_\_\_\_

Address \_\_\_\_\_

City \_\_\_\_\_

State \_\_\_\_\_ Zip \_\_\_\_\_

Phone ( ) \_\_\_\_\_

Call toll-free 800-521-3044. In Michigan,  
Alaska and Hawaii call collect 313-761-4700. Or  
mail inquiry to: University Microfilms International,  
300 North Zeeb Road, Ann Arbor, MI 48106.

useful for DX communications to most eastern, western, and northern areas of the world during daylight hours and into the evening most days, via long skip to 2000 miles per hop or by means of short-skip E<sub>s</sub>, with 1000-mile hops. The period of daylight is still relatively long, but will be noticeably shorter by the end of the month.

Thirty, 40, 80, and 160 meters are all good for nighttime DX, even though the background noise is severe in the evenings. The direction of the openings will rotate from the east to the south and then westward in the morning. If you want to avoid thunderstorm QRN, sporadic E propagation may be helpful in the early evening toward the east and south. Try the early morning hours for communication paths to the west and monitor WWV or WWVH on 2.5 and 5 MHz as beacons.

ham radio

# NUTS & VOLTS MAGAZINE

P.O. Box 1111-H  
PLACENTIA, CA 92670  
714-632-7721



Ham Radio  
Computer Hardware  
Computer Software  
Plans-Kits  
Schematics  
Test Equipment  
CB Gear  
Satellite TV  
Video  
Components  
Antique Electronics  
Cable TV  
Publications  
Repairs-Services  
New Products  
Events Calendar

**IF YOU ARE INTO ELECTRONICS AND SAVING MONEY IS IMPORTANT TO YOU, THEN YOU OWE IT TO YOURSELF TO TRY NUTS & VOLTS MAGAZINE. DISCOVER WHY THOUSANDS OF SMART PEOPLE NATIONWIDE TURN TO NUTS & VOLTS EACH MONTH TO MEET THEIR ELECTRONIC NEEDS. WHETHER YOU'RE BUYING, SELLING, OR JUST TRYING TO LOCATE THOSE UNIQUE OR HARD-TO-FIND ITEMS, FIND OUT HOW NUTS & VOLTS CAN HELP!**

### SUBSCRIBE TODAY!

CHECK  MONEY ORDER  VISA  MC

Name \_\_\_\_\_

Address \_\_\_\_\_

City \_\_\_\_\_

State \_\_\_\_\_ Zip \_\_\_\_\_

Card No. \_\_\_\_\_ Exp. Date \_\_\_\_\_

CALL FOR ADVERTISING INFORMATION  
DISTRIBUTOR INQUIRIES INVITED

### Subscription Rates

U.S. FUNDS REQUIRED

#### 3rd Class Mail - USA

One Year . . . . . \$12.00  
Two Years . . . . . \$21.00  
Lifetime . . . . . \$60.00

#### 1st Class Mail

One Year - USA . . . \$20.00  
Canada & Mexico . . \$22.00

#### Air Mail

Foreign - 1 Year . . . \$55.00

Includes one FREE 40-word  
Classified Ad

*A National Publication For The Buying And Selling Of Electronic Equipment*

# THE 1988 ARRL HANDBOOK

FOR THE RADIO AMATEUR



PUBLISHED BY  
THE AMERICAN RADIO RELAY LEAGUE

## NEW EDITION

The 1988 ARRL Handbook For The Radio Amateur carries on the tradition of the previous editions by presenting 1200 pages of comprehensive information for the radio amateur, engineer, technician and student. Clothbound only. \$21 in the U.S., \$23 in Canada and elsewhere.

THE AMERICAN RADIO RELAY LEAGUE  
225 MAIN STREET  
NEWINGTON, CT 06111

✓ 175

## Microflect's 700 Series Light-Duty Tower

This self-supporting tower series has 136 models to choose from, ranging from 10' to 160' in height, and a variety of pipe mounts, anchor bolts, and accessories to help support your antennas.

Send for your free catalog and price list.

✓ 176

**MICROFLECT**

3575 25th St. SE • P.O. Box 12985  
Salem, OR 97309-0985  
(503) 363-9267 • FAX (503) 363-4613  
TLX 510-599-0107

## Discover CAROLINA WINDOM

80-10 M  
Use transmatch  
132' overall  
Matching XFMR  
Line Isolator  
Vert Radiator  
Coax fed  
Assembled  
\$69.96

High performance  
Proven results  
\$70 Beam?

**RADIO WORKS**

Your Passport To a world Of new ideas And exceptional HF wire antennas

Rugged new balloons Full range of HF, UHF, mobile antennas, dunks, wire, coax, parts, line, accessories.

SEE WHAT WE'RE DOING NOW!

Contact Jim, W4THU - free discount catalog

Send \$1 for catalog by 1st Class mail. Box 6159, Portsmouth, VA 23703 (Dealer inquiries welcome)

804-484-0140

### CAROLINA WINDOM

SEE THE REVIEW IN JUNE '88 WORLD RADIO MAGAZINE. Enthusiastic users say it's the best wire antenna. Outperforms wire antennas previously used. Knock-your-socks-off performance on 80 - 10. A \$70 beam? If you hear one, you'll want one.

Made with pride by The RADIO WORKS in VA/USA

✓ 177

## A better way to design and analyze Long wires, Vee's, and Rhombics.

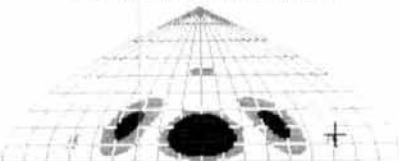

### LONG WIRE PRO

Easy to use, menu driven, select wire length, height, frequency, ground type, and get a color coded sinusoidal projection of your HF antenna. For the IBM PC and compatibles, DOS 2.0 or higher, 256K, color required.

Price \$35.00

EPSILON CO  
Box 715, Trumbull CT, 06611, (203) 261 7694

✓ 178

## BATTERIES

Nickel-Cadmium, Alkaline, Lithium, Etc.  
INDUSTRIAL QUALITY

YOU NEED BATTERIES?  
WE'VE GOT BATTERIES!  
CALL US FOR FREE CATALOG



E.H. YOST & CO.  
EVERETT H. YOST KB9X1  
7344 TETIVA RD  
SAUK CITY, WI 53583  
ASK FOR FREE CATALOG  
(608) 643-3194

✓ 179

# MADISON SHOPPER

CALL FOR ORDERS  
1 (800) 231-3057  
1-713-520-7300 OR 1-713-520-0550  
TEXAS ORDERS CALL COLLECT  
FAX 1-713-771-7759

ALL ITEMS ARE GUARANTEED OR  
SALES PRICE REFUNDED

New Icom IC 781 ..... Trades wanted  
Kenwood TH215A, TH25AT ..... Trade in your old HT



Kenwood TS 140S ..... Call for trade



New Kenwood TM-221A, 45W, mobile ..... Call  
ICOM 28H/TTM ..... 410.00



Icom 761	2300.00
Shure 444D	56.95
HEIL BM10 Boom Mike, wired 8 pin	69.00
HEIL HM5 Desk Mike	59.00
Cushcraft 124-WB (146 MHz)	33.00
Butternut HF6V, 80-10 vertical	125.00
Hustler G7-144	119.95
KLM KT-34A	399.00
NEW KLM 1.2-44LBX	129.00
G5 RV	44.00
Larsen 2-meter on glass	49.95
Anteco 2M, 5/8, Mag Mount, Comp	25.00
Van Gordon G5RLJ	44.00
Valor AB5 mobile	79.00
Thousands of panel meters	3.95 up CALL
Aerovox 1000 pf/500 V feedthrough caps	1.95
Transformer 120 V Pri., 1050 V/1A (Sec. #18 Wire)	50.00
100 mfd/450V Axial Cap	2.20
831SP-PL259 Silverplate (Amphenol)	1.25
82-61 N Male (Amphenol)	3.00
Double Female UHF	1.00
UG176 RG8X	each 30
GE 6146B	14.95
3-500Z	140.00
GE 12BY7A	7.00
6MJ6	12.95
6KD6	12.95
Cetron 572B	88.00
6JB6A	9.95
8950	18.00

### USED EQUIPMENT

All equipment, used, clean, with 90 day warranty and 30 day trial. Six months full trade against new equipment. Sale price refunded if not satisfied.

Call for latest used gear  
(800) 231 3057

GNU PROD  
TE Systems 2m Amp 30-160 watts GaAs fet ..... \$229.00

**POLICIES**  
Minimum order \$10.00. Mastercard, VISA, or C.O.D. All prices FOB Houston, except as noted. Prices subject to change without notice. Items subject to prior sale. Call anytime to check the status of your order. Texas residents add sales tax. All items full factory warranty plus Madison warranty.

Bird and Belden products in stock. Call today.

# MADISON

## Electronics Supply

3621 FANNIN  
HOUSTON, TEXAS 77004



✓ 180

July 1988 **HT** 87

# HAM MART

Ham Radio's guide to help you find your local

## California

**A-TECH ELECTRONICS**  
1033 HOLLYWOOD WAY  
BURBANK, CA 91505  
(818) 845-9203  
New Ham Store and Ready to Make a Deal!

**JUN'S ELECTRONICS**  
3919 SEPULVEDA BLVD.  
CULVER CITY, CA 90230  
213-390-8003  
800-882-1343 Trades  
Habla Espanol

## Colorado

**COLORADO COMM CENTER**  
525 EAST 70th AVE.  
SUITE ONE WEST  
DENVER, CO 80229  
(303) 288-7373  
(800) 227-7373  
Stocking all major lines  
Kenwood Yaesu, Encomm, ICOM

## Connecticut

**HATRY ELECTRONICS**  
500 LEDYARD ST. (SOUTH)  
HARTFORD, CT 06114  
203-527-1881  
Call today. Friendly one-stop shopping  
at prices you can afford.

## Delaware

**AMATEUR & ADVANCED COMMUNICATIONS**  
3208 CONCORD PIKE  
WILMINGTON, DE 19803  
(302) 478-2757  
Delaware's Friendliest Ham Store.

**DELAWARE AMATEUR SUPPLY**  
71 MEADOW ROAD  
NEW CASTLE, DE 19720  
302-328-7728  
800-441-7008  
Icom, Ten-Tec, Microlog, Yaesu,  
Kenwood, Santec, KDK, and more.  
One mile off I-95, no sales tax.

## Florida

**AMATEUR ELECTRONIC SUPPLY**  
1898 DREW STREET  
CLEARWATER, FL 33575  
813-461-4267  
Clearwater Branch  
West Coast's only full service  
Amateur Radio Store.  
Hours M-F 9-5:30, Sat. 9-3

**AMATEUR ELECTRONIC SUPPLY**  
621 COMMONWEALTH AVE.  
ORLANDO, FL 32803  
305-894-3238  
Fla. Wats: 1 (800) 432-9424  
Outside Fla: 1 (800) 327-1917  
Hours M-F 9-5:30, Sat. 9-3

## Georgia

**DOC'S COMMUNICATIONS**  
702 CHICKAMAUGA AVENUE  
ROSSVILLE, GA 30741  
(404) 866-2302 / 861-5610  
ICOM, Yaesu, Kenwood, Bird...  
9AM-5:30PM  
We service what we sell.

## Hawaii

**HONOLULU ELECTRONICS**  
819 KEEAUMOKU STREET  
HONOLULU, HI 96814  
(808) 949-5564  
Kenwood, ICOM, Yaesu, Hy-Gain,  
Cushcraft, AEA, KLM, Tri-Ex Towers,  
Fluke, Belden, Astron, etc.

## Idaho

**ROSS DISTRIBUTING COMPANY**  
78 SOUTH STATE STREET  
P.O. BOX 234  
PRESTON, ID 83263  
(208) 852-0830  
M 9-2; T-F 9-6; S 9-2  
Stock All Major Brands  
Over 7000 Ham Related Items on  
Hand

## Illinois

**ERICKSON COMMUNICATIONS, INC.**  
5456 N. MILWAUKEE AVE.  
CHICAGO, IL 60630  
312-631-5181  
Hours: 9:30-5:30 Mon, Tu, Wed & Fri;  
9:30-8:00 Thurs; 9:00-3:00 Sat.

## Indiana

**THE HAM STATION**  
220 N. FULTON AVE.  
EVANSVILLE, IN 47710  
(800) 523-7731  
(812) 422-0231  
ICOM, Yaesu, Ten-Tec, Cushcraft, Hy-Gain, AEA & others.

## Maryland

**MARYLAND RADIO CENTER**  
8576 LAURELDALE DRIVE  
LAUREL, MD 20707  
301-725-1212  
Kenwood, Ten-Tec, Kantronics. Full  
service dealer.  
M-F 10-7 SAT 9-5

## Massachusetts

**TEL-COM, INC.**  
675 GREAT ROAD, RTE. 119  
LITTLETON, MA 01460  
617-486-3400  
617-486-3040  
The Ham Store of New England  
You Can Rely On.

## Missouri

**MISSOURI RADIO CENTER**  
102 NW BUSINESS PARK LANE  
KANSAS CITY, MO 64150  
(800) 821-7323  
Missouri: (816) 741-8118  
ICOM, Kenwood, Yaesu  
Same day service, low prices.

## Nevada

**AMATEUR ELECTRONIC SUPPLY**  
1072 N. RANCHO DRIVE  
LAS VEGAS, NV 89106  
702-647-3114  
Dale Porray "Squeak," AD7K  
Outside Nev: 1 (800) 634-6227  
Hours M-F 9-5:30, Sat. 9-3

## New Hampshire

**RIVENDELL ELECTRONICS**  
8 LONDONDERRY ROAD  
DERRY, N. H. 03038  
603-434-5371  
Hours M-S 10-5; THURS 10-7  
Closed Sun/Holidays

**Dealers:** YOU SHOULD BE HERE TOO!  
Contact Ham Radio now for complete details.



# Amateur Radio Dealer

## New Jersey

### ABARIS SYSTEMS

276 ORIENTAL PLACE  
LYNDHURST, NJ 07071  
201-939-0015  
Don WB2GPU  
ARRL, Astatic, Astron, B&W, Belden,  
Bencher, Hustler, Kenwood, Larsen, RF  
Concepts, Tonna and much, much more!  
Tues-Fri 10 am-7:30 pm  
Thurs 10 am-9:00 pm  
Sat 10 am-4:00 pm  
VISA/MC

### KJI ELECTRONICS

66 SKYTOP ROAD  
CEDAR GROVE, NJ 07009  
(201) 239-4389  
Gene K2KJL  
Maryann K2RVH  
Distributor of: KLM, Mirage, ICOM, Lar-  
sen, Lunar, Astron. Wholesale - retail.

## New York

### BARRY ELECTRONICS

512 BROADWAY  
NEW YORK, NY 10012  
212-925-7000  
New York City's Largest Full Service  
Ham and Commercial Radio Store.

### VHF COMMUNICATIONS

915 NORTH MAIN STREET  
JAMESTOWN, NY 14701  
716-664-6345  
Call after 7 PM and save! Supplying all  
of your Amateur needs. Featuring ICOM  
"The World System." Western New  
York's finest Amateur dealer.

## Ohio

### AMATEUR ELECTRONIC SUPPLY

28940 EUCLID AVE.  
WICKLIFFE, OH 44092 (Cleveland Area)  
216-585-7388  
Ohio Wats: 1 (800) 362-0290  
Outside Ohio: 1 (800) 321-3594  
Hours M-F 9-5:30, Sat. 9-3

### DEBCO ELECTRONICS, INC.

3931 EDWARDS RD.  
CINCINNATI, OHIO 45209  
(513) 531-4499  
Mon-Sat 10AM-9PM  
Sun 12-6PM  
We buy and sell all types of electronic  
parts.

### UNIVERSAL AMATEUR RADIO, INC.

1280 AIDA DRIVE  
REYNOLDSBURG (COLUMBUS), OH  
43068  
614-866-4267  
Featuring Kenwood, Yaesu, Icom,  
and other fine gear. Factory author-  
ized sales and service. Shortwave  
specialists. Near I-270 and airport.

## Pennsylvania

### HAMTRONICS,

**DIV. OF TREVISE ELECTRONICS**  
4033 BROWNSVILLE ROAD  
TREVISE, PA 19047  
215-357-1400  
Same Location for over 30 Years

## Texas

### MADISON ELECTRONICS SUPPLY

3621 FANNIN  
HOUSTON, TX 77004  
713-520-7300  
Christmas?? Now??

### K COMM dba THE HAM STORE

5707A MOBUD  
SAN ANTONIO, TX 78238  
512-680-6110  
Stocking all major lines. San Antonio's  
Ham Store. Great Prices — Great  
Service. Factory authorized sales and  
service.  
Hours: M-F 10-6; SAT 9-3

### MISSION COMMUNICATIONS

11903 ALEIF CLODINE  
SUITE 500 (CORNER HARWIN &  
KIRKWOOD)  
HOUSTON, TEXAS 77082  
(713) 879-7764  
Now in Southwest Houston—full line  
of equipment. All the essentials and  
extras for the "ham."

## Wisconsin

### AMATEUR ELECTRONIC SUPPLY

4828 W. FOND DU LAC AVE.  
MILWAUKEE, WI 53216  
414-442-4200  
Wisc. Wats: 1 (800) 242-5195  
Outside Wisc: 1 (800) 558-0411  
M-F 9-5:30 Sat 9-3

## Foreign Subscription Agents for Ham Radio Magazine

Ham Radio Austria  
Karin Ueber  
Postfach 2454  
D-7850 Loerrach  
West Germany

Ham Radio Belgium  
Stereohouse  
Brusselssteenvoeg 416  
B-9218 Gent  
Belgium

Ham Radio Holland  
Postbus 413  
NL-7800 Ar Emmen  
Holland

Ham Radio Europe  
Box 2084  
S-194 02 Upplands Vastby  
Sweden

Ham Radio France  
SM Electronic  
20 bis, Ave des Clignons  
F-99000 Auxerre  
France

Ham Radio Germany  
Karin Ueber  
Postfach 2454  
D-7850 Loerrach  
West Germany

Canada  
Send orders to  
Ham Radio Magazine  
Greenville, NH 03048 USA  
Prices in Canadian funds  
1 yr \$41.85, 2 yrs \$74.25  
3 yrs \$99.90

Ham Radio Italy  
Via Manago 15  
I-20134 Milano  
Italy

Ham Radio Japan  
Katsumi Electronic Co. Ltd  
27-5 Ikegami  
4 Chome, Ota-Ku  
Tokyo 146, Japan  
Telephone (03) 753-2405

Ham Radio Switzerland  
Karin Ueber  
Postfach 2454  
D-7850 Loerrach  
West Germany

Ham Radio England  
c/o R S G B  
Lambda House  
Cranborne Road  
Porters Bar  
Herts EN6 3JW  
England

Holland Radio  
143 Greenway  
Greenside, Johannesburg  
Republic of South Africa

## QRV Solar Power for your Station



The \$289.95 Bullet-tested QRV Solar Power Supply keeps your  
repeater on the air round the clock or powers your 100 watt HF  
station 60 hrs a month. Control circuit speeds charge, protects gel  
cells & sealed batteries. Fully assembled, QRV, expandable, portable.  
Add \$10 S. & H. Info \$1 via first class mail. **Antennas West**  
Dept H, Provo, UT 84603-1144 (801) 373-8425

118

## MOVING? KEEP HAM RADIO COMING...

If possible let us know four to six weeks  
before you move and we will make sure  
your HAM RADIO Magazine arrives on  
schedule. Just remove the mailing label  
from this magazine and affix below.  
Then complete your new address (or any  
other corrections) in the space provided  
and we'll take care of the rest.

**ham  
radio**  
Magazine

Allow 4-6 weeks for  
correction.

Greenville, NH 03048

Thanks for helping us to serve you better.

Here's my new address:

Name \_\_\_\_\_  
Address \_\_\_\_\_  
City \_\_\_\_\_ State \_\_\_\_\_ Zip \_\_\_\_\_  
Call \_\_\_\_\_

**AFFIX  
LABEL  
HERE**



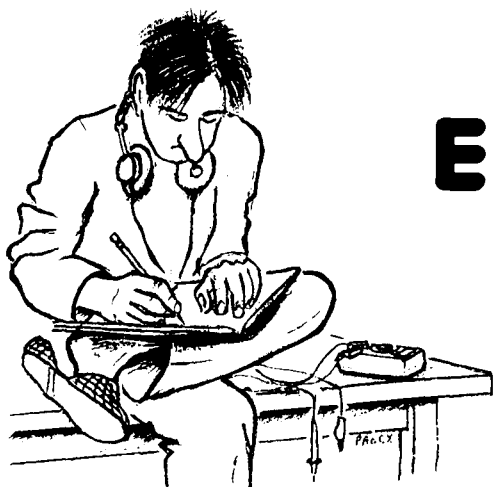

# ELMER'S NOTEBOOK

Tom McMullen, W1SL

## ten-meter skyware

The next upswing in the sunspot cycle is beginning, and the DX I've been hearing on the band lately indicates some interesting years ahead. It's time to get some equipment together, practice some operating techniques, learn to predict conditions, and use the band to garner a wall full of cards and awards.

Ten is a fun band. When it's open, big power and huge antennas don't count as much as operating technique and "being at the right place at the right time!" A few watts can pin an S-meter on the other side of the world, and there can be so many signals that you don't know which one to go after. At times you'll need a high frustration threshold; you'll hear plenty of loud signals that you can't work, but someone who is only an S7 or S8 will give you a "rock solid" QSO.

When the band decides to quit, the biggest beam and the highest power won't lengthen the QSO more than a few moments. That's what makes it so interesting for Novice operators. A 200-watt station and a modest antenna will often have a big signal; a few minutes spent analyzing the locations you're hearing and the paths that signals are using will tip you off as to what's going on.

## antenna choices

As in many other parts of the spectrum, you have several antenna choices for 10 meters: verticals, dipoles, wire arrays, and beams. A vertical antenna, like a 1/4-wave groundplane, is a great all-around antenna for 10, and when conditions are good, makes a good showing. It's also useful for local ragchews when the band is not open; its nondirectional pattern lets you hear everyone within range without adjustment. When the band is open, a 1/4 or 1/2-wave antenna's lack of gain won't be any great hindrance, but your range will be limited for local work.

A dipole performs in much the same way; it does well on an open band, but shows a pronounced directional pattern. If you can rotate the dipole, you can use the directional characteristic to decrease the strength of unwanted signals and still pick up the wanted DX. For local work, rotate a dipole to favor stations you want. Again, lack of gain will limit the range on local contacts.

Wire arrays are not common on higher bands like 10 meters. Because this is a cross-over region, it is just as easy to make a rotary beam antenna like a Yagi as to rig supports for multi-element wire arrays. A relatively small

lot can support a respectable amount of gain from arrays of phased dipoles, loops, etc., but you'll be gambling that the band will open in the direction that the array favors with its radiation pattern.

Ten-meter enthusiasts often choose Yagi antennas; it is surprisingly easy to put together a few pieces of tubing on an inexpensive rotator and push-up mast. Even a modest tripod on a roof will support a small beam. Let's look at a few basics of Yagi antennas and a couple of easy-to-construct examples.

The Yagi antenna was named for its developers — a couple of Japanese scholars named Yagi and Uda. It used to be called a "Yagi-Uda" array, but most people simply call it a "Yagi."

The Yagi array works on the principle that a piece of metal in the strong field of a nearby radiator will re-radiate a considerable amount of the energy it intercepts, and that this energy will differ in phase from that given off by the main radiating element. **Figure 1** shows this action in a two-element array. The main radiating element is the one that is fed energy from the transmitter and feedline. It is referred to as the driven element (DE). The second element intercepts the field radiated by the driven element. If the second ele-

ment is somewhat longer than the driven element, it is called a "reflector" (more on this later); if it is slightly shorter, it is called a "director." A simple two-element beam can be made with a driven element and *either* a reflector or a director; the difference in performance between the two types is minor. For slightly better performance, you can build a three-element Yagi using *both* a reflector and director.

In designing directional antennas of any type, the key to performance is the proper phasing of waves that interact

ing a weak-signal area ("null") off the back of the beam.

Some of the field is radiated up (where it's of no use) and some goes back toward the driven element. After this field passes the driven element it begins to do some good. If the reflector is spaced just right and is just the right length, the field it radiates forward will be "in phase" with the one from the driven element reinforcing it and providing gain in that direction. The name "reflector" comes from the element's apparent mirror reflection of the energy.

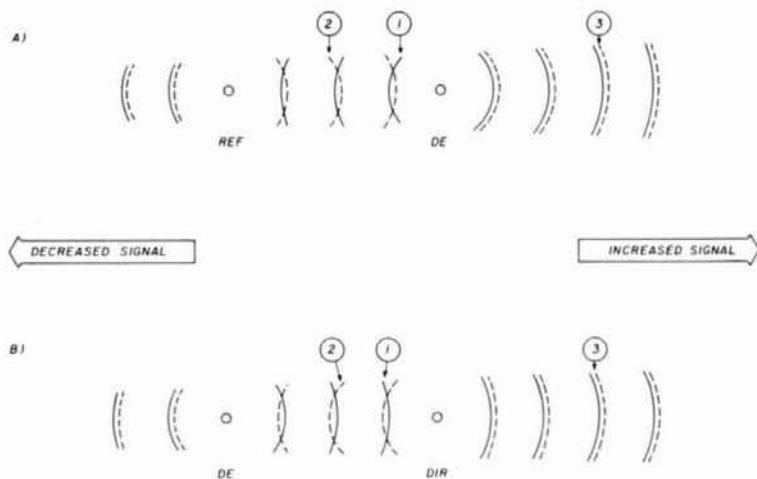

fig. 1. Yagi antennas work by radiated fields canceling or reinforcing each other. In A, the field (1) from the driven element (DE) is canceled to the rear by the field (2) from the reflector. The fields combine to provide a stronger signal (3) toward the front. The same action takes place in (B) where a director is used. The field from the director (2) cancels the driven-element's field (1) to the rear, and combines for a stronger field to the front (3).

with each other. Two sine waves exactly in phase will reinforce each other for a net gain; two that are exactly out of phase (180 degrees out) will cancel each other. The secret of directional antenna construction is to vary the spacing between elements and their length to get the correct phase for the desired result.

In fig. 1A, the second element (a reflector) has had energy induced in it by the field from the driven element and re-radiates that energy as a field of its own (the dotted pattern). Some of this field continues to the back of the array, where it partially cancels the field from the driven element, produc-

A director re-radiates the energy in a way that reinforces the field from the driven element after that field has passed the director (see fig. 1B). This achieves the desired result of providing gain at the "front" of the beam, but doesn't produce as deep a null at the back. The director element is slightly shorter than the driven element. This length, along with the spacing from the driven element, provides the correct phasing so that the waveforms reinforce rather than cancel each other.

### what's critical

The dimensions of the reflector and

### 5-1000 MHZ PREAMPLIFIERS

	NF	G	P(1dB)	\$
WLA21m	3dB	13dB	8dBm	54
WLA22m	4	11	12	58
WLA23m	4	23	12	83
WLA24m	3	20	18	109

### 430/50MHZ CONVERTER

RCX431	.15µV	20dB	99
--------	-------	------	----

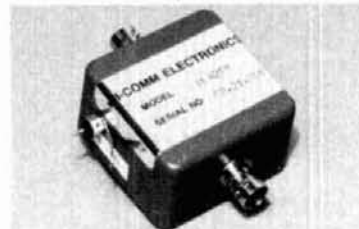

WILAM TECHNOLOGY, Div. of

WI-COMM ELECTRONICS INC.

P.O. Box 5174, MASSENA, N.Y. 13662  
(315) 769-8334

181

### Fox-Tango Crystal Filters

For most Ham Rigs from:  
KENWOOD • YAESU • HEATHKIT  
Also Drake R-4C/7 Line, COLLINS 75S3-B/C  
and ICOM FL44A, FL52A, FL53A clones.

Finest 8-pole Construction  
ALL POPULAR TYPES IN STOCK  
CW • SSB • AM

Ask about our 250 Hz  
CW filter special for  
Heath HW-9 QRP rig.

Phone for Information or to Order.

VISA/MC or COD accepted  
Why risk disappointment? Buy time-  
tested Fox-Tango Filters to be sure!

**FOX-TANGO Corp.**

Box 15944, W. Palm Bch, FL 33416  
Telephone: (305) 683-9587

### COUNTER DIALS



100-turn counter with crank, 0.1 to  
99.9 indicated, 3x3 front plate;  
shaft 2 1/4" L x 1/4" dia with coupler.  
3 lbs sh. #CR-100T-339,  
used.....\$19.95  
#KN-100T-339, as above but with  
knob.....\$16.95

CERAMIC ROLLER INDUC-  
TOR, 14.3 uH; 24 turns #12  
tinned-copper wire in  
3.3" L x 2" dia coil. Shaft  
3/8" L x 1/4" dia. 0/a 3x5x6, 4 lbs  
sh.  
#339-L44-MED,  
used.....\$28 \$24



Prices F.O.B. Lima, O. • VISA, MASTERCARD Accepted.  
Allow for Shipping • Write for 1988 Catalog  
Address Dept. HR • Phone 419/227-6573

FAIR RADIO SALES  
1016 E. EUREKA • Box 1105 • LIMA, OHIO • 45802

director, and their spacing from the driven element are crucial to a Yagi's performance. The lengths are most critical. If they are too short or too long, they won't work, or will produce a beam pattern that has more holes than gain. The spacing between elements is not as critical as is their length — a reflector can be moved several inches (or a considerable fraction of a wavelength) before performance begins to fall off. However, the spacing between elements does have a great effect on the impedance of the driven element. It's possible to vary the spacing and element length to obtain a very deep null at the back of the antenna, but these are not the same dimensions that produce the maximum gain at the front. Most designs are a compromise that favors maximum gain, acceptable front-to-back ratio, and a driven element impedance that you can live with.

**Table 1** shows dimensions you can use to put together two- or three-element beams and the approximate gain you can expect. The spacing between elements is not too critical; it can vary a couple of inches either way to take advantage of boom length. The element lengths shown should work very well, but are probably not optimum because the diameter-to-length ratio of the tubing used has some effect on the resonant frequency. If the antenna has a persistent high VSWR at your operating frequency, try changing the driven element length an inch or so. A wide range of impedance matching can be handled by the gamma match described later.

### getting it all together

There are numerous advertisements in *ham radio* for antennas that come ready to assemble and put up, and you can hardly go wrong by this route. Some are single-band antennas, and many are versatile multiband systems that allow you to switch to a lower band when the highest frequency one folds up for the day.

If you're an incurable experimenter, it's easy to grab a few pieces of aluminum, some screws and bolts, and

**Table 1. Element dimensions and spacing for two- and three-element beams. Two two-element types are shown along with two sizes of three-element beams.**

Reflector Length (Feet)	Spacing (Feet)	Driven Element Length (Feet)	Spacing (Feet)	Director Length (Feet)	Approximate Gain (dBd)*
17.6	5.21	16.8	—	—	4.5
—	—	16.8	3.47	16.1	4.5
17.6	3.47	16.8	5.21	16.1	7.8
17.6	6.95	16.4	6.95	15.7	8.5

\*dBd = gain referenced to 1/2-wave dipole.

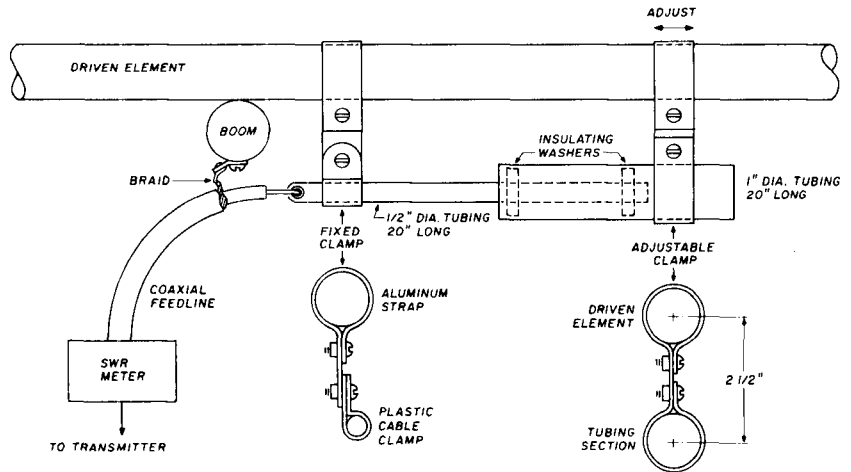

**fig. 2. Gamma match will match coaxial-cable impedance (50 or 75-ohms) to the driven element of a Yagi antenna. The fixed clamp is not moved. The adjustable clamp is moved along the driven element, and the tubing section is moved within the clamp to provide lowest VSWR. Plastic or Teflon® washers inside the larger tubing keep the smaller tubing centered. The coaxial cable braid can be fastened to the boom with a sheet-metal screw, or a coaxial fitting and bracket can be placed there to make a more "professional" installation.**

put together a simple signal snagger that satisfies the urge to try something new. Many hardware stores and do-it-yourself centers have aluminum angle stock and tubing that can be pieced together to make a respectable two- or three-element beam for 10 meters. Pieces of angle stock placed back-to-back form a "T" section boom that make it a cinch to fasten elements. Pieces of tubing that telescope into each other make excellent elements. Use a hacksaw to make slits in the ends of the larger pieces, slide the smaller ones inside a short distance, and use a stainless hose clamp to squeeze the larger one to grip the smaller. Sliding the outer sections in and out (especially on the driven element) allows some adjustment for proper VSWR. Don't worry about in-

ulating the elements from the boom — it's not necessary.

You can often pick up damaged antennas of various types for next to nothing and salvage the parts to build your beam. Although damaged TV antenna elements are not large enough for 10-meter or lower bands, element-mounting hardware, boom material, and brackets to fasten the boom to the rotator mast are worth harboring for future need.

Another source of good parts is cast-off or surplus antennas for the 27-MHz Citizen's Band. Simply shorten the elements to the correct length and they'll work fine on 28 MHz. A word of advice — don't go for the fancy types with strange shapes or gadgets hanging from the elements; they add nothing but wind resistance. Fol-



**\$369.95\***  
**20 MHz DUAL TRACE**  
 Features component testing circuit for resistors, capacitors, digital circuits and diodes—TV sync filter—high sensitivity—Z axis—XY mode—built-in calibrator—5X horizontal magnifier

**UNSURPASSED QUALITY • SUITABLE FOR HOBBY, SERVICE & PRODUCTION**

MODEL	BAND WIDTH	# TRACES	CRT SIZE	VERTICAL SENSITIVITY	MAXIMUM TRIG FREQ	USEABLE MAXIMUM BANDWIDTH
2200	20 MHz	(2)	8x10CM	5 mV per div	35 MHz	30 MHz
3500	35 MHz	(2)	8x10CM	1 mV per div	50 MHz	60 MHz

All include high quality 1:1, 10:1 hook on probes, instruction/service manual with schematic and component layout, 1 year warranty.

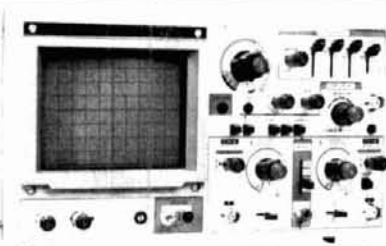

**\$499.95 \***  
**35 MHz DUAL TRACE**  
 wide frequency bandwidth—optimal sensitivity—delayed triggering sweep—hold off—ALT trigger—single sweep TV sync 5X magnification—XY or XYZ operation—HF, LF noise reduction



**\$2495.00\*** **THE COMMUNICATIONS SERVICE MONITOR THAT WORKS HARDER FOR LESS.**

Introducing COM-3... the new service monitor designed by service technicians for service technicians. It works harder for less... giving you advanced testing capabilities at a very affordable price.  
**FEATURES •** Direct entry keyboard with programmable memory • Audio & transmitter frequency counter • LED bar graph frequency/error deviation display • 0.1-10,000  $\mu$ V output levels • High receive sensitivity, less than 5  $\mu$ V • 100 KHz to 999.995 MHz Continuous frequency coverage • Transmit protection, up to 100 watts • CTS tone encoder, 1 KHz and external modulation

\*Add an additional \$10.00 for each unit for shipping.

### MINI-100 COUNTER



**\$119.95** CHARGER, NICAD BATTERIES, AC ADAPTER INCLUDED

### CT-70 7 DIGIT 525 MHz



**\$139.95** WIRED, INCLUDES AC ADAPTER

### CT-90 9 DIGIT 600 MHz



**\$169.95** WIRED INCLUDES AC ADAPTER

### CT-50 8 DIGIT 600 MHz



**\$189.95** WIRED INCLUDES AC ADAPTER

### CT-125 9 DIGIT 1.2 GHz



**\$189.95** WIRED INCLUDES AC ADAPTER

MODEL	FREQ RANGE	SENSITIVITY	ACCURACY	DIGITS	RESOLUTION	PRICE
MINI-100	1-500 MHz	Less than 250mv	1 PPM	7	100 Hz, 1 KHz	119.95
CT-70	20 Hz-550 MHz	50mv to 150 MHz	1 PPM	7	1 Hz, 10 Hz, 100 Hz	139.95
CT-90	10 Hz-600 MHz	10mv to 150 MHz 150mv to 600 MHz	1 PPM	9	0.1 Hz, 1 Hz, 10 Hz	169.95
CT-50	5 Hz-600 MHz	LESS THAN 25 mv	1 PPM	8	1 Hz, 10 Hz	189.95
CT-125	10 Hz-1.25 GHz	25mv @ 50 MHz 15mv @ 500 MHz 100 mv @ 800 MHz	1 PPM	9	0.1 Hz, 1 Hz, 10 Hz	189.95
CT-90 WITH OV-1 OPTION	10 Hz-600 MHz	10mv to 150 MHz 150mv to 600 MHz	0.1 PPM	9	0.1 Hz, 1 Hz, 10 Hz	229.90

## RAMSEY FREQUENCY COUNTERS

Ramsey Electronics has been manufacturing electronic test gear for over 10 years and is recognized for lab quality products at breakthrough prices. Our frequency counters have features and capabilities of counters costing twice as much.



**RAMSEY D-4100 COMPACT DIGITAL MULTITESTER**  
**\$2495**

test leads and battery included

Compact sized reliability and accuracy. This LCD digital multimeter easily fits in your pocket, you can take it anywhere. It features full overload protection • 3 1/2 digit LCD readout • recessed input jacks • safety probes • diode check function • 2000 hours battery life



**RAMSEY D-5100 HANDHELD DIGITAL AUTORANGING METER**  
**\$49.95**

Includes Probes 1 Year Warranty

Provides distinctive audible chirp after contact has been made and meter reading has stabilized. Has TOUCH-HOLD feature to allow readings to be logged or referred to before making the next reading. Up to 10 AMP current capability and a continuity function which beeps on zero Ohms



**\$4995**  
 wired includes AC adapter  
 PR-2 kit \$39.95

**PR-2 COUNTER PREAMP**  
 The PR-2 is ideal for measuring weak signals from 10 to 1,000 MHz • flat 25 db gain • BNC connectors • great for sniffing RF • ideal receiver / TV preamp



**\$6995**  
 wired  
 PS-2 kit \$49.95

**PS-2 AUDIO MULTIPLIER**  
 The PS-2 is handy for high resolution audio resolution measurements, multiplies up in frequency • great for PL tone measurements • multiplies by 10 or 100 • 0.01 Hz resolution & built-in signal preamp/conditioner



**\$8995**  
 wired includes AC adapter

**PS-10B 1 GHz PRESCALER**  
 Extends the range of your present counter to 1 GHz • 2 stage preamp • divide by 1000 circuitry • super sensitive (50 mV typical) • BNC connectors • 1 GHz in, 1 MHz out • drives any counter

## MINI KITS—EASY TO ASSEMBLE—FUN TO USE—FOR BEGINNERS, STUDENTS AND PROS

**tone decoder**  
 Complete tone decoder on a single PC board. Features: 400-5000 Hz adjustable range via 20 turn pot, auto regulation, 56 dB, useful for touch tone bus detection, FSK etc. Can also be used as a stable tone encoder. Runs on 5 to 12 volts.  
 Complete kit \$5.95

**40 WATT 2 mtr PWR AMP**  
 Single Class C power amp features 8 times power gain 1 W in for 80 W 2 W in for 15 W 5 W in for 40 W out. Max output of 50 W, incredible value, complete with all parts, less case and 1 Relay.  
 PR-1 40 W per amp kit \$22.95  
 TR-1 80 W per amp kit \$6.95

**voice activated switch**  
 Voice activated switch kit provides switched output with current capability up to 100 mA. Can drive relays, lights, LEDs or even a tape recorder motor. Runs on 9VDC.  
 VS-1 kit \$6.95

**color organ**  
 See music come alive! 3 different lights flicker with music. One light each for high mid range and lows. Each individually adjustable and drives up to 300 W runs on 120VAC.  
 ML-1 kit \$8.95

**video modulator**  
 Converts any TV to video monitor. Super stable, tunable over ch 4-6. Runs on 5-12V accepts S-10 video signal. Best used on the market. Complete kit, VD-1 \$7.95

**LED Blinky Kit**  
 Alternately flashes 2 pulse LEDs. Use for name badges, buttons, warning panel lights. Runs on 3 to 15 volts.  
 BL-1 kit \$2.95

**universal timer**  
 Provides the basic parts and PC board required to provide a source of precision timing and pulse generation. Uses 555 timer IC and includes a range of parts for most timing needs.  
 UT-1 kit \$5.95

**whisper light**  
 An interesting & small mike picks up sounds and converts them to light. The louder the sound, the brighter the light. Includes three coin cells up to 300 W runs on 120VAC.  
 WL-1 kit \$6.95

**FM wireless Mike**  
 Transmits up to 300 to any FM broadcast radio uses any type of mike. Runs on 3 to 9V. Type FM-2 has added sensitive mike preamp stage.  
 FM-1 kit \$3.95  
 FM-2 kit \$4.95

**super sleuth**  
 A super sensitive amplifier which will pick up a pin drop at 15 feet. Great for monitoring baby's room or as general purpose amplifier. Full 2W rms output, runs on 6 to 15 volts, uses 8-45 ohm speaker.  
 SN-1 kit \$5.95

**siren**  
 Produces upward and downward wail. 5 W peak audio output, runs on 3 to 15 volts, uses 3-45 ohm speaker.  
 Complete kit SM-3 \$2.95

**60 Hz time base**  
 Runs on 5 VDC. Low current (25mA) 1 min. month accuracy.  
 TB-6 kit \$5.50  
 TB-6 Assy \$9.95

**FM receiver**  
 For built-in applications or hobby experimentation. Full featured super-heterodyne receiver. microvolt sensitivity 30 / MHz IF integrated. Circuit defect for 50 mV audio amplifier. 90 external power source operation on standard FM broadcast band as well as large portions on each side. compact 6" square. No bug detection or reception.  
 FR-1 kit \$14.95  
 FR-1 kit \$14.95

**FM mini Mike**  
 A super high performance FM wireless mike kit. Transmits a stable signal up to 300 yards with exceptional audio quality by means of its built-in electret mike. Kit includes case, mike, kit off switch, antenna, battery and super instructions. This is the finest available.  
 FM-3 kit \$14.95  
 FM-3 Wired and tested \$19.95

### ACCESSORIES FOR RAMSEY COUNTERS

- Telescopic whip antenna—BNC plug ..... \$ 8.95
- High impedance probe, light loading ..... 16.95
- Low pass probe, audio use ..... 16.95
- Direct probe, general purpose use ..... 13.95
- Tilt bail, for CT-70, 90, 125 ..... 3.95

### PHONE ORDERS CALL

**716-586-3950**

TELEX 466735 RAMSEY CI

FAX 716-586-4754



TERMS: • satisfaction guaranteed • examine for 10 days, if not pleased, return in original form for refund • add 6% for shipping and insurance to a maximum of \$10.00 • foreign add 15% for surface mail • COD add \$2.50 (COD in USA only) • orders under \$15.00 add \$1.50 • NY residents add 7% sales tax • 90 day parts warranty on all kits • 1 year parts & labor warranty on all wired units.

RAMSEY ELECTRONICS, INC.  
 2575 Baird Rd.  
 Penfield, N.Y. 14526





Your SINGLE  
SOURCE for  
**MOBILE  
ANTENNAS!**

NEW...2 meter squared SSB mobile \$50<sup>00</sup>

\*Bug Catchers\*... still the best HF mobile antenna 250 watt & 1kw sizes 80-10meters (we pay shipping on above items)

Call for other antennas available—both commercial and amateur

**MISSION COMMUNICATIONS**

11903 Alief Clodine Rd #500  
Houston, Texas 77082  
713-879-7764  
telex 166872 MCON UT  
(MC/VISA/COD/Amex)

✓ 184

**Factory-less,  
jumper-less,  
ROM-less programming.**



With the new S-COM 5K Repeater Controller, you'll be able to configure your repeater remotely — using DTMF commands. Only the 5K offers this capability for just \$189, wired and tested.

**S-COM Industries**  
P.O. Box 8921  
Fort Collins, CO 80525  
(303) 493-8316

✓ 185

NEW!

The classic "Antenna Bible"  
now in a thoroughly-revised, much-enlarged  
edition

**ANTENNAS**  
2nd edition

by John Kraus, W8JK  
Ohio State University

Covers both theory and its applications to practical systems. Over 1000 illustrations and nearly 600 worked examples and problems. Over 100 new topics. Complete with design formulas, tables and references

917 pages, hardcover. \$51.95

Add \$2.50 per book for shipping and handling U.S., \$5.00 elsewhere.

**CYGNUS-QUASAR BOOKS**  
P.O. Box 85, Powell, Ohio 43065  
Tel. 614-548-7895

✓ 186

**TOWERS** by ALUMA <sup>HR-2</sup>

**HIGHEST QUALITY ALUMINUM**

- TELESCOPING (CRANK-UP)
- GUYED (STACK-UP)
- TILT-OVER MODELS

Easy to install. Low Prices. Crank-ups to 100 feet.

**EXCELLENT FOR AMATEUR COMMUNICATIONS**

Over 36 types aluminum towers made — specials designed and made — Write for details.

T-140 40' Crank-Up Tower

T-40H 40' Heavy Duty Ham Tower Crank-Up

Mobile Trailer Type

Mobile Truck Type

**SPECIAL Four Section 50 Ft. Van Mounted Crank-up Aluma Tower**

Fixed Base

**ALUMA TOWER CO.**  
BOX 2806HR  
VERO BEACH, FL 32961-2806  
(305) 567-3423 803405 MAIN-VERO

✓ 187

**SPECIALIZED COMMUNICATIONS**  
FOR TODAY'S RADIO AMATEUR!



Our 20th Year!

Since 1967, covering all modes of Amateur Radio "specialty" communications; Fast Scan TV, SSTV, FAX, Packet Radio, Computers, RTTY, AMTOR, Satellites, TVRO, Microwave, Lasers and more! 10 issues per year. Back issues available, SASE brings TRS80C, C64, IBM software catalog. U.S. subscribers \$20/year. Foreign slightly higher. Add \$2.00 for Index Issue.

**SPEC-COM Communications & Publishing Group**  
P.O. Box H  
Lowden, Iowa  
52255-0408



5% Added

low the dimensions given here or in any good antenna manual and you'll get performance and satisfaction.

There are larger CB antennas made on the "quad" principle, and some of these could perform quite well. Quad antenna design is almost a science unto itself and there's not enough space to cover it here. If you get the urge to try one of these, remember these points: frequency of operation is determined by the total length of the wire around the outside of the supports, not the tip-to-tip length of the crossed supports; and, the feedpoint determines whether the polarization is vertical or horizontal. If the feedline is attached at the bottom, the quad will radiate as if it were a horizontal antenna; if fed at the side, it will act like a vertical antenna.

**matching**

The feed impedance of the driven element in a Yagi antenna can vary from a few ohms up to 100 or so, depending upon element lengths and spacing. A versatile matching device for use with coaxial cable is shown in fig. 2. Called a gamma match, it works by providing a variable tap point to the driven element, a variable inductance (the adjustable length of tubing), and a variable capacitance (the smaller tubing that slides inside the larger). To adjust the match for your antenna move the tap point along the driven element an inch or so at a time, then slide the outer section of tubing toward or away from the boom an inch or two and check the VSWR to note whether or not it improved. After making all your adjustments, weatherproof the assembly with clear Krylon.

I talked about power and SWR meters and their use in the January and February 1988 issues of *ham radio*; here's a chance to try them. Get out your hacksaw, drill, screwdriver, and some pieces of aluminum. You'll have some fun building something and using it afterward. (I think I'll follow my own advice and then submit the results as a "Weekender" project! Watch to see how I make out.)

ham radio



## THE MOST AFFORDABLE REPEATER

ALSO HAS THE MOST IMPRESSIVE PERFORMANCE FEATURES  
(AND GIVES THEM TO YOU AS STANDARD EQUIPMENT!)

**KIT, ONLY \$675**  
**WIRED \$975**  
**VHF OR UHF**



### FEATURES:

- **SENSITIVITY SECOND TO NONE!** GaAsFET front end on vhf models gives 12dB SINAD of 0.12uV (vhf), 0.15uV (220). UHF model 0.25uV std, 0.1uV with optional helical resonator preamp.
- **SELECTIVITY THAT CAN'T BE BEAT!** Both 8-pole xtal filter & ceramic filter for > 100dB at only ±12kHz. Helical resonator front end to combat desense & intermod.
- **CLEAN, STABLE TRANSMITTER**, up to 18W output standard; 50W with accessory power amplifier.
- **FCC TYPE ACCEPTED** for commercial high band and uhf.
- **Courtesy beep**, field-programmable CWID, flutter-proof squelch, automatic frequency control to compensate for off-frequency transmitters (all standard features).
- **Full range of options** available, such as autopatch, phone line or radio remote control, sub-audible tones, duplexers.

## HIGH PERFORMANCE TRANSMITTERS & RECEIVERS FOR REPEATERS AUDIO & DIGITAL LINKS, TELEMTRY, ETC.

### FM EXCITERS:

- Kits \$99, w/t \$179. 2W continuous duty. TCXO & xtal oven options available.
- **TA51 for 10M, 6M, 2M, 150-174, 220 MHz.**
- **TA451 for uhf.**

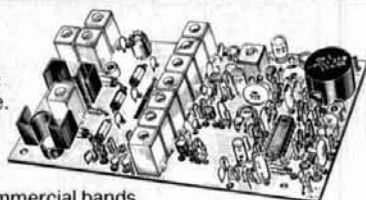

FCC type accepted for commercial bands.

- Call for latest information on 900 MHz transmitters.
- **VHF & UHF AMPLIFIERS.** For FM, SSB, ATV. Output from 10 to 50 Watts. Several models, kits starting at \$79.

- **R144/R220 FM RECEIVERS** for 2M, 150-174, or 220 MHz. GaAs FET front end, 0.12uV sensitivity! Both crystal & ceramic filters plus helical resonator front end for exceptional selectivity: > 100dB at ±12kHz (best available anywhere)! Flutter-proof squelch. AFC tracks drifting transmitters. Kit \$149, w/t \$229.

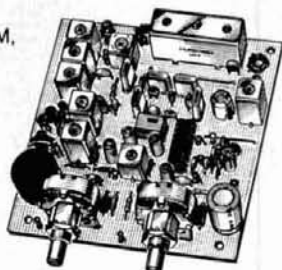

- **R451 UHF FM RCVR.** Similar to above. Tuned line front end, 0.25uV sens. (0.1uV with optional hel. res. preamp). Kit \$149, w/t \$229.
- **R901 FM RCVR FOR 900 MHZ.** Triple-conversion, GaAs FET front end, 0.2uV sens. Kit \$169, w/t \$259.
- **R76 ECONOMY VHF FM RCVR** for 10M, 6M, 2M, 220. Without hel res or afc. Kits only \$129.
- **Weather satellite & AM Aircraft receivers also avail.**

FCC TYPE-ACCEPTED TRANSMITTERS & RECEIVERS AVAILABLE FOR HIGH-BAND AND UHF. CALL FOR DETAILS.

- **Send \$1 for 36 page catalog by return mail.** (Send \$2.00 or 4 IRC's for overseas mailing)
- **Order by phone or mail • Min \$3 S & H per order**
- **Use Visa, Mastercard, Check, or UPS COD.**

## GaAs FET PREAMPS at a fraction of the cost of comparable units!

### LNG -(\*)

#### GaAs FET PREAMP

**ONLY \$59!**  
Wired/tested



### FEATURES:

- **Very Low Noise:** 0.7dB VHF, 0.8dB UHF
- **High Gain:** 13-20dB, depending on frequency
- **Wide Dynamic Range:** to resist overload
- **Stable:** new-type dual-gate GaAs FET

\* Specify tuning range desired: 26-30, 46-56, 137-150, 150-172, 210-230, 400-470, or 800-960 MHz.

### LNW -(\*)

#### MINIATURE GaAs FET PREAMP



**ONLY \$24/kit,**  
**\$39 Wired/tested**

GaAs FET Preamp similar to LNG, except designed for **low cost & small size.** Only 5/8"W x 1-5/8"L x 3/4"H. Easily mounts in many radios.

\* Specify tuning range desired: 25-35, 35-55, 55-90, 90-120, 120-150, 150-200, 200-270, or 400-500 MHz.

### LNS-(\*)

#### IN-LINE PREAMP

**ONLY \$79/kit,**  
**\$99 Wired/tested**



GaAs FET Preamp with features similar to LNG series, except **automatically switches out of line during transmit.** Use with base or mobile transceivers up to 25W.

\* Specify tuning range desired: 120-175, 200-240, or 400-500 MHz.

## HELICAL RESONATOR PREAMPS

Low-noise preamps with helical resonators **reduce intermod & cross-band** interference in critical applications.

**MODEL HRA-(\*)**, \$49 vhf, \$84 uhf.

\* Specify tuning range desired: 143-150, 150-158, 158-162, 162-174, 213-233, 420-450, 450-465, or 465-475 MHz.

## NEW HIGH-SPEED DIGITAL RF LINKS

You've waited a long time for a simple, reliable, **low-cost 9600 baud PACKET NETWORKING** system. Now you've got it! Our new MO-96 MODEM and direct FSK Transmitters and Receivers for 220 or 440 MHz interface directly with most TNC's. Fast diode switched PA's output 15 or 50W. **Call for complete info on the right system for your application.**

## ACCESSORIES

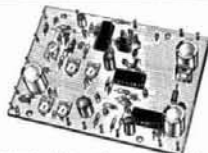

- **COR-3 Kit.** Control ckts and audio mixers needed to make a repeater. Tail & time-out timers, local spkr ampl, courtesy beep ..... \$49
- **CWID Kit.** Field programmable, timers, the works ..... \$59
- **TD-2 DTMF DECODER/CONTROLLER Kit.** Full 16 digits, switches 5 functions, toll call restrictor, programmable, much more. Great for selective calling too! ..... \$79
- **AP-3 AUTOPATCH Kit.** Use with above for repeater autopatch. Reverse patch and phone line remote control std. .... \$79
- **AP-2 SIMPLEX AUTOPATCH TIMING BOARD Kit.** Use with above for simplex autopatch ..... \$39
- **MO-202 FSK DATA MODULATOR Kit.** Run up to 1200 baud digital signals through any fm transmitter with full handshakes. Radio link computers, telemetry gear, etc. .... \$39
- **DE-202 FSK DATA DEMODULATOR Kit** for rcvr end of link ..... \$39

## RECEIVING CONVERTERS



	Antenna Input Range	Receiver Output
	28-32	144-148
	50-52	28-30
	50-54	144-148
VHF MODELS	136-138	28-30
	144-146	28-30
Kit with Case	\$59	146-148
Kit less Case	\$39	220-222
Wired w/case	\$89	222-224
UHF MODELS	432-434	28-30
Kit with Case	\$69	432-436
Kit less Case	\$49	432-436
Wired w/case	\$99	902-928
		902-922
		430-450

See catalog for full line of 2w transmitting converters for vhf & uhf. Kits only \$79. Linear Amplifiers avail. up to 50 w.

Our 25th Anniversary

**hamtronics, inc.**  
65-H MOUL ROAD • HILTON NY 14468-9535  
Phone: 716-392-9430 Hamtronics® is a registered trademark

# flea market

**RATES** Noncommercial ads 10¢ per word; commercial ads 60¢ per word **both payable in advance.** No cash discounts or agency commissions allowed.

**HAMFESTS** Sponsored by non-profit organizations receive one free Flea Market ad (subject to our editing) on a space available basis only. Repeat insertions of hamfest ads pay the non-commercial rate.

**COPY** No special layout or arrangements available. Material should be typewritten or clearly printed (not all capitals) and must include full name and address. We reserve the right to reject unsuitable copy. **Ham Radio** cannot check each advertiser and thus cannot be held responsible for claims made. Liability for correctness of material limited to corrected ad in next available issue.

**DEADLINE** 15th of second preceding month.

**SEND MATERIAL TO:** Flea Market, Ham Radio, Greenville, N. H. 03048.

**TEST EQUIPMENT WANTED.** Don't wait — we'll pay cash for LATE MODEL HP, Tek, etc. Call Glenn, N7EPK, at SKAGITRONICS CO. (800) 356-TRON.

**MOTOROLA T45 RTA** 860 MHz Trunking \$450. Several H23, H33, HT 220's VHF low split \$100 each. Scott (801) 224-3783.

**MACINTOSH SATELLITE** Tracking and Propagation Software. MacTrak™ displays graphic maps (rectangular, polar, great circle), views from space, schedules, windows. Also tracks Sun and Moon. Compatible with KLM/MIRAGE rotor interface. Shows gray line, sunrise/sunset, bearing/distance, mUF vs time, areas of world "open". SASE for info or \$49.95 from R. Stegemeyer, PO Box 1550, Port Orchard, WA 98366.

**TEKTRONIX 547** Oscilloscope, 50 MHz BP \$135, Tek-1A1 \$60, Tek-1A4 \$120, Tek-1L30 Spectrum Analyzer, 0.9-10.5 GHz \$350, Hewlett-Packard 606A Signal Generator, 0.05-65 MHz, \$100K, HP-8708A Synchronizer \$150, HP-3300A Function Generator \$95, HP-686C Sweep Generator, 8-12 GHz \$95, HP-9865A Cassette Memory \$95, Lambda LB-701-FMV Variable Regulated Power Supply, 300 amps, new \$295, A. Emerald, 8956 Swallow, Fountain Valley, CA 92708. (714) 962-5940.

**HALL ELECTRONICS** buys radio broadcast equipment for cash! Jon Hall, WB4MMV, PO Box 7732, Charlottesville, VA 22906. (804) 973-8697.

**WANTED** Old and Unique bugs especially looking for Dow Key and Vibroplex Zephyr models. Smiley White, WB4EDB, POB 5150, Fredericksburg, VA 22403. (703) 373-0996.

**MININEC** antenna analysis for IBM-PC. New enhanced version \$10. With plotting \$35. With antenna and plot libraries \$50. See May QST p. 70. K6STI, 507-1/2 Taylor, Vista, CA 92084.

**CUSTOM EMBROIDERED EMBLEMS,** & Enameled Pins, your design, excellent quality, low prices, free booklet. A.T. PATCH CO, Box 682 Dept 19, Littleton, NH 03561. (603) 444-3423.

**BM-PC RTTY/CW.** New CompRtty II is the complete RTTY/CW program for IBM-PC's and compatibles. Now with larger buffers, better support for packet units, pictures, much more. Virtually any speed ASCII, BAUDOT, CW. Text entry via built-in screen editor! Adjustable split screen display. Instant mode/speed change. Hardcopy, diskcopy, break-in buffer, select calling, text file transfer, customizable full screen logging. 24 programma-

ble 1000 character messages. Ideal for MARS and traffic handling. Requires 256K PC or AT compatible, serial port, RS-232C T.U. \$65. Send call letters (including MARS) with order. David A. Rice, KC2HO, 25 Village View Bluff, Ballston Lake, NY 12019.

**SELL:** AEA PK64A/HFM packet \$175. ICOM IC-271A 25W, 2m Xcvr \$525. Hallicrafters SX115 Receiver \$250. Spectrum Communications 450/2m repeater circuit boards TX/RX \$50 each and RF power amplifiers \$35 each. VHF Engineering ID #25 and COR \$10. Radio Shack Color 3 Computer with RS-232C interface \$150. ICOM 251A 2m, 10W multimode Xcvr \$300. Floyd Chowning, K5LA, 5637 Prince Edward Avenue, El Paso, Texas 79924. (915) 751-6204.

**HAMLOG COMPUTER PROGRAMS.** 17 modules auto-logs, sorts 7-band WAS/DXCC. Full features. Apple \$19.95, IBM or CP/M \$24.95. KA1AWH, POB 2015, Feabody, MA 01960.

**DIGITAL AUTOMATIC DISPLAYS.** All Radios. GRAND SYSTEMS, POB 2171, Blaine, Washington 98230.

**CHASSIS & CABINETS KITS.** SASE. K31WK, 5120 Harmony Grove Rd, Dover, PA 17315.

**GIANT POWERSTAT** Variable Transformer. 240V input, 28 Amps. 0-280V output, 7.8KVA \$145. plus ship. Joseph Cohen, 200 Woodside, Winthrop, MA 02152 (617) 846-6312.

**COMMODORE/AMIGA CUSTOM CHIPS FOR C64/128** Computer/peripherals at low prices. 24 hour delivery. #6510 - \$9.95, #6526 - \$9.95, #6567 - \$14.75, #6581 - \$12.85, PLA - \$12.50, 901 ROMS at \$10.95 each and many others, including Amiga... "The COMMODORE DIAGNOSTICIAN". A complete diagnostic reference chart for fixing Commodore computers, etc. An absolute must for those who want to fix their own computers and save money and downtime. \$6.95 plus \$1.00 postage... COMMODORE REPAIR. We are the largest/oldest Authorized Service Center in the country. (eg. C64 - \$39.95). (We ship worldwide). Heavy duty Power Supply for C64 - \$27.95 plus UPS. Send for complete chips/parts catalog... VISA/MC... Kasara, Inc, 36 Murray Hill Drive, Spring Valley, NY 10977. 1-800-642-7634, 800-248-2983 (outside NY) or 914-356-3131.

**WANT COLLINS KWM 2/A** and accessories. Also looking for other Collins gear. Call after 4 PM EDST (201) 728-7938.

**ANTENNA TUNER WANTED.** Heath Model SA-2500 only, non-working acceptable. W2BL, RD 2, Box 72, Boonton, NJ 07005.

**WANTED RECEIVERS.** (ICOM: IC-745, IC-R7000, Bearcat DX-1000). Scopes and Monitors: Heath: EVV-3 Imp scope, SB-620 spect. analyzer, SB-610 monitor. Tektronix: 502A, 544, 546, 547, 548, 556; a relatively new 5 MHz to 10 MHz scope, single channel, do not need time delay; a 500 MHz to 1 GHz scope without the use of sampling. Scope Plug In's: Tektronix. I can use most of the 1 ser. and letter series plug in's, including the spectrum analyzer plug in's, (IL5, IL10, IL20, IL30, IL40) for the 530-, 540-, 550- series main frame. I have a special need for the Type "T" time base plug in. POWER SUPPLIES: Tektronix, type 127, 132, 133. SIGNAL GENERATOR: Hewlett Packard: 606B or 606A, 608F, 608C, 608E, 612A or 610B, 614A, 616B or 616A. FUNCTION & SWEEP GEN: Heath: UE-81A, IG-1271, IG-1273, IG-52, IG-1275. NOISE GEN: For the 5 Hz to 2 GHz range. STEREO AMPS: Heath: AA-2004, AA-15, AA-1506, AA-1640, AA-2005A, AA-29, AA-1515, AA-1219. POWER SUPPLIES: Heath: IP-17 or IPW-17 or IP17A, IP-2700, IP-2701, IP-28, IP-2718, IP-15, IP-18, IP-2715, IP-12. FILTERS: Receiver audio output filters—tunable; woodpecker noise blanker. PREAMPS: Receiver RF preamps—tunable. WATT METER: B&W 334A dummy load watt meter. VIDEO: Video cameras as used in closed circuit TV. CAR RADIO MOUNT: IIX Equipment Ltd. Mobile radio mount MM1007 or MM10013. ANTENNAS: Wide band scanning antennas for 10 kHz to 2 GHz. Write to: J.L. Courtney, PO Box 391, Canal Winchester, OH 43110.

**CALL SIGN BADGES:** Custom license plate holders. Personal, distinctive. Club discounts. SASE. WB3GND, Box 750, Clinton, MD 20735. (301) 248-7302.

**FOR SALE:** Kenwood TS-820S, digital display. Excellent condition, very clean. \$475. Matt, WA1HRE, (203) 693-0468.

**PROFESSIONAL QUALITY** DTMF Decoder and Select Call System, by Vince Yakamavich, AA4MY, see Feb QST Magazine for details. Blank board #152-PCB only \$17.95. Kit of Parts including board, #152-KIT only \$69.95. Assembled and tested board #152-ASY only \$99.95. Add \$2.50 per order S/H. A & A ENGINEERING, 2521 W. LaPalma, Unit K, Anaheim, CA 92801. (714) 952-2114.

**ANALOG AND RF CONSULTING** for the San Francisco Bay area. Commercial and military circuits and systems. James Long, Ph.D., N6VY (408) 733-8329.

**WANTED:** Klystron tubes especially 2911; Magnatrons; also 304TL, 6012, 810 and 5CX1500A. All types of sockets for transmitting tubes. Harold Branstedt, 6104 Egg Lk Rd, Hugo, MN 55038. (612) 429-9397.

**UHF PARTS.** GaAs fets, mimics, chip caps, trimmer caps, and other builder parts. MGF 1402 @\$14.00 MFG 1320 @\$10.00. 8-117F Trimmer caps @\$3.75. Porcelain chip caps @.80-1.75. Orders add \$1.00 p+h. SASE for complete list. MICRO-WAVE COMPONENTS, 11216 Cape Cod, Taylor, MI 48180.

**JENNINGS UCS-300-7.5 KV** variable vacuum capacitor \$135, RJ1A/HC-1 vacuum relay \$75, RJ2C \$140. Cardwell 2100PF-3 KV variable capacitor \$45. Eimac 3CX1200A7 \$375, 4CX3, 000A \$675, 4CX5, 000A \$950, SK-2210/SK-2216 \$85. Centralab 858-1000PF \$5 ea. (All new). A. Emerald, 8956 Swallow, Ptn. Vty, CA 92708 (714) 962-5940.

**PACKET: Macintosh** packet program, \$39.95. For details write to S. FINE SOFTWARE, POB 6037, State College, PA 16801.

**PHOTOVOLTAIC PANELS.** Lowest prices on Sovonics, Arco panels. From 1 watt to 50. Send \$1 for price specs and data sheets. Michael Bryce, 2225 Mayflower, Massillon, Ohio 44646.

**RTTY JOURNAL**—Now in our 36th year. Read about RTTY, AMTOR, PACKET, MSO'S, RTTY CONTESTING, RTTY DX and much more. Year's subscription to RTTY JOURNAL \$10.00, foreign slightly higher. Order from: RTTY JOURNAL, 9085 La Casita Ave., Fountain Valley, CA 92708.

**IMRA** International Mission Radio Association helps missionaries. Equipment loaned. Weekday net, 14.280 MHz, 1-3 PM Eastern. Nine hundred Amateurs in 40 countries. Rev. Thomas Sable, S.J., University of Scranton, Scranton, PA 18510.

**MARCO:** Medical Amateur Radio Council, Ltd. operates daily and Sunday nets. Medically oriented Amateurs (physicians, dentists, veterinarians, nurses, physiotherapists, lab technicians, etc) invited to join. Presently over 560 members. For information write MARCO, Box 73's, Acme, PA 15610.

**RUBBER STAMPS:** 3 lines \$5.00 PPD. Send check or MO to G.L. Pierce, 5521 Birkdale Way, San Diego, CA 92117. SASE brings information.

**ELECTRON TUBES:** Receiving, transmitting, microwave... all types available. Large stock. Next day delivery, most cases. DAILY ELECTRONICS, PO Box 5029, Compton, CA 90224. (213) 774-1255.

**CUSTOM MADE EMBROIDERED PATCHES.** Any size, shape, colors. Five patch minimum. Free sample, prices and ordering information. HEIN SPECIALTIES, Inc., Dept 301, 4202 N. Drake, Chicago, IL 60618.

**RECONDITIONED TEST EQUIPMENT** \$1.25 for catalog. Walter, 2697 Nickel, San Pablo, CA 94806.

## COMING EVENTS

Activities — "Places to go . . ."

**SPECIAL REQUEST TO ALL AMATEUR RADIO PUBLICITY COORDINATORS:** PLEASE INDICATE IN YOUR ANNOUNCEMENTS WHETHER OR NOT YOUR HAMFEST LOCATION, CLASSES, EXAMS, MEETINGS, FLEA MARKETS, ETC. ARE WHEELCHAIR ACCESSIBLE. THIS INFORMATION WOULD BE GREATLY APPRECIATED BY OUR BROTHER/SISTER HAMS WITH LIMITED PHYSICAL ABILITY.

**BRITISH COLUMBIA:** July 8-10. The Okanagan Ham Society is sponsoring the annual Okanagan Ham Fair, Illahie Beach RV Park, Hwy 97 N., Summerland, BC. 4 PM Friday to 4 PM Sunday. Admission \$5.00. Flea market, auction, new equipment, surplus and more. Talk in on 146.34/94 or 146.52. Contact VE7GSB, Glenn Borgens at (604) 492-5684 or write Okanagan Ham Fair, Box 477, Penticton, BC, Canada V2A6K6 or VE7BEE at (604) 493-1122.

**WISCONSIN:** July 9. Swapfest '88 sponsored by the South Milwaukee ARC. American Legion Post 434, Oak Creek. Starts 7 AM. Tickets \$3. Amateur Radio exams. Talk in on 146.58, WA9TXE/9.

**OHIO:** July 10. The Wood County ARC is sponsoring their 24th annual Ham-A-Rama at the Wood County Fairgrounds, Bowling Green. 8 AM to 4 PM. Free admission. Tables \$7.00. Trunk sales \$3.00. Food and drink available. Talk in on 147.18/78 and 146.52. For more info contact Jim Davis, N8DWR, 10990 Newton Rd, Bowling Green, OH 43402. (419) 352-3321.

**ILLINOIS:** July 10. The DuPage Amateur Radio Club is sponsoring a Hamfest/Computer show, American Legion Post 80, 4000 Saratoga, Downers Grove. Admission \$3/gate or \$2/advance. Gates open 8 AM. Outdoor flea market and swappers row, indoor tables, VEC exams for all classes. Talk in on 146.52, 145.250-600, 224.55 and 442.55. For tickets or reserved tables SASE to Hamfest Chairman, W9DUP, PO Box 71, Clarendon Hills, IL 60514 or call (312) 985-0527 evenings or weekends.

**NEW YORK:** July 10. The 8th annual Batavia Hamfest sponsored by the Genesee Radio Amateurs, Alexander Firemen's Grounds, Rt 98, Alexander. 6 AM to 4 PM. Indoor exhibits open 9 AM. OM/YL programs, spacious flea market, chicken BBQ, free camping, VEC exams. Advance tickets \$3 before July 1. \$4/gate. Talk in on 144.71/145.31 and 146.52. For information G.R.A.M., POB 572, Batavia, NY 14021. For tickets Knute Carlson, N2DRX, 26 Burke Drive, Batavia, NY 14020.

**MAINE:** July 16. The First annual Mid-Coast/Yankee Hamfest, Union Fairgrounds, Union, midway between Augusta and Rockland. Tailgating, swap table space (bring your own tables), demonstrations, crafts, food and entertainment. Lobster dinner at 1 PM Saturday. Camping available Friday and Saturday. Talk in on 146.385/985. For more info Carl Ingerson, N1DXM, PO Box 929, Union, Maine 04862. (207) 785-4948 or on packet via KA1FKS-1 on 145.03.

**NEW JERSEY:** July 17. The Sussex County ARC will sponsor "SCARC '88", Sussex County Fairgrounds, Plains Road, off Rt 206, Augusta. Doors open 8 AM. Registration \$3.00. Indoor tables \$7.00 each. Tailgate space \$5.00. Food and refreshments. Plenty of free parking. For more info write Don Stickle, K2OX, Weldon Road, RD 4, Lake Hopatcong, NJ 07849. Tel: (201)-663-0677.

**CHARGE YOUR CLASSIFIED ADS** to your MC or VISA, write or call **HAM RADIO MAGAZINE** Greenville, NH 03048 (603) 878-1441

# SUBSCRIBE

—AND RENEW—

## TOLL-FREE

**MISSOURI:** July 17. The Zero Beaters ARC is sponsoring their 26th annual Zero Beaters Hamfest, Bernie H., Hillermann Park, Washington, 7 AM to 3 PM. Free admission. Parking \$2. for Flea Market. FCC exams. Talk in on 84/24 and 52. For information Al Lanwermeier, WB0QBS, (314) 239-2072.

**ILLINOIS:** July 17. The Fox River Radio League's annual Hamfest, Pheasant Run Lodge, North Avenue, St. Charles. Doors open 8 AM. Advance tickets \$4 plus SASE to Phil Fors, N9FXQ, 104 May Street, West Chicago, IL 60185. Indoor/outdoor flea market. VEC exams. Free parking. Fly in to DuPage County Airport. Talk in on 145.470-600 and 1465.210-600. Commercial and inside tables contact Kermit Carlson, W9XA, 36W345 McKee Rd, Batavia, IL 60510.

**ILLINOIS:** July 23-24. The Amateur Cross Link Repeater Club is having its 2 day Hamfest and Banquet, DeVry Institute of Technology, 3300 N. Campbell, Chicago. Advance tickets \$3; \$4/door. Setup 7 AM. Doors open 8 AM. Outdoor flea market sellers bring own tables. Indoor dealers tables provided. Banquet \$15. Guest speaker Gordon West, WB6NOA. For tickets SASE to Peter Hughes, WB9EYR, 3315 N. Oakley, Chicago, IL 60618. For more information call (312) 712-5100. Talk in on 147.225, 224.480 and 443.700.

**INDIANA:** July 20-24. The County Hunters 20th annual convention, Ramada Inn-South, Indianapolis. All Amateurs are welcome to attend and participate in the various activities. Tours of Conner Prairie Settlement and the Indy 500 Motor Speedway highlight the week. Interested Amateur should SASE for information and registration forms to Herb Morgan, WD9GBH, 735 East 50th Street, Marion, IN 46953.

**NEW JERSEY:** July 31. The W2WEB East Coast VHF Society's annual Antenna Gain Measuring Contest and Flea Market, Trenton State College, Ewing Township, Trenton. 8 AM. Flea Market Handicap and Wheelchair accessible. Free registration and parking. Talk in on 146.67- (W2ZQ/R). For information SASE to Russ Pillsbury, K2TXB, RR 7, Oakshade Rd, Tabernacle, NJ 08088 (609) 268-9586.

**ILLINOIS:** July 31. The 54th annual Hamfest sponsored by the Hamfesters Radio Club. NEW LOCATION - Will County Fairgrounds, Peotone. 5 AM to 3 PM DST. Admission \$3/advance or \$4/door. FCC exams, overnight parking. Nearby camping. Displays, swappers row. Talk in on 146.78/16 and 146.52. Club call W9AA. For tickets send check or MO in No. 10 SASE to Hamfesters Radio Club, 13068 Finch Ct, Lockport, IL 60441. For information John Schiptsch, W9ENR, 13068 Finch Ct, Lockport, IL 60441. (312) 403-1043.

## OPERATING EVENTS

"Things to do . . ."

**OKLAHOMA:** July 9-10. "Field Day" exercises conducted by Oklahoma Amateur Radio Operators at Lake Canton. Activities begin 3 PM Saturday and continue through the night until noon Sunday at the "Big Bend" picnic shelter in conjunction with the annual IARU "Radiosport" DX Contest. To highlight this special events, the Lake Canton Field Day Committee will provide a commemorative certificate for contacts with event stations WD5HPU, WA5LTM and other Amateur stations. Listen in the General phone portions 40-10m. Also 6 and 2m SSB.

**INTERNATIONAL HAMFEST.** July 7-9. VE4HF will be in operation to help celebrate the 25th anniversary of the International Hamfest held in the Peace Gardens on the Manitoba, Canada, and North Dakota, USA border. 9 AM CST to 9 PM CST. To receive the "Peace Garden Award" send a QSL and 3 IRC's along with SASE to VE4XN, Dave Snydal, 25 Queens Crescent, Brandon, Manitoba, Canada R7B 1G1.

**NEW YORK:** July 23 and 24. The Oswego County Amateur Radio Emergency Service (ARES) and the Fulton ARC will operate KY2F, 1500Z to 2300Z each day from the Oswego County Air Show. Lower third of General 40, 20, 15, 10 and 2m bands and Novice portion of 10m. For certificate send large SASE to Fred Swiatlowski, KY2F, PO Box 5227, Oswego, NY 13126.

**MARYLAND:** July 23-24. The Laurel ARC will operate special event station W3GFS from 1800Z 7/23 to 1800Z 7/24 from a small uninhabited island in Chesapeake Bay the world's largest estuary. Freqs: Lower 25 kHz of General 80-10m and 147.54. Attractive 8x11 certificate for SASE. QSL to LARC, PO Box 1436, Laurel, MD 20707.

**July 23-29:** The Long Island Mobile ARC will operate special event station W200VL. CW and phone on all HF bands. QSL with SASE via WA2KXE, 162 West Hudson Street, Long Beach, NY 11561.

**HAM RADIO TODAY** has joined the programming lineup from the Voice of the Andes, HCJB Radio, an international broadcasting station that has been operating from Quito, Ecuador since 1931. Programming includes news from all over the world, construction hints, propagation news, equipment reviews and much more. For more information contact John E. Beck, Producer, HAM RADIO TODAY, c/o HCJB Radio, Box 691, Quito, Ecuador, SA.

**HAM EXAMS:** The MIT UHF Repeater Association and the MIT Radio Society offer monthly Ham Exams. All classes Novice to Extra. Wednesday JUNE 22, 7 PM, MIT Room 1-150, 77 Mass Ave, Cambridge, MA. Reservations requested 2 days in advance. Contact Ron Hoffmann at (617) 646-1641. Exam fee \$4.50. Bring a copy of your current license (if any), two forms of picture ID, and a completed form 610 available from the FCC in Quincy, MA (617) 770-4023.

**ham  
radio**  
magazine



1 YR - \$22.95 2 YRS - \$38.95

3 YRS - \$49.95

Prices U.S. only



MASTERCARD  
 VISA  BILL ME  
Please have your charge card ready.

DATATEL 800™

# 800-341-1522

Weekdays 8 AM - 9 PM EST • Saturdays 9 AM - 5 PM EST  
IN MAINE CALL COLLECT (207) 236-2896

**OUR 800 NUMBER IS FOR SUBSCRIPTION ORDERS ONLY!**

For Errors or Change of Address CALL *ham radio*  
direct at (603) 878-1441 8-5 EST

# ADVERTISER'S INDEX AND READER SERVICE NUMBERS

Listed below are the page and reader service number for each advertiser in this issue. For more information on their products, select the appropriate reader service number make a check mark in the space provided. Mail this form to ham radio Reader Service, I.C.A., P.O. Box 2558, Woburn, MA 01801.

Name \_\_\_\_\_ Call \_\_\_\_\_

Address \_\_\_\_\_

City \_\_\_\_\_ State \_\_\_\_\_ Zip \_\_\_\_\_

\*Please contact this advertiser directly.

Please use before August 31, 1988.

READER SERVICE #	PAGE #	READER SERVICE #	PAGE #
144 - Ace Communications, Inc	53	108 - Kantronics	6, 7
120 - Advanced Receiver Research	24	117 - Kennedy Associates	20
149 - AEA	57	* - Kenwood U.S.A. Corp	2, 5, CIV
147 - All Electronics Corp	54	129 - Larsen Antennas	36
187 - Aluma Tower Co.	94	180 - Madison Electronics Supply	87
122 - AMC Sales, Inc	24	121 - Magnaphase Industries, Inc	24
130 - Amidon Associates	36	109 - MFJ Enterprises	8
*156 - AMSAT	62	150 - Micro Control Specialties	59
118 - Antennas West	20, 77, 89	176 - Microflex	87
141 - ARRL	49	116 - Midland Technologies	20
175 - ARRL	87	184 - Mission Communications	94
124 - Astron Corp	30	188 - Missouri Radio Center	99
168 - ATFAB Computers and Electronics	77	126 - Mobile Mark, Inc	32
* - Barker & Williamson	52	153 - Morlan Software	59
* - Barry Electronics	63	133 - Motron Electronics	36
191 - Bilal Company	98	119 - NCG	24
131 - Buckmaster Publishing	36	* - Nema Electronics	20
171 - Buckmaster Publishing	82	174 - Nuts & Volts	86
* - Butternut Electronics	20	193 - OPToelectronics	100
172 - C&S Sales	85	134 - P.C. Electronics	37
* - Caddell Coil Corp	82	125 - Pac-Comm Packet Radio Systems, Inc	32
145 - CIE	53	115 - Radio Shack	23
112 - Command Technologies	17	157 - Radiokit	62
140 - Communications Specialists	44	127 - Radiosporting	32
107 - Connect Systems Inc	1	177 - The Radio Works	87
196 - CTM	80	183 - Ramsey Electronics, Inc	93
186 - Cygnus-Quasar Books	94	152 - The RF Connection	59
195 - Datacom, International	53	167 - Riebstone Software Co	76
114 - DMQ	17	161 - Rutland Arrays	65
155 - Doppler Systems	63	185 - S-Com Industries	94
151 - Down East Microwave	59	* - Sherwood Engineering, Inc	77
158 - DRSI	65	* - Spec-Com	94
139 - EGE, Inc	47	132 - Stridsburg Engineering Co	36
* - Engineering Consulting	70	143 - STV/OnSat	52
178 - Epsilon Co	87	164 - Synthetic Textiles, Inc	76
182 - Fair Radio Sales	91	162 - TIC General	70
* - Fox Tango Corp	91	163 - Transverters Unlimited	73
154 - Giffler Shortwave	61	* - University Microfilm Int	86
135 - GLB Electronics	37	159 - Vanguard Labs	65
146 - Gordon West Radio School	55	113 - Varian EIMAC	16
123 - L.L. Grace	29	148 - VHF Communications	54
165 - GTI	76	166 - W9INN Antennas	76
190 - GTI	98	170 - Western Electronics	82
138 - HAL Communications Corp	43	181 - Wi-Comm Electronics Inc	91
189 - Doug Hall Electronics	98	137 - Yaesu USA	41
169 - Hal-Tronix	80	192 - Yaesu USA	CIII
111 - Ham Radio Outlet	14, 15	179 - E.H. Yost Co	87
* - Ham Radio's Bookstore	32, 52, 76, 77		
* - Hamtronics, NY	95		
128 - Henry Radio	35		
106 - ICOM America, Inc	CII		
142 - ICOM America, Inc	50, 51		
173 - Jan Crystals	86		
110 - JDR	13		
160 - Jensen Tools, Inc	65		
136 - Jun's Electronics	39		

### PRODUCT REVIEW/NEW PRODUCTS

* - Engineering Consulting	71
* - Ham Radio's Bookstore	71
302 - Kantronics	71
* - Kenwood U.S.A. Corp	71
301 - Universal Radio	71

## THE MULTIPLE RECEIVER SOLUTION

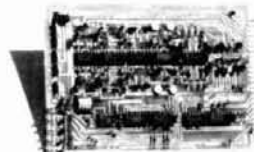

### 4 Channel Signal-to-Noise Voter

- Expandable to 32 Channel by Just Adding Cards
- Continuous Voting
- LED Indicators of COR and Voted Signals
- Built-in Calibrator
- Remote Voted Indicators Pinned Out
- 4 1/2 x 6 Double Sided Gold Plated 44 Pin Card
- Remote Disable Inputs
- MORE

Built, tested and calibrated with manual

**\$350.00**

Telephone interface now available  
For more information call or write

**DOUG HALL ELECTRONICS**  
Voter Department  
815 E. Hudson Street  
Columbus, Ohio 43211  
(614) 261-8871

✓ 189



### Wideband Preamp 10-1000 Mhz

Dual GasFet low noise preamplifier for HF, UHF or VHF systems. Just perfect for the R-7000. Excellent for Spec Analyzers, Scanners, etc. Gain 20 Db +/- 1 DB, -3 Db at 2 & 1100 Mhz. 1 Db compression of >10 Dbm. Intercept points >45 Dbm. New shipped price of only \$124.95. Pa. residents please add 6% state tax.

### GTI Electronics

RD 1 BOX 272  
Leighton, Pa. 18235  
717-386-4032

✓ 190

THE  
**YOSTRON**  
COMPACT ANTENNAS FROM 160-10 METERS

NO TUNERS!  
NO RADIALS!  
NO RESISTORS!  
NO COMPROMISE!

THREE EXCELLENT REVIEWS JUST  
DON'T HAPPEN BY CHANCE.  
CALL US FOR A FREE CATALOGUE.

\*See review in Oct 73, 1984  
\*Sept 73, 1985 \*March 73, 1986

**NEW LOCATION!**  
**BILAL COMPANY**  
137 Manchester Dr.  
Florissant, Colo. 80816  
(719) 687-0650



# MISSOURI RADIO CENTER

102 N.W. Business Park Lane, Kansas City, MO 64150 816-741-8118

Call Toll Free — 9am - 6pm Mon - Fri, 9am - 2pm Sat  
In Missouri Call — 816-741-8118

# 1-800-821-7323

TRADE INS ACCEPTED

MasterCard — VISA — Discover

## Dependable Service At The Right Price... Everytime

### KENWOOD



#### TS440S "DX-CITING"

- 100% Duty Cycle
- 100 Memories
- Direct Keyboard Entry
- Optional Built-in AT
- On Sale Now, Call for Price!

### YAESU



#### FT-767GX HF/VHF/UHF BASE STATION

- Add Optional 6m, 2m & 70cm Modules
- Dual VFO's
- Full CW Break-in
- Lots More Features

### ICOM



#### IC-761 NEWEST HF SUPER RIG

- 160-10M/General Coverage Receiver
- Built-in Power Supply and Automatic Antenna Tuner
- SSB, CW, FM, AM, RTTY
- QSK to 60 WPM

### ALINCO



#### ALD-24T DUAL BAND MOBILE

- 140-149.995 MHz/ 440-450 MHz
- 25 Watts on Both Bands
- Crossband Full Duplex
- 21 Memory Channels
- CTCSS Encoder/Decoder, Standard

### KENWOOD



#### TS-140S AFFORDABLE DX-ing!

- HF Transceiver With General Coverage Receiver
- All HF Amateur Bands
- 100W Output
- Compact, Lots of Features

### YAESU



#### FT-736R VHF-UHF BASE STATION

- SSB, CW, FM on 2 Meters and 70 cm
- Optional 50 MHz, 220 MHz or 1.2 GHz
- 25 Watts Output on 2 Meters, 220 and 70 cm
- 10 Watts Output on 6 Meters and 1.2 GHz
- 100 Memories

### ICOM



#### IC-735 COMPACT HF TRANSCEIVER

- All HF Band/General Coverage Receiver
- 12 Memories/Frequency and Mode
- USB, LSB, AM, FM, CW
- 100 Watts Output
- Includes HM-12 Scanning Mic

### concept

2m and 220 MHz Amplifiers  
GaAsFET Receive Pre-Amps  
and High SWR Shutdown  
Protection

MODEL	144 MHz	S A L E
2-23	2 in/30 out	P R I C E D
2-217	2 in/170 out	
2-117	10 in/170 out	
	220 MHz	
3-22	2 in/20 out	
2-211	2 in/110 out	
3-312	30 in/120 out	
	CALL	

### KENWOOD



#### TM-221A

- 2m FM Mobile Transceiver
- 45W Output w/HiLo Switch
- 14 Multi-Function Memories
- TM-421A Available For 440 MHz

### YAESU



#### FT-212RH

THE "ANSWERING MACHINE" MOBILE

- Rx: 138-174 MHz
- Tx: 144-148 MHz
- 45W Output
- Digital Voice Recorder
- FT-712 RH for 70cm

### ICOM



#### IC-900 SIX BANDS IN ONE MOBILE

- Remote Controller, Interface A Unit, Interface B Unit, Speaker, Mic and Cables
- Six Band Units to Choose
- 10 Memories Per Band
- Programmable Band Scan
- Fiber Optic Technology

### ASTRON CORPORATION



Power  
Supply

- RS7A ... \$48
- RS12A ... \$68
- RS20A ... \$88
- RS20M ... \$105
- VS20M ... \$125
- RS35A ... \$133
- RS35M ... \$149
- VS35M ... \$165
- RS50A ... \$189
- RS50M ... \$215
- RM50A ... \$219
- VS50M ... \$229

### KENWOOD

#### TH-25AT POCKET-SIZED AND POWERFUL



- Frequency Coverage: 141-163 MHz (Rx), 144-148 MHz (Tx)
- Front Panel DTMF Pad
- 5 Watts Output
- 14 Memories
- TH-45AT Available for 440 MHz

### YAESU



#### FT23/73R

- Super "Mini" HT's
- Zinc-Aluminum Alloy Case
- 10 Memories
- 140-164 MHz, 440-450 MHz
- 2W Battery Pack or Optional 5W Pack

### ICOM



#### IC-μ2AT IC-μ4AT

MICRO HT'S  
FOR 2M, 440

- Pocket Size HT Fun
- Ten Memories
- LCD Readout
- Wideband Coverage
- Up to 3 Watts Output
- 32 Built-in Subaudible Tones

### ASA



#### PK-64/HFM

- Morse, Baudot, ASCII, AMTOR and Packet
- Operates VHF and HF
- You Need Only Your Transceiver and a Commodore 64 or 128

**SPECIAL! FINAL CLEARANCE**  
**\$149.95** Limited Supply

YAESU  
WELZ  
VIKING  
VANGORDON  
TEN-TEC  
SANTEC  
RFCONCEPTS  
QUATRON  
NYE  
MIRAGE/KLM  
MFJ  
LARSEN



# NEW

## POCKET SIZE

SIZE: 4" H x 3.5" W x 1" D  
MADE IN USA

OPTOELECTRONICS INC.

# FREQUENCY COUNTERS TO 2.4 GHZ

8 LED DIGITS • 2 GATE TIMES  
ALUMINUM CABINET  
INTERNAL NI-CAD BATTERIES INCLUDED  
AC ADAPTER/CHARGER INCLUDED

EXCELLENT SENSITIVITY & ACCURACY

AC-DC • PORTABLE OPERATION



Small enough to fit into a shirt pocket, our new 1.3 GHz and 2.4 GHz, 8 digit frequency counters are not toys! They can actually out perform units many times their size and price! Included are rechargeable Ni-Cad batteries installed inside the unit for hours of portable, cordless operation. The batteries are easily recharged using the AC adapter/charger supplied with the unit.

The excellent sensitivity of the 1300H/A makes it ideal for use with the telescoping RF pick-up antenna; accurately and easily measure transmit frequencies from handheld, fixed, or mobile radios such as: Police, firefighters, Ham, taxi, car telephone, aircraft, marine, etc. May be used for counter surveillance, locating hidden "bug" transmitters. Use with grid dip oscillator when designing and tuning antennas. May be used with a probe for measuring clock frequencies in computers, various digital circuitry or oscillators. Can be built into transmitters, signal generators and other devices to accurately monitor frequency.

The size, price and performance of these new instruments make them indispensable for technicians, engineers, schools, Hams, Cbers, electronic hobbyists, short wave listeners, law enforcement personnel and many others.

### STOCK NO:

#1300H/A	Model 1300H/A 1-1300 MHz counter with preamp, sensitivity, < 1mV, 27MHz to 450MHz includes Ni-Cad batteries and AC adapter .....	\$169.95
#2400H	Model 2400H 10-2400 MHz microwave counter includes Ni-Cad batteries and AC adapter .....	\$299.95
#CCA	Model CCA counter/counter, for debugging, ultra sensitive, < 50 micro volts at 1.50MHz! 1-600 MHz with adjustable threshold, RF indicator LED. Includes Ni-Cad batteries and AC adapter .....	\$299.95

### ACCESSORIES:

#TA-1005	Telescoping RF pick-up antenna with BNC connector .....	\$12.00
#P-100	Probe, direct connection 50 ohm, BNC connector .....	\$20.00
#CC-12	Carrying case, gray vinyl with zipper opening. Will hold a counter and #TA-1005 antenna. ....	\$10.00

✓ 193



ORDER FACTORY DIRECT  
FLA (305) 771-2050 **1-800-327-5912**



AVAILABLE NOW!

# OPTOELECTRONICS INC.

5821 N.E. 14th Avenue  
Ft. Lauderdale, Florida 33334

Orders to US and Canada add 5% of total (\$2 min, \$10 max)  
Florida residents add 6% sales tax. COD fee \$2.  
Foreign orders add 15%

# Yaesu's FT-736R. Because you never know who's listening.



Why just dream of talking beyond earth?

With Yaesu's new FT-736R VHF/UHF base station, you can discover some of the best DX happening in ham radio. Via moonbounce. Tropo. Aurora. Meteor scatter. Or satellites.

You see, the FT-736R is the most complete, feature-packed rig ever designed for the serious VHF/UHF operator. But you'd expect this of the successor to our legendary FT-726R.

For starters, the FT-736R comes factory-equipped for SSB, CW and FM operation on 2 meters and 70 cm (430-450 MHz!), with two additional slots for optional 50-MHz, 220-MHz, or 1.2-GHz modules.

Crossband full duplex capability is built into every FT-736R for satellite work. And the satel-

lite tracking function (normal *and* reverse modes) keeps you on target through a transponder.

The FT-736R delivers 25 watts RF output on 2 meters, 220 MHz, and 70 cm. And 10 watts on 6 meters and 1.2 GHz. Store frequency, mode, PL frequency, and repeater shift in each of the 100 memories.

For serious VHF/UHF work, use the RF speech processor. IF shift. IF notch filter. CW and FM wide/narrow IF filters. VOX. Noise blanker. Three-position AGC selection. Preamp switch for activating your

tower-mount preamplifier. Even an offset display for measuring observed Doppler shift on DX links.

And to custom design your FT-736R station, choose from these popular optional accessories: Iambic keyer module. FTS-8 CTCSS encode/decode unit. FVS-1 voice synthesizer. FMP-1 AQS digital message display unit. 1.2-GHz ATV module. MD-1B8 desk microphone. E-736 DC cable. And CAT (Computer Aided Transceiver) system software.

Discover the FT-736R at your Yaesu dealer today. But first make plenty of room for exotic QSL cards. Because you *never* know who's listening.

## YAESU



192

Yaesu USA 17210 Edwards Road, Cerritos, CA 90701 (213) 404-2700. Repair Service: (213) 404-4884. Parts: (213) 404-4847

Prices and specifications subject to change without notice. PL is a registered trademark of Motorola, Inc. FT-736R shown with 220-MHz option installed.

# KENWOOD

...pacesetter in Amateur Radio

DX-celence!

## #1 Rated HF!

### TS-940S Competition class HF transceiver

TS-940S—the standard of performance by which all other transceivers are judged. Pushing the state-of-the-art in HF transceiver design and construction, no one has been able to match the TS-940S in performance, value and reliability. The product reviews glow with superlatives, and the field-proven performance shows that the TS-940S is "The Number One Rated HF Transceiver!"

- 100% duty cycle transmitter. Kenwood specifies transmit duty cycle **time**. The TS-940S is guaranteed to operate at full power output for periods **exceeding one hour**. (14.250 MHz, CW, 110 watts.) Perfect for RTTY, SSTV, and other long-duration modes.
- First with a full one-year limited warranty.
- Extremely stable phase locked loop (PLL) VFO. Reference frequency accuracy is measured in **parts per million!**

#### Optional accessories:

- AT-940 full range (160-10m) automatic antenna tuner • SP-940 external speaker with audio filtering • YG-455C-1 (500 Hz), YG-455CN-1 (250 Hz), YK-88C-1 (500 Hz) CW filters; YK-88A-1 (6 kHz) AM filter • VS-1 voice synthesizer • SO-1 temperature compensated

Complete service manuals are available for all Kenwood transceivers and most accessories. Specifications, features, and prices are subject to change without notice or obligation.

- crystal oscillator • MC-43S UP/DOWN hand mic. • MC-60A, MC-80, MC-85 deluxe base station mics. • PC-1A phone patch • TL-922A linear amplifier • SM-220 station monitor • BS-8 pan display • SW-200A and SW-2000 SWR and power meters • IF-232C/IF-10B computer interface.

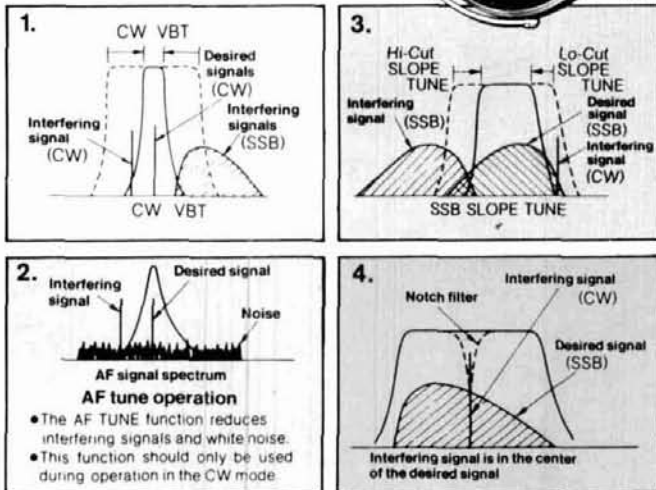

**1) CW Variable Bandwidth Tuning.** Vary the passband width continuously in the CW, FSK, and AM modes, without affecting the center frequency. This effectively minimizes QRM from nearby SSB and CW signals.

**2) AF Tune.** Enabled with the push of a button, this CW interference fighter inserts a tunable, three pole active filter between the SSB/CW demodulator and the audio amplifier. During CW QSOs, this control can be used to reduce interfering signals and noise, and peaks audio frequency response for optimum CW performance.

**3) SSB Slope Tuning.** Operating in the LSB and USB modes, this front panel control allows independent, continuously variable adjustment of the high or low frequency slopes of the IF passband. The LCD sub display illustrates the filtering position.

**4) IF Notch Filter.** The tunable notch filter sharply attenuates interfering signals by as much as 40 dB. As shown here, the interfering signal is reduced, while the desired signal remains unaffected. The notch filter works in all modes except FM.

- Complete all band, all mode transceiver with general coverage receiver. Receiver covers 150 kHz-30 MHz. All modes built-in: AM, FM, CW, FSK, LSB, USB.
- Superb, human engineered front panel layout for the DX-minded or contesting ham. Large fluorescent tube main display with dimmer; direct keyboard input of frequency; flywheel type main tuning knob with optical encoder mechanism all combine to make the TS-940S a joy to operate.
- One-touch frequency check (T-F SET) during split operations.
- Unique LCD sub display indicates VFO, graphic indication of VBT and SSB Slope tuning, and time.
- Simple one step mode changing with CW announcement.
- Other vital operating functions. Selectable semi or full break-in CW (QSK), RIT/XIT, all mode squelch, RF attenuator, filter select switch, selectable AGC, CW variable pitch control, speech processor, and RF power output control, programmable band scan or 40 channel memory scan.

# KENWOOD

KENWOOD U.S.A. CORPORATION  
2201 E. Dominguez St., Long Beach, CA 90810  
P.O. Box 22745, Long Beach, CA 90801-5745