

# **ham radio**

**magazine**



## **heavy-duty home-brew rotator**

*Barbara Smullen*



# ICOM IC-751A

## CAN YOU HANDLE THIS MUCH TRANSCEIVER?

- All HF Band Transceiver/General Coverage Receiver
- New Design
- 100% Duty Cycle Transmitter
- 105dB Dynamic Range
- All Modes Built-In USB, LSB, AM, FM, CW, RTTY
- 12 Volt Operation

The new IC-751A top-of-the-line HF base station transceiver is designed for the ham operator who demands high performance. Whether contesting or QSO'ing for pleasure, the 100 watt IC-751A incorporates the best features of the IC-751, plus brings you to the forefront with the following most-asked for additions.

**More CW Control.** For the CW enthusiast, the new IC-751A includes an electronic keyer unit, QSK rated at up to 40WPM, standard FL-32A 9MHz/500Hz CW filter and CW sidetone to

monitor your code in RX or TX modes... great for practice!

**All Amateur Band Coverage.** Plus general coverage reception from 100kHz to 30MHz. May be easily modified for MARS operation.

**Improved Smooth Tuning.** The IC-751A features a newly designed tuning knob for velvet smooth tuning.

**Added LED Annunciator.** For easily identifying if you're using the tuning speed, dial, or band switching functions.

**32 Memories.** Mode and frequency may be stored in any of 32 memories...all the memory capability that you'll ever need.

**More Stable.** Even in the receive mode, the IC-751A has a sophisticated thermal sensor to monitor the internal temperature. The sensor automatically activates the cooling fan which gives maximum stability...critical for contesting.

**Newly Designed Features.** The IC-751A boasts a number of newly designed features for better performance...new 9MHz notch filter to drastically reduce ORM, new AGC system, new compressor for better audio and a new AF gain control system to improve control of the CW sidetone volume.

**Options Available.** Options for the IC-751A include the IC-PS30 external AC system power supply, IC-PS35 internal AC power supply, IC-AT500 antenna tuner, IC-EX309 microprocessor interface connector, SM-8 or SM-10 desk mics, IC-2KL linear amplifier, RC-10 remote controller, SP-7 or IC-SP3 external speakers, IC-EX310 voice synthesizer, CR-64 high stability 30.72MHz crystal and GC-5 world clock

**Optional Filters.** FL-52A CW 455kHz at 500Hz, FL-53A CW-N 455kHz at 250Hz, FL-63A CW-N 9.0106MHz at 250Hz, and FL-33 AM 9.010MHz at 6000Hz filter.



**ICOM**  
First in Communications

# Work VHF or HF Packet On Any Computer With Kantronics Complete Packet Communicator KPC-2

From IBM to C-64, or any computer with an asynchronous serial port, you can now work packet on VHF or HF with one TNC, the KPC-2! Extra cost options are unnecessary. KPC-2 is packed full of features and backed by our full-time customer support departments. KPC-2 has totally new hardware and software, Kantronics designed. For more information contact Kantronics or a Kantronics dealer.

**Suggested Retail \$ 219.00**



## Features

- AX.25 Version 2.0 software
- Supports multiple connects, up to 26
- RS232 or TTL compatible (C-64 too!)
- HF modem included! (both U.S. and European tones)
- Carrier Detect, and software squelch operation
- FCC Part 15 Certified
- Kantronics industry standard extruded aluminum case
- Power supply and cabling included
- All EPROM software is Kantronics sourced and copyrighted

- 128K EPROM, 16K RAM — expandable to 32K, 4K EEPROM.
- Advanced software HDLC routines, eliminating costly out-of-date chips

## Customer Support

- Extensive dealer network
- In-house programmers/engineers
- In-house service representatives
- Periodic software updates (like 2.0!)

### Want more information on Packet?

Contact us about our new **PACKET VIDEO**.

\$ 25.00 (shipping included), VHS or BETA format.

**Kantronics**  
RF Data Communications Specialists

1202 E. 23 Street Lawrence, Kansas 66046 (913) 842-7745

# KENWOOD

...pacesetter in Amateur radio

**NEW!**  
Computer Interface!

## “DX-cellence!”

### TS-940S

The new TS-940S is a serious radio for the serious operator. Superb interference reduction circuits and high dynamic range receiver combine with superior transmitter design to give you no-nonsense, no compromise performance that gets your signals through! The exclusive multi-function LCD sub display graphically illustrates VBT, SSB slope, and other features.

- 100% duty cycle transmitter. Super efficient cooling system using special air ducting works with the internal heavy-duty power supply to allow continuous transmission at full power output for periods exceeding one hour.
- High stability, dual digital VFOs. An optical encoder and the flywheel VFO knob give the TS-940S a positive tuning “feel”.
- Graphic display of operating features.

Exclusive multi-function LCD sub-

display panel shows CW VBT, SSB slope tuning, as well as frequency, time, and AT-940 antenna tuner status.

- Low distortion transmitter. Kenwood's unique transmitter design delivers top “quality Kenwood” sound.
- Keyboard entry frequency selection. Operating frequencies may be directly entered into the TS-940S without using the VFO knob.
- QRM-fighting features. Remove “rotten QRM” with the SSB slope tuning, CW VBT, notch filter, AF tune, and CW pitch controls.
- Built-in FM, plus SSB, CW, AM, FSK.
- Semi or full break-in (QSK) CW.
- 40 memory channels. Mode and frequency may be stored in 4 groups of 10 channels each.
- Programmable scanning.
- General coverage receiver. Tunes from 150 kHz to 30 MHz.
- 1 yr. limited warranty. Another Kenwood First!

Optional accessories:

- AT-940 full range (160-10m) automatic antenna tuner
- SP-940 external

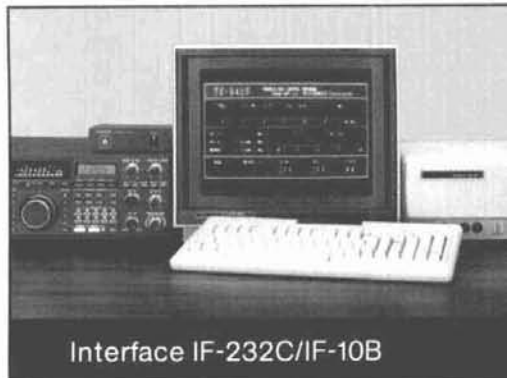

Interface IF-232C/IF-10B

speaker with audio filtering • YG-455C-1 (500 Hz), YG-455CN-1 (250 Hz), YK-88C-1 (500 Hz) CW filters; YK-88A-1 (6 kHz) AM filter • VS-1 voice synthesizer • SO-1 temperature compensated crystal oscillator • MC-42S UP/DOWN hand mic. • MC-60A, MC-80, MC-85 deluxe base station mics. • PC-1A phone patch • TL-922A linear amplifier • SM-220 station monitor • BS-8 pan display • SW-200A and SW-2000 SWR and power meters.

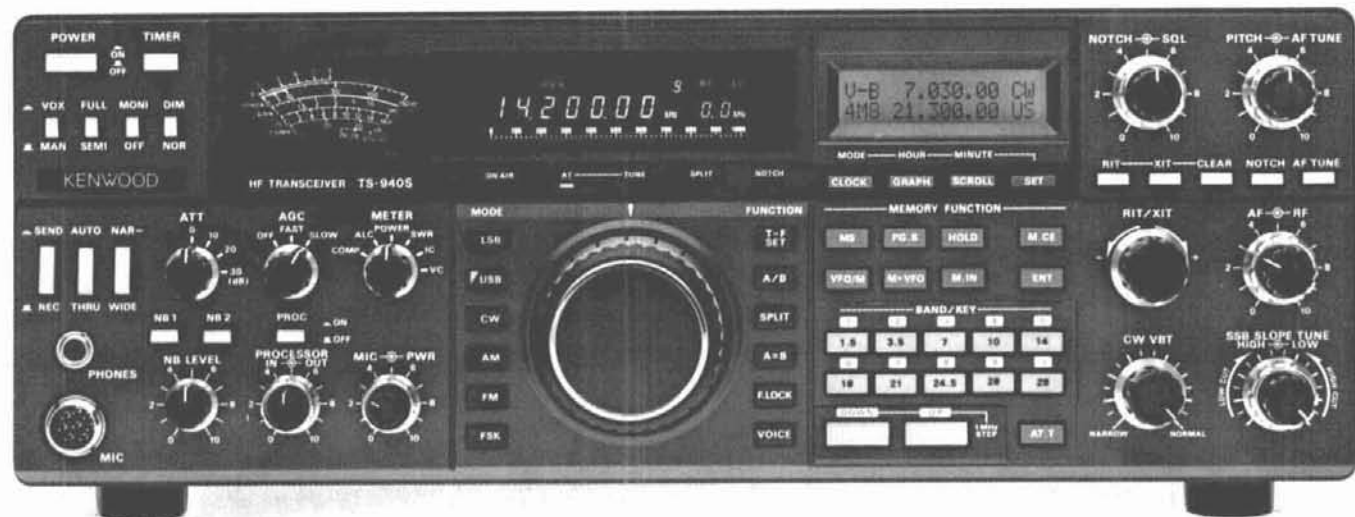

Complete service manuals are available for all Trio Kenwood transceivers and most accessories. Specifications and prices are subject to change without notice or obligation.



More TS-940S information is available from authorized Kenwood dealers.

## KENWOOD

TRIO-KENWOOD COMMUNICATIONS  
1111 West Walnut Street  
Compton, California 90220



# ham radio

magazine

**JUNE 1986**

**volume 19, number 6**

**T. H. Tenney, Jr., W1NLB**  
publisher

**Rich Rosen, K2RR**  
editor-in-chief  
and associate publisher

**Dorothy Rosa, KA1LBO**  
assistant editor

Joseph J. Schroeder, W9JUV  
Alfred Wilson, W6NIF  
associate editors  
Susan Shorrock  
editorial production

#### editorial review board

Peter Bertini, K1ZJH  
Forrest Gehrke, K2BT  
Michael Gruchalla, P. E.  
Bob Lewis, W2EBS  
Mason Logan, K4MT  
Ed Wetherhold, W3NQN

#### publishing staff

**J. Craig Clark, Jr., N1ACH**  
assistant publisher

**Rally Dennis, KA1JWF**  
director of advertising sales

Dorothy Sargent, KA1ZK  
advertising production manager

Susan Shorrock  
circulation manager

Therese Bourgault  
circulation

cover art:  
Barbara Smullen

ham radio magazine is published monthly by  
Communications Technology, Inc.  
Greenville, New Hampshire 03048-0498  
Telephone: 603 878 1441

#### subscription rates

United States:  
one year, \$22.95; two years, \$38.95; three years, \$49.95  
Canada and other countries (via surface mail):  
one year, \$31.00; two years, \$55.00; three years, \$74.00  
Europe, Japan, Africa (via Air Forwarding Service): one year, \$37.00  
All subscription orders payable in U.S. funds, via international  
postal money order or check drawn on U.S. bank

international subscription agents: page 103

Microfilm copies are available from  
University Microfilms, International  
Ann Arbor, Michigan 48106  
Order publication number 3076

Cassette tapes of selected articles from *ham radio*  
are available to the blind and physically handicapped  
from Recorded Periodicals,  
919 Walnut Street, Philadelphia, Pennsylvania 19107

Copyright 1986 by Communications Technology, Inc.  
Title registered at U.S. Patent Office

Second class postage paid  
at Greenville, New Hampshire 03048-0498  
and at additional mailing offices  
ISSN 0148 5989

Send change of address to *ham radio*  
Greenville, New Hampshire 03048-0498

## contents

**10 turning that big array**  
Victor Mozarowski, VE3AIA

**17 secrets of successful  
low-band operation: part 2**  
Rich Rosen, K2RR

**30 ham radio techniques**  
Bill Orr, W6SAI

**43 make a homebrew sheet metal brake  
for chassis construction projects**  
Cliff Kleinert, WB6BIH

**51 a regulated screen grid  
power supply**  
Richard Measures, AG6K

**58 direct currents  
reduce core permeability**  
Walter Kunde, K5BVM

**68 VHF/UHF world**  
Joe Reiser, W1JR

**85 a universal analog breadboard**  
Michael Gruchalla

**95 practically speaking**  
Joe Carr, K4IPV

**108 the Guerri report**  
Ernie Guerri, W6MGI

<b>110 advertisers index</b>	<b>106 ham mart</b>
<b>and reader service</b>	<b>105 new products</b>
<b>9 comments</b>	<b>6 presstop</b>
<b>101 DX forecaster</b>	<b>4 reflections</b>
<b>103 flea market</b>	<b>36 short circuits</b>



# REFLECTIONS REFLECTIONS

## Who is Dorothy Rosa?

**For the past three years** anyone who's telephoned or corresponded with the *ham radio* editorial department has probably had the pleasure of hearing the pleasant, patient voice of or receiving a well-wrought response from Dorothy Rosa, our Assistant Editor. Magazines, of course, represent team effort, a necessity in the consistent publication of issue after issue of timely, accurate information. Dorothy, KA1LBO, is an important team member who's involved in every aspect of production from initial edit to final proof just prior to press run.

Dorothy came to us at an important time in our development, replacing Marty Hanft, KA1ZM, and stepped into a position that requires an extremely fast learning curve. Deadlines and schedules in general do not conveniently wait for someone to come aboard and get up to speed. They're planned, they arrive, and must be met. Then they rapidly become a thing of the past, only to be replaced by new ones.

Dorothy, in a sense, is not a newcomer to radio. Though recently licensed, she shared, at an early age, in the excitement of radio. Her father, an avid experimenter and SWL'er, had the normal collection of vacuum tubes, countless bins and small wooden drawers of parts, as well as innumerable carcasses of radios and various sorts of instrumentation. She remembers playing in the tube-lit glow of his repair shop, the smell of solder ever-present. It was, she says, the stuff of magic because even with his eighth-grade education, he could put all the pieces together and make a radio — and receive signals from thousands of miles away.

At the time, the unfortunate and mistaken notion that radio was for boys and reading was for girls was prevalent, so Dorothy became a voracious and compulsive reader, and as she likes to say, "a passable speller and moderately able writer." Though her major and degree were in English, she studied "a little bit of everything" in high school and college because "it was all so interesting." After college, she worked for a medical magazine in New York City, then moved on to a weekly newspaper and finally to dailies.

She spent several years as an advertising copywriter and photographer, trying to live what she calls "the simple life — which was anything but simple" in a log cabin in Vermont. She taught high school English while still finding time to tend the gardens. She traded all that in for the present position at *ham radio* and we are much the better for it.

Presently, while raising two sons and juggling multiple issues of the magazine at the same time, she's working on upgrading her license. She says she feels that, in some very small way, she's working off a debt here at HR . . . to her father for giving her the world through radio and to the hams who sent word of her first child's birth to Vietnam in 1969.

**Rich Rosen, K2RR**  
Editor-in-Chief

# KENWOOD

...pacesetter in Amateur radio

## The Smallest HT!

### TH-21AT/31AT/41AT

Kenwood's advanced technology brings you a new standard in pocket/handheld transceivers!

- High or low power. Choose 1 watt high-enough to "hit" most local repeaters; or a battery-saving 150 mW low.
- Pocket portability! Kenwood's TH-series HTs pack convenient, reliable performance in a package so small, it slips into your shirt pocket! It measures only 57 (2.24) W x 120 (4.72) H x 28 (1.1) D mm (inch) and weighs 260 g (.57 lb) with PB-21.
- Expanded frequency coverage (TH-21AT/A). Covers 141.000-150.995 MHz in 5 kHz steps, includes certain MARS and CAP frequencies.  
**TH-31AT/A:** 220.000-224.995 MHz in 5 kHz steps.  
**TH-41AT/A:** 440.000-449.995 MHz in 5 kHz steps.



- Repeater offset switch.  
**TH-21AT/A:**  $\pm 600$  kHz, simplex.  
**TH-31AT/A:**  $-1.6$  MHz, reverse, simplex.  
**TH-41AT/A:**  $\pm 5$  MHz, simplex.
- Standard accessories: Rubber flex antenna, earphone, wall charger, 180 mAh NiCd battery pack, wrist strap.
- Quick change, locking battery case. The rechargeable battery case snaps securely into place. Optional battery cases and adapters are available.
- Rugged, high impact molded case. The high impact case is scuff resistant, to retain its attractive styling, even with hard use. See your authorized Kenwood dealer and take home a pocketful of performance today!



- Easy-to-operate, functional design. Three digit thumbwheel frequency selection and handy top-mounted controls increase operating ease.



#### Optional accessories:

- HMC-1 headset with VOX
- SMC-30 speaker microphone
- PB-21 NiCd 180 mAh battery
- PB-21H NiCd 500 mAh battery
- DC-21 DC-DC converter for mobile use
- BT-2 manganese/alkaline battery case
- EB-2 external C manganese/alkaline battery case
- SC-8/8T soft cases
- TU-6 programmable sub-tone unit
- AJ-3 thread-loc to BNC female adapter
- BC-6 2-pack quick charger
- BC-2 wall charger for PB-21H
- RA-8A/9A/10A StubbyDuk antenna
- BH-3 belt hook

# KENWOOD

TRIO-KENWOOD COMMUNICATIONS  
1111 West Walnut Street  
Compton, California 90220

TH-series transceivers shown with optional StubbyDuk antenna. TH-21AT shown with PB-21H. Specifications and prices are subject to change without notice or obligation. Complete service manuals are available for all Trio-Kenwood transceivers and most accessories.

# presstop de W9JUV

ARRL'S "NOVICE ENHANCEMENT" PROPOSAL IS NOW AN FCC NPRM, released by the Commission just in time for the Dayton Hamvention. As released, the Notice of Proposed Rule Making follows the League's original proposal very closely (see Presstop, July and August, 1985).

In Brief, The 10-Meter Novice Band Would Become 28.1-28.5 MHz with CW, RTTY, AMTOR and packet on the bottom 200 kHz plus SSB from 28.3-28.5 MHz; the 200 W power limit (Novices and Techs only) would remain. Full privileges on the entire 220 MHz band plus 1246-1260 MHz are also proposed, though with a 25 W power limit on 220 and 5 W on 23 cm.

Though 220 MHz is Included In The NPRM, There's A Serious Question as to whether it will remain as part of the final result. That band has been the subject of attack from other services in the past, and is presently part of an as yet unfinished FCC study. The latest threat is a Petition for Rule Making from the Association of Radio Reading Services, which proposes using frequencies in the 220-225 MHz band for a new service for the blind.

Though Originally Hailed As A Means Of Attracting New Novices, as written the proposal looks more effective as a means for retaining existing Novices. However, that in itself would be a worthwhile result as the Novice dropout rate has consistently been the highest.

Comment due date for the Novice Enhancement NPRM, PR Docket 86-161, is July 16. Reply Comments will be due at the Commission on August 20.

THE FCC HAS REVERTED TO ITS ORIGINAL DEFINITION OF "EMERGENCY COMMUNICATIONS" as defined in Part 97.3(w). In an April 14 news release, the Commission said it reinstated the old definition in response to petitions for reconsideration filed by the ARRL and David Popkin, W2CC. The League's petition maintained that the new definition, which had been part of BC Docket 79-47, was too specific. The issue really came to a head during the Mexican earthquake emergency last year, when a number of non-Amateur organizations were heard using the Amateur bands for support and coordination activities. However, the issue of emergency communications is still far from resolved and will be addressed again soon.

ANY TWO REPEATERS WITH AN INTERFERENCE PROBLEM ARE "EQUALLY AND FULLY RESPONSIBLE" FOR RESOLVING IT, the FCC decided in its Report and Order on PR Docket 85-22. If only one of them is coordinated, however, the uncoordinated repeater has "primary responsibility" for resolving the problem. In the same action the Commission also dropped its restrictions on repeater power and antenna height. Effective date for the Report and Order is July 12.

RFI PROBLEMS HAVE BROUGHT THE SHUTDOWN AND FINING OF A CANADIAN AMATEUR, VE3SR. Ruling on a nuisance complaint brought by neighbors, the judge found that the neighbors' rights had been "unreasonably invaded by conduct which forms a basis for liability" and issued a permanent injunction against VE3SR operating a transmitter! In addition, he fined VE3SR \$2500 for creating "inconvenience and interference with the enjoyment of various pieces of electronic equipment," \$58.50 in Special Damages, plus costs and interest.

Canadian Amateurs Are Appalled At The Adverse Decision, as VE3SR had been supported by the Canadian Department of Communications as well as the CRRL, CARF, and a number of both Canadian and U.S. Amateur clubs. VE3SR had made a strong effort to resolve the problem, which involved a number of the neighbors' home entertainment devices, but met with little cooperation from them. At presstime he had not decided whether to appeal the decision, in light of the considerable investment he's already made in defending himself.

PRB-1's First "Victory," Lakeside Park, (Kentucky), Is Still Not Resolved. WM4T still has to appear before a Federal District Court judge to determine what constitutes a "reasonable" antenna, and now the city has adopted a new antenna ordinance that it calls "fair and reasonable" but area Amateurs feel is little better than the old one.

Even A 2-Meter Vertical Can Get An Amateur In Trouble with the law. KA7TVC put a 2-meter vertical on the roof of his Kirkland, Washington, apartment building with the owner's permission, then found himself in trouble with the city over a law requiring engineering drawings, a public hearing, and a \$350 hearing examiner review fee before installation of any transmitting antenna! The law applies only to transmitting antennas, so the same antenna installed by a scanner user would not have been covered! KA7TVC is appealing his citation, and hopes with ARRL and PRB-1 help to be able to have the ordinance rescinded on the grounds that it is vague and unenforceable.

ROY NEAL, K6DUE, HAS BEEN NAMED "RADIO AMATEUR OF THE YEAR" by the Dayton Hamvention. The NBC newsman received the award for his many years of personal and public dedication to the Amateur Radio Service, and specifically for his key role in initiating Space Shuttle Amateur Radio activity. He's also been directly involved in many film and video promotions on behalf of Amateur Radio. U.S. Senator and former astronaut John Glenn paid a surprise visit to the Hamvention banquet to help honor Roy, who was also the banquet's keynote speaker.

The 1986 "Special Achievement Award" Went To Fr. Michael Mullen, C.M., WA2BGW, President of the International Mission Radio Association. He was cited for his dedication to IMRA and his accomplishments in supplying Amateur equipment to missionaries worldwide.

Doug DeMaw, W1FB, Received the 1986 "Technical Achievement Award" for his numerous contributions to Amateur Radio communications technology. Congratulations to all three!



# KENWOOD

...pacesetter in Amateur radio

Good  
for Satellite  
Digital QSOs

## Matching Pair

Look for  
JAS-1  
and  
PHASE III-C

### TS-711A/811A VHF/UHF all-mode base stations

The TS-711A 2 meter and the TS-811A 70 centimeter all mode transceivers are the perfect rigs for your VHF and UHF operations. Both rigs feature Kenwood's new Digital Code Squelch (DCS) signaling system. Together, they form the perfect "matching pair" for satellite operation.

**Highly stable dual digital VFOs**  
The 10 Hz step, dual digital VFOs offer excellent stability through the use of a TCXO (Temperature Compensated Crystal Oscillator).

**Large fluorescent multi-function display**  
Shows frequency, RIT shift, VFO A/B, SPLIT, ALERT, repeater offset, digital code, and memory channel.

**40 multi-function memories**  
Stores frequency, mode, repeater offset, and CTCSS tone. Memories are backed up with a built-in lithium battery.



- **Versatile scanning functions**  
Programmable band and memory scan (with channel lock-out). "Center-stop" tuning on FM. An "alert" function lets you listen for activity on your priority channel while listening on another frequency. **A Kenwood exclusive!**
- **RF power output control**  
Continuously adjustable from 2 to 25 watts.

- **Automatic mode selection**  
You may select the mode manually using the front panel mode keys. Manual mode selection is verified in International Morse Code.
- **All-mode squelch**
- **High performance noise blanker**
- **Speech processor**  
For maximum efficiency on SSB and FM.
- **IF shift**
- **"Quick-Step" tuning**  
Vary the tuning characteristics from "conventional VFO feel" to a stepping action.
- **Built-in AC power supply**  
Operation on 12 volts DC is also possible.
- **Semi break-in CW, with side tone**
- **VS-1 voice synthesizer (optional)**  
More TS-711A/811A information is available from authorized Kenwood dealers.



#### Optional accessories

- IF-10A computer interface
- IF-232C level translator
- CD-10 call sign display
- SP-430 external speaker
- VS-1 voice synthesizer
- TU-5 CTCSS tone unit
- MB-430 mobile mount
- MC-60A, MC-80, MC-85 deluxe desk top microphones
- MC-48 16-key DTMF, MC-42S UP/DOWN mobile hand microphones
- SW-200A/B SWR/power meters:  
SW-200A 1.8-150 MHz  
SW-200B 140-450 MHz
- SWT-1 2-m antenna tuner
- SWT-2 70-cm antenna tuner
- PG-2J DC power cable

## KENWOOD

TRIO-KENWOOD COMMUNICATIONS  
1111 West Walnut Street  
Compton, California 90220

Complete service manuals are available for all Trio-Kenwood transceivers and most accessories. Specifications and prices are subject to change without notice or obligation.

# AFFORDABLE PACKET RADIO FROM MFJ

An identical TAPR TNC 2 clone with a new cabinet and added features ... for an incredible \$129.95!



MFJ-1270  
\$129.95

Join the exciting packet radio revolution and enjoy error-free communications ... for an incredible \$129.95!

MFJ brings together efficient manufacturing and TAPR's (Tucson Amateur

Packet Radio) leading edge technology to bring you affordable packet radio. You get a nearly identical clone of the widely acclaimed TAPR TNC 2 with identical software and hardware. It's in a new cabinet and includes a TTL serial port for extra versatility.

All you need is your rig, home computer with a RS-232 serial port and a terminal program. If you have a Commodore 64, 128 or VIC-20 you can use MFJ's optional Starter Pack to get on the air immediately. You get interfacing cable, terminal software on tape or disk and complete instructions ... everything you need to get on packet radio. Order MFJ-1282 (disk) or MFJ-1283 (tape), \$19.95 each.

Unlike machine specific TNCs, you never have to worry about your MFJ-1270 being obsolete because you change computers or because packet radio standards change. You can use any computer with an RS-232 serial port and an appropriate terminal program. If packet radio standards change, software updates will be made available as TAPR releases them. Also speeds in excess of 56K bauds are possible with a suitable external modem! Try that with a machine specific TNC or one without hardware HDLC as higher speeds come into widespread use. You can also use the MFJ-1270 as an inexpensive digipeater.

It features the latest AX.25 Version 2.0 software, hardware HDLC for full duplex, true Data Carrier Detect for HF, 16K RAM, simple operation plus more.

Join the packet radio revolution now and help make history. Order the MFJ-1270 today.

Here are MFJ's latest and hottest products for improving your station's performance.

## SUPER KEYBOARD

MFJ-496  
\$169.95

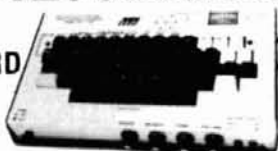

Price slashed 50% to \$169.95! Get a full feature Super Keyboard that sends CW/RTTY/ASCII for the price of a good memory keyer.

You get the convenience of a dedicated keyboard—no program to load—no interface to connect—just turn it on and it's ready to use.

This 5 mode Super Keyboard lets you send CW, Baudot, ASCII, use it as a memory keyer and for Morse Code practice. You get text buffer, programmable and automatic message memories, error deletion, buffer preload, buffer hold.

## TRIPLE OUTPUT LAB POWER SUPPLY

MFJ-4002 \$149.95



Lab quality power supply gives you plenty of voltage and current for all your analog and digital circuits. 3 completely isolated outputs: 2 variable 1.5-20 VDC at 0.5 amp and a fixed 5 VDC at 1 amp. Connect in series or parallel for higher voltage and current. It's short circuit protected, has excellent line (typ. 0.01%/V) and load regulation (typ. 0.1%). Lighted meters monitor volt./cur. 12x3x6 in. 110 VAC.

## CROSS-NEEDLE SWR/WATT METER

MFJ-815 \$59.95

MFJ's cross-needle SWR/Wattmeter gives you SWR, forward and reflected power—all at a single glance! SWR is automatically computed

—no controls to adjust. Easy-to-use push buttons select three power ranges that give you QRP to full legal limit power readings. Reads 20/200/2000 W forward, 5/50/500 W reflected and 1:1 to 1:5 SWR on easy-to-read two color scale. Lighted meter. Needs 12 V. ±10% full scale accuracy. 6½ x 3¼ x 4½ inches.



## 2 KW COAX SWITCHES

Instantly select any antenna or rig by turning a knob. Organizes coax cables and eliminates plugging and unplugging. Unused terminals are grounded to protect your equipment for stray RF, static and lightning. 2 KW PEP, 1 KW CW. For 50 to 75 ohm. Negligible loss, SWR, and crosstalk gives high performance. SO-239s. Convenient desk or wall mounting.

MFJ-1702, \$19.95. 2 positions. Cast aluminum cavity construction gives excellent performance up to 500 MHz with better than 60 dB isolation at 450 MHz. Heavy duty, low loss switch has less than 20 milliohm contact resistance, less than 0.2 dB loss and SWR below 1:1.2. 2 x 2½ x 1 inches.

MFJ-1701, \$29.95. 6 positions. White markable surface for recording ant. positions. 8½ x 1½ x 3 in.

MFJ-1702  
\$19.95



\$29.95 MFJ-1701



## ANTENNA CURRENT PROBE

MFJ-206 \$79.95

This new breakthrough MFJ Antenna Current Probe lets you monitor RF antenna currents—no connections needed! Determine current distribution, RF radiation pattern and polarization of antennas, transmission lines, ground leads, building wiring, guy wires and enclosures.

- Indicate transmission line radiation due to high SWR, poor shielding or antenna unbalance.
- Detect re-radiation from rain gutters and guy wires that can distort antenna field patterns.
- Detect RF radiation from ground leads, power cords or building wiring that can cause RFI.
- Determine if ground system is effective.
- Pinpoint RF leakage in shielded enclosures.
- Locate the best place for your mobile antenna.
- Use as tuned field strength meter.

Monitors RF current by sensing magnetic field. Uses an electrostatically shielded ferrite core, FET RF amplifier, op-amp meter circuit for excellent sensitivity, selectivity, 1.8-30 MHz. Has sensitivity, bandswitch, tune controls, telescoping antenna for field strength meter. 4 x 2 x 2 inches.



## MFJ's Best VERSA TUNER

MFJ-949C \$149.95



MFJ's best 300 watt tuner is now even better! The MFJ-949C all-in-one Deluxe Versa Tuner II gives you a tuner, cross-needle SWR/Wattmeter, dummy load, antenna switch and balun in a new compact cabinet. You get quality conveniences and a clutter-free shack at a super price.

A new cross-needle SWR/Wattmeter gives you SWR, forward and reflected power—all at a single glance. SWR is automatically computed with no controls to set. Has 30 and 300 watt scale.

Run up to 300 watts RF output—and match coax, balanced lines or random wires from 1.8 thru 30 MHz. Tune out SWR on dipoles, vees, long wires, verticals, whips, beams/quads. 10x3x7 in.

## DIGITAL SWR/WATTMETER

MFJ-818  
\$89.95

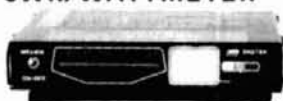

Fully automatic Digital SWR/Wattmeter reads SWR 1:1 to 1:9.9 directly and instantaneously—no SWR knob to set. Huge 0.6 inch bright orange digits make across-the-room reading easy. 12 segment LED bar graph wattmeter gives instantaneous PEP readings up to 200 watt RF output.

Good, bad, mismatch tri-color LEDs indicate SWR conditions. Small size (5½ x 4¼ x 1 in.) and easy-to-read digital display makes it ideal for mobile use. For 50 ohm systems. 1.8-30 MHz. 12 VDC or 110 VAC with MFJ-1312, \$9.95.

## MOBILE ANTENNA MATCHER

MFJ-910 \$19.95

Lower your SWR and Get more power into your mobile whip for solid signals and more QSOs. Your solid state rig puts out more power and generates less heat. For 10-80 meter whips. Easy plug-in installation. Complete instructions. Fits anywhere, 2½x2½in



ORDER ANY PRODUCT FROM MFJ AND TRY IT-NO OBLIGATION. IF NOT SATISFIED RETURN WITHIN 30 DAYS FOR PROMPT REFUND (less shipping).  
• One year unconditional guarantee • Add \$5.00 each shipping/handling • Call or write for free catalog, over 100 products.

# MFJ

MFJ ENTERPRISES, INC.  
Box 494, Mississippi State, MS 39762

TO ORDER OR FOR YOUR NEAREST DEALER, CALL TOLL-FREE

800-647-1800

Call 601-323-5869 in Miss. and outside continental USA Telex 53-4590 MFJ STKV



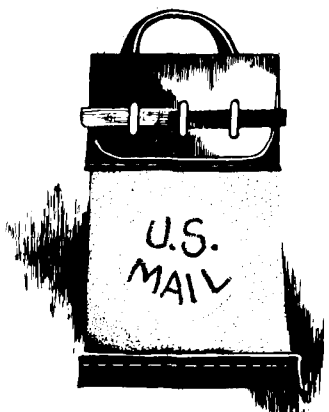

## comments

### improving "a frequency and level standard"

Dear HR:

While I always find several articles of interest in each issue of *ham radio*, the January, 1986 issue — with PA0CX's article, "A Frequency and Level Standard" (page 10) — was especially timely. I have needed a frequency standard usable up to the 70-cm ham band for some time. To get one with calibrated amplitude was too much to miss, so out came my breadboard.

I've since made several improvements to the circuits that appeared in the article.

The first change was to use a different oscillator circuit. I couldn't get the author's circuit shown in **fig. 3** (page 12) to oscillate with any 1-MHz crystal that I owned. The circuit shown below has worked with all 1-MHz crystals

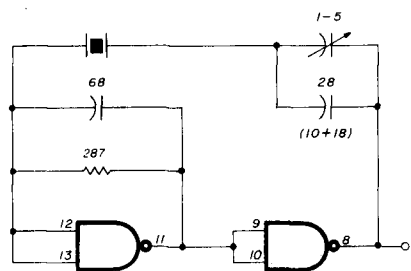

that I've tried. One advantage of this circuit is that it uses the 74LS00, which draws less current than the 7400. This aids frequency stability because the IC doesn't heat up as much. I measured approximately 15 Hz of drift at 200 MHz for a 7400, while the 74LS00 had less than 5 Hz from turn-on.

The second change is to substitute another 74LS00 for U3; this lowers current consumption and thus increases battery life.

I first built the circuit on a protoboard. The output amplitude was within 1 dB through 150 MHz, as the author, Hans Evers, had stated. This was without the use of any of the bypass capacitors shown in the schematic.

I then wired a final version on vector board for enclosure in a shielded box. This version did not have the flat amplitude response that protoboard had. In fact, there were a number of peaks in the response. Adding the 2.2  $\mu$ F capacitors (especially the ones on U2 and U3) improved the response at the higher frequencies, but the problems at 100 kHz and 1 MHz mentioned by the author still remained. This was cured by placing a 2.2  $\mu$ F capacitor from the 78L05 input to case ground (*not* circuit ground). I'm not sure if the regulator was oscillating or if there was a ground loop problem. I wired the IC grounds together with one long piece of No. 26 wire, although the protoboard has a good, wide low-impedance ground bus. The author's version appears to be wired in a similar fashion.

With the above changes the output amplitude was  $-73.0 \pm 0.5$  dBm from 100 kHz to 150 MHz and  $\pm 1$  dB to 220 MHz, as measured with an HP-71100A Spectrum Analyzer. For such a simple circuit, I couldn't ask for more.

The schematic (**fig. 3**) omits one important detail: pins 2, 3, 6, and 7 of U4 and U5 need to be grounded. This is correctly shown in **fig. 4** (page 14), but is easily overlooked when wiring up the circuit from the schematic diagram.

Thanks for the excellent article. I'll be waiting for the next issue of *ham radio*.

Steve Lund, WA8LLY  
Santa Rosa, California 95401

### on novice proposals

Dear HR:

I've been reading some negative comments about the proposals

before the FCC to enhance Novice privileges. Both the ARRL's RM-5038 and my own RM-5025 request small band segments, restricted power, and the inclusion of digital modes. We never intended to "give the store away," nor do we expect the FCC to grant all the privileges we requested. Our common interest is the growth of our hobby in a responsible way.

I fail to see what those who oppose these proposals fear. There will be no loss of "higher class" privileges. Who protested the access we gained to 30 meters, or 12 meters, or 902 MHz? The Novice operators have gained nothing. The Technicians gained a band, but it is not really an incentive to Novices to upgrade. The big incentive to Novices seems to be 2-meter FM, and that is why my proposal did not include that band.

The ARRL's proposal includes more kHz than mine and is less practical with its inclusion of the 1246 MHz band. I have seen my proposal mentioned in only one publication (*Worldradio*, September, 1985) and have received no comments. My aim is to offer non-hams a Novice license that will attract intelligent adults and young people. We need computer enthusiasts, storytellers, teachers, students, accountants, laborers, etc., etc. Our record shows that we cannot lure them in any numbers with our CW-only Novice license.

Teach a Novice or an upgrade course like I do and you will see the work that goes into each new ham. You old-timers may forget that ham radio and electronics are a new language to the non-ham. We can help squash the myth that equipment is too expensive if we offer new hams phone and digital modes as well as CW. The equipment will be of more use and will [therefore] seem a better value. Besides, Novices really do *earn* a license.

If, after reading this, you still think enhanced Novice privileges are a bad idea, go read the actual proposals and then comment to the FCC.

Larry W. Garens, WD5H  
Brady, Texas

# turning that big array

Homebrew this  
inexpensive,  
quiet rotator

I recently bought, and was faced with the problem of rotating, some large five-element monobanders made by a manufacturer whose promotional materials emphasize their products' ruggedness and resistance to wind damage. Until that time, my largest antenna had been a loaded 2-element beam for 40 meters that could be handled by a HAM IV rotor. But my new antennas were much more massive — for example, my booms measured 3 inches (7.6 cm) in diameter, thus presenting a wind load that was not only large, but unbalanced as well because the boom length each side on the mounting mast differs slightly. This imbalance increases the stress on any rotator in high winds. Wise heads, then, agreed that disaster would be certain unless I obtained a heavier rotator.

Unfortunately, such rotators are expensive. In the past, Amateurs used World War II surplus prop-pitch motors designed for bomber aircraft; these, however, are no longer plentiful and also come with their own set of problems. I concluded that it should be entirely possible, in a city as diverse as Toronto, to find enough surplus mechanical components to homebrew a rotator at reasonable cost. What follows is not a detailed, step-by-step construction article, but instead a description of a general approach that can be adapted to suit the materials at hand.

## mechanical design

A trip to the local surplus store uncovered a 20-to-1 worm gear reduction drive and a powerful single-

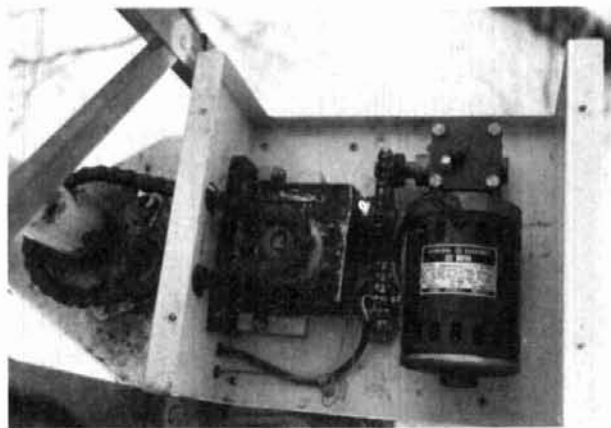

fig. 1. Worm gear reduction drive; input drive shaft is horizontal, output drive shaft is vertical.

phase, capacitor-start induction motor with integral gear reduction. The shaft speed of the motor is 56 rpm at 50 in.-lb (5.6 N.m) torque. It draws 2.1 amperes at 115 VAC. These two parts form the heart of the rotator and should be purchased first because the rest of the design will depend on how these have to be mounted and coupled together. The type of worm drive shown in fig. 1 is ideal, in that the input drive shaft is horizontal, and the output drive shaft is vertical; this facilitates running a chain drive to the mast. Furthermore, it mounts with four bolts at the bottom, making it easy to mount on a horizontal plate. Because a worm drive cannot be back-driven, no brake is required.

The type of motor used, common on the surplus market, is available with various speed and torque ratings. The exact rating isn't too critical, as long as the product of speed and torque is at least 1500 and the

By Victor Mozarowski, VE3AIA, 1 Belgrove Drive, Islington, Ontario M9B 1S2, Canada



speed is low enough so that the rest of the drive train can reduce it to the desired antenna rotation speed.

### drive motor and gearbox

A tremendous amount of torque is not required; the ruggedness of the gearbox is far more important. After all, if static friction is overcome, the antenna will eventually come up to speed, at which point its inertia will help keep it moving. Since most installations now use a high-quality ball-type mast bearing, starting would be a problem only if this bearing were iced up solid. Be that as it may, with the sprocket and gear ratios I used, and disregarding losses, the torque at the antenna mast works out to approximately 4500 in.-lb (508 N.m). (I suspect it might be possible to have a too-powerful motor that might damage the gearbox if the antenna mast were frozen.) There are formulas in machinery handbooks for calculating the size of components in the worm drive, but because these are based on a continuous running load and a certain working life, they're of little use if you want to know the ultimate yield strength under catastrophic load conditions. With carefully selected components, this type of failure would seem unlikely — and, in any case, as I'll show later, this type of failure isn't really catastrophic after all.

### other components

As for the various other drive parts, suppliers sell a standard range of mechanical components, such as bearings, drives, gears, sprockets, and chains, at reasonable prices. The particulars of these components can be found in specialized catalogs (such as from Boston Gear Company, 14, Hayward Street, Boston, Massachusetts 01271), in the same way that we select standard values of electronic components from manufacturers' and distributors' catalogs. If a part isn't in stock, the supplier can almost always get it quickly through a distribution network. All the components used here except the motor and gearbox, which were bought at surplus, and the mast coupling, which was custom-machined, are standard components.

When I disassembled the gearbox, I found that its gears were also standard Boston Gear parts, so that in the unlikely event of a failure, it could also be repaired. This is one advantage of building your own rotator; because the parts are standard, reasonably priced, and readily available.

The mechanical parts required include the following:

- **Flanged cartridge.** A high-quality, sealed, ball-bearing unit set in a horizontal mounting flange (fig. 2), it can support both thrust and radial loads. The one I used could take about 2000 pounds (907 kg), although it's only a small unit and takes a 1-1/8 inch shaft (2.85 cm). Mounted at the bottom of the mast, it takes the full weight of the antenna array through

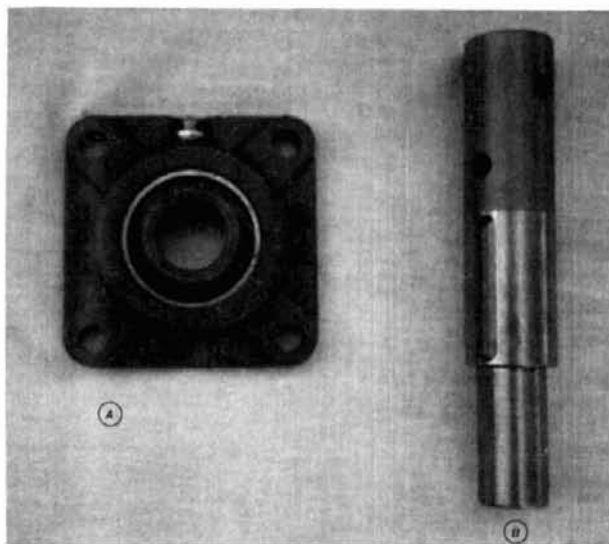

fig. 2. (A) Flanged cartridge is a high-quality ball-bearing unit set in a horizontal mounting flange. (B) Hollow steel pin secures mast adapter to the mast.

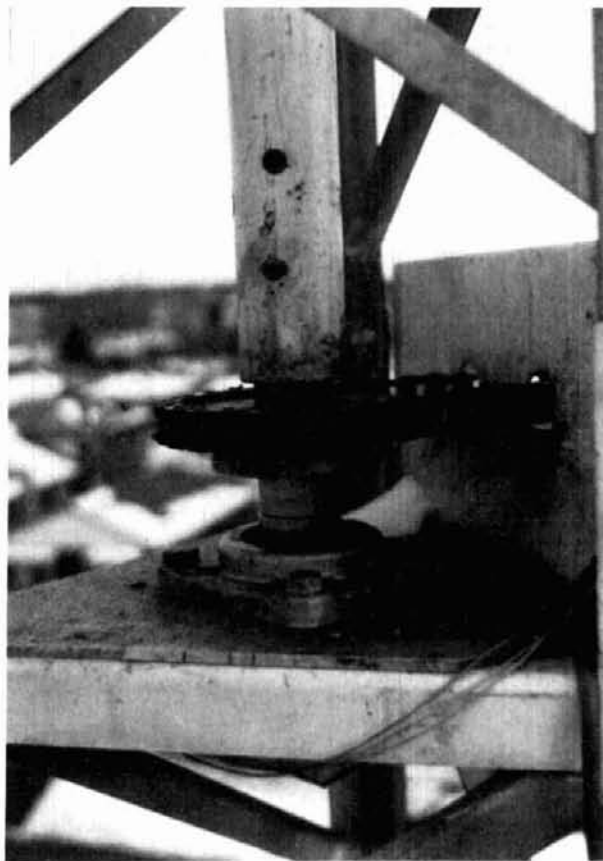

fig. 3. Completed mast assembly consists of chain drive steel pin and flanged cartridge.

the machined adapter shown in figs. 2 and 3. My unit's mounting holes were very close to the standard rotator mounting bolt pattern, so only a bit of

filing was necessary on the tower's existing mounting holes.

- **Sprockets.** These are quite similar to bicycle sprockets. The type I used is available for various shaft sizes and is keyed for convenience in mounting and to prevent any slippage between shaft and sprocket. When the sprockets are pinned with a piece of key-stock, slippage is impossible; no clamping method can ensure this.
- **Rolled pin (or split dowel).** This is a hollow steel pin with a slot running the length of it. It holds the mast adapter (fig. 2) in the mast, and is driven with a sledge hammer into a hole drilled through mast and adapter. The slot allows it to compress as it's driven in, for a tight fit. There are two good reasons to use a rolled pin or split dowel rather than a bolt: one, there's absolutely no free play — and any free play in a large system is dangerous, because the antennas can slam back and forth, loosening or even shearing hardware — and two, there's no protrusion as long as the correct length is used. I used two 2-inch (5 cm) rolled pins, each measuring 3/8 inch (9.5 mm) in diameter, at right angles. One is visible in the lower hole in fig. 3; the hole above allows ventilation to protect the mast against condensation. The pins are available in various sizes and lengths (check the Yellow Pages under *Fasteners — Industrial*), but are probably not available at your local hardware store.
- **Gears for the direction potentiometer.** Small aluminum gears in various ratios that gear down the mast rotation to drive the direction-indicator potentiometer are available from hobby shops. Make sure both gears have the same tooth size (pitch). This is readily visible; inspect carefully.
- **Chain.** Chain is available in various sizes from the same sources as the sprockets (see above). For the final drive to the mast, I used a No. 50 chain, which also happens to be a common motorcycle chain. Note that it's much cheaper to buy this from a motorcycle parts counter than from a machinery supplier. It may also be possible to scrounge the short length actually needed from a motorcycle or bicycle repair shop.
- **Keystock.** This steel rod, square in cross section, is available in 1-foot (30.48 cm) lengths. You cut the length you need with a hacksaw. The keystock fits into a keyslot machined in the sprocket and the shaft to prevent slippage.
- **Mast adapter.** This is a straightforward piece of custom-machined steel (fig. 2). The end with the two transverse holes slides into the bottom of your mast and is secured with two rolled pins through mast and adapter. The length of this portion isn't too critical, though it probably shouldn't be shorter



fig. 4. Bracing mounting plate to cross member prevents excessive flexing.

than 3 inches (7.6 cm), which is what I used, to minimize play. To determine the diameter for close fit, your machinist should measure the inside diameter of your mast, since it can vary significantly from nominal. Mine was 0.01 inch (0.5 mm) undersize, which means that if the adapter had been machined to nominal, it could not have been inserted! The sprocket fits into the middle part of the adapter, which should be long enough so you can line up this sprocket with the one on the gearbox. A key-slot should be machined to correspond to the key-slot in your sprocket. Be aware that sprockets for different shaft diameters will also use different key sizes. This portion was turned down to 1.5 inches (3.8 cm), which was the maximum shaft diameter for a keyed No. 50 sprocket with 24 teeth.

If you're using a large-diameter mast, I recommend machining a shoulder between the portion that slides into the mast and the portion that takes the sprocket. In this way, the shoulder takes the weight instead of the rolled pins or through-bolts.

The bottom part of the adapter, of smaller diameter, fits into the bearing in the flanged cartridge, resting on the shoulder formed by the middle part, which is of larger diameter. It should be long enough to protrude far enough below the rotor plate to mount a small gear for transmitting the motion to the direction pot. The end face was drilled and tapped in the center to take an insert onto which the gear could be mounted. Although the end could be machined down to the required 1/8 inch (3.1 mm) diameter, you would be unhappy if this little bit ever broke off. The insert is easy to machine.

The method described above for transmitting motion to the mast is superior to any mast clamping arrangement because the forces concentrated on this area are tremendous. The clamp on a popular commercial rotator has been known to loosen even in

# Take it with you.

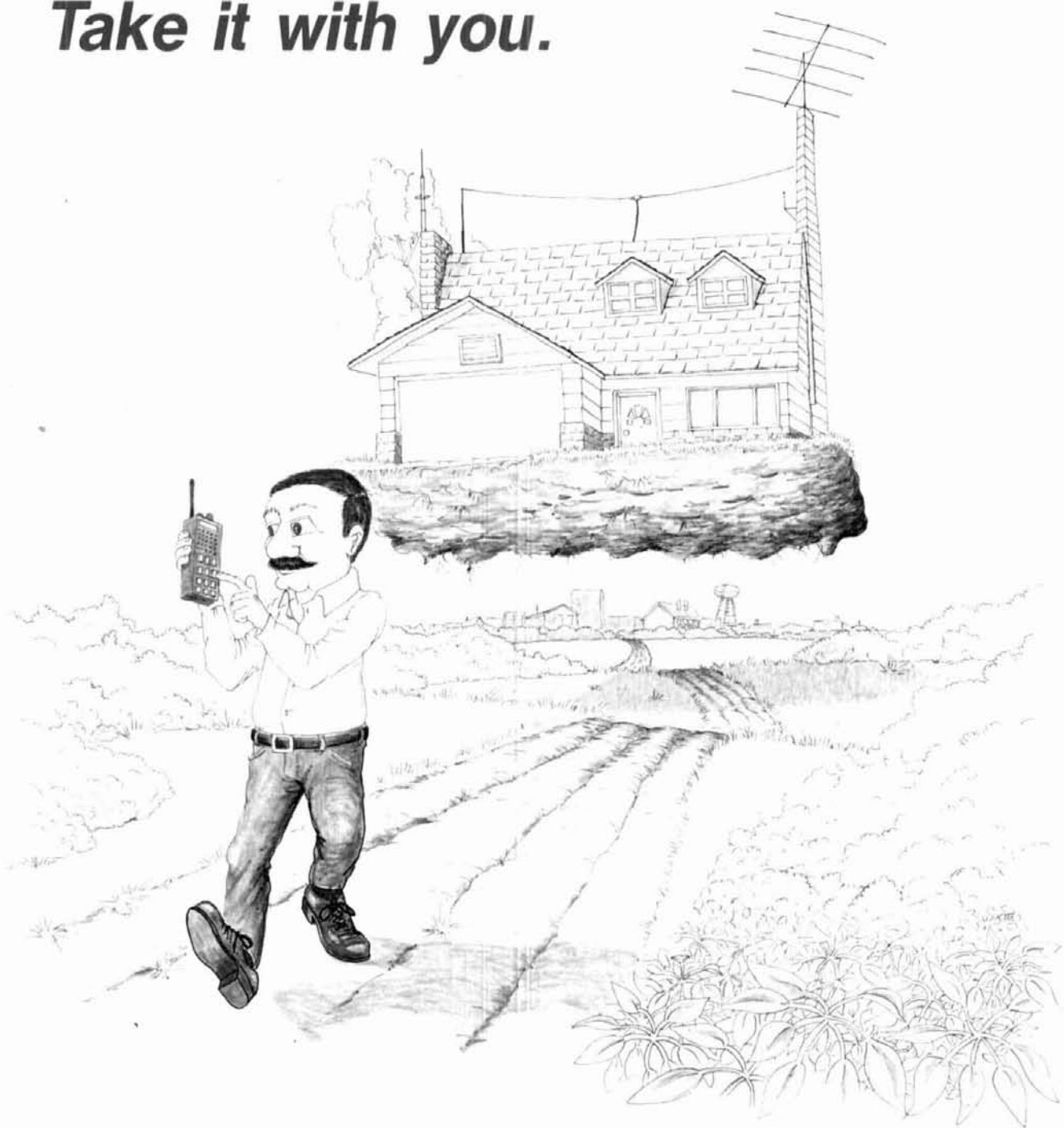

ShackMaster™ puts your home station in the palm of your hand. Whether portable, mobile, around the yard or around town you'll be linked through your handheld to your high performance equipment at home. Even call home from any Touch-Tone phone and operate.

Scan the bands, change modes, select antennas, turn gear on and off – all from your Touch-Tone keypad. Check into nets, work skeds, ragchew and DX without being tied down to the shack.

Exchange electronic mailbox messages with your family – like "I'll be late", or "All is OK". Or talk with your family directly through *ShackPatch*™, with you in remote control of your home station. Report traffic accidents or disabled motorists through your home phone while mobile or portable with *PersonalPatch*™.

All the power of your home station (and more) really can follow you anywhere... to find out more about ShackMaster™ just write, send us your QSL, or call and talk with us at 408-749-8330.

# acc

advanced  
computer  
controls, inc.

10816 Northridge Square • Cupertino, CA 95014

(408) 749-8330

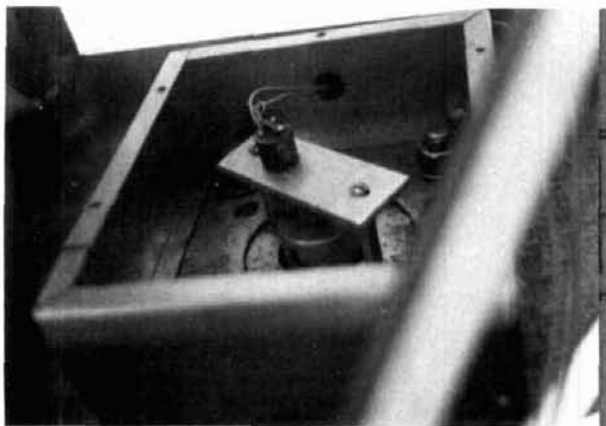

fig. 5. Rotation switch reverses output leads for reversing direction.

moderate winds, and the bolts have been known to shear altogether. A rotator manufacturer must accommodate a range of mast sizes, but you can make something that's perfect for the mast you're actually using.

As for having the machining done, any medium-size industrial town will have a number of shops that do general machining. I found one by driving through an industrial area and stopping at the first machine shop I saw; you may want to check the Yellow Pages or ask friends for their recommendations.

### final assembly

When the adapter has been machined, take your mast to the shop and have the machinist drill the holes through both pieces together. This also allows you to check the fit.

My objective was a rotation speed of approximately 0.7 rpm, as a compromise between speed of rotation and starting-torque stresses on the tower. In the case of giant arrays, 0.5 rpm or less may be preferable.

The sprockets were selected this way: I wanted to use the heaviest chain to the mast for which sprockets were available that would fit both the 5/8 inch (1.58 cm) gearbox output shaft and the 1.5-inch (3.8 cm) mast adapter. The Boston Gear catalog showed that sprockets for No. 50 chain were the biggest that would allow this.

To minimize the stress on the gearbox, I wanted the maximum possible reduction between gearbox and mast. With standard keyed sprockets, this was 9 teeth to 24 teeth. A much lighter chain (No. 35) could be used between motor and gearbox. To achieve the desired rotation speed with the motor and gearbox I had, a ratio of 9 teeth to 15 teeth was used between motor and gearbox. Luckily, the 15-tooth sprocket was also the largest sprocket that could fit on the gearbox input shaft without scraping the mounting plate.

The rotor is assembled on a piece of 3/16 inch (4.76

mm) hardened aluminum plate bought from a junkyard (also a good source of gearboxes). If normal aluminum is used, I would recommend at least 1/4 inch (0.635 cm) thickness. Steel is preferable because of greater stiffness, but is much harder to work with, especially when filing or cutting, since it can't be cut on a shear. The mounting holes for the motor and gear drive must be slotted to allow the chains to be tensioned. Since the main drive chain is too heavy to tension directly by hand, a mechanical method had to be incorporated. Fig. 1 shows the steel bar across the front face of the gearbox. Screws passing through it and the L-shaped blocks on either side of the gearbox are tightened to pull the gearbox in the direction away from the mast, thus tightening the chain. The gearbox mounting nuts and bolts are then tightened. The sprockets can be aligned by sliding them along the shafts, then securing them with the set screws. Fig. 3 shows the mounting plate braced to a cross member across the tower face to prevent excessive flexing.

If you live in the North, make sure the grease in the gearbox doesn't solidify at low temperatures. Also, build or buy an enclosure to protect the rotator against rain. (I built another small box below the rotor plate to house the direction pot.) The mounting holes for the potentiometer bracket should be slotted to allow alignment of the gears, as shown in fig. 4.

### electrical design

For obvious reasons, the motor must be reversible. A capacitor-start motor can be reversed by reversing the current in the starting winding. To do this, I used a 1:1 isolation transformer in the starting winding; the rotation switch reverses the output leads for the reverse direction (fig. 5). The starting winding is the one with the higher resistance; the other is the running winding. Since the entire motor is rated at 2.1 amperes, I would think that a 100-watt transformer would be more than adequate. Usually only three wires are brought out from the motor, since a common return is used for both windings. If you're lucky and find a motor with the windings brought out separately, no transformer will be needed for reversing.

### rotation switch and indicator pot

I didn't incorporate overtravel limit switches for a number of reasons. It was very awkward to mount microswitches and actuate them; also, many more heavy conductors would have been needed in the control cable. To minimize risk of overtravel, a spring-loaded rotation switch is used, with a center off position. Also, a meter was used for direction indication. Unlike a selsyn, this has no 0/360-degree ambiguity. If you want to use selsyns, install limit switches.

Since a pot turns only about 270 degrees, I used





# KENWOOD

...pacesetter in Amateur radio

**NEW**  
Compact 45 W 2

## 45 Affordable Watts!

### TM-201B/401B

#### Super-compact mobile transceivers

The TM-201B boasts a powerful 45 watts output, easy-to-operate front panel controls, and ultra-compact size. The GaAsFET receiver front end provides high sensitivity and wide dynamic range. Receive and transmit characteristics are tailored for minimum distortion and excellent audio quality. Both the TM-201B and the TM-401B are supplied with a high-quality external speaker, 16-key DTMF microphone and mounting bracket.

- 45 watt output, with HI/LO power switch (TM-401B has 25 watts output.) 5 W low.
- Dual digital VFOs  
TM-201B covers 142-149 MHz, includes certain MARS and CAP frequencies  
TM-401B covers 440-450 MHz
- 5 memories plus "COM" channel, with lithium battery back-up



- Programmable, multi-function scanning
- High quality external speaker supplied
- Audible beeper confirms operation

#### Optional accessories:

- PS-430 power supply
- TU-3 or TU-3A two frequency tone encoder
- FC-10 frequency controller
- MC-55 (8-pin) mobile microphone
- SP-40 compact mobile speaker

- SP-50 deluxe mobile speaker
- SW-100A/B SWR/power meters
- SW-200A/B SWR/power meters
- SWT-1 2 m antenna tuner
- SWT-2 70 cm antenna tuner
- PG-2K extra DC cable
- PG-3A DC line noise filter
- MB-201 extra mobile bracket



#### Optional FC-10 frequency controller

Convenient control keys for frequency UP/DOWN, MHz shift, VFO A/B, and MR (memory recall or change memory channel).

More information on the TM-201B/401B is available from authorized dealers.



25<sup>th</sup>  
Anniversary

## KENWOOD

TM-401B is similar to the TM-201B, but covers 440-450 MHz and is 25 watts.  
Specifications and prices subject to change without notice or obligation.  
Complete service manuals are available for all Trio-Kenwood transceivers and most accessories.

TRIO-KENWOOD COMMUNICATIONS  
1111 West Walnut Street  
Compton, California 90220

# secrets of successful low-band operation: part 2

Careful planning,  
quality components  
give DXing's "big guns"  
the competitive edge

**This concluding section** examines site requirements, lightning precautions, construction, maintenance, performance, and propagation. In addition, some of the most competitive stations reveal their plans for further improvements.

## siting

Though most stations surveyed opt for the highest, quietest location possible, several work within the *same constraints that the majority of us (the "little pistols")* must deal with. Those surveyed were asked to describe their sites in terms of near and far field topography, obstructions, and noise.

**Near field topography** is a description of the contours of land in the immediate vicinity (i.e., within approximately one wavelength) of the antenna system. Of those who responded to this question, 83 percent described their near field topography as being flat or having a negative slope; the remaining 17 percent indicated a positive slope. It's important to remember that especially on the lower bands, optimum launch angles often exceed 30 degrees, so perhaps that mountain range in your backyard doesn't have as deleterious an effect as it might on the higher HF bands.

**Far field topography** in which the land rises at some distance should have an even less pronounced effect on the reception and transmission of low-band signals. However, the actual slope is important (in both the near and far field) and can be determined through the

use of United States Geological Survey 7.5-minute (1:24,000) or 15-minute (1:62,500) maps.\* Those surveyed described their far field conditions in basically the same terms as near field: flat or negative horizon. For example, they used the words "flat to ocean," "flat many miles," "mountains 26 miles away," "top of hill," "top of ridge," "flat and drops off," "flat to within 1/2 mile in all directions," and "80 meters above local terrain." So you see what most of the big guns have in common: a good site — topographically speaking, at least.

**Obstructions.** In terms of obstructions on those sites, the worst offender appears to be trees. Yet many of the low-band installations depend on these trees for supporting wire antennas. To date I haven't seen any definitive studies indicating whether the presence or absence of trees greatly affects patterns or performance of low-band antennas. (Any reader who has information on this subject, please contact me.)

Many of those surveyed indicated "none" when asked about obstructions; it's no accident that the FCC at its various monitoring facilities has extremely stringent requirements with regard to the height and location of any obstructions (even in what's defined as the far field). Apparently development of many of the high-performance stations involved site examination and evaluation as a first necessary step. An example of a good near and far field site is seen from the boom's perspective of W6NLZ's 80-meter Yagi (**fig. 1**).

**Noise.** The oft-spoken adage, "If you can't hear them, you can't work them," certainly applies to low-band operation. (There are some who have a particular knack for working stations that just aren't there, but that's another story). The limiting factor in the reception of signals is noise, be it man-made or atmospheric.

\*Maps for areas east of the Mississippi are available in the United States from the United States Geological Survey, 1200 South Eads Street, Arlington, Virginia 22202. Maps for areas west of the Mississippi may be ordered from the United States Geological Survey, Box 25286, Federal Center, Denver, Colorado 80225. USGS maps are also sold by more than 1650 commercial dealers listed in the pamphlet, "Index to Topographic Maps," available without charge from either USGS distribution center listed above.

By Rich Rosen, K2RR, Editor-in-Chief, *ham radio*

After reviewing all the responses and assigning a range of 10 (no manmade noise whatsoever) to 1 (terrible), the average value appears to be around 8. Although most of the high-performance stations have a quiet noise environment, one of the top stations surveyed — with over 300 countries worked on 80 meters and well over 100 on 160 — described his location as “high noise,” with a 115-kv high-voltage line within 0.5 mile. Don’t give up hope for successful low-band operation if you have a high noise level. If it’s the result of faulty electrical equipment, power companies can be helpful in tracking down the source of the noise and correcting the problem.

Other sources of interference can sometimes be located using portable equipment (for example, a pocket AM radio with a ferrite loop or circuit designed especially for that purpose). Noise cancellation techniques have been used for many years with some degree of success.<sup>1,2,3</sup> Many who use directional arrays (phased verticals, for example) probably notice that switching the antennas around produces a noticeable increase or reduction in noise level. Sometimes it’s better to point the antenna’s null at the interference, trading off a dB or two of gain from the preferred signal direction. A suggestion from some of the veteran 160-meter operators is for newcomers to be aware of noise from TV horizontal oscillators, either your own or your neighbors’.

## lightning

The expression, “Into each life a little rain must fall” could be particularly applicable to big guns, whose large antenna systems are more exposed to the elements than others. Lightning poses a real threat to some of these stations, with their high towers and negative horizons. Precautions can be taken, however, and the danger lessened.

Two locations worthy of attention are in the shack and out at the antenna. Precautions taken at the shack include the simple expediency of disconnecting all transmission lines, grounding the equipment and/or antennas or a combination of both. Outdoor precautions include using antennas that are permanently DC grounded by design; for example, the base of a shunt-excited vertical is at DC ground. One method of DC grounding a horizontal wire antenna would be to attach a quarter-wave shorted stub (or odd multiple of a quarter wave) across the dipole’s feedpoint and ground it at the shorting bar at the opposite end. This technique, primarily used to drain off static charge, works well only if the antenna is used over a narrow band of frequencies. Otherwise the short reflects back to the feedpoint as other than an open circuit and must be accounted for (in matching). Some of those surveyed were quite satisfied that the grounding system designed as part of their antenna installation would prevent any lightning damage.



fig. 1. Sighting along boom of a KLM 4 element Yagi reveals unobstructed near field topography.

Even if a lightning discharge should occur at your antenna, shack damage is not inevitable. One “big gun” responding to the survey said he felt that by locating the antenna a considerable distance from the shack, the danger of damage occurring at the station end was greatly lessened.

Those who have taken direct strikes reported losses ranging from only a fuse box on one hand to almost total destruction of their home, with walls and windows blown out and ceilings collapsed. Anyone who’s ever experienced even a very close lightning strike knows that this is a subject to be taken seriously, with every reasonable precaution applied.

## construction

It’s one thing to design, on paper, a three-element 80-meter Yagi. It’s quite another matter to build, install, and keep it up. Wire antennas, though easier to install, still require an investment in quality materials, labor, and time.

Several of those surveyed built their own rotary Yagis. Noel, VE2HQ, described his efforts to construct his three-element, 515-pound, 43 square foot (wind-swept area) Yagi, the result of three years of planning, determination, and hard work, marked by several setbacks.

Working all winter in his basement, he built the linearly loaded elements, starting with 3-inch O.D. tubing and down to 0.5 inch in increments of 0.25 inch (11 different diameters). The linear loading was added 125 inches from the butt of each element by cutting the 2-inch diameter section, inserting a fiberglass tube and winding the coil with copper-clad wire. Additional element support was provided by double element guying on each side with Phyllystran.\*\*

The boom consisted of two 35-foot long flag poles

\*\* Phyllystran is a registered trademark of Philadelphia Resins Corp.



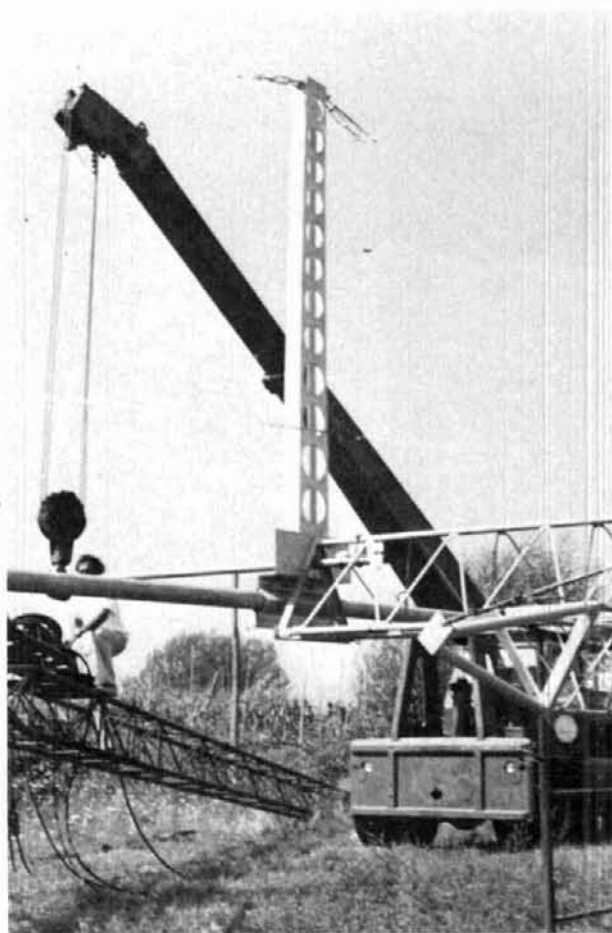

fig. 2. Vertical member and stays prevent element droop.

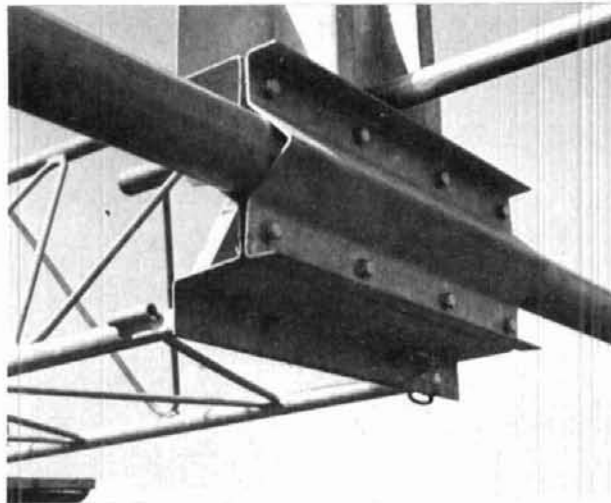

fig. 3. Method of attaching full length elements to boom involves use of 8 bolted through plate for mechanical rigidity.

(4.5 inch O.D., 0.25-inch wall) resulting in an overall length of 65 feet. At this point Noel had to consider what type of tower could support this heavy antenna. He purchased a commercial 60-foot tower

designed for supporting large microwave antennas and fabricated a 50-foot triangular extension measuring 33 inches on a side to be mounted on top of that.

The first time Noel installed his antenna at 110 feet, it resonated too high in frequency and had to be taken down. It was made to resonate at 3625 kHz at 15 feet above ground so that it would resonate at 3785 kHz at its final height.

Chris, 15NPH, erected an even larger three-element Yagi using full-size elements. A careful examination of **fig. 2** provides an appreciation of the size of the components used in this antenna. The structure at the right that looks like a tower is the end of the boom; the large tubing at the left, which looks like a large boom, is one of the parasitic elements. Notice the size of the vertical strut used to support the long elements. **Figure 3** shows the method used to attach the parasitic elements to the boom. When one considers the difficulty of installing a completed antenna, eight bolts in the element-to-boom clamp don't represent "overkill."

While W6RJ put his three-element KLM Yagi together on the tower, K3ZO completed his Yagi's construction on the ground and raised it with a 164-foot crane. WA1EKV used ropes strung from his tower in a vee to slide and pull his Yagi to the top.

Because wire antennas tend to break at the worst times, a quick means of lowering and raising them is necessary. Ropes, pulleys, and continuous halyards are successfully used by some to provide this capability. In addition, if you want your antenna to stay up, use the best quality material. One of those surveyed has had success with white/blue marine rope. Polypropylene rope, though less expensive, disintegrates after exposure to sunlight. It might take several years, but it *will* deteriorate; be sure to wear gloves when working with old polypropylene.

## installation and maintenance

Two more practical questions were asked of those questioned in this survey: "What precautions did you take in installing your system to make sure it would stay up?" and "What periodic maintenance procedures do you follow?"

In general the consensus of opinion can be summed up in a single word: *quality*. Though topnotch material costs more initially, it delivers years of consistent good performance and pays for itself.

The "big guns" offered specific advice on the subject of non-wire antennas (rotaries and towers). Here's what they recommend:

- Tighten all guy wires and clips to specification.
- Choose all materials carefully — anything that isn't aluminum or stainless steel will rust.
- Paint all towers and masts.
- Lubricate all moving parts properly.



## AMATEUR TELEVISION

**INTRODUCING OUR NEW SMALL ALL IN ONE BOX TC70-1  
ATV TRANCEIVER AT A SUPER LOW \$299 DELIVERED PRICE.**

### TC70-1 FEATURES:

- 10 pin VHS color camera and RCA jack video inputs.
- Crystal locked 4.5 MHz sound subcarrier.
- PTL (Push To Look) T/R switching.
- Dual gate GaAsfet tuneable downconverter.
- Two frequency 1 watt pep xmtr. 1 xtal incl.
- Xmit video monitor outputs to camera and jack.
- Small 7 x 7 x 2.5" for portable, mobile, or base.
- Draws only 500 ma (exc. camera) at 13.8 vdc.

Just plug in your camera, VCR, or computer composite video and audio, 70 cm antenna, 12 to 14 vdc, and you are ready to transmit live action color or black and white pictures. Sensitive downconverter tunes the whole 420-450 MHz band down to channel 3 on your TV set to receive. Both video carrier and sound subcarrier are crystal controlled. Specify 439.25, 434.0, or 426.25 MHz. Extra crystal \$15.

### WHAT ELSE DOES IT TAKE TO GET ON ATV?

Any tech class or higher amateur can get on ATV. If you already have a source of video and a TV, it costs about the same as getting on 2 meters.

DX with TC70-1s and KLM 440-27 antennas line of sight and snow free is about 15 miles, 7 miles with the 440-6 for portable use such as parades, races, search and rescue, etc. You can add one of the two ATV engineered linear amps listed below for greater DX.

At 70 cm, antenna height and gain is all important. Foliage can absorb much of the power. Also low loss tight braided coax such as the Saxton 8285 must be used.

The TC70-1 has full bandwidth for color, sound, and computer graphics. You can now show the shack, computer programs, home video tapes and movies, repeat SSTV or even space shuttle video if you have a TVRO.

**20 WATT SPECIAL \$399**

**SAVE \$9 on the TC70-1 & ELH 730G  
when purchased together**

### ACCESSORIES:



Mirage D24N 50 watt amp ..... \$189  
ATV, SSB, FM, 9 amps.

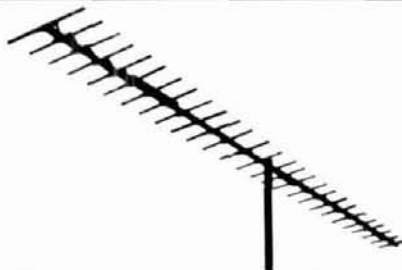

KLM 440-27 14.5 dbd antenna ..... \$89  
KLM 440-6 8 dbd antenna ..... \$38



Alinco ELH-730G 20 watt amp .... \$109  
ATV, SSB, FM, 4.5 amps.

With regard to wire antennas, they advise the following:

- Use quality halyards — for example, white/blue marine rope.
- Use steel line for the halyard section that goes over tree branches.
- Avoid the use of galvanized steel wire for radials.
- Protect all critical connections with a good weather-resistant sealant such as Coax-seal.®

Periodic maintenance procedures include:

- Tightening of guy wires, clips and hardware.
- Lowering wire antennas with pulleys to check the condition of the halyards, wire, and insulators.
- Cleaning insulators with a rag and water.
- Clearing foliage away from verticals.
- Repairing thin wire ground radial systems.
- Protecting systems with the same paint used on the undersides of boats.

Many of the big guns found that they experimented so frequently with new antennas that the short life cycle of their old antennas precluded the need for periodic maintenance.

## performance

The next question posed was, "How does your present antenna system perform in comparison to others — either your own or the competition's?" In general most felt that the latest was the best. Specifically:

**K3ZO** found that his three-element KLM rotary at 140 feet was 25 dB better than a half-wave sloper and up to 8 dB better than his previously used three-element, 80-foot boom delta loop beam.

**OH1RY** found his full-size three-element Yagi outperformed a dipole by 20 to 30 dB on the long path shot to the United States.

**4X4NJ** uses four tilted verticals on 160 meters, fed in various phase combinations with passive reflectors to create an electronically rotatable vertical beam system. He feels "it's almost as good as having a full rosette of Beverages, with the added advantage of having a good low-angle rotatable transmitting antenna."

**W2JB**, another 160-meter operator, stressed the importance of being able to *hear*. "Most of the DX runs low power and signals are usually at the noise level. That's where you need your Beverage antennas," he wrote.

**SP3GEM**, who trades off between a vertical and a delta loop, doesn't see much difference between the two in the favored delta loop direction. However, he prefers the vertical in other directions — that is, where the delta loop exhibits a null.

**KG7D**, like many others, believes slopers provide good performance by launching a low angle signal,

showing nulls off the sides, and having reasonable feedpoint impedances and consequently high efficiency.

One of the truly big signals from Japan on 80 meters, **JF11ST**, uses the Create Manufacturing CY-703 three-element Yagi and is very pleased with its electrical and mechanical performance. The specification sheet lists its forward gain, F/B ratio and 2:1 VSWR bandwidth as approximately 8.5 dBi, 20 dB and 100 kHz, respectively. JF11ST has his centered on 3.80 MHz, right in the middle of the Japanese SSB window.

**W1NH**, formerly W1SWX, can often be heard pulling out the rarest of stations on 80 meters, thanks to his three slopers and inverted vee from a 100-foot skyhook and six 1000-foot long Beverages. To illustrate its performance, he enclosed copies of QSL cards from VS5MC, HS5ABD (both short and long path) and JT0DAQ — all very difficult shots from the East Coast on 80.

**K5UR** attributes his success on the low bands to a superior receiving capability (Beverages once again). Considering that he holds the CQ Worldwide DX Contest U.S. record on 160 meters, his transmitted signal must also be outstanding to be heard above some of his competition on the East Coast. He does mention that his new 130-foot vertical appears to work noticeably better than his old 70-footer.

**YU7PFR's** three-element wire Yagi at 56 feet outperforms his previous single vertical or dipole while providing a 2:1 VSWR bandwidth of 250 kHz. With one of the strongest signals from Yugoslavia, he's consistently heard in the United States.

**SM4CAN** has noticed as much as a 6 dB improvement in signal level using his Bobtail curtain as compared to his gamma fed tower with 120 radials. However, on long path to the United States his delta loop performs better than the Bobtail *during the month of November*.

According to **SM6EHY**, it's possible to have too low an angle radiator. He says that his four-element phased vertical array just doesn't have that extra punch when high angle signals are propagated, and goes on to say that "the greatest advantage in using phased antennas is that you can reduce noise and QRM pickup from unwanted directions to such a degree that you can hear everything on the band."

**VE2HQ** compared his home-brewed three-element Yagi with a sloper at 155 feet and found the Yagi to be superior in terms of signal strength. He also estimated the front-to-back ratio to be 22 dB.

With over 300 countries worked on 80 meters, **W4DR**, in comparing his four-element phased vertical array with other antennas, says he believes that the really high horizontal beams still have the edge. **N4AR** uses a pair of phased Bobtail curtains on 80

meters and finds that the F/B ratio on low-angle signals is often in the 15-20 dB range and the front-to-side is "astronomical." He prefers this antenna over Beverages for receiving as well. He also says that having an antenna with noticeable gain and a very definite controllable pattern has provided him with insights on propagation on 80 meters. He's probably one of the few to have worked Laos (XW8BP) on 80 from the East Coast . . . .

Attributing his success to a two-element delta loop array, **DJOIA** says he's experimented with other antennas but keeps on coming back to it.

**W1FV**, showing true ham ingenuity, fit a well-designed and constructed phased vertical array into very narrow confines without any compromise in performance. He rates its overall performance on 80/75 meters as excellent. Winner of the single-band category in the 1984 CQ WW CW contest, he observed: "The vertical array is the best antenna I have ever used for the difficult paths (central Asia, Japan, deep Pacific, and Indian Ocean)." He has tried many slopers, high dipoles, and delta loops but finds the present configuration to be the best.

**EABADP** proves that sometimes a simple antenna can be a top performer if other conditions are met. His inverted vee has accounted for 225 countries worked on 80 meters in less than three years. He can normally be heard in the States when the rest of Europe is barely being copied. His inverted vee is supported at the 33-foot level on a tower atop a 148-foot high building situated on top of a hill.

## propagation

As far as I'm concerned, this has to be one of the most interesting areas considered in the survey. The perspective gained by being able to review responses from different countries, continents — and in general, both ends of a communications path — starts to explain observations made over the years but not understood. I feel fortunate to be the compiler of this information and I'll try to convey some propagational correlations and leave the rest to you. A special vote of thanks is due to **SM6EHY**, who provided an extremely detailed account of his observations made during 20,000 hours of listening on the low bands.

## 160-meter propagation

For those not familiar with 80 and 160 meters, there is a tendency to lump them both together as "those noisy, short-range bands." That static exists on the lower frequencies is undeniable; that the communications range is limited is true sometimes, but not always. How else could one explain stations working over 300 countries on 80 and 200 countries on 160 meters, given the right conditions and activity? Furthermore, 160-meter enthusiasts are quick to point out

that there's sometimes a world of difference between propagation modes on 160 meters and on 80 meters, and that one band should not be judged by the performance of the other. **K1MEM** best expressed this when he said "The basic creed is, don't go by 80-meter conditions to judge 160. 160 can be great to Europe or Africa when 80 is poor and vice-versa. QRN on one band is no indicator of the other. Also the beacons from Europe seem to have no relation to Amateur signals."

**K5UR** finds propagation to be best towards Africa and the Indian Ocean in the early evenings. At this time of day he's occasionally observed long path signals from Asia (YB, 9M, . . . ) coming from the direction of South America. The same stations are also heard on a skewed path at a bearing of 235 degrees in the morning. Signals from Russia appear on a bent path with a heading of 75 degrees.

From the northwest, **KG7D** believes that chordal propagation is the mode on 160 when Europe is being heard at his QTH, yet not being copied at other locations in the United States. He believes this occurs when the F1 and F2 layers fail to merge. "It would be nice to know the optimum takeoff angle for chordal propagation. For me it appears medium angle north/south, low to the east, and again medium angle to the west. Frequent openings do definitely occur along the terminator lines, with signals coming from over the poles. Frequently we see enhanced propagation effects from the auroral zone."

**VE7BS** found a good opening occurring to VK almost every day throughout the summer of 1985. It started well before his sunrise and ended well afterwards. The observation of this path, he believes, is largely a function of the operating habits of Australians, pointing out that in June and July, VE7 sunrise occurs at a reasonable time in the VK evening. At other times of the year — for example, when VE7's sunrise occurs at 1430Z — the VKs have already gone to bed . . . thus no communications. But the path may still exist. This is somewhat analogous to a tree's falling in the forest; is a sound made even though no one's there to hear it? The answer is an emphatic yes.

**SM6EHY** echoed this same point in discussing the polar path between Sweden and stations on the East Coast of the United States and in the Midwest. Stations can be worked from 0800 to 1200Z on 80. Bjorn believes that the same conditions should hold true for 160 and attributes the lack of contacts to the low level of activity in the northern United States at this time. Bjorn also wishes United States Amateurs would improve their receiving capability; for example, on the 10th of June he failed to attract the attention of W9s after 15 attempts. He also feels that 160 can open up on occasions to a degree that has never been observed on 80 meters. For example, ZL3GQ was 599



# ST-8000 HF-MODEM



The ST-8000 HF MODEM is a high-performance, fully adjustable modulator/demodulator for use in high-frequency radio data systems. The HF Modem features fully adjustable frequencies and baud rates, memories, diversity, regeneration, print squelch, CRT tuning indicator, and multiple AM or FM detectors. The bandwidths of the input filter, Mark filter, Space filters, and post-detection filters are tracked with the selected data rate (10 to 1200 baud) to assure optimum signal recovery for all signals. Front panel parameters may be controlled from an external ASCII terminal or computer. A full complement of I/O interface options allows use of the ST-8000 with virtually any terminal and radio system. Install the HAL DS3100ASR CRT terminal and ST-8000 HF Modem in your communications system and enjoy the benefits of a data system designed for radio operators.

- Tuneable from 500 to 4000 Hz in 1 Hz steps
- Set 10 to 1200 Baud in 1 baud increments
- Four input band-pass filters
- 32 matched Mark and Space filter bandwidths
- Mark and Space 7-pole linear phase LP filters
- Filter BW and selection computed and set by microprocessor front panel controls
- RTTY shifts from 40 to 3500 Hz
- Eight programmable non-volatile memories
- Split or transceive RX/TX tone selection
- FM or AGC-controlled AM signal processing
- 65 to + 20 dBm dynamic range (AM or FM)
- Exclusive HAL Digital Multi-Path Correction (DMPC™)
- M/S, Mark Only (MO) or Space Only (SO) detector modes using Adaptive Threshold Detector (ATD™)
- Adjustable Print Squelch and non-diversity Amplitude Squelch
- Exclusive HAL Infinite Resolution Diversity Control (IRDC™)
- Digital signal regeneration
- ASCII/Baudot code and speed conversion
- Quick Brown Fox and RYRY . . . test message generator
- Programmable Selective-call (SEL-CAL) printer control
- Transmitter PTT KOS control
- Antispace
- RS232C, MIL-188C, or TTL Terminal I/O
- LP1200 Option for polar or neutral loop
- 8, 600, or 10K ohm input impedance
- 8 or 600 ohm output with adjustable level
- AFSK or FSK transmitter outputs
- Remote terminal or computer control of all demodulator parameters
- Exclusive HAL Spectra-Tune™ and X-Y Mark/Space CRT tuning indicators with automatic trace on/off control
- 100-130/200-250 VAC, 44-440 Hz power
- 3.5" high rack mounting cabinet (14" deep)
- Shielded and filtered for radio system use

™ Infinite Resolution Diversity Control (IRDC), Spectra-Tune, Digital Multi-path Correction (DMPC), and Adaptive Threshold Detector (ATD) are trade marks of HAL Communications; patents pending.

Write or call for complete ST-8000 specifications. We think you will agree that it opens new frontiers in radio data communications. Contact the Government & Commercial Products Division for price and delivery information.



**HAL Communications Corp.**  
Government & Commercial Products Division  
1201 W. Kenyon Road  
P.O. Box 365  
Urbana, IL 61801-0365  
(217) 367-7373 TWX: 910-245-0784

+10 dB at 1652Z on December 24 for about 1 minute. The best he's been able to observe on 80 was 589 over both the short and long path.

## 80-meter propagation

Consisting of two DX segments separated by approximately 300 kHz, 80 meters sometimes also acts as if it were two different bands. Conditions can be excellent on the short path to Europe on SSB and poor on the CW portion and vice-versa.

More responses were received for this band than for 160 meters. Consequently the subject is divided into several sections: short path, bent path, long path and other influences.

• **Short path.** For the most part, those surveyed concentrated on the unusual paths either long path, bent, or skewed. Perhaps it's because the normal great circle path is in reality not all that common or at least certainly not as exciting. If one assumes that several "short paths" exist between two locations at the same time and one path is more severely attenuated than the other, then it's reasonable that the latter path (non great-circle) will be observed as the only path and classified as a bent path. For example, suppose a station in New Hampshire is in contact with a station in the U.K., and that they're both using single verticals. If at the time of the QSO the geomagnetic field is disturbed and the normal great circle path, at a bearing of 54 degrees, is severely attenuated, then signals coming from the second path, off the coast of North Africa, will provide the only viable means of communications. This situation, which has often been observed over the past several years from K2RR to the U.K., normally coincides with a fairly high K index. However, even the latter path disappears at still higher values of K approximately 24 to 36 hours after a major solar event. It's at these times that only signals from the South can be copied and usually only unilaterally. A case in point was during the recent Revilla Gigedo expedition, **XF4MDX**. It was as if a traveling blanket of absorption was moving from north to south. A few minutes after the fortunate contact, the signal from XF4 simply vanished. One could observe this effect by listening to which stations were able to get through W1 to W2 to W3, etc.

From his location in Louisiana, Mike, **NW5K**, is able to work into Africa between 0330 and 0630 and into Europe between 0600 and 0700Z via the short path.

Roy, **ZL4BO**, finds that the normal short path into Europe can vary as much as 30 degrees during his (southern) winter.

## bent path

The term "bent path" can probably best be explained by saying what it's not: it is *not* a short or long great circle path. Can we then consider the vast num-

ber of other possibilities as bent paths? Were it only that simple! Perhaps it's more accurate to say that any path that's strictly not great circle, short or long, contains some element of bending. Remember, the distances covered in some cases are to locations more than halfway around the globe, where the time-varying ionospheric layers are in a different state of flux. Perhaps the signal starts out on a great circle path, only to be diverted by conditions along the way. Maybe this also explains why some of the paths appear to be unilateral or one-way; wouldn't conditions between the stations have to be the mirror-image of each other to be reciprocal? One way to analyze this effect scientifically might be through the use of simultaneous encoded transmission beacons, each with its own directional antenna at both ends of each path, with each transmitter keyed to an atomic clock. Precise time measurements would then determine the path interval and at least its length. But this, some might say, would take the fun out of Amateur Radio. Isn't it the unpredictability of the arrival of signals from exotic locations that makes DXing so exciting?

But I'm straying from the subject. Let's get back to which bent paths, under what conditions, have actually been observed.

Using a three-element Yagi, **W6RJ** observes that most northern European openings are bent somewhat to the south. Furthermore, he states that two stations with coinciding sunrise and sunset times can communicate 90 percent of the time, in the absence of high QRN levels.

**ZL4BO** attributes his success in bent path propagation to his extreme southern latitude, utilizing the path over both the North and South Poles when the normal (short path) and long path conditions aren't good.

**SM4CAN** notices that the best direction for working United States stations "short path" is at a bearing of 270 degrees as opposed to the indicated 330-degree great circle azimuth. During auroral conditions, he has worked **W6NLZ** with signals appearing to come from South America; this correlates with Peter's (**W6NLZ**) observation from his end of the path.

**N4AR** has observed signals from Japan, Hong Kong, and Indonesia from the Southwest. In fact, he always hears **VS6DO** and **YB5ASO** more strongly on this bent path than from the great circle direction. "This bent path is clearly in the direction of the terminator line [Gray-line — Ed.] and somehow these far eastern Asiatic and Pacific signals scatter into the terminator line path," he says.

Using his full-size three-element Yagi, **OH1RY** observes signals from Hawaii at a bearing of 90 degrees (east), whereas great circle calculations would indicate a northerly direct path.

**W1FV**, as well as many others on the east coast of

the United States, has observed the same bent path towards Japan and Southeast Asia in the morning by beaming to the southwest. Not only have other stations observed this path, but they've also seen it change abruptly (within a matter of minutes) from the southwest to the northwest when hearing Japanese stations. Using a rapidly switched phased vertical array, John finds that it often exhibits ill-defined directional characteristics for long-haul paths around sunset and sunrise, although the antenna is otherwise quite directional. "Perhaps this is explained by multipath propagation or some unusual radiation-angle and/or polarization effects?" he wonders, adding that "this ill-defined directionality is also noted on most signals during periods of a disturbed geomagnetic field."

## long path

It's not uncommon to hear stations calling CQ long path around sunset from the east coast. What are they hoping to accomplish? And what's this phenomenon called "long path?" It's reasonable to assume that the practice first gathered momentum with stations on the higher HF bands — for example, on 20, 15, and 10 meters years ago. They observed that it was possible to contact stations by pointing their highly directional antennas in the opposite direction of the great circle short path. At the time very few stations on 80 meters had directional antennas and it was even less likely that *both* stations at opposite ends of the path would have directional arrays. That long path contacts occurred on 80 meters in those years was, however, certain; they just weren't called "long path." (I would like to hear from anyone who operated 80-meter long path years ago.)

**N4RJ**, **W4DR**, **K2FV** and **W1FV** have been able to work into western Australia, Indonesia, and Japan at their sunset by beaming southeast, utilizing primarily the "long path."

From the other side of the path, **VK6LK** finds that his long path opening to the East Coast of the United States normally starts about 15 to 20 minutes after his sunrise and lasts 20 to 30 minutes when the conditions are good. "My first long path opening was with **W1FC** on 13 September this year, and I would expect the path to close sometime next May. One problem here is short skip from **YB**. They can drown the weaker long path signals from the United States." From Japan, **JA1FRE** has also noticed the existence of a US-JA long path through his (reception) observations of east coast United States stations at 2130Z.

Other, long path shots not well known by US stations of course still occur. **JA1FRE** works into the UK and Scandinavian countries at 0800Z, taking advantage of this mode. **SP3GEM** and other European stations are able to work into the Pacific areas using the long path. **K5UR** has a morning long path into Europe

that isn't too common, but when it does occur, produces high signal levels.

Using his phased Bobtail curtain, **N4AR** has shown how reliable the early morning long path into central Asia can be. He has maintained a schedule over the years with **UL7GW**, talking to him approximately 100 times per season using this mode. "During that period, many other Asiatic Russians were easily worked on a daily basis," he wrote. Besides these USSR stations, he also worked **XW8BP** and other southeast Asians at this time of day.

What's even more interesting is that he found that the path essentially disappeared during the sunspot *minimum* of 1974-1975. This is contrary to the widely accepted belief that sunspot *minimum* years provide the best low-frequency DX. **N4AR** commented, "While stronger signals (during this period) were evident from Europe in the evening and an occasional **UA9** or **UL7** QSO was possible in the evening, for all practical purposes the morning long path disappeared."

As stated earlier, this path returned during the most recent solar maximum. Fortunately at that time, **HS1ABD** and **UL7GW** were again active, serving as markers for band openings.

**N4AR** remarked that with the phased Bobtails, "There's no question deciding if signals are indeed coming from the direction of the long path. This tends to be along the terminator line during the 1130 to 1230Z window. Looking at the MUF limited F2 hops doesn't seem to explain the loss of signal (during sunspot minimum) adequately. In any event, it's certainly a real phenomenon, at least from this part of the world."

**SM6EHY** disagrees with the contention that a true long path condition exists with signals *originating* and *terminating* in the same hemisphere. "Long path — with the meaning of true long path direction — does not occur on 80 meters," he wrote. Signals arriving at **SM6EHY**'s QTH from **KL7**, **KH6**, **VE7**, **W7** and **W6** have the same azimuth angle: 110 degrees. "They arrive at a very high angle (50 to 60 degrees), with some noticeable echo. This holds true only for the same hemisphere. Signals coming from the southern hemisphere have all true azimuth angles for both short and long paths." He also believes that at **W0**, **W6**, and **W7** sunrise, stations should not be beaming long path but using the Arctic path instead.

## other influences

Through his 20,000 hours of low-band observations, **SM6EHY** credits the significant influence of the aurora on propagation. "The conditions this far north are very heavily affected by aurora with regards to paths to stations in the northern hemisphere such as **JAs** and **Ws**. The maximum particle radiation from the sun (which causes the aurora) is predicted to occur ap-

The HF4B "Butterfly"™  
A Compact Beam  
for 20-15-12-10 Meters

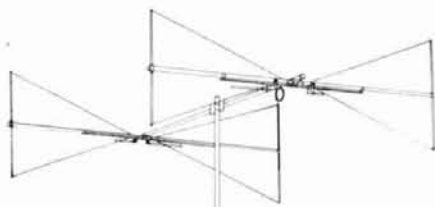

HF ANTENNAS FROM BUTTERNUT

- Unique design reduces size but **not** performance.
- No lossy traps; full element radiates on all bands.
- Retrofit kit for 17 meters coming soon.
- Turns with TV rotor
- Only 17 lbs.

**Butternut Verticals**

Butternut's HF verticals use highest-Q tuning circuits (not lossy traps!) to outperform all multiband designs of comparable size!

**Model HF6V**

- 80, 40, 30, 20 15 and 10 meters automatic bandswitching.
- Add-on kit for 17 and 12 meters available now.
- 26 ft. tall

**Model HF2V**

- Designed for the low-band DXer
- Automatic bandswitching on 80 and 40 meters
- Add-on units for 160 and 30 or 20 meters
- 32 feet tall - may be top loaded for additional bandwidth.

For more information see your dealer or write for a free brochure



**BUTTERNUT ELECTRONICS CO.**

405 East Market Lockhart, Texas 78644



**COMPUTER PROGRAMS FOR THE RADIO AMATEUR**  
by Wayne Overbeck, N6NB,  
and Jim Steffen, KC6A



Here's the first source book of computer programs for the Radio Amateur. Besides covering computer basics, this book gives you programs that will help you log, determine sunrise/sunset times, track the Moon's path across the sky, use Greyline propagation and set up record systems for WAS, DXCC and VUCC, or any other award. You can either buy the book alone or you can buy the book with the programs already on disk. Take full advantage of your computer with this well written source book. ©1984, 1st edition, 327 pages.

- HA-0657 Softbound \$16.95
- HA-0657 with program \$29.95  
specify computer (see list below)
- Program disk alone \$19.95

Programs available for: Apple II (DOS and CP/M), IBM (DOS), TRS-80 Model I and Model III and Commodore C-64. Please mark your order with the program disk you want.

Please include \$3.00 shipping and handling.

**Ham Radio's Bookstore**  
Greenville, NH 03048

**Learn Radio Morse Code**

on your IBM PC, PC JR.,  
PC-XT, PC-AT, or IBM compatible  
with

**CODE TUTOR**

- Learn the letters, numbers, and punctuation marks
- Practice receiving code at any speed from 1 to 40 words per minute (like having your own code machine)
- Includes 10 user-alterable messages, help screen, and function menu

**\$9.95 Postpaid**

**ARCHWAY DATA SYSTEMS**

13 Timber Road  
Edison, NJ 08820

✓ 112

**Our Very-Hard-To-Find Components List**

<b>CAMBIAN RF CHOKES</b>		
.15µh, 22µh, 33µh, 47µh, 10µh.....		1.20 ea.
<b>UNDERWOOD/SEMCO METAL-CLAD MICA CAPACITORS</b>		
Type J101: 5 pf, 10 pf, 15 pf, 25 pf, 30 pf, 40 pf, 60 pf, 80 pf, 100 pf, 200 pf, 250 pf, 390 pf, 470 pf.....		1.60 ea.
Type 3HS0006: 25 pf, 30 pf, 35 pf, 40 pf, 56 pf, 68 pf, 91 pf.....		1.60 ea.
Type J102: 1000 pf.....		2.00 ea.
<b>P.C. BOARDS FOR MOTOROLA BULLETINS</b>		
AN-762, EB-27A, EB-63, AN-758, EB-67.....		14.00 ea.
AN-791.....		10.00 ea.
<b>FERROXUBE DEVICES</b>		
VK200 20/4B RF Choke.....	1.20 ea.	56-590 65-3B Ferrite Bead..... 0.20 ea.
<b>MISCELLANEOUS</b>		
Arco 403 Trimmer Cap 3-35 pf.....	1.80	SBL 1 Double Balanced Mixer..... 6.50
Sprague GYA10000 Poly Trim 2-10 pf.....	1.10	T25-10 Toriod Core..... 0.40
NF2-12V Aromat Relay.....	6.25	T37-3 Toriod Core..... 0.40

We also carry a line of VHF, UHF amplifiers and ATV equipment.  
Call or write for our free catalog.



**CCI Communication Concepts Inc.**

2648 North Aragon Ave • Dayton, Ohio 45420 • (513) 296-1411



✓ 110

**COLLINS KWM-380 KEYBOARD**

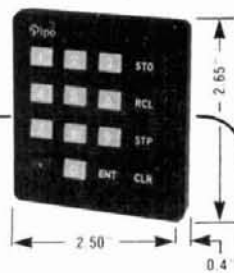

Pipo Communications Has The Keyboard That Is Used With The Collins KWM-380 For Remote Entry.

KEYBOARD-MOUNTING FRAME & SHIPPING \$25  
To know more about our Touch-Tone® Encoders,  
CALL OR WRITE FOR FREE CATALOG & INFORMATION GUIDE.

Pipo Communications  
P.O. Box 3435 • Hollywood, CA 90078  
213/852-1515

\*AT&T

**Pipo Communications®**  
Emphasis is on Quality & Reliability

✓ 113



proximately two years after the sunspot maximum. In this last cycle the aurora has consistently occurred from December, 1981, until now (March, 1986) leaving the polar path open only on special occasions." When this polar path is open SM6EHY can work the east coast and midwestern United States from 0800 till 1200Z. Japanese stations can be worked 24 hours a day. This occurs from mid-November until mid-February, when the path is open.

### where is this auroral activity?

SM6EHY continued, "The aurora expands between Spitzbergen (JX) and northern Norway (LA) and under most conditions the maximum activity is experienced close to 64 degrees N (latitude). From 144 MHz observations, the reflection belt travels from the far east through the north to the west and then disappears. Occasionally, it's the other way around.

Bjorn went on to mention that the aurora can change very rapidly — within a period of seconds — virtually closing down a good path. When the auroral activity is *south* of his location the "arctic is like an open field where signals experience very little attenuation."

### what other paths does it affect?

"A bent path has been observed during auroral activity," Bjorn wrote. "The signals coming from W1 [stations] just cannot travel through the arctic region [the auroral can be considered to be a 0 to 30 dB pad, depending on the level of activity and signal path — Ed.] and must be reflected in an area close to the equator and other places at the same time. This causes the signal to be heard with some echo and QSB."

### benefits of a low-angle radiator

With his phased vertical array and large ground system, Bjorn feels he's able to launch an extremely low-angle signal that can go *under* the aurora's attenuation belt. "The lower you go in frequency, the more important is the takeoff angle; the angle fluctuations are more pronounced at lower, rather than higher, frequencies," he said.

Bjorn believes it's important to transmit at angles between 0 degrees and 10 degrees on 80 meters. "A low takeoff angle antenna can be used very effectively during auroral activity to contact some stations at least *part of the way* through the auroral region. A case in point is when he's not able to hear the W1s, but can still work OX or VE8 stations with good signal strengths."

### ducting

Another propagation mode noticed by SM6EHY and others involves signals entering at one location, traveling and being trapped between ionospheric lay-

ers, and finally exiting at a second location, whereby stations in-between cannot copy either end point. Specifically, on north-south paths signals from stations as far south as 15 degrees follow normal paths. Further south, ducting appears to occur. There are times when Swedish stations north of SM6EHY are able to communicate with South Africa but not be heard by him.

Ducting also possibly occurs on the North Atlantic path between the east coast of the United States and Europe. This might explain the high signal strengths received across the Atlantic by stations using low dipoles that launch high-angle signals. If it were simply a case of multihop propagation between the ionosphere and earth, signal levels would be lower. However, reflections *between* layers, on the other hand, would account for less loss. The entrance and exit requirements for ducting might be high-angle.

### when are low-band conditions best?

SM6EHY echoes the sentiment expressed by N4AR that low-band conditions are probably best during the period of maximum solar activity (sunspot maximum). He explains that it's probably not noticed, since proportionately fewer stations operate on the low bands when the MUF is high and 10 through 20 meters are more heavily utilized at that time. It's possible to test this hypothesis during the next sunspot maximum, because there'll be more stations on than ever before using high-performance directional 80-meter antennas.

### disturbed geomagnetic field affects path

N4AR kept close track of WWV's A and K indices for many years and believes that neither the bent path nor the great circle long path appear to be beneficially influenced by geomagnetic disturbances. However, with the onset of a geomagnetic field disturbance, spectacular increases in signal strength are occasionally evident over the short path. Also observed by others, the latter situation is normally a precursor of the arrival of the lower energy electrons from the sun 24 to 36 hours later and its associated high level of D layer absorption.

### plans for the future

Because improvements are always possible in any station — big guns not excluded — the final question asked in the survey was "What improvements are you considering making to your station?" The responses to this question included ideas for improving receiving capability, installing higher performance transmitting arrays, increasing tower height, using a bigger radial system, installing lower loss transmission line and even acquiring a better site.

• **Receiving capability improvement.** K3ZO wants to improve his 160-meter reception in general. N1ACH

# K.V.G. CRYSTAL PRODUCTS



## 9 MHz CRYSTAL FILTERS

MODEL	Appli- cation	Band- width	Poles	Price
XF-9A	SSB	2.4 kHz	5	\$53.15
XF-9B	SSB	2.4 kHz	8	72.05
XF-9B-01	LSB	2.4 kHz	8	95.90
XF-9B-02	USB	2.4 kHz	8	95.90
XF-9B-10	SSB	2.4 kHz	10	125.65
XF-9C	AM	3.75 kHz	8	77.40
XF-9D	AM	5.0 kHz	8	77.40
XF-9E	FM	12.0 kHz	8	77.40
XF-9M	CW	500 Hz	4	54.10
XF-9NB	CW	500 Hz	8	95.90
XF-9P	CW	250 Hz	8	131.20
XF-910	IF noise	15 kHz	2	17.15

## 10.7 MHz CRYSTAL FILTERS

WRITE FOR FULL DETAILS OF CRYSTALS AND FILTERS  
Export inquiries Invited Shipping: \$3.75

## MICROWAVE MODULES EQUIPMENTS

Use your existing HF or 2M rig on other VHF or UHF bands.

### RECEIVE CONVERTERS

MMk 1691-137	259.95
MMk 1296-144G	169.95
MMc 439-ATV	94.95
MMc 432-28(S)	59.95
MMc 144-28(HP)	69.95
MMc 144-28	54.95

### LINEAR TRANSVERTERS

MMI 1296-144G	329.95
MMx 1268-144	239.95
MMI 435-28(S)	279.95
MMI 432-28(S)	259.95
MMI 144-28(R)	309.95
MMI 144-28	179.95

## LINEAR POWER AMPLIFIERS

2M		70cm	
MML 144-30-LS	124.95	MML 432-30-L	199.95
MML 144-50-S	129.95	MML 432-50	229.95
MML 144-100-S	219.95	MML 432-100	384.95
MML 144-100-LS	219.95		
MML 144-200-S	384.95		

## ANTENNAS

2M:			
10XY-2M	\$69.95	LOOP YAGIS	
70cm:		1268-LY	\$49.95
70/MBM28	\$39.95	1296-LY	49.95
70/MBM48	64.95	1691-LY	59.95
70/MBM88	94.95	order loop yagi connector extra	



Send 66¢ (3 stamps) for full details of all our VHF & UHF equipments and KVG crystal products

Shipping: FOB Concord, Mass.



# si

(617) 263-2145

**SPECTRUM  
INTERNATIONAL, INC.**

Post Office Box 1084  
Concord, MA 01742, U.S.A.

## BASEBALL CAP

How about an attractive **BASEBALL** style cap that has name and call on it. It gives a jaunty air when worn at Hamfests and it is a great help for friends who have never met to spot names and calls for easy recognition. Great for birthdays, anniversaries, special days, whatever occasion.

Hats come in the following colors:  
**GOLD, BLUE, RED, KELLY GREEN**

Please send call and name (maximum 6 letters per line).

UFBC-81

\$6.00

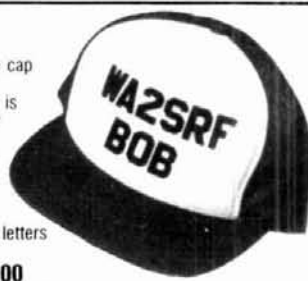

## I.D. BADGES

No ham should be without an I.D. badge. It's just the thing for club meetings, conventions, and get-togethers, and you have a wide choice of colors. Have your name and call engraved in either standard or script type on one of these plastic laminated I.D. badges. Available in the following color combinations (badge/lettering): white/red, woodgrain/white, blue/white, white/black, yellow/blue, red/white, green/white, metallic gold/black, metallic silver/black.

UID Engraved I.D. Badge

\$2.50

## Ham Radio's Bookstore

Greenville, NH 03048

Please Enclose \$2.00  
to cover shipping and handling

wants to lengthen his 160-meter Beverages from 1.5 to 2.0 wavelengths. **4X4NJ** looks forward to an improved R4C for 160 meters. **SM4CAN** wants to use better Beverages. **N4RJ** feels that his Beverages could be better tuned and that adding a preamp at the antenna would help. **K1MEM** will terminate his Beverages and run additional ones SE and SW.

• **Transmitting array improvement.** **VE3BMV** wants to put a two- or three-element quad on his tower. **OH1RY** wants to install a two-element shortened 160-meter rotary. **OE6MBG** would like a two-element driven IV beam; **K2FV**, an additional half square. Phased verticals or phased delta loops would please **SP3GEM**. **KG7D** plans a three-element 160-meter parasitic vertical array using shortened elements. **JF1IST** would prefer a four- or five-element 80-meter rotatable Yagi. **DL0WU** wants a three-wavelength on a leg 80-meter rhombic; **K5UR**, a two-element phased 160-meter vertical array. **YU7PFR** would like to construct four- or five-element wire Yagi, and **SM6EHY** a four-element 160-meter phased vertical array. A three-element full-size 80-meter Yagi at 160 feet would interest **VE2HQ**; **JA1FRE** would enjoy a two-element full-size Yagi. **W4DR** wants an 80-meter horizontal beam at 150 feet. **W6RJ** plans to raise his existing 80-meter three-element Yagi on his tower.

Other items on the big-gun wish list include increasing tower height (**PA3DFU**), adding more radials (**W3BGN** and **W1FV**), and using lower loss cable; **W1NH** wants to switch to hardline coax to reduce losses on his 500-foot run to the antenna. **WB2ITR** expresses a commonly felt need for a new site, one that has more land and better topography.

## conclusion

Well, now we have it: the secrets of successful low-band operation. Well, not quite. One necessary ingredient that's hard to quantify is, of course, the desire to succeed — in this case, to have the very best signal on the band. Besides the other three factors mentioned before (hard work, time, and expense) there's also the dream, the enthusiasm that keeps you climbing to greater heights, laying out just ten more radials and extending that Beverage even further, hoping that one night as you're scanning, that BY4 will come pounding through on 3.505 with a never-before-heard clarity and strength.

## references

1. William J. Prudhomme, WB5DEP, "Man-Made Interference: Causes and Cures," 73, September, 1971, page 78.
2. Jim Fisk, W1DTY, "Locating and Curing Noise Sources," *ham radio*, December, 1970, page 12.
3. Chapter 22, *From Beverages Through OSCAR: A Bibliography*, published by Rich Rosen, K2RR, 1979.

ham radio

# MIAMI'S LEADING YAESU DEALER..

## N&G DISTRIBUTING CORP.



**YAESU**



**FRG 9600**  
60-905 MHz Scanner



**YAESU**

**FT 757 GX**  
All Mode H.F.  
Transceiver

**YAESU**



**FT 270 R/H**  
2 Meter 45 Watt  
Mobile



**FT 209**  
R/H  
2 Meter  
5 Watt  
H.T.

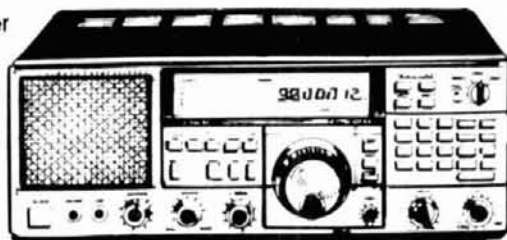

**YAESU**

**FRG 8800**  
General Coverage  
H.F. Receiver



**YAESU**

**FT-ONE**  
All Mode H.F.  
Transceiver

### N & G Airport

"Right next to Miami Int. Airport."

**7201 N.W. 12th St. Miami, Fla. 33126**

(Dade)

(Broward)

**1-(305) 592-9685 1-(305) 763-8170**

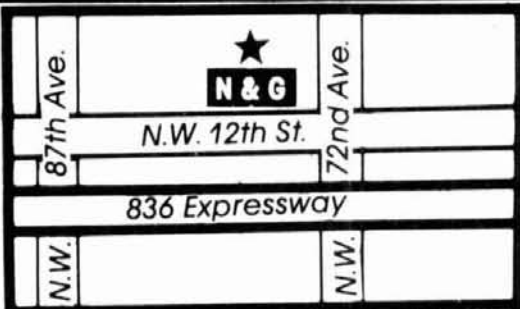

**NOSOTROS LE ENTREGAMOS SU ORDEN A**  
cualquier **EXPORTADOR, EMBARCADOR,**  
al **Aeropuerto Internacional de Miami**  
**GRATIS!** . . . Llámenos desde cualquier  
parte del mundo y le preparemos su  
**ENVIO a SU PAIS.**

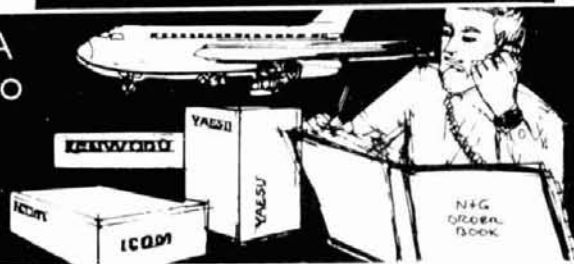

# ham radio TECHNIQUES

Bill Over  
W6SAI

## a wrangle over Wrangell

**Want to work a "new country?"** Maybe you can. Unknown to most radio Amateurs, the United States has claims to Wrangell Island (UA0) and other island territories north of the Soviet Union. The situation isn't clear, and maritime-boundary discussions about this region — spurred on by the discovery of oil — are underway.

In a recent editorial *The Wall Street Journal* called attention to deliberate Soviet harassment of U.S. drilling rigs in the Navarin Basin. This harassment, which includes dangerous overflights by Soviet aircraft, is one of several subjects of discussion between the two powers. Although the issue bears watching, only limited information about it has appeared in the daily press.

Little-known Wrangell Island seems to be assuming an importance greater than its size. I doubt if there will be much radio Amateur activity from that part of the world until the boundary issue is settled.

## the five-band coffee pot

Mobile antennas for the HF bands have always been a problem because of low operating efficiency and restricted bandwidth. A mobile enthusiast, Varouj Kalinian, (N6DBH, ex-OD5CS and F0HN) has solved this problem to his satisfaction. His solution is to use a short mobile antenna, but to increase the diameter of the element below the loading coil (fig. 1). For the base section, he used an old coffee pot about 8 inches (20 cm) in diameter and 14 inches (35 cm) tall. His

loaded whip sections were mounted to the top of the pot (fig. 2).

Varouj removed the electrical components of the pot, drilled a hole in the middle of the plastic cover, screwed the cover to the pot, screwed a 40-meter Hustler resonator and whip to the top and then adjusted the antenna to resonance. He found that

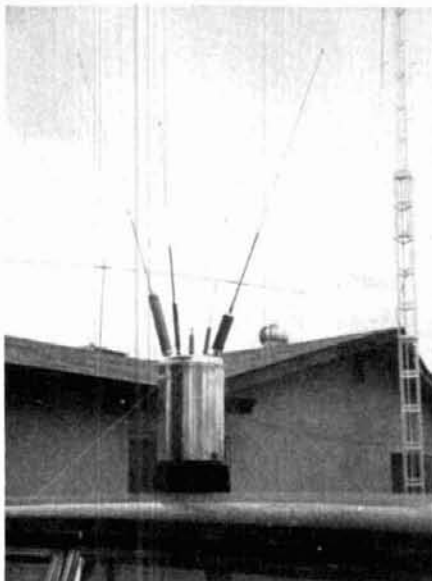

fig. 1. The "coffee-pot" mobile antenna of N6DBH mounted atop his station wagon. Separate resonators are used for various hf bands.

he had a bandwidth of 150 kHz between the 1.75-to-1 SWR points on the feedline on 40 meters.

Encouraged by the results, Varouj added other resonators and antenna tops for the other HF bands. The results were a bandwidth of 60 kHz on 80 meters, 200 kHz on 20 meters, 300

kHz on 15 meters, and 800 kHz on 10 meters. In a short time he had a "five-band coffee pot antenna."

Varouj admits the antenna looks a trifle bizarre and that he gets curious stares from other drivers. He reports that one driver pulled alongside, handed Varouj a coffee cup, and yelled, "Fill me up!"

## a mini-antenna for 160 meters

It's unfortunate that a halfwave antenna for 160 meters has to be so big. Walt Bollinger, AF3V, must have thought about this as he tried to put out a reasonable signal on that band from a small lot. His solution to this problem is shown in fig. 3. This configuration is a loaded Marconi antenna whose overall length is about 50 feet (15 meters). It is mounted about 20 feet (6 meters) above the ground. A 6-foot (1.8 meters) ground rod is used in conjunction with a 65 foot (19 meters) long counterpoise wire running beneath the antenna, just below the surface of the soil. As illustrated, the antenna operates over the range of 1.8 to 1.825 kHz with an SWR figure of 1.5-to-1 or less. If a variable capacitor is connected in series at the feedpoint (X), the antenna will operate over the rest of the band with low SWR. The approximate capacity necessary to achieve this without exceeding the 1.5-to-1 SWR is as follows: 1.85 to 1.92 MHz, 700 pF; 1.92 to 1.97 MHz, 450 pF; 1.97 to 2.00 MHz, 350 pF.

Walt uses a three-gang variable capacitor long ago removed from an old tuned-RF broadcast receiver (QRP only). It has three 365 pF capacitors on a common shaft. "For its size," Walt



says, "I think this antenna will surprise most everyone. It seems reasonably omnidirectional and provides me with a lot of fun on the 'top band'."

### a rectangular loop antenna for 80-10 meters

Walt, AF3V, checks in with a second interesting multiband antenna **fig. 4**. A rectangular loop in the vertical

plane, its overall length is about 58 feet (17.6 meters) with the bottom wire about 7 feet (2.13 meters) above ground. Its unique feature is the knife switch (SW) placed across the insulator in the center of the bottom wire. Easily reached, the switch permits the operator to change from an open loop to a closed one quickly. The feedline is a home-made, open wire line about 42 feet (12.8 meters) long. It drops down vertically to within 8 feet (2.4 meters) of the ground and then extends horizontally to the station, perpendicular to the plane of the antenna. The antenna is adjusted to resonance by means of an old Johnson "Match-box" tuner. The antenna switch is closed for operation on 7, 10, and 21 MHz and is open on the other bands. With a different length feedline, different switch settings may be necessary.

Walt supports the center of the top section to offset the weight of the feedline. He says that the antenna outperforms the center-fed horizontal wire that he had previously and reports that the pattern appears reasonably omnidirectional on all bands.

### a simple antenna for 40 and 30 meters

Many Amateurs say they enjoy the 30-meter (10 MHz) band because there are no disconcerting contests on it and because it's possible to rag-chew with a DX station without having a horde of eager beavers making rude noises

on the frequency, unhappy that they're thwarted in their search for a "new one."

Harvey Hunter, W8TYX, enjoys 40- and 30-meter operation with the simple antenna shown in **fig. 5**. Basically, it consists of a 30-meter ground plane antenna, roof-mounted, with a ground screen of 60 radials. The radials also serve with the 40-meter antenna, which is mounted a few feet away from the 30 meter whip. About 5 feet (1.5 meters) of the 40-meter antenna is vertical; the remainder is more or less horizontal, about 25 feet (7.62 meters) above the ground.

Slightly longer than a quarter-wavelength, the 40-meter wire antenna has a feedpoint impedance of close to  $50 + j50$  ohms. A good match to the 50-ohm transmission line is achieved by using a series capacitive reactance of  $-j50$  (450 pF) between the feedline and the base of the antenna.

The 30-meter antenna has a feedpoint resistance of about 35 ohms, so a simple L-network is used to match it to the transmission line. The antenna adjustments are slightly interactive, but tune-up using an SWR meter quickly compensates for that.

### the "hy-tower" antenna operates 160-10 meters

The many Amateurs who have the "Hy-Tower" vertical antenna may find the automatic tuning arrangement for multiband operation used by Paul Scholz, W6PYK, of interest. The scheme should work well for any vertical antenna over 35 feet (10.7 meters) high.

The basic network, shown in **fig. 6**, consists of a series-connected LC circuit (L1, C1) in parallel with a second inductor (L2). The series network is adjusted for minimum SWR on 75 meters with the parallel inductor set to maximum value. The last step is to adjust the parallel coil for resonance on the 160-meter band. The two adjustments don't interact if the 75-meter adjustment is done first. Operation of the antenna is normal on the higher frequency bands.

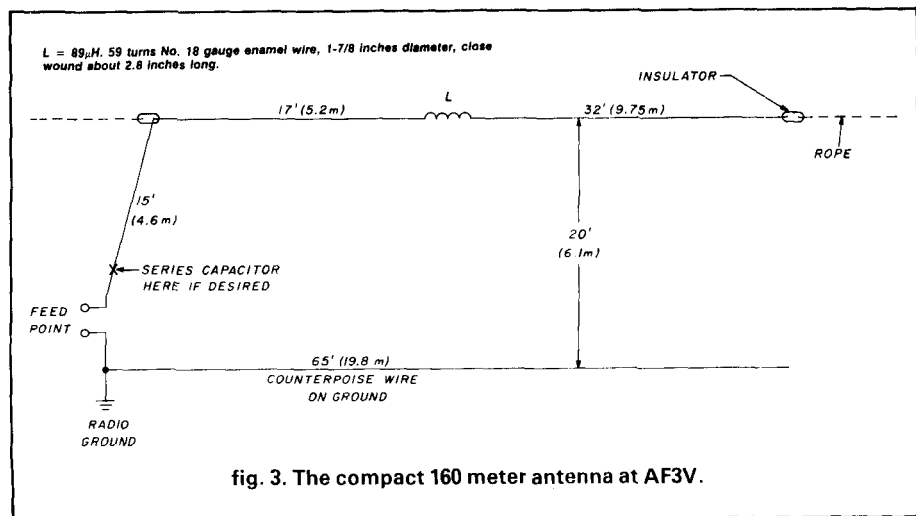
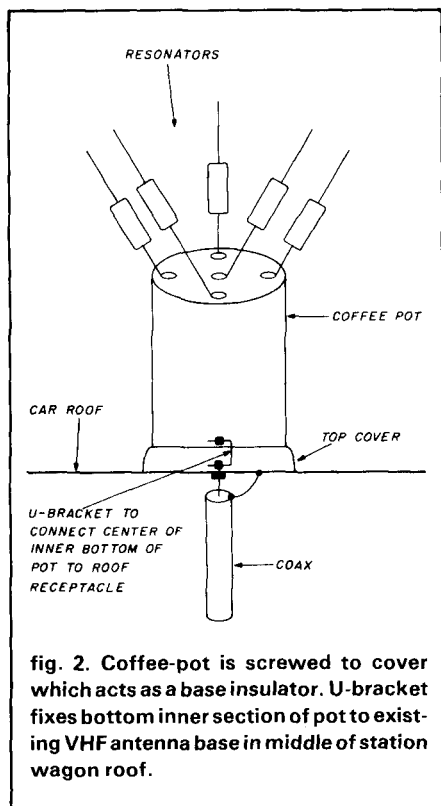

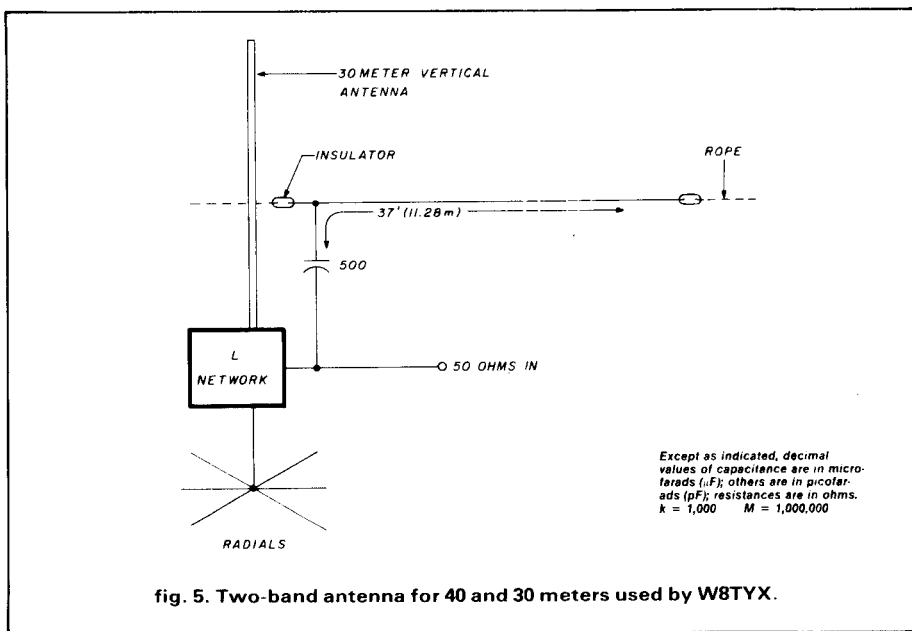
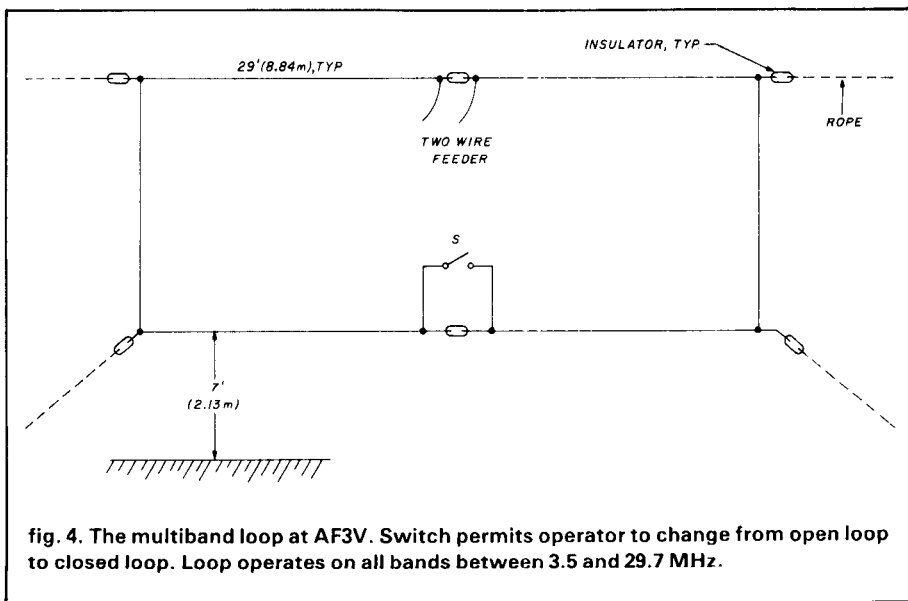

For 75-meter operation, a range of 200 kHz is obtained between the 2-to-1 SWR points. On 160 meters, operational bandwidth is about 50 kHz.

Although Paul recommends the component values shown in **fig. 6**, he has a computer program that provides component values for different LC ratios in the network. For low-power operation, 5 kV transmitting-type mica capacitors can be used; for high power, he recommends a variable air capacitor with 0.125 inch (3.2 mm) spacing.

### a rugged, long-life quad

Many exasperated Amateurs have wondered how it's possible to keep the Quad antenna alive and well year after year. The common weak point of many Quads is the junction between the wire and the Quad arm; the wire tends to either break at this point or "saw" its way through the Quad arm.

In my February, 1986, column I suggested one way of easing this vexing problem. I recently received a communication from Paul Atkins, K2OZ, sug-

gesting a different (and simpler) technique that has permitted his Quad to stay aloft for over 13 years. On the advice of a friend in the wire business, Paul rebuilt his Quad with silverplated teflon-coated wire. The teflon coating sheds water easily and retards ice buildup. The manner in which he attached the wire to the Quad arm is shown in **fig. 7**. The teflon covering is removed from the Quad wire about 10 inches (25 cm) out from each arm. The slug of teflon removed is about 2 inches (5 cm) long. A thermal stripper is recommended. Next, two pieces of No. 14 tinned copper wire long enough to be twisted in opposite directions are tightly wrapped around the wire element. Using a large iron, the ends of the twisted wires are soldered to the stripped portions of the antenna element. Run solder over the connections to stiffen them. This brings the moment arm away from the spreader arm and minimizes flexing at the point the element is secured to the spreader. Finally, the flux is wiped off the connections, which are then wrapped with

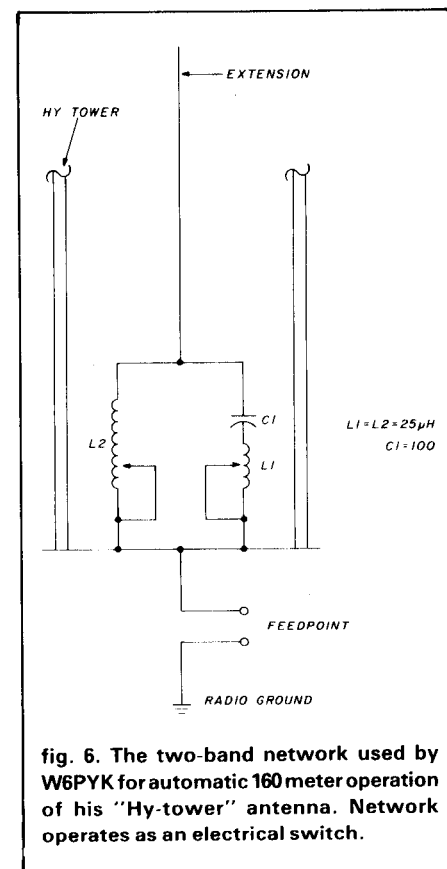

# TELEWAVE'S "PROBLEM SOLVERS"

*Transmitter Combiners • Receiver Multicouplers  
• Monitor Equipment • Test Equipment • Ferrite  
Isolators and Terminations • High Q Cavities  
and Filters • Duplexers • Systems Engineering*

Bandpass, Pass-Reject  
& Notch Cavity Filters

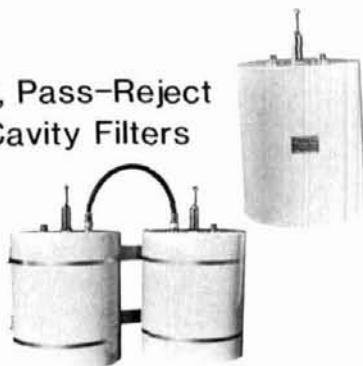

Transmitter Combining



Receiver Multicoupling

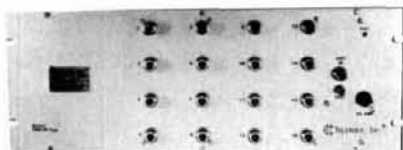

IM Suppression Panels

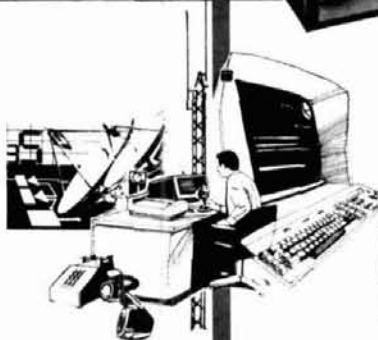

R.F. Power Monitoring



Duplexers & Preselectors



GSA Number 00K86AGS0646

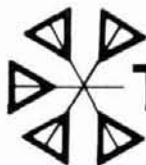

**Telewave, Inc.**



(415) 968-4400

1155 Terra Bella Ave., Mountain View, CA 94043

in Canada - contact Telewave Ltd., 11151 Horseshoe Way #4  
Richmond, B.C. Canada V7A4S5 (604) 274-8300

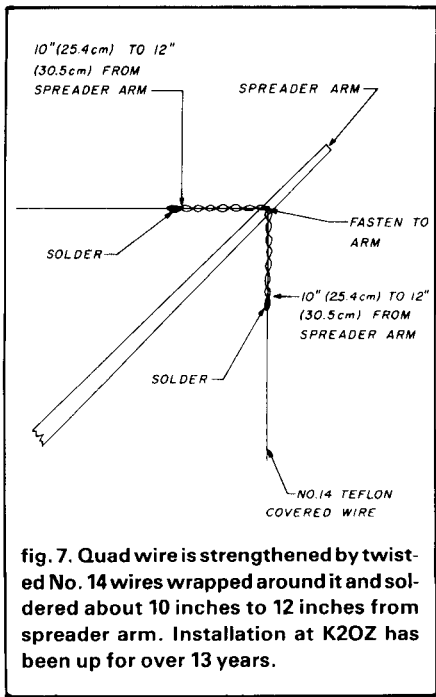

fig. 7. Quad wire is strengthened by twisted No. 14 wires wrapped around it and soldered about 10 inches to 12 inches from spreader arm. Installation at K2OZ has been up for over 13 years.

tape to protect the exposed soldered joint from the weather.

The final addition to Paul's Quad was to tie the driven element to the reflector element with polyethylene cord. The tie is made near the tips of the spreaders to keep the arms from distorting too badly in high winds or under heavy ice loading. The black polyethylene cord — about 1/8 inch (0.32 cm) in diameter — is still in service.

### the 40-meter DX beam at K6NQ/7

Forty-meter DX operators have heard the strong signal of Jim Villasana, K6NQ/7. This is a tough band for serious DX competition because some of the "big guns" use multielement Yagi and Quad beams. Great antennas, if you have the time, money and space to put 'em up!

Jim's solution to the 40-meter DX problem is to use two sloper dipoles hung from a 140-foot (42 meters) fir

tree and fed 270 degrees out-of-phase (fig. 8). The slopers are at a 45 degree angle with respect to ground. The centers of the dipoles are at the same height. This places the top ends of the dipoles at 100 feet (30.48 meters).

The dipoles are fed with equal lengths of RG-8X coax (230 feet/70.1 meters) and the phasing of the reflector element is accomplished by adding an extra 3/4 wavelength of line (approximately 86 feet, or 26 meters) coiled up inside the operating room.

While Jim has tried various other antenna arrangements, he finds that this simple antenna works best for DX. Dismayed to find that the array exhibited little gain on short-haul contacts, he was amazed at how well it worked on long-haul DX. He found, to his gratification, that his 7-MHz signal was as strong in Europe as those of other west coast DXers running high two- and three-element Yagi beams. On very good openings, the simple

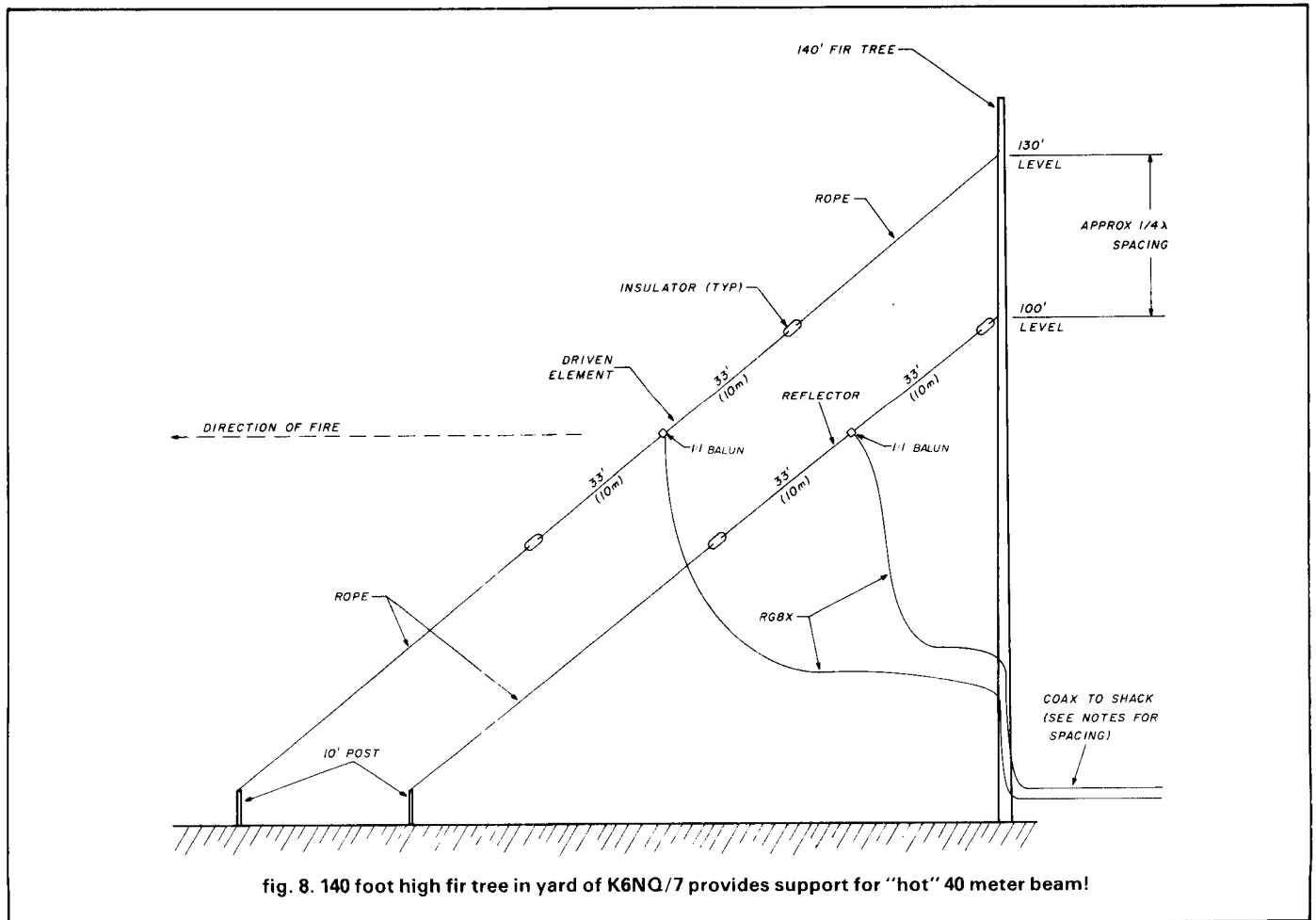

fig. 8. 140 foot high fir tree in yard of K6NQ/7 provides support for "hot" 40 meter beam!

sloper antenna was better than 1 S-unit over competitive Yagi antennas located at the 120-foot (36.6-meter) level.

Its beam pattern is broad enough to cover Europe and Northern Africa; Jim estimates about 90 degrees beamwidth to the -3 dB points. He tried several phasing schemes to get the required 90-degree phase difference and found out the hard way that the best results were obtained when the rear element used 3/4 wavelength phasing.

Jim wishes he had the room to string up two or three arrays of this type to get full coverage, but that will have to wait until he has more real estate. Meanwhile, he does a fine job with a very inexpensive antenna!

### the British "zip code"

Some time ago I admitted that the British Postal Code was a mystery to me — and to most other Amateurs as well, I suspect. Jim Miller, G3RUH, very kindly sent me a Post Office brochure explaining the system in such a lucid manner that even I could understand it. (The Canadian code works on the same principle, I am told).

In brief, the code is a simplified address, with each part of it focusing on a progressively smaller area. The United Kingdom is divided into 120 areas, each being identified by the first two letters of the code. As an example, the code MK42 8LA is given. The MK indicates the Milton Keynes area of England; the 42 stands for a district within the Milton Keynes area; the digit 8 indicates a sector in district 42; and the LA designation identifies the street. The code is read by a machine which converts it to two rows of blue dots imprinted on the envelope. The dots, in turn, are read by a mechanized system which sorts it on its way. Thus, the code helps identify an individual person on a particular mail route! It's also often imprinted on bicycles, automobiles, and other vehicles to assist in the return of stolen property.

### amateur service bulletins

The popular "moonbounce" notes have been reprinted and are again available. For a copy, send five first-

## Measure Up With Coaxial Dynamics Model 85A Termination Wattmeter

A direct-reading instrument for servicing 50 ohm communication systems and maintaining them at peak operation.

The Model 85A features:

- Dry load no coolant required.
- Replaceable connectors, interchangeable without affecting instrument calibration.
- Four power ranges easily switchable — 0-3/15/50 and 150 watts full scale.
- Frequency Range: 20 to 512 MHz
- Accuracy:  $\pm 5\%$  OFS
- Temperature Compensated

Contact us for your nearest authorized Coaxial Dynamics representative or distributor in our world-wide sales network.



**COAXIAL  
DYNAMICS, INC.**

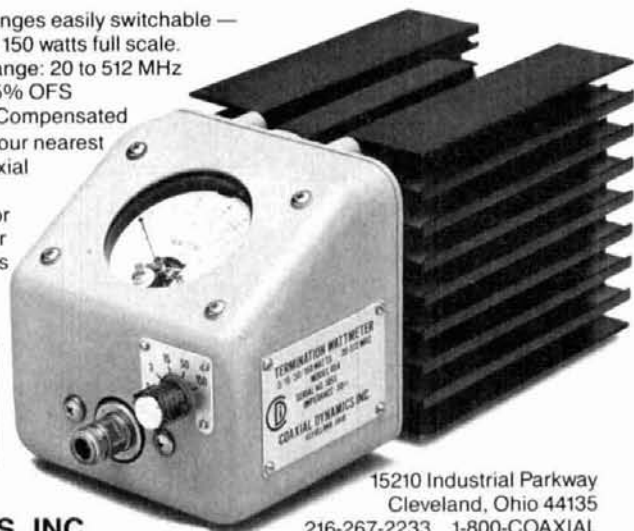

15210 Industrial Parkway  
Cleveland, Ohio 44135  
216-267-2233 1-800-COAXIAL  
Telex: 98-0630

*Service and Dependability... A Part of Every Product*

✓ 117

## We Give You VHF Without VHC.\*

(\* - Very High Cost)

Presenting Microwave Modules, the low-cost way to full-featured multimode operation on 50 MHz, 144 MHz, and 432 MHz.

Expand your HF transceiver's capabilities for less than the cost of a VHF multimode radio.

All models feature:

- 25 Watts RF output
- Low Noise GaAsFET front end
- Transmit ALC circuit
- RF sensed VOX TR switching
- All-mode operation—SSB, CW, FM, AM
- Easy hook-up to your present HF transceiver



New MMT 144/28R GaAsFET  
144 MHz Transverter  
List Price \$325.00  
(Other Models Available)

50MHz

AVAILABLE FROM:

432 MHz

1296 MHz

THE "PX" SHACK

VHF/UHF  
EQUIPMENT

Ivars Lauzums KC2PX  
52 Stonewyck Drive  
Belle Mead, New Jersey 08502  
(201) 874-6013



Hours: 11am - 3pm  
6pm - 10pm



MICROWAVE  
MODULES LTD.

✓ 118



# the HAM STATION



P.O. Box 4405  
220 N. Fulton Ave.  
Evansville, IN 47710

Stores Hours  
MON-FRI 9AM-6PM  
SAT 9AM-3PM

WARRANTY SERVICE CENTER FOR:  
ICOM, YAESU, TEN-TEC

### TERMS:

Prices Do Not Include Shipping.  
Price and Availability Subject to  
Change Without Notice  
UPS COD \$2.50 Per Package

**MOST ORDERS SHIPPED  
SAME DAY**

## YAESU



YAESU FT209RH  
5 watts  
Free FTS-6  
10 Memories  
CALL FOR YOUR  
SPECIAL PRICE



## ICOM

- 25 watts
- large LCD readout
- wideband coverage
- 21 memory channels

**NEW!** IC-28A  
2 Meter Mobile

Ham Net \$419.00 Call for  
Special Introductory Price



## WELZ

Lots of Welz  
Meters in Stock  
Call for Special  
Pricing and  
Details

Welz Meters



## YAESU

10 Memories  
45 Watts  
With FTS-8  
ORDER NOW

FT270R



## TENTEC

2510 Mode B  
Satellite Station



## ICOM

- all modes built in
- QSK up to 40 wpm
- built-in 500 Hz CW filter
- electronic keyer included
- 100% duty cycle

**NEW!** IC-751A  
HF Transceiver

Ham Net \$1499.00 Call for  
Special Introductory Price

AEA • ARRL • ALINCO • ALLIANCE • ALPHA DELTA • AMECO • AMERITRON • ANTENNA  
SPECIALISTS • ASTRON • B&W • BENCHER • BUTTERNUT • CSI • CALL BOOK  
• COMMUNICATION SPECIALISTS • CUSHCRAFT • DAIWA • DATASCAN • HEIL • HUSTLER  
• HYGAIN • ICOM • KDK • KLM • KANTRONICS • KEN PRO • LARSEN • MFJ • MICROLOG  
• MIRAGE • NYE • ROHN • SANTEC • SHURE • TEN TEC • TOKYO HY-POWER • UNADILLA  
• VALOR • VIBROPLEX • WELZ • YAESU

**ORDERS AND PRICE CHECKS ONLY, PLEASE**  
INFORMATION AND INDIANA  
SERVICE DEPT.

1-800-523-7731  
812-422-0231  
812-422-0252

## RF-CAD ELECTRONICS DESIGN PROGRAM Version 3.6 for IBM PC and compatible computers by Joe Reiser, W1JR and Gary Field, WA1GRC

This software package has been written by electronic engineers and contains nearly 40 tested and proven programs that will help the Radio Amateur or engineer design many common types of radio circuitry. Emphasis has been placed upon ease of use. Wherever possible, menus of choices with examples are displayed. Should the user be computer literate, the programs are not copy protected so they can be modified to meet your specific requirements. (full documentation is also provided.) Programs include: Filters, LC, active-LP, HP, BP, Inductor design, toroid, solenoid, straight wire; Matching networks; Crystal oscillators; Microstrip; Transmission lines; Antennas, Yagi-Uda, helix, dish, horn, element scaling; Pi and T attenuators. Also included: Radio Path calculations; FM modulation analysis; Miscellaneous conversions; Geostationary satellite pointing; Moon tracking aids; Receiver noise figure calculations and Spurious receiver response prediction. Requires IBM-PC with at least one floppy drive and 128k of RAM. © 1985.

RF-CAD

\$39.95

Please enclose \$3.50 for shipping

**ham radio** magazine **BOOKSTORE**  
GREENVILLE, NH 03048



class stamps or five IRCs (no envelope is necessary) to me at EIMAC, 301 Industrial Way, San Carlos, California 94070. Request bulletin AS-49.

Additional copies of "Design Considerations for Linear Amplifiers" are at hand, too. For a copy, send four first-class stamps or four IRCs to me at the above QTH. Ask for Bulletin AS-53.

Finally, copies of the 144-MHz EME Directory (AS-49-37), which lists worldwide EME operators, their QTHs, and station equipment, are available for five first-class stamps or IRCs.

ham radio

## short circuits

### narrowband filters

In WB4EHS's March article, "Build Narrowband RF Filters (page 10), the word "smaller" in the second sentence on page 14 should be changed to "larger."

In the program listing on page 15 (fig. 7), line 145 should be corrected to read as follows:

```
145 INPUT O:IF O<1 OR O<5  
THEN GOTO 145
```

### signal generator

Values for four capacitors and labels for three resistors were omitted from fig. 8 of YB9ATA's article, "Two-tone Signal Generator" (February, 1986, page 26). The corrected portion of the schematic is shown below.

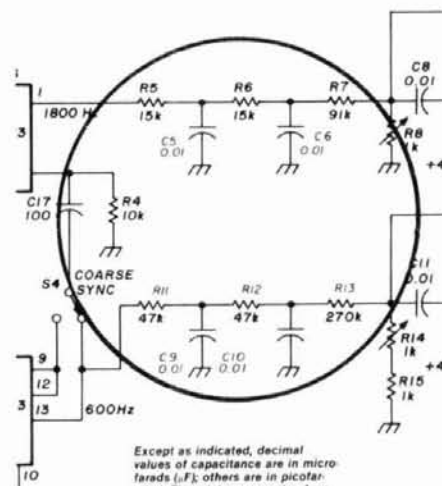

## BLACK DACRON® POLYESTER ANTENNA ROPE

- UV-PROTECTED
- HIGH ABRASION RESISTANCE
- REQUIRES NO EXPENSIVE POTTING HEADS
- EASY TO TIE & UNTIE KNOTS
- EASY TO CUT WITH OUR HOT KNIFE
- SIZES: 3/32" 3/16" 5/16"
- SATISFIED CUSTOMERS DECLARE EXCELLENCE THROUGHOUT U.S.A.

LET US INTRODUCE OUR DACRON® ROPE TO YOU • SEND YOUR NAME AND ADDRESS AND WE'LL SEND YOU FREE SAMPLES OF EACH SIZE AND COMPLETE ORDERING INFORMATION

MANUFACTURED BY  
**synthetic  
textiles, inc.** 2472 EASTMAN AVENUE, BUILDING 21  
VENTURA, CALIFORNIA 93003 (805) 656 7903



✓ 119

## SYNTHESIZED SIGNAL GENERATOR



MODEL  
SG-100F  
\$429.95  
delivered

MADE IN  
USA

- Covers 100 MHz to 199.999 MHz in 1 kHz steps with thumbwheel dial
- Accuracy +/- 1 part per 10 million at all frequencies
- Internal FM adjustable from 0 to 100 kHz at a 1 kHz rate
- External FM input accepts tones or voice
- Spurs and noise at least 60 dB below carrier
- Output adjustable from 5-500 mV at 50 Ohms
- Operates on 12 Vdc @ 1/2 Amp
- Available for immediate delivery • \$429.95 delivered
- Add-on accessories available to extend freq range, add infinite resolution, AM, and a precision 120 dB attenuator
- Call or write for details • Phone in your order for fast COD shipment.

### VANGUARD LABS

196-23 Jamaica Ave., Hollis, NY 11423  
Phone: (718) 468-2720 Mon. thru Thu.

✓ 120

## GROTH-Type

### COUNTS & DISPLAYS YOUR TURNS

- 99.99 Turns
  - One Hole Panel Mount
  - Handy Logging Area
  - Spinner Handle Available
- Case: 2x4"; shaft 1/4"x3"

TC2 \$12.50  
TC3 \$13.50  
Spinner Handle Add \$1.50

Model TC2: Skirt 2-1/8"; Knob 1-5/8"  
Model TC3: Skirt 3"; Knob 2-3/8"

Prices include UPS or Parcel Post in US

**R. H. BAUMAN SALES**

P.O. Box 122, Itasca, Ill. 60143

✓ 121

## High Performance vhf/uhf preamps



Receive Only	Freq. Range (MHz)	N.F. (dB)	Gain (dB)	1 dB Comp. (dBm)	Device Type	Price
P28VD	28-30	< 1.1	15	0	DGFET	\$29.95
P50VD	50-54	< 1.3	15	0	DGFET	\$29.95
P50VDG	50-54	< 0.5	24	+12	GaAsFET	\$79.95
P144VD	144-148	< 1.5	15	0	DGFET	\$29.95
P144VDA	144-148	< 1.0	15	0	DGFET	\$37.95
P144VDG	144-148	< 0.5	24	+12	GaAsFET	\$79.95
P220VD	220-225	< 1.8	15	0	DGFET	\$29.95
P220VDA	220-225	< 1.2	15	0	DGFET	\$37.95
P220VDG	220-225	< 0.5	20	+12	GaAsFET	\$79.95
P432VD	420-450	< 1.8	15	-20	Bipolar	\$32.95
P432VDA	420-450	< 1.1	17	-20	Bipolar	\$49.95
P432VDG	420-450	< 0.5	16	+12	GaAsFET	\$79.95
<b>Inline (rf switched)</b>						
SP28VD	28-30	< 1.2	15	0	DGFET	\$59.95
SP50VD	50-54	< 1.4	15	0	DGFET	\$59.95
SP50VDG	50-54	< 0.55	24	+12	GaAsFET	\$109.95
SP144VD	144-148	< 1.6	15	0	DGFET	\$59.95
SP144VDA	144-148	< 1.1	15	0	DGFET	\$67.95
SP144VDG	144-148	< 0.55	24	+12	GaAsFET	\$109.95
SP220VD	220-225	< 1.9	15	0	DGFET	\$59.95
SP220VDA	220-225	< 1.3	15	0	DGFET	\$67.95
SP220VDG	220-225	< 0.55	20	+12	GaAsFET	\$109.95
SP432VD	420-450	< 1.9	15	-20	Bipolar	\$62.95
SP432VDA	420-450	< 1.2	17	-20	Bipolar	\$79.95
SP432VDG	420-450	< 0.55	16	+12	GaAsFET	\$109.95

Every preamplifier is precision aligned on ARR's Hewlett Packard HP8970A/HP346A state-of-the-art noise figure meter. RX only preamplifiers are for receive applications only. Inline preamplifiers are rf switched (for use with transceivers) and handle 25 watts transmitter power. Mount inline preamplifiers between transceiver and power amplifier for high power applications. Other amateur, commercial and special preamplifiers available and available for high power applications. Other amateur, commercial and special preamplifiers available and available for high power applications. Please include \$2 shipping in the 1-1000 MHz range. Please include \$2 shipping in U.S. and Canada. Connecticut residents add 7-1/2% sales tax. C.O.D. orders add \$2. Air mail to foreign countries add 10%. Order your ARR Rx only or inline preamplifier today and start hearing like never before!

## Advanced Receiver Research

Box 1242 • Burlington, CT 06013 • 203 582-9409



✓ 122

## BELDEN 9913/9914 CABLE "N" Connectors \$3.50 Crimp or Solder Type

FOX INTERNATIONAL, INC.

717 W. UNION HILLS DR. #3-190  
PHOENIX, AZ 85027  
(602) 971-2755



"We Specialize In Custom Connectors"

✓ 123



## SWL's: Are You Plagued By Phantom Signals?



## Meet the Eliminator.

Don't let its small dimensions (4"x3"x2") fool you—the Grove **Minituner III** is a big weapon against images, intermod and phantom signals on your shortwave receiver!

This short wave/long wave pre-selector is designed to boost performance in the 100 kHz-30 MHz frequency range. If you own one of the popular general coverage communications receivers and are using an outside antenna, you **NEED** this extra measure of selectivity.

No power required. Simply connect between your receiver and antenna. Equipped for standard PL-259 connections. **Only \$39** (free UPS shipping; \$5 U.S. Mail/Parcel Post). Order TUN-3.



**Grove Enterprises**  
140 Dog Branch Road  
Brasstown, N.C. 28902

MC, Visa or COD call:  
**1-800-438-8155**

Shop Grove for fantastic values in shortwave receivers, antennas, cable, performance boosting accessories and literature.

Call (704) 837-9200 or write to above address for free catalog!

## ENCODERS THAT LIGHT

An ultra high quality Touch-Tone™ Encoder for absolute reliability and function. Incandescent illumination is a feature that makes night operation easy.

- Completely self contained • Simple 3 wire connection • Relay or solid state PTT output • Crystal controlled • Sounder • Wide voltage range 9-16 VDC • Wide temp. range -22° to +160°F • Easy level & timing adjustment • Supplied with instructions, schematic, template and hardware.

PP-5 \$60 PP-5-K SPST ADJ. RELAY \$67  
PP-5-V \$60 PP-5-V-K SPST ADJ. RELAY \$67

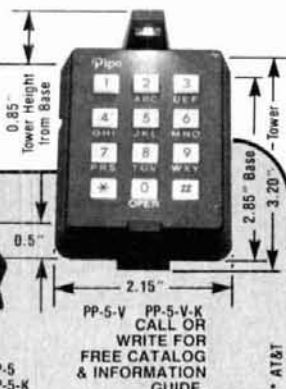

Mail Order To:

**Pipo Communications®**  
Emphasis is on Quality & Reliability

P.O. Box 3435  
Hollywood, California 90078  
213/852-1515

## REPEATER VOTER



### 4RV Four Channel Repeater Voter

- Signal to Noise Type
- Expandable to 32 Channel by Just Adding Cards
- Designed for Commercial and Amateur Service
- Continuous Instant Voting
- Dual or Single 12 Volt Supply
- LED Indicators of COR and Voted Signals
- Front Mounted Level Pots
- Built in Calibrator
- Remote Voted Indicators Pinned Out
- 4 1/2" x 6" Double Sided Gold Plated 44 Pin Card
- Unswitched Audio Input
- On Board Audio Switching and Mixing
- Audio Mixer Input Available for External Input
- Open Collector or Relay Contact Input
- Open Collector NPN Output
- Remote Disable Inputs
- More

4RV Kit including board and parts with 20 page manual ..... \$200.00  
Built, tested, and calibrated with manual ..... \$350.00

For more information call or write:

VOTER Hall Electronics (614)  
815 E. Hudson Street 261-8871  
Columbus, Ohio 43211

✓ 126

## DATA ACQUISITION



### \*\*\* RS 232C VOLTMETER FOR YOUR PC \*\*\*

8 channel, 4 1/2 digit AC/DC voltmeter & controller. **SENSATROL** talks your computer's language! Sensors hook up easily to differential inputs providing 15 bits of 100uV. Special tri-state serial output, allows networking. Includes seven binary control outputs. Uses simple PRINT and INPUT with BASIC. Detailed manual starts amateurs in sensor hookup & applications.

**\$425 COMPLETE!**

DEALER INQUIRIES WELCOME.  
603-588-3746

BOX 33, FRANCESTOWN, NH 03043

## DATA WORLD PRODUCTS

✓ 127

## Electronic Repair Center Servicing

Amateur Commercial Radio

The most complete repair facility on the East Coast.

Large parts inventory and factory authorized warranty service for Kenwood, Icom and Yaesu.

### SEND US YOUR PROBLEMS

Servicing "Hams" for 30 years, no rig too old or new for us.

**HAMTRONICS, INC.**

4033 Brownsville Road  
Trevose, Pa. 19047  
**215-357-1400**



**SAVE \$7.05\* with home delivery**

\*(One year newsstand cost \$30.00)

Here's my address label, enter my subscription.

- 1 Year . . . . . 12 issues . . . . . \$22.95
- 2 Years . . . . . 24 issues . . . . . \$38.95
- 3 Years . . . . . 36 issues . . . . . \$49.95 U.S. prices only

Payment enclosed  
Bill me later

Name \_\_\_\_\_

Address \_\_\_\_\_

City \_\_\_\_\_

State \_\_\_\_\_ Zip \_\_\_\_\_

Check here if this is your renewal (attach label)

**ham radio**  
magazine

Subscribe to

Please allow 4-6 weeks for delivery of first issues.

**Foreign rates:** Europe, Japan and Africa, \$37.00 for one year by air forwarding service. All other countries \$31.00 for one year by surface mail.

Please  
enter my  
subscription



**BUSINESS REPLY MAIL**  
First Class    Permit No. 1    Greenville, NH

Postage Will Be Paid By Addressee

**ham  
radio**

Greenville, NH 03048-9988



NO POSTAGE  
NECESSARY  
IF MAILED  
IN THE  
UNITED STATES







# Eureka!

We just struck gold with a miniature, high quality and very reliable DTMF decoder at a rock bottom price of \$59.95. Our DTD-1 will decode 5040, 4 digit codes with the security of wrong digit reset. It contains a crystal controlled, single chip DTMF decoder that works great in bad signal to noise environments and provides latched and momentary outputs. Why carry that heavy gear when its size is only 1.25 x 2.0 x .4 inches and it comes with our etched in stone, legendary, one year warranty.

Instead of sifting through the field...searching, use our super quick one day delivery and cash in on a rare find.

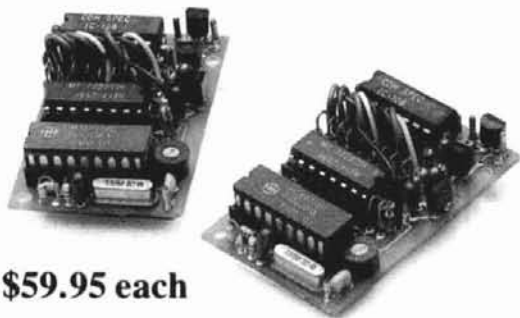

**\$59.95 each**

**COMMUNICATIONS  
SPECIALISTS**

426 W. Taft Ave., Orange, CA 92665-4296  
Local (714) 998-3021 • FAX (714) 974-3420  
Entire U.S.A. 1-800-854-0547



## Antennas

<b>BUTTERNUT</b>		
HF6V	80-10 vertical	125.00
HF2V	80-40 vertical	114.00
2MCV5	2MT vertical	52.95
RMK1J	roof mtg. kit	41.95
TBR160S	160m add on	45.00
MPS	mf. post sleeve	5.50
	AND MORE!	

<b>CUSHCRAFT</b>		
A4	4 el. triband	300.00
A3	3 el. triband	224.00
R3	10,15,20 remote tuned	
	vert.	275.95
AV5	5 band trap vert	105.00
32-19	19 el. 2mt. boomer	96.95
215WB	15 el. wide band 2mt.	
	boomer	79.95
424B	24 el. 70cm boomer	82.95
416TB	16 el. OSCAR 435	
	MHz	60.00
A144-10T	10 el. OSCAR 145.9	
	MHz	53.00
AOP-1	OSCAR pack 2mt. &	
	70cm	150.00
AR-2	2mt. vert. ringo	24.50
ARX-2	2mt. vert. ringo	
	ranger	30.00
ARX-2B	2mt. vert. ringo ranger	
	II	37.00
	AND MORE!	

<b>HUSTLER</b>		
6BT	6 band trap vert	128.95
5BT	5 band trap vert	108.95
4BT	4 band trap vert	84.95
G7-144	Fix stat. 2mt.	
	collinear	116.95
MO-1/MO-2	mobile mast	21.95
RM10/RM15	10m-15m resonator	
	(sta)	11.95
RM10S/RM15S	super resonator	16.95
RM20/RM20S	std. & super	
	resonator	15.95/21.95
RM30	30mt. std. resonator	16.95
RM40/RM40S	std. and super	17.95/25.95
RM75/RM80	75 or 80 std	18.95
RM75S/RM80S	75 or 80 super	36.95
BM-1	bumper mt	15.95
SSM-2	stainless ball mt	17.95
SSM-1	stainless ball & spring	
	mt	32.95
QD-1	quick disconnect	13.95
SGM-2	2mt. 5/8 mag. mt	28.95
HOT	trunk mt. w/swivel	
	bum	16.95
	AND MORE!	

<b>HY-GAIN</b>		
TH7DXS	7 el. triband	530.95
TH5MK2S	5 el. triband	457.95
EX-14	4 el. triband	362.95
TH3JRS	3 el. 750W pep	218.95
18AVT/WBS	5 band trap vert	121.95
14AVQ/WBS	4 band trap vert	74.95
V2S	2mt. omni-direct	50.95
V4	70cm omni-direct	59.95
HB144MAG	2mt mag mt	21.95
	AND MORE!	

<b>KLM</b>		
KT34A	triband 4 el	337.95
KT34XA	triband 5 el	485.95
2M-14C	2mt. satellite	87.95
2M-22C	2mt. satellite	117.55
435-18C	70cm satellite	113.95
435-40CX	70cm satellite	155.95

<b>MOSLEY</b>		
TA33	3 el. triband	239.00
TA33JR	3 el. triband	179.00
CL36	6 el. triband	359.00
CL33	3 el. triband	265.00
PRO37	7 el. triband	465.00

<b>VAN GORDEN</b>		
PD8010	80-10 dipole kit	34.95
PD8040	80-40 dipole kit	32.50
PD4010	40-10 dipole kit	30.95
SD80	80 shortened dipole	28.95
SD40	40 shortened dipole	25.95
ALL BANDER	160-10mt	28.95
	AND MORE!	

<b>LARSEN</b>		
LM150MM		41.90
NLA150MM		45.90
NMO150MM		45.90
KD4-142-HQ		16.95
	AND MORE!	

<b>CABLE &amp; CONNECTORS</b>		
Beiden 9913	49c/ft	
Columbia RG 213	32c/ft	
RG8/U	29c/ft	
RG 9X	14c/ft	
RG59/U	14c/ft	
PL259/Silver	1.10/1.49	
N-Male for 8/U	4.00	
BNC(M)-UHF(F)	4.80	
	AND MORE!	

## Towers

<b>ROHN</b>		
20G	10' sect	41.50
20AG	top sect	48.00
25G	10' sect	51.50
25AG	2.3 top sect	62.10
45G	10' sect	115.50
45AG	2.3 top sect	126.00
AS25G	access shelf	15.00
AS45G	access shelf	48.75
TB-3	thrust bear	53.95
M200	10' mast	22.25
SB25G	short base	26.25
SB45G	short base	49.50
EF2545G	gin pole	187.50

<b>HY-GAIN ROTORS</b>		
TXZ	20 sq. ft	315.95
HAM IV	15 sq. ft	262.95
CD45II	8.5 sq. ft	164.95

<b>KENPRO ROTOR</b>		
KR-500	elevation 12 sq. ft	161.95

<b>ALLIANCE ROTOR</b>		
U110	3 sq. ft	48.00

<b>DAIWA 750E ROTOR</b>			
Compare These Specs & Pricing-			
MR750E	1 Motor	2 Motor	4 Motor
Wind Load			
Sq. Ft.	16.1	21.5	30
Turn.			
Pwr.			
Lbs.	610	1200	2400
Break Pwr.			
Lbs.	5200	9600	18300
Price	\$250.00	\$340.00	\$520.00

Additional Motors \$90.00 Preset Add \$55.00		
Free U.S. Great Circle Transfer Map w/Rotor		
ALINCO "Quad Pod" the perfect match for today's antenna installations, i.e. OSCAR systems, light HF beams, VHF-UHF beams. 4 legs—strong—rotor plate—accepts optional thrust bearing, lightweight, durable aluminum construction—easy installation.		
ETS-120	46"	\$ 67.00
ETS-150	55"	\$ 79.00
ETS-180	67"	\$ 95.00
ETS-210	79"	\$107.00
AAZ-7A	Thrust Bear	\$ 36.00
AAZ-7	Rotor & Control	\$121.00
	See Alinco Ads for Details	

<b>TET</b>		
HB433SP	-40, 15, 10, 3 el.	244.95
MV3AH	7, 21, 28 vert	48.95
MV3AHR	7/21/28 vert	80.45 with radio
MV3BHR	14/21/28 vert	80.45 with radio
MLA-4	loop 3.5/7/21/28	139.95
SO-10	28 MHz Swiss Quad	118.95
SQY-06	2mt. Swiss Quad	55.95

<b>MISC.</b>		
Alpha Delta Twin Sloper		49.95
Larsen KD4-150-HO		16.95
Larsen Dual Banders		38.45
Unadilla 1:1		17.95
Ant. Spec. AP151.3G		34.50
X-Panda Five		14.95
Lightning Arrestor UHF-MF		3.80
Buttner HF3B		165.00
Hustler UGM		19.95
Antenna Dual Band		51.00

## Radios

**ALINCO ALR-206T SPECIAL \$ CALL**

- 5 & 25 watts—10 Ch memory.
- Scan control on Mic.
- Built in Sub Audio Tone.
- The ALR-206T is the safest mobile rig on the market. No need to take your eyes off the road—COMPLETELY PROGRAMMABLE FROM MIC.

**ALINCO ALM-203T SALE \$ CALL**

Don't buy any HT until you study this fantastic unit. Programmability identical to ALR-206T. You only need to learn one radio when you have both full featured, scan, memory, 5 watts, 2 sub audio tones. Receives 140-160 MHz.

**ICOM R71A HP—High Performance**

EEB has modified the world class R71A and enhanced its performance beyond the manufacturer's dream.

- 24 hour bench test and 6 month warranty.
- SSB filter upgrade to improve AM Narrow-SSB selectivity and dynamic range.
- Front end upgrade improves dynamic range plus preamp enables operation below 1600 kHz.
- 4 kHz filter replaces 6 kHz wide filter—improves AM selectivity.
- Audio output upgrade gives more audio at less distortion—more easy listening.
- AGC time constant for optimum AGC control.
- Shotkey diodes for clear sound-increased performance.
- Spike protection installed at the pwr. supply for max spike and surge protection.
- Final check out alignment.
- We also install ICOM options at no charge.
- R71A HP MF Mechanical Filter add \$200.00 to R71A.
- R71A HP XF 8 pole Xtal Filter add \$250.00 to R71A.
- R71A HP XFS 2.1 kHz Xtal Filter add \$300.00 to R71A.
- R71A 24 hour tested—no mods \$669.95

**ICOM R7000 VHF/UHF \$849.00**

EEB will offer a R7000 HP—Detail Release date July 86.

**MEC 71c**

Now you can control & enhance the performance of ICOM R71A, 751A, 271A, 471A, 1271A w/the amazing MEC 71c computer interface for the C-64.

- Display 1 print & receive memories
- Store or log 705 memories w/computer.
- Unlimited memory w/Disc storage.
- Keyboard entry or freq., mode, memory scan.

Get all the details—Call or write today. MEC 71c Introductory Price at \$199.95. Established Dealer Inquiries Invited.

## TRANSVERTERS UNLIMITED



**PA23/200**  
1296 MHz, 200 + W, 2 tube PA \$275

**T144/28**  
144 MHz TRANSVERTER, 25W \$189

**T220/28**  
220 MHz TRANSVERTER, 15W \$229

**WATER COOLING JACKETS**  
for 2C39, 7289 etc. \$10

ALL PRICES IN US\$ SHIPPING INCLUDED

## TRANSVERTERS UNLIMITED

BOX 6286 STATION A  
TORONTO, ONTARIO  
CANADA M5W 1P3

HANS PETERS (VE3CRU) ✓ 133  
(416) 759-5562, EVENINGS

May 17 - 9 a.m. to 4 p.m.

**GRAND OPENING**

**ESS**  
SURPLUS  
Computer & Electronic  
Store & Flea Market

9 Amherst St. Milford, NH 03055

Travel—Rt. 3 to exit 7W (Rt. 101A)  
10 mi. to Milford rotary  
1/4 around toward Mont Vernon,  
over bridge—first right.

**ESS** ELECTRONIC SURPLUS  
SERVICE

(603) 673-6728  
(603) 673-5690

134

WRITE FOR

**FREE BOOK CATALOG**

Ham Radio's Bookstore  
Greenville, NH 03048



**ELECTRONIC EQUIPMENT BANK**

516 Mill Street NE  
Vienna, VA 22180 USA

Prices & specs subject to change.  
Shipping charges not included.  
Returns subject to 20% restock charge.  
Free catalog in USA, all other 3 IRC's.  
**ORDER TOLL FREE 800-368-3270**  
Tech Info—VA orders 703-938-3350

# make a homebrew sheet metal brake for chassis construction projects

Save time, money  
— and build a  
better box

Radio Amateurs have been bending aluminum at home for years, making brackets, panels, and boxes for electronic construction projects. Light weight, workability, good corrosion resistance, and electrical conductivity make aluminum an ideal material for small hand-fabrication projects. But classical bending techniques that require a hammer, vise, and pliers can result in dents and scratches, and extra work straightening undesired bends.

This article describes how to make a sheet metal bending tool that makes quality bends in thin metal without damage. The tool is made with just a few dollars worth of steel angle stock and some common household hardware.

Because the correct choice of material is important, information is included to enable you to identify aluminum alloys for bendability, strength, and corrosion resistance. A construction project of a small box is included as an example.

## bending theory

Figure 1 shows the physical arrangement required to bend sheet metal without causing deformation in areas other than the bend. The bar holds the workpiece to the table while the leaf forms the corner around the bar's "knife edge." The major objective illustrated in fig. 1 is to maintain a precise hinge centerline between the moveable leaf and fixed table at the

bend corner. Figure 1B shows the direction of maximum bending force at the completion of the bend. The leaf must be rigid and the bar must be held securely to maintain a consistent bend radius along the work.

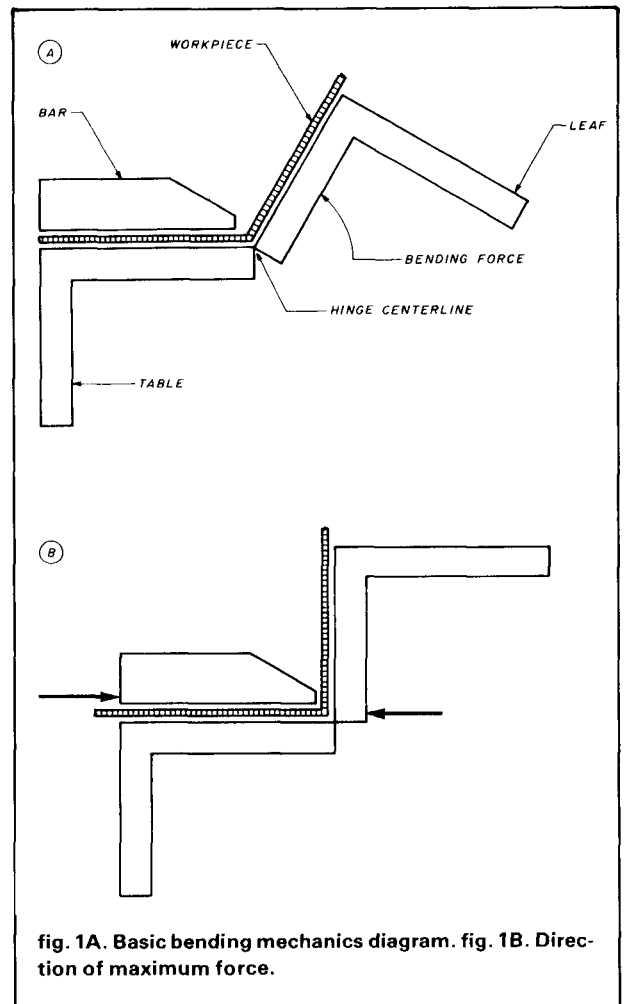

By Cliff Klinert, WB6BIH, 1126 Division Street,  
National City, California 92050

**table 1. List of aluminum alloys with zero bend radius (wrought sheet 0.062 inch (1.6 mm)-thick cold bent, 90 degrees)**

Alloy	Yield Strength (psi)	Corrosion Resistance
1100-0	5000	A
1100-H12	15000	A
1100-H14	170000	A
2014-0	14000	D
2024-0	11000	D
3003-0	6000	A
3003-H12	18000	A
3003-H14	21000	A
5005-0	6000	A
5005-H12	19000	A
5005-H32	17000	A
5005-H14	22000	A
5005-H34	20000	A
3004-0	10000	A
3004-H32	25000	A
3004-H34	29000	A
5050-0	8000	A
5050-H32	21000	A
5052-0	13000	A
5652-0	13000	A
6061-0	8000	B

Note: Corrosion resistance is given in decreasing merit from A to D. Metal with an A or B rating can usually be used outdoors without protection. A D rating indicates that protection is required to prevent corrosion. Data was compiled from references 1 and 2.

We will later see that this can be a limiting factor in bending thicker or stronger material.

### selection of alloys for bending

Availability of the correct material may limit the practicality of homebrew sheet metal projects. To determine which materials will be bendable, it helps to understand the use of *alloy numbers*. The most common system of alloy numbers uses a four-digit alloy number followed by a combination of a letter and numbers that indicate the temper or hardness. The two major types of hardening are the "H" (strain hardened) and "T" (thermal hardened) processes. In the strain hardened system, the H is followed by two or more numbers, the second of which indicates the relative hardness of the material. The T in the temperature hardening system is followed by one or more numbers, the first of which indicates the relative hardness. If the four-digit alloy number is followed by an "0," the material has been annealed to make it as soft as possible and is readily bendable. The 0 material is soft for easy forming with the possibility of being hardened later. Incidentally, material marked "alclad" is covered with a thin layer of relatively pure aluminum for extra corrosion resistance.

The most desirable alloy used for bending and forming is 3003-H14, which combines optimum strength

and workability, making it the ideal material for box and chassis construction. The "3003" indicates that this series of alloys is strain hardened without any subsequent heat treatment. The first temper digit, "1," indicates strain hardening without any subsequent heat treatment. (Another digit in the first position, such as a "3," could be used to indicate a low-temperature thermal "soak" to improve ductility.) The "4" indicates the relative hardness. A higher number denotes a harder material.

**Table 1** is a shopping list of alloys appropriate for bending<sup>1,2</sup>. Since low cost is almost always a consideration, the best source of materials in small quantities will usually be a salvage or surplus store. Aluminum manufacturers typically require a \$300 minimum purchase, and hardware store material is usually quite expensive in the small quantities required. For best results, take a pair of gloves, a tape measure, and a copy of **table 1** to all the metal salvage yards in your area. Prices should range from 75 cents to \$1.50 per pound. Sheets are marked in alloy numbers (as shown in **table 1**) and thickness in thousandths of an inch. The optimum thickness is ".040" (1.02 mm). If a sheet is not marked, try to bend a corner with your fingers to determine bendability. You'll usually be expected to buy the entire piece, and cutting service may or may not be provided. Cutting may cost from 50 cents to a few dollars, so you may wish to take some sort of cutting tool with you if you want to buy a piece too large to carry home uncut.

Salvage steel angle stock for making the bending tool should be available for ten to 25 cents per pound. The type of industries in your area will determine the type of salvage material available. Please note that "3003-H14-.040" is the optimum material for our projects. Thicker or harder material may produce bends with larger radii and make more crude-looking parts.

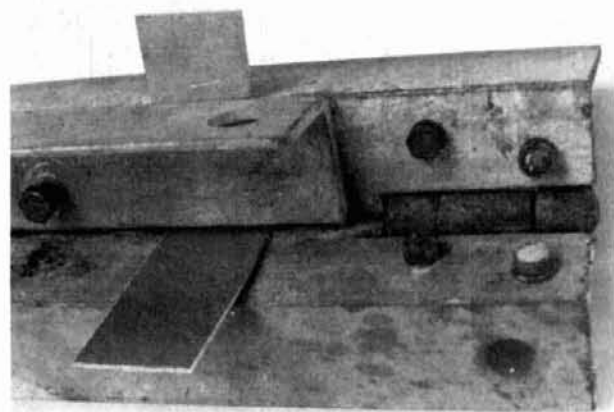

The construction of the bender, location of the hinges, attachment of the bar with bolts, and a small piece of sheet metal being bent.



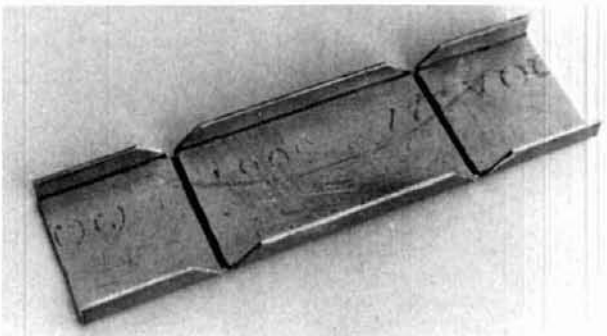
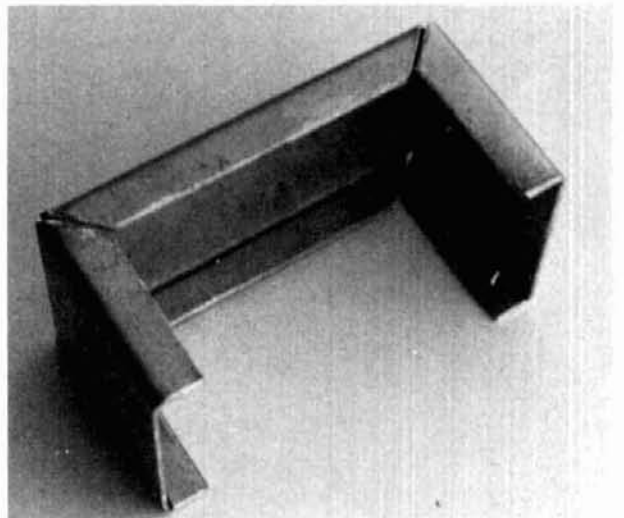
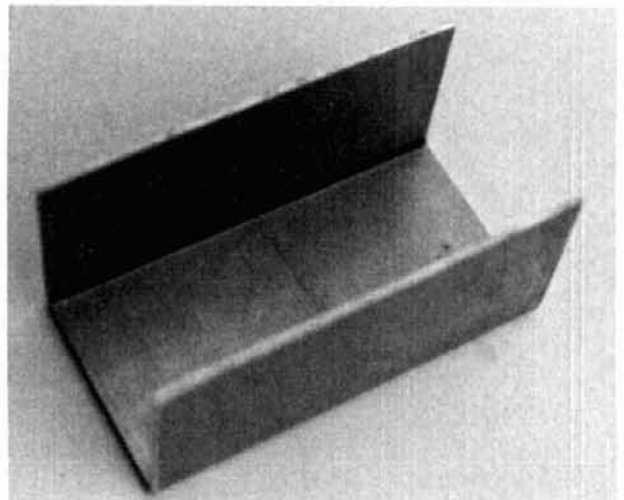
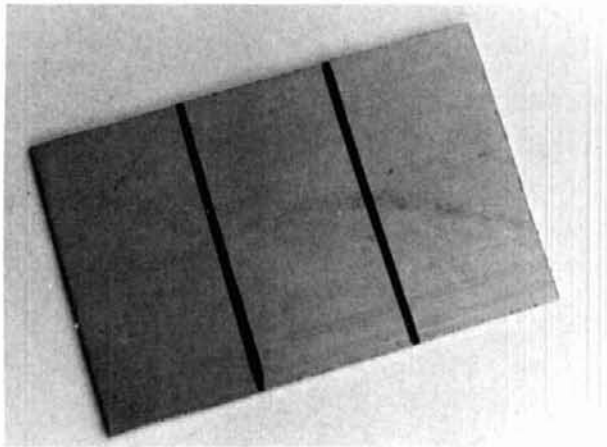

The bend sequence for making a small box. The material was 6061-00.062 thick, somewhat too thick for making precise bend corners. Note that a small hole was drilled at the intersection of the double bends to allow space for the material thickness.

## building the bender

The photographs show how the bender was assembled from angle steel and two door hinges. The overall width was about 3 feet (1 meter). You can select dimensions appropriate to the material available. The wider the bender, the more likely it is to warp in use. The photographs were taken to illustrate the geometry of the bender as shown in **fig. 1A**. Depending on the shape of the hinges used, the ends of the angle stock must be notched for clearance. In shimming the

hinges with washers, locating the hinge centerline required some patience.

The corners were cut with a circular saw using a metal cutting blade (i.e., a carborundum disc). Grinding or filing the angle steel edges along the hinge centerline to produce a square corner is optional since even a fairly crude tool will produce good results with the right material. The "bar" is another piece of the angle steel bolted to the table. The bar could be secured with C-clamps, but the bending force shown



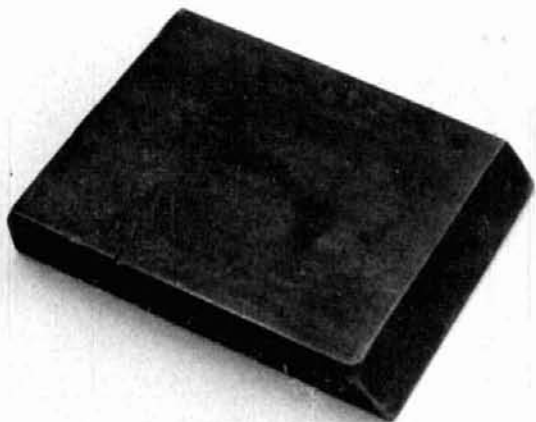

This piece was cut from a steel bar to allow making a double bend.

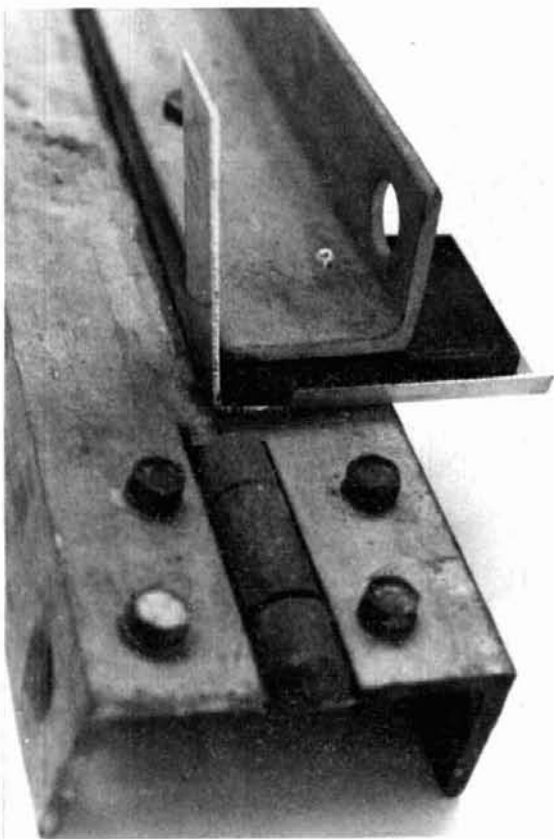

The die can be used to accommodate a part that has been bent in the opposite direction. The edge of the die is shown for clarity, but would normally be mounted between the two bolts holding the bar to the table.

in fig. 1B may cause the bar to slide away from the leaf when you bend stronger material. You may wish to reinforce the leaf by bolting another piece of steel behind it, if you have problems with warping later.

Clamp the table in a vise, attach Vise-grip<sup>®</sup> pliers to the leaf for handles, and the bender is ready for use.

## making a box

Obtain a sheet of bendable alloy and cut some pieces for practice bends. Mark bend lines on the aluminum as shown in the photographs. Some practice will be necessary to determine where to place the material relative to the bend line and to anticipate the amount of springback in the bend angle. You can use tin snips or a nibbler; most wood sawing methods (using power tools) can be applied to aluminum as well. A bandsaw is ideal for thin material, and a circular saw with a plywood cutting blade is excellent for thicker sheet. A router works well for trimming or shaping, and most of the bendable alloys can also be whittled with a pocket knife. Use paraffin to lubricate the blade, wear ear plugs, and observe the normal safety precautions.

The photographs illustrate the sequence of bends for making a small box. A die was made from a piece of steel bar with an angle cut for a knife edge. (The size of the die determines the size of the box to be bent.) The die was used as a "finger" in a pan brake to make a bend perpendicular to a previous bend. The bar in a pan brake is made of several removeable fingers in various widths to allow for making double bends like this.

It is common to etch the finished part in a lye and water bath to produce an attractive finish. If lye is not available, welding supply stores sell aluminum cleaning solutions that work faster, but are somewhat more expensive. A quart bottle of cleaning solution costs about \$5, but it can be diluted in water for several uses. Be sure to follow the safety instructions of the bottle since these solutions may contain a very powerful acid. Alloys receiving an *A* or *B* corrosion rating in **table 1** require no further treatment to prevent destructive corrosion for several years of use. A coating of clear lacquer or acrylic spray may be used to protect the porous metal surface from stains and cosmetic corrosion.

## conclusion

I don't expect anyone to start manufacturing chassis boxes at home; the process is far too time consuming. The main point in having a simple bending tool is to enable you to fabricate a special part in a size and shape not available commercially, with a professional, high-quality appearance.

## references

1. *Product and Data Catalog*, Reynolds Aluminum Supply Company, free to Reynolds customers at Reynolds distributors.
2. *Metals Handbook*, 8th Edition, Volume 1 (of 11 volumes), American Society for Metals, Metals Park, Ohio, 1977.

ham radio

**NEW**

## Frequency standard upgrades your counter

Get the precision you paid for from your frequency counter. Connect the Counter-Mate to the "EXT STD" input or periodically check the internal oscillator to get traceable accuracy instead of just resolution.

The Counter-Mate frequency standard employs a precision third-overtone 10 MHz crystal in a proportionally controlled copper oven maintained at a computer optimized temperature. The excellent long-term and short-term stability is in a class with units costing much more.

Check the specifications—the Counter-Mate out-performs and is less expensive than most counters' oven oscillator options, it needs no installation, and it has sufficient drive to serve several instruments.

The Counter-Mate comes calibrated against national standards and you do not lose your counter when it is time to recalibrate! The unique 50-turn adjuster makes calibration easy and mechanically stable. Periodic calibration at Wenzel Associates is just \$15 plus shipping.



### COUNTER-MATE SPECIFICATIONS

Model	CM-1
Frequency	1 MHz and 10 MHz
Output Drive	TTL and 50 Ohm
Rise & Fall Time	5 nsec
Aging Rate	< 3x10 <sup>-8</sup> /Month
Temperature	< -5x10 <sup>-8</sup> , 10° to 40° C
Setability	2x10 <sup>-9</sup> , 50 turns
Oven Warm-Up	10 minutes at 25° C
Power Requirements	9V Adapter included
Size	4.6" x 4.8" x 1.6"

### Wenzel Associates, Inc.

11124 Jollyville Road  
Austin, TX 78759  
(512) 345-2703 TWX 910-997-4554

ONLY  
**\$350**

### AUTHORIZED KENWOOD I-COM RADIO DEALER



H. L. HEASTER, INC., 203 Buckhannon Pike, Clarksburg, W. Va. 26301 Clarksburg Phone (304) 624-5485 or W. Va. Toll-Free 1-800-352-3177

HAROLD HEASTER, K80HX, 91 Ridgefield Place, Ormond Beach, Fl. 32074 Florida Phone (904) 673-4066

NEW NATION-WIDE TOLL-FREE TELEPHONE 1-800-84-RADIO 1-800-84-72346

Call us for a quotation, WE WILL SAVE YOU MONEY!

148 PAGES  
100'S OF NEW  
PRODUCTS



More pages, more products and it's hot off the press! Get the new 1986/7 DICK SMITH ELECTRONICS Catalog and find anything for the electronics enthusiast. The data section alone is worth the price of admission. Send for your copy today.

**SAY YOU SAW IT  
IN  
HAM RADIO**

Please reserve my copy of the 1986 Dick Smith Catalog. I enclose \$1 to cover shipping.

Name .....

Address .....

City .....

Zip .....



DICK SMITH ELECTRONICS INC.  
P.O. Box 2249 Redwood City CA 94063  
EVERYTHING FOR THE ELECTRONICS ENTHUSIAST!

## WACOM DUPLEXERS

Our Exclusive Bandpass-Reject Duplexers  
With Our Patented

**B<sub>p</sub> B<sub>r</sub> CIRCUIT® FILTERS**

provide superior performance... especially at close frequency separation.

Models available for all commercial and ham bands within the frequency range of 30 to 960 MHz.



CALL 817/848-4435



**WACOM**  
PRODUCTS, INC.

P.O. BOX 21145  
WACO, TEXAS 76702 • 817/848-4435

# Announcing!

## Commander II VHF 2M AMPS

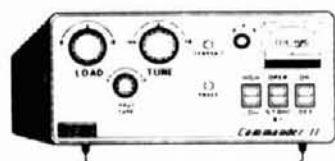

### With 3CX800A7

- Modern Stripline Circuit with tuned input for excellent efficiency.

- 650 Watts Output with 25 watts drive!
- Compact — 6" x 15" x 17" only 55 lbs.
- Includes Power Supply and Relays — 115/240 v.
- Precision ball drives with 6 to 1 ratio on all tuning controls for Smooth and Easy Tuning.
- Made in U.S.A. by Hams for Hams

Direct from the Manufacturer, only

# \$988.00

UPS Shippable

Prices Subject to Change Without Notice

Complete Service for all Dentron products Clipper-ton V updates, and quality stripline Modifications.

### Coming Soon:

- HF Amplifiers
- Antenna Tuners
- Improved Dummy Loads

## CCIE Manufacturing

104 W. Vine, Edgerton, Ohio 43517  
419-298-3051

✓ 129

## AIR-WOUND INDUCTORS



B&W Miniductors® and Air-Dux® have been the industry standard for over 50 years, wherever radio-frequency coils are used.

- For the experimenter, the radio amateur, the manufacturer
- Available in diameters from 1/2" to 6"
- Wire sizes from #24 to #8 AWG
- Also edge-wound and tubing coils for high-power applications.

Call or write for complete specifications.

ALL OUR PRODUCTS MADE IN USA



### BARKER & WILLIAMSON

Quality Communication Products Since 1932

At your Distributors. Write or Call.

10 Canal Street, Bristol PA 19007

(215) 788-5581



The monthly magazine with a natural blending of two popular hobbies — Ham Radio and Computers

- ★ Articles on Ham Radio & Most Personal Computers
- ★ Hardware & Software Reviews
- ★ Various Computer Languages
- ★ Construction Articles
- ★ Much Much More...

"...received my moneys worth with just one issue..."

—J. Trenbick

"...always stop to read CTM, even though most other magazines I receive (and write for) only get cursory examination..."

—Fred Blechman, K6UGT

U.S.A.....	\$15.00 for 1 year
Mexico, Canada .....	\$25.00
Foreign .....	\$35.00(land) - \$55.00(air)
(U.S. funds only)	
Permanent (U.S. Subscription) .....	\$100.00
Sample Copy .....	\$3.50



Circulation Manager

1704 Sam Drive

Birmingham, Alabama 35235

Phone 205/854-0271

Name \_\_\_\_\_

Call Sign \_\_\_\_\_

Address \_\_\_\_\_

City \_\_\_\_\_ State \_\_\_\_\_

Zip \_\_\_\_\_ Phone \_\_\_\_\_

Date \_\_\_\_\_

Signature \_\_\_\_\_

✓ 130

New

New

# THE STANDARD OF EXCELLENCE

## Definitely Superior!

# AZDEN PCS-5000

COMMERCIAL — GRADE



**UNPRECEDENTED WIDE FREQUENCY RANGE:** Covers 140,000-153,000 MHz in steps that can be set to any multiple of 5 kHz up to 50 kHz.

**CAP/MARS/NAVY MARS, BUILT IN:** The wide frequency range facilitates use of CAP and ALL MARS FREQUENCIES including NAVY MARS. **COMPARE!**

**TINY SIZE:** Only 2 inches high, 5 1/2 inches wide and 7/4 inches deep!

**MICROCOMPUTER CONTROL:** Gives you the most advanced operating features available.

**UP TO 11 NONSTANDARD SPLITS:** **COMPARE** this with other units!

**20 CHANNELS OF MEMORY IN TWO SEPARATE BANKS:** Retains frequency, offset information, PL tone frequency.

**DUAL MEMORY SCAN:** Scan memory banks separately or together. **ALL** memory channels are tunable independently. **COMPARE!**

**MEMORY SCAN LOCKOUT:** Allows you to skip over channels you don't want to scan.

**TWO RANGES OF PROGRAMMABLE BAND SCANNING:** Limits are quickly reset. Scan ranges separately or together with independently selective steps in each range. **COMPARE!**

**BUSY SCAN AND DELAY SCAN:** Busy scan stops on an occupied channel. Delay scan provides automatic auto-resume.

**DISCRIMINATOR CENTERING (AZDEN EXCLUSIVE PATENT):** Always stops on frequency desired when scanning.

**PRIORITY MEMORY AND ALERT:** Unit constantly monitors one memory channel for signals, alerting you when channel is occupied.

**LITHIUM BATTERY BACKUP:** Memory information can be stored for up to 5 years even if power is removed.

**FREQUENCY REVERSE:** Allows you to listen to repeater input frequency.

**ILLUMINATED KEYBOARD WITH ACQUISITION TONE:** Keys are easily seen in the dark, and actuation is positively verified audibly.

**CRISP, BACKLIGHTED LCD DISPLAY:** Easily read no matter what the lighting conditions!

**DIGITAL S/R/METER:** Shows incoming signal strength and relative transmitter power.

**MULTI-FUNCTION INDICATOR:** Shows a variety of operating parameters on the display.

**FULL 16-KEY TOUCHTONE PAD:** Keyboard functions as auto-patch when transmitting.

**MICROPHONE CONTROLS:** Up/down frequency control and priority channel recall.

**PL TONE GENERATOR BUILT IN:** Instantly program any of the standard PL frequencies into the microcomputer. **COMPARE!**

**TRUE FM, NOT PHASE MODULATION:** Unsurpassed intelligibility and audio fidelity. **COMPARE!**

**HIGH/LOW POWER:** Select 25 watts or 5 watts output — fully adjustable.

**SUPERIOR RECEIVER:** Sensitivity is better than 0.15 microvolt for 20-db quieting. Commercial-grade design assures optimum dynamic range and noise suppression. **COMPARE!**

**DIRECT FREQUENCY ENTRY:** Streamlines channel selection and programming.

**OTHER FEATURES:** Rugged dynamic microphone, built-in speaker, mobile mounting bracket, remote speaker jack, and all cords, plugs, fuses and hardware are included.

EXCLUSIVE DISTRIBUTOR: DEALER INQUIRIES INVITED FOR YOUR NEAREST DEALER OR TO ORDER:

**AMATEUR-WHOLESALE ELECTRONICS TOLL FREE...800-327-3102**

8817 S.W. 129th Terrace, Miami, Florida 33176 Telephone (305) 233-3631 Telex: 80-3356

MANUFACTURER:

**JAPAN PIEZO CO., LTD.**

1-12-17 Kamirenjaku, Mitaka, Tokyo, 181 Japan

Telex: 781-2822452





# COLORADO COMM CENTER

## KENWOOD



### TR-2600

2.5W/300MW (swt)  
• Handheld Meter  
• Handheld  
• LCD Readout  
• 10 Memories w/ Lithium Back-up  
• Band and Memory Scan



### TH-21AT

• Compact Pocket Size  
• 1 Watt  
• 0 Ph. 500 M.A. Battery



### TH-2570

• First 70 Watt FM Mobile • First with Memory & Auto-tuner • 23 Channel Memory • Front Panel Programmable CTCSS



### TS-940S

"DX-celence"

• Programmable Scanning  
• High Stability Dual-Digital VFO's  
• 40 L. Channel Memory  
• General Coverage Receiver

800-227-7373

- AEA
- ALINCO
- ASTRON
- AVANTI
- B&W
- BENCHER
- BUTTERNUT
- CUSHCRAFT
- DAIWA
- HAM-KEY
- HUSTLER
- HYGAIN
- ICOM
- KANTRONICS
- KDK
- KENPRO
- KENWOOD
- KLM
- LARSEN
- MFJ
- MIRAGE
- NYE VIKING
- QUATRON
- SANTEC
- WELZ
- YAESU

**COD'S WELCOME**

## YAESU



### FT-209RH

• 5 Watts  
• 10 Memories  
• LCD  
• Compact

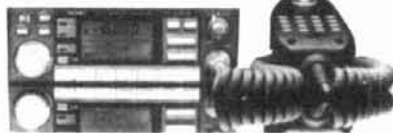

### FT-2700R

• Duo-Band Full Duplex  
• 25 Watt

### FRG-9600

• 100 Memories  
• 60 MHz - 905 MHz Continuous



4262 Lowell Blvd. • Denver, Co. 80211 • 433-3355



138

## The ISOTRON

NO TUNERS!  
NO RADIALS!

ANTENNAS FROM 160-10 METERS NO COMPROMISE!

Just a few comments from satisfied customers:

"...I have used your 80/40 Isotron while stationed in Guantanamo Bay Cuba and it worked great. BEST Dept. Of The Navy"

"On January 12, 1984 I got into the 75 watt ssb contest. I didn't try for maximum number of contacts. I tried for maximum number of states. No less than 30 states. Total time I worked 30 states and Puerto Rico, that is less than a \$800 mile haul from Aurora, Colorado.

Not too bad for what looks like a bird feed.

"I just got my Isotron 40 on the air and it has surpassed my wildest expectations. My first evening QSO was with KB6EUC and wait—my next was with HK8GUP in Columbia, South America. My antenna sits on a 80 foot mast and that is it. My BEST report is great.

Congratulations on developing the Isotron. I am spreading the good word among my friends. I think it's a super, compact antenna whose time has finally come!...KASQWE"

"About two months ago I got an Isotron 80 and just recently got it out of the shack on a 15-foot pole. I am really intrigued by it and have been having fun trying to convince other stations that it is one of the best. I worked California when it was hanging by a string from the ceiling of the shack and works even better on a pole. ...NEEDF" (Photo: Isotron 160)

WHY NOT ENJOY THEIR OPERATING PLEASURE & GIVE US A CALL. WE WILL LOOK FORWARD TO TALKING WITH YOU.

\*40-METER - \$52.95 PLUS \$3.75 SHIPPING 80-METER - \$63.95 Plus \$4.75 Shipping  
160-METER - ~~\$149.95~~ SALE! \$129.95 + \$5.50 shp Good through Sept. 30, 1986  
80-40 Combination - \$110.00 plus \$8.50 Shipping

ASK FOR PRICES ON OTHER MODELS

\*See review in October 73, 1984. \*\*See review in March 73, 1986

**BILAL COMPANY**

S.R. 2, Box 62, Dept 91

Eucha, OK. 74342 PH: 918-253-4094



## GET YOUR COMMERCIAL LICENSE

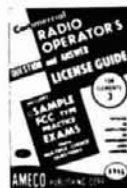

AMECO has the only books available written for the FCC administered General Radiotelephone and Marine Radio Operator Permit. General electronic theory is fully covered in the Commercial Radio Operator Theory Course, cat. #15-01. Two Q&A books cover the specific requirements for the FCC administered exams; Element 3, for the General Radio Telephone License, is contained in cat. #9-01 and Elements 1 and 2, for the Marine Radio Operator Permit, are covered in cat. #8-01. Fully up-to-date and revised per the current FCC exam syllabus.

15-01 Commercial Radio Operator Theory Course \$8.95  
9-01 Q&A Element 3 General Radio Telephone \$5.95  
8-01 Q&A Marine Radio Operator \$3.95

Please include \$3.50 shipping and handling

## Ham Radio's Bookstore

Greenville, NH 03048

1-603-878-1441



# a regulated screen grid power supply

An easy-to-build  
solid-state design  
using Motorola's new  
TMOS power-FET technology

For about the last 20 years, the most common type of amplifier used by hams has been the grounded-grid, class AB2 linear, sometimes erroneously referred to as "Class B." In Class B operation, no quiescent plate current is drawn; Class AB2, on the other hand, has quiescent plate current. Both classes run grid current when a signal is present. If there were no idling current in a grounded-grid amplifier, it wouldn't be linear. There is no such thing as a single-ended "grounded-grid Class B linear."

Every linear amplifier type has some advantages and some tradeoffs. One advantage of a grounded-grid amplifier is that it supposedly does not need to be neutralized. This is probably true for 813 tubes, which wouldn't take off and oscillate on a VHF parasitic frequency even if you wanted them to. An 813 doesn't even like to work at 29 MHz. Tubes such as the 3-500Z are designed to amplify well, or oscillate, at 100 MHz.

During the last ten years I have been involved in more than 30 cases of amplifier repair. More than 80% of these failures involved damage from parasitic oscillation in grounded grid amplifiers that supposedly do not need to be neutralized. A stable grounded grid amplifier design is not as easy as the popular literature on the subject indicates. This subject is covered in detail in the April 1986 issue of this magazine.

Another advantage of the grounded-grid configuration is that no screen or control grid bias supplies are needed. Control grid bias supplies are simple for Class AB-1 grid-driven amplifiers, since, typically, no

current flows. Screen grid supplies are a different matter because they must also furnish current — sometimes over 100 mA. One disadvantage in grounded-grid operation is that separate tuned inputs must be constructed for each band in use.

The grid-driven linear offers certain advantages. A separate tuned input is not required for each band, and up to approximately 23 dB of amplification can be obtained instead of the typical 12 dB gain from grounded-grid. This means you can drive a legal-limit amplifier with a 10-watt QRP transceiver. To do this you'd have to neutralize the amplifier; this would complicate the grid input circuit because the easy, 50-ohm grid swamping resistor circuit would not work. One disadvantage, however, is that you'd have to build a high-voltage screen supply. For a 4-1000A, a screen voltage of 1000 volts is required for Class AB1 linear amplifier service. With 6000 volts on the plate, this tube will deliver 1500 watts output. Another good tetrode for ham service is the 4CX1500A, which requires up to 750 volts for the screen grid.

The choice between grounded-grid and grid-driven Class AB1 would have to go to grounded-grid up until the World Administrative Radio Conference of 1979; until that time, amplifiers were in use on only about five Amateur Radio bands below 30 MHz, and building five tuned inputs for the common grounded-grid Class AB1 amplifier posed no problem. The advantages of using grid-driven Class AB1 amplifiers were not yet apparent, especially in light of the grief of building a regulated high-voltage screen supply. Most people would rather build the separate tuned inputs for the simpler grounded-grid triode circuit than use the inherently broad-band Class AB1 input circuit.

Today amplifiers are used on eight Amateur bands below 30 MHz, and can be used with reduced output on the 30-meter band. In a while we'll have nine bands on which amplifiers can be used below 30 MHz. Building nine separate Pi-networks requires 27 components

By Richard Measures, AG6K, 6455 LaCumbre Road, Somis, California 93066

and a rare nine-position bandswitch; in comparison, the Class AB1 input circuit begins to look very simple. Perhaps building a screen supply isn't really that much of a problem after all. . . .

For the Amateur who is also a MARS member, the new general-coverage transceivers are a blessing. A general coverage amplifier would be a nice accessory for a general coverage transceiver.

### to regulate or not

According to Eimac, "The power output from a tetrode or pentode is very sensitive to screen voltage. For this reason, any application requiring a high degree of linearity through the amplifier requires a well-regulated screen supply."<sup>1</sup>

For some small tetrodes, it's possible to use gas voltage regulator tubes. For larger tetrodes with higher than about 25 mA of screen current the VR tube isn't practical; a better choice is a conventional series pass regulator circuit, which offers the added benefit of adjustable screen voltage, to either control power output or to set the idling plate current to the desired value, a nice feature for those times when 100 watts isn't enough, but 1500 watts is too much. If a roller-coil is used for the plate tank inductor, a general coverage 1.8 to 30 MHz amplifier is yours. The only band-switching operation needed is that of adding loading capacitor paddlers for frequencies below about 5 MHz.

With the common grounded-grid amplifier, reducing power is not easy; in a Class AB1 amplifier, it's simple. Series pass transistor regulator circuits are used in 12- to 14-volt power supplies for Amateur transceivers and other low-voltage applications. Screen supplies for Class AB1 amplifiers typically must provide between 500 and 1500 volts. Until recently, a regulated supply for these voltages required tube circuits because transistors couldn't handle the required voltages and currents.

Bipolar transistors that would handle high voltages, at low current, for TV applications have been around for some time. The Motorola BU207 was one example. It could withstand either high voltage (up to 1300 volts) or high current — but not both at the same time, because of secondary breakdown effects: a 1500-volt, 8 ampere bipolar may be able to handle only 0.2 amps at 200 volts. Your 100-watt transistor is now a 40-watt transistor. Three transistors are required for 100 watts dissipation. High voltage bipolar transistors have another trade-off: low current gain. So you need a driver transistor to provide high base current. It was possible to use bipolars in high-voltage regulated supplies, but it took a bank of them to form the series pass element. (The first high-voltage regulated supply I built used six BU207 bipolars to produce 1500 volts at 0.2 amps. It worked, but it wasn't as simple as I'd have liked it to be.)

There has been progress, however. Just as FET RF power transistors are taking over jobs from bipolars, the high-voltage FET is now available for use in high-voltage applications such as regulated supplies. Motorola is using this new technology in its TMOS power FET. The TMOS offers high gain and virtually no secondary breakdown problems that would reduce the dissipation rating.

A TMOS FET is similar to a triode electron tube; the more positive the control element, the more current flows in the load. Tubes have some nasty disadvantages: they lose linearity when the control grid goes positive and start to draw lots of grid current at the same time. TMOS devices don't exhibit this effect. The gain of a triode is rated in micromhos — or more recently, in microSiemens. A triode with a transconductance of 25,000 micromhos is considered a "hot" tube.

The TMOS device I used to construct the power supply for this article has a transconductance of about 500,000 microSiemens in its linear range. As you may have guessed, the device drives so easily it can be a problem to keep it from taking off unless you swamp the control gate with a resistor and a capacitor.

### design considerations

In a typical 13.8-volt supply the filter capacitor is charged to about 22 volts. If a short circuit were placed across the output, 22 volts would appear across the pass transistor — until the fuse in the primary burned out. In a 1500-volt supply the filter capacitor can be charged to 1900 volts in the no-load condition. In this case a short would place 1900 volts on the pass transistor. Twenty-two volts isn't a problem for a typical 40-volt bipolar, so no protection is needed; 1900 volts, however, is a completely different matter. To protect the high-voltage power supply series pass element from short circuits, some kind of pass element crowbar is required. I used an SCR whose gate is fired by a string of zener diodes when the voltage gets into to danger region above 520 volts difference across the pass element. Since it takes about 2 microseconds to fire the SCR, an RC delay circuit is used (R3C1) to protect the pass element while the SCR is reaching threshold. R2 limits the current through the SCR to less than its rated 160 peak amps. R2 is 10 ohms for up to 1000 volts output and 20 ohms for up to 2000 volts output.

The voltage rating of the pass element needs to be slightly greater than the difference between no-load voltage across the filter capacitor and the desired regulated output voltage. Naturally, the power supply must provide enough voltage at full load or regulation is not going to occur. In addition, the product of current and voltage across the pass element must not exceed its dissipation rating.

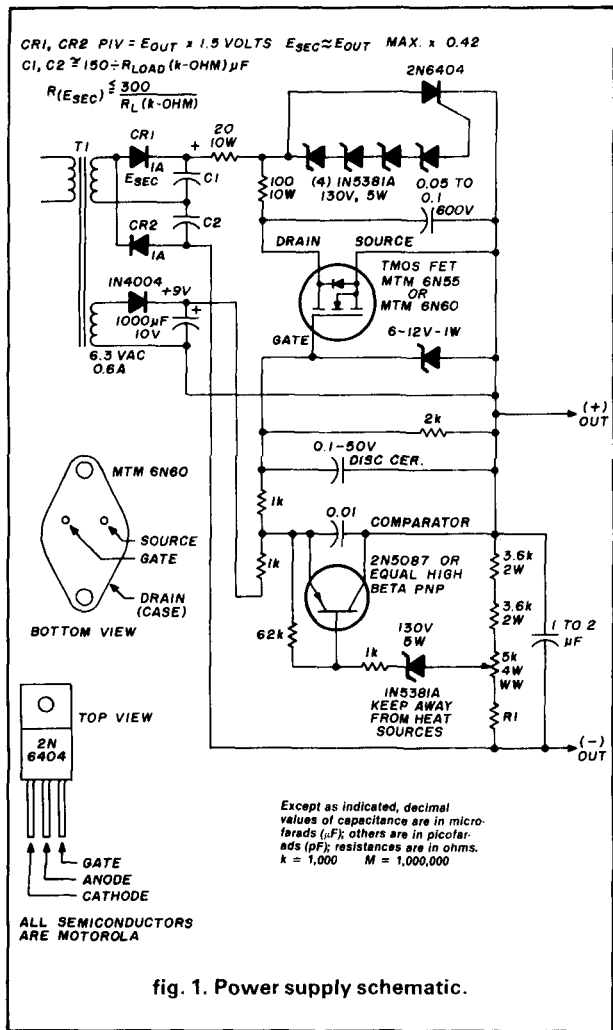

Most capacitor filter power supplies see a voltage drop of about 15 per cent from no-load to full load. This means that the pass element needs to withstand only about 15 percent of the output voltage plus a small safety factor. A 600-volt pass element can easily regulate a 3000-volt supply. The highest rated voltage available in the Motorola TMOS series is 1000 volts, which means you could build a regulated 5000-volt supply with an output current of 2 amps if you needed one. To achieve the current requirement it would be necessary to parallel some TMOS devices and connect equalizing resistors of a few ohms in each source lead. The comparator circuit, Q1, is simplicity itself, since no driver transistor is required for the TMOS pass device.

### circuit operation

The positive output terminal is the common reference point, or circuit common. When the output voltage rises to a high enough negative value  $V_z$  begins to conduct, causing Q1 to conduct. This increases the voltage drop across R4, causing the gate voltage of

Q2 to be less positive, which causes Q2 to conduct less. If Q2 is conducting less, then the output voltage begins to fall because of the increased voltage drop across the pass element. As the output voltage falls,  $V_z$  conducts less, causing Q1 to conduct less. This causes Q2's gate to go more positive. Q2 conducts more heavily, causing the output voltage to rise again. The process repeats and regulation results.

The threshold voltage for turn-on/turn-off is determined by the voltage division ratio of the R1, R5, R6 voltage divider and the  $V_z$  zener voltage. R6 is adjusted to the desired output voltage as long as not much more than 500 volts is dropped across the pass device. Setting the output voltage too low fires the pass-protect crowbar, causing the output voltage to rise to the voltage on the power supply filter capacitor less about 1 volt. At this point you need to turn the power off and on, unlocking the crowbar, and then make a mark on the R6 scale to indicate how low you can go. Starting the power supply with a heavy load in place will also fire the crowbar. This isn't a problem in screen supplies because the amplifier won't be operated until the final amplifier tube's filament comes up to temperature. This is about 1 second for a 4CX1500A. If you want to be able to start with a heavy load connected, you'll need to add one or more zener diodes from the drain to the gate of Q2 to start conduction when the voltage drop is about 20 volts less than the crowbar trigger voltage.

### performance

The load regulation is more than adequate for this application. With the output set for 900 volts on my prototype supply, the voltage drops to 896 volts with a 225 mA load. Reverse screen current up to about 20 mA is no problem. Beyond 20 mA reverse current, you'll need to add an appropriate bleeder resistor across the output terminals.

This screen supply can provide conventional positive output, or, negative output for grounded screen Class AB1 grid-driven amplifiers, in which the positive output terminal is grounded and the screen negative voltage is connected to the cathode or filament transformer center-tap. This configuration is used in many commercial short-wave transmitters because there's no need for a screen bypass capacitor and the unwanted added inductance associated with it.

### choosing the right fuse

It's important to fuse this supply in order to protect the screen of your amplifier tube from excessive dissipation, which will never occur unless you tune up under light load conditions, as might occur, for example, if your antenna were not connected. Light loading allows the instantaneous plate voltage to fall to a level that fails to attract the electrons coming from

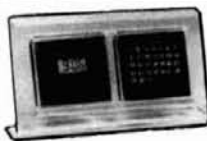

RECEIVE  
THIS LCD  
CALENDAR/  
CLOCK FREE  
WITH YOUR  
SUBSCRIPTION

## WHAT'S REALLY HAPPENING IN HOME SATELLITE TV?

# STV<sup>®</sup> THE HOME SATELLITE TELEVISION MAGAZINE™

A monthly of 100-plus pages—has everything you need to know about where to find equipment, how to install it, system performance, legal viewpoints, and industry insights! With your subscription to STV<sup>®</sup> you will receive a FREE LCD Calendar/Clock.

- Only \$19.95 per year (12 monthly issues)
- \$1.00 for sample copy

IF YOU HAVE  
A SATELLITE  
SYSTEM, THEN  
YOU REALLY  
NEED ...



# OnSat<sup>®</sup>

The best in satellite programming! Featuring: ★All Scheduled Channels ★Weekly Updated Listings ★Magazine Format ★Complete Movie Listing ★All Sports Specials ★Prime Time Highlights ★Specials Listing and ★Programming Updates!

- Only \$45.00 per year (52 weekly issues)
- 2 Years \$79.00 (104 weekly issues)
- \$1.00 for sample copy

Visa<sup>®</sup> and MasterCard<sup>®</sup> accepted (subscription orders only). All prices in US funds. Write for foreign rates.

Send this ad along with your order to:

**STV<sup>®</sup>/OnSat<sup>®</sup>**

P.O. Box 2384—Dept. HR • Shelby, NC 28151-2384  
**SUBSCRIPTION CALLS ONLY**  
**TOLL FREE 1-800-438-2020**

the cathode. These electrons will then find the relatively positive screen very attractive, causing an unhappily large flow of current in the screen grid. The screen grid will suffer a melt-down unless something is done quickly. An ordinary fuse will perform this duty faithfully if the right ampere rating is used.

With a capacitor filter supply, which normally has high peak currents in the primary of the power transformer, a fuse that is about 1.5 times larger than the screen dissipation rating would indicate is adequate. For example, with a 120-VAC primary, a 1-amp fuse would allow 120 watts to flow. This would be adequate for a screen grid rated at 80 watts maximum dissipation. The screen supply transformer should be connected to the same step-start source used for the plate transformer so that the regular fuse won't burn out at turn-on. A one-third duty cycle tuning pulser will save fuses if you make an error during tune-up.

### choosing the transformer

When you're selecting a power transformer for a screen supply, "heavy duty" is *out*. You don't want a screen supply that can do double duty as an arc-welder. A screen supply transformer should have about the same CCS current rating as the typical screen current on the tube's spec sheet. The transformer selected should also have a filament winding to provide the voltage to operate the comparator circuit, as shown in **fig. 1**. The current drawn by this circuit is about 6 mA — so any 6.3-volt or 12.6-VCT winding will do the job. Other transistors can be used in the comparator as long as they are high Beta and PNP.

Motorola TMOS power FETs have many other interesting uses besides series pass regulators. The MTM 6N60 I used in this article will make a nice shunt regulator at up to 600 volts at 100 watts dissipation — if you keep it cool. If that's not enough, the MTM 6N60 has a big brother, the MTE 40N60, which is a 40 amp, 600-volt device.

I believe we're going to see a lot more TMOS devices in Amateur Radio equipment. Military transceivers already use TMOS output amplifiers. How about 300 watts output on 2 meters with 5 watts of drive? That's a pair of Motorola MRF 150s, which will do the same job on 160 meters. TMOS RF amplifiers produce less intermodulation distortion than conventional bipolar RF amplifiers. Their use could represent a pleasant improvement on the ham bands. With RF-negative feedback it is possible to make a solid-state TMOS SSB signal as clean as some of the cleanest tube-type equipment such as the TS830S.

### references

Care and Feeding of Power Grid Tubes, EIMAC Division, Varian Inc., 301 Industrial Way, San Carlos, California 94070.

ham radio

The BEST is still  
"made in U.S.A."

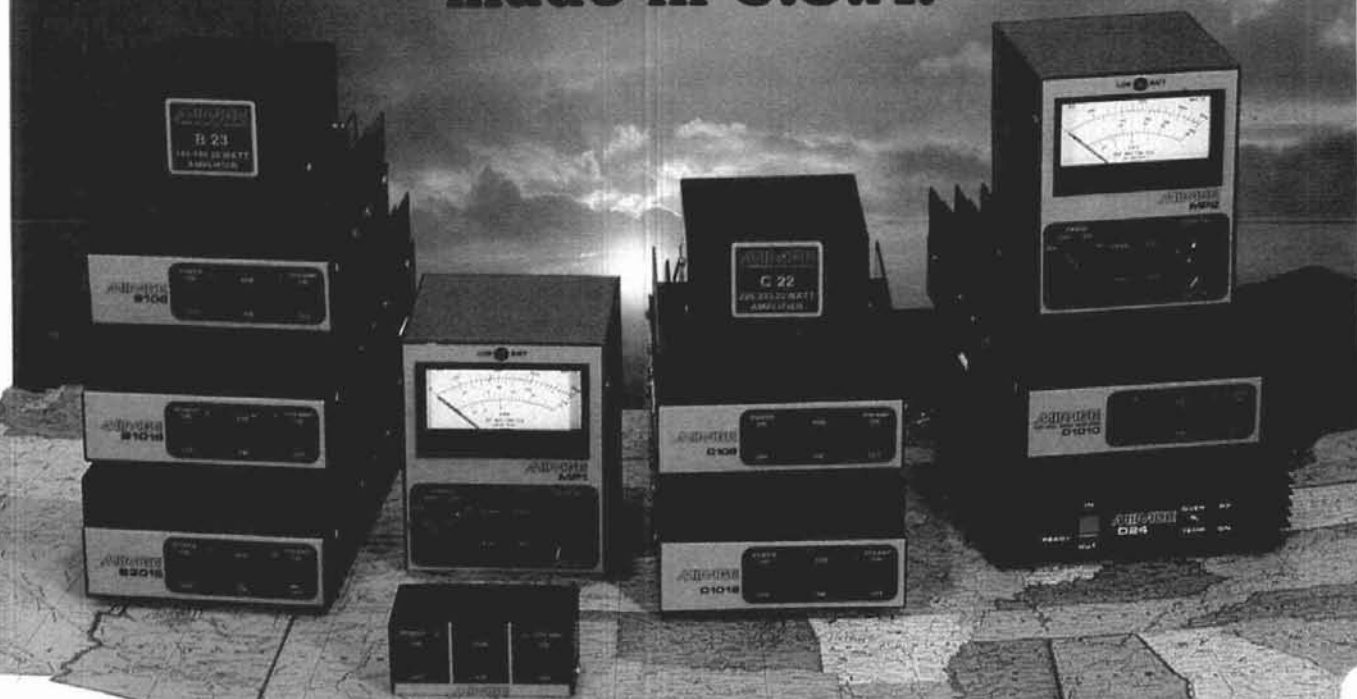

# MIRAGE/KLM

Under New Ownership

**American made RF Amplifiers and Watt/SWR Meters  
of exceptional value and performance.**

• 5 year warranty • prompt U.S. service and assistance

## RF AMPLIFIERS

### 2 METERS-ALL MODE

**B23** 2W in=30W out  
(useable in: 100 mW-5W)

**B108** 10W in=80W out  
(1W=15W, 2W=30W) RX preamp

**B1016** 10W in=160W out  
(1W=35W, 2W=90W) RX preamp

**B3016** 30W in=160W out  
(useable in: 15-45W) RX preamp  
(10W = 100W)

### 220 MHz ALL MODE

**C106** 10W in=60W out  
(1W=15W, 2W=30W) RX preamp

**C1012** 10W in=120W out  
(2W=45W, 5W=90W) RX preamp

**C22** 2W in=20W out  
(useable in: 200mW-5W)

### RC-1 AMPLIFIER REMOTE CONTROL

Duplicates all switches, 18' cable

## WATT/SWR METERS

- peak or average reading
  - direct SWR reading
- MP-1** (HF) 1.8-30 MHz  
**MP-2** (VHF) 50-200 MHz

### 430-450 MHz ALL MODE

**D24** 2W in=40W out  
(1W = 25W)

**D1010** 10W in=100W out  
(1W = 25W, 2W = 50W)

Available at local dealers throughout the world.

**MIRAGE/KLM**  
COMMUNICATIONS EQUIPMENT, INC.

✓ 142

16890 Church St., Morgan Hill, CA 95037, (408) 779-7363



NOW! FASTER SERVICE FOR OUR EASTERN CUSTOMERS.

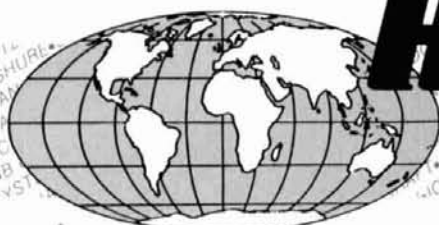

# HAM RADIO OUTLET

LARGEST HAM OUTLET IN THE WORLD

## 7 STORE BUYING POWER

### KENWOOD TS-940S



TOP-OF-THE LINE HF TRANCEIVER

**GREAT PRICES. CALL**

### KENWOOD HAND-HELDS

#### TH-21AT/41AT

Compact. Only 2.4"W, 4.74"H, 11"D. Outstanding performers in an ideal package size.



#### TR-2600A

Deserves its well-earned reputation as the leading HT

**CALL FOR PRICE**



### ELH-230D

2 METER  
3 IN/30 OUT



WE SHIP DIRECT TO YOU FROM ANY ONE OF OUR NATIONWIDE OUTLETS.



#### MA-40

40' TUBULAR TOWER

\$745 **SALE! \$549**

#### MA-550

55' TUBULAR TOWER

\$1245 **SALE! \$899**

- Handles 10 sq. ft. at 50 mph
- Pleases neighbors with tubular streamlined look

#### TX-455

55' FREESTANDING CRANK-UP

- Handles 18 sq. ft. at 50 mph
- No guying required
- Extra-strength Construction
- Can add raising and motor drive accessories

Shown with optional MARIH motor base

IN STOCK FOR QUICK DELIVERY  
OTHER MODELS AT GREAT PRICES

### ICOM IC-2KL



LINEAR AMPLIFIER

- Auto Band Switching
- Broadbanded
- HF 500 Watt Linear

AT GREAT LOW, LOW PRICES



### YAESU HANDHELD FT 209RH

5 WATT 2M/HT

**CALL FOR PRICE**

**CALL FOR PRICE**

### ICOM TR-751A



COMPACT 2-METER ALL MODE TRANCEIVER  
**SPECIAL NEW PRICE!**

### Tri-Ex W-51 TOWER SALE

51' CRANK-UP 9 SQ. FT. WINDLOADING

**\$899**

Limited Quantities Available

### ICOM IC-37A



IC-27A (25W, 2M, FM)

IC-27H (45W, 2M, FM)

IC-37A (25W, 220MHz, FM)

IC-47A (25W, 70cm, FM)

GREAT PRICES. CALL

**FREE SHIPMENT**  
Most items UPS surface

**All Major Brands in Stock Now!**

**CALL TOLL FREE (800) 854-6046**



Toll free including Alaska & Hawaii. Phone Hrs: 7:00 a.m. to 5:30 p.m. Pacific Time. California and Arizona customers call or visit nearest store. California and Arizona residents please add sales tax. Prices, specifications, descriptions subject to change without notice.



WORLDWIDE DISTRIBUTION

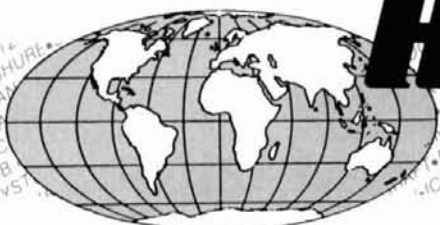

# HAM RADIO OUTLET

LARGEST HAM OUTLET IN THE WORLD

**ICOM DAY!**  
JUNE 14th — ATLANTA

## 7 STORE BUYING POWER

### ICOM IC-R71A



Superior Grade General Coverage Receiver

**SALE! CALL FOR PRICE**

### ICOM IC-3200A

**DUAL BANDER**



Covers Both 2 Meters & 70 cm

**LATEST EDITION**

### ICOM IC-1271A



1.2 GHz Transceiver:  
The First Full-featured  
1240-1300 MHz Transceiver  
**AT GREAT LOW, LOW PRICES**

### ICOM IC-28A/28H

**NEW**



2-METER MOBILES  
IC-28A (25w) IC-28H (45w)

**SPECIAL NEW PRICE!**

**NOW! RAPID DELIVERIES FROM OUR OUTLETS**

**COAST TO COAST**

**To Our Customers**

### ICOM HAND-HELDS

**VHF/UHF**



IC-02AT  
IC-04AT

IC-2AT IC-3AT  
IC-4AT

**WE SHIP DIRECT TO YOU FROM ANY ONE OF OUR NATIONWIDE OUTLETS.**

### ICOM IC-735



The Latest in ICOM's Long Line of HF Transceivers

**CALL FOR LOW, LOW PRICE**

### ICOM DAY!

June 14 at New Atlanta Store

- Drawings for free goods at Atlanta Store
- Special Pricing for ICOM available at all Ham Radio Outlet Locations & through our 800 number.

## All Major Brands in Stock Now!



**Bob Ferrero W6RJ**  
President  
**Jim Rafferty N6RJ**  
VP So. Calif Div.  
Anaheim Mgr.

**ANAHEIM, CA 92801**  
2620 W. La Palma  
(714) 761-3033, (213) 860-2040  
Between Disneyland & Knotts Berry Farm  
**ATLANTA, GA 30340**  
6071 Buford Hwy  
(404) 263-0700  
Neil, Mgr. KC4MJ  
Doraville, 1 mi. north of I-285

**BURLINGAME, CA 94010**  
999 Howard Ave.  
(415) 342-5757  
George, Mgr. WB6DSV  
5 miles south on 101 from SFO  
**OAKLAND, CA 94606**  
2210 Livingston St.  
(415) 534-5757  
Joe, Mgr. K50S  
17N-5th Ave. /17S-16th Ave

**PHOENIX, AZ 85015**  
1702 W. Camelback Rd.  
(602) 242-3515  
Bob, K7RDH  
East of Hwy 17  
**SAN DIEGO, CA 92123**  
5375 Kearny Villa Rd.  
(619) 560-4900  
Glenn, Mgr. K6NA  
Hwy 163 & Claremont Mesa Blvd

**VAN NUYS, CA 91401**  
6265 Sepulveda Blvd.  
(818) 988-2212  
Al, Mgr. K6YRA  
San Diego Fay  
at Victory Blvd

**STORE HOURS**  
10 AM-5:30 PM  
**CLOSED SUNDAYS**



# CALL TOLL FREE (800) 854-6046

Toll free including Alaska & Hawaii. Phone Hrs: 7:00 a.m. to 5:30 p.m. Pacific Time. California and Arizona customers call or visit nearest store. California and Arizona residents please add sales tax. Prices, specifications, descriptions subject to change without notice.



# direct currents reduce core permeability

BASIC program shows  
how to compensate  
for this effect

**Applications involving coils** that carry DC are common. Perhaps not so common, however, is the understanding that inductance determination requires a knowledge of the anticipated DC current. A DC bias reduces the inductance value and must be taken into consideration for accurate results.

Although this toroidal-inductor design program was written for Microsoft™ BASIC and tested on a Commodore Pet Computer with 32k of memory, no special machine-dependent functions were used; therefore, it can be used on virtually any home computer with little or no modification. Remark statements are liberally provided throughout the program listing to identify operations.

## design procedure

The design sequence of calculations for each wire size is as follows:

- Calculation of the number of turns (N) assuming a winding factor of 0.525.
- Calculation of DC resistance (RDC).
- Calculation of copper weight.
- Calculation of maximum DC current.
- Calculation of inductance (mH).
- Calculation of wound outside, inside diameter, and height of wire and core.
- Calculation of temperature rise in No. 30 AWG wire considering copper losses only.

A complete enamel wire table is included in the program for wire sizes No. 12 AWG through No. 46 AWG. Coils are designed to have a winding factor of 52.5 percent maximum.

Selection of a core size and core material for a

desired inductance can be determined by doing a set of iterative calculations using vendor curves (**fig. 1**) showing percent permeability reduction versus DC. The magnetizing force,  $H$ , (in oersteds) is:

$$H = 0.4\pi NI/P \quad (1)$$

where  $N$  = number of turns

$I$  = current in amperes

$P$  = magnetic path length  
in centimeters

In **fig. 1**, a certain percent permeability reduction is initially assumed for material of the selected permeability. This establishes the maximum magnetizing force,  $H$ , in oersteds, which must not be exceeded if the application's determined requirements are to be met. AC flux density (BAC) is assumed to be small.

The design program uses this information and other core data from the selected vendor data sheet to compute a table of inductor designs.

Toroidal Molypermalloy Powder (MPP) cores are a useful alternative for gapped cores in applications where there is a direct current component which tends to saturate the core. MPP cores are well suited for low inductances, below 2 mH. Advantages of using MPP cores are largely in elimination of assembly and labor costs for handling two core halves, fitting gap spacers and mechanical parts.

One vendor has published a core and permeability selection procedure that simplifies the choice of a core. Because selection of the core to avoid saturation is a most significant choice in inductor design, a modified version of this procedure, courtesy of Magnetics, Inc.,\* is used here as a part of the computer design program user instructions.

## program user information

Only two parameters for each (design) application must be known: inductance required under DC bias conditions and the amount of DC current.

Calculate the product  $LI^2$  where:

$L$  = inductance required with DC bias (millihenries)

$I$  = DC current (amperes).

Locate the  $LI^2$  value on the DC bias core selector chart (**fig. 2**). Follow this coordinate to the intersec-

By Walter Kunde, K5BVM, Route 3, Box 346,  
Quinlan, Texas 75474

\*Magnetics, Inc., P.O. Box 391, Butler, Pennsylvania 16003.

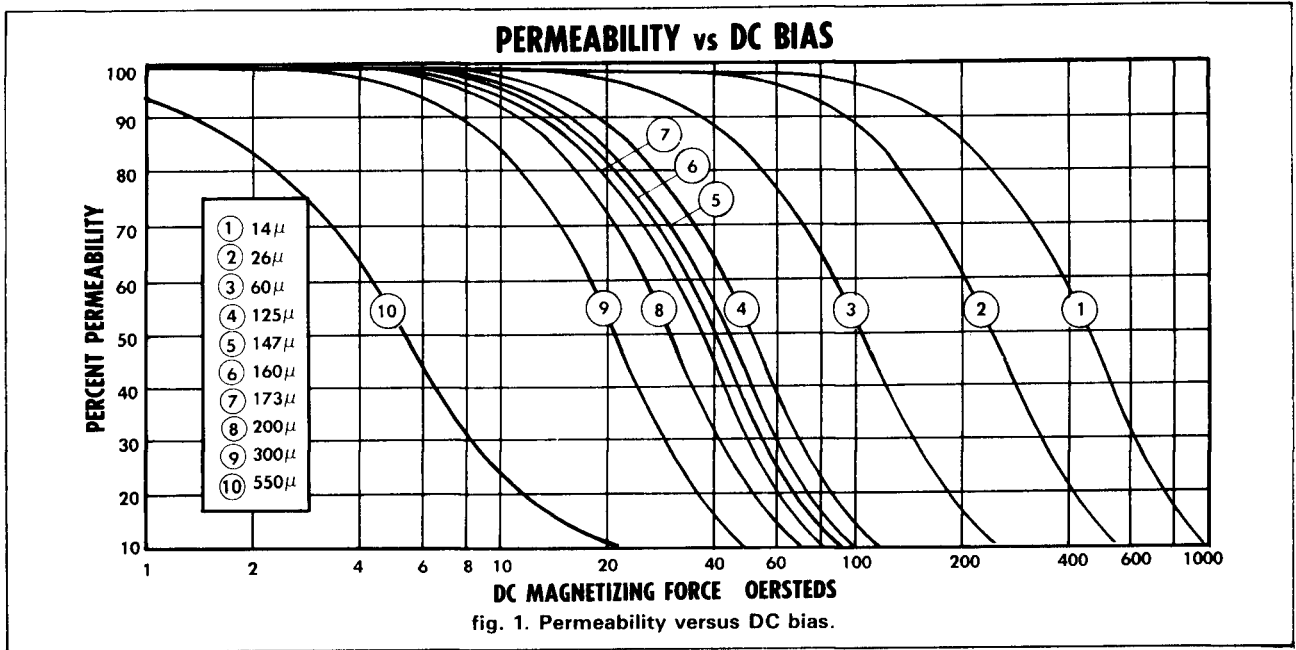

tion with the first core size that lies within the family of solid permeability lines. This core size is the smallest that can be used. (In fig. 2, small core sizes are at the bottom and large sizes at the top.)

Any solid permeability line that passes through the intersection point of the  $LI^2$  and core size coordinates or crosses the  $LI^2$  coordinate below this intersection point may be used.

The choice of permeability can be based on  $Q$  requirements at the operating frequency of the application. Use the  $Q$  curves in fig. 3 for this selection. If  $Q$  is not a consideration, use the highest permeability indicated. This choice will yield the lowest winding factor.

The design application may call for a  $Q$  requirement at a higher frequency than the core/permeability combinations indicated in steps 2 and 3. By following the  $LI^2$  coordinate to lower permeabilities and larger core sizes, an optimum choice for this type design may be made. For a given permeability, always use the core size just above the permeability line.

Inductance, core size and permeability are now known. The remaining core data is obtained from the selected core data sheet, see fig. 4. Use core dimensions which include the core finish.

Load the program and respond to input commands when requested.

Inputs include the following:

- core outside diameter (in inches)
- core inside diameter (in inches)
- core height (in inches)
- core permeability

- core mH/1000 turns
- magnetic path (in inches)
- window area (in circular mils) —  $CMIL^* \times 10^6$
- MLT (mean length of turn) — full winding (in inches)
- HDC (Peak) Maximum
- percent Nom. Perm @HDC (Peak) Maximum

Upon completion of the last input, "CALCULATING" will appear on the monitor screen as the program calculates all values. Results are displayed as printer outputs; see figs. 5 and 6.

### core selection example

Choose a core meeting the following requirements:

- minimum inductance with DC bias, 25  $\mu$ H
- DC current, 2 amps.
- operating frequency, 8 kHz.
- optimum  $Q$  is required.

The product of  $LI^2 = 0.1$ . Following this coordinate, the first core size encountered that falls within the solid line permeability family is the 55050 size.

The intersection point of the 0.1 coordinate and the 55050 core size coordinate falls between the 60 $\mu$  curve and the 125 $\mu$  curve. Only those permeability lines intersecting the  $LI^2$  coordinate below the core intersection are usable; either 125 $\mu$  or 160 $\mu$  may be used.

A review of the  $Q$  curves (fig. 3) indicates that a 55050 core in 160 $\mu$  peaks in the neighborhood of 8 kHz, whereas this size in 125 $\mu$  peaks near 20 kHz. For optimum  $Q$  at 8 kHz, 160 $\mu$  is chosen, core 55048. From fig. 1, determine magnetizing force  $H$  for the percent-





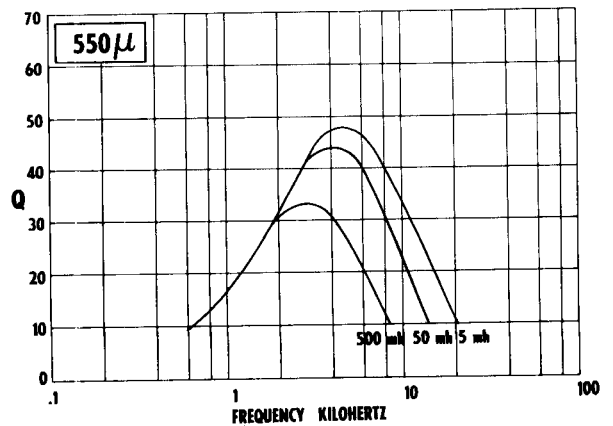
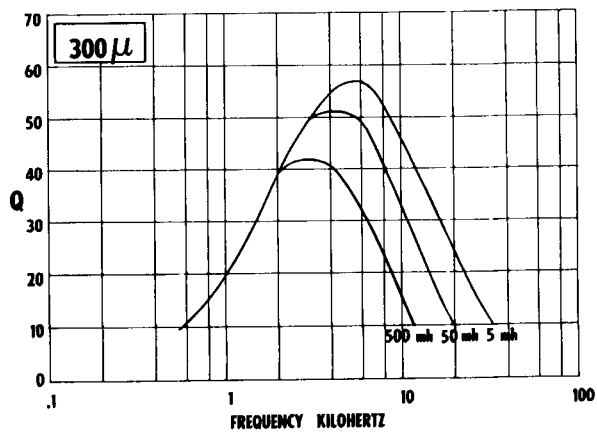
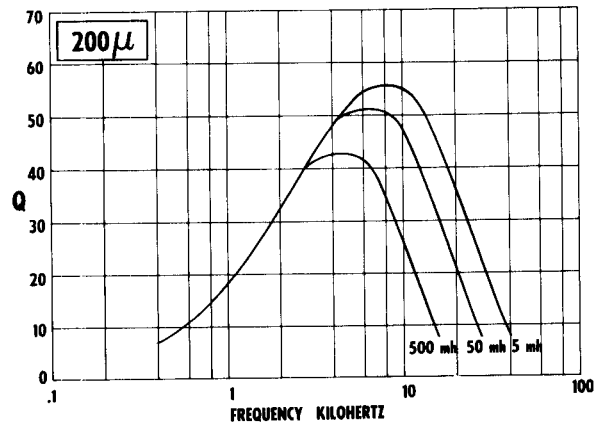
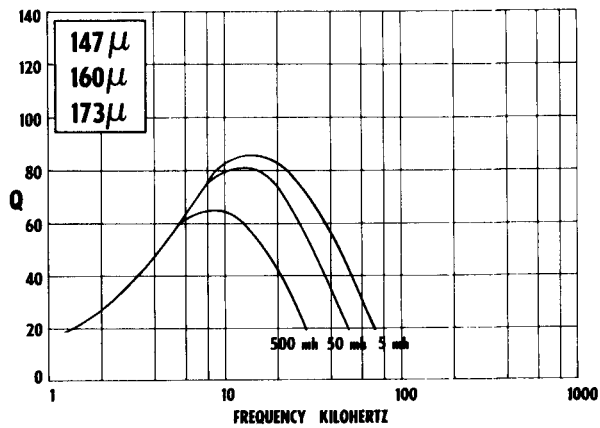
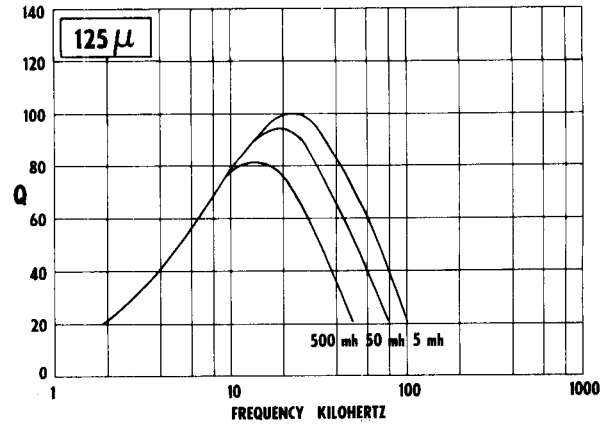
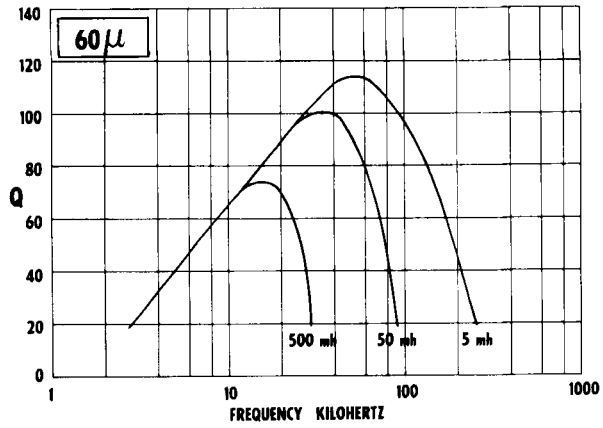
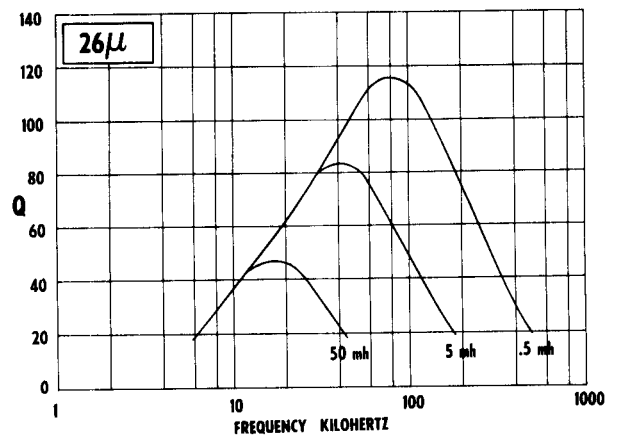
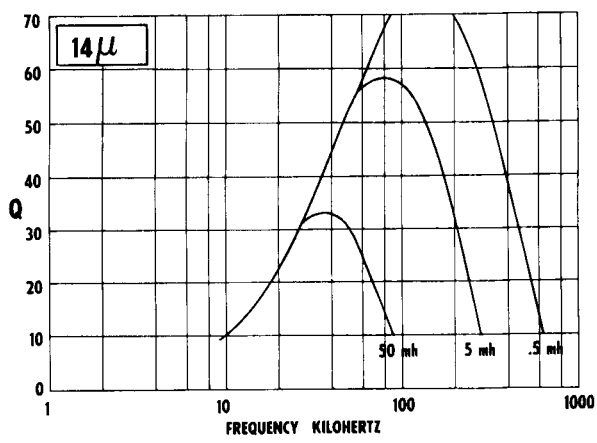

fig. 3. Using Q curves helps determine permeability.

# PAC-COMM

## Introduces the TNC-200



- Official TAPR TNC-2 design
- Top quality components throughout
- Standard AX.25 Version 2 protocol
- Full duplex hardware HDLC
- Five terminal data rates to 9600 baud
- Modem adaptable for HF packet
- 16K battery backed-up RAM
- 32K EPROM, software clock
- Latest multiconnect software
- Five labeled LED status indicators
- Level 3 networking compatibility
- Choose CMOS version for low power (100ma typical) or NMOS for lower cost

Assembled and tested	CMOS - \$ 219.95
	NMOS - \$ 199.95
Full kit with cabinet	CMOS - \$ 169.95
	NMOS - \$ 154.95
Full kit without cabinet	CMOS - \$ 144.95
	NMOS - \$ 129.95
Hard-to-find-parts kit	CMOS - \$ 84.95
	NMOS - \$ 79.95
Bare PC board + assy manual	\$ 39.95
Reference manual (100 + pg)	\$ 9.95
Cabinet with end plates	\$ 29.95

Macintosh Owners: MACPACKET TNC200 gives pull-down menus, split screens, file transfers, automatic routing and more!!  
MACPACKET/TNC200 \$69.95

Free UPS shipping in continental USA

Discount 10% for orders of five or more TNC-200s to the same address

ORDER TOLL FREE (24 hours)

800-835-2246 ext. 115

(Kansas 800-362-2421 ext. 115)

Information 813-689-3523



(No COD)



Florida addresses add 5%

PAC-COMM PACKET RADIO SYSTEMS, INC.

4040 W. Kennedy Blvd. Tampa, FL 33609

Intl TELEX 6502881526 WUI

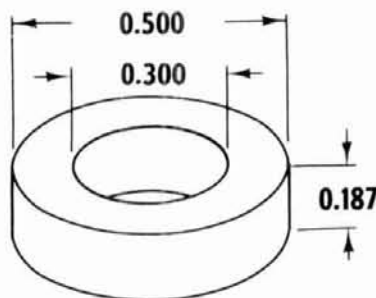

#### CORE DIMENSIONS AFTER FINISH

OD (MAX.)	0.530 in	13.46 mm
ID (MIN.)	0.275 in	6.99 mm
HT (MAX.)	0.217 in	5.51 mm

WINDOW AREA	75,600 cir. mils
CROSS SECTION	0.01767 in <sup>2</sup> 0.1140 cm <sup>2</sup>
PATH LENGTH	1.229 in 3.12 cm
WEIGHT	0.11 oz 3.1 gm
	(.0069 lb.)

#### WINDING TURN LENGTH

WINDING FACTOR	LENGTH/TURN
100% (UNITY)	0.0815 ft 2.49 cm
60%	0.0721 ft 2.20 cm
40%	0.0629 ft 1.920 cm
20%	0.0589 ft 1.797 cm
0%	0.0574 ft 1.751 cm

#### WOUND COIL DIMENSIONS

##### UNITY WINDING FACTOR

OD (MAX.)	0.717 in 18.2 mm
HT (MAX.)	0.451 in 11.5 mm

#### MAGNETIC INFORMATION

PART NO.	PERM $\mu$	INDUCTANCE @ 1000 TURNS MH <sup>2</sup> B%	NOMINAL DC RESISTANCE OHMS/MH <sup>2</sup> *	FINISHES AND STABILIZATIONS*	GRADING STATUS % BANDS	B/NI GAUSS PER AMP. TURN
55053-	14	6.4	2.67	A2	*	5.64 (<1500 gauss)
55052-	26	12	1.42	A2	*	10.5 (<1500 gauss)
55051-	60	27	0.633	ALL	*	24.2 (<1500 gauss)
55050-	125	56	0.305	ALL	YES	50.4 (<1500 gauss)
55049-	147	67	0.255	ALL	YES	59.2 (<1500 gauss)
55048-	160	72	0.237	ALL	YES	64.5 (<1500 gauss)
55044-	173	79	0.216	ALL	YES	69.7 (<1500 gauss)
55047-	200	90	0.189	ALL	YES	80.6 (<600 gauss)
55045-	300	134	0.127	A2 and L6	YES	121 (<300 gauss)
55046-	550	255	0.067	A2	YES	222 (<50 gauss)

#### WINDING INFORMATION

FOR UNITY WINDING FACTOR\*\*

AWG WIRE SIZE	TURN	R <sub>dc</sub> OHMS	AWG WIRE SIZE	TURN	R <sub>dc</sub> OHMS
16	25	0.00826	31	646	6.90
17	31	0.0129	32	788	10.40
18	39	0.0203	33	977	16.40
19	48	0.0318	34	1,244	26.5
20	61	0.0500	35	1,543	41.6
21	76	0.0789	36	1,905	64.4
22	93	0.1233	37	2,327	97.1
23	116	0.1925	38	2,909	153.6
24	144	0.302	39	3,744	258
25	178	0.470	40	4,727	414
26	222	0.743	41	5,817	626
27	280	1.173	42	7,414	1,003
28	344	1.829	43	9,003	1,570
29	420	2.81	44	10,360	2,186
30	525	4.45			

fig. 4. Core data.

## SPECIAL SALE — SAVE \$5 EACH

Have a name — but need the Call Sign?  
Traveling — and want to meet local Hams?

1985 1986 Amateur Radio

### NAME INDEX

By Name and Call. 583 pages

1985 1986 Amateur Radio

### GEOGRAPHICAL INDEX

By State, City, Street No. and Call. 653 pages

No frills directories of over 462,000 U.S. Radio Amateurs. 8½x11, easy to read format.

NAME INDEX—~~\$25.00~~ \$19.95

GEOGRAPHICAL INDEX—~~\$26.00~~ \$19.95

BUY BOTH SPECIAL \$35.95

Add \$3.50 shipping to all orders

ham  
radio magazine

BOOKSTORE

Greenville, NH 03048

## YAESU FT-757GX OWNERS

# Computer control your HF operation with GX Turbo.

Your computer belongs in your ham shack, especially now with powerful GX Turbo software.

GX Turbo runs with any Apple or Commodore 64/128, and really supercharges your FT-757GX operation.

Via computer control, you'll enter frequencies directly to VFOs and memories. Tune up and down, manually or automatically. Edit, save and load memory files. Exchange and copy frequencies between VFOs and memories. Even time a QSO and more.

So get the DX advantage with GX Turbo. For all the details, make a pit stop by your Yaesu dealer today.

Apple is a registered trademark of Apple Computer, Inc. Commodore 64 and Commodore 128 are registered trademarks of Commodore-Amiga, Inc.

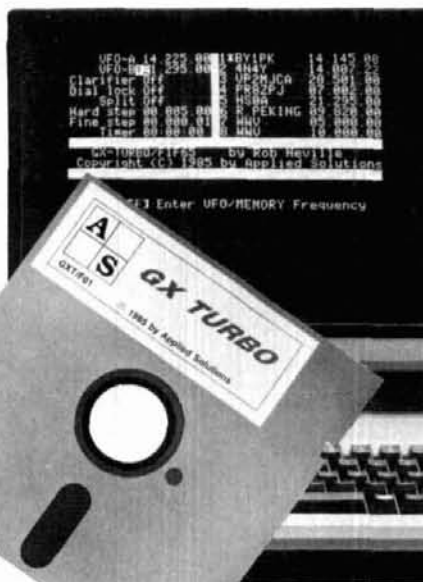

Prices and specifications subject to change without notice.

## YAESU Our 30th Anniversary.

Yaesu USA 17210 Edwards Road, Cerritos, CA 90701 (213) 404-2700

Yaesu Cincinnati Service Center 9070 Gold Park Drive, Hamilton, OH 45011 (513) 874-3100

✓ 149

**EXMET**, your source for METALLURGICAL ASSISTANCE and DISCOUNTED PRICING on Aluminum Tubing and Shapes, plus Carbon, Alloy, SS, and Galvanized Tubing. Examples below are only a small fraction of our stock. Please call or write for additional stock sizes.

### Aluminum Tubing (Alloy 6061-T6)

O.D. x Wall	Length	Price per Length
1/2" x .058"	12 ft.	\$ 10.26
7/8" x .058"	12 ft.	18.40
1" x .058"	12 ft.	21.82
1-1/4" x .058"	12 ft.	27.35
1-1/2" x .058"	12 ft.	33.37
1-1/2" x .125"	24 ft.	76.20
2" x .058"	12 ft.	44.93
2" x .250"	24 ft.	193.92
3" x .065"	12 ft.	76.14

Stainless Steel, Carbon Steel, Alloyed Steel, and Galvanized Steel Tubing in stock that meets ASTM Standards.

Policies: All prices FOB Twinsburg, Ohio. Payment by MC or Visa, check or money order or COD. Minimum order \$50.00. Volume and Club discounts available. Ohio residents add 5 1/2% Sales Tax.

**EXMET, INC.**

2170 E. Aurora Rd., P.O. Box 117  
Twinsburg, Ohio 44087 • 216-425-8455

✓ 146

## Save Time-Money with HAZER

- Never climb your tower again with this elevator system.
- Antenna and rotator mount on HAZER, complete system trams tower in verticle upright position.
- Safety lock system on HAZER operates while raising-lowering & normal position. Never can fall.
- Weight transferred directly to tower. Winch cable used only for raising & lowering. Easy to install and use.
- Will support most antenna arrays.
- High quality materials & workmanship.
- Safety - speed - convenience - smooth travel - inexpensive.
- Complete kit includes winch, 100 ft. of cable, hardware and instructions. For Rohn 25 G Tower.

Hazer 2-Heavy duty alum., 12 sq. ft. load \$297.00 ppd.  
Hazer 3-Standard alum., 8 sq. ft. load 213.00 ppd.  
Hazer 4-Heavy galv. steel, 16 sq. ft. load 278.00 ppd.  
Ball thrust bearing TB-25 for any of above 42.50 ppd.

**Satisfaction guaranteed. Call today and charge to Visa or MasterCard.**

As an alternative, purchase a Martin M-13 or M-18 aluminum tower engineered specifically for the HAZER system, or a truly self-supporting steel tower. Send for free details.



GLEN MARTIN ENGINEERING INC.  
P.O. Box H 253 Boonville, Mo. 65233  
816-882-2734

✓ 147

## AMATEUR RADIO MAIL LISTS

Self-stick 1x3 labels

- \*\*\* NEWLY LICENCED HAMS \*\*\*
- \*\*\* ALL NEW UPGRADES \*\*\*
- \*\*\* UPDATED EACH WEEK \*\*\*

Total List = 462,728 (ZIP sorted)  
Price is 2.5 cents each (4-up Cheshire)

BUCKMASTER PUBLISHING  
Mineral, Virginia 23117  
703:894-5777

✓ 148

## WRITE FOR

# FREE BOOK CATALOG

Ham Radio's Bookstore  
Greenville, NH 03048

## ALL BAND TRAP VERTICAL ANTENNAS!

FULL 1/4th WAVE - All Bands! Automatic Selection with proven Hi-Q Traps. 5 Models-ALL self supporting - Ground or roof mount. HI STRENGTH FIBERGLASS TUBING OVER - ALL NO WOBBLY, LUMPY TRAPS - NO UNSIGHTLY CLAMPS needed - Size 1 1/4" all the way up - Traps hidden inside. You can use it in a 1 ft. sq. Backyard! FOR APARTMENTS, MOBILE HOMES - CONDOS etc. where minimum space and neat appearance is MANDATORY! Instant "Drive In" ground mount (included)! Use with or without radials (included)! (All angle roof mount - Extra) COMPLETELY PRE-TUNED - NO ADJUSTMENTS NEEDED EVER! NO TUNER NEEDED FOR MOST TRANSCEIVERS! Use - RG8U feedline, any length! 2000 Watt PEP input power. Shipped - PREPAID IN USA. Assemblies in 10 min. using only screwdriver. WEATHERPROOF!

No.-AVT 80-10 - 5 Band - 25'6" - \$199.95  
No.- AVT 40-10 - 4 Band - 18'9" - \$139.95  
No.- AVT 20-10 - 3 Band - 11'4" - \$109.95  
No.- AVT 80-10-3 - 6 Band - 24'8" - \$229.95  
No.- AVT 40-10-3 - 5 Band - 17'9" - \$159.95

SEND FULL PRICE FOR PP DEL. IN USA (Canada is \$10.00 extra for postage, clerical, Customs ) or order using VISA, MASTER CARD or AMER-EXP. Ph 1-308-236-5333 9AM-6PM weekdays. We ship in 2-3 days - All Antennas Guaranteed for 1 year - 10 day money back trial. Free Int.

WESTERN ELECTRONICS

Dept. AH Kearney, Ne. 68847

✓ 150

\*\*\*\*\*

\*\*\* TORCHK1 PROGRAM \*\*\*

CORE O.D. : .53

160 PERM.

WIRE SIZE	FULL COIL TURNS	DC RES OHMS	CU WT	I PEAK AMPS	INDUC MHY
-----------	-----------------	-------------	-------	-------------	-----------

\*\*\*\*\*

12	5.4	0	.01	9.19	1.6E-03
13	6.7	0	.01	7.41	2.5E-03
14	8.4	0	.01	5.91	4E-03
15	10.5	0	.01	4.72	6.3E-03
16	13.2	0	.01	3.76	.01
17	16.3	0	.01	3.04	.0153
18	20.5	0	.01	2.42	.0242
19	25.4	.01	.01	1.95	.0371
20	31.8	.02	.01	1.56	.0582
21	39.4	.03	.01	1.26	.0894
22	49.1	.05	.01	1.01	.1388
23	61	.08	.01	.81	.2143
24	75.7	.14	.01	.65	.33
25	93.6	.21	.01	.53	.5046
26	116	.34	.01	.42	.775
27	145.9	.54	.01	.34	1.2261
28	181.2	.85	.01	.27	1.8912
29	228.4	1.29	.01	.22	2.7979
30	275.6	2.06	.01	.18	4.375
31	339.2	3.2	.01	.14	6.6272
32	413.4	4.82	.01	.12	9.8438
33	512.7	7.61	.01	.09	15.1408
34	652.7	12.28	.01	.07	24.5385
35	809.9	19.32	.01	.06	37.782
36	999.7	29.9	.01	.04	57.5654
37	1221.2	45.87	.01	.04	85.9005
38	1526.5	71.3	.01	.03	134.2196
39	1964.8	119.96	.01	.02	222.3612
40	2480.6	193.11	.01	.02	354.4344
41	3053	290.49	.01	.01	536.8785
42	3891.1	465.59	.01	.01	872.1019
43	4724.9	728.86	.01	.01	1285.9015
44	5436.9	1015.04	.01	0	1702.6491
45	7488.6	1807.25	.01	0	3230.1578
46	9020.4	2735.47	0	0	4686.7746

\*\*\*\*\*

fig. 6. Table of inductor designs.



# ICOM

# KENWOOD YAESU



IC-751 9 band XcVR, 1-30 MHz

<b>ICOM</b>		
<b>HF Equipment</b>		
IC-751 Xcvr	1399.00	Call \$
IC-751A Xcvr	NEW	Call \$
IC-745 Xcvr	999.00	Call \$
IC-735 Xcvr	889.00	Call \$
PS-55 Power Supply	169.00	Call \$
PS-35 Power Supply	169.00	Call \$
<b>Receivers</b>		
IC-R-7000	969.00	Call \$
IC-R71A	849.00	Call \$
<b>VHF/UHF</b>		
IC-02AT 2m, HT	369.00	Call \$
IC-2AT	269.00	Call \$
IC-271A 2m, Base	735.00	Call \$
IC-27A Compact	389.00	Call \$
IC-3AT, HT	299.00	Call \$
IC-37A Compact Mobile	449.00	Call \$
IC-04AT 440 MHz, HT	399.00	Call \$
IC-4AT	299.00	Call \$
IC-471H 75w, 440 MHz	1149.00	Call \$
IC-47A	489.00	Call \$
IC-3200A 25W, dual bander	569.00	Call \$
IC-290H 25W, 2M, SSB/FM	549.00	Call \$
IC-490A 10W, 440, SSB/FM	649.00	Call \$
RP-3010 UHF, Repeater	1049.00	Call \$
IC-1271A 1.2 GHz Base	1049.00	Call \$
IC-120 mobile	499.00	Call \$

### KENWOOD

<b>HF Equipment</b>		
TS-940S w/AT	1999.95	Call \$
wo/AT	1799.95	Call \$
TS-430S	899.95	Call \$
TS-830S	949.95	Call \$
TS-530S	749.95	Call \$
TS-670 Quad Bander	699.95	Call \$
<b>Receivers</b>		
R-2000	599.95	Call \$
R-1000	499.95	Call \$

### TS-440S ALL NEW COMPACT HF XcVR



### VHF/UHF

TR 2600A 2m, FM, HT	339.95	Call \$
TR 3600 440, HT	349.95	Call \$
TH 21AT Compact 2m	229.95	Call \$
TH 31AT Compact 220	239.95	Call \$
TH 41AT Compact 440	239.95	Call \$
TW 4000A 2m/70cm	599.95	Super
		<b>Special Call \$</b>
TM 2570A 70w, 2m	549.95	Call \$
TM 2550A 45w, 2m	459.95	Call \$
TM 2530A 25w, 2m	399.95	Call \$
TM 211A 2m, Mobile	369.95	Call \$
TM 411A 70 cm	449.95	Call \$
TM 201B 2m, FM Mobile	339.95	Call \$
TM 401B 70 cm Mobile	369.95	Call \$
TS-711A 2m, All Mode	799.95	Call \$
TS-811A 440, Base	899.95	Call \$

### ENCOMM

	<b>List</b>	<b>Juns</b>
<b>Santec</b>		
ST-20T 2m HT	349.95	Call \$
<b>Welz</b>		
Power Meters, Acces.		Call \$
<b>Tokyo Hy-Power</b>		
VHF/UHF Amps/ Tuners		Call \$



FRG 9600 60-905 MHz Rec.

### YAESU

<b>HF Equipment</b>		
FT ONE Xcvr	2859.00	Call \$
FT 757GX Xcvr	879.95	Call \$
FT 980 CAT System	1659.00	Call \$
FT-77 Compact Xcvr	599.00	Call \$
<b>Receivers</b>		
FRG 8800 150 kHz - 30 MHz	569.00	Call \$
FRG 9600 60 - 905 MHz	649.00	Call \$
<b>VHF/UHF</b>		
FT-203R/TT 2m, HT	259.95	Call \$
FT-209RH w/FTS-6	359.95	Call \$
FT-103R/TT 220 MHz	279.95	Call \$
FT-703R/TT 440 MHz	299.95	Call \$
FT-709 R w/FTS-6 440 MHz, HT	349.00	299.95
NC-15 Quick Charger	79.00	Call \$
FT-270 RH w/FTS-8 2m	439.00	Call \$
FT-2700RH w/FTS-8	599.95	Call \$
FT-726R All Mode		
OSCAR	925.00	Call \$
6m Module	215.95	Call \$
SU-726	109.95	Call \$
430/726	299.95	Call \$
440/726	299.95	Call \$
HF/726	225.95	Call \$

<b>TE SYSTEMS</b>	<b>Call \$</b>
<b>MIRAGE</b>	<b>Call \$</b>
<b>AMP SUPPLY</b>	<b>Call \$</b>
<b>AMERITRON</b>	<b>Call \$</b>
<b>BIRD Products In Stock</b>	<b>Call \$</b>
<b>KLM Antennas</b>	<b>Call \$</b>
<b>Hustler Antennas In Stock</b>	<b>Call \$</b>
<b>Larsen Antennas In Stock</b>	<b>Call \$</b>

### AMPLIFIERS

AEA	Products In Stock	• AMATEUR • TWO WAY • MARINE
Kantronics	Products In Stock	• CELLULAR MOBILE PHONE • SCANNER
Astron	Products In Stock	• Free U.P.S. Cash Order
Benchner	Products In Stock	(Most Item, Most Place)
Ameritron	Products In Stock	• Shoppers, call us last, save \$\$
		• SE HABLA ESPANOL

**JUN'S**  
**ELECTRONICS**  
INCLUDES ALASKA HAWAII  
**800-882-1343**

**(213)390-8003** 3919 Sepulveda Blvd. Culver City, CA 90230

## HF ANTENNAS — The Easy Way

by John Haerle, WB5IIR

This book has been published as a memorial to WB5IIR's work as an Amateur Radio teacher. Originally given as a series of

speeches or papers, this tutorial is an excellent source book on antenna theory and applications. Examples of areas covered are: *Fundamentals*, antenna and feedline

terminology, baluns, ground systems, lightning protection, *The Basic Antenna*, the dipole, the zepp, G5RV, Windom, *Special Antennas*, the sloper, DDDR, Beverage, folded unipole, *Beams*, W8JK, Yagi, two element quad, and the *160 meter band story*. John's writing is in an easy-to-understand conversational style and is full of examples and handy tips and hints. There are no drawings or illustrations but John's prose paints pictures for clear and complete understanding of the information being presented. ©1984 1st Edition.

JH-AT

**Softbound \$11.95**

Please add \$3.50 for shipping and handling.

**ham radio** magazine  
GREENVILLE, NH 03048

**BOOKSTORE**  
(603) 878-1441



# GLB TNC2A PACKET CONTROLLER

GLB Electronics - the first commercial producer of packet controllers joins the "TAPR Revolution" to bring you the GLB Model TNC2A Kit. This kit is the latest TAPR design and is supplied with top quality components. The GLB TNC2A is backed by over 14 years of experience in amateur radio kit products and our technical staff is available to assist you daily from 1 to 3 PM Eastern time.

## GLB Model TNC-2A Kit



### FEATURES

- AX 25 Version 2.0 Software
- Terminal baud rates - 300, 1200, 2400, 4800, 9600
- Multiple connects - up to 10 stations
- Datetime stamping
- Standard DB25 for RS232 connection
- Simple radio hookup
- Radio modem w/built-in counter for calibration
- Low power CMOS option
- Tuning indicator socket for HF & satellite work
- Modem disconnect for future options
- Lithium battery backup for RAM

Hardware  
Software  
Documentation

by TAPR

### SPECIFICATIONS

CPU	Z80A microprocessor
Clock	2.4576 Mhz standard, 4.9152 Mhz available
Memory	32K EPROM, 16K RAM standard
HDL	Packets are controlled by hardware for maximum performance permitting full duplex operation
Modem	1200 baud, Bell 202 compatible (standard) easily configured for 300 baud/200 Hz shift for HF use
Serial	Computer/Terminal port is industry standard RS 232 C compatible for use with most equipment
Radio	Watchdog timer for channel protection transmits audio levels adjustable for nearly any radio. Wide dynamic range demodulator. Channel busy input (RF DCD) to inhibit packet transmissions on a shared channel
LEDs	Power - tells you when power is applied Status - tells you when you have unacknowledged traffic in your buffers Connect - tells you when you are in the error-free mode DCD - tells you when your TNC2A senses other activity on the channel
Power	PTT - tells you when your TNC2A keys the transmitter - 10 to - 15 VDC CMOS-110 ma NMOS-260 ma Typical

Model TNC2A Kit NMOS	\$154.95
Model TNC2A Kit CMOS	\$169.95

Quantity  
discount schedule:

1-2 pcs - net
3-4 pcs - 7%
5-9 pcs - 10%
10-19 pcs - 15%
20 & up - 20%

Shipping weight - 5 lbs.

**GLB ELECTRONICS, INC.**  
151 Commerce Pkwy., Buffalo, NY 14224  
716-675-8740 9 to 4

## glossary of terms

**Winding factor** is the ratio of the total area of copper wire in the center hole of a toroid to the window area of the toroid.

**Window Area, CMIL - 1E6 circular.** The unit "Circular MIL" is the area of a circle 1 mil in diameter. The number of circular mils in a square

inch is, therefore  $\frac{4}{\pi} \times 10^6$ , or 1,273,237. Since

1 mil is the thousandth part of an inch; there are 1,000,000 square mils in a square inch. Thus the area of a cross-section expressed in circular mils is always bigger than the true area expressed in square mils, because the unit area to which the name "Circular Mil" has been given is smaller than the square mil.

**Heavy Enamel** is a magnet wire having an extra heavy film of enamel insulation (i.e., double coated). Its abrasion resistance is somewhat greater than regular enamel (i.e., single coated) magnet wire.

**MLT - full winding.** MLT is the mean length of a single turn of wire. This will vary considerably between a single layer of wire and a core full of wire. The values of MLT are listed on each core size data sheet (see fig. 4).

**HDC (peak) Max. (core bias).** DC current = peak current. If current is not direct continuous, then the peak (momentary) value is used to determine core operating conditions.

$$H = \frac{0.4\pi \cdot \text{turns} \cdot \text{peak magnetizing current}}{\text{mean magnetic path}}$$

$$\text{or } H = \frac{0.4\pi \cdot NI}{\ell} \text{ Oersteds}$$

bias range Oersteds	recommended permeability
below 6	500
6 to 22	300
22 to 35	200
22 to 35	173
22 to 35	160
35 to 70	147
40 to 140	125
70 to 150	60
150 to 330	26
above 330	14

## NEMAL ELECTRONICS

Your Authorized  
Distributor For



### INTRODUCTORY SALE!

Belden No.	Nemal No.	Description	Per 100 ft.	Per ft.
8214	1102B	RG8 /U Foam 96%	\$45.00	.50
8237	1100B	RG8/U Poly 96%	39.00	.44
8241	1500B	RG59/U Poly 96%	13.00	.15
8267	1130B	RG213/U Poly 96%	53.00	.59
9269	1600B	RG62A/U Poly 96%	15.00	.17
8216	1450B	RG174/U Poly 96%	12.00	.14
9913	1180	Low Loss 50 Ohm	46.00	.58

### OTHER QUALITY CABLES

Nemal No.	Description	Per 100 ft.	Per ft.
1110	RG8X 95% Shield (mini 8)	15.00	.17
1130	RG213/U Mil Spec. 96% Shield	34.00	.36
1140	RG214/U Mil Spec. - Silver	155.00	1.65
1705	RG142B/U Teflon - Silver	140.00	1.50
1310	RG217/U 5/8" 50 Ohm Dbl. Shld.	80.00	.85
1470	RG223/U Mil Spec. - Silver	80.00	.85
ROTOR CABLE - 8 COND.			
8C1822	2-18 Ga., 6-22 Ga.	19.00	.21
8C1820	2-16 Ga., 6-20 Ga. Heavy Duty	34.00	.36
HARDLINE - 1/2"			
FXA12	Smooth Alum. w/black jacket	79.00	.89
FLC12	Corrug'd. Copper (EQ. Helix LDF)	159.00	1.69
CONNECTORS - MADE IN U.S.A.			
NE720	Type N for Belden 9913	4.75	
PL259	Standard Plug for RG8, 213	.65	
PL259AM	Amphenol PL259	.89	
PL259TS	PL259 Teflon/Silver	1.59	
UG21D	Type N for RG8, 213, 214	3.00	
UG175	Adapter for RG58	.22	

Call or write for complete Price List

COD add \$2.00.

Shipping: Cable - \$3.00 per 100 ft.

Florida Residents add 5%.

Connectors - and 10%, \$3.00 minimum

Orders under \$20 Add \$2 Handling

Nemal's new 32-page Cable & Connector Selection Guide now available at no charge with orders of \$50 or more or at a cost of \$4.00 individually.

## NEMAL ELECTRONICS

12240 N.E. 14th Ave., Dept. Q., Miami, FL 33161

Telephone (305) 893-3924



## meteor scatter communications

It's been two years since my first article on improving meteor scatter communication appeared in this column.<sup>1</sup> That article generated lots of interest and many readers have used the techniques described to improve their own meteor scatter QSO success rate. In that column, I described a method and a computer program designed to help pinpoint the peak of each of the major meteor showers. The predicted peak for upcoming meteor showers you see listed at the end of each monthly column is derived using this method.

Since that column was written, many new improvements in prediction have taken place: shower peaks can now be predicted with greater accuracy, and computer programs that help optimize scheduling are readily available. Because the summer months — along with a short peak from December through early January — are prime time for meteor scatter communications, it seems this would be a good time to present some additional tips on improving meteor scatter communications.

### a quick review

Meteor scatter communications uses the ionized trails left by meteors as they enter the earth's ionosphere. There are two basic types of meteors, *sporadic* and *shower*. Sporadic meteors are random in nature. They peak daily at about 6 AM and are at their minimum at about 6 PM local time. Shower meteors, on the other hand, peak at specific times of the year and can begin at any time of the day, depending on the radiant (the place in

the sky from which the meteors seem to emanate).

Amateurs in North America most often use the shower types, believed to be the remnants of old or extinct comets. These meteors generally provide more ionization and their time of arrival is more predictable than that of sporadic meteors. Shower meteors usually are in greater quantity than sporadic meteors; the typical shower lasts from 12 hours to several days (for at least 25 percent of the peak time). As a result, meteor showers are more reliable for completing a QSO than sporadic types.

"That's fine," you say. "I've looked at the meteor shower peak prediction method in reference 1 and even ran schedules during the peak hours listed at the end of 'VHF/UHF World' each month with only limited success. What am I doing wrong?"

Several questions must be answered. First and foremost, was the other station definitely on the air during the schedule? Was it on the right frequency and using the correct timing sequence? Was all your gear and the other station's gear operational — or did one of the stations have a transmitter or receiver sensitivity problem? Was the transmitted power and antenna gain sufficient at each end of the path? "Of course," you insist. Then read on!

One potential problem is the distance between stations. Generally, the optimum distance for meteor showers is between 700 and 1000 miles (1125-1610 km). Distances less than about 700 miles are a problem because your antenna must be elevated for maximum signal strength and the bursts are usually shorter.

Longer distances out to about 1400 miles (2250 km) are possible using meteor scatter. However, for best results use only the high-speed meteor showers, which have increased ionization higher in the E region. (More on this later.)

The most productive schedules are usually run during the hours or days when the meteors are above 25 percent of the peak of the shower; this is called the *peak time* of the shower. Running a day or so ahead or behind the peak may be less productive, especially if the shower is one of short duration.

The procedure for determining the shower peak time and date was described in detail in reference 1, so it won't be repeated here, though **table 1** has been revised to show the latest ecliptic longitude at 0000 UTC. For those who don't care to work out the peaks or use the computer program listed in reference 1, the predictions of major showers are listed each month at the end of this column.

W9IP mentioned that the ecliptic longitude tables shown in reference 1 may not be accurate enough to be reused every four years as originally suggested. This is true because the tables may vary by up to several hours over a four-year period. So I've updated the daily ecliptic longitude in **table 2** and made appropriate corrections.

If a "fudge factor" of about 0.12 (equivalent to about three hours in four years) is added to the values shown in the tables every four years hence, the tables can be used for many years with a high degree of accuracy. For example, the 1986 table can be reused for 1990 by simply adding 0.12 to each value. Hence January 3, 1990 has a

Table 1.

Shower name	E.L.*	Best dates	Duration**	Hourly rate†	Velocity (km/sec)	Local time‡ rise/set
Quadrantids	282.855	January 2-4	14 hrs	110	41.5	2300-1800
April Lyrids	31.8	April 20-24	2.3 days	15	47	2100-1100
Eta Aquarids	44.5	May 2-7	3 days	20	67	0300-1200
Arietids	76.5	June 1-15	8 days	60	37	0300-1530
June Lyrids	84.5	June 10-21	7 days	10	31	2100-1100
Delta Aquarids	126.0	July 26-30	7 days	35	42	2200-0600
Perseids	139.3	August 10-14	4.6 days	65	60	(Note 1)
Orionids	207.4	October 18-23	2 days	30	67	2230-0930
Taurids	221.0	October 30- November 10	20 days	10	30	1900-0630
Leonids	234.7	November 14-19	4 days	20	71	2300-1230
Geminids	261.2	December 10-15	2.5 days	50	36	1800-1000
Ursids	270.5	December 20-24	2.2 days	15	33	(Note 2)

\*Ecliptic longitude in 1950 coordinates.

\*\*Duration is the amount of time that the meteors are above 25 percent of the peak of the shower.

†Estimated meteors per hour at maximum. Can vary greatly from year to year depending on shower.

‡Local time for northern mid-latitudes.

Note 1. Never sets. Minimum at 1730.

Note 2. Never sets. Minimum at 2030.

corrected ecliptic longitude of 282.43; 1994, a corrected value of 282.55. For maximum precision, the computer program shown in reference 1 is recommended, since it contains an algorithm for continuously updating the daily ecliptic longitude with minimal error, regardless of dates.

However, the primary factor in increasing the probability of a successful QSO is determining the optimum time of the day for the desired path direction during or near ( $\pm 12$  hours) the predicted peak of a meteor shower. W4LTU provided guidelines in his tables in references 2 and 3, but they were only guidelines and no specifics on distances or probabilities were included.

Why is this consideration so important? Meteors enter the ionosphere in a specific geometry, depending on where they're encountered by the earth in its orbit around the sun. If the meteors are entering on the opposite side of the earth from your QTH, the chance of a completed meteor scatter QSO is slim.

If the geometry of the meteor shower is favorable, there will be a time when the meteors enter the ionosphere in the optimum direction at the best entry angle, yielding specular (i.e., mirror-like) reflection to radio signals on a specific path as explained by Bain.<sup>2,3</sup>

Villard, et. al., described this geometry in detail in reference 4. Meeks and James further defined the ideal geometry for specular reflection on forward scatter, suggesting that the ideal geometry occurs when the meteors cross at right angles to the great circle path between the transmitter and receiver and enter the ionosphere at an elevation angle of 45 degrees.<sup>5</sup> Meeks and James then derived a complicated set of formulas for determining the decrease in performance from the ideal case. They called this term "effectivity."

This can best be visualized as a mirror reflecting the wave to the proper point. Whenever the trail is properly oriented (consider the reflection region to be the mirror), the incident wave will

be reflected directly back to the desired destination. Furthermore, the angle the incident wave makes with a perpendicular to the mirror will be the same as the angle the reflected wave makes with the perpendicular. As the mirror is moved from this ideal orientation, only a portion of the incident wave will be projected onto the correct region of the mirror for reflection back to the desired location.

Thus as the reflection mirror is tipped away from the ideal orientation, the amount of reflected signal in the desired direction falls off. By calculating the amount the reflecting surface is tipped away from the ideal orientation, it's possible to evaluate the "effectiveness" of the reflection process.

Damboldt simplified the equations for effectivity.<sup>6</sup> With the help of Chip Brown, KR1P, I have simplified these equations even further to yield a percentage of probability from the ideal case as follows:

Effectivity =  $200 \cdot [\sin H \cdot \cos H \cdot \sin(p-a)]$ . Where Effectivity is a percentage from 0-100 percent,  $H$  is the

**SPECIAL**  
**ICOM**  
**IC-745**  
**\$799.00**  
**w/hand mike**



# TEL-COM★

*Electronic Communications*

NEW ENGLAND'S ONLY FACTORY-AUTHORIZED SALES & SERVICE FOR

**KENWOOD**  **ICOM**

Also displaying the popular accessories needed to complete a HAM STATION . . .

- ARRL PUBLICATIONS • AEA PRODUCTS • AMPHENOL
- ALPHA DELTA • ASTRON • AUSTIN ANTENNAS • AVANTI
- BELDEN • BENCHER • B & W • DAIWA • ALINCO
- HUSTLER • KLM • LARSEN • MIRAGE • ROHN
- TELEX/HY-GAIN • TOKYO HY-POWER LABS
- TRAC KEYERS • VIBROPLEX • WELZ • ETC.

✓ 154

**SPECIAL**  
**NEW!**

**Kenwood**  
**TS-440S**  
**On Display**  
**CALL FOR PRICE**

**OPEN SIX DAYS A WEEK**

**Telephone 617/486-3400, 3040**

**675 Great Rd., (Rte. 119) Littleton, MA 01460**

**1 1/4 miles from Rte. 495 (Exit 31) toward Groton, Mass.**

**POPULAR PA 19**  
**Wideband Preamp**

- Over 8,000 sold since 1976
  - 0.5 - 200 MHz bandwidth
  - 19 dB gain
  - 50 Ω in/output
  - Increase sensitivity of receivers or counters
  - Built, tested & ready-to-go
- ONLY \$9.95 PPD**

**NEW POCKET SIZED**  
**500 MHz Freq. Counter**

- Compact design-pocket sized
- Measures frequency from 1 MHz to 500 MHz to within 1 kHz
- Built-in telescoping antenna
- Uses 1 standard 9 volt battery
- All units pre-tested and calibrated to .001%
- Professional and dependable performance at a low cost



**ONLY \$49.95 PPD**

✓ 155

**DIGITREX**

**1005 BLOOMER**  
**ROCHESTER, MI 48063**

**WEST COAST DISTRIBUTOR**  
**R. LUKASZEWICZ**

**20610 ALAMINOS DRIVE SAUGUS, CA 91350**  
**(805) 252-6021**

**PROPAGATION PUBLISHING**

Your source for amateur radio books, tapes and computer programs.

Now over 150 books, tapes and computer programs to keep you up to date in the ham world, and to help upgrade for that next ticket.

**"DX Power: Effective Techniques for Radio Amateurs"**

Here it is at last! You knew it had to be written, and now we have it. A complete survival manual for every radio amateur interested in the competitive world of DXing. Chip Tilton breaks tradition to reveal what *really* goes on in the DX world.

Postpaid in USA . . . . . **\$12.00**

Please send check or money order. Illinois residents please add 6% sales tax.

We are looking for authors!

**PROPAGATION PUBLISHING**

**P.O. Box 5255, NG9E**  
**Morton, Illinois 61550** ✓ 156

**This publication is available in microform from University Microfilms International.**



Please send information about these titles:

\_\_\_\_\_

Name \_\_\_\_\_

Company/Institution \_\_\_\_\_

Address \_\_\_\_\_

City \_\_\_\_\_

State \_\_\_\_\_ Zip \_\_\_\_\_

Phone (\_\_\_\_) \_\_\_\_\_

Call toll-free 800-521-3044. In Michigan, Alaska and Hawaii call collect 313-761-4700. Or mail inquiry to: University Microfilms International, 300 North Zeeb Road, Ann Arbor, MI 48106.



elevation angle of the meteor entry path,  $p$  is the azimuth of the great circle path, and  $a$  is the azimuth of the meteor path.

For example, if the great circle path from the transmitting to the receiving station is 225 degrees, the meteor path is 135 degrees, and the meteor enters the ionosphere at an elevation angle of 45 degrees, the effectivity is 100 percent. However, if the meteor enters on an azimuth path of 180 degrees at a 30-degree elevation angle, the effectivity is only about 62 percent. *Generally speaking, effectivities of greater than 50 percent are desired. If the effectivity drops below 25 percent, the path is very poor and probably not worth your precious time.*

### finding the best time for a path

As mentioned above, one of the most important considerations in setting up a schedule is choosing the optimum time for the desired path direction. Some of this information is included in the table prepared by W4LTU.<sup>2,3</sup> However, it is incomplete and doesn't list all the optimum times or all path directions, or cover different distances.

A computer program that calculates the most "effective" time for a meteor scatter path between your station and the station scheduled during any of the well-known annual meteor showers has been written. Even if you don't have a computer, read on; there will be useful information for you!

The program first determines the location (above the great circle path) in the E region where the scattering from the meteor trail will occur, provided that the meteor trail passes through this region in the correct direction. Either of W4LTU's *QST* articles<sup>2,3</sup> illustrate this meteor trail geometry for a given beam heading. The heading to the other station can be easily found using the equations for determining the great circle bearing direction.<sup>7</sup>

The program works out all the astronomical calculations necessary for the meteor shower selected. Armed with these three known quantities (the

**Table 2. Updated Ecliptic longitudes at 0000 UTC for selected days (from the American Ephemeris and Nautical Almanac for the year of interest). The tables can be used over every four years if a small correction is applied as described in the text.**

Date	1986	1987	1988	1989
Jan 3	282.31	282.13	281.91	282.68
Jan 4	283.33	283.15	282.93	283.70
Jan 5	284.35	284.17	283.95	284.72
Apr 21	30.61	30.43	31.20	30.97
Apr 22	31.58	31.41	32.18	31.94
Apr 23	32.56	32.38	33.15	32.92
May 4	43.25	43.08	43.84	43.61
May 5	44.22	44.04	44.81	44.58
May 6	45.19	45.01	45.78	45.54
Jun 5	74.06	73.89	74.65	74.41
Jun 6	75.02	74.84	75.60	75.37
Jun 7	75.98	75.80	76.56	76.32
Jun 14	82.67	82.50	83.25	83.02
Jun 15	83.62	83.45	84.20	83.97
Jun 16	84.58	84.41	85.16	84.93
Jul 27	123.69	123.52	124.27	124.04
Jul 28	124.65	124.47	125.23	125.00
Jul 29	125.60	125.43	126.18	125.96
Aug 11	138.05	137.88	138.63	138.40
Aug 12	139.01	138.84	139.59	139.36
Aug 13	139.97	139.80	140.55	140.32
Oct 20	206.31	206.13	206.90	206.67
Oct 21	207.30	207.12	207.90	207.67
Nov 2	219.28	219.09	219.88	219.64
Nov 3	220.28	220.09	220.88	220.67
Nov 4	221.28	221.09	221.88	221.67
Nov 16	233.34	233.15	233.94	233.70
Nov 17	234.32	234.16	234.95	234.71
Nov 18	235.35	235.17	235.96	235.72
Dec 12	259.66	259.48	260.27	260.03
Dec 13	260.68	260.50	261.29	261.05
Dec 14	261.70	261.51	262.31	262.06
Dec 21	268.82	268.64	269.43	269.19
Dec 22	269.84	269.65	270.45	270.21
Dec 23	270.85	270.67	271.47	271.23

location of the reflection point, the great circle path, and the direction of the path of the meteors as they enter the E region), the program will evaluate the "effectiveness" (or the orientation of the ionized trails in providing a properly positioned layer or surface on which the specular reflections can occur.)<sup>5</sup>

The orientation of the ionized meteor trails in this particular location in the E region varies as the earth rotates; the program will indicate the optimum or most "effective" time of the day for the use of the path. Because some showers are from radiants of high declination while others are from lower declination, it follows that some showers are better suited for particular great circle paths.

The program also calculates the beam offset angle from the great circle bearing path as a function of time for those who need to compensate for this effect.<sup>2,3</sup>

The astronomical calculations begin with the equations found in the annual *American Ephemeris and Nautical Almanac*. These equations are used to determine the day of the year when the earth passes through the shower and the "right ascension" of the shower at the start of that day. This information is then used to determine the direction of the meteors, since they'll be passing through the E region scattering location or volume. Moreover, because of the earth's rotation and its orbit about the sun, this location in the E region will continuously sweep

throughout the swarm of meteors in an ever-changing direction. The ideal direction of the trails as they pass through the E region will be such that specular reflections will take place over the desired path.

For some paths and some showers, these ideal direction situations may be reached. Though it sometimes lasts for only an hour, this near-ideal situation can persist for many hours in other combinations of paths and showers. For some showers this occurs only once a day; for others, it occurs twice during the same day.

The computer program recalculates all of these geometric changes of the path in the E region with respect to the desired propagation path at every 15-minute interval throughout the day. At each 15-minute interval the "effectiveness" of the path geometry is also evaluated.

The final output of the program is a tabulation and plot of the path's "effectiveness" at each 15-minute interval. Thus the "effectiveness" plot indicates the time of day when astronomical orientation of the meteor trails is most favorable for providing specular reflection along the desired path. The actual value of the plot is a measure of how near specular the reflections will be for the time of the calculation.

### computer programs

A copy of this program is being offered for IBM or IBM-compatible PCs at a nominal fee to cover cost of reproduction and mailing.\* A floppy disk copy of the program is also available.

Credit for writing this program goes to Chip Brown, KR1P, who spent many hours customizing and debugging it so that the results would be as accurate as possible.

A typical printout of the program is shown in fig. 1. This shows a southwesterly path of approximately 900

\*A copy of the meteor shower effectivity program written in BASIC for IBM or IBM-compatible PCs is available for \$2.00 from Gary Field, WA1GRC, 2 Pluff Avenue, Reading, Massachusetts 01824. A floppy disk with the same program is available for \$15.00, which includes cost of the disk and mailing.

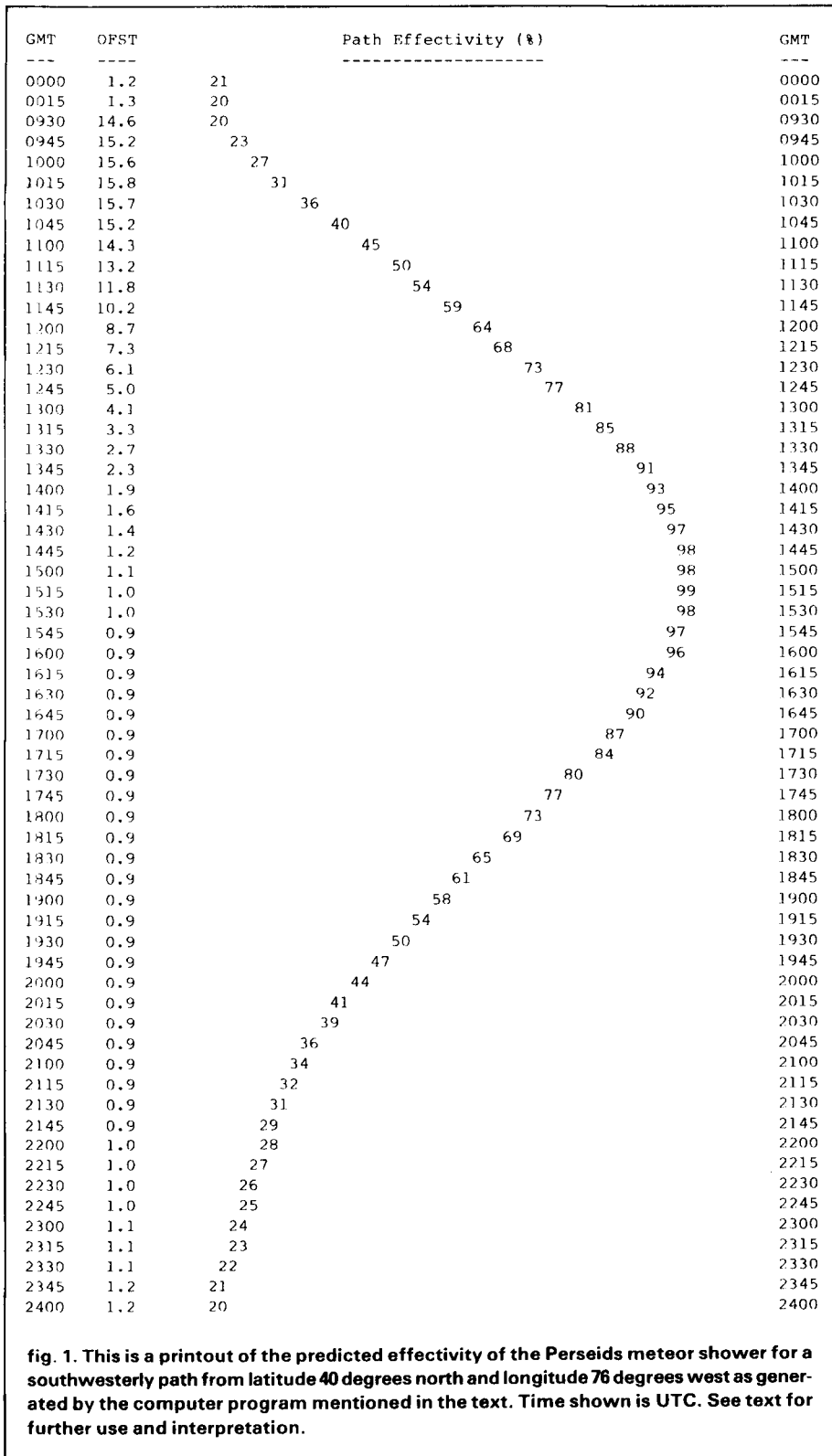

fig. 1. This is a printout of the predicted effectivity of the Perseids meteor shower for a southwesterly path from latitude 40 degrees north and longitude 76 degrees west as generated by the computer program mentioned in the text. Time shown is UTC. See text for further use and interpretation.

miles (1450 km) during the Perseids meteor shower from a latitude of 40 degrees north and a longitude of 76 degrees west (the corner of VUCC grid squares FM19, FM29, FN10 and

FN20), approximately in the middle of the Eastern Standard Time (EST) zone. This path can be duplicated or correlated later if you obtain the program.

# ham radio

## Reader Service

For literature or more information, locate the Reader Service number at the bottom of the ad, circle the appropriate number on this card, affix postage and send to us. We'll hustle your name and address to the companies you're interested in.

101 113 125 137 149 161 173 185 197 209 221 233 245 257 269 281 293 305 317 329 341  
102 114 126 138 150 162 174 186 198 210 222 234 246 258 270 282 294 306 318 330 342  
103 115 127 139 151 163 175 187 199 211 223 235 247 259 271 283 295 307 319 331 343  
104 116 128 140 152 164 176 188 200 212 224 236 248 260 272 284 296 308 320 332 344  
105 117 129 141 153 165 177 189 201 213 225 237 249 261 273 285 297 309 321 333 345  
106 118 130 142 154 166 178 190 202 214 226 238 250 262 274 286 298 310 322 334 346  
107 119 131 143 155 167 179 191 203 215 227 239 251 263 275 287 299 311 323 335 347  
108 120 132 144 156 168 180 192 204 216 228 240 252 264 276 288 300 312 324 336 348  
109 121 133 145 157 169 181 193 205 217 229 241 253 265 277 289 301 313 325 337 349  
110 122 134 146 158 170 182 194 206 218 230 242 254 266 278 290 302 314 326 338 350  
111 123 135 147 159 171 183 195 207 219 231 243 255 267 279 291 303 315 327 339  
112 124 136 148 160 172 184 196 208 220 232 244 256 268 280 292 304 316 328 340

*Limit 15 inquiries per request.*

NAME \_\_\_\_\_ CALL \_\_\_\_\_

ADDRESS \_\_\_\_\_

CITY \_\_\_\_\_ STATE \_\_\_\_\_ ZIP \_\_\_\_\_

Please use before July 31, 1986

**June 1986**

---

---

---

AFFIX POSTAGE  
OR  
POST OFFICE  
WILL NOT  
DELIVER

**ham**  
**radio**  
*magazine*

READER SERVICE CENTER  
P.O. BOX 2558  
WOBURN, MA 01888

ATTN: Reader Service Dept.

Because no real meteor shower enhancement is indicated from 0015-0930 UTC, this wouldn't be a good time to run this path direction. However, note that the path effectivity exceeds 50 percent (the typical minimum criteria as stated earlier) from about 1115 UTC (0615 EST) until after 1930 UTC (1430 EST). A long-duration smooth peak that reaches maximum at about 1515 UTC (1015 EST) is evident.

Figure 1 is also valid by simply scaling the time for schedules where one of the stations is near the 40th parallel but at a different longitude. A station located near a longitude of 91 west can use this path directly by just adding one hour to the times shown. Since the geometry moves westerly at a rate of 15 degrees per hour, a station near a longitude of 106 west can add two hours.

Beam offset is also shown on the printout for those who want to optimize this geometry. W4LTU has explained this principle in references 2 and 3. Normally this isn't important unless you're on the bands above 2 meters or if the gain of your antenna is high (narrow beamwidth). However, every little bit of help is worthwhile, especially on the higher bands.

### using the effectivity graphs

Judging from the many letters and questions received, there seems to be a lot of interest in finding the optimum time for a particular path during a meteor shower. The program described will do this for anyone with the appropriate computer. But some Amateurs interested in meteor scatter don't have computers; others are interested only in certain paths. Still others are interested only in some of the typical optimum paths for the major showers.

Tabulating all path possibilities like the one shown in fig. 1 would be a monumental task. Consequently, I've decided to provide optimum path data for three of the major meteor showers. Since much of the Amateur communications activity during meteor showers in North America has at least one of the stations near the 40th par-

allel, this is the data I tabulated. Other stations even several hundred miles north or south will often experience similar effectivity. Although it may be shifted an hour one way or the other, there probably won't be a great deal

of change if you're running near the peak effectivity points. If you don't have the computer capability, maybe the other station or a friend with the appropriate computer can run a listing for your specific shower and path.

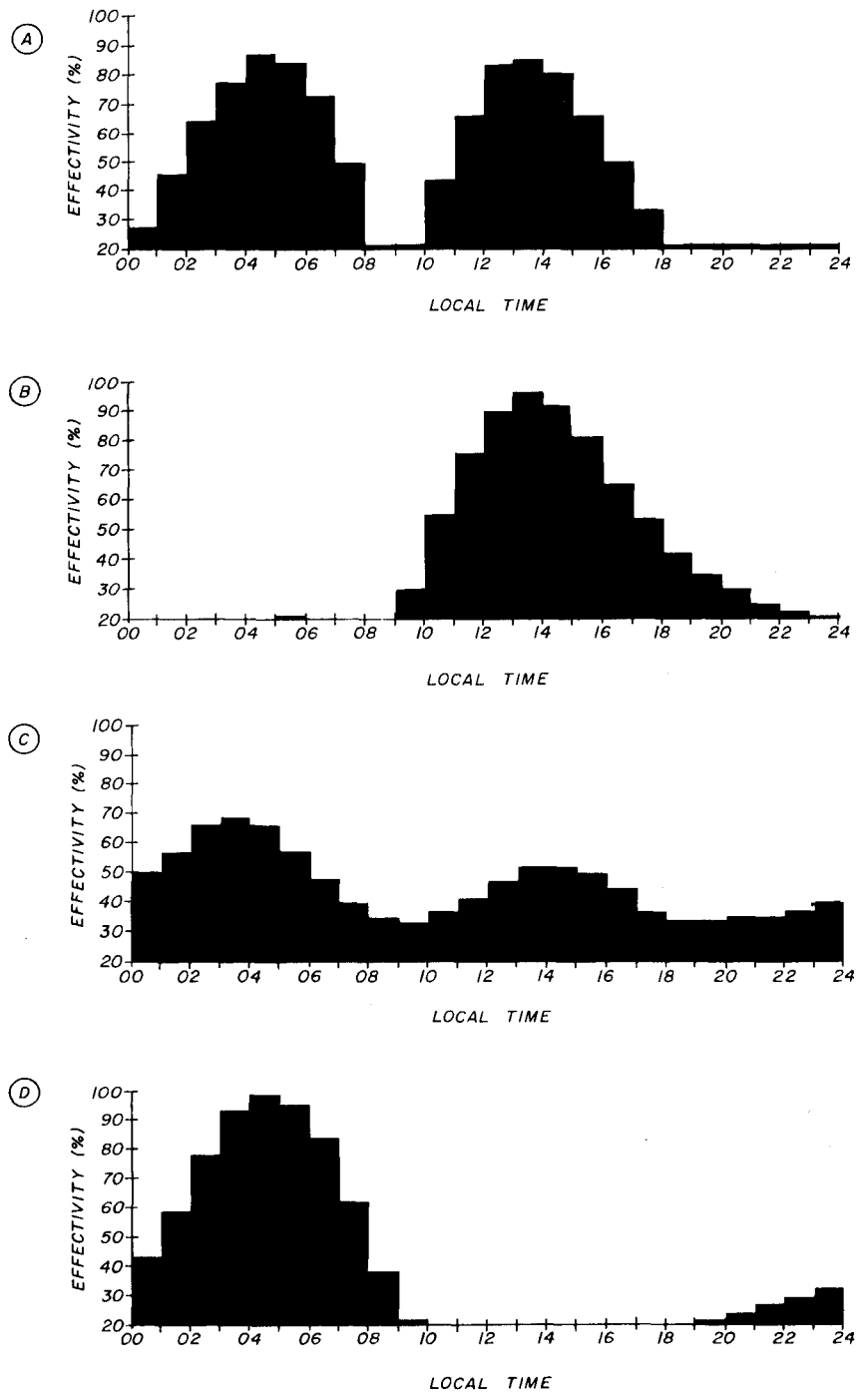

fig. 2. These graphs show the predicted effectivity for the Quadrantids meteor shower. All times shown are local. Original data was taken from latitude 40 degrees north and longitude 76 degrees west but can be used at other locations as explained in the text. Paths shown are as follows: A) north, B) northeast, C) east, D) southeast, E) south, F) southeast, G) west, H) northwest.





Telephone  
(714) 671-2009

## COM-SHACK 64 SIMPLEX AUTO-PATCH & REMOTE H.F. BASE

MODEL CS-64

**\$229<sup>95</sup>**

Includes  
Software  
(Program Disk),  
Hardware Interface  
& Instruction  
Manual

**NEW!**

- Simplex autopatch and H.F. remote base with clear voice messages
- Control your Yaesu FT 757 transceiver or ICOM-IC735 with your VHF/UHF portable or mobile
- Switch between the H.F. remote and the autopatch with DTMF tones
- Voice ID & all control functions & H.F. frequency are voice announced with your programmable access codes
- Autopatch works on any telephone line — tone or dial pulse
- Call waiting compatibility — after beep answer second incoming call while on the patch!
- Automatic redial last number (in dial pulse mode)
- Ring detect & automatic voice alert of incoming telephone call
- Inactivity timer turns off system [user programmable]
- Store B.H.F. memory frequencies + shift VFO's & change bands
- Fast scan & slow scan + dial up any frequency with DTMF tones all from your handheld VHF/UHF portable or mobile
- Use the autopatch or the remote base both for the price of one!
- User defined timing window, access codes, call sign
- Simple to install hardware interface cables, connectors supplied
- Hook mic input, PTT, spkr outputs & FM squelch connection 3 pin H.F. data cable and you are in control
- You supply — 1 Commodore 64 or 128 & 1 disk drive + base station
- No additional power supply required
- With human voice synthesized by Covox™.

Remote H.F.  
Now available for  
ICOM-IC735 and Yaesu FT757.

### TOUCHTONE™ DECODER KIT



MODEL TTK  
**\$22<sup>95</sup>**

- SSI201 DTMF Receiver
- Receive all 16 DTMF digits
- No additional filtering
- Output BCD or hex format
- Low power (29 ma @ 12V)
- Kit includes 3.58 Mhz crystal, 22 pin IC socket, resistor, capacitors, data sheet and schematics

### 4-DIGIT SEQUENCE DECODER



WIRED & TESTED  
MODEL TSD  
**\$59<sup>95</sup>**

- Completely wired & tested
- User programmable
- LED status indicator
- Open collector output
- Control relays; mute audio
- Control link on/off
- Custom IC insures high reliability & small size!
- Fits inside most rigs; runs on 12 VDC (35 ma)
- All 16 digits allow more than 50,000 combinations
- Makes excellent private call on busy repeaters!
- Use it to turn on audio or sound an alarm
- Momentary and latching outputs

Mastercard and Visa accepted  
Prices include postage & handling, U.S.A.  
California addresses add 6%.

### "DECODE-A-PAD"

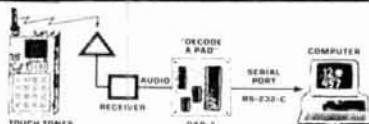

TOUCHTONE™ DTMF  
to RS-232-C MODEL DAP-1  
**\$89<sup>95</sup>**

- Use your computer to decode DTMF touchtones
- Receive all 16 digits as fast as they can be transmitted
- Easily program your computer in BASIC to decode multidigit "strings", display digits, sound alarms, observe secret codes, control relays
- Simple to use; just provide +12 VDC and audio, hook two wires to the RS-232-C serial input on your computer, enter a simple BASIC program and begin to decode
- Sample BASIC program and instructions included
- Data indicator
- Wired and tested

### TUNE THE WORLD FROM YOUR HANDHELD VHF/UHF RADIO

2 FOUR DIGIT DTMF DECODERS, PLUS 16 DIGIT KEYPAD CONTROL

Model RAP-1 **\$149<sup>95</sup>**  
REMOTE-A-PAD®

- Audio tones from any source, are converted to solid state switches which control any 16 digit keypad of a radio or other device
- Some examples you can control include the Pro-Search™ Rotator (rotate beam remotely); Remote controls: ICOM IC-701 or ICOM IC-211 when using the RM-2 controller; Kenwood 7950, IC751; Azden PCS 4000; handhelds such as Yaesu FT-208; FT-708; ICOM IC-02AT; and many more...
- Two [four-digit] pro-

REPEATER OWNERS/HAM CLUBS  
The CS-64 will function in the  
simplex or duplex mode.

### ICOM IC-02AT USER'S "AUDIO BLASTER" MODULE

1000's of Satisfied Customers  
Now Available for  
MODEL AB-1 IC-2AT & IC-04AT  
**\$19<sup>95</sup>**



- Module installs inside the radio in 10 minutes
- Boost audio to nearly one watt!
- Low power drain (4ma stand-by)
- Complete step-by-step instructions included
- Corrects the LOW audio problem!
- Drive external speakers to full volume, even signals with low deviation!

- grammable access codes are used to operate relays or other on/off functions
- LED decoder status indicators and momentary plus steady state decoder outputs are provided
- All CMOS low power drain (30ma); S.S.I. 201 Decoder
- Hook eight wires (4 rows and 4 columns) in parallel with the existing keypad of the radio you wish to control remotely
- Connect audio from any source, 12 volts D.C. and you are in control
- The dual 4 digit decoders will turn your links on and off using your programmable access code.

Name \_\_\_\_\_  
Address \_\_\_\_\_  
City \_\_\_\_\_ State \_\_\_\_\_ Zip \_\_\_\_\_  
MC/VISA No. \_\_\_\_\_ Exp. \_\_\_\_\_

ENGINEERING CONSULTING  
583 CANDLEWOOD ST., BREA, CA 92621, (714) 671-2009



Qty.	Model No.	Total
_____	CS-64	_____
_____	TTK	_____
_____	TSD	_____
_____	DAP-1	_____
_____	AB-1	_____
_____	RAP-1	_____
_____	Tax [CA]	_____
_____	<b>Total</b>	_____

The data shown on **figs. 2, 3, and 4** is for a nominal path length of 900 miles (1450 km). The times listed are local standard time. All the data was run from a latitude of 40 degrees north and a longitude of 76 degrees west, right in the middle of the Eastern time zone of the United States.

Because it's normalized to local time (even though the computer program uses UTC) the data in **figs. 2, 3, and 4** is directly usable in all time zones. In addition, eight different directions have been shown so that you can pick the optimum time based on the direction desired.

With these graphs, you'll be able to easily discern any path differences by comparing one with another. For instance, examine the graphs for the Perseids shower (**fig. 3**). You'll see that the east and west paths are fair at two different times per day while the southeast and southwest paths are good only once a day. You'll also notice that the east and west as well as the southeast and southwest paths are identical except for a time shift! However, the latter paths are better when open than the former paths. Other information can be gleaned by examining the graphs for the other paths and showers.

### monitoring a shower

Several suggestions about monitoring showers were made in reference 1. Lower frequencies can be monitored. Some Amateurs have suggested 75 MHz because the FAA has thousands of landing beacons on this frequency. Others prefer the FM band, 88-108 MHz.

If you use a lower frequency for monitoring, the lower directivity of your receiving antenna and the presence of bursts don't necessarily indicate that 2 meters or higher frequencies are optimum. Random meteors that will easily ionize up to 108 MHz are often present regardless of the time of day or year. Therefore, I still feel that it's better to use the video carriers on TV channels 12 or 13 as explained in reference 1. These frequencies are good indicators since they also show that the path is open up to at least 200 MHz, simplifying determination of the optimum path.

Furthermore, the speed of a meteor shower and the size of its particles are good indicators of the distance you can communicate. More specifically, because of the earth's velocity of rotation, meteors enter the ionosphere at approximately 15-70 km/second. The entering speed of the particles during a meteor shower is fairly well known and is tabulated in **table 1**.

Meteors typically ionize a fairly narrow region of the ionosphere between 50 and 75 miles above the earth.

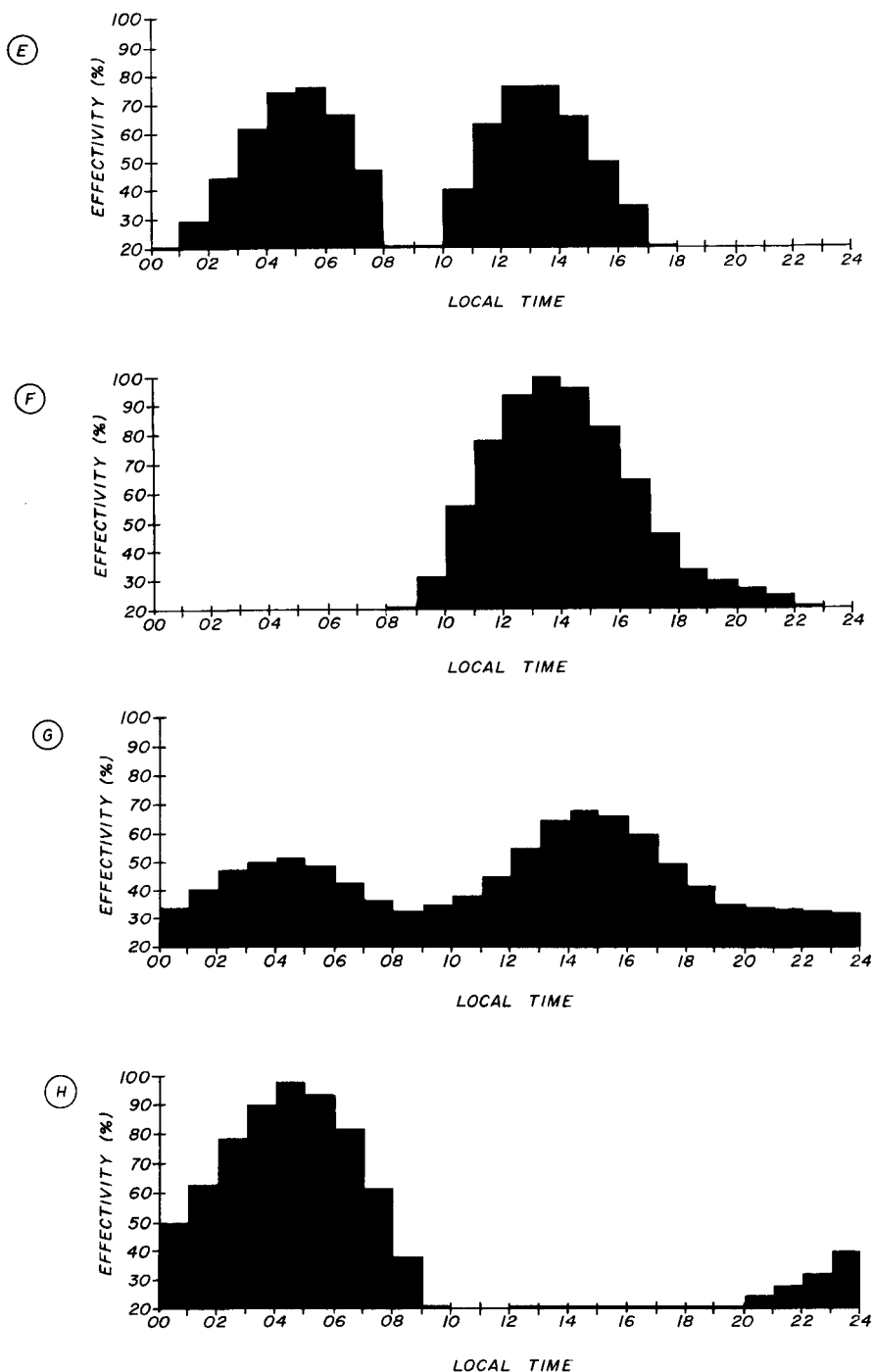

fig. 2. cont.

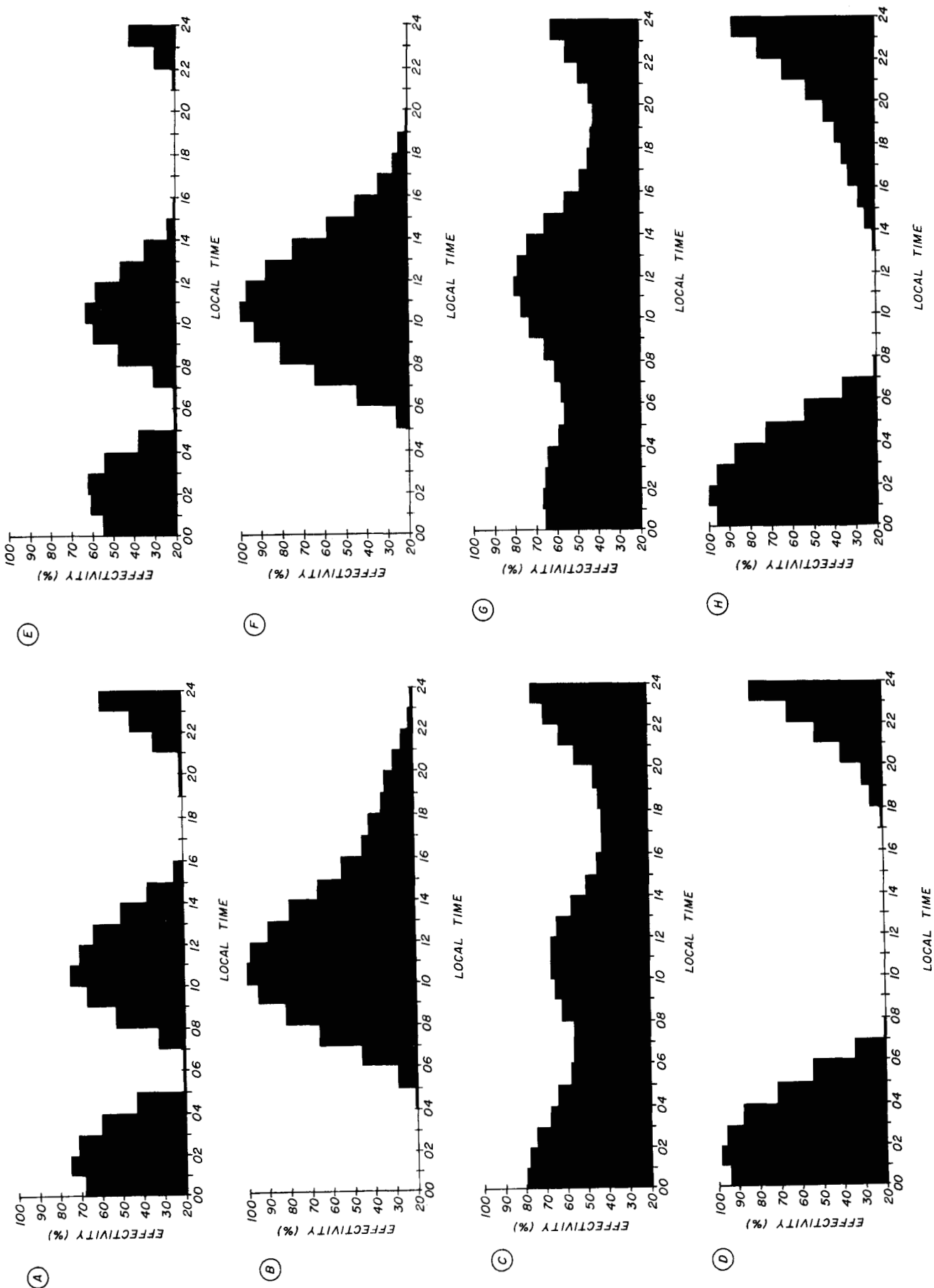

fig. 3. These graphs shown are the predicted effectivity for the Perseids meteor shower. All times shown are local. Original data was taken from latitude 40 degrees north and longitude 76 degrees west but can be used at other locations as explained in the text. Paths shown are as follows: A) north, B) northeast, C) east, D) southeast, E) south, F) southwest, G) west, H) northwest.

You NEED **CURLYCODE™** because it is:

- An Exciting NEW learning experience!
- Each code RHYTHM grows an "unforgettable" letter SHAPE in your mind's eye.
- Each sound ADDS to the growing letter shape.
- So all RHYTHMS that start the same way grow SHAPES that start the same way.
- You NEVER change your mind about the shape as it grows in your mind's eye.
- When the RHYTHM stops, the SHAPE stops, and it IS the letter, so just WRITE IT!

Perfect for **BEGINNERS**: NO senseless study - CURLYCODE shapes are SIMPLE and MAKE SENSE. Know only EIGHT shapes and you know HALF of EVERYTHING and MOST of the LETTERS. Know only TWO new endings for each shape and you will know everything!

IT'S LIKE "INSTANT CODE"!

Perfect for **EXPERTS**: NO struggling to break your "learning plateau" - once you know the CURLYCODE shapes they grow in your mind's eye at "any" speed. So take some time to REALLY KNOW the eight basic CURLYCODE shapes at slow speed to be well on your way to breaking your plateau.

IT'S LIKE "SUPERSONIC CODE"!

Fine for **CLUBS**: Attractive colored wall chart. SAVE with a 20% discount on ten or more sets!

PRICE: Complete set (Manual, Wall chart, Pocket card, Beginner's chart): \$11.50  
Money back guarantee. Phone 1703/448-6088

**MINDS** eye Publications, Dept H14  
Suite 113-199  
1330 Beverly Rd.  
McLean, VA 22101 ✓ 157

## MICROCOMPUTER REPEATER CONTROL



**\$129**

✓ 158

Introducing the MICRO REPEATER CONTROLLER RPT-2A, a new concept in LOW COST, EASY TO INTERFACE, microcomputer repeater control. Replace old logic boards with a state of the art microcomputer that adds NEW FEATURES, HIGH RELIABILITY, LOW POWER, SMALL SIZE, and FULL DOCUMENTATION to your system. Direct interface (drop in) with most repeaters. Detailed interface information included. Original MICRO REPEATER CONTROL article featured in QST Dec. 1983.

- Two CW ID Messages
- Reconfigurable COR Input
- Tone Out Toner
- High Current PTT Interface
- Pre-Timed Warning MSG
- Sine Wave Tone Generator
- Post-Timed CW MSG
- Low Power 9.15 VDC @ 200 ma
- Courtesy Beep
- Size 3.5" x 3.5"
- Auxiliary Inputs
- All Connectors Included

RPT-2A Kit Only \$129 plus \$3.00 shipping

**PROCESSOR CONCEPTS**  
P.O. BOX 32908  
MINNEAPOLIS, MN 55432  
(612) 780-0472 7pm-10pm evenings

CALL OR WRITE FOR FREE CATALOG AND SPECIFICATIONS

## CANOPIES

All weather protection for outdoor shows

SLANT, PEAK OR FLAT ROOFS  
FREE STANDING - FAST SET-UP  
NO TOOLS REQUIRED - SNAPS TOGETHER  
WHITE OR BLUE TARPS  
FITS IN THE TRUNK OF A CAR  
JOINTS & PARTS

PACKAGE COMPLETE - READY TO USE  
MONEY BACK GUARANTEE

Free brochure on request

**Elaine Martin inc.**  
DEPT. H  
P.O. BOX 261  
HIGHWOOD, IL 60040  
(312) 433-0106

✓ 159

# Barry Electronics Corp.

WE SHIP WORLDWIDE  
WORLD WIDE AMATEUR RADIO SINCE 1950  
Your one source for all Radio Equipment!

**KITTY SAYS WE ARE NOW OPEN 7 DAYS A WEEK. Saturday & Sunday 10 to 5 P.M. Monday Friday 9 to 6:30 PM Thurs. to 8 PM Come to Barry's for the best buys in town.**

**MAY We Help You With The Best in Commercial and Amateur Radio?** Jan KB2RV, Tom, Kitty WA2BAP, Mark K2CON  
See You at HOSA Hamfest Queens, NY/Newington, CT June 8th. See You at W2QW Hamfest Dunellen, NJ June 21st

**ONV Safety belts-in stock**  
IC R71A, 751A, 745, 28AH, 37A, 47A, R-7000, 1271A, 271AH, 3200A, 471AH, 735

**ICOM SMART PATCH**  
IC R71A, 751A, 745, 28AH, 37A, 47A, R-7000, 1271A, 271AH, 3200A, 471AH, 735

**YAESU**  
FT-ONE, FT-980, FT-757GX, FRG-8800  
FT-726R, FRG-9600 FT-270/770RH, FT-2700RH

**Land Mobile HT Midland-Standard Wilson Maxon Yaesu FIC 2203 FT 4703 Icom IC M12 Marine/M750 Tempo M-1 IC A2016**

**Antennas**  
A.A. Satchell  
No. 100  
No. 101  
No. 102  
No. 103  
No. 104  
No. 105  
No. 106  
No. 107  
No. 108  
No. 109  
No. 110

**KENWOOD**  
TS-440S/AT, R-1000, R-2000, TS-940 S/AT  
TM-201B TR26-3600A TM2570A/50A/30A  
TR-751A Kenwood Service/Repair  
TH213/141AT, TM-211A  
411A & TS-711A/811A  
TM-3530A  
COMPU-FIRE EXTINGUISHERS  
EXL5000E RTTY/AMTOR TERMINAL

**VoCom/Mirage/Daiva Tokyo Hy Power Amplifiers & 5/8 HT Gain Antennas IN STOCK**

**Alinco Power Supplies**

**AMERITRON AMPLIFIER AUTHORIZED DEALER**  
Yaesu FTR-2410, Wilson ICOM IC-RP 3010 (440 MHz) ICOM IC-RP 1210 (1.2 GHz)

**Computer Interfaces**  
stocked: MFJ-1224  
AEA CP-1, PK-80, DR. DX  
CP-100, PK-64, Dr. QSO,  
Morse Univ., PM-1

**Alpha Amplifiers**  
Complete Butternut Antenna Inventory In Stock!

**DIGITAL FREQUENCY COUNTERS**  
Pulsar Engineering  
Model 58-1000 0.1-10MHz 12MHz  
0.1-100 MHz 0.1-10MHz 12MHz  
0.1-100 MHz 0.1-10MHz 12MHz

**Long-range Wireless Telephone for export in stock**

**BENCHER PADDLES, BALUNS, AUDIO FILTERS, IN STOCK**  
MIRAGE AMPLIFIERS  
ASTRON POWER SUPPLIES  
Saxton Wire & Cable

**SANTEC**  
ST-222/UP  
ST 20T  
ST-442/UP  
HT 7

**MFJ Models**  
422, 313, 989B, & 941D

**MURCH Model**  
2000 A, ALS, B in stock

**SANGEAN Portable Shortwave Radios**

**HEIL EQUIPMENT IN STOCK**  
To Ex Towers  
Hy-Gain Towers  
& Antennas  
Rotors will be shipped direct to you FREE of shipping cost.

**New TEN-TEC**  
2591HT, Corsair II, Argosy II, Century 22, 2510

MAIL ALL ORDERS TO BARRY ELECTRONICS CORP., 512 BROADWAY, NEW YORK CITY, NY 10012.

**New York City's LARGEST STOCKING HAM DEALER COMPLETE REPAIR LAB ON PREMISES**

**"Aqui Se Habla Espanol"**  
BARRY INTERNATIONAL TELEX 12 7670  
MERCHANDISE TAKEN ON CONSIGNMENT FOR TOP PRICES  
Monday-Friday 9 A.M. to 6:30 P.M. Thursday to 8 P.M.  
Saturday & Sunday 10 A.M. to 5 P.M. (Free Parking)  
AUTHORIZED DISCS MCKAY DYMEK FOR SHORTWAVE ANTENNAS & RECEIVERS  
IREX "Spring St. Station"  
Subways: BMT - Prince St. Station  
IND - F Train - Bay Station  
Bus: Broadway #6 to Spring St  
Path - 9th St 6th Ave. Station

Commercial Equipment Stocked ICOM MAXON Midland-Standard Wilson Yaesu. We serve municipalities, businesses, Civil Defense, etc. Portables, mobiles, bases, repeaters.

WE NOW STOCK COMMERCIAL COMMUNICATIONS SYSTEMS DEALER INQUIRIES INVITED PHONE IN YOUR ORDER A BE REIMBURSED  
COMMERCIAL RADIOS stocked & serviced on premises.  
Amateur Radio Courses Given On Our Premises. Call ALL SALES FINAL  
Export Orders Shipped Immediately. TELEX 12-7670

## Get ★★★CONNECTED to Packet Radio

by Jim Grubbs, K9EI

The Packet Radio Handbook  
Over 150 pages of information exclusively on packet radio

17 Chapters including:

- ★ Choosing a TNC
- ★ Packet protocol for the beginner
- ★ Packet Accessories
- ★ How to make your first packet contact
- ★ Packet Bulletin Board Operations

\$12.95 plus \$2.50 for first class shipping and handling in U.S. and Canada.

Also available *The Commodore Ham's Companion* \$15.95  
(see January '86 QST page 47 or February '86 CQ page 68)  
and *Command Post* \$9.95.

**QSKY PUBLISHING** P.O. Box 3042  
Springfield, IL 62708

✓ 275

June 1986 **79**

★ QUALITY PARTS ★ DISCOUNT PRICES ★ FAST SHIPPING!

SEND FOR FREE 1986 CATALOG... 48 PAGES!

# ALL ELECTRONICS CORP.

## EDGE CONNECTORS

ALL ARE 1.56" SPACING.

- 22 EDGE CONNECTOR** \$1.25 ea  
solder lug style 10 for \$11.00
- 22/44 EDGE CONNECTOR**  
\$2.00 ea PC style 10 for \$18.00
- 22/44 EDGE CONNECTOR**  
solder lug style \$2.50 each
- 28/56 EDGE CONNECTOR**  
\$2.50 ea PC style 10 for \$22.00
- 36/72 EDGE CONNECTOR**  
PC style \$3.00 each
- 43/86 EDGE CONNECTOR**  
PC style \$4.50 each

- ## TRANSISTORS
- |           |              |
|-----------|--------------|
| 2N708     | 4 for \$1.00 |
| 2N2222A   | 3 for \$1.00 |
| PN2222A   | 4 for \$1.00 |
| 2N2904    | 3 for \$1.00 |
| 2N2904    | 3 for \$1.00 |
| 2N2905    | 3 for \$1.00 |
| MJ2855    | \$1.00       |
| 2N3055    | \$1.00       |
| PMD 10K40 | \$1.00       |
| TIP 121   | 75¢          |
| TIP 125   | 75¢          |

- ## TRANSFORMERS
- 120 volt primaries
- |                     |         |
|---------------------|---------|
| 5.6 volts @ 750 ma. | \$3.00  |
| 6 volts @ 150 ma.   | \$1.25  |
| 6.3 volt @ 600 ma.  | \$3.00  |
| 12 V.C.T. @ 200 ma. | \$2.00  |
| 12 V.C.T. @ 400 ma. | \$3.00  |
| 12 V.C.T. @ 1 amp   | \$4.00  |
| 12 V.C.T. @ 2 amp   | \$4.85  |
| 12 V.C.T. @ 4 amp   | \$7.00  |
| 18 volts @ 650 ma.  | \$3.50  |
| 24 V.C.T. @ 200 ma. | \$2.50  |
| 24 V.C.T. @ 1 amp   | \$4.85  |
| 24 V.C.T. @ 2 amp   | \$6.75  |
| 24 V.C.T. @ 3 amp   | \$9.50  |
| 24 V.C.T. @ 4 amp   | \$11.00 |
| 36 V.C.T. @ 135 ma. | \$3.00  |

- ## WALL TRANSFORMERS
- all plug directly into 120 vac outlet
- |                         |        |
|-------------------------|--------|
| 4 VDC @ 70 ma.          | \$2.00 |
| 6 VAC @ 500 ma.         | \$3.50 |
| 6 VDC @ 750 ma.         | \$4.50 |
| 9 VDC @ 500 ma.         | \$5.00 |
| 12.5 VAC @ 265 ma.      | \$3.00 |
| 18 VAC @ 180 ma.        | \$3.00 |
| 8.5 VAC @ 128 VA        | \$4.50 |
| 24 VAC @ 250 ma.        | \$3.00 |
| MULTI-VOLTAGE @ 500 ma. | \$7.50 |
| 3, 4, 6, 7, 9 or 12 VDC | \$7.50 |

- ## MINI-BOX
- Pomona #2104  
\$1.00 EACH

- ## FUSES
- 3AG (AGC) SIZE  
1, 1½, 2, 2½, 3, 4, 5, 6 AMP  
GMA SIZE  
1, 2, 3, 4, 5 AMP  
5 of any ONE amperage 75¢

## SOUND AND VIDEO MODULATOR FOR T.I. COMPUTER

T.I. # UM1381-1 Designed for use with T.I. computers. Can be used with video sources. Built-in A/B switch. Channel 3 or 4 selection switch. Operate on 12 vdc. Hook-up diagram included.

CAT# AVMOD WERE \$10.00 **REDUCED TO \$5.00 EACH**

## SLIM LINE COOLING FAN



Etr # 99KM182 low noise fan. Measures 3 3/4" square x 1" deep. 21 cfm. 23 db. 1700 rpm

**SPECIAL PRICE... \$12.50 each**

## 2K 10 TURN MULTI-TURN POT

SPECTROL #MOD 534-7161  
\$5.00 EACH

## SOLID STATE BUZZER

Star #SMB-06L  
6 vdc  
TTL compatible  
\$1.00 each  
10 for \$9.00

## ± 12 Vdc or 24Vdc POWER SUPPLY

DELTRON MODEL QD12/15-1.7  
Dual plus and minus 12Vdc open frame power supply. Can be used as 24Vdc @ 1.5 amp. INPUT: either 115 Vac or 230 Vac.  
Fully regulated computer grade supply.  
7" x 4 3/4" x 2 3/4"

**\$12.50 each 10 for \$110.00**

## SPECIALS

**1 AMP 50 VOLT DIODES**  
IN4001 TAPE AND REEL  
100 for \$4.50  
1000 for \$30.00

**SOLDER TAIL I.C. SOCKETS**  
24 PIN 10 for \$2.50  
100 for \$22.00  
1000 for \$200.00

## MICRO-CASSETTE MECHANISM

Micro-cassette tape transport for standard MC60 or MC45 micro-cassettes. 3 Vdc operation. Contains: drive motor, belt, head, capstan, pinch wheel and other components. 3 1/2" X 2 1/4" X 5/8"

CAT# MCMCEC \$3.00 each 10 for \$27.50

## 220 Vac COOLING FAN

ROTRON # MX77A3  
Mullin XL  
220 Vac  
4 1/8" square metal frame fan.

CAT# CF-220 \$6.50 ea  
10 for \$60.00 / 100 for \$500.00  
QUANTITIES AVAILABLE

## LINE CORDS

**TWO WIRE**  
6' 18/2 SPT-1 flat 3 for \$1.00  
6' 18/2 SPT-2 flat 2 for \$1.00  
6' 16/2 SJT round \$1.25 each

**THREE WIRE**  
6' 18/3 flat \$1.50 each  
8' 18/3 round \$2.00 each

## \*SPECIAL PRICE\* TRANSISTOR

plastic transistor  
PN3569 TO-92 N.P.N.

100 for \$8.00  
1000 for \$60.00  
LARGE QUANTITIES AVAILABLE

## COMPUTER GRADE CAPACITORS

2,000 mfd. 200 Vdc	\$2.00
1 3/4" x 5" high	
6,400 mfd. 60 Vdc	\$2.50
1 3/8" x 3 3/4" high	
9,700 mfd. 50 Vdc	\$2.50
1 3/8" x 4 1/2" high	\$3.00
31,000 mfd. 15 Vdc	\$3.00
1 3/4" x 4" high	\$2.50
50,000 mfd. 40 Vdc	\$2.50
3" x 5 3/4" high	\$4.50
66,000 mfd. 15 Vdc	\$3.00
3" x 3 3/4" high	\$4.00
60,000 mfd. 40 Vdc	\$3.50
3" x 5" high	\$3.50
66,000 mfd. 15 Vdc	\$3.00
3" x 3 3/4" high	\$3.00
66,000 mfd. 30 Vdc	\$3.50
3" x 5 1/4" high	\$3.50

5,500 mfd. 30 Vdc \$1.00  
1 3/8" x 3 1/2" high

5,900 mfd. 30 Vdc \$1.00  
1 3/8" x 2 1/4" high

9,300 mfd. 50 Vdc \$1.00  
2" x 4 1/2" high

18,000 mfd. 10 Vdc \$1.00  
1 3/8" x 2 5/8" high

48,000 mfd. 10 Vdc \$1.00  
2 1/2" x 3 1/4" high

100,000 mfd. 10 Vdc \$1.00  
2 1/2" x 6" high

185,000 mfd. 6 Vdc \$1.00  
2 1/2" x 4 1/2" high

## RELAYS

### 10 AMP SOLID STATE

CONTROL 3-32 vdc  
LOAD: 140 vac 10 amp  
SIZE: 2 1/2" x 3 1/4" x 1 1/2"

\$9.50 EACH 10 FOR \$90.00

## ULTRA-MINIATURE 5 VDC RELAY

Fujitsu # FB211NE00D5M20  
High sensitivity  
COIL: 120 ohms  
CONTACTS: 1 amp  
Mounts in 14 pin DIP socket

\$1.25 each 10 for \$10.00

## 6 VDC RELAY

Aromat #RSD-6V  
Super Small  
S.P.D. relay  
GOLD coil  
contacts rated

1 amp @ 30 vdc. Highly sensitive.  
TTL direct drive possible. 120 ohm coil.

Operate from 4.3 - 6 vdc.  
COIL: 120 ohms \$1.50 each  
1 1/4" x 1 1/2" x 1 1/8" 10 for \$13.50

## 13 VDC RELAY

CONTACTS: S.P.N.C.  
10 amp @ 120 vac  
Energize coil to open contact  
COIL: 13 vdc 650 ohms

**SPECIAL PRICE \$1.00 each**

## RECHARGEABLE NI-CAD BATTERIES

AAA SIZE 1.25V 500MAH	\$1.85
AA SIZE 1.25V 500MAH	\$1.85
AA with solder tab	\$2.00
C SIZE 1.2V 1200MAH	\$3.50
SUB-C SIZE solder tab	\$3.50
D SIZE 1.2V 1200MAH	\$3.50

## 3 1/2" SPEAKER

8 ohm impedance.  
Full range speaker.  
Box magnet  
4" diagonal mounting centers.

\$2.50 each 10 for \$20.00

## SPRING LEVER TERMINALS

Two color coded terminals on a sturdy 2 3/4" x 3 3/4" bakelite plate.  
Great for speaker enclosures or power supplies.

75¢ EACH 10 for \$6.00

## 7 CONDUCTOR RIBBON CABLE

Spectra-strip red marker strip.  
28 ga. stranded wire.  
\$5.00 per 100' roll

## XENON FLASH TUBE

3/4" long X 1/8" dia. Flash tube designed for use in compact camera flash units. Ideal for experimenters.

CAT# FLT-1 2 for \$1.00

## MINIATURE TOGGLE SWITCHES

ALL ARE RATED 5 AMPS @ 125 VAC

<b>S.P.D.T. (on-on)</b> PC style non-threaded bushing. 75¢ each 10 for \$7.00	<b>S.R.D.T. (on-on)</b> Solder lug terminals. \$1.00 each 10 for \$9.00 100 for \$80.00	<b>S.R.D.T. (on-off-on)</b> Solder lug terminals. \$1.00 each 10 for \$9.00 100 for \$80.00
<b>S.P.D.T. (on-off-on)</b> PC style non-threaded bushing. 75¢ each 10 for \$7.00	<b>S.R.D.T. (on-on)</b> PC lugs threaded bushing. \$1.00 each 10 for \$9.00 100 for \$80.00	<b>D.R.D.T. (on-on)</b> Solder lug terminals. \$2.00 each 10 for \$19.00 100 for \$180.00

## TI SWITCHING POWER SUPPLY

Compact, well-regulated switching power supply designed to power Texas Instruments computer equipment

INPUT: 14 - 25 vac @ 1 amp  
OUTPUT: +12 vdc @ 350 ma.  
+5 vdc @ 1.2 amp  
-5 vdc @ 200 ma.

SIZE: 4 3/4" x 4 1/4" x 1 1/4" high

**\*SPECIAL PRICE\* \$3.50 each**

## 13.8 VDC REGULATED POWER SUPPLY

These are solid state fully regulated 13.8 vdc power supplies. Both feature 100% solid state construction, fuse protection, and L.E.D. power indicator. U.L. listed

2 amp constant, 4 amp surge \$20.00 each  
3 amp constant, 5 amp surge \$27.50 each

## D.C. CONVERTER

Designed to provide a steady +5 vdc @ 240 ma. from a battery supply of 3.5 to 6.25 volts

2 1/16" x 1 1/4" x 1 1/16"

\$1.50 each

## TWIST-LOCK CONNECTOR

Same as Switchcraft #12CL5M.  
5 conductor in-line plug and chassis mount jack. Twist-lock style

\$2.50/SET

## UNIVERSAL CHARGER

Will charge 4-AA, C, D, or AAA ni-cads or one 9 volt ni-cad at one time...

\$11.00 per charger

## STANDARD JUMBO DIFFUSED T 1-3/4

RED	10 for \$1.50
	100 for \$13.00
GREEN	10 for \$2.00
	100 for \$17.00
YELLOW	10 for \$2.00
	100 for \$17.00

## D.P.S.T. LIGHTED ROCKER SWITCH

115 vac lighted rocker, snap mounts in 3/4" x 1 1/4" hole.  
Orange lens. 16 amp contact.

\$1.50

## FLASHER LED

5 volt operation  
red jumbo 1 3/4" size \$1.00 each  
NEW GREEN FLASHER  
CAT# LED-4G \$1.00

## MINI-PUSH BUTTON

S.P.S.T. momentary normally open 1/4" bushing.  
Red button.  
35¢ each  
10 for \$3.00

## BI-POLAR LED HOLDERS

Two piece holder for jumbo LED  
10 for 85¢ 100 for \$5.00

**CLEAR CLIPLITE LED HOLDER**  
Make LED a fancy indicator. Clear  
4 for \$1.00

## SNAP ACTION SWITCH

Cherry elect. #E-21. N.O. or N.C. 0.1A contacts. Suitable for alarms and other low energy circuits.  
1 1/4" lever

45¢ EACH 10 FOR \$4.20

## ROTARY ACTION MICRO

OMRON #C 5G3-C41  
Clockwise action micro used in cam operated mechanisms and low torque operations.  
RATED: 5 amps @ 125 Vac  
\$1.25 each 10 for \$11.00  
LARGE QUANTITIES AVAILABLE

**ALL ELECTRONICS CORP.**  
LOS ANGELES, CA STORE  
905 S. Vermont Ave.  
213 380 8000

VAN NUYS, CA STORE  
6228 Sepulveda Blvd  
818 997 1806

MAIL ORDERS TO:  
P.O. BOX 20406  
Los Angeles, CA 90006

TWX 5101010163 ALL ELECTRONIC  
EASYLINK MBX - 62887748



TOLL FREE ORDERS ONLY  
1-800-826-5432  
(ORDER ONLY)  
(IN CALIFORNIA: 1-800-258-6666)  
ALASKA, HAWAII,  
OR INFORMATION  
(213) 380 8000 NOC O.D.

QUANTITIES LIMITED  
MINIMUM ORDER \$10.00  
USA: \$3.00 SHIPPING  
FOREIGN ORDERS:  
INCLUDING SUFFICIENT  
SHIPPING  
CALIF RES. ADD 6 1/2%



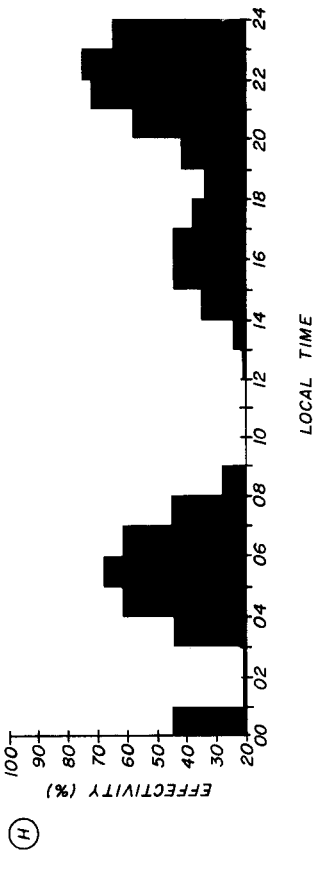
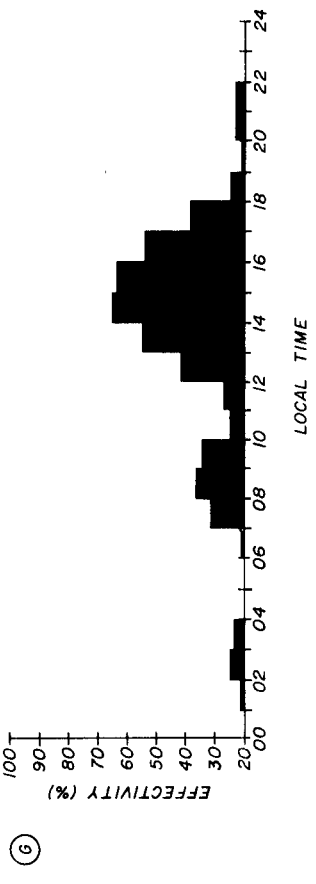
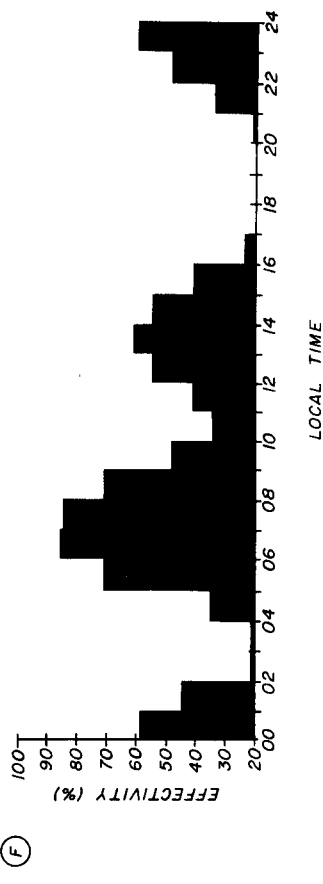
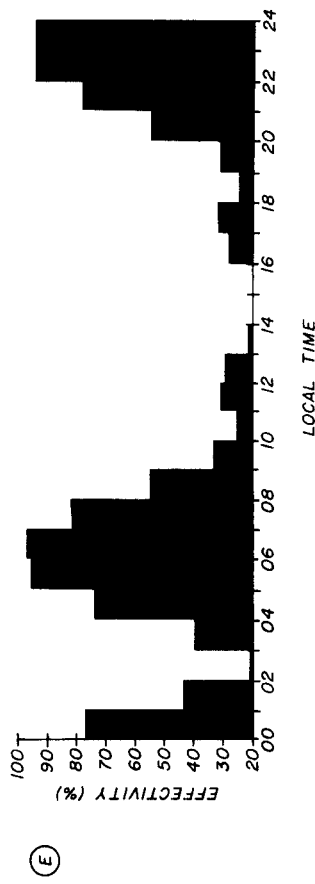
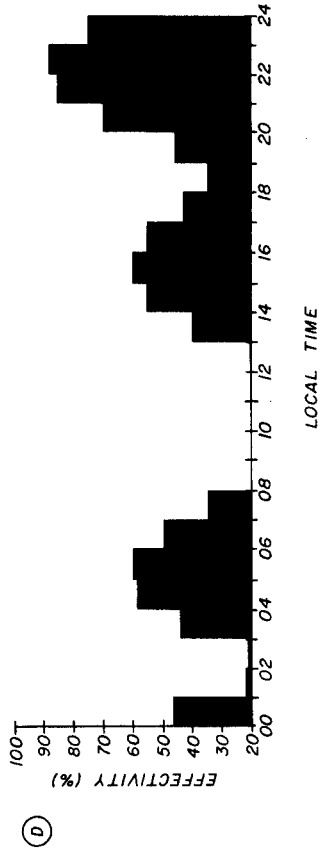
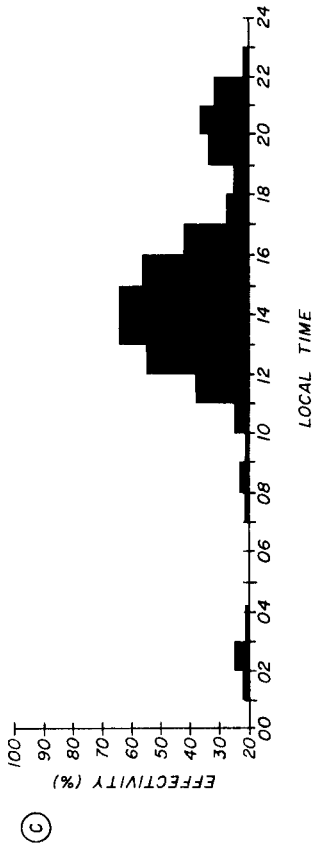
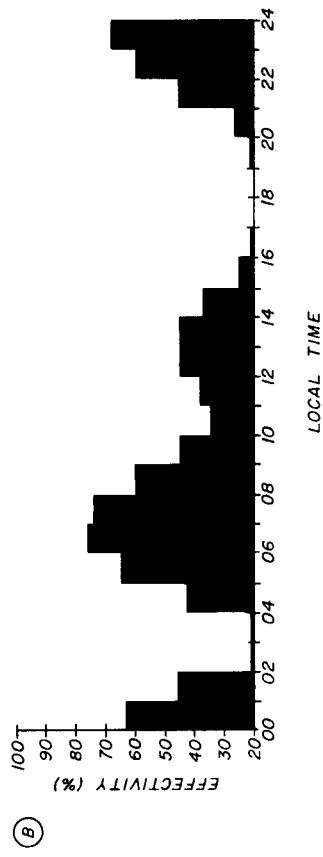
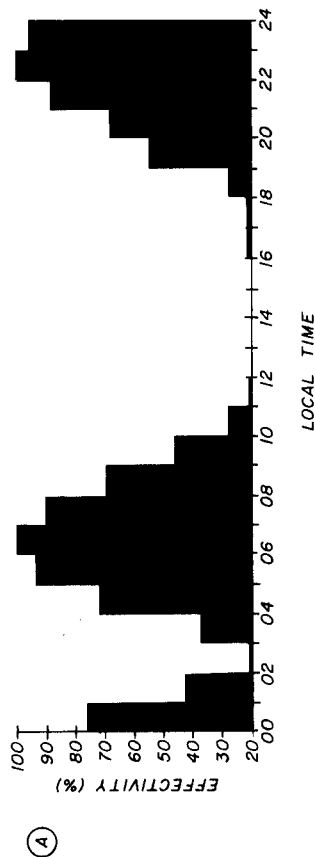

fig. 4. These graphs show the predicted effectivity for the Geminids meteor shower. All times shown are local. Original data was taken from latitude 40 degrees north and longitude 76 degrees west but can be used at other locations as explained in the text. Paths shown are as follows: A) north, B) northeast, C) east, D) southeast, E) south, F) southeast, G) west, H) northwest.

Generally speaking, the higher-speed showers ionize at the upper height and the lower-speed showers at the lower height. Also, those meteors with larger particles tend to ionize in the lower regions. What this means is that the lower the ionization takes place in the ionosphere, the shorter the DX path. The Geminids meteors, for example, have relatively large particles; they're also a relatively slow shower. Consequently, 1100 miles (1770 km) is about the maximum reliable distance.

The Perseids, Orionids, Eta Aquarids, and Leonids, on the other hand, are fast showers and therefore yield the longest communications distances — up to about 1400 miles (2250 km).

I've been trying to integrate this information for some time. Gritting my teeth, I prepared the graph shown in **fig. 5**. While it may not be technically accurate, especially at the upper end, it will at least show a trend based on my meteor shower speed and propagation observations.

From **fig. 5** it should be obvious that the Perseids, Eta Aquarids, Orionids, and Leonids are preferred for 135- and 70-cm operation. However, remember that *lots* of meteors are also desirable. Table 1 shows that among these four showers, only the Perseids has a high hourly rate, a necessary ingredient for completing a QSO. Don't fret. The Leonids are due to peak again in the late 1990s — so be ready!

### meteor scatter records

In last July's column, I listed North American meteor scatter records in **table 4**.<sup>8</sup> None exceeded 1470 miles (2365 km). Since then, several stations have sent me reports of being heard further than this distance, but it appears that no QSOs have been successfully completed. All of these contacts were during the Perseids meteor shower.

Ironically the 2-meter meteor scatter record has just been shattered by a great distance and during the Geminids meteor shower! Congratulations to K5UR in Cabot, Arkansas, and KP4EKG near San Juan, Puerto Rico,

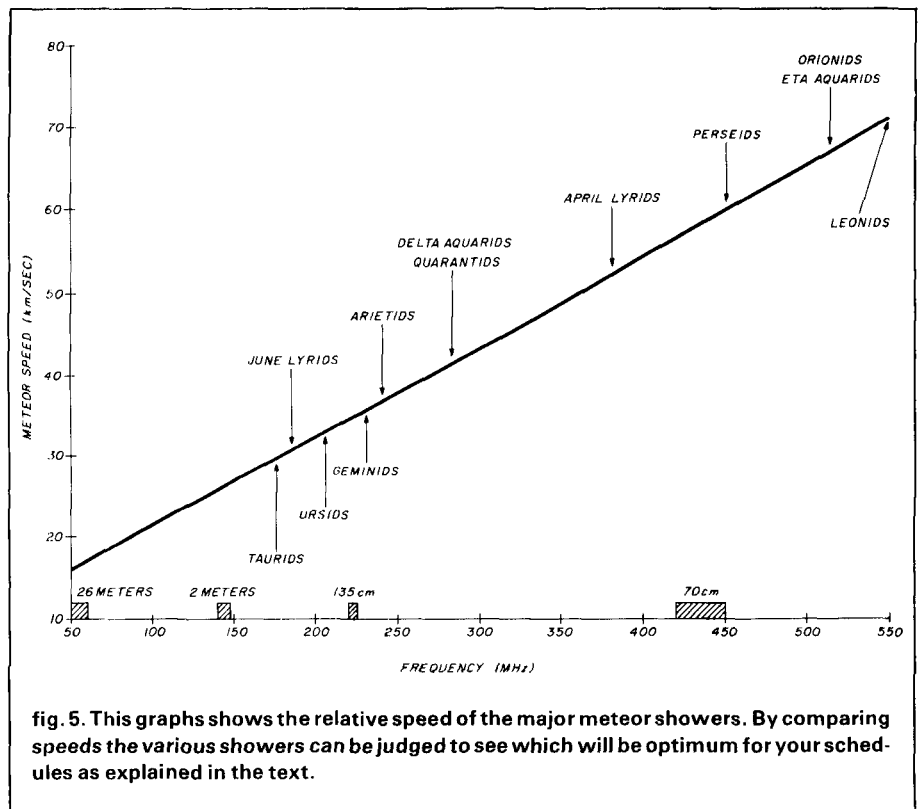

**fig. 5.** This graph shows the relative speed of the major meteor showers. By comparing speeds the various showers can be judged to see which will be optimum for your schedules as explained in the text.

who on December 13, 1985 completed a meteor scatter QSO during a schedule from 0400-0530 UTC. The length of this path was an incredible 1960 miles (3153 km)!

How can this long distance path exist? Since it took several bursts to complete the QSO and signals were moderate at best, the only plausible explanation is that they used double-hop meteors. This is probable since the quantity of the meteors in the Geminids shower is high and therefore would support such a theory. Does anyone have a better explanation?

### summary and conclusion

To improve your chances of successful meteor scatter communications, it's most important to use the optimum time for the desired path based on the geometry of the meteor shower. You can use the graphs and other information generated by the "effectivity"-predicting computer program to determine these optimum times.

Operating during the peak encounter of the shower with the earth is

important, but it will be useless if the meteors are on the other side of the earth, if the path of the shower was perturbed by an encounter with one of the other planets in the shower orbit, or if you're not properly oriented to increase the path "effectivity."

Packet radio is now a reality; 1986 should be the year in which many 2-meter QSOs will be completed using this relatively new mode. Europeans have been using a type of packet radio for many years in the form of high speed CW, sometimes exceeding 100 words per minute with great success — even in the absence of showers and at almost any hour of the day. At this high speed the bursts may be short, but if they're tape-recorded and played back at lower speed, a lot of information can be extracted from even a very short burst.

### acknowledgments

This month's column would not have been possible without the help of Chip Brown, KR1P, who provided the meteor scatter effectivity program discussed. I'd also like to thank Gary

Field, WA1GRC, who has volunteered to distribute this program, and Mike Owen, W9IP, who pointed me towards new references that yielded improved meteor shower data.

### important VHF/UHF events:

- June 6: Predicted peak of the daytime Arietids meteor shower at 0100 UTC
- June 7-8: ARRL VHF QSO Party
- June 15: Predicted peak of the June Lyrids meteor shower at 2100 UTC
- June 21: EME perigee
- June 21: Mean date  $\pm$  one month for the peak of sporadic-E propagation
- July 2:  $\pm$  2 weeks — look for European openings on 6 meters.
- July 18-20: CQ Magazine VHF WPX contest
- July 19: EME perigee
- July 20: Look for 2-meter sporadic E  $\pm$  2 weeks of this date.
- July 25-27: Central States VHF Conference in St. Louis, Missouri. (Contact NOIS for details.)
- July 29: Predicted peak of the Delta Aquarids shower at 0845 UTC.

### references

1. Joe Reisert, W1JR, "Improving Meteor Scatter Communications," *ham radio*, June, 1984, page 82.
2. Walter F. Bain, W4LTU, "VHF Meteor Scatter Propagation," *QST*, April, 1957, page 20.
3. Walter F. Bain, W4LTU, "VHF Propagation by Meteor-Trail Ionization," *QST*, May, 1974, page 41.
4. O.G. Villard, Jr., et. al., "The Role of Meteors in Extended-Range VHF Propagation," *Proceedings of the IRE*, October, 1955, page 1473.
5. M.L. Meeks and J.C. James, "On the Influence of Meteor-Radiant Distributions in Meteor-Scatter Communications," *Proceedings of the IRE*, December, 1957, Page 1724.
6. T. Damboldt, DJ5DT, "Meteor Scatter Communications," *VHF Communications*, winter issue, 1974, page 194.
7. *The ARRL Antenna Book*, 14th edition, chapter 16.
8. Joe Reisert, W1JR, "VHF/UHF World: Propagation Update," *ham radio*, July, 1985, page 86.

### ham radio

#### Invitation to Authors

*ham radio* welcomes manuscripts from readers. If you have an idea for an article you'd like to have considered for publication, send for a free copy of the *ham radio* Author's Guide. Address your request to *ham radio*, Greenville, New Hampshire 03048 (SASE appreciated).

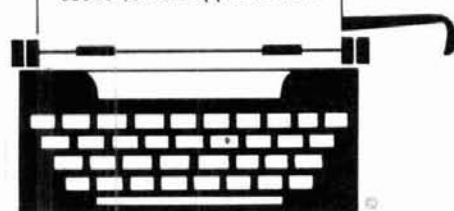

## GET A BIRD'S EYE VIEW

From GrafTrak II™ and your IBM® PC

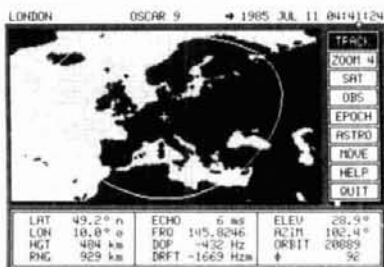
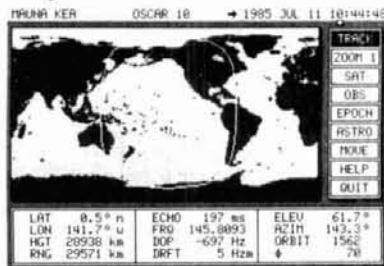
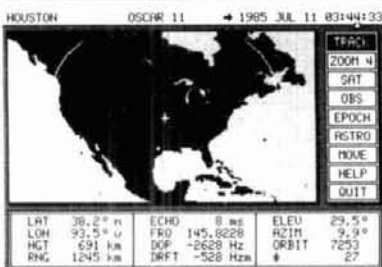
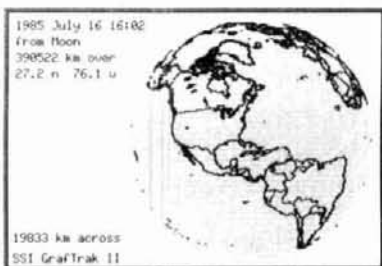

GrafTrak II™ provides realistic graphic display of a flat projection map which moves under the selected Satellite/Sun/Moon/Star coverage circle and updates once per second. Spherical projection views and graphic screen dumps to an IBM/Epson/Oki printer can also be produced. Requires an IBM PC, PC/XT, PC/AT, or true compatible, an IBM Color/Graphics Monitor Adapter or true compatible, 8087 math coprocessor, minimum 256K RAM with 512K recommended, DOS 2.0 or later, and either two 360K floppy drives or one 360K floppy and one hard drive.

SILICON EPHEMERIS™ provides tabular data output to the screen, printer, or disk file for the following operating modes: 1 observer to 16 satellites, 16 observers to 1 satellite, schedule for 1 observer to 1 satellite, window between 2 observers and 1 satellite, rise and set times for 1 satellite, time ordered rise and set times for 16 satellites, Almanac for Sun and Moon, 16 observers to Sun/Moon, schedule for 1 observer to Moon, window between 2 observers and Moon, schedule for 1 observer to Sun. Requires either an IBM PC, PC/XT, PC/AT, or true compatible, and IBM Monochrome or IBM Color/Graphics Monitor Adapter or true compatible, an optional 8087 math coprocessor, 256K RAM, DOS 2.0 or later, and one 360K floppy drive.

Each package includes SED, an editor program to construct and modify Satellite/Observer database files. These products can be run from a hard disk and are not copy protected.

GrafTrak II™ and SILICON EPHEMERIS™ are priced at \$119.95 each or \$199.95 for both. Texas residents add sales tax. Order by check, money order, MasterCard, or VISA.

Silicon Solutions, Inc. • P.O. Box 742546 • Houston, Texas 77274-2546 • (713) 661-8727

IBM is a registered trademark of IBM Corporation

GrafTrak II and Silicon Ephemeris are trademarks of Silicon Solutions, Inc.

## SPRING SUNSPOT SALE!

### SAVE \$700

#### COMPUTERIZED DX EDGE

**Generate your own Greylney display.** Xantek has adapted their best selling DX Edge to the computer world and it comes at a very reasonable price. This computerized operating aid brings into your ham shack the ability to know and predict when and where DX is going to appear. When you are using the program, the computer will automatically update the information as the sun progresses across the face of the Earth. To make the computerized DX Edge even easier to use, the display is keyed to the DXCC list and the 40 CQ zones. Disk and documentation included. This is something you've Got to have! ©1985.

☐ XN-C64 (For Commodore C-64) REG 34.95

Now JUST \$27.95

Please add \$3.50 for postage and handling

**ham radio** BOOKSTORE  
GREENVILLE, NH 03048



### STATE OF THE ART

*The ARRL 1986 Handbook For The Radio Amateur* carries on the tradition of the previous editions by presenting 1192 pages of comprehensive information for the radio amateur, engineer, technician and student. Paper edition: \$18 in the U.S., \$19 in Canada, and elsewhere. Clothbound \$27 in the U.S., \$29 in Canada and elsewhere.

THE AMERICAN RADIO RELAY LEAGUE  
225 MAIN ST.  
NEWINGTON, CT 06111

# RAMSEY

# THE FIRST NAME IN ELECTRONIC TEST GEAR



**\$30<sup>00</sup> OFF**

## Save \$30 on the RAMSEY 20MHz Dual Trace Oscilloscope

Unsurpassed quality at an unbeatable price, the Ramsey oscilloscope compares to others costing hundreds more. Features include a component testing circuit for resistor,

capacitor, digital circuit and diode testing • TV video sync filter • wide bandwidth & high sensitivity • internal graticule • front panel trace rotator • Z axis • high sensitivity x-y mode • regulated power supply • built-in calibrator • rock solid triggering

Was \$399.95 NOW ONLY **\$369.95** high quality hook on probes included



## NEW RAMSEY 1200VOM MULTITESTER

Check transistors, diodes and LEDs with this professional quality meter. Other features include, decibel scale • 20K volt metering system • 3 1/2" mirrored scale • polarity switch • 20 measuring ranges • safety probes • high impact plastic case

**\$19.95** test leads and battery included



## NEW RAMSEY D-4100 COMPACT DIGITAL MULTITESTER

Compact sized reliability and accuracy. This LCD digital multimeter easily fits in your pocket, you can take it anywhere. It features full overload protection • 3 1/2 digit LCD readout • recessed input jacks • safety probes • diode check function • 2000 hours battery life

**\$22.95** test leads and battery included

## NEW 35 MHz DUAL TRACE OSCILLOSCOPE



A heavy duty and accurate scope for service as well as production use. Features include • wide frequency bandwidth • optimal sensitivity • extremely bright display • delayed triggering sweep • hold off • ALT trigger • single sweep • TV sync • 5X magnification • XY or XYZ operation • HF/LF noise reduction

**3500 Dual Trace Oscilloscope \$499.95** includes 2 high quality probes

## ALL OSCILLOSCOPES INCLUDE 2 PROBES

## NEW 15 MHz DUAL TRACE PORTABLE OSCILLOSCOPE



Ideal for field/bench applications, this scope can display up to 15 MHz signals. Internal battery pack allows up to 2 hours operation on a single charge. Features include • built-in battery charger • 5X horizontal magnification • high brightness CRT • front panel trace rotator • internal rechargeable battery pack

**2500 Portable Oscilloscope \$449.95** includes 2 high quality probes

## MINI-100 FREQUENCY COUNTER

Features and capabilities of counters costing twice as much • compact • high sensitivity • low current drain • very accurate • leading zero blanking • field or shop use • 1 MHz to 500 MHz range • diode protected • 7 digit display

**\$99.95** BATTERY CHARGER NICAD BATTERIES AND AC ADAPTER INCLUDED



## CT-70 7 DIGIT 525 MHz COUNTER

Lab quality at a breakthrough price. Features • 3 frequency ranges each with pre amp • dual selectable gate times • gate activity indicator • 50mV @ 150 MHz typical sensitivity • wide frequency range • 1 ppm accuracy

**\$119.95** wired includes AC adapter  
CT-70 kit ..... \$99.95  
BP-4 nicad pack ..... 8.95

## CT-50 8 DIGIT 600 MHz COUNTER

**\$169.95** wired  
CT-50 kit ..... \$139.95  
RA-1 receiver adapter kit ..... 14.95



## CT-90 9 DIGIT 600 MHz COUNTER

The most versatile for less than \$300. Features 3 selectable gate times • 9 digits • gate indicator • display hold • 25mV @ 150 MHz typical sensitivity • 10 MHz timebase for VVV calibration • 1 ppm accuracy

**\$149.95** wired includes AC adapter  
CT-90 kit ..... \$129.95  
CW-1 0.1 PPM oven timebase ..... 59.95  
BP-4 nicad pack ..... 8.95

## CT-125 9 DIGIT 1.2 GHz COUNTER

**\$169.95** wired includes AC adapter  
CT-125 kit ..... \$139.95  
BP-4 nicad ..... 8.95



## DM-700 DIGITAL MULTIMETER

Professional quality at a hobbyist price. Features include 26 different ranges and 5 functions • 3 1/2 digit, 1/2 inch LED display • automatic decimal placement • automatic polarity

**\$119.95** wired includes AC adapter  
DM-700 kit ..... \$99.95  
MP-1 probe set ..... 4.95



## PR-2 COUNTER PREAMP

The PR-2 is ideal for measuring weak signals from 10 to 1,000 MHz • flat 25 db gain • BNC connectors • great for shifting RF • ideal receiver/TV preamp

**\$44.95** wired includes AC adapter  
PR-2 kit ..... \$34.95



## PS-2 AUDIO MULTIPLIER

The PS-2 is handy for high resolution audio resolution measurements, multiplies up in frequency • great for PL tone measurements • multiplies by 10 or 100 • 0.01 Hz resolution • built-in signal preamp/conditioner

**\$49.95** wired  
PS-2 kit ..... \$39.95



## PS-10B 1.5 GHz PRESCALER

Extends the range of your present counter to 1.5 GHz • 2 stage preamp • divide by 1000 circuitry • super sensitive (50 mV typical) • BNC connectors • 1 GHz in, 1 MHz out • drives any counter

**\$79.95** wired includes AC adapter

## MINI KITS—EASY TO ASSEMBLE, FUN TO USE BEGINNERS & PROS WILL HAVE A GREAT TIME WITH THESE KITS

### FM MINI MIKE

A super high performance FM wireless mike kit. Transmits a stable signal up to 300 yards with exceptional audio quality by means of its built in electret mike. Kit includes case, mike, on-off switch, antenna, battery and super instructions. This is the finest unit available.

FM-3 Kit ..... \$14.95  
FM-3 Wired and Tested ..... 19.95

### Color Organ

See music come alive! 3 different lights flicker with music. One light each for, high, mid-range and lows. Each individually adjustable and drives up to 300 W runs on 110VAC.

Complete kit, ML-1 ..... \$8.95

**Video Modulator Kit**  
Converts any TV to video monitor. Super stable, tunable over ch. 4-6. Runs on 5-15V ac/dc. Video signal. (Best unit on the market!) Complete kit, VD-1 ..... \$7.95

### Led Blinky Kit

A great attention getter which alternately flashes 2 jumbo LEDs. Use for name badges, buttons, warning panel lights, anything! Runs on 3 to 15 volts. Complete kit, BL-1 ..... \$2.95

### Super Sleuth

A super sensitive amplifier which will pick up a pin drop at 15 feet! Great for monitoring baby's room or as general purpose amplifier. Full 2W rms output, runs on 6 to 15 volts, uses 8-45 ohm speaker. Complete kit, BN-9 ..... \$5.95

**CPO-1**  
Runs on 3-12 Vdc. 1 wall out, 1 KHZ good for GPO, Alarm, Audio Oscillator. Complete kit ..... \$2.95

### FM Wireless Mike Kit

Transmits up to 300' to any FM broadcast radio, uses any type of mike. Runs on 3 to 9V. Type FM-2 has added sensitive mike preamp stage.

FM-1 Kit ..... \$3.95  
FM-2 Kit ..... \$4.95

### Whisper Light Kit

An interesting kit, small mike picks up sounds and converts them to light. The louder the sound, the brighter the light. Includes mike, controls up to 300 W runs on 110 VAC.

Complete kit, WL-1 ..... \$6.95

### Tone Decoder

A complete tone decoder on a single PC board. Features: 400-5000 Hz adjustable range via 20 turn pot, voltage regulation, 567 IC. Useful for touch-tone burst detection, FSK, etc. Can also be used as a stable tone encoder. Runs on 5 to 12 volts. Complete kit, TD-1 ..... \$5.95

### Siren Kit

Produces upward and downward wail characteristic of a police siren. 5 W peak audio output, runs on 3-15 volts, uses 3-45 ohm speaker. Complete kit, SM-3 ..... \$2.95

### 60 Hz Time Base

Runs on 5-15 VDC. Low current (25ma) 1 min/month accuracy. TB-7 Kit ..... \$5.50  
TB-7 Assy ..... \$5.95

### Universal Timer Kit

Provides the basic parts and PC board required to provide a source of precision timing and pulse generation. Uses 555 timer IC and includes a range of parts for most timing needs.

UT-5 Kit ..... \$5.95

### Mad Blaster Kit

Produces LOUD ear shattering and attention getting siren like sound. Can supply up to 15 watts of obnoxious audio. Runs on 6-15 VDC.

MB-1 Kit ..... \$4.95

## 30 Watt 2 mtr PWR AMP

Simple Class C power amp features 8 times power gain. 1 W in for 8 out, 2 W in for 15 out, 4 W in for 30 out. Max output of 35 W, incredible value, complete with all parts, less case and T-R relay.

PA-1, 30 W pwr amp kit ..... **\$229.95**  
TR-1, RF sensed T-R relay kit ..... **6.95**

## Power Supply Kit

Complete triple regulated power supply provides variable 6 to 18 volts at 200 ma and -5 at 1 amp. Excellent load regulation, good filtering and small size. Less transformers, requires 6 3V (a 1 A and 24 VCT. Complete kit, PS-3LT ..... **\$6.95**

## ACCESSORIES FOR RAMSEY COUNTERS

- Telescopic whip antenna—BNC plug ..... \$ 8.95
- High impedance probe, light loading ..... 16.95
- Low pass probe, audio use ..... 16.95
- Direct probe, general purpose use ..... 13.95
- Tilt bail, for CT-70, 90, 125 ..... 3.95



PHONE ORDERS CALL  
**716-586-3950**  
TELEX 466735 RAMSEY CI

TERMS: • satisfaction guaranteed • examine for 10 days; if not pleased, return in original form for refund • add 6% for shipping and insurance to a maximum of \$10.00 • overseas add 15% for surface mail • COD add \$2.50 (COD in USA only) • orders under \$15.00 add \$1.50 • NY residents add 7% sales tax • 90 day parts warranty on all kits • 1 year parts & labor warranty on all wired units



RAMSEY ELECTRONICS, INC.  
2575 Baird Rd.  
Penfield, N.Y. 14626

## Experiment with RF circuits using this fast, simple technique

# a universal analog breadboard

Even at its best, breadboarding is always a problem, particularly when a little circuit complexity is involved. Digital breadboarding has been made easier by the availability of various commercial breadboards that nicely accommodate the digital DIP packages; analog breadboarding, however, remains an art of arranging, in seemingly random fashion, a multitude of varied components on some substrate material.

Although digital breadboards can be used for analog breadboarding, the component leads just don't seem to fit properly and the interelectrode capacitance is much too high for analog circuits operating much above 1 MHz or so. Other materials such as perf-board work well for anyone who's organized enough to fully lay out the assembly carefully before starting, but if you're going to go to all that trouble, you might as well lay out a PC board. Also, if the circuit being breadboarded is RF in nature, a ground-plane substrate is necessary; this requires tedious cutting and peeling off the ground plane to fabricate a functional breadboard.

The primary value of the breadboard lies in its ease of preparation and use; if a great amount of planning is required for just building the breadboard, much of the advantage of its use is lost.

An analog breadboard system has to be versatile enough to accommodate the wide variety of analog component types, yet provide for very simple fabrication of the circuit. Stray capacitance and inductance must be made very low; good ground plane construction is a must. Changes, additions, and deletions must be simple to make.

### choosing a breadboard type

Having tried a variety of breadboards — from commercial spring-boards to nails driven into a piece of plywood — I thought a slightly different approach might be in order. One of my principal requirements was that the breadboard be adequate for simple RF designs. Generally, complex RF circuits such as complete receivers or high-gain amplifiers require more elaborate construction than a simple breadboard will

allow because of the difficulty in controlling unwanted coupling. However, crystal oscillators, single-stage RF amplifiers, and modulators, for example, should be appropriate applications for this breadboard technique.

The artwork for a good basic design, a 1/16 inch (0.16 cm) thick PC board with a ground plane on the bottom side and dot and trace pattern on the top side, is shown in **fig. 1**. The traces allow two power supplies and ground to be conveniently bussed around the breadboard. Running power to all the various points where it's needed always seems to present a problem in any breadboard, particularly when you're making a lot of changes as you try out different circuit configurations. The power busses provide a convenient means of accessing the power supplies without having to daisy-chain the power conductors.

Grounding in analog designs is particularly important. Daisy-chaining ground can lead to some very unusual performance (for example, when your amplifier works better as an oscillator than an amplifier). The ground bus provides a good ground for all but the most demanding circuit designs. Power and ground are brought onto the breadboard at the three terminals at the edge of the board. This keeps the power leads out of the circuit area, preventing disturbances that could be caused by the leads lying in the circuitry. It also helps prevent power leads from deciding to detach and fall on the most critical (or expensive) components, generally with spectacular results.

A set of pads for installing power supply bypass capacitors has been provided at the lower left and right-hand corners of the trace pattern. Since long leads are often used to supply power to an experimental circuit, good bypassing of the supplies on the breadboard is very important. The bypass capacitors are often rather large and inconvenient to have in the middle of the breadboard circuit. Placing them at the lower edges of the work space gets them out of the way.

By Michael Gruchalla, 4816 Palo Duro N.E.,  
Albuquerque, New Mexico 87110





INT'L MONTHLY MAGAZINE BY AND FOR ACTIVE RADIOAMATEURS

# RADIOSPORTING

Dedicated to quality and sportsmanship in amateur radio operating. Fresh, timely, practical and down to earth reading for little pistols and big guns written by world's best in their fields.

DX news, DXpeditioning, propagation, contest rules and results, emergency - traffic, FCC news, new products, antenna and technical articles, equipment reviews and modifications, computer programs, YL, RTTY, VHF, UHF, ATV, SSTV, AMTOR, classified ads and much more.

"Your publication is superb! Keep it up!"  
Joe Reisert, W1JR

"Your W2PV articles are priceless. Your magazine is Super!"  
Rush Drake, W7RM

"Let me congratulate you on a very impressive magazine. Just what I've been looking for as a DXer and Contester!"  
Dick Moen, N7RO

"RADIOSPORTING, once received, cannot be tossed aside until it is read from cover to cover. Then reviewed again and again."  
Chas Browning, W4PKA

Subscription rates: 1 year USA \$ 16, Canada \$ 22, Overseas US\$ 19

Membership in International Radio Sport Assn \$ 4/yr

TRY US! PHONE OR SEND YOUR QSL CARD FOR SAMPLE COPY

RADIOSPORTING Tel. (416) 438-6313  
Box 65, Don Mills, ON, M3C 2R6, Canada ✓ 164

## AVAILABLE NOW



### THE 1986 ARRL HANDBOOK

#### FOR THE RADIO AMATEUR

Great gift idea for a ham friend or for yourself!

The new 1986 ARRL HANDBOOK is chockfull of projects, ideas, hints and kinks, theory and thousands of other handy things for your hamshack. New items include: switching power supplies, data and telemetry transmission, a section on conjugate matching by Walt Maxwell, data interface and Packet Radio, and remote control aircraft to name just a few examples. New projects include: 30 amp power supply, ATV monitoring instruments, digital frequency synthesizer, 1500 watt output 160 meter amplifier, state-of-the-art preamps for all Amateur VHF/UHF frequencies and much, much more. A grand total of 244 new pages! This is the reference book to have. Order your's today. ~1985 Over 1100 pages

AR-HB86 Softbound \$17.95  
AR-BB86 Hardbound \$26.95

VISA Please enclose \$3.50 to cover shipping and handling

ham radio magazine BOOKSTORE  
GREENVILLE, NH 03048

## Join AMSAT...Today

### Amateur Radio Satellite OSCAR 10 provides:

- A New Worldwide DX Ham Band open 10 hours a day.
- Rag Chew With Rare DX Stations in an uncrowded, gentlemanly fashion.
- Popular Modes In Use: SSB, CW, RTTY, SSTV, Packet
- Full Operating Privileges open to Technician Class licensee or higher.

#### Other AMSAT Membership Benefits:

Newsletter Subscription:  
Dependable technical articles, satellite news, orbital elements, product reviews, DX news, and more.

Satellite Tracking Software  
Available for most popular PCs.

QSL Bureau, AMSAT Nets, Area Coordinator Support, Forum Talks

Construction of Future Satellites For Your Enjoyment!

AMSAT Membership is \$24 a year, \$26 outside North America. VISA and MC accepted.

AMSAT  
P.O. Box 27  
Washington, DC 20044  
301 589-6062

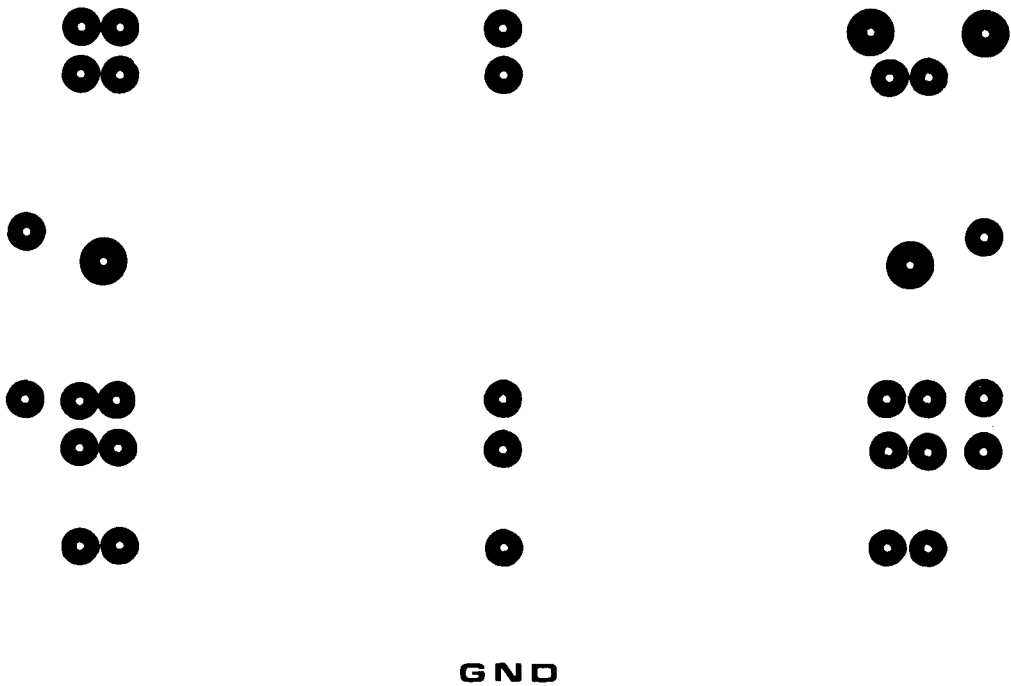
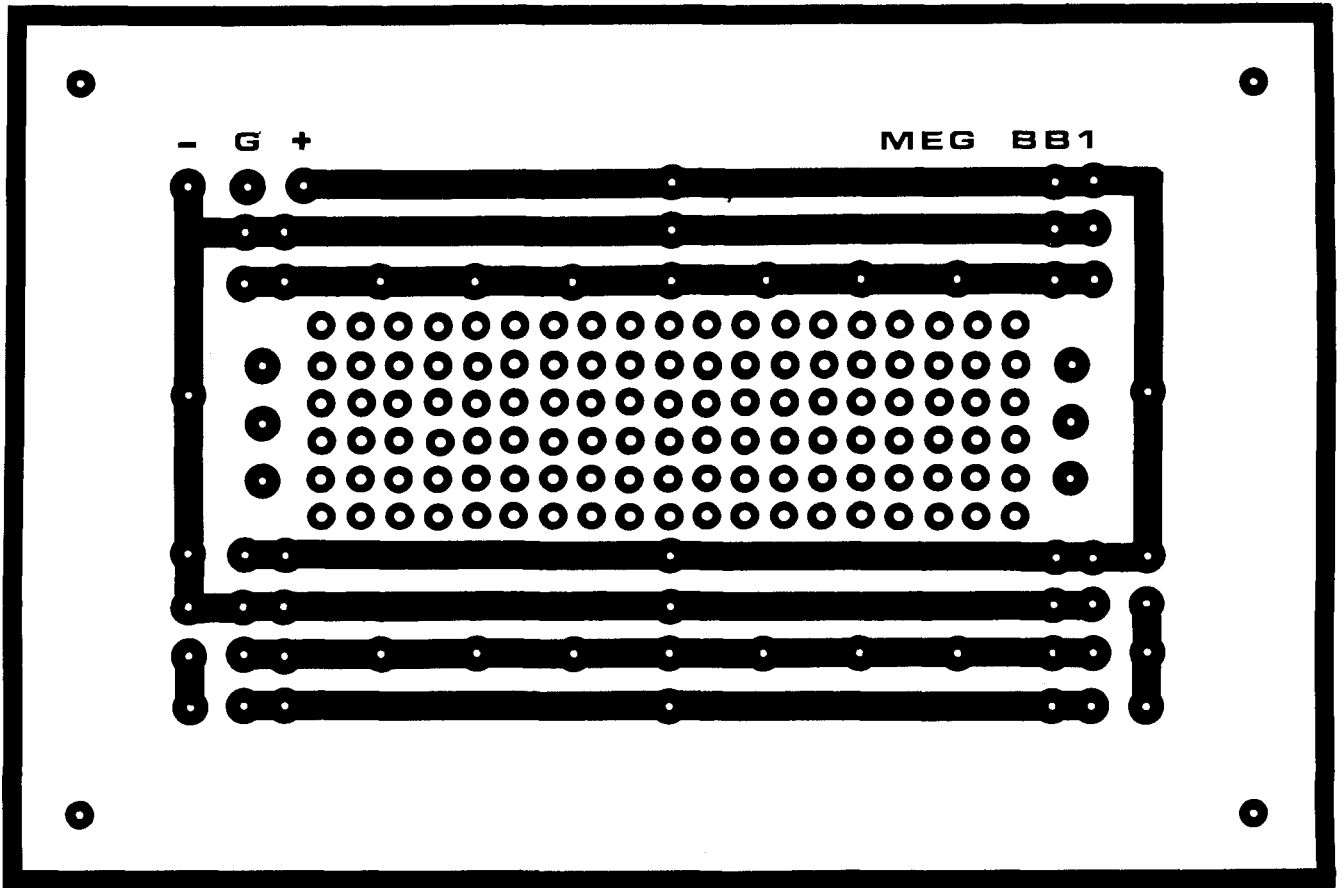

fig. 1. Breadboard artwork.

# SPRING SPECIALS POWERFUL PACKET.

New rigs and old favorites, plus the best essential accessories for the amateur.

3621 FANNIN ST  
HOUSTON, TX 77004-3913

CALL FOR ORDERS  
1-713-520-7300 OR  
1-713-520-0550

ALL ITEMS ARE GUARANTEED OR SALES PRICE  
REFUNDED

## EQUIPMENT

Kenwood	Call for prices on all Kenwood
Kenwood TS940S, contesters delight	Call
Kenwood TS 440	Call for trade
Icom R7000 25-2000 MHz	849.00
Icom IC3200	489.95
Santec ST20T Handi Talkie	289.00
Icom IC735	799.00
Ten-Tec 2510 (Easy OSCAR)	489.00



## ACCESSORIES

B&W VIEWSTAR ANTENNA TUNER	89.95
Heil HC3/HC4/HC5	Stock
Heil BM10 Boom Mike headset	59.95
CSI Private Patch III	469.95
FLUKE 77 auto-ranging digital multimeter	125.00
Bird 43 Wattmeter	Call
Bird Elements	In Stock, Call
Daiwa CN620B, 20-200, 2000W	109.95
Stabylex 20SR, 25 amp 12VDC, 16 amp cont. overvoltage protected	99.00
Alinco ELH 230D, Excellent buy	79.00
Nye MB5-A (for the big boys!)	529.00
Shure 444D	54.95
Wahl 7470 Soldering Station	49.00
Kenwood IF 10A, B, C	Stock
Kenwood IF 232C Level translator	49.00
Miller C514T Low pass filter	43.50

## "NEW" ALPHA DELTA 4 HEAVY DUTY COAX SWITCH

with ground pos. & lightning protection 69.00  
Collins KWM2/S line xtals 10.00 each



751A List 1499.00 Your Cost 1299.00

## KEYS

Benchler & Vibroplex Less 10%  
Benchler is now improved Screws & springs, all stainless steel and extra hand polishing.  
Trade in your old hand key on new Vibroplex/Benchler 5 00  
Nye ESK-001 Keyer 58.00

## TUBES

Collins & Drake Replacement tubes	stock
GE 6146B	11.95
Eimac 3-500Z	109.95
GE Industrial Tubes	Call
GE 12BY7A	7.00
GE 6JS6C	12.95
Cetron 572B	69.00
GE 8950	14.00

CALRAD 65-287 SWR, Relative Power Meter 32.95  
3-150MHz, KW +

## BOOKS

We stock SAMS, TAB, ARRL, RSGB, Ameco Radio  
Pubs Call  
Some of the best buys are the RSGB books.

## ANTENNAS

Isopole	44.95
A4	269.00
424B	279.95
402CD	84.00
215WB New, 15 E1, 2M beam	79.95
AOP-1, Complete Oscar Antenna	149.95
Butternut HF6V 80-10 vertical	125.00
HF2V, 80 & 40 vertical	119.00
HF4B	189.00
Hustler G7-144	119.95
Hustler 6BTV	139.00
Ham4 Rotator, T2X, CD45-2	Call
KLM HF World Class Series Antennas	Call Don
Alpha Delta Twin Sloper	49.00
Coax Seal	2.00/roll
B&W Dipoles	Less 10%
Hy-Gain TH7DXS	489.00
Explorer 14	349.00
Discoverer 1 element 40M	169.00
2 element 40M	369.00
3 element only	249.00
CD 45-2 Great Tribander Rotor	169.00
V2S (2meter)	59.00
HG52SS 52 ft. crankup tower	1199.00
Prepaid freight when you order other Hy-Gain items with tower	
KLM KT-34A	339.00
40M-2	299.00

## OTHER ANTENNAS

Larsen Kuldock	17.00
Larsen 440 HW 1/2 wave Kuldock	25.00
Avanti AP151 3G on Glass Antenna	36.00
Anteco 2M, 5/8 Mag. Mount, Comp	25.00
Avanti APR450 5G on glass	39.00
Orion 2M 1/2 wave handy Antenna	19.00
Van Gordon SLA-1 160-80-40 Sloper	34.00
Valor AB-5 Mobile	79.95
Stoner DA100 D Active Rx Antenna	190.00

## SURPLUS

24 Pin Solderless dip sockets	25/each
150MFD/400V DC	1.95
1.5 Amp/400V full wave bridge rectifier	1.95
2.5A/1000PIV Epoxy diode	29 each or 19.00/100
.0015/10KV or .001/20KV	1.95 each
3N201	.95
4 inch ferrite rod	1.95
365pF cap	1.95
Sanyo AAA AA Nicads w/tabs	2.00
2, 4, 5, 6, 8 pin mic plugs	3.00
1/8, 1/4, watt carbon resistors	.05 each
Meters 0-3000 VDC 2 1/2" Square 0-1 Amp DC	9.95
Drake—Collins mike plug	2.00
Miniature toggles, 5A/125VAC	1.50 each
Close out on rigs & accessories. All the time	Call
We may have what you're looking for	

## BELDEN

9913 low loss, solid center, foil/braid shield	51c/ft
8214 RG8 Foam	45c/ft
8237 RG8	39c/ft
8267 RG213	55c/ft
8000 14 Ga stranded copper ant. wire	13c/ft
8448 8 conductor rotor cable	33c/ft
9405 Heavy duty 2-16 Ga 6-18 Ga	56c/ft
9258 RG8x	20c/ft
9269 RG-62A/U	16c/ft
8403 Mic Cable, 3 condctr & shield	45c/ft
100 feet 8214 w/ends installed	54.00
8669 7/16" tinned copper braid	1.00/ft
International Wire RG214, non-mil good cable	70c/ft
International Wire 9086 exact replacement for Belden 9913	36c/ft
International 16 Ga stranded antenna wire	6c/ft

## AMPHENOL

831SP-PL259 Silverplate	1.25
UG176 reducer RG8X	.30
831J Double Female UHF	2.00
82-61 N Male	3.00
82-97 N Female Bulkhead	3.00
82-63 Inline Female N	4.00
82-98 N elbow	9.00
31-212 BNC-RG59	1.50
31-2 BNC-RG58	1.50
34025 N Male, RG58	3.00
34125 N Female, UHF male	9.00
3128 BNC Female-PC259	3.00

## TOWER ACCESSORIES

1/4" E.H.S. Guy cable, Rohn US, 1000 ft.	250.00
3/16" E.H.S. cable, Rohn US, 1000 ft.	210.00
1/4" Guy Cable, 6100 #7 x 7 strand, import	15c/ft.
3/16" Guy Cable, 3700 #7 x 7 strand, import	12c/ft.
3/8 x 6 E&J Turnbuckle	7.95
3/16" Wire Rope Clips	40
1/4" wire clips	50
1/4 Thimbles	45
Porcelain 500D Guy Insulator (3/16)	1.99
Porcelain 502 Guy insulators (1/4)	3.39

## COMPUTER STUFF

Kantronics UTU-XT 319.00  
Fits any computer (even yours!)  
Morse University (Great CW program for C-64) 39.00

## PACKET POWER

AEA PK-64, does RTTY, ASCII, AMTOR also	199.00
AEA PK-80 TAPR II	199.00
NEW Kantronics Packet II	199.00
Icom 271A Great packet radio	Call

## SERVICES

Alignment, any late model rig 50.00  
Flat fee Collins rebuild Call

## USED EQUIPMENT

All equipment, used, clean, with 90 day warranty and 30 day trial. Six months full trade against new equipment. Sale price refunded if not satisfied.

## POLICIES

Minimum order \$10.00. Mastercard, VISA, or C.O.D. All prices FOB Houston, except as noted. Prices subject to change without notice. Items subject to prior sale. Call anytime to check the status of your order. Texas residents add sales tax. All items full factory warranty plus Madison warranty.

# BIRD

## STOCK ITEMS CALL

Power Range	Frequency Bands (MHz)					
	2-30	25-60	50-125	100-250	200-500	400-1000
5 watts	5A	5B	5C	5D	5E	
10 watts	10A	10B	10C	10D	10E	
25 watts	25A	25B	25C	25D	25E	
50 watts	50H	50A	50B	50C	50D	50E
300 watts	100H	100A	100B	100C	100D	100E
250 watts	250H	250A	250B	250C	250D	250E
500 watts	500H	500A	500B	500C	500D	500E
1000 watts	1000H	1000A	1000B	1000C	1000D	1000E
2500 watts	2500H					
5000 watts	5000H					

# MADISON

## Electronics Supply

3621 FANNIN  
HOUSTON, TEXAS 77004

1-713-520-7300 OR 1-713-520-0550

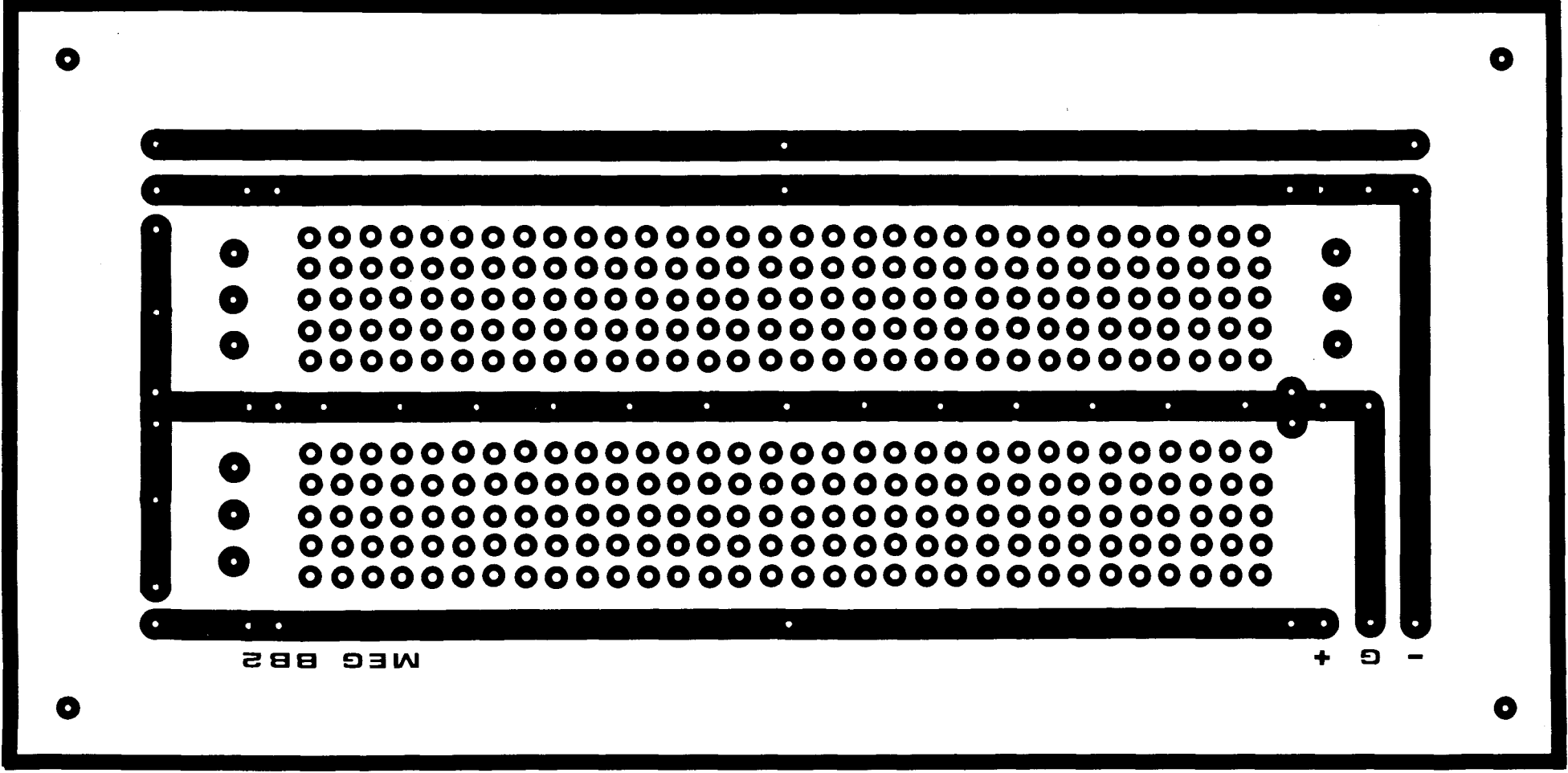

fig. 2A. Artwork for trace side for the larger breadboard.

The actual circuit nodes are simply PC dots arranged in rows and columns, allowing circuit components to be soldered directly to them without the need for holes to accommodate the component leads. The particular dot used has a very large center hole compared to normal PC dots of its size; this minimizes the capacitance of the dot to the ground plane and provides a dot large enough to solder to. The capacitance of each of the pads to the ground plane is about 0.5 pF, which is generally low enough to be usable up to 1 GHz.

Circuit ground can be provided in two ways. The ground bus is adequate for DC and low-frequency applications. High-frequency circuits generally require very tight grounding of various points, and in these cases the ground bus cannot be used very effectively because of the inductance of the wire that must be tied from the node to be grounded to the ground bus. Good grounding can be obtained by drilling through the board in the center of the pad that must be grounded, running a piece of bus wire through the hole, and then soldering it to both the ground plane and the pad. This grounding technique will provide good performance in circuits operating at frequencies as high as L-band (1.0 GHz).

### breadboard construction

A few pointers will help you build a more professional-looking breadboard. **Figure 1** shows 1:1 art work for one version of the breadboard, a small unit that's quite convenient for single-stage amplifiers, oscillators, and other small projects. **Figure 2** shows artwork for a larger version with the same basic design but with different features. Art for both the trace and ground plane sides are shown. If you don't have the capability for making double-sided PC boards, you can omit the ground plane art, leaving a full ground plane on the bottom side. You can then use a drill bit (about 1/4 inch) to cut away the ground from the few penetrations where needed — at the power terminals, for example. Use the bit by hand and cut just deep enough to remove the cladding. Though doing this requires some care, it's really quite simple.

The breadboard should be fabricated from high-quality PC board material. Epoxy-glass materials with 2-ounce copper are about the best. The pads will lift off very easily if an inexpensive material such as a phenolic base is used; eventually, after much use, the pads will tend to lift off even the best materials, but if you start with quality material, the pads shouldn't begin to separate until it's about time to retire the breadboard anyway. If possible, the board should be tin-lead plated to minimize oxidation of the conductors with time. After all, old breadboards may lie around in the junk box for years before being resurrected for a quick weekend project, and they're certainly expected to be as useful at that time as they were when they were new.



GND

fig. 2B. Artwork for the ground side of the breadboard.



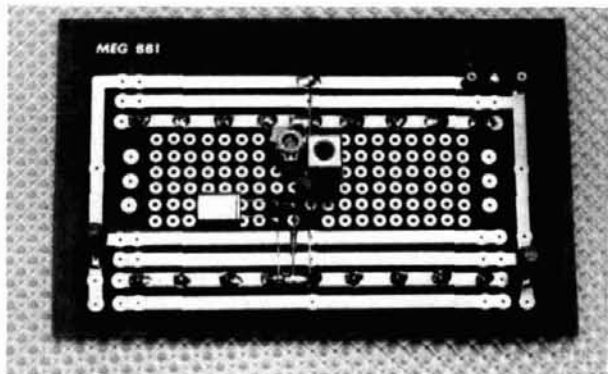

fig. 3. Crystal oscillator example.

If you have the breadboard fabricated commercially, don't have any holes drilled; this will reduce the cost and provide a good general-purpose board.

Before using the breadboard, tend to a few details to assure professional results. The three power terminals should be mounted at the indicated pads (+, G, and -). Drill a suitable hole through the center of the pads and swage in the terminals. Solder the two power terminals at the pad and the ground terminal at both the pad and ground. If you can't find terminals, you can use a loop of heavy bus wire; about 18 gauge works well. Solder the bus wire to the ground pad and ground plane. Make about a 1/4-inch (0.64 cm) loop in the wire and solder the end back to the ground pad. At the two power pads, solder the bus wire to the pad and loop it around to the corresponding conductor, making about a 1/4-inch loop, and then solder it to the trace. This will help prevent the power pads from pulling off because of the stress exerted by the external power leads. Next, drill holes in the bypass capacitor mounting pads and mount the two bypass capacitors. (A good choice of value is a 47 $\mu$ F, 35 V tantalum.) Be sure to observe the capacitor polarity when mounting. Even if you don't intend to use both supplies, at least drill the holes — you may eventually need an additional power supply, bias supply, or something similar, and having the holes there will prevent shorts that could be caused by metal chips trapped in a completed circuit. The two ground conductors aren't committed to be used as ground. They can be used for any type of bus, but at least one should be used as a ground. The lower is generally the most practical one. Drill holes in all the pads in the chosen ground bus, place bus wire in each hole, and solder to both the ground plane and the pad. Solder the ground plane first. (If you were to solder the pad side first, the piece of wire would probably fall out, since more heat is needed at the ground plane.)

Now, since several solder connections have been made to the ground plane, the board won't sit nicely on your work bench and the wire pieces are likely to scratch your work surface — not a desirable result if your work surface happens to be the dining room

- REALLY cramped for space?
- Want a 10, 15 or 20M concealable or portable antenna?
- Want a "bird dog" for your beam?
- Want 40M in a small space?
- Want to try the new WARC bands?

### MICROLOOP

These compact monoband loops provide omnidirectional (no rotator) horizontally-polarized (low-noise) coverage when parallel to ground, or performance approaching a full-size dipole when vertical. Tunable (SWR < 1.5:1) to your favorite band segment via built-in adjustable coaxial capacitor capable of continuous 200 watts CW or PEP.

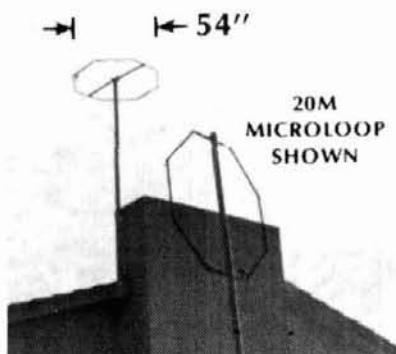

Cover other band segments via antenna tuner. Rugged low-loss copper with stainless steel hardware. 2" PVC mast required (not provided), or suspend from tree or ceiling with nylon rope. Prices include US shipping (except HI, AK). Florida add 5% sales tax. Send check with your order or call us with your VISA or MasterCard.

10, 12, 15, 16 or 20M MICROLOOP (20M is 54" across, others smaller) ..... \$83.50  
 30M or 40M MICROLOOP (108" across for 40M, 30M smaller) ..... \$93.50

ADN Advanced Design Networks, Inc.  
 8601 66th Street North • Pinellas Park, FL 33565

CALL TODAY (813) 544-2596

167

**HOT!!**



OSCILLOSCOPE

Turn Your Computer Into A

**DIGITAL STORAGE OSCILLOSCOPE**

And More With The

**MB230 WORKSHOP**

**\$129.95**

(C64 Version)



INTERFACE UNIT

The MB230 is designed for use with your home or personal computer. It is a complete Electronic Instrument and Electro-Mechanical Workshop which contains Interface Unit, D.C. Motors, Gears, Sensors, Construction Components, Disk Based Software and instructions for 50 sample projects.

Included are:

- Digital Storage Oscilloscope
- Digital Voltmeter
- Digital Speech & Sound (Record/Playback)
- A/D-D/A Conversion
- D.C. Motor Control (Var. Speed)
- Infrared Control
- Motors, Gears, Generators
- Motorized Mechanical Robotics
- Cars, Cranes, Toys, Etc.



VOLTMETER



MOTOR AND GEARS

The heart of the MB230 Workshop is the B100 Interface Unit which connects to all types of sensors and is able to control lights, motors, relays and other external devices. The MB230 manual contains suggestions and instructions for many advanced projects such as antenna positioning and relay control.

Available for the following computers:  
 Commodore 64 (\$129.95), Apple 2+, 2E (\$159.95),  
 Atari 800 (\$139.95).  
 Coming soon for IBM, Amiga, Atari 520ST.

To order or for more information call toll free 1-800-824-2549.  
 Cashier's check, Money order, VISA, or Mastercard orders accepted.

Order now to avoid delay!  
 ALL ORDERS SHIPPED UPS BLUE  
 AT NO EXTRA CHARGE

**MULTIBOTICS, INC.** 2561 South 1560 West  
 Woods Cross, Utah 84087

168

**DO YOU  
KNOW  
WHERE  
TO FIND  
REAL  
BARGAINS**

**NUTS & VOLTS**  
BUY • SELL • TRADE ELECTRONICS

HAM GEAR  
COMPUTERS  
SOFTWARE  
SCANNERS • OPTICS  
TEST EQUIPMENT  
MICROWAVE  
SATELLITE  
AUDIO VISUAL  
NEW PRODUCTS  
COMPONENTS • KITS  
ANTIQUE ELECT.  
PUBLICATIONS  
PLANS • SERVICES

**on NEW and USED  
ELECTRONIC Equipment?**

**You'll Find Them  
in the Nation's No. 1  
Electronic Shopper Magazine**

**NUTS & VOLTS**

**Now in Our 5th Year**

Nuts & Volts is published MONTHLY and features:  
**NEW STATE-OF-THE-ART PRODUCTS •  
SURPLUS EQUIPMENT • USED BARGAINS  
• LOW COST AD RATES • PRIVATE AND  
COMMERCIAL CLASSIFIEDS • NATIONAL  
CIRCULATION • NEW PRODUCT NEWS  
SECTION • AND A FREE CLASSIFIED AD  
WITH YOUR SUBSCRIPTION**

**SUBSCRIPTION RATES**

- One Year - 3rd Class Mail ..... \$10.00
- One Year - 1st Class Mail ..... \$15.00
- One Year - Canada & Mexico (in U.S. Funds) .. \$18.00
- Lifetime - 3rd Class Mail (U.S. Only) ..... \$35.00

**ORDER NOW!**

SEND:     CHECK     MONEY ORDER  
           VISA         MASTERCARD

TO:        **NUTS & VOLTS MAGAZINE**  
            **P.O. BOX 1111-H**  
            **PLACENTIA, CALIFORNIA 92670**  
            **(714) 632-7721**

Name \_\_\_\_\_  
Address \_\_\_\_\_  
City \_\_\_\_\_  
State \_\_\_\_\_ Zip \_\_\_\_\_  
Card No. \_\_\_\_\_  
Exp. Date \_\_\_\_\_

**IF YOU'RE INTO ELECTRONICS,  
THIS MAGAZINE WILL SAVE YOU MONEY!**

Dealer Inquiries Invited  169

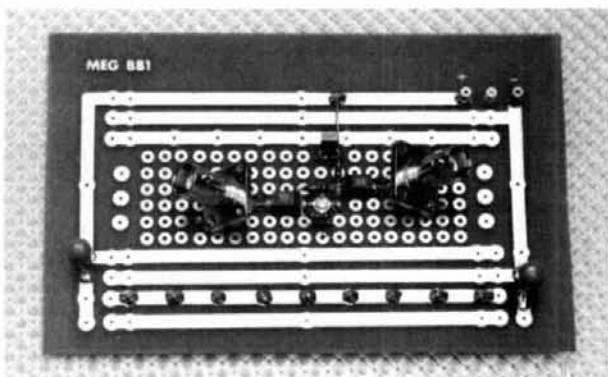

fig. 4. RF amplifier example

table). Adding four small rubber feet to the corners of the board eliminates this problem and gives the breadboard a pleasing appearance and better stability. Either self-adhesive feet or standard screw-mounted feet can be used. Small pads are included at the corners of the breadboard as markers for drilling foot mounting holes. Even standoff spacers can be used with rubber feet to provide space under the board if needed. For example, you could mount the bypass capacitor and power entry terminals under the board to provide more working space on the top side. You could even stack several breadboards together with spacers to form a multicircuit system.

Several extra pads and a bus are included on the artwork. Sufficient space is allowed around the edges of the board to allow for mounting of potentiometers, variable capacitors, connectors, and similar items.

There's nothing magic about the breadboard design, but I find this one quite useful for many analog circuits. Figure 3, for example, shows a crystal oscillator operating on TV channel 4 in a television interface application. Figure 4 shows an amplifier that has a bandwidth of 100 Hz to 1.2 GHz and 15 dB gain; this amplifier was assembled to demonstrate that the breadboard can be used to L-band. From these figures, it can be seen that although these are only breadboards, they make an attractive finished design. Carefully completed and nicely packaged, a relatively handsome finished product can result.

Don't be afraid to experiment with the basic design to find the best configuration for you. The variety is limitless and the configurations shown here are just two possibilities. Remember, for analog breadboards the most important features are low stray capacitance and inductance and good grounding and bypassing of the supplies at the board. Other features such as pad arrangement and size, number of nodes, bus structure, and space for peripheral elements are very much a matter of the specific requirements of the circuit and your personal preference. The basic design presented here should prove to be a good basis for other configurations as well.

**ham radio**

# THE MOST AFFORDABLE REPEATER

ALSO HAS THE MOST IMPRESSIVE PERFORMANCE FEATURES

(AND GIVES THEM TO YOU AS STANDARD EQUIPMENT!)

BAND	KIT	WIRED
6M, 2M, 220 440	\$630 \$730	\$880 \$980

(Also available for commercial bands)

## FEATURES:

- SENSITIVITY SECOND TO NONE; 0.15 uV (VHF), 0.2 uV (UHF) TYP.
- SELECTIVITY THAT CAN'T BE BEAT! BOTH 8 POLE XTAL FILTER & CERAMIC FILTER FOR > 100 dB AT ± 12KHZ. HELICAL RESONATOR FRONT ENDS TO FIGHT DESENSE & INTERMOD.
- OTHER GREAT RECEIVER FEATURES: FLUTTER-PROOF SQUELCH, AFC TO COMPENSATE FOR OFF-FREQ TRANSMITTERS, SEPARATE LOCAL SPEAKER AMPLIFIER & CONTROL.
- CLEAN, EASY TUNE TRANSMITTER; UP TO 20 WATTS OUT (UP TO 50W WITH OPTIONAL PA).



## HIGH QUALITY XMTR & RCVR MODULES FOR REPEATERS, LINKS, TELEMTRY, ETC.

- **R144/R220 FM RCVRs** for 2M or 220 MHz. 0.15uV sens.; 8 pole xtal filter & ceramic filter in i-f, helical resonator front end for exceptional selectivity, > 100dB at ± 12kHz, best available today. Flutter-proof squelch. AFC tracks drifting xmtrs. Xtal oven avail. Kit only \$138.
- **R451 FM RCVR** Same but for uhf. Tuned line front end, 0.3 uV sens. Kit only \$138.
- **R76 FM RCVR** for 10M, 6M, 2M, or 220. As above, but w/o AFC or hel. res. Kits only \$118. Also avail w/4 pole filter, only \$98/kit.
- **R110 VHF AM RECEIVER** kit for VHF aircraft or ham bands or Space Shuttle. Only \$98.
- **TA51 VHF FM EXCITER** for 10M, 6M, 2M, or 220 MHz. 2 Watts continuous, up to 3W intermittent. Kit only \$68
- **TA451 UHF FM EXCITER** 2W cont., up to 3W intermittent. Kits only \$68. Xtal oven avail.
- **VHF & UHF LINEAR AMPLIFIERS.** For either FM or SSB. Power levels from 10 to 45 Watts to go with exciters & xmtg converters. Several models. Kits from \$78.

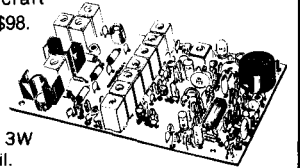
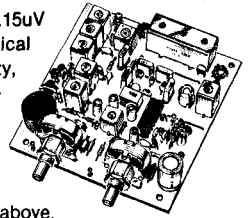

**NOW—FCC TYPE ACCEPTED TRANSMITTERS, RECEIVERS, AND REPEATERS AVAILABLE FOR HIGH-BAND AND UHF. CALL FOR DETAILS.**

## RECEIVING CONVERTERS

Models to cover every practical rf & if range to listen to SSB, FM, ATV, etc. NF = 2dB or less.



Antenna Input Range	Receiver Output
28-32	144-148
50-52	28-30
50-54	144-148
144-146	28-30
145-147	28-30
144-144.4	27-27.4
146-148	28-30
220-222	28-30
220-224	144-148
222-226	144-148
220-224	50-54
222-224	28-30
902-928	422-448

### VHF MODELS

Kit with Case	\$49
Less Case	\$39
Wired	\$69

### UHF MODELS

Kit with Case	\$59	432-434	28-30
Less Case	\$49	435-437	28-30
Wired	\$75	432-436	144-148
		439.25	50-54
			61.25

**SCANNER CONVERTERS** Copy 806 MHz band on any scanner. Wired/tested ONLY \$88.

## TRANSMIT CONVERTERS

For SSB, CW, ATV, FM, etc. Why pay big bucks for a multi mode rig for each band? Can be linked with receive converters for transceive. 2 Watts output vhf, 1 Watt uhf.

**For VHF, Model XV2**  
Kit \$79  
Wired \$149  
(Specify band)

Exciter Input Range	Antenna Output
28-30	144-146
28-29	145-146
28-30	50-52
27-27.4	144-144.4
28-30	220-222*
50-54	220-224
144-146	50-52
144-146	28-30

**For UHF, Model XV4**  
Kit \$79  
Wired \$139

\*Add \$20 for 2M input

**VHF & UHF LINEAR AMPLIFIERS.** Use with above. Power levels from 10 to 45 Watts. Several models, kits from \$78.

## LOW-NOISE PREAMPS

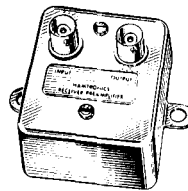

**Hamtronics Breaks the Price Barrier!**

**No Need to Pay \$80 to \$125 for a GaAs FET Preamp.**

### FEATURES:

- Very Low Noise: 0.7dB VHF, 0.8dB UHF
- High Gain: 13 to 20dB, Depending on Freq.
- Wide Dynamic Range for Overload Resistance
- Latest Dual-gate GaAsFET, Very Stable

MODEL	TUNES RANGE	PRICE
LNG-28	26-30 MHz	\$49
LNG-50	46-56 MHz	\$49
LNG-144	137-150 MHz	\$49
LNG-160	150-172 MHz	\$49
LNG-220	210-230 MHz	\$49
LNG-432	400-470 MHz	\$49
LNG-800	800-960 MHz	\$49

## HELICAL RESONATOR PREAMPS

Low-noise preamps with helical resonators reduce intermod and cross-band interference in critical applications. 12 dB gain.

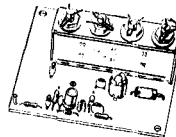

MODEL	TUNING RANGE	PRICE
HRA-144	143-150 MHz	\$49
HRA-(*)	150-174 MHz	\$49
HRA-220	213-233 MHz	\$49
HRA-432	420-450 MHz	\$64
HRA-(*)	450-470 MHz	\$64

\*Specify Center frequency desired

## MINIATURE PREAMPS

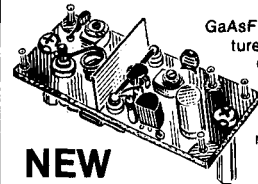

GaAsFET Preamps with features similar to LNG, except designed for LOW COST and SMALL SIZE: only 5/8" W x 1-5/8" x 3/4". Easily mounts inside many radios.

**NEW**

**Model LNW-(\*) . . . . . Only \$19/kit, \$34wired**

Models available to tune the following bands: 25-35, 35-55, 55-90, 90-120, 120-150, 150-200, 200-270, and 400-500 MHz.

\*Specify band

## IN-LINE PREAMPS

**NEW**

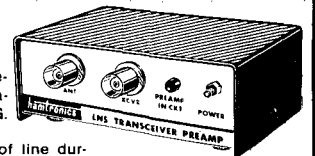

GaAsFET Preamp with features like LNG. Automatically switches out of line during transmit. Use with base or mobile transceivers up to 25W. Tower mtg hdwr incl.

MODEL	TUNES RANGE	KIT	WIRED
LNS-144	120-175 MHz	\$59	\$79
LNS-220	200-240 MHz	\$59	\$79
LNS-432	400-500 MHz	\$59	\$79

## ACCESSORIES

- **MO-202 FSK DATA MODULATOR.** Run up to 1200 baud digital or packet radio signals through any FM transmitter.
- **DE-202 FSK DATA DEMODULATOR**
- **COR-2 KIT** With audio mixer, local speaker amplifier, tail & time-out timers.
- **COR-3 KIT** with "courtesy" beep".
- **DTMF DECODER/CONTROLLER KITS**
- **AUTOPATCH KITS.** Provide repeater autopatch, reverse patch, phone line remote control of repeater, secondary control.
- **CWID KITS** • **SIMPLEX AUTOPATCH**

- **Send \$1 for Complete Catalog**  
(Send \$2.00 or 4 IRC's for overseas mailing)
- **Order by phone or mail • Add \$3 S & H per order**  
(Electronic answering service evenings & weekends)
- **Use VISA, MASTERCARD, Check, or UPS COD.**

# hamtronics, inc.

65-E MOUL ROAD • HILTON NY 14468

Phone: 716-392-9430

Hamtronics® is a registered trademark

## SPECIALIZED COMMUNICATIONS FOR TODAY'S RADIO AMATEUR!



If you are ACTIVE in FSTV  
SSTV, FAX, OSCAR,  
RTTY, EME, LASERS  
or COMPUTERS, you need

“THE SPEC-COM JOURNAL™”

Published 10 Times  
Per Year  
By WBØQCD

**CALL TOLL-FREE 1-800-628-2828 ext. 541**

...and place your subscription order today! Our Membership Services HOTLINE is good for all 50 U.S. States including Hawaii & Alaska and ALL of CANADA! U.S. subscriptions \$20 per year. Foreign slightly higher. Back issues are also available for \$2.00 each prepaid.



**THE SPEC-COM JOURNAL**  
P.O. BOX H,  
LOWDEN, IOWA 52255



Credit Card Orders (5% added)

Iowa Residents Add 4% State Sales Tax

### ATV

This converter covers all the 420 - 445 MHz ATV frequencies. This converter uses a crystal reference to lock onto the 439.25 MHz standard - or - a second channel at 421.25 or 426.25 or 436.25 MHz. This converter also supports a manual tuning mode for non-standard frequencies. The IF output can be ordered for channel 2 or 3. This ATV module is small and only requires +12VDC. A small 12V transformer is supplied with this assembled and tested converter. This converter uses a GaAs FET RF amp with a highly selective band-pass filter that will cut out strong UHF, TV and other strong out-of-band RF.

Typical rejection @ 500 MHz = -50 db, @220 MHz = -65 db, and @144 MHz = -70 db or greater. The pass-band is 420-445 MHz. Voltage regulation is very stable under varying DC input. Conversion gain is approximately 20 db with input and output surge protection. Input is via type "n" connector. Output is via a type "F" connector. Size is 5 1/2" x 5.5" x 1.5".

\$96.50

QUANTITY PRICING AVAILABLE FOR GROUP PURCHASES.

TECHNICAL DEVELOPMENT SYSTEMS  
3608 CHARLES STREET  
FORT WORTH, TEXAS 76118  
(817) 284-4290 ✓ 170

**TERMS: money order, certified check, UPS cash COD. Allow 2 weeks for personal or company checks to clear. Add \$4.50 for shipping & handling. Texas add 5.125% state sales tax.**

**33 cm. • 23 cm. • 13 cm.**

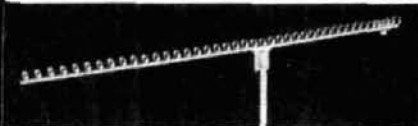

**LOOP YAGIS AND AMPLIFIERS FROM  
DOWN EAST MICROWAVE**

• TROPO		• OSCAR MODE L & MODE S		• WEAK SIGNAL	
• EME	• 902	• 1269	• 1296	• 2304	• 2400 MHz
2345LY	45 el loop Yagi	1296 MHz	20 + dBi	\$85	
2445LY	45 el loop Yagi	1269 MHz	20 + dBi	\$85	
1345LY	45 el loop Yagi	2304 MHz	20 + dBi	\$75	
3333LY	33 el loop Yagi	902 MHz	18.5 dBi	\$85	

above antennas are assembled and tested.  
All aluminum and stainless construction. Kits also available. Add \$8 (\$11 west of Rockies) per antenna for UPS shipping.

2 & 4 way power dividers, complete arrays available  
2316 PA Linear Amp 1w in 18w out 1296 MHz 13.5 V \$230  
2335 PA Linear Amp 10w in 36w out 1296 MHz 13.5 V \$280  
include \$5 for UPS Blue - 48 states

Write about Higher Power, 2304 linears, GaAs Fet preamps  
Free catalog

**DOWN EAST MICROWAVE**

Bill Olson, W3HOT  
Box 1655A, RFD 1, Burnham, ME 04922  
(207) 948-3741 ✓ 171

## BRAND NEW JUST RELEASED

THE RADIO AMATEUR'S  
**MICROWAVE  
COMMUNICATIONS  
HANDBOOK**

DAVE INGRAM, K4TWJ



**The Radio Amateur's  
MICROWAVE  
COMMUNICATIONS  
Handbook**

by Dave Ingram, K4TWJ

Explore the world of  
**Microwave communication!**

One of Amateur Radio's last frontiers is the microwave region. This book is the first available to give this ever expanding area of Amateur communications unique treatment. Areas covered include: communications equipment for 1.2, 2.3 and 10 GHz, networking and data packeting concepts with special attention to 24 GHz systems, design parameters, rf and environmental considerations and system design suggestions for future growth and modification, projects and much more. You also get information on TVRO and MDS systems with suggestions and ideas on how to build your own. © 1985 184 pages 1st Edition.

☐ T-1594 Softbound \$12.95

Please add \$3.50 for shipping and handling

**Ham Radio's Bookstore**  
Greenville, NH 03048



**PRC®**

SERVICE CENTER  
for  
**ICOM, KENWOOD**  
and **YAESU**

Fully equipped repair shop Amateur,  
Marine and Land Mobile repairs.

FCC NABER Lic  
Mon-Fri 10:00-4:00 pm  
**(206) 776-8993**

**PACIFIC RIM  
COMMUNICATIONS**

Bob KG7D  
23332 58th Ave. West  
Mountlake Terrace, Wa 98043



& C.O.D.S. Welcome ✓ 172



## selecting and using the right multimeter

Sooner or later almost everyone with more than a minimal interest in electronics begins to look at the various multimeters now on the market. These instruments are more than an aid in troubleshooting — they can be your right arm! A multimeter is a combination instrument that offers the benefits of several meters in one: a DC voltmeter, DC milliammeter, AC voltmeter, and an ohmmeter (plus other functions on certain premium-priced instruments). This month we're going to talk about the various instruments on the market, and what you should look for when selecting a particular one. Next month we'll examine some typical applications and problems.

## types of multimeters

Over the years several different forms of meters have been developed. There's also more than one way to classify meters. For example, we could classify them by their active elements: none, vacuum tubes, FETs, and so forth.

We could also classify them according to the display mechanism: analog or digital? Analog meters use a regular pointer-type meter movement based on either the D'Arsonval or Taut-Band designs (there are others, but they're found only rarely, if ever, in multimeters). Their scales are printed on the panel behind the movable pointer. The digital meter, on the other hand, uses digital techniques to make the measurement and displays the result on digital numerical readouts (either LED or LCD).

## world's oldest multimeter

Figure 1 shows a modern example of perhaps the oldest form of multimeter: the Volt-Ohm-Milliammeter, or "VOM." Based on an analog meter movement, this meter has switch-selectable ranges for DC volts, AC volts, DC milliamperes and resistance (ohms). Classical VOMs don't contain any active devices and don't require any power at all except for a single battery for measuring resistance.

Sensitivity is a determining factor in the purchase of such an instrument. The "sensitivity figure," a measure of the voltmeter's input impedance, tells us how much load the meter places on the circuit being tested. In the case of fig. 1, the sensitivity is 20,000 ohms/volt. If we multiply the full-scale voltage on any given range by the sensitivity, we find the input impedance. For example, when the 50-volt scale is selected, the input impedance is (50 V x 20,000 ohms/V), or 1,000,000 ohms.

The disadvantage of the VOM is that it sometimes loads circuits too much for practical use. In vacuum tube circuits, the meter works fine most of the time; in solid-state circuits, however, there are often problems. For example, when measuring the base voltage of an NPN common-emitter transistor amplifier (if operated from a single positive power supply), we expect to find a base-to-emitter voltage of 0.2 to 0.3 for germanium and 0.6 to 0.7 for silicon transistors. So, using the 1.5 volt DC scale, we find that the meter input impedance is (1.5 V x 20,000 ohms/V), or 30,000 ohms. Unfortunately, this resistance is on the same order of magnitude as bias resistances in transistor circuits, so the application



fig. 1. The oldest form of multimeters — the VOM.

of the meter probes changes the bias conditions — and renders the measurement invalid.

The advantage of the VOM is that it is truly a minimum-hassle instrument to keep, store, and use. It's also very portable. These factors make the VOM popular with people who work for long periods in remote areas without easy access to fresh batteries.

Finally, people who work around high-power RF amplifiers might want to keep one of these instruments in their tool kits even if they normally use a modern digital instrument. The classical VOM, without any active devices to be misbiased by strong RF fields, will work in the presence of transmitters, where other, more expensive instruments might fail.



## PACKET RADIO for the Apple Macintosh™



- Enhances your TNC so you can enjoy Packet Radio!
- Split screen display to separate send and receive data.
- Full Macintosh User Interface.
- TNC Commands and Parameters on pull down menus.
- Routing file for digipeater routes.
- File transfer using Session Layer protocol.
- Command procedure files.
- Free upgrades for one year after purchase.
- Packages and supported TNCs.

MacPacket/TAPRterm.....\$69.95  
TAPR TNC-2 AEA PK-80 GLB TNC-2A  
MEI Electronics MEI-1270 Pac Comm TNC-200

MacPacket/TAPRterm.....\$69.95  
TAPR TNC-1 AEA PKT-1 Heath HD-4040

MacPacket/KANterm.....\$69.95  
Kantronics Packet Communicator (KPC-1 V2.0 & KPC-2)

available from dealers or from:

Brincomm Technology  
3155 Resin Street  
Marietta, GA 30066

✓ 173

Georgia residents add appropriate state sales tax.  
Macintosh is a trademark licensed to Apple Computer, Inc.

### "HAM HOTLINE"

#### THE PROVEN MONEYMAKER

The "Ham Hotline" is a complete mailing list of novice amateur radio operators and current hams who have renewed, upgraded or modified their FCC licenses. These ham enthusiasts have proven to be excellent prospects for radio equipment, accessories and publications.

The Hotline is **UPDATED EVERY TWO WEEKS** with an average of 8,000 names and addresses each month. And, because we know the Hotline is the most up-to-date amateur radio listing available, we'll guarantee 98% deliverability.

Target your sales efforts to your most likely buyers. Call DCC Data Service today and begin your subscription to the "Ham Hotline" . . . the proven moneymaker.

DCC Data Service ✓ 174

1990 M Street, N.W. Suite 610  
Washington, D.C. 20036

Toll-free 1-800-431-2577

In DC & AK 202-452-1419

### MICROWAVE EQUIPMENT

For easy test and adjustment of 2.3 GHz microwave amplifiers.

Gain vs frequency display for RMBLA-2.3

2.3 GHz amplifier with 2.3 GHz center frequency. 100 MHz/cm horizontal and 5 MV/cm vertical sensitivity.

An RMSWG-2.1-3.0 Sweep Generator - \$144.00.  
RMUDD-12 Detector - \$24.00. RMLS-2 Line Stretcher/dc return - \$19.00. 20 & 30 ft. RG-58 cables (attenuators) and an oscilloscope with 5 MV/cm vertical sensitivity were used in this test.

2.3 GHz Bipolar Amplifier (RMBLA 2.3) +12 VDC. Greater than 14 dB gain at 2.3 GHz - \$45.00. 2.3 GHz GasFet Amplifier (RMGLA - 2.3) ± 5 VDC. Greater than 15 dB gain at 2.3 GHz - \$70.00. 2.3-2.45 GHz Signal Generator (RMSG-5) 8-30 VDC - \$55.00.

Prices include postage/handling if order includes check or M.O. FOB Brookfield, MO for C.O.D. or charge orders

#### ROENSCH MICROWAVE

R.R. 1, Box 156B, PH: 816-895-5431  
BROOKFIELD, MISSOURI 64628

✓ 175



## FET multimeters

Figure 2 shows another form of multimeter, the field effect transistor (FET) multimeter (FETVM or FETMM). This type is representative of a larger class of electronic voltmeters, and is a member of the class that includes vacuum tube voltmeters (VTVMs) and transistor voltmeters (TVMs). These devices are sometimes referred to collectively as electronic voltmeters, or EVMs. The names for these instruments are derived from the input circuit device: vacuum tube, transistor, or field effect transistor.

The purpose of the input amplifier device is to increase the input impedance, thereby reducing circuit loading. For example, a typical specification for the VTVM was an input-Z of 10 megohms, with an additional 1 megohm in the probe, for a total of 11 megohms. There is usually also 50 pF of capacitance shunting the input resistance. Modern FETVM and other EVM types sometimes sport input impedances even higher than 11 megohms — I can recall seeing 100 megohms advertised.

Like the VOM, the FETVM is a multi-range meter that uses a front panel switch to select range, although in this case the functions (DC volts, AC volts, ohms, etc.) are selected by pushbutton switches. Unlike the VOM, the FETVM (and all EVMs) require DC power supplies for their active devices. In most cases, the DC power supply is a battery, although some 115 VAC line operated models are available. Unlike the classical VOM, EVM instruments are somewhat sensitive to RF fields, so many of them will not work well around high power transmitters and other RF generators such as electrosurgery machines, diathermy, or inductive heating devices, for example.

Both the FETVM and VOM have an AC volts scale. Even where there's a low range scale for the AC mode, the AC voltmeter in these instruments is not a substitute for the AC voltmeter called for in the measurement, alignment, and troubleshooting of audio circuits and devices. The AC scales in



fig. 2. High input impedance is — provided by the FET multimeter.

these multimeter instruments are generally accurate only at power line frequencies. Beyond an upper limit of 400 Hz or so, the accuracy of these instruments falls off rapidly as frequency increases.

Examples of some representative digital multimeters are shown in **figs. 3 and 4**. These instruments use an internal analog-to-digital converter to convert the input voltage to seven-segment digital display output. Like the EVM and VOM, the digital multimeter (DMM) offers DC volts, AC volts, milliamperes, and ohms ranges.

### what's a "half-digit"?

You'll see DMMs advertised as "2-1/2 digit," "3-1/2 digit," or "4-1/2 digit." Care to guess what a "half-digit" is? Because the most significant digit (the one all the way to the left) can be just 0 or 1, it's billed as a half-digit. Consider, for example, the 3-1/2 digit instruments. The basic range of these instruments is 0 to 999 units, with 100 percent overrange, for a total of 0 to 1999 units. The number of digits is a rough measure of precision, although a load of digits doesn't necessarily guarantee a quality meter. Generally, most Amateur and hobby applications require no more than 3-1/2 digits. There are cases in which 2-1/2 digits isn't enough, yet the 4-1/2

digit instrument may be more expensive than warranted by the application. Emotionally, I prefer to have as many digits as possible, but when it comes to laying out my bucks I prefer to pay due regard to the realities of measurement making — and economics. Dollar for dollar, quality for quality, there is an optimum instrument for each application.

*But don't more digits mean more accuracy?* And isn't it true that DMMs are in fact inherently more accurate than VOM and other EVM instruments? No! In both cases, the statement is false. The accuracy of the meter depends less on the number of digits in the display than on the quality of the internal workings of the instrument. For example, the accuracy of the internal A/D converter and its voltage reference have considerable effect on accuracy. In general, ethical manufacturers don't display more digits than they can support, but the size of the display cannot be taken at face value as an indicator of meter quality.

Now, regarding the really big heresy: "Whaddya mean my Digital Frammitzenfritzer DMM isn't necessarily more accurate than your crummy old VOM?" Please, before you boil me in oil, let me assure you that I *am* digitally oriented. I sit here writing this article on an Apple IIe personal computer while my IBM-PC sits on the other side of the room, chattering out Chapter 8 of my next TAB book. While it's true that DMMs have the potential for greater initial and long-term accuracy than VOMs, it depends on the implementation, the quality of internal circuits and other factors. There's also the fact that noisy signals tend to be heavily integrated (i.e. low-pass filtered) by the damping inertia of the analog meter pointer, but these same signals will fool many digital meters.

In regard to accuracy and resolution, I recommend buying from a reputable manufacturer and *reading the spec sheet BEFORE you plunk down the money*. Also, be wary of over-spec'ing the instrument. When you're in the market for a troubleshooting instru-

# ege, inc. DISCOUNTS FOR AMATEURS

**Orders & Quotes Toll Free: 800-336-4799**

(In Virginia: 800-572-4201)

Information & Service: (703) 643-1063

Service Department: (703) 494-8750

13646 Jefferson Davis Highway

Woodbridge, Virginia 22191

Store Hours: M-F 10 am-6 pm

W-F 10 am-8 pm

Sat: 10 am-4 pm

Order Hours: M-F 9 am-7 pm

Sat: 10 am-4 pm



## New IC-735

Compact HF Transceiver  
Call for introductory Price

## New IC-751A

HF XCVR/Gen. Coverage Receiver.

## VHF/UHF

2m, 27A, 27H, 271A, 271H  
290 MHz-37A  
440 MHz- 471A, 471H, 47A

## IC-92AT, 94AT

Small, light HTs for 2m or 440 MHz. 10 memories and scan functions.

## IC-9AT, 3AT, 4AT

Handheld for 2m, 920 MHz, 440 MHz.

## New IC-A2 in stock

Aircraft handheld

## Shortwave

Sony  
Panasonic  
Yaesu  
Kenwood  
Icom

## Scanners

Uniden/Bearcat  
Regency

## More Helpers

- Marine radios by Regency Polaris and Icom
- Commercial Land Mobile by Yaesu and others
- Telephones by AT&T, Cobra, Southwestern Bell, and Panasonic
- CBs by Uniden, Midland, Cobra
- Radar Detectors by Uniden and Whistler



Our Associate Store  
Davis & Jackson Road, P.O. Box 993  
Lacombe, Louisiana 70445  
Information & Service: (504) 889-5355

**Much More in stock!  
Send \$1 for our  
New 1986 Buyer's  
Guide—Catalog.**

## KENWOOD

### New TS-440

HF XCVR with built-in Antenna Tuner.  
Call for intro price



### TS-940

HF XCVR/Gen. Coverage Receiver.

### New TM-2530A/50A/70A

25/45/70-watt mobile 2m rigs.

### New 201B In Stock

2m Mobile, 45-watts

### Handhelds

TR-2600A, TR3600, TH21AT, 31AT,  
41AT. Call for quotes

## YAESU



### FT-757GX

HF XCVR/Gen. Coverage Receiver.

## More Radios

Encomm/Santec  
KDK  
Ten-Tec

**Ask for Package  
Quotes on  
Radios/Accessories  
& Antennas/Towers**

## Visit Our New New England Store

8 Stiles Road  
Salem, New Hampshire 03079  
New Hampshire Orders: (603) 898-3750  
Information & Service: (603) 898-3750  
New England Orders: 800-937-0047  
Store Hours: Monday—Closed  
Tues-Sat: 10 am-4 pm  
TH: 12 noon-8 pm  
Sun: 12 noon-5 pm

\*Order and we'll credit you with \$1 for the call  
\*\*Closed some Sundays for Hanukkah. Call first.

Terms: No personal checks accepted. Prices do not include shipping. UPS COD fee: \$2.35 per package. Prices subject to change without notice or obligation. Products are not sold for evaluation. Authorized returns are subject to a 15% restocking and handling fee and credit will be issued for use on your next purchase. EGE supports the manufacturer's warranty. To get a copy of a warranty prior to purchase, call customer service at 703-643-1063 and it will be furnished at no cost.

## Antennas

HF, VHF, SWL, scanner, marine, & commercial for Mobile or Base.

Cushcraft  
Mini-Products  
B&W  
Van Gorden  
KLM  
AEA  
Butternut  
Mosley  
Hustler  
Telex Hy-Gain  
Larsen

## Towers

Unarco-Rohn, Hy-Gain, Tri-Ech  
Ask for special quotes on package deals including cable, guys, connectors, turnbuckles, etc.

## Accessories

Kenpro  
Alliance  
B&W  
Telex Hy-Gain  
Daiwa  
MFJ  
Bencher  
Amphenol  
Astron  
B+K Precision  
Welz

## Amplifiers

Vocom  
Diawa  
Ameritron  
Amp Supply  
TE Systems  
Tokyo Hy-Power

## Computer Stuff

Packet Radio  
Hardware and Software  
for RTTY/Morse  
Hal  
Kantronics  
AEA  
Microlog  
MFJ  
Ham Data Amateur Software.

✓ 176

**BRAND NEW  
JUST RELEASED**



ham  
radio magazine

**BOOKSTORE**

## ARRL 1986-87 Repeater Directory

- Fits in your shirt pocket 3-1/4" x 5-1/4"
- Over 10,000 listings from 28 MHz to 10 GHz
- Latest info on all repeaters

Also includes CTCSS (PL) tone chart, VHF/UHF and Repeater Advisory committee addresses, special mode repeaters (packet and ATV,) band plans, repeater operating practices, ARRL Frequency Coordinators, and Special Service Clubs.

☐ AR-RD86

Softbound \$3.00

Please add \$2.00 for shipping and handling

Greenville, NH 03048

(603) 878-1441



ment, don't let that gleam in your eye as you view the high-priced super-accurate laboratory models reach down as far as your wallet. Instruments such as those shown in **fig. 4** are very much in evidence in any electronic parts store you visit. Various low-priced models that not only make the classical measurements of the VOM, but do certain other things as well, are available. For example, I recently bought a handheld DMM that measures capacitance. The capacitance measurement scales run from 2000 pF full-scale (with 1 pF resolution) to 2000  $\mu$ F full-scale. In addition, that model is ruggedized enough to withstand my clumsy work habits . . . no small attribute for *any* practical instrument!

Other features to look for on DMMs are the "Diode" or "High Power" mode and a continuity tester with an aural indicator. The Diode mode is used to test PN junction diodes and bipolar transistors (NPN and PNP). The normal ohmmeter mode in DMMs uses a very low voltage, too low to forward-bias PN junctions. The Diode mode (usually indicated by a diode symbol on the function switch) is a resistance mode, but with a source voltage that's high enough to forward-bias PN junctions. The DMM can be used to measure resistances in-circuit while in the low-power mode, and then test the semiconductors out of circuit in the Diode mode.

The aural continuity tester is basically a resistance scale that goes "beep" when the meter sees a low resistance across the probes. Why is this feature important? Try ringing out a multi-conductor cable while managing the probes in your fingers. Or worse yet, try ringing out an intercom cable while standing on a ladder — or a transmission line while you're hanging off a tower. However clever you may be, you simply can't watch the meter scale and manage the probes — or your own safety — at the same time. The "beep" of the meter tells you when the connection is made, and its absence warns you of an open circuit.



fig. 3. Bench-type digital multimeter.



fig. 4. Handheld digital multimeter.

### which one to buy?

"OK, Carr, so you're a Certified Bright Guy (CBG) writing for a hot-shot national ham radio magazine — what kind of multimeter did *you* buy?" Believe me, I wish it were that easy! What *you* should buy depends on what kind of work you do, and to some extent, on what you can afford. Fortunately, the cost of a good quality troubleshooting-grade DMM instrument is way down from what it was a couple of years ago. Almost everyone can afford to buy one of those instruments.

Let me describe what I own and what type of work I use them for. The work consists of troubleshooting electronic equipment occasionally and developing small projects for Amateur Radio and electronic hobbyist magazine articles.

Because I have a ham radio set with a 2 kW linear amplifier, it's possible that the meter will have to work in high RF environments. As a result, I own a classical VOM that's almost older than I am. The old VOM has a 25 kV probe as an accessory, although I loaned it out and can't remember who borrowed it. I also own a handheld Beckman DM-25 that measures capacitance in addition to the other "normal" parameters. This last feature turns out to be of immeasurable value in developing projects for publication.

If I were doing any extensive audio work, then I'd probably also buy an AC voltmeter of audio grade. I suspect that most electronic workbench-oriented readers will opt for a small collection of meters that nearly matches my own . . . .

**ham radio**

**MULTI-BAND SLOPERS**  
 ALSO: DIPOLES & LIMITED-SPACE ANTENNAS  
 Outstanding performance of W9JNN antennas is well known — Now for multi-band BIG-SIGNAL reports! Automatic bandswitching — Very low SWR — Coax feed — 3kw power — Compact — FULLY ASSEMBLED to your specified center frequency each band — Easy to install — Very low profile — Complete instructions — Your personal check accepted

4 BAND SLOPER - 160, 80, 40, 30, or 20M	60 ft long	\$ 48 ppd
3 .. .. . 160, 80, 40M	60 ft ..	\$ 43 ..
2 .. .. . 80, 40M	40 ft ..	\$ 35 ..
3 .. NO-TRAP DIPOLE - 160, 80, 40M	113ft long	\$ 71 ..
2 .. .. . 80, 40M	85ft ..	\$ 55 ..
9 BAND SPACE SAVER DIPOLE - 160 thru 10M*	46ft long	\$ 85 ppd

\* Requires wide range tuner (60, 40, 20, 15M without tuner).  
 SEND BASE for complete details of these and other unique antennas  
 W9JNN ANTENNAS 312-394-3414  
 BOX 393-H MT. PROSPECT, IL 60056

✓ 177

**WORLD-TECH PRODUCTS**

**SALE PRICE \$34.95**  
 List Price \$44.<sup>95</sup>

Model M3111A (S)

**KNOW THE TIME ANYWHERE - EVERYWHERE - INSTANTLY**

- 12/24 Hour Time Piece
- Dual Dial World Time Clock
- Easy to read local time in cities around the world
- Gold or silver time piece handsomely displayed in a smoked acrylic or clear stand
- Daylight/Nighttime shown on 24-hr dial.
- Accuracy assured to  $\pm 15$  seconds per month with quartz movement.
- Time piece diameter 6 7/8", height 9", width 8". Uses 1 "AA" battery, not included.

ORDER YOUR CLOCKS TODAY  
**CALL (813) 442-5862**  
 Florida residents add 5%. Please add \$2.50 for shipping  
 or write: 1233 Kapp Dr., Clearwater, FL 33575

✓ 139



# the HAM STATION

P.O. Box 4405  
220 N. Fulton Ave.  
Evansville, IN 47710

Stores Hours  
MON-FRI 9AM-6PM  
SAT 9AM-3PM

WARRANTY SERVICE CENTER FOR:  
ICOM, YAESU, TEN-TEC

### TERMS:

Prices Do Not Include Shipping.  
Price and Availability Subject to  
Change Without Notice  
UPS COD \$2.50 Per Package

### USED EQUIPMENT

AEA	
MBA RO Reader	\$ 129.95
MM-2 Morse Matic	149.95
CP-1 Interface	139.95
<b>COLLINS</b>	
75S-3 Rcvr/CW	\$ 209.95
32S-3 Xmtr/516F-2 P.S.	399.95
<b>DENTRON</b>	
Clipperton L-Amp	\$ 475.00
MLA 2500B-Amp	575.00

<b>DRAKE</b>	
TR5/P.S./1.8 SSB Filt.	\$ 489.95
T4XC, R4C, AC4, MS4	519.95
TR4C, AC4	299.95
RV4C	84.95
R4C, MS4	219.95
TR6, AC4	374.95
UV-3 (2M & 440) TT Mic, P.S.-3	399.95

<b>ENCOMM</b>	
ST-142 2M H.T.	\$ 209.95
ST-144 2M H.T.	179.95
ST-144/PL Encoder	189.95
HT1200 2M H.T.	139.95
HL-120U 10/120W 440Mhz	319.95
HL-90U 10/90W 440Mhz	289.95
HL-160V 10/160W 2M	279.95
HL-82V 10/80W 2M	139.95
HL-32V 2/30W 2M	49.95
HC-2000 2KW Tuner	269.95
KDK FM-240/Voice 2Mtr.	279.95

<b>HAL</b>	
MPT-3100 (No Monitor)	CALL
CRI-200 Interface	189.95

<b>HEATHKIT</b>	
SB-200 Amp	\$ 329.95
HD-3030 Interface w/Options	179.95

<b>ICOM</b>	
745/FL52 Xcvr	\$ 654.95
745 Gen. Cov. Xcvr	619.95
740/PS	599.95
740 Xcvr	499.95
730 Pblt/CW	489.95
730 Xcvr	459.95
730/EX 202	464.95
PS-15 Power Supply	99.95
Phone Patch (720, 30)	89.95
2AT 2M H.T.	159.95
735 Xcvr	649.95
560 6M Xcvr	339.95
451A 430-440Mhz Xcvr.	449.95

<b>KANTRONICS</b>	
Interface II	\$ 169.95
Interface I	69.95
Field Day 2 Reader	109.95

<b>KENWOOD</b>	
TS-520 SE Xcvr	\$ 399.95

<b>KENWOOD</b>	
TS-520 D Xcvr	349.95
TS-520 Xcvr	349.95
T-599/R599 w/2 & 6M/Spkr	299.95
2600 2M H.T.	219.95
2400 2M H.T.	149.95
VFO-280	99.95
VFO-520	89.95
VFO-240 (830)	114.95
700A 2M All Mode W/Vox	275.00
R-300 Short Wave Rcvr.	149.95
TS 620S/CW	499.95

<b>MICRO LOG</b>	
Air 1 W/Amtor-C-64	\$ 159.95

<b>SWAN</b>	
1500ZA Amp Very Nice	\$ 375.00

<b>TEN-TEC</b>	
Titan Amp	\$1875.00
Triton IV	269.00
Century 21	199.95
263 VFO-Corsair	134.95
544 Triton (Digital)	329.00
262M Power Supply	89.00
VFO-Triton	124.95

<b>YAESU</b>	
FT-980/Keyer	\$1175.00
FT-980/Gen. Cov. Xmt.	1150.00
FT-980/Gen. Cov. Xmt/AM Filter	1189.00
FT 107M/DMS, FP-107E P.S.	569.00
FT902DM	699.00
FT101ZD, CW, Fan	549.95
FT101ZD	499.95
FT101ZD, Warc Bands	524.95
FT101ZD, Fan	524.95
FT101Z, CW, Fan	499.95
FV101Z Remote VFO	99.95
FT101E, Fan	429.95
FT101E, Fan, CW	449.95
FT101EE	399.95
FTV-250 2M Xvtr	149.95
FTV-650B 6M Xvtr	149.95
FT225RD 25W 2M All Mode	469.00
FT221R 2M All Mode	259.95
FT221/Pre-Amp	239.95
FT221 All Mode	229.95
FRG 7700/Mem. Gen. Cov. Rcvr.	349.95

<b>YAESU</b>	
FT208R 2M H.T.	169.95
FT708R 440 H.T.	179.95
FRG 9600 60-905 MHZ Rcvr	389.95

<b>MISC.</b>	
KLM PAIO-70B 2M	\$ 69.95
Robot 800CH	299.95

### CLOSE OUT

<b>AEA</b>	
Amt-1 Interface	\$ 229.95
KI-3 Keyer-Trainer	89.95
MP-20 Interface/MBA-Text	119.95
MP-64 Interface/MBA-Text	119.95
MAP-64 Interface/MBA-TOR	169.95

<b>DENTRON</b>	
QRO 2KW Amp	\$ 650.00

<b>ENCOMM</b>	
ST-440 440MHZ H.T.	\$ 254.95
ST-222 220MHZ H.T.	254.95
KDK7033 440MHZ 10-W	279.95

<b>KANTRONICS</b>	
Hamtext Vic 20	49.95
Hamtext C-64	49.95

### DEMONSTRATORS

HAL CRI-200 Interface	\$ 194.95
HAL CRI-100 Interface	169.95
VOCOMM 25/100W 2 Mtr Amp	104.95
YAESU 2700 RH w/Voice	479.95

30 Day Warranty on Used Equip. except items on Consignment (C)

Send SASE for our new & used equipment list.

AMEX. MC. VISA & C.O.D.'s WELCOME

For Orders and Price Checks Call 800-523-7731

Indiana call 1-812-422-0231  
Service Dept. 1-812-422-0252

# THEY'RE ALL NEW FOR 1986!

Significant changes for 1986 mandate that all hams get both the North American and International Callbooks. **DX'ers and Contester's note** — Having both books is the only way you'll have all Foreign Amateur listings.

## NORTH AMERICAN CALLBOOK

The old US Callbook has been expanded and now contains the listings of all hams in North America plus Hawaii and US Possessions. This improved operating aid has all the latest calls and QTH information available at press time and will be an invaluable reference guide. With calls from Panama to Greenland, every ham should have a copy of this new book in their shack.

©1985.

CB-US86 Softbound \$21.95

## INTERNATIONAL CALLBOOK

The Foreign Callbook is no more! In its place, the new International Callbook includes all Amateurs outside of the North American continent. All the latest callsigns and QTH's are listed to help ensure you get that prized QSL card. Universally recognized as the source of information. Order your's today. ©1985.

CB-F86 Softbound \$20.95

Order Both and SAVE.  
Reg. Price \$42.90

**SPECIAL PRICE**  
**SAVE \$2.95**

**\$39.95**

CB-USF

Please enclose \$3.50 to cover postage and handling.

AVAILABLE NOW



ham radio magazine **BOOKSTORE**

GREENVILLE, NH 03048



## Don't buy from Hamtronics . . .

Unless you want the best possible equipment  
at the lowest possible price!!

The "wheeler-dealer" is back and he's beating everyone else's "deals."

We all know there's no such thing as a free lunch . . .  
so How Can We Do This?

- **We don't** run alot of ads featuring sale items
- **We don't** spend alot of money on full page ads
- **We don't** have sales on just the fastest selling products
- **We don't** short cut you on service. We are a factory warranty repair facility for everything we sell!
- **We don't** mail out free catalogs
- **We don't** have a free WATS number.

You and every other Ham customer is paying for all these do-dads and sales gimicks.

**Hamtronics** puts the savings into your pocket.

**Hamtronics** guarantees to meet or beat any advertised price on every item we sell.

### Hamtronics Has It All!

Let **Hamtronics** be your Ham Radio equipment dealer. We're celebrating our 35th year in the Ham business at the same location.

# HAMTRONICS, INC.

A DIVISION OF TREVOSE ELECTRONICS  
4033 BROWNSVILLE RD., TREVOSE, PA 19047  
(215) 357-1400



178

**SAVE SAVE SAVE SAVE**

**1983-84 ARRL**

**AMATEUR RADIO CALL DIRECTORY**

**WAS \$15.75 NOW \$4.95 SAVE \$10.80**

Please add \$3.50 to cover shipping and handling



**Ham Radio's Bookstore**  
GREENVILLE, NH 03048



## 40m Phased Array —the Easy Way!

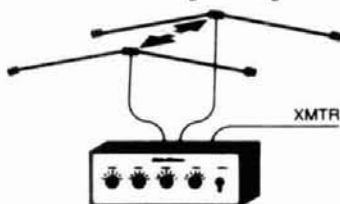

**OPTI-PHASOR™** by BaileyTech

- Change direction instantly
- High F/B, adjustable phasing
- Low SWR over entire 40m band
- Just 2 dipoles gives 4 db gain

**\$119.95** Also available with matched dipoles and feed lines.

Check, MO, VISA, M/C  
Call or Write for Complete Catalog.  
TET Antennas, Larsen, Hy-Gain,  
Alpha Delta, etc.

# SULTRONICS

1587 U.S. 68 N Xenia, OH 45385  
(513) 376-2700

179

### QEP'S COAX. SALE

BELDEN 9913 Low Loss Cable  
100 ft. & up - 38¢/ft.  
99 ft. & less - 39¢/ft.  
BELDEN 9258 RG-8X  
\$160 per 1000 ft. or 17¢/ft.

Amphenol connectors:

UG-21D	'N' Male cable end	3.00
UG-21D	'Fitted for Belden 9913'	4.50
UG-29A	'N' Barrel connector	4.75
UG-58A	'N' Female chassis mount	3.50
UG-146	'N' Plug to UHF jack	7.50
UG-83	'N' Jack to UHF plug	8.50
PL-259	UHF Male cable end silver	1.25
PL-258	UHF Barrel connector	2.00
UG-175	Reducer for RG-58 cable	.35
UG-176	Reducer for RG-59-MiniX	.35
UG-88	BNC Plug for RG-58	2.00
UG-260B	BCN Plug for RG-59	2.10
UG-260B	BNC Plug for MiniX-fitted	1.60

8 gauge hook-up wire 28¢/ft.

Perfect for power supplies. Red or Black only  
COMPLETE STOCK, SAME DAY SHIPPING

U.S. Geological Survey Maps

Complete N.J. index in stock plus

201-887-6424  
110-4 Route 10  
E. Hanover, N.J. 07936

**QEP's**

180

## TechMart

TEST EQUIPMENT SPECIALISTS

Bird Wattmeters

Fluke Multimeters

Hitachi Oscilloscopes

And other quality test instruments.

You'll be glad you  
called TechMart!



**TOLL FREE 800-554-8305**  
**GEORGIA 404-325-0759**

181



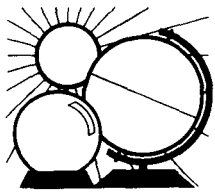

## DX FORECASTER

Garth Stonehocker, KØRYW

### sporadic E DX

In last month's column we discussed the characteristics (in terms of location and propagation) of Sporadic E, or E<sub>s</sub>. This month, let's take a look at how Sporadic E (E<sub>s</sub>) propagation can be used for DX operation.

Because E<sub>s</sub> propagation normally provides short-skip conditions — i.e., 1000 miles (1600 km) maximum hop length, with typically one or two hops at best, the range of communications is limited in this mode. The take-off angle must be low (5 to 10 degrees) in order to obtain the maximum distance per hop. Signal attenuation increases with more hops because of D-region absorption and lossy ground reflections. On the higher frequency bands where horizontal beam (Yagi) antennas are used, this means towers exceeding 60 feet — or even better, more than 100 feet. At the lower frequencies (below 10 MHz) vertical antennas on unobstructed, treeless sites, situated over moist earth and equipped with sufficiently large ground systems are needed to obtain 5- to 10-degree take-off angles. These are the antenna systems DXers dream about and a few build.

To obtain the highest probability of "reflecting" from an E<sub>s</sub> "cloud," a fairly wide beamwidth should be used. Because the beamwidth of Yagis (50 to 60 degrees) is greater than the beamwidth of rhombics (20 to 30 degrees), Yagis are preferred for "hitting the clouds." E<sub>s</sub> clouds usually measure about 6 by 60 miles (10 by 100 km) in length and about 1 mile (1.6 km) in thickness. They are oriented along the geomagnetic field line direction —

i.e., roughly north-south over the United States. Their thin, dense configuration results in mirror-like *reflections* rather than the hundreds of kilometer thickness *refractions* that are characteristic of the F-region of the ionosphere. Signal strengths are, on the average, 25 dB higher due to the reflective as compared to refractive mode.

Another rule of thumb for E<sub>s</sub> operation is to use the *lowest* frequency that still doesn't have excessive absorption. (For example, during daytime, don't use 10 meters if 20 is usable.) The probability of a good E<sub>s</sub> opening occurring is greater with the lower frequency band.

There are trade-offs involved, however, in choosing either the lower or higher bands. You may, for example, want to select a lower band where E<sub>s</sub> openings, though more probable, are limited by a higher take-off angle, more hops, and more loss. Or you might choose to go to a higher band for that occasional E<sub>s</sub> opening, taking advantage of smaller take-off angles, fewer hops, and diminished losses (since the antenna is proportionately higher, with respect to wavelength, than the lower band version). Of course, if you're a 6-meter DXer, there's no choice — you'll have to wait for the E<sub>s</sub> opening.

Early indications of E<sub>s</sub> openings on the higher-frequency bands can be obtained by monitoring beacons on 6 and 10 meters and on CB channel 19. You can also monitor locally unused TV channels 2 through 5 for 6-meter openings. You may want to try W3ASK's system described in the June, 1985 "DX Forecaster." The lower frequency bands don't need beacon monitoring because E<sub>s</sub> openings (sunrise and sunset hours) are available most of the time.

### last-minute forecast

DX conditions are expected to be best for the higher frequency bands (10 to 30 meters, which are daytime bands) from the 12th through the 21st of the month, providing long and short skip openings. Look for short skip con-

ditions the remainder of the month. The lower frequency bands (30 to 40 meters) should be best the first and the last weeks of the month, including daytime signals when the solar flux is below 70 units. The 80- and 160-meter bands will provide only fair DX conditions because of atmospheric noise build-up, except for some E<sub>s</sub> short skip openings toward the end of the month.

The Aquarid meteor shower starts around the 18th, peaks about the 28th, and lasts until approximately August 7th. The maximum radio-echo rate will be approximately 34 per hour. The full moon is on June 29th, lunar perigee on the 21st, and summer solstice on the 21st at 1630 UT.

### band-by-band summary

*Six meters* will provide occasional openings to South Africa and South America around local noontime via the E<sub>s</sub> short-skip propagated mode.

*Ten and fifteen meters* will have many short-skip openings, and long skip during high solar flux to most southern areas of the world during daylight hours. Some enhanced trans-equatorial openings associated with disturbed ionospheric-geomagnetic conditions may occur in the evening hours this month.

*Twenty, thirty, and forty meters* will be useful for DX operation from most areas of the world during the daytime and into the evening almost every day, either long-skip to 2500 miles (4000 km) per hop or short-skip E<sub>s</sub> to 1000 miles (1600 km) per hop. Since the period of daylight is now at its peak, high maximum usable frequencies will be practical for many hours of distance operation.

*Thirty, forty, eighty and one-sixty meters* will provide opportunity for nighttime DX operation. However, there will be many nights later this month when only 30 and 40 meters will be usable because of high thunderstorm QRN on 80 and 160. Nevertheless high signal levels, the result of short-skip E<sub>s</sub> conditions, may help to overcome the static toward the end of the month.

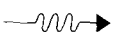

**WESTERN USA**

GMT	PDT	Directional Indicators							
		N	NE	E	SE	S	SW	W	NW
0000	5:00	20	20	20	12	20	10	10	15
0100	6:00	20	30	20	15	20	10	10	15
0200	7:00	15	30	20	15	20	10	10	15
0300	8:00	15	30	30	20	20	10	10	15
0400	9:00	15	30	30	20	30	10	10	15
0500	10:00	20	20	20	20	30	10	10	15
0600	11:00	20	20	15	20	30	10	12	15
0700	12:00	20	20	20	20	30	12	15	20
0800	1:00	20	20	20	20	40	15	20	20
0900	2:00	20	20	20	20	40	15	20	20
1000	3:00	30	20	20	30	40	20	20	20
1100	4:00	30	20	20	20	40	20	20	20
1200	5:00	30*	20	15	20	40	20	20	20
1300	6:00	20	20	12	20	40	20	20	20
1400	7:00	20	20*	12	15	40	20	30	20
1500	8:00	20	15	10	12	40	20	30	*30
1600	9:00	20	15	10	12	40	20	30	30
1700	10:00	20	15	10	12	30	20	30	30
1800	11:00	20	15	12	10	20	15	30	20
1900	12:00	30	15	15	10	20	12	20	20
2000	1:00	30	20	15	10	20	10	12	20
2100	2:00	20	20	20	10	20	10	10	20
2200	3:00	20	20	20	10	20	10	10	20
2300	4:00	20	20	20	10	20	10	10	20

**MID USA**

MDT	COT	Directional Indicators							
		N	NE	E	SE	S	SW	W	NW
6:00	7:00	20	20	20	12	20	10	10	15
7:00	8:00	20	20	20	15	20	10	10	15
8:00	9:00	20	20	20	15	20	10	10	15
9:00	10:00	20	30	30	20	30	10	10	20
10:00	11:00	15	30	30	20	30	10	10	20
11:00	12:00	20*	20	20	20	30	10	10	20
12:00	1:00	20	20	20	20	40	15	15	20
1:00	2:00	20	20	20	20	40	15	20	20
2:00	3:00	30	20	15	20	40	15	20	20
3:00	4:00	30	20	15	30*	40	20	20	30
4:00	5:00	30	20	15	20	40	20	20	30
5:00	6:00	20	20	15	20	40	20	20	30
6:00	7:00	20	20	12	20	40	20	20	20
7:00	8:00	20	20	12	15	40	20	30	20
8:00	9:00	20	20	10	12	40	20	30	20
9:00	10:00	20	20	10	12	40	20	30	20
10:00	11:00	20	15	10	12	40	20	30	20
11:00	12:00	20	15	10	10	30	20	30	20
12:00	1:00	20	15	12	10	20	15	30	20
1:00	2:00	30	15	15	10	20	12	15	20
2:00	3:00	30	20	15	10	20	10	12	20
3:00	4:00	30	20	20	10	20	10	10	20
4:00	5:00	20	20	20	10	20	10	10	15
5:00	6:00	20	20	20	10	20	10	10	15

**EASTERN USA**

EDT	COT	Directional Indicators							
		N	NE	E	SE	S	SW	W	NW
8:00	7:00	20	20	20	12	20	10	10	15
9:00	8:00	20	20	20	15	20	10	10	15
10:00	9:00	20	20	20	15	30	10	10	20
11:00	10:00	20	30	30	20	30	10	10	20
12:00	11:00	20	30	30	20	30	10	10	20
1:00	12:00	30	20	20	20	40	1?	12	20
2:00	1:00	30	20	20	20	40	15	15	20
3:00	2:00	20	20	20	20	40	15	20	20
4:00	3:00	20	20	20	20	40	15	20	20
5:00	4:00	20	20	20	30	40	20	20	30
6:00	5:00	20	20	15	20	40	20	20	20
7:00	6:00	20	20	15	20	40	20	20	20
8:00	7:00	20*	20	12	15	40	20	30	20
9:00	8:00	15	20	12	12	40	20	30	20
10:00	9:00	15	20	10	12	40	20	30	20
11:00	10:00	20	20	10	12	40	20	30	20
12:00	11:00	20	15	10	10	30	20	30	20
1:00	12:00	20	15	10	10	20	20*	30	20
2:00	1:00	20	15	12	10	20	12	30	20
3:00	2:00	20	15	15	10	20	12	15	20
4:00	3:00	30	20	15	10	20	10	12	20
5:00	4:00	30	20	20	10	20	10	10	20
6:00	5:00	30	20	20	10	20	10	10	20
7:00	6:00	20	20	20	10	20	10	10	15

The italicized numbers signify the bands to try during the transition and early morning hours, while the standard type provides MUF during "normal" hours.  
 \*Look at next higher band for possible openings.

**ham radio**

# flea market



**RATES** Noncommercial ads 10¢ per word; commercial ads 60¢ per word **both payable in advance.** No cash discounts or agency commissions allowed.

**HAMFESTS** Sponsored by non-profit organizations receive one free Flea Market ad (subject to our editing) on a space available basis only. Repeat insertions of hamfest ads pay the non-commercial rate.

**COPY** No special layout or arrangements available. Material should be typewritten or clearly printed (not all capitals) and must include full name and address. We reserve the right to reject unsuitable copy. **Ham Radio** cannot check each advertiser and thus cannot be held responsible for claims made. Liability for correctness of material limited to corrected ad in next available issue.

**DEADLINE** 15th of second preceding month.

**SEND MATERIAL TO:** Flea Market, Ham Radio, Greenville, N. H. 03048.

**DX ANTENNAS FOR 160-10 METERS.** Small size, broadband, high performance. Also, antenna parts, Beverage insulators, wire and cable. Low prices and fast service. SASE for catalog. W1FB, Oak Hills Research, POB 250, Luther, MI 49656.

**CABLE TV CONVERTERS & EQUIPMENT:** Plans and parts. Build or buy. SASE for information. C & D Electronics, PO Box 1402, Dept. HR, Hope, AR 71801.

**WANTED:** Anything made by Kinematics True Time, Inc. Receivers, WWW clocks, time code readers, manuals, incomplete assemblies, etc. C.K. Barber, 3112 Ursula Street, Aurora, CO 80011.

**WANTED:** Spaulding (Rohn) AX series tower sections (straight sections only). Need any two of sections AXS-8, AXS-7, AXS-6, AXS-5, AXS-4 or AXS-3. Bill, W0YDB, Rt. 3, Box 267-H, Anandale, MN 55302 (612) 274-5684.

**DISCOUNT CATV CONVERTERS/DECODERS** and Video accessories. solar cells for remote power and battery charging applications. Send for free information and prices—it could save you BIG MONEY on your next purchase of these and other CATV items. Easy View, PO Box 221, Arlington Heights, Illinois 60006. (312) 952 8504. Ask for Rudy Valentine.

**ELECTRONIC DESIGN** experienced in RF, Audio, and Microprocessors. Complete laboratory and facilities. John Battle & Associates, 1000 South Peachtree #101, Norcross, Georgia 30071. (404) 449-8536.

**WANTED:** Operations manual Hammarlund 105TR. Andy Nagy, 1444 Dill Road, South Euclid, Ohio 44121.

**YAESU OWNERS:** Hundreds of modifications and improvements for your rig. Select the best from fourteen years of genuine top-rated Fox-Tango Newsletters by using our new Comprehensive Index. Only \$4 postpaid with Rebate Certificate creditable toward Newsletters purchases. Includes famous Fox-Tango Greensheet and Filter information for your rig (if specified). N4ML, FTC, Box 15944, W. Palm Beach, FL 33416. Telephone (305) 683-9587.

**IBM-PC RTTY/CW.** CompRtty II is the complete RTTY/CW program for the IBM-PC and compatibles. Virtually any speed AS-CII, BAUDOT, CW. Text entry via built-in screen editor! 10,000 character transmit/receive buffers. Adjustable split screen display. Instant mode/speed change. Hardcopy, diskcopy, break-in buffer, select calling, text file transfer, customizable full screen logging, 24 programmable 1000 character messages. Now with WRU (simple mailbox). Ideal for MARS and traffic handling. Requires 128k PC, XT, AT, PCjr, PC-DOS, serial port, RS-232C TU \$65. Send call letters (including MARS) with order. David A. Rice, KC2HO, 7373 Jessica Drive, North Syracuse, NY 13212.

**ATTENTION AMATEURS** Send for Free discount catalog. Amateur Communications, 2317 Vance Jackson, San Antonio, TX 78213. (513) 734-7793.

**BEAM HEADING CHART,** 10 page report in binder with 9 data fields calculated from your exact QTH to over 540 DX locations. \$9.95 from John Daley, KB6JGH, PO Box 4794, San Jose, CA 95150.

**C64, VIC 20, TI99/4A, TS1000, TS2068 Software:** Catalog \$1.00 refundable. Turn your programs and public domain software into PROFITs. Steve's Software Source, 9922 Harwich, Crestwood, MO 63126-2318. \*FM\* 8877 VHF AMP KITS: HV power supplies, CX600N relays, Mu-Tek LTD front end boards for IC251/IC271, EME newsletter and QRO parts. SASE for new catalog. KB7Q, "Q" Products, 417 Staudaher Street, Bozeman, MT 59715.

**NEW Low Frequency Receiving Accessories.** The L-400 LF active gain antenna (5 kHz-500 kHz) with excellent broadcast intermodulation rejection. LF receiving systems and more. Write for our catalog. LF Engineering Co., 17 Jeffrey Road, East Haven, CT 06512.

**YAESU HT-208R** Charger, belt clip, ducks, 5/8 superstick, module for 12V base, manuals. Like new \$180.00. N6BBA (209) 255-0431.

**ANNOUNCING** Iowa's new Computer BBS. (319) 557-9659. 24 hours per day. Contact User -8, A19D for more information.

**IBM/APPLE COMPUTER** full feature log program, "Hamlog". Send SASE KAT1AWH, Box 2015, Peabody, MA 01960.

**TRANSFORMERS** wound to 300 watts. Peter Robson Co., 18 Washington Trail, Hopatcong, NJ 07843.

**ELECTRON TUBES:** Radio, TV & Industrial Types—Huge inventory. Send for 80% off tube listing. Call Toll Free (800) 221-5802 or write Box HR, Translertonic, Inc., 1365 39th Street, Brooklyn, NY 11218 (718) 633-2800.

**THE GOOD SAM HAMS** invite RV operators to check in the Good Sam Ham net 14.240 Sundays 1900Z also 3.880 Tuesdays at 2359Z. Net control N5BDN, Clarksville, IN

**OLD RADIO** transcription discs wanted. Any size, speed. W7FIZ, Box 724 HR, Redmond, WA 98073-0724.

**RTTY-EXCLUSIVELY** for the Amateur Teleprinter. One year \$10.00. Beginners RTTY Handbook \$8.00. PO Box RY, Cardiff, CA 92007.

**IMRA**, International Mission Radio Association helps missionaries. Equipment loaned. Weekday net, 14.280 MHz, 2.3 PM Eastern. Eight hundred Amateurs in 40 countries. Brother Frey, 1 Pryer Manor Road, Larchmont, New York 10538.

**RUBBER STAMPS:** 3 lines \$4.50 PPD. Send check or MO to G.L. Pierce, 5521 Birkdale Way, San Diego, CA 92117. SASE brings information.

**ELECTRON TUBES:** Receiving, transmitting, microwave... all types available. Large stock. Next day delivery, most cases. Daily Electronics, PO Box 5029, Compton, CA 90224. (213) 774-1255.

**CUSTOM MADE EMBROIDERED PATCHES.** Any size, shape, colors. Five patch minimum. Free sample, prices and ordering information. Hein Specialties, Inc., Dept 301, 4202 N. Drake, Chicago, IL 60618.

**RECONDITIONED TEST EQUIPMENT** \$1.25 for catalog. Walter, 2697 Nickel, San Pablo, CA 94806.

**PRINTED CIRCUIT BOARDS** and kits for QST articles. Call or write for information. A&A Engineering, 7970 Orchid Drive, Buena Park, CA 90620. (714) 521-4160.

**PACKET/ASCII/BAUDOT/CW** for IBM-PC. SASE to: Emile Al-line, 773 Rosa, Metairie, LA 70005.

**CABLE TV CONVERTERS/DESCRAMBLERS.** Guaranteed lowest prices in US. Jerrold, Hamlin, Zenith—Many others. Lowest dealer prices! Orders shipped within 24 hours! MasterCard, VISA, COD accepted. Free Catalog—call (800) 345-8927 only Pacific Cable Co., Inc., 7325 1/2 Reseda Blvd, #1012, Reseda, CA 91335. (818) 716-5914.

**CHASSIS** and cabinet kits. SASE K3IWK, 5120 Harmony Grove Road, Dover, PA 17315.

**2 METER AMP KITS:** 8877 legal limit kit \$395. 3CX800A7 900W kit \$325. Also HV power supplies, CX600N relays, parts and EME newsletter. SASE for catalog. 2 Meter EME Bulletin, 417 Stauda-her St., Bozeman, MT 59715.

## COMING EVENTS

Activities — "Places to go . . ."

**CALIFORNIA:** Flea Market/Boneyard Sale. Foothill College, Los Altos Hills, March-Sept. 2nd Saturday of every month 7 AM Sellers. 7:15 AM buyers. Talk in 145.27(-) or 147.570 simplex. FCC exams (408) 255-9000.

**WASHINGTON:** Central Washington Hamfest sponsored by the Apple City Amateur Radio Club, W7TD. June 14 and 15, Rocky Reach Dam near Wenatchee. Registration \$5 for Amateurs. Others \$1.00. Under 12 free. Banquet \$7.00. Equipment displays, Swap Shop, ARRL VE license exams. Free camper/trailer space with power provided by Park. Talk in on 146.07/67 or 146.49 simplex.

**NEW YORK:** The Mt. Beacon Amateur Radio Club Hamfest, Saturday, 12, Arlington Senior High School, Poughkeepsie/LaGrange. Tickets \$3.00 (hams and computer hobbyists). Tailgating space \$4.00. Tables \$6.00—one free table and admission. Doors open 8 AM. Talk in on 146.37/97 and 146.52. For more info: Julius Jones, W2IHY, RR 2, Vanessa Lane, Staatsburg, NY 12580 (914) 889-4933.

**INDIANA:** The Lake County Amateur Radio Club's 14th Annual Fathers' Day Hamfest, Sunday, June 15, Lake County Fairgrounds Industrial Building. Free parking. Tables available. Admission \$3.00. No advance. 8 AM to 2 PM. Setup 6 AM. MARS, ARRL, ARES information. Refreshments. Overnight accommodations nearby. Talk in on Lake County ARC repeater 147.84/24 or 146.52 simplex. For further information: Bill DeGeer, W9TY, 3601 Tyler Street, Gary, IN 46408 (219) 887-5413 evenings after 6 PM.

**NEW HAMPSHIRE:** Fly-in to New Hampshire's 2nd largest Amateur Radio/electronic flea market, Saturday, June 21, Manchester Municipal Airport. Sponsored by the New Hampshire FM Association. Rain date Sunday, June 22. Starts 9 AM. General admission \$1.00. Sellers \$5.00, bring own tables. Commercial displays welcome. Refreshments available. Pre-registration to 123 Woodlawn Circle, Portsmouth, NH 03801. Talk in on 146.52 FM. For information: Doug Aiken, K1WPM, (603) 62-0831 or Pete Henriksen, WA1R3C, 123 Woodlawn Circle, Portsmouth, NH 03801. (603) 431-5432.

**WISCONSIN:** The South Milwaukee Amateur Radio Club's annual Swapfest, Saturday, July 12. American Legion Post 434, 9327 South Shepard Avenue, Oak Creek. 7 AM to 4 PM. Parking, picnicking, food and refreshments available. Admission \$3.00 includes "happy time" with free beverages. The Milwaukee Volunteer Core Group will conduct Amateur Radio exams during the day. For more details, including a map, write: South Milwaukee ARC, PO Box 102, South Milwaukee, WI 53172-0102.

**1986 "BLOSSOMLAND BLAST"** Sunday, October 5, 1986. Write "BLAST", PO Box 175, St. Joseph, MI 49085.

**CALIFORNIA:** FCC exams, Novice-Extra. Sunnyvale VEC ARC. (408) 255-9000 24 hour. 73, Gordon, W6NLG, VEC

**PENNSYLVANIA** (Meadville) — July 5. Firecracker Hamfest by Crawford Amateur Radio Society. Electronics, radios, computers. New location at Meadville Recreation Center just off Rt. 27 E in Meadville. All indoors; no rain out. One olympic and two child-size deluxe swim pools with lockers and showers and other sports available in Center. Free indoor fleamarket space; bring table. Dealers: free indoor space and table(s) available by pre-registration; reserve early. Admission adult \$2.00, children free, swimming for small extra. Talk in 144.53/145.13, W3ME/R. For information write CARS Hamfest-86, PO Box 653, Meadville, PA 16335 or call Ben Ferer, KF3F, 814/724-2432.

**KENTUCKY:** The Antique Radio Club of America (ARCA) will hold a convention, June 11 through 14 in Louisville. Club members collect and restore antique wireless and radio equipment from before World War I through the 40's and 50's. At this year's convention there will be speakers, tours of radio collections and also tours of the Louisville area. Massive flea market and auction. Louisville offers much in the way of recreation for the entire family. For information: ARCA, 81 Steeplechase Road, Devon, PA 19333 or call (215) 688-2976.

### Foreign Subscription Agents for Ham Radio Magazine

Ham Radio Austria  
Karin Ueber  
Postfach 2454  
D-7850 Loerrach  
West Germany

Ham Radio Belgium  
Stereohuis  
Brussesteenenweg 416  
B-9218 Gent  
Belgium

Ham Radio Holland  
Postbus 413  
NL-7800 Ar Emmen  
Holland

Ham Radio Europe  
Box 2084  
S-194 02 Upplands Vasby  
Sweden

Ham Radio France  
SM Electronic  
20 bis, Ave des Claires  
F-89000 Auxerre  
France

Ham Radio Germany  
Karin Ueber  
Postfach 2454  
D-7850 Loerrach  
West Germany

Canada  
Send orders to  
Ham Radio Magazine  
Greenville, NH 03048 USA  
Prices in Canadian funds  
1 yr \$29.95, 2 yrs \$53.30  
3 yrs \$75.40

Ham Radio Italy  
Via Maniago 15  
I-20134 Milano  
Italy

Ham Radio Switzerland  
Karin Ueber  
Postfach 2454  
D-7850 Loerrach  
West Germany

Ham Radio England  
c/o R.S.G.B.  
Alma House  
Cranborne Road  
Pottery Bar  
Herts EN6 3JW  
England

# STUDY GUIDES

## AMECO STUDY GUIDES

### Designed for VEC Exams

AMECO Study Guides are taken from the FCC Amateur Exam syllabus, PR-1035 and have answers keyed to ARRL's recently released study material. These study guides are compatible with ARRL and all other VEC Exams. While nothing can guarantee that you will pass, AMECO Study Guides will make sure that you are fully prepared and ready to go when you sit down for the exam. Written in clear, concise, easy-to-read format, each question fully explained. Novice and General books cross referenced to AMECO's 102-01 for a more thorough explanation.

- ☐ 27-01 Novice Class **Softbound \$3.50**
- ☐ 12-01 General Class **Softbound \$4.95**
- ☐ 26-01 Advanced Class **Softbound \$4.95**
- ☐ 17-01 Extra Class **Softbound \$4.95**
- ☐ AM-1 Get All Four **\$14.95**

## ARRL Q&A LICENSE MANUALS

ARRL Q&A License Manuals are keyed to the latest FCC Exam syllabi now in use by the Volunteer Examiners. These books are written in an easy-to-read conversational style that enhances understanding without scaring the student away. All technical subject areas are explained in clear terminology and with plenty of illustrations, diagrams and schematics. Rules are also fully covered. Each book has the official ARRL multiple choice question Pool with answers and a key to the FCC Exam syllabus for reference to other study publications. These are *the* study guides to have. All books. © 1985 1st Editions.

- ☐ AR-TG General **Softbound \$5.00**
- ☐ AR-AG Advanced **Softbound \$5.00**
- ☐ AR-EG Extra **Softbound \$5.00**
- ☐ AR-SG Get All Three **\$12.95**

## NEW TITLES

### FIRST STEPS IN RADIO

by Doug DeMaw, W1FB

This new anthology has been taken from DeMaw's '84 and '85 series in QST magazine. It has been written to give beginners the basic electronic theory needed for upgrading and the ins and outs of how radios work. Using a building block approach, DeMaw first explains what the different components are, then assembles them into basic circuits and ends up with how these circuits work in your radio. You also get articles on antennas, propagation and beginners level RFI problems and suggestions on how to resolve them. Great review for more experienced Hams. Perfect for the beginner. © 1985.

- ☐ AR-FS **Softbound \$4.95**

### LANDMOBILE AND MARINE RADIO TECHNICAL HANDBOOK

by Edward Noll, W3FQJ

This is THE HANDBOOK for those who operate, install or service two-way radios. Covers private landmobile services, marine radiotelephone and radiotelegraph, marine navigation and Citizen's Band. An excellent reference book for those studying to pass the NABER technician certification exam. Areas covered include: transmission characteristics and modulation systems, basic solidstate theory, digital and microprocessor electronics, antenna systems, test equipment, repeaters and much more. © 1985 1st edition 576 pages.

- ☐ 22427 **\$24.95**

### THE COMMODORE

#### HAM'S COMPANION by Jim Grubbs, K9EI

Here's your guide to using the Commodore C-64 computer in your Ham shack. Good solid information on where to find software and hardware for CW, RTTY, AMTOR, SSTV, propagation prognostication, antenna modeling, satellite tracking and much more. Includes a list of over 80 sources of software and hardware. Also includes a bibliography of over 60 magazine articles and reviews about using the Commodore. ©1985, 160 pages, 1st edition.

- ☐ JG-CC **Softbound \$15.95**

Please add \$3.50 to cover postage and handling.

**Ham Radio's Bookstore**  
Greenville, NH 03048

**ILLINOIS:** The Egyptian Radio Club will hold its 57th annual Hamfest, Sunday, June 8, 8 AM to 3 PM, at their clubhouse. Free 10' flea market spaces available on first come basis. Additional spaces \$5.00. Tickets \$1.00 advance, \$2.00 each or 3/\$9.00 at the door. Talk in on 146.16/76 or 146.52 simplex. For information or tickets SASE to Egyptian Radio Club, PO Box 562, Granite City, IL 62040.

**BRITISH COLUMBIA:** Maple Ridge Hamfest, July 12 and 13, St. Patricks Center, 22589 121 Avenue, Maple Ridge. Admission Hams \$6.00; non-hams over 12 \$3.00. Under 12 free. Two hams in family \$9.00. Commercial displays, flea market, food, children's programs. Nearby shopping and recreation areas. Camper space, no hookups. Talk in on 146.20/80 and 146.34/94. For more information: Bob Houghton, VE7BZH, Box 292 Maple Ridge, BC V2X 7G2 or phone (604) 467-4915.

**NEW YORK:** Ham Family Day, June 1, Becks Grove, Bloisvale. Sponsored by the Rome Radio Club. QRP contest, flea market, tech talks. Non-ham activities. Talk in on 146.28/88 and 146.34/94. For information: Rome Radio Club, Box 721, Rome, NY 13440 or call William Effland (315) 853-5700.

**MINNESOTA:** The North Area Repeater Association's Swapfest and exposition, Saturday and Sunday, June 7 and 8, Minnesota State Fairgrounds in St. Paul. Free overnight parking for SC campers June 6 and 7. Exhibits, commercials, dealers, giant outdoor flea market. Amateur license exams will be given. Admission \$4 advance, \$5 at gate. For more information, tickets, etc: Amateur Fair, PO Box 857, Hopkins, MN 55343 or call (612) 566-4000.

**NEW JERSEY:** The Raritan Valley Radio Club's 15th annual Hamfest, Saturday, June 21, Columbia Park, Denellen. Gates open 8 AM. Sellers spots \$5.00/space or \$10.00 multiple spaces. No tables supplied. Lookers \$3.00 donation. Spouse and kids free. Food and drink available. Talk in on Club repeater W2QW/R 146.025/625 and 146.52 simplex. For information call Dave, KA2TSM (201) 763-4849 or Bill, N2AZX (201) 467-7342, 8 AM to 5 PM.

**PENNSYLVANIA:** Harrisburg annual Firecracker Hamfest, Friday, July 4, Bressler Fire Company picnic grounds. Sponsored by the Harrisburg RAC. Tailgating no charge with admission of \$3.00. XYL and kids free. Nearby restaurants and motels. Parking on grounds. Talk in on 52.52 simplex or local repeaters. For details/table info: Dave, KC3MG, 131 Livingston St, Swatara, PA 17113 or call (717) 939-4957.

**WEST VIRGINIA:** The 8th annual TSAC Wheeling Hamfest/Computer Fair, Sunday, July 20, Wheeling Park, 9 AM to 4 PM. WV's largest. Dealers welcome. 30,000 sq. ft. under roof. 5 acres of flea market. Family activities at Park. Admission \$3.00 in advance, \$4.00 at door. To reserve space contact: Jay Paulovicks, KD8GL, RD 3 Box 238, Wheeling, WV 26003 (304) 232-6796. For tickets, TSAC, Box 240, RD 1, Adena, OH 43901 (614) 546-3930.

**MARYLAND:** The Frederick Amateur Radio Club's 9th annual Hamfest, June 15, Frederick Fairgrounds. 8 AM to 4 PM. Admission \$3.00. Tailgaters \$2.00 extra. YL's and kids free. Gates open for exhibitors 8 PM June 14. Exhibitors tables \$10.00 first, \$5.00 each extra. For information: Jim Kasunic, KA3LPC, 9419 Highlander Ct, Walkersville, MD 21793.

**INDIANA:** The 16th annual Indiana ARRL Convention and Indianapolis Hamfest, Saturday and Sunday, July 12 and 13, Marion County Fairgrounds, Indianapolis. Featuring the largest electronic flea market and new Amateur Radio equipment display in the state. Gate fees \$5.00 with free parking on grounds. Gates open 6 AM. Large covered flea market. Inside tables \$8 each. 2m Fox Hunt, homebrew contest. QSL card contest. Free camper hookups available on grounds. Nearby restaurants and motels. For information contact Bill Evans, WB9BEN (317) 745-6389.

**MASSACHUSETTS:** The MIT UHF Repeater Association and the MIT Radio Society offer monthly Ham Exams. All classes Novice to Extra. Wednesday, June 18, 7 PM, MIT Room 1-134, 77 Mass Avenue, Cambridge MA. Reservations requested 2 days in advance. Contact Ron Hoffmann (617) 253-0160/646-1641 or Craige Rodgers (617) 494-1986. Exam fee \$4.25. Bring copy of current license (if any), two forms of picture ID and completed form 610 available from FCC in Boston (223-6609).

**PENNSYLVANIA:** The 12th annual Warminster Amateur Radio Club's Hamfest, Sunday, June 8, Middletown Grange Fairgrounds, Penns Park Road, Wrightstown. Gates open 7 AM (vendors 6 AM). Donation \$3.00. XYL's and kids free. Outdoor tailgating \$5.00 per space. Indoor space \$5.00 with 8' table and power available. Talk in on 147.69/09 and 146.52. For information and preregistration: Chuck Dunn, KA3FOQ, 1414 Bradley Lane, Warminster, PA 18974.

## OPERATING EVENTS

"Things to do . . ."

The **LINCOLN TRAIL ARC** will operate W4BEJ from Abraham Lincoln Birthplace National Historic Site near Hodgenville Kentucky during Field Day June 28 and 29. For a commemorative certificate send QSL and SASE to LTARC, PO Box 342, Vine Grove, KY 40175.

**ACB RADIO AMATEURS** a special-interest affiliate of the American Council of the Blind (ACB) will operate special event station KW4U from 0000Z July 29 to 2400Z July 5 from the Hilton Hotel in Knoxville, TN in conjunction with ACB's silver anniversary convention. Submit QSL card confirming QSO with KW4U during convention week and receive an attractive commemorative certificate. Send QSL's to John McCann, KW4U, 2105 N. Illinois Street, Arlington, VA 22205.

**BUZZARD ROOST REPEATER** will operate special event station WB0UPK, 1500Z July 4 to 0100Z July 5, from the Neligh Mills, a state historical site. QSL's may be obtained by sending SASE to WB0UPK, 804 East 1st Street, Neligh, NE 68756.

**EASTERN CONNECTICUT ARA** will operate special event station, K1MUJ, to help celebrate the Woodstock Connecticut Tercentenary on July 4. For a commemorative certificate send SASE and QSL card to KB1SP.

**ARGONNE ARC** will operate W9QVE, June 21 from 11 AM to 4 PM CST to commemorate the 40th anniversary of the establishment of the US National Laboratory System of which, Argonne is the first. Send QSL and SASE to AARC, PO Box 275, Argonne, IL 60439.

**SOUTH JERSEY RADIO ASSOCIATION**, the oldest radio club in the US, will operate a special event station, K2AA, from 1200Z June 7 to 0400Z June 16 to celebrate its 70th birthday. For a commemorative QSL send SASE and QSL or log info to South Jersey RA, PO Box 1026, Haddonfield, NJ 08033.

## HAM DATA C-64 Software

### SUPER LOG

Super log gives you all the advantages of a computerized data base without significantly changing the traditional log format. For contesters, Super Log can be configured to either manually or automatically enter contact number as well as time of contact. Make an error and you can easily go back and edit the entry. Super Log also allows you to print out either selected contents or the whole log. Will print QSLs.

- ☐ JHD-SL (For C-64) **\$19.95**

### CONTEST LOG

This disk contains four different contest programs; ARRL Sweepstakes, Field Day, Universal WW Contest log, plus a dupe checking routine. Each program is designed for real time use. It automatically enters date, time, band and serial number for each contact. A 24-hour clock is displayed at the top of the VDT screen. When the contest is over, the program will print your results listing all duped and scored contacts in serial sequence with all the necessary information as well as completed score at the bottom of the page.

- ☐ JHD-CL (For C-64) **\$24.95**

### MASTER LOG

Over three years of development went into this program. It creates a file of 2100 individual records with up to 13 different entries per record. Master Log can do a search and select based upon time, frequency, mode or any of the other variable parameters. It keeps track of DXCC and WAS status, prints QSL labels and can search its whole file in less than 5 seconds! Complete documentation is included to help you learn and use this truly state-of-the-art logging program.

- ☐ JHD-ML (For C-64) **\$28.95**

Please enclose \$3.50 for shipping

**HAM RADIO'S BOOKSTORE**  
Greenville, NH 03048

## CHARGE YOUR CLASSIFIED ADS

to your  
MC or VISA  
write or call



### HAM RADIO MAGAZINE

Greenville, NH 03048

(603) 878-1441



product

# REVIEW

## 500 MHz Pocket Counter

Here's a neat little product every ham will want to have: a 500-MHz counter from Digitrex that fits into a shirt pocket, measures just 1 x 3.5 x 2.7 inches, and weighs less than 8 ounces with the 9-volt battery installed. The LED readout display measures 0.14 inch; the unit draws less than 100 mA. Battery life is estimated to be several weeks in normal use. The unit uses six ICs, five transistors, three diodes, and a 2.56 MHz internal crystal oscillator.

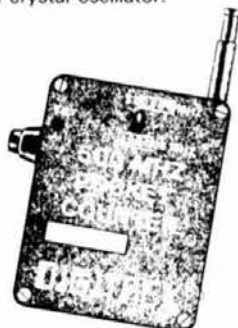

The counter has a sensitivity of less than 50 millivolts, 1-500 MHz, 1.5 volts RMS maximum and the resolution is four digits (switchable to six) down to 1 kHz. A seven-digit modification that gives resolution down to 100 Hz is available. The counter has a short-term accuracy of 1 ppm when calibrated against a known signal using an internal trimmer capacitor. Over the long term, its accuracy is 1 kHz at 500 MHz over a temperature range of 10-40 degrees C.

To use the unit, you first install a 9-volt transistor battery, extend the internal 19-inch antenna, select the MHz range, and depress the counter's on/off button, which also functions as a press-to-read control. All you do is read the frequency — it's really as simple as that!

Not having a lab-grade frequency generator with which to compare readings limits the scope of this review to using the VFOs (and internal frequency calibrators) of several different transmitters as frequency standards. All readings were found to be within manufacturer's specifications.

This is really a "neat" product and at the price, it's one good value for your dollar. While you can't expect lab-grade measurements, you'll be pleased with the unit's accuracy.

The price is \$49.95 plus \$2 shipping and handling. For more information, contact: Digitrex, 1005 Bloomer, Rochester, Michigan 48063.

— N1ACH



# NEW products

## triple output power supply

MFJ Enterprises, Inc. has announced the release of its Triple Output Lab Power Supply. For \$149.95 (plus \$6.00 shipping and handling), the MFJ-4002 offers two variable 1.5 to 20 VDC outputs at 0.5 amp and one fixed 5 VDC output at 1 amp. It's designed for heavy duty commercial use to give years of trouble-free service.

There's plenty of voltage and current for both analog and digital circuits. It's ideal for education, circuit design, product development, testing and repair, quality control and production.

Separate transformers are used for completely isolated outputs. This allows the outputs to be connected in series or parallel for higher voltage or current. It's short circuit protected, has excellent line regulation (typically 0.1 percent V) and load regulation (typically 0.1 percent) and has very low ripple.

Two lighted 3-inch precision meters are provided for monitoring voltage and current simultaneously. Rugged 5-way binding posts are used for all outputs. A separate binding post is used for chassis ground.

The MFJ-4002 is made in America and built with heavy gauge aluminum to take lots of abuse. It measures 12x36x6 inches, uses 110 VAC with a 3-wire safety power cord and fast acting pop-out fuse. For details, contact MFJ Enterprises, Inc., 921 Louisville Road, Starkville, Mississippi 39759.

Circle #301 on Reader Service Card.

## new heathkit catalog

A wide variety of electronic products in kit form and assembled versions are showcased in the new Heathkit Catalog from Heath Company of Benton Harbor, Michigan. A new 2-meter handheld/mobile system featuring greater ease of operation and greater flexibility is offered, as is a low-cost, user-installed satellite system featuring the General Satellite Dish and the Norsat Satellite Receiver.

The HW-6502 2-Meter Hand-held Transceiver comes complete with a built-in CTCSS encoder, S/BATT meter, squelch control and thumb-wheel channel selector switches with +5 kHz switch. The operating frequency range is 144 MHz to 147.995 MHz and sensitivity is 0.25 $\mu$ V. The mobile console unit, HWA-6502-2, houses the transceiver and is able to provide 25-watt mobile operation with the optional 25-watt 2-meter amplifier. The console, which includes power, UHF and VHF switches and lit frequency display, measures 2-1/4 x 6-1/2 x 8-1/2 inches (excluding projection).

The Heathkit Satellite System combines the Norsat receiver and the General Satellite Dish for the user to install and receive satellite relayed programming. The Heathkit Site Survey kit is used to determine acceptable sites for positioning the system's dish antenna.

Over 400 electronic products are offered in the new Heathkit Catalog. To receive a free copy, contact Heath Company, Benton Harbor, Michigan 49022.

Circle #302 on Reader Service Card.

## cable connectors

Nemal Electronics International has introduced a new line of connectors designed to fit the Belden 9913- and 8214-type cables. The new connectors are available from stock in both type N (part #NE720) and BNC (part #NE860) series and will accommodate the 9-1/2 to 11 gauge center conductors in these and other similar cables.

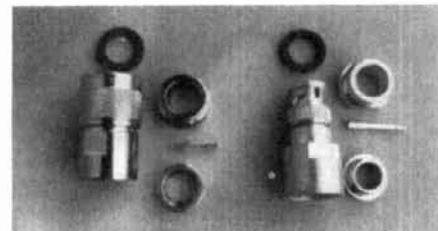

Both series of connectors meet the electrical and mechanical requirements of MIL-C-39012 and incorporate silver plated contacts and teflon insulation. Each connector is fully compatible with all other standard connectors in its series.

For information, contact Nemal Electronics International, 12240 NE 14th Avenue, North Miami, Florida 33161.

Circle #303 on Reader Service Card.

## new VOM

Mercer Electronics, a division of Simpson Electric Company, has introduced a new VOM; Model 9120 has 25 ranges including dB, 20,000 ohms/volt DC sensitivity (5,000 ohms/volt AC) and a frequency response up to 100 kHz on 3, 12, and 60-volt AC ranges. It will measure up to 12 Amperes DC, has a 3-volt AC range, and provides excellent resolution. DC accuracy is  $\pm 3$  percent fs. Convenience features include a front panel polarity reversal switch, single-knob range/function switch with an "off" position, an output jack for DC isolation, and a large, easy-to-read, 3.5-inch mirrored, color-coded scale.

Also included is a high-energy fusing system along with standard fusing and diode meter protection. The unit measures 4 x 6 x 1-3/4 inches and weighs 13 ounces. It comes complete with batteries, test leads and an operator's manual.

For details, contact Mercer Electronics, 859 Dundee Avenue, Elgin, Illinois 60120.

Circle #304 on Reader Service Card.





*Ham Radio's guide to help you find your local*

## California

**C & A ROBERTS, INC.**  
18511 HAWTHORN BLVD.  
TORRANCE, CA 90504  
213-370-7451  
24 Hour: 800-421-2258  
Not The Biggest, But The Best —  
Since 1962.

**FONTANA ELECTRONICS**  
8628 SIERRA AVENUE  
FONTANA, CA 92335  
714-822-7710  
714-822-7725  
The Largest Electronics Dealer in San  
Bernardino County.

**JUN'S ELECTRONICS**  
3919 SEPULVEDA BLVD.  
CULVER CITY, CA 90230  
213-390-8003  
800-882-1343 Trades  
Habla Espanol

## Colorado

**COLORADO COMM CENTER**  
4262 LOWELL BLVD.  
DENVER, CO 80211  
(303) 433-3355  
(800) 227-7373  
Stocking all major lines  
Kenwood Yaesu, Encomm, ICOM

## Connecticut

**HATRY ELECTRONICS**  
500 LEDYARD ST. (SOUTH)  
HARTFORD, CT 06114  
203-527-1881  
Call today. Friendly one-stop shopping  
at prices you can afford.

## Delaware

**AMATEUR & ADVANCED COMMUNI-  
CATIONS**  
3208 CONCORD PIKE  
WILMINGTON, DE 19803  
(302) 478-2757  
Delaware's Friendliest Ham Store.

**DELAWARE AMATEUR SUPPLY**  
71 MEADOW ROAD  
NEW CASTLE, DE 19720  
302-328-7728  
800-441-7008  
Icom, Ten-Tec, Microlog, Yaesu,  
Kenwood, Santec, KDK, and more.  
One mile off I-95, no sales tax.

## Florida

**AMATEUR ELECTRONIC SUPPLY**  
1898 DREW STREET  
CLEARWATER, FL 33575  
813-461-4267  
Clearwater Branch  
West Coast's only full service  
Amateur Radio Store.  
Hours M-F 9-5:30, Sat. 9-3

**AMATEUR ELECTRONIC SUPPLY**  
621 COMMONWEALTH AVE.  
ORLANDO, FL 32803  
305-894-3238  
Fla. Wats: 1 (800) 432-9424  
Outside Fla: 1 (800) 327-1917  
Hours M-F 9-5:30, Sat. 9-3

## Georgia

**DOC'S COMMUNICATIONS**  
702 CHICKAMAUGA AVENUE  
ROSSVILLE, GA 30741  
(404) 866-2302  
ICOM, Yaesu, Kenwood, KDK, Bird...  
9AM-5:30PM  
We service what we sell.

## Hawaii

**HONOLULU ELECTRONICS**  
819 KEEAUMOKU STREET  
HONOLULU, HI 96814  
(808) 949-5564  
Serving Hawaii & Pacific area for 53  
years.

## Idaho

**ROSS DISTRIBUTING COMPANY**  
78 SOUTH STATE STREET  
PRESTON, ID 83263  
(208) 852-0830  
M 9-2; T-F 9-6; S 9-2  
Stock All Major Brands  
Over 7000 Ham Related Items on  
Hand

## Illinois

**ERICKSON COMMUNICATIONS, INC.**  
5456 N. MILWAUKEE AVE.  
CHICAGO, IL 60630  
312-631-5181  
Hours: 9:30-5:30 Mon, Tu, Wed & Fri;  
9:30-8:00 Thurs; 9:00-3:00 Sat.

## Indiana

**THE HAM STATION**  
220 N. FULTON AVE.  
EVANSVILLE, IN 47710  
812-422-0231  
Discount prices on Ten-Tec, Cubic,  
Hy-Gain, MFJ, Azden, Kantronics,  
Santec and others.  
SASE for New & Used Equipment List.

## Massachusetts

**TEL-COM, INC.**  
675 GREAT ROAD, RTE. 119  
LITTLETON, MA 01460  
617-486-3400  
617-486-3040  
The Ham Store of New England  
You Can Rely On.

## Michigan

**ENCON PHOTOVOLTAICS**  
Complete Photovoltaic Systems  
27600 Schoolcraft Rd.  
Livonia, Michigan 48150  
313-523-1850  
Amateur Radio, Repeaters, Satellite,  
Computer applications.  
Call Paul WD8AHO

## Minnesota

**TNT RADIO SALES**  
4124 WEST BROADWAY  
ROBBINSDALE, MN 55422 (MPLS/ST.  
PAUL)  
TOLL FREE: (800) 328-0250  
In Minn: (612) 535-5050  
M-F 9 AM-6 PM  
Sat 9 AM-5 PM  
Ameritron, Bencher, Butternut, Icom,  
Kenwood

## Missouri

**MISSOURI RADIO CENTER**  
102 NW BUSINESS PARK LANE  
KANSAS CITY, MO 64150  
(800) 821-7323  
Missouri: (816) 741-8118  
ICOM, Kenwood, Yaesu  
Same day service, low prices.

## Nevada

**AMATEUR ELECTRONIC SUPPLY**  
1072 N. RANCHO DRIVE  
LAS VEGAS, NV 89106  
702-647-3114  
Dale Porray "Squeak," AD7K  
Outside Nev: 1 (800) 634-6227  
Hours M-F 9-5:30, Sat. 9-3

**Dealers:** *YOU SHOULD BE HERE TOO!*  
*Contact Ham Radio now for complete details.*

# Amateur Radio Dealer

## New Jersey

**KJI ELECTRONICS**  
66 SKYTOP ROAD  
CEDAR GROVE, NJ 07009  
(301) 239-4389  
Gene K2KJI  
Maryann K2RVH  
Distributor of: KLM, Mirage, ICOM, Larsen, Lunar, Astron. Wholesale - retail.

## New York

**BARRY ELECTRONICS**  
512 BROADWAY  
NEW YORK, NY 10012  
212-925-7000  
New York City's Largest Full Service Ham and Commercial Radio Store.

**VHF COMMUNICATIONS**  
915 NORTH MAIN STREET  
JAMESTOWN, NY 14701  
716-664-6345

Call after 7 PM and save! Supplying all of your Amateur needs. Featuring ICOM "The World System." Western New York's finest Amateur dealer.

## North Carolina

**F & M ELECTRONICS**  
3520 Rockingham Road  
Greensboro, NC 27407  
1-919-299-3437  
9AM to 7PM Closed Monday  
ICOM our specialty — Sales & Service

## Ohio

**AMATEUR ELECTRONIC SUPPLY**  
28940 EUCLID AVE.  
WICKLIFFE, OH 44092 (Cleveland Area)  
216-585-7388  
Ohio Wats: 1 (800) 362-0290  
Outside Ohio: 1 (800) 321-3594  
Hours M-F 9-5:30, Sat. 9-3

**DEBCO ELECTRONICS, INC.**  
3931 EDWARDS RD.  
CINCINNATI, OHIO 45209  
(513) 531-4499  
Mon-Sat 10AM-9PM  
Sun 12-6PM  
We buy and sell all types of electronic parts.

**UNIVERSAL AMATEUR RADIO, INC.**  
1280 AIDA DRIVE  
REYNOLDSBURG (COLUMBUS), OH 43068  
614-866-4267  
Featuring Kenwood, Yaesu, Icom, and other fine gear. Factory authorized sales and service. Shortwave specialists. Near I-270 and airport.

## Pennsylvania

**HAMTRONICS, DIV. OF TREVISE ELECTRONICS**  
4033 BROWNSVILLE ROAD  
TREVISE, PA 19047  
215-357-1400  
Same Location for over 30 Years

**LaRUE ELECTRONICS**  
1112 GRANDVIEW STREET  
SCRANTON, PENNSYLVANIA 18509  
717-343-2124  
ICOM, Bird, Cushcraft, Beckman, Larsen, Amphenol, Astron, Belden, Antenna Specialists, W2AU/W2VS, Tokyo Hy-Power Labs, WELZ, Daiwa, Sony, Saxton, Vibroplex, Weller.

## Tennessee

**MEMPHIS AMATEUR ELECTRONICS**  
1465 WELLS STATION ROAD  
MEMPHIS, TN 38108  
Call Toll Free: 1-800-238-6168  
M-F 9-5; Sat 9-12  
Kenwood, ICOM, Ten-Tec, Cushcraft, Hy-Gain, Hustler, Larsen, AEA, Mirage, Ameritron, etc.

## Texas

**MADISON ELECTRONICS SUPPLY**  
3621 FANNIN  
HOUSTON, TX 77004  
713-520-7300  
Christmas?? Now??

## Wisconsin

**AMATEUR ELECTRONIC SUPPLY**  
4828 W. FOND DU LAC AVE.  
MILWAUKEE, WI 53216  
414-442-4200  
Wisc. Wats: 1 (800) 242-5195  
Outside Wisc: 1 (800) 558-0411  
M-F 9-5:30 Sat 9-3

**SAY YOU SAW IT  
IN  
HAM RADIO**

# RF TRANSISTORS

FRESH STOCK - NOT SURPLUS  
TESTED — FULLY GUARANTEED

P/N	2-30 MHz 12V (* = 28V)		Match Pr.
	Rating	Each	
MRF406	20W	\$14.50	\$32.00
MRF412,IA	80W	18.00	45.00
MRF421	100W	25.00	56.00
MRF421C	110W	—	60.00
MRF422*	150W	38.00	82.00
MRF426,IA*	25W	18.00	42.00
MRF428**	150W	55.00	125.00
MRF433	12.5W	12.00	30.00
MRF435*	150W	42.00	90.00
MRF449,IA	30W	12.50	30.00
MRF450,IA	50W	14.00	31.00
MRF453,IA	60W	15.00	35.00
MRF454,IA	80W	16.00	36.00
MRF455,IA	60W	12.00	28.00
MRF458	80W	20.00	46.00
MRF460	60W	18.00	42.00
MRF464*	80W	25.00	60.00
MRF466*	40W	18.75	48.00
MRF475	12W	3.00	9.00
MRF476	3W	2.75	8.00
MRF477	40W	11.00	25.00
MRF479	15W	10.00	23.00
MRF485*	15W	6.00	15.00
MRF492	90W	18.00	40.00
SRF2072	75W	15.00	33.00
SRF3662	110W	28.00	60.00
SRF3775	75W	15.50	34.00
SRF3795	85W	16.50	37.00
CD2545	50W	23.00	52.00
SD1076	70W	17.00	40.00
SD1451	50W	15.00	36.00

Selected High Gain Matched Quads Available

### VHF/UHF TRANSISTORS

Rating	MHz	Net Ea.	Match Pr.	
MRF212	10W	136-174	\$16.00	—
MRF221	15W	136-174	10.00	—
MRF222	25W	136-174	14.00	—
MRF224	40W	136-174	13.50	32.00
MRF231	3.5W	66-88	10.00	—
MRF234	25W	66-88	15.00	39.00
MRF237	4W	136-174	3.00	—
MRF238	30W	136-174	12.00	—
MRF239	30W	136-174	15.00	—
MRF240	40W	136-174	18.00	—
MRF245	80W	136-174	28.00	65.00
MRF247	75W	136-174	27.00	63.00
MRF250	50W	27-174	20.00	46.00
MRF260	5W	136-174	7.00	—
MRF261	10W	136-174	9.00	—
MRF262	15W	136-174	9.00	—
MRF264	30W	136-174	13.00	—
MRF607	1.75W	136-174	3.00	—
MRF641	15W	407-512	22.00	—
MRF644	25W	407-512	24.00	54.00
MRF646	40W	407-512	26.50	59.00
MRF648	60W	407-512	33.00	69.00
2N3866*	1W	30-200	1.25	—
2N4427	1W	136-174	1.25	—
2N5591	25W	136-174	13.50	34.00
2N5642*	20W	30-200	13.75	34.50
2N5945	4W	407-512	10.00	—
2N5946	10W	407-512	12.00	—
2N6080	4W	136-174	6.25	—
2N6081	15W	136-174	7.50	—
2N6082	25W	136-174	8.90	—
2N6083	30W	136-174	9.30	24.00
2N6084	40W	136-174	11.75	28.50

### TMOS FET

MRF134*	5W	2-200	\$10.50	—
MRF137*	30W	2-200	22.50	—
MRF138**	30W	1.5-150	35.00	—
MRF150**	150W	1.5-150	80.00	—
MRF172*	80	2-200	65.00	—

Selected, matched finals for Kenwood, Yaesu, Icom, Atlas, etc. Technical assistance and cross-reference information on CD, PT, RF, SRF, SD P/Ns.

**QUANTITY DISCOUNTS AVAILABLE**  
**WE SHIP SAME DAY C.O.D./VISA/MC**  
INFORMATION AND CALIF. ORDERS: (619) 744-0728  
OUTSIDE CALIF. ORDER DESK: 800-854-1927



## RF PARTS

1320-16 Grand Ave., San Marcos  
California 92069 (619) 744-0728

# THE GUERRI REPORT by Ernie Guerri, W6MGI

## **new communications satellites will use laser links**

A new concept in communications satellites is in the development stages in European laboratories. The large data capacity of optical communications links will be exploited by incorporating a carbon dioxide laser into a geosynchronous satellite. The CO<sub>2</sub> laser operates in the far infrared region, at a wavelength of about 11 microns (27,000,000 MHz).

In spite of substantial technical hurdles, its benefits are thought to justify the effort. Advantages include simultaneous bi-directional data capacity of more than 1 gigabit/sec., with an accuracy of about 10 bits (an error rate of 1 part in 10<sup>9</sup>) at an altitude of about 37,000 km. The transmissions would have high resistance to interference and jamming because the frequencies are removed from present high-density traffic, and the laser beam is very narrow — less than 1 km wide at geosynchronous altitude.

The choice of the CO<sub>2</sub> laser is based on the fact that highly sensitive detectors already exist, the technology for the needed power levels is well advanced, and relatively conventional optics can be used. The system would consume about 250 watts in order to produce a little more than 1 watt of modulated power. Transmitter bandwidth will be about 5 GHz, permitting higher data rates as technology and traffic demand mature. Two technical areas will need considerable attention in order to achieve successful operation. The optical receivers need to be cooled to -173 degrees C (100 degrees K) for optimum sensitivity, and the pointing and tracking system must be able to keep the very narrow

beam centered on the respective receivers. Present technology is marginal in each of these areas.

Components for the planned satellite will begin to be assembled as a laboratory breadboard as early as 1987. The first flight tests are planned for 1990-91, and an operational satellite is contemplated for 1994-95.

## **emergency transmitter gives directions when lost**

The Federal Aviation Administration requires that all aircraft carry an emergency locator transmitter (ELT) that can help pinpoint the aircraft's location in the event of a crash. The device is a small battery-powered unit that transmits on 121.5 and 243.0 MHz. A newly-developed unit takes full advantage of today's IC's to greatly enhance the data sent by the beacon.

As the aircraft flies, a circuit in the locator continuously enters the current position of the plane from the aircraft's LORAN-C navigation system. In the event of a crash, the locator broadcasts a synthesized speech message beginning with the word "mayday" and stating the aircraft's registration number, its longitude/latitude, the elapsed time since impact (very important in harsh environments), and other key information — all in plain English. This improvement will simplify search and rescue operations and expand the number and type of observers who can participate in radiolocation searches — Amateurs, SWLs, scanner buffs, and so on.

## **chip inductors join new component ranks**

Since the beginning of the era of solid-state circuits, component manufacturers have been quick to keep pace with designers' needs. Components of all types have shrunk in size and taken

on the shapes appropriate to the application. Inductors have resisted most attempts at going "monolithic" and have caused a lot of otherwise elegant designs to be much larger and less reliable than the designer might have wished.

We still haven't found any magic way to solve the problem, but there has been significant progress in magnetic materials combined with creative new packaging techniques. Given incentive by the move to surface-mounted components, leadless "chip" inductors are making their debut. Using ceramic or ferrite cores, these ultra-miniature inductors can be made with very small gauge wire because of the low power levels associated with modern IC circuits. Eliminating leads also reduces stray capacitance and parasitic inductance, thereby making the component a little closer to ideal.

Chip inductors have evolved in a few "standard" packages, which makes the layout job easier for the circuit designer. Inductance values cover the full range from about 3 nH to 1 mH, and include both fixed and variable type. Because these inductors mount directly on the circuit substrate, great care must be taken in the choice of temperature coefficients. If the inductor is not matched to the substrate, expansion and contraction can cause severe lead stress, and in the worst cases can actually lift the inductor from the substrate. Shielding poses serious problems on all but small inductance values. At present, shielding simply takes up real estate — which of course defeats the purpose of using the chip inductors. Notwithstanding the difficulties, before long you can expect to be staring at a totally unfamiliar-looking component on a circuit board — a "chip" inductor.

**ham radio**

# SUBSCRIBE

AND RENEW  
TOLL-FREE

**ham  
radio**  
magazine



1 YR - \$22.95 2 YRS - \$38.95

3 YRS - \$49.95

Prices U.S. only

MASTERCARD

VISA

Please have your charge card ready.

BILL ME

DATATEL 800™

## 800-341-1522

Weekdays 8 AM - 9 PM EST • Saturdays 9 AM - 5 PM EST  
IN MAINE CALL COLLECT (207) 236-2896

**OUR 800 NUMBER IS FOR SUBSCRIPTION ORDERS ONLY!**

For Errors or Change of Address CALL *ham radio*  
direct at (603) 878-1441 8-5 EST

## MULTI BAND TRAP ANTENNAS

### TRAP DIPOLES:

Model	Bands	Traps	Length	Price
D-42	10/15/20/40	2	55"	\$59.95
D-52	10/15/20/40/80	2	105"	54.95
D-56	10/15/20/40/80	6	82"	109.95
D-66	10/15/20/40/80/160	6	163"	129.95

### TRAP VERTICALS - "SLOPERS":\*

VS	Bands	Traps	Length	Price
VS-41	10/15/20/40	1	28"	44.95
VS-52	10/15/20/40/80	2	49"	59.95
VS-53	10/15/20/40/80	3	42"	69.95
VS-64	10/15/20/40/80/160	4	73"	89.95

\*Can be used without radials  
\*Feed line can be buried if desired

\*Permanent or Portable Use

ALL TRAP ANTENNAS are Ready to use - Factory assembled - Commercial Quality - Handle full power - Comes complete with - Deluxe Traps, Deluxe center connector, 14 ga Stranded CopperWeld ant. wire and End Insulators. Automatic Band Switching - Tuner usually never required - For all Transmitters, Receivers & Transceivers - For all class amateurs - One feedline works all bands - Instructions included - 10 day money back guarantee!

### SINGLE BAND DIPOLES (Kit form):

Model	Band	Length	Price
D-15	15	22"	18.95
D-20	20	33"	19.95
D-40	40	66"	22.95
D-80	80-75	130"	25.95
D-160	160	260"	34.95

Includes assembly instructions, Deluxe center connector, 14 ga Stranded CopperWeld Antenna wire and End insulators.

### COAX CABLE: (includes PL-259 connector on each end)

Type	Length	With antenna purchase	Separately
RG-58	50'	\$8.00	\$11.95
RG-58	90'	12.00	16.95

### DELUXE CENTER CONNECTOR

- NO RUST Brass Terminals
- NO Jumper Wires Used
- NO Soldering
- Built in Lightning Arrestor
- With 50 23R Receptacle
- Handles Full Power!
- Completely Sealed - Weatherproof
- Easy Element Adjustments
- Commercial Quality



### DELUXE ANTENNA TRAPS: Completely sealed & weatherproof - Solid brass terminals - Handles Full Power - NO jumpers - NO Soldering

- Instructions included
- For 4-band Dipole Ant. 40/20/15/10 \$36.00/pr
- For 5-band Dipole Ant. 80/40/20/15/10 \$38.00/pr

ORDER DIRECT FROM FACTORY: All orders shipped US Postpaid VISA/MC - give card #, Exp. date, Signature

### SPI-RO MANUFACTURING, INC.

Dept. 103, P.O. Box 1538

Hendersonville, NC 28793

Dealer Inquiries Invited



✓ 183

## NEW BOOKS

### AMATEUR RADIO SOFTWARE by John Morris, GM4ANB

Brand new from RSGB, this computer source book is chock full of computer programs, hints, tips and handy ideas for computer owners and users. Nearly 100 programs include contest logging routines, EME, construction, Morse training, and Packet Radio to name just a few. Morris' approach to writing this book was twofold. One was to give the computer user programs that had been de-bugged and were ready to type in and run. The second was as a source book for programming ideas and expansion. Most programs are written in BASIC so at least a fundamental knowledge of simple programming will be helpful to get maximum use from this book. 1985 328 pages 1st edition.

RS-ARS

Hardbound \$14.95

### ARRL COMPUTER NETWORKING CONFERENCES 1-4 Pioneer Papers on Packet Radio 1981-1985

This collection of Packet Radio papers should be in every Packet enthusiasts shack! Written during the formative years of Packet development, these papers (too numerous to mention them all) cover: theory, practical applications, protocols, software and hardware subjects. You also get a complete up-to-date collection of all published "Gateway", the ARRL Packet Radio newsletter. As big as the ARRL HANDBOOK, this new book is sure to be the ARRL's next best seller! 1985 over 1000 pages.

AR-CNC

Softbound \$17.95

Please enclose \$3.50 shipping and handling



**HAM RADIO'S BOOKSTORE** Greenville, NH 03048

## Crystal Filters

for KENWOOD TS830, TS930, TS940

Our filters have received universal praise. As famous contesteer VE3BMV wrote recently in Radiosporting's review: *Kenwood filters are great but 8-pole Fox Tango filters are better. I have put a pair in my 930 and the improvement is fantastic.*

**FOX TANGO MATCHED-PAIR FILTER KITS**  
2.1 kHz for SSB: 400 Hz for CW .....\$170/pair  
Both SSB and CW SPECIAL .....\$315 for four

Kits include detailed instructions and all needed parts. Specify bandwidths and Kenwood Model when ordering. FOX TANGO filters equal or exceed the claims of imitators. Why risk disappointment? Get the real thing!  
SHIPPING: \$5 Air (US & Canada) \$12 Elsewhere  
Order by mail or phone • VISA/MC or COD accepted  
Ask about Our Filters For Many Other Rigs

**FOX-TANGO Corp.**

Box 15944, W. Palm Bch, FL 33416  
Telephone: (305) 683-9587

# 1986 CALLBOOKS

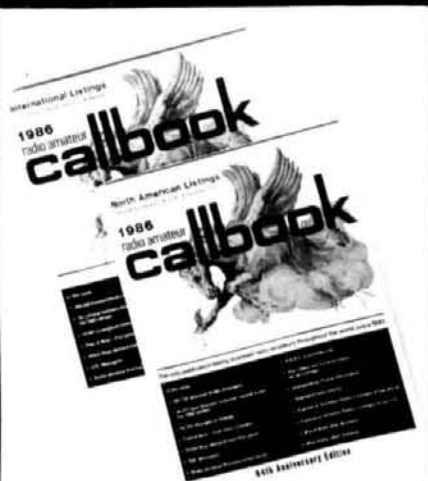

## The "Flying Horse" has a great new look!

It's the biggest change in Callbook history!  
Now there are 3 new Callbooks for 1986.

The North American Callbook lists the amateurs in all countries in North America plus those in Hawaii and the U.S. possessions.

The International Callbook lists the calls, names, and address information for licensed amateurs in all countries outside North America. Coverage includes Europe, Asia, Africa, South America, and the Pacific area (exclusive of Hawaii and the U.S. possessions).

The Callbook Supplement is a whole new idea in Callbook updates. Published June 1, 1986, this Supplement will include all the activity for both the North American and International Callbooks for the preceding 6 months.

Publication date for the 1986 Callbooks is December 1, 1985. See your dealer or order now directly from the publisher.

- North American Callbook  
incl. shipping within USA \$25.00  
incl. shipping to foreign countries 27.60
- International Callbook  
incl. shipping within USA \$24.00  
incl. shipping to foreign countries 26.60
- Callbook Supplement, published June 1st  
incl. shipping within USA \$13.00  
incl. shipping to foreign countries 14.00

### SPECIAL OFFER

- Both N.A. & International Callbooks  
incl. shipping within USA \$45.00  
incl. shipping to foreign countries 53.50

Illinois residents please add 6 1/4% sales tax.  
All payments must be in U.S. funds.

RADIO AMATEUR  
**callbook** INC.



Dept. F  
925 Sherwood Dr., Box 247  
Lake Bluff, IL 60044, USA

Tel: (312) 234-6600



## ADVERTISER'S INDEX AND READER SERVICE NUMBERS

Listed below are the page number and reader service number for each company advertising in this issue. To get more information on their advertised products, use the bind-in card found elsewhere in this issue, select the correct reader service number from either the ad or this listing, check off the numbers, fill in your name and address, affix a postage stamp and return to us. We will promptly forward your request to the advertiser and your requested information should arrive shortly. If the card is missing, send all the pertinent information on a separate sheet of paper to: *ham radio* magazine, Attn: Reader Service, Greenville, NH 03048.

READER SERVICE #	PAGE #	READER SERVICE #	PAGE #
167 - ADN	91	159 - Elaine Martin, Inc.	79
107 - Advanced Computer Controls, Inc.	13	147 - Glen Martin Engineering	63
122 - Advanced Receiver Research	37	106 - MFJ Enterprises	8
144 - AEA	60	157 - Minds Eye Publications	79
160 - All Electronics Corp	80	142 - Mirage/KLM	55
131 - Amateur Wholesale Electronics	49	168 - Multibotics, Inc.	91
165 - AMSAT	86	115 - N&G Distributing Corp.	29
112 - Archway Data Systems	26	153 - Nema Electronics	66
162 - ARRL	83	169 - Nuts & Volts	92
* Barker & Williamson	48	108 - P.C. Electronics	20
* Barry Electronics	79	145 - Pac-Comm Packet Radio Systems, Inc.	62
121 - R.H. Bauman Sales	37	172 - Pacific Rim Communications	94
140 - Bilal Company	50	113 - Pipo Communications	26
173 - Brincomm Technology	96	125 - Pipo Communications	38
148 - Buckmaster Publishing	63	158 - Processor Concepts	79
* Butternut Electronics	26	156 - Propagation Publishing	70
129 - CCIE Mfg	48	118 - The PX Shack	35
117 - Coaxial Dynamics, Inc.	35	180 - OEP's	100
138 - Colorado Comm Center	50	275 - OSKY Publishing	79
110 - Communication Concepts, Inc.	26	185 - Radio Amateur Callbook	110
128 - Communications Specialists	41	164 - Radiosporting	86
186 - Connect Systems, Inc.	112	163 - Ramsey Electronics, Inc.	84
130 - CTM	48	182 - RF Parts/Westcom Eng	107
127 - Data World Products	38	175 - Roensch Microwave	96
174 - DCC Data Service, Inc.	96	161 - Silicon Solutions, Inc.	83
* Dick Smith Electronics	47	* Spec Com	94
155 - Digitrex	70	114 - Spectrum International, Inc.	28
171 - Down East Microwave	94	183 - Spi Ro Distributing	109
132 - EEB	42	141 - STV OnSat	54
176 - EGE, Inc.	97	179 - Sultronics	100
* Engineering Consulting	76	119 - Synthetic Textiles, Inc.	37
134 - ESS	42	181 - TechMart	100
146 - Exmet	63	170 - Technical Development Systems	94
123 - Fox International, Inc.	37	154 - Tel Com	70
* Fox Tango Corp	109	116 - Telewave, Inc.	33
152 - GLB Electronics	66	133 - Transverters Unlimited	42
124 - Grove Enterprises	38	* University Microfilm Int	70
136 - H L Heaster, Inc.	47	120 - Vanguard Labs	37
109 - Hal Communications Corp.	23	177 - W9INN Antennas	98
126 - Hall Electronics	38	137 - Wacom Products, Inc.	47
143 - Ham Radio Outlet	56, 57	135 - Wenzel Associates, Inc.	47
* Ham Radio's Bookstore	15, 28, 36, 50, 60, 62, 63, 65, 70, 83, 86, 94, 97, 99, 100, 104, 109	150 - Western Electronics	63
* The Ham Station	36	139 - World Tech Products	98
* The Ham Station	99	187 - Yaesu Electronics Corp	Cover III
* Hamtronics, NY	93	149 - Yaesu Electronics Corp	63
178 - Hamtronics, PA	100		
* Hamtronics, PA	128		
104 - ICOM America, Inc.	Cover II		
151 - Jun's Electronics	65		
105 - Kantronics	1		
184 - Kenecom/MCS	111		
* Trio Kenwood Communications	2, 5, 7, 16, Cover IV		
166 - Madison Electronics Supply	88		

### PRODUCT REVIEW/NEW PRODUCT

* Digitrex	105
302 - Heath Company	105
304 - Mercer Electronics	105
301 - MFJ Enterprises	105
303 - Nema Electronics	105

\*Please contact this advertiser directly.

Limit 15 inquiries per request.

Please use before July 31, 1986.



# Message Master™

Real-voice message system  
for any repeater or base



Now you can communicate vital information even when the station you are calling is not on the air — with Message Master. Message Master is a solid state voice recording system which can record messages just by listening to you speak, store messages in memory, and deliver messages on demand. If you can't be there to deliver your messages let Message Master deliver them for you - any messages in any language and in your own voice!

Message Master connects easily to any radio system for remote access: repeaters, base stations, even transceivers. It can even be connected to an autopatch device to exchange messages between your radio system and the telephone network.

Message Master is a multi-user system with mailbox style personalized message service for a hundred users. With 8 minutes of message storage it can store hundreds of messages simultaneously making it ideal for large, active repeater groups.

Would you like your callsign identifications, tail messages, and bulletin messages sent in real-voice? Message Master can send them so. Record several identification messages and it will even send a different ID each time. Almost like magic, Message Master knows when to send identifications and tail messages so it needs no special control signals from your base or repeater.

Call or write for further information before you make another wasted call.

Commercial users: Ask for a brochure on the Message Master Electronic Dispatcher with group and all call messaging.

- **Create messages just by talking.** Message Master's 'real-voice' technique saves YOUR VOICE in digital memory to deliver messages in your own voice, language and dialect.
- **Mailbox-style operation gives individual message delivery service to 100 system users.**
- **Easily added to any repeater or base station for remote operation with only four connections.**
- **Special features include callsign identifications, tail messages, and bulletin messages.**
- **Digital message storage provides instant playback of stored messages.**
- **Modular memory meets your exact needs from 2 to 8 minutes of total message storage.**

## Serving all your repeater needs

- *Mark 4 Repeaters and Repeater Controllers are THE PERFORMANCE LEADERS with real voice, more autodial numbers, more synthesized voice and more features.*
- *Mark 3 Repeaters offer the winning combination of high performance and high value.*
- *LR-1 Repeaters boast superb RF circuitry at an economical price.*
- *MR-4 Receivers with 7 helical resonators are the only receivers to choose in harsh RF environments.*
- *PA-100 Amplifiers with rugged TMOS power FETs give you a continuous duty high power signal.*



COMING SOON: A 4-channel receiver voting system which operates on true signal-to-noise ratio to extend your coverage by linking to remote receivers.

**KENDECOM INC.**  
**MICRO CONTROL SPECIALTIES**

23 Elm Park  
Groveland, MA 01834  
(617) 372-3442

## THINGS TO LOOK FOR (AND LOOK OUT FOR) IN A PHONE PATCH

- One year warranty.
- A patch should work with any radio. AM, FM, ACSB, relay switched or synthesized.
- Patch performance should not be dependent on the T/R speed of your radio.
- Your patch should sound just like your home phone.
- There should not be any sampling noises to distract you and rob important syllables. The best phone patches do not use the cheap sampling method. (Did you know that the competition uses VOX rather than sampling in their \$1000 commercial model?)
- A patch should disconnect automatically if the number dialed is busy.
- A patch should be flexible. You should be able to use it simplex, repeater aided simplex, or semi-duplex.
- A patch should allow you to manually connect any mobile or HT on your local repeater to the phone system for a fully automatic conversation. Someone may need to report an emergency!
- A patch should not become erratic when the mobile is noisy.
- You should be able to use a power amplifier on your base to extend range.
- You should be able to connect a patch to the MIC and EXT. speaker jack of your radio for a quick and effortless interface.
- You should be able to connect a patch to three points inside your radio (VOL high side, PTT, MIC) so that the patch does not interfere with the use of the radio and the VOL. and SQ. settings do not affect the patch.
- A patch should have MOV lightning protectors.
- Your patch should be made in the USA where consultation and factory service are immediately available. (Beware of an inferior offshore copy of our former PRIVATE PATCH II.)

**ONLY  
PRIVATE PATCH III  
GIVES YOU ALL  
OF THE ABOVE**

# PRIVATE PATCH III

## SIMPLEX SEMI-DUPLEX INTERCONNECT

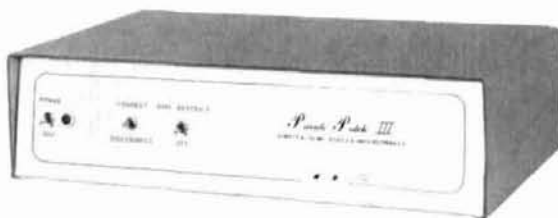

The telephone is the most powerful mode of communications . . . PRIVATE PATCH III gives you full use of your home telephone from your mobile and HT radios!

### VOX . . . the right choice!

With only three simple connections to your base station radio, PRIVATE PATCH III will give you more communications power per dollar than you ever imagined possible.

Suddenly the utility of your radio is drastically increased. There are new sounds . . . dial tones, ring tones, CW ID and the sound of voices you never expected to hear on your mobile or HT radio! What a convenience!

PRIVATE PATCH III frees you from memberships, cliques and other hassles common to many repeater autopatches. You can call who you want, when you want and for as long as you want. You can even receive your incoming calls!

To Learn more about PRIVATE PATCH III and the advantages of the VOX concept, call or write for our four page brochure today!

VOX based phone patches offer many performance and operational advantages over the sampling method. These include operation through repeaters, compatibility with an radio, no lost words or syllables, greater range smooth audio free of continual noise bursts etc., etc.

Most amateurs are not aware that the competition's top of the line patch is VOX based. (You know . . . the \$1000 model they enthusiastically call "our favorite commercial simplex patch on page 3 of their SP brochure.)

PRIVATE PATCH III offers about the same capability, performance and features as the top model but is priced closer to their bottom of the line (SP) model!

So why settle for SP when top of the line cost little more?

### PARTIAL LIST OF FEATURES

- OPERATES SIMPLEX, THROUGH REPEATERS, OR DUPLEX ON REPEATERS • VOX BASED • TOL RESTRICT (Digit counting and programmable first digit lockout) • SECRET CODE DISABLES TOL RESTRICT FOR ONE TOLL CALL—Automatic re-arm • AUTOMATIC BUSY SIGNAL DISCONNECT
- CONTROL INTERRUPT TIMER (Maintains positive mobile control) • CW ID When you connect again o disconnect. Free ID chip. • SELECTABLE TONE OR PULSE DIALING • MOV LIGHTNING PROTECTORS
- THREE DIGIT ACCESS CODE (e.g. ★91) • RINGOUT (Reverse patch) Ringout inhibit if channel busy
- RESETTABLE THREE MINUTE TIMER • SPARE RELAY POSITION • 115VAC SUPPLY

Options:  
FCC approved coupler  
12 VDC or 230 VAC power

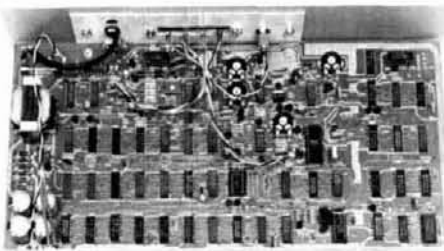

### DEALERS

- |  |   |
|--|---|
| AMATEUR ELECTRONIC SUPPLY<br>Milwaukee WI, Wickliffe Oh,<br>Orlando FL, Clearwater FL,<br>Las Vegas NV | MADISON ELECTRONICS SUPP<br>Houston, TX         |
| BARRY ELECTRONICS CORP.<br>New York, NY  | MIAMI RADIO CENTER CORP.<br>Miami FL            |
| COLES COMMUNICATIONS<br>San Antonio TX   | MIKES ELECTRONICS<br>Ft. Lauderdale, Miami FL   |
| EGE, INC.<br>Woodbridge, VA  | N&G DISTRIBUTING CORP.<br>Miami FL              |
| ERICKSON COMMUNICATIONS<br>Chicago IL  | PACE ENGINEERING<br>Tucson AZ                   |
| HAM RADIO OUTLET<br>Anaheim CA, Burlingame CA,<br>Oakland CA, Phoenix AZ,<br>San Diego CA, Van Nuys CA | THE HAM STATION<br>Evansville IN                |
| HENRY RADIO<br>Los Angeles CA  | TEXAS TOWERS<br>Plano, TX                       |
| INTERNATIONAL RADIO<br>SYSTEMS<br>Miami, FL  | TNT RADIO SALES<br>Robbinsdale, MN              |
| JUNS ELECTRONICS<br>Culver City CA   | WESTCOM<br>San Marcos, CA                       |
|  | CANADA:<br>DOLLARD ELECTRONICS<br>Vancouver, BC |
|  | SKYWAVE RADIO SYSTEMS, L'<br>Burnaby, B.C.      |

**CONNECT  
SYSTEMS  
INCORPORATED**

(213) 373-6803

23731 Madison St., Torrance, CA 90501

# More output for the money you put out.



Why buy a low-power thumbwheel HT when Yaesu's high-power handhelds are available for virtually the same price?

Ours give you 2.5 watts RF output right off the shelf. Or 3.7 watts with the optional FNB-4 battery pack.

Ours come with a hi/low power switch. A relative signal strength/PO meter with nightlight. And built-in VOX capability. (Optional headset required.)

Plus ours offer options like a DTMF keypad. And a plug-in sub-audible tone board with both encode and decode capability.

And thanks to our unique robotic assembly of surface mount components, it's all enclosed in a lightweight and compact case, measuring just 2.6 x 1.4 x 6.1 inches.

Choose from three models: the FT-203R for 2 meters, the FT-703R for 440 MHz, and the FT-103R for 220 MHz.

As standard equipment you get a rechargeable battery, AC wall charger, rubber duck, earphone, belt clip and soft case.

Plus a wealth of optional accessories. Including a fast charger, VOX headset with boom mic. Mobile

radio hanger. Speaker/microphone. DC car adapter. And much more.

So don't settle for low power in a thumbwheel HT.

Go with Yaesu. The best way to get more power for your dollar.

## YAESU

### Yaesu USA

17210 Edwards Road, Cerritos, CA 90701  
(213) 404-2700

### Yaesu Cincinnati Service Center

9070 Gold Park Drive, Hamilton, OH 45011  
(513) 874-3100

Prices and specifications subject to change without notice.

# KENWOOD

...pacesetter in Amateur radio

Here Now  
220 MHz

## 220: Kenwood Style!

### TM-3530A

The first comprehensive  
220 MHz FM transceiver

**TM-3530A—25 watts of 220 MHz FM—Kenwood style! Features include built-in 7-digit telephone number memory, auto dialer, direct frequency entry and big LCD. All this makes the TM-3530A the most sophisticated rig on 220 MHz!**

- **First** mobile transceiver with telephone number memory and auto-dialer (up to 15 seven-digit telephone numbers)
- Frequency range 220-225 MHz
- Automatic repeater offset selection—**a Kenwood exclusive!**
- Direct keyboard entry of frequency
- 23-channel memory for offset, frequency and sub-tone



- Big multi-color LCD and back-lit controls for excellent visibility
- Optional front panel programmable 38-tone CTCSS encoder **includes 97.4 Hz**

- Frequency lock switch
- Digital Channel Link (DCL) option
- **Unique** offset microphone connector—relieves stress on microphone cord

### TH-31AT/31A

**Kenwood's advanced technology brings you a new standard in pocket/handheld transceivers!**

- 1 watt high, 150 mW low
- Super compact and lightweight (about 8 oz. with PB-21)
- Frequency range 220-224.995 MHz in 5-kHz steps
- Repeater offset: -1.6 MHz, reverse, simplex
- **Supplied accessories:** rubber flex antenna, earphone, wall charger, 180 mAh NiCd battery and wrist strap
- Quick change, locking battery case
- Rugged, high-impact case

TH-31AT/31A optional accessories:

- **HMC-1** headset with VOX
- **SMC-30** speaker microphone
- **PB-21** NiCd 180 mAh battery
- **PB-21H** NiCd 500 mAh battery
- **DC-21** DC-DC converter for mobile use
- **BT-2** manganese/alkaline battery case
- **EB-2** external C manganese/alkaline battery case
- **SC-8/8T** soft cases with belt hook
- **TU-6** programmable sub-tone unit
- **AJ-3** thread-loc to BNC female adapter
- **BC-6** 2-pack quick charger
- **BC-2** wall charger for PB-21H
- **RA-9A** StubbyDuk antenna
- **BH-3** belt hook

- 16-key DTMF pad, with audible monitor
- Center-stop tuning—**another Kenwood exclusive!**
- **New** 5-way adjustable mounting system
- High performance GaAs FET front end receiver
- HI/LOW power switch (adjustable LOW power)



TH-31AT with DTMF pad shown  
Optional RA-9A attached



TM-3530A optional accessories:

- **PS-430** DC power supply
- **TU-7** 38-tone CTCSS encoder
- **MU-1** DCL modem unit
- **VS-1** voice synthesizer
- **PG-2K** extra DC cable
- **PG-3A** DC line noise filter
- **MB-10** extra mobile bracket
- **CD-10** call sign display
- **MC-60A/MC-80/MC-85** desk mics.
- **MC-48** extra DTMF mic. with UP/DOWN switch
- **MC-42S** UP/DOWN mic.
- **MC-55** (8 pin) mobile mic. with time-out timer
- **SP-40** compact mobile speaker
- **SP-50** mobile speaker
- **SW-200B** SWR/power meter
- **SW-100** compact SWR/power meter

# KENWOOD

TRIO-KENWOOD COMMUNICATIONS  
1111 West Walnut Street  
Compton, California 90220

Complete service manuals are available for all Trio Kenwood transceivers and most accessories.  
Specifications and prices are subject to change without notice or obligation.