

\$1.50

# ham radio

magazine



## SEPTEMBER 1978

broadband balun	12
T-network	22
matching 75-ohm cable	31
RTTY modulator- demodulator	34
1-GHz prescaler	84
and much much more . . .	

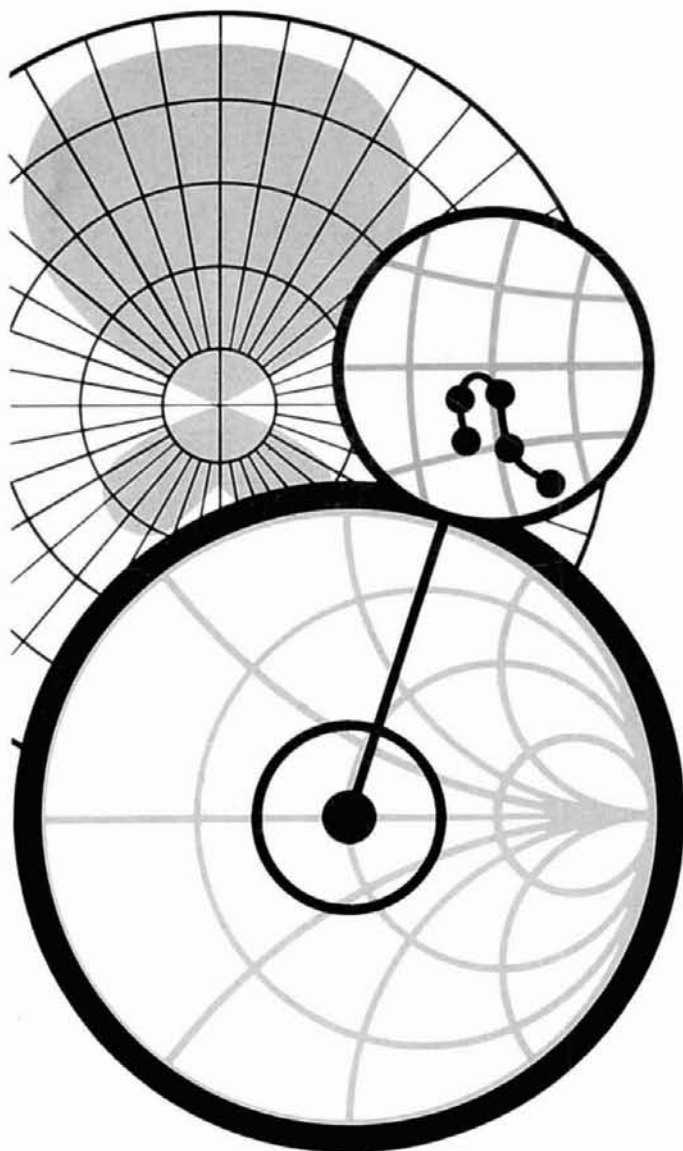

Antenna Matching Systems

# Before you buy an amplifier



## Lift the Lid

Before you invest your hard earned money in a linear amplifier, consider what's inside. That's where the difference in quality is obvious. No lightweight, cheaply built components... In Henry amplifiers you will find only the best quality, heavy duty components. We build our amplifiers to perform at peak level month after month, year after year. Both the 2KD-5 and the 2K-4 will operate full legal power continuous duty on all modes. We offer the amateur the linear amplifier that we would want in our own stations.

At Henry Radio we know how to build only one kind of amplifier...the best!

### 2KD-5 GENERAL SPECIFICATIONS:

- \* The 2KD 5 is a 2000 watt PEP input (1200 watt PEP nominal output) RF linear amplifier, covering the 80, 40, 20, and 15 meter amateur bands.
- \* Two Eimac 3 500Z glass envelope triodes operating in a grounded grid circuit.
- \* Pi-L plate circuit with a rotary silver plated tank coil for greatest efficiency and maximum attenuation of unwanted harmonics.
- \* Full legal input in all modes. 2000 watts PEP input for SSB, 1000 watts DC input for CW, RTTY and AM.
- \* Jumper for 115 or 230 VAC, 3 wire single phase.
- \* 10.5" high x 15" wide x 17.5" deep
- \* Price... \$895.00

**2K-4...LINEAR AMPLIFIER.** Offers engineering, construction and features second to none. Provides a long life of reliable service, while its heavy duty components allow it to loaf along even at full legal power. Operates on all amateur bands, 80 thru 15 meters. If you want to put that strong clear signal on the air that you've probably heard from other 2K users, now is the time. Move up to the 2K-4 Floor console. \$1095.00

**TEMPO 2002.** The same fine specs and features as the 6N2, but for 2 meter operation only... \$745.00

**TEMPO VHF/UHF AMPLIFIERS.** Solid state power amplifiers for use in most land mobile applications. Increases the range, clarity, reliability and speed of two-way communications. FCC type accepted also.

**LOW BAND VHF AMPLIFIERS (35 to 75 MHz)**  
FCC Type Accepted only.

Model	Drive Power	Output Power	Price
Tempo C100C30	30W	100W	\$250.00
Tempo C100C10	10W	100W	\$240.00
Tempo C100C02	2W	100W	\$285.00

**HIGH BAND VHF AMPLIFIERS (135 to 175 MHz)**

Tempo 130A30	30W	130W	\$199.00
Tempo 130A10	10W	130W	\$189.00
Tempo 130A02	2W	130W	\$209.00
Tempo 80A30	30W	80W	\$159.00
Tempo 80A10	10W	80W	\$149.00
Tempo 80A02	2W	80W	\$169.00
Tempo 50A10	10W	50W	\$ 99.00
Tempo 50A02	2W	50W	\$129.00
Tempo 30A10	10W	30W	\$ 69.00
Tempo 30A02	2W	30W	\$ 89.00

**UHF AMPLIFIERS (400 to 512 MHz)**

Tempo 70D30	30W	70W	\$210.00
Tempo 70D10	10W	70W	\$240.00

Tempo 70D02	2W	70W	\$270.00
Tempo 40D10	10W	40W	\$145.00
Tempo 40D02	2W	40W	\$165.00
Tempo 25D02	2W	25W	\$125.00
Tempo 10D02	2W	10W	\$ 75.00

**TEMPO 100A10 VHF LINEAR AMPLIFIER.** Completely solid state, 144-148 MHz. Power output of 100 watts (nom.) with only 10 watts (nom.) in. Reliable and compact... \$209.00  
TEMPO 100A10/B BASE AMPLIFIER. \$359.00

Henry Radio also offers a broad line of commercial and FCC type accepted amplifiers covering the range of 3 MHz to 500 MHz. Henry amplifiers are in use all around the world. Commercial and export inquiries are invited.

Tempo solid state amplifiers are available at Tempo dealers throughout the U.S.

please call or write for complete information.

# Henry Radio

All of the above except the 2002 are available at Tempo dealers throughout the U.S.

11240 W. Olympic Blvd., Los Angeles, Calif. 90064 213/477-6701  
931 N. Euclid, Anaheim, Calif. 92801 714/772-9200  
Butler, Missouri 64730 816/679-3127

Prices subject to change without notice

# ASK ANY HAM WHO OWNS ONE: THE Wilson

## SYSTEM ONE™ 20-15-10 METER TRIBANDER



*"One thing is for sure. If you can't hear the DX you can't work it. With my new System One by Wilson, that problem is all but eliminated. I can hear a lot of stations that others seem not to hear. Sure helps with the DX"*

... RON-WB4GWA  
HERMITAGE, TN.



*"Just put up a System One ... went up as slick as a whistle ... more pile-ups than I can handle".*  
... JOAN-WD6BNH  
SANTA BARBARA, CA.

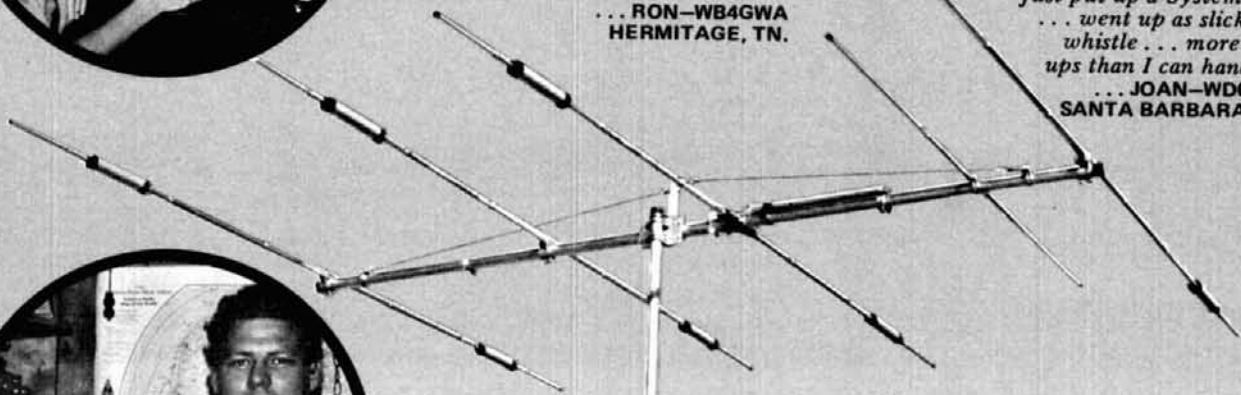

*... "As far as performance, the operation of the new System One is expressed by my increased success among the ruthless 20 meter pile-ups"*

... RICK-WB9AZN  
FT. WAYNE, IN.



*"After using the System One to contact DX stations throughout the world, I am convinced that it would take a much larger antenna to make any significant difference at either end. A frequent comment from European stations on 15 meters was, 'You are the only West Coast Station coming through'.*

*On 10 meters I worked all continents in less than 3 hours."*

... AL-K7ICW  
LAS VEGAS, NV.



*"The System One is providing good results ... it takes the waiting out of a pile-up."*  
... LES-N1BH  
NARRAGANSETT, R.I.

## ... THE ACCEPTED INDUSTRY STANDARD

From the seasoned professional operator to the novice ... all agree that the System One™ outperforms anything available ... the ultimate Tribander! Real monoband performance with 4 full elements on 20 and a separate 10 meter reflector, all on a 26' boom.

You can obtain more information on the System One™ and Wilson's other antenna, radio, tower and rotor products by contacting your nearest amateur dealer.



Consumer Products Division

# Wilson Electronics Corp.

4288 S. Polaris / P. O. Box 19000 / Las Vegas, Nevada 89119 / (702) 739-1931 / TELEX 684-522

# NEW! MFJ INTRODUCES THE GRANDMASTER MEMORY KEYERS

At \$139.95 this MFJ-484 GRANDMASTER memory keyer gives you more features per dollar than any other memory keyer available — and Here's Why . . .

**WEIGHT CONTROL** TO PENETRATE QRM. **PULL** TO COMBINE MEMORIES A AND B FOR 1, 2, OR 3 FIFTY CHARACTER MESSAGES.

**MESSAGE BUTTONS** SELECT DESIRED 25 CHARACTER MESSAGES.

**RESETS MEMORY** IN USE TO BEGINNING.

**SPEED CONTROL**, 8 TO 50 WPM. **PULL** TO RECORD.



**LEDs (4)** SHOW WHICH MEMORY IS IN USE AND WHEN IT ENDS.

**TONE CONTROL.** **PULL** TO TUNE.

**VOLUME CONTROL.** POWER ON-OFF.

**DELAY REPEAT CONTROL** (0 TO 2 MINUTES). **PULL** FOR AUTO REPEAT.

**LED INDICATES** DELAY REPEAT MODE.

**MEMORY SELECT:** POSITIONS 1, 2, 3 ARE EACH SPLIT INTO MEMORY SECTIONS A, B, C, D (UP TO TWELVE 25 CHARACTER MESSAGES). SWITCH COMBINES A AND B. **POSITION K** GIVES YOU 100, 75, 50, OR 25 CHARACTERS BY PRESSING BUTTONS A, B, C, OR D.

**NOW YOU CAN CALL CQ, SEND YOUR QTH, NAME, ETC., ALL AUTOMATICALLY.**

And only MFJ offers you the MFJ-484 Grandmaster memory keyer with this much flexibility at this price.

Up to twelve 25 character messages plus a 100, 75, 50, or 25 character message (4096 bits total).

A switch combines 25 character messages for up to three 50 character messages.

To record, pull out the speed control, touch a message button and send. To playback, push in the speed control, select your message and touch the button. That's all there is to it!

You can repeat any message continuously and even leave a pause between repeats (up to 2 minutes). Example: Call CQ. Pause. Listen. If no answer, it repeats CQ again. To answer simply start sending. LED indicates Delay Repeat Mode.

Instantly insert or make changes in any playing message by simply sending. Continue by touching another button.

Memory resets to beginning with button, or by tapping paddle when playing. Touching message button restarts message.

LEDs show which 25 character memory is in use and when it ends.

Built-in memory saver. Uses 9 volt battery, no drain when power is on. Saves messages in memory when power loss occurs or when transporting keyer. Ultra compact, 8x2x6 inches.

PLUS A MFJ DELUXE FULL FEATURE KEYER. Iambic operation with squeeze key. Dot-dash insertion.

Dot-dash memories, self-completing dots and dashes, jamproof spacing, instant start (except when recording).

All controls are on front panel: speed, weight, tone, volume. Smooth linear speed

control. 8 to 50 WPM.

Weight control lets you adjust dot-dash-space ratio; makes your signal distinctive to penetrate QRM.

Tone control. Room filling volume. Built-in speaker.

Tune function keys transmitter for tuning. Ultra reliable solid state keying: grid block, cathode, solid state transmitters (-300 V, 10 ma. max., +300 V, 100 ma. max.). CMOS ICs, MOS memories. Use 110 VAC or 12 to 15 VDC. Automatically switches to external batteries when AC power is lost.

OPTIONAL SQUEEZE KEY for all memory keyers. Dot and dash paddles have fully adjustable tension and spacing for the exact "feel" you like. Heavy base with non-slip rubber feet eliminates "walking". \$29.95 plus \$2.00 for shipping and handling.



THIS MFJ-482 FEATURES FOUR 25 OR A 50 AND TWO 25 CHARACTER MESSAGES.

- Speed, volume, weight, tone controls
- Combine memory switch
- Repeat, tune functions
- Built-in memory saver

**\$99<sup>95</sup>**



Similar to MFJ-484 but with 1024 bits of memory, less delay repeat, single memory operating LED. Weight and tone controls adjustable from rear panel. 6x2x6 inches. 110 VAC or 12 to 15 VDC.

THIS MFJ-481 GIVES YOU TWO 50 CHARACTER MESSAGES.

- Repeat function
- Tune function
- Built-in memory saver



**\$79<sup>95</sup>**



Similar to MFJ-482 but with two 50 character messages, less weight controls. Internal tone control. Volume control is adjustable from rear panel. 5x2x6 inches. 110 VAC or 12 to 15 VDC.

For Orders **Call toll-free 800-647-1800**

Order any product from MFJ and try it. If not delighted, return within 30 days for a prompt refund (less shipping). Order today. Money back if not delighted. One year unconditional guarantee. Add \$2.00 shipping/handling. For technical information, order/repair status, in Mississippi, outside continental USA, call 601-323-5869.

Order By Mail or Call TOLL FREE 800-647-1800 and Charge It On  

**MFJ ENTERPRISES, INC.** P. O. BOX 494 MISSISSIPPI STATE, MISSISSIPPI 39762

# ham radio

magazine

SEPTEMBER 1978

volume 11, number 9

**T. H. Tenney, Jr., W1NLB**  
publisher

**James R. Fisk, W1HR**  
editor-in-chief

**editorial staff**

Martin Hanft, WB1CHQ  
administrative editor

Charles J. Carroll, K1XX  
Patricia A. Hawes, WA1WPM  
Alfred Wilson, W6NIF  
assistant editors

Thomas F. McMullen, Jr., W1SL  
Joseph J. Schroeder, W9JUV  
associate editors

Wayne T. Pierce, K3SUK  
cover

**publishing staff**

C. Edward Buffington, WB1AMU  
assistant publisher

Fred D. Moller, Jr., WA1USO  
advertising manager

James H. Gray, W1XU  
assistant advertising manager

Therese R. Bourgault  
circulation manager

ham radio magazine  
is published monthly by  
Communications Technology, Inc  
Greenville, New Hampshire 03048  
Telephone: 603-878-1441

**subscription rates**

United States: one year, \$12.00  
two years, \$22.00; three years, \$30.00  
Canada: one year, \$14.00  
two years, \$26.00; three years, \$36.00

Europe, Japan, Africa:  
(via Air Forwarding Service)  
one year, \$25.00

North America, South America, Australia  
and Asia (except Japan):  
(via Surface Mail)  
one year, \$18.00

**foreign subscription agents**

Foreign subscription agents are  
listed on page 117

Microfilm copies  
are available from  
University Microfilms, International  
Ann Arbor, Michigan 48106  
Order publication number 3076

Cassette tapes of selected articles  
from ham radio are available to the  
blind and physically handicapped  
from Recorded Periodicals  
919 Walnut Street, 8th Floor  
Philadelphia, Pennsylvania 19107

Copyright 1978 by  
Communications Technology, Inc  
Title registered at U.S. Patent Office

Second-class postage  
paid at Greenville, N.H. 03048  
and at additional mailing offices  
Publication number 233340



## contents

**12 efficient broadband balun**

Joseph H. Reisert, Jr., W1JR

**16 20-meter delta-loop array**

Glenn S. Williman, N2GW

**22 T-network impedance matching  
to coaxial feedlines**

Jack M. Shulman, W6EBY

**28 75-ohm CATV cable  
for amateur installations**

Gordon K. Woods, W7VK

**31 matching 75-ohm CATV hardline  
to 50-ohm systems**

Charles J. Carroll, K1XX

**34 RTTY modulator-demodulator**

Howard L. Nurse, W6LLO

**42 integrated-circuit arrays**

Peter A. Lovelock, K6JM

**56 tracking down repeater jammers**

R. P. Haviland, W4MB

**64 high-performance rf-agc amplifier**

Andrew J. Borsa, WA1FRJ

**68 modified quad antenna**

Joseph B. W. Jackman, ZF1MA

**74 phase-locked loop fm demodulator**

Timothy A. Daneliuk, KL7IPS

**80 calibrating meter amplifiers**

Howard J. Stark, W4OHT

**84 1-GHz prescaler**

Robert S. Stein, W6NBI

**92 digital keyboard entry system**

Bruce McNair, N2YK  
Glenn S. Williman, N2GW

- |                              |                           |
|------------------------------|---------------------------|
| <b>4 a second look</b>       | <b>8 letters</b>          |
| <b>142 advertisers index</b> | <b>104 new products</b>   |
| <b>117 flea market</b>       | <b>6 presstop</b>         |
| <b>132 ham mart</b>          | <b>142 reader service</b> |
| <b>100 ham notebook</b>      | <b>84 weekender</b>       |

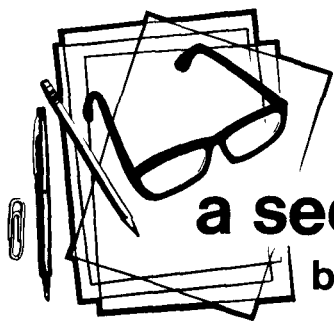

## a second look

by Jim Fisk

The editor of an amateur radio magazine must wear several different and diverse hats. In fact, I could use up several pages describing all the details that need attention to keep the magazine running smoothly. However, I'd like to talk for a moment about one very important task that sets the tone of the magazine: selection of articles.

Most of the articles published in *ham radio* are contributed by readers who want to share an idea or the details of a particularly successful project. Authors range from enthusiastic hams who have never written anything more than a short story for their English professor to fellows with engineering backgrounds who make their livings in front of a typewriter; all want to share an idea. I welcome the output of anyone who is interested in contributing something that will benefit all amateurs.

Prospective authors often ask, "What kind of articles are you looking for?" That's difficult to answer because new manuscripts arrive in the mail every day, so our needs are continually changing. However, I'm always on the lookout for simple construction projects that can be put together in one or two weekends. Larger projects are also welcome, but most of our readers must divide their leisure time between amateur radio and other interests, so they don't have time to build a Chinese copy of a complex piece of equipment. I'm also interested in good technical articles that cover any facet of radio communications.

Although I can accept only technical or construction articles for *ham radio*, articles for our sister publication, *Ham Radio Horizons*, can focus in on any aspect of amateur radio. In addition to simple construction projects for the beginner, I'm looking for DXpedition travelogues, adventure tales, articles on getting started in ham radio, and human interest stories with an amateur radio theme. If you have something you think would be of interest to our *Horizons* readers, I would like to have the opportunity to consider it for publication.

Once a month we set aside one or two days to go over all the manuscripts that have come in during the previous month. Since I seldom use more than a dozen articles in any issue, I don't accept more than that during any one-month period. This is sometimes a nearly hopeless task because there may be three-dozen or more to be considered. The first things I look for are originality and interest value. If the contribution passes this test, the next thing I look for is technical accuracy and attention to detail.

The contributed article doesn't have to be a literary masterpiece to be accepted. If you have a good idea and it's well documented, if the illustrations and technical discussion are clear and accurate — you may have a winner! On the other hand, if the article rambles from one topic to another, or presents inaccurate or misleading information, you will receive a rejection slip.

If your article has been accepted for publication, don't expect to see it published in the very next issue. The production times for a monthly magazine are probably much longer than you ever imagined. The articles for this issue, for example, were being prepared for publication during the month of May. As you are reading this we are putting together material for the December issue of *ham radio*.

In addition to writers, I am always on the lookout for new and unusual ways of *looking* at amateur radio, especially for *Ham Radio Horizons*. If you are an illustrator, painter, photographer, or sculptor, I would like to have an opportunity to review drawings, slides, or pictures of artwork for possible future consideration. Media can include airbrush, pen and ink, wash, watercolor, oils, collage, paper sculpture, *ad infinitum*; subject matter includes full-color covers and lead artwork for articles covering every aspect of amateur radio: antennas, hamshacks, satellites, vhf fm, DXing, field days, etc. Obviously, all artwork which is submitted for publication must be of professional caliber. Artwork done on consignment involves preliminary layouts or sketches, and must follow a regimented deadline schedule. If the prospect interests you or any part-time Rembrandts you know who enjoy amateur communications, write directly to our art editor, Jim Wales, for more information.

**Jim Fisk, W1HR**  
editor-in-chief

# The ICOM LSI System



## COMPATABILITY IS THE KEY TO SUCCESS

Owning an ICOM LSI radio is a true pleasure for anyone in Ham Radio. Putting two of them side by side in a matching station certainly more than doubles the pleasure and performance. The compatible styling of the **IC-211** and **IC-701** provides an operating station which is a beauty to look at as well as a joy to operate. The compactness of the units and the similarity of controls and switch layout help to take the confusion out of knowing which knob to turn. Microphones and other accessories are also compatible with both radios, such as the **RM-2** remote microprocessor frequency controller, shown above.

When used with the **IC-211** or **IC-701** (or **IC-245**, for that matter), the **RM-2** provides memory and frequency control, including automatic band change and memories for four different frequencies, plus auto-increment or single step tuning in 100 Hz, 1 KHz or 15 KHz steps. The **RM-2** also provides automatic offset for repeater operation when used with the **IC-211** or **IC-245**. The tone generator accommodates operation of telephone type devices or a two-tone signal for an external amp that needs to be tuned. (Naturally there is no tuning needed on an **IC-211** or **IC-701**.)

No one could ask for a better Oscar station than the **IC-211** and **IC-701** together for "mode A": and adding a transverter to the **IC-701** mode B or mode J opens newer, better satellite horizons. Within the ICOM LSI based radios there is the capacity for the technically minded Amateur to tune one radio of the pair with the VFO knob of the other. (Oscar transceive, anyone?) In addition, the LSI lends itself to being controlled by a parallel port on one of the increasing number of microprocessors now available for Amateur use.

The complexity of features built into these ICOM LSI twins will be used for a long time into the future. The possibilities are so numerous that even we have not thought of all of them yet.

All ICOM radios significantly exceed FCC specifications limiting spurious emissions.

Shown left to right: **IC-211**, multi-mode 4MHz trxvr; **RM-2**, remote microprocessor; **IC-701**, multi-mode HF trxvr; **IC-701PS**, power supply / speaker.

HF/VHF/UHF AMATEUR AND MARINE COMMUNICATION EQUIPMENT

DISTRIBUTED BY:



# ICOM

ICOM WEST, INC.  
Suite 3  
13256 Northrup Way  
Bellevue, Wash. 98005  
(206) 747-9020

ICOM EAST, INC.  
Suite 307  
3331 Towerwood Drive  
Dallas, Texas 75234  
(214) 620-2780

ICOM CANADA  
7087 Victoria Drive  
Vancouver B.C. V5P 3Y9  
Canada  
(604) 321-1833

EXPANSION OF U.S. AMATEUR PHONE bands, proposed in four Petitions for Rule Making (RMs 2150, 2828, 2870, and 2999), has been rejected by the FCC. The Petitions were dismissed on the grounds that the subject had already been covered in Docket 19162 and that the subject had already been covered in Docket 19162 and that strong opposition from overseas Amateurs made any U.S. subband expansion unwise at this time, just before the 1979 World Administrative Radio Conference, where the bands are likely to be shaken up anyway.

RESPONSE TO THE EIGHTH NOTICE of Inquiry on WARC 79 was by far the heaviest yet, with almost all of the increase apparently from Amateur Radio ranks. In a quick review of the 400 or so Amateur submissions, the majority — perhaps 95% — were concerned principally with potential Amateur losses at 160 and 80 meters and changing 40 to exclusively Amateur use. Most said a few words endorsing a new band at 160-190 kHz. The proposed new 10, 18, and 24 MHz Amateur bands got surprisingly little comment — though one Amateur actually opposed them as being ripoffs by Amateur equipment manufacturers so they can sell new gear!

Still Another Notice of Inquiry appears likely, with the end of September the target date to permit replies to be in and analyzed before the year's end. This NOI, if it does come out at all, would be of limited scope, probably touching only those areas in which severe conflicts still remain.

A COMBINED AMATEUR MEDIA and WARC Advisory Committee for Amateur Radio meeting is being considered for sometime in October, following release of the anticipated additional WARC Notice of Inquiry. Tentative plans are to have the two-day session in Gettysburg, where excellent meeting facilities are available and those attending would have a chance to see the Commission's licensing facility in operation.

Suggestions As To Topics for the media meeting, timing and location should go to John Johnston at the FCC.

CB RULES VIOLATORS and "HF" outlaws are losing not only their CB licenses but their right to upgrade (legitimately) to an Amateur license. FCC releases have detailed a number of such cases in which an otherwise qualified applicant for an Amateur license was rejected because of a past history of FCC rules violations, plus several cases in which the licenses of Amateurs were revoked for operating on the "HF" frequencies just below 28 MHz.

Instructors of Amateur Radio training courses would do well to warn their students of the risks that illegal operating poses to their future Amateur licenses.

FIELD DAY NETTED AN AIRCRAFT CONTACT for W8TN that won't be included in his Field Day score but did generate some nice publicity for Amateur Radio in area papers. He and WD8CPN had set up at the Jackson County (West Virginia) airport and were still going strong at 4 AM when they heard an airplane circling the darkened field. After attracting the pilot's attention with a flashlight, Clark was able to contact him by using the radio in a parked aircraft and learned he'd been trying unsuccessfully to activate the field's radio-controlled runway lights (they were down due to construction damage a week earlier). The two Amateurs then positioned cars at opposite ends of the runway with their headlights on, and, after making an exploratory pass, the pilot landed safely.

OSCAR 8'S ORBITAL DATA is off 0.00205 minutes per orbit, an error of two minutes, 55 seconds for orbit 1427, for example, and three minutes and 35 seconds for orbit 1748.

OSCAR 8's Delta Launch Vehicle's first stage was mistaken for OSCAR 8 by the tracking radar, leaving OSCAR 8 unnoticed above and behind the rest of the launch payload and accounting for the error in its orbital data. At present OSCAR 8 is about 1700 km behind its "imposter." Updated correction data for the OSCAR 8 orbital predictions will be provided periodically, rather than by attempting to prepare a predictions booklet this year.

AT THE JULY BOARD meeting, the Directors approved the CAC's recommendation that the 1979 ARRL DX Contest be cut back to one weekend per mode, with the specific weekends still to be decided. In addition, any submitted log with 2% unpurged duplicate contacts will result in automatic disqualification. Also, more than 2% "rubber-clocking" — the practice of running over the permitted amount of operating time, will similarly result in automatic disqualification.

ANOTHER SUPER POWER RADAR is reported to be about ready for test in or near unspecified Amateur VHF/UHF bands. Any reports of reception of pulse-type signals in the Amateur bands should be reported to ARRL and ham radio. The system in question is supposed to be a 10-15 megawatt over-the-horizon radar.

HAWAIIAN USE OF 1800-1810 kHz has been extended indefinitely by IRAC following a one-year trial period during which no interference to Pacific area navigational signals was noted.



The fully-synthesized TR-7400A 2-meter FM transceiver operates on 800 channels and features repeater offset over the entire 144-148-MHz range, dual frequency readout, six-digit display, and subaudible tone encoder and decoder. RF output is at least 25 watts!

The TR-7400A 2-meter FM transceiver provides fully synthesized operation, including 600-kHz repeater offsets, over the entire 144-148-MHz range. It can operate on any of 800 channels, spaced 5 kHz apart. RF output is at least 25 W, and typically 30 W. A low power position produces 5-15 W (adjustable). Included is a dual frequency readout with large six-digit LED display plus a dial readout. The subaudible CTCSS signaling feature may be used on transmit and receive, or transmit only. Optional tone-burst modules are available. Receiver sensitivity is better than 0.4  $\mu$ V for 20 dB quieting. Large, high-Q, helical resonators minimize interference from outside the band. A two-pole 10.7-MHz monolithic crystal filter provides excellent selectivity. Optional active filters are available for 15-kHz "split" operation. Intermodulation distortion is down more than 66 dB, spurious rejection is better than -60 dB, and image rejection is better than -70 dB.

See your local Authorized Kenwood Dealer today, for a demonstration of the fantastic TR-7400A.

# TR-7400A



## PS-8

The PS-8 AC power supply matches the TR-7400A 2-meter FM transceiver, and produces 13.8 VDC at 8 A intermittent (50% duty cycle) and 5 A continuous. It can also be used with other Kenwood VHF and UHF mobile transceivers. It is well-regulated (less than  $\pm 4\%$  fluctuation), has low ripple (less than 10 mV rms), and features current limiting (less than 3 A short circuit).



## MC-30S & 35S

The MC-30S and MC-35S dynamic mobile microphones provide 150-5000 Hz frequency response (150-4000 Hz when operated as noise-cancelling microphones). The MC-30S impedance is 500  $\Omega$  and the MC-35S is 50 k $\Omega$ .

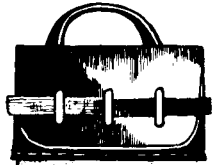

## comments

### calculator design

Dear HR:

I just have to tell you how much I've enjoyed and appreciated your articles in the last six months or so on various kinds of design approaches suitable for use with pocket calculators.

The Whyman pi network article in the September, 1977 issue; the Anderson circuit analysis article in the October issue; and the Ball satellite tracking article in the February issue were very good indeed; and you really hit the jackpot with the Anderson, Hoff, McNally-Keen, Fisk, and MacCluer articles, in March, 1978 *ham radio*. While I'm still digesting this last batch, you come along with several more juicy items in April and May; so unless you slacken up a bit, I may never catch up.

I acquired a TI-59 calculator just about the time this string started and have really enjoyed the task of digging into all the design methods and programming them for my TI machine. Having to "translate" the HP-25 program listings into the corresponding algorithms only added to the spice. And, with the 480-step/60-memory capacity of the TI-59, there was plenty of room to expand and improve the programs. I recall that one of the articles mentioned that the calculations were awkward to handle on non-RPN calculators, but I found them to be very straightforward and easy on the TI-59.

It is a bit ironic that I no longer have any real need for any of this. I retired

from my engineering career about three and a half years ago at age 67, so have no use for it professionally. I got back on the ham bands at about the same time (after being off some forty-four years), but am not particularly interested in doing my own building or design work. There is just a very high degree of simple intellectual pleasure in finding out what really goes on in networks, transmission lines, and the like.

The orders of magnitude improvement in the speed and accuracy with which one can do complicated calculations can really make all those equations in our musty old engineering textbooks come alive in a way they could never do when one had to struggle with manual calculations, slide rules, and log tables. What an incalculable boon the calculators must be to young engineers just starting out and facing the awesome potential range of engineering knowledge and techniques.

These marvelous little calculators can also be used in ways which were never contemplated by their designers. I've come up with one such use for my TI-59, a fairly simple little program that will convert the TI-59 into an ID timer to let me know when it is time to send my call sign during a QSO.

**Robert F. White, W6PY**  
Palo Alto, California

### noise bridge construction

Dear HR:

I have just finished constructing and compensating the noise bridge described in the February, 1977, issue of *ham radio*. I had not expected that a major source of trouble would be the 180 pF capacitor. First, I used a ceramic capacitor, since I assumed it would be the least inductive. But, after a long and often disappointing search for the source of the erroneous behavior of my bridge, I found that this capacitor had 1 or 2 ohms of effective series resistance.

Since the equivalent parallel resistance at 28 MHz, was only 500 ohms, the  $R_p$  reading was too low at the higher frequencies. Several different types of capacitor were tried, but most of them gave the same poor results. The only good results were obtained with a Philips 82 pF ceramic capacitor, and later with a 180-pF "micropoco" capacitor of the same brand. The latter type is a miniature, tubular-molded film capacitor with a polystyrene dielectric.

With this capacitor, the compensation of the bridge was completed as described. It certainly pays to give some attention to this detail beforehand, as it took me quite a long time to find out what was wrong with my bridge.

I built the series range expander in a UG-260/U and a UG-1094/U screwed together. The dielectric and the center conductor of the UG-1094/U have to be shortened, and a little hole is drilled into the remaining part of the center conductor. The two are locked with the large nut from the UG-1094/U.

**Arjen Raateland, OH2ZAZ**  
Helsinki, Finland

### micoder matching

Dear HR:

In your May, 1978, issue of *ham radio*, Wesley Johnson presented a circuit in the *ham notebook* for impedance matching of a Heath HD-1982 micoder. It works beautifully. However, he specifies miniature Calectro coupling capacitors. Like many hams, I just couldn't find these parts anywhere. I eventually substituted 0.47  $\mu$ F and 4.7  $\mu$ F Radio Shack tantalum caps; they are small enough and can easily be purchased. I made a 2.5 x 2.5 cm (1 x 1 inch) printed circuit board and as he described, it fits perfectly between the top mounting posts and the case. Using the micoder with a Yaesu FT227R yields very good audio reports.

**R. A. Stellarini, WB8VUN**  
Canton, Ohio

# A Blend of Art and Amplifier

There are certain times when amplifiers transcend their function and approach the status of art. An amplifier as a reliable source of power is fundamental, an amplifier as an artful precision instrument is unique.

The DTR-2000L achieves this uncommon standard by employing the most powerful final tube legally permitted in the amateur service. The world famous Eimac 8877. Then, following through with features such as a vacuum impregnated power transformer, continuous duty power supply, hi-lo power switching, pressurized forced air cooling, harmonic suppression far exceeding FCC specification, dual meters for monitoring plate voltage and current.

We are confident you'll agree that the DTR-2000L is an exciting blend of art and amplifier. Now available at Dentron dealers throughout the world.

- Covers 160-15 meters & most MARS freqs.
- Continuous 1KW input CW, SSTV, RTTY, 2KW PEP SSB
- Built-in adjustable ALC
- Easily changed 117V or 234V AC, 50-60 Hz
- FCC TYPE ACCEPTED
- DTR-2000L suggested price \$1099.50



**Dentron**<sup>®</sup>  
Radio Co.

2100 Enterprise Parkway  
Twinsburg, Ohio 44087  
(216) 425-3173



TS-1



TS-1JR



PE-2



SD-1

# THE DAWNING

The age of tone control has come to Amateur Radio. What better way to utilize our ever diminishing resource of frequency spectrum? Sub-audible tone control allows several repeaters to share the same channel with minimal geographic separation. It allows protection from intermod and interference for repeaters, remote base stations, and autopatches. It even allows silent monitoring of our crowded simplex channels.

We make the most reliable and complete line of tone products available. All are totally immune to RF, use plug-in, field replaceable, frequency determining elements for low cost and the most accurate and stable frequency control possible. Our impeccable 1 day delivery is unmatched in the industry and you are protected by a full 1 year warranty when our products are returned to the factory for repair. Isn't it time for you to get into the New Age of tone control?

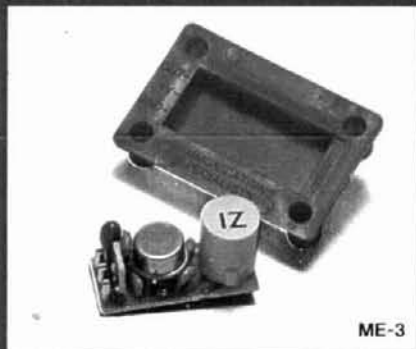

ME-3



TE-8

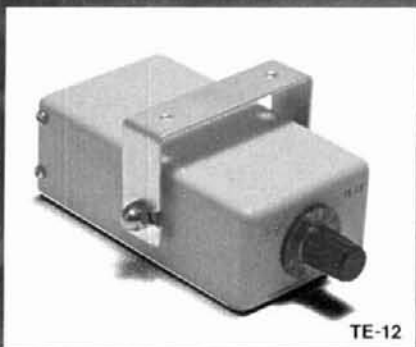

TE-12



ST-1

# OF A NEW AGE.

**TS-1** Sub-Audible Encoder-Decoder • Microminiature in size, 1.25" x 2.0" x .65" • Encodes and decodes simultaneously • **\$59.95** complete with K-1 element.

**TS-1JR** Sub-Audible Encoder-Decoder • Microminiature version of the TS-1 measuring just 1.0" x 1.25" x .65", for hand-held units • **\$79.95** complete with K-1 element.

**ME-3** Sub-Audible Encoder • Microminiature in size, measures .45" x 1.1" x .6" • Instant start-up • **\$29.95** complete with K-1 element.

**TE-8** Eight-Tone Sub-Audible Encoder • Measures 2.6" x 2.0" x .7" • Frequency selection made by either a pull to ground or to supply • **\$69.95** with 8 K-1 elements.

**PE-2** Two-Tone Sequential Encoder for paging • Two call unit • Measures 1.25" x 2.0" x .65" • **\$49.95** with 2K-2 elements.

**SD-1** Two-Tone Sequential Decoder • Frequency range is 268.5 - 2109.4 Hz • Measures 1.2" x 1.67" x .65" • Momentary output for horn relay, latched output for call light and receiver muting built-in • **\$59.95** with 2 K-2 elements.

**TE-12** Twelve-Tone Sub-Audible or Burst-Tone Encoder • Frequency range is 67.0 - 263.0 Hz sub-audible or 1650 - 4200 Hz burst-tone • Measures 4.25" x 2.5" x 1.5" • **\$79.95** with 12 K-1 elements.

**ST-1** Burst-Tone Encoder • Measures .95" x .5" x .5" plus K-1 measurements • Frequency range is 1650 - 4200 Hz • **\$29.95** with K-1 element.



**COMMUNICATIONS  
SPECIALISTS**

426 W. Taft Ave., Orange, CA 92667  
(714) 998-3021



## simple and efficient broadband balun

Construction of a  
new, improved balun  
which introduces  
no reactive components  
to the antenna  
feed system

**Balanced versus unbalanced**, balun or no balun — how many times have you heard long, philosophical discussions on this subject? I must admit I have had many sessions on the subject myself. Some of the pros and cons on baluns will be discussed in this article; then a new and improved broadband balun design will be described.

### **Balun vs no balun**

It seems obvious that a ground-plane antenna is an example of an unbalanced antenna and therefore can be fed directly with an unbalanced feedline such as coaxial cable. It also seems obvious that a center-fed dipole is a balanced antenna and therefore requires a balanced feed system. This could be twin lead, open-wire line, or a balun fed with coax cable.

Judging from discussions heard on the air, it isn't obvious why a balanced feed system is required or what it "buys" the user. Reading the advertisements of some manufacturers could lead you to believe that a balun is required to prevent TVI or to lower your vswr. This is nonsense, as you will see later.

By **Joe Reisert, W1JR**, 17 Mansfield Drive,  
Chelmsford, Massachusetts 01824

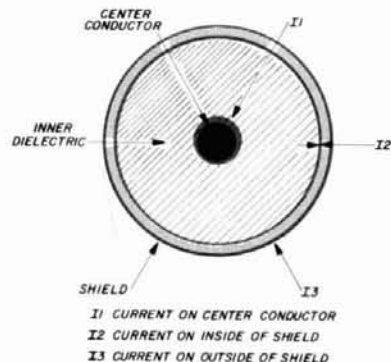

fig. 1. Three-wire representation of a coaxial feedline.

Over the years, coaxial feedline has become very popular while open-wire lines have practically vanished. One erroneous and often-heard story is that open-wire lines radiate, while coax does not; this is not true. The main reasons coax cables are popular are that they do not require special mounting techniques and they are easily monitored for both power and vswr. This has often led to the use of coax cables to directly feed a balanced antenna, especially on the amateur bands below 14 MHz.

There is a simple way to look at this situation;<sup>1,2</sup> a coaxial cable can be viewed as a three-wire feed system since the skin effect will allow one current to flow on the inside of the shield and another, a different current, on the outside (see fig. 1). The current on the inside of the shield is equal and opposite to the current flowing on the center conductor. The current on the outside of the shield, however, is a function of the currents induced by the field of the antenna (see fig. 2). This current is affected primarily by the geometry; the least current on the outside of the coax occurs when the feedline is at a right angle to the antenna, a rather unlikely situation.

How does feeding a balanced antenna directly with a coaxial cable affect the antenna's performance? The most obvious point is that when a horizontal antenna is used, the feedline re-radiation, if pres-

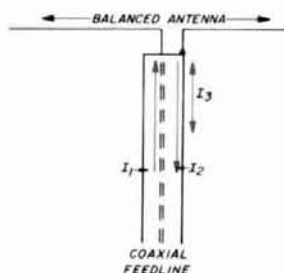

fig. 2. Current on the outside of the coaxial shield,  $I_3$ , is affected by relationship of the feedline to the antenna.  $I_3$  is minimum when the feedline is located at right angles to the antenna.

ent, will most likely be in the vertical plane. Hence, some of the transmitted signal will also be radiated vertically. Below 14 MHz this probably won't degrade performance because the antenna pattern is probably already distorted — a little vertical radiation may fill in some nulls as well as radiate some power at lower angles. Another effect will be to cause rf feedback or a "hot" rig.

When balanced, directional antennas are fed with coax, however, especially on 14 MHz and above, the feedline re-radiation as described above can be dev-

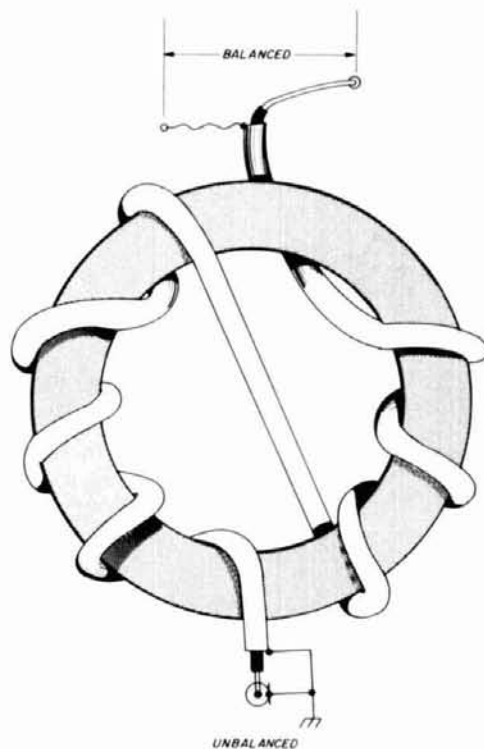

fig. 3. Construction of the improved broad-band balun.

astating, since it may cause undesirable high-angle signal off the back of the antenna or strong, local, vertically polarized signals which interfere with weak DX signals. Therefore, if coax cable is to be used to feed a balanced antenna, always use a balun.

### balun types

The most common baluns are the toroid and ferrite-rod types.<sup>1,3</sup> The biggest problem with all these baluns is that they are all frequency sensitive to one degree or another, especially if a wide frequency range (3 to 30 MHz) is desired. Personally, I have had the best luck with the ferrite-rod type.

There are several other problems with toroid and ferrite-rod baluns: they all have some loss and, if not perfectly constructed, can introduce a mismatch; a

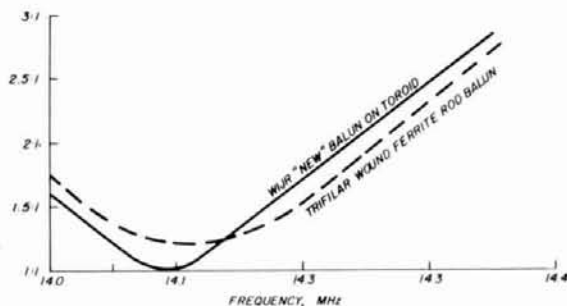

fig. 4. Measured vswr of a TH6DX antenna on 20 meters with a ferrite-rod balun compared to vswr with the improved coaxial balun. The ferrite-rod balun contributes reactive components to the feed system, as discussed in the text.

less understood problem is the effect of using a toroid or ferrite-rod balun with a mismatched antenna, a common situation since a 1:1 vswr is only present at one discrete frequency on any band. This led me to search for a new type balun which did not suffer from these problems.

### new type of balun

In the search for a better balun, I studied the coil of coax approach which is recommended by several antenna manufacturers. This type of balun solves some of the difficulties with mismatch loss, since the impedance is constant, but the thought of using 6-10 meters (20-30 feet) of coax with its loss was not too appealing.

Looking at fig. 2, it seems that all we have to do is prevent rf current from flowing on the outside of the coax. In other words, we must devise an rf choke on the outside of the coax shield. This can best be accomplished by wrapping the feedline on a ferrite rod or a toroid core, but some external field will still be present.

Then I saw an article on a super toroid, one that had almost no external field. *Voila*, an answer to my prayer! I quickly wound some RG-58/U coax on a Micrometals T-200-2 toroid, but results were disappointing. I reckoned that an inductive reactance of 500 ohms on the outside shield should be a minimum requirement. But the permeability of this powdered-iron toroid is so low that 14 turns were required on 10 meters — the toroid was barely large enough for that many turns, and 40 turns were required on 3.5 MHz! Hence, a search was conducted for a better core.

Then I looked at Indiana General's *Ferramic* cores and noted that the permeability of their Q1 material was 125 and suitable for operation from 3.5-30 MHz. The F568-1 core\* also has a larger inside diameter —

\*Indiana General toroids and coaxial cable are available from G. R. Whitehouse, 10 Newbury Drive, Amherst, New Hampshire 03031.

35.5 cm (1.4 inch) versus 28.5 cm (1.25 inch) for the T-200 toroid. With the higher permeability, a suitable balun could be built at 3.5 MHz with only 12 turns of coaxial cable. Also the strays are lower, since the balun is based on coax which has the same impedance as the antenna.

### construction

The new toroid balun construction is shown on fig. 3. Note that an even number of turns is preferred, with half the turns going on one side and the other half in opposition. Note also that the ends of the coax are on opposite sides of the toroid, which is very desirable mechanically.

For a kilowatt balun for 3.5 to 30 MHz, the Indiana General F568-1 type core is preferred. RG-8/U coax is too large and RG-58/U is undesirable except for levels below 200 watts. A check of available coax cables narrowed the choice to RG-141/U, which is approximately 6.35 cm (0.25 inch) OD with a Teflon dielectric and can easily handle 1000 watts. However, RG-142/U is also acceptable but is quite costly, since it uses a double silver-covered braid. W2DU has also suggested RG-303/U. A 12-turn balun requires approximately 90 to 100 cm (36-40 inches) of coaxial cable.

Table 1 shows the minimum required turns versus frequency. Hence, a 10-turn coil would suffice for 7-30 MHz, but 12 turns are desired for 3.5-30 MHz and should also work at 1.8 MHz with slightly poorer performance. For lower frequencies the type TC9 core material would be a better choice with an appropriate number of turns as discussed above.

Photograph of the improved broad-band balun. The cast aluminum box is a Bud CU234 or similar.

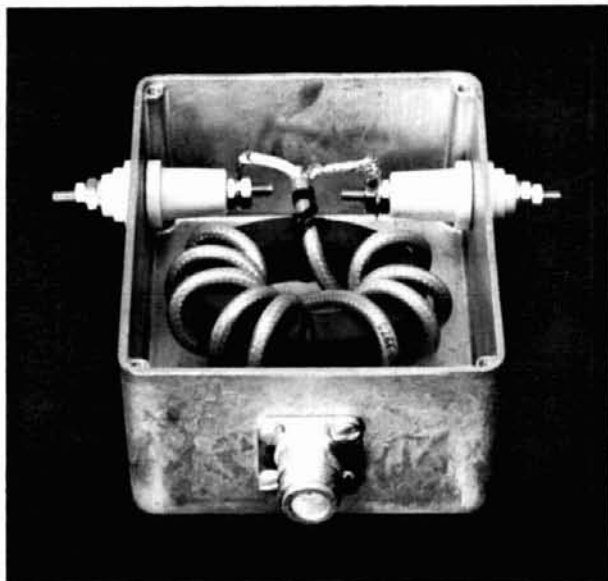



The finished toroid can be placed in an aluminum or plastic box. I mounted mine in a Budd-type CU234 cast-aluminum box with a connector at one end and two insulated, ceramic feedthroughs on the sides. The coax shield should be debraided at each end and then twisted for insertion in the connector and solder lugs as shown in the photograph.

## performance

I reasoned that a simple lab test would be to terminate the balun in its characteristic impedance, measure the *vswr*, and then measure the *vswr* with a short from the center pin side of the load to ground. If the balun is truly balanced, the short circuit should not affect *vswr* to a large degree. Indeed, a 10-turn balun tested at 10 MHz showed only negligible change when either of the output leads was grounded. Similar results were noted at frequencies with proper turns. Loss was negligible.

table 1. Minimum number of turns vs. lowest frequency of operation for the improved broad-band balun (assumes 500 ohms reactance for 50-ohm system).

frequency	inductance	turns	
		T-200-2	F568-1 Q1
3.5 MHz	22.74 H	40	12
7 MHz	11.37 H	28	10
14 MHz	5.69 H	20	6
21 MHz	3.79 H	16	4
28 MHz	2.84 H	14	4

The supreme test was to replace my ferrite-rod balun on a TH6DXX tribander to see if the *vswr* would change. You will note from fig. 4 that the original balun had a higher *vswr* at resonance and a somewhat lower *vswr* at the high end of the band than the new improved balun. This confirms that the ferrite-rod balun introduces a mismatch at resonance. The lower *vswr* at the high end of the band is probably due to the increased loss of the ferrite-rod balun, which tends to make the *vswr* look lower than it really is. Additional baluns are also now in use on a 160-meter dipole and several G5RV slopers on 80 and 40 meters.

## other variations

This balun is not restricted to 50 ohms; indeed, any impedance coax could be used if the turns are calculated to yield a reactance at least 10 times the impedance. Smaller or larger cores or coax can also be used if lower or higher power is required. In addition, this type of balun is not frequency-limited to the high frequencies; it also works well at vhf if attention is paid to layout and lead length. The beauty of this type of balun is that it does not introduce any additional reactive components to the feedline.

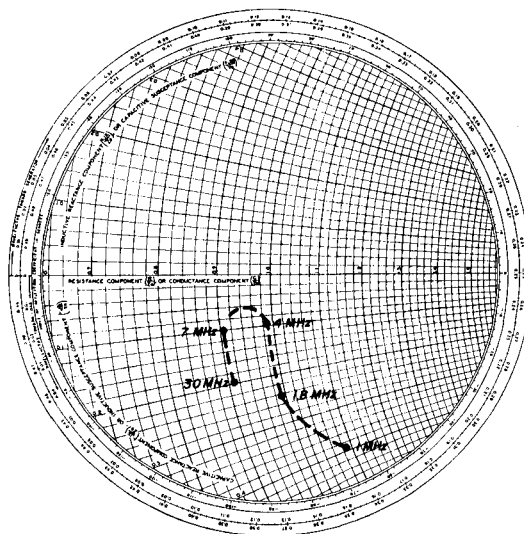

fig. 5. Smith chart plot of a 10-turn broad-band balun built by W1JR, as measured by DJ2LR over the frequency range from 1 to 30 MHz. *Vswr* is 1.3:1 or less on all high-frequency amateur bands.

I would like to express special thanks to Walt Maxwell, W2DU, and to Ulrich Rohde, DJ2LR, for their encouragement and assistance in preparing this material.

## reference

1. Lew McCoy, W1ICP, "Is a Balun Required?" *QST*, January, 1968, page 28.
2. William Orr, W6SAI, "Broadband Antenna Baluns," *ham radio*, June, 1968, page 6.
3. T. A. O. Cross, "Super Toroids with Zero External Field made with Regressive Windings," *Electronic Design*, September 1, 1976.

ham radio

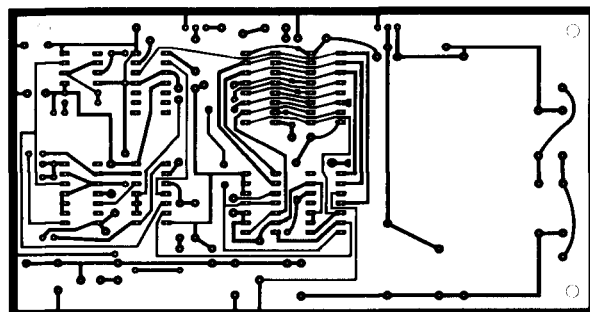

# 20 meter delta-loop array

The use  
of a scale model  
and simple,  
but effective,  
construction techniques  
produces an effective  
delta-loop array

The cubical quad type of loop antenna has been a very popular and effective antenna for amateur use between 14 and 30 MHz. The Yagi antenna is probably the most popular of all amateur antennas, and both types have their avid defenders for the most "effective" antenna on a particular band. An excellent comparison of the two antennas is presented in an article by Lindsay, W0HTH.<sup>1</sup> There is another type of loop antenna, however, which is generally overlooked in amateur publications — the delta loop. The delta loop is simply another configuration of a full-wavelength loop antenna like a quad, but the delta loop offers certain advantages: plumber's delight type construction and extremely good vswr bandwidth.

There have been few articles written on either the design or the construction of the multi-element delta-loop antenna,<sup>2,3</sup> and none describe the antenna for use on 20 meters. After reviewing the available information, I concluded that the reasons for neglecting the delta loop on 20 meters were the physical size of the antenna and the resultant problems with successful construction. I hope that my results will bring to light a successful construction technique and a proof of performance that will encourage other amateurs to experiment with and use this antenna.

## delta loop vs quad

Consider the current distribution of the familiar quad loop antenna shown in fig. 1. A current reversal occurs at the junction of each half wavelength section, so there is a current minimum in each verti-

cal leg and a current maximum 180 degrees from the feedpoint. The electric field polarization of the quad loop is derived from the fact that the vertical components of the current elements produce radiated fields that tend to cancel each other,  $y_1 + y_2 = y_3 + y_4 = 0$ , and the horizontal components of the current elements produce radiated fields that are additive,  $x_1 + x_2 + x_3 = x_4$ , where  $x_4$  is the effective field-producing current of the loop. The polarization of the electric field is a plane perpendicular to the plane of the loop. This same explanation of the properties of the full wavelength loop apply whether the loop is a square, a diamond, a circle, or a triangle.

For the case of the triangular or delta loop antenna, the current elements are shown in fig. 2. Again, the current reversal occurs at the junction of each half wavelength. Each current element can be broken into vertical and horizontal components. The vertical components of the current elements produce radiated fields that tend to cancel each other. Unlike the square loop, diamond, or circle, the delta loop produces a horizontal field component (proportional to  $x_1 + x_4$ ) which is 180 degrees out of phase with  $x_0$ ,

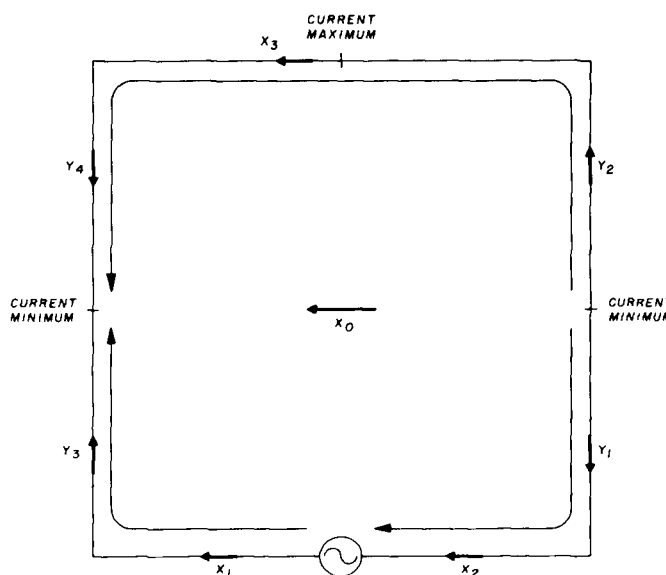

fig. 1. Current flow in a one-wavelength square loop produces two current nulls, one at the center of each vertical side. However, the horizontal current components do not cancel, producing horizontal polarization.

By Glenn Williman, N2GW, 145 Whalepond Road, Oakhurst, New Jersey 07755

the effective field current. Due to the geometry of the delta loop, however, the magnitude of this component, when compared with the magnitudes of all other horizontal components, yields the same overall effective field component as the other types of loops,  $x_0$ . Therefore, although the shapes of different full-wavelength loops vary, the effective field produced is of the same magnitude and of the same polarization when fed at corresponding locations. Admittedly, the preceding discussion is a simplistic view of electromagnetic field theory, but, without getting bogged down in the math involved, the concepts are adequate to subjectively describe the radiation of the loop antenna.

It is interesting to note that there is evidence that for a simple full-wavelength loop, the gain is approximately 4 dB above isotropic. In other words, assuming 2.15 dBi gain for a half-wave dipole, the full-wave loop shows a gain of 1.85 dBd (dB above half-wave dipole). This predicted gain differential has been experimentally supported by Lindsay's results.<sup>1</sup> The effect of this differential is to say that, for a given boom length, the loop parasitic array will exhibit a 1.85 dB gain above a Yagi array. Stating it another way, Lindsay's results show the array length of a Yagi must be about 1.8 times as long as the length of the loop parasitic array. This explains why an optimally spaced 2-element loop array is comparable in gain to an optimally spaced 3-element Yagi array.

### antenna model

Since I was unfamiliar with the delta loop when I began this project, I decided the easiest way to ex-

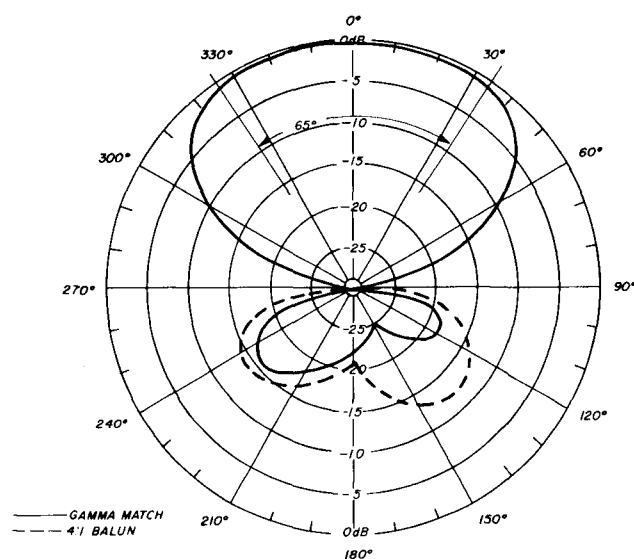

fig. 3. E-field patterns from the scale-model 2-element delta loop. This test was performed at 147 MHz and produced a front-to-back ratio of 22 dB and a front-to-side ratio in excess of 30 dB. The half-power beamwidth measured 65 degrees.

periment with a design for the antenna would be to build an operating scale model. A model design frequency of ten times the intended frequency reduced the dimensions by a factor of ten. I chose 147 MHz for the model because the dimensions were manageable and measurements could easily be made on 2 meters.

The generally accepted formulas for element length worked very well.

$$\text{driven element} = \frac{306.3}{f_{\text{MHz}}} \text{ meters}$$

$$= \frac{1005}{f_{\text{MHz}}} \text{ feet}$$

$$\text{reflector} = \frac{314}{f_{\text{MHz}}} \text{ meters}$$

$$= \frac{1030}{f_{\text{MHz}}} \text{ feet}$$

An element spacing of  $0.17\lambda$  was chosen, as there was no noticeable difference between that and  $0.2\lambda$  as seen using the model. Also,  $0.17\lambda$  translated very closely to a 3.7 meter (12 foot) boom length on the full-size antenna. The model was constructed using 6.5 mm (1/4 inch) copper tubing for the sides of the loops and wire for the tops of the loops. The size of the copper tubing was a poor choice for the model because it presented an unrealistic element-diameter-to-wavelength ratio. But, as it turned out, the

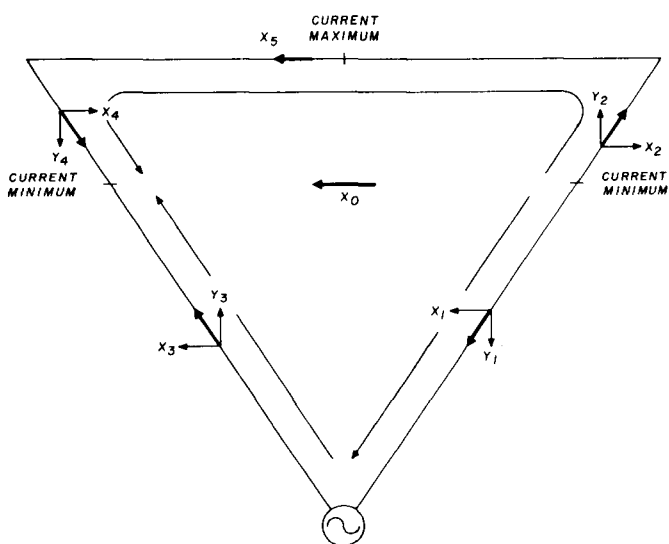
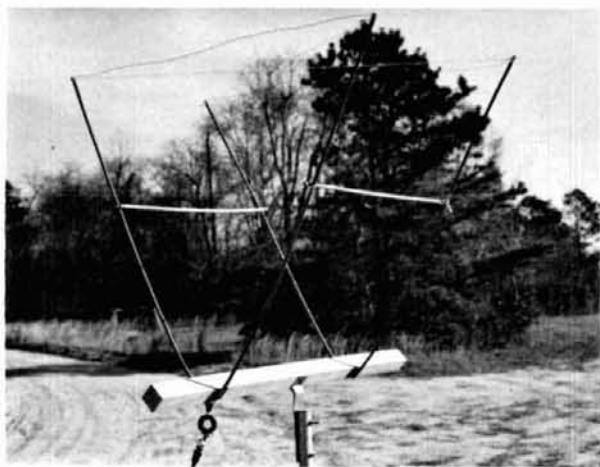

fig. 2. In a full-wavelength delta loop, the electric field is the same as that of the other configurations due to cancellation of the current components.



Scale model of the 2-element delta loop. This model was used for measurements at 147 MHz.

performance of the model accurately predicted what I would eventually find with the 20-meter antenna.

Two methods of feeding the antenna were also tried. Measuring a single circular loop of wire showed the resistance to be between 140 and 150 ohms. With a 4:1 balun feeding the driven element, the

vswr was about 1.4:1, as would be expected. A better match was obtained with a conventional gamma match, and a vswr of 1.1:1 was easily obtained. Both matching schemes provided an extremely wide vswr bandwidth. At the design frequency of 147 MHz, the vswr remained below 1.5:1 for 18.4 MHz (-9.4 MHz to +9.0 MHz), or a bandwidth of slightly greater than 12 per cent. E-field patterns were also measured with both versions of the scaled antennas, with the results shown in fig. 7. Using laboratory grade test equipment, the gain was measured on both versions and found to be 8 dBd at the design frequency. I was very encouraged with these results, and while I worked on the design of the full-size version, the model was used on 2 meters (vertical polarization is obtained by rotating the array 90 degrees — on its side).

### construction

Each delta-loop element consists of two arms of aluminum tubing joined together at one end of the boom, with a third arm of wire completing the loop. As determined from an unsuccessful construction attempt, the critical part of the design is a reliable method of attaching the delta elements to the boom

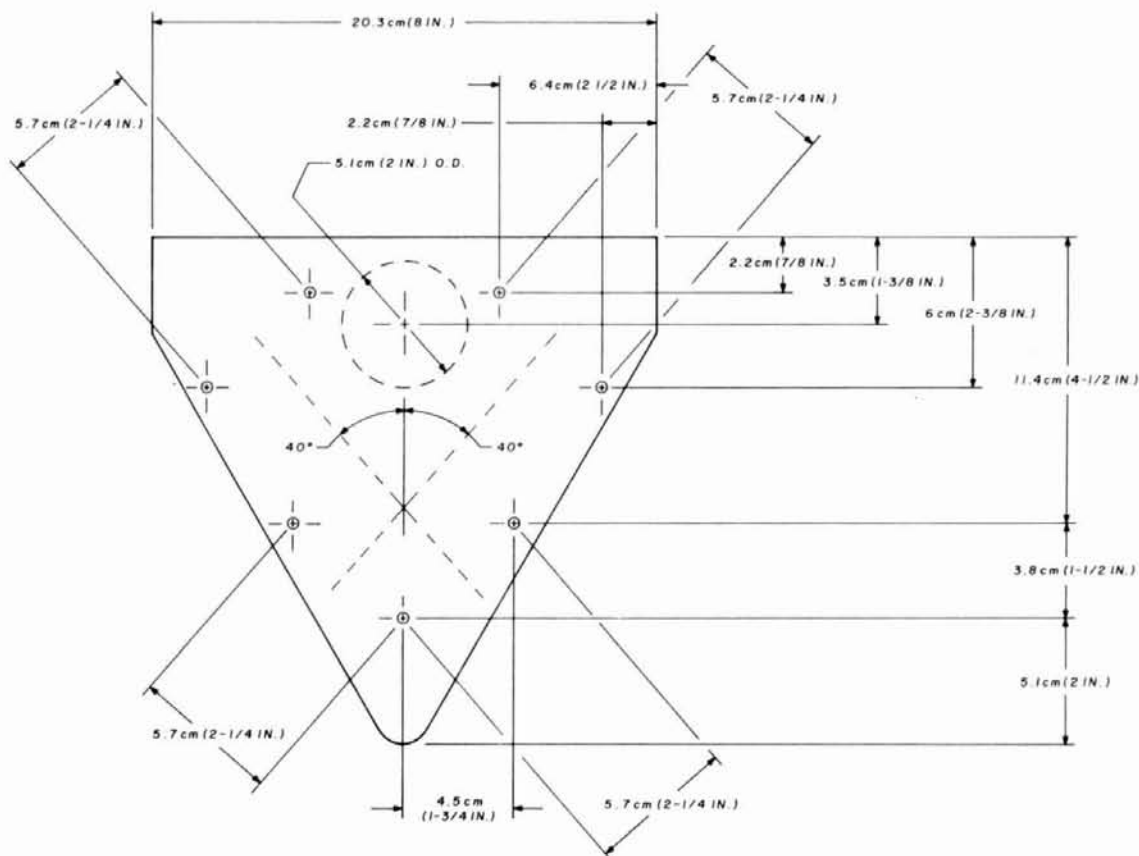

fig. 4. Drilling template for the element mounting plates.

— a method which will be stable in high winds and remain as light in weight as possible. I devised the following solution:

Two triangular aluminum plates are cut from 6.5-mm (1/4-inch) stock and shaped into the form shown in **fig. 4**. These plates are then welded onto the boom. (Any local welder with the ability to work with aluminum should be able to do the job inexpensively.) Care should be taken to ensure that both end plates are perfectly parallel and are not skewed around the boom. This would tend to make the assembled antenna unbalanced and will also degrade the front-to-back ratio.

Next, using **fig. 4** as a guide, holes for the galvanized pipe clamps are drilled in the end plates. The 19-mm (3/4-inch) pipe clamps work very nicely, and are a good deal less expensive than 25.5-mm (1-inch) U bolts. With respect to the end plate vertical centerline, each leg is angled 40 degrees, making a total angle of 80 degrees between the two legs. After both end plates are drilled and the pipe clamps are loosely mounted, one pair on each side of the plate, most of the work is done. All that remains is to make up the individual arms.

Each of the four arms is identical, consisting of a 2.7-meter (9-foot) section, a 2.4-meter (8-foot) section, and another 2.4-meter (8-foot) section, with respective diameters of 25.5 mm (1 inch), 22 mm (7/8 inch), and 19 mm (3/4 inch). Since this tubing is usually supplied in 3.7-meter (12-foot) lengths, the extra 1.2-meter (4-foot) section of 22-mm (7/8-inch) tubing is inserted into the bottom of the 25.5-mm (1-inch) tubing. One end of the 25.5-mm (1-inch) and 22-mm (7/8-inch) tubing is slotted, with hose clamps securing the three sections together. In addition, two sheet metal screws are used to secure the piece of 22-mm (7/8-inch) reinforcing tubing. All the aluminum should be type 6061-T6.

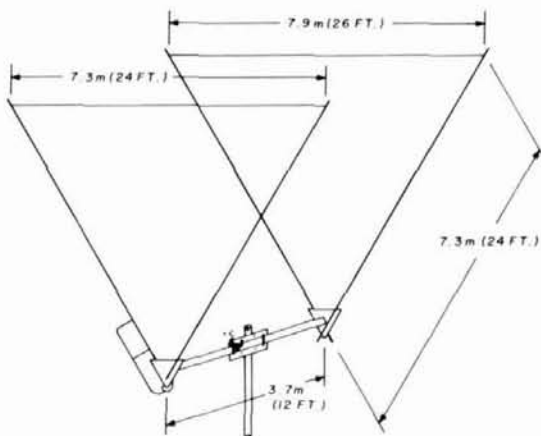

**fig. 5.** Final dimensions for the two-element delta-loop array.

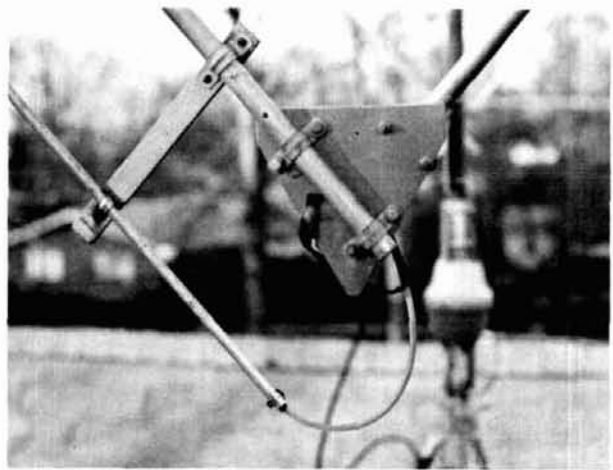

**Details of the gamma match system.** Moving the tap point of the gamma arm and changing the amount of coax inserted in the gamma arm will allow you to adjust for minimum vswr.

After the four arms are completed, the top of each is drilled to accept a small eyebolt. The wire legs are then cut to the appropriate lengths and wrapped and soldered to the eyebolts. If the eyebolts are cleaned and well fluxed, a small blow torch will ensure a well-soldered joint.

The last item to be made is the plate that is used to attach the boom to the mast. This should be made of 6.5-mm (1/4-inch) aluminum or 3-mm (1/8-inch) steel. The boom is attached to the plate with 5.1-cm (2-inch) muffler clamps and the mast is attached using U bolts of the size required for the mast. The boom is a 3.7-meter (12-foot) length of 5.1-cm (2-inch) OD tubing with a 3-mm (1/8-inch) wall thickness, also of 6061-T6 material. **Fig. 5** shows the dimensions of the assembled antenna.

## final assembly and testing

The antenna should be assembled either on the ground, using a ground-rigged mast, or in a position where it can easily be reached. I assembled mine on a 1-meter (3-foot) roof tower, but only after I had proven to myself that everything would fit.

Fix the boom to the mast and tighten all the clamps securely. Then, with someone to help support the boom, insert one leg at a time into the end plate and tighten the securing clamps. After both legs are in place, the completed element will be well-balanced and self-supporting. Finally, move the other end of the boom and complete assembly of the other element. The basic antenna is now complete, and all that remains is to add the gamma match assembly shown in **fig. 6**.

The gamma-match assembly is a length of 9.5-mm (3/8-inch) aluminum tubing, slotted at one end and bent at the other to the dimensions shown. The outer

braid of the coax feedline is stripped away (about 1 meter [3 feet]) and the center conductor, with its insulation, is inserted into the gamma rod. The center conductor of the coax and tubing form the gamma capacitor, with the coax center-conductor insulation forming the capacitor dielectric. The length of coax inside the gamma rod is adjusted for minimum vswr and then secured by a small hose clamp at the bottom of the gamma rod. This is a trial-and-error procedure, and successive lengths of the center conductor can be cut off until the right amount of capacitance is obtained for resonance. Best results will be obtained if the vswr is measured right at the antenna while the adjustments are being made.

One obvious advantage of working with the scale model is the ease with which performance tests can be made. The measurements are more difficult to make with the full-size array, but the agreement in results obtained between the model and the full-size version was very good, and convinced me of the performance of the full-size version. Fig. 7 shows the vswr and the front-to-back ratio measured at a distance of about  $300\lambda$ . The reflector is easily tuned by loosening the pipe clamps and sliding the tubing down, thus shortening the overall circumference of the reflector loop. The initial dimensions for the re-

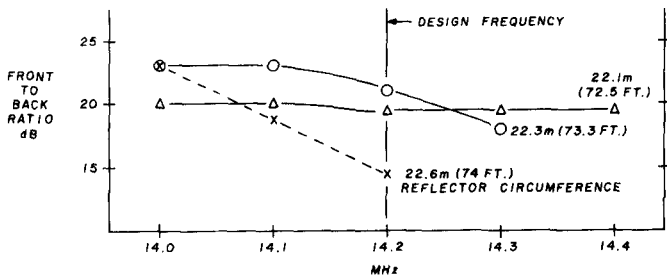
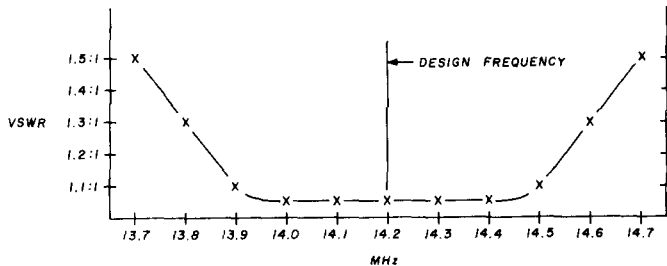

Boom length	3.7 meters (12 feet)
Turning radius	4.3 meters (14 feet)
Weight	18.1 kg (40 pounds)
Wind load 97 km/h (60 mph)	36.3 kg (80 pounds)
Forward gain	8 dBd
Front-to-back ratio	>20 dB
1.5:1 vswr bandwidth	1 MHz
Impedance	52 ohms with gamma match
Half-power beamwidth	65 degrees horizontal
Cost	\$100 price range

fig. 7. Front-to-back ratio and vswr curves for the full-size delta loops.

flector were purposely made long so that tuning could be accomplished.

### conclusion

The 2-element delta loop has been a real performer for me. It's allowed me to compete in several DX pile-ups and compare favorably with others using full-size 3-element Yagis and 2-element quads. Even after my linear was recently sidelined, I was still able to work out very nicely just using my exciter. Also, the low vswr allowed me to bypass my antenna tuner and still enjoy a vswr of less than 1.5:1 across the entire band.

### references

1. J. E. Lindsay, Jr., W0HTH, "Quads and Yagis," *QST*, May, 1968, page 11.
2. Harry R. Habig, K8ANV, "The HRH Delta-Loop Beam," *QST*, January, 1969, page 26.
3. Lewis G. McCoy, W1ICP, "The Delta-Loop Beam on 15," *QST*, January, 1969, page 29.

ham radio

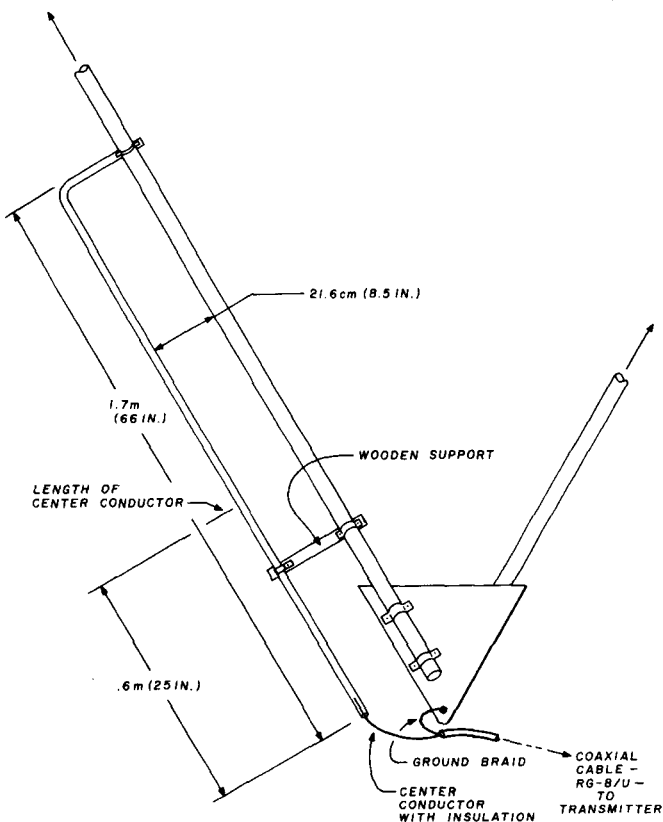

fig. 6. Details of the gamma match for feeding the delta loops.

# DSI Instruments Inc.

## Performance You Can Count On



**MODEL 3550W**  
\$149.95  
INCLUDES TCXO  $\pm 1$  PPM



**MODEL 3600A**  
\$199.95  
INCLUDES OVEN TIMEBASE  $\pm .5$  PPM



**MODEL 3240HH**  
\$119.95  
BATT. OPERATED

The 3600A, 3550W and 3240HH Frequency Counters represent a significant new advancement, utilizing the latest LSI Design ... which reflects DSI's ongoing dedication to excellence in instrumentation, for the professional service technician and amateur radio operator. Before you buy a DSI instrument you know that the specification is. We publish complete and meaningful specifications which state accuracy over temperature and sensitivity at frequencies you need. And we guarantee those specifications in writing. **JOIN THE RANKS OF THOUSANDS OF SATISFIED CUSTOMERS. PLACE YOUR ORDER TODAY AND BE THE ONE ON FREQUENCY.**

### DSI — GUARANTEED SPECIFICATIONS — MADE IN U.S.A.

Model	Frequency Range	Accuracy Over Temperature	@150MHZ	@250MHZ	@500MHZ	Number Of Readouts	Size Of Readouts	Power Requirements	Size
3600A	50HZ-600MHZ	OVEN 5PPM 50° to 100°F	10MV	10MV	50MV	8	.5 inch	115VAC or 8.2-14.5VDC	2 1/4" H x 8" W x 5" D
3550W	50HZ-550MHZ	TCXO 1PPM 65° to 85°F	25MV	25MV	75MV	8	.5 inch	115VAC or 8.2-14.5VDC	2 1/4" H x 8" W x 5" D
3240HH	2MHZ-250MHZ	3PPM 65° to 85°F	100MV	100MV	NA	7	.4 inch	4AA Batt.	5" H x 3" W x 2" D

ALL UNITS ARE FACTORY ASSEMBLED,  
TESTED AND CARRY A FULL 1 YEAR WARRANTY.

See Your Dealer  
OR

Call Toll Free (800) 854-2049 DSI Instruments, Inc.

California Residents, Call Collect (714) 565-8402

VISA • MC • AMERICAN EXPRESS • CHECK • MONEY ORDER • COD  
7914 Ronson Road, No. G, San Diego, CA 92111

#### • NO EXTRA COSTS •

**FREE** Shipping anywhere in U.S.A.  
& Canada. All other countries, Add \$10.00.  
Strongest warranty in the counter field.  
**ONE YEAR** Parts and Labor  
Satisfaction Guaranteed.

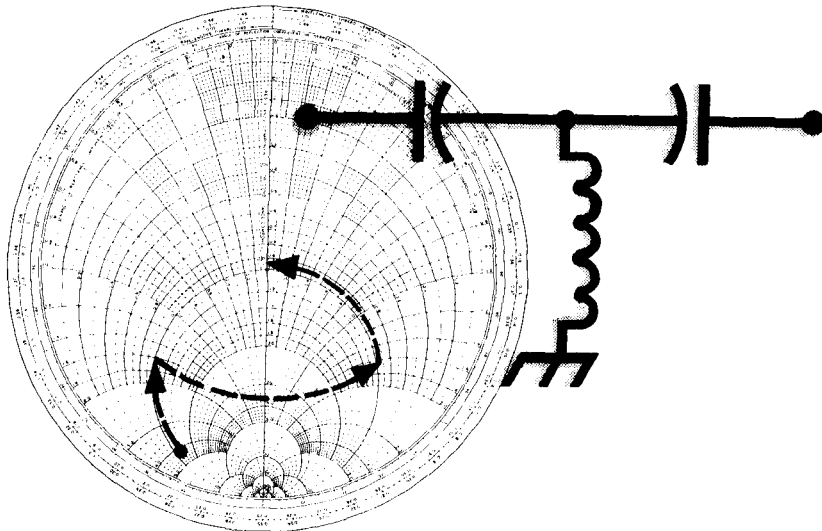

## T-network

### impedance matching to coaxial feedlines

Design of a  
five-band T-network  
for matching antennas  
to 50-ohm  
transmitters

The output circuits of almost all high-frequency transmitters, transceivers, and power amplifiers are designed for use with coaxial transmission lines. Most have a nominal impedance rating of 50 ohms; this means the equipment would like to see  $50 + j0$  ohms at the output terminals. The transmitter or amplifier is then matched to the antenna for any length of line; maximum power is transferred and loading is easy because the net effect is equivalent to connecting a 50-ohm non-inductive resistor across the output terminals. Reciprocally, this optimum condition also applies to receivers designed for 50 ohms input — maximum power transfer occurs from antenna to receiver.

It is not difficult to achieve the matched condition at a single frequency in a single high-frequency amateur band, but few amateurs limit their operation to a single frequency. Two simple antennas with low feedpoint impedance (when cut to resonance) that have an input resistance close enough to 50 ohms to make a reasonably good match with direct coaxial feed are shown in fig. 1. The quarter-wavelength vertical operated against a good ground has an input resistance near 35 ohms, and the half-wavelength center-fed dipole has an input resistance near 70 ohms. In both cases the standing wave ratio is less than 1.5:1 when 50-ohm coaxial cable is used and the tuning circuits in the transmitter can easily compensate for this small amount of mismatch.

By Jack M. Shulman, W6EBY, 789 Garland Drive, Palo Alto, California 94303



In practice there are two considerations which make the simple direct coaxial feed scheme of **fig. 1** unsatisfactory. First, many low feedpoint impedance antennas have an input resistance not equal to or even near 50 ohms. In **fig. 2A** for example, if input resistance  $R_a$  is 17 ohms, a 3:1 swr will exist at terminals **JK**. The impedance at the sending end of the line, terminals **AB**, will then be a function of line length,\* and, depending on this length, may contain both resistance and reactance. **Fig. 3** shows impedances at all line lengths away from antennas which have an swr of 2, 3, and 4. These are determined from the constant swr circles which cross 2.0, 3.0, and 4.0 on the resistance axis of a Smith chart.<sup>1</sup>

The second consideration is that operation over an entire amateur band is usually desired, not just on one frequency. When an antenna with a low feed-

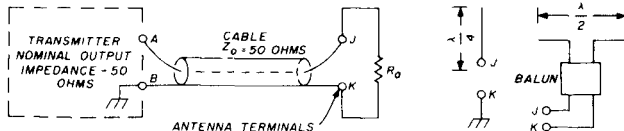
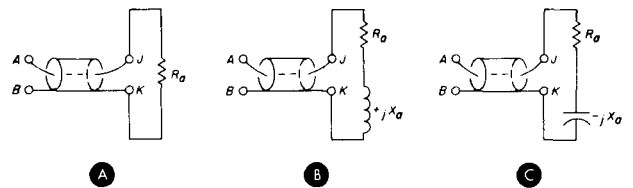

**fig. 1.** The quarter-wavelength vertical (above good ground) and half-wavelength horizontal dipole are two popular antennas which provide a suitable match to 50-ohm coaxial cable ( $R_a = 35$  to 70 ohms).

point impedance is operated away from its resonant frequency, resistance changes at a slow rate but reactance departs from zero at a rapid rate as shown in **fig. 4**. This is discussed in detail in reference 2. For any given antenna the actual value of  $R_a$  and antenna reactance  $X_a$  above and below resonance will depend on many variables: the conductor length-to-diameter ratio, antenna height above ground, orientation (horizontal or vertical), number and spacing of elements (if more than one), and proximity to conducting objects. **Figs. 2B** and **2C** show the equivalent circuits of an antenna when operated above and below resonance. A typical set of swr measurements taken at terminals **AB** is shown in **fig. 5**.

Whatever the exact values of  $R_a$  and  $X_a$  for any low feedpoint impedance antenna at any particular frequency in a band, the important point is they are *low* — probably less than 200 ohms in all cases over the frequency range of interest. It's the job of the matching network to make some low value of anten-

\*The impedance at the input of any transmission line is a function of the length of the line and the impedance at the load end. If the load resistance is purely resistive and equal to the characteristic impedance of the line, however, the impedance at the input end is equal to the load impedance, regardless of the length of the line.



**fig. 2.** Equivalent circuit of an antenna at resonance (A), above resonance (B), and below resonance (C). With 50-ohm coaxial line, if the antenna resistance  $R_a$  is not near 50 ohms at resonance, the impedance at **AB** is a function of line length and the match may be unsatisfactory with direct coaxial feed.

na impedance at terminals **JK** look like  $50 + j0$  ohms at terminals **AB**. The T network is ideally suited for doing just that. Moreover, the T network can be made extremely simple with only two active components, one coil and one variable capacitor. The operational fundamentals and design of such a network will be described in this article.

## impedance matching fundamentals

Assuming that the impedance at the point on the line near **AB** where the matching network will be inserted contains both resistance and reactance, the matching process consists of two steps:

1. Inserting opposite reactance at the output end of the network to result in a net reactance of zero
2. Transforming the remaining resistance value to 50 ohms

The reactance initially present, as represented by

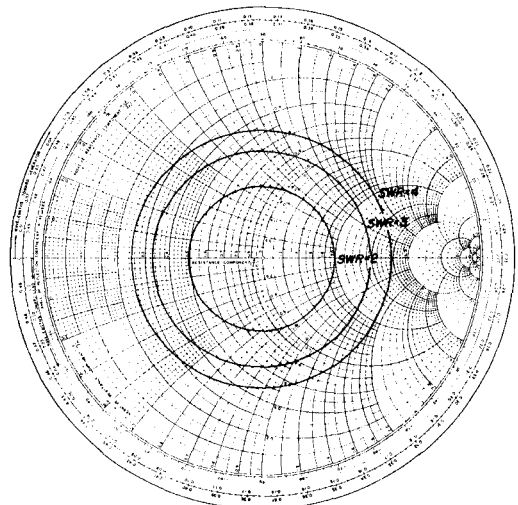

**fig. 3.** Effect of transmission line length on impedance for swr of 2:1, 3:1, and 4:1. Concentric circles are constant swr values of  $R \pm jX$  along the transmission line.

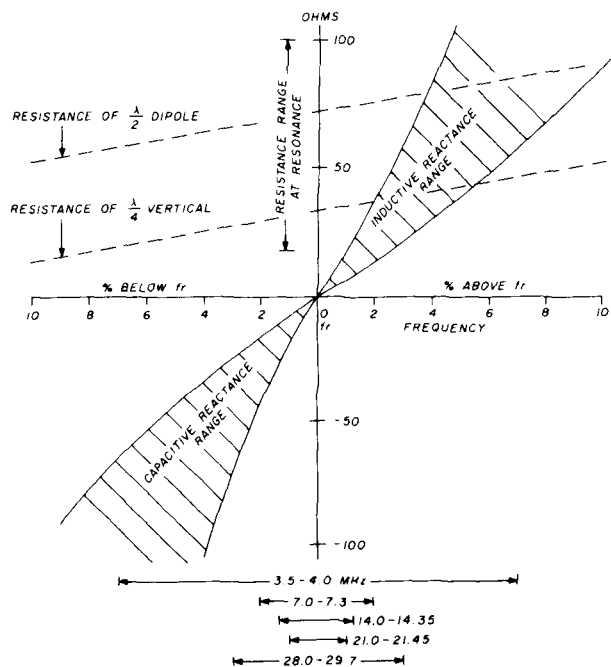

fig. 4. Typical change in resistance and reactance of an antenna as the operating frequency is moved away from resonance. The scales show the corresponding widths of each of the high-frequency amateur bands with resonance at the center of the band.

$+jX$  or  $-jX$  in series with  $R$  at terminals **AB**, will be low as indicated by fig. 3. To compensate for this reactance a low equal value of capacitive or inductive reactance must be inserted either in series or in parallel. If inductive reactance is needed, it can easily be provided with a small coil. If a small amount of capacitive reactance is required, however, the size of the capacitor may be impractically large.

A simple way to take care of the reactance compensation for either case is to incorporate a series inductance leg at the output end of the matching network, and vary that inductance a small amount above and below the design value. This can be done by adjusting a tap on the output end. A T-network inherently provides this series inductance leg.

Having compensated for reactance at the output end of the network, the second step is to transform the remaining resistance to 50 ohms. A network containing inductance and capacitance is capable of doing this because for any series circuit containing  $R_s$  and  $X_s$ , fig. 6, there exists an equivalent parallel circuit containing  $R_p$  and  $X_p$  where in general  $R_p$  is different from  $R_s$ .

By definition, equivalence is the case where both series and parallel circuits exhibit the same magnitude and phase angle of impedance to an external circuit. To state this another way, both circuits must have the same external circuit  $Q$  where  $Q$  is defined

as  $X_s/R_s$  for the series circuit, and  $R_p/X_p$  for the parallel circuit.

The equations relating  $R_p$  to  $R_s$  and  $X_p$  to  $X_s$  for any value of  $Q$  are as follows:

$$R_p = R_s (Q^2 + 1) \quad (1)$$

$$X_p = X_s \left( \frac{Q^2 + 1}{Q^2} \right) \quad (2)$$

If  $Q$  is 5 or more, eqs. 1 and 2 can be simplified to the following with less than 4 per cent error.

$$R_p = Q^2 R_s \quad (3)$$

$$X_p = X_s \quad (4)$$

The L network in fig. 7 is the basic matching network for transforming one resistance at terminals **AB** to another at **CD**. The pi network and T network in fig. 8 can be thought of as two L networks connected in series. Because of the practical limitations on the size of capacitors for  $X_p$ , L networks are best suited for matching a low resistance to a high resistance or vice versa. The pi network is best suited for matching a high resistance to a high resistance, and the T network for matching a low resistance to a low resistance.

If a pi network is best suited for matching one high resistance to another high resistance, you might logically question why it is so universally used in the output stages of transmitters and amplifiers where the output resistance to be matched is 50 ohms. One of the reasons the pi network is popular is that, if a set

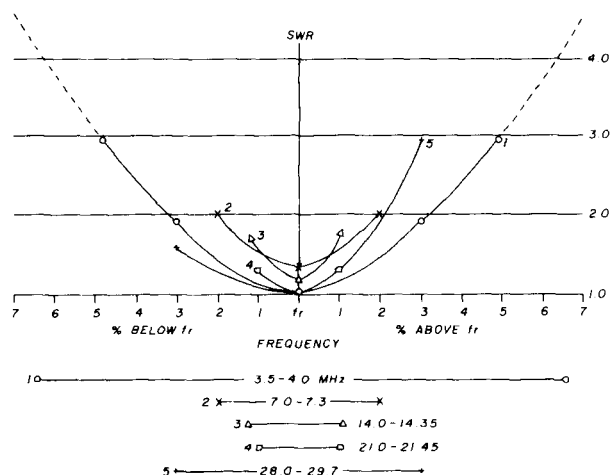

fig. 5. Plots of standing wave ratio as measured at the transmitter output terminals for an 80-meter inverted vee (1), 40-meter inverted vee (2), and three-band Yagi for 14 MHz (3), 21 MHz (4), and 28 MHz (5).

of fixed coil taps is used for all high-frequency bands and if the resistance on the input side is near 50 ohms and there is little or no reactance, adjustment of the capacitor on the output side is noncritical for proper loading.

If, however, the resistance is not near 50 ohms, or if considerable reactance exists on the output side (as occurs when changing frequency away from resonance), the pi network may not be able to provide satisfactory loading. Adding a series inductance leg on the output side to form a pi-L network is one way to take care of this problem.

### T network external to transmitter

A T-network assembled as an individual unit can be inserted in a coaxial feedline at any convenient distance from the transmitter, as shown in **fig. 9**. Any reactance which exists initially at **AB** can be

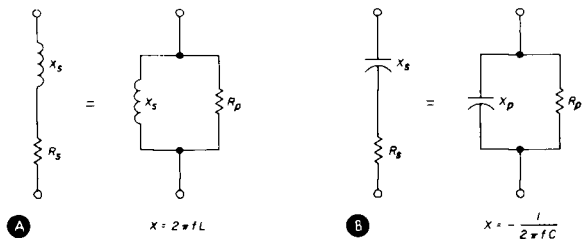

**fig. 6.** Equivalence of series and parallel circuits containing resistance and reactance. The equivalent element values may be determined from the relationship  $X_s/R_s = R_p/X_p$ .

tuned out by moving the coil tap on  $X_{s1}$ . Elements  $X_{p1}$  and  $X_{p2}$  of **fig. 7D** are combined into a single value of  $X_p$  equal to

$$X_p = \frac{X_{p1} X_{p2}}{X_{p1} + X_{p2}}$$

The right-hand side of the T network transforms the low resistance at **AB** to a high resistance at **CD**. The left-hand side then transforms the high resistance at **EF** to  $50 + j0$  ohms. The high resistance at **CD** to **EF** is referred to as the *virtual* or "apparent" resistance, transformed from **AB** and **GH**, respectively. The resultant virtual resistance across  $X_p$  is

$$R_p = \frac{R_{p1} R_{p2}}{R_{p1} + R_{p2}}$$

If the resistance at **AB** in **fig. 9** is 50 ohms, and the effective resistance at **GH** is also 50 ohms, the T network becomes symmetrical;  $X_{s1}$  is equal to  $X_{s2}$ , and

\*The ARRL L/C/F Calculator Type A is available for \$3.00 from the American Radio Relay League, 225 Main Street, Newington, Connecticut 06111.

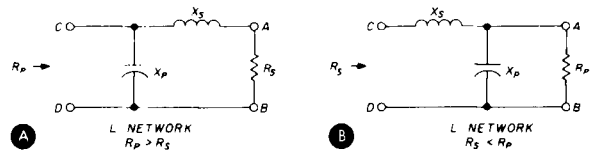

**fig. 7.** L networks are very useful for transforming one resistance value to another. Design formulas for L networks are found in reference 3.

$X_p$  is one half of  $X_{s1}$ ;  $R_{p1}$  is equal to  $R_{p2}$ , and their resultant,  $R_p$ , is one half of  $R_{p1}$ .

### T network with single center-tapped coil

The two series inductance legs of the T network,  $X_{s1}$  and  $X_{s2}$  (**fig. 9**), don't have to be separate coils. Use of a single center-tapped coil not only simplifies construction but also increases the effectiveness of the network in its operation as a lowpass filter to attenuate harmonics. Each of the two series legs must have a larger inductance than two separate coils would have for a given value of  $Q$ , and the extra inductive reactance additionally impedes the flow of harmonic currents through the network.

**Fig. 10A** shows a center-tapped coil with connections **a** and **c** at its ends, and **b** at the center tap. The equivalent circuit is shown in **fig. 10B** and the coil assembled into a T network in **fig. 10C**. When connected as in **fig. 10C**, the coefficient of coupling  $k$  is negative and the effective inductance of each coil half is less than  $L$ .

Inductance of the coil alone, measured between **a** and **c**, is greater than twice the inductance between **a** and **b** or **b** and **c** by the factor  $2Lk$ , where  $k$  is defined as the ratio of mutual inductance  $M$  to  $L$ . To obtain a desired value of  $L$  for a T network, a relation between  $k$  and coil dimensions is needed. A curve of  $k$  vs the length-to-diameter ratio of a center-tapped coil is available,<sup>1</sup> but the same data can be obtained directly for any given set of coil parameters by using an ARRL L/C/F calculator Type A.\*

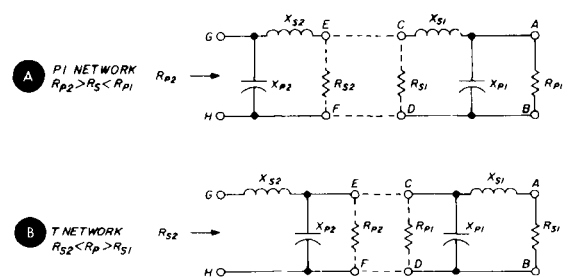

**fig. 8.** L networks may also be combined into a pi network (**A**) or a T network (**B**). The design of pi networks is discussed in references 4, 5, and 6.

There are only two active components to be considered in designing a practical single-coil T network: the variable capacitor C1 and the full coil **ac** center-tapped at **b**. Determination of both depends on the lowest frequency at which the network is to be used,

The effective inductance of  $L$ ,  $L_e$ , is  $L(1+k)$ .

$$L_e = 12.8 (1 - 0.21) = 10.1 \mu H$$

If the resistance at **GH** and **AB** is 50 ohms, and the full coil is in the circuit at 7.0 MHz, the network com-

fig. 9. A T-matching network inserted in the line at or near the transmitter output terminals.

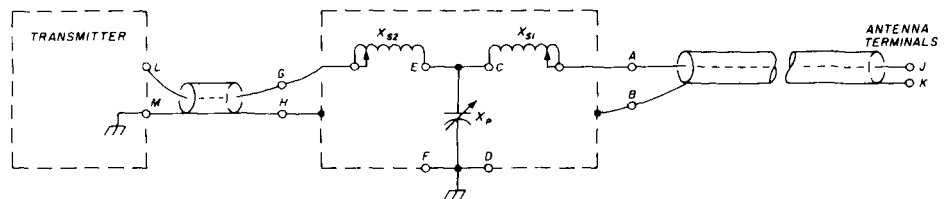

so you must decide whether this will be 3.5 or 7.0 MHz. If you choose 3.5 MHz, a second decision must be made as to whether a very large coil should be used to give a network  $Q$  of 8 to 10 at that frequency, or a more reasonable sized coil to give that  $Q$  at 7 MHz. In the latter case an additional fixed capacitor must be switched across C1 for operation on the 3.5-4.0 MHz band.

An air-wound coil 6.35 cm (2.5 inches) in diameter, 10.2 cm (4 inches) long, and 8 turns per inch (3 turns per cm) is readily available (B&W 3030). It is of reasonable size, and nearly optimum for 7 MHz, so it was chosen with the option of using additional capacitance at 3.5 MHz. A transmitting type variable capacitor should be used for C1 because the  $rf$  voltage across it will be  $Q$  times that at the input terminals **GH**. The capacitor should be calibrated so that values of  $X_c$  can be readily determined from the dial settings. A 30-220 pF transmitting unit was selected in my case.

ponents, **fig. 7D**, are as follows:

$$X_{s1} = X_{s2} = 2\pi f L_e = 444 \text{ ohms}$$

$$Q = 444/50 = 8.88$$

$$X_{p1} = X_{p2} = 444 \text{ ohms}$$

$$(X_p = 222 \text{ ohms (C1 at 7 MHz)$$

$$= 1/2\pi f X_p = 102 \text{ pF})$$

$$R_{p1} = R_{p2} = 78.85 \times 50 = 3942 \text{ ohms}$$

$$R_p = 1971 \text{ ohms}$$

At 3.5 MHz the network  $Q$  is 4.44 and  $X_p$  is 111 ohms, requiring a total capacitance at C1 of about 400 pF. A fixed transmitting capacitor of 0.0002  $\mu F$  in parallel with the 220 pF variable may be used.

### T network for five-band coverage

**Fig. 11** shows the schematic of a tapped-coil network built from the above design data. Construction

fig. 10. Inductance of a center-tapped coil is shown at (A) with its equivalent circuit at (B). A two-component T network with a center-tapped coil is shown at (C).

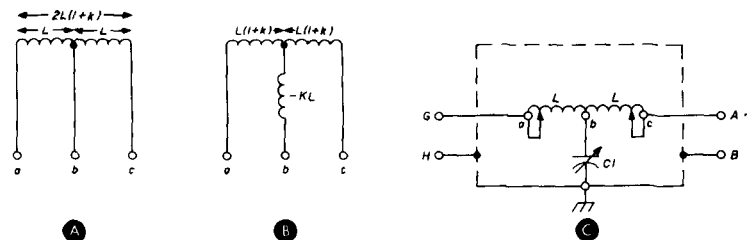

Using a Type A calculator the inductance of half coil  $L$  is determined as follows:

$$L_{ac} = 31 \mu H$$

$$L_{ab} = L_{bc} = L = 12.8 \mu H$$

$$L_{ac} = L_{ab} + L_{bc} - 2M = (2L - 2M)$$

$$M = -2.7$$

$$k = M/L = -0.21$$

details are omitted because of the large number of possible options in components and additional convenience features such as tap switches. You may also want to add a coaxial switching scheme to bypass the network so that operation with a given antenna can be quickly compared with and without the matching network. The main construction criterion is to preserve electrical and mechanical symmetry between the input and output sides of the network.

A good method of determining coil tap locations is to connect a transmitter with a nominal 50-ohm output impedance at J1 and a 50-ohm dummy load at J2. An swr indicator should be inserted between the transmitter and J1. With a 50-ohm load the network will be symmetrical. For all bands higher than 7 MHz where the full coil is used, a set of taps can be found which give a 1:1 swr at any desired  $Q$ . The calculated values of  $X_p$ ,  $X_s$ , and  $Q$  for the coil taps of fig. 11 are listed in table 1.

With the antenna and coaxial feedline combinations which produce resistance at J2 anywhere between 25 and 100 ohms, the capacitor dial settings  $X_p$  will be close to the values in the table and the indicated swr will be at or very close to 1.0:1. At frequencies off resonance, where reactance appears at J2, the swr will still be close to 1:1 except at the edges of the widest amateur bands.

Maximum swr readings for antennas 2, 3, 4, and 5 of fig. 5, without moving any of the coil taps, were 1.2:1 on the 7 MHz antenna and 1.7:1 on the 28 MHz antenna. It is possible to get a 1.1 swr reading with any of these antennas on any frequency in the band by moving coil taps slightly, but this is not normally necessary.

With a 3.5-MHz antenna you should not attempt to use the antenna and network combination at frequencies where the swr is greater than 3:1 without the network. A broadband or two-frequency antenna should be used if full-band coverage is routinely required.

### conclusions

Use of a T network in the manner described here is new only in the sense that its advantages have long been overlooked. I have been using a network similar

table 1. Calculated capacitance, inductance, and  $Q$  for the network of fig. 11, with 50 ohms at both input and output.

frequency (MHz)	C1, or (C1 + C2) (pF)	$X_p$ (ohms)	$X_s$ (ohms)	$Q$
3.50	394	115	230	4.60
3.75	342	124	248	4.96
4.00	302	132	264	5.28
7.00	102	222	444	8.88
7.15	98	227	454	9.06
7.30	94	232	464	9.26
14.00	41	277	554	11.08
14.175	40	281	562	11.22
14.35	39	284	568	11.38
21.00	49	155	310	6.18
21.225	48	156	312	6.24
21.45	47	158	316	6.32
28.00	45	126	252	5.06
28.85	43	128	256	5.14
29.70	40	134	268	5.36

to fig. 11 at W6EBY for more than 15 years, and it has been used successfully on all frequencies in all five bands with a kilowatt amplifier. In fact, the acquisition of the amplifier and the distressing events which occurred when its load departed too much

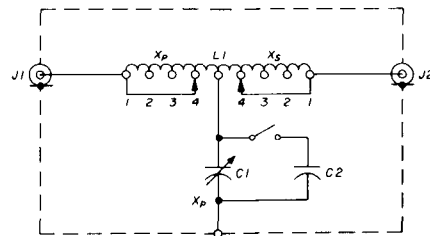

- C1 30-220 pF transmitting type variable capacitor
- C2 200 pF, 5000 Vdc
- J1, J2 SO-239 coaxial socket
- L1 31  $\mu$ H air-wound coil, 6.35 cm (2.5") diameter, 10.2 cm (4") long, 3.2 turns per cm (8 turns per inch), B&W 3030 or equivalent.

coil taps	1	2	3	4
Band, MHz	3.5, 7	14	21	28
Active turns	32	26	14	10
Turns each leg	16	13	7	5

fig. 11. Tapped-coil T matching network for the five high-frequency amateur bands, 3.5 through 29.7 MHz.

from  $50 + j0$  ohms were the motivations which originated the matching network in the first place.

The network can be just as useful, even essential in some cases, with lower power transmitters. Some of the new units with solid-state final stages are not tolerant of an swr greater than 3:1 and they are designed to shut themselves off when confronted with high swr. T networks, although they can't improve the performance of the antenna, will at least allow operation with the antenna as it is.

### references

1. J. R. Fisk, W1HR, "How to Use the Smith Chart," *ham radio*, March, 1978, page 92.
2. H. Jasik, *Antenna Engineering Handbook*, McGraw-Hill, New York, 1961, Chapter 3.
3. R. E. Leo, W7LR, "How to Design L Networks," *ham radio*, February, 1974, page 26.
4. E. W. Whyman, W2HB, "Pi Network Design and Analysis," *ham radio*, September, 1977, page 30.
5. L. H. Anderson, "Pi Network Design," *ham radio*, March, 1978, page 36.
6. I. M. Hoff, W6FFC, "Pi Matching Networks — Tables of Values," *ham radio*, June, 1977, page
7. R. W. Johnson, W6MUR, "Multiband Tuning Circuits," *QST*, July, 1954, page 25.

ham radio

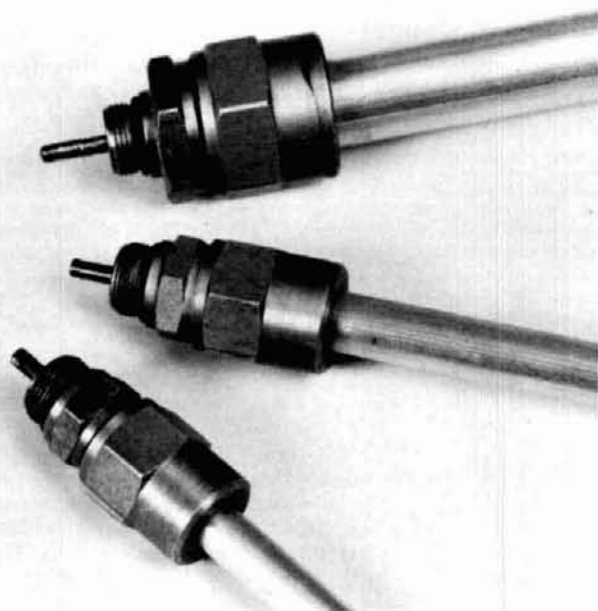

## 75-ohm cable in amateur installations

Making use of  
75-ohm CATV cable  
results in  
lower line loss,  
which means more  
power to the antenna

**Many hams are not aware** of one of the best coaxial cables available, the 75-ohm, solid-aluminum sheathed cable made specifically for cable television (CATV). The coax used in these systems is characterized by a minimum attenuation loss, minimum random-signal pickup, excellent weather resistance, and high structural return loss. All this notwithstanding the fact that it can usually be obtained as scrap for next to nothing.

\*The number assigned to each cable is actually the outside diameter of the aluminum sheath in inches. With cable of primarily U.S. manufacture, this number has become the generic name of the cable.

Leading the list of features is low attenuation loss. As a result, a 100-watt-output, 420-MHz transmitter, feeding power through 30.5 meters (100 feet) of 0.750\* hardline, will deliver 75 watts to the antenna; this is quite an improvement over the 40 watts delivered by a comparable length of RG-8/U!

To further illustrate, **fig. 1** shows the loss exhibited by several different types of cable, starting with the relatively lossy RG-58 and ending with 0.750 cable. With CATV cable, even at the lower frequencies, impressive gains are available to people who use long cable runs.

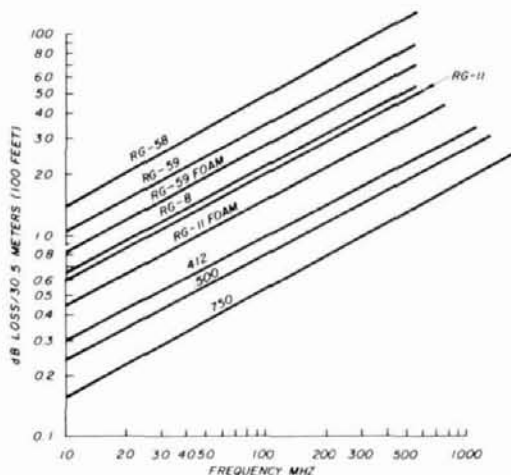
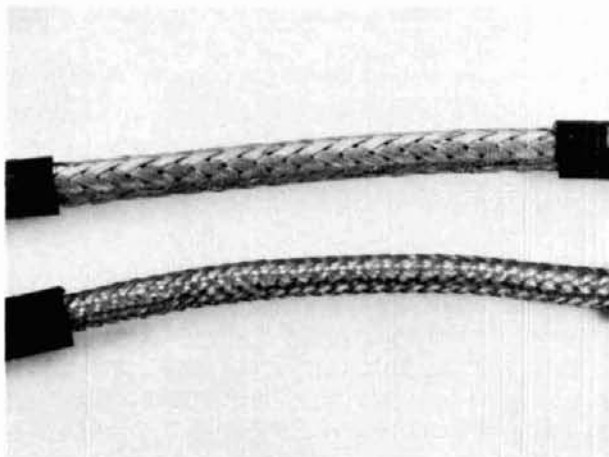

**fig. 1.** Loss vs. frequency for several types of cable. The CATV cable examples refer to cable manufactured by Systems Wire and Cable, Inc., of Phoenix, Arizona. Cable from other manufacturers may have different attenuation values, but as a rule will be very close to these figures.

In addition to its lower attenuation figures, solid aluminum sheath also reduces random-signal pickup and leakage. The best military braid specifications require only 96 per cent shielding, as compared to the 100 per cent provided by seamless CATV cable. And, as it turns out, most braided cable used by amateurs has a braid coverage in only the 75 to 90 per cent range, and sometimes as low as 60 per cent (see photograph)!

Weather resistance is also greatly improved by using cable with a seamless sheath. After a period of

**By Gordon K. Woods, W7VK, 6022 North Second Avenue, Phoenix, Arizona 85013**



As seen in this photograph, braid coverage can vary radically. The two examples are both RG-59/U, except that the top cable is normally used in CATV installations. Use of the bottom cable may result in unwanted signal pickup and/or emission.

exposure to sunlight and air, the copper conductors in ordinary braid become corroded; they do not form an electrical bond to one another, but function more as insulated wires, increasing random-signal pickup and radiation losses. This can be easily checked by terminating a well weathered RG-8 line and noting the background noise level. Then, change to CATV cable, equally terminated, and your receiver will be dead.

CATV cable is normally bare, but it is also produced with a black polyethylene jacket if the cable is to be exposed to salt spray, fog, or industrial contaminants. It is also manufactured with a "flooded" polyethylene jacket for underground or underwater installation.



Different examples for using the adapters between 75-ohm CATV hardline and standard UHF connectors.

## connectors

The major problem encountered by amateurs using 75-ohm CATV cable has been finding suitable connectors to use between the cable and ordinary UHF fittings. (Special cable connectors which mate with type N and F fittings are available, but they are difficult to locate and buy in small quantities.) There is a practical solution to this problem, however. This is the use of standard CATV "feedthrough" connectors, which, fortunately, end up with 6.5 mm (1/4 inch) of male 5/8 x 24 (M16-2) thread, the same thread as standard UHF connectors.

Making the adapter begins, as shown in fig. 2, with the installation of the appropriate feedthrough connector on the end of the cable. To mate with the UHF connectors, a PL258 female-to-female adapter is slipped over the end of the exposed center conduc-

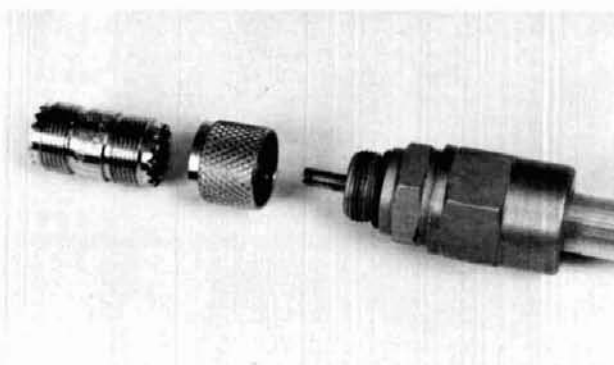

fig. 2. As shown in this photograph, adapting CATV cable to a normal UHF connector requires the use of a CATV feedthrough connector attached to the end of the cable. The 0.500 cable in this illustration has the brass tubing sweated over its center conductor. The threaded coupling cut from a PL259 connector attaches the PL258 adapter to the feedthrough connector.

tor. Joining the adapter and feedthrough connector is accomplished by using the threaded portion of the barrel from a PL259 connector.

On the 0.412 and 0.500 cable, you will have to sweat solder a piece of 4-mm (5/32-inch) OD brass tubing over the center conductor. (The brass tubing is available in short lengths from most hobby stores.) The center conductor of the 0.750 cable is heavily tinned to increase its diameter from 3.7 to 4 mm (0.146 to 0.156 inch).

If you want to directly hardwire the CATV cable to an SO-239 chassis connector, prepare the cable end as shown in fig. 3. Then, connect the SO-239 to the feedthrough connector, prior to inserting the cable. The final step consists of inserting the cable into the feedthrough connector, making sure that the center conductor mates with the SO-239, and tightening the cable ferrule. Generally, connectors are available from CATV equipment supply sources, although they

## The Microwave Module line of linear transverters.

Use your present HF equipment on 144 or 432 MHz. These units are not the least expensive on the market . . . we believe they are the finest!

The standard IF is 28 to 30 MHz. However, we will provide 50 to 54 MHz or 144 to 148 MHz upon request. All units are covered by a full **one year guarantee**.

**MMT 432/28S** \$259.95  
**MMT 144/28S** \$198.95

Receiving converters available for 2 meters, 432 and 1296 MHz. **Write for complete catalog.**

### POWER SUPPLIES

**28 Volt, 18 Amp Regulated Power Supplies** (110V in) \$75.00  
**12 Volt, 18 Amp Regulated Power Supplies** (110V in) \$85.00  
**Dual 300V D.C.** 1 amp fully metered \$85.00

### RECEIVERS

**Collins 651F-1**, 2 to 30 MHz in 100 cycle steps, digital tuning, USB/LSB/ISB. Stability: 1 part in 10<sup>8</sup>. Completely remote controlled, with all racks, connectors, control head. \$1400.00  
**R-388/51J** — Collins 0.54 to 31 MHz \$375.00  
**R-390A** — 0.54 to 31 MHz, overhauled complete \$595.00  
**Astrocom SR201**, 30-300 MHz, all solid state \$450.00  
**RACAL Model 6217A**, 980 kHz, 32 MHz, All Solid State, takes about 3 inches of rack space, digital tuning \$1600.00  
**LTV G111 Panoramic Recvr** includes CRT display, 100-150 MHz with converters. Will make a fine spectrum analyzer. \$150.00



**TMR-5** with front end plug-ins to cover 105-140 MHz and 200-260 MHz. \$250.00  
2200 to 2300 MHz available.  
We have complete documentation for all TMR-5 series including plug-ins.

**CEI type 415**, 60-250 MHz, all solid state, modular constr., xtal controlled, 4 channels. Incredible value. \$85.00  
**635V-1 Collins Preselector band pass Filters** — They're back! 2 to 30 MHz. 1 kHz steps, with copy of manual and rack and connector. \$275.00  
**SX-115** Immaculate with speaker and manual. \$450.00  
**ANWRR2**, 2-30 MHz, synthesized or continuous tuning, completely bench checked. \$600.00

### TEST EQUIPMENT

**URM-25H Sig. Gen.**, 10 kHz to 50 MHz calibrated attenuator. \$195.00  
**TS-419/U Sig. Gen.** — 900 to 2200 MHz \$175.00  
**Jerrold 707P Sweep Gen.** main frame with D51 detector. \$125.00  
**Bird 6835 Termination Wattmeter** complete RF Assy. — NEW! 1.2 KW, 600 watts, 120 watts full scale. You add oil and meter. \$95.00  
**SPECIAL:** Micromatch in-line wattmeters, complete guts, less meters, good to 500 MHz. You add 50µA meter. Removed from equipment. \$24.95  
**HP400DR Audio VTVM** — NEW \$125.00  
**Solartron DA410** Transfer Function Analyzer with manual. \$475.00  
**Weinschel 693-1** Power Attenuators, 30 watt avg., 10KW peak. \$65.00  
**HP764D** Dual directional coupler, 200-500 MHz. \$100.00

### TRANSCIVERS

**Collins KWT6-6/URC32** — 2-30 MHz, 1 kHz steps, complete xcvr, 500 watt PEP output, 500 watt CW output, AM capability. Complete and running. \$1850.00  
**PRC 47 Transceiver**, 2 to 11,999 MHz, synthesized, 1 kHz steps, 100 watts PEP, AM/CW/SSB/RTTY. Built-in antenna tuner. \$200.00  
or with CV-2455 \$235.00  
**RTTY Converter CV-2455/PRC-47** Built-in loop supply (60 mA or 20 mA) — requires rcvr audio and 24 volts. It's also an AFSK Keyer. 850 Hz shift. \$65.00



**T/T to Pulse Converter** — requires 12-24 VDC \$34.95

**Standard T/T pad** mounted in a sturdy steel case incl. 2 volume pots & 1 push button labeled "Stereo". Also has 2 phone jacks for headphones, microphone, etc. Will make a fine control head. \$24.95

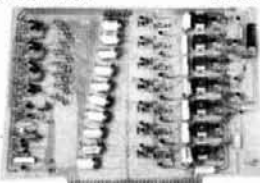

**Wanted:** Documentation for AN/WRR-2, plug-ins and IF Amplifiers for TMR-5.

**DISC-CAP**, 1434 REYNOLDS ST.    
AUGUSTA, GA. 30902 404-722-1121

Ga. Residents - add State Sales Tax. Unfortunately, Disc-Cap can only service U. S. customers.

are not enthusiastic about small-quantity orders. (Try these sources only if you can't con the local CATV system installer out of a few.)

## installation

When installing solid-sheath aluminum cable, note that all bends should be made over a grooved form block. Also ensure that all bends are *never* made to a radius of less than ten times the cable diameter. Observing this precaution will prevent wrinkling the sheath, which can cause impedance bumps. Too tight a bend may also force the center conductor to one side, since the foamed dielectric is soft and subject to cold flow.

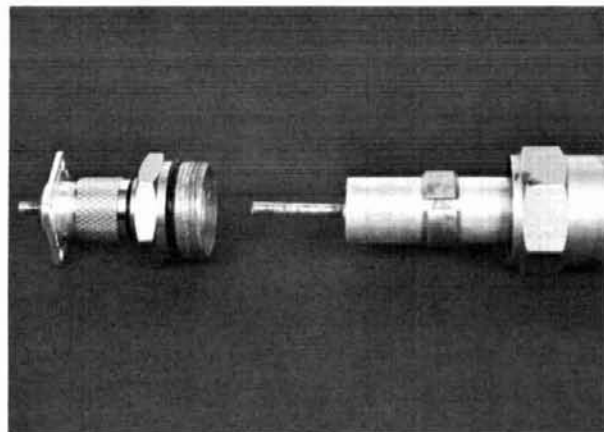

**fig. 3. Attaching the hardline to a chassis-mounted SO-239 can be accomplished in the same manner. In this case though, the feedthrough connector and the SO-239 are mated before the cable is attached.**

Another item available from equipment supply stores is special heat-shrink tubing that slides over the entire connector assembly. These tubes are usually about 23 cm (9 inches) long and have a special sealant inside that is effective against moisture.

## summary

Before changing to 75-ohm transmission line, it is best to ensure that your transmitter and antennas will match the higher impedance. In general, most transmitters with a pi network will match the impedance presented when using 75-ohm cable. Even gamma matches on Yagi arrays can be readjusted to match the new cable. Unfortunately though, it can be an expensive proposition if you try to change your power meters to read correctly in a matched 75-ohm system.

Even with the small problems presented by connectors and, in some cases, matching, the use of 75-ohm CATV cable has one big advantage: more power at the antenna at a highly economical price.

**ham radio**



# matching 75-ohm CATV hardline to 50-ohm systems

The previous article by W7VK pointed out the significant attenuation differences between the more commonly used RG-8 type coaxial cables and 75-ohm CATV type "hardline." In some amateur installations, changing to hardline could mean large increases in the power delivered to the antenna, especially where long cable runs are being used. As Woods pointed out, switching to this type of cable usually involves only antenna rematching and retuning the transmitter. Unfortunately, in some cases, rematching the antenna to 75 ohms is not possible, and the resultant swr may be intolerable; the ultimate isolation between sections of a repeater duplexer, for example, can be degraded by a high swr on the line. The matchable bandwidth of an antenna can also be reduced, since the output pi network was originally designed for 50-ohm loads. And finally, 75-ohm power meters are not commonly available.

## matching

The standard quarter-wavelength transformer or  $Q$  section, one of the most popular forms of matching, is unfortunately not readily suited for this task. The impedance of the matching section has to be the geometric mean between the two impedances to be matched, or in this case  $\sqrt{Z_1 \cdot Z_2} = 61.3 \text{ ohms}$ , not a common coax impedance value.

One little-known matching technique, the nonsynchronous impedance matching transformer, does offer a solution to the problem. W5TRS originally described this method in *ham radio*,<sup>1</sup> though only providing basic design information (see fig. 1). In a

subsequent letter,<sup>2</sup> W3DVO briefly discussed the bandwidth in relation to a standard quarter-wavelength transformer. Until now, however, nothing has been published on the use of the nonsynchronous transformer. Since the required sections are the same impedance as those to be matched, this method would seem to be an easy solution to the 75-to-50 ohm matching problem, and warrants further examination.

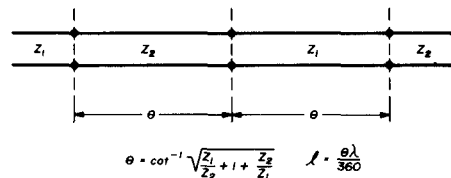

fig. 1. Diagram of the basic nonsynchronous matching transformer as described by W5TRS. The lengths of the two matching sections will vary according to the impedance ratio.

To evaluate this method, I decided to compare the nonsynchronous transformer to another technique, stub matching. Fig. 2 illustrates the situations that were considered. (If the load were replaced by an antenna, the system would not be too different from a typical antenna installation.) The main feedline was considered to have a 1 dB insertion loss and be 0.25 wavelength long at the center frequency. Since there will be a perfect match at only one frequency, having the feedline 0.25 wavelength long provided the maxi-

By Charles J. Carroll, K1XX, *ham radio*,  
Greenville, New Hampshire 03048

table 1. Impedance values along the lines shown in fig. 1.

frequency, MHz	nonsynchronous transformer			final swr
	point A	point B	point C	
144	74.63 + j0.63	75.34 - j0.50	49.86 - j0.44	1.0093
145	74.82 + j0.31	75.15 - j0.24	49.93 - j0.21	1.0044
146	75.01 - j0.02	74.99 + j0.02	50.00 - j0.01	1.0002
147	75.20 - j0.36	74.85 + j0.29	50.08 + j0.22	1.0047
148	75.37 - j0.70	74.72 + j0.56	50.16 + j0.41	1.0089

frequency, MHz	stub matching			final swr
	point A	point B	point C	
144	75.60 - j0.12	75.75 - j0.18	50.02 + j0.86	1.0173
145	75.31 - j0.06	75.39 - j0.09	50.00 + j0.42	1.0084
146	75.02 - j0.00	75.03 - j0.01	50.00 - j0.02	1.0004
147	74.74 + j0.05	74.67 + j0.06	49.99 - j0.01	1.0002
148	74.45 + j0.12	74.30 + j0.11	49.97 + j0.04	1.0009

imum impedance change at other than the center frequency. This, along with the low insertion loss, will provide close to the worst-case swr. The matching sections were considered to be lossless lines.

### test results

Table 1 shows the different impedance values as the 50-ohm load was rotated back toward the generator. In actuality, the values were determined with the aid of an HP-25 programmable calculator; the use of the Smith chart was precluded since the final differences were extremely small, and beyond the accuracy resolution of even an expanded chart.

Because the initial results proved so favorable, another set of calculations were performed. This time, instead of the relatively narrow bandwidth

afforded by the 2-meter frequencies (approximately 1.5 per cent), calculations were carried out for 80 through 10 meters, with the 80-meter extreme of 6 per cent bandwidth. Table 2 shows the results for the nonsynchronous transformer when applied to fig. 2A.

As a final test, the line was terminated with eight different reactive loads, each selected to be on the 2:1 swr circle on a Smith chart (see fig. 3). The inner points represent the same impedances, but as seen at the generator (transmitter) end after the different rotations. Table 3 lists the actual computed values.

### summary

The nonsynchronous impedance matching transformer can be an extremely valuable tool. With a bandwidth basically comparable to either stub or

table 2. Swr values for the nonsynchronous transformer when used for 80 through 10 meters.

frequency, MHz	final swr	frequency, MHz	final swr
3.5	1.0571	14.3	1.0048
3.6	1.0322	14.4	1.0091
3.7	1.0091	21.0	1.0063
3.8	1.0086	21.1	1.0029
3.9	1.0224	21.2	1.0003
4.0	1.0319	21.3	1.0034
7.0	1.0150	21.4	1.0059
7.1	1.0045	28.0	1.0097
7.2	1.0038	28.2	1.0045
7.3	1.0188	28.4	1.0003
14.0	1.0097	28.6	1.0048
14.1	1.0045	28.8	1.0091
14.2	1.0003		

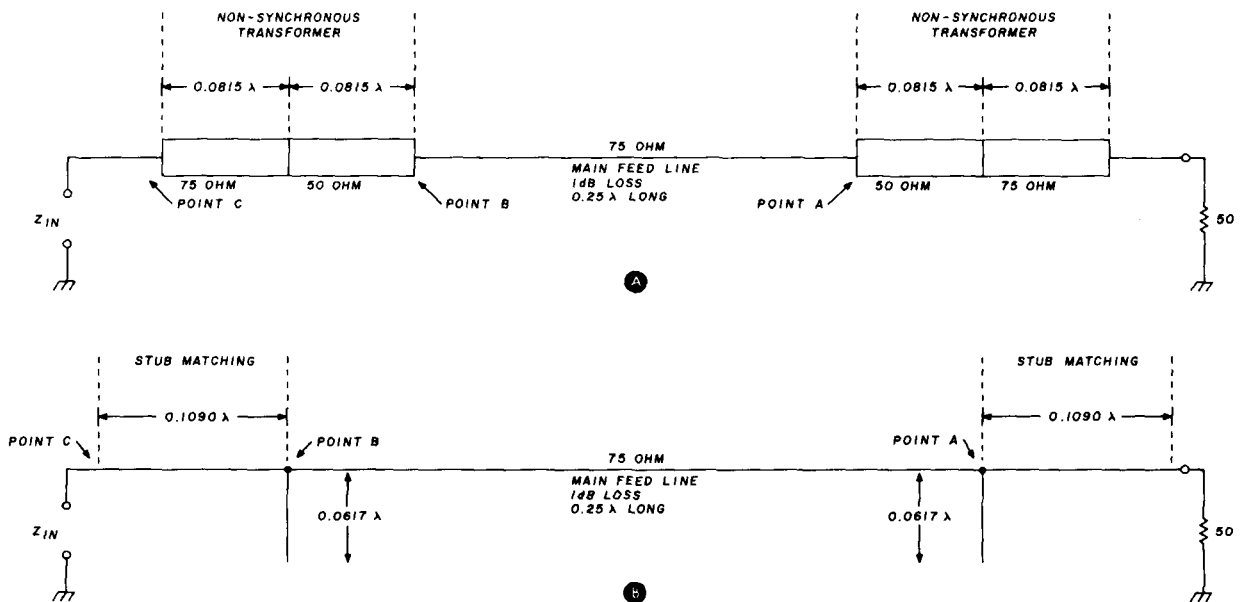

fig. 2. Schematic diagram of the system used to evaluate the bandwidth of the two matching systems. The main feedline, as used in both systems, has 1 dB loss. Points A, B, and C correspond to the impedance values listed in the tables.

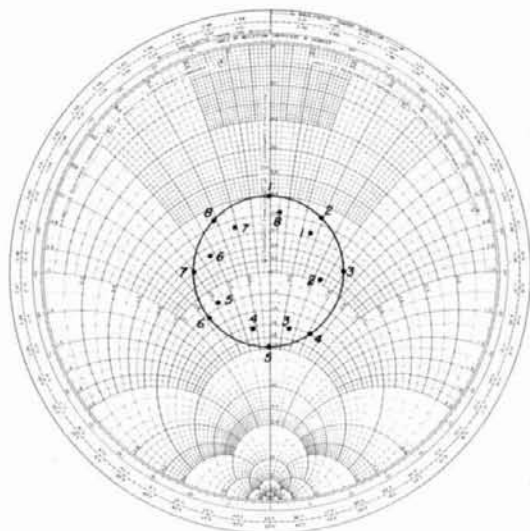

fig. 3. Smith chart presentation of the eight reactive loads used to terminate the line. The inner points represent the final impedances as seen at the transmitter end.

Q-section matching, it has the added advantage of requiring one-third less coax than the quarter-wave-length section and one-half less than a stubbed system. Though these differences may not be significant at vhf, they can save a considerable amount of cable on 80 through 10 meters. In addition, the construction of a nonsynchronous transformer appears to be inherently easier than that of a stub system because of the difficulty in correctly placing a T-type connector. Probably the two biggest disadvantages are that the feedlines have to be dedicated to a par-

table 3. Computed swr values at 14 MHz with the line terminated in reactive loads.

termination	computed impedance values	final swr
25.00 ± j0	34.17 + j15.90	1.7097
28.09 + j14.90	48.40 + j26.48	1.7040
40.02 + j30.01	74.23 + j22.41	1.7080
69.53 + j36.84	83.89 - j10.66	1.7193
100.0 ± j0	59.09 - j28.80	1.7311
69.39 - j36.86	39.16 - j22.24	1.7367
39.95 - j29.96	30.58 - j9.84	1.7327
28.06 - j14.85	29.21 + j3.11	1.7215

ticular band (since each transformer length is frequency dependent), and the requirement that the coax be the same impedance as those to be matched. These factors certainly prevent its qualifying as an all-encompassing matching method, but it more than adequately will handle the problem of matching 75-ohm CATV hardline to a 50-ohm system.

### references

- Henry Keen, W5TRS, *ham notebook, ham radio*, September, 1975, page 66.
- Raymond Aylor, W3VDO, *comments, ham radio*, May, 1976, page 63.

ham radio

# FREQUENCY COUNTERS

BY POPULAR DEMAND — we are continuing to offer with any purchase of \$99 or more from ad or flyer, a Fairchild clock module FCS-8100A (suggested retail price \$20).



## Look at these Summer Specials

**COMPLETE KITS:** CONSISTING OF EVERY ESSENTIAL PART NEEDED TO MAKE YOUR COUNTER COMPLETE. **HAL-600A** 7-DIGIT COUNTER WITH FREQUENCY RANGE OF ZERO TO 600 MHZ. FEATURES TWO INPUTS: ONE FOR LOW FREQUENCY AND ONE FOR HIGH FREQUENCY; AUTOMATIC ZERO SUPPRESSION. TIME BASE IS 1.0 SEC OR .1 SEC GATE WITH OPTIONAL 10 SEC GATE AVAILABLE. ACCURACY ± .001%, UTILIZES 10-MHZ CRYSTAL 5 PPM.

COMPLETE KIT... \$149... \$129

**HAL-300A** 7-DIGIT COUNTER WITH FREQUENCY RANGE OF ZERO TO 300 MHZ. FEATURES TWO INPUTS: ONE FOR LOW FREQUENCY AND ONE FOR HIGH FREQUENCY; AUTOMATIC ZERO SUPPRESSION. TIME BASE IS 1.0 SEC OR .1 SEC GATE WITH OPTIONAL 10 SEC GATE AVAILABLE. ACCURACY ± .001%, UTILIZES 10-MHZ CRYSTAL 5 PPM.

COMPLETE KIT... \$124... \$109

**HAL-50A** 8-DIGIT COUNTER WITH FREQUENCY RANGE OF ZERO TO 50 MHZ OR BETTER. AUTOMATIC DECIMAL POINT, ZERO SUPPRESSION UPON DEMAND. FEATURES TWO INPUTS: ONE FOR LOW FREQUENCY INPUT, AND ONE ON PANEL FOR USE WITH ANY INTERNALLY MOUNTED HALTRONIX PRE-SCALER FOR WHICH PROVISIONS HAVE ALREADY BEEN MADE. 1.0 SEC AND .1 SEC TIME GATES. ACCURACY ± .001%. UTILIZES 10-MHZ CRYSTAL 5 PPM.

COMPLETE KIT... \$124... \$109

### ATTENTION RADIO CLUBS

For club or group projects, request FREE information about our DISCOUNTS on any of the HAL-TRONIX kits. Discounts range from 10-25%, depending upon the quantity needed. We are experienced in supplying kits in volume quantities to schools, laboratories, clubs, and common-interest groups. Nobody beats HAL-TRONIX quality and price. Just try us and see for yourself.



### FROM HAL-TRONIX

#### DELUXE 12-BUTTON TOUCH-TONE ENCODER KIT

utilizing the new ICM 7206 chip. Provides both VISUAL AND AUDIO indications! Comes with its own two-tone anodized aluminum cabinet. Measures only 2 3/4 x 3 3/4". Complete with Touch-Tone pad, board, crystal, chip and all necessary components to finish the kit.

PRICED AT... \$29.95

For those who wish to mount the encoder in a hand-held unit, the PC board measures only 9/16" x 1 1/4". This partial kit with PC board, crystal, chip and components.

PRICED AT... \$14.95

### PRE-SCALER KITS

**HAL 300 PRE** ..... \$19.95

(Pre-drilled G10 board and all components)

**HAL 300 A/PRE** ..... \$29.95

(Same as above but with preamp)

**HAL 600 PRE** ..... \$34.95

(Pre-drilled G10 board and all components)

**HAL 600 A/PRE** ..... \$39.95

(Same as above but with preamp)

### SPECIAL — due to OVERSTOCK (while they last!) FAIRCHILD FND-70

common cathode readouts (can replace FND-359... same pin-out)

Qty.	Price each	Amount
10	40c	\$4.00
100	35c	35.00
500	30c	150.00
1000	25c	250.00



"HAL"  
HAROLD C. NOWLAND  
W8ZXH

## HAL-TRONIX

PO BOX 1101, SOUTHGATE, MI 48195  
PHONE (313) 285-1782

### SHIPPING INFORMATION:

ORDERS OVER \$15.00 WILL BE SHIPPED POSTPAID EXCEPT ON ITEMS WHERE ADDITIONAL CHARGES ARE REQUESTED. ON ORDERS LESS THAN \$15.00 PLEASE INCLUDE ADDITIONAL \$1.00 FOR HANDLING AND MAILING CHARGES. SEND SASE FOR FREE FLYER.

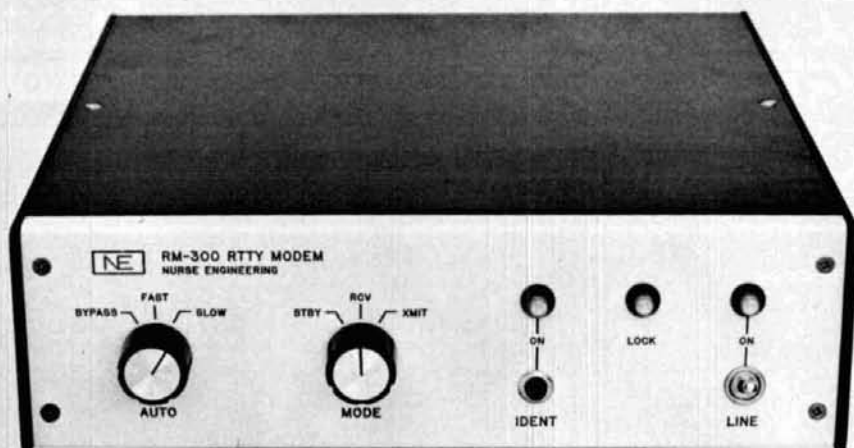

## RM-300 Modem

### RTTY modulator- demodulator for vhf operation

Design and  
construction details  
for the hardware  
to get started  
in the RTTY mode  
on the vhf  
amateur bands

Operating RTTY on vhf fm is a joy. Bothersome fading, static crashes, interfering signals, and drifting VFOs don't stand between you and a QSO. Whether across town on simplex or across the state through a repeater, vhf RTTY is a reliable, trouble-free mode ideally suited for rag chewing or unattended operation.

The ingredients for a vhf RTTY station include a standard fm transceiver, a Teletype machine, a terminal unit (demodulator), an AFSK oscillator (modulator), and a means of sending your call in Morse code as required by the FCC.

The RM-300 Modem (*Modulator-Demodulator*) was developed to provide a simple way for those interested in vhf RTTY to get on the air. The RM-300 contains a phase-locked loop (PLL) demodulator to convert the 2125/2295-Hz tones from your transceiver speaker terminals to Teletype keying pulses, a stable AFSK modulator to feed the microphone input of your transceiver, a read-only memory CW identifier, and auto-start logic — all on a single 114 x 152 mm (4.5 x 6 in.) circuit board. A second board, the RP-400, contains loop and low-voltage power supplies and loop keying circuits.

A schematic diagram for the RM-300 is given in fig. 1. The three major functions mounted on the cir-

\*A complete kit of all parts is available from Eclipse Communications, 5 Westwood Drive, San Rafael, CA 94901. The RM-300 kit less PROM costs \$71.25. A PROM programmed with one or two call signs (specify) costs \$7. The cost of the RM-300 circuit board alone is \$21.25. (The board is double-sided with plated-through holes and a solder mask on both sides. The component side is screened with part numbers and component values.) Add \$1 for postage and handling with all orders. California residents add 6 per cent sales tax.

By Howard L. Nurse, W6LLO, 665 Maybell Avenue, Palo Alto, California 94306

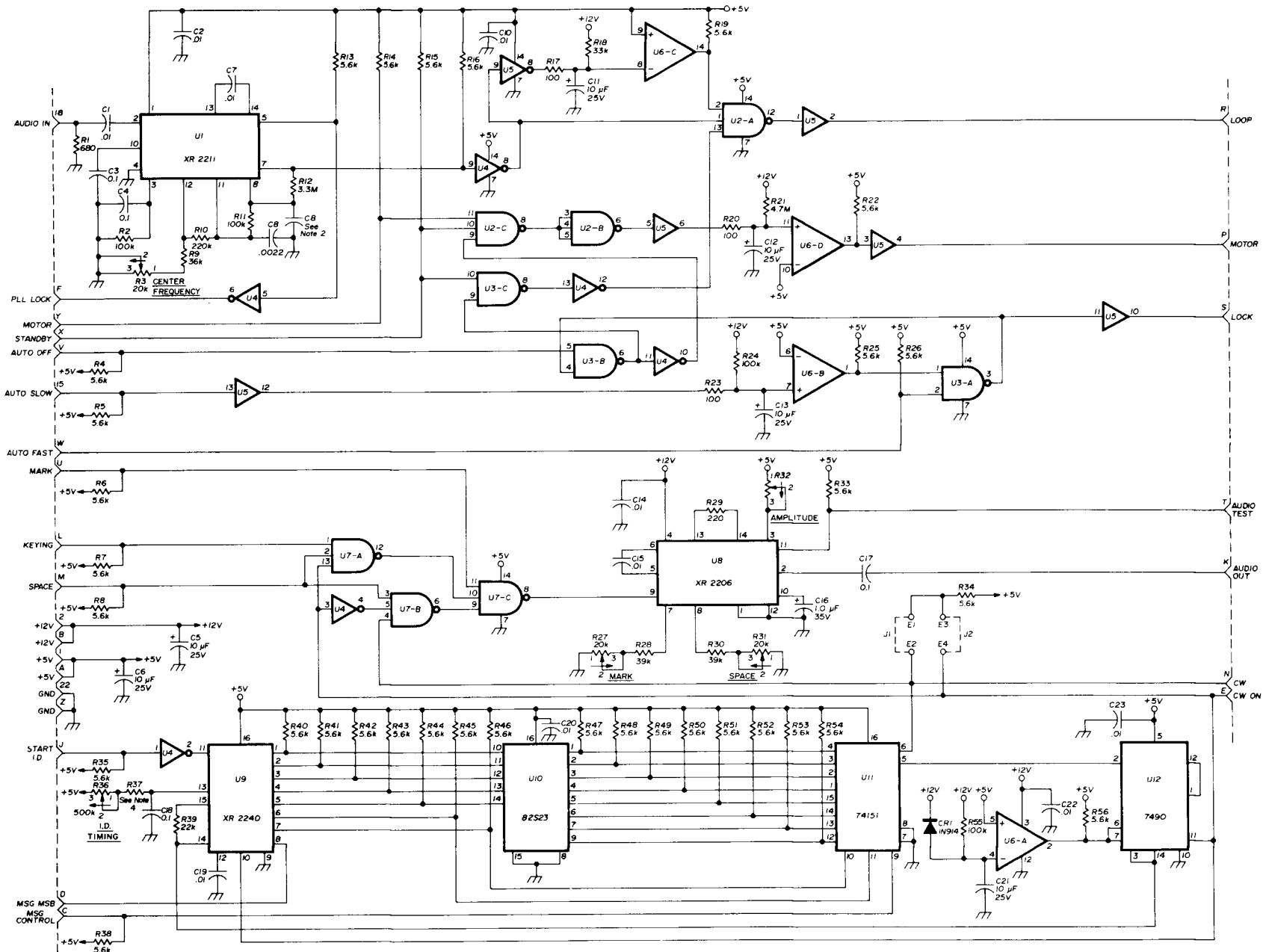

fig. 1. Schematic of the RM-300 Modem (modulator-demodulator) for those interested in vhf RTTY. A complete kit of all parts is available (see text).

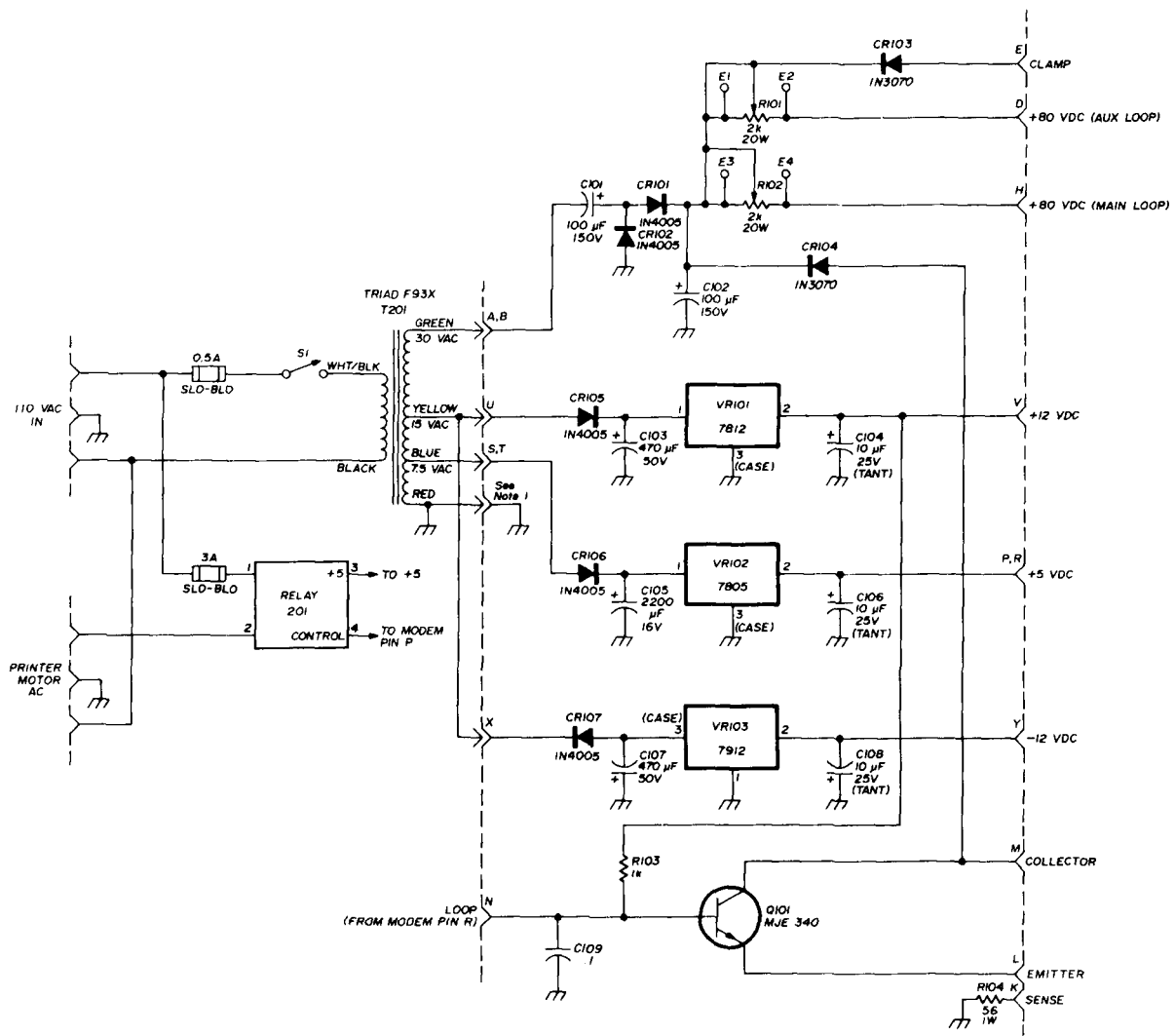

fig. 2. Schematic of the RP-400 power supply. The design features an auxiliary -12 V dc supply in addition to power required for the RM-300 Modem. Kits are available.

circuit board are grouped on the schematic. The demodulator portion is shown in the top third, the AFSK modulator in the middle third, and the CW identification circuitry in the bottom third of the schematic. Detailed descriptions of connections to and from the RM-300 circuit board are given in table 1.

### demodulator and autostart

Audio from the transceiver is fed to the XR2211 PLL through pin 18 on the board edge connector. The PLL output on U1 pin 7 is at a TTL-compatible high level when the input tone is 2125 Hz (MARK) and low when the input tone is 2295 Hz (SPACE). The frequency at which the PLL switches from high to low is the PLL center frequency as determined by center-frequency potentiometer, R3.

The PLL output signal is inverted by U4 and applied to the antispacer circuit (U5 and U6-C) and the keying inhibit gate, U2-A.

The antispacer circuit prevents *space* tones longer than approximately 200 milliseconds from keying the loop. The output from U5 pin 8 clamps the voltage across C11 near ground as long as the PLL is detecting a *mark* tone. A *space* tone allows the voltage across C11 to rise at a rate determined by R18. If the voltage rises above 5 volts, the output of U6-C goes low, which forces the loop into *mark*-hold.

The autostart circuit and standby logic can also be used to force the loop into *mark*-hold. The PLL contains a carrier detector, which has a TTL-compatible output on pin 5 of U1. This output is low when a signal within the lock range of the PLL is detected. The carrier-detect output, after inversion by U4, can be used to control the *fast* or *slow* modes of the autostart. The *fast* mode allows the Modem to respond immediately to a detected signal, which is desirable when operating fast break-in. The *slow* mode yields a 0.5-second delay before the Modem responds, which gives sufficient noise immunity on vhf circuits. When

a carrier is detected by the PLL, the *lock* output (edge connector pin S) goes low. This output can be used to control an LED on the Modem front panel.

If the *auto off* input (edge connector pin V) is grounded or a carrier has been detected, and the *standby* input (pin X) is high, the loop can be keyed by the PLL because pin 13 on U2-A will be high.

The open-collector loop output from U5 pin 2 is high for *mark* and low for *space*. It can be connected directly to a loop keying transistor or to the serial input of a UART.

The *motor* output (pin P) is low when a signal has been detected, the *standby* input is grounded, or the *motor* input (pin Y) is grounded. The *motor* output will remain low for approximately 25 seconds after a

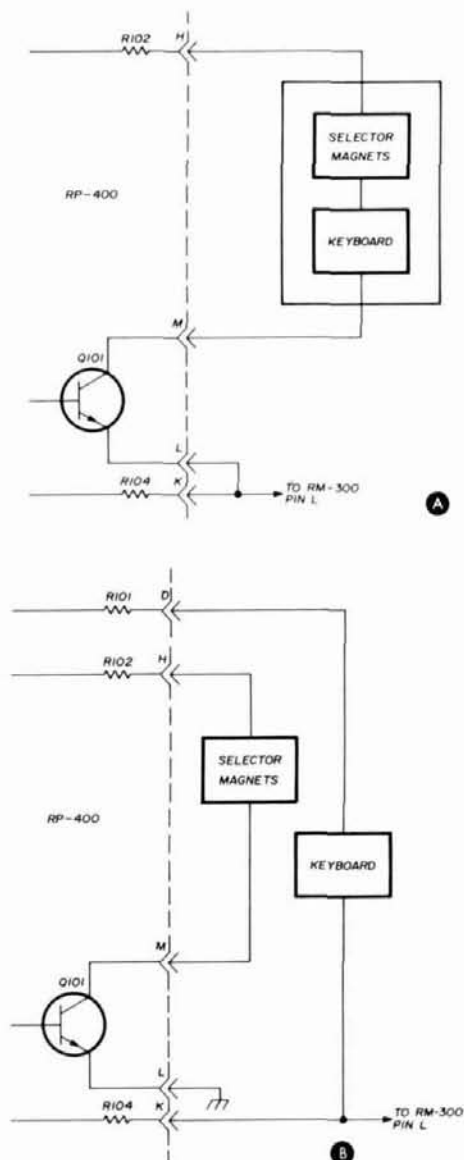
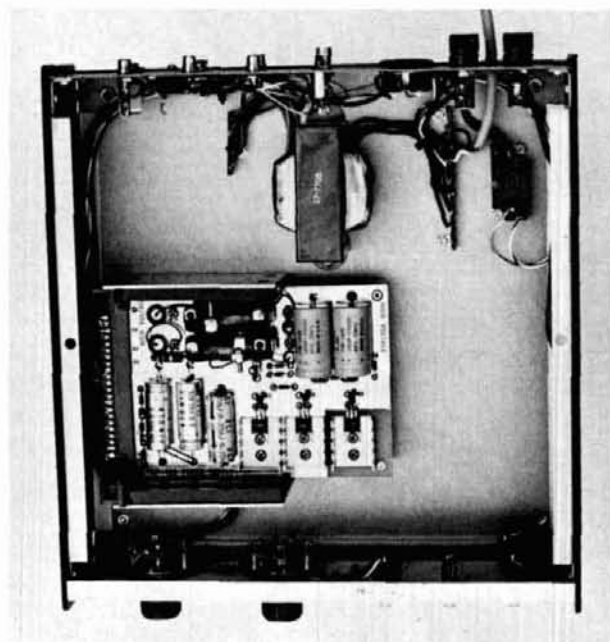

fig. 3. Two suggested ways of connecting your RTTY machine to the loop supplies and keying transistors. Sketch A shows the usual connection. Separate selector magnet and keyboard connections are shown in B.



Interior of the RM-300 Modem. A solid-state motor-control relay is near the power cable at the rear of chassis. The RM-300 board is below the RP-400 power-supply board.

signal has dropped. This timing is determined by the RC time constant of R21 and C12.

### AFSK modulator

The heart of the AFSK modulator is an XR-2206 function generator integrated circuit. It produces low-distortion sine wave tones at a frequency determined by capacitor C15 and the resistance between pin 7 or 8 and ground, depending on the control input on pin 9. When pin 9 is high (*mark*), R27 sets the output frequency to 2125 Hz; and when pin 9 is low (*space*), R31 sets the output frequency to 2295 Hz. The output frequency can be monitored at the *audio test* output (pin T), which provides a TTL-compatible square-wave replica of the function generator output waveform.

The AFSK modulator output level should be adjusted to match the requirements of your transmitter's audio circuit using potentiometer R32. The output amplitude can be adjusted to a maximum level of approximately 5 volts peak-to-peak.

All control inputs to the AFSK modulator are TTL-compatible. The teleprinter keyboard signals are applied to the *keying* input (pin L). Consistent with the design convention used throughout the board, a high input yields a *mark* tone, while a low input yields a *space* tone. *Mark* and *space* override inputs are provided on pins U and M respectively. These inputs can be used to force the AFSK modulator to either state despite information present on the *keying* input. The remaining control input to the AFSK modulator is from the CW identifier.

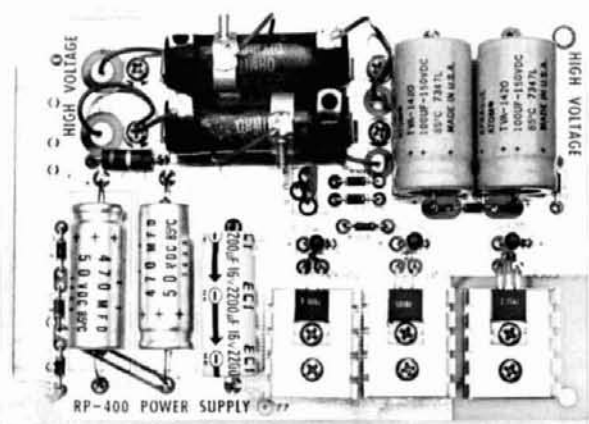

The RP-400 power-supply board. The board is 114 × 152 mm (4.5 × 6 in.). See text for kit information.

table 1. RM-300 RTTY Modem input-output descriptions

name/pin number	description
AUDIO IN/18	Audio from receiver. 680-ohm impedance. Input level 10 mVrms to 3 Vrms.
PLL LOCK/F	TTL high when PLL locked to input signal.
MOTOR/Y	When grounded causes MOTOR/P to go low.
STANDBY/X	When grounded causes MOTOR/P to go low and LOOP/R to go high (MARK level).
AUTO OFF/V	When grounded forces Modem into receive mode without control by the PLL LOCK/F function.
AUTO SLOW/15	0.5-second Autostart control line.
AUTO FAST/W	Instantaneous Autostart control line.
MARK/U	When grounded forces AFSK modulator to MARK.
KEYING/L	Normal RTTY keying line. MARK (2125 Hz) is high and SPACE (2295 Hz) is low. This input is overridden by CW IDENT cycle.
SPACE/M	When grounded forces AFSK modulator to SPACE.
+12/2, B	+12 Vdc at 20 mA maximum.
+5/1, A	+5 Vdc at 200 mA or less.
START ID/J	Momentary ground starts CW IDENT cycle.
MSG MSB/D	Logic low for first 128 cycles of CW IDENT.
MSG CONTROL/C	When grounded enables first half of CW IDENT memory. When high, enables second half.
LOOP/R	Loop control output, high for MARK and low for SPACE. Can sink 40 mA at 15 volts.
MOTOR/P	Output goes low to turn on motor. Can sink 40 mA at 15 volts.
LOCK/S	Output goes low when PLL has locked.
AUDIO TEST/T	AFSK oscillator test output, 5 V p-p.
AUDIO OUT/K	AFSK modulator output, 600-Ohms, 6 V p-p maximum.
CW ON/E	Output goes low during CW IDENT.
CW/N	Output goes low during each IDENT key closure.

## CW identifier

The CW identifier output signals include the CW keying line, which provides full-shift keying, and a CW on control line, which precludes all other keying when active. The CW identifier, started by momentarily grounding the *start ID* input (pin J), causes either O or . characters to be printed by the receiving station. The timing and memory programming required to accomplish this format were described in reference 1.

One new feature, available with the "0" option, is the ability to have two call signs in the read-only memory. One call sign is accessed by grounding the *message control*, pin C, while the other is obtained by leaving pin C open. If your call is too long to fit into half of the memory (128 bits), the whole memory can be used by connecting the *MSG MSB* output, pin D, to pin C on the edge connector.

On-off control of the CW identifier is accomplished with U9, an XR-2240, which contains an oscillator, an eight-stage divider, and a control flip-flop. The timing of the CW output is established by adjusting the *ID timing* potentiometer, R36. Five of the eight divider outputs from U9 address the 32 bytes of memory in U10, while the remaining three extract the CW characters from the selected bytes with multiplexer U11. Decade counter U12 monitors the CW output for consecutive "blanks;" after it detects eight, it turns off the control flip-flop in U9. Comparator U6-A and its associated circuit resets the decade counter so that the counter will start with the correct count when power is first applied.

## adjustments

Proper adjustment of the Modem requires a frequency counter and a voltmeter or oscilloscope. The Modem can be adjusted with help from another sta-

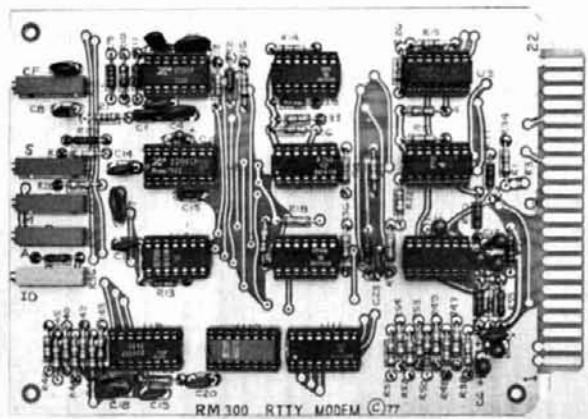

The RM-300 Modem circuit board, which is the same size as the RP-400 power supply board. Kits are available (see text).



tion which has a counter or an AFSK oscillator/demodulator that has a known calibration.

**AFSK generator.** Connect a counter to *audio test*, pin T. Ground *mark*, pin U. Adjust R27 (M) to obtain a counter reading of 2125 Hz. Move the ground lead

with R36 until the other machine prints the encoded message correctly.

### power supply

The RP-400 power supply was designed to furnish the voltages required by the RM-300, in addition to

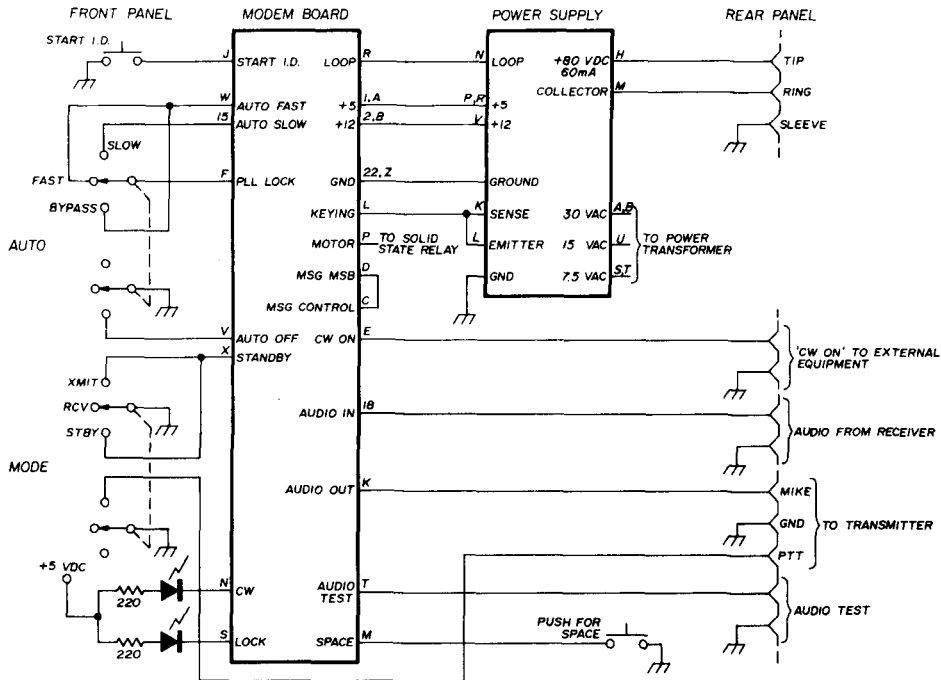

fig. 4. Interface wiring for the PC boards, front-panel controls, and rear-panel connectors.

from pin U to *space*, pin M. Adjust R31 (S) to obtain a counter reading of 2295 Hz. Use a voltmeter or oscilloscope connected to *audio out*, pin K, to adjust the output to a level compatible with your transmitter audio input using R32 (A). Remove the ground lead.

**Phase-locked loop (U1).** Use a jumper to connect *audio out*, pin K, to *audio in*, pin 18. Connect an oscilloscope or voltmeter to hex inverter U4-8. (This voltage will swing between ground and approximately 3 volts.) Ground *mark*, pin U, and adjust R3 (CF) until the hex inverter output goes high. Remove the ground from *mark*, pin U, and ground *space*, pin M. While counting turns, adjust R3 until U4-8 just goes low. (R3 should be adjusted in a ccw direction.) Divide the number of turns by two and adjust R3 in a cw direction by that number.

**CW identifier timing.** This adjustment is most easily made with the aid of another station. Initiate an ident while the other station monitors your signal with his printer. When the timing is adjusted correctly his printer should print 00000000. . . with the number of zeroes determined by your call sign. If you've selected the Baudot ident option, adjust the timing

an auxiliary - 12 Vdc supply for other circuits you may wish to add, such as a UART. Included on the board are the following:

- two 80 Vdc, 60-mA loop supplies
- one + 12 Vdc, 100-mA supply
- one + 5 Vdc, 300-mA logic supply
- one - 12 Vdc, 100-mA auxiliary supply

A high-voltage loop keying transistor is also located on the RP-400 power-supply board. A schematic for the board is given in fig. 2.\*

The loop supplies run from a voltage doubler consisting of C101, CR101, and CR102. The resulting dc is filtered by C102 before being sent to the adjustable wirewound resistors, R101 and R102.

Two suggested ways of connecting your Teletype machine to the loop supplies and keying transistor are shown in fig. 3. The usual connection, with the

\*A complete kit of all the parts for the RP-400 power supply is available from Eclipse Communications, 5 Westwood Drive, San Rafael, CA 94901. The RP-400 kit costs \$71.25. The cost of the RP-400 circuit board alone is \$21.25. (The board is double-sided with plated-through holes and a solder mask on both sides. The component side of the board is screened with part numbers and component values.) Add \$1 for postage and handling on all orders. California residents add 6 per cent sales tax.

selector magnets and keyboard contacts in series, is shown in **A** of the figure. Resistor R104 provides a TTL-compatible low level when the loop is open. If you desire separate selector magnet and keyboard connections, use the wiring diagram shown in **B** of **fig. 3**. Split wiring might be used when you wish to use the output of a repeater to provide local copy through a demodulator. By operating in this manner it's possible to tell instantly if you aren't making it through the repeater.

The low-voltage power supplies are similar in design. Each has a half-wave rectifier, filter capacitor, and three-terminal regulator.

### construction

The RM-300 Modem board, the RP-400 power supply, the solid-state motor-control relay, and the

power supply fit nicely inside a 30.5 x 30.5 x 8 cm (12 x 12 x 3 in.) Moduline enclosure.

**Fig. 4** is a schematic showing one way to connect the boards, front panel controls, and rear panel connectors. Variations on this wiring will be determined by your requirements.

### acknowledgments

Special thanks are due Herbert Drake, Jr., WB6IMP, Rod Roderique, WA0QII, and Alan Bowker, WA6DNR, for their encouragement and suggestions during the development of the RM-300/RP-400 Modem and power supply.

### reference

1. Howard L. Nurse, W6LLO, "CW Memory for RTTY Identification," *ham radio*, January, 1974, pages 6-12.

ham radio

## stressed quad

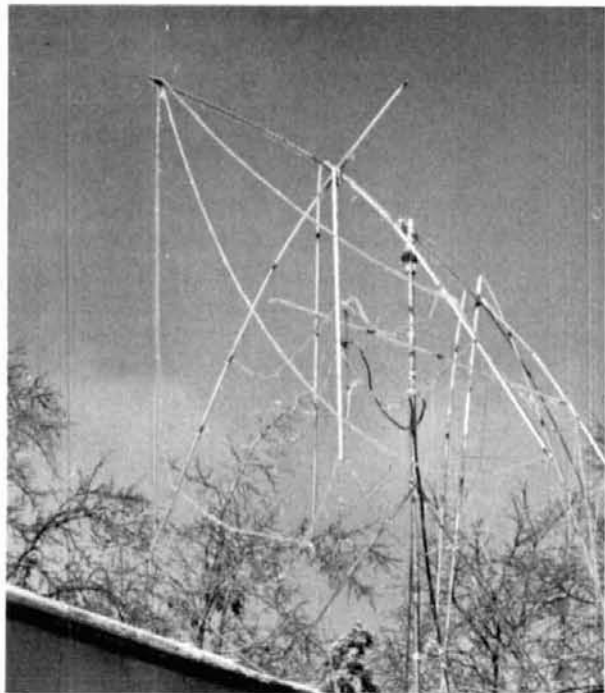

As you can see by the photo, I have a problem. To eliminate this problem in the future, I have devised a means of stressing a quad (see **fig. 1**). As seen in **fig. 1**, the ends of the spreaders are connected together with 3 meter (10 foot) lengths of 45 kg (200 pound) test mono-filament fishing line. In addition, three 3 meter (10 foot) lengths of conduit are connected together with sleeve couplings and extended through the boom approximately 3 meters (10 feet) beyond the ends of the boom. Additional lengths of fishing

line connect the ends of the spreaders to the extended ends of the conduit. With the lines tight, the quad now has the general appearance of a Zeppelin, but is stressed to withstand a large wind load. I also attempted this method with nylon cord, but it had too much stretch; the monofilament fishing line does not. Had I used fishing line first, I would not have this picture.

Ira Hargis, W5TIU

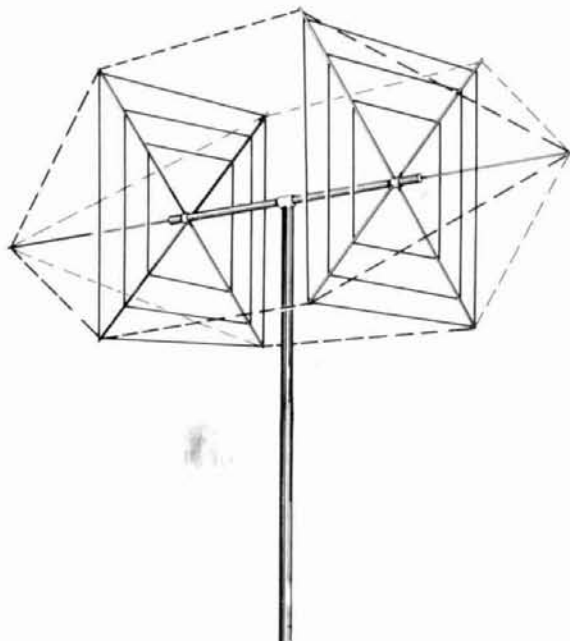

**fig. 1.** Diagram of the stressed quad as described by the author. The fishing line is almost invisible, yet keeps the spreaders under stress, increasing its survivability during high wind loads.



# The HEATHKIT SB-104A

good enough to measure up...to you!

In choosing the SB-104A you join a pretty select fraternity of fellow Amateurs. They're individuals whose imaginations were fired by the looks, feel, and reputation for outstanding performance that, since its inception, has become the trade mark of Heath's entire line of famous SB series Amateur equipment.

You've joined a group of people who want state-of-the-art perfection, still insist on building their own to insure handcrafted quality, and above all want a rig that's good enough to measure up to their abilities, standards, and the reputations they've built for themselves.

Heath's SB-104A, it's the only choice when you're ready for a transceiver that's good enough to measure up....to you!

**Heath Amateur Radio Gear....  
....the quality that measures up!**

## FREE Heathkit Catalog



HEATH  
Schlumberger

Heath Company,  
Dept. 122-450  
Benton Harbor,  
MI 49022

Gentlemen, please send me my free Heathkit Catalog  
I am not on your mailing list.

Name \_\_\_\_\_

Address \_\_\_\_\_

City \_\_\_\_\_ State \_\_\_\_\_

AM-360A \_\_\_\_\_ Zip \_\_\_\_\_

# integrated circuit arrays

Using IC arrays  
permits the designer  
to reduce size  
and component count —  
without sacrificing  
performance

**Integrated circuits have been** around for a decade or so; starting off with just a few transistors on a single chip, inter-connected in amplifier arrangements, they have developed into complex circuits incorporating many transistors, diodes, Zeners, and other components in a single package, often requiring a minimum of external parts to perform the functions of any linear, digital, or logic application. Most hams are familiar with the smaller, linear ICs designed for specific applications. And generally, many would not bother to use discrete transistors for an i-f amplifier or audio power output stage when a single TO-5 can or 14-pin dual inline IC makes construction simpler and more reliable. The majority of ICs are "committed" devices, developed to perform a specific function. Their popularity in amateur construction projects has long been established from the proliferation of articles published on amplifiers, balanced modulators, and phase-lock-loops, in receivers, transmitters, and test equipment.

Much less apparent is the constructor's use of the "uncommitted" IC. These devices are independent diodes and transistors on a single chip, individually connected to the package pins. Known as IC arrays, they are widely used in commercial and industrial equipment for minimizing space and assembly effort. There are also "semi-committed" arrays, in which only two of the transistors have internal connections (such as a differential or darlington pair).

For building equipment, there are several reasons why using IC arrays, instead of discrete transistors or diodes, can be an advantage.

1. In many cases, the IC will cost about the same, or less, than the equivalent discrete components. Due to broad commercial use, many types are fairly inexpensive and easy to find — even at bargain prices from some surplus outlets.
2. The individual transistor and diode parameters are much more closely matched than discrete components of the same type, and also retain matching over wide temperature variations, due to the individual devices being etched on a common substrate. Some arrays have two specially matched transistors, ideal for balanced-circuit applications.
3. Printed circuit board layout may be simplified, using less space than with discrete devices.
4. By using low-profile IC sockets, troubleshooting and repair can be as simple as plugging in a new IC.

Most of the major solid-state device manufacturers

**By Peter A. Lovelock, K6JM, Hughes Aircraft Company, P.O. Box 90515, Los Angeles, California 90009**

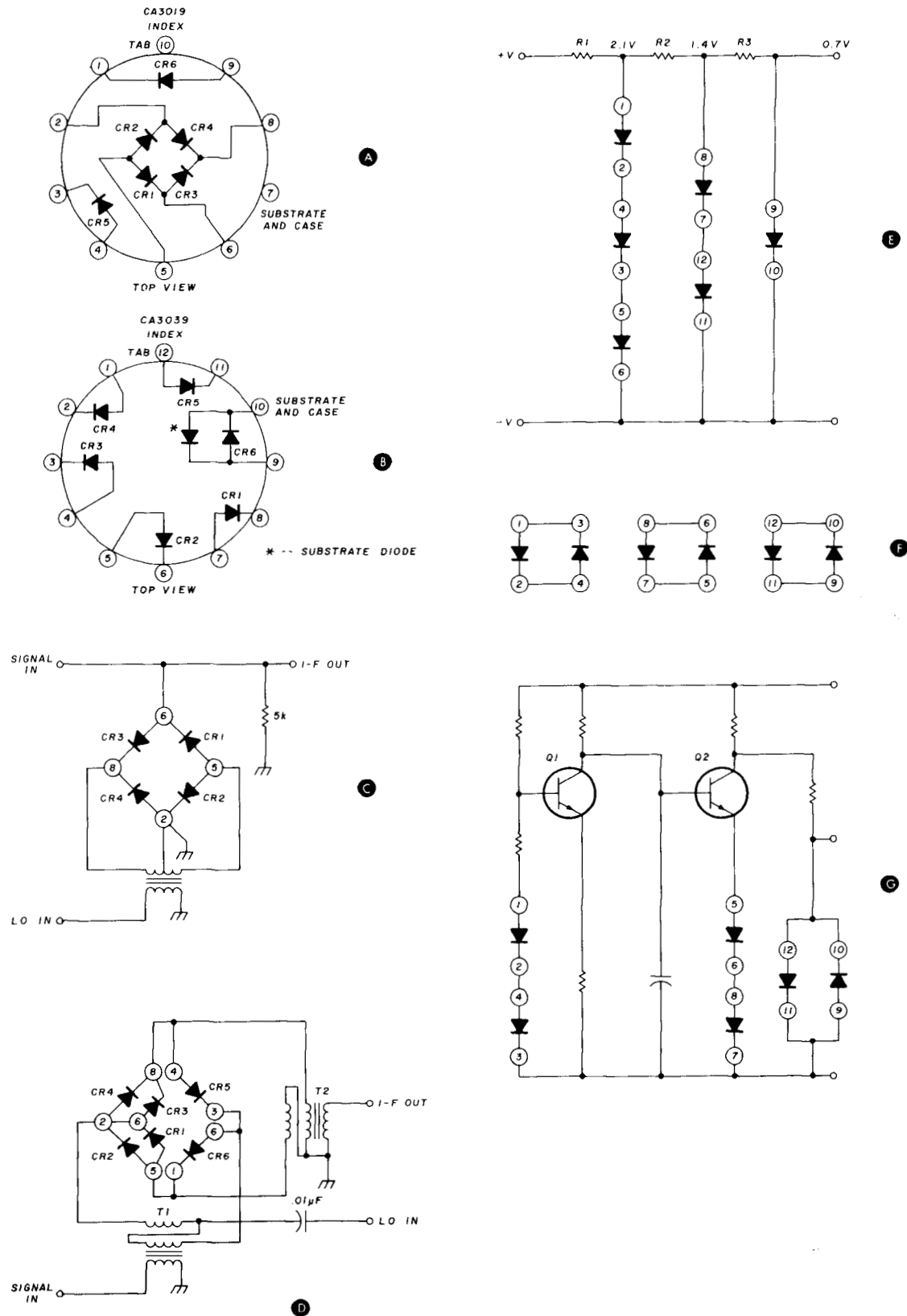

fig. 1. Pinout diagrams for the CA3019 and CA3039 are shown in A and B, respectively; C and D show two configurations for the CA3019, a balanced modulator and a double-balanced ring mixer. A 3-voltage regulator or reference, E, is obtained by using the forward-voltage drop across the diodes. By connecting the diodes back-to-back, they will also function as clippers (F). A typical application for almost the entire CA3039 package, including temperature compensation, emitter bias, and output limiting is shown at G.

produce transistor arrays. For the purpose of reviewing the more commonly available types, reference is made only to the RCA numbers. When a pin compatible equivalent is made by other manufacturers, the RCA number has an asterisk, and the equivalents will be found in **table 1**. Also, this review is divided into four logical categories, for easy future reference.

1. Diode arrays.
2. Uncommitted-transistor arrays.
3. Semi-committed transistor arrays.
4. Hybrid arrays (incorporating transistors and diodes, both uncommitted and semi-committed).

**table 1. Pin compatible IC array equivalents**

RCA	National	Fairchild
CA3019	LM3019	$\mu$ A3019
CA3039	LM3039	$\mu$ A3039
CA3018	LM3018	$\mu$ A3018
CA3086	LM3086	$\mu$ A3086

The review includes only essential information, and some basic applications circuits for each type, to assist device selection. The reader should refer to the manufacturers specification sheets, data manual, and application notes for complete information on any specific device. Some complete IC array circuits, both amateur and commercial, are included after the device review.

## diode arrays

### 1. CA3019\*

**Configuration:** Six silicon diodes, four internally connected as a quad, two independent.

**Package:** 10 pin, TO-5 (**fig. 1A**).

**Applications:** Modulators, mixers, analog switches (**figs. 1C** and **1D**).

### 2. CA3039\*

**Configuration:** Six ultra fast, low capacitance silicon diodes, independently connected.

**Package:** 12 pin, TO-5 (**fig. 1B**).

**Applications:** Balanced modulators, demodulators, voltage reference and bias regulators, clipper limiters, (**fig. 1D**).

The inherent advantage of the diode arrays (**figs. 1A** and **1B**) is the close matching of the diodes when used as single or double-balanced mixers or product detectors. While the diodes in the CA3019 and CA3039 do not have identical characteristics, they are essentially interchangeable in many circuits. **Fig. 1C** shows the CA3019 quad as a balanced modulator. For this application, the diode "ring" is more commonly used. **Fig. 1D** shows how the CA3019

diodes can be connected as a "ring" in a double-balanced mixer. Since this involves paralleling the quad diodes, (CR1, CR2 and CR3, CR4) connecting pins 2 and 6, and using the independent diodes CR5 CR6 to complete the ring, balance will not be as perfect as with four individual diodes, though adequate for most purposes. If the circuit in **fig. 1D** is used as a product detector, it is recommended that the LO be fed into T2 and audio output be taken from the center of T1's secondary.

The CA3039's independent diodes lend themselves to any circuit requiring up to six fast silicon diodes. **Figs. 1E, 1F, and 1G** show these diodes used for low-voltage regulation, varistors, or transistor amplifier biasing with temperature compensation and output limiting (clipping). Note that the voltage regulator is for low current, limited to the maximum forward current of the diodes. It is best applied as a voltage reference, rather than high current applications in which reverse-polarity zener diodes are used. By using one to six diodes in series, low current, stable reference voltages of 0.7 V, 1.4 V, 2.1 V, 2.8 V, 3.5 V, and 4.2 V can be derived from one CA3039. As shown, regulated positive voltages are obtained, but by reversing the supply and diode polarity, negative voltages for fet or mosfet device biasing can be achieved.

## uncommitted transistor arrays

### 1. CA3083/3183/3183A\*

**Specification:** Five general-purpose silicon NPN transistors, independent substrate connection. Two transistors (Q1, Q2) matched.  $I_{cmax}$  100 mA,  $h_{FE}$  76 typical.

**Package:** 16 pin, plastic DIP (**fig. 2A**).

**Applications:** Signal processing/switching from dc to vhf, lamp and relay driver, differential amplifiers (**fig. 2E**).

### 2. CA3127

**Specification:** Five high-frequency general-purpose silicon, NPN transistors, with independent substrate connection. DC to 500 MHz. Low noise (3.5 dB at 100 MHz). High power gain (30 dB at 100 MHz).

**Package:** 16-pin plastic DIP (**fig. 2B**).

**Applications:** vhf amplifiers, mixers and oscillators. I-f amplifiers, synthesizers, synchronous detectors (**fig. 2F**).

### 3. CA3096A/3096AE

**Specification:** Three general-purpose high-voltage silicon NPN transistors, and two general-purpose, high-

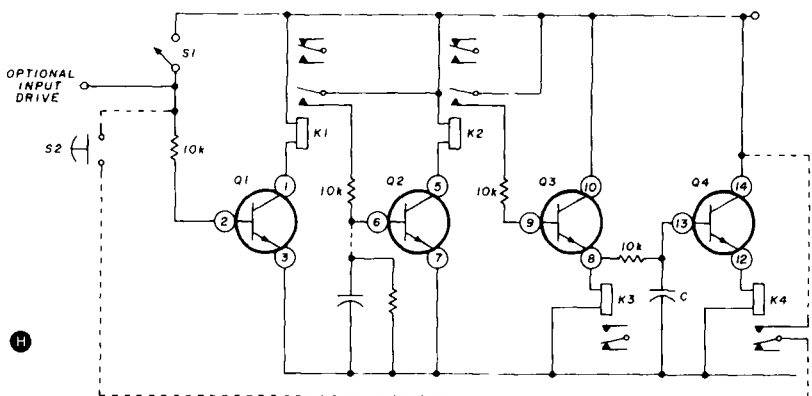
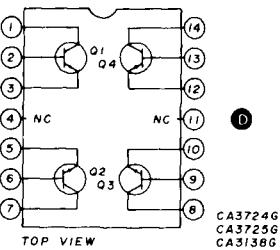
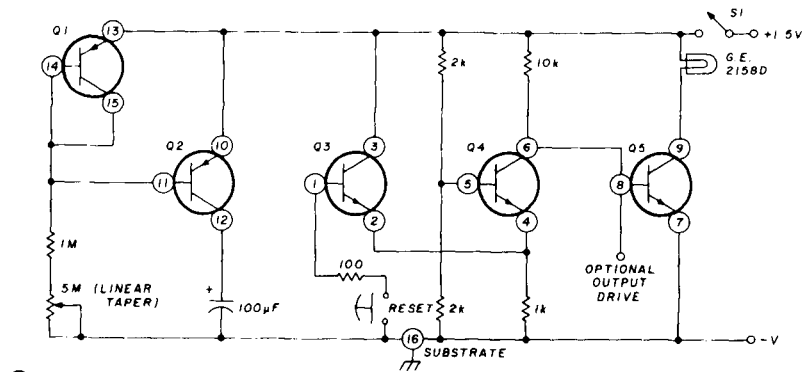
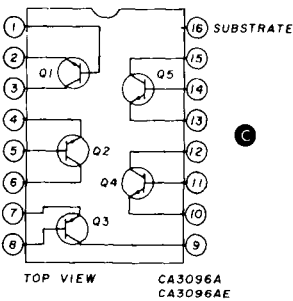
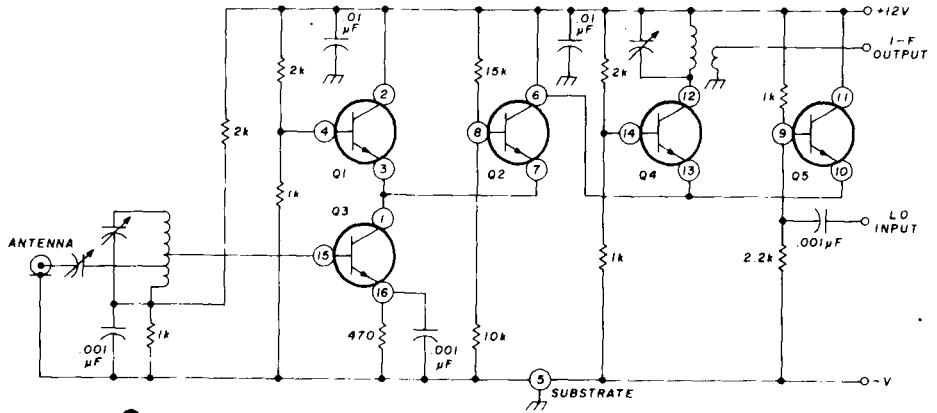
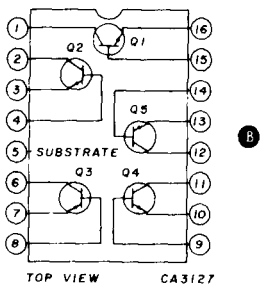
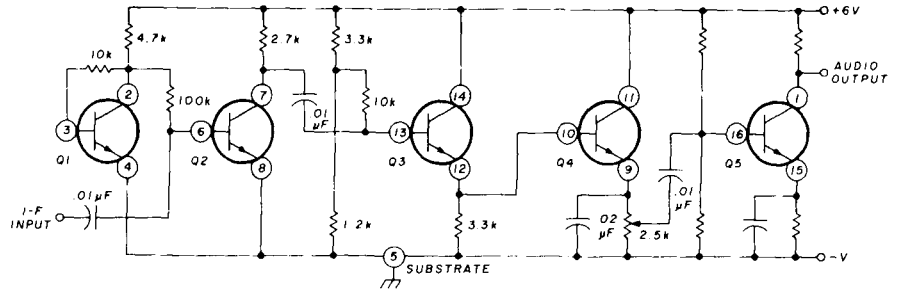
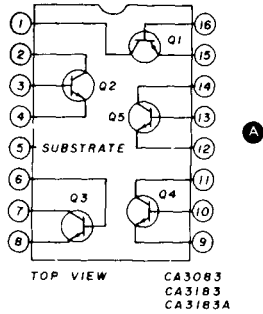

fig. 2. Pinout diagrams for different transistor arrays are shown in A through D; typical applications are shown in E through H. In H, the parallel time constant, from the base of Q2 to ground, causes K2 to open only after K1 has opened. This delay is adjustable according to the values used for the resistor and capacitor. By using S2 and the drive line from K4, the relays can be activated by S1 and de-energized by S2.

voltage silicon, PNP transistors, independent substrate connection.

Package: 16 pin, plastic DIP (fig. 2C).

Applications: Differential amplifiers, dc amplifiers, timers, lamp and relay drivers (fig. 2G).

#### 4. CA3724G/3725G/3138G

Specification: Four high-current silicon NPN transistors.  $I_{cmax}$  1 A fast switching (30 ns at 0.5 A).

Package: 14 pin, plastic DIP (fig. 2D).

Applications: High-speed switching, high-voltage switching, high-current LED, lamp and relay drivers (fig. 2H).

The first two devices in this group, the CA3083 and CA3127, have a lot in common, both having five independent NPN transistors which can be used in a very wide variety of circuits. However, the transistor characteristics in each type are quite different, even though there may be some circuits in which either could be made to work. The CA3083 has higher  $I_{cmax}$ , and is suited more for hf and audio circuits which require transistors with high-signal level parameters. Fig. 2E is a typical application for a final i-f amplifier (untuned), second detector, and first audio amplifier, using all five transistors in the CA3083. Q1 is used for bias stabilization of the first i-f amplifier. If Q2 was conventionally biased with two resistors, Q1 could be applied to some other function.

In contrast, the CA3127 incorporates transistors specifically designed for small signal, high power gain characteristics up to 500 MHz, making it ideal for receiver front-end use, including rf amplifier/mixer/oscillator combinations.<sup>1</sup> Fig. 2F is such an application, using all five transistors for the rf amplifier and mixer stages of a front-end suitable for vhf. Needless to say, with the high power gain of the individual transistors, considerable care should be exercised in the layout of such circuits to avoid building only oscillators.

The CA3096 is an interesting IC which contains a mixture of three NPN and two PNP transistors. The CA3096AE has more closely matched parameters between transistors, useful for complementary pair circuits.

Fig. 2G is the circuit of a ten-minute interval timer using all the transistors in the CA3096 — a handy device as an identification reminder for ragchewers. The time constants allow adjustment of the timer from 1.6 to 10 minutes by changing the 5-megohm potentiometer. The maximum time can be changed by increasing or decreasing the value of the 100  $\mu$ F

capacitor; minimum time is varied by changing the value of the 1-megohm fixed resistor in series with the pot. The lamp indicator may be replaced by a relay or audio reminder (such as NE555 oscillator), so long as Q5's collector current does not exceed 50 mA, or a load of less than 30 ohms at 1.5 volts.

Since the CA3724 was meant to be a high-current driver, an appropriate application is shown in fig. 2H. Many times it is necessary to close and release relays in proper sequence. Closing S1 turns on Q1, which closes K1, but two normally-open contacts on K1 are employed to put forward bias on Q2. Thus, K2 can close only after K1. Opening S1 will cause both relays to release at almost the same time.

If reverse sequencing is required, a parallel RC time constant, from Q2's base to ground, will cause K2 to open after K1. K3 and K4 are driven by the emitters of Q3 and Q4, with the voltage across the coil of K3 used to drive Q4. This technique eliminates the need for a pair of normally open relay contacts as in the Q1, Q2 arrangement. The single capacitor, from base to ground of Q4, provides for a time-delay release of K4; the time constant is dependent on the value of C, the 10-k ohm base resistor, and the resistance of K3's coil.

If a latching relay combination is desired, the normally open contacts of K4 can be used to connect drive through S2 (momentary pushbutton, normally on) to the base resistor of Q1. S1 should be changed to a momentary pushbutton, normally off. Push S1 to activate the relays and push S2 to release.

The circuits in fig. 2G and 2H can be combined by connecting the optional drive output, from pin 8 of the CA3096, to the optional drive input of the CA3724. With this combination, the timer will activate the relay driver circuit after a preset time delay, initiated by the timer ON switch. This arrangement would be useful for a high-voltage time delay turn on in tube-type linears. S1 would, of course, be eliminated in this arrangement, but S2 may be left as an emergency OFF switch.

### semi-committed transistor arrays

#### 1. CA3018/3018A/3118/3118A\*

Specification: Four general-purpose silicon NPN transistors, two independent; two internally connected as a Darlington pair. Independent substrate connection.

Package: 12 pin, TO-5 (fig. 3A).

Applications: General use in signal processing, dc through vhf range. Suitable for use in circuits similar to CA3083.

#### 2. CA3086/3146/3146A/3045/3046\*

Specification: Five general-purpose silicon NPN



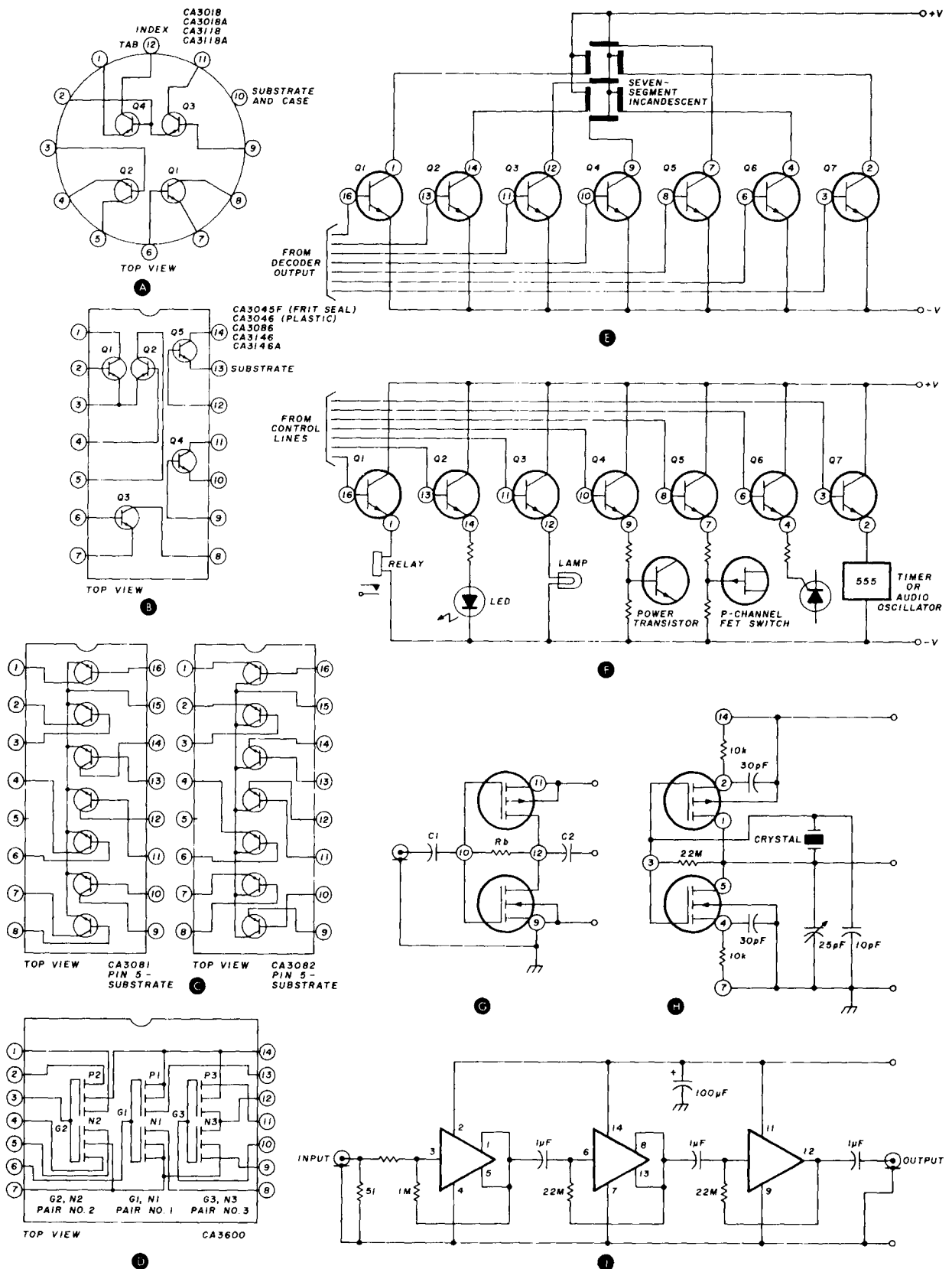

fig. 3. Pinout diagrams for transistor arrays which have internal connections between the transistors (semi-committed arrays). Various applications for the arrays are illustrated in E through I. Using the CA3600 mosfet array in I will limit the upper frequency to approximately 5 MHz. Even though the CA3600 has protected inputs, normal precautions should be exercised while working with the IC.

transistors, three independent; two internally connected as a differential pair (common emitters).

Package: 14 pin, DIP package type varies with type number. CA3086/3146/3146A are plastic package (fig. 3B).

Applications: General purpose use for signal processing in the dc to 120 MHz range.

### 3. CA3081 and CA3082

Specification: Seven high-current silicon NPN transistors. (CA3081) All emitters internally connected in common. (CA3082) All collectors internally connected in common.

Package: 16 pin, plastic DIP (fig. 3C).

Applications: Lamp, LED, and relay drivers.

### 4. CA3600

Specification: Complementary mosfet array of 3 N-channel and 3 P-channel enhancement mode mosfets, gate protected.

Package: 14 pin, plastic DIP (fig. 3D).

Applications: High input-impedance linear amplifiers, low-power oscillators.

As mentioned earlier, this group of arrays has two or more of the transistors internally connected in a partial circuit, but this does not eliminate their use as independent transistors, though there are more limitations than the undedicated group.

The characteristics of the individual transistors in the CA3018 and CA3086 families are sufficiently close to the CA3083 so that RCA specifies the same application note for all three. The CA3083 has an  $I_{cmax}$  of 100 mA, while the CA3018 and CA3086 have  $I_{cmax}$  of 50 mA. Otherwise, the parameters are close enough to make these three devices interchangeable in almost any circuit where the partially committed arrangement of the latter two permits. In both the CA3018 and CA3086, the four transistors may be used independently by allowing the pins of the fifth device to float unconnected. Or, in the CA3086, the pins of the differential pair may be jumpered (5-1 and 4-2) creating a single transistor with an  $I_{cmax}$  of 100 mA. Also, the darlington pair in the CA3018 may be used as a single, super-beta transistor by using pins 11 and 12 as the collector, 9 as the base, and 1 as the emitter. Since applications for the CA3018 and CA3086 are similar to the uncommitted CA3083, no basic circuits are shown for these types.

The CA3081 and CA3082 both incorporate seven NPN transistors having identical characteristics, the CA3081 having all collectors connected together,

and the CA3082 with all emitters connected. These devices were designed to drive seven-segment displays as shown in fig. 3E. However, these devices can be used for low-current, remote driving of a variety of other components including relays, LEDs, incandescent lamps, power transistor switches, fet switches, SCRs, and complex devices such as an NE555 oscillator. The only constraint is that current supplied to the driven device does not exceed the  $I_{cmax}$  of 50 mA for each transistor. If a higher current rating is required, two or more of the transistors may be paralleled.

The CA3081 may also be used as seven independent amplifiers in circuits where grounded emitters are appropriate. Likewise, the CA3082 may be employed as seven emitter followers with independent inputs and outputs. Such circuits may be used as buffer mixers (separate inputs, common output) or distribution isolators (common input, separate outputs).

The CA3600 may be one of the less familiar ICs. This device has three pairs of complementary mosfet transistors, with the input gates of each pair connected. Each pair has one P-channel and one N-channel *enhancement*-mode mosfet. The N-channel, *depletion*-mode mosfet is familiar to most, appearing frequently in single- or double-gate versions for rf amplifiers and mixers. The depletion-mode devices have channels which are normally ON in the absence of gate bias. Enhancement mode mosfets have channels normally OFF until bias is applied to the gates, positive bias for P-channel and negative bias for N-channel. Using an ac input signal as bias, the linear amplifier shown in fig. 3G will have the P-channel transistor conducting on positive half cycles, and the N-channel device on negative half cycles. The output from C2 will be a complete, amplified replica of the ac input.

One nice thing about complementary amplifiers of this type is that they maintain a high-linearity output swing, over almost the entire limit of supply voltage. Therefore, you can obtain close to 10 V p-p output with a 10 Vdc supply. In addition, the input impedance is very high, with the circuits requiring a minimum of external components. Fig. 3H shows the basic amplifier expanded into a crystal oscillator, and fig. 3I illustrates the entire IC connected as a complete, cascaded 100 dB amplifier. The high input impedance and high off-resistance of the P and N channel enhancement-mode mosfets make them highly suited for switching circuits where the load current does not exceed 10 mA. For those who are hesitant to use CMOS devices, considering their sensitivity to static voltages, the CA3600 device has resistor/zener diode-protected gates to minimize the chance of static damage.

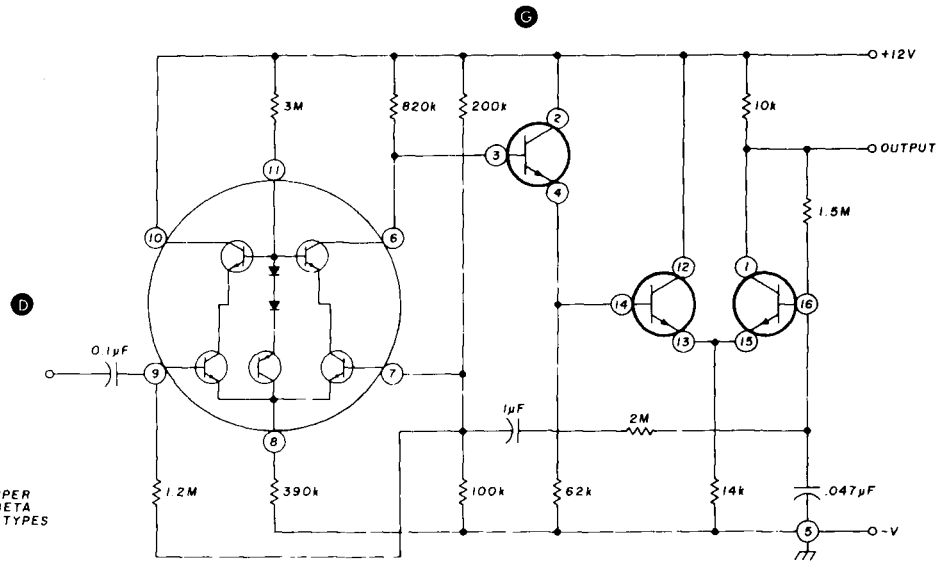
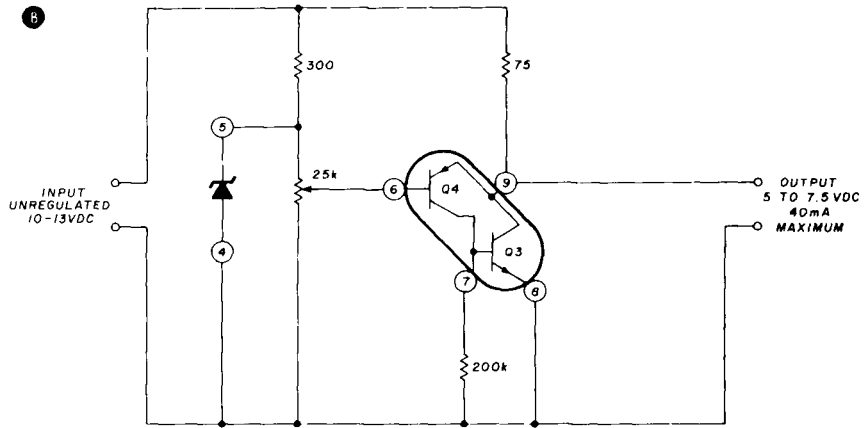
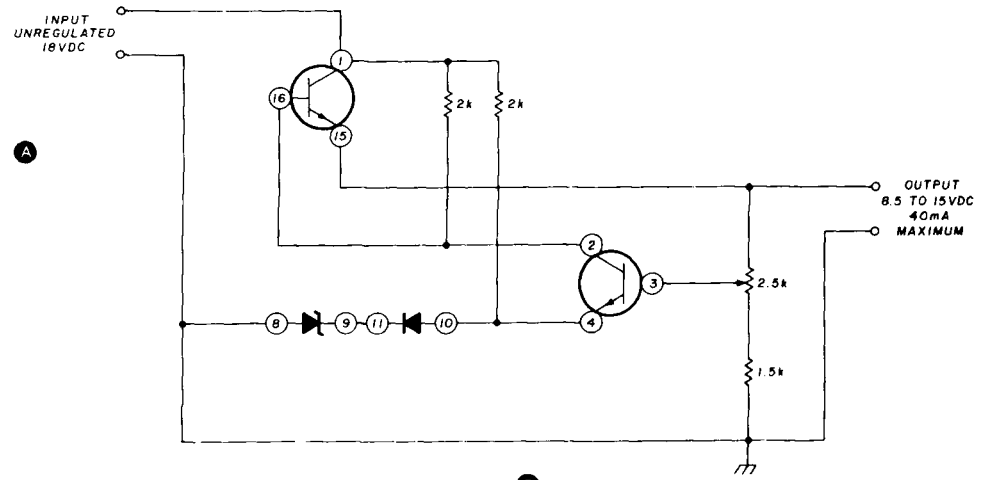
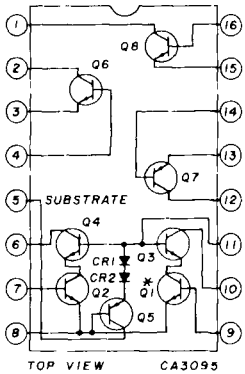
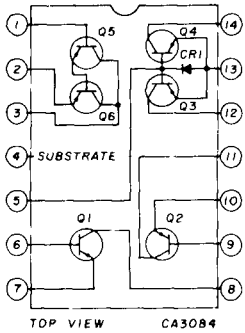
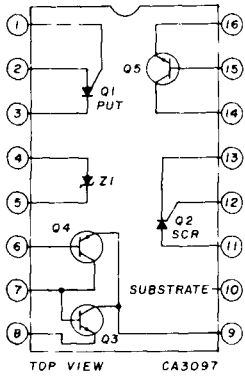
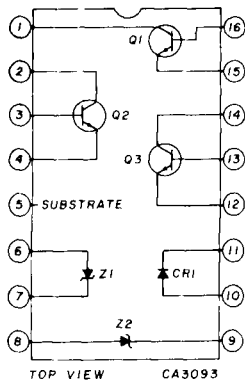

fig. 4. Pin diagrams for the hybrid integrated circuit arrays are shown in A through D. Applications for this group of arrays include voltage regulators and a low-noise preamplifier, as shown in E through G. The amplifier in G has a voltage gain of 30 dB and a noise factor of 2 dB at 10 Hz, decreasing to 0.3 dB at 1 kHz.

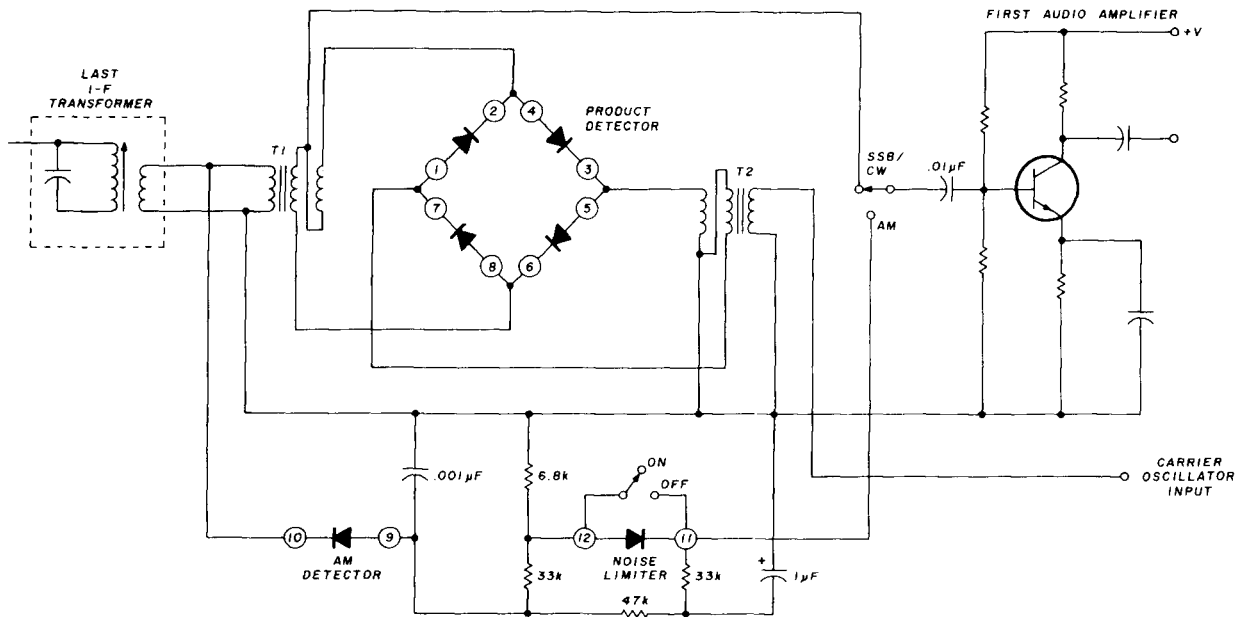

fig. 5. Schematic diagram of a product detector, a-m detector, and noise limiter using the CA3039. T1 and T2 are Q2 ferrite cores wound with 12 turns of no. 26 AWG (0.4 mm) enameled wire. The individual wires should be twisted approximately 1 turn per centimeter (3 turns/inch). The carrier oscillator signal (+7 dBm) must be off when the detector is used for a-m.

## hybrid arrays

### 1. CA3093

Specification: Three independent general-purpose, high-current silicon NPN transistors — two independent 7-volt, 1/4-watt zener diodes; one general-purpose silicon diode. Two of the transistors, Q1 and Q2, are closely matched at 1 mA.

Package: 16 pin, plastic DIP (fig. 4A).

Applications: Signal processing/switching from dc to vhf. Temperature compensated voltage and current regulators.

### 2. CA3097

Specification: One independent silicon NPN transistor. An NPN and PNP transistor pair, one zener diode, one programmable unijunction transistor, and one silicon-controlled rectifier.

Package: 16 pin, plastic DIP (fig. 4B).

Applications: Voltage regulators, timers, constant current source, oscillators, multivibrators.

### 3. CA3084

Specification: Two independent general-purpose silicon PNP transistors, two PNP transistors connected as

a Darlington pair, combination of two PNP transistors and one diode connected as a "current mirror."

Package: 14 pin, plastic DIP (fig. 4C).

Applications: General signal processing, low power, low frequency; double-balanced mixers/modulators, product detectors.

### 4. CA3095

Specification: Three independent high-voltage silicon NPN transistors, five NPN transistors, differential amplifier array, two of which (Q1 and Q2) are super-beta types.

Package: 16 pin, plastic DIP (fig. 4D).

Applications: Super-beta preamplifiers, high-impedance dc meter amplifier, low-noise video amplifier. The independent transistors are usable for signal processing from dc to vhf.

This group of arrays will test your imagination for using different solid-state devices. However, the manufacturers were not arbitrary in selecting the different devices.

Fig. 4E, one example of a use for the CA3093, is a temperature compensated, series voltage regulator, adjustable from 8.5 to 15 volts at a maximum of 100

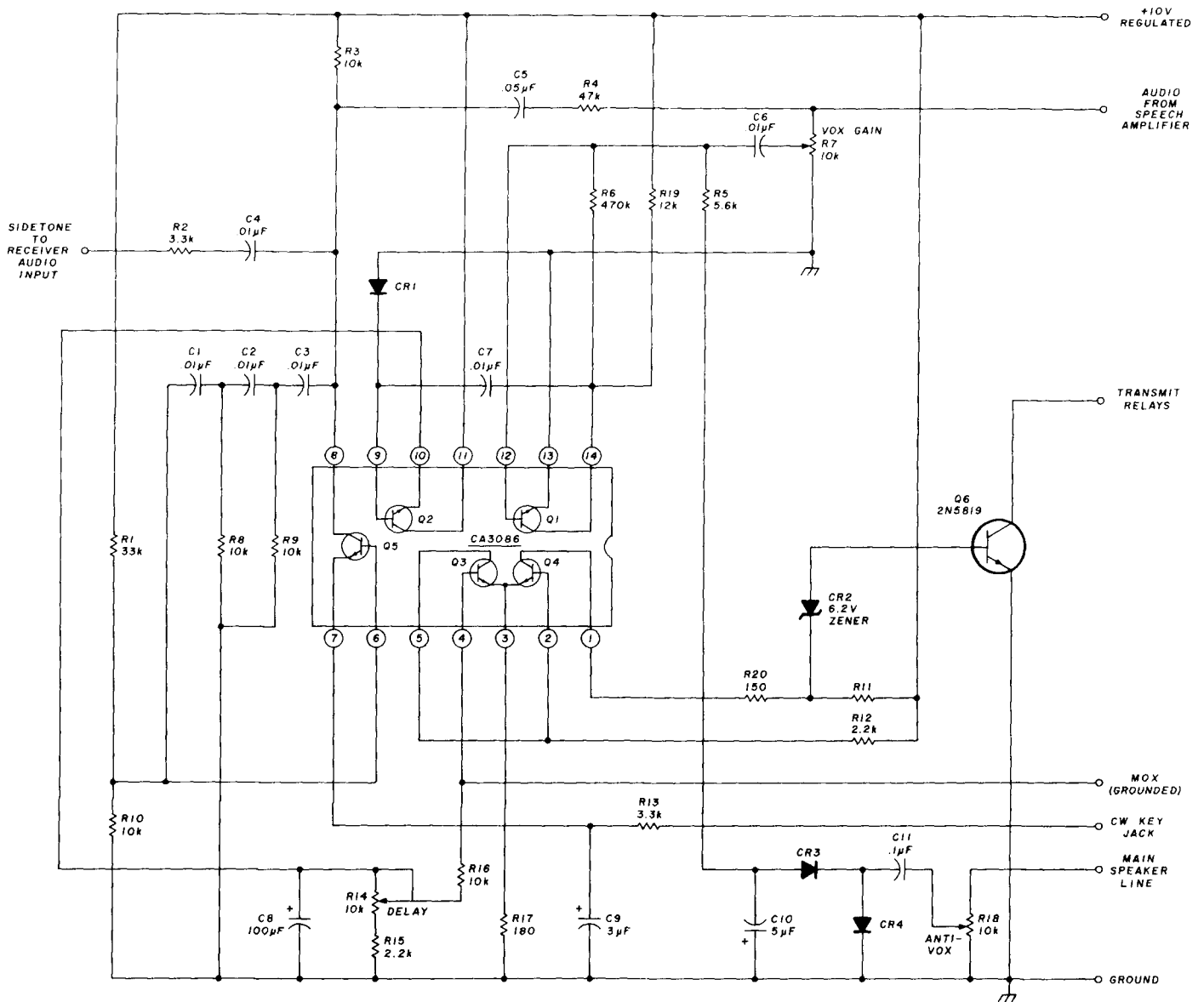

fig. 6. Schematic diagram for a vox/semi-break-in system using the CA3086. Q6 is an external transistor which must have a collector current rating sufficient to control the external relays. CR2 is a 6.2 volt, 1-watt Zener diode. CR3 and CR4 must be germanium diodes.

mA. Fig. 4F is a shunt voltage regulator using the CA3097, leaving one transistor, SCR, and a programmable UJT for other use.

The CA3084 includes four general-purpose PNP transistors, with Q3 and Q4 connected as a darlington pair. Also included is a "current mirror" arrangement of two PNP transistors and a diode. The two independent PNP transistors are closely matched, and can be employed in separate circuits, or as part of a balanced complementary circuit with NPN transistors. The darlington pair, having three basic connections (base, collector, emitter), can be considered as a single super-beta transistor with an  $h_{FE}$  of 1250.

The PNP current mirror is suited as an active load for differential amplifiers which use NPN transistors. In general, the CA3084 device is used to furnish circuit sections for other ICs or discrete devices, rather than providing a complete circuit function.

Three independent general-purpose NPN transistors are contained in the CA3095, in addition to a differential-amplifier array of five NPN transistors and two diodes. Two of the transistors (Q1 and Q2) are super-beta types with an  $h_{FE}$  of more than 1000. The differential amplifier and independent transistors may be used separately, or combined (fig. 4G) into a very high-input impedance, low-noise amplifier.

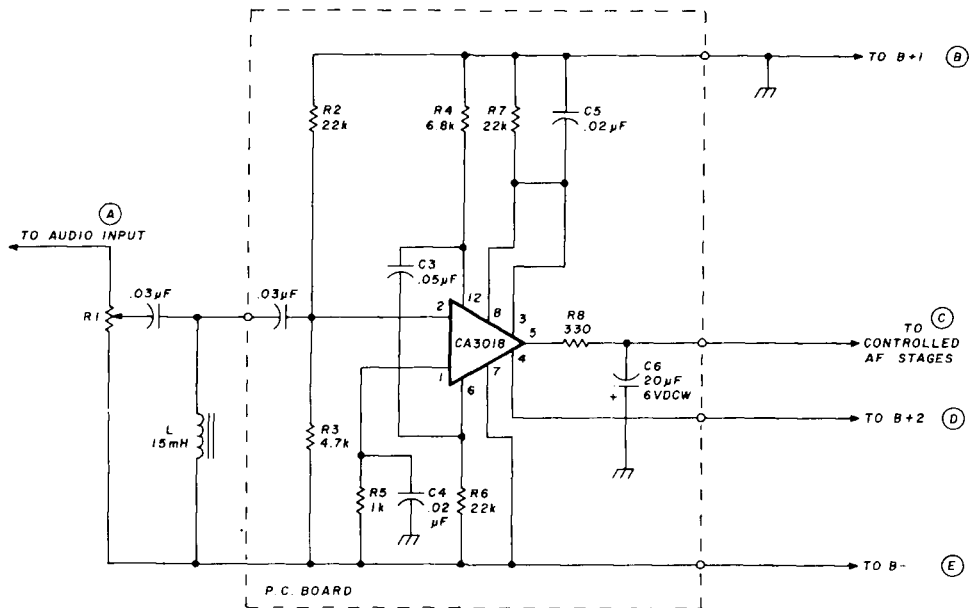

fig. 7. Schematic diagram of a squelch circuit using the CA3018.

## getting the most from practical circuits

The basic circuits, illustrating the use of each type array, were intended as examples of the versatility of these devices. Many different uses will be found by the enterprising builder. Some of the array devices, such as the uncommitted transistor arrays, will find many more applications than the more specialized types.

Determining whether to build a project with an IC

array or discrete components is a matter of planning and trade-offs. Once you have a circuit to construct, research the available devices to see if one of them incorporates all, or most, of the active components required. After all, it doesn't make sense to use a CA3093 to use only two transistors, leaving the third, plus two zeners and a diode as spares; though on occasions, one unused section can come in handy for later modifications. The real trick is working all of the active IC sections into a construction project, and

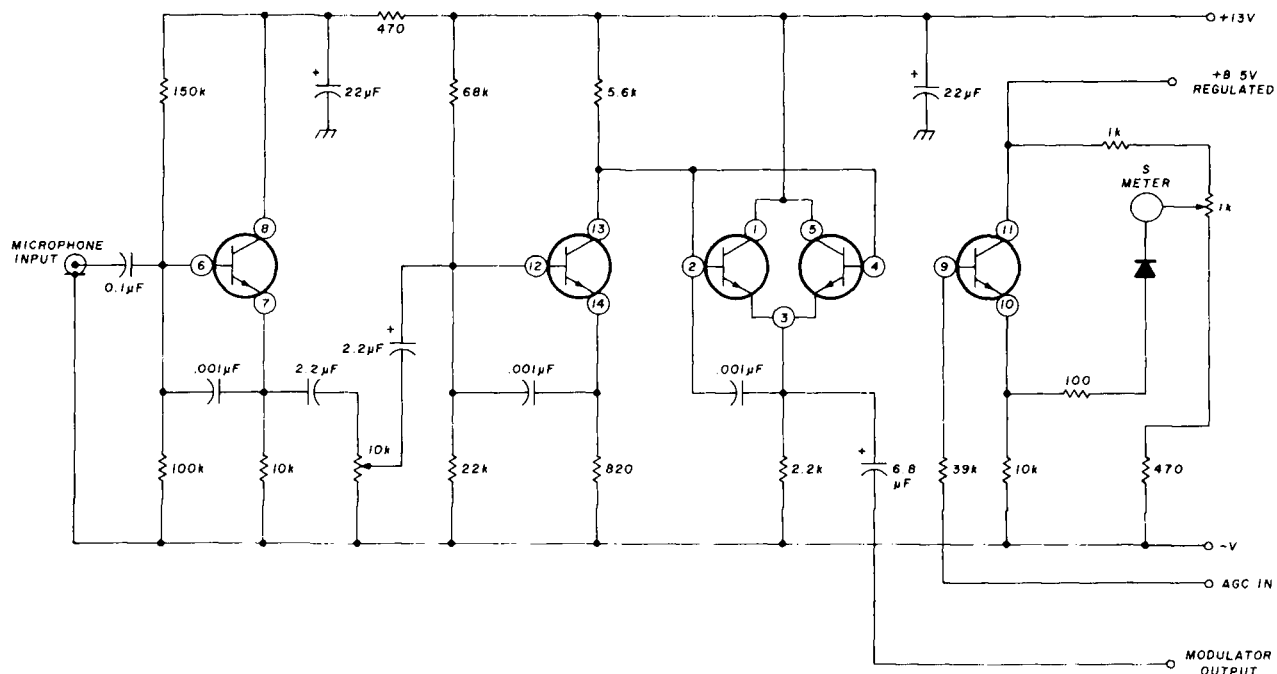

fig. 8. The CA3086 has been used to its fullest advantage in the Atlas series transceivers. This schematic shows the microphone/modulator amplifiers, and S-meter amplifier in the transceivers.

this article would not be complete without including some practical amateur and commercial circuits where this has been achieved to advantage.

Fig. 5 is a double-balanced, diode-ring product detector, a single-diode detector, and a series-gate noise limiter, using all the devices in a CA3039. The TO-5 package occupies less space than individual diodes flat on the board. In addition, the matched diodes give superior performance in the product detector. A module of this type, to replace the triode product detector in a tube receiver, has been built on a printed-circuit board measuring only 4 x 4 cm (1-1/2 x 1-1/2 inch).

Fig. 6A is the circuit of a complete vox and semi-break-in CW module, including sidetone using a single CA3086 IC. One external transistor, Q6, is used as a solid-state switch to energize the transmitter relays.

The output from Q1, the input audio amplifier, is rectified by CR1, applying bias to Q2. This emitter follower (Q2) with a variable RC time constant in the emitter lead, sets the vox delay. The differential pair Q3 and Q4, are connected as a Schmitt trigger, with Q4 normally conducting, its collector voltage is about +2 volt and the 6.2 volt zener (CR2) cannot conduct. When rectified audio causes the Schmitt trigger to switch, Q4 conducts and the resultant 10-volt collector voltage causes CR2 to conduct, turning on Q6. Q5 is an RC coupled, phase-shift audio oscillator,

with an output from 700 to 800 Hz. When its emitter resistor is grounded through the key jack, the tone output is fed to the transceiver (or receiver) audio output stages, providing a sidetone in the CW mode. The oscillator's output is also fed to Q1, causing the vox circuit to function in the same manner as with a normal microphone input. A manually operated mode is provided by grounding the base of Q3. CR3 and CR4 rectify the speaker output, providing the anti-vox control.

Fig. 7 is the circuit of a squelch module, based on the CA3018,<sup>2</sup> for use with fm receivers. The entire circuit was built on a board measuring only 2 x 3.5 cm (0.8 x 1.4 inches).

The circuit for the microphone amplifier, balanced-modulator audio driver, and S-meter amplifier stages used in the popular Atlas Radio 210/215 series transceivers is shown in fig. 8. This is an excellent example of making full use of an IC array. Q1 is a high impedance emitter follower, Q2, a voltage amplifier, Q3 and Q4, a differential pair strapped to form a single low-impedance emitter follower.

#### references

1. Bill Hoisington, K1CCL, "Two High-Gain RF Stages in One IC for 2-Meter FM," 73, May, 1974, page 47.
2. Peter Lovelock, K6JM, "The Postage Stamp Squelcher," 73, May, 1975, page 103.

ham radio

# WE KNOW YOU WANT THE VERY BEST!

In a market already over crowded by others, all making claim to being "THE BEST", we knew we had to be better. \*COMMUNICATOR I our 6 channel, 3 watt handheld, and COMMUNICATOR II our 800 channel synthesized 25 watt mobile offer all the

features of the "BEST" — and a few extra, including our one year warranty and a toll free 800 number answered by other hams who speak your language.

PACE COMMUNICATOR — THE VERY BEST!



**pace**  
**COMMUNICATOR**

AMATEUR PRODUCTS GROUP PATHCOM INC. 24105 SOUTH FRAMPTON • HARBOR CITY, CA 90710

\*Communicator I will be available in the fall, Communicator II is in stock for immediate shipment.

**BREAKS THROUGH EVERY  
HF SOUND BARRIER  
--INSIDE AND OUT!**

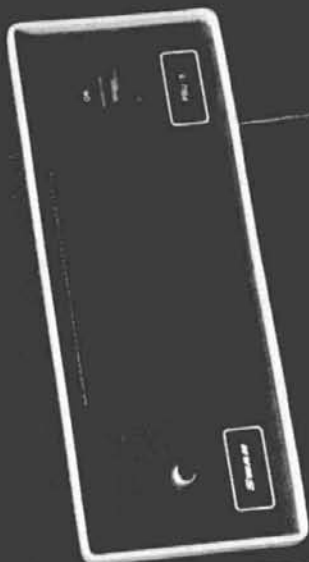





**The revolutionary Swan 100 MX: 100% new, 100% solid state,  
100% portable from home station to mobile!**

Introducing a superb "get up and go" transceiver, superbly designed for 100% mobility and control, as only new Swan space-age technology could do it!

**100% solid state 100 MX:** the compact HF unit you can take seriously — anywhere you choose to operate.

At home, set into Swan's unique new style-coordinated station, with *matching* antenna tuner and power supply.

Or *on the road* — it's easy to relocate 100 MX. Instantly. Just two simple connections on the back panel: snap out, snap in... and run!

**100% improved audio quality:** home or mobile, transmit or receive. 100 MX electronics cut through SSB sound barriers — producing a natural clarity reported comparable to AM!

**Your most-wanted extras, 100% built-in:** like noise blanker and VOX. Like a pre-

selector to optimize signals. Like a real RF GAIN control, and CW sidetone.

Swan includes the RIT control ( $\pm 1.5$  kHz) you'd like too. Plus, for stability, a permability tuned oscillator with 1Kc readout.

A powerful package, delivering a minimum 100 watts PEP output on all bands, 10-80 meters.

**Setting a 100% new state of art:** 100 MX and our matched-station units. Ready for check out today at your Swan dealer, the first major breakthrough in Swan's new program dedicated to changing the face — and performance — of ham equipment 100%... inside and out!

**Special Introductory Price**  
to September 30, 1978:

**Swan 100 MX: \$799.95**  
(Reg. List: \$849.95)

Matching Power Supply PSU-5: \$179.95

Matching Antenna Tuner ST-3: \$169.95

Available only through authorized Swan dealers.

Please rush full specs on Swan's all-new 100 MX home/mobile transceiver.

Name \_\_\_\_\_

Address \_\_\_\_\_

City \_\_\_\_\_

State \_\_\_\_\_ Zip \_\_\_\_\_

HAM 9/78

 **SWAN**  
ELECTRONICS

a member of the Cubic Corporation family of companies

305 Airport Road, Oceanside, CA 92054  
(714) 757-7525

Swan's continuing commitment to product improvement may affect specifications and prices without notice.

# tracking down repeater jammers

Malicious interference  
is increasing  
on the amateur bands,  
particularly on 2 meters —  
here are some ideas  
for concerned  
hams who want  
to do something about it

**Repeaters seem to attract** a variety of intentional jammers. Kerchunking is by far the most common offense, and nearly every 2-meter operator does it at one time or another to check that the rig is getting out. But there are others who do it regularly and repeatedly, even to the point of trying to play "Jingle Bells." They have been heard to say, "I guess I'll wear out another relay."

## the problem

Almost every time a 2-meter rig is ripped off in the mistaken belief that it can be peddled as CB, there's an epidemic of jamming. It starts with kerchunking, progresses to attempts to raise another CBer, then often proceeds to false calls, obscenity, or the type of operation that's led to the term "Chicken Band."

Another source of repeater jamming is the malcontent who's unhappy because the repeater is operating on *his* frequency. Some of his tricks are blocking signal levels, noise modulation, endless kerchunking, and retransmission of signals from other channels or of other services. A really mean trick is to key the transmitter at a rate that may simulate "picket fenc-

ing," or may lead users to believe that a rig or repeater malfunction has occurred.

Amateur clubs (and stations) should have the ability to track down and identify these jamming sources.\* For one thing, this can lead to the recovery of a stolen rig and to the word being passed to stay off ham equipment. Also, besides leading to a better repeater operation, the track and identification capability should be of major value in a manmade noise program. This can help all hams, not just repeater users.

Although the operations involved require individual effort, it's probably better to undertake such a program as a club effort. Some reasons for this are discussed at the end of the article.

## interference plan

For an anti-jamming or interference program to work, a plan of action is needed. The basic elements are:

1. Detection
2. Alerting
3. Preliminary locating
4. Spotting
5. Identifying
6. Acting

Each involves some effort and some time. Several elements also involve some skill, but the effort per person can be kept low. These factors are among the reasons this anti-jamming effort makes a good club project.

## detection

Detection can be left to chance, but it's a good idea to have at least some planned effort. In fact, jamming detection can also serve another purpose — intruder detection: the steps and procedures are the same.

One way to handle the detection problem is to

\*An example of what's being done to stem the vhf jammer problem appears in reference 1. Editor.

By R. P. Haviland, W4MB, 2100 South Nova Road, Daytona Beach, Florida 32019

combine it with another one. At any time a club probably has one or more members who are shut in for some reason, usually illness. Many of these people are happy to have some light chore to help pass the time. Monitoring can help. The club can help by having a set of loan equipment available, or possibly two sets, one receive-only for nonlicensed members.

While any reasonable antenna and receiver combination is suitable for monitoring, a comprehensive plan should be based on the use of scanners. Very good commercial scanners covering up to ten channels or so are available at reasonable cost. Panoramic vhf receivers can sometimes be found in surplus sources, or a Panadaptor can be added to a vhf receiver. Incidentally, it doesn't make much difference whether an a-m or fm receiver is used. So older rigs can serve the monitoring function. A mechanical dial drive along the lines of the General Radio 1521 drive unit could be worked out for older, continuously tuned rigs.

Owners of synthesized rigs are in a good position to check all or at least a good number of the channels. However, doing this by throwing lever switches becomes very tedious. The procedure can be mechanized by the simple addition of a counter chain that feeds the rig's internal counters. The basic principles are shown in fig. 1. The OR gates can be mechanical switches, but a diode or IC OR gate is simpler. Some form of level changing will be needed to allow the squelch to stop scanning; it can be a relay. The same circuit can start a recorder.

A few simple logic circuits can be used to give a no-noise, unattended monitor system, which can also reduce time in checking for interference. The trick is to use two tape recorders. One would be set up to run when a signal is detected. Ideally it would be a two-track unit with time on the second track, say by digital clock readout or WWV/CHU recording. The other recorder would start when a signal is received and run for about thirty seconds. Then it

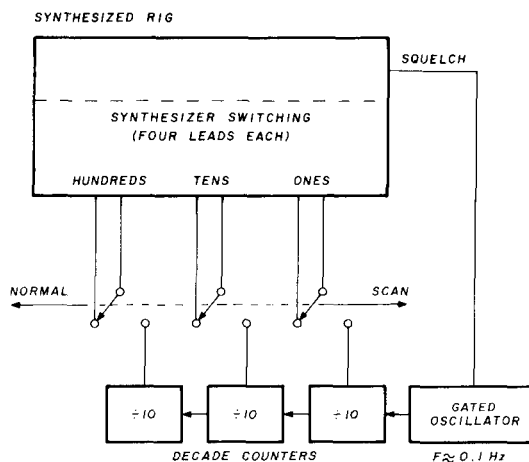

fig. 1. Adding scan-capability to a synthesized radio. Switching can be mechanical or by logic elements.

would not restart until the signal had been off for, say, fifteen seconds. This avoids recording most legitimate contacts and long patches of interference. The compression allows fast review of a day's record. If suspicious signals are found, the full tape can be reviewed.

This type of system doesn't permit immediate action, but it is good for uncovering the operating habits of intruders, or of intentional jammers. It also gives a useful record for analysis and possible action.

## alerting

The purpose of alerting is to bring the locating and identifying resources of the interference plan into play. For several reasons it's best to use a small number of alerters. This helps prevent false alerts and callup for marginally traceable interference. Also it helps prevent annoyance to a number of people — if a dedicated, intentional jammer is around it's virtually certain that he'll try to harass all concerned by trying to break up contacts by 3 AM phone calls or even dirtier tricks.

The alerters must be prepared to put up with such tricks and should be ready with appropriate counters — fast frequency change, power increase if necessary, and call monitoring by the phone company. In severe problems it may be necessary to go to a two-tier alerting plan — a fairly large number of people who will relay a detection notice to the actual alerter.

The alert should be in stages. The first step is to determine if further effort will be worthwhile. This can be done by one or two stations who can tell if the signals are strong enough to get a good DF bearing, if the interference source is fixed or moving, if it's distant or local, or if the problem warrants further action.

If further actions seems in order, enough direction-finding stations should be alerted to get a good fix.

Public awareness of personal two-way radio communication is keeping pace with the population — both are increasing. Adding fuel to the fire is the increasing availability of low-cost equipment, which means that almost anyone who wants to own a two-way radio can be in business with little effort and a modest outlay of cash, often without bothering to obtain a license. Along with this upsurge of personal radio activity is the inevitable: an increase in malicious interference by those of marginal mentality who seem to enjoy disrupting legitimate communications. The problem exists in the Citizen Band radio service as well as the Amateur service; the problem is particularly severe on 2 meters.

Radio amateurs are noted for policing their operating frequencies. In this article, author Haviland offers some ideas for those interested in ferreting out jammers on two meters. He presents an interference plan and suggestions for implementing it together with suggestions on avoiding legal pitfalls during final action. The theory behind the program is that, once the program is working and the pressure is on, jammers will give up and disappear. Editor.

One situation needing fast action is that of a ripped-off rig being tested. This is almost always a local fixed-station problem. Chronic and intentional interference may be local or distant, but doesn't require immediate action — it may be better to wait, perhaps

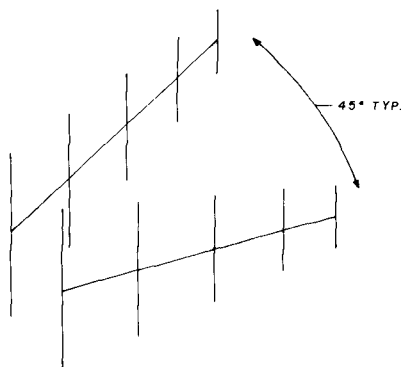

fig. 2. Skewed Yagis for direction finding. Feed may be switched between antennas or at the receiver.

until a key DF station is available or until signal levels increase so that a good DF bearing and good identification are possible.

Overall, the alerting must involve decisions on:

1. Preliminary evaluation
2. DFing
3. Mobile DFing
4. Identification
5. Urgency

Some of these decisions can be handled by land-line but others require coordination and passing of data. A "jammer net" is good, with the alerting station acting as net control. Obviously, coordinating operations should not be on the channel subject to interference. Probably the operations should be simplex, although the net alert can be called by a repeater.

## direction finding

The DF techniques will vary somewhat for fixed and mobile interference and for local and DX signals. The standard rules apply, of course: a minimum of two bearings are needed. A minimum signal-to-noise ratio is needed for good angle accuracy, and for good geometric resolution the bearings must cross at angles approaching 90°.

For preliminary evaluation, bearings can be obtained from any station with a rotary beam. Two such stations may give sufficient accuracy on local signals to justify dispatching one or more mobiles for pinpointing the source.

Better DF accuracy can be secured with a special DF antenna setup. One simple method, shown in fig. 2, is to mount two identical beams at an angle of 40° to 60° using two feed lines to a switch, which may be at the receiver. Rotating the array until the signals from the two beams are the same gives the signal bearing as the bisector of the angle between the arrays.

Somewhat better accuracy can be obtained with phased antennas. The Adcock array of fig. 3 is very good. For this antenna the bearing is the angle giving a null signal and lies at right angles to the plane of the elements. Watch the 180° null.

For distant signals working at the null is not too accurate, and it may be necessary to use lobe-switched arrays as shown in fig. 4. As for the skewed array, (fig. 2), the bearing is that giving equal signals as the switch is operated.

Various refinements to these simple techniques can be made, such as fast switching, synchronized indicator switching for right-left indication, and visual presentation. See the various handbooks, such as Terman's *Radio Engineers Handbook* for ideas and data.

If the interference source is moving a special problem exists, which is related to the problem of relative motion for ships at sea. See Dutton's *Navigation* for solution to these problems by use of the maneuvering board.

## pinpointing

Sometimes bearings from fixed stations will give sufficient accuracy to pinpoint a source, but it's often necessary to call on mobiles.

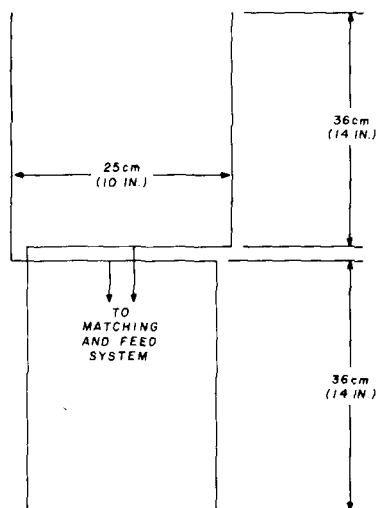

fig. 3. Simplified Adcock array. Matching may be omitted for receive only. The feed impedance is low. System can be made from simple materials.

Fair results can be obtained with mobiles having simple antennas if the receiver has an S-meter.<sup>1</sup> The procedure is to drive in directions that give signal-strength increases. Driving around a suspected area may confirm that the signal source is enclosed, and it may be possible to spot an antenna system. Mobiles doing this should remain on public access roads or areas and probably should not stop for any reason.

Better and faster results can be secured if the mobile has DF capability. Probably the simplest DF unit is made of two half-wavelengths of wire mounted on a wood pole, as shown in fig. 3. It's not too difficult to work out a window mount, which will allow DFing while in motion.

With this type of antenna, a very close fix is possible by using the process called "doubling the angle on the bow," a nautical technique. Drive in a straight line past the suspected location. When the angle to the signal is 45° to the line of motion, note the position along the route. Continue driving until the bearing is 90°. The signal is coming from a point at right angles to the route, and its distance from the route is equal to the distance from the first position, as shown in fig. 5. See navigation texts for variations in the technique.

This mobile pinpointing can be speeded up if the fixed-location DFing stations track the mobiles with respect to the interference. Angle differences can be measured more accurately.

## identification

While locating and pinpointing are going on, steps that will permit identification of the signal can start. One element of this procedure is to show that harm to communications actually results from the interference. Another part is to show that the signal is coming from the pinpointed location. A final goal is to identify the transmitter causing the interference, or even the person responsible. This identification is not just for information — it may be crucial if action is to be taken, as discussed later.

The first element of identification is *complete* and *accurate* logging. This should show as a minimum

1. Date and time
2. Band and frequency
3. Station or communications being interfered with
4. Description of interference

In addition it's desirable to record any analysis of the interference, including bandwidth, center frequency, results of a-m and fm reception, and approximate or exact spectral distribution. Each log entry should be signed, and, if possible, witnessed.

The use of tape recordings for interference detection has been mentioned. These records are valuable in identification, especially if some simple precautions are taken. Each tape should start with an announcement of the fact that it is an interference

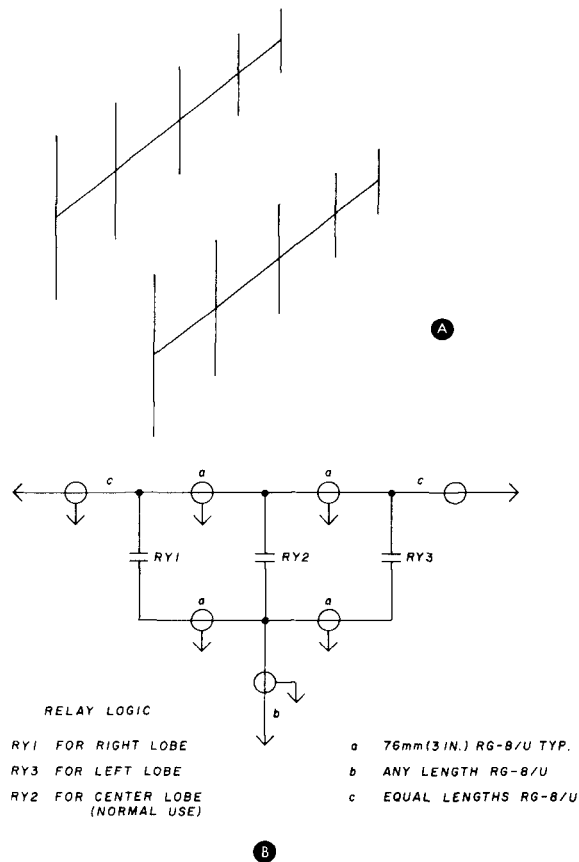

fig. 4. Lobe-switched system for DXing. Sketch A shows the antenna arrangement. Booms are parallel; spacing is typically one wavelength. The connection harness is shown in B.

record, and the date, time, operator, and place given. It is well to state the make and serial number of equipment used in reception and in recording. Before the recorder is shut off, the date and time should be repeated. Strip charts are also useful. These may give the pattern of interference, including times of occurrence and relative levels of wanted signal and interference.

Recordings should also be made by the mobiles used in pinpointing. Signal level at various locations is helpful in showing the extent of interference and the general location of the source. When the source location has been identified, simultaneous recordings at the locating mobile or mobiles and the tracking stations should be made. Each should be identified, of course.

In many interference cases pinpointing the location of a jammer, and showing by records that the interference *does* come from that location, is sufficient for action. However, cases may arise where further identification is needed.

Identification of a particular transmitter or person is not easy but possible. Two types of material are needed: the interference records and identified records of suspected sources. The identification rests on "signature" analysis and matching, that is,

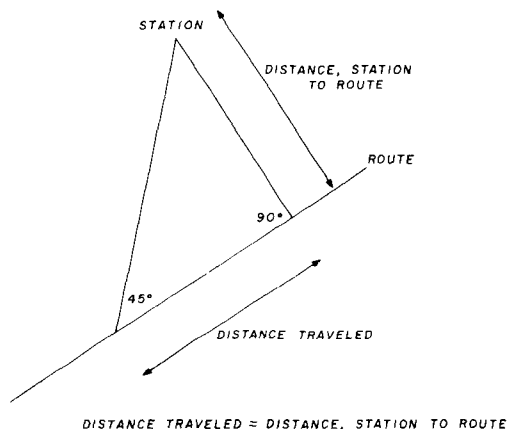

fig. 5. Method for pinpointing source location by using the navigational system of "doubling the angle on the bow."

an identifiable element of the signal that forms an identifiable characteristic. For example, the bias frequency in recorders varies. The frequency can be determined by comparing it to the 60-Hz hum frequency when present. Recorders, receivers, and transmitters may be identified by comparing the relative magnitude of hum components at 60 Hz, 120 Hz, etc. Sometimes special components are present, such as parasitics, peculiar background noise, or peculiarities of off-on characteristics.

Identification of individuals is also based on a form of signature analysis. For CW, this may be the ratio of dot to dash lengths, the way dash length changes from character-to-character, or individual tricks in spacing. For voice, the relative strength of components in the three major speech bands form identifier elements, as do word choice, syllable rates, and many other factors. It requires some detective work, but it can be done.

Signature analysis is certainly beyond the capability of most amateurs, and probably beyond the capability of most clubs. Those groups in areas with good laboratories can probably do the work or get it done: arrangements might be made to call on one of these groups if simpler steps are not sufficient. In any event, recordings should be made with the thought

that analysis may be required as a part of the remedial action taken. Make at least *some* records with good-quality tape recorders; and, if there's reason to suspect an identified station or individual, make recordings of this station, giving identification.

## action

In many cases interference of the type considered here disappears when the fact of an anti-jammer program becomes known. When this happens the plan should go into standby. It's a good idea to demonstrate that it works, say by a hidden transmitter hunt.

Unintentional interference will probably be corrected when the source is advised of its existence. If this type appears, a letter or telephone call discussing the problem appears to be in order.

Casual interference, say by kids, is usually not a great problem. If it persists, tracking down and notifying parents, the organization concerned, or even passing the information along the grapevine usually clears up the matter.

Interference caused by stolen rigs doesn't usually last long. If an attempt is to be made to recover the rig, however, fast action is needed. Several accounts of approaches to this problem have been published.

If interference continues and appears intentional or willful, there may be grounds for complaints to the FCC. Such factors as unidentified signals, or illegal forms of modulation, are direct grounds. However, interference *per se* is not necessarily adequate grounds. No amateur station has prior or exclusive rights to a frequency, and it's necessary to show that willful or malicious intent exists, which is difficult. In these continued interference problems, it's probably best to review the matter and the available records with the Commission field offices. But remember that these offices are understaffed and busy, so make sure you have a legitimate problem.

Some states have laws intended to apply to franchised communication services, which also apply to at least some amateur communications. Competent legal advice should be sought before any action is taken.

One thing should be watched. Individual action is not only unwise — it may even be dangerous. The news accounts of Cbers' quarrels show this. Even group or club action should be carefully considered.

Fortunately, most interference problems can be handled without too much trouble. As noted, they tend to go away when there is a program to take care of them.

## reference

1. Alf Wilson, W6NIF, "Happy Flyers — Helping People," *Ham Radio Horizons*, March, 1978, pages 12-22.

ham radio

*The standard of station excellence*

**TODAY**

- Any NEW Hf Ham Bands • Ham Bands or MARS
- Choice of Selectivity for Ssb, RTTY, Cw, or A-m
- DX Chasing or Traffic Handling • 160 thru 10



*...The Drake C-Line*  
*is ready for* **TOMORROW**

NEW and EXPANDED amateur bands will be proposed at the 1979 World Administrative Radio Conference!

If you have the Drake C-Line, you are ready NOW for any of these hf

frequencies by using Drake selectable range crystals.

Drake C-Line equipment is designed for you to use — without fear of obsolescence — year after year after year.

*A recent C-Line addition:*

**Drake MN-4C Antenna Matching Network**



- 160-10 meters, 250 watts continuous rf output • Out-of-band coverage for future expansions • Unique "low-pass filter" design of MN-4C provides significant harmonic reduction to help fight TVI • Built-in rf antenna switch allows unit to be by-passed regardless of antenna in use. No need to disconnect feedlines. Switch also permits front panel selection of various antennas. • Built-in rf wattmeter/VSWR bridge

*Other C-Line Accessories:*

- Standard Range Crystals for T-4XC or R-4C • Accessory Selectivity Filters
- Matching Speaker • Antenna Matching Networks • Ac Power Supply
- L-4B Linear Amplifier • W-4 Wattmeter • Noise Blanker

To receive a FREE Drake Full Line Catalog, please send name and date of this publication to:

**R. L. DRAKE COMPANY**



540 Richard St., Miamisburg, Ohio 45342  
Phone: (513) 866-2421 • Telex: 288-017

Western Service Center, 2020 Western Street, Las Vegas, Nevada 89102 • 702/382-9470

# HAMTRONICS, INC.

WHERE THE HAM IS KING

FOR OVER 30 YEARS



## • PICK YOUR OWN PACKAGE •

**KENWOOD**



TS-520S  
160-10M TRANSCEIVER  
**\$739.00**

**KENWOOD**



TS-820S  
160-10M TRANSCEIVER  
**\$1098.00**

**YAESU**



FT-101E  
160-10M TRANSCEIVER  
**\$799.00**

**BUY ANY ONE OF THE ABOVE RIGS AT PRICE SHOWN  
AND SELECT ANY ONE OF THE FOLLOWING FOR \$5.00**

**CDE**



CD-44 Rotor  
Value **\$159.95**

**DENTRON**



160-10AT Tuner  
Value **\$129.50**

**BIRD**



Model  
43 Meter  
Value  
**\$125.00**

a Division of TREVOSE ELECTRONICS, INC/ 4033 Brownsville Road, Trevose, PA 19047

FREE UPS SHIPPING  
ON PREPAID ORDERS



TOLL FREE  
QUOTES

# 800-523-8998



# HAMTRONICS, INC.

WHERE THE HAM IS KING

FOR OVER 30 YEARS



## LET US QUOTE YOUR SPECIFIC NEEDS FROM OUR \$2,000,000.00 AMATEUR GEAR INVENTORY.

**AEA**  
**ATLAS** List  
 350 XL 1195.00  
 350 P.S. 229.00  
 305 VFO 155.00  
 DD6-XL Digital 229.00  
 DMK-Deluxe Mobile Mt. 65.00  
 210X 765.00  
 215X 765.00  
 Also All Accessories

**B&W**  
**COLLINS** List  
 KWM2A 3533.00  
 32S3A 3250.00  
 75S3C 3000.00  
 516F2 440.00  
 Also All Accessories

**DENTRON** List  
 MLA 2500 B 899.50  
 160-10AT 129.50  
 MT2000A 199.50  
 MT3000A 349.50  
 Jr. Monitor 79.50  
 Also All Accessories

**ICOM** List  
 IC245 SSB 599.00  
 IC280 425.00  
 IC211 749.00  
 IC701AC 1499.00  
 Also All Accessories

**NPC**  
**WM NYE**

**KENWOOD** List  
 TS820S 1098.00  
 TS820 919.00  
 TS520S 739.00  
 TS700SP 729.00  
 TR7400A 399.00  
 VFO820 155.00  
 VFO520 139.00  
 SM220 329.00  
 Also All Accessories

**MIDLAND** List  
 13-510 399.00  
 13-513 499.00  
 Also All Accessories

**R. L. DRAKE** List  
 T4XC 699.00  
 R4C 699.00  
 TR7/DR7 1072.00  
 MN4C 165.00  
 MN2000 250.00  
 Also All Accessories

**STANDARD** List  
 SRC146A 259.00  
 C-6500 379.00  
 Also All Accessories

**SWAN** List  
 350B 649.95  
 350D 749.95  
 350A 599.95  
 750CW 679.95  
 Also All Accessories

**TEMPO**  
**TEN-TEC** List  
 Tritan IV 699.00  
 Tritan IV Dig 869.00  
 Century 21 299.00  
 Century 21 Dig 399.00  
 Also All Accessories

**VIBROPLEX**  
**WILSON** List  
 Mark II 229.95  
 Mark IV 259.95  
 1402SM 254.95  
 1405SM 329.95  
 1407SM 384.95  
 Also All Accessories

**YAESU** List  
 FT-101E 799.00  
 FT-101EE 759.00  
 FT-101EX 699.00  
 FL-2100B 529.00  
 FT-301 769.00  
 FT-301D 935.00  
 FT-901DM 1459.00  
 FT-901D 1259.00  
 FT-901DE 1259.00  
 FL-101 649.00  
 FR-101D 749.00  
 FR-101S 599.00  
 FRG-7000 655.00  
 FT-227R 349.00  
 FT-225R 840.00  
 FT-625RD 895.00  
 Also All Accessories

### ANTENNAS • ROTORS • TOWERS

**CUSHCRAFT**  
**HY-GAIN**  
**HUSTLER**  
**MORGAIN**  
**MOSLEY**  
**ROHN TOWERS**  
**WILSON**  
**ALLIANCE**  
**CDE**

**ALLIANCE** List  
 HD73 179.95  
 U-100 69.95  
**HY-GAIN** List  
 TH6DXX 296.95  
 TH3MK III 219.95  
 TH3JR 144.50  
 HY QUAD 229.95  
 18 AVT/WB 97.00  
 18HT 299.95

**CDE** List  
 HAM III 194.93  
 T2TX 349.95  
 CD44 154.95  
 BT-1 114.95  
**WILSON** List  
 SY-1 274.95  
 SY-2 219.95  
 WV-1 79.95  
 WR1000 ROTOR 469.00  
 WR500 ROTOR 149.95

**ROHN TOWERS**  
**MOSLEY** List  
 TA33 206.50  
 TA33JR 151.85  
 TA36 335.25  
 CL33 232.58  
 CL36 310.65  
**MORGAIN** List  
 75-10HD 74.50

**Give us a try before you buy • Call Jim Titus Toll Free and ask him to quote your requirements from this ad**

a Division of TREVOSE ELECTRONICS, INC/ 4033 Brownsville Road, Trevoese, PA 19047

FREE UPS SHIPPING ON PREPAID ORDERS



TOLL FREE QUOTES

# 800-523-8998

# high-performance rf-agc amplifier

Presenting a  
small step forward  
in front-end  
receiver design —  
an amplifier  
with high power gain  
and good agc  
characteristics

During construction of a 6-meter ssb transceiver, I needed an improved rf-agc amplifier. My requirements called for 15-dB minimum power gain, low noise figure, and good signal-handling capability that wouldn't deteriorate with the application of agc. Furthermore, a good input/output match to 50 ohms had to be maintained over the agc range. The well-known circuits I had used or seen in the past wouldn't meet all these requirements *simultaneously*. What follows is my approach to the problem of compatibility between a high-gain rf input amplifier and really good agc control. Also offered are some suggestions on further improving input/output linearity, and some equations for calculating power gain and impedance.

## initial experiments

The dual-gate mosfet amplifier worked fine with constant bias, but signal-handling capability deteriorated with agc. Also, this circuit required a high-input impedance transformation for a match, a no-no in good front-end design. Next I considered the grounded-gate circuit, where an input match was easily obtained with a low-impedance transformation. Available power gain was disappointingly low, however, and input-impedance change with agc was totally unacceptable. From this initial investigation I reached two conclusions: A new amplifier configuration was necessary to meet gain, impedance match, and signal-handling requirements; and agc control

By **Andy Borsa, WA1FRJ**, 6 Colby Lane,  
Pelham, New Hampshire 03076

must not involve changing amplifier bias level in any way.<sup>1</sup>

## final circuit design

To make a long story short, the circuit evolved into that shown in **fig. 1**. The basic arrangement is a cascode jfet amplifier. However the input fet, Q1, receives drive at both gate and source terminals. This provides two advantages, the first being an input match with a transformation only slightly higher than that of a simple common-gate stage. Second, this type input permits a choice of gain in the range between common source and common gate arrangements.

turn on, shunting more and more signal current away from Q2, decreasing stage gain accordingly. Maximum gain cut is determined by the saturated ON resistance of Q3 in series with the coupling-capacitor impedance, together with the  $g_m$  (forward transconductance) of Q2. With a good high-current switch at Q3 (such as a 2N2222), a very respectable agc range of at least 35-40 dB can be achieved.

There are other, less obvious, advantages with this agc circuit. First, control takes place at the point of smallest signal voltage, or lowest impedance. Second, the control element operates with increasing forward bias as gain decreases (input signal increases). Both points are extremely desirable from

**fig. 1. Schematic of the 50-54-MHz rf/agc amplifier. The input transformer is wound on a small toroid core; total secondary inductance is 0.5  $\mu$ H. Coil data are sketchy because of the use of surplus cores and forms of unknown origin and characteristics.**

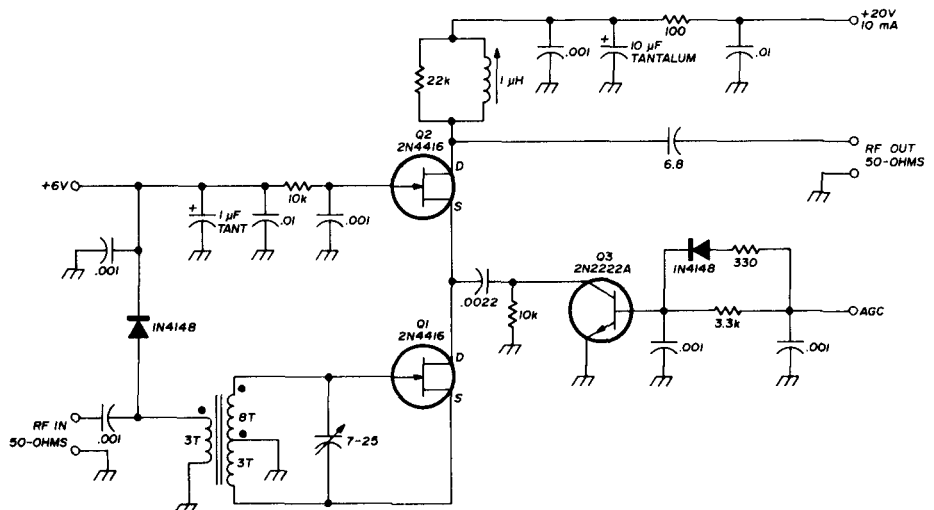

In a related fashion, noise figure follows a similar relationship. The output fet, Q2, is conventional. Any reasonable output network may be used to meet gain and impedance requirements. The circuit isn't original with me, as a bipolar version is mentioned by Rheinfelder.<sup>2</sup> A similar arrangement has been described for use in vacuum-tube linear power amplifiers;<sup>3</sup> however, I've never seen its excellent capabilities put to use in modern ham equipment.

## agc control

The method of agc control is unconventional (as far as I know) for an fet amplifier. It does bear some resemblance to a bipolar cascode circuit using a differential pair with current source, although operation does not involve changing amplifier bias level. In **fig. 1**, a transistor is ac-coupled to the interface between the fets. As long as this transistor remains biased off, it has little effect on the signal current passing from Q1 to Q2. With increasing agc voltage, Q3 begins to

a dynamic-range point of view. Finally, circuit complexity is only slightly greater than that of a standard cascode or mosfet stage.

## circuit description

The circuit of **fig. 1** uses low-Q input and output networks to achieve an almost flat 16-dB power gain over the entire 6-meter band. A high-value shunt resistor across the output coil was sufficient to limit the gain to the desired value because of the low unloaded Q of the miniature coil I used. (A high-Q coil here would have resulted in a much lower shunt resistor to keep the gain down.) Input and output amplifier ports provide a very good match to 50 ohms, an important consideration for low-input vswr presented to the vhf antenna and cable and for the following multi-pole bandpass filter.

The agc transistor, a 2N2222A, receives its base drive through a nonlinear resistor-diode network. This arrangement linearizes the dB gain cut versus

control voltage characteristic over the range 1 required. This or similar networks (using zeners, for example) can be used to tailor the agc levels and response curve to meet your specific requirements.

I found no need for parasitic suppression with this circuit; however, the layout is very compact with good bypassing and grounding, so other construction methods might require resistors or ferrite beads applied to Q2 gate and drain. A further point in this circuit is that Q2 was selected for a slightly higher  $I_{DSS}$  (zero-bias drain current) than Q1. This would not be necessary with sufficient source bias at Q1.

## test results

Fig. 2 is a plot of the agc characteristics for the circuit. The linearity is acceptable but could be further improved by operating on the base drive to Q3. My test setup was limited to the 30-dB of gain cut shown, but at least 40 dB should be achievable.

Further tests of input-output linearity revealed a 1-dB gain compression level at +7 dBm output to 50 ohms, corresponding to a -9 dBm input level. Even at a gain cut of 30 dB, the input level for 1-dB compression didn't drop more than a couple of dB. Although this performance is good, further work is indicated, since this rf stage is still (on paper) the limiting strong-signal factor in my receiver.

Some possibilities for improvement: operate Q3 with some collector-to-emitter-current bias; use higher  $g_m$  fets; and maybe substitute PIN or rectifier diodes for Q3. Noise figure and IMD measurements are still awaiting completion of the receiver section, although I expect performance in this area to be good, at the very least.

## calculating gain and impedance

When looking at published schematics, I've often wondered how other authors arrived at particular circuit values. So, at the risk of being blamed for too many technicalities, I'd like to present some equations and information for those wishing to experi-

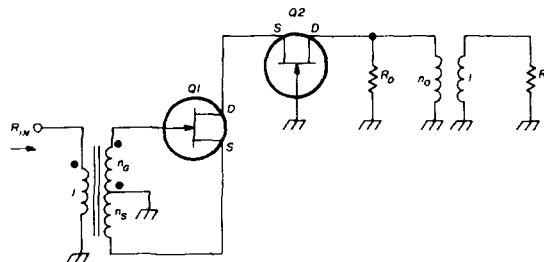

fig. 3. Simplified ac equivalent circuit for power gain and impedance calculations.

ment. For this, I'll use the simplified ac equivalent circuit of fig. 3:

$$\text{power gain} = \frac{R_{in}R_L}{4} [g_m n_o (n_G n_s)]^2 \quad (1)$$

where

- $n_o$  = output voltage step down ratio
- $n_G$  = gate winding step up ratio
- $n_s$  = source winding step up ratio
- $g_m$  = ac forward transconductance
- $R_D$  = combined resistive loading and coil losses
- $R_{in}$  = input impedance presented to input transformer primary
- $R_L$  = load resistance

Normally,  $R_{in} \approx R_L = 50$  ohms. In eq. 1 it's assumed that sufficient resistive and coil loading exists so that  $R_D = (n_o)^2 R_L$ , which makes the circuit output resistance equal to that of the load. Once  $R_{in}$  is set, the following equation should be used to define the input turns ratios:

$$n_s(n_G + n_s) = \frac{1}{g_m R_{in}} \quad (2)$$

A few iterations between these equations may be required to achieve reasonable proportions for the input and output turns ratios. But reasonable numbers usually result by choosing  $n_s = 1$  so that  $n_G = \frac{1}{g_m R_{in}} - 1$ . Then all that's left is to solve eq. 1 for the output turns ratio corresponding to the desired power gain.

It is my hope that the data presented here will help produce some small advance in communications-receiver performance. Obviously, this amplifier circuit isn't limited to the 6-meter band; in fact, I use similar versions for my receiver's 9-MHz i-f chain. I'd truly appreciate hearing from anyone who either uses or further evaluates this circuit.

## references

1. Sabin, "The Solid-State Receiver," *QST*, July, 1970, pages 35-43.
2. Rheinfelder, *Design Of Low-Noise Transistor Input Circuits*, Hayden Book Co., 1964, page 25.
3. Pappenfus, Bruene, and Schoenike, *Single Sideband Principles and Circuits*, McGraw-Hill Book Co., 1964, page 159.

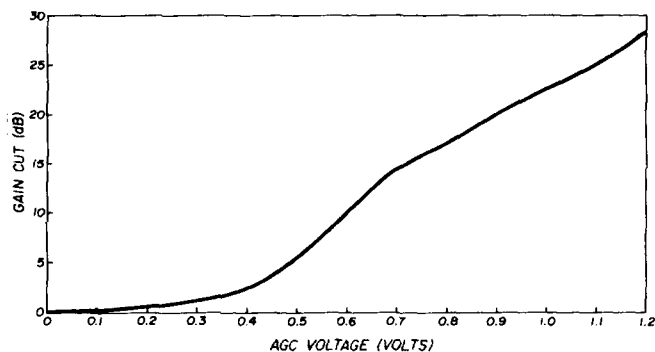

fig. 2. Agc characteristics for the circuit of fig. 1.

ham radio

# King of the Road

## ATLAS 210x/215x

5 BAND—200 WATT—ALL SOLID STATE  
HF SSB/CW TRANSCEIVER



### The Perfect Mobile Rig

With its exclusive PLUG-IN-AND-GO MOBILE MOUNT, its light weight (7 pounds), and compact size (3½" high X 9½" wide X 9½" deep) the Atlas 210x/215x is the perfect mobile rig.

To go mobile just slip the 210x into its mobile mount and all connections are made automatically.

In just 10 seconds you're on the air mobile!

(ATLAS 210x or 215x \$765)  
with noise blanker \$810



**ATLAS**  
RADIO INC.

417 Via Del Monte, Oceanside, CA 92054

Phone (714) 433-1983

Special Customer Service Direct Line

(714) 433-9591

MADE IN AMERICA

# modified quad antenna

If you haunt the  
20-meter band for DX  
you've no doubt  
heard ZF1MA —  
here's a description  
of the antenna  
that puts out his  
big signal

**The quad has** long been acclaimed a great DX antenna ever since Clarence C. Moore, W9LZX, made history with it in the mountains of Ecuador in 1939. Very few articles have appeared in the literature regarding its design changes. This article describes some novel changes to the quad, which makes it an efficient DX antenna.

## construction

**Fig. 1** illustrates the basic design of the quad. This antenna was made from locally available materials. Its design departs from conventional quads in several respects.

**The spider.** The first part to be constructed is the spider, which must be lightweight and strong. I made several spiders using different materials (aluminum and galvanized iron). These spider designs were abandoned as being either too heavy or too weak. Finally, a spider made from a 61-cm (24-inch) length of 51-mm (2-inch) diameter galvanized tubing had the necessary structural characteristics. This spider was cut as shown in **fig. 2**. The photo shows the spider in the half-finished stage.

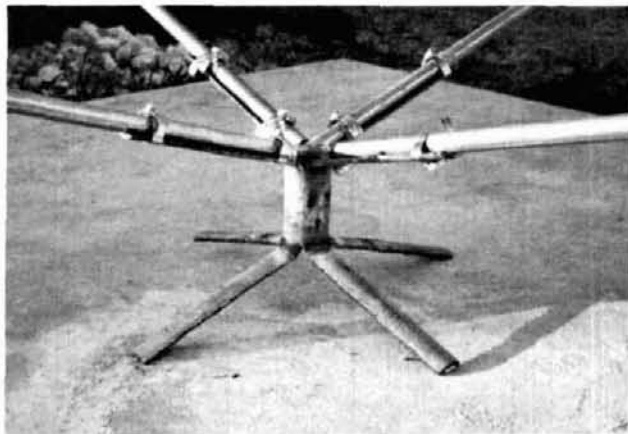

Details of the spider used in the modified quad showing hose-clamp connections for the elements. All materials were obtained locally.

**By Joseph B. W. Jackman, ZF1MA, P.O. Box 459, Grand Cayman Island, British West Indies**

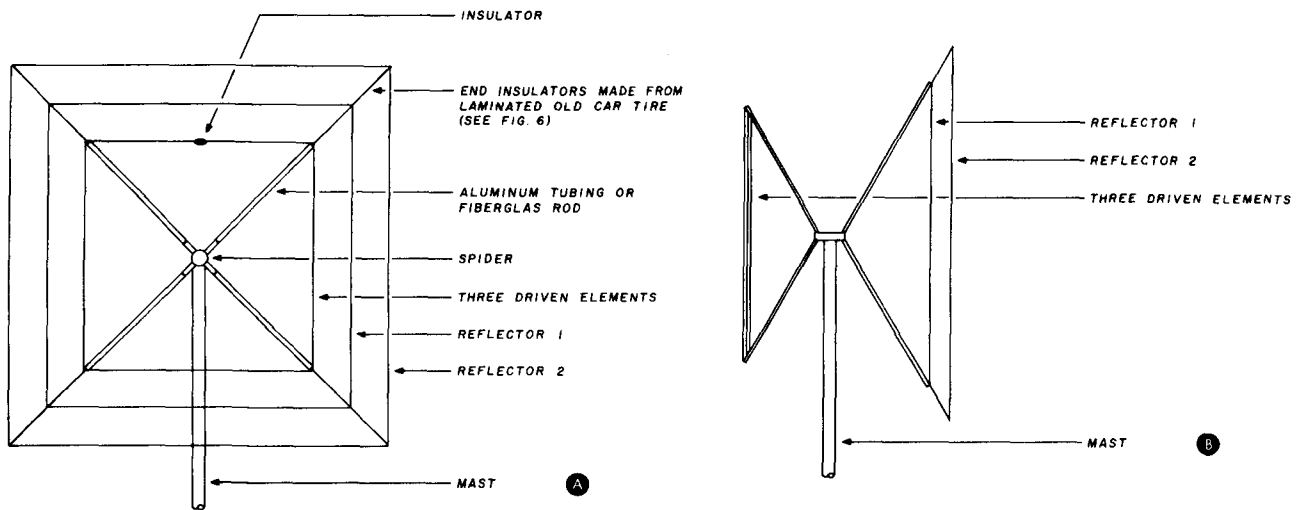

fig. 1. The modified quad antenna used at ZF1MA. Design uses three driven elements, which are fed with 450-ohm open-wire transmission line. Front view is shown in sketch A; side view in B.

**Spider template.** A template was used to bend the cut sections of tubing to the required angle consistent with the spacing used. The angle can be between 108 and 112 degrees. The template was made of stiff cardboard, which was cut as shown in fig. 3.

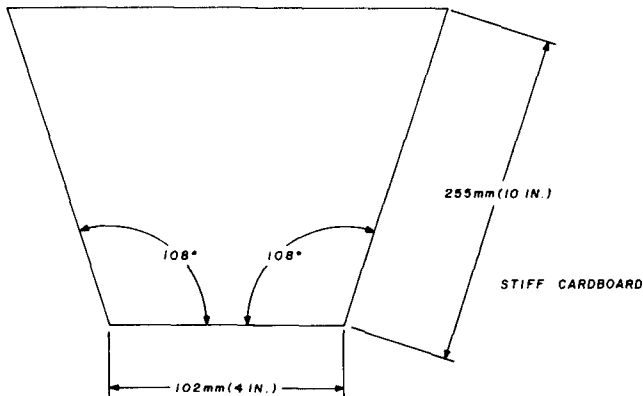

fig. 3. Template used for forming spreader-to-spider angles.

When tube bending has been completed, the spider should look as shown in the photo. The photo also shows how the spreaders are attached to the spider with stainless-steel 7.5-cm (3-inch) hose clamps.

To strengthen the spider, four pieces of 12.5-mm

(1/2-inch) conduit was welded between each bent arm, so that the 108-degree angle, or whichever angle you choose, is maintained. See fig. 4. The drawing is simplified for clarity.

The spider can either be used as is, with only the addition of a mast-to-spider plate, or you can do as I did and weld a 0.9-meter (3-foot), 51-mm (2-inch) diameter pipe onto the spider, as shown in fig. 5. The mast is welded to the spider, depending on the shape quad desired.

**Spreaders.** Spreaders can be made from any of the conventional materials. In the tropics bamboo is the most available and is gratis; however, fiberglass, aluminum, or wood can also be used. This, of course, will depend upon where you live and what materials are most available. I had a few lengths of aluminum, so these were used. However, to prevent the spreaders from resonating, the horizontal spreaders on the driver and reflector elements were broken with insulators. For years I used wood, and at least one commercial company uses Bakelite. I decided to use rubber from old car tires cut into small strips and laminated together with contact cement. Incidentally, the same idea can be used to make standoff insulators or center insulators. Eight insulators were also

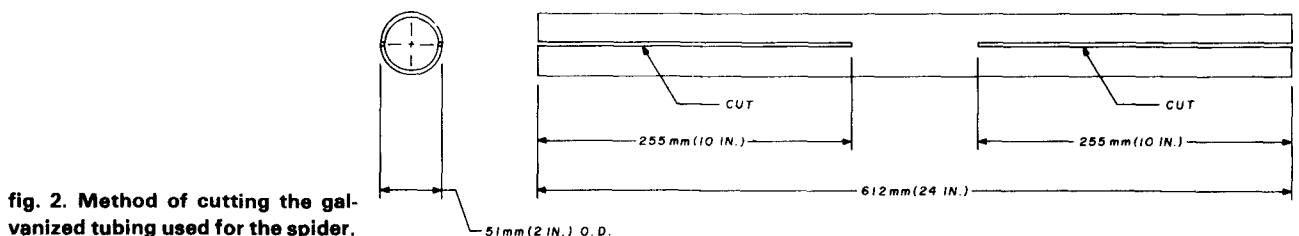

fig. 2. Method of cutting the galvanized tubing used for the spider.

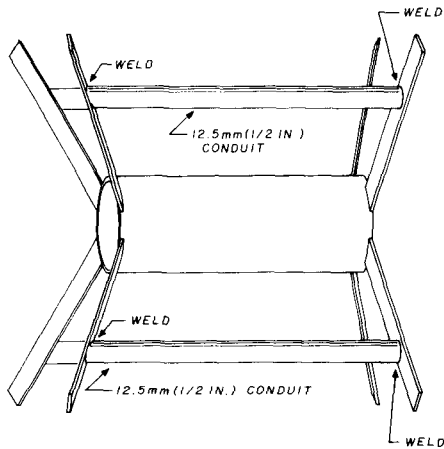

fig. 4. Galvanized conduit, 12.5 mm (1/2 inch) in diameter, is welded between spreader attachments for structural strength.

made to put into the end of the aluminum tubing (fig. 6). This practice proved to be well worth the time spent in making them, as the flexible rubber moves with the wind and precludes broken elements on the quad. The three holes spaced 51 mm (2 inches) apart are for the driven-element spreaders only (fig. 6).

The per-side dimensions I used for the quad were:

three driven elements	5.3 meters (17.3 feet)
reflector 1	5.4 meters (17.8 feet)
reflector 2	5.6 meters (18.3 feet)

The three driven elements (fig. 7) were made up and passed through the holes in the end of the spreader insulator. The middle wire was open at the top and

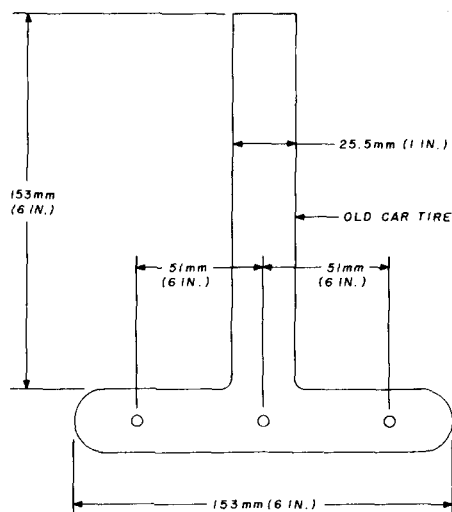

fig. 6. An old auto tire, which moves with the wind and eliminates broken elements, can be used for insulation material. Small strips of tire rubber were cut and laminated together with contact cement.

one of my car-tire insulators inserted. This was also done on the number-one reflector only. The feed-point was connected with 450-ohm open-wire transmission line to a universal transmatch, thence to a standing-wave-ratio meter, thence to the transmitter.

### performance

The quad was mounted on a 12-meter-high (40-foot) mast and vswr checks were made. Having satisfied myself that all systems were go, I tuned up to 20 meters, pointed the antenna toward Europe and called CQ DX. I called only once, and all Europe seemed to call me! The first callsign I picked out was my longtime radio friend Paul, SM7CMC, who gave me a 5-9 + 20 report, and since it has been ever thus. That night I pointed the beam toward Australia and

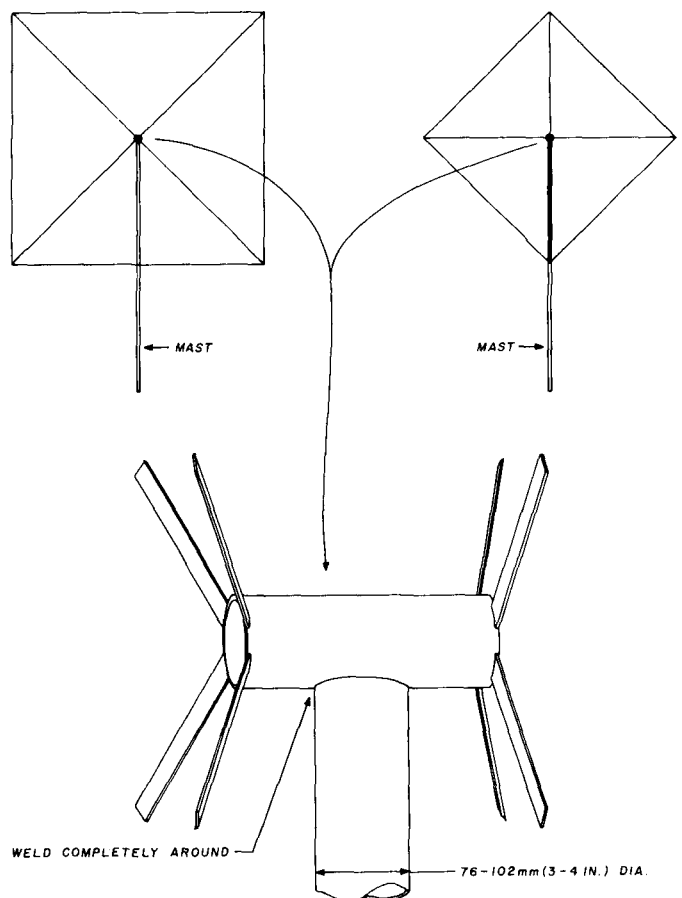

fig. 5. Method of welding spider-to-mast section to obtain a square or diamond-shaped quad.

the same thing happened. It seemed that all the Pacific stations were lining up to say what a great signal I had, including ZL and VK, but also P26, DU, FO8, and others. At this time I ran tests with some of these



stations. From their observations the following antenna performance figures were deducted:

	20 meters	15 meters	10 meters
Gain	8.5 - 9 dB	9.5 - 10 dB	10.5 - 12 dB
Front-to-side ratio	40 - 45 dB	35 - 40 dB	40 dB
Front-to-back ratio	30 - 35 dB	25 - 30 dB	25 dB

The next morning at about 4:30 AM I crawled into bed, tired but contented, and next day I tried the beam first on 15 then on 10 meters. Needless to say, the results were even better than those received on 20 meters.

Since that time, whenever I get on the air on any of these bands, there's a pileup. So many amateurs have asked about my antenna system that I decided to write about it, and this is the story.

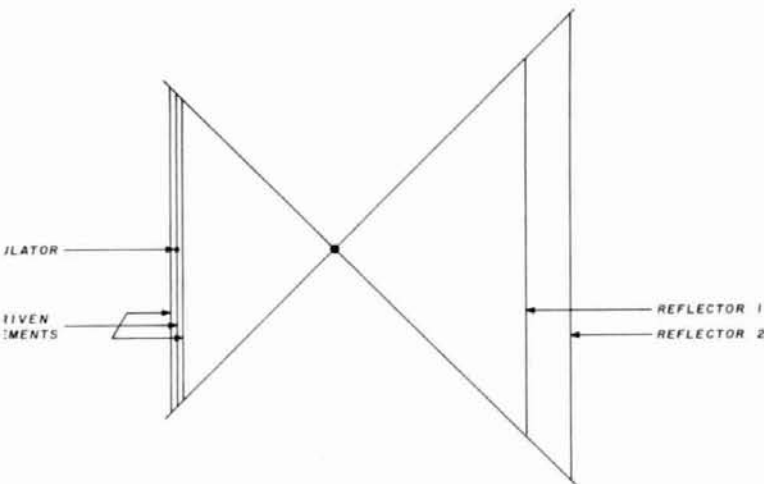

fig. 7. View looking down on the quad elements. Three driven elements are used; the center element is separated with an insulator to which a 450-ohm open-wire transmission line is connected. Reflector 1 is 3 per cent longer than the driven elements; reflector 2 is 6 per cent longer than the driven elements.

### closing comments

I'd like to thank the many amateur radio operators around the world who have helped in testing this antenna. It's my hope that any amateur who decides to build this antenna will have as much pleasure with it as I've had.

### bibliography

1. W. I. Orr, *All About Cubical Quad Antennas*, Radio Publications, Inc., Second Edition, 1976.
2. J. R. Fisk, W1HR, *Ham Notebook Volume 1*, Communications Technology, 1975.
3. *Radio Handbook*, 20th Edition, 1976, Editors and Engineers.

ham radio

WHERE THE HAM  
IS KING



SERVICE FOR  
OVER 30 YEARS

## SEPTEMBER'S SPECIAL OF THE MONTH



ICOM's mobile IC-22S has won tremendous approval in the Amateur world. So much in fact that it has been the most popular radio offered by ICOM.

### Specifications:

Frequency Range: 146-148 MHz  
Voltage: 13.8 v DC neg. ground  
Number of channels: 22 selected from 256 possible  
Size: 2.3" H x 6.2" W x 8.6" D  
Weight: 4.2 lbs.  
List Price: \$299.00

**YOUR SPECIAL PRICE \$229**

A DIVISION OF TREVOSE ELECTRONICS

# HAMTRONICS, INC.

4033 BROWNSVILLE ROAD, TREVOSE, PA. 19047

CALL TOLL FREE  
FOR QUOTES

**800-523-8998**



GREGORY ELECTRONICS  
*The FM Used  
Equipment People.*

## New Low Price!

**2 Meter Portable**  
**G.E. MASTR PR 36**  
132-150 MHz - 5 Watts  
**ALL SOLID STATE**  
**with Ni-Cad Battery**

Reg. ~~\$228~~ **\$188.**  
NOW



**Vehicular Charger 4EP63A** (sold only with unit) **\$25.**  
**A.C. Charger** (subject to availability)..... **\$25.**  
**Speaker/Mike Type EM36** ..... **\$15.**



**GREGORY ELECTRONICS CORP.**

245 Rt. 46, Saddle Brook, N.J. 07662  
Phone: (201) 489-9000

 **KENWOOD**  
...pacesetter in amateur radio

*You can still  
buy one of the world's  
best HF transceivers  
for under \$1,000*

# TS-820

Even without the digital display, Kenwood's TS-820 provides extremely sensitive and accurate tuning, plus all of the electronic and mechanical advantages found only in the TS-820S. Its reliability has been proven through thousands of hours of use under all environmental conditions.

The TS-820 stands out from all the other rigs on the band. Its adjustable RF speech processor, utilizing a 455 kHz circuit to provide quick-time-constant compression, will get your message through the pile ups. RF negative feedback is applied from the final to the driver to improve linearity, and third-order products are at least -35 dB. Harmonic spurious emissions are less than -40 dB and other spurs are less than -60 dB. RF input power is 200 W PEP on SSB, 160 W DC on CW, and 100 W DC on FSK. Receiver sensitivity is better than 0.25  $\mu$ V for 10 dB S/N. The TS-820 is known for its superb receiver selectivity, and its famous IF shift easily eliminates heavy QRM. That's why the TS-820 series is the DXer's choice.

And, of course, anytime you might want to add a digital display, it's simply a matter of installing the DG-1 option.



**TS-820 VFO-820S SP-820**

Kenwood's unbeatable combination. The VFO-820 solid state remote VFO adds greatly to the versatility of your TS-820. It has its own RIT circuit and control switch and is a perfectly matched accessory. The SP-820 deluxe external matching speaker includes audio filters for added versatility on receive and two audio inputs.

THE KENWOOD NAME HAS GROWN TO REPRESENT THE FINEST AMATEUR RADIO EQUIPMENT AVAILABLE. THE TL-922A LINEAR AMPLIFIER CARRIES ON THAT TRADITION. AS A LINEAR IT GETS YOUR SIGNAL THROUGH TODAY'S CROWDED BANDS AND PROVIDES THE POWER TO REACH THOSE FAR AWAY PLACES WITH EASE. AND BECAUSE IT'S KENWOOD YOU CAN COUNT ON ITS DEPENDABILITY. THE TL-922A IS FCC TYPE ACCEPTED. IT RUNS THE FULL LEGAL LIMIT ON ALL HAM BANDS FROM 160-15 METERS AND IS COMPATIBLE WITH MOST AMATEUR EXCITERS. CONTACT YOUR NEAREST AUTHORIZED KENWOOD DEALER FOR COMPLETE SPECIFICATIONS AND THE BEST DEAL.

# TL-922A

**WHY SHOULD THE TL-922A BE PART OF YOUR STATION? COMPARE THESE FEATURES AND SPECS ... THE ANSWER WILL BE OBVIOUS.**

**Instant heating filaments** — The 3-500Z tubes require no warm up period. Just turn it on and go!

**Time delay fan circuit** — Even after you turn the TL-922 off, the super quiet fan continues to work for approximately 2 minutes to greatly extend tube life.

**Adjustable ALC output voltage** — Lets you tailor the ALC voltage to your exciter.

**Standby position** — Provides amplifier bypassing without having to turn the AC power off.

**Two independent safety interlocks** — One disconnects AC line voltage and the second shorts B+ to ground when tripped.

**Vernier plate control** — For smooth, easy tune-up.

**Diecast side panels** — Includes functional carrying handles for easy transportation.

**Thermal protection of power transformer** — Amplifier automatically switches to standby if power transformer temperature exceeds 145°F.

**Tuned Input Circuit** — Means improved spurious characteristics.

**Line voltage selector** — Easily switched between 120 and 240 VAC.

**Multimeter** — Reads high voltage, relative output or grid current (selectable)

**Plate Current Meter** — Separate meter allows continuous monitoring of plate current.



Shown with top panels removed

**Frequency Range:** Amateur bands, 160-15 meters  
**Drive Power Required:** 80 W nom, 120 W max  
**Mode and Duty Cycle:** SSB, cont for 30 min CW and RTTY, key-down cont for 10 min  
**RF Input Power:** SSB: 2,000 watts PEP; CW, RTTY: 1,000 watts DC  
**Plate Voltage:** (at idle) 3.1 kV SSB, 2.2 kV CW, RTTY  
**Circuit Type:** Class AB<sub>2</sub> grounded grid linear amplifier  
**Input Impedance:** 50 Ω, unbalanced at better than 1.5:1 SWR  
**Output Impedance:** 50 to 75 Ω, unbalanced.  
**Harmonic Suppression:** min 40 dB, depending on exciter used  
**Fan Motor Delay Time:** 140±30 seconds (at room temperature)

**ALC:** Negative going, adjustable threshold. —8 VDC max output (typ)  
**Tubes:** Two Eimac 3-500Z  
**Semiconductors:** 18 diodes, 1 Zener diode  
**Power Requirements:** 120 V, 28 A; 220/240 V, 14 A, 50/60 Hz; for maximum SSB input  
**Dimensions:** 390 mm (15½") x 190 mm (7½") x 407 mm (16")  
**Weight:** Net 31 kg (68 lbs); Shipping 38 kg (83 lbs)

The above specifications are subject to change without notice due to developments in technology.

**TRIO-KENWOOD COMMUNICATIONS INC.**  
 1111 WEST WALNUT/COMPTON, CA 90220

# fm demodulator using the phase-locked loop

Another application  
of the PLL  
for fm circuits,  
including design notes  
and theory of operation

The **phase-locked loop** has been around for some time and has many applications including frequency synthesis, clock synchronization, and a-m detection. IC technology has made the design of PLLs available at low cost and in small packages. This article provides some nonmathematical background on PLL theory and describes its application as an fm demodulator.

## operation

A PLL is a loop circuit with feedback. It may be viewed as an electronic servo with the ability to lock onto and track a reference signal. The lock-and-track process is accomplished through phase-comparing circuits. However, because frequency is the rate of change of phase with respect to time ( $\Delta\omega = d\theta/dt$ ), the PLL lock-and-track mechanism is meaningful in terms of frequency.

Basic PLL operation is as follows (**fig. 1**). The voltage-controlled oscillator (vco) output frequency depends on dc-voltage value from the phase detector and loop filter. As long as the phase difference between vco output and the reference signal is con-

stant, the vco control voltage will be constant and its output frequency won't change. However, when the phase difference between vco output and reference signal begins to change (as would happen as the vco output frequency changes), the phase detector and loop filter provide a dc error voltage, which shifts the vco frequency to re-establish the original phase relationships. In this manner the vco output frequency is maintained at the value of the reference frequency. This is the lock condition of the PLL.

Even during lock a finite phase difference exists between output frequency and reference frequency because each PLL has a characteristic free-running frequency. That is, with no reference voltage applied to the PLL, some quiescent output frequency exists at which it rests. Hence, with a reference signal,

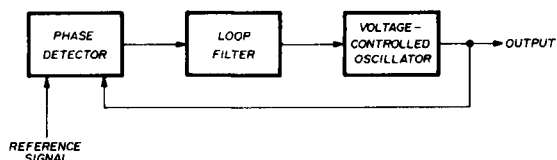

**fig. 1.** Block diagram illustrating PLL operation. A phase detector, filter, and voltage-controlled oscillator (vco) form an electronic servo in which vco output frequency and reference frequency are constant.

some phase difference between vco output and the reference signal must be present to provide an error voltage that will shift the vco output from its free-running value to the reference value. Often, terminals on the IC package are included for an external capacitor, which can be used to trim the free-running frequency

By Tim Daneliuk, KL7IPS, Room 0-408A, 820 North LaSalle Street, Chicago, Illinois 60610

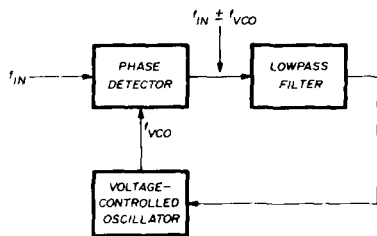

fig. 2. Example of a PLL with a phase detector used as a mixer so that  $f_{in} \pm f_{vco}$  applied to a lowpass filter results in an output with a dc component that drives the vco so that loop lock is established.

as close as possible to the reference frequency. This action reduces pull-in time — i.e., the total time required for the PLL to establish the locked condition.

### a different perspective

Fig. 2 shows the phase detector as a mixer whose output is  $f_{in} \pm f_{vco}$ . At lock,  $f_{vco}$  is such that the difference between the two frequencies is zero. The lowpass filter (LPF) attenuates the sum frequency and passes the difference frequency. Hence, at lock, the LPF output is a dc voltage (since the difference frequency is zero at lock). From this point of view it's seen that, if the PLL is not in lock but the difference frequency is within the LPF passband the filter output will not be dc but will be an ac beat frequency. This ac voltage is applied to the vco control terminal and, in effect, frequency modulates the vco output frequency. During the time  $f_{vco}$  is modulated so that it's closer to  $f_{in}$ , the error between the two signals decreases and the resulting beat frequency at the LPF output is lower. Thus the amplitude at the filter output is greater because, in a lowpass filter, less attenuation occurs for increasingly lower frequencies (fig. 3).

This entire process results in a filter output that is sinusoidal but decreases in frequency as a function

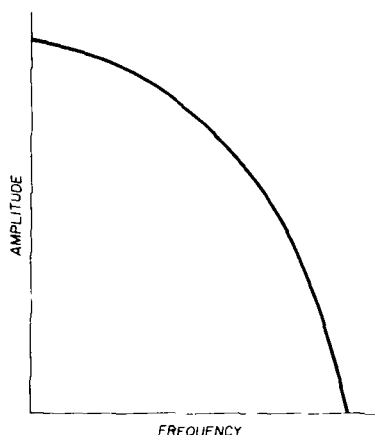

fig. 3. Amplitude as a function of frequency in a lowpass filter.

of time while increasing in amplitude (fig. 4). This waveform has a net dc component that drives the vco frequency to establish lock in the loop, which in turn results in a continuous dc output level from the filter. If the pull-in time is shorter than the period of the beat note appearing at the LPF output, the loop can lock without this oscillating error transient.

### capture and lock range

It's important to understand the terms *capture* and *lock* and their mutual relationship. Consider the situation where the loop is not locked and the difference frequency is outside the LPF bandpass. The vco remains at its initial free-running frequency, and no real change occurs in the loop. However, as the difference frequency becomes smaller (as  $f_{in}$  approaches  $f_{vco}$ ), a point is reached where an error voltage is passed by the LPF to the vco control terminal, which in turn shifts  $f_{vco}$  so that the difference frequency is even lower. This is a *positive feedback* mechanism, which causes the loop to become locked.

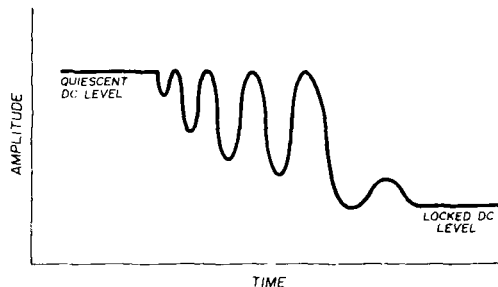

fig. 4. Lowpass-filter output response with time. The signal is sinusoidal but decreases in frequency while increasing in amplitude.

The capture range, then, is "the frequency range centered about the vco initial free-running frequency over which the loop can acquire lock with the input signal."<sup>1</sup> It is determined primarily by the LPF band edge and the system closed-loop gain. This action is contrasted with the loop lock range, which is "the frequency range usually centered about the vco initial free-running frequency over which the loop can track the input signal once lock has been achieved."<sup>1</sup>

The limiting factor of the lock range is the maximum amount of error voltage available and the corresponding maximum frequency swing the vco can produce. Because, in lock, the error voltage is a dc voltage, the lock range is not a function of the LPF bandpass characteristics. Note that the capture range is never greater than the lock range and is, in fact, often less. That is, a PLL may be able to track a signal and maintain lock over a greater frequency range than over which it was initially able to acquire lock.

table 1. Characteristics of several PLL ICs used for fm detection.

device	distortion (per cent)	upper frequency (MHz)
NE 560	0.3	30.0
NE 562	0.5	30.0
NE 565	0.2	0.5
NE 567	5.0	0.5

## fm detection using the PLL

The basic circuit of a PLL fm detector is shown in fig. 5. Here, instead of a constant reference frequency, a frequency modulated signal is applied to the phase detector. The PLL is locked to the fm carrier frequency. With no modulation no frequency deviation occurs and the LPF output is a constant dc voltage. However, as soon as the wave is modulated and frequency deviation occurs, an error voltage appears at the LPF output which is proportional to the frequency deviation. The circuit demodulates the incoming fm signal. It's essential that the filter have a bandpass characteristic that doesn't attenuate the highest expected modulating frequency — i.e., for a high-fidelity system, a bandpass all the way to 20 kHz would be desirable.

## linearity

Another important consideration (particularly in high-fidelity systems) in the design of PLL fm detectors is linearity. The loop must detect the signal without introducing excessive distortion. Also, the PLL must operate at a frequency equal to the carrier frequency plus the *maximum positive frequency deviation* encountered. With modern devices this is usually not a great problem, since detection occurs after mixing and i-f amplification. For example, common i-fs are 455 kHz and 10.7 MHz. Table 1 shows the distortion and upper frequency limits of several common PLLs used in fm detectors.

## response in noise

One of the side benefits of this system of fm demodulation is its ability to detect signals in noise. Since the error voltage is filtered, the control voltage to the vco is "devoid of phase deviations produced by noise."<sup>2</sup> The main requirement is that the incom-

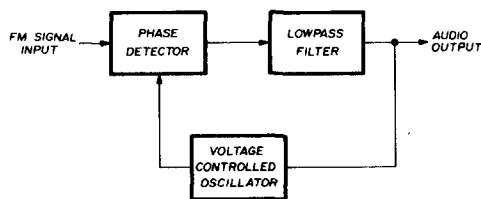

fig. 5. Fm detector using the PLL principle.

ing signal be strong enough to activate the phase detector. This is not, perhaps, overly critical in the fm broadcast situation, where the receiver is in an area of fairly high signal strength (since fm broadcast is intended primarily for local coverage). However, incoming signal amplitude becomes exceedingly important, for example, in high-frequency RTTY FSK demodulation. Here, the incoming signal is often plagued by atmospheric noise and other disturbances. Unless the demodulated signal is an *exact* reproduction of the transmitted signal, the resulting printout will be gibberish. A similar application would be in the vhf fm telemetry systems.

## conclusion

Since the introduction of the initial IC PLL, technology has produced complete fm stereo demodulators available on one IC. Fig. 6 shows one of these

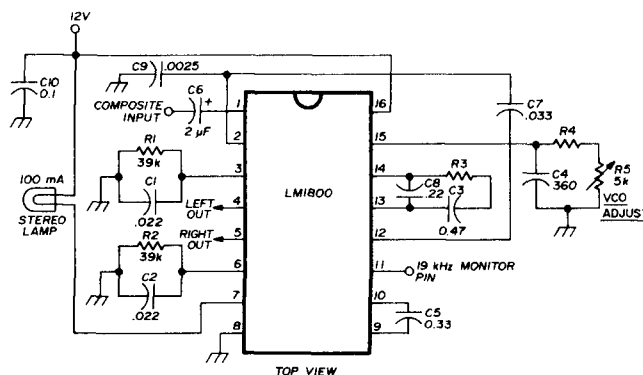

fig. 6. Typical fm detector using an IC chip from National Semiconductor. Additional data is available from their *Linear Applications Handbook, Vol. II*.

circuits. It's from National Semiconductor's *Linear Applications Handbook Vol. II*. This approach decreases parts count and improves reliability. It's safe to assume that this approach will be the industry trend in the future for such applications.

## references

1. "Phase-Locked Loops," *Signetics Application Notes*, Signetics Corporation, Sunnyvale, California, page 6-5.
2. Nash and Garth, "Locking in on Phase-Locked Loops," *Motorola Monitor*, Vol. VIII, No. 2, page 23.

## bibliography

- "Phase-Locked Loop FM Stereo Demodulator," Application Note AN-81, *Linear Applications*, Vol. II, National Semiconductor, Santa Clara, California, 1976.
- "Phase-Locked Loop Application Notes," Signetics Corporation, Sunnyvale, California, 1972.

ham radio

# Incredible...



Incredible, that's the word people are using to describe the CT-50 frequency counter. Why? Simple, the CT-50 is an achievement in design; exceptionally low in cost, compact, easy to use and unmatched in performance and reliability.

Features of the CT-50 include; easy pushbutton operation, fully automatic decimal point positioning, quality shielded metal case, and dependable LSI circuitry. Full eight digit readout allows resolution to 1 Hz at 65 mHz, 10 Hz at 650 mHz, and the decimal point is always correct. Input protection to 50 volts insures against accidental burnout or overload. And, the best feature of all is the easy assembly. Clear, step by step instructions guide you to a finished unit you can rely on.

Use the order blank below or call us direct and order yours today!

CT-50, 60 mHz Counter Kit	\$89.95
CT-50 WT, 60 mHz counter, wired, tested	159.95
CT-600, 600 mHz prescaler option for CT-50, add	29.95

## ACCESSORIES

DC probe, direct input, general purpose type	\$12.95
High impedance probe, does not load circuit	15.95
Low pass probe, used when measuring audio	15.95
High pass probe, reduces low freq pickup	15.95
VHF flexible rubber antenna, BNC connector	12.95
Color burst adapter, for calibration, high accuracy typically 0.001 ppm accuracy, stability	14.95

# ramsey electronics

P.O. Box 4072 Rochester NY 14610

(716) 271-6487

## SPECIFICATIONS

Frequency range: 5 Hz to 65 mHz, 600 mHz with CT-600  
 Resolution: 10 Hz @ 0.1 sec gate, 1 Hz @ 1 sec gate  
 Readout: 8 digit, 0.4" high LED, direct readout in mHz  
 Accuracy: adjustable to 0.5 ppm  
 Stability: 2.0 ppm over 10° to 40° C, temperature compensated  
 Input: BNC, 1 megohm/20 pf direct, 50 ohm with CT-600  
 Overload: 50VAC maximum, all modes  
 Sensitivity: less than 25 mv to 65 mHz, 50-150 mv to 600 mHz  
 Power: 110 VAC 5 Watts or 12 VDC @ 400 ma  
 Size: 6" x 4" x 2", high quality aluminum case, 2 lbs  
 ICS: 13 units, all socketed  
 CT-600: 600 mHz prescaler option, fits inside CT-50  
 CB-1: Color burst adapter, use with color TV for extreme accuracy and stability, typically 0.001 ppm

## Ramsey Electronics

Box 4072 716-271-6487

Rochester, NY 14610



Quantity	Description	Price
	Shipping, handling, insurance	\$5.00
	N.Y. state residents, add tax	
	Total	
Name _____		
Address _____		
City _____ State _____ Zip _____		

# Don't miss Chicago's

## 8th annual

### SEPT. 30/ OCT. 1

### Manufacturer's displays • Forums

### \$5000 in prizes.

All-weather flea market and camp area open Friday.

LADIES PROGRAMS.

TICKETS: \$2.00 in advance, kids under 12 free. Exhibitors: Call 312-690-1177 for info.

# RADIO EXPO '78

For tickets & info. write: Radio Expo, Box 305, Maywood, IL 60153

## RTTY for ALL Systems



### ELECTROCOM® "SERIES 400" FREQUENCY SHIFT CONVERTERS

Professionally engineered for outstanding performance, stability, and reliability, the Electrocom® Models 400 and 402 add new dimensions of compatibility between radio and teletypewriter systems. Manufactured to highest quality standards—an Electrocom tradition for nearly two decades—these units are ideal for military, government, commercial, civil defense and amateur applications. The Model 400 front panel digital knob accurately selects shifts up to 1000 Hz., while two such knobs on the Model 402 independently set the mark and space frequencies. Both models may also be preset with any tone pair between 1000 and 3200 Hz.

Optimum performance with FSK or AFSK

systems is assured by matched filters, precision linear detectors, baud rate selector, bias compensation, and semi-diversity circuitry. Operation is enhanced by a CRT monitor, autostart with solid-state motor switching, antispacer, markhold, EIA/MIL output voltages, and a constant current loop supply. In addition, various options are available including rack mounting and polar current output.

Write or call us for complete product details and specifications. Learn why Electrocom® "400" Converters are designed not only for today's communication environment, but ultimately to fulfill RTTY requirements for years to come.

**Electrocom**® INDUSTRIES  
1105 N. IRONWOOD DRIVE, SOUTH BEND, INDIANA 46615  
Telephone: (219) 232-2743

## SYNTHESIZERS

We have the worlds largest selection of synthesizers for receivers, transmitters and transceivers. For complete details see our 1/3 page ad in the April 1976 issue of this magazine or call or write for additional information. Phone orders accepted between 9 AM and 4 PM EDT. (212) 468-2720

### VANGUARD LABS

196-23 JAMAICA AVENUE  
HOLLIS, N. Y. 11423

IN STOCK FOR IMMEDIATE DELIVERY!



MODEL 43  
\$125  
Plus Shipping



BROAD LINE OF BIRD PRODUCTS STOCKED IN DEPTH

AUTHORIZED DEALER/DISTRIBUTOR



**SPECTRONICS**, INC.  
(312)848-6777  
1009 GARFIELD ST.  
OAK PARK, ILL. 60304



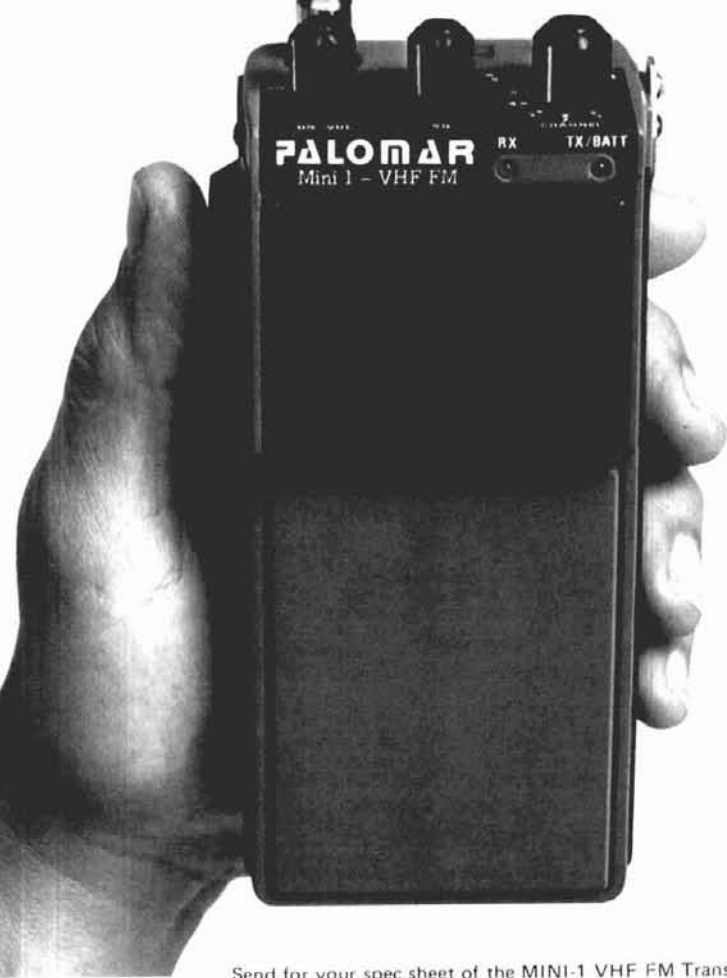

# WE'LL KEEP YOUR COMMUNICATIONS NEEDS FROM GETTING OUT OF HAND.

Introducing the PALOMAR MINI-1 VHF FM TRANSCEIVER... the Amateur Hand-Held set that's small enough to fit in your palm.

You're never out of touch with thousands of repeaters, so you're never out of touch with home... associates... friends. The PALOMAR

MINI-1 operates normally in the Amateur 144-148 VHF region and with the AUTO-PATCH OPTION, you can access the telephone repeater and communicate through the telephone system.

The PALOMAR MINI-1 VHF FM TRANSCEIVER is only 152 mm high by 67 mm wide. Transmitter minimum output is one watt of power, with a total of 18 channels available, utilizing up-down split, down-up split or simplex, all with only 6 crystals.

The PALOMAR MINI-1 VHF FM TRANSCEIVER... it has all your communications needs well in hand.



*Worth every dollar.  
(And about the same size!)*



Send for your spec sheet of the MINI-1 VHF FM Transceiver to: PALOMAR ELECTRONICS, 665 OPPER STREET, ESCONDIDO, CA 92:

## The parameters of the Palomar PTR-130k are the outer perimeters of logic technology.

Never before has any transceiver approached the capabilities of the Palomar PTR-130k!

It's the first completely multi-functional transceiver ever made available to the public!

The Palomar PTR-130k is a miniaturized mobile transceiver

capable of operating in 100 cycle resolution from 100 KHz to 30 MHz in all modes of transmission and reception. Instant frequency selection is available with the touch of a finger.

The Palomar PTR-130k.

technology is pure space age... the price is strictly down-to-earth.

Send for our full color brochure to:

Palomar Electronics Corporation  
665 Opper Street  
Escondido, CA 92025  
Telephone: (714) 748-2666



TECHNOLOGY AT THE SPEED OF SOUND

# calibrating meter amplifiers

Meter amplifiers help provide increased sensitivity for high-current meters, but not without the need for a final accurate calibration

**Meter-amplifier circuits** have been around for several years, generally using conventional transistors, field-effect transistors, or operational amplifiers. If you want increased meter sensitivity in a wavemeter or grid dip meter configuration, then calibration may not be of much concern. In these cases you're more apt to want sensitivity (in the microampere range) to detect small radio-frequency currents.

When using meter amplifiers for absolute readings, however, several questions arise. How much amplification is expected, and in conjunction with what meter? What will be the final calibration of the new meter?

The data presented in **tables 1, 2, and 3** should provide an indication of what to expect from a meter amplifier, as it relates to current measurements.

The circuit used is shown in **fig. 1**. It is a common-source configuration using an MPF102 field-effect transistor.<sup>1</sup> For testing purposes, I constructed the circuit in a mini-box, with six insulated binding-posts for the input, output, and 9-volt supply to the circuit. The amplifier was mounted on a small printed-circuit

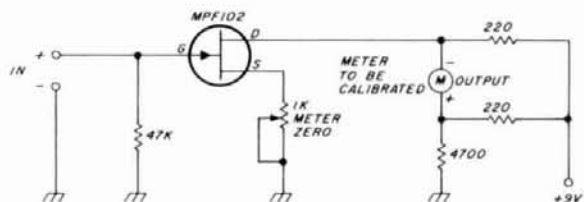

**fig. 1.** Schematic diagram of the simple meter amplifier. The pot connected to the fet's source is used to zero the meter to be calibrated.

board. The 1k pot was mounted in the center of the front panel. **Fig. 2** shows a block diagram of the interconnections used to calibrate the meters.

As can be seen from **table 1**, you should expect a seven- to eight-time increase in the readings of a

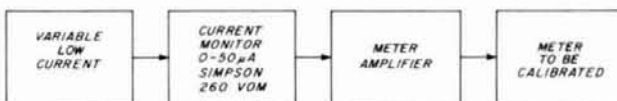

**fig. 2.** Test set-up for calibrating a meter movement. Using this system, the final calibration and accuracy will be determined by the current monitor.

By Howard J. Stark, W4OHT, 9231 Caribbean Boulevard, Miami, Florida 33189

table 1. Calibration for a COMCO 50 $\mu$ A meter.

Simpson 260	meter readings $\mu$ A	reduced to unity $\mu$ A
1 $\mu$ A	7.0	7.0
2 $\mu$ A	14.0	7.0
3 $\mu$ A	24.0	8.0
4 $\mu$ A	33.5	8.37
5 $\mu$ A	44.0	8.8

50 $\mu$ A meter. The popular 1 mA meter is more likely to be used with an amplifier to raise its sensitivity. Not having a 1 mA meter available, I calibrated two identical 1.5 mA meters made by Marion Electric Company. Table 2 shows the results of the calibration.

table 2. Calibration readings for the Marion Electric 0-1.5mA meters.

meter 1			
Simpson 260	meter reading	divisions on scale	$\mu$ A per scale division
10 $\mu$ A	48	8	1.25
20 $\mu$ A	90	19	1.05
30 $\mu$ A	128	28	1.07

meter 2			
Simpson 260	meter reading	divisions on scale	$\mu$ A per scale division
10 $\mu$ A	43.0	8.5	1.17
20 $\mu$ A	93.0	18.5	1.08
30 $\mu$ A	135.5	27.0	1.11

The significant points to note are that 30  $\mu$ A produced near full-scale deflection on the meters and that each division was slightly more than 1 $\mu$ A. As a final step, I checked Simpson 500  $\mu$ A meter (see table 3).

table 3. Simpson 0 to 500  $\mu$ A meters calibration.

Simpson 260	meter readings 0-500 $\mu$ A	divisions on scale	$\mu$ A per scale division
5 $\mu$ A	127	17	.29
10 $\mu$ A	325	35	.28
14 $\mu$ A	500	50	.28

If the meter amplifier is to become a permanent part of the metering system, some relabeling of the face will be required to reflect the increased sensitivity. When using an amplifier with other meters, the basic resistance of the meter will effect the final sensitivity and calibration.

### reference

1. Doug DeMaw, W1FB, editor, *ARRL Electronics Data Book*, American Radio Relay League, Newington, Connecticut, 1976, page 22.

ham radio

# TPL 1/4 KILOWATT LINEAR AMPLIFIER

TPL proudly presents the first true power 1/4KW SSB/AM, FM or CW solid state 2 meter linear amplifier



A remote control plug allows you to operate with the amplifier ON or OFF, or in SSB/AM, FM or CW from the dashboard.

The 2002 utilizes the latest state of the art engineering including micro-strip circuitry and modular construction. The three final transistors combine to produce 250W when driven by 15W or more at 13.8VDC.

<b>POWER INPUT:</b> 5-20W Carrier FM or CW 20W PEP maximum SSB or AM	<b>HARMONIC ATTENUATION:</b> All Harmonics Attenuated 60 dB or Greater
<b>POWER OUTPUT:</b> 200-250W carrier FM or CW 300W PEP SSB or AM	<b>CURRENT DRAIN:</b> FM-40 Amps @ 250W SSB-30 Amps @ 300W PEP
<b>FREQUENCY RANGE:</b> 144 to 148 MHz* * will operate with slight degradation at 142-150 MHz.	<b>DUTY CYCLE:</b> FM 50% @ 150W 33% @ 250W SSB 60% @ 150W 50% @ 250W

Model 2002 \$479.00

can be ordered for repeater application for additional information contact

## TPL COMMUNICATIONS INC.

1324 W. 135TH ST., GARDENA, CA 90247 (213) 538-9814

Canada: Lenbrook Industries, Ltd., 1145 Bellamy Rd., Scarborough, Ontario M1H 1H5  
Export: EMEC Inc., 2350 South 30th Avenue, Hallandale, Florida 33009

WHERE THE HAM IS KING



SERVICE FOR OVER 30 YEARS

## DEALERS WANTED

Hamtronics, Inc. is a stocking distributor for all major lines of Radio Communications Equipment, parts and accessories.

If you are presently in the electronics sales and service business, and have experienced difficulty in maintaining proper inventory to serve your customers or if you are contemplating going into your own business, we may be able to solve your problem with our large inventory.

For more information fill in coupon below and mail today with your letterhead or Tax Exempt Number.

A DIVISION OF TREVOSE ELECTRONICS

# HAMTRONICS, INC.

4033 BROWNSVILLE ROAD, TREVOSE, PA. 19047

Business Name \_\_\_\_\_  
 Street \_\_\_\_\_  
 City, State \_\_\_\_\_ Zip \_\_\_\_\_  
 Telephone No. \_\_\_\_\_  
 Tax Exempt No. \_\_\_\_\_  
 Name, Title \_\_\_\_\_

# GUNNPLEXER™ TRANSCEIVER

"FRONT END" BY  
MICROWAVE ASSOCIATES

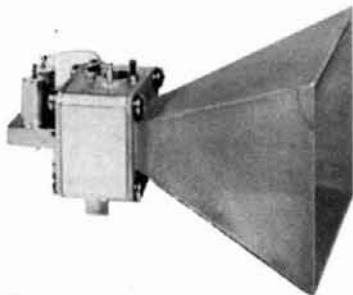

## Features

- Low Cost • High Sensitivity
- Integrated Assembly • Electronically Tunable • High Reliability
- Low Operating Voltage

## THE GUNNPLEXER SYSTEM

The fascination of amateur microwave is unique. Microwave systems have an 'exotic' ring to them. Until the appearance of the Gunnplexer, getting into microwaves required either a six foot rack of surplus gear or a friend on the inside of a microwave hardware supply company. The Gunnplexer has changed all of that; now you don't need any friends in the microwave business (in fact it may be better if you don't have any prior microwave knowledge because the Gunnplexer pretty much throws away the book on standard microwave design practices!)

Equally fascinating is the wide band capability of the microwave region. The 10 GHz assignment has spectrum-space for 111 simultaneous video (4.5 MHz wide) channels. Try that even using SSTV in the 20 meter assignment.

The bottom line on microwaves is simply that it will do much more communicating than you might first suspect.

## TWO-WAY COMMUNICATIONS

The primary application of the Gunnplexer "front end" is for 2-way communications. Two units, one a transmitter and the other a receiver down converter, are used with their carrier frequencies off-set to provide a reasonable IF (30 MHz or higher). Applications range from linking remote receivers to VHF repeaters, transmitting color video, linking homemade computers, full duplex mountain top DXing or over water duct DXing. A separate power supply and simple FM modulator must be provided; the MA-86551 (17 dB) horn antenna (shown here) is suggested.

## WHY A GUNNPLEXER?

Amateur microwave communication is fascinating and challenging. Now with the revolutionary MICROWAVE ASSOCIATES Gunnplexer front end this exotic form of communications is available to virtually anyone. And at an unbelievably low cost!

MA-87141-1 2 Complete Gunnplexer transceivers (MA-87127-1, 15mW typical and 2 horn antennas MA-86551, 17dB) just \$199.95 plus \$2.00 shipping and handling.

Rush Your Order by Calling (603) 673-7724. Or send for our FREE Detailed Information Package.

VISA and Master Charge Orders Welcomed

G.R. WHITEHOUSE & CO.  
10 Newbury Drive, Amherst, N. H. 03031

Exclusive distributor for MICROWAVE ASSOCIATES products in the U.S and Canada.

# PUNCH UP



Your

## Most Called Numbers with a Single Key Punch!

Now you can dial up to 18 complete 7 or 8-digit phone numbers by punching only one (or two) keys on your pad. The AD-1 Auto Dialer's 10 number capacity RAM can be completely programmed from its own pad in less than a minute. The optional field-installable factory-programmed PROM adds 8 more numbers for \$4.95. The AD-1 is ideal for mobile autopatches, home or business use. It features a unique MOS microprocessor which permits both tone duration and spacing to be programmed along with the numbers, adding versatility for repeater or similar control functions. Its crystal controlled tone generator assures high stability over a wide temperature range. The AD-1 is fully automatic and foolproof in operation. Coil cord provides convenient connection to your rig. Suggested Amateur net price \$129.95. A PROM order card is packed with each AD-1.

The AD-1 Auto Dialer is available at the finest amateur radio dealers and distributors everywhere.



Advanced Electronic Applications, Inc. P.O. Box 2160, Lynnwood, Washington 98036

## \* ATTENTION KENWOOD & YAESU OWNERS!!! \*

### the W6TOG\*

## RECEIVER MODIFICATION KIT

- |                                      |                      |         |
|--------------------------------------|----------------------|---------|
| • INCREASES SELECTIVITY              | TS-520 KIT .....     | \$27.50 |
| • IMPROVES SENSITIVITY               | TS-520S KIT .....    | 32.50   |
| • LOWERS INTERNAL NOISE              | TS-820 & 820S KIT .. | 34.50   |
| • COMBATS BLOCKING FROM LOCAL SIGNAL | FT-101 SERIES KIT .. | 32.50   |
| • IMPROVES NOISE BLANKER OPERATION   | FR-101 SERIES KIT .. | 34.50   |

EXPLICIT INSTRUCTIONS MAKE MODIFICATION A CINCH

\* WELL KNOWN DXer WITH OVER 300 COUNTRIES CONFIRMED.

Order from

**S-F AMATEUR RADIO SERVICES**

4384 KEYSTONE AVE., CULVER CITY, CA. 90230

(213) 837-4870

## IT'S MAGIC—IT'S "MAGICOM" PROCESSOR MODIFICATION KIT

IMPROVES AUDIO PUNCH • IMPROVES PROCESSED SPEECH QUALITY

Converts TS-820 speech processor from RF compressor to RF clipper

The "MAGICOM" RF processor module provides up to 6db increase in output with smooth, clean, non-distorted audio and more penetration for those pile-ups. Price \$27.50

ENDORSED BY W6TOG AND BIG GUN DXers WORLD WIDE

SATISFACTION GUARANTEED OR MONEY REFUNDED

All prices postpaid - in Calif. add 6% sales tax - Mastercharge & Visa accepted

# Full Features and Superior Performance

## ST-6000 RTTY DEMODULATOR

Select Rx & Tx Shifts  
 Accurately Tuned Rx Filters  
 Crystal Controlled Tx Tones  
 True Transceive Operation

Invert Both Rx Demod,  
 and Tx Tones

Data Status Indicators  
 Loop 1 Post-Autostart Pre-Autostart

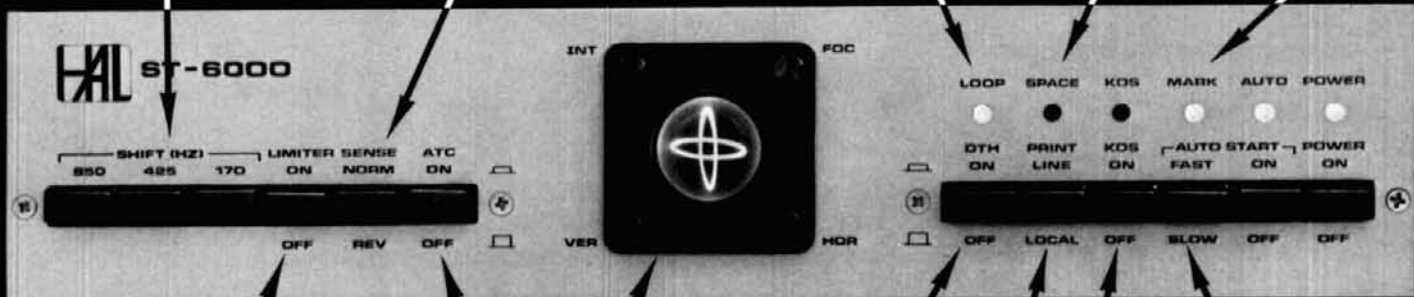

Hard-Limiting [FM]  
 or  
 Non-Limiting [AM]  
 Reception

Correct for  
 Bias Distortion

Correct For  
 Multi-Path Distortion

Local Loop Operation

Autostart with:  
 ◦ Motor Control  
 ◦ Mark Hold  
 ◦ Antispace

Tuning Oscilloscope  
 [Front Panel Controls]  
 Meter Indicator Option  
 Also Available

Automatic Tx/Rx Station  
 Control with Keyboard  
 Operated Switch [KOS]

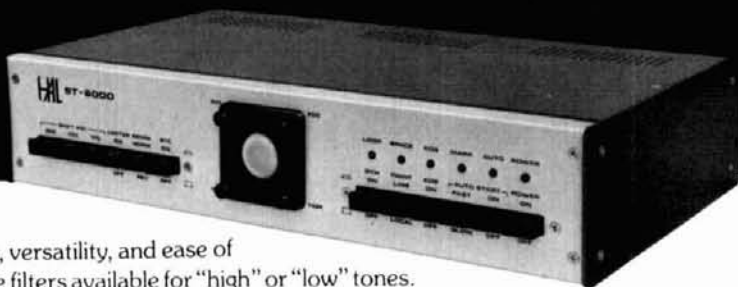

Why not have the best?

The HAL ST-6000 Demodulator offers outstanding performance, versatility, and ease of operation. The Receive Demodulator features multiple-pole active filters available for "high" or "low" tones. These filters are frequency-matched to the transmit tone crystals for true transceive operation. Input bandpass filters, discriminator filters, and post-detection filters are carefully designed and tested for optimum weak-signal recovery. The ST-6000 has an internal loop power supply, 2 loop keyers, RS-232, MIL-188C, and CMOS data I/O, and rear panel connections to data and control circuits for connection to UART and computer devices. Use it with the HAL DS-3000 KSR for the best in RTTY performance.

**\$595.00**

Write today for HAL's latest RTTY catalog.



**HAL COMMUNICATIONS CORP.**  
 Box 365  
 Urbana, Illinois 61801  
 217-367-7373



For our Overseas customers:  
 see HAL equipment at:  
 Richter & Co.; Hannover  
 I.E.C. Interrelco; Bissone  
 Vicom Imports; Auburn, Vic., Australia

# the weekender



## 1-GHz prescaler for frequency counters

Amateurs fall into many categories — operators, experimenters, contesters, and so on. In addition, they may be full- or part-time mobile radio service or television technicians. These technicians, as well as the experimenters, often find themselves unable to measure frequencies in the low uhf region, especially between 500 and 1300 MHz.

While the 1-GHz prescaler described in this article will not quite reach 1300 MHz, it can be of considerable use in the range just above the limits of many of the inexpensive frequency prescalers available commercially. Although the Fairchild 11C05 used in this prescaler is guaranteed only to 1000 MHz, two that I have used have functioned well above 1200 MHz but couldn't make it to 1300.

In addition to possible application in the new 900-MHz mobile band, the prescaler may help you if you have to repair your TV set. The FCC's requirement for positive-detent tuning of the uhf TV channels has resulted in a proliferation of exotic front-end circuits. The use of digitally tuned oscillators and frequency synthesizers no longer permits us to check oscillator output by means of an electronic voltmeter. This will indicate only that the circuit is oscillating — but at what frequency? One of the solutions to this problem is this 1-GHz frequency prescaler, which can be used with virtually any counter and costs but a fraction of the price of a complete counter capable of operating at that frequency.

The prescaler will accept a signal between 25 and 1000 MHz, probably as high as 1200 MHz, and scale (divide) its frequency by either 10 or 100, depending on the position of a front-panel SCALE switch. Thus the frequency to be measured can be converted to one within the range of the counter which is connected to the prescaler. The accuracy of the meas-

urement remains a function of the counter's accuracy multiplied by the scale factor.

If the prescaler is used with a 30-MHz counter, for example, frequencies between 30 and 300 MHz can be read on the counter by scaling by 10, which will result in read-outs between 3 and 30 MHz. Frequencies above 300 MHz can be scaled by 100, so that a 1-GHz signal can be read as 10 MHz on the counter. Obviously, it is necessary to multiply the counter reading by the scale factor to determine the input frequency, but multiplying by 10 or 100 should not tax anyone's mathematical prowess.

### circuit operation

A block diagram of the prescaler is shown in fig. 1, and the overall schematic appears in fig. 2. U1 is an Amperex ATF417 broadband hybrid amplifier designed to operate from 40 to 860 MHz, and is usable from below 25 MHz to over 1200 MHz. Because the amplifier has a nominal input impedance of 75 ohms, a minimum-loss pad consisting of resistors R1 and R2 is incorporated to convert the prescaler input to 50 ohms. R2 also affords overload protection in conjunction with hot-carrier diodes CR1 and CR2. As shown in fig. 3, the input vswr (referenced to 50 ohms) is less than 1.5:1 below 1 GHz, and is less than 2:1 at 1.2 GHz. The sensitivity of the overall prescaler also appears in fig. 3.

The amplified signal is applied to U2, a Fairchild 11C05\* divide-by-four circuit. The output of U2 feeds U3, a Fairchild 95H91 divide-by-five/six which is

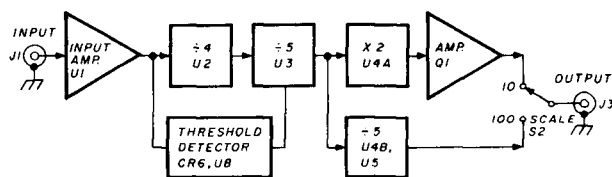

fig. 1. Block diagram of the 1-GHz prescaler.

arranged to divide by five. Thus, the input frequency has been divided by twenty at the output of U3. To scale by 100, the frequency is again divided by five, this time in the quinary section of U5, a 10138 bi-quinary counter whose output is connected to the 100 position of SCALE switch S2. Gate U4B buffers the output of U3 from the loading effect of U5.

Since the input frequency has been divided by twenty in U2 and U3, it is necessary to multiply it by

By Robert S. Stein, W6NBI, 1849 Middleton Avenue, Los Altos, California 94022

\*The Plessey SP8610 is a recently announced pin-for-pin replacement for the Fairchild 11C05.

two to obtain a scale factor of 10. This is accomplished in U4A, one section of a 10113 quad exclusive-OR gate. Frequency doubling is achieved by taking advantage of the finite rise and fall transition times of

the complementary outputs of U3, as well as the slight difference in the propagation delays from input to each output. Because an exclusive-OR gate produces an output only when one, but not both, of

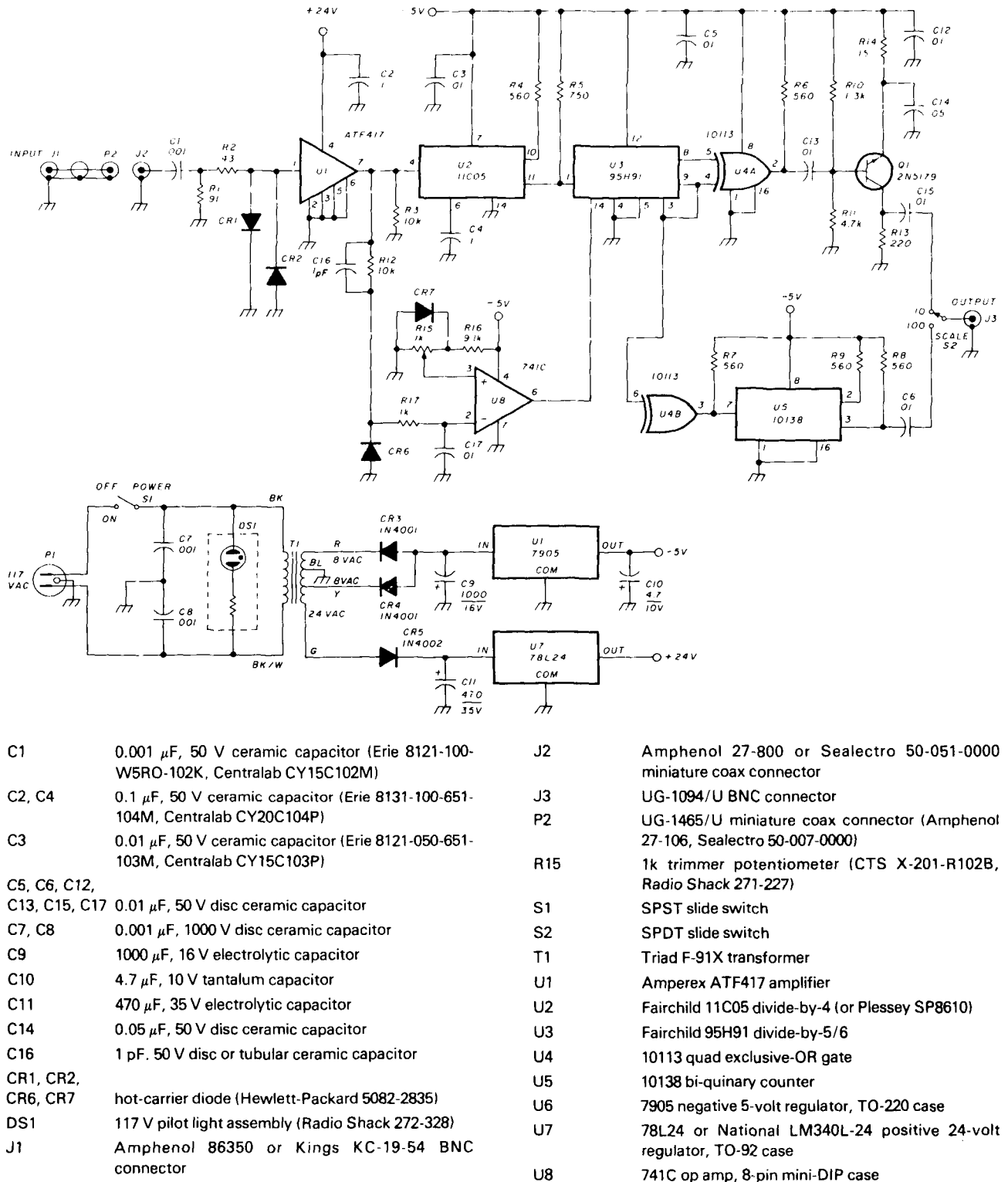

- |                            |  |     |   |
|----------------------------|--|-----|---|
| C1                         | 0.001 $\mu$ F, 50 V ceramic capacitor (Erie 8121-100-W5RO-102K, Centralab CY15C102M) | J2  | Amphenol 27-800 or Sealectro 50-051-0000 miniature coax connector           |
| C2, C4                     | 0.1 $\mu$ F, 50 V ceramic capacitor (Erie 8131-100-651-104M, Centralab CY20C104P)    | J3  | UG-1094/U BNC connector   |
| C3                         | 0.01 $\mu$ F, 50 V ceramic capacitor (Erie 8121-050-651-103M, Centralab CY15C103P)   | P2  | UG-1465/U miniature coax connector (Amphenol 27-106, Sealectro 50-007-0000) |
| C5, C6, C12, C13, C15, C17 | 0.01 $\mu$ F, 50 V disc ceramic capacitor  | R15 | 1k trimmer potentiometer (CTS X-201-R102B, Radio Shack 271-227)             |
| C7, C8                     | 0.001 $\mu$ F, 1000 V disc ceramic capacitor   | S1  | SPST slide switch   |
| C9                         | 1000 $\mu$ F, 16 V electrolytic capacitor  | S2  | SPDT slide switch   |
| C10                        | 4.7 $\mu$ F, 10 V tantalum capacitor   | T1  | Triad F-91X transformer   |
| C11                        | 470 $\mu$ F, 35 V electrolytic capacitor   | U1  | Amperex ATF417 amplifier  |
| C14                        | 0.05 $\mu$ F, 50 V disc ceramic capacitor  | U2  | Fairchild 11C05 divide-by-4 (or Plessey SP8610)                             |
| C16                        | 1 pF, 50 V disc or tubular ceramic capacitor   | U3  | Fairchild 95H91 divide-by-5/6   |
| CR1, CR2, CR6, CR7         | hot-carrier diode (Hewlett-Packard 5082-2835)  | U4  | 10113 quad exclusive-OR gate  |
| DS1                        | 117 V pilot light assembly (Radio Shack 272-328)                                     | U5  | 10138 bi-quinary counter  |
| J1                         | Amphenol 86350 or Kings KC-19-54 BNC connector                                       | U6  | 7905 negative 5-volt regulator, TO-220 case                                 |
|                            |  | U7  | 78L24 or National LM340L-24 positive 24-volt regulator, TO-92 case          |
|                            |  | U8  | 741C op amp, 8-pin mini-DIP case  |

fig. 2. Prescaler schematic diagram. All fixed resistors are 1/4 watt, 5% composition or carbon film.

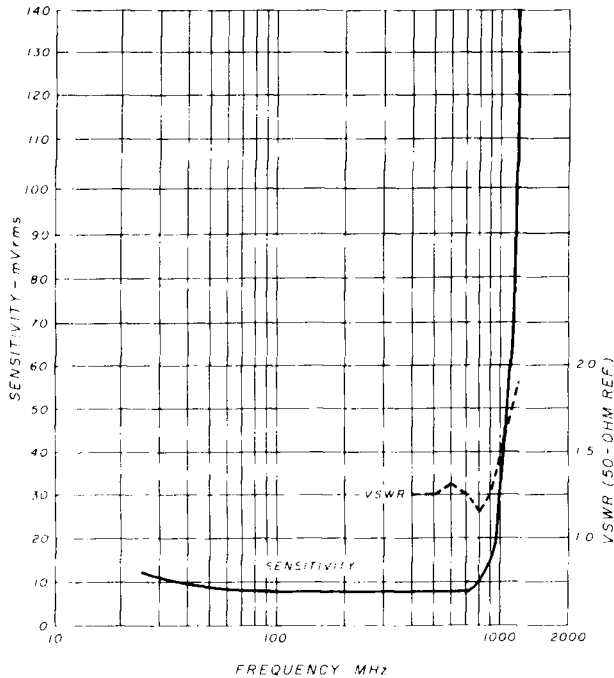

fig. 3. Prescaler sensitivity and vswr, plotted against frequency. Test equipment limitations precluded vswr measurements below 400 MHz.

its inputs is high, there is a very short period of time during the input transitions when *both* inputs are high or low, resulting in the output of the gate going low for this brief time. This is shown in **fig. 4**, as is the fact that two output pulses are generated for each cycle of the input frequency.

The extremely short time period during which the output pulses are developed prevents them from reaching full ECL-output level. Therefore, they are amplified by Q1 to a peak voltage level of at least 300 millivolts before being routed to the 10 position of switch S2. When S2 is set to the 10 position, the 25- to 1000-MHz input range is scaled to 2.5 to 100 MHz. When S2 is set to 100, the same input frequency range is scaled to 0.25 to 10 MHz.

As with all logic devices, U2 has a minimum input level below which it will not clock. However, at frequencies below 50 MHz, it may also divide by two or three just below this critical input voltage. To prevent this from appearing as a false reading on the counter, a threshold detector comprising CR6 and U8 is incorporated, which inhibits the output of U3 whenever the input voltage to the prescaler is below a predetermined level.

The output of amplifier U1 is sampled and rectified by diode CR6. The resultant dc is filtered and applied to the inverting input of U8, a 741C op amp configured as a dc comparator. The non-inverting input is connected to a voltage divider (R15 and R16)

across the negative 5-volt supply; R15 establishes the reference voltage for the comparator. If the prescaler input level is insufficient for proper operation of U2, the voltage applied to the inverting input of U8 will be less than the reference voltage at the non-inverting input. This will cause the output of the op amp to go high, activating the master reset (pin 14) of U3 and inhibiting its output. As soon as the input signal reaches the required threshold, the op amp input conditions reverse, and the resultant low output enables U3.

### construction

Except for power transformer T1, the primary power circuit, the INPUT and OUTPUT connectors, and the SCALE selection switch, the entire prescaler is built on a printed-circuit board measuring 8.9 x 7.9 cm (3-1/2 x 3-1/8 inches).\* The board is two-sided; one side contains the printed-wiring traces, while the opposite side, on which the various components are mounted, provides a ground plane. I chose to mount the board vertically, parallel to the front of the cabinet, with the component side of the board facing the front. Two small right-angle brackets were used for mounting feet, as shown in the parts layout, **fig. 5**.

The first step in assembling the board is to mount connector J2. A complete bead of solder must be made to the ground plane around the entire periphery of the connector. Next, capacitor C1 must be soldered between the center pin of J2 and the adjacent trace, as shown in **fig. 6**. This arrangement is necessary to keep the lead inductance of C1 to an absolute minimum. The capacitor leads must be carefully bent and trimmed as shown. Then the shorter lead is soldered to the trace so that none of the wire is visible, and the longer lead is wrapped around the center pin of J2 and similarly covered with solder.

To keep the cost of the printed-circuit board

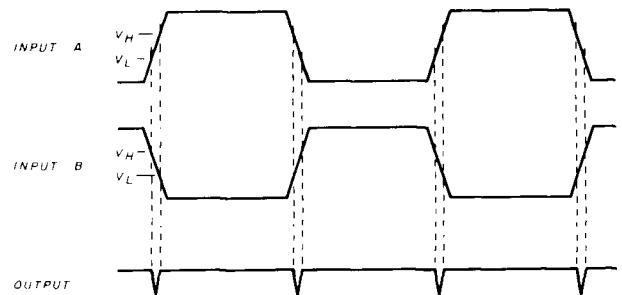

fig. 4. Waveforms showing operation of the exclusive-OR frequency doubler.

\*If there is sufficient interest, the author will supply PC boards at nominal cost. Please enclose a SASE with all inquiries.



down, plated-through holes were not used. Instead, ground connectors are made by soldering the applicable component leads directly to the ground plane.

Before installing regulator U6 on the board, attach a TO-220 type heatsink to the tab of the regulator. Use a thin layer of silicone heat-transfer compound between the heatsink and the tab. The heatsink must not be grounded to the board, since the tab is internally connected to the input terminal of the device.

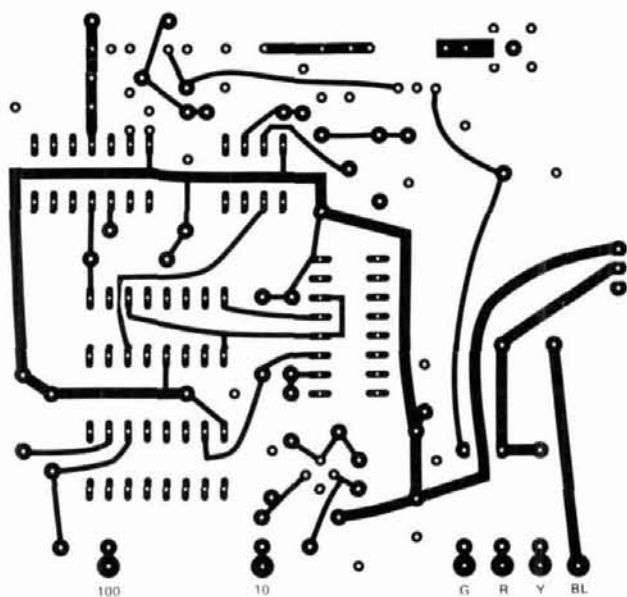

fig. 5. PC board component layout and wiring to transformer and output circuit.

Be sure that the polarities of the electrolytic capacitors and diodes are correct, and that none of the integrated circuits are reversed. After completing the board assembly, examine it carefully for solder bridges between traces or for any other foreign matter that might cause a short circuit.

Next, fabricate the input cable assembly which runs between the board and the front panel. Using a 7.6-cm (3-inch) length of RG-174/U coaxial cable, terminate one end with INPUT connector J1 and the other end with connector P2. Instructions for assembling the connectors to the cable appear in figs. 7 and 8.

A recommended arrangement of the overall prescaler is shown in fig. 9. OUTPUT connector J3, POWER switch S1, SCALE switch S2, pilot light DS1, and the input cable assembly (terminated by INPUT connector J1) are mounted on the front panel. Transformer T1 is mounted directly behind the printed-circuit board, and capacitors C7 and C8 are wired to a terminal strip located near the transformer.

Before mounting the circuit board in the cabinet, solder a short length of insulated wire to each of the output pads, designated 10 and 100, on the board. Then solder the secondary leads from transformer T1 to the pads marked G, R, Y, and BL on the board, matching the wire colors to the appropriate pad. Mount the board in the cabinet and connect the wires from the output pads to the corresponding terminals of SCALE switch S2. Finally, connect the input cable assembly between the front panel and J2 on the board.

### operating considerations

It would appear obvious that after the prescaler has been wired and checked, all that remains is to connect it to the counter and plug it in. Maybe — and maybe not! Unfortunately *no* prescaler is all things to all counters. This one produces outputs of two types: the scaled-by-10 output is a train of very short, fast positive pulses having a peak-to-peak amplitude of 300 to 400 millivolts; the scaled-by-100 output is a square wave of approximately 800 millivolts peak-to-peak amplitude. Both are supplied from low-impedance sources.

Without going into a detailed explanation of transient response and reflections from improperly terminated transmission lines, it can be stated that what appears at the counter end of a coaxial cable connected to the prescaler output depends on the characteristic impedance of the cable, the length of the cable, the input impedance of the counter, and the frequency and waveform of the prescaler output signal. Since only the last of these factors is established (and varies over the prescaler's range), there may be considerable differences as to how the pre-

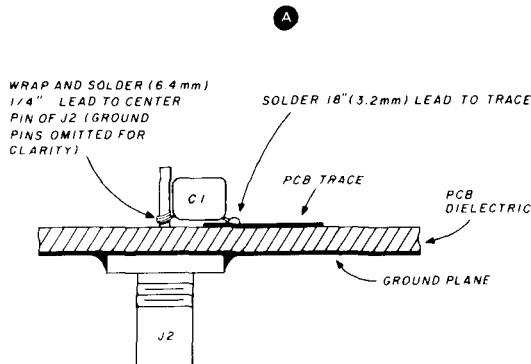
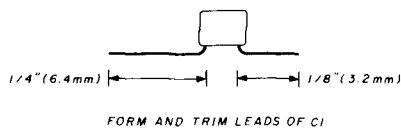

fig. 6. Method of installing capacitor C1 on PC board.

scaler will perform in conjunction with different counters and different cable lengths.

Now for the good news. Although you cannot tell how the prescaler will perform with your counter until you try it, there is a simple remedy if it does not appear to work properly. And that is merely to terminate the connecting cable in its characteristic impedance. Assuming that the connecting cable is 50-ohm coax (RG-58/U or equivalent), you need only to terminate it with a 50-ohm load at the *counter* end. If the counter already has a 50-ohm input impedance, the cable will automatically be properly terminated. However, most low- and medium-frequency counters have a high input impedance. Therefore an external termination may be required.

The simplest way of terminating the cable is to use a 50-ohm feedthrough termination, such as the Heath SU-511-50, Tektronix 011-0049-01, Hewlett-Packard 10100C, or Systron-Donner 454. An alternate method is to use a tee-connector at the counter input, with the connecting cable on one side of the tee and a 50-ohm termination on the other side. Or if you are ingenious, you can fabricate a cable with a 51-ohm composition resistor shunted across the counter end.

Another factor which enters into the picture is the characteristic behavior of the counter's input signal processor. All counters must convert the input signal to an appropriate logic level over the specified frequency range of the counter. Of the infinite variety of signals that can be applied to a counter, a symmetrical waveform is the easiest to process. Thus, your counter may exceed its specified maximum frequency when measuring the sine-wave output from a signal generator, but may not perform as well when

counting an asymmetrical pulse train. Therefore, even if the counter's frequency range appears to be better than the published specifications, do not expect it to be so on the scaled-by-10 output from the prescaler.

As an example, on two different 80-MHz counters (one home-built, the other a Hewlett-Packard Model 5381A), the upper frequency limit when checked using a signal generator was well over 120 MHz for each. However, the maximum scaled-by-10 count from the prescaler which could be measured was between 80 and 90 MHz, corresponding to a prescaler input between 800 and 900 MHz. Of course, switching to the scaled-by-100 output permitted measurements to the limit of the prescaler. On the other hand, a counter *specified* to perform at 120 MHz should permit use of the scaled-by-10 output over the entire frequency range of the prescaler, as did a 500-MHz counter used to verify the prescaler output.

### threshold-level adjustment

Before initially operating the prescaler, fully rotate the thumbwheel of potentiometer R15 toward the top of the board. This effectively disables the thresh-

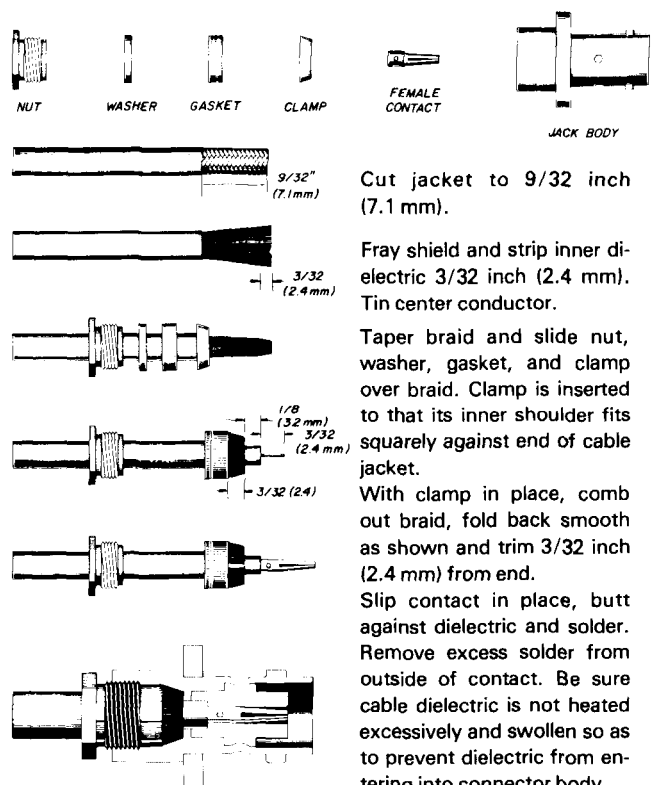

Push assembly into body as far as it will go. Slide nut into body and screw in place with wrench until tight. For this operation, hold cable and shell rigid and rotate nut.

fig. 7. Assembling connector J1 to input cable (courtesy Amphenol).

old detector and will permit a check of the prescaler in conjunction with the counter. Apply signals of known frequencies to the prescaler INPUT connector (noting the approximate minimum levels required, as shown in fig. 3) and check the counter readings in both the 10 and 100 positions of the SCALE switch. **Caution:** Although U1 will withstand a 10-volt peak-to-peak input without damage, it is recommended that inputs to the prescaler be limited to 1 volt peak-to-peak (approximately 350 millivolts rms, or 2.5 milliwatts across 50 ohms) to prevent clipping by diodes CR1 and CR2.

To adjust the threshold level, apply a 25- to 30-MHz input to the prescaler using a signal generator or any other signal source whose output level can be controlled. Feed enough signal to the prescaler to obtain a properly scaled reading on the counter, then slowly reduce the signal level until that reading is lost; as the signal level is reduced, readings of two, three, or four times the correct scaled reading will appear. Bring the input-signal level back up to the point where the last false reading is obtained, just before the correct reading appears, and adjust potentiometer R15 carefully to make the counter

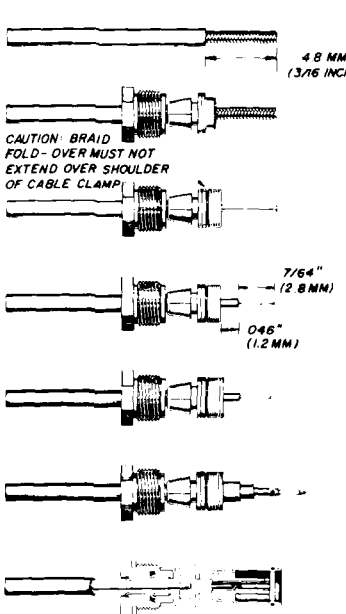

Cut end of cable even. Trim jacket to 3/16 inch (4.8 mm). Be careful not to nick braid. Slide nut over jacket. Place cable clamp assembly over braid and push back against cable jacket as shown. Comb out braid and fold evenly over cable clamp assembly and trim braid wires as shown, avoiding bunching. Cut cable dielectric to .046 inch (1.2 mm). Cut must be sharp and square. Do not nick center conductor. Dimension of bared center conductor should be as shown; trim if necessary. Tin center conductor and remove excess solder. Place washer over core. Slide rear insulator or insulator washer over center conductor.

Make sure rear insulator or insulator washer butts flush against washer and cable core. Solder contact to center conductor — contact must butt against rear insulator as shown. Do not get any solder on outside surfaces of contact. Insert prepared cable termination into connector body. Secure by wrench-tightening body while holding nut stationary.

fig. 8. Assembling connector P2 to input cable (courtesy Amphenol).

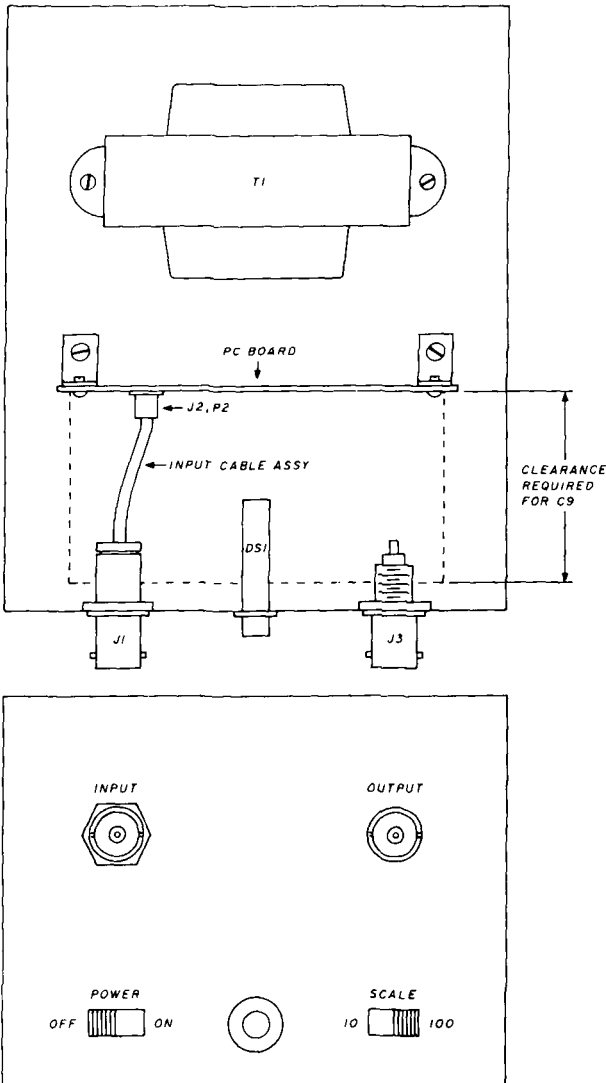

fig. 9. Suggested layout for complete prescaler. Wiring to and from the PC board is shown in fig. 5.

read zero. Then increase the signal level slightly to be certain that a true reading can be obtained. This is a critical adjustment, in that it establishes the sensitivity of the prescaler from 25 to 900 MHz. If the potentiometer is set past the position which just eliminates the false counts, the prescaler sensitivity will be reduced.

If you have no need to use the prescaler below 50 MHz or so, the overall sensitivity of the prescaler can be improved below 900 MHz by simply keeping the arm of R15 rotated fully toward the top of the board, thereby disabling the threshold detector. For those who desire maximum sensitivity above 900 MHz, a slight improvement will result from omitting C16 and R12 (in which case all other parts associated with U8 can also be eliminated).

ham radio

# Clegg is



## VHF Head- quarters

### AND HAS BEEN FOR MORE THAN 25 YEARS!

Regardless of your VHF interest — FM/CW/AM/SSB — Clegg has what you need. The Clegg FM transceivers are judged tops by experienced FM'ers. After 3 years nothing has come along to match the FM-DX. And nothing represents the values of the FM-28, MARK 3 or FM-76.

We also stock all of the high quality MUTLI-MODE VHF Transceivers. Like the ICOM 211 and 245. Like the new YAESU FT-225RD. Or choose between the WILSON HT's or ICOM PORTABLES. We have them both with thousands of crystals.

Planning a 220 Repeater? We have a complete low cost system. Need a new antenna? We stock KLM, WILSON, HUSTLER, MOSLEY, ASP and others.

Whatever your needs for VHF (or HF & UHF) call Clegg Toll Free. ASK FOR OUR LATEST CATALOG!

TOLL FREE  
1-(800)-233-0250  
In PA call COLLECT  
(717) 299-7221

**Clegg** Communications Corp.  
1911 Old Homestead Lane  
Greenfield Industrial Park East  
Lancaster, PA 17601

# NEW

## 1800 Hz 8 pole xtal FILTER

YAESU AND KENWOOD FT-101,  
FR-101, FT-301, TS-820, TS-520, R-599



For any rig listed

# \$50

AIRMAIL  
Postpaid  
USA & Canada  
Overseas add \$3.

### SSB OPS! Win the Battle against QRM!

Since all CW Filters are optional, why not get the best? This new sharp filter is ideal for DX and Contest work; yet not too narrow for regular operation. Superior to audio filters, yet works well with them to improve Receiver performance even more, if desired.

Mounts easily on circuit boards predrilled for the purpose by manufacturer of your rig. See your

Manual for installation instructions. A built-in component; not a hang-on. No alignment required. Satisfaction Guaranteed! Tested and Recommended by International Fox Tango Club.

**Special for FT-101 Series only:** Miniature diode-switching board permitting use of BOTH the standard 600 Hz and the new 250 Hz filters, switch-selectable. With complete instructions. DSB-1 \$10 Allow up to three weeks for delivery.

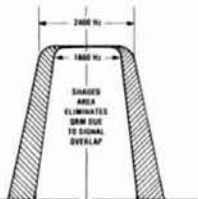

### DIODE SWITCHING BOARDS permit easy mounting

(without drilling) of up to two crystal filters of any type in addition to those for which the manufacturer provides space. These boards will accommodate any of the filters listed and other types planned for the future. To avoid error when ordering, specify filter number desired as well as rig with which it is to be used. Complete instructions. SPECIFY Set with which board is to be used. \$15 with purchase of any filter. \$20 without filter. Airmail Ppd. US & Canada. Overseas add \$1.

Rig	Filter No. YF	Used for	Center Freq. kHz.	No. of Poles	Band Width	Notes
FT(FN)-101	31H250	CW	3179.3	8	250 Hz	Sharp unit for DX and contest work Use instead of standard 600 Hz unit Same as standard XF-30C unit, \$40 For narrow SSB Substitute for XF-30A(6 pole) in early units Same as standard XF-30B unit, \$40
	31H500	CW	3179.3	8	500 Hz	
	31F600	CW	3179.3	6	600 Hz	
	31H1.8	SSB	3180	8	1.8 kHz	
	31H2.4	SSB	3180	8	2.4 kHz	
	31F6.0	AM	3180	6	6.0 kHz	
FT-301	89H250	CW	8999.3	8	250 Hz	Sharp unit for DX and contest work Use instead of standard 600 Hz unit For narrow SSB Substitute for speech processor
	89H500	CW	8999.3	8	500 Hz	
	90H1.8	SSB	9000	8	1.8 kHz	
	90H2.4	SSB	9000	8	2.4 kHz	
TS-520 R-599	33H250	CW	3395	8	250 Hz	Sharp unit for DX and contest work Use instead of standard 500 Hz unit For narrow SSB
	33H400	CW	3395	8	400 Hz	
	33H1.8	SSB	3395	8	1.8 kHz	
TS-820	88H250	CW	8830.7	8	250 Hz	Sharp unit for DX and contest work Use instead of standard 500 Hz unit
	88H400	CW	8830.7	8	400 Hz	

YAESU SERIES

KENWOOD SERIES



### FOX-TANGO CORP.

Box 15944, W. Palm Beach, FL 33406

## Repeater Jammers Running You Ragged?

Here's a portable direction finder that REALLY works—on AM, FM, pulsed signals and random noise! Unique left-right DF allows you to take accurate (up to 2°) and fast bearings, even on short bursts. Its 3dB antenna gain and .06 μV typical DF sensitivity allow this crystal-controlled unit to hear and positively track a weak signal at very long ranges—while the built-in RF gain control with 120 dB range permits positive DF to within a few feet of the transmitter. It has no 180° ambiguity and the antenna can be rotated for horizontal polarization.



The DF is battery-powered, can be used with accessory antennas, and is 12/24V for use in vehicles or aircraft. It is available in the 140-150 MHz VHF band and/or 220-230 MHz UHF band. This DF has been successful in locating malicious interference sources, as well as hidden transmitters in "T-hunts", ELTs, and noise sources in RFI situations.

Price for the single band unit is \$170, for the VHF/UHF dual band unit is \$205, plus crystals. Write or call for information and free brochure.

L-TRONICS  
5546 Cathedral Oaks Road  
(Attention Ham Dept.)  
Santa Barbara, CA 93111

WD6ESW

W6GUX

# BE PREPARED FOR CYCLE 21 GET HY-GAIN'S NEW LONG-JOHNS "THE STACKABLES"

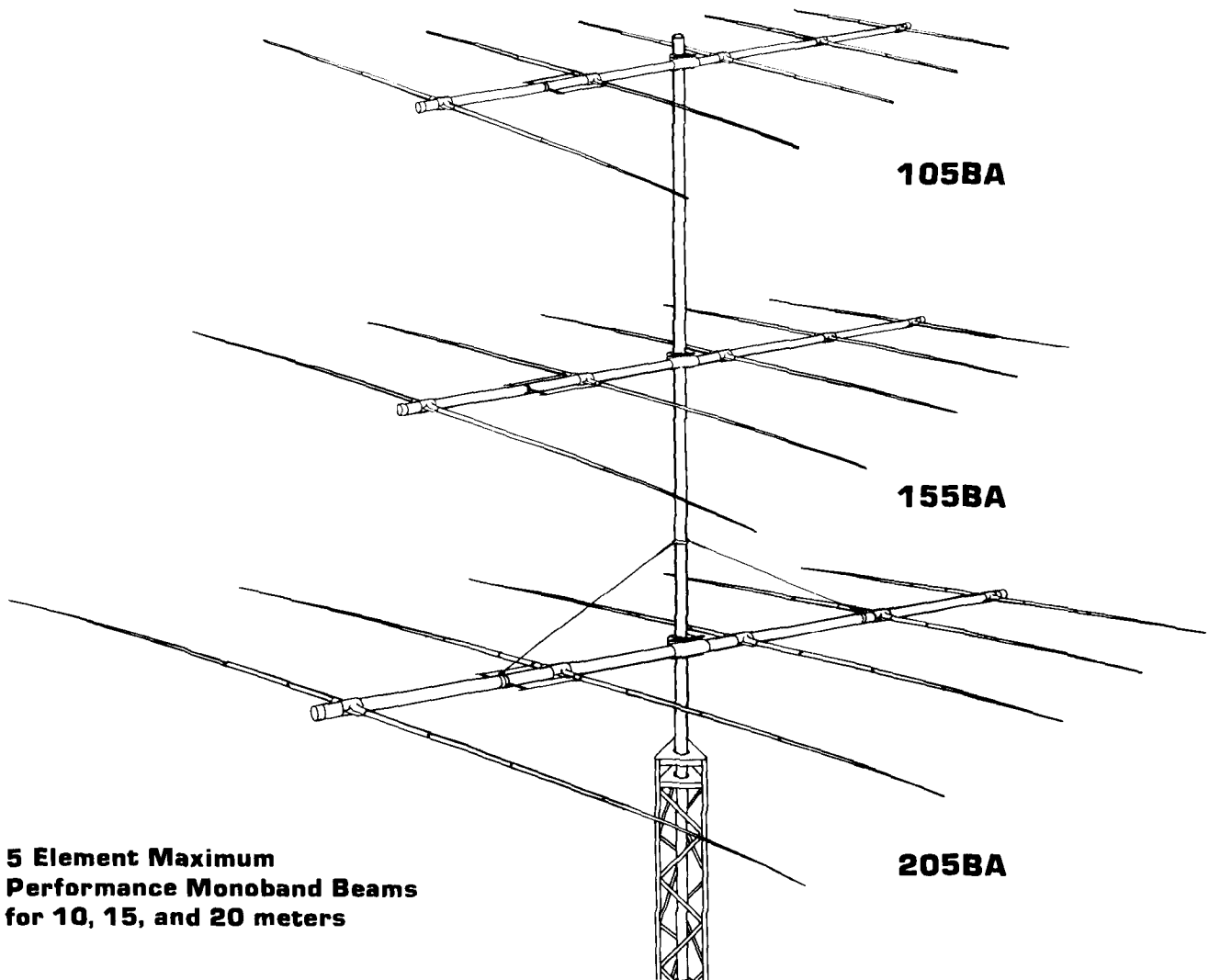

**5 Element Maximum  
Performance Monoband Beams  
for 10, 15, and 20 meters**

With sunspot cycle 21 now in the upswing, you should be prepared for the DX available on the 3 top HF bands, if not, our new "Long-Johns" are for you. The new 5 element "Long-John" monobanders are ideal for the serious DX'er. Each utilizes Hy-Gain's unique Beta-match for optimum power transfer. Also each antenna uses taper-swaged tubing for *minimum* wind load and *maximum* strength. For maximum durability each "Long-John" uses Hy-Gain's rugged boom-to-mast clamp.

## Specifications:

Order Number	377	376	375
Model Number	205BA	115BA	105BA
Gain	11.6 dB	12.0 dB	12.0 dB
Front-to-back ratio	20 dB minimum	20 dB minimum	20 dB minimum
SWR (at resonance)	Less than 1.5:1	Less than 1.5:1	Less than 1.5:1
Impedance	50 ohms	50 ohms	50 ohms
Power rating	Maximum Legal	Maximum Legal	Maximum Legal
2:1 VSWR Bandwidth	400 KHz	500 KHz	1.5 MHz
Longest Element	36 1/2"	24 1/2"	18 1/2'
Boom Length	34'	26'	24'
Boom Diameter	2"	2"	2"
Turning Radius	25'	17 1/2"	15'
Surface Area	9.0 sq. ft.	5.2 sq. ft.	3.9 sq. ft.
Wind Load at 80 mph	230 lbs.	133 lbs.	100 lbs.
Maximum Wind Survival	80 mph	100 mph	100 mph
Mast DIA Accepted	1 1/4" to 2 1/2"	1 1/4" to 2 1/2"	1 1/4" to 2 1/2"



**HY-GAIN ELECTRONICS**  
8601 Northeast Hwy 6  
Lincoln, Nebraska 68505  
(402) 467-5321 telex: 48-4324

# digital keyboard entry system

By sampling the signals  
from an inexpensive  
pocket calculator,  
you can build  
a complete  
data entry system

While working on a recent synthesizer project, it became apparent that the conventional methods used to enter the frequency control information, such as thumbwheel or rotary switches, are generally cumbersome. Keyboard entry has become popular with the widespread use of *Touch-Tone*\* phones and hand-held calculators — so, it seemed to be a natural choice for a new design. This same choice has been made by a few manufacturers of digitally controlled signal generators and vhf/uhf scanning receivers. The advantage of a keyboard entry device is that, while providing a means of frequency control (as in our case), other digital information can be entered. If plans for the system change, new functions can be

\**Touch-Tone* is a registered trademark of the American Telephone and Telegraph Company.

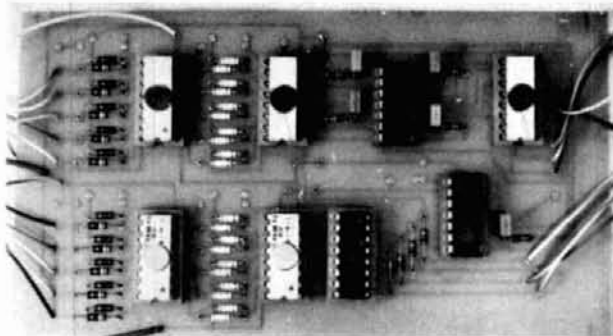

The complete data entry system, with the exception of the 74175 latches.

added by assigning a code to that particular function and inputting the code via the keyboard. In our keyboard-synthesizer system, we have incorporated the ability to step the frequency up or down by a fixed increment at the touch of a switch.

After giving the keyboard-system problem some thought, the solution became a standard four-function calculator with a programmable automatic constant capability. At this point it should be stressed that our application was a frequency synthesizer, but any system that requires digital information in binary coded decimal (BCD) format could use the ideas presented in this article.

## theory of operation

There are several problems when trying to build a keyboard encoder. First, the information from the

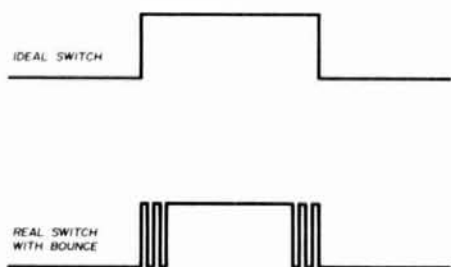

fig. 1. Waveforms generated by the ideal switch and a real switch which exhibits bounce.

keyboard is presented in 1-out-of-10 format; that is, you must encode the operation of 1-of-10 switches. Second, the keys will be presented in some sequence, and you must store the information as each new key is pressed. Finally, there is the problem of key bounce. As you actuate or de-actuate a key, the contacts of the switch bounce, giving a fairly noisy signal as illustrated in fig. 1.

A four-function calculator, of course, uses a key-

By **Bruce McNair, N2YK**, and **Glenn Williman, N2GW**. Mr. McNair's address is 12 Marion Avenue, Howell, New Jersey 07731; Mr. Williman's address is 145 Whalepond Road, Oakhurst, New Jersey 07755.

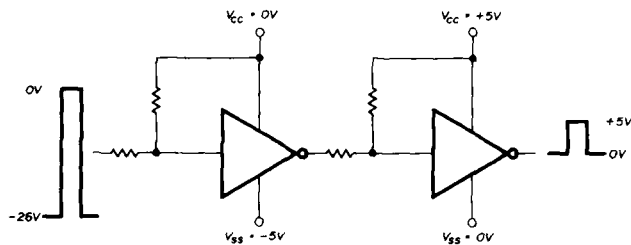

fig. 2. Level translators used to transform the signal voltages from the display to the standard TTL voltage levels.

board for information entry and has all the necessary circuitry to decode, remember the inputs, and debounce the keys. An added benefit of the calculator is the fact that it also displays the entered information. You can take advantage of this fact by using the calculator display as a display for the synthesizer or system you are controlling.

However, there are certain problems associated with the use of a calculator. The information that you need is only present at the calculator display terminals. The information is not BCD encoded, but has been encoded to drive seven-segment displays. Further, to save pins on the calculator chip, the information is multiplexed. Seven lines carry the segment information to all the digits while (in the case of the calculator we used) eight lines enable the correct digit at the proper time.

To use the data from the calculator there are three steps to go through:

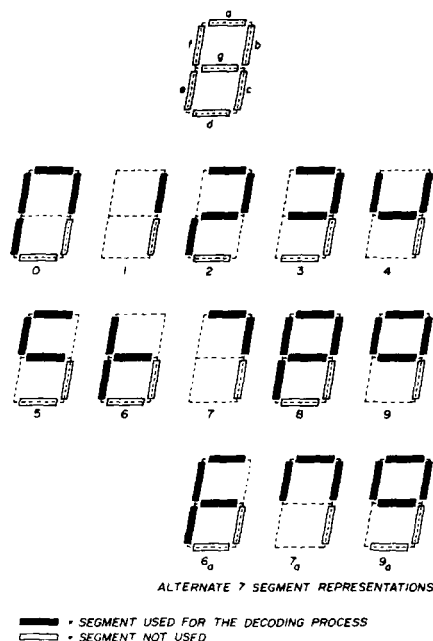

fig. 3. Segments used for the input to the 8223 PROM to convert between the 7-segment display information and the BCD code. As can be seen, segments c and d are not needed for code conversion. Each character is unique, regardless of whether c or d are present.

1. Shift the voltage levels of the display signals to that of the logic devices used in the decoder, and buffer these signals to prevent the calculator from being loaded down.
2. Decode the seven-segment information to BCD.
3. Demultiplex the BCD data and store the data.

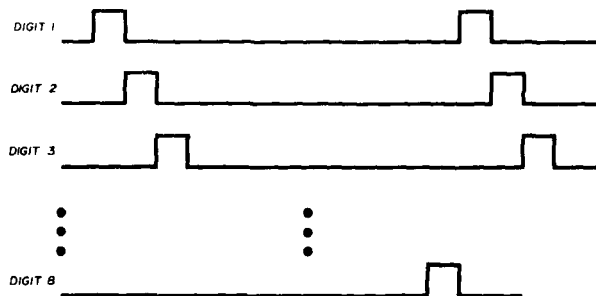

fig. 4. Timing diagram for the digit enable lines.

Each of these operations is accomplished as described in the following sections.

### level shifting and buffering

The calculator we chose to use was a TI 1265. This is a simple, four-function calculator with automatic constant, non-blanking display, and low cost (in the \$10 price range). Automatic constant is a convenient

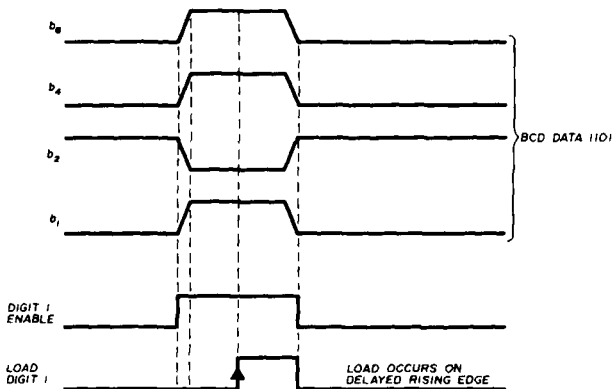

fig. 5. The latches will load the information on the leading edge of the respective digit's load pulse.

feature because by continually adding the fixed constant to the display, you can increment the synthesizer frequency by a constant amount. In 2-meter operation, for example, it would be best to store 0.015 as the fixed constant. Each time you press + the frequency goes up by 15 kHz, the channel spacing on 2 meters. To step down by a fixed amount, make the constant positive and the display negative (or vice versa), each time you press + you will be subtracting a fixed amount.

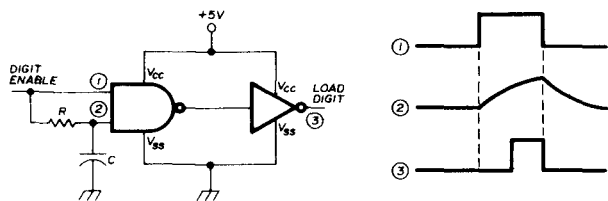
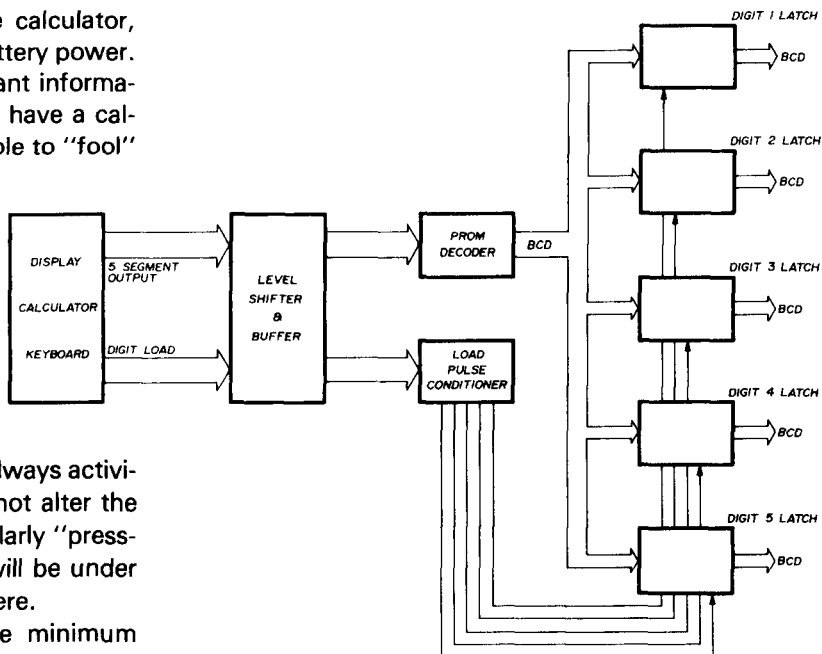

fig. 6. The time-constant formed by the R and C values provide a delay before the gate is enabled. This allows time for the data to settle.

A non-blanking display is an important feature to look for. Some of the calculators on the market will shut off the display, or even the entire calculator, after a period of inactivity to conserve battery power. Since the display conveys all the important information, this is unacceptable. If you already have a calculator with this feature, it may be possible to "fool"

fig. 8. Block diagram of the complete system for using a calculator keyboard as a data entry system.



the calculator into thinking that there is always activity. Find a key that when pressed does not alter the memory of the display. If this key is regularly "pressed" by an added circuit the calculator will be under the impression that the operator is still there.

Finally, some calculators display the minimum number of digits to accurately represent the stored information. For example, 25. may represent the sum of 21.58 and 3.42. To be usable for this system, the calculator must retain the same number of decimal places at all times. That is,  $21.58 + 3.42 = 25.00$ ; the two zeros after the decimal place remain.

table 1. Truth table for the outputs of the 8223 PROM.

number	prom address 7-segment code					prom outputs BCD output			
	a	b	e	f	g	b <sub>8</sub>	b <sub>4</sub>	b <sub>2</sub>	b <sub>1</sub>
0	1	1	1	1	0	0	0	0	0
1	0	1	0	0	0	0	0	0	1
2	1	1	1	0	1	0	0	1	0
3	1	1	0	0	1	0	0	1	1
4	0	1	0	1	1	0	1	0	0
5	1	0	0	1	1	0	1	0	1
6	0	0	1	1	1	0	1	1	0
7	1	1	0	0	0	0	1	1	1
8	1	1	1	1	1	1	0	0	0
9	1	1	0	1	1	1	0	0	1
6 <sub>a</sub>	1	0	1	1	1	0	1	1	0
7 <sub>a</sub>	1	1	0	1	0	0	1	1	1
9 <sub>a</sub>	1	1	0	1	1	1	0	0	1

Now, consider the type of display the calculator uses; two of the more popular are LED and fluorescent. Most of the LED displays consume a great deal of battery power and blank the display after some period of time. The TI 1265 has a fluorescent display and is not blanked. Other TI calculators that are worth considering are the TI 1200 (very similar to the TI 1265) and the TI 1000 (a low cost calculator that uses an LED display but meets most of the other requirements). Since we did use a calculator with a fluorescent display, this is the type of interface we will

describe. Interface with an LED-type display would actually be easier.

The display voltage levels in the TI 1265 are 0 and -26 volts. This nonstandard signal can be translated to CMOS/TTL levels of 0 and +5 volts with the circuit shown in fig. 2. CMOS 4049 inverters are used to minimize loading on the calculator outputs. The same circuit is used in each data line for seven-segment as well as digit information. All resulting signals will drive CMOS or a single TTL load.

### segment decoding

The information generated by the calculator chip is coded as a seven-segment signal to be directly used by the calculator display. To make use of this data, it is necessary to translate it to BCD. At first, it would appear that a complicated circuit with seven inputs and four outputs would be necessary. As it turns out, this will take four chips. Another possibility would be to use a special IC to perform the decoding (a 74C915). Unfortunately, these chips are not readily



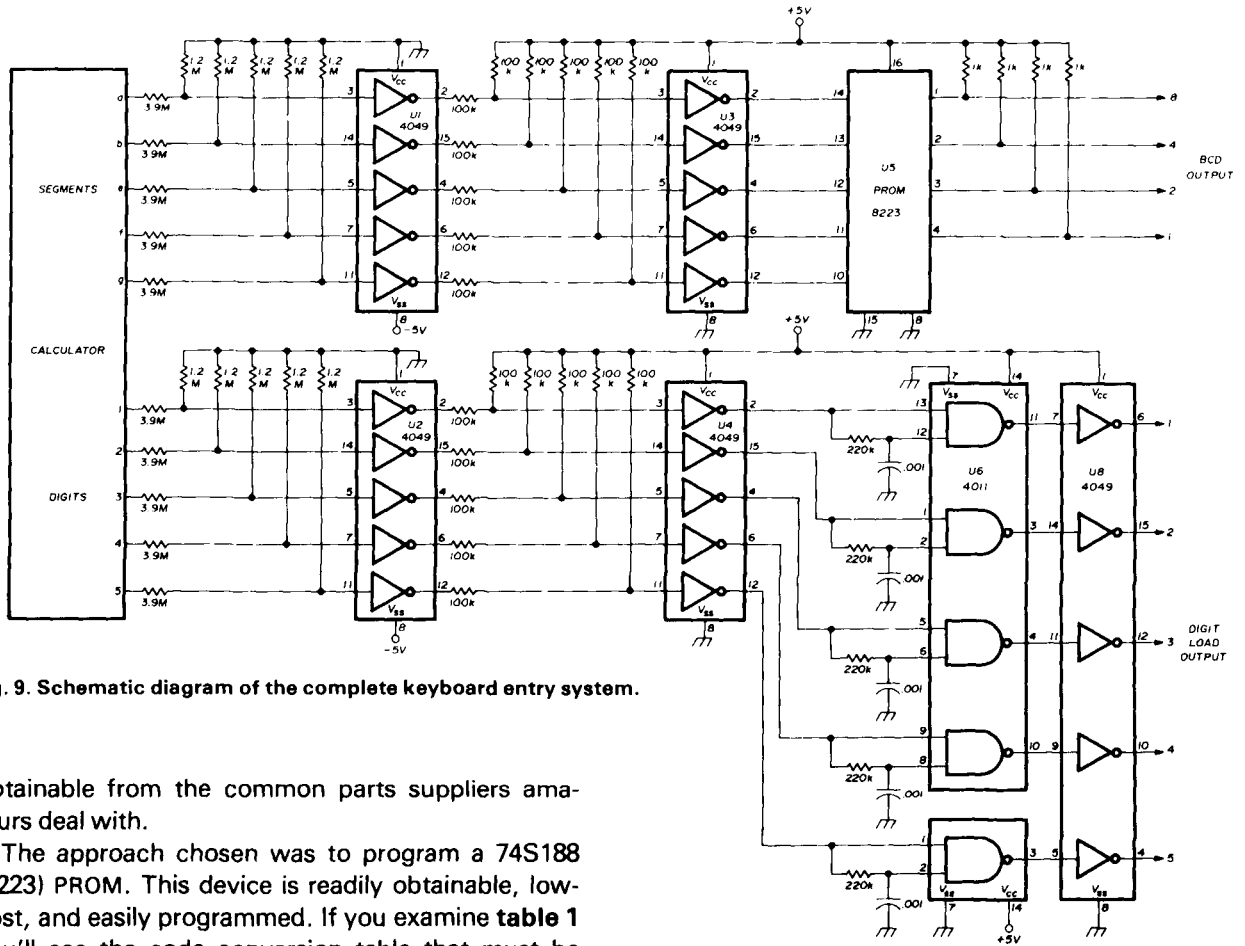
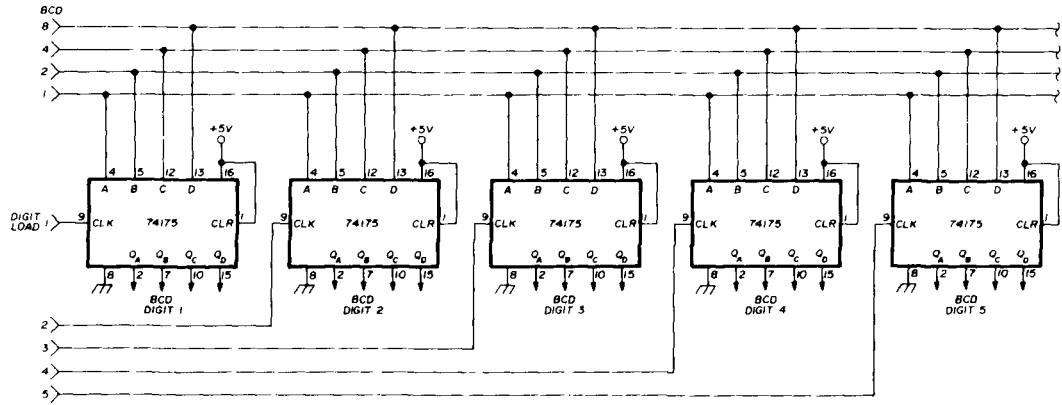

fig. 9. Schematic diagram of the complete keyboard entry system.

obtainable from the common parts suppliers amateurs deal with.

The approach chosen was to program a 74S188 (8223) PROM. This device is readily obtainable, low-cost, and easily programmed. If you examine table 1 you'll see the code conversion table that must be burned into the PROM. It is also interesting to note that only five of the segments are needed to decode

the information displayed. Segments *c* and *d* convey no new information. This is shown in fig. 3.

### demultiplexing

To minimize the number of outputs on the calculator chip, most manufacturers multiplex the display information. The segment lines go to the same segments in each digit while the digit lines enable each digit in turn. For example, to light segment *g* of digit 1 (a minus sign in the first digit) this combination of digit and segment lines would be simultaneously ena-

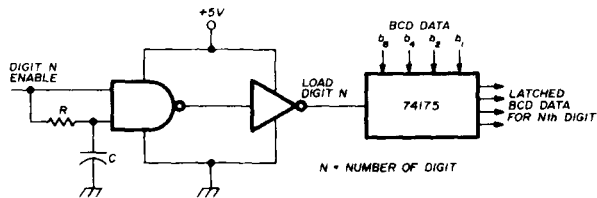

fig. 7. Overall diagram of the circuit necessary to demultiplex the BCD data for each digit.

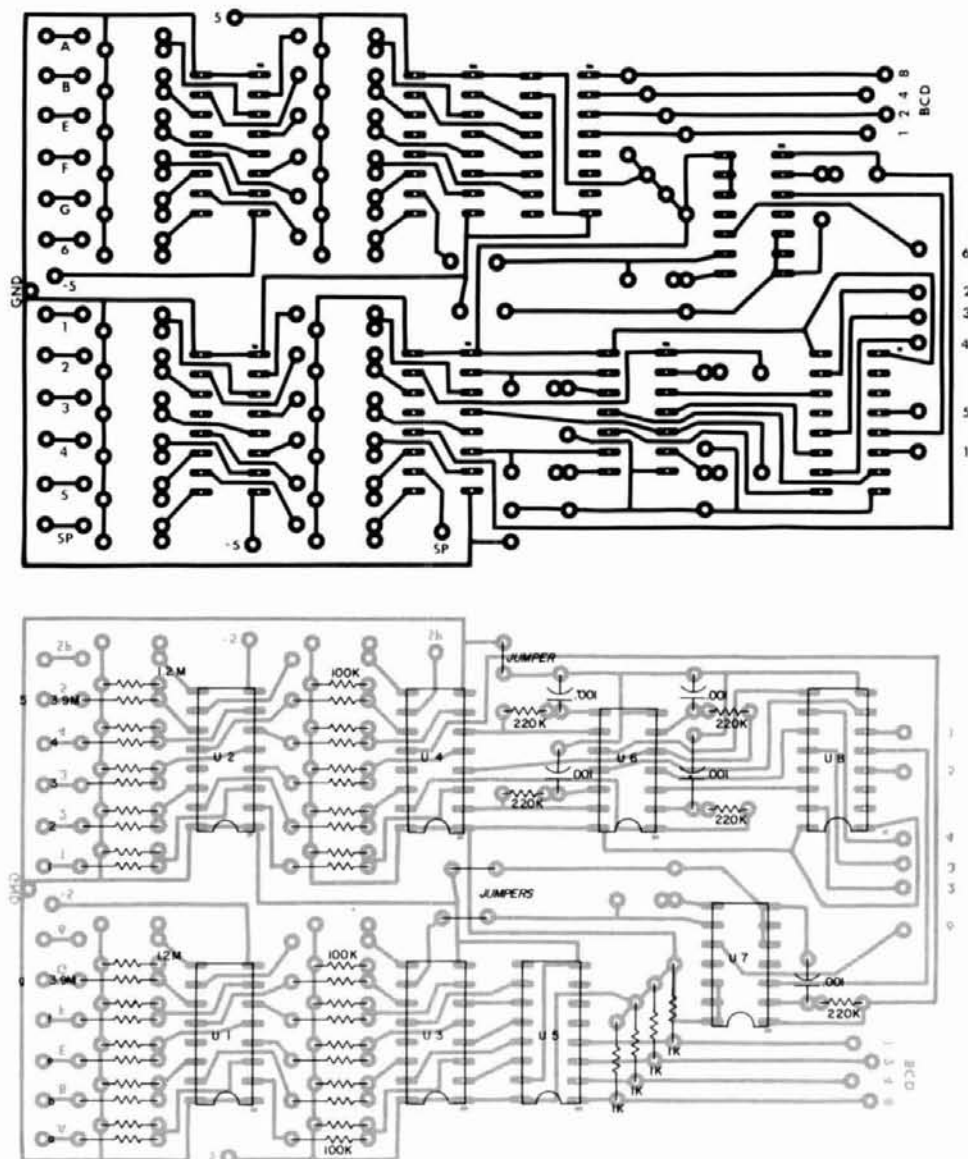

fig. 10. The foil pattern for the circuit board is shown in A. This does not include the 74175 latches. A parts placement diagram is also shown in B.

bled. A representative timing diagram of the digit enable lines is shown in fig. 4.

Demultiplexing the segment data can be done by generating a signal while the desired digit is turned on and using this signal to enable a latch to store the data. For this circuit 74175s are used. These ICs are four D-type flip-flops in one package, or one for each BCD bit. The timing diagram for this circuit is shown in fig. 5. The latch load signal is generated by the circuit shown in fig. 6. The RC time-constant delays the load pulse, so that data will be valid for any calculator that might be used. The overall demultiplexing circuit is shown in fig. 7.

If you are going to be transmitting the data from one board to another in your system (as we were),

you should do the actual demultiplexing at the data's destination. What we did was to locate the 74174s right next to the synthesizer's divide-by-N counters. In this way, interboard wiring was limited to 4 BCD bits plus one line for each digit used. Tying the whole system together results in the block diagram shown in fig. 8, with its schematic shown in fig. 9.

### construction

As shown in the photographs, our original circuit was patched together on a number of breadboards. For our final system, and this article, a PC board was designed and is shown in fig. 10A, with the parts placement shown in fig. 10B. This board is designed for five segment lines, six digit lines, and a spare line.

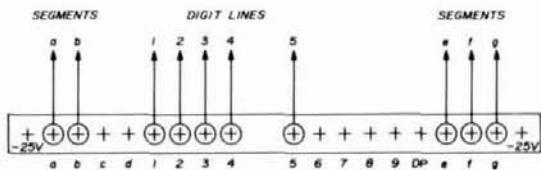
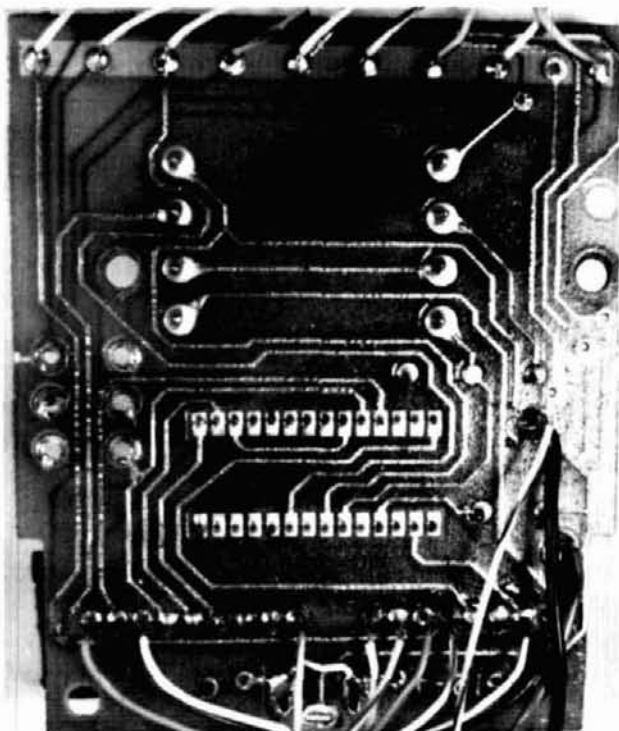

fig. 11. Connecting points on the calculator display board.

In general, construction is not critical. Just try to keep the connections to the calculator as neat as possible to prevent crosstalk and avoid loading down the calculator outputs. For those who choose to build this project with the TI 1265, the photographs also show the location for obtaining the necessary signals. A PC board and the 74S188 PROM are available from the authors; send a self-addressed, stamped envelope for details.



Connections on the calculator board.

What we have shown in this article is a simple, inexpensive system for using a calculator and its keyboard to control a digital system via BCD signals. Of course, if your system is not using BCD coding, you could devise your own programming for the code-converter PROM.

Once your system is designed, it would be a good idea to remount the calculator board, display, and perhaps use a different keyboard tailored to your individual needs, eliminating extra keys and labeling those with special functions.

ham radio

State  
of the art



by

K.V.G.

## CRYSTAL FILTERS and DISCRIMINATORS

### 9.0 MHz FILTERS

XF9-A	2.5 kHz	SSB TX	\$33.55
XF9-B	2.4 kHz	SSB RX/TX	\$47.75
XF9-C	3.75 kHz	AM	\$51.40
XF9-D	5.0 kHz	AM	\$51.40
XF9-E	12.0 kHz	NBFM	\$51.40
XF9-M	0.5 kHz	CW (4 pole)	\$35.95
XF9-NB	0.5 kHz	CW (8 pole)	\$63.95

### 9.0 MHz CRYSTALS (Hc25/u)

XF900	9000.0 kHz	Carrier	\$4.15
XF901	8998.5 kHz	USB	\$4.15
XF902	9001.5 kHz	LSB	\$4.15
XF903	8999.0 kHz	BFO	\$4.15
F-05	Hc25/u	Socket Chassis	.50
F-06	Hc25/u	Socket P.C. Board	.50

Export  
Inquiries  
Invited

Shipping  
\$1.50  
per filter

## ANTENNAS

### UHF LOOP YAGIS



26 LOOPS	GAIN +20 dBi		
1250-1340 MHz	1296-LY		\$56.95
1650-1750 MHz	1691-LY		\$63.95



420-450 MHz  
MULTIBEAMS

48 EL.	GAIN +15.7 dBd	70/MBM48	\$49.95
88 EL.	GAIN +18.5 dBd	70/MBM88	\$73.50

### 144-148 MHz J-SLOTS

8 OVER 8 HORIZONTAL POL.	+12.3 dBd	D8/2M	\$45.95
8 BY 8 VERTICAL POL.		D8/2M-VERT.	\$53.95
8 + 8 TWIST 8XY/2M	\$47.65		



ANTENNAS

(FOB CONCORD, VIA UPS)

## RECEIVE CONVERTERS



MODELS FOR ALL BANDS 50 MHz  
THRU 1296 MHz. LOW NOISE OP-  
TIONS AT 432 MHz.

Send 30¢ (2 stamps) for full details of KVG crystal products and all your VHF & UHF equipment requirements.

Pre-Selector Filters	Amplifiers	SSB Transverters
Varactor Triplers	Crystal Filters	FM Transverters
Decade Pre-Scalers	Frequency Meters	VHF Converters
Antennas	Oscillator Crystals	UHF Converters



si

Spectrum  
International, Inc.  
Post Office Box 1084  
Concord, Mass. 01742, USA

# HEADQUARTERS

## for YAESU



**FT-7 MOBILE  
HF TRANSCEIVER**



**FT-227R  
MOBILE FM TRANSCEIVER**



**FT-901D  
HF TRANSCEIVER**



**FRG-7000  
GENERAL COVERAGE RECEIVER**



**FT-301D  
HF TRANSCEIVER**



**FT-101E  
HF TRANSCEIVER**

**NEAR CHICAGO? COME IN AND SEE US!**



**Tim WB8SBL and Mike WN9ANF  
serving you!**



Hours: 9:30-9:00 Mon. & Thurs.  
9:30-5:30 Tues., Wed. and Fri.  
9:00-3:00 Saturday

**And... All These Other Fine Lines:**

- Alda • Ameco • ASP • Atlas • Belden • Bencher • Bird • CDE
- CIR • CES • Cushcraft • DenTron • Drake • Hy-Gain • Icom
- KLM • Kenwood • Larsen • MFJ • Midland • Mosley • NPC
- Newtronics • Nye • Palomar • Regency • Shure • Swan
- Standard • Tempo • Ten-Tec • Transcom • Wilson • Yaesu



**CALL FOR ERICKSON'S  
LOW PRICE TODAY**



**ERICKSON  
COMMUNICATIONS, INC.**

5935 North Milwaukee Avenue, Chicago, IL 60646 Tel. (312) 631-5181

Practical experience with  
Superior Quality Materials  
and Construction that's...

# TOWER POWER by TRISTAO

Tristao isn't just a trade name... it's a man called Lou, and he's been designing towers for hams all his life...the pioneer. That's why Tristao towers above all. And because he knows hams, he engineers quality at prices you can afford. From Mini-Masts to the giants, it's TOWER POWER all the way with Tristao.

**WRITE RIGHT NOW FOR  
FULL SPECS and dealer nearest  
you. PROMPT DELIVERY.**

## TRISTAO TOWER

Division of Palmer Industries, Inc.  
415 E. 5th St. - P.O. Box 115  
Hanford, CA 93230 / Ph. (209)582-9016

**JAN CRYSTALS  
KEEP YOU  
ON THE AIR**



- CB
- CB standard
- 2 meter
- Scanners
- Amateur Bands
- General Communication
- Industry
- Marine VHF
- Micro processor crystals

**easy  
to  
charge**



Send 10¢ for our latest catalog  
Write or phone for more details

2400 Crystal Drive  
Ft. Myers, Florida 33901  
all phones (813) 936-2397

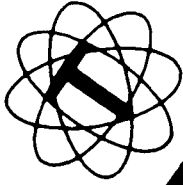

# NEW FROM TAYLOR HQ-1040-AV WIDE BAND TRAP VERTICAL

## Introducing A Wide Band 10 thru 40 Meter Vertical

The HQ-1040-AV is a self supporting trapped antenna with automatic band selection. It provides omnidirectional performance 40 thru 10 meters. The traps are all High-Q with optimum band width characteristics and provides peak performance by isolating the unused portion of the vertical.  $\frac{1}{4}$  wave vertically polarized Extra strong aluminum alloys and extra built-in mechanical strength in the traps make this antenna a winner. We use circular aluminum clamps for full circumference clamping at all tubing joints. Mounting bracket is a full 12" of heavy gauge aluminum, with 5/16" U-bolts will secure on any ground mast up to 1.58". The HQ-1040-AV will become your favorite vertical, and a sample of products to come from TAYLOR.

Contact our Dealers or Write us. Watch for more HF Antennas.

- Heavy wall drawn aluminum tubes (no welded seams)
- Taper swaged to reduce wind load
- Omnidirectional
- Automatic band selection
- Wide band performance
- High-Q — High performance
- Heavy duty mounting bracket
- SO-239 connector
- Input impedance 50 ohm (nominal)
- 2000 Watts PEP
- Low VSWR 1.4:1 or better at Resonance
- A combination of High-Q Performance Strength and Low Cost — We've left nothing out! A Super Performer at an economical price.

## TAYLOR RADIO COMPANY, INC.

3305 Commerce Drive - North Lee Industrial Park  
Augusta, Georgia 30609 - Phone 404-736-3336

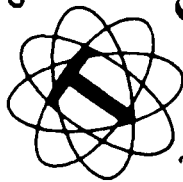

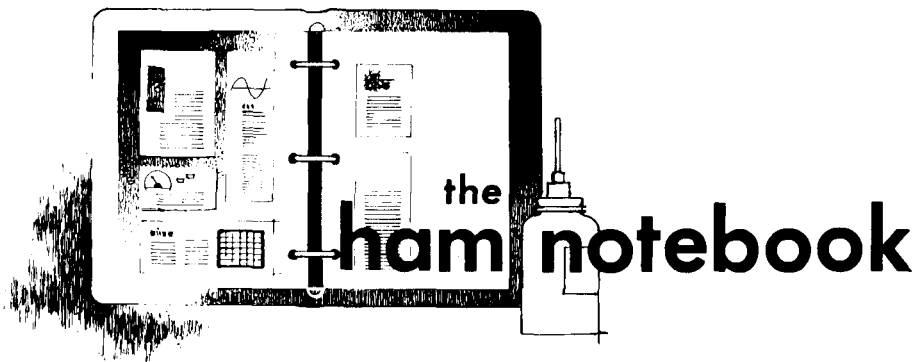

## constant pitch monitor for cathode or grid-block keyed transmitters

After acquiring my old cathode-keyed Heath DX-40 transmitter and a new Novice ticket, WD4MNR found he needed a CW monitor. He didn't want to bother with either an rf-activated device that required connection to the coax or a separate signal pickup wire. Some published monitor circuits have obtained their operating voltage across a small dropping resistor connected in series with the key. This approach was tried, but we found that the final tube in his DX-40 keyed erratically if more than a few ohms were inserted in the cathode circuit. Even if this had not happened, the voltage drop

across the resistor would have varied and changed the oscillator pitch every time the transmitter was loaded. A similar problem exists when rf pickups are used.

The circuit shown in **fig. 1** was developed to avoid problems. It keys reliably and at absolutely constant pitch, regardless of transmitter loading or band, and works equally well with other cathode keyed or grid-block keyed transmitters and transceivers. The open-circuit voltage across the key (about 75 volts in our case) turns on an optocoupler which gates a 555 oscillator circuit. Operation of the monitor is unchanged, even for manyfold variations in key-up voltage, as long as enough is there to turn on the MCT-2.

To use this monitor with rigs having different key-up voltages, tempo-

rarily substitute a 500k-ohm potentiometer for the 100k resistor connected to the key. With the monitor connected, the transmitter turned on, and the pot at maximum resistance, the monitor should produce a tone. Reduce the resistance of the pot until the oscillator just turns off; remove and measure the pot, and substitute a fixed resistor of the next lowest standard value. The monitor will now produce a tone when the key is closed.

Bill Clements, K4GMR

## direct-conversion receivers

I read with interest Dick Rollema's article on direct-conversion receivers (DCR) in your November, 1977, issue of *ham radio*. Since Dick also mentioned some previous work of mine, I feel compelled to give some additional information concerning DCRs.

It seems that the balanced transistor mixer which I used (as shown in **fig. 2** on page 46 of *ham radio*) has been surpassed through the work of a Soviet amateur, V. Polyakov (RA3AAE). So I must draw your attention to his basic article published in the December, 1976, issue of the Soviet magazine *Radio* (later articles appeared in the November, 1977, and December, 1977, issues). Using the first article, I built an experimental receiver and obtained excellent results, which I published in the September, 1977, issue of our Yugoslav radio amateurs' magazine, *Radio-amater*. I enclose partial copies of all those articles; however, I suppose you cannot read Russian or Yugoslav — so I shall give you a summary of the texts.

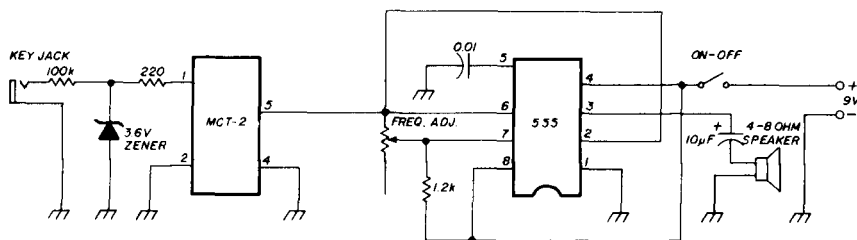

fig. 1. Schematic diagram of the constant-pitch CW monitor. The optical coupler is used to isolate the 555 from the actual transmitter circuitry.

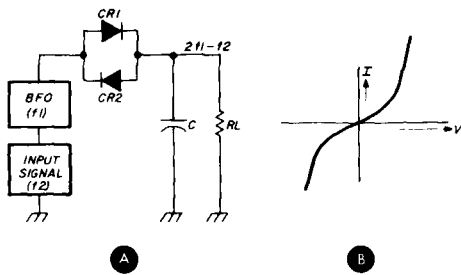

fig. 2. Mixer circuit for double-conversion receivers suggested by RA3AAE, and its characteristic curve.

On page 46 Dick Rollema rightly concludes that a good mixer for DCR should be a switching-type detector. Polyakov's solution is based on two matched silicon or germanium high-frequency diodes, connected in parallel and back-to-back. The local oscillator (in fact, bfo) must work on half of the received frequency, and the output from the detector is CW or ssb audio frequency. The integrated characteristic of the two diodes is represented with an inverted S-shaped curve (fig. 2A). Theoretically, the characteristic is similar to a cubical parabola ( $I = AV + BV^3$ ), which

means that this detector does not use square functions — thus making a-m detection impossible.

For popular explanation refer to the following. The lower cutoff points of the two diodes are used to obtain a switching device that can be opened and closed by the high-frequency voltage of the local oscillator (bfo). The so-called potential barrier for silicon diodes is about 0.5V and for germanium diodes about 0.1V. Therefore, in the middle part of the characteristic, neither of the two diodes conducts — which makes the switching function possible. The switching point occurs when the high frequency voltage of the bfo passes through zero and comes to one of the cutoff points. (Therefore the bfo's high frequency voltage, brought to the diodes through coil L-4, must exceed the potential barrier twice or more.) Since there are two zeroes in each cycle, it becomes obvious that the bfo must work on half of the received frequency. It can be equally said that the diodes CR1 and CR2 are closed sequentially when positive and negative half-waves of

the bfo high frequency voltage reach their peaks. In those moments, the received signal — fed through coil L2 — will pass through one of the diodes and beat against the bfo voltage. At the same time the matched pair of diodes — connected back-to-back — cancel any a-m detection or a-m breakthrough, so this switching mixer is exceptionally insensitive to a-m detection.

In addition to simplicity, this mixer has several other qualities. Because the bfo works on half of the received frequency, it is easier to obtain good stability and to prevent unwanted radiation through the antenna. It is also very resistant to cross-modulation and overloading. Although Polyakov recommends silicon diodes — because of their higher potential barrier — I found germanium diodes to be more sensitive without losing other qualities of the mixer.

In the experimental receiver I built the rf resonant circuit C1-L2, for simplicity, was set on the middle of the 80-meter band once for ever (see fig. 3). The number of turns of the secondary coils L3 and L4 is one-fourth that of their primary coils, L2 and L5. Because there is no dc component after detection, the usual loading resistor was omitted and the high frequency components are shorted to ground through a 0.01  $\mu$ F capacitor. I found it essential to use a low-noise audio preamplifier after detection — and one BF 173 did the job. The audio amplifier can be any integrated circuit or operational amplifier with possibility to include negative feedback through  $C_x$  and  $R_x$  — thus peaking the resonant frequency of the amplifier at 1 kHz. Later I added also an rf stage ahead of the mixer — by using an fet — which made this little receiver a real marvel of clean CW reception, selectivity, stability, sensitivity, and resistance to cross-modulation and over-loading.

Because I am too busy for it at the moment, I hope that Dick Rollema and others will have some more time to experiment with this type of mixer.

Bozidar Pasric, YU2HL

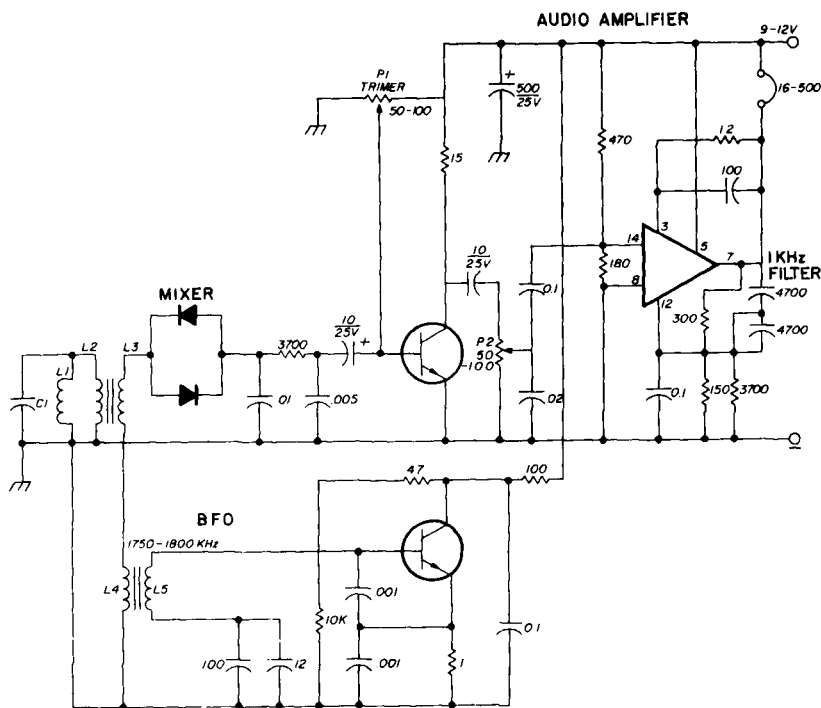
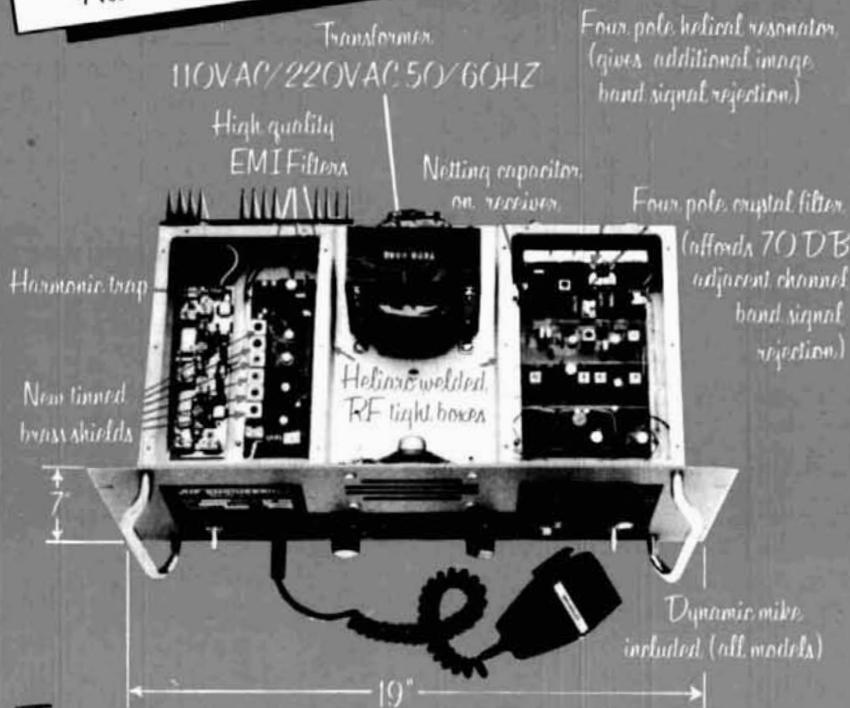

fig. 3. Experimental direct-conversion receiver built by YU2HL that uses the improved diode-mixer circuit.

**INTER-OFFICE MEMO**

TO: TOM BALL, Sales Manager  
 FROM: ROBERT BROWN, Chief Engineer

Here is the information on our "B" series of repeaters.  
 All features are standard on all units; kits as well as wired.  
 All checks indicate this is the hottest repeater on the market.



Tom - Not shown in photo is new power supply. Has fold back current limiting (you can short supply & will not damage it), also over voltage protection (a short in the supply will shut it down so repeater is not damaged.) Don't forget our CWID with its 159 bit field programable memory.

Bob

RPT 50B Kit . . . .	Repeater-6 meter-25w-complete (less crystals)	\$499.95
RPT 144B Kit . . . .	Repeater-2 meter-15w-complete (less crystals)	499.95
RPT 220B Kit . . . .	Repeater-220 MHz-15w-complete (less crystals)	499.95
RPT 432B Kit . . . .	Repeater-432 MHz-10w-complete (less crystals)	579.95
RPT 50B W/T . . . .	Repeater-6 meter-25w-factory wired & tested	799.95
RPT 144B W/T . . . .	Repeater-2 meter-15w-factory wired & tested	799.95
RPT 220B W/T . . . .	Repeater-220 MHz-15w-factory wired & tested	799.95
RPT 432B W/T . . . .	Repeater-432 MHz-10w-factory wired & tested	849.95



**vhf engineering**

Division of Brownian Electronics Corp.

320 WATER STREET / BINGHAMTON, N.Y. 13901 / Phone 607-723-9574

Prices and specifications subject to change without notice. / Export prices slightly higher.



**AMIDON**  
*Associates*

Write for details

**EMI - LINE  
 NOISE FILTERS**

THEY REALLY WORK!

MOBILE OR FIXED

ON . . .

- Alternator Whine
- Ignition Noise
- TV & FM Saturation
- Power Line Coupling
- Xmtr Harmonic Radiation
- Hi Fi & PA Interference
- Speaker/Audio Lead Pickup

also ask about our

FREE **TECH-DATA** FLYER  
 ON FERROMAGNETIC MATERIALS

12033 Otsego Street  
 North Hollywood, CA 91607

**Get the most  
 from  
 your antenna!**



With the Omega-t Antenna Noise Bridge you can test for resonant frequency and impedance . . . adjust and retest . . . until your antenna performs at its optimum. Use the Noise Bridge to trim RF lines for best performance, too.

This patented design uses your sensitive receiver as a bridge detector, outperforming more expensive test equipments.

Reduce power loss due to mismatch — now! Get more details or order today.

Model TE7-01 . . . 1-100 MHz range: \$34.95  
 Model TE7-02 . . . 1-300 MHz range: \$44.95

**ESI ELECTROSPACE SYSTEMS, INC.**

P.O. BOX 1359  
 RICHARDSON, TEXAS 75080  
 TELEPHONE (214) 231-9303

Sold at Amateur Radio Dealers  
 or Direct from Electrospace Systems, Inc.



# FOR THE

# EXPERIMENTER

INTERNATIONAL CRYSTALS & KITS

OSCILLATORS • RF MIXERS • RF AMPLIFIER • POWER AMPLIFIER

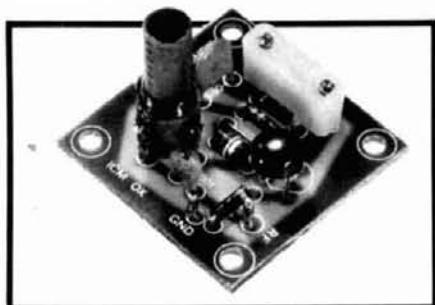

### OX OSCILLATOR

Crystal controlled transistor type. 3 to 20 MHz, OX-Lo, Cat. No. 035100. 20 to 60 MHz, OX-Hi, Cat. No. 035101.

*Specify when ordering.*

\$4.95 ea.

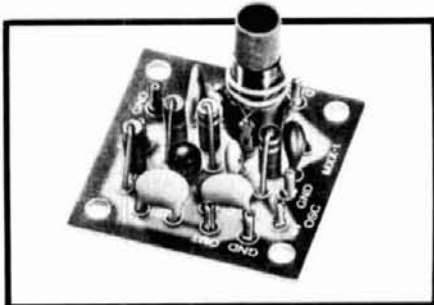

### MXX-1 TRANSISTOR RF MIXER

A single tuned circuit intended for signal conversion in the 30 to 170 MHz range. Harmonics of the OX or OF-1 oscillator are used for injection in the 60 to 179 MHz range. 3 to 20 MHz, Lo Kit, Cat. No. 035105. 20 to 170 MHz, Hi Kit, Cat. No. 035106.

*Specify when ordering.*

\$5.50 ea.

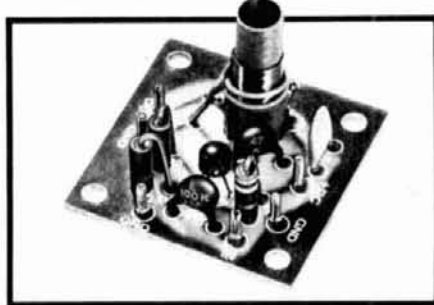

### PAX-1 TRANSISTOR RF POWER AMP

A single tuned output amplifier designed to follow the OX or OF-1 oscillator. Outputs up to 200 mw, depending on frequency and voltage. Amplifier can be amplitude modulated 3 to 30 MHz, Cat. No. 035104.

*Specify when ordering.*

\$5.75 ea.

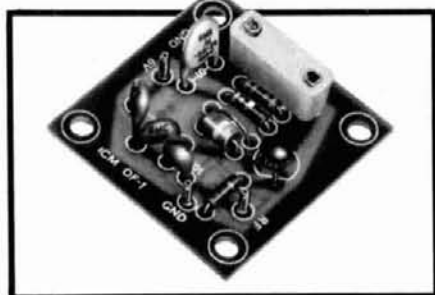

### OF-1 OSCILLATOR

Resistor/capacitor circuit provides osc over a range of freq with the desired crystal. 2 to 22 MHz, OF-1 LO, Cat. No. 035108. 18 to 60 MHz, OF-1 HI, Cat. No. 035109.

*Specify when ordering.*

\$4.25 ea.

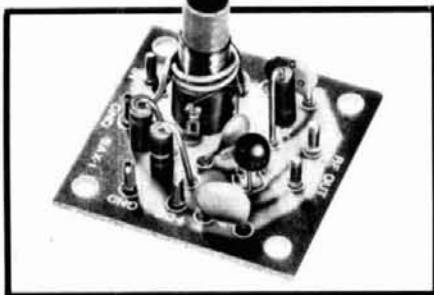

### SAX-1 TRANSISTOR RF AMP

A small signal amplifier to drive the MXX-1 Mixer. Single tuned input and link output. 3 to 20 MHz, Lo Kit, Cat. No. 035102. 20 to 170 MHz, Hi Kit, Cat. No. 035103.

*Specify when ordering.*

\$5.50 ea.

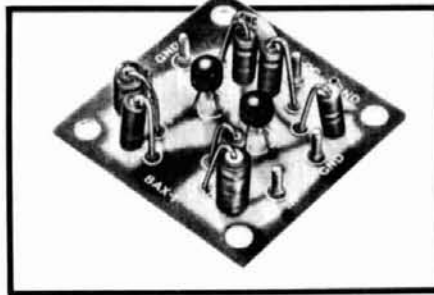

### BAX-1 BROADBAND AMP

General purpose amplifier which may be used as a tuned or untuned unit in RF and audio applications. 20 Hz to 150 MHz with 6 to 30 db gain. Cat. No. 035107.

*Specify when ordering.*

\$5.75 ea.

.02% Calibration Tolerance  
**EXPERIMENTER CRYSTALS**  
(HC 6/U Holder)



Cat. No.	Specifications	
031080	3 to 20 MHz — for use in OX OSC Lo	\$5.95 ea.
	<i>Specify when ordering</i>	
031081	20 to 60 MHz — For use in OX OSC Hi	\$5.95 ea.
	<i>Specify when ordering</i>	
031300	3 to 20 MHz — For use in OF-1L OSC	\$4.75 ea.
	<i>Specify when ordering</i>	
031310	20 to 60 MHz — For use in OF-1H OSC	\$4.75 ea.
	<i>Specify when ordering</i>	

Shipping and postage (inside U.S., Canada and Mexico only) will be prepaid by International. Prices quoted for U.S., Canada and Mexico orders only. Orders for shipment to other countries will be quoted on request. Address orders to:

M/S Dept., P.O. Box 32497,  
Oklahoma City, Oklahoma 73132.



**International Crystal Mfg. Co., Inc.**  
10 North Lee  
Oklahoma City, Oklahoma 73102



# NEW products

For literature on any of the new products, use our *Check-Off* service on page 142.

## Triplett 100-T pocket VOM

Two very useful measurements are beyond the capability of most amateur and commercial workshops: temperature and ac current. The temperature of a device can be an important indicator of proper or improper operation. For instance, the relative temperatures of a transistor and its heatsink can tell you if the thermal path between the two is adequate, or whether or not the transistor is operating within its safe dissipation rating. The same is true of resistors and other components in a circuit — too often the extra dissipation is detected by the "scorched finger" method.

The need to measure the amount of current flowing in ac circuits comes up often enough that most amateurs and engineers wish they had an instrument designed for that purpose. A clamp-on ammeter will do the job, if it is available.

The new Triplett model 100-T VOM is a welcome addition to the lab or workbench because it includes the capability of measuring temperature and ac current in addition to the standard VOM functions that you would expect from this fine instrument.

A first in versatility and temperature sensitivity for its size, the new model 100-T features a hand-size

VOM with  $-50^{\circ}$  to  $+300^{\circ}\text{F}$  temperature ranges. It is contained in a handy leather carrying case that includes the temperature probe, VOM leads, a clamp-on ac ammeter, plus a plug-in line separator for current readings on standard line cords. The 100-T is designed for checking motors, ac and dc lines, machinery, electronic circuitry, appliances, and temperature.

The basic Model 390 "shirt pocket" VOM includes five ac/dc voltage ranges from 0-1200 volts, four dc milliamp ranges from 0.6-600mA, and four resistance ranges from 10k to 10 megohms. Two direct-reading temperature scales from  $-50^{\circ}\text{F}$  to  $+150^{\circ}\text{F}$  and  $+50^{\circ}\text{F}$  to  $+300^{\circ}\text{F}$  are also included for use with the temperature probe.

The Triplett Model 10 Clamp-on ac ammeter permits current readings in 6 ranges (up to 300 amps) to be performed without circuit interruption. And, the Model 101 plug-in line separator "divides" a standard line cord to permit clamp-on ac current measurements at directed and extra-sensitive 0.6 and 0.3 amp full scale readings. An extension for the ac clamp-on probe is also included.

Temperature readings are accomplished by using the Triplett thermistor probe. The bare probe is used for surface temperature measurements. An aluminum shield is provided to protect the sensitive probe from damage when taking air temperature measurements, or when the probe is stored in the VOM case.

For further information on this new ultra-compact, versatile, model 100-T, priced at \$120 complete with accessories, contact Triplett Corporation, Department PR, Bluffton, Ohio 45817, or ask your local electronic distributor for a demonstration.

## Wayne Bracket

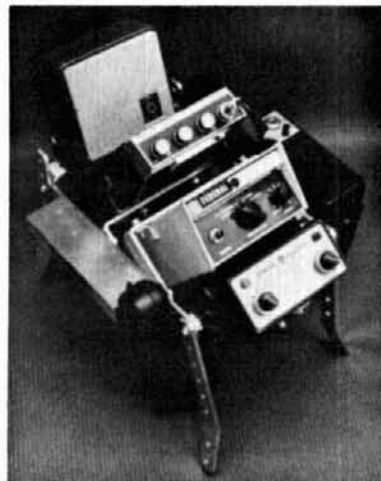

The Wayne Bracket Communications Command Console provides a way to mount and install expensive communications equipment in any vehicle. The rugged, solid-aluminum bar-stock frame and crossmembers allow you to position all sorts of electronic equipment for convenience and safety. An investment in this infinitely practical bracket makes the installation neat, quick, easy, and economical. It fastens over the drive shaft tunnel in any nonconsole, column-shift vehicle using only four sheet-metal screws. Models are available for flat-surface installations.

The bracket provides an ideal place for a first-aid kit, fire extinguisher, and flashlight. It completely eliminates dash-mount hassles and mickey-mouse floor rigs. The Wayne Bracket's low center of gravity and central location protects expensive equipment while providing maximum front-seat room. For more information, request our "10 basic benefits" brochure at no obligation. Write to E. Lee Reid, Wayne Communications, Inc., Post Office Box 57, Doctors Inlet, Florida 32030.

## tunable ATV converter



Science Workshop has introduced a new tunable ATV converter, which connects between an ordinary uhf antenna and the vhf input of any television set.

Features and specifications of the model ATVC-10 are a low-noise, high-gain rf amplifier stage with varactor-tuned input and outputs, an active mixer with varactor-tuned input, a varactor-tuned oscillator stage, and adjustable rf gain control.

The built-in ac power supply uses a transformer for power line isolation and a full-wave bridge, supplying a regulated voltage for the four tuning varactors. The converter is electrically tuned from 420 to 450 MHz, with outputs on vhf TV channels 2 through 6.

The ATVC-10 comes completely wired and tested and guaranteed for two years. It is housed in an attractive two-tone (walnut and beige) finished aluminum cabinet which measures only 4.75 x 10.85 x 10.5 cm (1-7/8 x 4-1/4 x 4-1/8 inches).

The prices: factory wired, only \$49.95; semi-kit (critical circuits pre-wired and aligned), \$39.95. Full instructions are included.

For additional information write to Science Workshop, Box 393, Bethpage, New York 11714.

## Hiram Percy Maxim — a biography

Probably Hiram Percy Maxim has contributed more to amateur radio than any other single person. Historically, he founded *QST Magazine*, the American Radio Relay League, and the International Amateur Radio Union. He pleaded the amateur's cause very successfully

# CUSHCRAFT IS THE FM ANTENNA COMPANY.

Cushcraft manufactures the world's most complete line of quality antennas for amateur VHF-FM repeater service including high-gain multi-element vertical beams, stacked arrays, 5/8-wavelength mobile whips, half-wavelength Ringo® verticals, and the world-famous Ringo Ranger®, which features stacked vertical half-wavelength elements for 4.5 dBd omnidirectional gain. Whether your favorite repeater is next door or across the state, Cushcraft has a VHF-FM antenna which is exactly engineered to your needs.

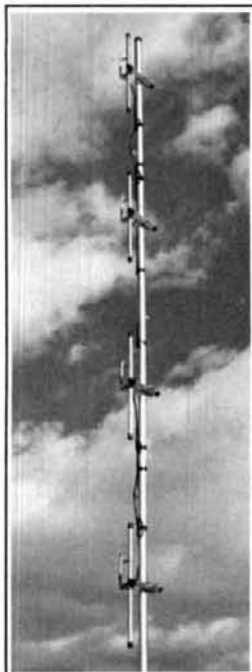

Four Pole



5/8 wave Mobile

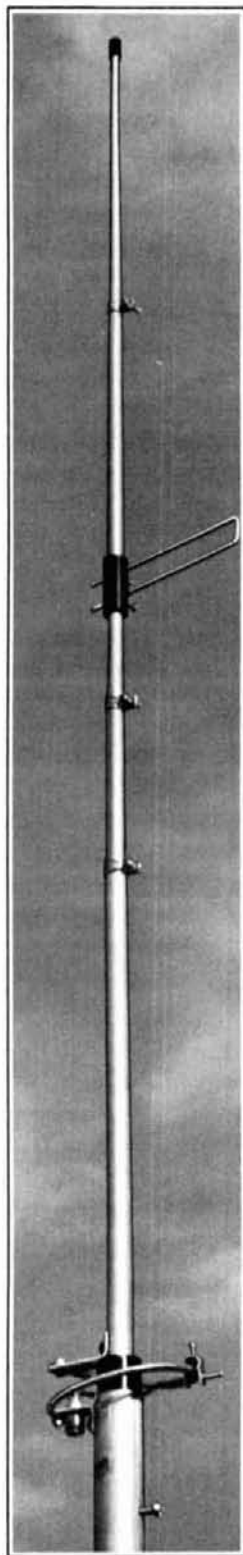

Ringo Ranger®



UPS SHIPPABLE  
**cushcraft**  
CORPORATION

In Stock With Dealers World Wide P.O. Box 4680, Manchester, N. H. 03108

# Rugged Giants Tri-Ex Sky Needle Towers Give your antennas a big lift!

Regular and  
heavy duty  
towers

This advanced state-of-the-art "Sky Needle" is fast earning its own special place of honor in the ham-communications field. Tri-Ex takes great pride in being the developer and first to build this crank-up, freestanding tubular tower for the amateur. Uniquely eye-pleasing, the slim and graceful "Sky Needle" is a symbol of pride to its owner as well as proof positive that he has the very best in towers. Tri-Ex offers immediate delivery. Act now! Write for your free brochure, today.

\*Three Hy-Gain 10, 15, 20M long Johns.  
\*\*Log-periodic antenna for MARS use 13 to 30 MHz.

MODEL	HEIGHT	
	EXTENDED	NESTED
TM-240	40'	22'
TM-358	58'	22½'
TM-370/370HD	70'	27'
TM-490	90'	28'
TM-5100R	100'	29'

**Tri-Ex TOWER CORPORATION**

7182 RASMUSSEN AVE., VISALIA, CALIF. 93277

before American and international forums bent on abolishing the hobby, and he held one of the most famous ham call signs of all time: W1AW. Taken together, he organized, nurtured, defended, and disciplined the hobby in its critical formative years; amateur radio still bears the distinctive stamp of his gentlemanly personality.

Maxim is best known outside the world of amateur radio for his inventions and pioneering work in the development of the automobile and noise-control devices. A holder of 49 patents, he was also a pioneer in aviation, air conditioning, motion pictures, and radio astronomy. He was an accomplished international diplomat, screen writer, urban ecologist, and nationally-syndicated newspaper columnist. In short, he was a true Renaissance man; the embodiment of the line from *The Amateur's Code*, "an amateur is balanced."

This is the only available biography of a great and unique American character. It is a fascinating and painstakingly well-researched account that brings his personality to life. The author, Alice Clink Schumacher, avoids dull scholarship and makes the reader feel that he is overhearing a collection of treasured family anecdotes told by close friends and relatives.

The book provides a unique insight into one man's life and an era of unprecedented technological progress in dozens of fields. Perhaps the feature which most commends this book to every amateur's library is the lengthy excerpting from Maxim's incomparable series of "The Old Man" editorials. Printed anonymously in early issues of *QST*, they are amusing, humorous yet thought-provoking caricatures of radio amateurs and their foibles. They are still amazingly accurate today.

Certainly few men were as well-liked and respected, nor did as much to make amateur radio the most gentlemanly of hobbies, than The Old Man — Hiram Percy Maxim.

Soft cover, 153 pages, \$4.50 from Ham Radio's Communications Bookstore, Greenville, New Hampshire 03048. Order catalog HR-HPM.

## Bristol electronics 10-meter transceiver



Bristol Electronics of New Bedford, Massachusetts, now offers two mobile transceivers for the amateur 10-meter band. The HAM-10 is a 10-watt, 40-channel unit that covers 40 channels with 10-kHz spacing, starting at 28.965 for channel 1. The HAM-100 is a 100-watt version of the same synthesized transceiver.

Frequency control is by means of a patented Phase-Lock Loop synthesizer, and the receiver may be tuned between channels for better reception of off-frequency stations.

These transceivers are not worked-over CB units, but are, according to Bristol Electronics, designed and engineered for amateur 10-meter band use. The equipment is of the same lightweight and compact style that amateurs are accustomed to using in the vhf part of the spectrum.

Additional features include an automatic noise-limiter, combined S- and rf-power meter, LED modulation monitor, and a jack for an external speaker. A microphone and all mounting hardware are included.

The modulation system is a-m, with a capability of 95 to 100 per cent modulation. Spurious signals are suppressed better than 60 dB, and harmonics are suppressed better than 45 dB. The HAM-100 has a selector switch for either full power or a 10-watt level for local work.

For more information, contact Bristol Electronics, Inc., 651 Orchard Street, New Bedford, Massachusetts 02774.

# CUSHCRAFT IS THE HF MULTIBAND ANTENNA COMPANY.

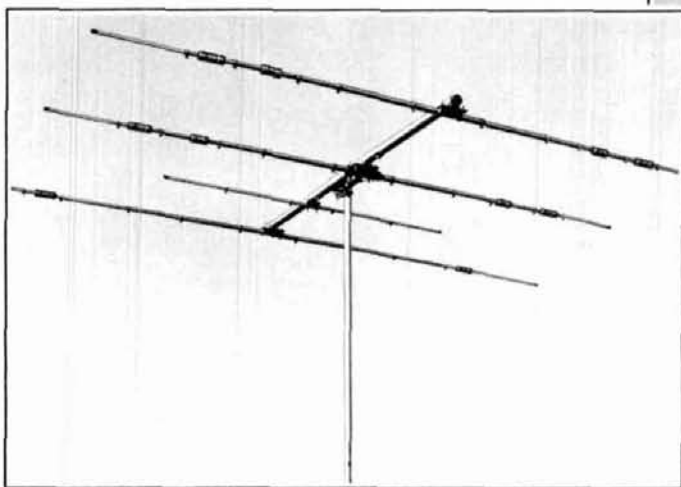

ATB-34, Three Band

Cushcraft manufactures a full range of high-frequency antennas which are performance engineered for the most discriminating amateur. For the amateur who demands top performance in a multiband Yagi beam there's the incomparable ATB-34 three-band beam for broadband, high-gain coverage on 10, 15 and 20 meters.

And for the Amateur with limited antenna space and budget who wants reliable, multiband radio communications there are three Cushcraft multiband verticals to choose from: the three-band ATV-3 for 10, 15 and 20; the four-band ATV-4 for 10, 15, 20 and 40 meters; and the ATV-5 for low VSWR five-band performance from 80 through 10 meters.

Cushcraft high-frequency antennas are quality engineered for top performance; they are often imitated, but never duplicated.

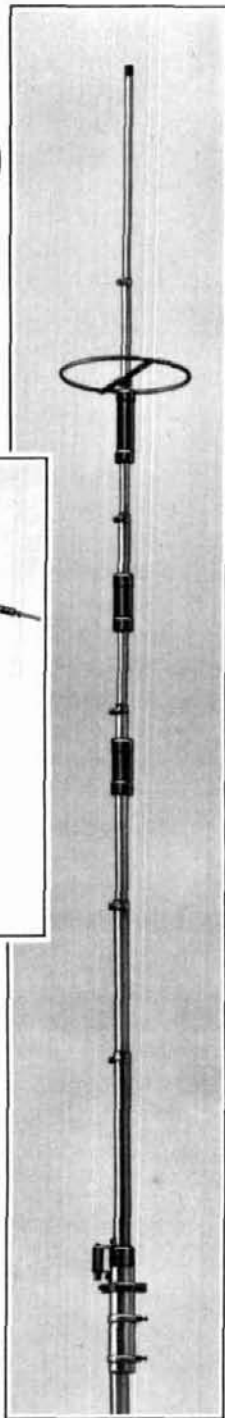

ATV-4, Four Band



In Stock With Dealers World Wide P.O. Box 4680, Manchester, N. H. 03108

# RF Transformer



- **New! Broadband antenna matching.**
- **Convenient switch selection of impedance taps.**
- **For verticals and mobile whip antennas.**
- **Taps at 8, 12.5, 16, 22, 32 and 50 ohms.**
- **Full 500 watt capability. No time limit.**

Here is the answer to the matching problem for vertical antennas and mobile whips. A broadband transformer that really works. Plenty of taps to match your 50 ohm transmitter to any short vertical.

And with no tuning or other adjustment. The 500 Watt RF Transformer is completely broadbanded 1-30 MHz (1-10 MHz below 20 ohms). So when you change frequency within a band you need only retune the antenna loading coil to resonance; not fiddle with a matching network.

Also, more power goes into your antenna. The 500 Watt RF Transformer is more efficient than a matching network or tuner — less than .1 db loss.

As always, when you buy Palomar Engineers you get the best; large ferrite toroid core, teflon insulated wire, rugged ceramic switch, heavy die cast aluminum case, full 500 watt CW capability.

Free descriptive brochure on request.

Improve your mobile operation. Simplify your tuneup. Get better results with the new Palomar Engineers 500 Watt RF Transformer.

**Order yours now! Price \$35.00 plus \$2 shipping/handling U.S. & Canada. Calif. residents add sales tax.**

## standard C-6500 general-coverage receiver

The Model C-6500 is a synthesized, general-coverage, communications receiver; a new "Standard" with high-quality, low-cost performance that will please the most critical listener. Reception capability is provided for a-m, CW, and ssb. Unusual stability is achieved by using a synthesized, drift-cancelling injection system in 30 tunable ranges, covering the entire broadcast band starting at 500 kHz through 30 MHz. A 10-MHz reference oscillator provides the frequency stability necessary for excellent ssb reception. Dial accuracy is better than 5 kHz, which is sufficient to locate and identify stations on known frequencies.

There are two separate detectors, product and diode, to provide excellent performance for both ssb and a-m signals. A mode switch provides wide or narrow selectivity. A tunable preselector allows the user to adjust for maximum sensitivity and interference rejection. Completely solid-state in design, the Standard C-6500 operates from ac mains as well as eight internal type "D" flashlight cells. Automatic switchover to battery operation is accomplished if the ac power should fail. For information write Standard Communications Corporation, Post Office Box 92151, Los Angeles, California 90009.

## two-volume course on microcomputer programming

A two-volume course that integrates introductory experiments in digital electronics with programming and interfacing an 8080A-based microcomputer is now available. *Bugbooks V and VI* by D. G. Larsen, P. R. Rony, and J. A. Titus are lab experiment-oriented texts that are intended for study and guidance in the performance of "hands on"

# Palomar Engineers

Box 455, Escondido, CA. 92025 • Phone: [714] 747-3343

experiments with the aid of a low-cost microcomputer, breadboarding kits, and readily available components. The books may be purchased individually.

The course material is organized for teaching microcomputer programming and the interfacing of a microcomputer to external digital devices for practical applications. The course content is derived from the authors' experience in teaching the subjects to college students, scientific researchers, and engineers with a need for mastery of microcomputers but no formal background in either digital electronics or computer programming. The student or hobbyist is expected to perform the suggested experiments to obtain the most benefit from the course material.

Integrated circuits and the microprocessor are treated as functional black boxes with specific electrical characteristics; semiconductor physics and mathematical analysis is omitted. Laboratory experiments and text review questions and answers are included to test reader understanding of the subjects covered.

*Bugbook V*, with 15 units in 493 pages covers the basics of 8080A microcomputer programming and instructions as well as digital codes, register, logic gates, and truth tables. An introduction to breadboarding is followed by instructional units and experiments covering 7400 series TTL integrated circuit chips, including flip-flops and latches, decoders, counters, digital signal gates, and multivibrators.

*Bugbook VI* has eight units in 490 pages; it integrates the digital concepts discussed in *Bugbook V* into a treatment of 8080A microcomputer interfacing and programming. Detailed instructions and related laboratory experiments cover select pulses, the 8080A instruction set, three-state bussing techniques, and introductions to accumulator and memory-mapped input/output techniques. Other topics in *Bugbook VI* include

# CUSHCRAFT IS THE VHF-UHF ANTENNA COMPANY.

Cushcraft precision engineered VHF/UHF Yagi beams have become the standard of comparison the world over for SSB and CW operation on 6 meters through 432 MHz. Built by skilled craftsmen from the best available materials, these beams represent that rare combination of high electrical performance, rugged construction, and durability.

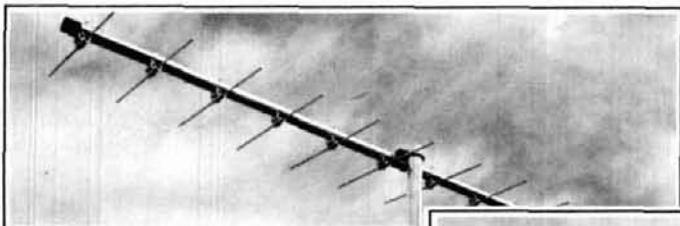

1 1/2-Meter Yagi

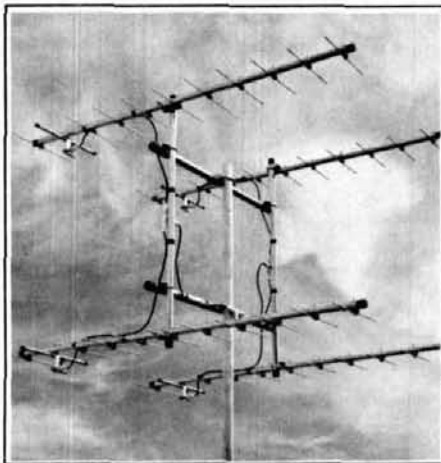

Quad Array

Cushcraft's Quad Arrays for 144, 220, and 432 MHz use four matched 11-element Cushcraft Yagis and are the ultimate in a high-performance Yagi array. These arrays have been carefully engineered for maximum forward gain, high front-to-back ratio, and broad frequency response. All antennas provide a low VSWR match to 50-ohm coaxial feedline.

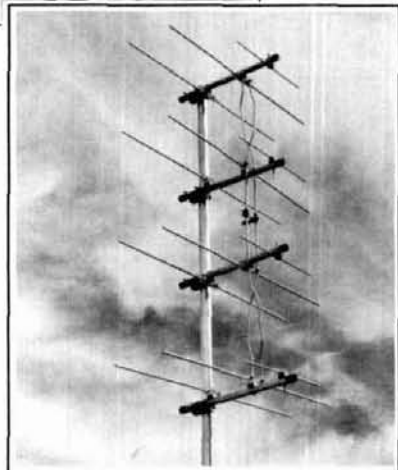

20 Element DX Array

Cushcraft's wide variety of VHF/UHF Beams includes an antenna for every amateur activity above 50 MHz, whether local ragchewing or long-haul over-the-horizon DX. All models have been carefully optimized for maximum forward gain with high front-to-back ratio. The heavy-wall bright hard-drawn aluminum booms and elements are combined with heavy formed aluminum brackets and plated mounting hardware for long operating life and survival in severe weather.



In Stock With Dealers World Wide P.O. Box 4680, Manchester, N. H. 03108

# SCR 1000

## Standard of Comparison IN VHF FM REPEATERS!

2M & 220 MHz



Optional Cabinet \$130.00

### Now Available with Autopatch — and Many Other Options!

Now Spec Comm has taken the hassle out of putting an autopatch repeater on the air! The SCR1000/SCAP is a fully self-contained 30 watt repeater with built-in autopatch and land line control. You simply plug in the phone line, hook up the duplexer, and you're on the air! The usual months of problems are eliminated! The SCR1000/SCAP has been meticulously engineered to provide the smoothest performing patch together with a positive land line control of the repeater. Just look at all these features:

#### Features:

- Normal patch, or secure "reverse" patch accessed by control op.
- 3 digit anti-falsing access — single digit disconnect
- 3 digit on-off control of repeater transmitter
- Wide range audio AGC on input and output
- 4 sec. time limit on access
- Built-in adjustable time-out function — patch shuts down in 30-90 sec. if no carrier is received
- User can mute phone line audio simply by keying his mic button — prevents embarrassing language from being repeated
- Patch access and repeater control — either over the air or over the land line

The SCR1000/SCAP is a complete Autopatch Repeater — fully assembled, set-up and checked-out in our lab. As with all Spec Comm products, all workmanship and components are of the very highest quality. The price? A very reasonable \$1605.00 — complete! (\$2100.00 w/WP641 Duplexer.) (For Rptr., w/o FL-6 Rcvr. Preselector, deduct \$85.00.) Get your order in A.S.A.P.!

- **The SCR 1000 — the finest repeater available on the amateur market . . .** often compared to "commercial" units selling for 3 times the price! This is a 30Wt. unit, with a very sensitive & selective receiver. Included is a built-in AC Supply, CW, IDer, full metering and lighted status indicators/control push buttons, crystals, local mic, etc. Also, jacks for emergency power, remote control, autopatch, etc.
- **Custom options available:** Duplexers, Cable, 'PL', HI/LO Power, Touch Tone Control, 60-70W. Transmitter, Racks, etc. Inquire.
- **The Spec Comm Repeater System . . .** a sound investment . . . available only by direct factory order. SCR1000 w/FL-6 Rcvr. Preselector \$1055.00 (\$970.00 w/o FL-6.) Commercial price somewhat higher.
- **A Full Line of Repeater Boards & Assemblies Are Also Available:** Inquire.

Call or write today and get the details! Send for Data Sheets!  
Export Orders — Contact Shere in our International Department.

### SPECTRUM COMMUNICATIONS

1055 W. Germantown Pk., Norristown PA 19401 (215) 631-1710

advanced input/output concepts and interrupt servicing. Complete appendixes for both volumes at the back of *Bugbook VI* include references, definitions, and descriptions of available breadboarding accessories and microcomputer recommended for use in the experiments.

*Bugbook V* and *Bugbook VI* are priced at \$9.50 each from Ham Radio's Communications Bookstore, Greenville, New Hampshire 03048.

### feather touch keyer



The new Kantronics Feather Touch Keyer is the world's first commercially available keyer with no moving parts. The Feather Touch responds to your lightest touch, not to mechanical connections or switches. No moving parts means the end of slapping and bouncing. There are no adjustments to be made before each contact, and no mechanical parts to wear out.

Feather Touch sends self-completing dots and dashes, with a speed range of 7-1/2 to 50 words per minute. The keyer operation is semi-iambic, with dot priority. This keyer is great for portable or field-day use, where it can be powered by a single 9-volt internal battery. An extra-life battery can provide 24 hours of reliable keying under average conditions. At home, the unit can operate from any 5- to 15-volt dc power source.

The attractive design and compact size make the Feather Touch a professional addition to any ham station. Price: \$69.95 from Kantronics, Inc., 1202 East 23rd St., Lawrence, Kansas 66044. For more information, write to them.



# MADISON ELECTRONICS SUPPLY, INC.

1808 MCKINNEY  
713/555-0288

HOUSTON, TEXAS 77002  
Niles 713/487-5883

## NEW! EXCITING! BREAKTHROUGH! DRAKE TR-7 TRANSCEIVER & ACC.



TR-7	\$886.00
TR-7 & DR-7 DIGITAL R/O	\$1072.00
PS-7 POWER SUPPLY	\$166.00

### CALL FOR QUOTES ON:

<b>YAESU</b>	<b>KENWOOD</b>
FT901 DM	TS820S
FT625	TS520S
FT225	TR7400A

ALDA, AMCOMM, ETO ALPHA  
TEMPO VHF ONE PLUS



## ANTENNAS

Model OJA-146

TWO METER AMATEUR BAND 146-148MHz

- NO GROUND PLANE REQUIRED
- USE FIXED, MOBILE, OR PORTABLE
- 5dB GAIN OVER ISOTROPIC IN MOST MOBILE APPLICATIONS
- OVERALL LENGTH: LESS THAN 64 INCHES
- COLLAPSIBLE TO 22 INCHES. MAY BE PACKED IN SUIT-CASE FOR THOSE OUT-OF-TOWN TRIPS
- STEEL WHIP AND ADAPTER INCLUDED FOR MOBILE AND FIXED APPLICATIONS
- VSWR: LESS THAN 1.2:1

**PRICE \$39.95** UPS Prepaid

220 MHz — \$37.95 450 MHz — \$37.95

### AMATEUR BEAMS—In stock—

FINCO A62 6/2m	\$61.00
TELREX TB5 EM	\$415.00
RIW 432-19	\$49.95

**CALL FOR FAST QUOTES  
SPECIAL ORDERS WELCOME**

**TERMS:** All prices FOB Houston. Prices subject to change without notice. All items Guaranteed. Some items subject to prior sale. Send letterhead for Amateur dealers price list. Texas residents add 5% tax. Please add postage estimate.

## MADISON FABULOUS FALL BUYS

- KLM: Antennas, Linears, Accessories All in Stock. Free balun w/2 meter base antenna.
- FINCO AMATEUR BEAMS in Stock — Call! A62.6 and 2 Meter ..... \$61.00
- 2 + 2 Horiz/vertical ..... \$37.50
- BIRD 43 Wattmeter plus slugs, in stock, prepaid freight.
- BENCHER keyer paddles in stock \$39.95; chrome \$49.95
- YAESU
- FT-301D + Free FP301 ..... \$935
- FT-301 + Free FP301 ..... \$789
- YAESU FT-901D series ..... Call for Quote
- TELE-TOWER: 40' w/breakover ..... \$299
- 55' w/breakover ..... \$399
- MICROWAVE MODULES MMT 432-28S ..... \$259
- UPS Paid.
- F9FT TONNA antennas: 144/16 el ..... \$55.95
- 9/19 OSCAR ..... \$53.00
- JANEL Preamps QSA-5 ..... \$39.95
- TECHNICAL BOOKS: ARRL, Sams, TAB, TI, Rider, Radio Pub., Callbook, Cowan, TEPABCO, may others ..... call
- HAM X ROTOR (New Model) Turns 28 sq. ft. of antenna. List \$325. In stock ..... Your Price \$249
- CDE HAM-III ..... \$129.00
- SWAN METERS: WM 6200 VHF Wattmeter ..... \$49.95
- SWR 3 Mobile ..... \$9.95
- TELEX HEADSETS: ..... In stock
- CETRON 572B ..... \$27.95 ea.
- RAYTHEON 572B ..... \$24.95
- ADEL nibbling tool, \$6.45; punch \$3.50
- CABLE 5/32", 6-strand, soft-drawn guy cable. For mast or light tower, 3¢ foot.
- BELDEN COAX CABLE: 9888 double shield RG8 foam coax, 100% braid, suitable for direct bury 39¢ ft., 8237 RG8 21¢ ft., 8214 RG8 foam 25¢/ft., 8448 8-wire rotor cable 18¢ ft., 8210 72 ohm kw twinhead \$19/100 ft., 8235 300 ohm kw twinlead \$12/100 ft., Amphenol PL-259, silverplated 59¢, UG175 adapter 19¢, PL-258 dbf female \$1.00. BNC female chassis mount 59¢ ea.;
- BELDEN 14 gauge cop. stranded antenna wire ..... \$5/100 ft.
- TIMES 1/2" foam hardline 60¢/ft. .... connectors \$15 ea.
- 7/8" Foam Hardline 1.50 ft. Connectors ..... \$25.00 ea.
- KESTER SOLDER 1 lb. 60/40 .062 ..... \$6.50
- LEADER — GDM LDM815 ..... \$89.95
- MALLORY 2.5A/1000 PIV epoxy diode ..... 19¢ ea.
- .001 MFD 20 KV CAP ..... \$1.95
- Ge receiving tubes ..... 50% off list
- GE6146B,8950 ..... \$7.95 ea.
- SWAN 750CW + Free PSU-3 ..... \$675

### THIS MONTH'S SPECIAL

**KENWOOD TR7500A ..... \$249**

### 16 ELEMENTS — F9FT — 144 MHz



The 'Tonna' You've been hearing about

144/146 MHz	SWR 1.2:1
17.8 dBi	Wt. 4.4 kg.
50 ohms	Horiz./Vert.
length 6.4 m.	F/B ratio 22 dB
Side lobe attenuation 60 dB	
Horizontal aperture 2 x 16° (-3 dB)	
Vertical aperture 2 x 17° (-3 dB)	

**\$55.95**

AUTHORIZED DEALER

**Vhf engineering**

Makers of the World's Most Complete Line of VHF-FM Equipment

# WANTED FOR CASH



**490-T Ant. Tuning Unit**  
(Also known as CU1658  
and CU1669)

Highest price paid for these units. Parts purchased.  
Phone Ted, W2KUW collect. We will trade for new  
amateur gear. GRC106, ARC105 and some aircraft  
units also required.

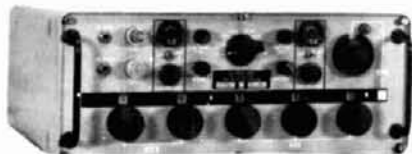

R1051 or T827

*We stand on our long term offer to pay 5% more  
than any other bonafide offer.*

*See last month's ad for other items available.*



**618-T Transceiver**  
(Also known as MRC95,  
ARC94, ARC102, or VC102)

## THE TED DAMES CO.

308 Hickory Street  
(201) 998-4246

Arlington, N.J. 07032  
Evenings (201) 998-6475

## QUALITY KENWOOD TRANSCEIVERS ... from KLAUS RADIO

The TS-820S is the rig that is the talk of the Ham Bands. Too many built-in features to list here. What a rig and only \$1098.00 ppd. in U.S.A. Many accessories are also available to increase your operating pleasure and station versatility.



**TS-820S**  
160-10M TRANSCEIVER

Super 2-meter operating capability is yours with this ultimate design. Operates all modes: SSB (upper & lower), FM, AM and CW. 4 MHz coverage (144 to 148 MHz). The combination of this unit's many exciting features with the quality & reliability that is inherent in Kenwood equipment is yours for only \$729.00 ppd. in U.S.A.



**TS-700SP**  
2M TRANSCEIVER

Guess which transceiver has made the Kenwood name near and dear to Amateur operators, probably more than any other piece of equipment? That's right, the TS-520S. Reliability is the name of this rig in capital letters, 80 thru 10 meters with many, many built-in features for only \$739.00 ppd. in U.S.A.



**TS-520S**  
80-10M TRANSCEIVER

This brand new mobile transceiver (TR-7400A) with the astonishing price tag is causing quite a commotion. Two meters with 25W or 10W output (selectable), digital read-out, 144 through 148 MHz and 800 channels are some of the features that make this such a great buy at \$399.00 ppd. in U.S.A.



**TR-7400A**  
2M MOBILE TRANSCEIVER

Send SASE NOW for detailed info on these systems as well as on many other fine lines. Or, better still, visit our store Monday thru Friday from 8:00 a.m. thru 5:00 p.m. The Amateurs at Klaus Radio are here to assist you in the selection of the optimum unit to fulfill your needs.

# KLAUS RADIO Inc.

8400 N. Pioneer Parkway, Peoria, IL 61614  
Jim Plack W9NWE — Phone 309-691-4840

## SUB-AUDIBLE GENERATOR for FM

THE CUBE

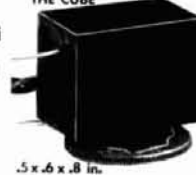

5 x .6 x .8 in.

- Inexpensive multi tone encoder
- Compatible with PL-CG-QC
- Low distortion sinewave
- Input 8-18 VDC unregulated
- Rugged, plastic encased with leads
- Adjustable frequency (98-250 Hz), Lower available
- Excellent stability

Price \$19.95

Freq. set at  
factory  
\$5.00 extra

Calif. res. add 6%

Send for more info

lyle  
Products

Dept. hr P.O. Box 2083 Santa Clara, CA. 95051

## NEW FROM GLB

A complete line of **QUALITY 50 thru 450 MHz TRANSMITTER AND RECEIVER KITS**. Only two boards for a complete receiver. 4 pole crystal filter is standard. Use with our **CHANNELIZER** or your crystals. Priced from \$69.95. Matching transmitter strips. Easy construction, clean spectrum, **TWO WATTS** output, unsurpassed audio quality and built in **TONE PAD INTERFACE**. Priced from \$29.95.

**SYNTHESIZER KITS** from 50 to 450 MHz. Prices start at \$119.95.

Now available in **KIT FORM** — **GLB Model 200 MINI-SIZER**.

Fits any HT. Only 3.5 mA current drain. Kit price \$159.95 Wired and tested. \$239.95

Send for **FREE 16 page catalog**.

We welcome Mastercharge or VISA

**GLB ELECTRONICS**  
1952 Clinton St., Buffalo, N. Y. 14206

## NEW FM/CW EXCITER KITS

BUILD UP YOUR OWN GEAR FOR MODULAR STATIONS, REPEATERS, & CONTROL LINKS

- Rated for Continuous Duty
- Professional Sounding Audio
- Built-in Testing Aids



T50 Six Channel, 2W Exciter Kit for 2M, 6M, or 220 MHz ..... \$49.95

## FAMOUS HAMTRONICS PREAMPS

let you hear the weak ones!

Great for OSCAR, SSB, FM, ATV. Over 10,000 in use throughout the world on all types of receivers.

**P9 Kit \$12.95**  
**P14 Wired \$24.95**

Deluxe vhf model for applications where space permits.



- 1-1/2 x 3"
- Covers any 4 MHz band
- 12 Vdc
- Ideal for OSCAR
- Diode protection
- 20dB gain

MODEL	RANGE
P9-LO	26-88 MHz
P9-HI	88-172 MHz
P9-220	172-230 MHz
P14 Wired	Give exact band



**P8 Kit \$10.95**  
**P16 Wired \$21.95**

- Covers any 4 MHz band
- 20 dB gain
- 12 Vdc
- Miniature VHF model for tight spaces - size only 1/2 x 2-3/8 inches.

MODEL	RANGE
P8-LO	20-83 MHz
P8-HI	83-190 MHz
P8-220	220-230 MHz
P16 Wired	Give exact band

**P15 Kit \$18.95**  
**P35 Wired \$34.95**

- Covers any 6 MHz band in UHF range of 380-520 MHz
- 20 dB gain
- Low noise



## YOU ASKED - HERE THEY ARE! VHF Linear PA's

- Use as Linear or Class C PA's
- For XV-2 Xmtg Converters, T50 Exciters, or any 2W Exciter

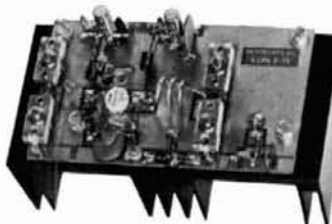

LPA 2-15 Kit \$59.95

- 15W out (linear) or 20W (class C)
- Solid State T/R Switching
- Models for 6M, 2M, or 220 MHz

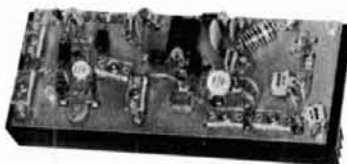

LPA 2-45 Kit \$109.95

- 45W out (linear) or 50W (class C)
- Models for 6M or 2M
- LPA 8-45 Kit \$89.95
- For 2M, 8-10W in, 45W out

# AT LAST! 6M, 2M, & 1 1/4 M SSB TRANSMITTING CONVERTERS

## At a price you can afford

Use inexpensive recycled 10 or 11 meter ssb exciter on VHF bands!

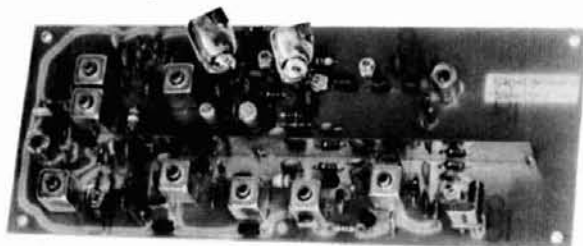

### FEATURES:

- Linear Converter for SSB, CW, FM, etc.
- A fraction of the price of other units
- 2W p.e.p. output with 1 MW of drive
- Use low power tap on exciter or attenuator pad
- Easy to align with built-in test points

**XV2-( ) TRANSVERTER KIT \$59.95**  
**A25 Optional Cabinet for Xverter & PA \$20**

### Frequency Schemes Available:

XV2-1	28-30 MHz =	50 - 52 MHz
XV2-2	28-30 MHz =	220-222 MHz
XV2-4	28-30 MHz =	144-146 MHz
XV2-5	28-29 MHz =	145-146 MHz
XV2-6	26-28 MHz =	144-146 MHz

## New VHF&UHF Converter Kits

let you receive OSCAR signals and other exciting SSB, CW, & FM activity on your present HF receiver.



either one  
**- ONLY \$34.95**  
including crystal



MODEL	RF RANGE (MHZ)	I-F RANGE
C50	50-52	28-30
C144	144-146	28-30
C145	145-147 (OSCAR)	28-30
C146	146-148	28-30
C110	Aircraft	28-30
C220	220 band	28-30
Special	Other i-f & rf ranges available	

MODEL	RF RANGE (MHZ)	I-F RANGE
C432-2	432-434	28-30
C432-5	435-437 (OSCAR)	28-30
C432-7	427.25	61.25
C432-9	439.25	61.25
Special	Other i-f & rf ranges available	

A9 Extruded Alum Case/Connectors \$12.95

## VHF/UHF FM RCVR KITS

- NEW GENERATION RECEIVERS
- MORE SENSITIVE • MORE SELECTIVE (70 or 100 dB)
- COMMERCIAL GRADE DESIGN
- EASY TO ALIGN WITH BUILT-IN TEST CKTS
- LOWER OVERALL COST THAN EVER BEFORE



R70 6-channel VHF Receiver Kit for 2M, 6M, 10M, 220 MHz, or com'l bands..... \$69.95  
Optional xtal filter for 100 dB adj chan 10.00



R90 UHF Receiver Kit for any 2 MHz segment of 380-520 MHz band..... \$89.95

## \* FREE 1978 CATALOG \*

NEW JUNE 1978 CAT. IS YOURS FOR THE ASKING!

### IT'S EASY TO ORDER!

- CALL OR WRITE NOW FOR FREE CATALOG OR TO PLACE ORDER!
- PHONE 716-663-9254. (Answering service evenings and weekends for your convenience. Personal service 9-5 eastern time.)
- Use credit card, c.o.d., check, m.o.
- Add \$2.00 shipping & handling.

IN CANADA, send to Comtec; 5605 Westluxe Ave; Montreal, Que H4W 2N3 or phone 514-482-2640. Add 38% to cover duty, tax, and exchange rate.

# hamtronics, inc.

182-K Belmont Rd; Rochester, NY 14612

# We're Proud of Our Flock!



MODEL 43

## BIRD

ALL MODELS AND TABLE I ELEMENTS IN STOCK.  
WE ALSO CARRY OTHER BIRD PRODUCTS... WRITE!

**NEW PRICE \$125.00**

AUTHORIZED BIRD DISTRIBUTOR — DEALER INQUIRIES INVITED.

We are also Dealers for:



YAESU

KLM electronics

Mosley



Wilson



ALL PREPAID & CREDIT CARD ORDERS SHIPPED NO CHARGE IN U.S.  
SALES TAX 4% TO VIRGINIA RESIDENTS ONLY.  
SPECIALISTS IN HANDLING FOREIGN ORDERS



**ELECTRONIC EQUIPMENT BANK, INC.**

516H MILL STREET, VIENNA, VA 22180

CALL 703-938-3511

# ALUMA TOWERS

60 Ft.  
Ham Crank-Up  
Model T-60-H

40 Ft.  
Crank-Up  
Ham Model T-140

HIGHEST QUALITY

MADE IN ALUMINUM

★ TELESCOPING  
(CRANK UP)

★ GUYED

★ TILT OVER MODELS

QUALITY MADE

Excellent for

**HAM COMMUNICATIONS**

MANY MODELS MFG.

Towers to 100 feet. Specials designed & made. See dealer or send for free catalog.

**ALUMA TOWER CO.**  
BOX 2806HR  
VERO BEACH, FLA. 32960  
PHONE (305) 567-3423

SURPLUS  
GOODIES

**Wilson**

Jennings Vacuum Relay  
RF2B \$18.00

Muffin Fan  
\$7.50

Send stamp  
for catalog



**TETRA TOWER SPECIALS**

"While They Last"

Lightweight, easy to assemble tower kits. Properly guyed, will handle 10 sq. ft. antenna at 68 ft.

68' Tower (List \$389.70) \$235.00  
45'4" Tower (List \$259.80) \$160.00

Accessories (Optional):

Guy Kit for 68' tower \$137.95  
Guy Kit for 45'4" tower \$93.95  
Rotor Plate Kit \$29.95

**Amateur Radio Center**  
11 S. Morris, Mesa, AZ 85202

(602)833-8051

Please allow for shipping charges. AZ residents add sales tax.

**Eimac TUBES**  
In Stock

3-400Z	4-65A
3-500Z	4-250A
3-1000Z	4-400A
3CX2500F3	4-1000A
4CX250B	7289
4CX250BC	8873
4CX250K	8874
4CX250R	8875
4CX350A	8877
4X150A	& More

Sockets, chimneys, plate connectors & finger stock also available. All tubes are new, Eimac guaranteed. Call or write for quotes.

**BENCH POWER SUPPLY**  
5 to 30 VDC ADJUSTABLE



Newest, state-of-the-art IC regulator chip provides outstanding features at low cost.

- Adjustable 5 to 30 VDC
- Regulation 1% of Vo, No Load to Full Load
- Deluxe Panel Meter
- 1 Amp Output Current
- Thermal Overload Protection
- Short Circuit Protection
- Metal Cabinet

An honest value at \$48.50  
Prepaid UPS anywhere in USA  
(Please Include Street Address)

**Harper-Stanley Co.**  
305 University Tower Bldg.  
Little Rock, Ark. 72204



## TROUBLE FREE TOUCH - TONE ENCODER



PP-1

POSITIVE TOUCH (KEYS DEPRESS) • MOBILE • HANDHELD  
POSITIVE MOUNT • NO POTTED PARTS (SERVICEABLE)  
MIL. SPEC. COMPONENTS • NO RFI • SELF CONTAINED  
XTAL CONTROLLED • LEVEL ADJUSTMENT FROM FRONT  
Supplied with: Instructions, schematic, template, hardware. Operating Voltage: 4.5 - 60V. PP-1A, designed for Standard Communications Handhelds.

(California residents add 6% sales tax.)  
PP-1=\$55.00, PP-2=\$58.00, PP-1A=\$58.00  
PP-1M=\$55.00, PP-2M=\$58.00, M series-Mobile  
PP-1K=\$66.00, PP-2K=\$69.00.

K-series = Self Contained Delay Relay  
LETTERING OF UNITS OPTIONAL

Available at: Ham Radio Center (800) 325-3636  
Denver Colo., CW Electronics (303) 893-5525  
Medford, MA, Tufts (617) 395-8280  
Los Angeles, Henry Radio (213) 272-0861  
New York City, Harrison (800) 645-9187



PP-2

Mail Order To **Pipo Communications**

P.O. Box 3435, Dept. B  
Hollywood, California 90028  
213/852-1515

**COMPLAINTS?**  
... SEE FOR YOURSELF!

**NATIONWIDE SPECTRUM-ANALYSIS SERVICE**

FOR ALL LEGAL AMATEUR TRANSMITTERS.

Most FM-up \$1795  
Most HF \$2500

Now you can get written proof of your unit's transmission purity with spectrum analysis done on HP lab equipment. All units carefully re-packed, insured, and shipped within 24 hrs. Send 25¢ or 5ASE for full details and authorization form.

Photograph optional at \$5.00 additional cost.

**SPECTRONICS, INC.**  
1009 GARFIELD ST.  
OAK PARK, ILL. 60304  
(312)848-6777

# the super-compact ALDA 103

only 3 1/4" high x 9" wide x 12 1/2" deep • less than 8 1/4 pounds

ALDA 103, the trim little powerhouse with incredible performance for the price! ALDA 103 provides a full 250 watts PEP input for SSB operation, and 250 watts DC input for CW. And when it comes to performance, ALDA 103 is the hottest little transceiver going — all solid state, totally broadbanded and super-stable VFO.

Ideal first transceiver for brand new novices! You'll want a full-capability CW/USB/LSB unit with all the power and performance you can use. ALDA 103 gives you 250 watts DC input for CW, the maximum allowable power for your novice license. When you upgrade to technician, you've got 2 bands

for CW operation. And with your general license, just plug in your mic and use the ALDA 103's full 250 watts PEP on SSB!

Perfect second or mobile unit for seasoned hams! If you're looking for a super-sharp, compact unit to use in your car or boat, ALDA 103 will live up to your expectations. Absolute worst case sensitivity 0.5  $\mu$ V for 10 dB S+N/N — a must for mobile operation. Receiver audio output of 3 watts minimum — another must. Also, very low receiver power drain of only 5.5 watts — that's 0.4 amps at nominal 13.8 VDC including power for dial and meter lamps!



## GENERAL SPECIFICATIONS

**Semiconductors:** 39 diodes, 23 transistors; 11 integrated circuits

**Power Requirements:** Nominal 13.8 VDC input at 15 amps, negative ground only

**Power Consumption:** Receive — 5.5 watts (includes dial and meter lamps); Transmit — 260 watts

**Dimensions:** 3-1/4" high x 9" wide x 12-1/2" deep (82.55 mm x 228.6 mm x 317.5 mm)

**Weight:** 8-1/4 lbs. (3.66 kg)

## PERFORMANCE SPECIFICATIONS

**Frequency Range:** 80 meter band — 3.5 to 4.0 MHz  
40 meter band — 7.0 to 7.5 MHz  
20 meter band — 14.0 to 14.5 MHz

**Modes:** CW, USB, LSB

**RF Input Power:** SSB — 250 watts PEP nominal  
CW — 250 watts DC maximum (adjustable)

**Transmitter:**

Antenna Impedance: 50 ohm, unbalanced

Carrier Suppression: Better than -45 dB

Side-Band Suppression: Better than -55 dB at 1000 Hz

**Distortion Products:** Better than -26 dB  
500 to 2500 Hz

**AF Response:** Harmonics better than -45 dB below 30 MHz; better than -60 dB above 30 MHz

**Spurious Radiation:** Less than 100 Hz drift per hour (from a cold start at room temperature)

**Frequency Stability:** High impedance 3000 ohm

**Microphone:**

**Receiver:**

**Sensitivity:** Better than 0.5 watts audio output for 0.5  $\mu$ V input

**Signal-to-Noise Ratio:** Better than 10 dB S+N/N for 0.5  $\mu$ V input

**Image Ratio:** Better than -60 dB  
(typical with respect to 0.5  $\mu$ V input: 80 meters — -130 dB; 40 meters — -100 dB; 20 meters — -75 dB)

**IF Rejection:** Better than -70 dB  
(typical with respect to 0.5  $\mu$ V input: 80 meters — 110 dB; 40 meters — 80 dB; 20 meters — 75 dB)

**Intermodulation Intercept Point:** Better than 10 dBm

**Selectivity:** 2.5 kHz — 6 dB; 5.0 kHz — 60 dB

**Audio Output Power:** More than 3 watts

**Audio Distortion:** Less than 5% at 3 watts

# \$495

## OPTIONS & ACCESSORIES

Noise Blanker —  
Model No. PC 701 . . . . . \$39.95

100 kHz and 25 kHz  
Dual Crystal Calibrator —  
Model No. PC 801 . . . . . \$19.95

Portable Power Supply — Model  
No. ALDA PS 115: average duty  
15 amp unregulated; input —  
115/230 VAC, 50/60 Hz; output —  
13.8 V nominal at 15 amps . . . \$84.95

Heavy Duty Power Supply — Model  
No. ALDA PS 130: output —  
regulated 30 amp at 13.8 VDC; input —  
115/230 VAC, 50/60 Hz . . . . \$149.95

alda communications, inc. 215 Via El Centro Oceanside, CA 92054 (714) 433-6123

EUROPE: Contact Datacom, Box 442, S-194 04 Upplands Vasby, Sweden

EXCEPT FRANCE: Poussielgues Diffusion Electronique Sarl, 89 Bis Rue De Charenton — 75012 Paris

ALDA 103 is completely manufactured in the U.S.A.

POLY PAKS



REBELLION

WE'RE FIGHTING BACK INFLATION WITH THIS EXCLUSIVE 1¢ SALE BUY 1 AT SALE PRICE, GET 2ND FOR 1¢ MORE!!!

THIS SPECIAL ONE CENT SALE IS FOR MAGAZINE ADS ONLY

LED WATCH GUTS \$1.95 2 for \$1.96

Factory "lay-arounds." Do they work? Who knows! A micro digital technicians bonanza. The complete guts are there. With clock case and leatherette band. 5 functions: HOURS, MINUTES, SECONDS, MONTH, & DATE. Sorry, no specs. Cat. No. 9H5267 Wt 4.0z.



IMAGINE GETTING A CALCULATOR REJECT FOR ONLY A PENNY!!!! Your Choice \$5.95 2 for \$5.96 LED OR FLOURESCENT CALCULATOR GAMBLE!

PARTS ALONE ARE WORTH MORE THAN PRICE!

The gamble of a lifetime... YOU CAN'T LOSE! Factory dumps his production-line rejects and rejects? Mostly keyboard problems, we are told. But at these prices, who cares! Vest pocket size only 3.6 x 1.1. Dept. # 9H5292 Fluorescent # 9H5291 LED.

Choose from 2 styles: GREEN fluorescent 12 1/2 digits, or RED all LED 12 1/2 digits. Both styles feature 8 digits, 22 keys, 4 arithmetic functions, 4 memory functions, percent, equals, clear. All units complete, and include operation manual. (Batteries not included) Wt. 6 ozs.

PARTS & SEMI "ONE CENTERS"

Table listing various electronic components like channel selectors, relays, capacitors, and resistors with their descriptions and prices.

TTL'S AT "CENT-CIBLE" PRICES

Table listing TTL integrated circuits with their part numbers, descriptions, and prices.

POP-AMPS AT "CENT-CIBLE" PRICES

Table listing various pop-up amplifiers with their part numbers, descriptions, and prices.

PENNIES FOR YOUR MEMORIES!

Table listing small electronic components like RAM and PROMs with prices.

14000 Epoxy Rectifiers

Table listing 14000 series epoxy rectifiers with their specifications and prices.

BULLET RECTIFIERS!

Table listing bullet rectifiers with their specifications and prices.

10 AMP POWER TABS!

Table listing 10 amp power tabs with their specifications and prices.

CONDENSER MIKE

Condenser microphone with tie-pin type, 7/16 x 1/2 inch, 1/2 inch long. Price \$4.96.

ZENERS!

Table listing various Zener diodes with their specifications and prices.

7-SEGMENT READOUTS

Table listing 7-segment readouts with their specifications and prices.

RELAYS!

Table listing various relays with their specifications and prices.

AMPLIFIERS!

Table listing various amplifiers with their specifications and prices.

DIP SWITCHES!

Table listing various DIP switches with their specifications and prices.

IC SOCKETS!

Table listing various IC sockets with their specifications and prices.

POLY PAKS

Send for FREE CATALOG P.O. BOX 942-H9 LYNNFIELD, MA ZIP 01940

LYTIC KLINIK

Electrolytic capacitors in various styles and values.

# flea market



**CANADIANS:** 1,000,000 surplus electronic parts. Hundreds of fantastic bargains! Good deals on Yaesu & Icom. Free catalog. ETCO-HR, 183G Hymus Blvd., Pointe Claire, Quebec H9R 1E9.

**UNLIMITED VHF/UHF EQUIPMENT** is at Radios UNlimited. From transverters to specialized transceivers, from mobile whips to E-M-E Arrays. Plus all accessories. Authorized dealer for top manufacturers. (Also all your needs from 160 to 10) RUN in, write or phone — Radios UNlimited, 1760 Easton Avenue, Somerset, New Jersey 08873, 201-469-4599 — Hours 1 to 8 Mon-Fri; 10 to 8 Sat.

**BUY-SELL-TRADE.** Send \$1.00 for catalog. Give name, address and call letters. Complete stock of major brands new and reconditioned equipment. Call for best deals. We buy Collins, Drake, Swan, etc. SSB & FM. Associated Radio, 8012 Conser, Overland Park, KS 66204. 913-381-5900.

**ELECTRONIC EQUIPMENT HOTLINE** is a new classified advertising newsletter for buying and selling professional, industrial, and surplus electronic equipment. Subscriptions \$6/year, ads 50¢/word. Prepublication offer: \$1 off subscriptions and 20% off all ads postmarked by October 1, 1978. Electronic Equipment Hotline, P.O. Box 4768, Panorama City, CA 91402.

**PORTA PAK** the accessory that makes your mobile really portable. \$67.50 and \$88.00. Dealer inquiries invited. P.O. Box 67, Somers, Wisc. 53171.

**HAM RADIO HORIZONS**, a super new magazine for the Beginner, the Novice and anyone interested in Amateur Radio... What it's all about, How to get started, The fun of ham radio. It's all here and just \$10.00 per year. HURRY! HURRY! Ham Radio HORIZONS, Greenville, NH 03048.

**FREE CATALOG** of new merchandise. Resistors, capacitors, IC's, semiconductors, and more. Send to: Key Electronics, Box 3506H, Schenectady, New York 12303.

**MOTOROLA HT220, HT200, and Pageboy** service and modifications performed at reasonable rates. WA4FRV (804) 320-4439, evenings.

**AUTHORIZED DEALER** for DenTron, KLM, Larsen, Bearcat, etc.. Big Catalog 201-962-4695 Narwid Electronics, 61 Bellot Road, Ringwood, N.J. 07456.

**RECONDITIONED TEST EQUIPMENT** for sale. Catalog \$5.50. Walter, 2697 Nickel, San Pablo, Ca. 94806.

**TELETYPEWRITER PARTS WANTED:** for all machines manufactured by: Kilenschmidt Corp., Teletype Corp. and Mite. Any quantity, top prices paid send list for my quote. Phil Rickson, W4LNW, Rt. 6, Box 1103G2, Brooksville, FL 33512.

**VERY In-ter-est-ing!** Next 3 issues \$1. "The Ham Trader", Sycamore, IL 60178.

**QSL CARDS 500/\$10.** 400 illustrations, sample. Bowman Printing, Dept. HR, 743 Harvard, St. Louis, MO 63130.

**HOME BREWERS:** Stamp brings component list. CPO Surplus, Box 189, Braintree, Mass. 02184.

**CREATIVE QSL CARDS** — New designs. Send 50¢, receive catalog, samples. WILKINS CREATIVE PRINTING, Box 787-2, Atascadero, CA 93422.

**SELL:** Tektronic 545B with manual \$495. Plug-ins and calibration equipment also available. WB9JGP. (303) 722-2257.

**DRAKE SPR-4 RECEIVER.** Mint condition. Includes noise blanker, calibrator and crystals for 10-80M, foreign broadcast, CB. \$455. K4KZE, 2337 3rd Place NW, Birmingham, AL 35215.

**CENTRAL ELECTRONICS 100V \$295.00.** National NC300 with Johnson 6 & 2 Converter \$150.00, TT-16/FG Repeater \$25.00, Tape Reader \$15.00, HB 2kW 2 Meter Linear with three 4 x 150s \$75.00, K0PUX. (308) 254-6330.

**ROHN TOWERS** — Buy Wholesale from National Distributor — 48' Foldover Tower \$471.50 freight paid — 25G sections \$33.86 each — 45G sections \$54.89 each — 48' BX free standing \$240.67. Order now and beat August 1 price increase. Hill Radio, 2503 G.E. Road, Bloomington, IL 61701. (309) 663-2141.

**YAESU EQUIPMENT OWNERS** — Present or Prospective — Join the seven-year-old 3500 member, 46 country, International Fox-Tango Club. Members receive valuable monthly Newsletter, money-saving purchasing service, technical committee consultation, free ads, FT net, more. Back issues of Newsletter available from 1972. To join, send \$6 for calendar year (includes all 1978 issues of Newsletter) or \$1 creditable towards dues, for complete information and sample Newsletter. Milton Lowens, WA2AOC/N4ML, 248 Lake Dora Drive, W. Palm Beach, FL 334111.

**RATES** Non-commercial ads 10¢ per word; commercial ads 60¢ per word both payable in advance. No cash discounts or agency commissions allowed.

**HAMFESTS** Sponsored by non-profit organizations receive one free Flea Market ad (subject to our editing). Repeat insertions of hamfest ads pay the non-commercial rate.

**COPY** No special layout or arrangements available. Material should be typewritten or clearly printed (not all capitals) and must include full name and address. We reserve the right to reject unsuitable copy. Ham Radio cannot check each advertiser and thus cannot be held responsible for claims made. Liability for correctness of material limited to corrected ad in next available issue

**DEADLINE** 15th of second preceding month.

**SEND MATERIAL TO:** Flea Market, Ham Radio, Greenville, N.H. 03048.

**WANTED:** Magnum 6 Speech Processor for Drake Separates. K1XX, 603-899-5621

**WANTED:** Skynedle or equivalent crank-up tower, minimum 75 feet. Must support 16 square feet ungued. N1GL, 136 Knob Loch Lane, Stamford, CT 06902. (203) 348-1331 (eves); (212) 953-5943 (days).

**ELECTRONIC BARGAINS, CLOSEOUTS, SURPLUS!** Parts, equipment, stereo, industrial, educational. Amazing values! Fascinating items unavailable in stores or catalogs anywhere. Unusual FREE catalog. ETCO-012, Box 762, Plattsburgh, N.Y. 12901. SURPLUS WANTED.

**MOBILE IGNITION SHIELDING** provides more range with no noise. Available most engines. Many other suppression accessories. Literature, Estes Engineering, 930 Marine Dr., Port Angeles, WA 93862.

**HAPPY BIRTHDAY!** Now ten years fighting TVI. The RSO low pass filter. For brochure write: Taylor Communications Manufacturing Company, Box 126, Agincourt, Ontario, Canada MIS 3B4.

## Foreign Subscription Agents for Ham Radio Magazine

Ham Radio Austria  
Karin Ueber  
Postfach 2454  
D-7850 Loerrach  
West Germany

Ham Radio Holland  
MRL Electronics  
Postbus 88  
NL-2204 Delft  
Holland

Ham Radio Belgium  
Stereohouse  
Brusselsesteenweg 416  
B-9218 Gent  
Belgium

Ham Radio Italy  
STE Via Maniago 15  
I-20134 Milano  
Italy

Ham Radio Canada  
Box 114, Goderich  
Ontario, Canada N7A 3Y5

Ham Radio Switzerland  
Karin Ueber  
Postfach 2454  
D-7850 Loerrach  
West Germany

Ham Radio Europe  
Box 444  
S-194 04 Upplands Vasby  
Sweden

Ham Radio UK  
P.O. Box 63, Harrow  
Middlesex HA3 6HS,  
England

Ham Radio France  
Christiane Michel  
F-89117 Parly  
France

Holland Radio  
143 Greenway  
Greenside, Johannesburg  
Republic of South Africa

Ham Radio Germany  
Karin Ueber  
Postfach 2454  
D-7850 Loerrach  
West Germany

## 430-450 MHz

### UHF POWER MODULE

 430-450 MHz — Factory New, leading manufacturer. 200 Milliwatts input at 430-450 MHz will get 12 Watts output. Input Voltage is 13.6 Volts DC. No tuned circuits required. Hook-up supplied and all units tested before shipment.  
**\$10.00 ea. ppd.**

Highest Quality E. F. Johnson Trimmer Caps. Hard-to-find P.C. board mount. .5-11 mfd. No junk. 90¢ each; 10 for \$7.50 ppd.

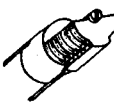

In-Line Fuseholder — Complete with 5 Amp fuse. 50¢ ea. ppd.



XTAL Socket — Standard HC-6 style 10¢ ea. ppd.

Vertical Mount Trimmer Pots — All highest quality. No junk. 100 - 1000 - 2000 - 5000 - 10K - 20K - 25K - 50K - 250K - 500K Ohms. All have thumbscrew adjust. Your choice 5 for \$1.00 ppd.

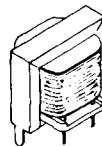

Transformer — 115 VAC Primary. 12 Volt AC 200 mA Secondary. PC board type. \$1.00 ea. ppd.

Mini-LEDs — Factory New — Color red. 15¢ ea. ppd.



Germanium Diodes — 1N34A. Factory New — full leads. 12¢ ea. ppd.

1N914-1N4148 Type diodes — full leads. 10¢ ea. or 100 for \$8.00

6 foot AC Line Cords. 2 conductor heavy duty. Color white. 40¢ ea. ppd.

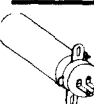

**SUPER-BUY** — 5000 mfd. @ 40 volt electrolytic cap. factory new and complete w/all hardware. \$1.35 ea. ppd.

1000 volt PIV 2 amp diodes .10 ea.

88 mHy unpotted toroids 5 for \$3.50

S0239 Coax Fittings . . . . . 50¢ ea.  
PL259 Coax Fittings . . . . . 50¢ ea.

Transformer: 115V AC Primary, Secondary 17-0-17V @ 7 Amps. We tested and find good for 10 Amps intermittent duty. Ideal for 2M rigs! \$8.00 ea. ppd.

ALL ITEMS PPD USA  
SEND STAMP FOR LIST OF BARGAINS  
PA RESIDENTS ADD 6% SALES TAX  
FONE 412-863-7006



**Full Electronics**  
12690 ROUTE 30  
NORTH HUNTINGDON, PA. 15642

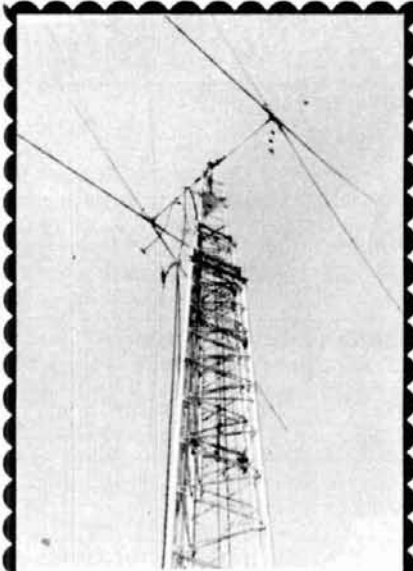

## The Popular CUA 64-12 by Heights

Light,  
permanently  
beautiful  
**ALUMINUM**  
towers

**THE MOST IMPORTANT  
FEATURE OF  
YOUR ANTENNA  
IS PUTTING  
IT UP WHERE  
IT CAN DO  
WHAT YOU EXPECT.  
RELIABLE DX —  
SIGNALS EARLIEST IN  
AND LAST OUT.**

### ALUMINUM

Complete Telescoping  
and Fold-Over  
Series Available  
Self-Supporting  
Easy to Assemble  
and Erect  
All towers mounted  
on hinged bases

And now, with motorized options, you can crank it up or down, or fold it over, from the operating position in the house.

Write for 12 page brochure giving dozens of combinations of height, weight and wind load.

Please include 30¢ (stamps or coins) for postage and handling when requesting our free literature.

ALSO TOWERS FOR WINDMILLS

## HEIGHTS MANUFACTURING CO.

In Almont Heights Industrial Park  
Almont, Michigan 48003

# flea market

**CQ AND QST** 1950-1975 issues for sale. Send SASE if ordering Ham Radio, 73, or other CQ and QST issues. One dollar minimum order and all issues cost 25¢ each, including USA shipping. Send chronological list and full payment to W6LS, 2814 Empire, Burbank, CA 91504.

**TECH MANUALS** for Govt. surplus gear — \$6.50 each: SP-600JX, URM-25D, OS-8A/U, TS-173/UR. Thousands more available. Send 50¢ (coin) for 22-page list. W3IHD, 7218 Roanne Drive, Washington, DC 20021.

**CUSTOM** printed and photo QSL's, very economical; free samples. Stamp appreciated. Stu, K2RPZ, Box 412, Rocky Point, NY 11778. (516) 744-6260.

**TELETYPE EQUIPMENT** for beginners and experienced operators. RTTY machines, parts, supplies. Beginner's special: Model 15 Printer and demodulator \$139.00. Dozen black ribbons \$6.50; case 40 rolls 11/16 perf. tape \$17.50 FOB. Atlantic Surplus Sales, 3730 Nautilus Ave., Brooklyn, N. Y. 11224. Tel: (212) 372-0349.

**THE "CADILLAC"** of QSL's! Samples: \$1.00 (Refundable) — W5YI, Box #1171-D; Garland, Texas 75040.

**TELETYPEWRITER PARTS**, gears, manuals, supplies, tools, toroids. SASE list. Typetronics, Box 8873, Ft. Lauderdale, FL 33310. N4TT Buy parts, late machines.

**EXCLUSIVELY HAM TELETYPE** 24th year, RTTY Journal, articles, news, DX, VHF, classified ads. Sample 35¢. \$3.50 per year. 1155 Arden Drive, Encinitas, Calif. 92024.

**MANUALS** for most ham gear made 1937/1970. Send only 25¢ coin for list of manuals, postpaid. HI, Inc., Box H864, Council Bluffs, Iowa 51501.

**QSL FORWARDING SERVICE** — 30 cards per dollar. Write: QSL Express, 30 Lockwood Lane, West Chester, PA. 19380.

**RECEIVE PARTS LISTS** regularly for \$4/yr. Surplus Parts, P.O. Box 7057, Norfolk, VA 23509.

**WANT UP-TO-DATE INFORMATION?** Radio-Hobbyist Newsletter issued every 2 weeks. Only \$5.00 year. W5YI, Box 1171-D, Garland, Texas 75040.

**EZ deals** are the best! Try me and see for Yaesu, Drake, KLM, Swan, Cushcraft, DenTron, VHF Eng, ICOM, CDE, Hustler, Wilson and more. Call, see or write W0EZ, Bob Smith Electronics, RFD 3, Hwy 169 & 7, Fort Dodge, IA 50501. (515) 576-3886.

**THE MEASUREMENT SHOP** has used/reconditioned test equipment at sensible prices; catalog. 2 West 22nd St., Baltimore, MD 21218.

**RADIO MUSEUM NOW OPEN.** Free admission, 15,000 pieces of equipment from 1850 telegraph instruments to amateur and commercial transmitters of the 1920s. Amateur station W2AN. Write for information: Antique Wireless Assn., Main St., Holcomb, NY 14469.

**AMATEUR MICROPROCESSOR EXPERIMENTERS:** 10 MHz  $\pm$  20 ppm Coldweld crystals. 1 ppm/yr. 32 pF. C<sub>0</sub> 6 pF. \$4.25 ea. postpaid. Savoy Electronics, Inc., P.O. Box 5727, Ft. Lauderdale, FL 33310. 305-563-1333.

**AUTHORIZED DISTRIBUTOR** F9FT Antennas, Microwave Modules, RIW Products' new tandem reflector, 19 element, 432 MHz Yagi — Radio Clinic — N2MB (formerly WA2BIT) 212-327-4952.

**SEE SST ANTENNA TUNERS** — Large ad this issue. Builders also send for our catalog of hard-to-find components and much more. SST Warehouse Outlet, 1215 Manhattan Ave., Hermosa Beach, CA 90254. (213) 376-5887.

**HENRY 4K-2** Linear 4kW SSB, 2 kW CW, 3.5/30 MHz floor model, used little, mint \$700 K6PS, 4211 Beresford Way, Flintridge, CA 91011.

**SWAN 500C** w/ac supply, good cond., \$400; Swan 350 w/ac, mint, \$300; 12 V supply for either \$35, Johnson kW match box \$75; SWR bridge for above \$25, 150 acres water front near Baddeck, Nova Scotia, \$20,000; K6PS, 4211 Beresford Way, Flintridge, CA 91011.

**HAM RADIO HORIZONS**, a super new magazine for the Beginner, the Novice and anyone interested in Amateur Radio... What it's all about, How to get started, The fun of ham radio. It's all here and just \$10.00 per year. HURRY! HURRY! Ham Radio HORIZONS, Greenville, NH 03048.

**TEST EQUIPMENT CATALOG** listing used Tektronix, HP and GR equipment at bargain prices. PTI, Box 8699, White Bear Lake, MN 55110. Price \$1.00 refundable with first order.



## HAM REPEATER AUTOPATCH

Offer your club **COMPLETE**  
emergency communications

Commercial quality, gold plated contacts, plug in, epoxy glass PC boards. 12 volt DC or 115 volt AC operation — Power supply included. Four digit access — Single digit releases — field programmable. Hybrid network — No switching required. FCC certified telephone line coupler. Auxiliary "In Use" contacts supplied. Land line "call-in" signalling control contacts provided. Price complete \$498 + \$3 shipping & handling. Master Charge, Bank money order, or certified check acceptable.

Accessories: CES-300 powered tone pad — \$59 BUS-COM Soft-touch® telephone powered mike/pad element — \$34.95.



**MONROE ELECTRONICS, INC.**  
410 Housel Ave., Lyndonville, N.Y. 14098

## H.P. BROADBAND AMPLIFIER MODULE

1.75" x 1" x 0.31", 12 to 20 volts, 50 to 100 ohms in/out, 30 dB gain, 3 dB bandwidth, 10-300 MHz, 100 mW minimum output, 50 MHz N.F. = 7 dB; can be used for receiver preamp, transmitter predriver, TV-FM line amplifier, counter preamp, etc.

New Amplifier, with data \$10 ppd. NY residents add 6% sales tax.

Dealer Inquiries Invited.

## APPLIED INVENTION

RFD #2, ROUTE 21  
HILLSDALE, N. Y. 12529

## MILITARY SURPLUS WANTED

**WE NEED:** ARC-34, ARC-51BX, ARC-92, ARC-94, ARC-102, ARC-109, ARC-115, ARC-116, ARC-131, ARC-134, ARC-164, ARN-82, ARN-83, ARN-84, ARA-48, ARA-50, APN-81, APN-123, APN-147, APX-64, APX-72, 618T, 490T-1, CU-1658A, CU-1669A, 807A, GRC-106, URC-9. **TOP DOLLAR PAID OR TRADE FOR NEW AMATEUR GEAR. WRITE OR PHONE BILL SLEP, (704) 524-7519, SLEP ELECTRONICS COMPANY, HIGHWAY 441, OTTO, NORTH CAROLINA 28763.**



# A NEW GENERATION of the Info-Tech M-200 Series



## M-200E TRI-MODE CONVERTER

### Converts Morse, RTTY & ASCII to Video

- **Morse Reception:** 6-60 wpm with automatic speed & wordspace
- **RTTY Reception:** 4 speeds, 3 shifts, unshift on space select, automatic threshold select, auxiliary baudot loop output, tuning meter, auto. speed readout
- **ASCII Reception:** 110 Baud with built-in T.U.
- **Video Outputs:** 32 character line x 16 line video with scrolling  
72 character line x 16 line video with scrolling
- **Special Feature:** ASCII, Loop or RS232 output on all modes

**PRICE:** M-200E (32) \$500.00  
M-200E (72) 525.00

### Order Direct or From These Dealers

**Advanced Electronics**  
1349 W. King St.  
Cocoa, Florida 32922  
305-631-1190

**Cohon Amateur Supply**  
Highway 475  
Trenton, Ky. 42286

**Emona Electronics**  
661 George St.  
Sidney, N.S.W. Australia  
212-4815

**Germantown Amateur Supply**  
3202 Summer Ave.  
Memphis, Tenn. 38112  
800-238-6168

**Ham Radio Center**  
8342 Olive Blvd.  
St. Louis, Mo. 63132  
800-325-3636

**G. Hutter-Kunststofftechnik**  
Postfach 2129  
D-8990 Lindau (B)  
West Germany  
*(Dealer for Germany, Austria, Switzerland)*

**International Commercial Sales**  
14 Pleasant View Drive  
Annawan, Ill. 61234  
309-935-6567

**Mid Com Electronics, Inc.**  
2506 South Brentwood Blvd.  
St. Louis, Mo. 63144  
314-961-9990

**N&G Distributors**  
4545 N.W. 7th St.  
Miami, Florida 33126  
305-448-7530

**Rickles Electronics**  
2800 W. Meighan Blvd.  
Gadsden, Ala. 35904  
205-547-2534

**Universal Amateur Radio, Inc.**  
1280 Aida Drive  
Reynoldsburg, Ohio 43068  
614-866-4267

Visa & Master-Charge Accepted

# INFO-TECH

## INCORPORATED

Specializing in Digital Electronic Systems

2349 Weldon Pkwy. St. Louis, Missouri 63141 Phone (314)576-5489

# flea market

**QSL CARDS.** Design your own and have printed for less than 3¢ each! Complete instructions. \$1.00. Lionel Industries, Box 64, Lincoln, MA 01773.

**STOP LOOKING** for a good deal on amateur radio equipment — you've found it here — at your amateur radio headquarters in the heart of the Midwest. We may not have a toll free number but we'll save you more in the long run! We are factory-authorized dealers for Kenwood, Drake, Yaesu, Collins, Wilson, Ten-Tec, Atlas, ICOM, DenTron, MFJ, Tempo, Regency, Hy-Gain, Mosley, Alpha, CushCraft, Swan, and many more. Write or call us today for low quote and try our personal and friendly Hoosier service. **HOOSIER ELECTRONICS, P.O. Box 2001, Terre Haute, Indiana 47802. (812) 238-1456.**

**WANTED** — manuals, info, schematics, for: TS-1871 Spectrum analyzer, 881-M1 EEC VLF Receiver, R-839/FLR-2 Receiver, TPG-2 Pulse Generator, R-1037E Receiver, R-1010 AC Regulator. Kernaghan, P.O. Box 17688, Honolulu, HI 96817.

**QUARTZ CRYSTAL CONTROLLED** Clock Movements — \$15.95. Transistorized Movement — \$7.95. Hands included use 'C' cell. Peko, Box 5476, Sherman Oaks, CA 91413.

**SWAN 350 TRANSCEIVER**, power supply, speaker and home brew RF power meter. All good condition \$250. You ship. Ray Foster WA2OOH, Cranford, N. J. 07016. (201) 276-8429.

**40' ROHN TOWER**, Galv. Steel, HAM-M rotator, Kirk 2-element tri-band Super Quad for 10, 15 and 20 meters — fiberglass. All in excellent condition, \$300. Ray Foster WA2OOH, Cranford, N. J. 07016. (201) 276-8429.

**COLLINS 7553B** (SN 17952), 32S3 (SN 13555), 312B4, AC supply, DX Engr Speech Processor, 2.1 and 500 kHz filters, and Hallcrafters "TO" Keyer. \$1200.00 firm, will ship. Richard Somers W6NSV, 9197 Crescent Drive, Los Angeles, CA 90046. (213) 654-7481.

**ATLAS 215X** All Factory Mods (SN 5476) w/noise blanker, MBK mobile mount with cable, MT-1 antenna matching transformer, SWAN #45 All Band antenna w/mount, \$550.00, will ship. Richard Somers W6NSV, 9197 Crescent Drive, Los Angeles, CA 90046. (213) 654-7481.

**MOTOROLA L-53 & L-43 VHF FM 30 & 30 watt** base stations less cabinets, 5 units available, \$75.00 each firm, will ship; GENERAL ELECTRIC UHF FM Pre Prog. Base less cabinet, \$50.00, will ship; MOTOROLA FSATR 250BRA low-band 250 watt base in cabinet, pick up only, \$185.00; MOTOROLA 60 watt VHF Base w/homemade rack mount AC supply less cabinet, will ship, \$50.00; Richard Somers W6NSV, 9197 Crescent Drive, Los Angeles, CA 90046. (213) 654-7481.

**HALLICRAFTERS FPM-300** 80-10 Meter SSB/CW Transceiver w/built-in 12/110/220V supply, will ship, \$285.00 firm. Richard Somers W6NSV, 9197 Crescent Drive, Los Angeles, CA 90046. (213) 654-7481.

## Coming Events

**BYTE**, Drink and be merry at the Tidewater Hamfest, Flea Market and Computer Show, Norfolk, Virginia. September 23-24. Over 60,000 sq. ft. of exhibit and flea market space. All indoors. All air-conditioned. Write TRCI, P.O. Box 9371, Norfolk, Virginia 23505.

**ILLINOIS:** The Sangamon Valley Radio Club of Springfield, Third Annual Hamfest Sunday, September 24th, Sangamon County Fairgrounds in New Berlin, 16 miles west of Springfield. Hear Hugh Vandegriff W4WME talk on the Clipperton DX-pedition! Various exhibits, kids activities and food. Camping. First Prize — Bearcat 210; Tickets: \$1.50 advance, \$2.00 at gate. Information — Al K9QFR; Tickets — Carole WB9QWR, write C/O 1025 S. Sixth, Springfield, Illinois 62703.

**OHIO:** 42nd Annual Cincinnati Hamfest — Sunday, September 17, 1978 at Stricker's Grove on State Route 128, one mile west of Ross (Venice) Ohio. Exhibits, Prizes, Good Food, Refreshments, Flea Market (radio related products only) Music, Good Fellowship, Hidden Transmitter Hunt and Sensational Air Show. No increase in cost, same as last year — \$7.50 in advance. For further information: Lillian Abbott, K8CKI, 1424 Main Street, Cincinnati, Ohio 45210.

**ELMIRA, NEW YORK HAMFEST** — September 30th from 9-5. Door prizes, grand prize, Free Flea Market, tech talks, and more! Contact WA2FJM, John Breese, 340 West Avenue, Horseheads, New York 14845 for tickets and info.

## DIPOLE HEADQUARTERS

### Famous "W2AU" Balun



MODEL 1:1 OF MODEL 4:1 **\$14.95**



HANDLES FULL 2 KW PEAK AND THEN SOME. Broad Banded 3 to 40 Mc. HELPS TRY PROBLEMS by Reducing Coax Line Radiation. NOW ALL STAINLESS STEEL HARDWARE. 50233 Double Silver Plated IMPROVES I/B RATIO by Reducing Coax Line Pick-Up. REPLACES CENTER INSULATOR. Withstands Antenna Pull of Over 400 Lbs. BUILT-IN LIGHTNING ARRESTER. Helps Protect Balun — Could Also Save Your Valuable Gear. BUILT-IN HAND-UP WOOD. Ideal for Inverted Yees, Multi-Band Antennas, Dipoles, Beams and Quads.

MINIMUM ORDER **\$10.00**

**CABLE**  
 8U FOAM, hi density braid, 50' ..... \$11.95  
 8U FOAM, hi density braid, 100' ..... 22.00  
 RG58/U, stranded center, 100' ..... 9.95  
 RG58, 2 ft. w/PL259 on each end, ..... 3.05  
 RG58, 3 ft. w/PL259 on each end, ..... 3.35  
 RG58, 5 ft. w/PL259 on each end, ..... 3.63  
 RG58, 12 ft. w/PL259 on each end, ..... 4.40  
 RG58, 50 ft. w/PL259 on each end, ..... 7.40  
 GUY WIRE, steel/plastic, 100 ft., ..... 4.95

**COPPER WIRE**  
 #14 STRANDED 100' spool, ..... \$5.95  
 #14 SOLID, enameled, 100' spool, ..... 5.95

**INSULATORS**  
 AIRPLANE style, porcelain ins., wt. 2 lb., ..... 2/3 .99  
 DOG BONE style, porcelain ins., wt. 2 lb., ..... 1/2 1.25  
 MAIL KNOB style, stand off ins., wt. 3 lb., ..... 4/ 1.20  
 HY GAIN #155 center insulator, wt. 1.5 lb., ..... 4.95  
 HY GAIN Cycloac end ins. pair, wt. 1 lb., ..... 3.95  
 MOBLEY dipole center insulator, wt. 1 lb., ..... 2.28

**CONNECTORS and ADAPTORS**  
 PL259, UHF male conn., ..... 2 for \$1.50  
 SO236, UHF female, chas. mg., ..... .89  
 UG175, Adaptor RG58 to PL259 ..... 2 for .89  
 UG178, Adaptor RG58 to PL259 ..... 2 for .89  
 PL259, UHF double female ..... .99  
 DSI-5P, UHF double male conn., 1 lb., ..... 1.89  
 M359, 90 deg. UHF elbow conn., ..... 2.10  
 UG88U, BNC male for RG58 ..... 1.49  
 1004, BNC female chassis mg., ..... .99  
 M568, UHF "T" connector ..... 2.10  
 UG235, Adaptor UHF female to BNC male ..... 2.89  
 UG275, Adaptor BNC female to UHF male ..... 1.59

## SPECTRONICS, INC.

1009 Garfield St., Oak Park, Illinois - 60304  
 (312) 848-6777

## PARTS BONANZA

### BC-191 / BC-375 TRANSMITTER TUNING UNITS

We have these Plug-In Tuners available once again — as an excellent source of hard-to-find radio parts! Each includes a 2 1/2" Vernier Dial; a right angle Drive; three 100 Watt Variable Capacitors (except TU-26); Mica Capacitors; Coils; ceramic Band Switches; and more. All are unused. Listing of parts for each available with SASE. 9 x 17 x 7 1/2"; Sh. Wt.: 18 lbs.

TU-5B, 1500-3000 KHz \$12.95 • TU-6B, 3000-4500 \$12.95  
 TU-7B, 4500-6200 \$9.95 • TU-10B, 10000-12500 \$9.95  
 TU-26B, 200-500 \$8.95 • ALL Prices F.O.B., Lima, Oh.  
 Use your VISA, BAC or Master Charge card!  
 Send for our FREE Surplus Electronics Catalog WS-78  
 Address Dept. HR • Phone: 419 227-6573

## FAIR RADIO SALES

1016 E. EUREKA • Box 1105 • LIMA, OHIO • 45802

## LEARN RADIO CODE

### THE EASY WAY!

Based on modern psychological techniques — This course will take you beyond 13 w.p.m. in LESS THAN HALF THE TIME!

**\$9.95**  
 Album contains three 12" LP's  
 2 1/2 hr. instruction

- No Books To Read
- No Visual Gimmicks To Distract You
- Just Listen And Learn

Available in Cassette also for only \$10.95.

## EPSILON RECORDS

P.O. Box 626, San Jacinto, CA 92383

<p><b>REGULATORS</b></p> <p>LM304H \$1.40                  LM309K .95                  LM340-5 .95                  7805 .75                  7808 .85                  7812 .85                  7905 1.10                  7912 1.10                  7915 1.10                  723 DIP .65                  723 TO3 .65</p>	<p><b>JOCKEY STICK</b></p> <p>X-Y FUNCTION                  10K LINEAR POTS                  \$3.95</p>
<p><b>toggle switch</b></p> <p>P-C OR PANNEL MOUNT MINI SWITCH SPOT \$1.00 10/\$8.</p>	<p><b>1N4007</b></p> <p>PRIME 10c NEW</p> <p>1000 PIV 1 AMP.</p>
<p><b>HIGH VOLTAGE diode</b></p> <p>3000PIV 250MA \$1.55                  8000PIV 350MA \$1.25                  6000PIV 750MA \$2.75                  8000PIV 1000MA \$3.50</p>	<p><b>'Spectra Strip'</b></p> <p>12 CONDUCTOR 22 AWG. \$2.50                  5 FT \$2.50                  10 FT 4.00</p>
<p><b>CMOS</b></p> <p>CHIP \$ CHIP \$</p> <p>4000 .20 4027 .45                  4001 .20 4028 .75                  4002 .20 4030 .40                  4006 1.10 4033 1.75                  4007 .25 4035 .95                  4008 .95 4040 1.15                  4011 .20 4042 .75                  4012 .20 4043 .85                  4013 .60 4044 .85                  4014 .90 4049 .50                  4015 .90 4050 .50                  4016 .35 4066 .90                  4017 1.10 4068 .45                  4018 1.25 4069 .40                  4019 .70 4073 .70                  4020 .90 4078 .28                  4021 1.10 4516 1.00                  4023 .20 4528 .98                  4025 .30</p>	<p><b>KIT</b></p> <p>VARIABLE POWER SUPPLY ALL PARTS INCLUDED</p> <p>PS1 5-12 V \$9.95                  PS2 12-28 V 5.95</p>
<p><b>PHOTO CELL</b></p> <p>C.P. CLARE NO. CL-703                  \$1.50 EA. 10/\$4.00</p>	<p><b>50 ohm COAX</b></p> <p>RG 174 U 50 FT. \$2.75</p>
<p><b>CONNECTORS</b></p> <p>BNC-M/UHF-F UG-255U \$3.00</p> <p>BNC-F/UHF-M UG-273U \$2.50</p> <p>N-F/BNC-M UG-349U \$3.75</p> <p>N-F/UHF-M UG-83BU \$4.25</p> <p>N-M/UHF-F UG-146U \$4.25</p> <p>BNC-F/BNC-F UG-914U \$2.00</p> <p>UHF-F/UHF-F PL-258 \$1.50</p> <p>RGB ADPT. UG 175 \$ .25</p>	<p><b>NYLON CABLE TIES</b></p> <p>4 INCH 100EA \$1.50                  6 INCH 100EA \$2.50</p> <p>SO-239 65c                  PL-259 65c                  10/56.00 MIX/MATCH</p>
<p><b>MOLEX PINS</b></p> <p>200 EACH \$1.95                  1000 EACH \$7.95</p>	<p><b>MJE3055</b></p> <p>0 WATTS 60VCE                  10 AMPS NPN                  2/\$1.50</p>
<p><b>JUMBO RED LEDS</b></p> <p>10 EA FOR \$1.00                  100 EA FOR \$7.95</p>	<p><b>.1 ohm FIVE WATT RESISTOR</b></p> <p>5/\$1.00</p>

# YOU ASKED FOR IT YOU GOT IT DSI QUIK-KIT®

## 550 MHZ COUNTER KIT Performance You Can Count On



### OPERATES ON

- Batt 6-C Size
- DC 8.2 To 14.5 VDC
- AC Batt. Eliminator

**\$99.95**  
MODEL 3550 KIT

### DSI OFFERS THE BEST OF TWO WORLDS . . .

An unprecedented DSI VALUE . . . in a high quality, LSI Design, 550 MHZ frequency counter kit. And, because it's a DSI innovation, you know it obsoletes any competitive makes, both in price & performance. The basic 550 MHZ counter & time base are factory assembled, tested and burned-in. The problems of bad LEDs, IC's, capacitors, are a thing of the past with DSI QUIK-KIT®. But you can take pride in assembling the power supply, PC mounted selector switch, input connectors, and the final mechanical assembly of your 550 MHZ counter, into its' handsome cabinet. **GO WITH THE LEADER . . . BUY A DSI FREQUENCY COUNTER KIT. SAVE TIME & MONEY AND BE ASSURED IT WILL WORK THE FIRST TIME.**

### SPECIFICATIONS

**Time Base** TCXO 1PPM 65° to 85°F  
**Frequency Range** 50HZ to 550MHZ  
**Resolution** 1HZ to 55MHZ, 10HZ to 550MHZ  
**Gate Time** 1 second - 1/10 second  
**Sensitivity** 25MV 150 & 250MHZ 75MV 550MHZ  
**Display** Eight 1/2-inch LEDs  
**Input** Two SO239 Connectors  
**Power** 6C-Size Batt., 15HR, or 8.2VDC to 14.5VDC  
**Current** 150 Ma standby 300 Ma operational

### 3550 KIT INCLUDES

- Pre-assembled, tested counter board
- Case, power supply, connectors, hardware
- Built-in prescaler & preamp
- Gate Light - Automatic Zero Blanking
- Automatic Decimal Point
- One to two hours assembly time
- One Year Warranty on all parts
- All new parts - not factory seconds or surplus

3550 Kit . . . . . **\$99.95**  
 T-101 Telescopic Antenna . . . . . **3.95**  
 AC-9 Battery Eliminator . . . . . **7.95**  
 Cigarette Lighter DC Adapter . . . . . **2.95**

**TERMS:** Orders to U.S. and Canada, add 5% to maximum of \$10.00 per order for shipping, handling and insurance. To all other countries, add 15% of total order. California Residents add 6% State Sales Tax.

SEE YOUR LOCAL DEALER  
OR

CALL TOLL FREE (800) 854-2049  
California Residents, Call Collect (714) 565-8402

**DSI INSTRUMENTS, INC.**

7914 Ronson Road No. G, San Diego, CA 92111

VISA • MC  
AMERICAN EXPRESS  
CK • MONEY ORDER  
COD

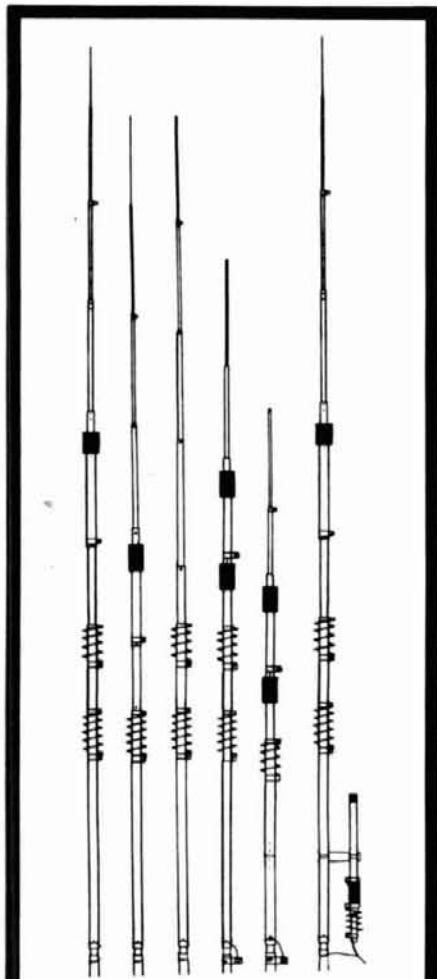

## PILE-UP TESTED!

Model HF5V-II -- Automatic bandswitching 80-10 meters.

Model HF4V-II -- Automatic bandswitching 40-10 meters.

Model HF3V -- Automatic bandswitching 80-20 meters.

Model HF5V-S -- Automatic bandswitching 80-10 meters.

Model HF4V-S -- Automatic bandswitching 40-10 meters.

MODEL TBR -- 160 Meter base resonator unit.

The most choice  
in vertical antennas from



BUTTERNUT  
ELECTRONICS CO.

ROUTE 1: LK. CRYSTAL, MN. 56055

Phone: (507) 947-3126

AT YOUR DEALER OR FACTORY DIRECT...  
FREE INFO!

# flea market

LANSING, MI CMARC Swap-Shop. Oct. 1, 1978. Grand Ledge High School. Prizes — Food — Tables. CMARC Box 10073, Lansing, MI 48901.

ILLINOIS: Rockford ARA Hamfest and ARRL State Convention, September 10, 1978, Winnebago County Fairgrounds, Pecatonica, 10 miles west of Rockford on U.S. 20. Large inside and outside display areas; inside tables available \$3. Snack bar/free camping (electrical hookup \$4). Prizes, microcomputer seminar, ARRL technical discussion, OSCAR presentation, contest talk, Midwest Country Cousins meeting, many others. Come one, come all for FUN. Talk-in on 146.01/61 and 146.52 simplex. Tickets \$1.50 advance, \$2 at door. SASE to Rockford County Amateur Radio Association, P.O. Box 1744, Rockford, Illinois 61110.

WASHINGTON, DC — 1978 ARRL Technical Symposium Saturday, September 16, 1978 at the Tysons Corner Ramada Inn, Falls Church, Virginia in conjunction with the National Capital DX Association's DXPO 78. The Symposium is managed by the Amateur Radio Research and Development Corporation (AMRAD) and sponsored by the Northern Virginia Amateur Radio Council (NOVARC). Previously unpublished papers are invited on all technical subjects relating to amateur radio. Prospective contributors are asked to forward informal summaries along with a photo of the author and a one-page bio sketch of the author's amateur/electronic background by July 15. Manuscripts are due by August 15. Please write or call: Paul Rinaldo, WARI, 1524 Springvale Ave., McLean, VA 22101, (703) 356-8918 eves. or weekends.

NINTH ANNUAL DELTA QSO Party sponsored by the Delta Division of the American Radio Relay League, from 1800Z Sept. 23 to 2400Z Sept. 24, 1978. No time or power restrictions. Amateurs outside of the Delta Division will attempt to contact as many amateurs inside of the Delta Division (Ark-La-Miss-Tenn) as possible. Delta Division Amateurs will attempt to contact as many amateurs as possible both inside of and outside of the Delta Division. The exchange will consist of QSO Number, RST, and QTH (ARRL section for non-Delta Division, county and state for Delta Division). Logs must include date/time, station worked, exchange, band, emission, and multiplier. Stations may be worked on each band/mode. Portables and mobiles may be reworked on the same band/mode if they change counties. Suggested Frequencies: CW 50 kHz from low end and SSB 10 kHz from high end, 28590; Novice center of each novice band. Logs must be postmarked no later than Oct. 21 to be eligible for award consideration. Logs will be returned if requested. Send logs to Malcolm P. Keown, W5RUB, 213 Moonmist, Vicksburg, Miss. 39180.

WESTERN ELECTRIC KEARNY RADIO CLUB will host its 19th annual CQ-WE contest October 28-29, 1978. All amateurs employed by or retired from Western Electric, Bell Labs, Teletype Corporation, and AT&T, as well as their club stations, are invited to participate. The phone sessions are Saturday, October 28th from 1700 to 2200, and 2300 to 0300 GMT. CW and RTTY sessions are Sunday, October 29th from 1800 to 2200 and 0000 to 0300 GMT. The first hour of each CW session is reserved for contacting Novices and Technicians only on at least one end of the two-way QSO. Detailed information and log sheets from the local WORKS COORDINATOR: At Kearny: John Markunas, W2JVJ, Bill Rodney, W2IKH or write Amateur Radio Club, WEKEARNY Club Office, Western Electric Company, 100 Central Avenue, Kearny, New Jersey 07032.

LOUISIANA: New Orleans Hamfest/Computer Fest, September 16th and 17th, Airport Hilton Inn, Kenner, Louisiana. DX Forums, antenna discussions, computer seminars, satellite demonstrations, Navy MARS meeting, FCC exams Sunday morning (make reservations through the committee in advance), Saturday-night luau for 300 persons. Special amateur radio information for CBers. Reserve early because the All-Spinks flight is the same weekend. Talk-in on 34/94. Details from New Orleans Hamfest/Computerfest, P.O. Box 10111, Jefferson, Louisiana 70181.

OHIO: 36TH ANNUAL FINDLAY HAMFEST — Riverside Park, Findlay, Ohio — Sept. 10th. One of Ohio's Finest Hamfests, Giant Flea Market, Two Meter Xmitter Hunt, MARS, P.O., Buckeye Belles, SSB, Net Meetings, Talk-in — 75/15 and 52/52. Advance tickets \$1.50 at the gate \$2.00. For tickets and additional information send a SASE to Clark Foltz W8UN, 122 W. Hobart, Findlay, OH 45840.

## COLLINS & MORE

### Ham Gear

Collins 180S1 Antenna tuner	\$295
Collins 312B4, Sta. Cntl., rd., exc.	\$250
Collins 312B5, Vfo Console, vy gd	\$495
Collins 312B5, Vfo Console, new, orig. box	\$795
Collins 32S3, Transmitter, rnd., exc.	\$850
Collins 75S3B, Ham receiver, vy gd	\$695
Collins 75A4, Ham receiver, vy gd	\$425
Collins 51S1, 2-30MHz rcvr	Special
Collins R-388/51J3 receiver, vy gd	\$425
Hammariund SP-600JX, rcvr	\$395
Collins CP-1 Crystal Pack	\$195
Racal 6217E, .5-30MHz receiver	Special
New R390A rcvr avail.	Call for quote.
Collins 32S3A Transmitter, rnd., new, orig. box	\$1495
Collins 312B4 Console, rnd., new, orig. box	\$325
Collins 30S1 Linear, wing, excellent	\$1695
Collins 30S1 Linear, round, excellent	\$1995
National NCL 2000, 2kW Linear, exc.	\$550

### Test Gear

Boonton Radio 225A 10-500MHz sig. gen., like new	\$550
Boonton Electronics 91CA rf voltmeter, no probe	\$225
Gertsch FM-9 freq./dev. meter	\$795
HP-200CD wide-range oscillator	\$175
HP-202H 54-216MHz AM/FM sig. gen.	\$695
HP-608D 10-420MHz sig. gen.	\$550
Power Designs	
#605, 6VDC, 500mA, lab. p/s	\$60
#1210, 12VDC, 10A, lab. p/s	\$95
Measurements Mod. 65B, LF sig. gen.	\$325
260A Q-meter, exc.	\$450
Model 80, 2-400 MHz sig. gen.	\$350

We stock good, used equipment from Collins, Drake, Heath and other manufacturers. Hundreds of test items also available. Call for specific requirements, or

write for free catalog.

## DAMES COMMUNICATION SYSTEMS

201-998-4256

10 SCHUYLER AVENUE  
NORTH ARLINGTON, N. J. 07032

All equipment sold checked  
and realigned

## 16-POLE R-4C SSB!

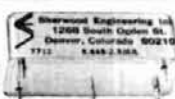

Improve the early-stage selectivity of your Drake R-4C while adding 8 additional poles (total 16) with an internally-mounted, switchable set of first-IF crystal filters. Reduce QRM, leakage, overload. Ideal for DX and contest work. Overall shape factor better than 1.4. Maximum skirt selectivity with CF-2.1K/8: 2100 Hz at -6dB, 2900 Hz at -60 dB. Modest variable bandwidth. Other bandwidths available. Filter set can be mounted in receiver and relay switched with our kits which start at \$33.00. 3 and 4 filter switching options can include our CF-600/6 and/or existing 8-kHz first-IF filter, all internally mounted, controlled from rear or front panel. USB and LSB CF-2.1K/8 pair is \$120.00 per set. Money back if not satisfied. Add \$3 shipping per order. \$6 overseas air. Dealer inquiries welcome.

### Sherwood Engineering Inc.

1268 South Ogden St.

Denver, Colo. 80210

(303) 722-2257



## RADIO WORLD

CENTRAL NEW YORK'S FASTEST  
GROWING HAM DEALER



FT-101E ICOM IC-211

Featuring - Yaesu, ICOM, Drake, Atlas, Den-Tron, Ten-Tec, Swan, Regency, Standard, Tempo, KLM, Hy-Gain, Mosley, Larsen, Midland, Wilson, Southwest Tech Products. We service everything we sell. Write or call for quote. YOU WON'T BE DISAPPOINTED.

We are just a few minutes off the  
NYS Thruway (I-90) - Exit 32.

## RADIO WORLD

ONEIDA COUNTY AIRPORT

TERMINAL BUILDING

ORISKANY, NY 13424

315-337-2622

Warren  
K21XN

Bob  
WA2MHS

# SST T-1 RANDOM WIRE ANTENNA TUNER

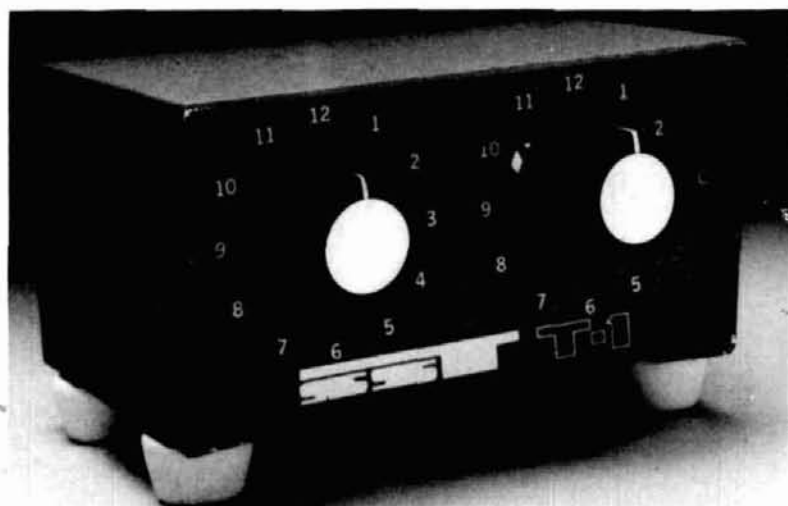

All band operation (160-10 meters) with any random length of wire. 200 watt output power capability—will work with virtually any transceiver. Ideal for portable or home operation. Great for apartments and hotel rooms—simply run a wire inside, out a window, or anyplace available. Efficient toroid inductor for small size: 4-1/4" x 2-3/8" x 3", and negligible loss. Built-in neon tune-up indicator. SO-239 connector. Attractive bronze finished enclosure.

only **\$29.95**

THE ORIGINAL Random Wire Antenna Tuner... in use by amateurs for 6 years.

## SST T-2 ULTRA TUNER

Tunes out SWR on any coax fed antenna as well as random wires. Works great on all bands (80-10 meters) with any transceiver running up to 200 watts power output.

Increases usable bandwidth of any antenna. Tunes out SWR on mobile whips from inside your car.

Uses efficient toroid inductor and specially made capacitors for small size: 5-1/4" x 2-1/4" x 2-1/2". Rugged, yet compact. Negligible line loss. Attractive bronze finished enclosure. SO-239 coax connectors are used for transmitter input and coax fed antennas. Convenient binding posts are provided for random wire and ground connections.



only **\$39.95**



only **\$19.95**

## SST T-3

### Mobile Impedance Transformer

Matches 52 ohm coax to the lower impedance of a mobile whip or vertical. 12-position switch with taps spread between 3 and 52 ohms. Broadband from 1-30 Mhz. Will work with virtually any transceiver—300 watt output power capability. SO-239 connectors. Toroid inductor for small size: 2-3/4" x 2" x 2-1/4". Attractive bronze finish.



**GUARANTEE**



All SST products are guaranteed for 1 year. In addition, they may be returned within 10 days for a full refund (less shipping) if you are not satisfied for any reason. Please add \$2 for shipping and handling. Calif. residents, please add sales tax. COD orders OK by phone.

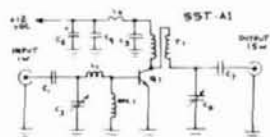

only **\$29.95**

\$49.95 wire and tested

## SST A-1 VHF Amplifier Kit

1 watt input gives you 15 watts output across the entire 2 meter band without re-tuning. This easy-to-build kit (approx. 1/2 hr. assembly) includes everything you need for a complete amplifier. All top quality components. Compatible with all 1-3 watt 2-meter transceivers. Short and open protected—not damaged by high SWR.

Kit includes:

- Etched and drilled G-10 epoxy solder plated board.
- Heat sink and mounting hardware. All components—including pre-wound coils.
- Top quality TRW RF power transistor.
- Complete assembly instruction with details on a carrier operated T/R switch.



## ELECTRONICS

P.O. BOX 1 LAWDALE, CALIF.  
90260 (213) 376-5887

# BIG REGENCY FM CLOSEOUT

Don't pass up the Savings!

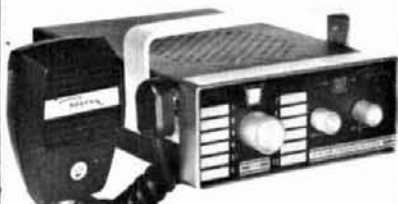

HR-2B 2m Fm Xcvr. 15w, 12ch w/ 94 crystals, mic & mt. (Reg. \$229) ... **CLOSEOUT \$139.00**



HR-312 2m FM Xcvr. 30w, 12ch T/R w/ 94, mic & mt. (Reg. \$269) ... **CLOSEOUT \$169.00**

HR-6 6m FM Xcvr. 25w, 12 ch T/R w/52 525, mic & mt. (Reg. \$239) ... **CLOSEOUT \$149.00**

HR-220 220 MHz FM Xcvr. 12 ch T/R w/223.5, mic & mt. (Reg. \$239) ... **CLOSEOUT \$149.00**

HR-440 440 MHz FM Xcvr. 10w, 12 ch w/ 446.0, mic & mt. (Reg. \$349) ... **CLOSEOUT \$249.00**

AR-2 2m FM Power Amplifier. 13.8vdc - 9 A. max. 5db power gain. 10 to 25w input for 32 to 80w output. (Reg. \$119) ... **CLOSEOUT \$99.00**

HRT-2 Basic 2m FM Hand-Held Xcvr. 2 or 1w, 5 ch w/ 94 crystals. Whip antenna. No other accessories. (Reg. \$179) ... **CLOSEOUT \$99.00**

HRT-2 Deluxe. As above, but includes Nicad Battery, Charger, Flexible Antenna, External Microphone, Earphone, Case and DC Cord with plug. (Reg. \$295) ... **CLOSEOUT \$195.00**

All NEW - Full Warranty!

Extra crystals for 2/6m - \$5.00 each, 220/440 MHz - \$10.00 each. Quantities Limited - Order direct from this ad. Send Check, Money Order or use your Mastercharge or BankAmericard (VISA). Allow \$5.00 for UPS shipping charges.

Write for FREE  
1978 CATALOG



**AMATEUR  
ELECTRONIC SUPPLY®**  
4828 West Fond du Lac Avenue  
Milwaukee, Wisconsin 53216  
Phone (414) 442-4200

**BRANCH STORES:**  
28940 Euclid Avenue; Wickliffe, Ohio 44092  
Phone: (216) 585-7388  
621 Commonwealth Ave.; Orlando, Fla. 32803  
Phone: (305) 894-3238

Note: Branch Stores are set-up to handle Walk-in business or telephone orders only. They do not have facilities to respond to written inquiries.

# flea market

**NEW HAMPSHIRE:** Evans Radio, Inc., of Concord, New Hampshire, celebrates its 45th anniversary as a wholesale distributor of electrical and electronic equipment and components, as well as radio and electronics supplies. An open house will take place September 15, 16 from 9:00 to 4:30 at the firm's headquarters at Route 3A, Bow Junction, and a trade show at the New Hampshire Highway Hotel will feature some 85 displays of electrical and electronic manufacturers products. Buses carrying guests will run continually between the headquarters and trade show throughout the two day celebration. One of the highlights of the day will include a trip for two to a vacation paradise as yet not disclosed.

**MICHIGAN: BLOSSOMLAND** Annual Swap-Shop, Sunday, October 1st, Berrien County Youth Fair Grounds, Berrien Springs. Large facilities. Prizes, refreshments. Open all night for set-up. Table space restricted to radio and electronic items. Advance ticket \$1.50. Tables \$2. Write: John Sullivan, P.O. Box 345, St. Joseph, Mich. 49085. Make checks payable to Blossomland Hamfest.

**GEORGIA:** August ARCA Hamfest, Sunday, September 17 at Julian Smith Casino. Hospitality room Saturday. Bar-B-Q Sunday. Bingo, flea market, prizes. Prize tickets \$1.00, 6 for \$5.00. For info: ARCA, Box 3072, Augusta, GA 30904.

**GEORGIA:** Lanierland ARC fifth annual Hamnic Lanier Islands Dogwood Pavilion, Gainesville. September 24. Swap-shop, exhibits. Food. \$2.00 per car. Picnic, hiking, swimming for kids. First prize: KDK FM2015R. Other prizes. Talk-in on W4IKR on .071.67. For info write: Bob Cochran, W4DNX, 607 East Lake Dr., Gainesville, GA 30501.

**PENNSYLVANIA:** Central Pennsylvania Repeater Association's 5th annual Electronic Swap Fest. Sunday, September 17, Harrisburg. Gates open 8:00 AM. Park-N-Shop garage, Walnut St. Registration: \$3.00, spouse and children free. Free tailgating. Talk-in 146.16/76, 146.34/94, WA3KXG .52/52. Refreshments. For info: WB3HXH, (717) 944-7017.

**PENNSYLVANIA:** Third annual HamJam sponsored by the Radio Association of Erie, Sunday, September 24 from 9 AM to 4 PM at Waldameer Park in Erie. Admission \$1.50 advance, \$2.00 at the gate. Refreshments, prizes, talk-in on 34/94, 22/82 and 52. Write HamJam '78, Radio Association of Erie, Box 844, Erie, PA 16512.

**IOWA:** Cedar Valley ARC ARRL Hamfest, Sunday, October 8. Hawkeye Downs Exhibition Building. Doors open 7:00 AM. Tickets: \$1.50 advance, \$2.00 door. Tables: 1st - \$3.00, others \$5.00. Overnight camping, picnic area, movies. Many prizes. Talk-in 146.16-76, 146.52, 223.5, 3.970. Early birds: 2 meter XMTX Hunt, 2:00 PM Saturday, October 7. 2 free steak dinners to winner. For info write: CVARC Hamfest, P.O. Box 994, Cedar Rapids, IA 52406.

**SOUTH TEXAS SWAPFEST** - Corpus Christi, Texas. Saturday, September 30, 1978. 9 to 5. Texas National Guard Armory, 1430 Horne Rd. Free admission and tables. Dealer displays, contests, door prizes. Talk-in 34/94, 28/88. Jointly sponsored by Corpus Christi ARC and So. Texas Amateur Repeater Club. Additional info from J. E. Rehler, W5KNZ, 526 Pasadena, Corpus Christi, Texas 78411.

**FLORIDA:** The 13th Annual Melbourne Hamfest, Saturday and Sunday, September 9-10, 9 AM to 5 PM at the Melbourne Civic Auditorium, Hibiscus Boulevard. Donation is \$3.50 per family. Forums, meetings, swap tables, commercial exhibits, awards, prizes. Talk-in on 25/85 and 52. Sponsored by Platinum Coast ARS. For more info write P.O. Box 1004, Melbourne, FL 32901.

**ARIZONA:** The Cochise Amateur Radio Association's 4th Annual Round-Up, September 9. Sierra Vista Community Center, starting at 0900. Talk-in on 16/76 and 52/52. First prize is Atlas 210X, plus many others. For tickets and more info, write CARA, P.O. Box 1855, Sierra Vista, AZ 85635. Tickets are \$3.00.

**OHIO:** Cincinnati Hamfest, Sunday, September 17, Stricker's Grove, Venice (Ross). Exhibits, flea market, prizes, air show. \$7.50 advance. For info request Hamfest issue of "The Mike and Key", WBALW, 3965 Harmar Ct., Cincinnati, OH 45211, WA8STX, 10615 Thornview Dr., Cincinnati, OH 45241, K8CKI, 1424 Main St., Cincinnati, OH 45210.

**INDIANA:** 21st annual Peoria Hamfest, Sept. 17, Exposition Gardens, W. Northmore Rd. Admission: \$1.50 advance, \$2.00 door, grounds free. Ladies free bus trip to shopping mall. 100 stores. 2-meter talk-in 146.76. Local repeaters 16-76, 25-85, 37-97. Write: John Sutton, WD9BJJ, 608 W. Teton Dr., Peoria, IL 61614.

# Regency Scanner

BRINGS  
YOU THE  
NEWS  
WHILE ITS  
HAPPENING



10 channels covering  
all 5 bands. AC/DC operation.

SAVE \$40 **\$89.95**  
LIST-\$129.95



1,000's OF CRYSTALS

•H25C Case Scanner Monitor  
•10.7 Amateur Ham  
•2 Meter, CB, Standard

1 to 9 **\$3.70** 10 to 49 **\$3.00** 50 and UP **\$2.50**

**CRYSTAL BANKING SERVICE**  
P.O. BOX 683  
LYNNFIELD, MASS. 01940

## ALDELCO ELECTRONICS COMPANY

**RF DEVICES**  
2N3375 3W 400 MHz ..... 5.50 2N6080 4W 175 MHz ..... 5.40  
2N3866 1W 400 MHz ..... 99 2N6081 15W 175 MHz ..... 8.45  
2N5589 3W 175 MHz ..... 4.75 2N6082 25W 175 MHz ..... 10.95  
2N5590 10W 175 MHz ..... 7.80 2N6083 30W 175 MHz ..... 12.30  
2N5591 25W 175 MHz ..... 10.95 2N6084 40W 175 MHz ..... 16.30

**ALD-1158 12 Watts, 200 MHz, T0117.** Has B/32 Heat Sink Stud. Similar to 25C1177. Fits Standards. **Only \$12.30**

**OVERVOLTAGE PROTECTION, OV-12** Provides protection from runaway Power Supply Voltage. Triggers @ 16V. 25 Amp rated. 1 piece moulded unit for 12 Volt DC fused Power Supply **\$7.95** OV-5 for 5 Volt PS triggers at 7V **\$7.95** Other Voltages **\$9.95**

**ACCUCKEYER KIT.** Similar to Handbook version. Includes PC Board, IC's, Sockets & all parts. **\$19.95**

**ACCUCKEYER MEMORY KIT.** Matches our Accucyker and many other keyers. Two memories of 30 Characters each. (2 1101 Memory Chips). Includes PC Board, IC's, Sockets and all parts. **\$19.95**

**Dual digital 12 or 24 HOUR CLOCK KIT.** NOW WITH A NEW WALNUT WOOD GRAIN CABINET. Model ALD 5-W. Six Big 0.5 Displays. **Only \$49.95** 12 or 24 Hour Operation - Each Clock controlled separately.

Freeze Feature for Time Set - Easy assembly for clock and Cabinet. 

Model ALD 5-P. Same Kit as above but with unassembled Black Plastic Cabinet with Red Filter. **Only \$44.95**

**ALARM CLOCK KIT.** Six 0.5 LED Display Readouts. Elapsed Time indicator. 12 Hour Format with 24 Hour Alarm Snooze feature. AM/PM indicator. Power Supply power failure indicator. **Only \$18.95** 12 or 24 Hour Clock Kit. 0.5 Display LED's **\$19.95** Wood Grain Cabinet **\$4.95**

**TUNABLE AMATEUR TV CONVERTER.** Receive Fast Scan ATV in the 420 MHz Band with any TV Set. Low noise high gain Amplifier stage with Varactor Tuned input and output. Built-in 110 VAC Supply. Two Tone Walnut & Beige Cabinet measuring 1-7/8" x 4-1/4" x 4-1/8". Factory Wired & Tested. 2 Year Warranty **Only \$49.95**

**Adjustable Power Supply Kits.** 500 mA 5 to 15 Volts **\$6.95**  
12 to 20 Volts **\$6.95**  
Power Supply Kit of Parts, 5 Volt 6 Amp **\$17.95**  
(add \$1.00 per Power Supply shipping)

Add 6% for Shipping. Min. Order \$10.00 out of USA send Certified Check or Money Order. Include Postage.

# ALDELCO

2281H Babylon Turnpike, Merrick, N. Y. 11566  
(516) 378-4555

Send 1st class stamp for our catalog.

# MANUAL INPUT

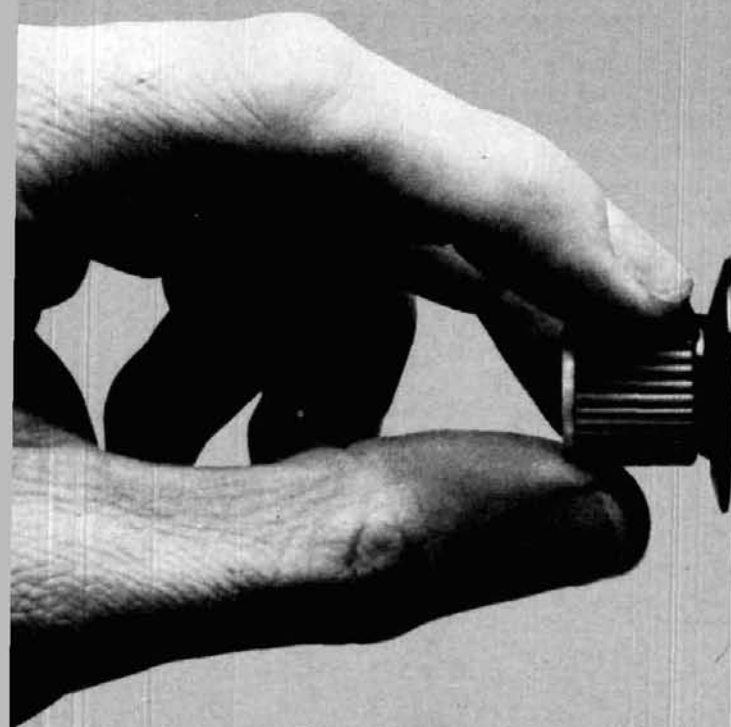

If you're still using potentiometers to help convert mechanical motion into digital signals, there's an easier, less expensive way.

Switch to Disc Instruments' new fingertip-controlled PANELCODER™ Series optical encoders. Their digital outputs eliminate the need for the A to D converters which analog pots require. No more pot noise and wiper wear, either.

They're rugged and accurate, too. Up to 250 pulses per revolution with a 100,000-hour LED light source, and accurate to  $\pm 10$  minutes of arc. Power input is 5 Vdc  $\pm 5\%$  at 60 mA maximum. They're sized (1½" diameter) to fit the same space a potentiometer used to occupy.

Switching from pots to PANELCODERS drops your component costs by eliminating the analog-to-digital conversion step.

Not only saves you money, but improves your product performance.

# DIGITAL OUTPUT

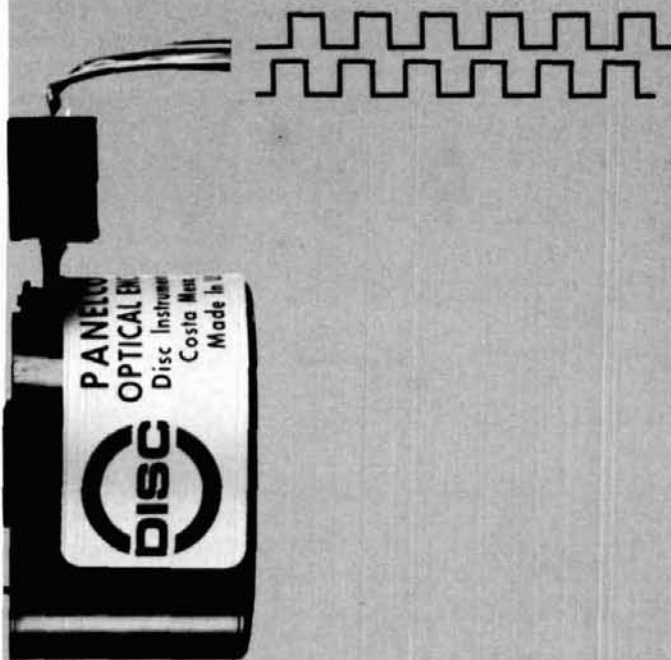

Disc Instruments is ready to serve you worldwide with the broadest line of rotary and linear encoders in the industry. If our standard products do not fit your exact encoder requirements, we'll make a special for you.

Write or call us for details. And, if you're an OEM, ask on your letterhead for a free PANELCODER evaluation sample.



Disc Instruments, Inc.  
102 E. Baker St.  
Costa Mesa, California 92626  
Phone: 714/979-5300

# NEW & USED AMATEUR EQUIPMENT

# SALE

## COLLINS

Receiver Model 651S1, Used, Clean	3,500.00
Receiver Model 51S1, New	1,500.00
Receiver Model R-390A, New	800.00
Receiver Model R-390A, Used	600.00
Receiver Model 51J4, Used, Clean	600.00
Linear Model 30S1, New	1,500.00

## ALPHA

Linear Model 374A, New	1,495.00
Linear Model 76/PA, New	1,100.00
Linear Model 76P, New	1,395.00
Linear Model 76CA, New	1,595.00
Linear Model 374A, New	1,495.00
Linear Model 77DX, New	3,195.00
Linear Model 77S, New	3,795.00
Vomax Speech Processor, New	179.00
Vomax 120VAC Power Adapter for above	15.00

## ALDA

103 Transceiver, New with N.B. Crystal Calib.	475.00
---	--------

## AMCOMM

2 Mtr Digital Transceiver, New, Model S-225325.00	
S-240 Remote 2 Mtr Digital Transceiver	450.00
Base Station P.S. with Clock, BSM-15, New	119.00
Base Station P.S. without Clock, BSM-15C, New	97.00
Matching Touch tone pad, TTE-200, New	48.00

## CETRON

Tubes Type 572B, New	ea. 25.00
----------------------	-----------

## DRAKE

Receiver, DSR-2 Digital Readout, New	2,700.00
Two Meter Transceiver Model UV-3, All Three Bands, New	750.00
Matching Power Supply Model PS-3	
Comes with above.	

## EIMAC

Tube Type 8877/3cx1500A7, New, pre-paid, Ship	260.00
Tube Type 3-500Z, New, pre-paid, Ship	74.50
Tube Type 8874, New, pre-paid, Ship	130.00
Tube Type 8875, New, pre-paid, Ship	130.00

## HY-GAIN

Model 3750 Digital Readout Transceiver, New	1,695.00
Matching Remote VFO Model 3855, New	400.00
Military SSB Transceivers Model COMM1A, B Frequency coverage 3-8 MHz SSB	
Reg. Price 600.00/Special 250.00	
Matching Fixed P.S. for above transceivers, New	170.00
Receivers Model R-1350 General Coverage, New	ea. 700.00
Speakers for above model S-1530, New	ea. 50.00

## KENWOOD

TS-820S, New	970.00
KDKFM2015R 2 Mtr Digital Readout Transceiver, New	380.00
FPM Matching Power Supply for above, New	49.95

## LARSEN

2 Mtr Magnet Mount Antenna, LM-150K, New	30.00
2 Mtr Magnet Mount 1/4 Wave Model NLAQ150K, New	25.00

## WILSON

2 Mtr Portable Transceiver, WE800, New	459.00
2 Mtr Hand Held Model 1405, New	300.00
2 Mtr Hand Held Model 1407, New	335.00
2 Mtr Hand Held Model Mark II, New	229.95
2 Mtr Hand Held Model Mark IV, New	259.95

## PIPO

Touch Tone Pad Model PP-1, 12 Key, New	50.00
Touch Tone Pad Model PP-2, 16 Key, New	58.00

## GALAXY

Transceiver Model GT550A, Used	275.00
--------------------------------	--------

All the above New Equipment comes with a Factory 90 Day Warranty. All Used Equipment maybe traded back in within Ten Days against New Equipment. This is a Clearance Sale of both New and Used Equipment. Quantities are Limited. All prices are FOB N.Y. U.S.A. Export Inquiries are invited.



Communications  
Technology  
Group, Incorporated

P. O. Box 103, Rockville Centre, N. Y. 11571  
516-536-5724

# flea market

**CALIFORNIA:** 1978 Region 6 AFCS MARS Conference. Hosted by Mather Air Force Base Support Team, 29 September — 1 October 1978, at The Mansion Inn, Sacramento. Tours of Mather AFB, Seminar by Command MARS Director, Regional and State reports, Emergency exercise highlights, Open forum discussions, Banquet, Awards, Equipment drawings; Reports on MTS program, equipment issue, emergency operations, improvements; papers on switching power supplies, becoming a frequency monitor, and much more. Specially selected location brings lots for XYL and kids to see and do within walking distance. Details from Jack Bayha, 23009 Vanowen St., Canoga Park, California 91304. Tel: (213) 887-4568 evenings or call on 6S1.

**NEW YORK:** Ham-O-Rama "78", Saturday, September 16, 9:00 AM to 5:00 PM, Erie County Fairgrounds just south of Buffalo, NY. Flea markets, women's programs, contests, prizes. Admission: \$3.00 advance, \$4.00 gate, Children under 12 free. Recreational parking with hookup \$4.00. Talk-in on WR2ABU 146.31/91. For further info: Bert Jones, W2CUU, 143 Orchard Dr., Kenmore, NY 14223, (716) 873-3984 or Jim Clurczak, WB2IVO, 10404 Cayuga Dr., Niagara Falls, NY 14304, (716) 297-0539.

**PENNSYLVANIA:** Butler County ARA Hamfest Sunday, September 10, from 11 AM to 4 PM, Butler County Farm Show Grounds adjacent to Butler Roe Airport with a paved runway for fly-ins. Check-ins on 90/30 and 52 simplex. For further info contact John, K3HJH, or Cliff, WB3CDA.

**PENNSYLVANIA:** 2nd annual Mid-Atlantic States VHF conference Saturday, September 30, Treadway Inn on Easton Rd., Willow Grove. Advance registration includes admission to Hamarama '78. — Mt. Airy VHF Radio Club Hamarama '78 at Bucks Co. Drive-In Theater, Route 611, Warrington, Sunday, October 1, 8:00 AM to 4:00 PM. Registration \$2.00, tailgating \$2.00/space (own table). Talk-in via W3CCX/3 on 146.52. Information for both events: Ron Whitsel, WA3AXV, Chairman, P.O. Box 353, Southampton, PA 18966, (215) 355-5370.

**PENNSYLVANIA:** Skyviews annual swap and shop, Saturday, September 17, new location, Sokol Camp, Lower Burrell. Registration \$1.00 at gate. First prize: Icom IC22S. CW contest. Talk-in 146.04/64. For info write: Jim Jackson, Jr., K3VRU, Rt. #1, Box 7A, Apollo, PA 15613.

**ILLINOIS:** Peoria Area ARCs 21st Annual Hamfest, Sunday, September 17th at the Exposition Gardens. Free coffee and donuts 8:30 to 9:00 AM. Camping space available Saturday night. Smorgasbord dinner Heritage House Restaurant at 7:00 PM Saturday, no reservations. Free bus trip to Northwoods Mall for the ladies. Talk-in .16/76, call W9UJL. Advance tickets \$1.50, Door tickets \$2.00. Write John Sutton, WD9BJJ, 608 W. Teton Drive, Peoria, Illinois 61614.

**KENTUCKY:** The Eighth Annual Greater Louisville Hamfest Saturday, Sept. 30th and Sunday, Oct. 1st at the West Hall of the Kentucky Fair and Exposition Center in Louisville. Air conditioned indoor exhibitors area and flea market, a ladies program. Camping is free on grounds (no hook ups). For more information contact Greater Louisville Hamfest, P.O. Box 34444, Louisville, KY 40232 or phone (502) 634-0619.

**NEW YORK CITY** — 2 Fleamarkets bigger and better than ever. Indoor-outdoor rain-shine, Sunday, Sept. 10 9AM to 4PM. The Municipal Parking Lot 80-25 126th Street., Queens, N.Y. One block off Queens Blvd. Free parking for 1000 cars, Raffle, Refreshments, Fun. Sellers \$2.00; Buyers \$1.00. Talk-in: 52/52, 40/00. Info: (212) 699-9400 days. Sponsored by Hall of Science Amateur Radio Club, WB2TBC.

**RADIO EXPO '78.** Special late dates for this year only are September 30, October 1. Dozens of exhibits. Indoor/outdoor flea market, open Friday for set-up. Free camping. Thousands of dollars in door prizes. The convention center is the Holiday Inn, Mundelein, IL. Tickets: \$2 advance, \$3 gate. The Lake County IL Fairgrounds at Routes 45 and 120 in Grayslake, IL. For info or tickets, write Chicago FM Club, P.O. Box 305, Maywood, IL 60135.

**MICHIGAN:** L'Anse Creuse ARC's 6th annual swap and shop, September 17, L'Anse Creuse High School, Mt. Clemens 0900-1500. Prizes. Talk-in 14769.09 and 146.52. \$1.50 door, \$1.00 advance. SASE to WB8ZME, 35751 Dunston, Sterling Heights, MI 48077.

**MICHIGAN:** Adrian Hamfest Sept. 24, Lenawee County Fairgrounds, Adrian. Tickets: \$1.50 advance, \$2.00 gate. Tables: \$4.00 full table, \$2.00 half. Trunk sales: \$1.00 per space. Write: Adrian ARC, P.O. Box 26, Adrian, MI 49221. (517) 265-8016. Talk-in WB7QE on 146.31/91 or 146.52 MHz.

# THIS IS IT



MODEL 4431 THRULINE®

RF DIRECTIONAL WATTMETER  
with VARIABLE RF  
SIGNAL SAMPLER — BUILT IN  
IN STOCK FOR PROMPT DELIVERY

AUTHORIZED DISTRIBUTOR

**Webster**  
associates

115 BELLARMINE  
ROCHESTER, MI 48063

CALL TOLL FREE  
800 — 521-2333

IN MICHIGAN 313 — 375-0420

2-METER  
FAVORITES

**RUBBER DUCKIES**

<b>Model HM-4.</b> Has 5-16" 32 thread. Fits Motorola HT's ICOM IC215 and Standard 146A	<b>\$7.00</b>
<b>Model HM-5.</b> Same as above. but with PL-259 connector	<b>\$7.00</b>
<b>Model HM-226.</b> Same. with TNC connector for Wilson 1405	<b>\$16.00</b>
<b>Model HM-227.</b> Same. but with BNC connector termination	<b>\$11.00</b>
<b>Model HM-228.</b> With F connector for Wilson 1402 & Tempo	<b>\$10.00</b>

ADD \$1.00 to each order for shipping.

**SPECTRONICS, INC.**

**(312)848-6777** 1009 GARFIELD ST.  
OAK PARK, ILL. 60304

**TEXAS TOWERS** offers warehouse-direct sales of amateur radio antenna system products — shipping directly to hams and clubs nationwide. America's best

lower buy. Consolidated HD-16 (interchangeable with Rohn 25G), 60 foot with top and base section \$215 FOB. HD-18 (rated at 66% of HD-16 capacity) 60 foot \$175 FOB. heavy-duty guy kit for 60' towers \$39.50. New ham radio product. **crank-up guy masts**, rated for 3 sq. ft. antenna. 40' \$74.50, 50' \$84.50 FOB. **TOWER GOODIES:** 3/16" Galvanized aircraft guy cable \$8/100' — \$75/1000'; 1/4" EHS guy cable \$12/100' — \$99/1000'; 3/16" plated cable clamps 30¢ — \$28/100; 1/4" cable clamps 42¢ — \$40/100; 1/4" Preformed deadends (guy wrap) \$1.65. Heavy duty guy insulators \$1.10. 3/8" eye/jaw galvanized turnbuckles \$5.50. 1/2" turnbuckles \$6.75. FOB. 5000 ft. reels of guy cable — 3/16" \$300; 1/4" \$450 FOB. **CDE ROTORS:** CD-44 \$99, HAM III \$118, Tail Twister \$212, all postpaid in Continental U.S.

**CLUBS/GROUPS:** 25 sections HD-16 \$799, freight prepaid most states east of Rockies. Send SASE for our latest price list and product information.

**Write TEXAS TOWERS**  
Gerald Williamson, K5GW  
113 Starlite Drive  
Plano, TX 75074 or call  
214-423-2376 nites/weekends



# BULLET ELECTRONICS

P.O. Box 19442 Dallas, TX. 75219 (214)823-3240

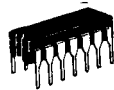

**MC3301P HOUSE #**  
4 OP AMPS IN ONE PACKAGE. USES SINGLE SUPPLY, (4 to 28VDC). INTERNALLY COMPENSATED. SIMILAR TO MC3401, BUT HIGHER GAIN. **49¢**

**MC1351P FM-IF AMP AND DISCRIMINATOR**

USED IN FM & TV SOUND CIRCUITS. REQUIRES MINIMUM EXTERNAL COMPONENTS. 14 PIN DIP. DIRECT REPLACEMENT FOR HEPC 6060, ECG 748 and MANY OTHERS. HOUSE # **50¢** WITH SPECS

HOUSE #

**LM3900 QUAD NORTON AMP**

WE BOUGHT A LARGE QUANTITY OF THESE HOUSE NUMBERED PARTS AT A BARGAIN PRICE THAT ALLOWS US TO SELL THEM AT A LOW, LOW **39¢**

**TIL312 COMMON ANODE READOUT**



3" CHARACTER SIZE WITH PINOUT **.65 6/3.00**

**MC1437P DUAL 709 OP AMP**

HIGH OPEN LOOP GAIN, LOW NOISE 14 PIN DIP **3/1.00**

**MPF131 N-CHANNEL DUAL GATE MOSFET**



**50¢**

DESIGNED FOR AMPLIFIER AND MIXER APPLICATIONS TO 200 MHZ. PLASTIC CASE UNITS ARE HOUSE NUMBERED WITH SPECS.

**IL-1 OPTO ISOLATORS**

BY LITRONIX 6 PIN DIP STANDARD PINOUT LED-TRANSISTOR COMBINATION. **50¢** WHILE THEY LAST!



**SMALL SKIRTED BLACK INSTRUMENT KNOB.**

FITS 1/4" SHAFT WITH SET SCREW.

**5/1.00**



**MJ900 - MJ1000**

COMPLIMENTARY PNP, NPN DARLINGTON POWER TRANSISTORS. 8 AMPS. WE SUPPLY A SCHEMATIC TO BUILD A HIGH POWER (35W) LOW DISTORTION AUDIO AMP WITH ONLY ONE ADDITIONAL TRANSISTOR AND A DOZEN INEXPENSIVE COMPONENTS! TO-3 CASE STYLE **BUY A PAIR FOR \$3.00!**

**1N4148 DIODES**

LEADS ARE TARNISHED BUT CLEAN UP EASILY. THE BOSS SAYS "DUMP 'EM"...SO CHECK THIS PRICE! **50/1.00**

**HOUSE # PNP POWER TO-3**

150 WATTS  
80 VCEO  
10 AMPS



IDENTICAL TO 2N3790 **1.00**

**MC1469R POSITIVE VOLTAGE REGULATOR**

1/2 AMP COMPLETE SPECS AND APPLICATIONS SHOW HOW TO BUILD FIXED OR VARIABLE POWER SUPPLIES FROM 3 TO 30VDC. DRIVE EXTERNAL SERIES PASS FOR CURRENT TO 20 AMPS!

**1.25 EA.**

**10/10.00**

HOUSE #



**FANTASTIC SOUND EFFECTS CHIP**

AVAILABLE ONLY FROM BULLET!

THIS 28 PIN MARVEL CONTAINS A LOW FREQUENCY OSCILLATOR, VCO, NOISE OSCILLATOR, ONE SHOT, MIXER AND ENVELOPE CONTROL. WITH 8 PAGE MANUAL. 5 to 9VDC **3.95**

**ALL COMPONENTS 100% GUARANTEED**

- CA3011 WIDEBAND IF AMP w/specs **50¢**
- 2N3569 NPN EPOXY 1W **6/1.00**
- 741 OP AMP 8 PIN DIP **5/1.00**
- 723 VOLTAGE REG. 14 PIN DIP **50¢**
- MPS6530 NPN HOUSE # **8/1.00**
- 725 OP AMP LOW NOISE HOUSE # **99¢**
- 7815 15V 1A REGULATOR HOUSE # **69¢**
- LM340T-12 12V 1A VOLT. REG. w/specs **75¢**
- TCA430 QUAD OSCILLATOR 1/specs **69¢**
- 2N4343 P CHANNEL J FET **4/1.00**
- 2N6111 PNP MED PWR 40W TO-220 **3/1.00**
- 2N6028 PROGRAMMABLE UNIUNCTIION w/specs **50¢**
- TRIAC 200V 8A UNMARKED **3/1.00**

**INCANDESCENT PANEL LAMP**

WITH TINNEMAN NUT YOUR CHOICE OF RED, GREEN, YELLOW, WHITE 12-24VDC **15¢**

**POWER SUPPLY METERS**

Quality 3 1/2" meters for the P-S14. 0-15VDC & 0-25A. Matched set, individually packaged. NOT SURPLUS! **12.95/set**

**CAPACITORS**

SMALL SIZE!

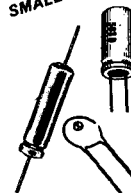

- 2200 MFD @ 16 VDC RADIAL **3/1.00**
- 500 MFD @ 35VDC **5/1.00 AXIAL**
- 220 MFD @ 25VDC **7/1.00 AXIAL**
- .1 MFD @ 20VDC DISC CERAMIC **15/1.00**

**FND510 69¢**

COMMON ANODE READOUT 1/2" CHARACTER **LIMIT 24 PER CUSTOMER!**



Miniature 7K Pot w/switch PC Mount or panel mount 1/8" shaft #9 Black of plastic knob for above FREE

LIMITED QTY Computer Grade FILTER CAP Screw Terminals 2 1/2" x 9/16" 9600 mfd @ 75V 2.95 or 4.95

**NEW!** **ULTRASONIC SENDER RECEIVER KIT US-02**

**TOTAL SECURITY!** Completely invisible ultrasonic (23KHz) sound beam works like a photoelectric beam but is unaffected by light, heat or noise. Separate Transmitter and Receiver can be used from 6 inches to 25 feet! A solid object breaking the beam causes an output to go low that will sink up to 150 MA to Drive a Relay, TRIAC, etc. Complete electronics are provided. Works on 12VDC (unregulated) and draws less than 100 MA. Use it for burglar alarms, object counters, automatic door opens, automatic door bells, electronic rat traps! and more.

Optional entry delay and Alarm Timeout Circuit **3.95**  
will source or sink up to 200 MA DC.

**COMPLETE KIT LESS CASES 21.50**

**LED'S JUMBO: RED 5/.89 GREEN 4/.89**

- MEDIUM: RED .15 MINI: GREEN .16 RED .10
- YELLOW .16

1.5V 10-30 ma

**POWER SUPPLY KIT PS-14**

- Better than 200MV load and line regulation
  - Foldback Current Limiting
  - Short Circuit Protected
  - Thermal Shutdown
  - Adjustable Current Limiting
  - Less than 1% ripple.
  - 15 amps 11.5 to 14.5V
  - All parts supplied including heavy duty transformer.
  - Quality plated fiberglass PC board.
- Less Case, meters & jacks

**42.95** UPS SHIPPING PAID!

**OVERVOLTAGE PROTECTION KIT 6.95**

Provides cheap insurance for your expensive equipment. Trip voltage is adjustable from 3 to 30 volts. Overvoltage instantly fires a 25A SCR and shorts the output to protect equipment. Should be used on units that are fused. Directly compatible with the PS-12 and PS-14. All electronics supplied. Drilled and plated PC board. (Order OVP-1)

**WATCH FOR IT! Coming next month, a special kit for HAMS!**

**MINI GRANDFATHER CLOCK KIT**

- Chimes the hour (ie: 3 times for 3 O'clock)
  - Unique "swinging" LED pendulum
  - Tick tock sound matches pendulum swing.
  - Large 4 digit .5" LED readout
  - All CMOS construction
  - Complete electronics including transformer & speaker; drilled and plated PC boards measure 4.5" x 6.5"
- BEAUTIFUL SOLID WALNUT**  
Custom case for above kit. Over 9 1/2" tall. **19.95**

**MK-03A CLOCK/TIMER KIT**

Features 24 hour Zulu time and up to 24 hours of elapsed time on the same set of six digit LED readouts. Totally independent operation of both functions. Clock has pre-settable alarm with 10 minute snooze. Timer has reset, hold, and count functions. Full noise and overvoltage protection. 24 hour only. Readouts has dimmer feature or they can be turned off without disturbing the clock or timer. Timebase included (.01% accuracy). Because of the many options and mounting considerations the case and switches are not included. Switches are standard types. Will fit inside standard aircraft instrument case.

9-14VDC **28.95**

**WARBLE ALARM Kit**

A fun EASY kit to assemble that emits an ear piercing 10 watt dual tone scream. Resembles European siren sound. Great for alarms or toys. Operates from 5-12VDC at up to 1 amp (using 12VDC x 8 ohm speaker). Over five thousand have been sold. All parts including PC board, less speaker. ORDER WB-02

**2.50**

- \* NO C.O.D.'S
- \* SEND CHECK M.O. OR CHARGE CARD NO.
- \* PHONE ORDERS ACCEPTED ON VISA AND MASTERCARD ONLY.

- \* ADD 5% FOR SHIPPING
- \* TX. RES. ADD 5% STATE SALES TAX
- \* ORDERS OF \$50. & OVER TAKE 10% DISCOUNT
- \* FOREIGN ORDERS ADD 10% (20% AIRMAIL) U.S. FUNDS ONLY.

## REGULATORS SOLD HERE SPECIAL \$1.00

Last two digits indicate voltage; 78 series regulators are positive and cost \$1.25 each, 79 series regulators are negative and cost \$1.35 each. Voltages available: 7805, 7806, 7808, 7812, 7815, 7824; 7905, 7906, 7908, 7912, 7915, 7918, 7924.

## QUALITY SOCKETS

Sockets simplify maintenance and servicing, eliminate heat damage while soldering, and minimize CMOS static problems... we've got the right sockets at the right prices.

### Low Profile Soldertail (tin plated)

SKL8	8 pin	10/ \$1.85
SKL14	14 pin	10/ 1.95
SKL16	16 pin	10/ 2.15
SKL18	18 pin	8/ 2.25
SKL20	20 pin	8/ 2.75
SKL22	22 pin	8/ 2.95
SKL24	24 pin	3/ 1.10
SKL36	36 pin	5/ 2.75
SKL40	40 pin	2/ 1.25

## THE CLOCK

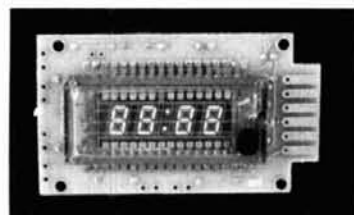

The MA1003 is a complete clock module, requiring only time-setting switches, case, and 12V DC. With built-in crystal controlled timebase (ideal for car or van clock) and low power, highly visible fluorescent blue readouts.

**\$16.50 each or 3 / \$46.**

# GODBOUT

BILL GODBOUT ELECTRONICS  
BOX 2355, OAKLAND AIRPORT, CA 94614

TERMS: Please allow up to 5% for shipping; excess refunded. Add \$1 handling for orders under \$10. Cal res add tax. COD OK with street address for UPS. For VISA® /Mastercharge® orders call our order desk (24 hrs) at (415) 562-0636. Prices good through cover month of magazine.

## QUARTZ CRYSTALS



"IN A HURRY"

SINCE 1970

### CRYSTALS AVAILABLE FOR:

- CB - Synthesizers
- Amateur - HF, VHF, UHF
- Industrial
- Scanner
- Marine - LB & VHF
- Conversion Crystals
- Special Attention to R & D.
- Micro-processor Types.

DISCOUNTS AVAILABLE TO DEALERS & MANUFACTURERS

CALL "BONNIE" FOR PRICES & DELIVERY

VISA & MASTER CHARGE

credit cards accepted.



CAL CRYSTAL LAB, INC.

1142 N. Gilbert Street  
Anaheim, CA 92801  
(714) 991-1580

# Barry Electronics . . .

Your One Source for Amateur Radio Gear

### FEATURING: ANTENNA SPECIALISTS

Yes, we have EIMAC Tubes & Chimneys, and YAESU Replacement Tubes in stock!	ATLAS BIRD COLLINS CUSHCRAFT DENTRON EIMAC E-Z WAY	HY-GAIN ICOM KDK KLM MOSLEY NEWTONICS ROHN	SWAN TRI-EX WILSON YAESU
---	--	--	-----------------------------------

**BARRY ELECTRONICS 512 BROADWAY  
(212) 925-7000 NEW YORK, N. Y. 10012**



*our little boxes  
replace a lot of cable!*

- select any of five antennas at the turn of a knob, with just one feedline and a control cable to the remote switching unit.
- saves coax, simplifies station layout.
- handles 4 kw p.e.p.
- other models to nine positions.
- full one-year warranty.

model sw-5 heavy duty -  
REMOTE CONTROLLED ANTENNA SWITCH - \$135.00 plus \$3 shipping  
• order direct or write for brochure •

**ANTENNA MART**

515-292-7114

box 1010, i.s.u. station, ames, iowa 50010

NEW ELECTRONIC PARTS  
IC'S - TRANSISTORS - PROTOBOARDS - RESISTORS  
CAPACITORS - DIODES - SWITCHES - CONNECTORS  
VOLTAGE REGULATORS - CABINETS - HEAT SINKS  
FUSES & MUCH MORE--STAMP BRINGS CATALOG

### SPECIALS

### KEYBOARD ENCLOSURES

TWO SIZES	W	D	H	PRICE
	14	8.3	3	\$15.20*
	14	11.3	3	\$16.50*

BLUE BASE SPECIFY  
WHITE OR BLACK TOP

### BREADBOARD KIT \$10.75\*



2" X 6"

\*SHIPPING INCLUDED

NuData Electronics

104 N. EMERSON ST. MOUNT PROSPECT, ILLINOIS 60056

## BIRD WATCHERS

Don't be absurd, buy a BIRD!  
... from your Bird distributor

MODEL  
43



\$120

ALL ITEMS AND ELEMENTS  
ORDINARILY IN STOCK  
Prepaid Shipment in Continental USA Only

**MADISON  
ELECTRONICS SUPPLY, INC.**

1508 MCKINNEY HOUSTON, TEXAS 77002  
713/658-0268 Nites 713/497-5683

CALL TOLL FREE

**1-800-228-4097**  
**Communications Center**  
 443 N 48th Street  
 Lincoln, Nebraska 68504  
 In Nebraska Call (402)466-8402

**1-800-634-6227**  
**Communications Center**  
**West**  
 1072 N. Rancho Drive  
 Las Vegas, Nevada 89106  
 In Nevada Call (702)647-3114

# Antenna Sale!

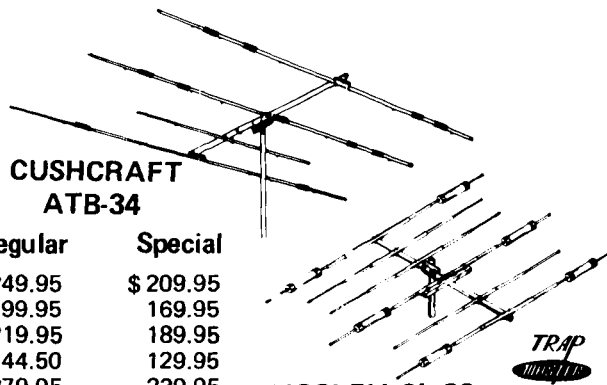

CUSHCRAFT  
ATB-34



MOSLEY CL-36

HY-GAIN		Regular	Special
TH6-DXX	Super Thunderbird	\$ 249.95	\$ 209.95
TH3-MK3	3 ele. 10, 15, 20 Mtr. beam	199.95	169.95
Hy-Quad	2 ele. Quad 10, 15, 20 Mtr.	219.95	189.95
TH3-Jr.	3 ele. 10, 15, 20 Mtr. beam	144.50	129.95
18 HT	Hy-Tower 10-80 Mtr. Vertical	279.95	239.95
14AVQ/WB	10-40 Mtr. Trap Vertical	67.00	57.00
18AVT/WB	10-80 Mtr. Trap Vertical	97.00	84.95
203	3 ele. 2 Mtr. beam	12.95	
205	5 ele. 2 Mtr. beam	16.95	
208	8 ele. 2 Mtr. beam	19.95	
214	14 ele. 2 Mtr. beam	26.95	

MOSLEY		Regular	Special
Classic 33	3 ele. 10, 15, 20 Mtr. beam	232.50	189.95
Classic 36	6 ele. 10, 15, 20 Mtr. beam	310.65	249.95
TA-33	3 ele. 10, 15, 20 Mtr. beam	206.50	169.95
TA-36	6 ele. 10, 15, 20 Mtr. beam	335.25	279.95
TA-33 Jr.	3 ele. 10, 15, 20 Mtr. beam	151.85	129.95
TA-40KR	40 Mtr. add on	92.25	74.95

CUSHCRAFT		Regular	Special
ATB-34	4 ele. 10, 15, 20 Mtr. beam	259.95	209.95
ARX-2	2 Mtr. Ringo Ranger	36.95	32.95
A147-20T	2 Mtr. Twist	59.95	52.95
A144-10T	10 ele. Twist 2 Mtr.	39.95	32.95
A144-20T	20 ele. Twist 2 Mtr.	59.95	52.95

HUSTLER		Regular	Special
4BTV	10-40 Mtr. Trap Vertical	99.95	82.95
RM-75	75 Meter Resonator	15.50	13.50
RM-75s	75 Meter Super Resonator	30.00	26.50
G6-144-A	6 db. 2 Mtr. Base Colinear	67.55	57.95

WILSON		Regular	Special
System One	5 ele. 10, 15, 20 Mtr. beam	274.95	239.95
System Two	4 ele. 10, 15, 20 Mtr. beam	219.95	189.95

CDE ROTORS		Price
Ham III		\$125.00
T2X Tail Twister		\$249.00
CD-44		\$105.00

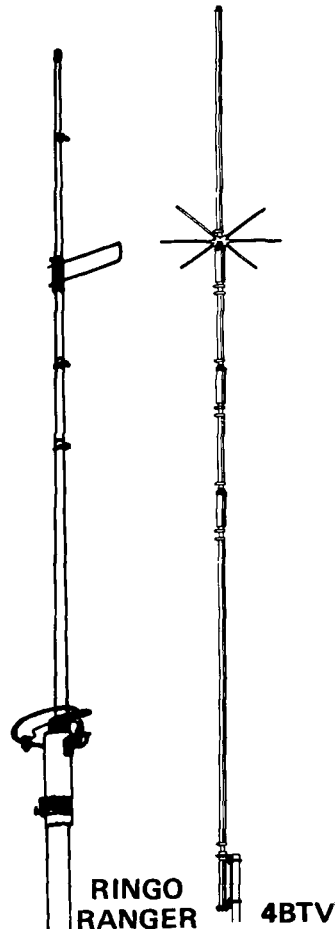

RINGO RANGER 4BTV



18HT

**We carry all major brands of ham radios AT DISCOUNT PRICES**

Yaesu — Kenwood — Drake — ICOM — Dentron —  
 Ten-Tec — Swan — Tempo — Midland — E.T.O. — Wilson



# a NEW antenna principle

PROVEN IN EXACTING TESTS AND MANY YEARS ON THE AIR AT W<sub>0</sub>MBH — K<sub>0</sub>AST — K8VRM



## THE *Little* GIANT BEAM ANTENNA

only 27 inches high  
by 22 inches wide

### A COMPLETELY NEW ANTENNA

Here is an ultra compact beam antenna which can be tuned to any frequency between 7.0 and 14.5 MHz. Weighing only 18 lbs. this antenna may not outperform a full sized beam but it sure will give you your share of DX and stateside contacts. Will handle 1 KW over a 100 kHz bandwidth.

- Fully weather proof
- Mounts easily on TV masting
- Figure 8 pattern

- HI-Q, attenuates harmonics
- Comes assembled & tested

KITS 10-40 \$122.50

**\$149.50**

Add \$3 trans.

**LITTLE GIANT MODEL 100X1000-40**

Other models available for 10, 15 & 20 meters

**Little Giant Antenna Labs, Box 245, Vaughnsville, Ohio 45893**

Subsidiary "Apollo Products" Village-Twig Co.

**419-646-3495**

## Apollo Products-Little Giant Trans Systems Tuner Kit — \$122.50 Wired & Tested — \$144.50

Designed and engineered after "Apollo" — "Little Giant" 2500X-2, for an "engineered performance" Trans Systems Tuner and Adaptations of the Lew McCoy Transmatch, with power handling at the KW plus level!



### Kit includes:

- 1 200 pfd wide-spaced variable with isolantite insulation rated 3,000 volts
- 1 200 pfd dual section parallel condenser isolantited
- 2 finger-grip pointer knobs 2" diam, white indented
- 1 pvc insulated shaft couplings 1/4 to 1/2
- 3 SO-239 coax chassis connectors. Tunes 52 ohm or 52-300-600\* or random wires

- 1 heavy inductance for 10-15-20-40-80 meters
- 6 pvc stand-offs, 4 for condensers and 2 for inductance
- 1 HD switch for band catching 10 thru 80 meter coverage
- 1 pkg 12-gauge tinned round wire Cabinet included — Apollo "Shadow Boxes" M Kit includes schematic. Recommend parts layout.
- INFO NOTE \*377 OHM and \*\*600 OHM "Open wire spaced ladder line" air dielectric. \*53 x wire diam. \*\*84 x wire diam. info only — not supplied.

**Apollo Products, Box 245, Vaughnsville, Ohio 45893 419-646-3495**

Subsidiary "Little Giant Antenna Labs"

## FT-227 "MEMORIZER" OWNERS: SCANNER KIT

- Selectable sweep width (up to full band)
- Scans **only** the portion of band you select
- Scans at the rate of 200 kHz per second
- Switch modification on mike allows you to scan past, or lock on, any occupied frequency
- Complete kit with detailed instructions
- Installs **inside** rig; no obtrusive external connections
- Rig can easily be returned to original condition whenever desired
- Scans to preset limits and reverses
- Automatic bypass of locked frequency in 3-1/2 seconds unless you press lock-on switch

Kit \$34.95 preassembled and tested **\$54.00**

add \$1.50 postage and handling

Also available: Scanners for your IC-22S; \$29.95 kit; \$39.95 assembled

DEALER INQUIRIES INVITED



**AED ELECTRONICS**  
750 LUCERNE RD., SUITE 120  
MONTREAL, QUEBEC, CANADA H3R 2H6  
TEL. 514-737-7293



## TOWER PACKAGE SPECIALISTS

in Steel and Aluminum

**CRANK-UP CRANK-OVER SELF-SUPPORTING**

*Call or Write for Your Custom Tower Package.*

### TOWERS BY

ALUMA  
E-Z WAY  
HEIGHTS  
ROHN  
TRI-EX  
TRISTAO  
UNIVERSAL

### ROTORS BY

CDE  
CHANNELMASTER  
HY-GAIN  
KLM  
TELREX  
WILSON

*Your Antenna Dream Comes True — at a Price You Can Afford*

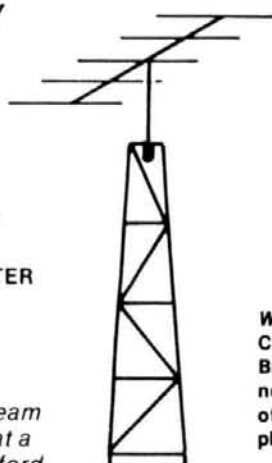

### ANTENNAS BY

A-S  
CUSHCRAFT  
HY-GAIN  
KLM  
LARSEN  
MOSLEY  
NEUTRONICS  
SWAN  
TELREX  
WILSON

### We also stock:

Coaxial Cable, Tuners, Bridges, Baluns, Wire Connectors, and dozens of other "goodies" to complete your custom package.

**Communications Specialists Serving Hams — Since 1939**

**ELECTRONIC DISTRIBUTORS, INC.**

1960 PECK STREET  
TELEPHONE (616) 726-3196

MUSKEGON, MICHIGAN 49441  
TELEX 22-8411

## TRANSFORMERS

American made, 115V Pri. All ppd.  
12V 1.2 amp \$2.84 ea.  
12V 3 amp \$4.48 ea.  
12V, 1/4 amp for P.C. \$1.66 ea.  
36VCT, 1A; 14VCT, 400Ma \$4.20 ea.  
44VCT, 1A; 6.3V 1/4 amp tap \$3.47 ea.  
48VCT, 1A, 6.3V, 1/4 amp tap \$3.46 ea.

6.3V, 1 amp shielded \$1.80 ea.

UNPOTTED TOROIDS — Center tapped.  
88 MHY - 5 oz. 5/\$2.95; 9 oz. - 5/\$3.49  
44 MHY - 5/\$3.95

3000 MFD Capacitors. @ 30 Volts  
1" Dia. x 3" — 90¢ ea. or 3/\$2.25

NEW — LINE CORDS — US — 7 AMP  
6' — Bk — 50¢ ea. 4/\$1.50 ppd.  
8' — Gray — 60¢ ea. 4/\$1.90 ppd.

EDGEVIEW METERS 250 µa 'S' METERS  
NEW — \$2.65 ea. 3/\$7.25 ppd.

**m. weinschenker**  
electronic specialties-BOX 353, IRWIN, PA 15642

## DON'T KEEP A GOOD ANTENNA DOWN

...put it up instead. Install the World-Record Breaking antenna that won W6TYP the QRP ARC 1,000,000 miles/watt award.

### THE JOYSTICK VFA

(Variable freq. ant) gives low angle, omni-directional, harmonic free radiation on all bands 160 thru 10 (+MARS and receive on all BC & SW)

1000's of glowing reports in our files of the VFA in use, often in poor QTH and/or under QRP. contests, etc.

**SYSTEM 'A' \$84.00**

250W P.E.P. &/or Receiving only

**SYSTEM 'J' \$110.00**

500W P.E.P. &/or Improved Q Factor Receive

Air mail cost included (Each system 3 sections easily assembled to make unit 7' 6" long. Matching ATU). Not only will you save space but you get better value per \$ if buying direct UK manuf. Rush your order - Mastercharge, Visa, Bankamcard, or check, or ask for brochure -

PARTRIDGE (HR)

ELECTRONICS LTD

Broadstairs, Kent, England

Tel: 0843 62535

G3CED

G3VFA

**DIODES/ZENERS**

1N914	100v	10mA	.05
1N4005	600v	1A	.08
1N4007	1000v	1A	.15
1N4148	75v	10mA	.05
1N4733	5.1v	1 W Zener	.25
1N753A	6.2v	500 mW Zener	.25
1N758A	10v	"	.25
1N759A	12v	"	.25
1N5243	13v	"	.25
1N5244B	14v	"	.25
1N5245B	15v	"	.25

**SOCKETS/BRIDGES**

8-pin pcb	.20	ww	.35
14-pin pcb	.20	ww	.40
16-pin pcb	.20	ww	.40
18-pin pcb	.25	ww	.75
22-pin pcb	.35	ww	.95
24-pin pcb	.35	ww	.95
28-pin pcb	.45	ww	1.25
40-pin pcb	.50	ww	1.25
Molex pins .01	To-3 Sockets		.25
2 Amp Bridge	100-prv		.95
25 Amp Bridge	200-prv		1.95

**TRANSISTORS, LEDS, etc.**

2N2222	NPN (2N2222 Plastic .10)	.15
2N2907	PNP	.15
2N3906	PNP (Plastic - Unmarked)	.10
2N3904	NPN (Plastic - Unmarked)	.10
2N3054	NPN	.35
2N3055	NPN 15A 60v	.50
T1P125	PNP Darlington	.35
LED Green, Red, Clear, Yellow		.15
D.L. 747	7 seg 5/8" High com-anode	1.95
MAN72	7 seg com-anode (Red)	1.25
MAN3610	7 seg com-anode (Orange)	1.25
MAN82A	7 seg com-anode (Yellow)	1.25
MAN74A	7 seg com-cathode (Red)	1.50
FND359	7 seg com-cathode (Red)	1.25

**CMOS**

4000	.15
4001	.15
4002	.20
4004	3.95
4006	.95
4007	.20
4008	.75
4009	.35
4010	.35
4011	.20
4012	.20
4013	.40
4014	.75
4015	.75
4016	.35
4017	.75
4018	.75
4019	.35
4020	.85
4021	.75
4022	.75
4023	.20
4024	.75
4025	.20
4026	1.95
4027	.35
4028	.75
4030	.35
4033	1.50
4034	2.45
4035	.75
4040	.75
4041	.69
4042	.65
4043	.50
4044	.65
4046	1.25
4049	.45
4050	.45
4066	.55
4069/74C04	.25
4071	.25
4081	.30
4082	.30
MC 14409	14.50
MC 14419	4.85
4511	.95
74C151	1.90

7400	.10
7401	.15
7402	.15
7403	.15
7404	.10
7405	.25
7406	.25
7407	.55
7408	.15
7409	.15
7410	.15
7411	.25
7412	.25
7413	.25
7414	.75
7416	.25
7417	.40
7420	.15
7426	.25
7427	.25
7430	.15
7432	.20
7437	.20
7438	.20
7440	.20
7441	1.15
7442	.45
7443	.45
7444	.45
7445	.65
7446	.70
7447	.70
7448	.50
7450	.25
7451	.25
7453	.20
7454	.25
7460	.40
7470	.45
7472	.40

7473	.25
7474	.30
7475	.35
7476	.40
7480	.55
7481	.75
7483	.75
7485	.55
7486	.25
7489	1.05
7490	.45
7491	.70
7492	.45
7493	.35
7494	.75
7495	.60
7496	.80
74100	1.15
74107	.25
74121	.35
74122	.55
74123	.35
74125	.45
74126	.35
74132	.75
74141	.90
74150	.85
74151	.65
74153	.75
74154	.95
74156	.70
74157	.65
74161	.55
74163	.85
74164	.60
74165	1.10
74166	1.25
74175	.80

**- T T L -**

74176	.85
74180	.55
74181	2.25
74182	.75
74190	1.25
74191	.95
74192	.75
74193	.85
74194	.95
74195	.95
74196	.95
74197	.95
74198	1.45
74221	1.00
74367	.75
75108A	.35
75491	.50
75492	.50
74H00	.15
74H01	.20
74H04	.20
74H05	.20
74H08	.35
74H10	.35
74H11	.25
74H15	.45
74H20	.25
74H21	.25
74H22	.40
74H30	.20
74H40	.25
74H50	.25
74H51	.25
74H52	.15
74H53J	.25
74H55	.20

74H72	.35
74H101	.75
74H103	.55
74H106	.95
74L00	.25
74L02	.20
74L03	.25
74L04	.30
74L10	.20
74L20	.35
74L30	.45
74L47	1.95
74L51	.45
74L55	.65
74L72	.45
74L73	.40
74L74	.45
74L75	.55
74L93	.55
74L123	.85
74S00	.35
74S02	.35
74S03	.25
74S04	.25
74S05	.35
74S08	.35
74S10	.35
74S11	.35
74S20	.25
74S40	.20
74S50	.20
74S51	.25
74S64	.15
74S74	.35
74S112	.60
74S114	.65

74S133	.40
74S140	.55
74S151	.30
74S153	.35
74S157	.75
74S158	.30
74S194	1.05
74S257 (8123)	1.05
74LS00	.20
74LS01	.20
74LS02	.20
74LS04	.20
74LS05	.25
74LS08	.25
74LS09	.25
74LS10	.25
74LS11	.25
74LS20	.20
74LS21	.25
74LS22	.25
74LS32	.25
74LS37	.25
74LS38	.35
74LS40	.30
74LS42	.65
74LS51	.35
74LS74	.35
74LS86	.35
74LS90	.55
74LS93	.55
74LS107	.40
74LS123	1.00
74LS151	.75
74LS153	.75
74LS157	.75
74LS164	1.00
74LS193	.95
74LS367	.75
74LS368	.65

**MCT2**

MCT2	.95
8038	3.95
LM201	.75
LM301	.45
LM308 (Mini)	.95
LM309H	.65
LM309K (340K-5)	.85
LM310	.85
LM311D (Mini)	.75
LM318 (Mini)	1.75
LM320K5(7905)	1.65
LM320K12	1.65

**LINEARS, REGULATORS, etc.**

LM320T5	1.65
LM320T12	1.65
LM320T15	1.65
LM324N	1.25
LM339	.75
7805 (340T5)	.95
LM340T12	.95
LM340T15	.95
LM340T18	.95
LM340T24	.95
LM340K12	1.25

LM340K15	1.25
LM340K18	1.25
LM340K24	1.25
78L05	.75
78L12	.75
78L15	.75
78M05	.75
LM373	2.95
LM380 (8-14 PIN)	.95
LM709 (8, 14 PIN)	.25
LM711	.45

LM723	.40
LM725N	2.50
LM739	1.50
LM741 (8-14)	.25
LM747	1.10
LM1307	1.25
LM1458	.65
LM3900	.50
LM75451	.65
NE555	.35
NE556	.85
NE565	.95
NE566	1.25
NE567	.95

**9000 SERIES**

9301	.85	95H03	1.10
9309	.35	9601	.20
9322	.65	9602	.45

**MICRO'S, RAMS, CPU'S, E-PROMS**

74S188	3.00	8214	8.95
1702A	4.50	8224	3.25
MM5314	3.00	8228	6.00
MM5316	3.50	8251	8.50
2102-1	1.45	8255	10.50
2102L-1	1.75	8T13	1.50
2114	9.50	8T23	1.50
TR1602B	3.95	8T24	2.00
TMS 4044-	9.95	8T97	1.00
		2107B-4	4.95
8080	8.95	2708	9.50
8212	2.95	Z80 PIO	8.50

**INTEGRATED CIRCUITS UNLIMITED**

7889 Clairemont Mesa Boulevard, San Diego, California 92111  
(714) 278-4394 (Calif. Res.)

All orders shipped prepaid No minimum  
Open accounts invited COD orders accepted

Discounts available at OEM Quantities California Residents add 6% Sales Tax  
All IC's Prime/Guaranteed. All orders shipped same day received.

24 Hour Toll Free Phone 1-800-854-2211

American Express / BankAmericard / Visa / MasterCard

**SPECIAL DISCOUNTS**

Total Order	Deduct
\$35 - \$99	10%
\$100 - \$300	15%
\$301 - \$1000	20%



*Ham Radio's guide to help you find your local*

## Alabama

### LONG'S ELECTRONICS

2808 7TH AVENUE SOUTH  
BIRMINGHAM, AL 35202  
800-633-3410

Call us Toll Free to place your order

## Alaska

### RELIABLE ELECTRONICS

3306 COPE STREET  
ANCHORAGE, AK 99503  
907-279-5100  
Kenwood, Yaesu, DenTron, Wilson,  
Atlas, ICOM, Rohn, Tri-Ex.

## Arizona

### HAM SHACK

4506 A NORTH 16TH STREET  
PHOENIX, AZ 85016  
602-279-HAMS  
Serving all amateurs from  
beginner to expert.

### KRYDER ELECTRONICS

5520 NORTH 7TH AVENUE  
NORTH 7TH AVE. SHOPPING CTR.  
PHOENIX, AZ 85013  
602-249-3739  
We service what we sell.

### POWER COMMUNICATIONS

6012 NORTH 27th AVE.  
PHOENIX, AZ 85017  
602-242-6030  
Arizona's #1 Ham Store.  
Kenwood, Drake, ICOM & more.

### QSA 599 AMATEUR RADIO CENTER

11 SOUTH MORRIS STREET  
MESA, AZ 85202  
602-833-8051  
Eimac Distributor. New & Used  
Equipment, Parts - Surplus too!

## California

### C & A ELECTRONIC ENTERPRISES

22010 S. WILMINGTON AVE.  
SUITE 105  
P. O. BOX 5232  
CARSON, CA 90745  
213-834-5868  
Not the Biggest, but the Best —  
since 1962.

### HAM RADIO OUTLET

999 HOWARD AVENUE  
BURLINGAME, CA 94010  
415-342-5757  
Visit our stores in Van Nuys  
and Anaheim.

### QUEMENT ELECTRONICS

1000 SO. BASCOM AVENUE  
SAN JOSE, CA 95128  
408-998-5900  
Serving the world's Radio Amateurs  
since 1933.

### TOWER ELECTRONICS CORP.

24001 ALICIA PARKWAY  
MISSION VIEJO, CA 92675  
714-768-8900  
Authorized Yaesu Sales & Service.  
Mail orders welcome.

## Colorado

### MILE-HI COMMUNICATIONS, INC.

1970 SOUTH NAVAJO  
DENVER, CO 80223  
303-936-7108  
Rocky Mountain's newest  
ham store. Lee Tingle KØLT.

## Connecticut

### AUDIOTRONICS INC.

18 ISAAC STREET  
NORWALK, CT 06850  
203-838-4877  
The Northeast's fastest growing  
Ham Dept. dedicated to service.

## Florida

### AGL ELECTRONICS, INC.

1800-B DREW ST.  
CLEARWATER, FL 33515  
813-461-HAMS  
West Coast's only full service  
Amateur Radio Store.

### AMATEUR RADIO CENTER, INC.

2805 N.E. 2ND AVENUE  
MIAMI, FL 33137  
305-573-8383  
The place for great dependable  
names in Ham Radio.

### MARC'S

CENTRAL EQUIPMENT CO., INC.  
18451 W. DIXIE HIGHWAY  
NORTH MIAMI BEACH, FL 33160  
305-932-1818  
See Marc, WD4AAS, for complete  
Amateur Sales & Service.

### RAY'S AMATEUR RADIO

1590 US HIGHWAY 19 SO.  
CLEARWATER, FL 33516  
813-535-1416  
West coast's only dealer:  
Drake, Icom, Cushcraft, Hustler.

## Illinois

### AUREUS ELECTRONICS, INC.

1415 N. EAGLE STREET  
NAPERVILLE, IL 60540  
312-420-8629  
"Amateur Excellence"

### ERICKSON COMMUNICATIONS, INC.

5935 NORTH MILWAUKEE AVE.  
CHICAGO, IL 60646  
312-631-5181  
Hours: 9:30-5:30 Mon, Tues, Wed,  
Fri; 9:30-9:00 Thurs; 9:00-3:00 Sat.

### SPECTRONICS, INC.

1009 GARFIELD STREET  
OAK PARK, IL 60304  
312-848-6777  
Chicagoland's Amateur Radio  
leader.

## Indiana

### HOOSIER ELECTRONICS, INC.

P. O. BOX 2001  
TERRE HAUTE, IN 47802  
812-238-1456  
Ham Headquarters of the Midwest.  
Store in Meadows Shopping Center.

### KRYDER ELECTRONICS

GEORGETOWN NORTH  
SHOPPING CENTER  
2810 MAPLECREST RD.  
FORT WAYNE, IN 46815  
219-484-4946  
We service what we sell. 10-9 T,  
TH, F; 10-5 W, SAT.

*Dealers - You should be here too! Contact Ham Radio today for complete details.*

# Amateur Radio Dealer

## Iowa

**BOB SMITH ELECTRONICS**  
RFD #3, HIGHWAY 169 and 7  
FT. DODGE, IA 50501  
515-576-3886  
For an EZ deal.

## Kansas

**ASSOCIATED RADIO**  
8012 CONSER P. O. B. 4327  
OVERLAND PARK, KS 66204  
913-381-5901  
Amateur Radio's Top Dealer.  
Buy — Sell — Trade

## Kentucky

**COHOON AMATEUR SUPPLY**  
HIGHWAY 475  
TRENTON, KY 42286  
502-886-4535  
Yaesu, Ten-Tec, Tempo, DenTron.  
Our service is the BEST.

## Maryland

**THE COMM CENTER, INC.**  
9624 FT. MEADE ROAD  
LAUREL PLAZA RT. 198  
LAUREL, MD 20810  
301-792-0600  
R.L. Drake, Ten-Tec, Icom, Wilson,  
Tempo, DenTron, Mosley, Cushcraft

**PROFESSIONAL  
ELECTRONICS CO., INC.**  
1710 JOAN AVENUE  
BALTIMORE, MD 21234  
301-661-2123  
A professional place for amateurs.  
Service-sales-design.

## Massachusetts

**TEL-COM, INC.**  
675 GREAT RD. RT. 119  
LITTLETON, MA 01460  
617-486-3040  
The Ham Store of New England  
you can rely on.

**TUFTS RADIO ELECTRONICS**  
209 MYSTIC AVENUE  
MEDFORD, MA 02155  
617-395-8280  
New England's friendliest  
ham store.

## Michigan

**ELECTRONIC DISTRIBUTORS**  
1960 PECK STREET  
MUSKEGON, MI 49441  
616-726-3196  
Dealer for all major amateur  
radio product lines.

**RADIO SUPPLY & ENGINEERING**  
1207 WEST 14 MILE ROAD  
CLAWSON, MI 48017  
313-435-5660  
10001 Chalmers, Detroit, MI  
48213, 313-371-9050.

## Minnesota

**PAL ELECTRONICS INC.**  
3452 FREMONT AVE. NORTH  
MINNEAPOLIS, MN 55412  
612-521-4662  
The Midwest's Fastest Growing  
Ham Dealer.

## Missouri

**HAM RADIO CENTER, INC.**  
8340-42 OLIVE BLVD.  
ST. LOUIS, MO 63132  
800-325-3636  
For Best Price and Fast Delivery  
Call toll free 1-800-325-3636

**MIDCOM ELECTRONICS, INC.**  
2506 SO. BRENTWOOD BLVD.  
ST. LOUIS, MO 63144  
314-961-9990  
At Midcom you can try before you  
buy!

## Nebraska

**COMMUNICATIONS CENTER, INC.**  
443 NORTH 48 ST.  
LINCOLN, NE 68504  
800-228-4097  
Kenwood, Yaesu, Drake and more  
at discount prices.

## Nevada

**COMMUNICATIONS CENTER WEST**  
1072 RANCHO DRIVE  
LAS VEGAS, NV 89106  
800-634-6227  
Kenwood, Yaesu, Drake and more  
at discount prices.

## New Hampshire

**EVANS RADIO, INC.**  
BOX 893, RT. 3A BOW JUNCTION  
CONCORD, NH 03301  
603-224-9961  
Icom, DenTron & Yaesu dealer.  
We service what we sell.

## New Jersey

**ATKINSON & SMITH, INC.**  
17 LEWIS ST.  
EATONTOWN, NJ 07724  
201-542-2447  
Ham supplies since "55".

**RADIOS UNLIMITED**  
1760 EASTON AVENUE  
SOMERSET, NJ 08873  
201-469-4599  
New Jersey's newest  
complete Amateur Radio center

**THE BARGAIN BROTHERS**  
216 SCOTCH ROAD  
GLEN ROC SHOPPING CTR.  
WEST TRENTON, NJ 06828  
609-883-2050  
A million parts - lowest prices  
anywhere. Call us!

## New Mexico

**ELECTRONIC MODULE**  
601 N. TURNER  
HOBBS, NM 88240  
505-397-3012  
Yaesu, Kenwood, Swan, DenTron,  
Tempo, Atlas, Wilson, Cushcraft

## New York

**ADIRONDACK RADIO SUPPLY, INC.**  
185 W. MAIN STREET  
AMSTERDAM, NY 12010  
518-842-8350  
Yaesu dealer for the Northeast.

**GRAND CENTRAL RADIO**  
124 EAST 44 STREET  
NEW YORK, NY 10017  
212-682-3869  
Drake, Atlas, Ten-Tec, Midland,  
Hy-Gain, Mosley in stock

# HAM MART

## HAM-BONE RADIO

3206 ERIE BLVD. EAST  
SYRACUSE, NY 13214  
315-446-2266

We deal, we trade, all major brands!

## RADIO WORLD

ONEIDA COUNTY AIRPORT  
TERMINAL BLDG.  
ORISKANY, NY 13424  
315-337-2622

New & Used ham equipment.

See Warren K2IXN or Bob WA2MSH.

## Ohio

## AMATEUR RADIO

**SALES & SERVICE INC.**  
2187 E. LIVINGSTON AVE.  
COLUMBUS, OH 43209  
614-236-1625  
Antennas for all services.

## UNIVERSAL AMATEUR RADIO, INC.

1280 AIDA DRIVE  
REYNOLDSBURG, (COLUMBUS) OH  
43068  
614-866-HAMS  
Drake, Yaesu, Ten-Tec, KDK, Wilson,  
DenTron, Tempo, Sigma.

## Oklahoma

## RADIO STORE, INC.

2102 SOUTHWEST 59th ST.  
(AT 59th & S. PENNSYLVANIA)  
OKLAHOMA CITY, OK 73119  
405-682-2929  
New and used equipment —  
parts and supply.

## Oregon

## PORTLAND RADIO SUPPLY CO.

1234 S.W. STARK STREET  
PORTLAND, OREGON 97205  
503-228-8647  
Second location, 1133 S. Riverside  
Avenue, Medford, OR 97501.

## Pennsylvania

## ARTCO ELECTRONICS

302 WYOMING AVENUE  
KINGSTON, PA 18704  
717-288-8585

The largest variety of semiconduc-  
tors in Northeastern Pennsylvania

## ELECTRONIC EXCHANGE

136 N. MAIN STREET  
SOUDERTON, PA 18964  
215-723-1200  
Demonstrations, Sales, Service  
New/Used Amateur Radio Equip.

## "HAM" BUERGER, INC.

68 N. YORK ROAD  
WILLOW GROVE, PA 19090  
215-659-5900  
Delaware Valley's Fastest Growing  
Amateur Radio Store

## HAMTRONICS, DIV. OF TREVISE ELECTRONICS

4033 BROWNSVILLE ROAD  
TREVISE, PA 19047  
215-357-1400  
Same Location for 30 Years.

## Tennessee

## GERMANTOWN AMATEUR SUPPLY

3203 SUMMER AVE.  
MEMPHIS, TN 38112  
800-238-6168  
No monkey business. Call  
Toll Free.

## Texas

## AGL ELECTRONICS

3068 FOREST LANE, SUITE 309  
DALLAS, TX 75234  
214-241-6414 (within Texas)  
Out-of-State, Call our toll-free  
number 800-527-7418.

## HARDIN ELECTRONICS

5635 E. ROSEDALE  
FT. WORTH, TX 76112  
817-461-9761  
Your Full Line Authorized  
Yaesu Dealer.

## Wisconsin

## AMATEUR

**ELECTRONIC SUPPLY, INC.**  
4828 WEST FOND du LAC AVENUE  
MILWAUKEE, WI 53216  
414-444-4200  
Open Mon & Fri 9-9, Tues, Wed,  
Thurs, 9-5:30, Sat, 9-3.

## Washington

## AMATEUR RADIO SUPPLY CO.

6213 13TH AVENUE SOUTH  
SEATTLE, WA 98108  
206-767-3222  
First in Ham Radio in Washington  
Northwest Bird Distributor

## BARBER

# TONE ENCODER

### FEATURES:

- Crystal Controlled - Digitally Synthesized Tones.
- Low Current Drain CMOS Logic.
- RFI Immune
- 16-Button Tactile Feedback Keyboard.
- Will Interface to Transceivers Using Dynamic Microphones with Only Two Wires.
- Provisions for Three Wire Interface Are Provided.
- Gold-Plated Keyboard Contacts Provided for Maximum Reliability.
- Operating Voltage Range 9-18VDC.
- Size: 2.1" x 2.1" x .250" Without Case. 2.1" x 2.1" x .312" With Case.
- 2" Square Velcro Available for Convenient Mounting - Dashboard - Sun Visor - Radio - etc.



Tone Encoder .....	\$46.00
Case .....	\$ 2.00
Velcro .....	\$ .50

### NEW! GOLDLINE AMP - 2M

1-4 Watts In, 7-25 Watts Out .....\$46.50

Ohio Residents Add 4.5% Sales Tax

Send Check or Money Order To:

## WREN CO.

8630 WINTON RD.  
CINCINNATI, OHIO 45231

## TECHNICIAN — FIELD TECHNICAL REP Fort Lauderdale

Require man with MF, SSB, VHF, FM experience, or amateur who has built and can troubleshoot equipment. Second-Class Commercial Radio-telephone License desirable, but not necessary. Basic hand tools and V-O-M required, other equipment supplied by employer.

We are a technically-based, medium-sized (\$1 million), growing, marine electronics sales, installation, and service company. We offer a well-equipped, waterfront shop, major medical plan, and paid vacation.

This is interesting, challenging, constantly varying, but demanding work. You must be neat in appearance and you must especially know and love electronics.

## MARINE ELECTRONICS INTERNATIONAL

1525 Southeast 16th Street  
Fort Lauderdale, Florida 33316  
Telephone (305) 525-3478

## YOUR MARK II & MARK IV HEADQUARTERS!

**MARK II** 2.5-WATT  
**MARK IV** 4-WATT  
**\$229<sup>95</sup>** **\$259<sup>95</sup>**  
Plus Shipping Plus Shipping

## IN STOCK

THEY WORK  
AS GOOD AS  
THEY LOOK!

SHOWN WITH OPTIONAL TT PAD



**SPECTRONICS, INC.**

1009 GARFIELD ST.  
OAK PARK, ILL. 60304





# ALL-MODE VHF amplifiers

115V/230VAC OPERATION  
FOR BASE STATION & REPEATER USE

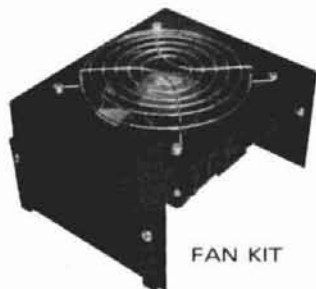

FAN KIT



- ☆ No Power Supply Needed
- ☆ AM-FM-CW-SSB-RTTY
- ☆ 60dB Harmonics
- ☆ 60dB Spurious
- ☆ Heavy Duty Design

- ☆ Illuminated Panel Meter
- ☆ Internal T/R Switch
- ☆ Fully Protected
- ☆ + 13V/3A Accessory Socket
- ☆ U.S. Manufactured

FCC Type Accepted Models also available, Parts 89,91,93.

MODEL	FREQUENCY	INPUT	OUTPUT	SIZE WxDxH	WEIGHT	FAN KIT Required	PRICE
V70	144-148MHz	10-15W	75-90W	216x330x178mm	11.7 kg (26 lbs)	NO	\$315.00
V71	144-148MHz	1-3W	75-90W	216x330x178mm	11.7 kg (26 lbs)	NO	\$349.00
V180	144-148MHz	8-15W	170-200W	216x330x178mm	13.5 kg (30 lbs)	CW & FM	\$539.00
*V350	144-148MHz	10-20W	350-400W	432x330x178mm	20.2 kg (45 lbs)	YES	\$875.00
V130B	220-225MHz	10-15W	70-85W	216x330x178mm	11.7 kg (26 lbs)	NO	\$329.00
V135B	220-225MHz	25-35W	140-160W	216x330x178mm	11.7 kg (26 lbs)	CW & FM	\$469.00
F110	FAN KIT, 115VAC			135x135x50mm	1 kg (2.2 lbs)	-	\$ 33.00
F220	FAN KIT, 230VAC			135x135x50mm	1 kg (2.2 lbs)	-	\$ 33.00
RM-1	19 INCH RACK ADAPTOR			483x3x178mm	1 kg (2.2 lbs)	-	\$ 25.00

\*Available after September 1, 1978

OTHER FREQUENCIES AVAILABLE ON REQUEST.  
CALL FRANK KALMUS - WA7SPR



**RF POWER LABS, INC.**

11013-118th Place N.E. • Kirkland, Washington 98033 • Telephone: (206) 822-1251 • TELEX No. 32-1042



## MILITARY SURPLUS WANTED

Space buys more and pays more. Highest prices ever on U.S. Military surplus, especially on Collins equipment or parts. We pay freight. Call collect now for our high offer. 201 440-8787. **SPACE ELECTRONICS CO.** div. of Military Electronics Corp. 35 Ruta Court, S. Hackensack, N.J. 07606

## COLLINS RECEIVERS MODEL 651S1

**\$3500**

FOB NY USA



General coverage, freq. range: 250kHz-29.999 MHz in 100 Hz steps. All solid-state, digital readout, desk-top rcvr. Orig. price \$10,000. Used, clean, recond., orig. fact.-sealed cartons.

EXPORT INQUIRIES INVITED  
**COMMUNICATIONS TECHNOLOGY GROUP, INC.**  
Box 103, Rockville Centre, NY USA 11571 (516) 536-5724

# 432 Yagis by K2RIW

IF YOU'RE SERIOUS ABOUT 432...

... MEET RIW'S 432-19

- 1st PLACE - EAST COAST VHF SOCIETY'S 1977 ANTENNA GAIN CONTEST
- 19 ELEMENTS, TANDEM-REFLECTOR\*
- 12-MHz BANDWIDTH, 432-MHz CF
- INTEGRAL BALUN, 50 Ω TYPE N
- ALL ELEMENTS INSULATED FROM BOOM - NO GAIN LOSS FROM WEATHERING!
- 13-FT SELF-SUPPORTING BOOM
- WEIGHS ONLY 2-3/4 POUNDS!

\*PATENT PENDING

MODEL 432-19 . . . \$59.95

441 MHz CF ATV MODEL 441-19 . . . \$59.95

New POWER DIVIDERS New

- FOR FEEDING MULTIPLE ANTENNAS  
420 - 450 MHz - RUGGED - WEATHERPROOF
- 2-WAY SPLIT, MODEL 4PD2 . . . \$24.95
  - 4-WAY SPLIT, MODEL 4PD4 . . . \$29.95
  - 8-WAY SPLIT, MODEL 4PD8 . . . \$49.95

PLEASE ADD \$2.00 PER ITEM SHIPPING/HANDLING. N.Y.S. RESIDENTS ADD SALES TAX. QUANTITY AND PACKAGE DISCOUNTS AVAILABLE - WRITE.

**riw PRODUCTS**

BOX 191, BABYLON, N.Y. 11702

## TEST EQUIPMENT

All equipment listed is operational and unconditionally guaranteed. Money back if not satisfied. Prices listed are FOB Monroe.

- HP120B 450kHz gen pur scope . . . . . \$215
- HP170A (USM140) 30MHz scope with reg horiz, dual trace vert plugs . . . . . 475
- Meas Mod 80 Stand sig gen . . . . . 225
- 2-400MHz with calib atfn . . . . . 225
- Quantech 303 Wave Anal . . . . . 445
- Tek565 Dual beam 10MHz scope less plug ins (3 series) . . . . . 625
- Tek585 80MHz gen pur scope less plugin . . . . . 645
- URM25 Stand Sig Gen 10kHz-50MHz calib atfn . . . . . 225

For complete list of all test equipment send stamped, self-addressed envelope.

**GRAY Electronics**

P.O. Box 941, Monroe, Mich. 48161

Specializing in used test equipment.

**NEW!**

## DAVIS ELECTRONICS

### 600 MHz Mini Counter

- NOW . . . . .
- Completely PORTABLE with Ni-Cad Batteries
  - Crystal Oven Available



General Purpose Low Cost Counter Without the Sacrifice of Basic Performance  
"Check the features we have that some other low cost counters don't have."

- All Metal Cabinet
- Sensitivity 10 MV at 60 MHz
- Completely Auto Decimal Point
- 8 Digit A" LED Display
- 115V or 12V Operation
- Selectable Gate Times (1 sec & .1 sec)
- Input Cable Included
- Push Button Controls
- Built-in Preamp (optional)
- 12V Input Jack
- Gate Light
- Crystal Time Base (1 ppm after cal.)

7208K 600 MHz Kit . . . . \$149.95    7208A Assembled . . . . \$199.95

- OPTIONS . . . . .
- 01) Portable w/Ni-Cad Battery (Built-in Charger) . . . . \$39.95
  - 02) Crystal Oven (1 ppm 0 to 60°C) \$39.95    03) Handle . . . \$5.00
  - 04) Built-in Preamp 10 MV @ 150 MHz . . . . . \$10.00



DAVIS ELECTRONICS 636 Sheridan Dr., Tonawanda, NY 14150 716/874-5848

Pre-Amp PROBE  
10-500 MHz  
Only \$49.95



## CURTIS SYSTEM 4000 Automatic CW-RTTY



**CURTIS KEYSER CHIP now \$14.95**

- 8043-1; IC only (Qty pricing available) \$ 14.95
- 8043-3; IC, PCB, Manual (New Item) . . \$ 24.95
- 8043-4; Semi-kit (New Item) . . . . . \$ 54.95

Add for postage and handling . . . \$ 1.50

- \*Apr 76 HR, Feb 76 QST, Radio Hobb 76, APRIL Hobb 77-78
- EK-430 CMOS Keyer (Feb 76 QST) . . . \$124.95
- IK-440A Instructokeyer (Mar 76 QST) . . \$224.95
- SYSTEM 4000 Ham Computer (S-100 buss compatible)

NEW! See Jan 78 Ad in QST or write for info . . .

Curtis Electro Devices, Inc.

(415) 954-3135

Box 4090, Mountain View, CA 94040



## Lightweight Headphones



**HFC-91**  
 Ultra-light undercush. Acoustic delay of 1 millisecond enhances intelligibility on CW or SSB. Low impedance 8-20 ohms. Shaped response—100 - 3,000 Hz, 1.5 ounces.  
 Order by Catalog No. 18135-013 \$8.95



**HMC-2**  
 Featherweight—Undercush rugged aluminum tone arms direct signals into the ear—great for contests. 1.2 ounces. 100 - 3,000 Hz. Low impedance. 8-20 ohms.  
 Order by Catalog No. 18183-002 \$13.85



**HTC-2**  
 Lightest Dual driver headset. Choice of the pros who must wear them for hours. 1.6 ounces. 100 - 3,000 Hz. Low impedance. 8-20 ohms.  
 Order by Catalog No. 3775-002 \$22.00

## Mobile Microphones



**ProCom I & II Electret**  
 Broadcast quality—clarity and crispness, describe the audio of the electrets. 1.4 v battery provides bias to the electret in the ProCom I. In the ProCom II the 1.4 volt battery also powers the 10dB amplifier.  
**ProCom I** Low impedance  
 Order by Catalog No. 63540-000  
**ProCom II**  
 Usable in low or high impedance  
 Order by Catalog No. 63550-000



**CB-73**  
 Flight Line audio quality and performance for that FM transceiver. Rugged selectable noise canceling. 43 dB sensitivity variable gain, shaping amplifier. Use on high or low Z applications. Available in grey, cyanotic, or clear. Tenth.  
 Clear—Order by Catalog No. 63373-003  
 Grey—Order by Catalog No. 63373-002  
 \$42.95

## Special Headsets



**NOISE BREAKER**  
**Lightweight Headset**  
 VHF operation will never be the same. Noise canceling magnetic microphone. 8 ohm microphone, in-line PTT and variable gain shaping amplifier (better performance). Hams have been waiting for—43 dB maximum microphone sensitivity at 600 ohms—compatible with eyeglass adapter.  
 Order by Catalog No. 43388-002  
 \$69.95



**— Mobile "FM" —**  
 VHF House or Mobile—high performance audio on transmit and receive—Fat amplifier, low Z microphone. Earphone. 8 ohms—in-line PTT.  
 Order by Catalog No. 63360-002  
 \$59.95

## Dual Muff Headphones/Headsets



**C-1320 Headphone**  
 Top of the line, fully cushioned audiometric type drivers are ultra-sensitive—DXers choice. 20 - 20,000 Hz. Low impedance 8-20 ohms.  
 Order by Catalog No. 61320-012  
 \$39.80



**CM-1320 Headset**  
 Top of the line, with a boom microphone—ceramic, high impedance. The choice of DX-peditions.  
 \$71.70  
 Order by Catalog No. 61320-013



**C-1210 Headphone**  
 Ultimate comfort and performance—mylar diaphragms assure continued sensitivity for digging out the weak ones. 20 - 20,000 Hz. low impedance. 8-20 ohms.  
 Order by Catalog No. 61210-031  
 \$28.30



**CM-1210 Headset with microphone**  
 Ceramic 50,000 ohms. Ideal for traffic nets.  
 Order by Catalog No. 61200-058  
 \$59.75



**C-610 Headphone**  
 Lightweight 8 ounces. An ideal headphone for code courses, code practice or actual operating. Low impedance. 50 - 12,000 Hz.  
 \$9.95  
 Order by Catalog No. 61630-063



**CM-610 Headset**  
 with high impedance ceramic microphone. 50,000 ohms. Economical price—professional convenience.  
 Order by Catalog No. 61630-064  
 \$44.95



**PC-100 Headphone**  
 Full cushion comfort—performance and long life make these dynamic phones ideal for novice or extra. 50 - 12,000 Hz. Low impedance. 8 - 200 ohms. weight 12 ounces.  
 Order by Catalog No. 63510-010  
 \$16.95

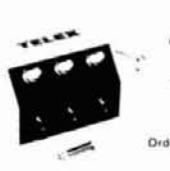

**Headphone Jack Box**  
 Ham Clubs, field day, contest operation. No more jury rigs for multiple headphones, six 1/4" phone jacks with individual volume controls, 4 foot cord with 1/4" phone plug.  
 Order by Catalog No. 62753-000  
 \$16.25

## the indispensable **BIRD43** THRU LINE WATTMETER



Power Range	Frequency Bands (MHz)				
	2-30	100-1000	200-1000	300-1000	400-1000
1-watt	1.4	1.4	1.4	1.4	1.4
10-watt	10.6	10.6	10.6	10.6	10.6
25-watt	25.4	25.4	25.4	25.4	25.4
50-watt	50.8	50.8	50.8	50.8	50.8
100-watt	101.6	101.6	101.6	101.6	101.6
250-watt	254.0	254.0	254.0	254.0	254.0
500-watt	508.0	508.0	508.0	508.0	508.0
1000-watt	1016.0	1016.0	1016.0	1016.0	1016.0

MODEL 43 Elements (Table 1) 2-30 MHz \$125.00  
 Elements (Table 1) 25-1000 MHz 45.00  
 Carrying case for Model 43 & 6 elements 38.00  
 Carrying case for 12 elements 27.50  
 Carrying case for 12 elements 17.00

READ RF WATTS DIRECTLY! (Specify Type N or SO239 connectors) 0.45 - 2300 MHz, 1-10,000 Watts ±5%, low insertion VSWR - 1.05. Unequaled economy and flexibility. Buy only the element(s) covering your present frequency and power needs, add extra ranges later if your requirements expand.



## BOMAR Crystal Company

### TWO METER CRYSTALS

Standard / Icom / Heathkit / Ken / Clegg / Regency / Wilson / VHF Eng. / Drake / Motorola HT 220 - and others!

### LIFETIME GUARANTEE!

Now Only \$7.00 Per Pair!

Make/Model	Xmit Freq.	Rec. Freq.

Don't Miss The N.E. ARRL CONVENTION  
 At the Beautiful Sheraton Boxborough  
 Boxborough, Mass. Oct 14-15th.  
 GIANT FLEA MARKET!

Name \_\_\_\_\_ Call \_\_\_\_\_

Address \_\_\_\_\_

City \_\_\_\_\_

State \_\_\_\_\_ Zip \_\_\_\_\_

Order: \_\_\_\_\_

Check enclosed  Visa  Master Charge  
 American Express

Credit card # \_\_\_\_\_

Card expiration date \_\_\_\_\_

Signature \_\_\_\_\_

SEND FOR FREE CATALOG!



Radio Electronics  
 209-H Mystic Avenue  
 Medford, Mass. 02155  
 (617) 395-8280

Master Charge • Visa • American Express  
 Minimum \$3.00 shipping & handling for ALL orders.

Prices FOB Medford Mass. (Mass. residents add 5% sales tax)



# STEP UP TO TELREX

## Professionally Engineered Antenna Systems

### Single transmission line "TRI-BAND" ARRAY

MONARCH  
TB5EM/4KWP

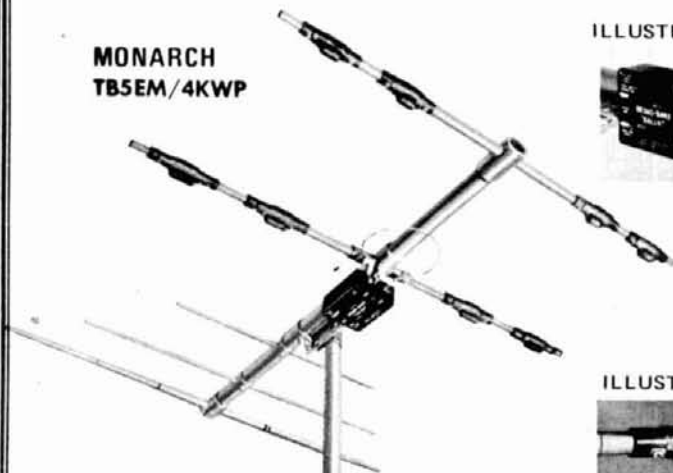

ILLUSTRATION BALUN



ILLUSTRATION TRAP



By the only test that means anything... on the air comparison... this array continues to outperform all competition... and has for two decades. Here's why... Telrex uses a unique trap design employing 20 HiQ 7500V ceramic condensers per antenna. Telrex uses 3 optimum-spaced, optimum-tuned reflectors to provide maximum gain and true F/B Tri-band performance.

For technical data and prices on complete Telrex line, write for Catalog PL 7

COMMUNICATION SYSTEMS SINCE 1971 **telrex** Laboratories  
ASBURY PARK, NEW JERSEY 07712, U.S.A.

## YOU'VE SEEN THE MAGAZINE ARTICLES

Here's what you can expect from the **DX ENGINEERING** RF Speech Processor

- 6 db INCREASE IN AVERAGE POWER
- MAINTAINS VOICE QUALITY
- IMPROVES INTELLIGIBILITY
- NO CABLES OR BENCH SPACE REQUIRED
- EXCELLENT FOR PHONE PATCH
- NO ADDITIONAL ADJUSTMENTS — MIKE GAIN ADJUSTS CLIPPING LEVEL
- UNIQUE PLUG-IN UNIT — NO MODIFICATIONS REQUIRED



This is RF Envelope Clipping—the feature being used in new transmitter designs for amateur and military use.

Models Now Available  
Collins 32S, KWM-2 ..... \$ 98.50 ea.  
Drake TR-3, TR-4, TR-6, TR-4C,  
T-4, T-4X, T-4XB, T-4XC \$128.50 ea.  
Postpaid — Calif. Residents  
add 6% Tax

Watch for other models later!

**DX Engineering**

1050 East Walnut, Pasadena, Calif. 91106

## ARRL HUDSON DIVISION CONVENTION

PLAYBOY RESORT & COUNTRY CLUB  
AT GREAT GORGE

McAFEE, NEW JERSEY

SPONSORED BY THE HUDSON AMATEUR RADIO COUNCIL, INC.

NOVEMBER 10, 11, 12, 1978  
SPECIAL PROGRAM FRIDAY NIGHT

EXHIBITS --- LECTURES --- FORUMS --- FLEA MARKET  
FREE PARKING --- COME FOR THE DAY OR THE WEEKEND  
LOW ROOM RATES --- INDOOR POOL --- FAMILY FUN  
ATTEND THE SATURDAY NIGHT BANQUET AND ENJOY  
RON SWOBODA WA2HVM AND JEAN SHEPHERD K2ORS



ADDITIONAL INFORMATION CAN BE OBTAINED FROM: HANK WENER WB2ALW,  
CHAIRMAN, BY WRITING TO HIM AT 53 SHERRARD STREET, EAST HILLS, N. Y. 11577

FLEA MARKET INFORMATION: Write to Peter Karpak, 23 Rowland Avenue,  
Clifton, N.J. 07012. Please enclose a large S.A.S.E. You can call Pete  
nights at 201 779-4590 or Dave Rettig, days at 201 354-1600.

USE COUPON (OR FACSIMILE) TO ORDER REGISTRATION AND BANQUET TICKETS

TO: NANCY ISCARO WA2GKC  
P.O. BOX 214  
BRONX, NEW YORK 10463

MY CHECK TO "HUDSON DIVISION CONVENTION" FOR \$ \_\_\_\_\_ IS ENCLOSED.  
THE NAMES AND CALL SIGNS (IF ANY) FOR THOSE WHO WILL  
BE USING THESE BANQUET TICKETS ARE ATTACHED.

HERE IS MY LARGE S.A.S.E. PLEASE SEND

REGISTRATION(S) AT \$2.50 \_\_\_\_\_ NAME \_\_\_\_\_ CALL \_\_\_\_\_  
ADDRESS \_\_\_\_\_  
BANQUET TICKET(S) AT \$15.00 \_\_\_\_\_ CITY \_\_\_\_\_ STATE \_\_\_\_\_ ZIP \_\_\_\_\_

See our **HAM MART**  
listings to find the  
Amateur Radio  
dealers nearest you.

## K-ENTERPRISES

Frequency Counters  
Prescalers  
Marker & Peaking  
Generators  
Power Supplies  
Amplifiers  
Frequency  
Standards

Write for Free Catalog

Box 410 (Pump Sta. Rd.) Fairland, OK 74343  
Phone: 918-676-3752

## FACSIMILE

COPY SATELLITE, PHOTOS,  
WEATHER MAPS, PRESS!

The Fax Are Clear — on our full size (18-1/2" wide) recorders. These commercial-military units now available at surplus prices. Learn how to copy with our FREE Fax Guide. Tel: (212) 372-0349

ATLANTIC SURPLUS SALES

3730 NAUTILUS BROOKLYN, N.Y. 11224

## DIPOLE ANTENNA CONNECTOR



HYE-QUE (HQ-1) dipole connector has coax SO-239 socket molded into glass filled plastic body to accept coax PL-259 plug on feedline. Drip-cap keeps coax fittings dry. Instructions included. Guaranteed. At your dealers or \$4.95 postpaid. Companion insulators 2/\$9.95.

BUDWIG MFG. Co. PO Box 97H, Ramona, CA 92065

# REPEATER USERS — Stay in Touch — with DSI

## UNIVERSAL

## TOUCH-TONE®

## ENCODERS

The Data Signal TTP Series of keyboard encoders is used to generate the standard 12 or 16 DTMF digits. The encoders provide fully automatic transmitter keying and feature a delayed Transmit Ready light, an interdigit timer, and a built-in audio monitor. Features also include all solid-state, crystal-controlled, digitally-synthesized tones and an optional internal mount Automatic Number Identifier (ANI).

TTP-1 (12-digit)  
TTP-2 (16-digit)

\$59.00  
\$69.00

**MODEL DTM** — Completely self-contained miniature encoder for hand-held portables. Only 5/16" thick. Three wire connection. Automatic PTT keying optional. With your choice of keyboards. Price DTM - \$39.00, DTM-PTT - \$49.00.

\*Touch-Tone is a registered trade name of AT&T.

TTP-1



DTM



TTP-2



## SUB-MINIATURE ENCODERS



**MODEL SME** — Smallest available Touch Tone Encoder. Thin, only .05" thick, keyboard mounts directly to front of hand-held portable, while sub-miniature tone module fits inside. This keyboard allows use of battery chargers. Price \$29.00, with your choice of keyboards. SME (less keyboard) \$24.00

## AUTOPATCH — Ready to go!

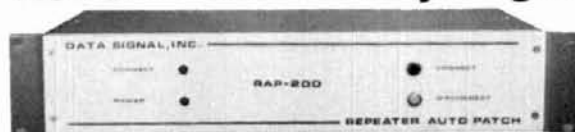

A Complete Autopatch facility that requires only a repeater and a telephone line. Features include single-digit access/disconnect, direct dialing from mobile or hand-held radios, adjustable amplifiers for transmitter and telephone audio, and tone-burst transponder for acknowledgement of patch disconnect.

RAP-200 P. C. Card  
RAP-200R Rack Mount

\$199.50  
\$249.50

# DATA SIGNAL, INC.

2403 COMMERCE LANE  
ALBANY, GEORGIA 31707, 912-883-4703



Be sure to ask about our new keyers and CW memory for CW buffs.

# WE CARRY OCEANS OF MANUFACTURERS

Call the Communications Leader in the Northwest for Price Quotes on your Amateur and other Communications Needs.

TOLL FREE

Weller  
Standard  
Pipo  
Callbook  
ICOM  
Vector  
ICC  
Yaesu  
Antenna Specialists  
GC Electronics  
Hitachi

Bearfinder  
CDE  
Panasonic  
G.E.  
Fairchild  
Mosley  
Cushcraft  
Howard Sams  
Valor



From Alaska in the Northwest to Florida in the Southeast  
From Maine in the Northeast to Hawaii in the Southwest  
Call TOLL FREE on . . .

800-426-6937

Residents of the State of Washington call TOLL FREE on 800-562-7625

Regency  
EMI  
Jim-Pak  
Larsen  
Sanyo  
Veco  
Midland  
Shakespeare  
Jensen  
Duracell  
Whistler  
Ungar  
Wilson  
Shure  
Amp  
Hustler  
Clarion  
Atlas  
Bearcat  
Turner  
CIR  
B & W  
Kenwood  
SBE

Orders are normally shipped in 48 hours.

17550 15th AVE. N.E.

ABC COMMUNICATIONS  
SEATTLE, WASH. 98155

206-364-8300



# Join the OSCAR Generation

## GETTING TO KNOW OSCAR FROM THE GROUND UP

by the ARRL

**AR-OSC** This anthology of reprinted articles from the popular QST series will give you all the OSCAR basics — how to get started, locating OSCAR satellites and how to use them. You'll learn all the important aspects of Amateur satellite communications with this super book! 45 pages . . . © 1977. **Softbound \$3.00**

## OSCAR - AMATEUR RADIO SATELLITES

by Stratis Caramanolis

**RS-O** Originally a European best-seller, this newest English language edition offers Radio Amateurs one of the most comprehensive works available on OSCAR satellites. You'll learn the principles and then examine OSCAR from concept to actual use. This handsome volume, profusely illustrated with charts, diagrams and photos, gives you a fascinating, factual view of OSCAR. 193 pages . . . © 1976. **Softbound \$8.50**

Send payment or credit card information plus .40 for each book you order to:

**Ham Radio's Communications Bookstore, Greenville, NH 03048**

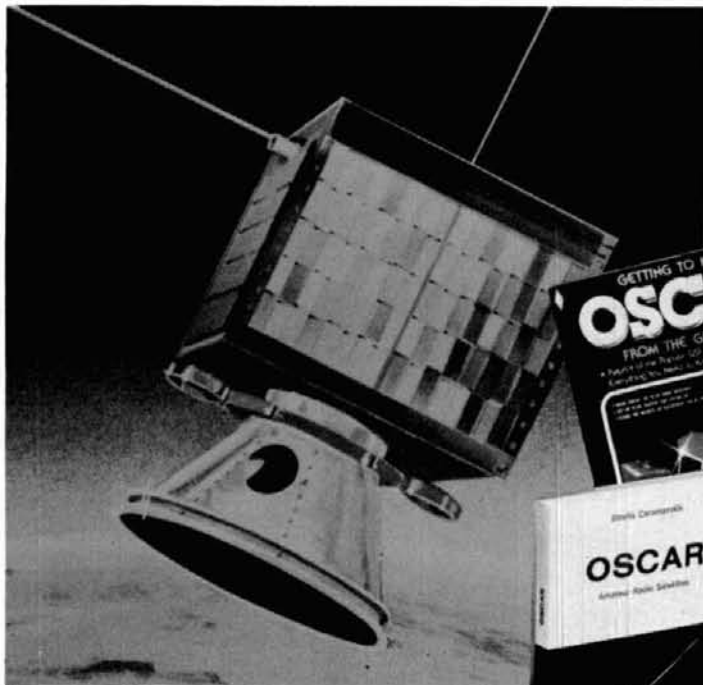

**ham radio's**  
**communications**  
**bookstore**



# ALL BAND TRAP ANTENNAS!

PRE-TUNED - COMPLETELY ASSEMBLED - ONLY ONE NEAT SMALL ANTENNA FOR UP TO 6 BANDS! EXCELLENT FOR CONGESTED HOUSING AREAS - APARTMENTS LIGHT - STRONG - ALMOST INVISIBLE!

FOR ALL MAKES & MODELS OF AMATEUR TRANSCEIVERS - TRANSMITTERS - GUARANTEED FOR 2000 WATTS 5SB 1000 WATTS CW. FOR NOVICE AND ALL CLASS AMATEURS!

COMPLETE AS SHOWN WITH 90 ft. RG58U-52 ohm feedline, and PL259 connector, insulators, 30 ft. 300 lb. test dacron end supports, center connector with built in lightning arrester and static discharge - molded, sealed, weatherproof, resonant traps 1"X6"-you just switch to band desired for excellent worldwide operation - transmitting and receiving! WT. LESS THAN 5 LBS.

80-40-20-15-10 bands 2 trap --- 102 ft. with 90 ft. RG58U - connector - Model 998BU . . . \$49.95  
40-20-15-10 bands 2 trap --- 54 ft. with 90 ft. RG58U coax - connector - Model 1001BU . . . \$48.95  
20-15-10 bands 2 trap --- 26 ft. with 90 ft. RG58U coax - connector - Model 1007BU . . . \$47.95

SEND FULL PRICE FOR POST PAID INSURED DEL. IN USA. (Canada is \$5.00 extra for postage - clerical - customs - etc.) or order using VISA Bank Americard - MASTER CHARGE - AMER. EXPRESS. Give number and ex. date. Ph. 1-308-236-5333 9AM - 6PM week days. We ship in 2-3 days. PRICES MAY INCREASE SO - ORDER NOW AND SAVE! All antennas guaranteed for 1 year. Money back trial! Made in USA. FREE INFO. AVAILABLE ONLY FROM.

WESTERN ELECTRONICS

Dept. AR-9

Kearney, Nebraska, 68847

## "WAZYERBESPRIS?"

(607) 739-0187

YAESU

DRAKE

CALL US FOR OUR "CASH-AND-CARRY" PRICE

IN-STOCK ITEMS SHIPPED UPS WITHIN 24 HOURS

PHONE: TUESDAY - FRIDAY 10-5

OTHER HOURS BY APPOINTMENT ONLY



**C F P COMMUNICATIONS**

211 NORTH MAIN STREET  
HORSEHEADS, N. Y. 14845  
PHONE: 607-739-0187



# MOVING?

KEEP HAM RADIO COMING . . .

If possible let us know four to six weeks before you move and we will make sure your HAM RADIO Magazine arrives on schedule. Just remove the mailing label from this magazine and affix below. Then complete your new address (or any other corrections) in the space provided and we'll take care of the rest.

**ham radio**  
Magazine

Allow 4-6 weeks for correction.

Greenville, NH 03048

Thanks for helping us to serve you better.

Here's my new address:

Name \_\_\_\_\_  
Address \_\_\_\_\_  
City \_\_\_\_\_ State \_\_\_\_\_ Zip \_\_\_\_\_

**AFFIX LABEL HERE**

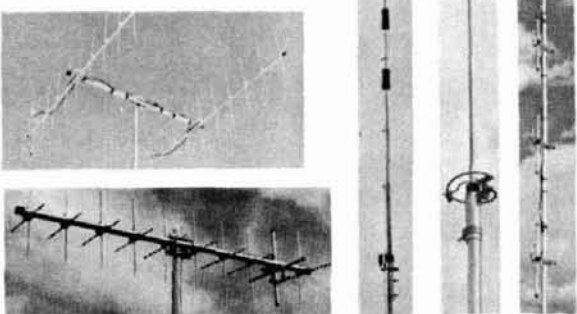

ARX 2	Ringo Ranger	\$36.95
AR 2	FM Ringo	\$24.95
AFM 4D	Four Pole	\$64.95
A147-4	4 element yagi	\$22.95
A147-11	11 element yagi	\$34.95
A147-20T	FM/SSB Twist	\$59.95
ATV 3	10/15/20 meter vertical	\$49.95
ATV 4	10/15/20/40 meter vertical	\$89.95
ATV 5	10/15/20/40/80 meter vertical	\$109.95
ATB 34	10/15/20 meter beam	\$259.95

With purchase over \$50 you get 100',  
buy under \$50, get 50'.

Columbia 1109 reg. \$20/c

1401 Blake St. Denver, Co. 80202

303-893-5525



Colo. residents add 3%

**Radio Amateurs Reference Library of Maps and Atlas**

**WORLD PREFIX MAP** — Full color, 40" x 28", shows prefixes on each country . . . DX zones, time zones, cities, cross referenced tables **\$1.25**

**RADIO AMATEURS GREAT CIRCLE CHART OF THE WORLD** — from the center of the United States! Full color, 30" x 25", listing Great Circle bearings in degrees for six major U.S. cities; Boston, Washington, D.C., Miami, Seattle, San Francisco & Los Angeles. **\$1.25**

**RADIO AMATEURS MAP OF NORTH AMERICA!** Full color, 30" x 25" — includes Central America and the Caribbean to the equator, showing call areas, zone boundaries, prefixes and time zones, FCC frequency chart, plus useful information on each of the 50 United States and other Countries **\$1.25**

**WORLD ATLAS** — Only atlas compiled for radio amateurs. Packed with world-wide information — includes 11 maps, in 4 colors with zone boundaries and country prefixes on each map. Also includes a polar projection map of the world plus a map of the Antarctica — a complete set of maps of the world. 20 pages. Size 8 3/4" x 12" **\$2.50**

Complete reference library of maps — set of 4 as listed above **\$3.75**

See your favorite dealer or order direct.  
Mail orders please include \$1.25 per order for shipping and handling.

**RADIO AMATEUR callbook INC.**  
Dept. E 925 Sherwood Drive  
Lake Bluff, Ill. 60044

**WRITE FOR FREE BROCHURE!**

# "THE PROFESSIONALS"

## NEW MODEL CTR-2A • 500 MHz & 1 GHz COUNTERS

NEW  
Period  
Measurement

NEW  
Built-in  
Pre-Amp

1 us to  
1 sec. 10 mv @  
150 MHz

The New Model CTR-2A Series Counters are designed and built to the highest standards to fulfill the needs of commercial communications, engineering labs and serious experimentors. With an accuracy of + .00005% (oven option) the CTR-2A can handle the most critical measurements and is about half the cost of other commercial counters.

If you need a reliable counter at an affordable price, the CTR-2A is the answer.

- Built-in Pre-Amp 10 mv @ 150 MHz
- 8 Digit .3" LED Display
- High Stability TCXO Time Base
- Built-in VHF-UHF Prescaler
- Automatic Dp Placement
- TCXO Std. ± 2 ppm
- Period Measurement (Optional)
- Input Diode Protected
- 12V-DC Operation (Optional)
- Oven Controlled Crystal (Optional) ± .5 ppm
- Selectable Gate Times - .1 & 1 sec.

500 MHz Kit CTR-2A-500K	.....	\$249.95
500 MHz Assembled CTR-2A-500A	.....	349.95
1GHz Kit CTR-2A-1000K	.....	399.95
1GHz Assembled CTR-2A-1000A	.....	549.95

**OPTIONS . . . .**

02) Oven Crystal	\$49.95	05) 10 sec. Time Base	\$ 5.00
03) .43" LED	10.00	06) Period	15.00
04) 12 V-DC	10.00	07) Handle	10.00

**DAVIS**

**PROBES**  
Hi-Z  
\$15.00  
•  
Low Pass  
\$15.00

DAVIS ELECTRONICS 636 Sheridan Dr., Tona., N.Y. 14150 716/874-5848

# Advertisers check-off

... for literature, in a hurry — we'll rush your name to the companies whose names you "check-off"

Place your check mark in the space between name and number. Ex: Ham Radio  234

## INDEX

ABC	571	Heights *	
AED	710	Henry	062
ARRL *		Hy-Gain	064
ALDA	625	Icom	066
Adv. Elect.		Info-Tech	351
Appl.	677	Integ. Circuits	518
Aldelco	347	Int. Crystal	066
Aluma	589	Jameco	333
Am. Elect. Supply *		Jan	067
Am. Rad. Center	638	Jones	626
Amidon	005	K-Enterprises	071
Antenna Mart	009	Kantronics	605
Apollo	011	Kenwood *	
Applied Inv.	711	Klaus	430
Atlantic Surplus	644	L Tronics	576
Atlas	198	Little Giant	011
Barry *		Long's	468
Bristol	717	Lyle	373
Budwig	233	MFJ	082
Bullet	328	Madison *	
Butternut *		Marine Elec. Int.	714
CFP	022	Monroe	715
CW Elect.	533	NuData	456
Cal Crystal	709	Palomar Elec.	673
Clegg	027	Palomar Eng.	093
Communications Center	534	Partridge	439
Comm. Spec.	330	Pathcom	705
Comm. Tech. Group	645	Pipo	481
Crystal Banking	573	Poly Paks	096
Curtis Electro	034	RF Power Labs	602
Cushcraft	035	RIW *	
DSI	656	Callbook	100
DX Eng.	222	Radio Expo *	
Dames Comm.	551	Radio World *	
Dames, Ted	324	Ramsey	442
Data Signal	270	S-F A. R. S.	640
Davis Elec.	332	SST	375
DenTron	259	Science Workshop	680
Disc-Cap	449	Sherwood	435
Disc Instru.	712	Slep	232
Drake	039	Space	107
E. T. O. *		Spectronics	191
Electrocom	663	Spect. Comm.	366
Elec. Distr.	044	Spectrum Int.	106
Elec. Equip. Bank	288	Standard Comm.	109
Electospace	407	Swan	111
Epsilon	046	TPL	240
Erickson *		Taylor	674
Fair Radio	048	Telrex	377
Fox-Tango	657	Texas Towers *	
GLB	552	Tri-Ex	116
Godbout	647	Triplet	544
Gray	055	Tristao	118
Gregory *		Tufts	321
Gull	635	VHF Eng.	121
Hal	057	Vanguard Labs	716
Hal-Tronix	254	Varian	043
HRCB	150	Wayne	697
HR Magazine	150	Webster Assoc.	423
Hamtronics NY	246	Weinschenker	122
Hamtronics PA *		Western *	
Harper-Stanley	713	Whitehouse	378
Heath	060	Wilson	123
		Wren	702
		Yaesu	127

\*Please contact this advertiser directly.  
Limit 15 inquiries per request.

**September, 1978**

Please use before October 31, 1978

Tear off and mail to

HAM RADIO MAGAZINE — "check off"  
Greenville, N. H. 03048

NAME .....

CALL .....

STREET .....

CITY .....

STATE ..... ZIP .....



There's  
nothing  
like it !

RADIO AMATEUR  
**callbook**

Respected worldwide as  
the only complete authority  
for radio amateur  
QSL and QTH information.

The U.S. Callbook has over 300,000 W & K listings. It lists calls, license classes, names and addresses plus the many valuable back-up charts and references you come to expect from the Callbook.

Specialize in DX? Then you're looking for the **Foreign Callbook** with almost 300,000 calls, names and addresses of amateurs outside of the USA.

**U.S. Callbook \$14.95**

**Foreign Callbook \$13.95**

Order from your favorite electronics dealer or direct from the publisher. All direct orders add \$1.50 for shipping. Illinois residents add 5% Sales Tax.

RADIO AMATEUR  
**callbook** INC.  
Dept. E 925 Sherwood Drive  
Lake Bluff, Ill. 60044



# Advertisers iNdex

ABC Communications	139
AED Electronics	130
ARRL, Hudson Division	138
ALDA Communications	115
Advanced Electronic Applications	82
Aldelco	124
Aluma Tower Co.	114
Amateur Electronic Supply	124
Amateur Radio Center	114
Amidon Associates	102
Antenna Mart	128
Apollo Products	130
Applied Invention	118
Atlantic Surplus Sales	138
Atlas Radio	67
Barry Electronics	128
Budwig Mfg. Co.	138
Bullet	127
Butternut Electronics	122
CFP Communications	140
CW Electronic Sales Company	141
Cal Crystal Lab, Inc.	128
Clegg	90
Communications Center	128
Communications Specialists	10, 11
Communications Technology Group	126, 136
Crystal Banking Service	124
Curtis Electro Devices	136
Cushcraft	105, 107, 109
DSI Instruments	21, 121
DX Engineering	138
Dames Communications Systems	122
Dames, Ted	112
Data Signal, Inc.	139
Davis Electronics	136, 141
DenTron Radio Company	9
Disc-Cap	30
Disc Instruments, Inc.	125
Drake Co., R. L.	61
Echhorn Technological Operations	143
Electrocom Industries	78
Electronic Distributors	130
Electronic Equipment Bank	114
Electospace Systems	102
Epsilon Records	120
Erickson Communications	98
Fair Radio Sales	120
Fox-Tango Corporation	90
GLB	112
Godbout Electronics	128
Gray Electronics	136
Gregory Electronics	71
Gull Electronics	117
Hal Communications Corp.	83
Hal-Tronix	33
Ham Radio's Communications Bookstore	140
Ham Radio Magazine	140
Hamtronics, Inc., Rochester, NY	113
Hamtronics, Inc., Treviso, PA	62, 63, 71, 81
Harper-Stanley Co.	114
Heath Company	41
Heights Mfg. Co.	118
Henry Radio Stores	Cover II
Hy-Gain Electronics	91
Icom	5
Info-Tech	119
Integrated Circuits Unlimited	131
International Crystal	103
Jameco Electronics	135
Jan Crystals	98
Jones, Marlin P. & Assoc.	120
K-Enterprises	138
Kenwood Communications, Inc.	7, 72, 73
Klaus Radio, Inc.	112
L Tronics	90
Little Giant	130
Long's Electronics	144
Lyle Products	112
MFJ Enterprises	2
Madison Electronic Supply	111, 126
Marine Electronics International	134
Monroe Electric	118
NuData Electronics	128
Palomar Electronics Corp.	79
Palomar Engineers	108
Partridge (HRI) Electronics	130
Pathcom, Inc.	53
Pipo Communications	114
Poly Paks	116
RF Power Labs	136
RIW Products	136
Radio Amateur Callbook	141, 142
Radio Expo	78
Radio World	122
Ramsey Electronics	77
S-F Amateur Radio Service	82
SST Electronics	123
Sherwood Engineering	122
Slep Electronics	118
Space Electronics	136
Spectronics	78, 114, 120, 126, 134
Spectrum Communications	110
Spectrum International	97
Swan Electronics	54, 55
TPL Communications	81
Taylor Radio Co., Inc.	99
Telrex Laboratories	138
Texas Towers	126
Tri-Ex Tower Corporation	106
Tristao Tower	98
Tufts Radio Electronics	137
VHF Engineering, Div. of Brownian	102
Vanguard Labs	78
Varian, Eimac Division	Cover IV
Webster Associates	126
Weinschenker	130
Western Electronics	140
Whitehouse, G. R. & Co.	82
Wilson Electronics	1
Wren Company	134
Yaesu Electronics Corp.	Cover III



# Maximum Legal Power... ALPHA Style!

It's yours in these great new powerhouses from ETO

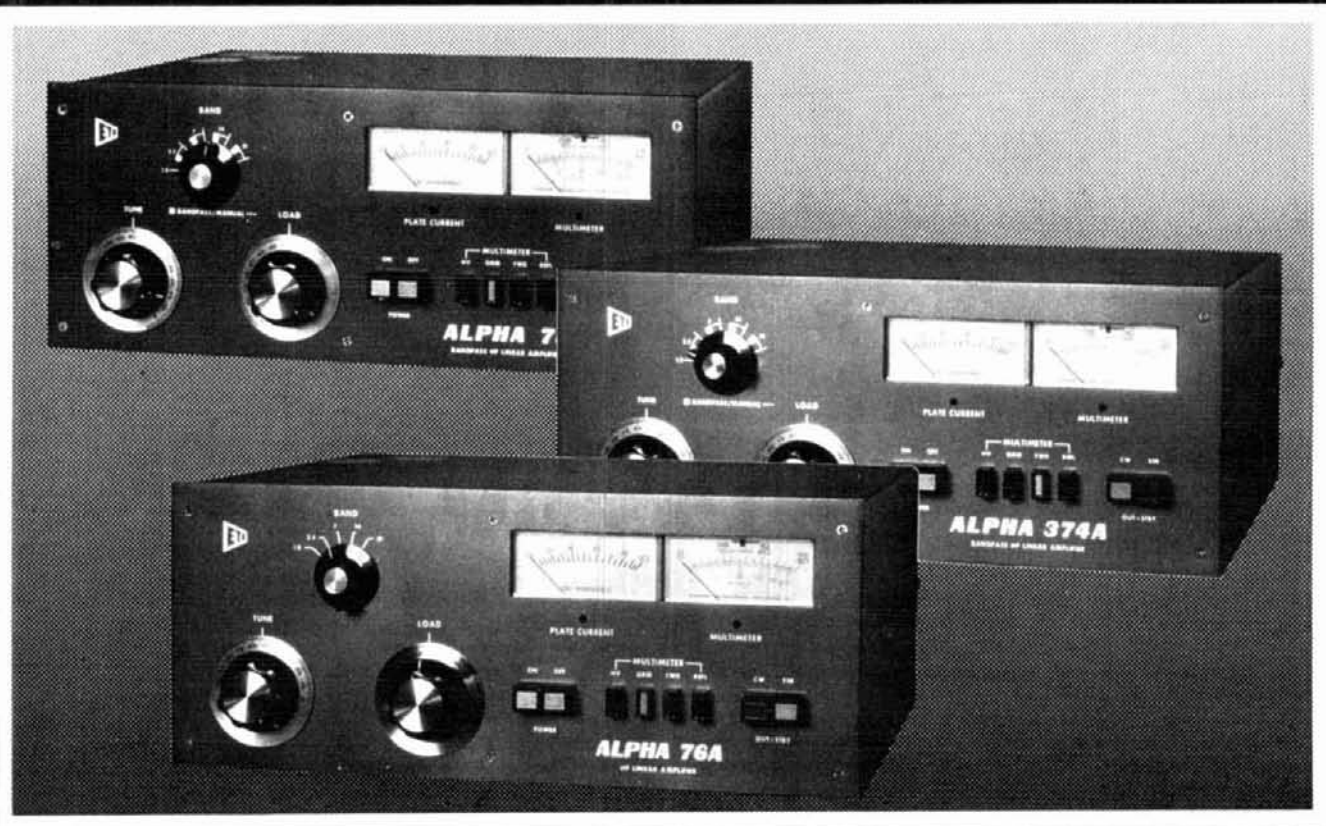

There are many so-called "Maximum Legal Power" linear amplifiers on the market. Why do so many knowledgeable amateurs, after checking out (or even owning) other makes, ultimately choose ALPHA?

Well, "maximum legal power" can be misleading... it doesn't tell the whole story. Most manufacturers' ratings assume that amateur service is inherently intermittent, so terms such as "continuous" and "100% duty" may be meaningless unless explicitly defined. The result can be a power transformer or tube going up in smoke during a long operating period.

But every ALPHA amplifier is explicitly rated to run a full 1000 watts of continuous, average DC power input, in any mode, with No Time Limit (NTL).

You could leave your ALPHA (any ALPHA) all day with a brick on the key, at a kilowatt input (or at 2 KW PEP input, two tone SSB) without hurting it. In fact, you could leave it for weeks: last year we ran a standard ALPHA 76 key-down at a kilowatt for 18 days without ill effect.

That's "Maximum Legal Power" . . . ALPHA style.

#### PLEASURE OF OWNERSHIP . . . ALPHA STYLE!

The pleasure of owning and using a new ALPHA is now even greater. There's rugged, handsome new metalwork . . . refined metering and push-button control systems . . .

improved bandpass circuits in the no-tune-up models. One model combines the conveniences of no-tune-up operation and full CW break-in. Another brings ALPHA POWER to 6 meters.

#### ENGINEERING AND CRAFTSMANSHIP . . . ALPHA STYLE!

These new ALPHA models are pleasing to the eye . . . but the real beauty is inside, where engineering and craftsmanship tell the story. The husky components and basic circuitry are the same ones that kept the ALPHA 76 and ALPHA 374 so amazingly free of major failures.

#### WARRANTY PROTECTION . . . ALPHA STYLE!

Other manufacturers give you just 90 days' warranty protection on their linears. Now ETO extends the famous ALPHA warranty to **TWO YEARS — EIGHT TIMES AS MUCH PROTECTION** as the industry standard! Tells you something about ALPHA quality, doesn't it?

The new ALPHA 76A series is FCC type-accepted and available now. For details, descriptive literature, and fast delivery on a great new ALPHA, see your dealer or contact ETO direct.

And ask for a copy of our free guide, "Everything You Always Wanted To Know About (Comparing) Linears . . . But Didn't Know Whom to Ask."

ALPHA - Sure you can buy a cheaper linear . . . But is that really what you want?

**ETO** Ehrhorn Technological Operations, Inc.  
P.O. Box 708 · Cañon City, Colorado 81212 · (303) 275-1613

# LONGS RECOMMENDS ACCESSORIES

CALL TOLL FREE! 1-800-633-3410

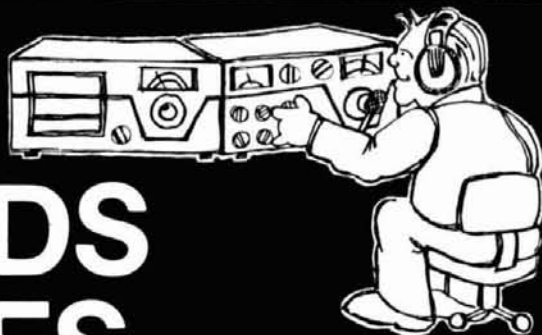

## Lumitime CC-24 24 hour digital clock



The CC-24 is the perfect addition to any ham shack. Large 2 inch digital display makes telling time easy at a glance.  
 • 24 hour alarm with 8-10 min. snooze button can also be used as a station ID buzzer. • 110 volts A/C operation.

**29.95** Call for yours today.

## KENWOOD MC-50 desk microphone

The MC-50 dynamic mike has been designed expressly for amateur radio operation. • Complete with PTT & LOCK switches. • Easy conversion from HI to LOW impedance • Uni-directional • Mike plug on coil cord for instant hook-up to any Kenwood rig.



**39.50**  
Call for quote.



## DENTRON Big Dummy Load

Tune-up off the air with Dentron's Big Dummy Load. A full power dummy load, it has a flat SWR, full frequency coverage from 1.8 to 300 MHz. A high grade industrial cooling oil is furnished with the unit. Fully assembled and warranted. Help cut out the QRM factor NOW!

**29.50** Call for yours today.



## YAESU SP-101PB speaker / phone patch

The SP-101PB features a response speaker from 300 to 3000 Hz • Built-in hybrid phone patch • VU meter • Full VOX phone patch operation • Receiver input impedance: 4 or 600 ohm • Output impedance: 600 ohm or high impedance.

**64.00** Call for yours today.



## AEA AD-1 automatic dialer

You get 18 numbers from a 1-2 punch. Make quick and safe auto patch calls. The AD-1 features:  
 • Key-Pad programmable memory • Built in speaker • MOS micro-processor • Crystal controlled • Mates with virtually all amateur FM transceivers.

**129.95** List. Call for quote.



# Long's Electronics



MAIL ORDERS: P.O. BOX 11347 BIRMINGHAM, AL 35202 • STREET ADDRESS: 2808 7TH AVENUE SOUTH BIRMINGHAM, ALABAMA 35233

Remember, you can Call Toll Free: 1-800-633-3410 in the U.S.A. or call 1-800-292-8668 in Alabama for our low price quote. Store hours: 9:00 AM til 5:30 PM, Monday thru Friday.



## THE 901DM "SMART RADIO" FAMILY

HERE NOW  
left to right

- YD-844A High/Low Impedance Microphone (50K/600 Ohms)
- FC-901 Antenna Tuner
- FV-901DM Synthesized Scanning VFO
- FT-901DM HF All Mode Transceiver
- FTV-901 Multi Band Transverter—2 meter/6 meter/3/4 meter
- SP-901P Speaker Phone Patch

And Specifications Subject To  
Change Without Notice Or Obligation

THERE'S MORE TO COME . .

**arma**  
patent-pending manufacturer's association



YAESU  
**The radio.**

YAESU ELECTRONICS CORP., 15954 Downey Ave., Paramount, CA 90723 ● (213) 633-4007  
YAESU ELECTRONICS Eastern Service Ctr., 9812 Princeton-Glendale Rd., Cincinnati, OH 45246

# EIMAC tubes win a place in Rockwell-Collins' HF-80 systems.

## Rockwell-Collins chooses EIMAC tubes again.

To power their new HF-80 family of 1 to 10 kW hf single sideband radio equipment, Rockwell-Collins needed tubes as well-constructed and reliable as the HF-80 system itself. That's why they went with EIMAC, the way they have for every hf system they've built since 1958.

## The deciding factors— EIMAC's quality, backup, availability and customer acceptance.

The new HF-80 equipment ranges from operator-attended receivers and transmitters to fully automated, remotely located communications stations. The HF-80 is used worldwide in business, military and general government communications. So Rockwell-Collins needed tubes with worldwide availability and technical back-up. EIMAC's proven customer acceptance and well-established reliability were more pluses.

The HF-80 uses EIMAC's 4CX1500B at 1 kW, 4CX5000A at 3 kW, and 4CX15000A at 10 kW with EIMAC's 4CX350A as drivers.

For more information on what makes these and other EIMAC tubes so special, contact Varian, EIMAC Division, 301 Industrial Way, San Carlos, California 94070. Telephone (415) 592-1221. Or contact any of the more than 30 Varian Electron Device Group Sales Offices throughout the world.





Share the Heathkit experience with your kids!

Send for the big new

# HEATHKIT<sup>®</sup> CATALOG

You'll find nearly 400 fun-filled kit building experiences both you and your family can enjoy. There's ham gear, color TV's, stereo components, digital clocks, test instruments, treasure finders, computers, peripherals, and MORE—all with easy, step-by-step instruction manuals. Share the Heath experience—it'll make your whole relationship...a lot more special!

It's FUN to build-in more quality for your electronics dollars! Send for your

**FREE**  
HEATHKIT CATALOG

**yes**

Send me my personal copy of the newest Heathkit Catalog. I am not currently on your mailing list.

Heath Company, Dept. 122-450, Benton Harbor, MI 49022

NAME \_\_\_\_\_

ADDRESS \_\_\_\_\_

CITY \_\_\_\_\_

STATE \_\_\_\_\_ ZIP \_\_\_\_\_

Ham Radio PC-129

**Start a worthwhile family hobby today!**



enjoy the world's  
leading electronic  
kit catalog...



**FREE**

**THE ALL-NEW  
HEATHKIT CATALOG**

Nearly 400 build-it-yourself  
kits that the entire family  
can enjoy

Send for your free copy today!

**HEATH COMPANY**  
Benton Harbor, MI 49022

PLACE  
STAMP HERE  
Post Office  
will not  
deliver mail  
without  
postage