

\$1.50

ham radio

magazine

hr 

AUGUST 1978

- frequency-locked vfo 17
- locating TVI 24
- high-resolution frequency synthesizer 34
- noise-figure measurements 40
- RTTY keyboard 56
- and much more . . .

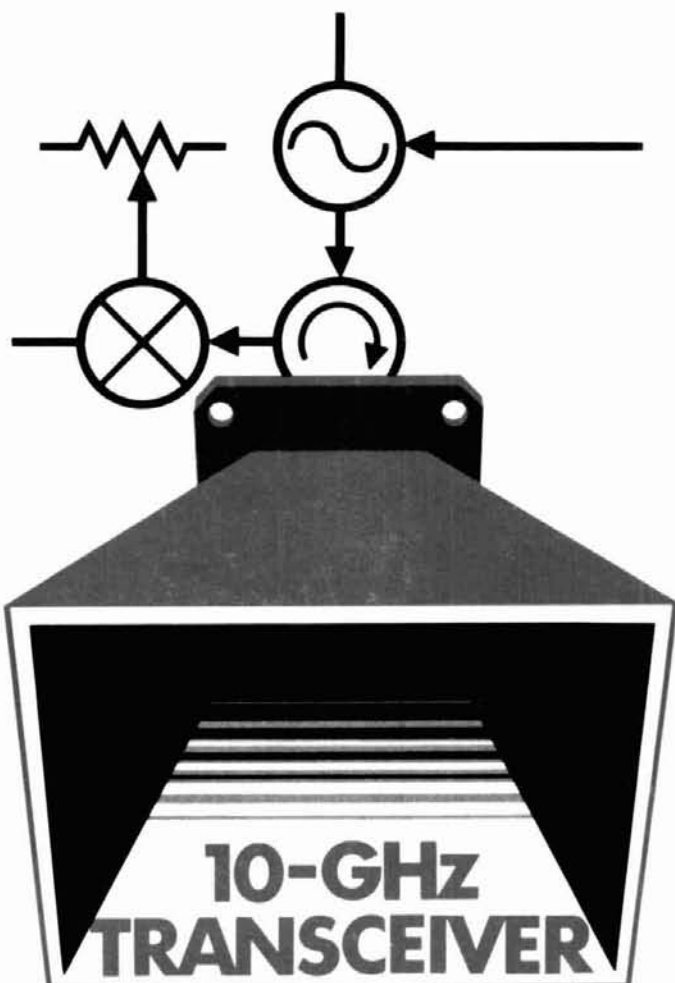

**10-GHz
TRANSCEIVER**
**for amateur
microwave
communications**

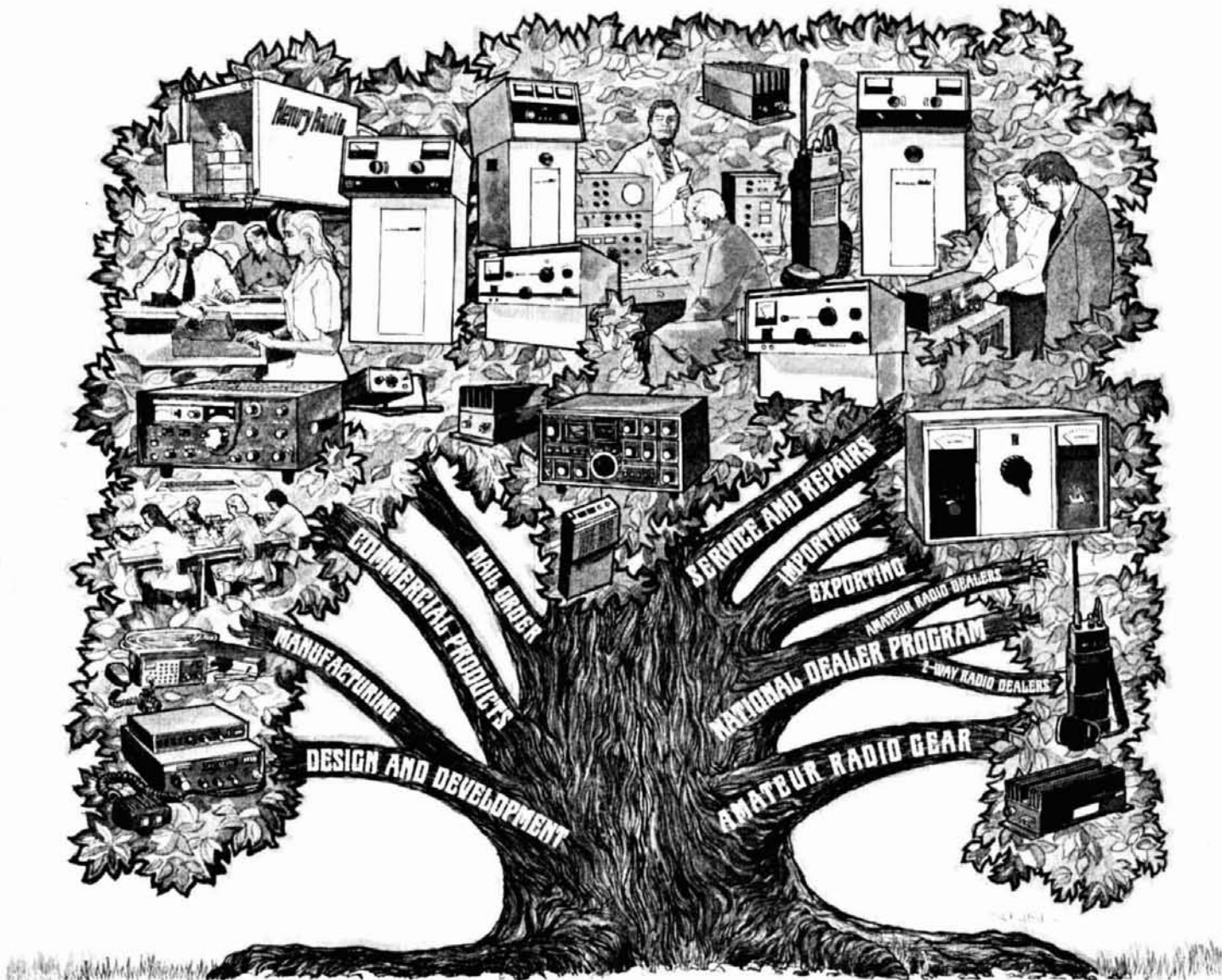

Our tree has many branches

At Henry Radio, we are proud that amateurs not only in the United States but throughout the free world look to us as their pre-eminent supplier of fine communications equipment. For fifty years this has been our principal business and it still is.

Most amateurs don't fully understand, however, the manner in which we have grown and grown so that every year we are better equipped to provide a genuine service to the world amateur fraternity and at the same time extend our unique blend of responsible, expert service to many electronic services in addition to the amateurs.

Our tree has indeed grown many new and sturdy branches. Yes, as always we distribute all the available high quality amateur equipment. In addition, we manufacture a full line of linear amplifiers that have become world famous for quality and reliability. These have provided the standard of reference in amateur radio for many years and are widely employed by commercial and government users. More recently our tube amplifiers have been supplemented by a broad line of solid state amplifiers for the HF, VHF and UHF bands. Many of these amplifiers are type accepted by the FCC for business, Public service, RCC and marine two-way service.

Out of this program has grown an entire new operation providing high quality FM handhelds, mobiles and fixed station transceivers for all these services. Moreover, as an off-shoot of our vacuum tube amplifier program we now supply R.F. power generators to industry. These are used as plasma generators in thin film plating and other exotic scientific processes.

What does all this mean to our most important customers, the amateur radio operators of the world. Simply this. As Henry Radio grows these sturdy new branches on our tree of electronic expertise, we continually strengthen our ability to help the amateurs of the world satisfy their communications requirements. As always, we offer expert, responsible assistance, the kind amateurs need and want. Wherever you live in the world, we invite you to turn to Henry Radio, the pioneer in service to the amateur radio fraternity.

Henry Radio

11240 W. Olympic Blvd., Los Angeles, Calif. 90064 213/477-6701
 931 N. Euclid, Anaheim, Calif. 92801 714/772-9200
 Butler, Missouri 64730 816/679-3127

BUILT FOR ACTION FROM THE GROUND UP

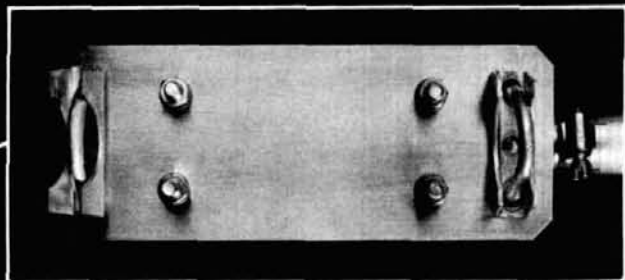

If you've got a calling for far-reaching action, have we got a number for you!

Swan's 4010V: precision engineered for 40-20-15-10 meters.

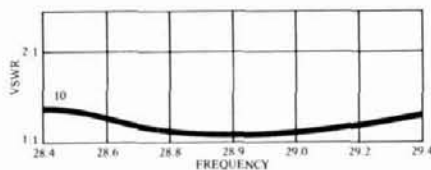
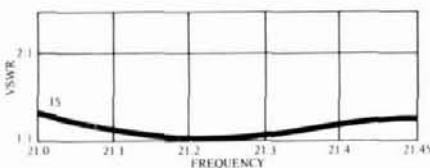
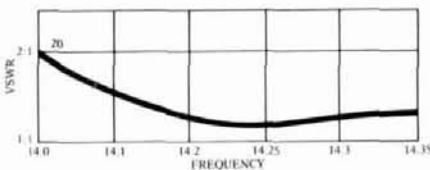
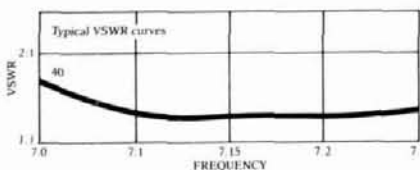

With slim-line traps, this 4-band vertical offers advanced light-weight construction *with* heavy weight performance.

4010V's fine-tuned to handle 2000 PEP. With a typical VSWR of 1.5:1 at resonance.

Powerfully designed—yet powerfully simple to set up.

No-hassle installation. The 21' vertical comes in short, easy to assemble lengths. Complete with mounting hardware. You're up and running in record time.

Expandable too. No trick at all to stretch your reach into 75 meters, with the optional Swan 75 AK Kit.

Just \$79.95 for an outstanding 4-band trap vertical, the 4010V

(and \$39.95 for the 75-meter add-on kit), at your Swan dealer. And by all means, use your Swan Credit Card.

Please rush full specs for Swan's

4010V 4-band trap vertical antenna

75 AK 75-meter Kit

Name _____

Address _____

City _____

State _____ Zip _____

FREE! Personalized call-letter plaque

2 1/2" x 4" with stand, no charge
 Please send my plaque imprinted with my station call



HAM 8/78

SWAN
ELECTRONICS
a subsidiary of Cubic Corporation

305 Airport Road, Oceanside, CA 92054

Swan's continuing commitment to product improvement may affect specifications and prices without notice.

This NEW MFJ Versa Tuner II . . .

has SWR and dual range wattmeter, antenna switch, efficient airwound inductor, built in balun. Up to 300 watts RF output. Matches everything from 160 thru 10 Meters: dipoles, inverted vees, random wires, verticals, mobile whips, beams, balance lines, coax lines.

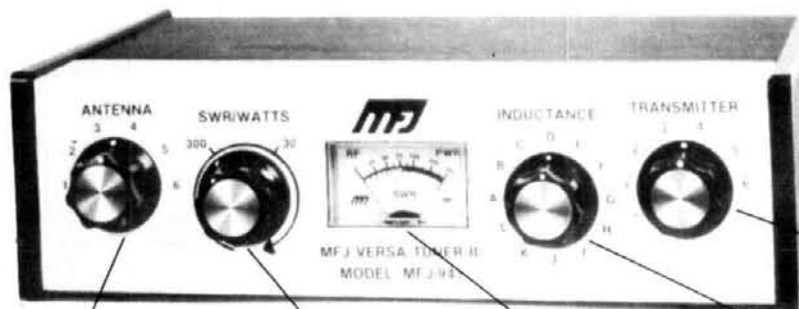

\$79⁹⁵

Antenna matching capacitor. 208 pf. 1000 volt spacing.

Sets power range, 300 and 30 watts. Pull for SWR.

Meter reads SWR and RF watts in 2 ranges.

Efficient airwound inductor gives more watts out and less losses.

Transmitter matching capacitor. 208 pf. 1000 volt spacing.

Only MFJ gives you this MFJ-941 Versa Tuner II with all these features at this price:

A SWR and dual range wattmeter (300 and 30 watts full scale) lets you measure RF power output for simplified tuning.

An antenna switch lets you select 2 coax fed antennas, random wire or balance line, and tuner bypass.

A new efficient airwound inductor (12 positions) gives you less losses than a tapped toroid for more watts out.

A 1:4 balun for balance lines. 1000 volt capacitor spacing. Mounting brackets for mobile installations (not shown).

With the NEW MFJ Versa Tuner II you can run your full transceiver power output — up to 300 watts RF power output — and match your

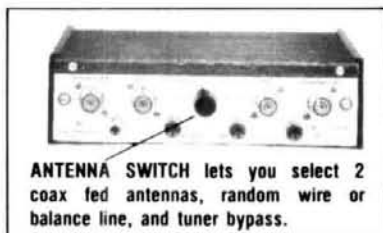

ANTENNA SWITCH lets you select 2 coax fed antennas, random wire or balance line, and tuner bypass.

transmitter to any feedline from 160 thru 10 Meters whether you have coax cable, balance line, or random wire.

You can tune out the SWR on your dipole, inverted vee, random wire, vertical, mobile whip, beam, quad, or whatever you have.

You can even operate all bands with just

one existing antenna. No need to put up separate antennas for each band.

Increase the usable bandwidth of your mobile whip by tuning out the SWR from inside your car. Works great with all solid state rigs (like the Atlas) and with all tube type rigs.

It travels well, too. Its ultra compact size 8x2x6 inches fit easily in a small corner of your suitcase.

This beautiful little tuner is housed in a deluxe eggshell white Ten-Tec enclosure with walnut grain sides.

SO-239 coax connectors are provided for transmitter input and coax fed antennas. Quality five way binding posts are used for the balance line inputs (2), random wire input (1), and ground (1).

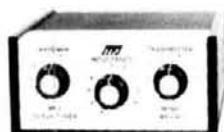

\$59⁹⁵

BRAND NEW

MFJ-901 VERSA TUNER

New efficient air wound coil for more watts out.

Only MFJ uses an efficient air wound inductor (12 positions) in this class of tuners to give you more watts out and less losses than a tapped toroid. Matches everything from 160 thru 10 Meters: dipoles, inverted vees, random wires, verticals, mobile whips, beams, balance lines, coax lines. Up to 200 watts RF output. 1:4 balun for balance lines. Tune out the SWR of your mobile whip from inside your car. Works with all rigs. Ultra compact 5x2x6 inches. SO-239 connectors. 5 way binding posts. Ten Tec enclosure.



\$49⁹⁵

BRAND NEW

MFJ-900 ECONO TUNER

Same as MFJ-901 Versa Tuner, but does not have built-in balun for balance lines. Tunes coax lines and random lines.



\$39⁹⁵

MFJ-16010 RANDOM WIRE TUNER

Operate 160 thru 10 Meters. Up to 200 watts RF output. Matches high and low impedances. 12 position inductor. SO-239 connectors. 2x3x4 inches. Matches 25 to 200 ohms at 1.8 MHz.



\$39⁹⁵

BRAND NEW

MFJ-400 8043 ECONO KEYSER

MFJ brings you a reliable, full feature economy keyer using the famous CURTIS-8043 keyer-on-a-chip.

Panel Controls: Speed (8 to 50 WPM), pull-to-tune; volume, on/off; 3 conductor, 1/4 inch phone jack for keying output and key paddle input.

Internal weight control lets you adjust dot-dash-space ratio for a distinctive signal to penetrate QRM for solid DX contacts. Sidetone and speaker. Internal tone control.

Lambic operation with squeeze key. Dot memory. Instant start. Self completing. Jamproof spacing. Reliable solid state keying: grid block, cathode, solid state transmitters (-300V, 10 ma. max. and +300V, 100 ma. max.).

For Orders

Call toll-free 800-647-8660

For technical information, order and repair status, and in Mississippi, please call 601-323-5869.

Order any product from MFJ and try it. If not delighted, return within 30 days for a prompt refund (less shipping).

Order today. Money back if not delighted. One year unconditional guarantee. Add \$2.00 shipping/handling.

Order By Mail or Call TOLL FREE 800-647-8660 and Charge It On



MFJ ENTERPRISES

P. O. BOX 494
MISSISSIPPI STATE, MISSISSIPPI 39762

ham radio

magazine

AUGUST 1978

volume 11, number 8

T. H. Tenney, Jr., W1NLB
publisher

James R. Fisk, W1HR
editor-in-chief

editorial staff

Martin Hanft, WB1CHQ
administrative editor

Charles J. Carroll, K1XX
Patricia A. Hawes, WA1WPM
Alfred Wilson, W6NIF
assistant editors

Thomas F. McMullen, Jr., W1SL
Joseph J. Schroeder, W9JUV
associate editors

Wayne T. Pierce, K3SUK
cover

publishing staff

C. Edward Buffington, WB1AMU
assistant publisher

Fred D. Moller, Jr., WA1USO
advertising manager

James H. Gray, W1XU
assistant advertising manager

Therese R. Bourgault
circulation manager

ham radio magazine
is published monthly by
Communications Technology, Inc
Greenville, New Hampshire 03048
Telephone: 603-878-1441

subscription rates

United States: one year, \$12.00
two years, \$22.00; three years, \$30.00

Canada: one year, \$14.00
two years, \$26.00; three years, \$38.00

Europe, Japan, Africa:
(via Air Forwarding Service)
one year, \$25.00

North America, South America, Australia
and Asia (except Japan):
(via Surface Mail)
one year, \$18.00

foreign subscription agents

Foreign subscription agents are
listed on page 101

Microfilm copies
are available from
University Microfilms, International
Ann Arbor, Michigan 48106
Order publication number 3076

Cassette tapes of selected articles
from *ham radio* are available to the
blind and physically handicapped
from Recorded Periodicals
919 Walnut Street, 8th Floor
Philadelphia, Pennsylvania 19107

Copyright 1978 by
Communications Technology, Inc
Title registered at U.S. Patent Office

Second-class postage
paid at Greenville, N.H. 03048
and at additional mailing offices
Publication number 233340



contents

10 10-GHz transceiver

Klaus H. Hirschelmann, DJ700

17 frequency-lock loop

J. Crawford MacKeand, WA3ZKZ

**24 locating TVI caused by
metallic rectification**

John E. Pitts, W6BD

**30 seven-element
forty-meter quad**

Paul Kiesel, K7CW

**34 high-resolution
frequency synthesizer**

William E. Coleman, N4ES

**40 automatic
noise-figure measurements**

Robert S. Stein, W6NBI

56 electronic RTTY keyboard

Lewis A. Stapp, W0PHY

**60 improved grounding for the
1296-MHz microstrip filter**

H. Paul Shuch, N6TX

**66 simple monitor
for accurate reports
on two-meter fm**

Edward R. Spadoni, W1RHN

70 single-tone decoders

Steve S. Kraman, WA2UMY

**75 electronic bias switching
for the Henry 2K4 and 3KA**

Michael James, W1CBY

4 a second look
128 advertisers index
101 flea market
116 ham mart
80 ham notebook

6 letters
84 new products
8 presstop
126 reader service
40 repair bench

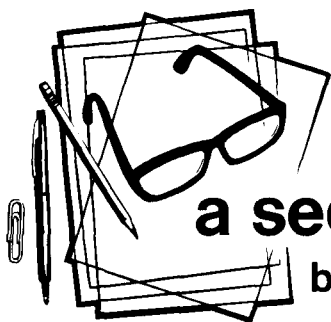

a second look

by Jim Fisk

In recent months there has been rising concern about the possible harmful effects to living tissue due to heating by radio-frequency energy at 10 MHz and above. The weekly CBS TV news magazine, *60 Minutes*, devoted a segment to this topic several months ago, numerous "rf radiation" stories have been published in newspapers and magazines, and now there is a best-selling book on the subject: *The Zapping of America*, by Paul Brodeur. Although much of Brodeur's book is devoted to what he calls the "deadly risk of microwave radiation" and its "cover-up" by the government, he apparently doesn't know the difference between high-power radar or TV transmitters and high-frequency amateur and CB equipment. He would have you believe that little or no research has been done on the dangers of electromagnetic radiation; if your neighbors believe him, you may find your radio activities squelched by local citizens who are afraid of being "zapped" by your amateur transmitting equipment.

Contrary to what Brodeur says, microwave engineers have been aware of rf radiation hazards for 30 years or more, and the scientific community has spent thousands of man hours investigating its effects and establishing safety standards. It is known, for example, that the internal body organs are susceptible to damage from heating caused by high-power radio energy in the range from 150 to 1200 MHz, and that the eye is especially prone to damage from radiation above 1000 MHz. More importantly, it is known that power levels which cause damage are much higher than those found in the average ham shack. Kilowatt transmitters on the amateur uhf bands (432 MHz and above) are potentially hazardous, but if they are completely shielded they are not dangerous to your health. On the lower frequencies there is practically no danger, even if you're running 2000 watts PEP.

Based on present knowledge, which is extensive, various government agencies have established rf radiation safety standards with recommended exposure limits referred to as Radiation Protection Guide Numbers (RPGN). The accepted RPGN value is 10 milliwatts per square centimeter of body area, the standard set by the Occupational Safety and Health Administration (OSHA). Although there are some scientists who disagree with this standard, most agree that rf power levels one-half the OSHA standard (5 mW/cm^2) have little effect on the human body, and practically no one objects to a standard of 1 mW/cm^2 . Note that this is based on *continuous* exposure.

If your transmitter is well shielded, and you use coaxial transmission line, the only possible danger is radiation from your antenna. Assuming a kilowatt linear with 65% efficiency and no feedline loss places about 650 watts at the antenna; what is the minimum safe distance? This depends on the directivity of your antenna, but for a half-wavelength dipole it equates to a distance of about 3 meters (10 feet) for a power density of 5 mW/cm^2 . If you're running less than a kilowatt, of course, the safe distance is less. Since most amateur dipoles are installed at least 8 meters (25 feet) above the ground, they obviously pose no radiation threat.

What about multi-element Yagi beams and stacked arrays? Since most of the power is concentrated in front of the beam, there is little danger above or below the antenna. Even with 650 watts input, the beam must have at least 15 dBd gain before the power density reaches 5 mW/cm^2 in the center of the forward lobe, 10 meters (30 feet) in front of the antenna. Few amateur antennas have this much gain, and those that do are used on uhf where it's impossible to generate 650 watts into the antenna and stay within the legal power limit.

On the high-frequency bands, if your beam is on a tower at least 10 meters (30 feet) high and not pointed into a building less than 10 meters away, there is absolutely no hazard at *legal* amateur power levels. Keep this in mind if you start getting grief from your neighbors.

Jim Fisk, W1HR
editor-in-chief

New, Remotable 2meter Mobile!



ICOM's New IC-280

ICOM introduces its new 2 meter mobile radio with the detachable microprocessor control head, the **IC-280**. Bright, easy to read LED's and a new style meter grace the brushed aluminum "new look" front panel of the detachable control head, which provides memory and frequency control for the remotely mountable main section.

The **IC-280** comes as one radio to be mounted in the normal manner: but, as an option, the entire front one third of the radio detaches and mounts by its optional bracket and the main body tucks neatly away out of sight. Now you can mount your 2 meter mobile radio in places that seemed really tight before.

With the microprocessor head the **IC-280** can store three frequencies of your choice, which are selected by a four position front panel switch. These frequencies are retained in the **IC-280's** memory for as long as power is applied to the radio. Even



when power is turned off at the front panel switch, the **IC-280** retains its programmed memories; and when power is completely removed from the radio, the ± 600 KHz splits are still maintained!

Frequency coverage of the **IC-280** is in excess of the 2 meter band; and the new band plan (144.5-145.5 MHz repeaters) can easily be accommodated, since it was included in the **IC-280's** initial planning by the ICOM design team.

The main section of the **IC-280** puts you up to the minute with the latest state of the art engineering. The new **IC-280** includes the latest innovations in large signal handling FET front ends for excellent inter-modulation character and good sensitivity at the same time. The IF filters are crystal monolithics in the first IF and ceramic in the second, providing narrow band capacity for today and tomorrow's crowded operating conditions. Modular PA construction with broad band tuning provides full rated power across the full 2 meter band (plus a little).

All ICOM radios significantly exceed FCC specifications limiting spurious emissions.

Specifications subject to change without notice.

IC-280 Specifications: Frequency Coverage: 143.90—148.11 MHz Operating Conditions: Temperature: -10°C to 60°C (14°F to 140°F), Duty Factor: continuous Frequency Stability: ± 1.5 KHz Modulation Type: FM (F3) Antenna Impedance: 50 ohms unbalanced Power Requirement: DC 13.8V $\pm 15\%$ (negative ground) Current Drain: Transmitting: 2.5A Hi (10W), 1.2A Lo (1W), Receiving: 0.630A at max audio output, 0.450 at SQL ON with no signal Size: 58mm(h) x 156mm(w) x 228mm(d) Weight: approx. 2.2 Kg Power Output: 10W Hi, 1W Lo Modulation System: Phase Max. Frequency Deviation: ± 5 KHz Spurious Output: more than 60 dB below carrier Microphone Impedance: 600 ohms dynamic or electret condenser type, such as the SM-2 Receiving System: Double superheterodyne Intermediate Frequency: 1st: 10.695 MHz, 2nd: 455 KHz Sensitivity: 1 uv at S+N/N at 30 dB or better, Noise suppression sensitivity 20 dB, 0.6 uv or less Selectivity: less than ± 7.5 KHz at -6 dB, less than ± 15 KHz at -60 dB Audio Output: More than 1.5W Audio Output Impedance: 8 ohms

HF/VHF/UHF AMATEUR AND MARINE COMMUNICATION EQUIPMENT

DISTRIBUTED BY:



ICOM

ICOM WEST, INC.
Suite 3
13256 Northrup Way
Bellevue, Wash. 98005
(206) 747-9020

ICOM EAST, INC.
Suite 307
3331 Towerwood Drive
Dallas, Texas 75234
(214) 620-2780

ICOM CANADA
7087 Victoria Drive
Vancouver B.C. V5P 3Y9
Canada
(604) 321-1833

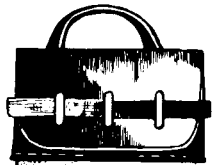

comments

microstripline impedance

Dear HR:

The formula W1HR deduced for microstrip impedance in the December, 1977, issue is interesting because it can be rewritten in the following way:

$$Z = \frac{376.7}{\sqrt{E_r}} \cdot \frac{h}{w+h} \text{ ohms} \quad (1)$$

where Z = stripline impedance (ohms)

h = height of stripline

w = width of stripline (in same units as h)

E_r = relative permittivity of dielectric

The number 376.7 ohms (per square) is the intrinsic impedance of free space which by coincidence is nearly equal to 120π .

If there were no fringing of the electric field at the edges of the stripline the characteristic impedance of the line would be given *exactly* by

$$Z = \frac{376.7}{\sqrt{E_r}} \cdot \frac{h}{w} \text{ ohms} \quad (2)$$

In eq. 1 the $w+h$ in the denominator takes account of the fringing effect by considering that the stripline is *effectively* wider than its actual width w by the amount of the height h . As the ratio of the width to height becomes larger, the effect of the fringing becomes less significant and for a very wide stripline its characteristic impedance would approach that of eq. 2.

The above discussion is derived directly from a consideration of the field cell concept and of field maps for the transmission lines. It also follows that a line of *any shape* can be either calculated from a map or measured very simply with an ohmmeter and resistance paper as described on page 492 of *Electromagnetics* by J. D. Kraus and K. R. Carver (McGraw-Hill, New York, 1973).

John Kraus, W8JK
Director, The Ohio State
University Radio Observatory

bandspreading techniques

Dear HR:

I read with interest Mr. Leonard Anderson's excellent article on bandspreading techniques in February, 1977, *ham radio*. I would like to propose an alternate to his standard capacitor. By using a 3-wire *guarded* circuit, as shown in fig. 1, the cable

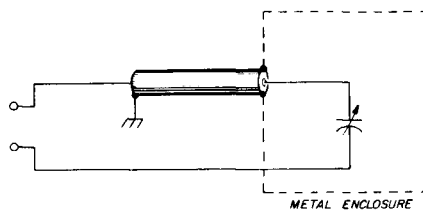

length will not cause the standard to read in error. This is due to the shield of the coax acting as a shield between the two leads from the capacitor. This method is used quite frequently by GenRad and other companies when measuring very accurate capacitance values. The main disadvantage of the guard circuit is that the capacitor must be isolated from ground.

Robert Heider, W0EJO
Glendale, Missouri

antenna noise bridges

Dear HR:

I found the recent article on RX noise bridge measurements very interesting. As the developer of the original antenna noise bridge I would like to point out that two basic models were developed. The TE701 used a similar output circuit to the one shown in the article and worked well to over 100 MHz. The Model TE702 used a variation and worked to over 250 MHz. The bridge circuit was as follows:

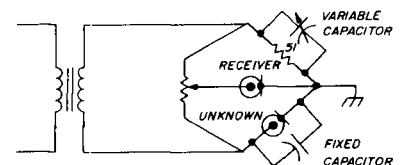
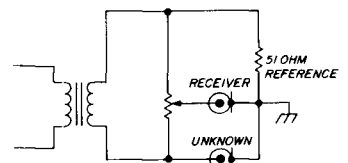

Note that the transformer does not need to be accurately center tapped and that it can be bifilar wound. Also, with a 100-ohm variable pot the calibration range is zero to infinity. To make a reactance bridge, place a fixed capacitor across the unknown terminal and a variable capacitor across the reference resistor. With less effort a lot more accuracy is available with this network over a wider frequency range.

Ted Hart, W5QJR*
Richardson, Texas

*W5QJR is the inventor of the Antenna Noise Bridge, and holds the patent on this very useful device. Readers who are interested can obtain copies of the patent (number 3,531,717, dated September 29, 1970) for 50 cents from the Commissioner of Patents, Washington, DC 20231.

Editor

(Continued on page 82.)

The evolution of the MLA

When the MLA-2500 was first introduced it was a new concept in high performance amplifiers. Low and sleek yet powerful enough for the military. Some wondered . . . needlessly.

A promise kept.

The MLA-2500 promised 2000 watts PEP input on SSB. A heavy duty power supply. Two Eimac 8875's. And as thousands of Amateurs across the world have proven, the MLA-2500 delivers!

Now DenTron is pleased to bring you **The new MLA-2500 B.** Inherently the same as the original MLA-2500, the B model includes all of the above specifications plus a few refinements. New high-low power switching for consistent efficiency at both the 1KW and 2KW power levels, and 160 - 15 meters.

Tested and proven.

What better test for an amplifier than the Clipperton DXpedition? Even after 32,000 QSO's, and an accidental dunk in the ocean, the same 3 MLA-2500's are still amplifying other rare DXpeditions around the world — listen for them.

Convinced? Isn't it time you owned the amplifier that powered Clipperton and thousands upon thousands of radio stations throughout the world?

MLA-2500 B \$899.50.



DenTron[®]
Radio Co., Inc.

2100 Enterprise Parkway
Twinsburg, Ohio 44087
(216)425-3173



CB'S THREAT TO 220 MHZ is far from dead, as indicated by an in-depth study just published by the FCC. "Alternatives for Future Personal Radio Services" is a two-volume set produced by the Commission's Office of Plans and Policy following a 20-month study by the Personal Radio Planning Group. After weighing all possible factors, the study concludes that 220-225 and the 900-MHz land mobile reserve bands are the best spots for a new CB service, and economics, performance, timing, and possible medical considerations all lean toward 220 MHz.

One Factor That Shouldn't be overlooked is that this study was done when Carlos Roberts headed the Office of Plans and Policy — and he's now head of the Safety and Special Services Bureau which includes Personal Radio Services (Amateur Radio and CB) among its Divisions.

THE FCC'S BAN ON 10-METER LINEARS was upheld in June by the Commissioners by a 5-1 vote despite a significant shift in FCC staff support. This time the Safety and Special Services Bureau joined the Chief Engineer's office in opposing the ban on legitimate Amateur linears, but the Field Bureau stated they found the ban to be very effective and the Commissioners went along.

AMATEUR RADIO WASN'T involved in FCC's discussion of interconnects (Docket 20846) in June, but the tone of the meeting was that commercial systems resembling Amateur autopatch repeaters were "dangerously close" to being common carriers and would be undergoing careful scrutiny in the near future. The implications for Amateur Radio are far from clear at this time, but Amateur repeater users and operators alike would be wise to be very careful in the operation of their systems.

AMATEURS REQUESTING CALLSIGNS not currently available (1x2s for Extras or "counterpart" 1x3s for oldtimers switching call areas, for example) may find themselves stuck with a new callsign they really didn't want. So many Amateurs have been making improper requests that it's caused a serious backlog, about 8500 at last count. So, in the future, such applicants won't be asked whether they want one of the new callsigns, instead of what they'd requested, but will simply be issued one.

Amateurs Who Upgrade must request a callsign change in the FCC Field Office at the time of the exam — later requests for a new callsign (except by Extras) will be returned without action.

FCC'S EX PARTE COMMUNICATIONS rules, which severely limit Commission people's ability to discuss pending Notices of Proposed Rule Making, is now the subject of a Notice of Inquiry (General Docket 78-167). Until it acts on that NOI, the Commission has adopted an interim policy requiring outsiders planning to discuss a pending issue with the Commission to submit beforehand a memo for the record describing what they plan to discuss (according to current interpretations, the limitations on informal discussions do not apply to Petitions for Rule Making or Notices of Inquiry).

Comments On The NOI are due August 9, and Reply Comments by August 23.

"MEDIUM BANDWIDTH" ATV on 10 meters has been okayed by the FCC for a two-year test period starting June 16. The five stations receiving the Special Temporary Authority will be permitted the use of A5 or F5 with a maximum bandwidth of 35 kHz from 29.0 to 29.3 MHz. The five involved are W9NTP, W3EFG, W0LMD, W6MXV, and WB9LVI — the STA was in response to a request from the ARRL.

THE PROPOSED REVISION OF THE 1934 Communications Act unveiled in June held no surprises for Amateur Radio, though it would abolish the FCC in favor of a "Communications Regulatory Commission" and delegate frequency allocation to the "National Telecommunications Agency." The only obvious effect on Amateurs would be the increase in license terms to 10 years, and reintroduction of license fees. Passage of the revised act is a long way off, however.

ALIEN AMATEURS SEEKING permission to operate in the United States should now send their Form 610-A applications direct to Gettysburg (FCC, Box 1020, Gettysburg, Pennsylvania 17325) instead of to Washington as in the past. Part 97.305 (b) of the Rules has just been revised to permit the change, which accelerates processing.

420-450 MHZ BAND USERS may be in for severe interference problems when the Air Force's "PAVE PAWS" radar goes into operation in the next year or so. The very-long-range system has an average ERP of about a billion watts, and one estimate says that when it's aimed at the moon the reflected signal would illuminate an entire hemisphere of the earth with a 10-20 microvolt signal. The main beam could also burn up a receiver front end 15 km away.

First Operational Site for PAVE PAWS is Cape Cod (Massachusetts) and a second installation is slated for Beale Air Force Base in California. PAVE PAWS has the potential for doing real damage to the Amateur satellite program as well as other weak-signal work on the 70 cm band. Both AMSAT and the ARRL are carefully studying the problem.

Don't be Fooled!

Not all dealers are Kenwood dealers...and all dealers who carry Kenwood products are not Authorized Kenwood dealers. But when you see this plaque you'll know you're in the right place.

Only an Authorized Kenwood dealer offers factory trained service technicians and sales personnel, an extensive stock of spare parts and a direct line of communications with factory technicians. He offers the complete Kenwood line...the finest line of Amateur Radio equipment available.

Kenwood is unique in the industry, offering seminars for its dealers' personnel, bringing the latest information from the factory to the people you deal with. This is just one more example of the ways in which Kenwood has become the Pacesetter of Amateur Radio.

When you buy Kenwood...you buy the best.

ALABAMA, Long's Electronics, Birmingham • ALASKA, Reliable Electronics, Anchorage • ARIZONA, Power Communications, Phoenix • CALIFORNIA, Ham Radio Outlet, Burlingame - Ham Radio Outlet, Van Nuys - Ham Radio Outlet, Anaheim - Henry Radio Company, Anaheim - Henry Radio, Incorporated, Los Angeles - Webster Radio, Fresno • COLORADO, CW Electronics, Denver • IOWA, HI Inc., Council Bluffs • FLORIDA, Amateur Electronic Supply, Orlando - Amateur Radio Center, Miami - Grice Electronics, Pensacola • HAWAII, Lafayette Radio Company, Honolulu • ILLINOIS, Erickson Communications, Chicago - Klaus Radio, Peoria • INDIANA, Graham Electronics, Indianapolis - Hoosier Electronics, Terre Haute - Kryder Electronics, Fort Wayne • KANSAS, Associated Radio, Overland Park • LOUISIANA, Digital Electronics, New Orleans • MAINE, Craig Radio Company, Portsmouth • MARYLAND, Electronic International Service, Wheaton • PROFESSIONAL ELECTRONICS, Baltimore • MASSACHUSETTS, Tufts Electronics, Medford • MICHIGAN, Electronic Distributors, Muskegon - Radio Supply and Engineering, Clawson • MINNESOTA, Electronic Center, Minneapolis • MISSOURI, Ham Radio Center, St. Louis - Henry Radio Company,



KENWOOD

Authorized Dealer

Butler - Midcom Electronics, St. Louis • MONTANA, Conley Radio Center, Billings • NEBRASKA, Communications Center, Lincoln • NEW MEXICO, Electronic Module, Hobbs • NEW YORK, Adirondack Radio Supply, Amsterdam - Harrison Radio, Farmingdale • NORTH CAROLINA, Freck Radio Supply, Asheville - Vickers Electronics, Durham • OHIO, Amateur Electronic Supply, Wickliffe - Srepc Electronics, Dayton • OKLAHOMA, Derrick Electronics, Broken Arrow - Radio, Incorporated, Tulsa • OREGON, Portland Radio, Medford - Portland Radio, Portland • PENNSYLVANIA, Electronic Exchange, Souderton - Hamtronics, Trevese - JRS Distributors, York • SOUTH CAROLINA, Accutek, Incorporated, Greenville • SOUTH DAKOTA, Burghardt Amateur Center, Watertown • TENNESSEE, Amateur Radio Supply of Nashville, Madison - Sere-Rose and Spencer, Memphis • TEXAS, AGL Electronics, Dallas - Douglas Electronics, Corpus Christi - Electronics Center, Dallas - Madison Electronics, Houston • UTAH, Manwill Supply Company, Salt Lake City • WASHINGTON, Amateur Radio Supply Company, Seattle - ABC Communications, Seattle • WISCONSIN, Amateur Electronic Supply, Milwaukee.

As of May 31, 1978

TRIO-KENWOOD COMMUNICATIONS INC.
1111 WEST WALNUT/COMPTON, CA 90220

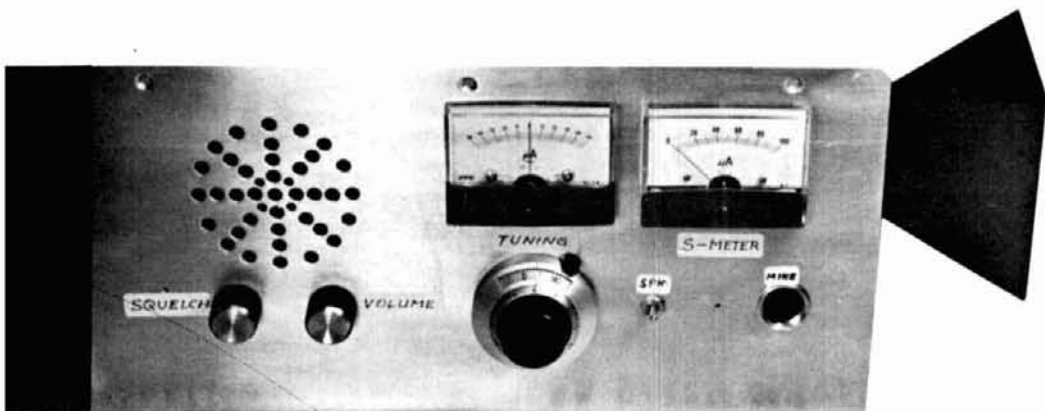

10-GHz transceiver for amateur microwave communications

Construction
of a complete 10-GHz
Gunnplexer transceiver
with 30-MHz i-f and
automatic
frequency control

A little over a year ago Microwave Associates introduced a new component for amateurs which greatly simplifies the construction of a 10-GHz transceiver for operators who are interested in microwave communications but don't have experience with

This article was translated from German by Konrad Benz, Microwave Associates, Inc., Burlington, Massachusetts 01803

microwave construction techniques. Without special knowledge or an extensive test setup amateurs can now use a Microwave Associates MA-87127 Gunnplexer to operate on the 3 cm (10 GHz) amateur band. No special mechanical work is required. The Gunnplexer is a complete transceiver which consists of a varactor-tuned Gunn diode rf source, a ferrite circulator which decouples the transmit and receive functions, and a Schottky mixer diode for the receiver signal.¹ A diagram of the basic Gunnplexer system is shown in fig. 1; a block diagram of the complete transceiver is shown in fig. 2.

The Gunn diode oscillator requires a regulated 10 Vdc source which is capable of supplying 200 mA. The rf output power is approximately 20 mW;* a 17 dB gain horn antenna is available from Microwave Associates. The frequency of the Gunn diode can be tuned with the built-in varactor diode over a frequency range of 60 MHz minimum (100 MHz typical). The required varactor bias is +1 volt to +20 volts and should be controlled by a good quality multi-turn potentiometer.

The Gunnplexer can be easily frequency modulated with a small modulating voltage (mV range) which is superimposed on the varactor's dc bias supply. Since a very small modulating voltage is required, the

*Three models are available: the 15-mW MA-87127-1, the 25-mW MA-87127-2, and the 40-mW MA-87127-3. Units are stocked by Glen Whitehouse, Newbury Drive, Amherst, New Hampshire 03031, and in Europe by Microwave Associates, Munich.

By Klaus H. Hirschelmann, DJ700, Reger
Strasse 4, 6500 Mainz 31, West Germany

amplification factor of a single-transistor microphone amplifier is sufficient.

i-f amplifier

To complete the 10-GHz transceiver, an i-f amplifier is required. Because the antenna and Gunnplexer and its antennas are normally physically separated from the operating position (for roof or tower mounting), an i-f amplifier with a low noise figure should be connected directly to the Gunnplexer's mixer diode. A noise figure of 1.5 dB or less and a good impedance match ($Z = 200\text{ ohms}$ at 30 MHz) is required to obtain an overall system noise figure of 12 dB or better. With careful design, a system noise figure of less than 10 dB can be achieved.

The coaxial connection between the i-f preamplifier and the post amplifier/receiver at the operating position is not critical; a proven design is presented later in this article. When considering the noise figure of a Gunnplexer system it's important to remember that the receiver has no preselection so the two receiver sidebands (carrier plus and minus the i-f) contribute equally to the overall noise figure.

Standardization of a single i-f system is essential for the operation of a 10-GHz system among a large group of amateur microwave enthusiasts. A 100-

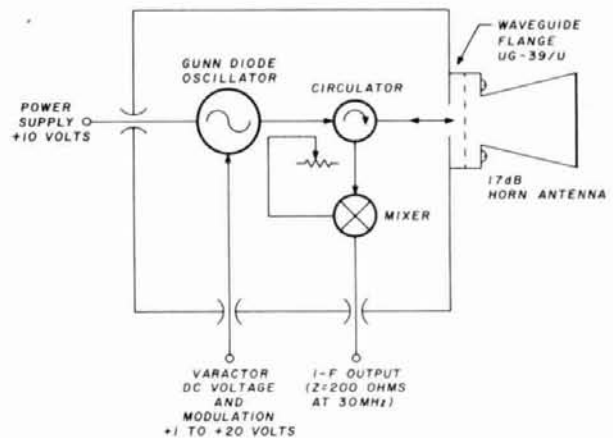

fig. 1. Basic Gunnplexer system showing the varactor-tuned Gunn-diode oscillator, ferrite circulator, and Schottky mixer diode. A portion of the rf power from the oscillator is coupled to the mixer through the circulator. The i-f output impedance at 30 MHz is 200 ohms; a 4:1 transformer is required to provide a good match to 50 ohms (see fig. 2).

MHz i-f has been recommended by several German amateurs,² but this is useful only if communications between two fixed stations is all that you want. The result is a full duplex system without transmit-receive switching where the Gunn oscillator operates simultaneously as a receiver local oscillator and frequency-modulated transmitter. Each partner operates at a different frequency, which results in the intermediate frequency as shown in fig. 3.

In most cases, however, amateurs want to contact as many other 10-GHz stations as possible. This requires that each station must be able to transmit and receive on either frequency. Since the varactor diode provides a maximum frequency tuning range of only 60 MHz, the use of a 100-MHz i-f would require mechanical tuning of the Gunn oscillator. Mechanical tuning of the Gunnplexer provides a tuning range of ± 100 MHz minimum, but this would unduly complicate a two-way communications set-up. By choosing a 30-MHz i-f, however, you can switch frequencies with a simple voltage change on the varactor diode.

In the Rhein-Main area in West Germany various Gunnplexers are operated at 10350 MHz (transmit) with +4 volts of varactor bias; with +10 volts on the varactor the transmit frequency is 30 MHz higher at 10380 MHz. If an operator knows whether the other station is using the lower (10350 MHz) or higher (10380 MHz) frequency, it is only necessary to tune the receiver over a small range of frequencies.

The instability of the self-oscillating Gunn diode requires wideband frequency modulation; a transmit bandwidth of 75 kHz and an i-f bandwidth of 200 kHz gives satisfactory results.

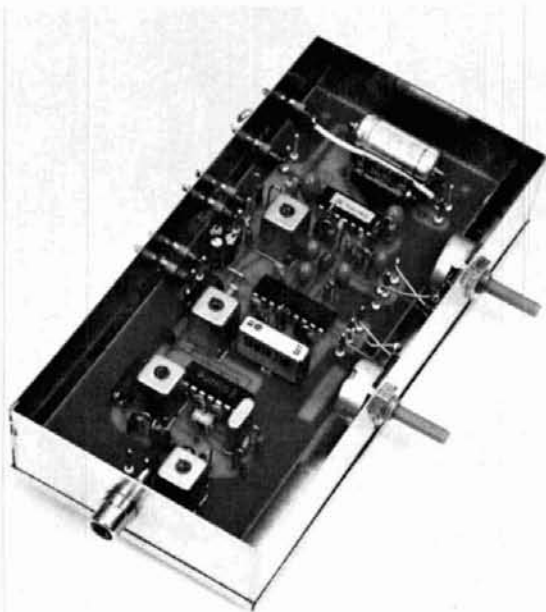

Construction of the 30-MHz receiver designed by DJ700. At the bottom left is the mosfet input stage, followed by the 40.7 MHz local oscillator and mixer, TDA1047 fm i-f strip, and TAA611 audio power amplifier. The two potentiometers are for squelch and audio gain.

fig. 3. Duplex operation of the 10-GHz Gunnplexer system, showing the oscillator frequencies for 100-MHz and 30-MHz intermediate frequencies. As discussed in the text, a 30-MHz i-f is preferred because of the 60-MHz tuning range provided by the varactor; the use of a 100-MHz i-f would require mechanical tuning of the Gunnplexer.

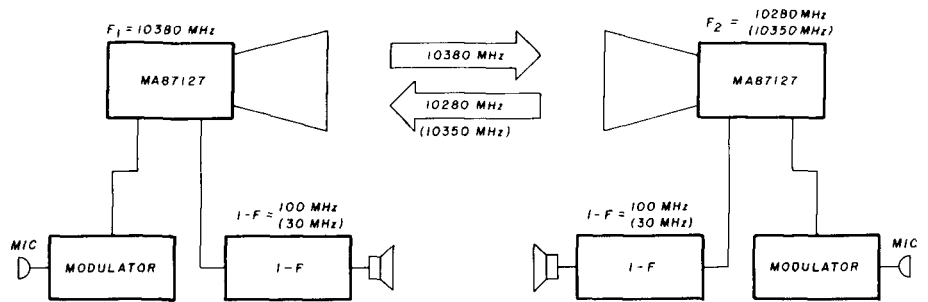

i-f post-amplifier

The 30-MHz i-f post-amplifier and receiver shown in fig. 4 was developed by the Zweite Deutsches Fernsehen amateur group. More than fifty of these receivers have been built and used on the air, and all operate well.*

The first 30-MHz amplifier stage uses a dual-gate BF900 MOSFET transistor (similar to the RCA 40673). The self-oscillating mixer is based on a Siemens SO42P IC and translates the 30-MHz input signal down to the 10.7-MHz i-f. The parallel tuned circuit

(L1-C1) resonates at 40.7 MHz, the frequency of the third-overtone crystal. Without inductor L1 in the circuit the oscillator has a tendency to run at the crystal's fundamental at approximately 13.56 MHz; this can result in unwanted modulation products ($13.56 + 10.7 = 24.26 \text{ MHz}$).

The Murata SFW10.7MA ceramic filter determines the i-f response characteristics of the receiver; the 3 dB bandwidth is $220 \pm 40 \text{ kHz}$. The Siemens TDA1047 IC, which was developed for fm broadcast radios, is used as an amplifier and fm demodulator; it has excellent limiter capabilities and includes a built-in squelch circuit — its symmetry guarantees trouble-free operation.

An S-meter is connected to pin 14 of the TDA1047

*Kits to build your own 30-MHz post-amplifier are available from Elektronik Laden, Wilhelm-Mellies-Strasse 88, D4930 Detmold 18, West Germany; the price is 89 DM (\$45) postpaid.

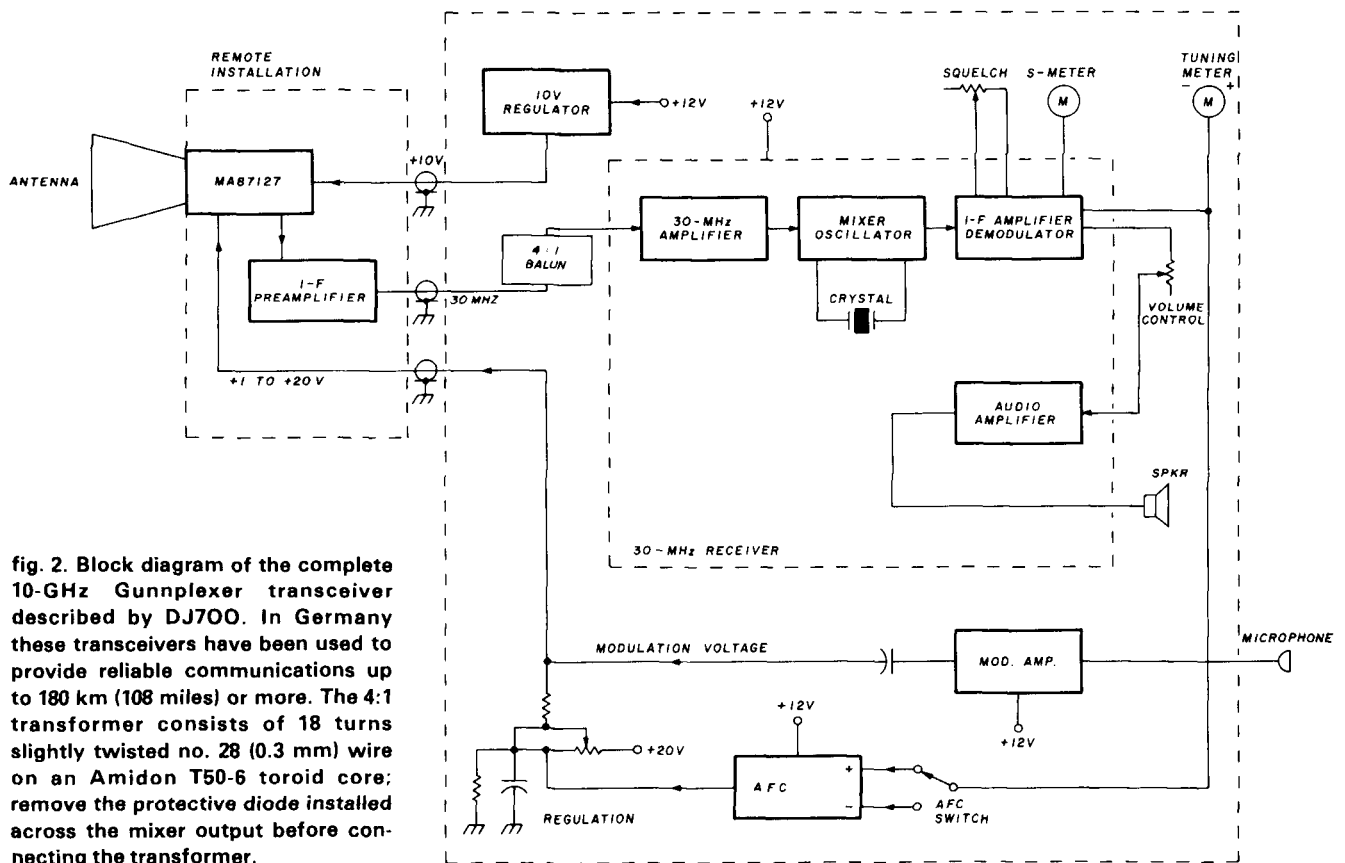
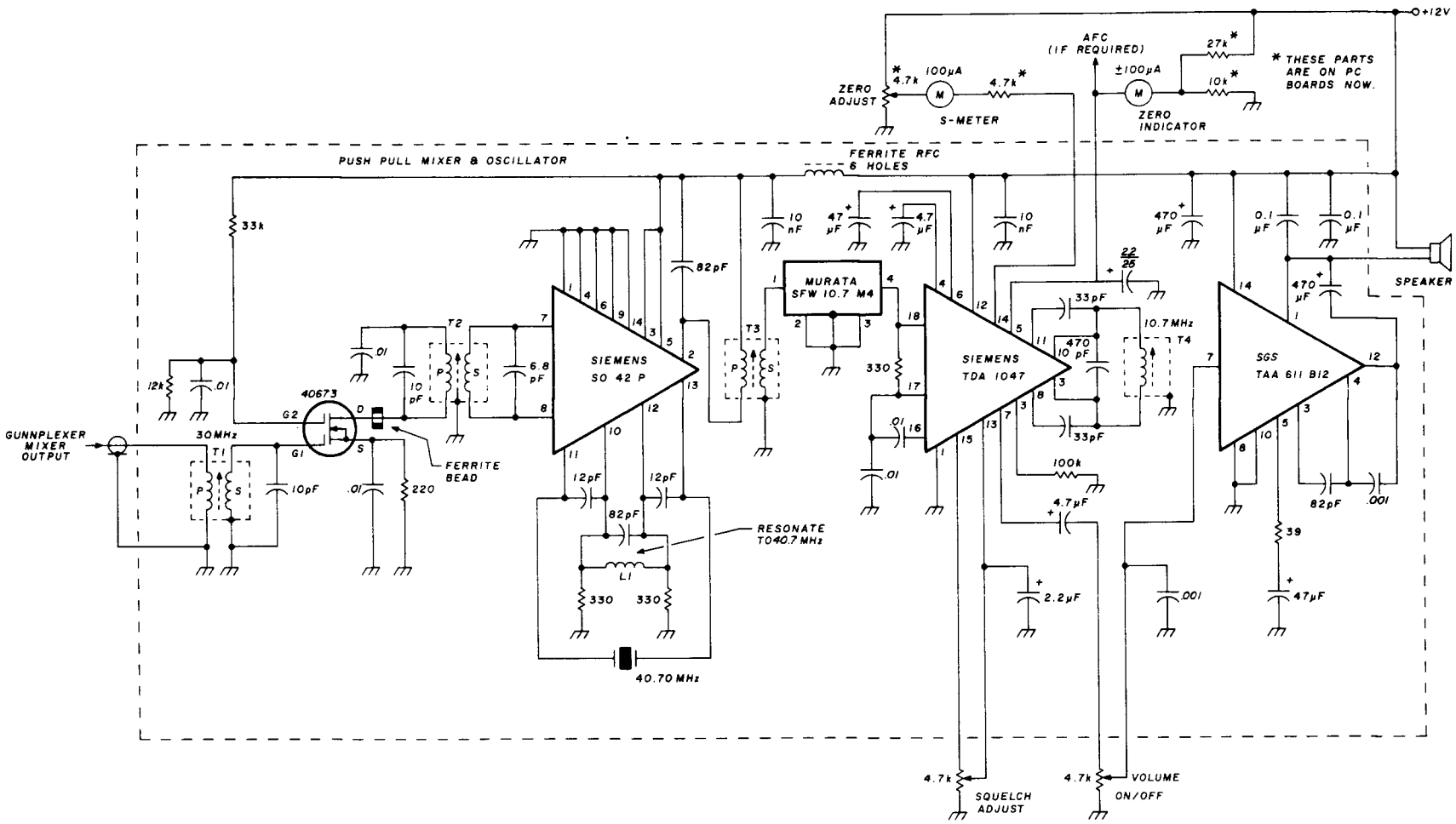

fig. 2. Block diagram of the complete 10-GHz Gunnplexer transceiver described by DJ700. In Germany these transceivers have been used to provide reliable communications up to 180 km (108 miles) or more. The 4:1 transformer consists of 18 turns slightly twisted no. 28 (0.3 mm) wire on an Amidon T50-6 toroid core; remove the protective diode installed across the mixer output before connecting the transformer.



- L1 15 turns no. 28 AWG (0.3mm) unsupported, closewound on 4 mm (5/32 inch) diameter mandrel
- T1 Primary, 3 turns; secondary, 18 turns
- T2 Primary, 18 turns; secondary, 5 turns
- T3 Primary, 18 turns; secondary, 5 turns
- T4 8 turns

All transformers wound with no. 32 AWG (0.2mm) wire on Vogt D41-2520 forms.

fig. 4. Schematic diagram of a broadband 30-MHz i-f post-amplifier/receiver which features a MOSFET input stage, SO42P self-oscillating mixer, 10.7-MHz ceramic filter, TDA1047 amplifier/demodulator, and TAA611 audio power amplifier. The complete receiver is built into a package measuring 14.7 cm long, 7.4 cm deep, and 2.9 cm high (5.8 x 2.9 x 1.1 inches). A kit is available.

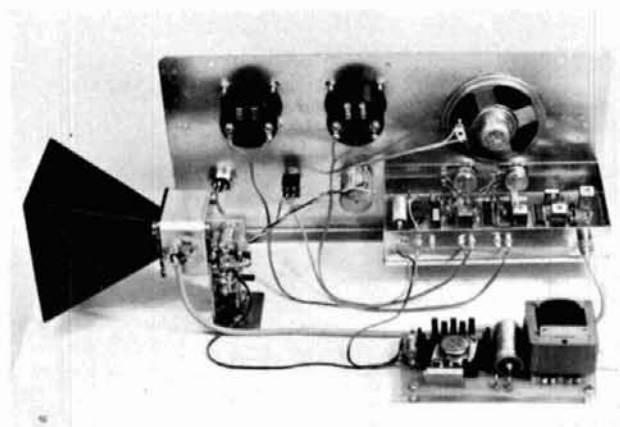

Layout of DJ3KM's 10-GHz Gunnplexer system, as set up for display at a German club meeting. The 30-MHz receiver is mounted on the front panel, under the speaker; the avc circuitry is built on a small board mounted next to the Gunnplexer. An ac power supply for the system is in the right foreground (photo by DB3PR).

amplifier/demodulator. This is a big help when aligning antennas for maximum received signal. The inherent noise of the TDA1047 produces a small current through the S-meter which can be nulled out by adjustment of the 4700-ohm ZERO ADJUST potentiometer. The output at pin 5 of the TDA1047 is a frequency-dependent dc voltage which can be connected to a carrier meter and/or an AFC circuit for the Gunnplexer (fig. 5). The Fairchild SGS TAA611B12 (or Texas Instruments 76001) serves as an audio power amplifier.

The frequency stability of the Gunnplexer is important for successful two-way communication; the

manufacturer specifies a drift of -350 kHz per $^{\circ}\text{C}$ maximum. When the Gunnplexer is first turned on, the oscillator will drift a few MHz as the Gunn diode warms up, so the 220-kHz i-f bandwidth requires continuous tuning of the oscillator. The Gunnplexer also continues to drift slightly after the initial warm-up period. A simple solution to this problem is to compensate for the drift of the free-running oscillator by changing the operating frequency of the station at the other end of the link.

The AFC circuit shown in fig. 5 uses the frequency-dependent voltage available from the i-f post-amplifier, as discussed previously. During two-way communications only one operator has his AFC circuit switched on; the Gunnplexer at the other end of the link is allowed to run free. A three-position switch is used because the frequency change might be up or down (center position is AFC OFF). The coupling between the AFC circuit and the Gunnplexer determines the system's holding range.

performance

The successful operation of various 10-GHz amateur stations in the Rhein-Main area, operating with the equipment described here, has proved the system's feasibility and reliability. The use of 17-dB horn antennas at both ends of the link allows communications up to 60 km (35 miles) or more. The 3-dB beamwidth of the horn antenna is approximately 30 degrees, so antenna alignment is not particularly critical.

Some stations are using home-built 23 dB horn antennas or 2 meter (6 foot) parabolic reflectors, so there have been many 10-GHz contacts in the range

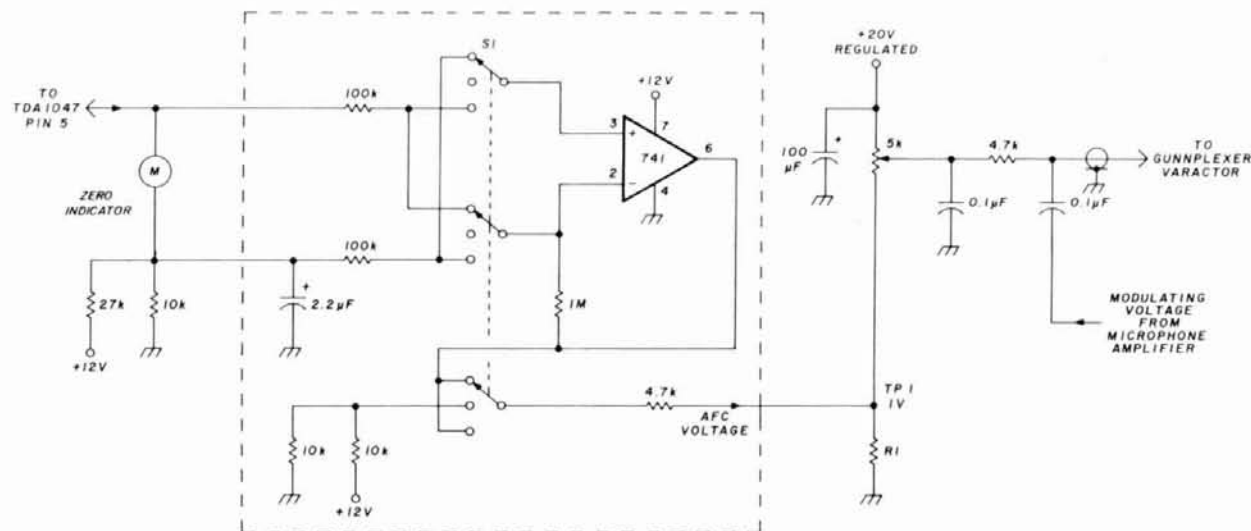
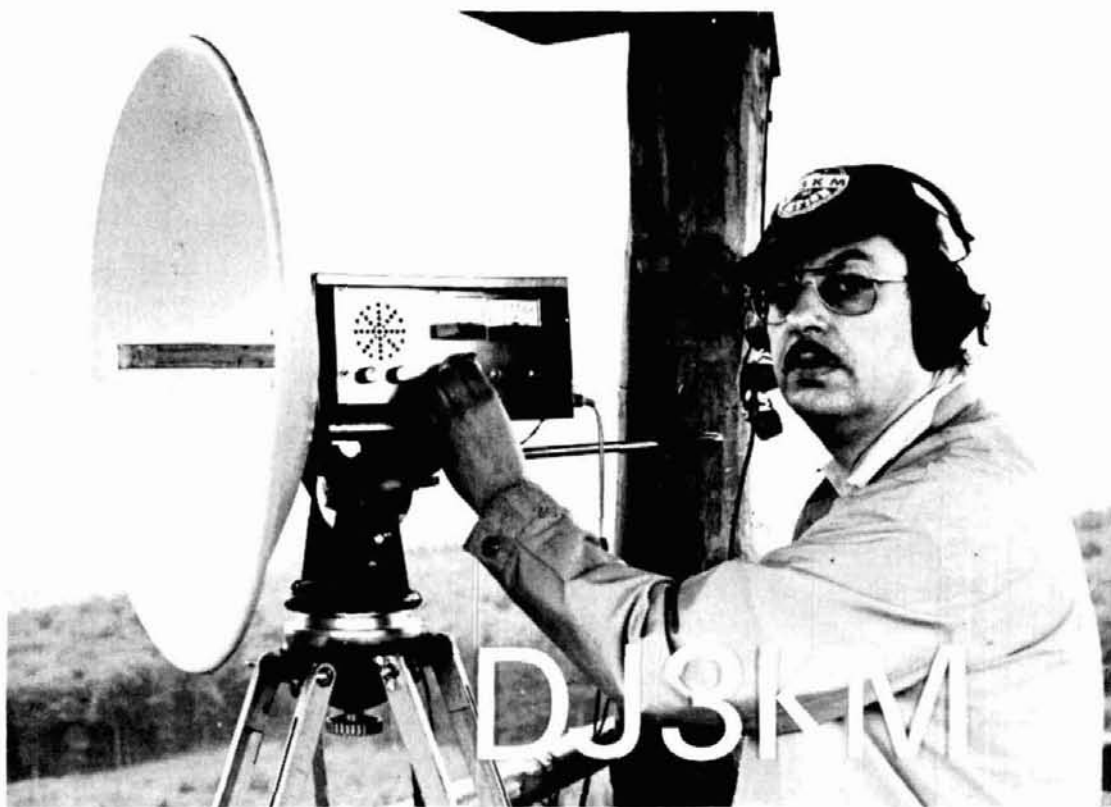

fig. 5. AFC voltage for the 10-GHz Gunnplexer transceiver is derived from the frequency-dependent voltage available from the 30-MHz receiver (fig. 4). The value of resistor R1 (approximately 330 ohms) must be determined experimentally so that 1 volt is measured at TP1.



QSL card used by DJ3KM showing his 10-GHz Gunnplexer and 30-MHz i-f receiver.

of 100 to 200 kilometers (60-120 miles). Since a pair of Gunnplexers with these high-gain antennas has a calculated systems range of at least 400 km (240 miles), we could work over distances greater than 200 kilometers (120 miles) if we could find a non-obstructed path that long.

When setting up the Gunnplexers it's helpful to have a secondary link on 144 or 432 MHz, but many contacts have been achieved without it. The operation of a microwave transceiver with the aid of a map

and compass is a new challenge and hobby for many amateurs in Germany.

Activity on 10 GHz in Europe has now reached the point that a 10-GHz bandplan has been approved by amateur groups in Germany, Holland, and Switzerland. In addition to providing space for communications between individual amateurs, the bandplan accommodates beacons, repeaters, and narrowband modes (CW, RTTY, SSTV, and single sideband).

Trial runs with higher gain antennas, narrower i-f bandwidths, and phase-locked loop circuitry for frequency stability are presently going on (reference 3, which describes a phase-locked Gunnplexer system devised by WA6EXV, is available from Microwave Associates).

I would especially like to thank DJ6RW, DJ3KM, DK2DRX, DJ8QL, and DJ8CY for their help in the construction and planning of this equipment.

references

1. J. R. Fisk, W1HR, "Solid-State Microwave RF Generators," *ham radio*, April, 1977, page 10.
2. B. Heubush, DC5CS, Dr. Ing. A. Hock, DC0MT, and H. Knauf, DC5CY, "Ein Sende-Empfänger für das 10-GHz Band," *UKW Berichte*, Autumn, 1976, page 184; Winter, 1976, page 245; and Spring, 1977, page 47.
3. C. Swedblom, WA6EXV, "ROCLC Gunnplexer Stabilization System," available from Microwave Associates, Inc., South Avenue, Burlington, Massachusetts 01803.

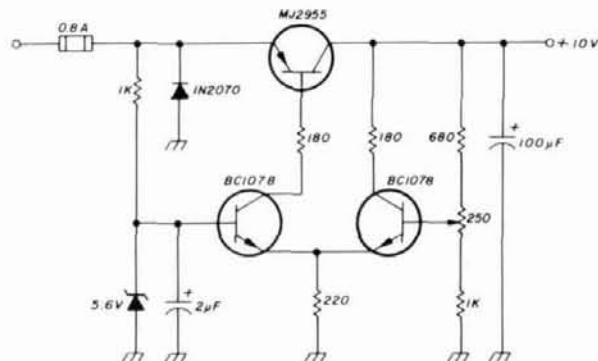

A +10 volt regulated power supply recommended for use with the 10 GHz Gunnplexer transceiver. The BC107B transistors may be replaced by any small-signal NPN silicon transistors such as the 2N4124. The MJ2955 may be replaced by a 2N3789 or similar 10 amp PNP device.

ham radio

GUNNPLEXER™ TRANSCEIVER

"FRONT END" BY MICROWAVE ASSOCIATES

Features

- Low Cost
- High Sensitivity
- Integrated Assembly
- Electronically Tunable
- High Reliability
- Low Operating Voltage

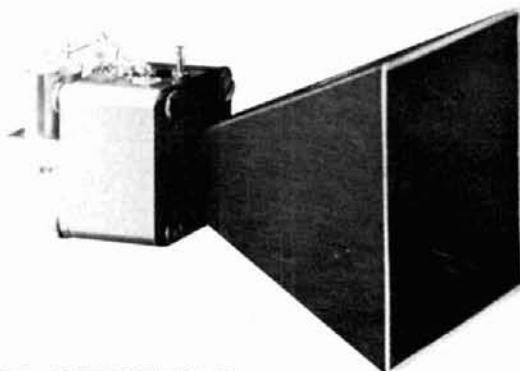

PRACTICAL RANGE CONSIDERATIONS

The actual usable range is a function of characteristics such as output power, frequency stability and noise figure. Generally, it's desirable to deviate the FM signal so that the available IF bandwidth is completely filled.

The graph in Figure 1 below indicates the maximum achievable range vs. IF bandwidth at threshold with threshold defined as the beginning of intelligible speech. Higher gain antennas will obviously greatly increase range.

THE GUNNPLEXER SYSTEM

The fascination of amateur microwave application is unique. First of all, microwave systems have an 'exotic' ring to them. Until the appearance of the Gunnplexer, getting into microwaves required either a six foot rack of surplus gear or a friend on the inside of a microwave hardware supply company. The Gunnplexer has changed all of that; you can hold the whole thing in the palm of your hand and you don't need any friends in the microwave business (in fact it may be better if you don't have any prior microwave knowledge because the Gunnplexer pretty much throws away the book on standard microwave design practices!)

An equal fascination is the wide band capability of the microwave region. The 10 GHz assignment, for example, has spectrum-space for 111 simultaneous video (4.5 MHz wide) channels. Try that even using SSTV in the 20 meter assignment. The bottom line on microwaves is simply that it will do much more communicating than you might first suspect.

DESCRIPTION

The MA-87127 series of frequency modulated transceiver "front ends" using Gunn oscillators and Schottky mixer diodes has been specially designed to operate in the amateur 10.0 to 10.5 GHz band.

The rear portion of the unit consists of a Gunn oscillator which directly converts DC to RF energy. The oscillator is delivered pre-set at 10.250 GHz (oscillators pre-set to other frequencies are available on special order 10.0 - 10.4 GHz). Mechanical tuning is available to shift the center frequency ± 100 MHz. A tuning varactor is mounted close to the Gunn diode which will deviate the fundamental frequency typically 60 MHz when the proper tuning voltage is applied. FM, including both audio and video, can be applied to the tuning varactor input. The receiver noise figure is approximately 12 dB depending on auxiliary equipment used. A ferrite circulator has been integrated into the waveguide mount to isolate the transmitter and receiver functions.

TWO-WAY COMMUNICATIONS

The primary application of the Gunnplexer "front end" is for 2-way communications. Two units, one a transmitter and the other a receiver down converter, are used with their carrier frequencies off-set to provide a reasonable IF (30 MHz or higher). Applications range from linking remote receivers to VHF repeaters, transmitting color video, linking homemade computers, full duplex mountain top DXing or over water duct DXing. A separate power supply and simple FM modulator must be provided; the MA-86551 (17 dB) horn antenna (shown here) is suggested.

WHY A GUNNPLEXER?

Amateur microwave communication is fascinating and challenging. Now with the revolutionary MICROWAVE ASSOCIATES Gunnplexer front end this exotic form of communications is available to virtually anyone. And at an unbelievably low cost!

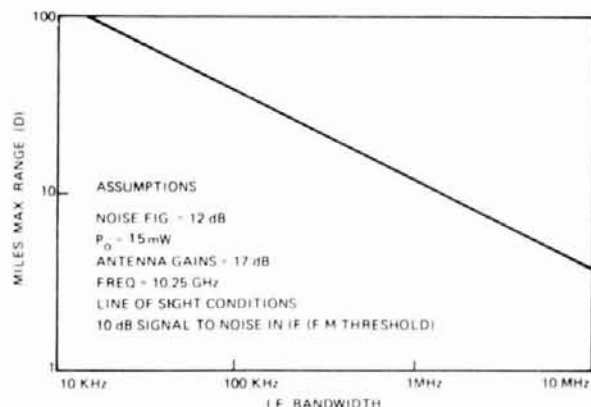

FIGURE 1

MA-87141-1 2 Complete Gunnplexer transceivers (MA-87127-1, 15mW typical and 2 horn antennas MA-86551, 17dB) just \$199.95 plus \$2.00 shipping and handling.

Rush Your Order by Calling (603) 673-7724. Or send for our FREE Detailed Information Package.

VISA and Master Charge Orders Welcomed

G.R. WHITEHOUSE & CO.
10 Newbury, Amherst, NH 03031

Exclusive distributor to Hams for MICROWAVE ASSOCIATES products in the U.S. and Canada.

frequency-lock loop

Oscillator stability
can be improved
by applying
this simple
but effective
frequency-lock loop

One of the main considerations in the design of radio communications systems is frequency stability. The objectives in the amateur radio service, however, are often quite different from those of other hf services. Amateurs have band allocations, while most other users have spot frequencies to work on, and consequently the vfo is usually our preferred primary frequency source. There are three basic frequency generation techniques in common use at the present time. The vfo is the oldest, offering simplicity and the very real asset of continuous tuning, but it is difficult to achieve high stability, especially in the long term. The crystal-controlled oscillator is also simple and very stable, but offers little flexibility, although such variations as the vxo and the "Rock-Mixer" have offered some help in this direction. Finally, there is the synthesizer, based on the phase-locked loop. At the expense of some complexity, this method offers excellent stability and can be very flexible. However, it is inherently a noncontinuously-tuned device, and, therefore, not as well suited to amateur applications — especially on the hf bands.

The vfo, in all respects except stability, offers what we need. It seems a pity to throw away all the results of the continuing development which have made the vfo as good a piece of equipment as it is, and start all

over again with the synthesizer. On the other hand, the approach I have taken with the frequency-lock loop (FLL) takes advantage of the positive points of the vfo and adds to it the stability of the crystal oscillator. Moreover, you can readily add an FLL as an outboard unit to an existing vfo without major modification to your equipment.

basic principles

If you have a good frequency counter with a read-out down to 1 Hz, you can, by manual tuning adjustments made suitably often, keep the vfo on the required frequency indefinitely. The stability in the medium to long term is that of the counter's clock. The function of the FLL is to automate this operation.

The frequency-lock loop consists of a simplified counter with a crystal derived clock, an error detector and latch circuit, a filter section, and a controlled reactance to compensate for drift in the vfo tank circuit. The error detector may be compared with the operator's recognition of a significant change in frequency, the filter his decision on the magnitude of the correction, and the controlled reactance the action of his hand on the vfo tuning knob.

counter

The purpose of the counter in the FLL system is not to display frequency, but to control it. And, as there is no reason to operate in the decimal or BCD modes, the simple binary counter is used. Comparing the FLL with the manual control, it should be obvious that there is no need to consider the most significant digits of the count. It is hoped that the vfo will not drift so much that the tens and hundreds of kHz would ever change, and surely not the MHz! So, for compensation of drift instabilities, only a small portion of a counter is required, and that can be in binary form.

The gate period is also of fundamental importance.

By Crawford MacKeand, WA3ZKZ, 115 South Spring Valley Road, Greenville, Delaware 19807

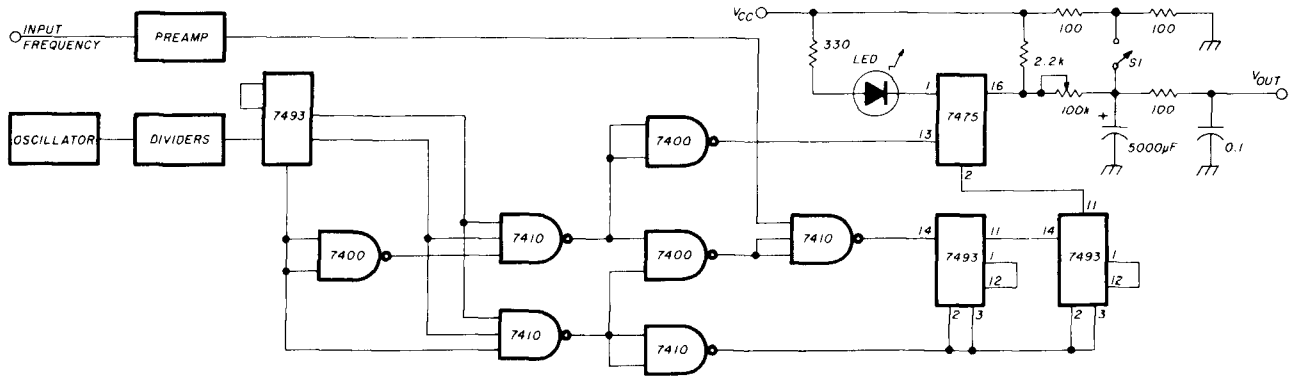

fig. 1. Partial schematic diagram of the basic frequency lock loop circuit. At this point, interpolation within the 256 cycle groups has not been taken into account.

I originally decided on an updating frequency, based on my feelings for drift rate, of once every 3 seconds, (clock 4.2 Hz), arguing that no significant drift would occur in a gate period of 2.8 seconds. Although this is true, I have changed to a higher clocking frequency of about 420 Hz and a gate of 28 mS. The longer period works fine, but the device takes so long to decide what to do next that the user rapidly loses patience with it.

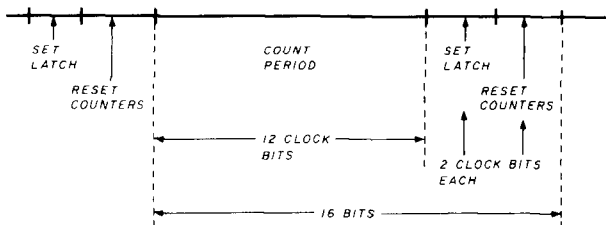

fig. 2. Timing cycle of the basic FLL system.

The counter gate logic is a modification of that presented by MacLeish.¹ The crystal oscillator and dividers can be any arrangement that supplies the correct clock frequency, provided that it has the requisite stability. The counter preamplifier is also a standard circuit for sampling the output of the controlled oscillator.²

error detector and latch

At the end of each count period the counter will be in a state which is dependent on the frequency of the controlled oscillator. If the frequency does not vary, neither will the counter's state at that instant. I initially felt that I would need to devise a circuit which would provide an output indicating whether the controlled oscillator was too high or too low in frequency. The obvious way to do this was by the use of a binary logic comparator such as the 7485. However, this would entail the use of switched inputs to cover all the 256 possible states of the counter. Of course,

one point of the 256 is available without any comparator at all: when the final stage of the 8-bit counter makes a transition, either 1 to 0 or 0 to 1. This means that during the period the gate was open some multiple of 128 cycles of the input frequency has been counted (256 cycles if you are only looking at the 1 to 0 transition). Therefore, without any further circuitry, the basic FLL shown in fig. 1 would indicate whenever the input frequency would satisfy these conditions. Assuming that we consider only 1 to 0 transitions, two successive frequency groups are related by:

$$f_n - f_{n-1} = \frac{k}{12} \cdot f_t \quad (1)$$

where

k = counter total

f_t = clock frequency in Hz

To complete the error detector, I used a latch to hold the output from one count to the next. The output of the latch is a TTL signal; one state indicates that the input frequency is too high and the other state indicates that the input frequency is too low.

filter

If the latch output were applied directly to the controlled reactance, the output frequency of the vfo would constantly be pulled one way and then the

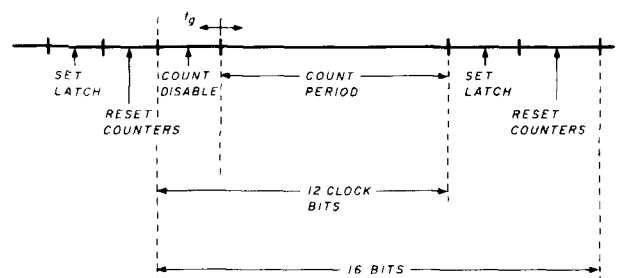

fig. 3. Timing cycle of the frequency lock loop system with interpolation. The 74121 is used to shorten the count period, permitting resolution within a 256 cycle group.

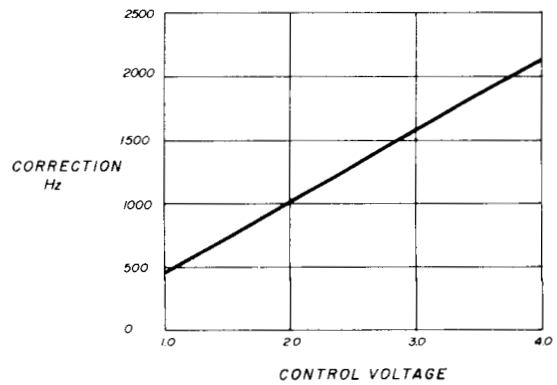
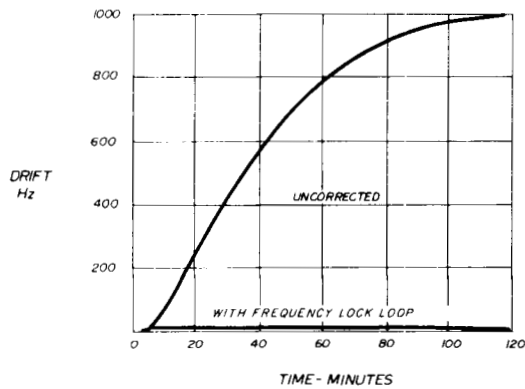

fig. 5. Oscillator drift with, and without, the frequency lock loop system. The range of the correction voltage is shown at the right.

other. However, the mean frequency would be correct. Intuitively, it seems that some smoothing is required. The FLL is very similar to a "bang-bang" servo, and can be readily stabilized by a first order filter or integrator composed of a single RC stage. The optimum filter is probably worth some investigation; nonlinear circuitry may also offer some advantages (a possible approach is described in reference 5).

The filter time constant t_f should be long enough

to reduce the fm on the vfo to an acceptable amount, and yet not so long as to make the balancing time excessive. My experiments in this area seem to indicate that somewhere in the region of 50 to 100 seconds is a good starting point.

voltage-controlled reactance

The obvious choice for the controlled tuning reactance is a voltage-variable capacitor diode (varactor

fig. 4. Schematic diagram of the full FLL system, including interpolation. The clock input frequency is approximately 420 Hz. The input to the preamplifier comes from the oscillator to be controlled.

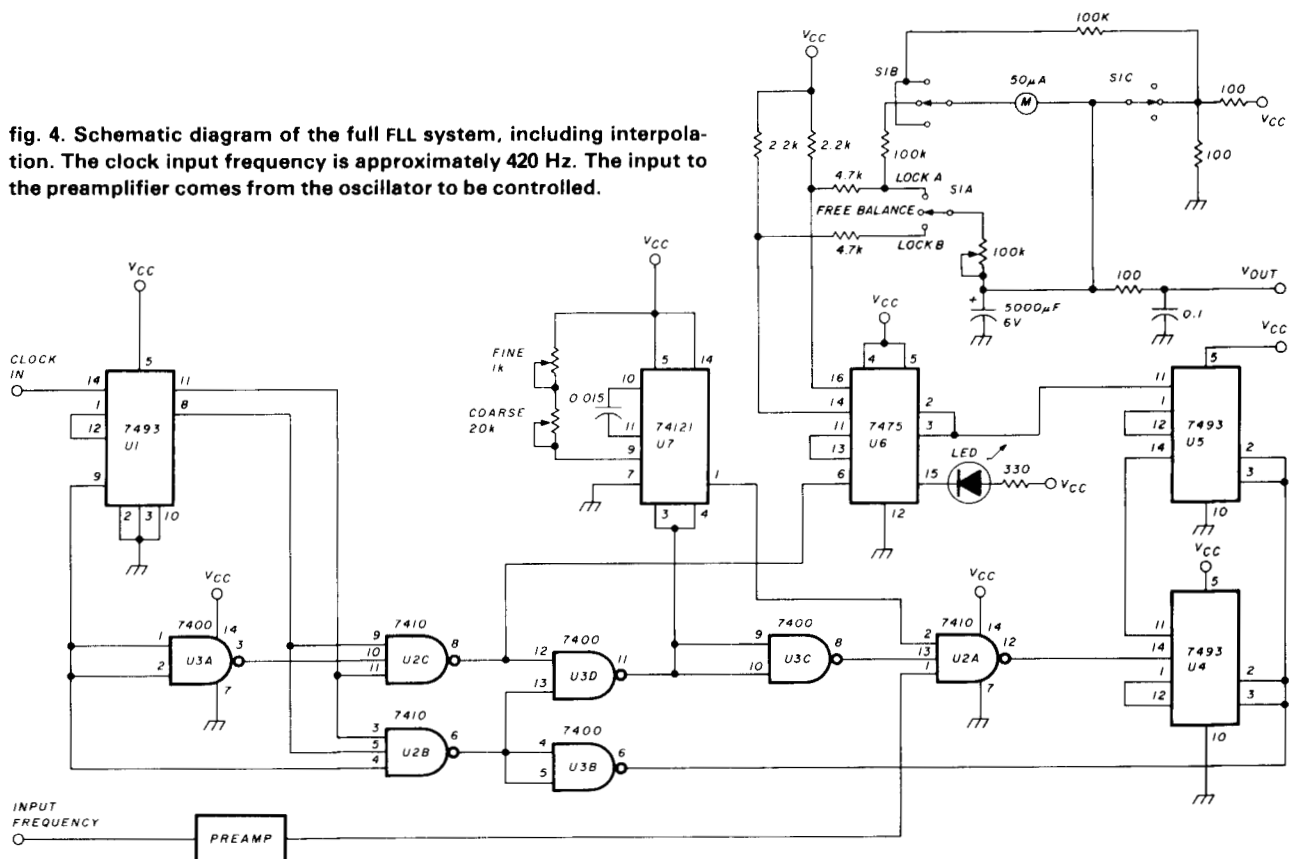

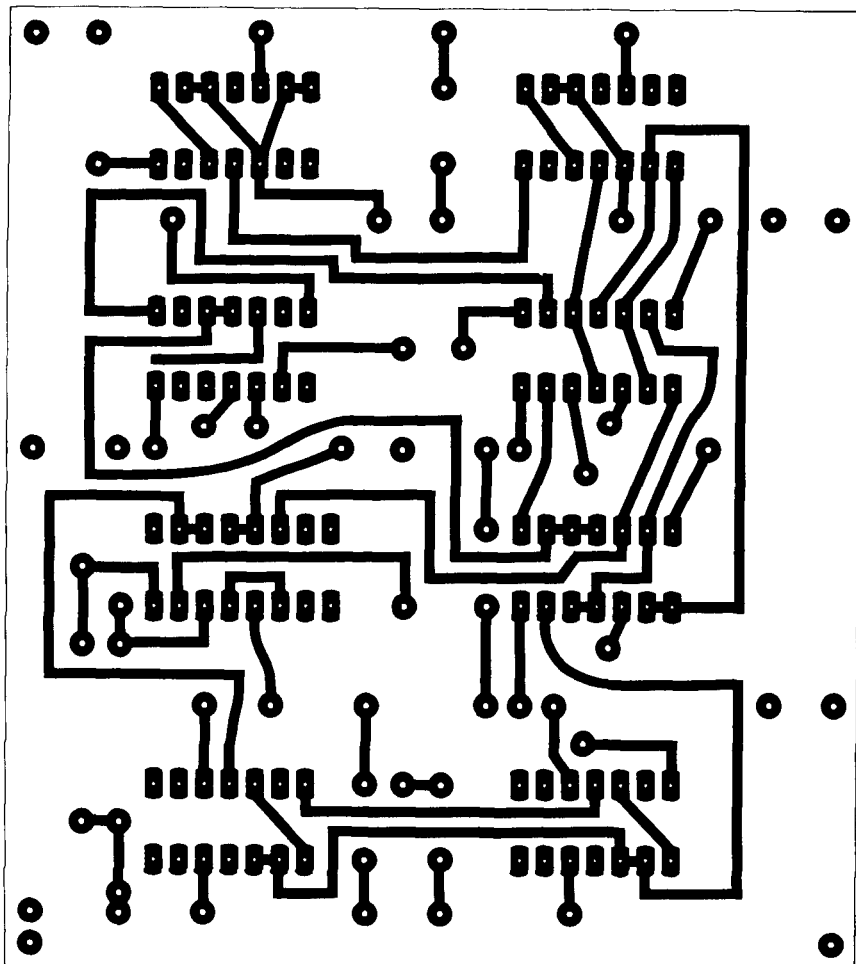

fig. 6. Circuit board layout for the frequency lock loop. Shown above is the back side of the board, with most of the interconnecting wiring; drawing on next page shows the top side of the board and the parts placement diagram. Although not included in fig. 5, this board contains an additional 7490 which is one of the input dividers from the oscillator. Also not shown in fig. 5 are the numerous 0.1- μ F bypass capacitors included on the board.

or varicap). Its application is dependent on the design of the vfo which is to be stabilized. The filter output has a useful range of about +1.5 to 3.5 V dc, although it would be a simple matter to include an op amp if a greater swing were required. The varicap should be connected to the oscillator tank so that it produces, with this voltage range, a frequency variation greater than the drift which is to be corrected.

In my Hammarlund HQ215 receiver I have been able to stabilize the high-frequency oscillator by coupling into a diode frequency shifter, which is provided for resetting the calibration when changing modes from USB to CW to LSB. Many transceivers have RIT circuits which provide similar access to the oscillator tank, while most transmitters and vfos can easily be modified as if you were providing for FSK operation.

interpolation

The basic FLL of fig. 1 will stabilize a vfo at discrete fixed frequencies, based on a fixed count period determined by the counter clock. The first method of interpolation I considered was that of varying the clock-oscillator frequency, using a vxo as the clock oscillator. With this arrangement I found that

$$\Delta f_a / f_a = \Delta f_x / f_x \quad (2)$$

where

- f_a is the basic clock oscillator frequency
- Δf_a is the change produced by pulling the vxo
- Δf_x is the resulting change
- f_x is the controlled frequency

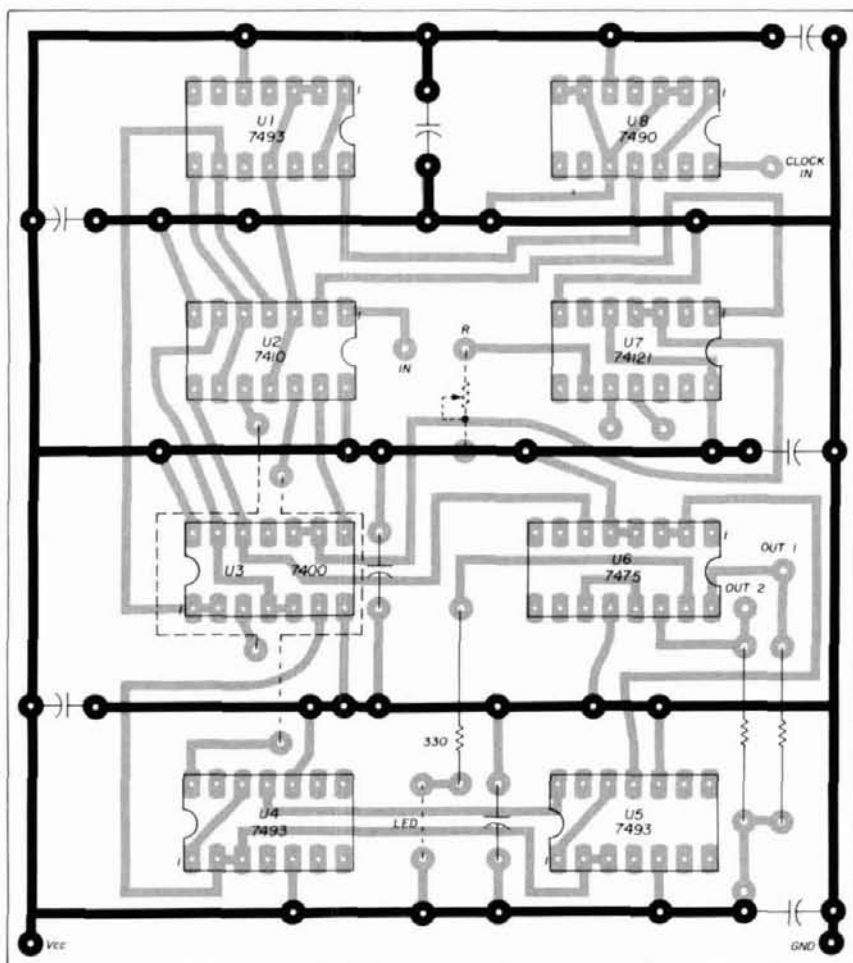

This places another constraint on the design, in that Δf_x must be at least as large as $f_n - f_{n-1}$, the difference between successive discrete stabilizing frequencies. But Δf_a is limited by the design of the vxo. Because of this factor, and also the decreased stability of a vxo compared with a regular crystal oscillator, this method was set aside for future consideration in favor of an alternative which permitted the use of a fixed-clock frequency.

The basic timing cycle is shown in **fig. 2**. It should be obvious that if the total counting period could be varied, by at least the time required to count one group of 256 cycles, then the problem of interpolation would be solved. A non-retriggerable one-shot multivibrator is used to create a noncounting period.

The new timing diagram incorporating the interpolating one-shot is shown in **fig. 3**; the schematic diagram shown in **fig. 4**.

operation

The lock switch, S1, is initially set to FREE. In this position the oscillator will be at its nominal calibrated frequency, because R1 and R2 have forced the tun-

ing voltage to its center value. The LED indicator will show the latch's output state. As the oscillator is tuned across its operating range, the LED will cycle on and off every time the frequency changes by $f_n - f_{n-1}$.

If we now choose an operating frequency, the interpolation control is adjusted until the LED flickers, showing that the FLL is ready to lock. The lock point may be either at a 1 to 0 or a 0 to 1 transition as the frequency increases. At this point S1 is moved to either LOCK A or LOCK B. You will know if you've selected the wrong one because the oscillator will rapidly drive off frequency. Initially it is useful to establish a rule such as: clockwise rotation of pot, lights the LED, S1 to LOCK A. After this is established, when you select S1, you're on frequency to stay. Minor frequency adjustments can be made with the potentiometer.

A steady flashing of the LED is a good indication of continuing operation. Meter M1 is valuable in the lock mode to show how far you have drifted and how much corrective capacity you have left. While in the FREE position, it can be used to show which lock

Larsen... the coolest antenna in town gives you the hottest performance!

Since the first Larsen Antenna was introduced some 15 years ago, this basic fact has not changed: **Larsen Mobile Antennas are designed and built to outperform.**

With the introduction of the Larsen exclusive Kūrod whip, this superior performance is a fact more than ever.

We're not going to confuse you with details on metallurgy, radiation resistance, plating systems and all that. Instead we suggest that you make this simple test:

Take any antenna other than a Larsen . . . one with a regular unplated 17-7 PH stainless steel (.100/.050) tapered whip. Apply a good husky signal to it . . . 100 watts, for, say, a full minute. Then, power off, feel the antenna. Careful! Burn blisters aren't pleasant.

Next . . . try a Larsen Kūrod Antenna. Put it to the same test.

Amazing isn't it!

That's our story. Heat means power . . . power that isn't radiated . . . power you shouldn't throw away. With the Larsen Kūrod, power goes into communicating instead of heating the antenna. That's why **you can HEAR the difference.**

Larsen Antennas are available to fit all styles of mounts and to cover Amateur frequencies from 6 meters through 450 MHz. Write for complete catalog and list of dealers nearest you.



Larsen Antennas

11611 N.E. 50th Ave.
P.O. Box 1686
Vancouver, WA 98663
Phone: 206/573-2722

In Canada write to:
Canadian Larsen
Electronics, Ltd.
1340 Clark Drive
Vancouver, B.C. V5L 3K9
Phone: 604/254-4936

* Kūrod is a Registered
Trademark of Larsen
Electronics, Inc.



position to use and also which way to move the interpolation pot.

performance

In this system almost all of the stability is derived from the crystal clock, with the remainder determined by the RC product in the interpolator. Using the constants discussed, on 80 meters, this amounts to one group out of about 400. In other words, during the total gate period, about 400 groups of 256 cycles are passed, and therefore, only one four-hundredth of the period is dependent on the one-shot's stability. If this is as good as 0.1 per cent, the overall stability is close to one part in 400 000. There is, however, an interesting series of trade-offs between the various constants and values selected. A short-gate period makes the job of the filter easier and reduces the fm effect caused by ripple on the control voltage. A long-gate period, on the other hand, makes the unit difficult to use, but reduces the dependence of the overall stability on the one-shot. Having decided on the gate period, the frequency difference $f_n - f_{n-1}$ is a function of the total count k . If $f_n - f_{n-1}$ is too small, jumping from one stable point to another could presumably occur.

There are a number of points which can be further refined if greater stability were required, but I have found, for instance, that the present design has made it possible to operate unattended on 3600 kHz RTTY autostart, where a stability of ± 10 Hz is desired. My actual achieved stability, as shown in **fig. 5**, is closer to ± 5 Hz, which seems to indicate little drift in the one-shot.

conclusion

The frequency-lock loop provides a simple and effective way of improving the stability of a vfo, effectively competing with a crystal oscillator. Equipment modifications are minimal and can be largely outboard. The components of the FLL itself are all TTL, readily available and inexpensive, while the control system is easy to use and has no tricky components or adjustments. Construction follows normal TTL practice and the simple double-sided layout shown in **fig. 6** is suggested for the main board.

references

1. Kenneth MacLeish, W1EO/7, "A Frequency Counter for the Amateur Station," *QST*, October, 1970, page 20.
2. Jerry Hall, K1PLP and Charles Watts, WA6GVC, "Learning to Work with Integrated Circuits, Part 8," *QST*, October, 1976, page 22.
3. Dr. Arthur D. DeLagrange, "Lock onto Frequency," *Electronic Design*, June 21, 1977.
4. Ulrich L. Rohde, DJ2LR, "The Frequency Counter as a Synthesizer," *ham radio*, September, 1977, page 44.
5. John C. West, "Servomechanisms," *Textbook of Servomechanisms*, English Universities Press, London, England, 1953.

ham radio

RTTY Can Be Easy!

Have You Wondered . . .
What Owning a RTTY Station Would be Like?
Have You Thought . . .
About Finding Out but Didn't Know Who to Ask?

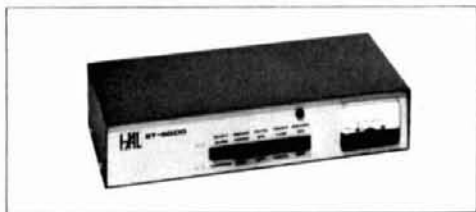
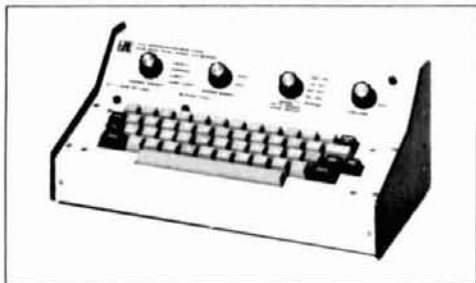

ASK THE GUYS AT HAL!

Our sales and service staff will be happy to assist you in your choice of RTTY equipment, answer questions about RTTY, and provide assistance if problems do arise. In addition, all HAL amateur RTTY equipment manuals can be purchased for \$10.00 each for an advance look (applicable to future purchase of that unit).

Answers to common RTTY questions are featured in the center fold of our new amateur radio catalog. Such questions as "What do I need?", "How do I hook it up?", and "What frequencies do I use?" are discussed. Technical points concerning RTTY pulses, FSK and AFSK, and high-tones vs low-tones are covered.

Write today for HAL'S new catalog and RTTY guide and discover how much fun RTTY can be.



HAL COMMUNICATIONS CORP.
Box 365
Urbana, Illinois 61801
217-367-7373

For our European customers
see HAL equipment at:

Richter & Co., Hannover
I.E.C. Interlec, Bissone
Prometek Systems, Handen, Sweden
Radio Shack of London

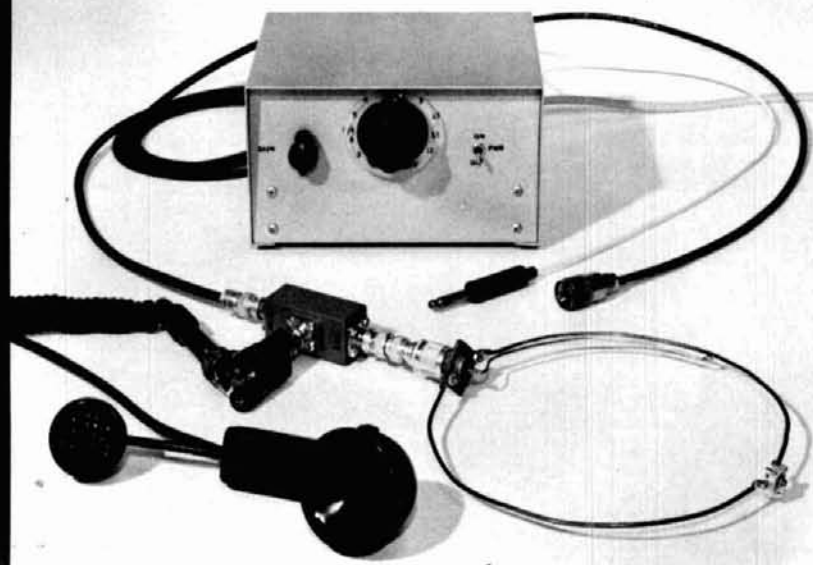

TVI locator

Locating and correcting the source of TVI is perhaps one of the most difficult tasks facing a radio amateur, one which must be performed methodically if satisfactory results are to be obtained. Much has been learned and written about transmitter harmonic radiation and TV receiver overload, but often very little is said about another prevalent and frustrating source of TV trouble, nonlinear rectification TVI.

Rectification TVI is caused by poor or intermittent contact between two conductors in the radiation field of a transmitting antenna. No amount of filtering or shielding at either the transmitter or TV set will correct the problem, since the interference is generated in the TV spectrum as direct harmonics of the transmitter's fundamental frequency.

In January, 1953, a fine article by Mack Seybold, W2RYI, was published in QST,¹ but I have seen nothing of a concrete nature on this particular problem since that time.

how do I know I have it

Rectification TVI can be suspected when suddenly there is TVI on one or more channels where there was none before, and no changes have been made in transmitter operation. Any metallic discontinuity can cause rectification TVI. In 1947, when I was living in a small town and in the days before the blessings of TV, my next-door neighbor said he heard voices coming from his bathtub drain. Another neighbor heard voices coming from her electric kitchen range. Both voices were caused by detection of my 75-meter a-m kilowatt rig. These two phenomena, no doubt, were caused by rectification.

The strength of the TVI will depend on the efficiency of the rectifier, the length of the "antenna" con-

nected to the nonlinearity, the distance from the transmitting antenna, and the transmitter output power. Two signals on widely separated frequencies can also combine to produce a signal at a third frequency — the faithful $2A \pm B$, or intermodulation products. For example, if two hams live near each other, and one is on 21 MHz and the other on 28 MHz, interference can be caused on channel 4 ($2 \times 21 + 28 = 70$ MHz) or channel 5 ($2 \times 28 + 21 = 77$ MHz), or both, if a nonlinear discontinuity exists in the area. These two signals, of course, will exist only when both stations are transmitting. Also, each signal alone can cause TVI on channel 2 (28×2), channel 3 (21×3), and channel 6 (28×3 and 21×4).

Visible TVI can be caused by an interfering signal as weak as 40 dB below the video carrier, depending on the frequency of the interference. A $1000 \mu\text{V}$ video signal, which is an adequate signal, can be interfered with by a $10 \mu\text{V}$ harmonic. If the amateur transmitter is running one-kW input, this does not leave much margin for harmonic generation.

All 14-MHz harmonics through the sixth can cause trouble, but the greatest problem is caused by the odd harmonics, the third and fifth. **Table 1** shows the harmonic relationships of the 14, 21, and 28 MHz amateur bands with respect to the TV channels. The worst interference is caused at or near the video carrier, 1.25 MHz above the lower TV channel edge. With all stations using color, however, a particularly vicious interference is caused by a harmonic falling on or near the color subcarrier frequency, 4.8 MHz above the lower TV channel edge.

By John E. Pitts, W6BD, 1068 Eden Bower Lane, Redwood City, California 94061

This effect was noted at W6BD on channel 4 when operating near 14.2 MHz. The interference appeared as wide diagonal color (rainbow type) bars on the screen. The fifth harmonic of the fundamental fell within 200 kHz of the color subcarrier at 70.8 MHz. Operation in the CW portion below 14.1 MHz caused no interference. Substitution measurements with a calibrated signal generator showed that color bars were caused by an interfering signal at 71.0 MHz with a signal strength of less than 300 μV . The desired channel 4 signal was 1500 μV . The cause was eventually traced to rectification TVI and was located by the methods presented here.

the fix for the hex

The harmonic chaser used in this hex-pedition (an expedition to find the hex) is simple to construct, easy to use, and will rapidly locate the source of the harmonic radiation. It is also, by today's standards at least, inexpensive. In this instance, the whole system was constructed and tested and the TVI source found in one weekend, so the work involved in the project is not great.

table 1. Amateur-band harmonic relationships to low-frequency TV channels. All frequencies are in MHz.

fundamental	28	21	14	harmonic	TV frequency	TV channel
harmonics				frequency	band	number
2			4	56	54 - 60	2
		3		63	60 - 66	3
			5	70	66 - 72	4
					76 - 82	5
3	4		6	84	82 - 88	6

Since the harmonic strength will be a relative measurement, a narrow-band receiver, tuned to the harmonic frequency, will be used. The easiest approach is to use a TV tuner whose i-f output is in an amateur band. This allows the selective station receiver to become the i-f amplifier and detector.

There are generally two types of tuners used for replacement purposes, the turret type and the wafer type. Due to the coil arrangement of the wafer-type tuner, it is unsuited for this purpose because the tuner's oscillator frequency must be changed. The most easily modified is the turret type, because the coils

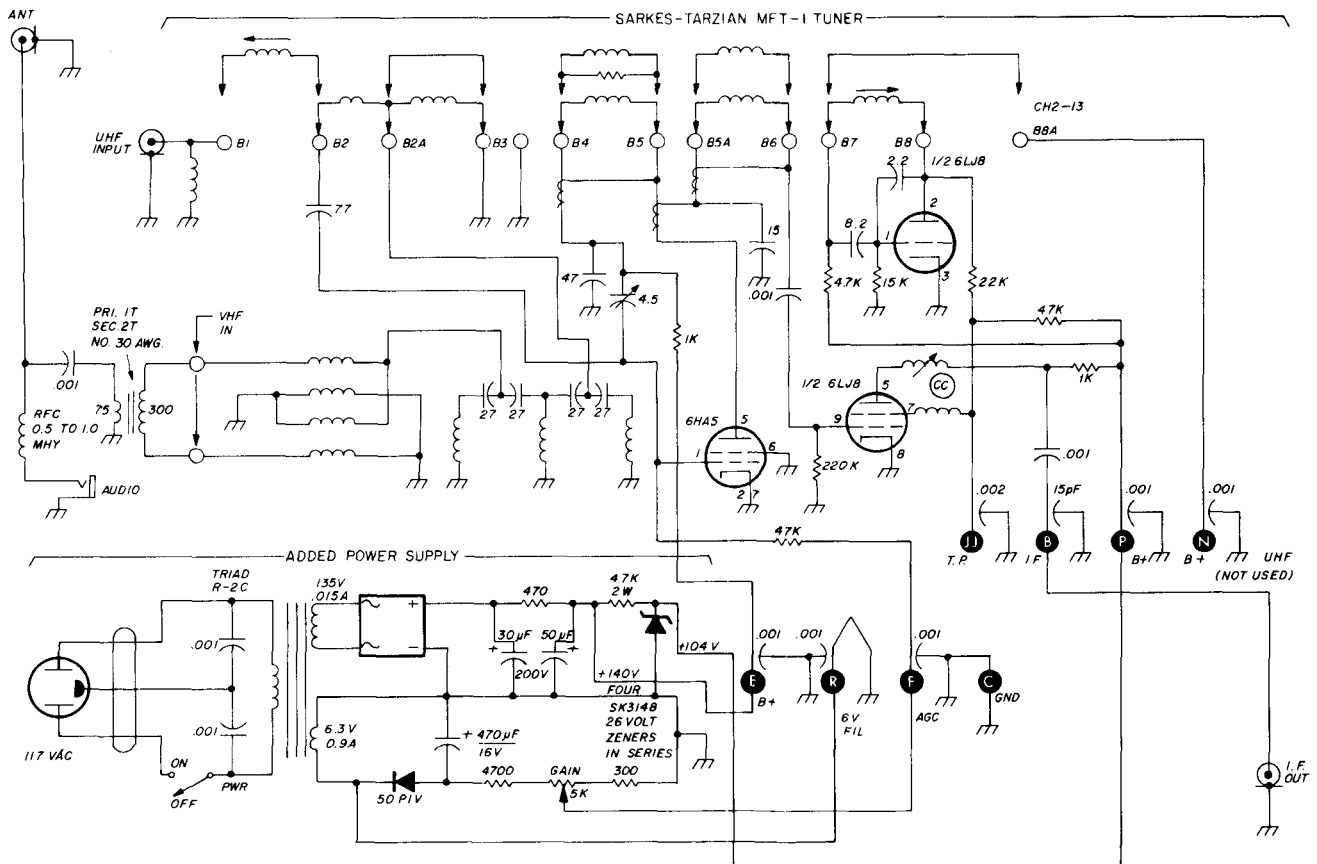

fig. 1. Schematic diagram of the Sarkes-Tarzian tuner and power supply. The coil marked CC is tuned for maximum signal into the receiver. You should not use more than about 60 cm (2 feet) of cable between the tuner and the receiver, otherwise the tuner may not cover the desired output frequency range.

for each channel are mounted on an easily removable bar. Present-day tuners have an i-f of 41.25 to 47.25 MHz, out of the range of most ham receivers. The widest high-frequency amateur band is 28 to 29.7 MHz. Therefore, the oscillator frequency needs to be lowered only about 10 to 12 MHz to produce an i-f output at 29.0 MHz.

The tuner used is a replacement type, Sarkes-Tarzian MFT-1 preset replacement tuner (see **fig. 1**). It is housed, with a small power supply, in an LMB 12.7 x 11.4 x 19.1 cm (5 x 4-1/2 x 7-1/2 inch) W-2F chassis cabinet. Except for the tuner and cabinet, which cost about \$27, all parts came from the junk box. Purchasing everything, and with a little horse trading and typical ham ingenuity, the entire cost should not exceed \$40.

construction

The original cut-and-try coil modification was performed using a frequency counter. A counter is not absolutely necessary, but if one is available, the job is much easier. If not, a reasonably accurate grid-dip oscillator (GDO) can help set the tuner's oscillator to the required frequencies. The oscillator was tuned to the high side of the desired signal because it did not want to oscillate on the low side. Therefore, as shown in **table 2**, the 10-meter receiver tunes backwards.

The only coil to be rewound is in the oscillator, the coil with the fine-tuning screw slug. Remove the snap-off shield from the tuner chassis. The channels to be modified are 2 through 6, since 7 and above are

not normally subject to rectification TVI. Channel 5 doesn't have to be modified, since no discrete amateur-band harmonic normally falls in this channel. Citizens band harmonics, however, do fall in channel 5.

Rotate the shaft until the bar with the greatest number of coil turns (channels 2 through 6), starting with the bar adjacent to the uhf strip, can be pulled out with the long-nose pliers. The uhf strip has no oscillator coil. The bars are easily removable, but use caution, as they can be broken. Pull at the pressure-finger point, the end with the tuning screw.

Remove all turns from the oscillator coil and clean the soldered portion of the contacts. Use care not to get solder on the switch contact portion of the terminals. Rewind the coils as shown in **table 2**; number 28 (0.32mm) AWG or number 30 (0.25mm) AWG enameled wire can be used. Wind on the number of turns indicated for each channel, observing the same winding direction as used on the other coils on the bar. Wind the turns close-wound, starting at the slug end. If necessary, the turns can be spaced later for the proper frequency range. Unscrew the fine-tuning screw about five turns out from full in. This will provide adjustment range later for the oscillator. Screwing the slug *into* the coil *raises* the oscillator frequency, and therefore raises the intermediate frequency to which the receiver is tuned. After each coil is rewound, return the bar to its original position in the turret to prevent mixing their positions.

Install and wire the power supply, jacks, and splitting filter as shown in **fig. 1**. Jacks and power supply may be whatever you have on hand in the junk box. Plate voltage for the tuner may be anything between 110 and 140 volts dc. The bias voltage is obtained from a rectifier on the 6-volt ac filament winding. The values shown for the resistors give a minimum of -0.8 volt and a maximum of about -4 volts. Normal operation is at full negative, but, if desired, the bias may be permanently set at -3 volts by selection of appropriate resistor values.

Install the tuner in the cabinet, mounting it with screws and spacers to the panel. Three of the front holes (near the shaft) will conveniently accept a 6-32 (M3.5) tap or a number 6 sheet-metal screw. For ease of fine-tuning adjustment, a piece of lucite (*Plexiglas*) — cut to 5.7 cm (2-1/4 inches) in diameter by a circle cutter — forms a good control wheel, similar to the fine-tuning control on a TV set. The center hole is sized for a force fit on the fine-tuning shaft, which is 9.5 mm (3/8 inch) in diameter. Mark the plastic shaft and then cut it to length with a hacksaw, after which the fine-tuning wheel may be forced onto the shaft.

Mark the length required on the selector shaft, cut it with a hacksaw, and smooth with a file. Rotate the

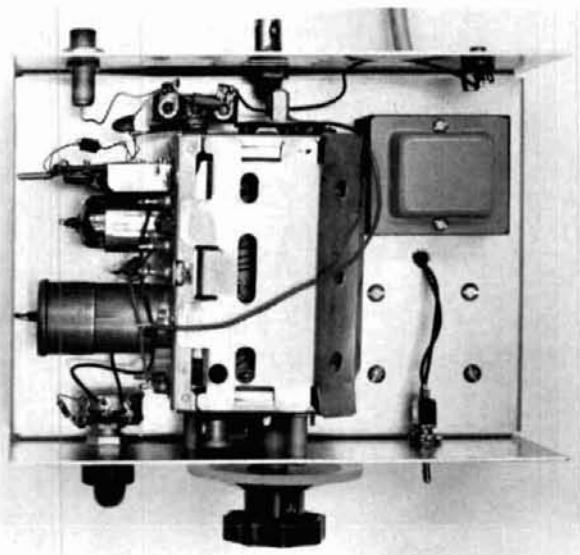

Interior view of the tuner section. Loop-antenna input connector is at the left rear, i-f output jack to the receiver in the center, and audio from the receiver is at the extreme right. The 4:1 balun, to match the 75-ohm line to the 300-ohm input, can be seen just below the type-F connector.

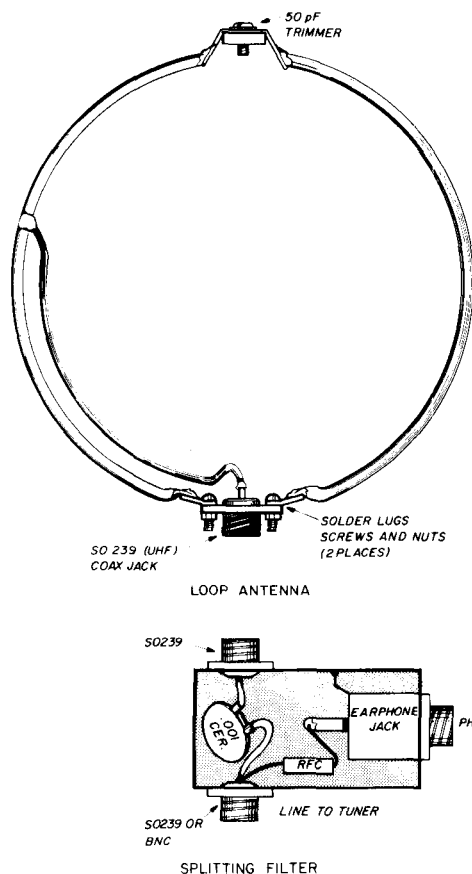

fig. 2. Diagram of the loop antenna and splitting filter. The filter is constructed in a small box, such as an LMB-M-00. The capacitor at the top of the loop is a 50-pF compression trimmer and is used to tune the loop to the desired frequency.

shaft with pliers so the uhf strip is in its operating position, then mount a skirt-type knob with the indicator mark toward the bottom of the panel. Channel 2 will be at the first position to the left of bottom as the turret knob is rotated clockwise.

loop antenna

The loop is constructed of two 25-cm (10-inch) lengths of number 10 (2.6 mm) AWG wire formed into a loop about 18.5 cm (7-1/4 inches) in diameter

(see fig. 2). The base of the loop is fastened to the shell of an SO239 uhf jack, with screws and nuts holding two soldering lugs onto which the loop wires are soldered.

A 50-pF trimmer is soldered to the wires at the top of the loop. A piece of number 12 (2 mm) AWG or number 14 (1.6 mm) AWG copper wire is soldered to the inner terminal of the SO239 jack, formed to the contour of the loop with 6- to 9-mm (1/4-to-3/8-inch) separation, and soldered to the loop 13 cm (5 inches) up its circumference.

Using appropriate connectors and a very small metal box, the splitting filter is constructed for the earphone or telephone connection at the base of the loop. When connecting the filter to the antenna, observe the connections shown in the figure. If connected backwards, the loop will work, but no sound will be heard in the phones.

tuning

Connect the tuner and station receiver together as shown in fig. 3. Temporarily connect the harmonic-producing network (fig. 4) between the tuner and transmitter output. Place the tuner on channel 2; tune the receiver to 29 MHz and the transmitter to 28.000 MHz or 14.000 MHz. Only very low output is necessary, just enough to make the diode conduct, producing harmonics. Turn the transmitter on, and also the receiver bfo. *Very slowly*, rotate the fine-tuning control until the transmitter harmonic at 56 MHz is heard. Verify this frequency by using the GDO as a signal generator. If no signal is heard, tune the receiver between 28 and 30 MHz and adjust the fine-tuning control until the 56 MHz harmonic is received. Do not confuse the desired signal with the fundamental or second harmonic of the transmitter output, bypassed around the tuner. Then jockey the receiver tuning and fine-tuning control on the tuner until the second harmonic of 28 MHz or the fourth harmonic of 14 MHz (56 MHz) is at 29 MHz on the receiver. Look up the signal frequencies for the various TV channel video and sound carriers in table 2. If channel 2 exists in your area, it can easily be heard when an antenna is connected to the tuner input and the

table 2. LO coil winding and i-f frequency output data for TV tuner modification. All frequencies are in MHz.

channel	LO coil number of turns	LO frequency	receiver dial frequency								
			TV video receiver i-f	TV sound receiver i-f	31	30	29	28	27	26	25
2	16	85	55.25	59.75	54	55	56	57	58	59	60
			29.75	25.25							
3	14	92	61.25	65.75	61	62	63	64	65	66	67
			30.75	26.25							
4	14	99	67.25	71.75	68	69	70	71	72	73	74
			31.75	27.75							
6	11	113	83.25	87.75	82	83	84	85	86	87	88
			29.75	25.25							

receiver is tuned to the indicated i-f frequency. In my test set-up, a $3 \mu\text{V}$ signal on any of the converted TV channels could easily be heard in the receiver.

Repeat the tuning procedure for the other channels and amateur bands according to the table. Note that the video or sound carrier can be used as check points if they're within the tuning range of the station receiver. I use my old Hammarlund HQ129X. The video carrier is a strong signal with 15.75 kHz sidebands extending several hundred kHz each side. The sound carrier has distorted modulation, since it is fm.

The loop is connected to the tuner via a convenient length of RG-58 or RG-59 cable equipped with suitable connectors. The most inexpensive connectors are F-type, used for TV cable connections. In my case, in order to reach the source of the rectification, 60 meters (200 feet) of cable was required. If you use F-type connectors, note that they are designed for coax with a solid center conductor.

The loop antenna operates as a radio direction

finder to locate the source of signal rectification causing generation of harmonics. In order to hear the effect of loop rotation on the signal, the audio output of the receiver is sent via the coax cable to headphones or a telephone carried by the loop-antenna operator. While slowly rotating the loop about its vertical axis, a distinct null, about 2 or 3 degrees wide, is easily heard.

Although a loop is normally bidirectional, in this case, due to the tapped feed point, it exhibits about 10 dB of front-to-back ratio when properly tuned. With the operator looking through the loop, he is facing the signal when the deepest null is heard with the feed tap on the *left* side of the loop. Rotating the loop about its horizontal axis will indicate, by a deeper null, the angle of elevation of the incoming signal. For maximum directivity, the trimmer capacitor must be tuned for maximum signal at the frequency of interest.

Loop operation can be verified by tuning it and the

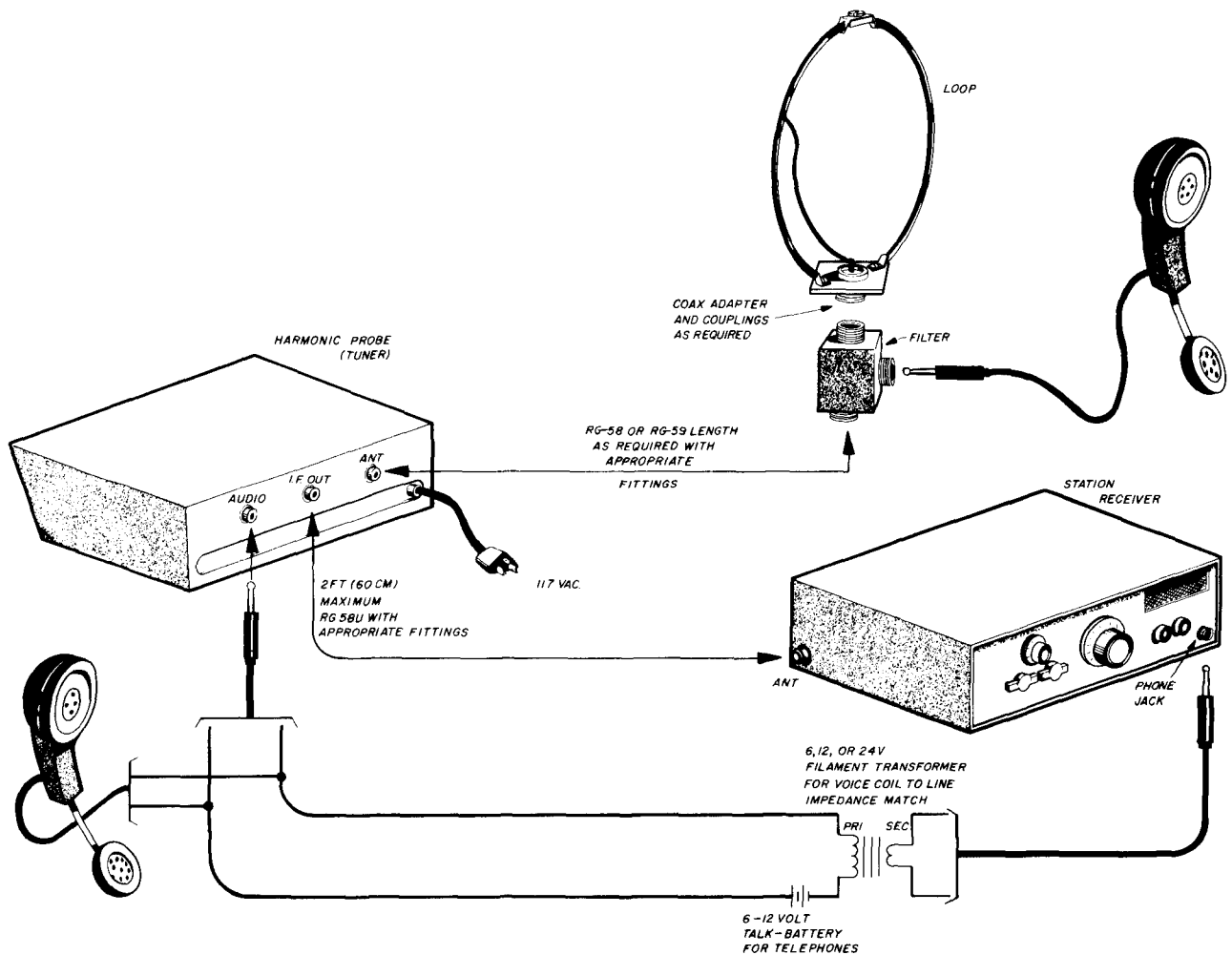

fig. 3. Interconnection diagram of the loop, tuner, and receiver. The earphone and microphone of each handset are connected in series. The battery is not required if the earphones alone are used.

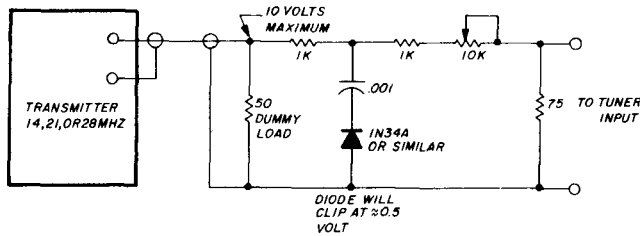

fig. 4. Schematic diagram of the harmonic-producing network. This circuit is used to produce harmonics to calibrate the tuner and receiver. A maximum of 2 watts should be applied.

receiver to a TV station and observing the effect of rotation. This test may be invalid if many echoes exist from pipes, ducts, or other large metal surfaces. This same effect must be considered when looking for TVI.

finding the hex

Set up the equipment as shown in the block diagram, fig. 3. Tune the TV set to the channel having interference. Turn on the transmitter and verify that it is causing interference, then turn the tuner to the same channel. Use only sufficient transmitter power to cause TVI. Tune the receiver to 29 MHz and find the harmonic. Note that table 2 is based on the lower edge of the 14-, 21-, and 28-MHz bands. Also note that the receiver, used as an i-f amplifier, tunes backwards. For example, if 21 MHz interferes with channel 3, the third harmonic is at 63 MHz and is tuned on the receiver at 29 MHz. If the transmitter is tuned to 21.3 MHz, the third harmonic is at 63.9 MHz and will fall at an i-f frequency of 28.1 MHz on the receiver dial.

Set the receiver controls for CW operation, and tune the harmonic so that its detected audio frequency is about 1 kHz. It will be necessary to retune the receiver from time to time since the oscillator will drift slightly. Therefore, an operator should be at the receiver for periodic tuning, and to key the transmitter on request. If two telephone handsets or operator's headsets are available, constant communication between the antenna and receiver operators is possible.

Go outside the house and take a preliminary bearing on the interference source. Note the direction (a rough sketch or map may be helpful). Go to a second location and take a second bearing. In all but the most elusive cases of interference, two or three bearings will suffice. Rotating the loop axis vertically, rather than horizontally, will indicate the elevation of the source above ground level.

Under certain conditions, it may be advantageous to turn off the receiver agc and have the receiver op-

erator control the signal level with the receiver's rf gain control. When nearing the interference source, or when using the probe as a "sniffer" for harmonics radiating from equipment, a coax plug fitted with a few centimeters of stiff wire will serve as a probe antenna.

Due to the attenuated response of the loop antenna at the normal amateur frequencies, a highpass filter of the TV type was not found necessary. If one is used, it must be located after the splitting filter in the tuner, or the telephone extension will not work.

where to look

Many things can cause a rectification-harmonic problem. Some of these are rain gutters, downspouts, roof flashing (the metal under shingles), corroded TV antennas, rusty TV masts, poor (unsoldered) splices in TV feedlines (or in the station antenna system both transmitting and receiving), poor electrical conduit joints and other metal junctions of this nature, all transistorized equipment, intercoms, pipes, telephones, concrete reinforcing bars — the list is almost endless. Any two touching pieces of metal more than a few centimeters long in the field of the transmitting antenna are suspect. The obvious solution to the problem is to permanently bond the two pieces, or, if no electrical continuity is necessary, to permanently insulate them.

Three cases have been found and corrected at my location, galvanized-tin roof flashing and corroded TV antennas on two adjacent houses being the cause. In the latter case, good relations have always been maintained with the neighbors, so no problem existed in correcting the situation. In fact, one case resulted in a very nice Christmas gift as an expression of gratitude. The tin flashing problem was fixed by permanently connecting the two pieces with sheet metal screws and anti-corrosive grease, permanent separation being impractical. The corroded TV antennas were scraped clean at the connection points and then painted with an anti-corrosive grease.

About eight years ago, long before this equipment was built, I found a source of rectification in my own TV antenna so severe that a 75-watt transmitter on 3.5 MHz feeding a dummy load caused TVI. A friend and I found the cause, wholly by accident, after a prolonged search. With the equipment described here, it would have been found in minutes. Now that you have the tools, good hunting, and may all your hexes be easy ones.

reference

1. Mack Seybold, "Harmonic Radiation from External Nonlinear Systems," *QST*, January, 1953, page 11.

ham radio

a dream realized: the ultimate antenna array

A 7-element quad
on 40 meters?
You'd better believe it!
Here's an account
of how one DXer
solved the problem
of big antennas

Most of us at one time or another have fantasized about having the ultimate array: the antenna to make you king of the band; the supergain bone crusher. Usually these dreams are dashed away by the reality of circumstances, but sometimes someone will succeed in getting one of these monsters up. Although, generally, this supreme achievement will go unnoticed by most, the rewards of the labor are still collected in abundance by the ambitious amateur who undertakes the challenge and succeeds.

The following account isn't meant to be a construction project but is presented with the hope that some of the ideas will convince others that, first, you don't need a lot of money to build a large array; and, second, some dreams can come true with a little applied ingenuity.

how it all began

Having been one of those few fortunates who've had the pleasure of operating at a large multi-multi station during DX contests, I've become appreciative of the merits of high-gain antennas. One day in early 1973 I was discussing various antennas with Jerry, WA7KYZ, when the subject of 40-meter arrays came up. Since 40 meters is generally considered to be the transition between wire dipoles and rotatable beams, we decided to experiment with some high-gain fixed-wire antennas on that band. Fortunately, we had a sizable piece of land on which to work. This property was dotted with 46-meter (150-foot)-high Douglas fir trees.

initial attempts

The first antenna we tried was a full-size four-section 8JK beam. On paper it looked really simple, but it turned out to be a real monster. We had to resort to using 2.6 mm (no. 10) copper-plated steel wire for the elements and 17-foot-long 1x6s (5 meters x 25 x

**By Paul Kiesel, K7CW, 3522 N.E. 115th Street,
Seattle, Washington 98125**

152 mm) for the spreaders. We finally got the thing up in the air by pulling up the ends with a pickup truck.

The antenna worked reasonably well. It seemed to have a low angle of radiation, as it was supposed to, and it definitely had gain. But it performed well in only two directions. It had a very narrow beamwidth. Additionally, we had a problem that we hadn't contemplated: we had to keep untangling the open-wire feedlines. Also, we had to use a transmatch, which made things even more cumbersome. The antenna eventually came down when an ambitious ten-year-old neighbor untied one of the support ropes at the base of the tree. We had mixed feelings about the array's demise.

the grand experiment

We fiddle-fumbled around for some time before we came up with the ultimate solution, the utopian array. It was to be a multi-element delta-loop quad. We decided to go with seven elements aimed at Europe. Every amateur in Washington state who works DX knows that the European path is the toughest nut to crack, because we have to battle the northern auroral zone. The east-coast guys have the same problem working into Japan. So we had to have a lot of gain; however, we didn't want to narrow the pattern of the array too much. We could have put three times as many elements on the thing,

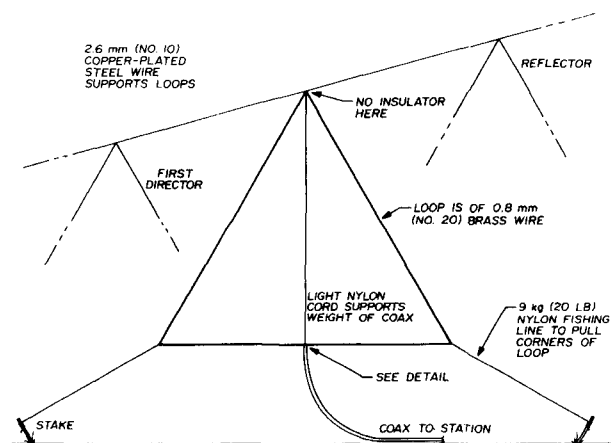
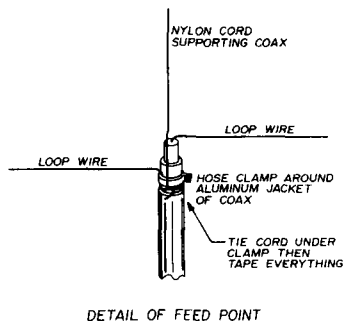

fig. 1. Details of the driven element for the 7-element, 40-meter delta-loop quad antenna. High Douglas fir trees provided the supports. Handbook data were used for loop dimensions and element spacing, which was 0.2 wavelength. The v_{swr} was measured at 1.5.



since the supporting wire was 137 meters (450 feet) long! We couldn't use the 2.6-mm (no. 10) wire for all the elements and support because it would have made the antenna much too heavy, so we used 0.8-mm (no. 20) brass wire for the elements. Sounds

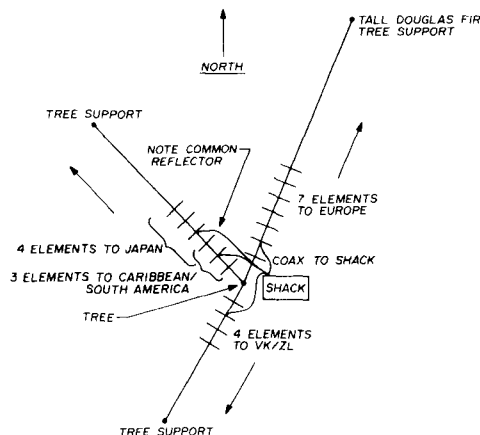

fig. 2. The ultimate antenna farm, which includes three switchable monster arrays covering Oceania, Europe, and South America, including the long path to the Orient.

flimsy, all right, but it works fine for a temporary effort. We really lucked out on the element wire. I picked up 1220 meters (4000 feet) of it at a surplus place for \$4.00. We used 9 kg (20-lb) nylon fishing line to pull out the corners of the loops. Jerry picked up some 75-ohm coax remnants from the local cable television company, so we used some of this for the feedline.

up she goes

Now, back to the support wire. Our two support trees were 137 meters (450 feet) apart. We couldn't afford polypropylene or similar rope, so we decided to use some of the 2.6-mm (no. 10) wire left over from the 8JK project. We used no insulators to separate the loops from the support wire as they were unnecessary. As soon as the array was secured, we checked the swr to find that it was only about 1.5:1. We used 0.2-wavelength spacing between elements and the customary formula for loop dimensions. We kept all directors the same size. We found that the array would sway freely but not excessively with the breeze.

I wanted to photograph our antenna for posterity, but this proved impossible. All that was visible in the photos was a 137-meter-long (450 feet) wire, two trees, and a piece of coax reaching up into the air and seemingly terminating into nothing. There are definite possibilities here for those who need to display as little antenna as possible.

It took Jerry, my brother, John (K7TU, ex-WA7OTT), and me about a day and a half to build the antenna from scratch. As we secured each element, we pulled up the support wire a bit. We used a small butane torch to solder the loops to the supporting wire. To support the coax so it wouldn't pull the loop out of shape, we ran a nylon cord down from the supporting wire to the feed point (fig. 1).

performance

I only use published gain figures as a ballpark method for deciding what kinds of array to consider, and I never tried to measure the gain of this antenna with respect to another antenna because of the many variables involved. My method of evaluation is to just get on the air and see how well the array works by communicating.

With the antenna connected to the rig, we tuned through the CW band and came across several UA1s and UA3s. (Remember — this was on the 40-meter band.) Their signals were so weak the S-meter didn't move, but all were solid copy. The only other signals on the band were some rag-chewing W6s. It doesn't sound too impressive until I mention that this first check was carried out at 12 o'clock noon.

A couple hours later we were able to work into Europe with consistent S4-S6 signals using only a barefoot T4X exciter. Later on that evening we were getting consistent 599 reports from all over Europe. The Europeans we worked were all solid copy. Our antenna was turning out to be a great performer.

further experiments

When we found out how well our antenna was performing, we decided to erect three more of similar type. We had enough material to erect three elements centered on the Caribbean/South America region, four elements on Japan, and four elements on the VK/ZL/Europe long path (fig. 2). By now we knew how to go about constructing the antennas, and the three new ones only took another day to erect. Upon trying them out we found that all three new antennas performed very well also.

sidelights

At this point a small anecdote relative to our antennas is appropriate. Soon after we got the four arrays up I was stringing JAs at about 9 o'clock in the evening when Gordy, W7SFA (now W7FU), broke in. He wanted to know how well I was hearing Japan. I told him that signals were moderate. This revelation must have surprised him, because he asked me what kind of antenna I had. I told him I was using a 4-element quad and that it was working quite well. Upon being asked by him if I could rotate my

quad, I replied that I could and told him to stand by. At that point I paused and flipped the antenna switch over to the European 7-element job, which just happened to be pointing directly at him. I hit the key again and asked him how it sounded. I won't repeat his reply here. And, quite frankly, his signals came up so much with the switch of antennas that their strength almost blasted me right out of my chair. Whew!

As flimsy as the antennas appeared, they proved to be very durable. They remained erect through several storms and during both weekends of the CQ WW DX Contest. In fact they were still in the air when the location had to be vacated a couple of months later.

Although we couldn't use the antennas on a permanent basis, they were still well worth the effort. I'll never forget how much fun it was to tell the Europeans on 40 meters; "The antenna here is a 7-element quad."

ham radio



"Since you're afraid of heights I was sort of hoping for a brother to help with my antenna."



Pictured
with optional
HD-1984 Micoder II™

The HEATHKIT HW-2036A

...just that much better!

We'll give it to you straight! The HW-2036 was a great 2-meter transceiver – but our new HW-2036A is just that much better.

It boasts the same impressive specifications, but now gives you a full 4 MHz of coverage over any portion of its 143.5 to 148.5 MHz operating range. But most startling of all is the price tag. At \$269.95* in easy-to-build kit form, the HW-2036A is the lowest priced, synthesized 2-meter transceiver you'll find anywhere!

At Heath we're holding down the soaring cost of Amateur Radio. Look over our entire line of quality kit products. Then join the thousands of Radio Amateurs who've taken the sensible alternative – and built Heath!

Heath Amateur Radio Gear...
...the quality that measures up!

More Details? CHECK – OFF Page 126

Send for your FREE Heathkit Catalog today!

Or you may obtain a catalog by bringing this coupon to one of the 50 Heathkit Electronic Centers coast-to-coast (units of Schlumberger Products Corp.). Where Heathkit products are displayed, sold, and serviced. Retail prices on some products may be slightly higher. See the white pages of your telephone directory.

Heath Company, Dept. 122-440, Benton Harbor, MI 49022



HEATH
Schlumberger

Heath Company
Dept. 122-440
Benton Harbor, MI 49022

Please send me my FREE Catalog. I am not on your mailing list.

Name _____

Address _____

City _____ State _____

*Price is mail order, F.O.B. Benton Harbor, MI. Zip _____

Prices and specifications subject to change without notice. AM-366

higher frequency resolution for an hf synthesizer

A unique method
for obtaining
10-Hz increments
from an hf synthesizer
using a
dual vco system

The advent of low cost phase-locked-loop frequency synthesizers has had considerable impact on vhf amateur radio equipment. Unfortunately, the frequency synthesizer is most adaptable to channelized systems, consisting of a finite number of discrete operating frequencies. Typical high-frequency amateur activity consists of tuning an analog-oscillator controlled radio to a clear frequency and making a call. To answer such a call, with single-sideband equipment, you must tune to within 50 Hz of the originating station's frequency for near natural voice reproduction. This means that a practical, synthesized, hf ssb transceiver must be capable of continuously tuning in 100 Hz steps, and requires an internal, loop-reference frequency of 100 Hz in a conventional configuration. The loop filter cut-off frequency required to effectively eliminate reference frequency sidebands from the synthesizer's output increases the loop lock-up time to several seconds after each frequency change. The ideal amateur CW receiver, equipped with narrowband i-f or audio filters, must be continuously tunable in 10-Hz steps, and this would have ten times longer lock-up time between frequency changes.

This article briefly describes a less common approach to an hf synthesizer which offers 10-Hz frequency steps from a 10000 Hz reference, and therefore offers 1000 times faster recovery after frequency excursions. In addition, less rugged mechanical construction of system oscillators is possible because of loop correction of low-frequency fm due to vibration.

Fig. 1 is a functional block diagram of a conventional PLL frequency synthesizer. The phase detector

supplies correction pulses to the vco, through a low-pass filter, at a frequency equal to the reference frequency, until the vco is locked at a frequency equal to N times the reference frequency. A lower reference frequency requires a lower filter cutoff for a given attenuation of the ac component of the reference frequency. The filter is part of the closed loop and its response determines the maximum rate of vco frequency correction.

Fig. 2 is a functional block diagram of a two-part synthesizer, offering 10-Hz steps with the advantages of a 10 kHz reference frequency. Note the use of two reference frequencies, 10.000 kHz and 9.990 kHz. The output frequency is actually the difference frequency between two phase-locked oscillators. To change the output frequency by 10 Hz, we move the first oscillator 10.00 kHz; next, we move oscillator number two 9.99 kHz in the same direction. The difference between the oscillators' frequencies has only changed 10 Hz.

In the following example, I have made provisions for high-side LO injection in a super-heterodyne application, employing a 9.0 MHz i-f system. Also, sample calculations are shown for bfo/carrier frequencies of 8998.5 kHz for lower sideband and 9001.5 kHz for upper sideband (remember the sideband inversion with high-side local oscillator injection). The actual operating carrier frequency is programmed in BCD into the circuit's adders. Functionally, the circuit is divided into two major sections. Section two covers a range of approximately 50 to 60 MHz, with section one covering approximately 59 to 99 MHz.

To run section two at approximately 50 MHz, a divide ratio (programmed vco 2 offset) of 5005 is initially chosen for divider 2. To the resulting frequency

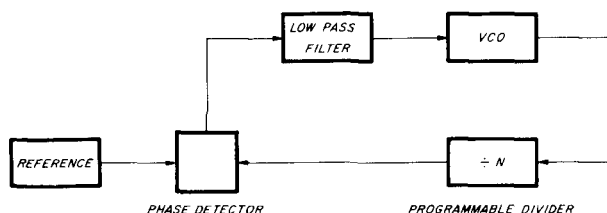

fig. 1. Block diagram of a conventional PLL synthesizer.

By William E. Coleman, N4ES, E-Systems/ECI Division, Box 12248, MS 11, St. Petersburg, Florida 33733

(49999.95 kHz) is added the bfo frequencies of 8998.5 kHz and 9001.5 kHz, producing the initial vco 1 frequency. This procedure allows us to calculate the final required programmed offsets for dividers 1 and 2 (fig. 3).

Therefore, for a programmed operating frequency of 00000.00 kHz, divider 1 must divide by 6744 for lower sideband, and 6045 for upper sideband as shown in fig. 1. Vco 1 will then operate at 67440 kHz for LSB and 60450 kHz for USB (fig. 4).

And, for a programmed operating frequency of 00000.00 kHz, divider 2 will divide by 5850 for LSB and 5150 for USB. Vco 2 will operate at 58441.5 kHz for LSB, and 51448.5 kHz for USB (fig. 5).

With a sample operating frequency of 14307.96 kHz USB programmed into the synthesizer's data input, divider 1 would divide by 8271. Vco 1 would

ESTABLISHING VCO STARTING FREQUENCIES AND I-F OFFSET.

5005	49,999.95kHz	49,999.95kHz
$\times 9.99\text{kHz}$	$+ 8,998.50\text{kHz}$	$+ 9,001.50\text{kHz}$
49,999.95kHz	58,998.45kHz	59,001.45kHz
VCO 2 INITIALLY SELECTED FREQUENCY	INITIAL VCO 1 LSB FREQUENCY	INITIAL VCO 1 USB FREQUENCY

fig. 3. The initial frequency for vco 2 is determined by assuming there is no programmed input frequency (00,000.00 kHz). For the vco to be at its proper lower frequency limit, the divider would have to have an initial divide factor of 5005, producing a 49999.95 kHz output. Vco number 1 will also start with the same frequency, except with the added offset required for either LSB or USB.

operate at 82710 kHz (fig. 6A). Divider 2 would divide by 5946, and vco 2 would operate at 59400.54 kHz (figs. 6B and 6C).

The i-f offset is implemented by separating the divide cycle of each programmable divide chain into

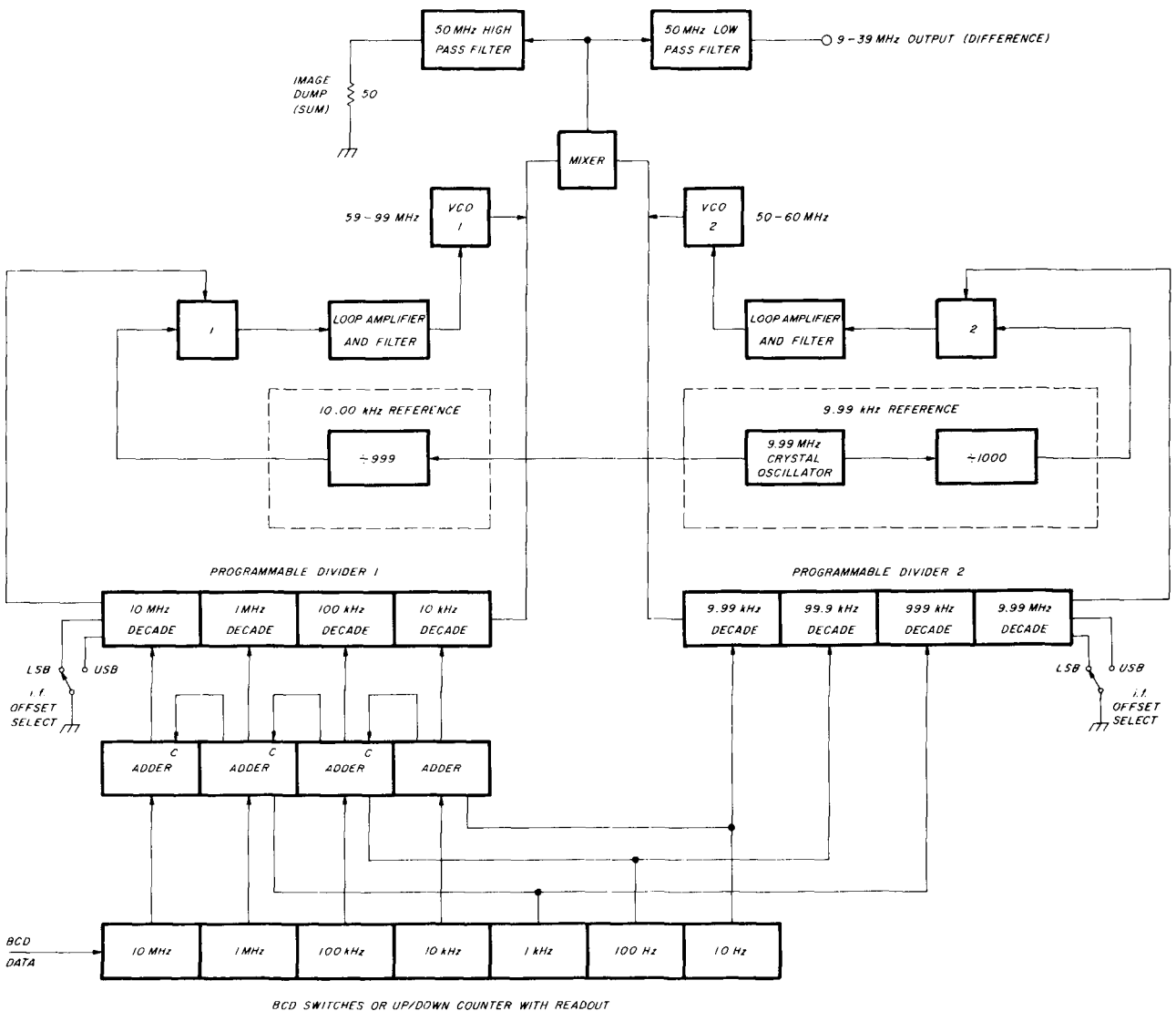

fig. 2. Functional block diagram of a high frequency synthesizer capable of 10-Hz steps, with a 10-kHz reference.

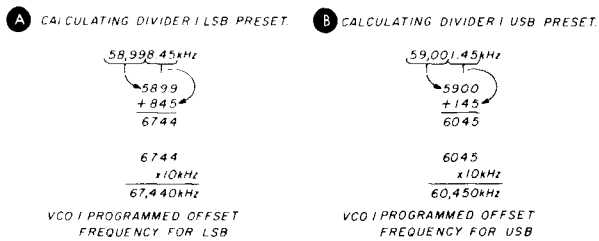

fig. 4. As seen in fig. 2, the data from the three most significant digits is added to the data from the fourth through the sixth significant digits. This number is then the final number which is used to control the programmable divider number one. (B) shows the same divider calculation, except for USB instead of LSB. The divider then controls vco 1 in 10 kHz steps.

two subcycles. During the first subcycle, the chain is loaded from and divides by the number programmed in a diode ROM (i-f offset data for the sideband in use). For the second subcycle, the chain is loaded with and divides by the data presented to the BCD frequency-select input lines. After both subcycles are completed, one pulse is sent to the phase comparator, and the entire cycle repeats. This approach may also be applied to single-divider PLL systems.

The reference frequencies are derived by dividing a 9.99-MHz crystal oscillator's output by 1000 and 999 to obtain outputs at 9.99 kHz and 10.00 kHz, respectively. An oven is recommended if the synthesizer's 10-Hz resolution is to be used to full advantage.

Vco 1 and vco 2 are combined in a mixer, which supplies the difference-frequency output through a 50-MHz lowpass filter. The mixer is image terminated through a highpass filter to reduce any unwanted intermodulation products which would result from an impedance mismatch at the vco sum frequencies.

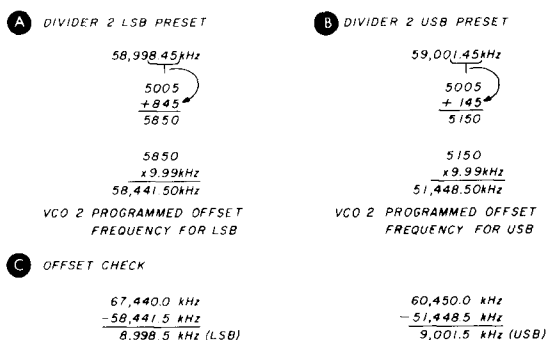

fig. 5. For vco 2, the same initial frequency, as determined in fig. 3, is preset into the counters, plus the three most significant digits from the data switches. The final divider number, times 9.99 kHz, produces the required vco frequency, except now in 9.99 kHz steps. As a check, subtracting the value of the two vco frequencies will equal the sideband offset value (C).

Both filters must employ T-input sections so they appear invisible to the mixer in their cutoff regions.

Because the high-reference frequencies used in this synthesizer allow loop correction of vco microphonics below about 1 kHz, this circuit is ideal for mobile applications where vibration would otherwise require the use of extremely rugged oscillator enclosures.

This approach may be expanded to yield 1 Hz steps, or to utilize a 100 kHz reference, but either change would require a ten times greater frequency

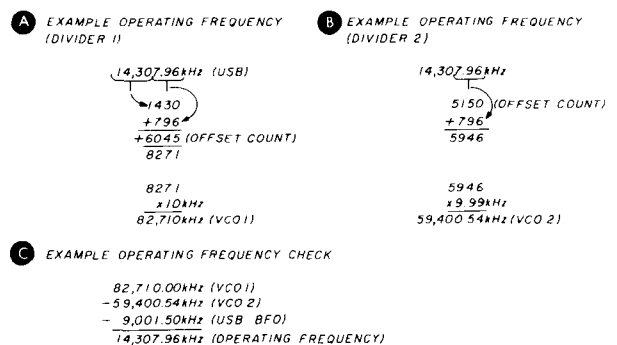

fig. 6. With a sample operating frequency of 14,307.96 kHz (USB), the programmable divider, for vco 1, would have a value of 8271. The offset is that calculated in fig. 4B. This final value determines the frequency of vco 1. The programmable divider for vco 2 uses the input from the data switches plus the offset from fig. 5B to determine the vco's frequency. Since this synthesizer is actually a local oscillator in a transmitter or receiver, its output will differ from the actual transmitted (or receiver) frequency by the value of the i-f frequency. Therefore, the difference between vco 1 and vco 2 will equal the operating frequency plus the i-f offset. Or, subtracting both the i-f offset and vco 2's frequency from vco 1, will give the actual operating frequency (C).

range of vco 2, and that much additional range added to the upper frequency limit of vco 1.

A recommended frequency programming scheme would incorporate thumbwheel switches to set the MHz range, with smaller frequency divisions being continuously tunable by an optically coupled, tuning-knob-controlled, up-down counter with readout. The high speed of this synthesizer makes it an ideal candidate for use in an automated, microprocessor controlled station, in which case tuning could be implemented with the computer's ASCII keyboard, or even remote controlled via a modem. Wouldn't it be nice to have a remote 20-meter transceiver atop a 150-meter (500-foot) building?

I would like to thank Fred Studenberg, W4CK, and Chuck Jackson for their technical advice and constructive criticism of this article.

ham radio

THE SYSTEM TWO™ TRIBANDER ANTENNA ...

Top Performance for 20 - 15 - 10 Meters!

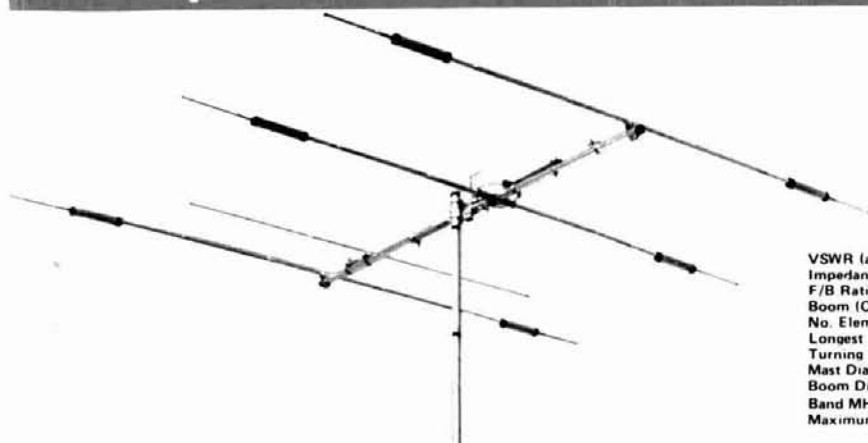

Wilson SY-2

SPECIFICATIONS

VSWR (at Resonance)	1.5:1	Gain (dB)	8.5
Impedance	50 Ohms	Surface Area (Sq. Ft.)	6.15
F/B Ratio (dB)	20:25	Wind Loading	
Boom (O.D. x Length)	2" x 18'6"	at 80 mph	153
No. Elements	4	Assembled Weight	
Longest Element (Ft.)	26'7"	(Lbs. Approx.)	47
Turning Radius (Ft.)	16'4"	Shipping Weight	
Mast Diameter	2" O.D.	(Lbs. Approx.)	50
Boom Diameter	2" O.D.	Matching Method	Beta
Band MHz	14.21-28	Only One Feed Line Required	
Maximum Power Input	4 Kw	SHIPS BY U.P.S.!!!	

Delivers outstanding performance on 20, 15 and 10 meters. Features Wilson's large diameter, High-Q Traps, feeds with 52 ohms coax, a Beta Match method provides most efficient 3 band matching and DC ground to eliminate precipitation static. The result is SWR less than 1.5 to 1 at resonance on all bands and maximum front-to-back. An added feature is the separate 10 meter reflector for correct monoband spacing. Add to this the rugged boom to element mounting, heavy duty taper swaged elements, and you have

SYSTEM TWO™

... space efficient, high performing, cost effective new tribander.

For best installation use Wilson's MT-61 61 ft. Crank-up Tower and WR-500 Rotor. Recommended Balun: Wilson's BN-50-A

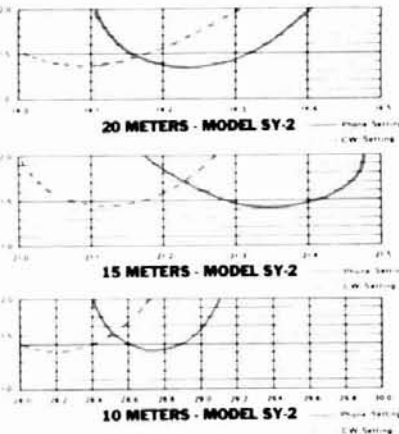

40 THRU 10 METERS VERTICAL TRAP

WV-1 WILSON VERTICAL TRAP ANTENNA

No bandswitching necessary with this vertical. An excellent low cost DX antenna with an electrical quarter wavelength on each band and low angle radiation. Advanced design provides low SWR and exceptionally flat response across full width of each band. Featured is the Wilson large diameter High-Q traps which will maintain resonant points with varying temperatures and humidity. Easily assembled, the WV-1 is supplied with base mount bracket to attach to vent pipe or to mast driven in the ground. The new WV-1 Antenna is value priced ... and ships via UPS!

SPECIFICATIONS

Input Impedance: 50 ohms • Powerhandling capability: Legal Limit • Two High-Q Traps with large diameter coils • Low Angle Radiation Omnidirectional performance • Taper Swaged Aluminum Tubing • Automatic Bandswitching • Mast Bracket furnished • SWR: 1.1:1 on all Bands • 1½" O.D. heavy wall aluminum tubing • Does not require guying • Overall length: 19' 8"

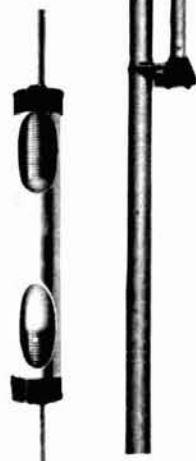
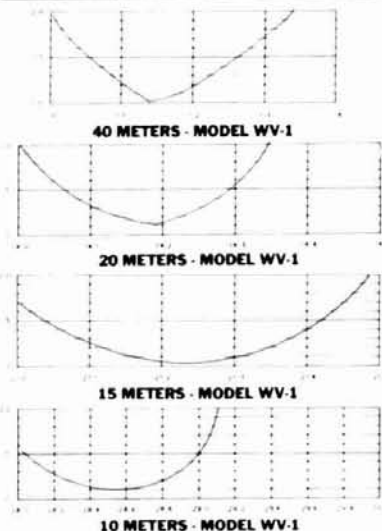

MODEL WV-1



Wilson Electronics Corp.

4288 SO. POLARIS AVENUE • LAS VEGAS, NEVADA 89103 • (702) 739-1931 • TELEX 684-522

Consumer Products Division



DRAKE UV-3 multi-band

144-220-440 MHz



Optional
Drake 1525EM
Encoding
Mike

Designed and manufactured in the U.S.A.

- Model 1346** Drake UV-3 (144-220-440) \$795.00
- Model 1344** Drake UV-3 (144-440) \$695.00
- Model 1343** Drake UV-3 (144-220) \$695.00
- Model 1345** Drake UV-3 (220-440) \$695.00
- Model 1340** Drake UV-3 (144) \$595.00
- Model 1359** Drake UV-3E (144-430)*

(Models above include factory installed modules for bands as listed, standard dynamic mike, and mobile mounting bracket.)

* This model tuned for European fm bands.
See your dealer for price details.

Add-on modules expand band coverage of models which may have been purchased in a single band or two band configuration. Prices include factory installation which is necessary to meet FCC receiver certification requirements.

- Model 1504** Drake PS-3 AC Power Supply \$ 89.95
- Model 1525** Drake 1525EM Encoding Mike . . . \$ 49.95
- Model 1330** UMK-3 Remote Trunk-Mount Kit . . \$ 69.95

NOTE: Certain of the above models will be available before others. Check with your dealer for specific availability.

synthesized fm system

For the serious amateur who...

- considers fm a vital part of a total communication system
- needs multi-band coverage in a single transceiver
- needs to continuously scan-monitor a priority amateur repeater dedicated to public service, weather, or DX alerts
- needs extra programmed channels for quick selection, in addition to the synthesizer...

The Drake UV-3 provides it all!

- Continuous priority channel scan
- Remote trunk operation (optional)
- Four extra diode-programmed channels on each band
- All three bands in a single bandswitched unit, or start with basic models and add extra band-modules later
- Non-standard offsets available for each band

The Priority Channel Scan

You can diode-program your priority channel in one of the fixed channel positions. It can be con-



tinuously monitored from any other synthesized or fixed channel. If you're operating on the priority channel, or another programmed fixed channel, you can scan-monitor any synthesizer frequency you choose.

The Extra Diode-Programmed Channels

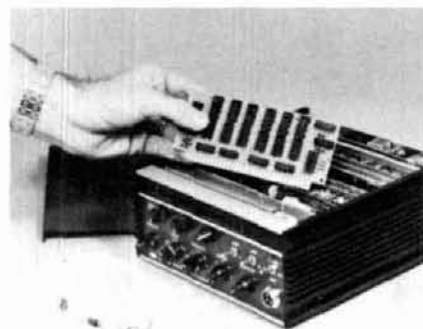

You can diode-program up to four fixed channels, with their offsets, for each band. This feature allows super-quick selection of favorite channels. The five-kHz synthe-

sizer operates independently of these programmed channels. And best of all, soldering is not necessary for programming. The program board has special sockets mounted on it for direct insertion of diodes. We even provide the diodes.

Remote Trunk Mount Kit

The control panel of every UV-3 removes for installation in the UMK-3 Remote Kit. This provides for safety, as well as easy installation in small cars where under-dash space is limited.

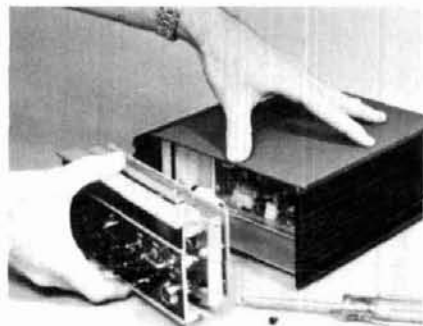

Write for a fully illustrated brochure on the Drake UV-3 System.

R. L. DRAKE COMPANY



540 Richard St., Miamisburg, Ohio 45342
Phone: (513) 866-2421 • Telex: 288-017

Western Sales and Service Center, 2020 Western Street, Las Vegas, Nevada 89102 • 702/382-9470

repair bench

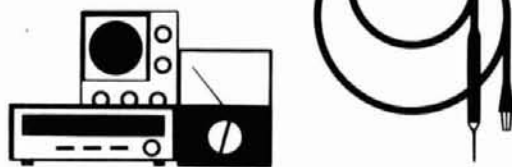

Bob Stein, W6NBI

automatic noise-figure measurements — fact and fancy

One of the major attractions at the regional vhf/uhf conferences is the noise figure measurement session. Everyone with a new converter or preamp, and especially anyone who does not possess or have access to calibrated noise-figure measuring equipment, anxiously awaits the measurement results. The session becomes a contest of sorts, in which you find out how your latest endeavor or purchase compares with the best of show.

Invariably these measurements are made using automatic noise-figure equipment because of the simplicity and speed with which measurements may be accomplished. Given any one test setup, the comparisons among the various units under test may be valid, in that the relative noise figures for each unit can be determined, as can the difference in noise figure between any of the units. But what about a preamp whose measured noise figure was 1.5 dB at the West Coast Conference and another which yielded 1.7 dB at the East Coast Conference? Is this a valid comparison, or going one step further, is either measurement really accurate? The discussion which follows will, I hope, provide these answers.

In addition, this article becomes another in the series devoted to the use and application of available surplus test equipment. Automatic noise-figure meters, such as the Hewlett-Packard models 340A, 340B, and 342A, and the AILTECH* types 74A and 75, are typical of those in general use. Noise sources which are usable from 10 MHz to 5 GHz, and which

may be used with one or more of these instruments, are the Hewlett-Packard models 343A, 345B, and 349A, and the AIL types 7006, 7010, 7011, and 7012. **Tables 1 and 2** list the pertinent specifications for the noise-figure meters and noise sources, respectively.

With the exception of the AIL 75, which is probably too new to show up on the surplus market, all of these noise-figure meters and noise sources are available from time to time. Oftentimes a solid-state noise source also becomes available. If it is one of the AIL series 76, it is compatible with the AIL 75 noise-figure meter; if it is manufactured by another company, it may be adaptable to one of the aforementioned noise-figure meters, but detailed information must be obtained from the manufacturer. However, because of their relative scarcity and the fact that they may not be truly compatible with most of the available noise-figure meters, no coverage can be provided in this article for any solid-state noise source.

As noted in **table 1**, many of the Hewlett-Packard instruments have been special versions which accept one or more input frequencies different from those in the standard models. This should present no problem to the potential user, even if none of the instrument input frequencies corresponds to the output frequency from his converter. Either the converter output can be heterodyned to the noise-figure meter input frequency, as explained later, or the noise-figure meter can be modified. This modification involves nothing more than retuning or replacing coils in the instrument's tuned amplifier, and is described in the appendix.

noise-figure equations

Before we can analyze the operation of automatic

The Hewlett-Packard model 340B Noise Figure Meter can be used with either a gas-discharge noise source or a temperature-limited diode source. Models 340A and 342A are similar in appearance (courtesy Hewlett-Packard Company).



*AILTECH, a Cutler-Hammer Company, was formerly Airborne Instruments Laboratory. Throughout this article, AIL will be used to identify equipment manufactured under either name.

noise-figure meters, it is necessary to understand the mathematical definition of noise figure insofar as it applies to the noise-figure meter. I will skip the basic mathematical derivation, since this has been covered extensively in references 1 through 5. Instead, I will start with a mathematical definition of noise figure and proceed to derive the relationships which permit the automatic noise-figure meter to function.

To eliminate any confusion between noise figure expressed as a numerical ratio and the logarithmic equivalent expressed in dB, I will limit the use of the term *noise figure* (NF) to the logarithmic version and call the numerical ratio *noise factor* (F).

The noise factor of a receiver is defined as the input signal-to-noise power ratio divided by the output signal-to-noise power ratio, and is expressed as

$$F = \frac{S_i/N_i}{S_o/N_o} \quad (1)$$

where S_i is the input signal power, N_i is the noise power at the input, S_o is the output signal power, and N_o is the output noise power.

If a broadband noise source is used at the receiver input

$$S_i/N_i = EN = \frac{T_2 - T_o}{T_o} \quad (2)$$

where

EN = excess noise power (generally expressed in dB, but the equivalent numeric ratio in this case)

T_2 = equivalent absolute temperature of noise source when on, in °K

T_o = °K

If we designate the output power from the receiver when the noise source is off as N_1 , and the receiver

output power when the noise source is on as N_2 , the output signal power, S_o , can be expressed as

$$S_o = N_2 - N_1 \quad (3)$$

and since

$$N_o = N_1 \quad (4)$$

$$S_o/N_o = \frac{N_2 - N_1}{N_1} = \frac{N_2}{N_1} - 1 \quad (5)$$

Rewriting eq. 1 by substituting eqs. 2 and 5, we get

$$F = \frac{\frac{T_2 - T_o}{T_o}}{\frac{N_2}{N_1} - 1} \quad (6)$$

Converting eq. 6 to the equivalent noise figure, where $NF = 10 \log F$,

$$NF = \left[10 \log \frac{T_2 - T_o}{T_o} \right] - \left[10 \log \left(\frac{N_2}{N_1} - 1 \right) \right] \quad (7)$$

Since the first term in eq. 7 is the logarithmic equivalent of eq. 2, it is equal to the excess noise ratio (ENR), in dB, of the noise source. Therefore eq. 7 can be rewritten

$$NF = ENR - 10 \log \left(\frac{N_2}{N_1} - 1 \right) \quad (8)$$

The ratio N_2/N_1 is often designated the Y-factor, so that an equivalent expression for eq. 8 is

$$NF = ENR - 10 \log (Y - 1) \quad (9)$$

Thus we have arrived at an expression for noise figure in which the only variable is Y when a noise

table 1. Automatic noise-figure meter specifications.

model	NF ranges and accuracy	input frequencies (MHz)	bandwidth (MHz)	sensitivity (dBm)	agc range (dB)
Hewlett-Packard 340A, B	0-15 dB: ± 0.5 dB 3-30 dB: ± 0.5 dB from 10-25 dB ± 1.0 dB from 3-10 dB ± 1.0 dB from 25-30 dB	*30, 60	1 (min.)	- 60	50
Hewlett-Packard 342A	Same as 340A, B	*30, 60, 75, 105, 200	1 (min.)	- 60	50
AIL 74A	0-25 dB: ± 0.5 dB 23-36 dB: ± 1.0 dB	**One of the following: 10, tunable 20-60 30 30, tunable 40-180 60	2 6 2 6	- 67 - 73 - 67 - 67	65
AIL 75	0-15 dB: ± 0.15 dB from 0-3 dB ± 0.25 dB from 3-6 dB 3-18 dB: ± 0.15 dB from 3-6 dB ± 0.25 dB from 6-9 dB 6-21 dB: ± 0.15 dB from 6-9 dB ± 0.25 dB from 9-12 dB 12-27 dB: ± 0.5 dB from 12-18 dB 18-33 dB: ± 1.0 dB	30 (other options available)	5 (min.)	- 73	65

*Standard input frequencies are listed; many special models were manufactured with one or more different input frequencies.

**Depends on i-f amplifier installed in noise-figure meter.

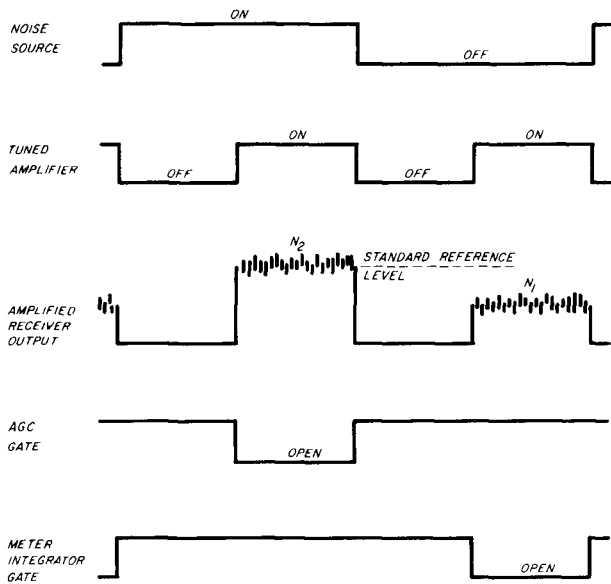

fig. 2. Operational effect of the switching circuit in the automatic noise-figure meter.

source of known ENR is used. Furthermore, since Y is the ratio of N_2/N_1 , we need only measure this ratio, without regard to absolute power levels, in order to obtain the receiver noise figure.

automatic noise-figure meters

Now that we have a simplified noise-figure equation, let us investigate the actual method by which noise figure is measured automatically. Fig. 1 shows a simplified block diagram of a typical Hewlett-Packard noise-figure meter. The external noise source and receiver under test are included in the diagram so as to close the loop.

The noise source, powered by the noise-figure meter, is connected to the antenna input of the receiver under test, and the i-f output from the receiver is connected to the input of the noise-figure meter. A switching circuit in the noise-figure meter gates the tuned amplifier, meter integrator, agc, and

noise source (via its power supply) on and off at a low audio-frequency rate. As shown in fig. 2, the noise source is gated on and approximately one-quarter cycle thereafter the tuned amplifier is gated on and the agc gate is opened. During this "on" time the receiver output, N_2 , consists of the amplified power from the noise source plus the amplified receiver noise. This is used to establish a standard reference level through agc action.

After the noise source is gated off, the amplifier is again gated on, as is the meter integrator. During this time the receiver output, N_1 , consists only of the amplified receiver and input termination noise, which is detected and integrated, and applied to the meter. Since the noise-source ENR is known, and N_2 is always amplified to a standard reference level, the only variable in eq. 8 is the metered value of N_1 . The meter can therefore be calibrated to display noise figure directly, as a function of N_1 .

The tuned amplifier is gated on for only one-half of the noise-source on and off periods in order to be certain that the output from the noise source has reached its maximum level or has fallen to its quiescent level.

The AIL noise-figure meters function in a similar manner, although there are differences in the actual circuits used to achieve the resulting indication.

noise sources

Although both coaxial and waveguide noise sources are available for use with automatic noise-figure meters, this discussion will be limited to the coaxial types, since waveguides presently have limited amateur use.

The Hewlett-Packard model 343A VHF Noise Source provides a wideband noise spectrum from 10 to 600 MHz and has a source impedance of 50 ohms. It generates an excess noise ratio of 5.2 to 6.6 dB, depending on the measurement frequency, at its specified current of 3.31 mA; refer to table 2. The noise source employs a special temperature-limited

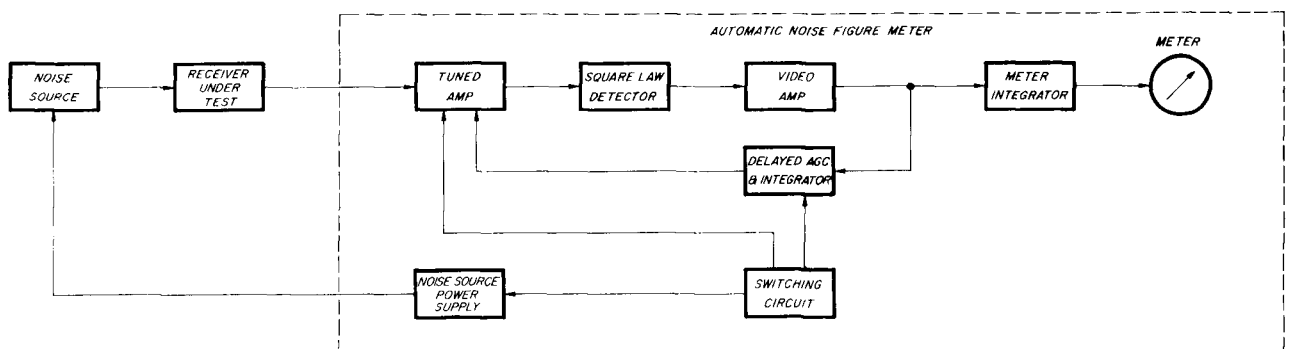

fig. 1. Simplified block diagram of the Hewlett-Packard model 340A or 340B Noise Figure Meter.

vacuum-tube diode (similar to the Sylvania 5722) whose plate and filament voltages are supplied by the Hewlett-Packard 340A, 340B, or 342A noise-figure meter. The noise output of a saturated temperature-limited diode is a function of plate current, which is set to an established value by means of a control on the noise-figure meter.

The Hewlett-Packard model 345B IF Noise Source produces an excess noise ratio of 5.2 dB from any one of four switch-selected source impedances: 50, 100, 200, or 400 ohms. Since tuned circuits within the noise source limit its spectrum to either 30 or 60 MHz, also switch-selected, it has limited amateur application and can be dismissed without further discussion.

Also usable with any of the Hewlett-Packard noise-figure meters are several 5722 noise generators whose construction has been described in references 6 through 8. It should be noted that most, if not all, of these homebrew noise sources suffer from impedance mismatch problems when used above 400 MHz. However, it is possible to build a noise source which compares favorably with the Hewlett-Packard 343A to at least 450 MHz; its construction will be described in a future article.

For receiver frequencies above 450 MHz, a noise source using a gas-discharge tube is generally used. Coaxial noise sources of this type may also be used at frequencies as low as 200 MHz. The Hewlett-Packard model 349A UHF Noise Source and the AIL Type 7010, 7011, and 7012 Coaxial Noise Generators all employ an argon-filled gas-discharge tube coaxially mounted in a helical transmission line. These noise



The Hewlett-Packard model 343A VHF Noise Source utilizes a temperature-limited diode, and can be used from 10 to 600 MHz (courtesy Hewlett-Packard Company).

sources produce excess noise ratios of 15.2 to 15.7 dB over their specified frequency ranges, as shown in table 2.

A simplified diagram of a coaxial gas-discharge tube noise generator is shown in fig. 3. The tube is alternately turned on and off by the switched power supply in the noise-figure meter. When a high-voltage pulse is applied between the anode and cathode of the tube, the argon gas ionizes and noise is generated. The noise is coupled into the helix and appears at the two coaxial connectors. One connector is used

table 2. Coaxial noise-source specifications.

model	frequency range (MHz)	excess noise ratio (dB)	operating current (mA)	output vswr
Hewlett-Packard 343A	10-600	5.2 ± 0.2 from 10-30 MHz 5.5 ± 0.25 at 100 MHz 5.8 ± 0.3 at 200 MHz 6.05 ± 0.3 at 300 MHz 6.3 ± 0.3 at 400 MHz 6.5 ± 0.5 at 500 MHz 6.6 ± 0.5 at 600 MHz	3.31	10-400 MHz: 1.2 max. 400-600 MHz: 1.3 max.
Hewlett-Packard 345B	30 or 60, switch selected	5.2	0.41 to 3.31	50, 100, 200 or 400 ohm (± 4%) source impedance, switch selected
Hewlett-Packard 349A	400-4000 (usable to 200)	14.6 ± 0.6 at 220 MHz 15.6 ± 0.6 from 400-1000 MHz 15.7 ± 0.5 from 1-4 GHz	150	200-2600 MHz: 1.35 max. fired 1.5 max. unfired 2.6-3.0 GHz: 1.5 max. fired 1.5 max. unfired 3.0-4.0 GHz: 2.0 max. fired 3.0 max. unfired
AIL 7006	10-250	15.2 ± 0.5	33.1	1.2 max.
AIL 7010, 7011	200-2600	15.2 ± 0.3	175	1.15 (nominal) fired 1.3 (nominal) unfired
AIL 7012	2-5 GHz	15.5 ± 0.2	175	1.5 (nominal) fired 2.0 (nominal) unfired

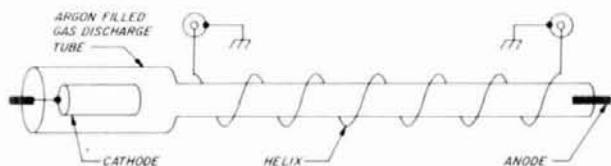

fig. 3. Simplified diagram of a gas-discharge tube noise source. One connector is used for the noise output; the other must be terminated by a precision 50-ohm load.

for the noise output, while the other must be terminated by a precision 50-ohm load.

connecting the noise source to the noise-figure meter

Obviously each manufacturer supplies noise sources which are compatible with his own noise-figure meters. There is nothing, however, other than the problem of physically interconnecting the source and noise-figure meter, which precludes using one manufacturer's gas-discharge source with another's noise-figure meter.

The same interchangeability is not true for diode noise sources. The AIL type 7006 noise diode can be used only with the AIL 74A noise-figure meter, and the Hewlett-Packard diode noise sources can only be used with the Hewlett-Packard noise-figure meters. But, as previously mentioned, there are several 5722 noise generators which can also be used with the Hewlett-Packard noise-figure meters.

All of the Hewlett-Packard noise-figure meters discussed in this article originally included an interconnecting cable for that manufacturer's gas-discharge noise sources. Unfortunately, the cable is invariably missing when the instrument reaches your local surplus emporium. On the other hand, the interconnections are rather simple, so that with the information which follows, you should be able to solve all of your interface problems.

To connect the Hewlett-Packard 349A coaxial (or any of the Hewlett-Packard 347-series waveguide) gas-discharge noise source to any Hewlett-Packard noise-figure meter, a 6-foot (1.8-meter) type 340-16A cable was originally furnished. You can buy a re-

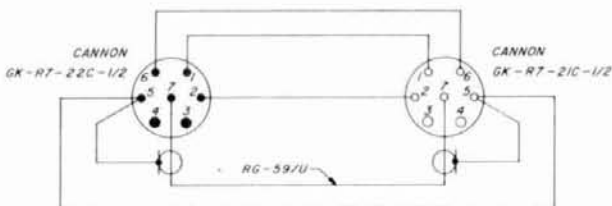
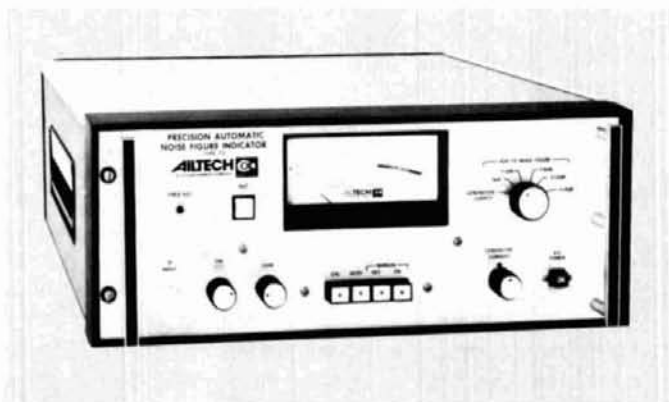

fig. 4. Interconnecting cable for use between a Hewlett-Packard 349A or 347-series noise source and a Hewlett-Packard 340A, 340B, or 342A noise-figure meter. The cable length should be limited to about 2 meters (6 feet).

placement directly from Hewlett-Packard, but the price was \$100 the last time I checked. A good alternative is to make your own cable, as shown in fig. 4.

If you want to connect a Hewlett-Packard gas-discharge source to either the AIL 74A or 75 noise-figure meter, it will be necessary to modify the captive cables on the AIL instrument, as follows.*

1. Cut the high- and low-voltage cables at a point at least 20 inches (51 cm) back from the connector ends.



The AILTECH type 75 Precision Automatic Noise Figure Indicator is the latest and most versatile instrument of its kind on the market. It can be supplied for use with both gas-discharge and solid-state noise sources, or for use with the latter type only (courtesy AILTECH).

2. Wire the cables from the noise-figure meter as shown in fig. 5A.
3. Wire the cable ends with the connectors attached as shown in fig. 5B.

The instrument cables, now terminated in a single multipin connector, will plug into the connector on the Hewlett-Packard noise source. An AIL noise source can still be used by connecting the multipin connector on the instrument cables to the mating connector on the now separate cable assembly shown in fig. 5B, thereby restoring the original configuration.

Fig. 6 shows the cabling needed to connect an AIL 7010, 7011, or 7012 noise source to any of the Hewlett-Packard noise-figure meters. The high-voltage connector required to mate with the anode connector on the AIL 7010 or 7012 is not available except as a part of the AIL 7003 cable set. Therefore it must be fabricated by using brass tubing of the appropriate size and suitable high-voltage insulating material

*Taken from AIL Application Engineering Bulletin 70-15, dated August, 1961.

(teflon, polystyrene, etc.) between the inner high-voltage and outer ground conductors. **WARNING:** the anode lead and connector must be insulated for up to 5 kV; USE EXTREME CARE.

The Hewlett-Packard 343A and 345B noise sources each have a captive cable and connector to mate with the Hewlett-Packard 340B and 342A noise-figure meters. If you intend to use any of the previously referenced 5722 noise generators, the appropriate connector wiring is shown in **fig. 7**. The 5722 filament draws between 1.5 and 2 amperes, so

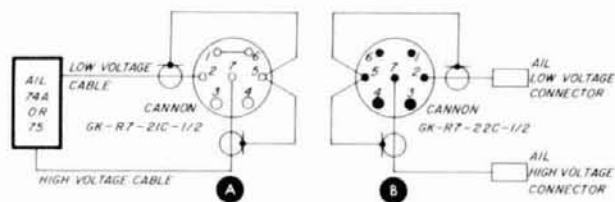

fig. 5. Modification of the AIL 74A or 75 noise-source cables which will permit use of Hewlett-Packard 349A or 347-series noise sources. (After AIL Application Bulletin 70-15, August 1961).

the connector on the instrument. The filament connections on the old 3-pin connector are pins 1 and 2; pin 3 connects to ground.

The Hewlett-Packard 343A noise source can only be used with the 340A if the 5-pin connector has been installed. Before trying to use it, however, check the internal wiring to the connector to be sure that there is a connection to pin 4. If there is no wire on pin 4, run one from that pin to the black center-tap lead of transformer T101. (The transformer may be identified by tracing the leads from pins 1 and 2 of the connector, which are wired to the green and yellow leads, respectively, of T101.)

measurement techniques

We can now discuss the procedures and techniques of measuring noise figure with an automatic noise-figure meter. Because the actual operating procedures vary, depending on the instrument being used, no attempt will be made to describe the detailed operational steps. These appear in the instruction manual for the specific instrument, available from the manufacturer at nominal cost. In general, operation of the noise-figure meter consists of the following steps:

1. Connecting the receiver under test as shown in **fig. 8**. For the purposes of this discussion, the term "receiver" means any receiver or portion thereof (such as a converter, mixer, etc.) which provides an output signal at the input frequency of the noise-figure meter.

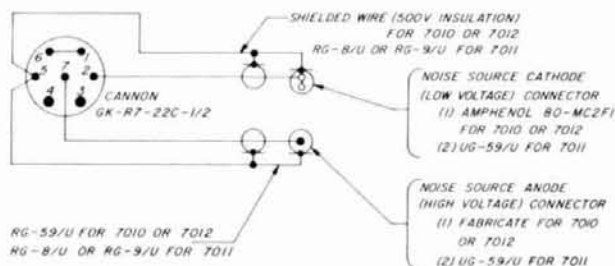
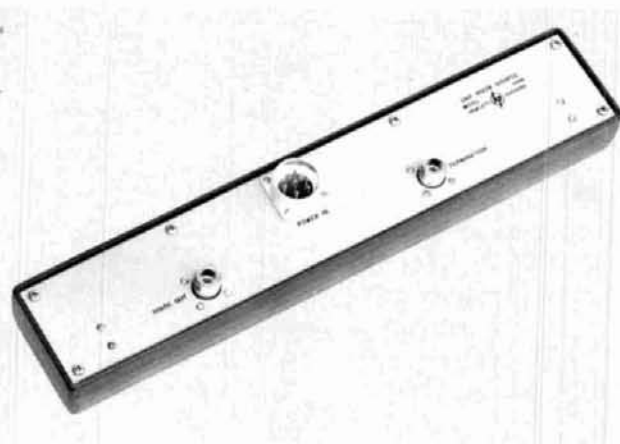

fig. 6. Interconnecting cable for use between an AIL 7010, 7011, or 7012 noise source and a Hewlett-Packard 340A, 340B, or 342A noise-figure meter.



The Hewlett-Packard model 349A UHF Noise Source is a gas-discharge type using an argon-filled tube. Its usable range is 200 MHz to 4 GHz (courtesy Hewlett-Packard Company).

be sure to use wire that is large enough to minimize the voltage drop between the tube and the noise-figure meter.

Connecting any of the commercial or homebuilt diode noise sources to the Hewlett-Packard 340A noise-figure meter requires somewhat more discussion. The *diode* panel connector on the 340A was originally a 3-pin connector, rather than the 5-pin Cannon WK-5-31S connector used on the later 340B and 342A models. (It was intended to mate with the long obsolete 345A noise source.) However, Hewlett-Packard Service Note 340A-1A* described how to replace the old 3-pin connector with the later 5-pin connector, and virtually everyone who had a 340A made the change. In fact, I have never seen an instrument with the old connector still in place.

If a new connector has been installed and you are going to use a homebuilt 5722-type noise source, the wiring information in **fig. 7** applies. If the old connector is still on the instrument, you will have to be lucky enough to find a mating connector or else change

* Available from Hewlett-Packard Company, 1820 Embarcadero Road, Palo Alto, California 94303.

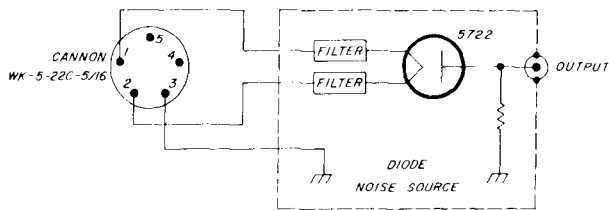

fig. 7. Wiring a homebuilt 5722-tube noise source to permit its use with a Hewlett-Packard 340B or 342A noise-figure meter. See the text for additional information applicable to the Hewlett-Packard 340A.

2. Energizing the noise-figure meter and establishing the fixed agc reference level.
3. Setting the noise-source operating current.
4. Calibrating the noise-figure meter to the noise-source ENR. (This step is not applicable to Hewlett-Packard noise-figure meters.)
5. Reading the receiver noise figure on the meter, and correcting for noise-source characteristics and/or loss-pad attenuation.

Although this generalized procedure sounds almost too simple to be true, it is just about as easy in practice. Any adjustments on the receiver can be made while it is under test by merely tuning for the best noise figure. Compare that to measuring noise figure by the manual twice-power method!

Let us now examine fig. 8 block by block. Most important, there should be a direct connection between the noise-source output connector and the loss pad, and between the pad and the receiver. This means *no cables*, and a minimum of adapters.

The use of a loss pad between the noise source and the receiver is an absolute necessity when using a gas-discharge source, and is highly recommended for diode noise sources. One of the disadvantages of gas-discharge noise sources is that they require a high-voltage ionizing pulse, typically several kilovolts. Because of capacitive coupling between the tube and the helix, this pulse appears as a spike in the noise output. Although the pulse is attenuated, the amplitude of the spike may still be several volts, which may be enough to destroy your expensive low-noise transistor. Therefore, a 6- to 10-dB pad must always be used with a solid-state receiver to attenuate the spike. Even with a 10-dB pad, there may be sufficient spike voltage to destroy certain GaAs fets. A solid-state noise source should be used to check devices of this type.

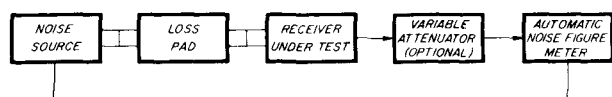

fig. 8. Measuring noise figure with the automatic noise-figure meter. The use of the loss pad and variable attenuator are discussed in the text.

ate the spike. Even with a 10-dB pad, there may be sufficient spike voltage to destroy certain GaAs fets. A solid-state noise source should be used to check devices of this type.

The use of a loss pad with a diode noise source is not absolutely essential, but can minimize several problems. First of all, most receivers (remember the general use of this term) do not present a 50-ohm input when optimized for a noise match. Because the rated ENR of a noise source is based on a 50-ohm load, there will be an indeterminate mismatch loss if the receiver vswr is greater than 1.0:1. A 3- to 6-dB pad will not eliminate the mismatch loss, but may reduce it somewhat.

A second reason for using a loss pad is to ensure a 50-ohm source impedance for the receiver, since the vswr of the noise source also is not a perfect 1.0:1.

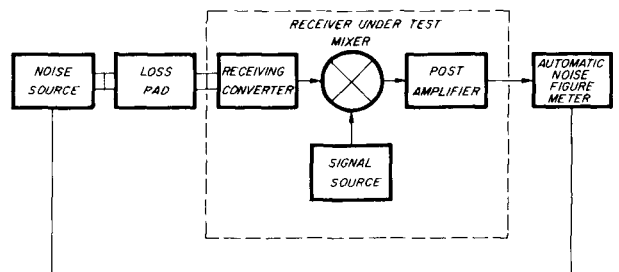

fig. 9. Using an external mixer and signal source to convert the receiver output frequency to that of the noise-figure meter input. The "receiver under test" corresponds to the equivalent block in fig. 8.

Any tendency of the receiver to "take off" when looking into an impedance of other than 50 ohms will be reduced by use of a pad.

Both of these reasons apply equally to gas-discharge noise sources, but are automatically realized by the absolute necessity of using a loss pad to protect the receiver. In either case, the attenuation of the pad must be known to a fair degree of accuracy; remember that the loss, in dB, must be subtracted from the reading obtained on the noise-figure meter, since any loss ahead of a receiver adds algebraically to the receiver noise figure.

In addition to providing an output at a frequency which is compatible with the noise-figure meter, the receiver must also provide enough gain to amplify the noise input to a level which exceeds the sensitivity of the noise-figure meter. However, the difference in the receiver output levels with the noise source on and off must not exceed the agc range of the instrument and overload it. This means that the output from the receiver, when the noise source is off, should be only slightly above the sensitivity level of the noise-figure meter. This can be determined by

the use of the variable attenuator shown in **fig. 8**. The amount of attenuation which is introduced should be 6 to 10 dB less than the value which causes the receiver output to fall below the threshold required to establish the reference level.

Conversely, if the receiver has insufficient gain, it will not be possible to establish a signal reference level in the noise-figure meter. In that case, a post-amplifier must be substituted for the variable attenuator to provide sufficient overall gain.

receiver configuration

Thus far we have imposed two conditions which the receiver must satisfy — its gain must be compatible with the sensitivity requirement and agc range of the noise-figure meter, and its output frequency must match that of the noise-figure meter input. We

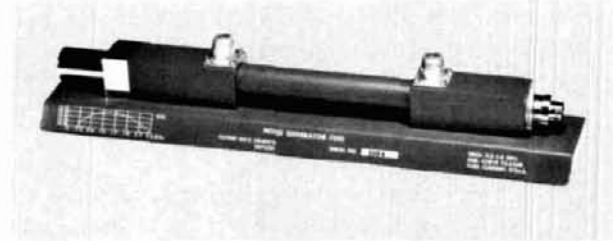

The AILTECH type 7010 Noise Generator covers the range from 200 MHz to 2.6 GHz. The similar appearing type 7012 is used between 2 and 5 GHz. Both noise sources utilize gas-discharge tubes (courtesy AILTECH).

have already discussed the first of these, and can proceed to the second.

The typical vhf or uhf receiving converter provides an output which is applied to a communications receiver used as a tunable *i-f* amplifier, detector, and audio amplifier. This output can fall anywhere in the entire hf, vhf, or even uhf spectrum. On the other hand, the input to the noise-figure meter must be at a specific frequency which may not correspond to the output from the converter. The combination of a 30-MHz amplifier in most of the noise-figure meters and most receiving converters with a nominal 28-MHz output has sufficient bandwidth to permit meaningful measurements.

For other converter output frequencies which do not correspond to the noise-figure meter input, an external mixer and signal source can be used to convert the output frequency of the receiving converter to the input frequency of the noise-figure meter. **Fig. 9** shows the connections for such a frequency conversion. Any type of mixer can be used, although a

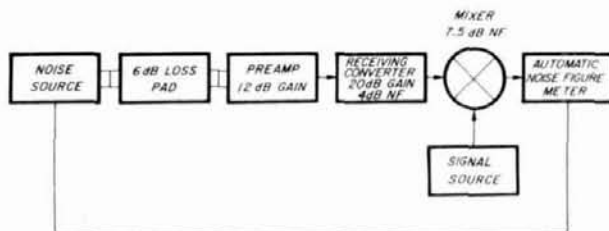

fig. 10. Test setup to determine receiving system and preamplifier noise figures, using a receiving converter following the preamplifier.

packaged double-balanced mixer with coaxial connectors will prove to be the most convenient and versatile. These are available commercially;* a less expensive mixer can be packaged as described by Paul Shuch.¹⁰

The signal source functions as a local oscillator for the mixer, and may be anything which generates a relatively stable unmodulated output, such as a signal generator or vfo. The sum of the converter and signal-source frequencies, or the difference between them, must result in the input frequency required by the noise-figure meter. It makes no difference whether the sum or difference frequency is used; however, the signal source must not be set to a frequency which is close to or is a subharmonic of the noise-figure input frequency.

For example, if the receiving converter output is 14 MHz and the noise-figure meter input is 30 MHz, a signal-source frequency of either 16 or 44 MHz would provide the proper output frequency from the mixer. In this case, the 16-MHz choice should be avoided because its second harmonic at 32 MHz may appear at the mixer output and fall within the passband of the noise-figure meter. This, of course, will render any measurements meaningless, since the noise-figure meter cannot distinguish between the receiver signal and the spurious mixer output.

If a signal generator is used as the signal source, it can function indirectly as the variable attenuator shown in **fig. 8**. Varying the signal-generator output will vary the conversion loss of the mixer and permit

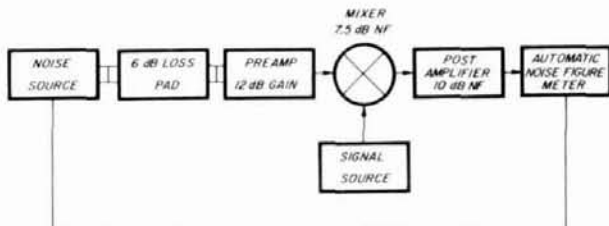

fig. 11. Test setup to determine receiving system and preamplifier noise figures, using a mixer following the preamplifier. In this case, a poor post-amplifier contributes significantly to the overall noise figure.

*Available from Mini-Circuits Laboratory, Merrimac Industries, Anzac Electronics, Hewlett-Packard, Cimmarron, and others.

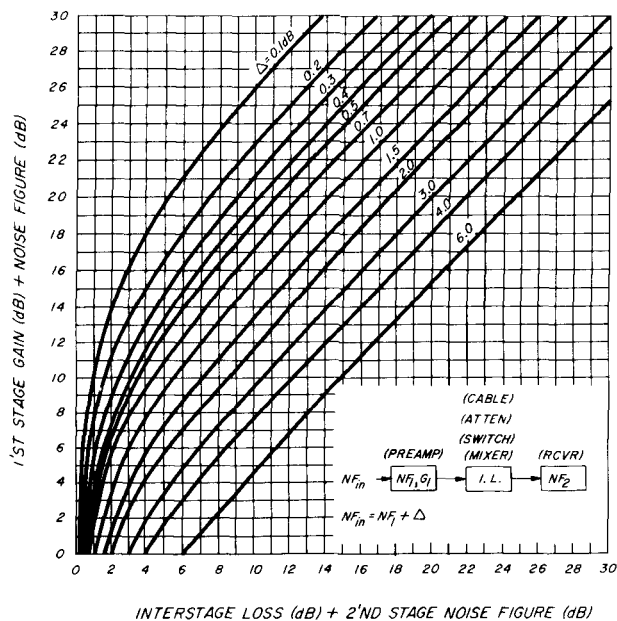

fig. 12. The system noise figure (NF_{IN}) can be found from these curves when the first- and second-stage noise figures, first-stage gain, and interstage losses are known (courtesy Daico Industries, Inc.).

control of the mixer output level. A post-amplifier has been shown in fig. 9 because the receiving converter gain, less the mixer conversion loss, will generally be insufficient to provide the necessary signal level into the noise-figure meter. This post-amplifier can be any type, such as a surplus i-f strip or a broadband amplifier, which will amplify the desired mixer output frequency. The mixer image frequency will be rejected by the tuned amplifier in the noise-figure meter.

The configuration shown in fig. 9 will result in valid noise figures only if the gain of the receiving converter is 20 dB or more. If the converter gain is less than 20 dB, the indicated noise figure will be worse than the actual noise figure because of the noise contribution of the external mixer. The actual noise figure must then be calculated, as explained later.

preamplifiers

In order to measure the noise figure of a preamplifier, the test setup of either fig. 8 or fig. 9 is used, with the preamp inserted between the loss pad and the receiver. To prevent any possible instability of either the preamp or the converter, in the event that either is not unconditionally stable, it is wise to use an additional loss pad between the preamp and the converter, directly at the converter input. This pad should provide about 3 dB loss; the exact value is not critical nor need it be known accurately. Its effect will be incorporated into the measured noise figure of the

receiver (without the preamp), since this measurement is necessary to calculate the true noise figure of the preamp, as explained in the following section. If only an overall system noise figure is of interest, then the second loss pad should not be used.

A major consideration in the measurement of preamp noise figure is that of image response and the effect of filters on that response. It is mentioned here as a preliminary precaution only, and will be covered in detail under the heading *image response error*.

cascaded stages

The overall noise figure of any receiver depends primarily on the noise figure of the first stage. However, the noise generated by succeeding stages will contribute to the overall noise figure and, if the gain of the first stage is not over 20 dB or so, have a significant effect. Since low-noise preamps seldom have gains in excess of 15 dB, taking the noise contribution of the following stages into account is of major importance in determining the preamp noise figure.

The general equation for the noise factor of networks in cascade is

$$F_s = F_1 + \frac{F_2 - 1}{G_1} + \frac{F_3 - 1}{G_1 G_2} + \dots \quad (10)$$

where

F_s = system noise figure

F_1, F_2, F_3 = noise factor of first, second, third stages

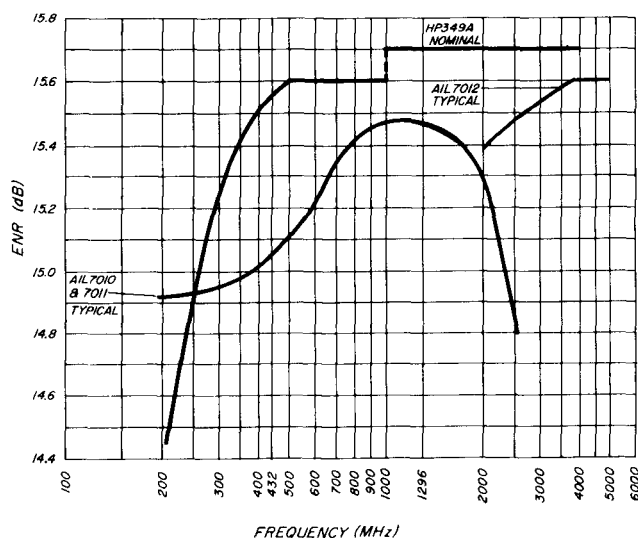

fig. 13. Excess noise ratios for Hewlett-Packard and AIL coaxial noise sources which utilize gas-discharge tubes. The curve for the Hewlett-Packard 349A is subject to the ENR tolerances listed in table 2; those for the AIL noise sources are typical and take into account the gas-tube-variations and hot-cold insertion losses.

G_1, G_2 = power-gain ratio of first, second stages

The system noise figure, NF_s , is derived from the expression

$$NF_s = 10 \log F_s \quad (11)$$

It can be seen from eq. 10 that the numerical value of the second and succeeding terms is a function of the first-stage gain; the higher the gain, the lower will be the values of those terms. If all stages are active amplifiers, only the second-stage noise will be of importance, and only the first two terms of eq. 10 need be used in the calculation. However, if any of the early stages in the receiver has a gain of 1 or less (e.g., mixers and loss pads), three or even four terms of the equation may have to be taken into account.

As an example, refer to the test setup shown in fig. 10. Assume that the preamp gain (A_1) and the converter gain (A_2) have been measured at 12 dB and 20 dB respectively; the measured converter noise figure (NF_2) is 4 dB; and the measured mixer noise figure (NF_3) is 7.5 dB. The system noise figure indicated on the noise-figure meter is 8.65 dB. What is the preamp noise figure (NF_1)?

First, we must subtract 6 dB from the noise-figure meter reading, since that is the increase in noise figure caused by the 6-dB pad. Therefore the actual system noise figure (NF_s) is 2.65 dB. Second, we must convert the noise figures and gains (in dB) to noise factors and numerical gain ratios, as follows:

$$F_s = \text{antilog} \frac{NF_s}{10} = \text{antilog} \frac{2.65}{10} = 1.841$$

$$F_2 = \text{antilog} \frac{NF_2}{10} = \text{antilog} \frac{4}{10} = 2.512$$

$$F_3 = \text{antilog} \frac{NF_3}{10} = \text{antilog} \frac{7.5}{10} = 5.623$$

$$G_1 = \text{antilog} \frac{A_1}{10} = \text{antilog} \frac{12}{10} = 15.849$$

$$G_2 = \text{antilog} \frac{A_2}{10} = \text{antilog} \frac{20}{10} = 100$$

By rearranging eqs. 10 and 11, and substituting the above values,

$$\begin{aligned} NF_1 &= 10 \log \left(F_s - \frac{F_2 - 1}{G_1} - \frac{F_3 - 1}{G_1 G_2} \right) \\ &= 10 \log \left(1.841 - \frac{2.512 - 1}{15.849} - \frac{5.623 - 1}{15.849 \times 100} \right) \\ &= 10 \log (1.841 - .095 - .003) \\ &= 10 \log 1.743 = 2.41 \text{ dB} \end{aligned} \quad (12)$$

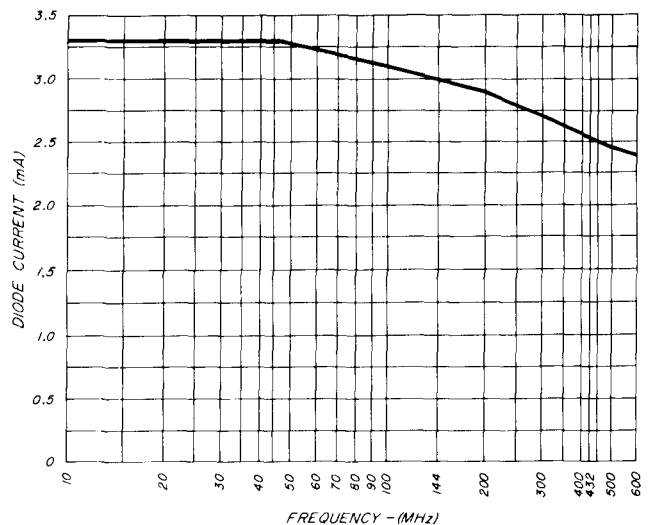

fig. 14. Diode current required by the Hewlett-Packard 343A VHF Noise Source to maintain a nominally constant 5.2-dB excess noise ratio (curve by J. R. Reisert, W1JR).

It can be seen from inspection of the above example that the third term is insignificant and can be ignored. However, suppose that the configuration shown in fig. 11 is being used to check out the same preamp, using the same mixer and a post-amplifier with a measured noise figure of 10 dB. Now the mixer is the second stage, so that $F_2 = 5.623$. Since, in a stage having a gain of less than 1, the noise figure is equal to the loss, the converse must be true. Therefore, the mixer loss ratio is also 5.623, making the gain (G_2) the reciprocal of 5.623, or 0.178. The post-amp noise figure of 10 dB results in F_3 being equal to 10 (the antilog of 10 divided by 10). In this case, the receiver noise figure reading on the noise-figure meter is 13.2 dB. Subtracting 6 dB for the loss pad, we obtain an actual noise figure (NF_s) of 7.2 dB, or a noise factor (F_s) of 5.248.

Again substituting the measured noise factors and gain ratios in eq. 12, we arrive at the following:

$$\begin{aligned} NF_1 &= 10 \log \left(5.248 - \frac{5.623 - 1}{15.849} - \frac{10 - 1}{15.849 \times .178} \right) \\ &= 10 \log (5.248 - .292 - 3.190) \\ &= 10 \log 1.766 = 2.47 \text{ dB} \end{aligned}$$

This is approximately the same noise figure as was calculated in the previous example, taking into account rounded-off numbers. Note that in this case the third term of the equation contributes significantly to the overall system noise figure, which leads to the conclusion that a low-noise post-amplifier should always follow a mixer when there is only one stage of amplification ahead of the mixer. If the post-amplifier noise figure were reduced to 1.0 dB, the system

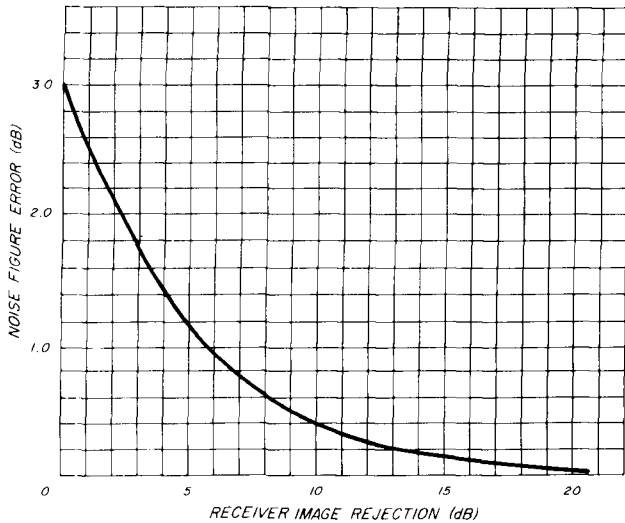

fig. 15. Noise-figure error as a function of receiver image rejection.

noise figure would improve from 7.2 to 3.3 dB. To paraphrase many textbooks, the calculation of this improvement is left as an exercise to the reader.

An interesting graphical representation of the relationships expressed in eq. 12 is shown in fig. 12. If the various stage noise figures, gains, and losses are known in dB, the difference between the system and first-stage noise figures can be read as Δ , directly from the curves, which is added to the known first-stage noise figure to obtain the system noise figure.

For instance, let's use the same preamp and mixer, and the 1-dB post-amplifier from the preceding example. The first-stage gain plus noise figure is 14.4 dB, and the interstage (mixer) loss plus second-stage (post-amplifier) gain is 8.5 dB. The curves of fig. 12 show that Δ is 0.9 dB at the intersection of these two

values. Thus, the system noise figure is equal to the preamp noise figure plus 0.9 dB, or 3.3 dB.

noise-source ENR corrections

In our discussion of the noise-figure equations which govern the operation of automatic noise-figure meters, we established that the only variable in eq. 8 was the ratio N_2/N_1 , and that the ENR term in that equation was a fixed value determined by the noise source. It follows, therefore, that the noise-figure meter calibration must be based on a known or pre-determined ENR.

In the case of the AIL noise-figure meters, the operating procedures entail calibrating the instrument to the ENR of the noise source. For the AIL 7006 diode noise source used with the AIL 74A noise-figure meter, the ENR is 15.2 ± 0.5 dB when the diode current is set to 33.1 mA. If a gas-discharge noise source is to be used with either the AIL 74A or 75 noise-figure meter, the instrument is calibrated for the ENR of the source at the frequency of measurement. Fig. 13 shows typical values for the AIL noise sources and the nominal ENR for the Hewlett-Packard 349A for frequencies between 200 and 5000 MHz.

The meter scales of the Hewlett-Packard 340A, 340B, and 342A noise-figure meters are based on a fixed ENR of 5.2 dB from a diode noise source and a fixed ENR of 15.2 dB from a gas-discharge noise source. There is no adjustment for other values of ENR; if the noise-source ENR is different from the value upon which the calibration is based, a correction factor must be applied to the noise-figure reading. If the ENR exceeds the noise-figure meter calibration design value, the "excess" ENR must be added to the noise-figure readings. If the ENR is less than the calibration design value, the difference be-

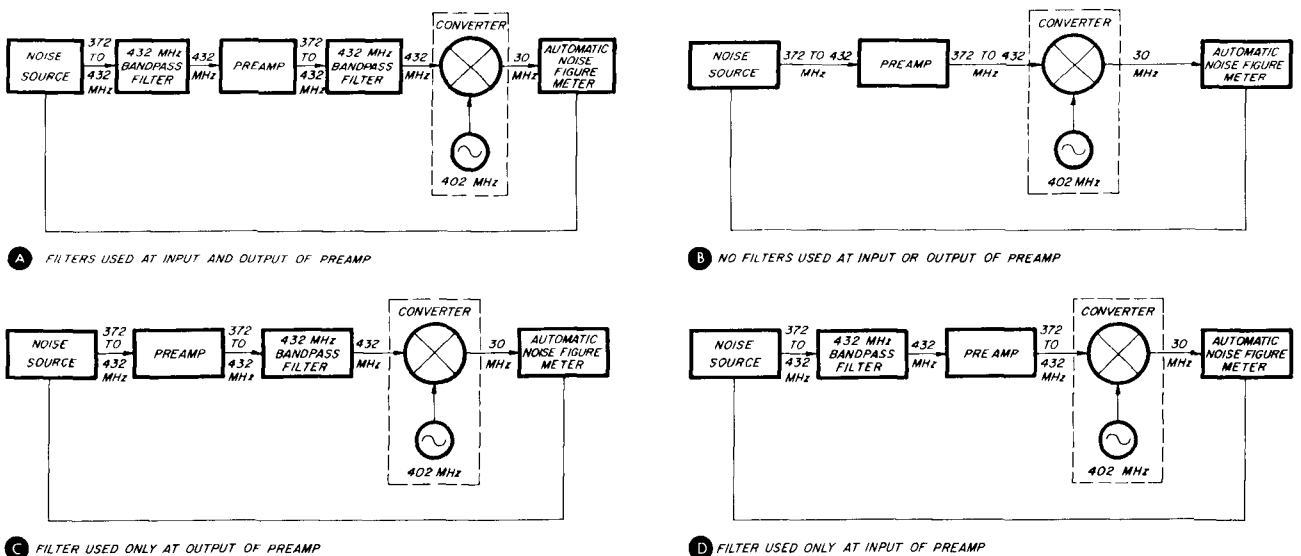

fig. 16. Simplified test setups for noise-figure measurements, using an untuned pre-amp and bandpass filters. The positions of the filters in each test setup are different. All configurations, except that at D, yield valid system noise figures.

tween the two values must be subtracted from the noise-figure readings.

An examination of **table 2** reveals that the only noise sources which match either of the Hewlett-Packard design values are the Hewlett-Packard 343A, only when used below 30 MHz, and the Hewlett-Packard 345B, which has little amateur application. This means that whenever the 343A is used above 30 MHz, the indicated noise figure must be increased by the difference between 5.2 dB and the noise-source ENR at the frequency of use. If the measurements were being made at 400 MHz, for instance, the indicated noise figure would be too low, requiring a corrective addition of 1.1 dB to the meter reading.

Fortunately, in the case of the 343A, there is a simpler method which allows use of the noise-figure meter readings without correction. This involves reducing the diode current from its specified 3.31-mA value to one which maintains a nominally constant 5.2-dB ENR. **Fig. 14** is a plot of the diode current versus frequency, which provides this compensation.

Varying the current in a gas-discharge noise source has little effect on its ENR, typically only 0.005 dB/mA. Therefore, the Hewlett-Packard noise-figure meter readings must be corrected if the noise-source ENR is not 15.2 dB at the frequency of measurement. See **fig. 13** to determine the difference between the ENR and 15.2 dB; remember that the difference is added to the noise-figure readings if the ENR exceeds 15.2 dB, and is subtracted if the ENR is less than 15.2 dB.

If measurements are being made with a Hewlett-Packard noise-figure meter at one or only a few frequencies, as is the usual case for amateur receivers, the need for making corrections to the noise-figure readings can be eliminated by the use of a selected loss pad. The graduations on the two scales of the Hewlett-Packard instrument meters correspond, differing by exactly 10 dB. Therefore, if the noise-source ENR were exactly 15.2 dB, and a precision 10-dB pad were used between it and the receiver under test, the noise figure could be read directly on the meter *diode* scale, which is based on an ENR of 5.2 dB. Since the noise-source ENR is not 15.2 dB, a pad must be selected so that its loss is algebraically equal to the difference between 5.2 dB and the ENR shown in **fig. 13**. Thus for the 349A noise source, the use of a 10.35-dB pad at 432 MHz, or a 9.5-dB pad at 220 MHz, will allow direct readout of noise figure on the *diode* scale of the noise-figure meter.

image-response error

Noise figure, as we have been using the term, is more correctly designated as the single-sideband noise figure. This has nothing to do with ssb as a

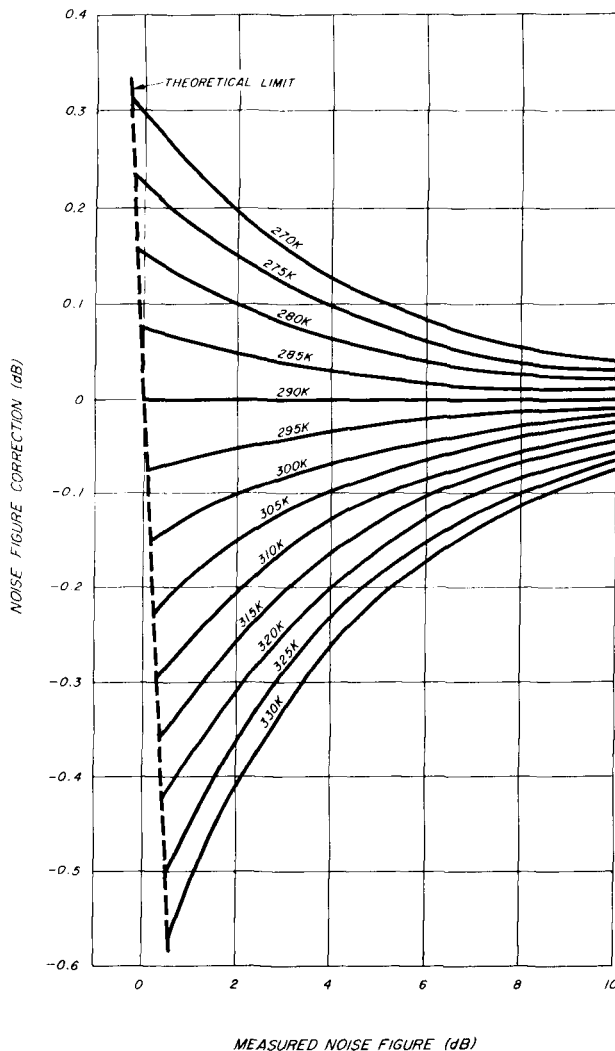

fig. 17. Noise-figure corrections, as a function of termination temperature, for a typical gas-discharge noise source (courtesy AILTECH).

method of modulation; it refers to the fact that any superheterodyne receiver has both a signal and an image sideband (channel), and that we are interested in measuring the noise figure in only a single (the signal) sideband.

The image response of a system consisting of wideband amplifiers followed by a heterodyne receiver (converter) can be an important factor when measuring noise figure. The image-channel signal adds to the signal-channel signal and results in a measured noise figure which is lower than the true noise figure. The noise-figure error is a function of the receiver gain at the signal and image frequencies, as expressed by the following equation:

$$Error_{NF} (dB) = 10 \log \left(1 + \frac{G_i}{G_s} \right) \quad (13)$$

where G_i is the image-channel gain ratio and G_s is the signal-channel gain ratio. It can be seen that, for

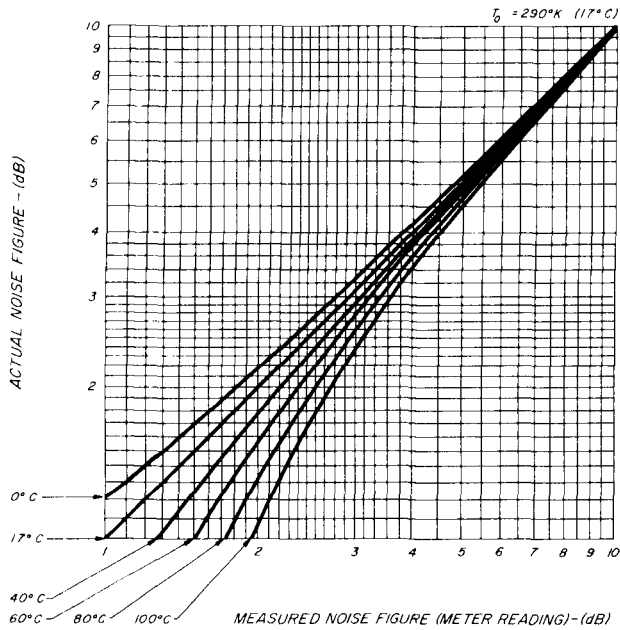

fig. 18. Temperature corrections for the Hewlett-Packard model 343A VHF Noise Source (courtesy Hewlett-Packard Company).

equal signal- and image-channel gains, the error will be equal to $10 \log 2$, or 3 dB.

Fig. 15 is a graphical representation of eq. 13, and shows the amount by which the measured noise figure must be increased. It is apparent that the noise-figure error is negligible if the receiver image rejection is greater than 20 dB. However, the corrections, especially when measuring low noise figures, can be significant at image rejections under 20 dB.

Which brings us back to the measurement of low-noise preamp noise figure. The prevailing concept in the design of low-noise amplifiers is to have untuned input and output circuits, and to rely on a separate high-Q filter ahead of the preamp to discriminate against unwanted signals. This is a valid design concept, but may lead to serious errors in the measurement of noise figure, especially at the aforementioned vhf/uhf conferences.

Fig. 16 illustrates, in simplified form, the four possible configurations of measuring preamp noise figure, using a receiving converter and a noise-figure meter with a 30-MHz input. In the examples shown, measurements are to be made at 432 MHz, and both the noise source and the preamp are assumed to be flat from 372 to 432 MHz. The bandpass filters can be of any type — tuned circuits, cavities, stub tuners, etc. — and may actually be part of the input or output circuits of any of the individual blocks. However, the absence of a filter indicates that it does not exist, either separately or as a part of any circuit; thus, in fig. 16B, the preamp has no filter in either its input or

output circuit, and the converter has no filter at its input. The converter output circuit has no effect on this discussion, and is assumed to be tuned to 30 MHz.

In fig. 16A, bandpass filters at the input and output of the preamp limit the overall system response to 432 MHz. This is the normal communications configuration, and yields valid noise-figure measurements. In fig. 16B, both filters have been eliminated, so that the preamp accepts noise inputs from 372 to 432 MHz and, in addition, contributes its internal noise over the same frequency range. Since the converter produces a 30-MHz output from the noise power at both 372 and 432 MHz equal to $2N_2/2N_1$, the ratio remains the same as from one channel only, resulting in a valid noise figure.

Fig. 16C shows a test configuration in which a filter is used only between the preamp and the converter. It can be seen from the frequencies indicated on that diagram that only the 432-MHz noise signal reaches the converter, so that it too is a valid method of measuring noise figure. (It is equivalent to using an untuned preamp with a normal, tuned-input converter.)

In fig. 16D, the filter position has been changed from the output to the input of the preamp. Notice that in this arrangement the noise input to the preamp is limited to 432 MHz. However, this amplified noise plus the internal noise generated by the preamp at both 372 and 432 MHz are converted to the 30-MHz input of the noise-figure meter. Therefore, the noise-figure reading will be erroneous. The conclusions to be drawn from this discussion are that meaningful noise figures will be obtained if no filters are used, or if a filter is used following the preamp, but in no case should a filter be used ahead of the preamp without an equivalent filter at the output.

temperature error

In the derivation of the noise-figure equations, T_0 is equal, by definition, to 290°K and represents the noise temperature of the noise source when de-energized. It is therefore apparent that if the noise source is at a temperature other than 290°K (17°C or 62.6°F), an error will be introduced. Although such errors are of relatively small magnitude, especially over a limited ambient temperature range, it may be necessary to take them into account when measuring very low noise figures. Fig. 17 shows the noise-figure correction, as a function of measured noise figure and temperature, for a typical gas-discharge noise source. It can be seen that if a noise-figure measurement of 2.0 dB were made in a room where the temperature was 80°F (approximately 27°C or 300°K), a correction of -0.1 dB should be made,

making the corrected noise figure 1.9 dB. Extended use of a gas-discharge noise source also raises the cold temperature, so that the source should be allowed to cool down to room ambient when accurate measurements are required.

The temperature-correction curves for the Hewlett-Packard 343A diode noise source appear in **fig. 18**. Since the diode heat will cause the termination temperature inside the noise-source housing to be somewhat higher than the ambient, this factor should be taken into account when establishing a corrected noise figure.

Noise power obeys all power-transfer laws, but because noise is random in phase, mismatches cause ambiguous errors rather than known power losses. Because an automatic noise-figure meter measures the ratio N_2/N_1 , a mismatch affecting both of these powers has no effect on accuracy, since the ratio remains unchanged.

The major consideration in matching involves the excess noise power available from the noise source. The *ENR* of any of the noise sources discussed in this article, excluding the Hewlett-Packard 345B, is based on developing the noise power in a 50-ohm resistive load. If the load is not 50 ohms, the *ENR* will be indeterminate.

The mismatch error must be calculated for each

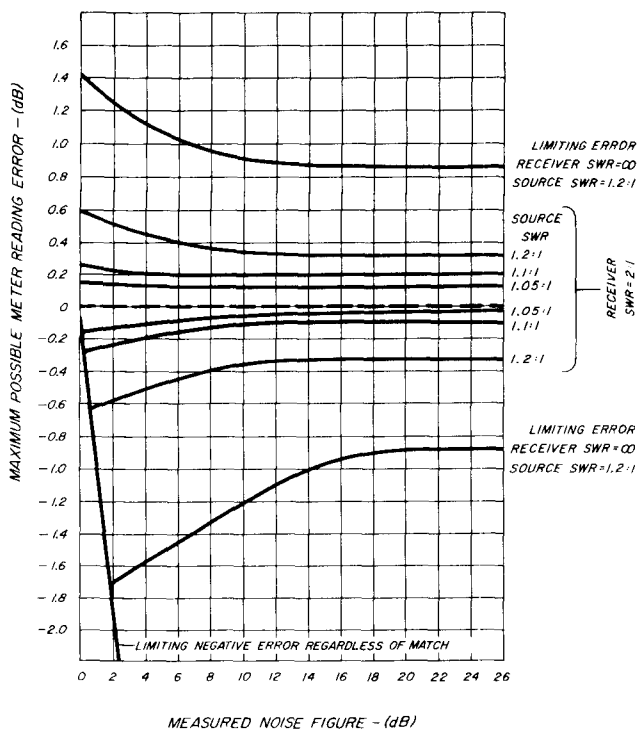

fig. 19. Typical errors for several possible conditions of mismatch between the noise source and receiver (courtesy Hewlett-Packard Company).

system by considering that noise power follows the power-transfer laws. A typical plot of error limits for a receiver swr of 2:1 is shown in **fig. 19**; the actual error can fall anywhere between the limits indicated.

transmission-line (insertion loss) error

This error is a function of the coupling of the gas-discharge tube to the helical transmission line (see **fig. 3**) and the attenuation of the transmission line, and always reduces the noise-source *ENR*. In **fig. 13**, this error has been taken into account in determining the excess noise ratios of the AIL noise sources. It has not been considered in the *ENR* curve for the Hewlett-Packard 349A, but according to the published data, the error is less than 0.25 dB. This is well within the *ENR* tolerances specified in **table 2**.

cumulative errors

If all errors are in decibels, they accumulate additively. Therefore, the total possible measurement error will be the sum of the following:

1. Noise-figure meter accuracy
2. Noise-source accuracy, corrected for frequency
3. Receiver image-response error
4. Temperature error
5. Mismatch error
6. Transmission-line (insertion-loss) error, if a gas-discharge noise source is used.

This is an imposing list, and could total well over 1.5 dB if all errors were of the same algebraic sign. However, many of these errors will cancel because of opposite signs, and generally the accuracy of the test equipment is far better than the limits of its specifications. Nevertheless, these possibilities of error are very real and cannot be ignored except for *comparative* measurements using the same equipment at one particular time. And even then, the mismatch errors between the noise source and the different receivers under test still exist.

summary

We have seen how automatic noise-figure measurements are accomplished, and have discussed their limitations and areas of inaccuracy. We can therefore answer the questions posed at the beginning of this article. A difference of 0.2 dB, or even 0.5 dB, in the noise figures of two different preamps measured at two different times on two different test setups is meaningless. Furthermore, the accuracies of such measurements, especially outside of a labor-

atory environment, are subject to rigorous examination. This is not a criticism of those amateurs who spend many hours at vhf/uhf conferences performing the tests; they know the limitations of their methods and equipment. Rather it is meant to warn those who accept noise figures as gospel that such is not the case.

The same warning applies equally to the "typical noise figure" specifications on some transistor data sheets. Unless an accurately calibrated hot-cold noise source is used to determine the noise figure of the device (and I personally know of cases where this was not done), the published figures may be no more accurate than you or I could obtain with surplus equipment — *caveat emptor*.

The automatic noise-figure meter can also be used to measure noise figure by the twice-power or Y-factor methods. However, since this article was intended to cover only the automatic mode of measurement, no attempt has been made to discuss manual operation. Gain measurements may also be made, in a clever application described by Paul Shuch.¹¹

I sincerely hope that this article has taken some of the mystery out of automatic noise-figure measurements. More important, I hope that it will dispel any idea that you know your receiver or preamp noise figure to within a tenth of a dB.

appendix

To change the input frequency of a Hewlett-Packard noise-figure meter, only the frequency-determining circuits in the instrument's tuned amplifier need be changed to the desired frequency. If the new frequency is relatively close to one already established in the instrument, it may be possible to make the change merely by retuning the variable inductors in the tuned circuits. Otherwise, the coils will have to be modified or replaced.

The Hewlett-Packard models 340A and 340B employ a four-stage tuned amplifier. The front-panel input frequency switch selects one of two coils in each stage of the amplifier. In the standard models, these coils and their inductance ranges are as follows:

input frequency (MHz)	model 340A	model 340B	inductance (μH)
30	L1, L3, L5, L7	L6, L8, L10, L12	1.2 - 1.75
60	L2, L4, L6, L8	L5, L7, L9, L11	0.27 - 0.41

Regardless of whether the standard model, having the above input frequencies, or a special model having different input frequencies, is involved, the coil designations will be the same.

The coils resonate with approximately 20 pF. If the existing coils have sufficient inductance range to permit retuning, the procedure is simple. Set the METER FUNCTION switch to NOISE FIGURE and turn the INF CALIBRATION potentiometer fully clockwise. Then, using a signal generator, feed an unmodulated signal at the new frequency into the input of the noise-figure meter. Keep the signal level low enough so that the meter is never at full scale, and adjust the appropriate coils for maximum meter reading. If the meter reaches full scale, reduce the input signal before continuing the adjustments.

If new coils are required for the desired input frequency, select

four adjustable coils whose mid-range inductance will resonate with 20 pF at the new frequency. Coils in the Miller 4300 series or Cambion 556-3338 series will replace those in the instrument without any mechanical modifications. After replacing the existing coils in the noise-figure meter with the new ones, retune the amplifier as described above. If the new frequency is 30 MHz or lower, a 3300-ohm composition resistor can be connected across each coil to broaden the amplifier response.

The Hewlett-Packard model 342A has provisions for five input frequencies. Instead of switched coils throughout the tuned amplifier, a fixed-tuned 30-MHz i-f amplifier is used in conjunction with a mixer and local oscillator circuit, which heterodynes four of the five input frequencies to 30 MHz. The fifth input frequency is 30 MHz, which is fed through the mixer with the oscillator disabled.

In the standard model 342A, the following coils and frequencies are used in the mixer-oscillator circuit:

input frequency (MHz)	mixer coil	oscillator coil	oscillator frequency (MHz)
30	—	(100-ohm resistor)	—
60	L10 (0.32 - 0.55 μH)	L14 (0.156 - 0.228 μH)	90
70	L9 (0.32 - 0.465 μH)	L13 (0.156 - 0.228 μH)	100
105	L8 (0.156 - 0.228 μH)	L12 (0.32 - 0.465 μH)	75
200	L7 (0.0392 - 0.0412 μH)	L11 (0.057 - 0.063 μH)	170

Special versions of the 342A will have one or more input frequencies which differ from those listed above. Therefore the coil inductances may also be different, but the designations will be the same.

To change any of the input frequencies except the 30-MHz input, either retune the coils associated with the input switch position to be changed, or use new adjustable coils whose mid-range inductance will resonate with 14 pF at the required frequencies. The mixer coil obviously must be tuned to the input frequency. The oscillator coil must be tuned to a frequency which is 30 MHz above or below the input frequency; be sure that the oscillator frequency and its harmonics are well removed from the 30-MHz intermediate frequency.

Set the local oscillator on frequency by means of a frequency counter or a dip oscillator. Then adjust the oscillator and mixer coils (but not the coils in the i-f stages) as previously described for the model 340A or 340B, using a signal generator at the new input frequency.

references

- "An Automatic Noise Figure Meter For Improving Microwave Device Performance," *Hewlett-Packard Journal*, Vol. 9, No. 5, Hewlett-Packard Company, Palo Alto, California, January, 1958.
- "Noise Figure Primer," Application Note 57, Hewlett-Packard Company, Palo Alto, California, January, 1965.
- James R. Fisk, W1DTY, "Receiver Noise Figure, Sensitivity and Dynamic Range — What the Numbers Mean," *ham radio*, October, 1975, page 8.
- Benjamin L. Lowe, K4VOW/WA5UVM, "Hot and Cold Resistors As UHF Noise Sources," *QST*, September, 1976, page 32.
- Charles E. Swedblom, WA6EXV, "Receiver Noise — Theory & Measurement," unpublished.
- Joseph H. Huie, K2PEY, "A VHF Noise Generator," *QST*, February, 1964, page 23.
- Ronald E. Guentzler, W8BBB, "Noise Generators," *QST*, March, 1972, page 44.
- Louis N. Anciaux, WB6NMT, "Accurate Noise-Figure Measurements for VHF," *ham radio*, June, 1972, page 36.
- Hank Olson, W6GXN, and Gene Lehman, WA6JZN, "Noise Generators for 420 Mc. and Up," *QST*, February, 1964, page 33.
- H. Paul Shuch, WA6UAM, "Circuit Packaging for UHF Double-Balanced Mixers," *ham radio*, September, 1977, page 41.
- H. Paul Shuch, N6TX, "Calculating Preamp Gain from Noise-Figure Measurements," *ham radio*, November, 1977, page 30.

ham radio



The parameters of the Palomar PTR-130k are the outer perimeters of logic technology.

Never before has any transceiver approached the capabilities of the Palomar PTR 130k!

It's the first completely multi-functional transceiver ever made available to the public!

The Palomar PTR 130k is a miniaturized mobile transceiver

capable of operating in 100 cycle resolution from 100 KHz to 30 Mhz in all modes of transmission and reception. Instant frequency selection is available with the touch of a finger.

The Palomar PTR 130k.

technology is pure space age . . . the price is strictly down-to-earth. Send for our full color

brochure to:
Palomar Electronics Corporation
665 Opper Street
Escondido, CA 92025
Telephone: (714) 746-2666

PALOMAR ELECTRONICS

TECHNOLOGY AT THE SPEED OF SOUND

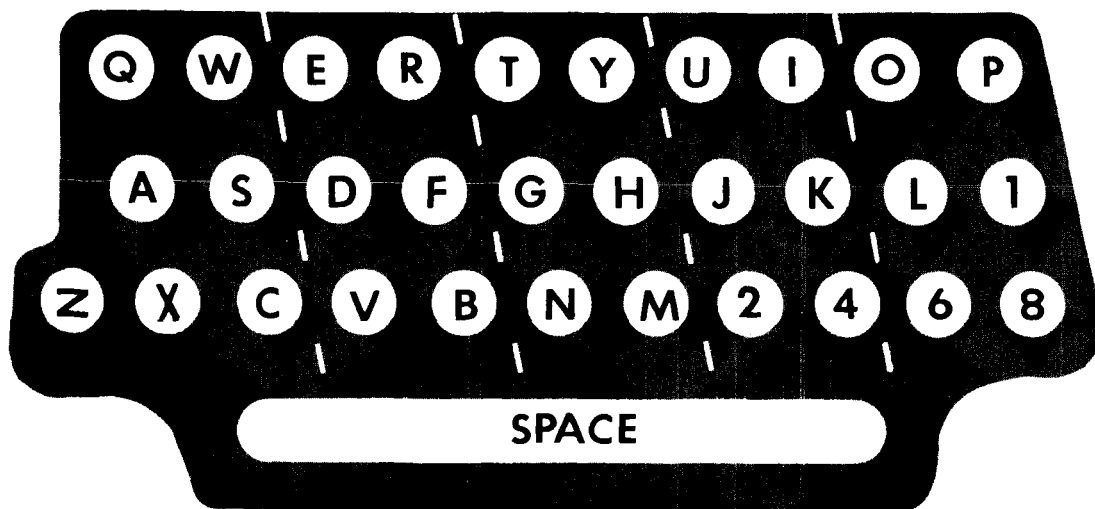

electronic teleprinter keyboard

This novel
electronic keyboard
uses toroids
and a pulse generator
to create the
correct mark/space coding

This project grew out of a desire to design an electronic Teletype keyboard which would permit handicapped people to communicate with others. I took an initial design suggested by Ed Brown, WØEPV, determined that it was feasible, and developed the circuit shown in this article. The keyboard itself would generally have to be custom designed for each particular individual; for amateur use any surplus keyboard with a simple, closing-type contact will be sufficient.

circuit description

The heart of the circuit is a set of eight shift registers, composed of four 7474 ICs (see fig. 1). During static conditions, the \bar{Q} outputs of the shift registers are all high, forcing the 7430 NAND gate low. This low disables the clock, while also enabling the pulse generator. When a particular key is actuated (key line taken low), the pulse generator is discharged through the respective cores. For example, if the Y line went low, the pulse generator would be discharged through cores T1, T3, T5, T6 and T7. The pulse from each core sets its respective shift register, causing the \bar{Q} output to go low. Now that one of the inputs of the 7430 has been driven low, its output will change states, both enabling the clock and disabling the pulse generator.

Prior to the change in the 7430, the magnet driver was held in a mark condition by the action of U2.

By L. A. Stapp, WØPHY, 2903 Ash Street,
Hays, Kansas 67601

With both inputs to U2A now low, U2 pin 8 will go high, forcing the magnet driver into the space condition. Since the clock has now been enabled, it will put out a pulse after 21 ms, moving the contents of the shift register down one increment. Each low state, on the Q₀ line, will create a *mark*, while a high forms a *space*.

With the clock free running, as long as there is a low into U1, the shift register will receive pulses and move the data one increment for each clock pulse. After 8 shift operations, the registers will be clear and their high outputs will cause U1 to change states again, completing the character.

construction

Building this electronic keyboard is extremely straight-forward with the use of TTL circuitry.* Before operation, R5 should be adjusted with U1 pin 8 high, to provide 1.6 volts on pin 6 of the NE555. If

*A copy of the circuit board layout and parts placement diagram is available by sending a self-addressed, stamped envelope to *ham radio*, Greenville, New Hampshire 03048.

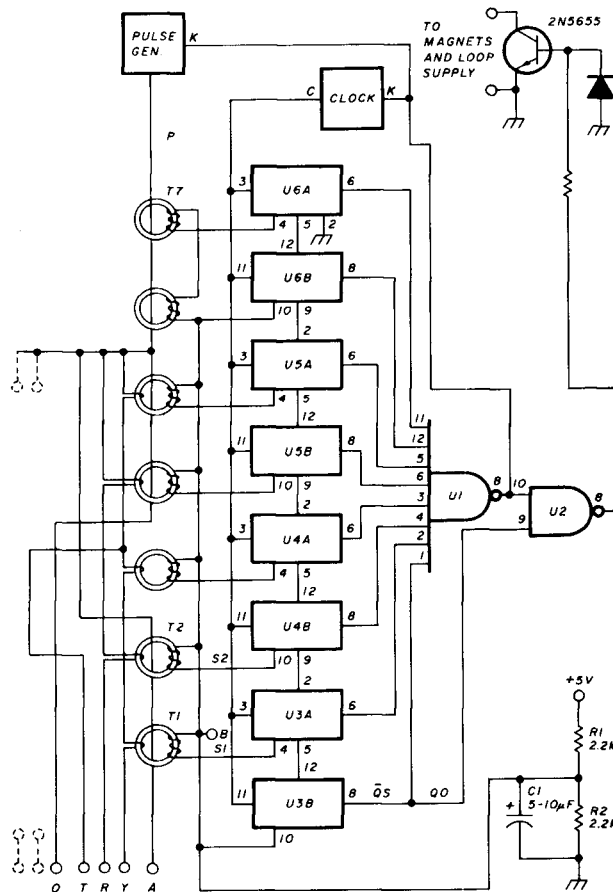

fig. 1. Schematic diagram of the electronic keyboard. Each toroid is an Indiana General CF-102, 0-6, wound with a 10-turn primary. The wires from the pulse generator are fed through the appropriate core to form the mark periods for each character.

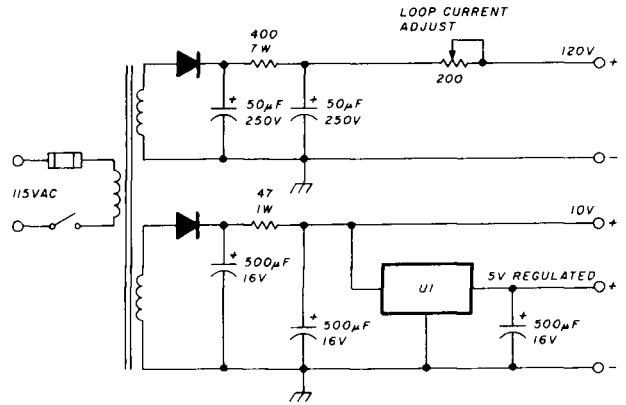
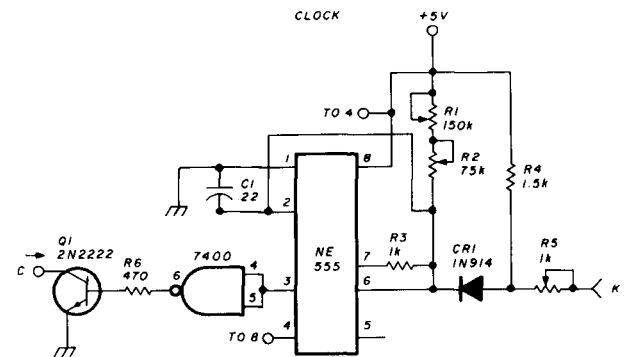
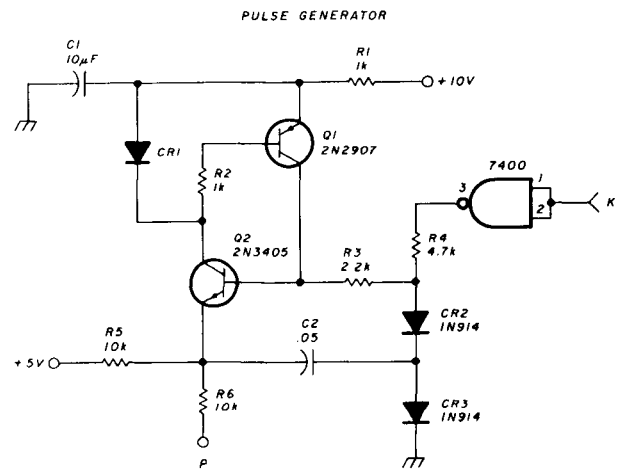

fig. 2. This power supply will provide voltages for both the keyboard plus the Teletype loop. The transformer is a Stancor 8626.

the keyboard is to be used at 60 words per minute, R1 should be adjusted so the 555 oscillates at 45 Hz; for 75 words per minute, use 61 Hz.

ham radio





TS-1



TS-1JR



PE-2



SD-1

THE DAWNING

The age of tone control has come to Amateur Radio. What better way to utilize our ever diminishing resource of frequency spectrum? Sub-audible tone control allows several repeaters to share the same channel with minimal geographic separation. It allows protection from intermod and interference for repeaters, remote base stations, and autopatches. It even allows silent monitoring of our crowded simplex channels.

We make the most reliable and complete line of tone products available. All are totally immune to RF, use plug-in, field replaceable, frequency determining elements for low cost and the most accurate and stable frequency control possible. Our impeccable 1 day delivery is unmatched in the industry and you are protected by a full 1 year warranty when our products are returned to the factory for repair. Isn't it time for you to get into the New Age of tone control?

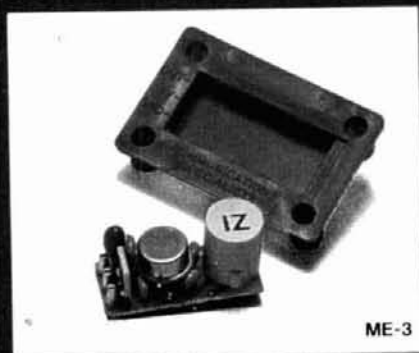

ME-3



TE-8

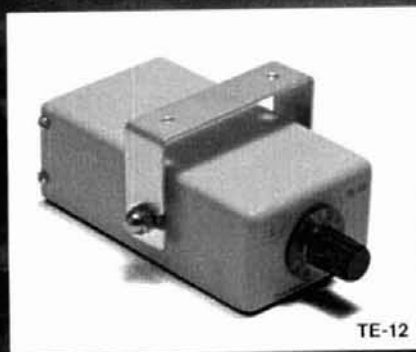

TE-12

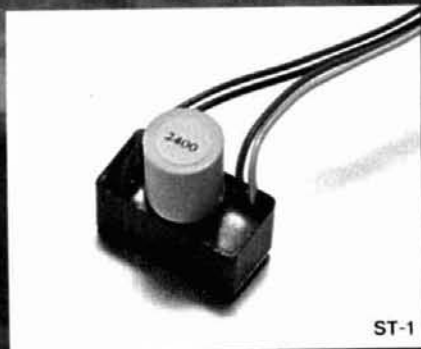

ST-1

OF A NEW AGE.

TS-1 Sub-Audible Encoder-Decoder • Microminiature in size, 1.25" x 2.0" x .65" • Encodes and decodes simultaneously • **\$59.95** complete with K-1 element.

TS-1JR Sub-Audible Encoder-Decoder • Microminiature version of the TS-1 measuring just 1.0" x 1.25" x .65", for hand-held units • **\$79.95** complete with K-1 element.

ME-3 Sub-Audible Encoder • Microminiature in size, measures .45" x 1.1" x .6" • Instant start-up • **\$29.95** complete with K-1 element.

TE-8 Eight-Tone Sub-Audible Encoder • Measures 2.6" x 2.0" x .7" • Frequency selection made by either a pull to ground or to supply • **\$69.95** with 8 K-1 elements.

PE-2 Two-Tone Sequential Encoder for paging • Two call unit • Measures 1.25" x 2.0" x .65" • **\$49.95** with 2K-2 elements.

SD-1 Two-Tone Sequential Decoder • Frequency range is 268.5 - 2109.4 Hz • Measures 1.2" x 1.67" x .65" • Momentary output for horn relay, latched output for call light and receiver muting built-in • **\$59.95** with 2 K-2 elements.

TE-12 Twelve-Tone Sub-Audible or Burst-Tone Encoder • Frequency range is 67.0 - 263.0 Hz sub-audible or 1650 - 4200 Hz burst-tone • Measures 4.25" x 2.5" x 1.5" • **\$79.95** with 12 K-1 elements.

ST-1 Burst-Tone Encoder • Measures .95" x .5" x .5" plus K-1 measurements • Frequency range is 1650 - 4200 Hz • **\$29.95** with K-1 element.



**COMMUNICATIONS
SPECIALISTS**

426 W. Taft Ave., Orange, CA 92667
(714) 998-3021

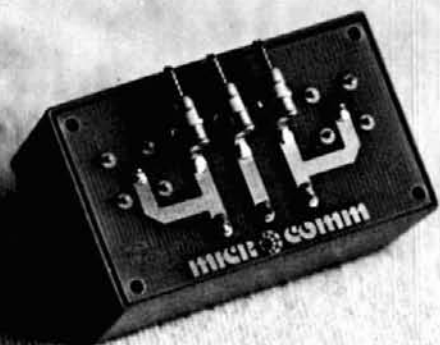

improved grounding for the 1296-MHz microstrip filter

Construction techniques
for improving
the performance
of the three-pole
1296-MHz bandpass
microstripline filter

The 1296-MHz microstripline bandpass filter I discussed in a previous article has allowed dozens of uhf experimenters to "clean up their act" on the 23-cm band.¹ As shown in fig. 1, the filter consisted of three top-coupled parallel-resonant circuits with grounded microstripline inductors. The filter is easy to assemble and tune, but several amateurs who have built it experienced difficulties caused by erratic stripline grounding. The new design presented here eliminates those difficulties and provides lower insertion loss and steeper skirts that will not tend to degrade as the filter is used.

The grounding of the microstriplines in the original design was accomplished by wrapping a thin brass or copper strap around the edge of the PC board, soldering it to the stripline on one side of the board and the groundplane on the other. Although this method of grounding worked well in the prototypes, the stripline inductance is a function of the placement of the grounding strap. Furthermore, the strap's placement on the edge of the board makes it extremely susceptible to physical damage, especially when installing or removing the filter board from its box. A third difficulty with wraparound grounding is that it forces the end of the microstripline inductor to extend to the edge of the board, where stray coupling can cause the tuning of the filter to change when the unit is placed inside an enclosure.

All of these difficulties can be easily eliminated by placing the grounded end of the microstripline inductors somewhat away from the edge of the board and drilling through the board for the installation of a grounding wire or post. With the ground connection running through (rather than around) the board, its mechanical integrity is assured, and the groundstrap inductance is more nearly constant from one filter to the next, especially if the diameter of the grounding wire or post is specified.

By H. Paul Shuch, N6TX, Microcomm, 14908
Sandy Lane, San Jose, California 95124

Although a short length of number 18 (1.0 mm) tinned copper wire makes an acceptable through-board ground connection, maximum grounding effectiveness and mechanical integrity, I have found, can be achieved by installing small electronic eyelets through the board, setting them with a press, and soldering both sides. The eyelets I use are made of thin brass, measuring 0.47 inch (1.2 mm) diameter by 0.093 inch (2.5 mm) long. They look something like tiny rivets. The eyelets are available from a number of vendors* and can be easily set using a center-punch (or sharp nail) and hammer.

grounding the trimmer capacitors

Another area of difficulty encountered by several readers is the grounding of the piston trimmer capacitors. The capacitors I originally used were designed for chassis mounting, so it was necessary to modify

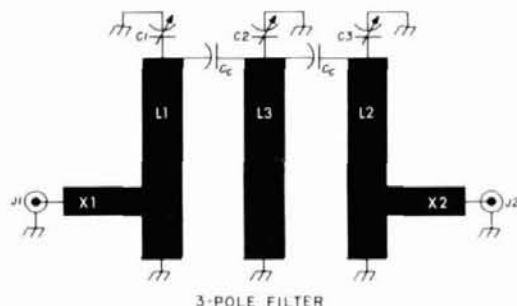

- C1 - C3 1.5-pF ceramic piston trimmer (Triko 202-08M or equivalent)
- C_c Stray coupling capacitance between stator ends of trimmer capacitors
- J1, J2 SMA or equivalent microstripline launchers (E.F. Johnson 142-0298-001 or similar)
- L1, L2, L3 Microstripline inductor, 0.5" (13 mm) long, 0.1" (2.5 mm) wide, spaced 0.3" (7.5 mm) center to center. Bottom ends strapped to ground plane with thin copper strap
- X1, X2 50-ohm microstripline, 0.1" (2.5 mm) wide, any length. Centerline tapped to L1 and L2 0.2" (5 mm) from grounded end

fig. 1. Three-pole microstripline bandpass filter, which will tune the range from 1100 to 1500 MHz. Full-size printed-circuit layout for this filter is shown in fig. 2.

them for circuit-board use by adding a bus-wire loop around the terminal nearest the adjusting screw (see fig. 4 of reference 1). It would have been better to use a trimmer specifically designed for PC use, with legs installed for grounding the rotor end through the circuit board. One such capacitor is the R-Triko 202-

*One acceptable eyelet is part number F-4793-B, available from International Eyelets, Inc., 528 Santa Barbara Street, Santa Barbara, CA 93101.



fig. 2. Full-size printed-circuit layout for the three-pole 1296-MHz bandpass filter. Etched on double-clad 1/16" (1.5 mm) fiberglass-epoxy circuit board; the unetched side serves as a ground plane.

08M, a German ceramic piston trimmer available in the required 1-to-5-pF range.* I find filters using this capacitor easier to tune up, although I caution the builder against repeated adjustments because the tuning mechanism loses spring tension and becomes erratic after a couple dozen adjustments. The best procedure is to set the filter on frequency *once*, and then place a dot of nail polish, epoxy paint, or *Loctite* on the tuning screw as a reminder to leave it alone!

assembling the modified filter

Fig. 2 is a full-size printed circuit layout for the 3-pole bandpass filter, modified for through-board grounding. The board should be etched from double-clad 1/16-inch (1.5-mm) fiberglass-epoxy printed-circuit stock, with one side left unetched to serve as a ground plane. The board should be drilled in the same manner as the template in fig. 3 and the three eyelets installed at the bottom end of the microstriplines.† Don't forget to remove a bit of ground plane

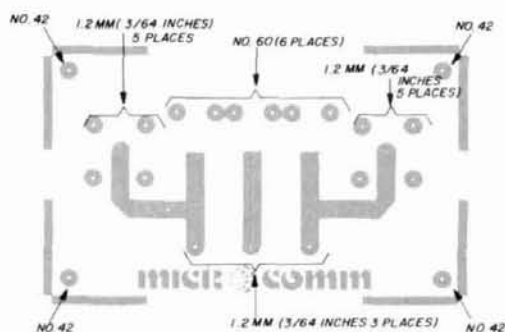

fig. 3. Full-size drilling template for the bandpass filter board.

*These capacitors are available in the United States through Stettner-Trush, Inc., 67 Albany Street, Cazenovia, NY 13035.

†Completely etched, drilled, and plated printed circuit boards, with the three eyelets installed, are available for \$4.50 postpaid within the U.S. and Canada, \$5.00 elsewhere, from Microcomm, 14908 Sandy Lane, San Jose, CA 95124. Completely assembled, tuned, and tested filters are also available. Send a stamped, self-addressed envelope for details.

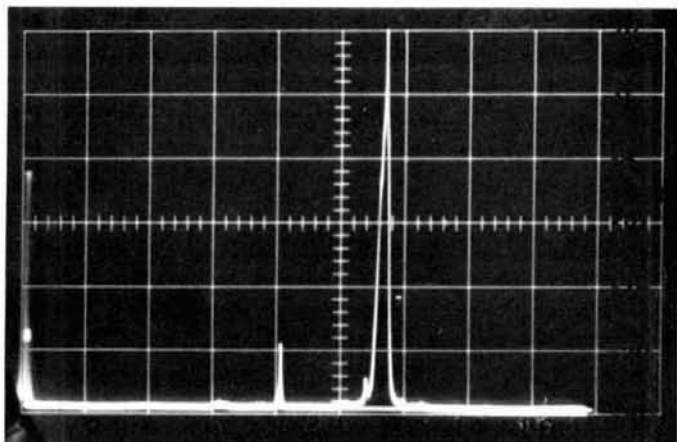
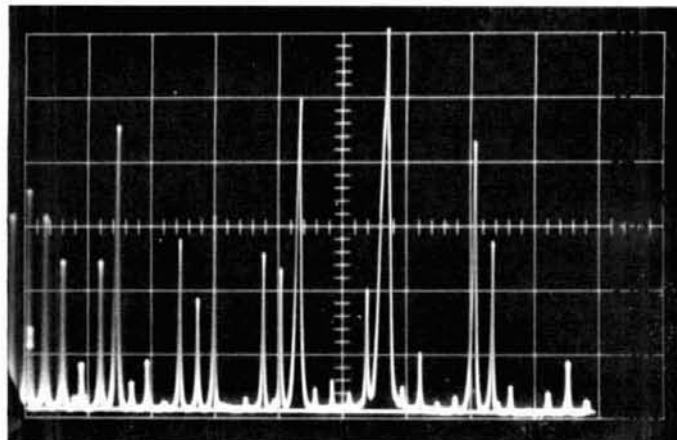

fig. 4. Effect of the bandpass filter on a 1296-MHz local oscillator chain. Spectrum display at top shows the various spurious outputs of a poorly designed LO. Spectrum at bottom is the result of passing the LO signal through a three-pole bandpass filter of fig. 1. The worst remaining spurious component is suppressed 25 dB. (Both displays: dc - 1.8 GHz sweep; horizontal scale, 200 MHz/division; vertical scale, 5 dB/division.)

metallization from around the center-pin holes for the input and output coaxial connectors so the signal isn't grounded out. A 1/8-inch (3-mm) twist drill, used as a deburring tool, works well for this operation.

Connectors J1 and J2 are installed next, soldering the center pin to the input and output microstrip lines, and running a bead of solder around the connector body on the ground-plane side of the board. The trimmer capacitors are installed last. If you use the recommended Triko trimmer, be sure to bend the two mounting legs nearest the adjusting screw down against the ground plane before soldering. The photograph of the completed filter will assist you in assembly.

filter performance

Reference 1 included a swept response curve for the original bandpass filter, as measured on a net-

work analyzer. The response curve for the modified filter design shows slightly reduced insertion loss (on the order of 0.5 dB) and slightly steeper skirts. Perhaps the most realistic indication of filter performance is not its swept response, but the filter's behavior in an actual system. Fig. 4 shows the effect of installing the bandpass filter behind an extremely spurious local oscillator chain. Note that the numerous spurious components are all significantly suppressed, with the worst remaining spur reduced from -5 dB to about -25 dB, relative to the desired output.

Fig. 5 shows the results when the filter is used to clean up the output of a previously published transmit balanced mixer.² Notice that the i-f feedthrough signal and its harmonics, the LO feedthrough, the

fig. 5. Effect of the three-pole bandpass filter on the output of a 1296-MHz transmit mixer. Spectrum display at top shows the output from a singly balanced diode mixer; visible spurious components include the desired signal and image, some LO feedthrough, a very strong component of the i-f injection, and its second and third harmonics, and transmit intermods (resulting from these harmonics mixing with the LO signal). With the three-pole bandpass filter installed in the system, the spectrum (bottom photo) shows that all spurious outputs have been attenuated by more than 25 dB. (Both displays: dc - 1.8 GHz sweep; horizontal scale, 200 MHz/division; vertical scale, 5 dB/division.)

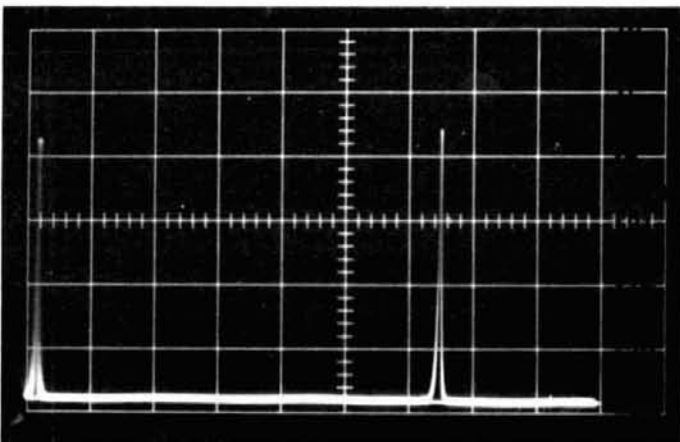
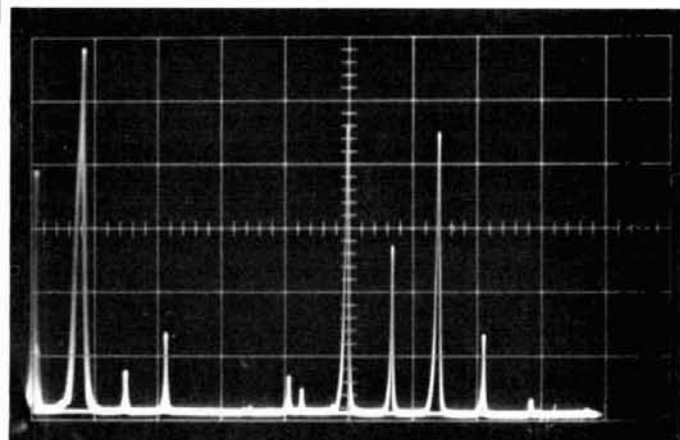

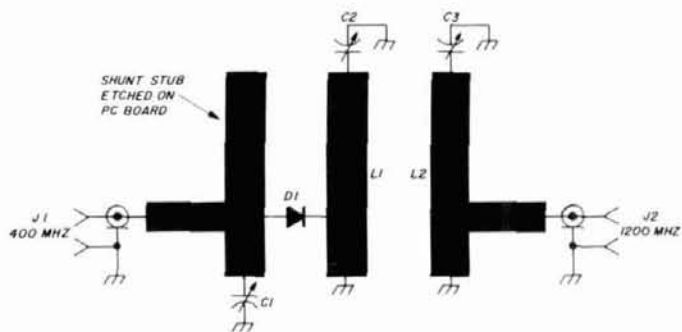

- C1 1-9 pF piston trimmer (Triko 203-09M or equivalent)
 C2, C3 1-5 pF piston trimmer (Triko 201-01M or equivalent)
 CR1 Step recovery diode (H-P 5082-0180)

- J1, J2 SMA coaxial connector (E.F. Johnson 142-0298-001 or similar)
 L1, L2 Microstripline inductors (see fig. 2)

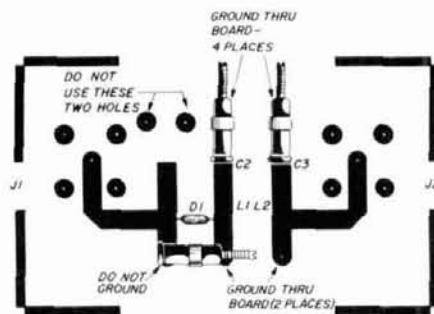

fig. 6. Circuit and construction details for a local-oscillator multiplier which provides 0.5 mW at 1200 MHz from a 5-mW 400-MHz drive signal. This circuit uses the same printed-circuit layout as the bandpass filter (see fig. 2). Output spectrum of this circuit is shown in fig. 7.

image signal, and the intermodulation products are all suppressed below the dynamic range of the spectrum analyzer.

local-oscillator multiplier

In a previous article I described a diode multiplier for developing local-oscillator injection for a 1296-MHz converter.³ As this multiplier used a microstrip-line output filter, it seemed reasonable to assemble a similar multiplier on the bandpass filter PC board, thus allowing one PC artwork to do the job of two. The circuit, which makes a rather nice low-level tripler, is shown in fig. 6. Note that the microstripline previously associated with the first filter pole is now used to support the multiplier diode and its input matching circuit. Do *not* install a grounding eyelet on this first stripline if you are building the multiplier! The other two filtering poles help reject the many other harmonic components generated by the step-

recovery diode, as shown in the spectrum analyzer display of fig. 7. When driven by the 5-to-10 mW signal from my uhf LO chain, this multiplier provides about 0.5 mW of third-harmonic output. This power level can be easily buffered in a 1296-MHz preamp,⁴ applied to a 3-pole filter for additional spurious rejection, and used to drive the LO port of a transmit or receive balanced mixer.

I should point out that the circuit of fig. 6 provides no dc return for the anode side of the multiplier diode. A dc return is necessary for the diode to properly develop self-bias; in my system this dc path is provided at the output of the uhf LO. If the driving stage does not offer dc continuity to ground, it will be necessary to install a dc return circuit on the multiplier board. This can be most readily accomplished by adding a small (0.33- μ H) rf choke to ground at the location normally occupied by the first trimmer capacitor when this board is used as a filter.

fig. 7. Output spectrum of the 400-MHz to 1200-MHz LO multiplier. Note that the tripler circuit provides some degree of filtering of the 400-, 800-, and 1600-MHz components from the step recovery diode.

summary

The printed-circuit layout can be used to fabricate high-quality bandpass filters and diode multipliers for the amateur 23-cm band. The designs are based upon previous articles, but the addition of through-board eyelet grounding significantly improves performance and reliability. Further details on construction, tune-up and testing, and system application are discussed in reference 1.

references

1. H. Paul Shuch, WA6UAM, "Microstripline Bandpass Filters for 1296 MHz," *ham radio*, December, 1975, page 46.
2. H. Paul Shuch, WA6UAM, "Rat-race Balanced Mixer for 1296 MHz," *ham radio*, July, 1977, page 33.
3. H. Paul Shuch, WA6UAM, "Easy-to-build SSB Transceiver for 1296 MHz," *ham radio*, September, 1974, page 8.
4. H. Paul Shuch, WA6UAM, "Low-cost 1296-MHz Preamp," *ham radio*, October, 1975, page 42.

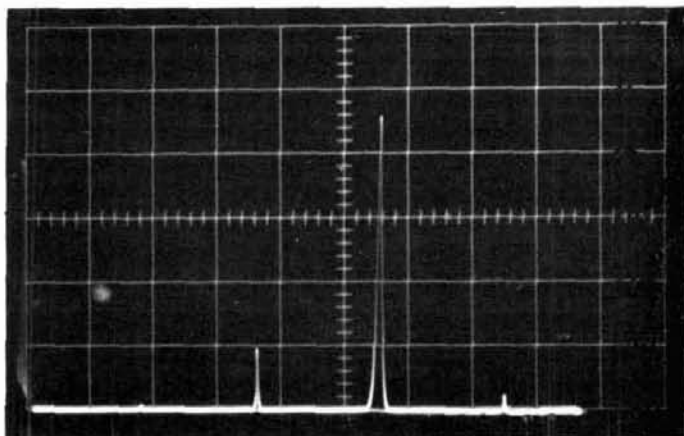

 **KENWOOD**
...pacesetter in amateur radio

STILL THE SAME FINE, TIME PROVEN RIG. BUT NOW WITH THE SIMPLE ADDITION OF A PLUG-IN CRYSTAL, THE TS-700SP WILL BE ABLE TO UTILIZE THE NEW REPEATER SUB-BAND (144.5 to 145.5 MHz) STILL FEATURES ALL OF THE FINE ATTRIBUTES OF THE TS-700S: A DIGITAL FREQUENCY DISPLAY, RECEIVER PRE-AMP, VOX, SEMI-BREAK IN, AND CW SIDETONE. OF COURSE, IT'S ALL MODE, 144-148 MHz, VFO CONTROLLED... AND KENWOOD QUALITY THROUGHOUT.

Features: 4 MHz band coverage (144 to 148 MHz) • Automatic repeater offset capability on all FCC authorized repeater subbands including 144.5-145.5 MHz • Simply dial receive frequency and radio does the rest... simplex, repeater, or reverse. Same features on any of 11 crystal positions • Transmit/Receive capability on 44 channels with 11 crystals • Operates all modes: SSB (upper and lower), FM, AM and CW • Digital readout with "Kenwood Blue" digits • Receiver pre-amp • Built-in VOX • Semi break-in on CW • CW sidetone • All solid-state • AC and DC capability. 10 watts RF output on SSB, FM, CW • 3 watts on AM • 1 watt FM low-power switch • 0.25 μ V for 10 dB (S+N)/N SSB/CW sensitivity • 0.4 μ V for 20 dB quieting FM sensitivity.

10 watts RF output on SSB, FM, CW • 3 watts on AM • 1 watt FM low-power switch • 0.25 μ V for 10 dB (S+N)/N SSB/CW sensitivity • 0.4 μ V for 20 dB quieting FM sensitivity.

TS-700SP



The TS-700SP shown with the matching VFO-700S and SP-70. Also shown is Kenwood's new MC-30 noise cancelling hand held microphone, HS-4 headphone set and the MC-50 dynamic microphone.

*You can still
buy one of the world's
best HF transceivers
for under \$1,000*

TS-820

Even without the digital display, Kenwood's TS-820 provides extremely sensitive and accurate tuning, plus all of the electronic and mechanical advantages found only in the TS-820S. Its reliability has been proven through thousands of hours of use under all environmental conditions.

The TS-820 stands out from all the other rigs on the band. Its adjustable RF speech processor, utilizing a 455 kHz circuit to provide quick-time-constant compression, will get your message through the pile ups. RF negative feedback is applied from the final to the driver to improve linearity, and third-order products are at least -35 dB. Harmonic spurious emissions are less than -40 dB and other spurs are less than -60 dB. RF input power is 200 W PEP on SSB, 160 W DC on CW, and 100 W DC on FSK. Receiver sensitivity is better than 0.25 μ V for 10 dB S/N. The TS-820 is known for its superb receiver selectivity, and its famous IF shift easily eliminates heavy QRM. That's why the TS-820 series is the DXer's choice.

And, of course, anytime you might want to add a digital display, it's simply a matter of installing the DG-1 option.



TS-820 VFO-820S SP-820

Kenwood's unbeatable combination. The VFO-820 solid state remote VFO adds greatly to the versatility of your TS-820. It has its own RIT circuit and control switch and is a perfectly matched accessory. The SP-820 deluxe external matching speaker includes audio filters for added versatility on receive and two audio inputs.

TRIO-KENWOOD COMMUNICATIONS INC.
1111 WEST WALNUT/COMPTON, CA 90220

simple scope monitor for vhf fm

In the dark
about those signal reports
on two meters?
This easy monitoring system
pays off in
increased versatility

Adding an inexpensive oscilloscope to your fm transceiver will make your base station much more versatile. You'll have a signal monitor capable of measuring (+0-) carrier frequency, peak-deviation modulation, per cent noise quieting, and *Touch-Tone* signal levels. You'll be able to tweak transmit crystals in other rigs (great for netting CD-MARS members on frequency) and much more. Now blow the dust off your old scope and put it to good use — or give the test scope a dual function, as I did.

fm signal reports

How often have you heard, "You're 40 per cent quieting but Q5 copy," and wondered how the operator on the other end arrived at the 40 per cent figure? He must have been good at guessing, had a super trained ear, or maybe trying to be friendly.

When I became interested in two-meter fm I was very much confused with per cent quieting signal reports (especially if I had to give one). The transceiver I used was an ICOM IC20 and it did have a relative strength S-meter. While working simplex, whatever the meter indicated would be the report I gave. However, working through repeaters presented a whole new ball game. Unlike simplex, repeaters may come slamming into your location, but the signal on the input side may be quite weak. Under such circumstances the S-meter reading is invalid for a report,

but a monitor scope would immediately show the per cent noise quieting into the machine. One day while working on a circuit and using my old EICO model 460 scope, I saw the light for a per cent quieting indicator.

operation

After examining the IC20 schematic for a good signal pickoff point, I decided the best place would be at the output of the discriminator stage (at TP3) and ahead of the audio control circuit (see fig. 1).

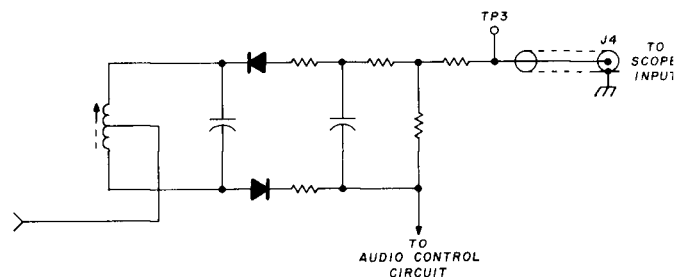

fig. 1. Pickoff point in a typical amateur 2-meter transceiver for connecting a monitor scope. In this case it's at TP3 in the popular ICOM model IC20. The pickoff point should be made at the receiver discriminator output, but ahead of the audio control circuit.

Several advantages would be obtained by doing this: 1) I'd see the noise figure as it appeared, unaffected by audio and squelch-control settings; 2) I'd see peak deviation (modulation); 3) by connecting directly from the discriminator output to my scope's dc vertical input I'd be able to measure the dc voltage produced by the received-signal carrier. Most fm transceivers (or receivers) have a test point at the location mentioned for alignment purposes. Your manual or schematic should indicate if this point is available.

connection

Modification and wiring of the transceiver was simple (fig. 1). Connection to the outside world was made using a small-diameter, single-conductor, shielded cable from the discriminator circuit to a

By Ed Spadoni, W1RHN, 91 Tower Street,
Dedham, Massachusetts 02026

rear-panel-mounted phono connector (Radio Shack No. 274-346) designated J4 in fig. 1. The shield was wired to J4 ground lug only. Next my scope was connected through a suitable length of shielded cable, with a male phono plug on the end, to mate with J4.

calibration

Scope control settings will vary depending on the types of scope used. My EICO 460 control settings were as follows: Vertical attenuator in the DC-X1 position, horizontal sweep at 100 Hz, and sync ON INTERNAL. With the transceiver tuned to an inactive channel, adjust the vertical gain for 51 mm (2 in.) p-p noise level (fig. 2). The noise as seen on the scope indicates the total passband of the rig's receiving section. My IC20 has a passband of better than 16 kHz, which allows me to see signals ± 8 kHz from the passband center with reasonable accuracy. At present I can read 1 kHz = 2.5-mm or 0.1-in. division on the scope with good linearity to ± 8 kHz.

It's essential to have your receiver properly aligned and your receiving crystals adjusted to the passband center. If you're synthesized, be sure the receive oscillator is also properly adjusted. I've found that a very convenient frequency reference source is a repeater output signal. By tuning in several machines you can see if things are properly adjusted by noting if the repeater signals are located in the passband center. If not, a little trimming must be done.

Working someone with a synthesized or vfo rig can prove very helpful in determining the linear portion of your receiver and its frequency limits. After determining the useful reading range of your transceiver-scope combination, you should be able to read signals to ± 1 kHz of your receiver passband center.

using your scope

Here are some samples of the more important waveforms observed while monitoring both simplex and repeater signals.

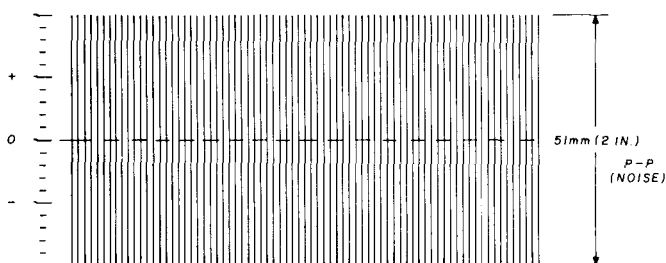
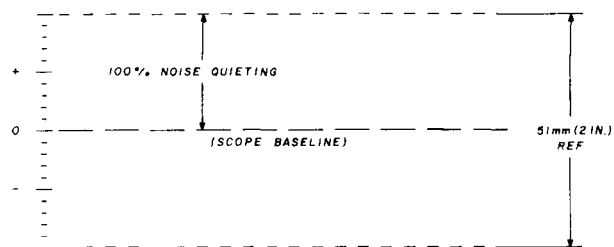
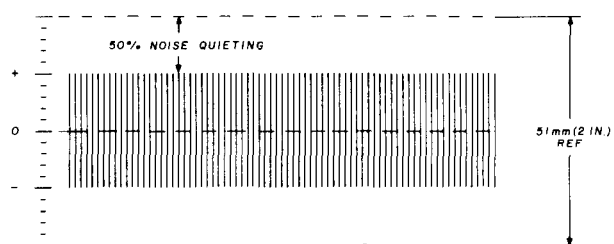

fig. 2. Scope presentation for calibration. Peak-to-peak noise should occupy the entire scope face, which represents the total passband of the receiver on noise.

1. 100 per cent noise quieting signal, either simplex or repeater, with a pause in modulation:



2. 50 per cent noise quieting signal, either simplex or repeater, with a pause in modulation:



3. Normal signal showing deviation (modulation). Most transceivers and repeaters have their deviation set for a nominal peak of 5 kHz:

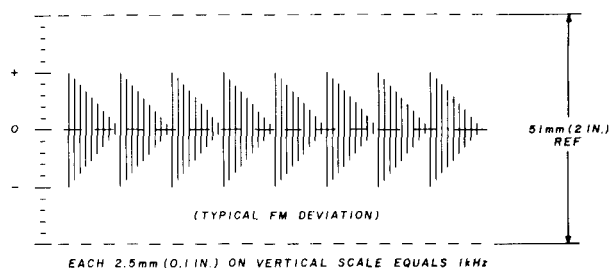

4. 100 per cent quieting repeater signal received at your location with a weak and noisy input signal. Horizontal sweep adjusted for expanded one or two speech waveforms:

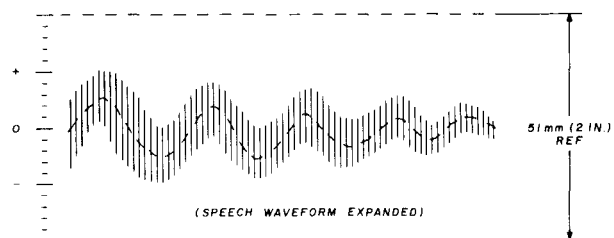

5. Repeaters normally produce equal swings of deviation, in both up and down directions, with most input signals. If a new station comes into the machine and produces the pattern shown below, this means that the new signal's carrier frequency is off and higher than the repeater passband center. The opposite would be true with a low-frequency carrier signal into the machine:

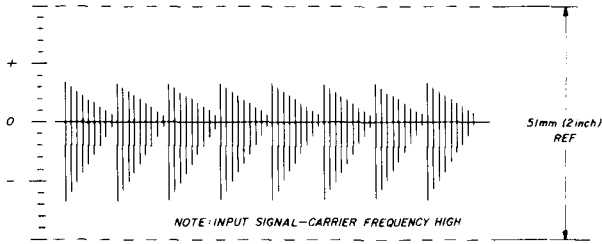

6. Hum accompanying signal. Frequency and ratio of hum to modulation can be determined. Hum frequency is referenced to 60 Hz.

$$\text{Per cent of hum} = \frac{\text{hum } p-p}{\text{deviation } p-p} \times 100:$$

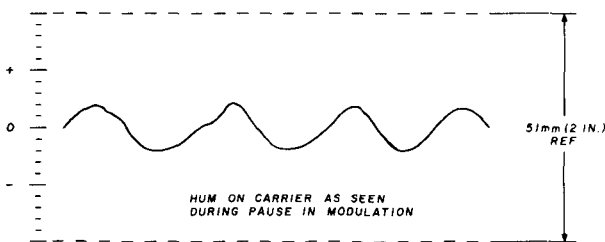

7. Power supply whine accompanying the received-signal carrier has a constant amplitude and frequency. Mobile alternator whine is similar, except the amplitude and frequency will change as the vehicle is accelerated or decelerated. Whine appears as a high-frequency modulated carrier with or without voice modulation:

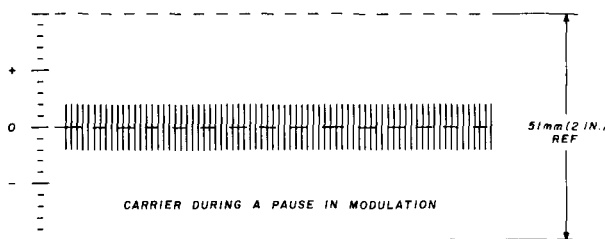

8. Upper-channel interference from a strong simplex or repeater station. Many hams have experienced this condition and termed it (in error) intermodulation. Lower-channel interference is similar, except that the baseline would appear on the lower side of the passband with audio transients shooting upward:

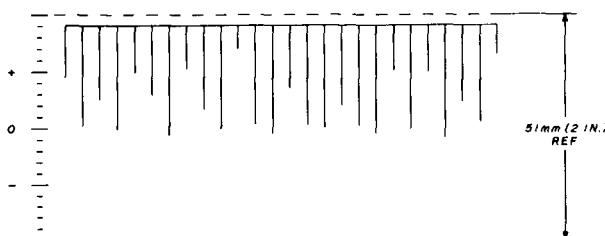

9. Checking and adjusting *Touch-Tone* signals. Preferably, use a simplex channel and have the operator close-talk into the microphone at a normal voice level. (Note the peak deviation.) Next, have the operator switch in the TTP, push buttons 1 and 2 or 1 and 4, and observe the peak amplitude. Peak deviation and amplitude should be the same for both; if not, adjust TTP output level. Then have the operator push all buttons to see if all levels are the same. When a single button is pressed a dual frequency is generated and is a normal function for a TTP, as shown below. Each button produces its own set of different frequencies:

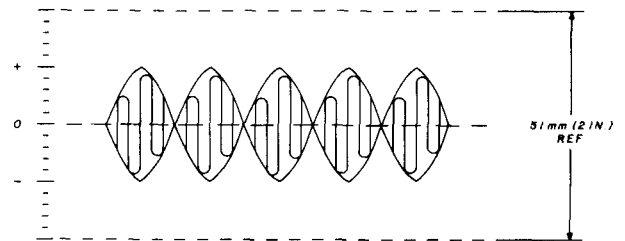

10. Frequency measuring. Using a scope with your transceiver gives you a limited-range frequency meter, allowing you to read up to ± 8 kHz per channel on 2 meters. The range is restricted only by the passband capability of your transceiver.

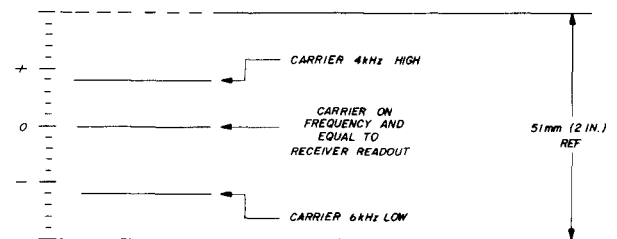

final comments

You can leave the scope in the circuit without affecting transceiver performance. If you have separate receive-transmit capability, the scope can also be used to monitor your own transmitted signal. The waveforms illustrated are those most often encountered and are therefore the most important.

Scopes aren't difficult to come by. Try surplus houses, auctions, or build one from a kit. A monitor scope beats the cost of frequency counters and you see much more. Making this simple modification to your radio and adding a scope will allow you to keep watch over other rigs (your hand-held; repeater output), especially the transmitted signals. The combination becomes unbeatable when used with synthesized transceivers or those with ± 5 -kHz offset or with transceivers having a VFO and 1-kHz readout.

ham radio

ATLAS 350-XL

Champion of Clipperton!



Clipperton '78 DXpedition

Used Atlas 350-XL's exclusively

Three stations worked 24 hours a day for 7 days, and made 29,069 contacts. The outstanding performance of the Atlas rigs is now well known. No breakdowns, no failures, no problems. Just solid, uninterrupted, top notch performance. If you want a proven performer, get the Atlas 350-XL! It's a real classic.
 Atlas 350XL \$1195



ATLAS RADIO INC.
 417 Via Del Monte, Oceanside, CA 92054 (714) 433-1983
 Special Customer Service Direct Line (714) 433-9591
 TWX 910-322-1397

F6AQO HB9AHL F6AOI F9IE HB9(SWL) F6ARC
 HB9AEE F5II F6BFH F9JS F6BBJ

single-tone decoder for vhf fm

Design and construction
of a false-free device
using a single tone
to alert you
on two-meter fm

A single-tone decoder is adequate for many applications on vhf fm, but very little practical information on these devices has been published. Several years ago K2OAW described the use of a 741 op amp as a carrier-operated relay (COR) and tone decoder,¹ but I didn't know what a COR was at that time. So I read the part about the tone decoder, and within 15 minutes I was at the junk box struggling to put a reasonable fascimile together to see whether or not all that was claimed for this circuit was true. The claims were that the decoder would not trigger on noise, speech, or even singing but would activate immediately in response to the chosen tone. Beyond that, the decoder bandwidth was not supposed to get any broader as the input amplitude increased. Also, the decoder was not supposed to trigger on the selected tone if that tone were accompanied by any other tone or noise.

This article describes a single-tone decoder with hints on how to set it up. It has the advantage of being free from falsing while coming on quickly enough to stop a scanner on the frequency where the tone was transmitted. An appropriate encoder, small enough to fit in most hand-held transceivers, is also described.

In those days I had two CB hand-held transceivers with built-in tone encoders for mutual noise making on 11 meters. I wanted to use the decoder (if it worked) with these units. Fortunately I had all I needed on hand to make the circuit on a perf board. When I was finished, lo and behold, it worked! It was so selective that it wouldn't false, even on channel 11 with the band open; when my tone came through, the decoder came right on.

I put it all together in a box with a speaker and some jacks and used it that way for several years until I got on 2-meter fm. I then discovered some problems and shortcomings that needed solutions. Over the years I came up with a modified circuit that filled my needs and has been working well ever since. Before going any further, let me explain why I used a single-tone decoder rather than *Touch Tones*, sequential tones, or some other type of selective decoding device. It's not really the decoder but the *encoder* that makes the difference. A stable, single-tone encoder can be easily and inexpensively built to fit into a hand-held transceiver, and that's exactly what I did.

operation

The radio is on at all times and tuned to a repeater frequency, but a relay directs the audio to a 10-ohm, 2-watt resistor and the decoder input. When the desired tone is received the audio is directed through a 7-second timer to both a local and an extension speaker. (The extension speaker, in my case, is located in the kitchen.) After seven seconds the unit resets, and the audio is removed from the speakers. My wife (the technician in the house) then goes to the shack and operates a toggle switch that defeats the decoder, disconnects the extension speaker, and supplies the audio at a conversational level to the

By Steve S. Kraman, MD, WA2UMY, 2901B
Candlelight Way, Lexington, Kentucky 40502

Incredible...



Incredible, that's the word people are using to describe the CT-50 frequency counter. Why? Simple, the CT-50 is an achievement in design; exceptionally low in cost, compact, easy to use and unmatched in performance and reliability.

Features of the CT-50 include; easy pushbutton operation, fully automatic decimal point positioning, quality shielded metal case, and dependable LSI circuitry. Full eight digit readout allows resolution to 1 Hz at 65 mHz, 10 Hz at 650 mHz, and the decimal point is always correct. Input protection to 50 volts insures against accidental burnout or overload. And, the best feature of all is the easy assembly. Clear, step by step instructions guide you to a finished unit you can rely on.

Use the order blank below or call us direct and order yours today!

CT-50, 60 mHz Counter Kit	\$89.95
CT-50 WT, 60 mHz counter, wired, tested	159.95
CT-600, 600 mHz prescaler option	
for CT-50, add	29.95

ACCESSORIES

DC probe, direct input, general purpose type	\$12.95
High impedance probe, does not load circuit	15.95
Low pass probe, used when measuring audio	15.95
High pass probe, reduces low freq pickup	15.95
VHF flexible rubber antenna, BNC connector	12.95
Color burst adapter, for calibration, high accuracy	14.95
typically 0,001 ppm accuracy, stability	

ramsey electronics

P.O. Box 4072 Rochester NY 14610

(716) 271-6487

SPECIFICATIONS

Frequency range: 5 Hz to 65 mHz, 600 mHz with CT-600
 Resolution: 10 Hz @ 0.1 sec gate, 1 Hz @ 1 sec gate
 Readout: 8 digit, 0.4" high LED, direct readout in mHz
 Accuracy: adjustable to 0.5 ppm
 Stability: 2.0 ppm over 10° to 40° C, temperature compensated
 Input: BNC, 1 megohm/20 pf direct, 50 ohm with CT-600
 Overload: 50VAC maximum, all modes
 Sensitivity: less than 25 mv to 65 mHz, 50-150 mv to 600 mHz
 Power: 110 VAC 5 Watts or 12 VDC @ 400 ma
 Size: 6" x 4" x 2", high quality aluminum case, 2 lbs
 ICS: 13 units, all socketed
 CT-600: 600 mHz prescaler option, fits inside CT-50
 CB-1: Color burst adapter, use with color TV for extreme accuracy and stability, typically 0.001 ppm

Ramsey Electronics
 Box 4072 716-271-6487
 Rochester, NY 14610



Quantity	Description	Price
	Shipping, handling, insurance	\$5.00
	N.Y. state residents, add tax	
	Total	
Name _____		
Address _____		
City _____ State _____ Zip _____		

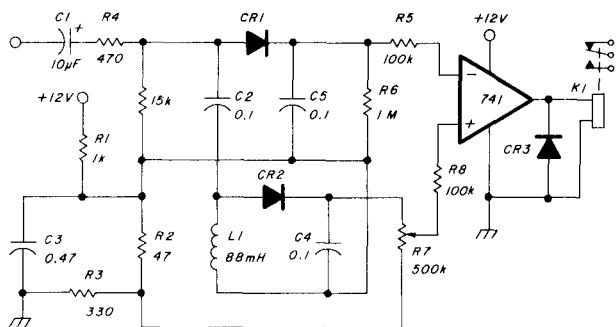

fig. 1. Original circuit of the single-tone decoder, which forms the basis of the modified system. (From 73, July, 1972.)

local speaker. After two-way communications are completed, the same switch returns the unit to normal operations. Nothing need be disconnected from the rig at any time.

The original circuit is reproduced here (fig. 1) to demonstrate its operation. I'll dispense with a detailed description of how the decoder works. Briefly, the incoming signal is separated into two components — the desired component and all others. The two voltages so derived are rectified and fed respectively to the positive and negative inputs of the 741 op amp. The voltage at the positive input must exceed that at the negative input for the 741 to turn on. The bandwidth is set by R7, which determines the op amp bias. (A complete description of the circuit can be found in the original article.)¹

modified decoder

Fig. 2 shows the modified circuit. C1, the frequency-determining capacitor, is replaced by seven

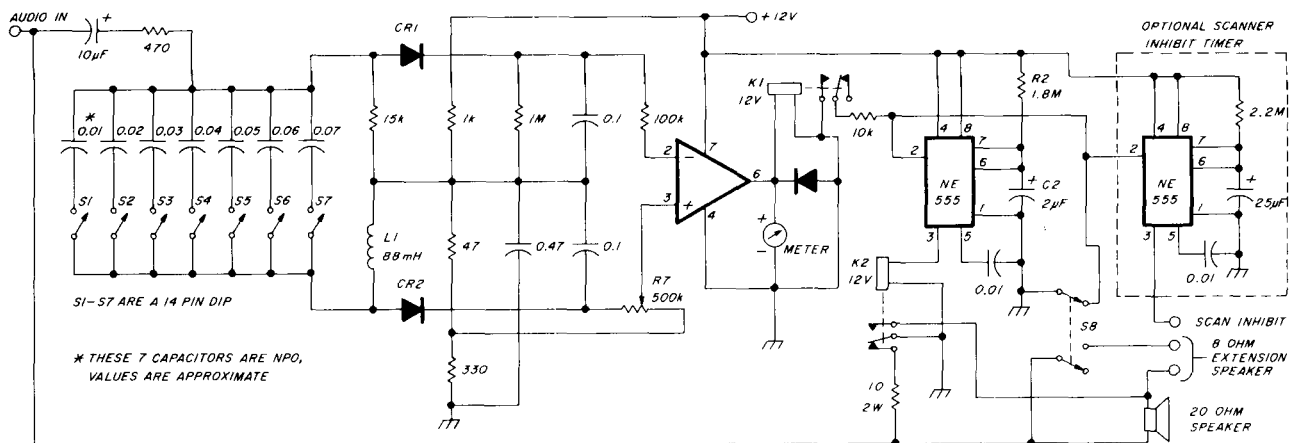

fig. 2. Modified decoder featuring easy frequency change using 7 NPO capacitors and a 7-pole, single-throw switch on a 14-pin dual in-line package. Unit decodes frequencies from 300-600 Hz. The universal 741 op amp does the work; bandwidth is set by resistor R7.

capacitors and a seven-pole, single-throw switch on a 14-pin DIP. (This is only a convenience to allow easy frequency change.)

choosing capacitors

Be sure to use only NPO capacitors for C1; that is, capacitors whose values do not change with temperature, otherwise you may find, as I did, that on warm or cool days the decoder will not respond to your tone. A drift of only a few hertz can prevent the decoder from working. If you're not sure of your capacitors but have access to a capacitance bridge, connect the chosen capacitor across the bridge, take a reading, and then cool the capacitor with freeze mist and take a second reading. If the change is more than slight (say about 10 per cent), don't use it. You'll find that most disk ceramics will change value by as much as 50 per cent under these conditions. Mylar or tantalum capacitors are usually good.

My unit is set up to decode frequencies between 300-600 Hz using a 150-µH toroid; an 88-µH toroid, as originally described, is fine. Experiment with values of C1 to see where you are and work up or down from there. If you have a low-band rig, connect the audio output to the decoder and use the crystal calibrator to generate a test signal. Of course, an audio signal generator may be used, but remember that the amplitude must be similar to that of an audio power amplifier since these are the conditions under which the decoder was designed to work.

adjustment and tests

If the decoder doesn't operate at first, test the frequency determining components by placing a dc voltmeter across the 741 positive and negative inputs. Sweep an audio-frequency generator over as

wide a band as possible. The voltage will peak at one frequency and remain negative at all others. Play around with the bandwidth while you are doing this.

The 555 timer is set to keep the speakers on for about seven seconds, but you can substitute a pot for R2 to give different lengths of time.

The meter across K1 is used to adjust the encoder to the decoder frequency. The meter will read highest at the decoder's most sensitive frequency. The meter is also useful for quick checks and adjustments. Almost any sensitive meter can be used with the appropriate series resistor to keep it in range. I used a tape recorder VU meter.

encoder

I tried several circuits as an encoder, but by far the best is the "Twin-T Oscillator" taken from the *Radio Amateur's VHF Manual*. While the output amplitude is low and must be fed into the transmitter mike input, the frequency is completely independent of the supply voltage over its operating range. When NPO capacitors are used, a very stable source of oscillation results, which is mandatory if the encoder-decoder pair are to work reliably. It's best to set up the encoder with an oscilloscope to try to achieve a near-perfect sine wave. Other waveforms contain harmonics, which will tend to desensitize the decoder. Keep this in mind when you operate through a repeater. The repeater's audio shaping, or your own overdeviation, may cause tone distortion.

suggested improvements

This unit has worked well for several years, but, for still further usefulness, the following may be done. A scanning board can be added to the receiver and connected so that the decoder, when coming on, will inhibit the scanner and lock the receiver onto the tone frequency. This may be accomplished by a second 555 timer set to lock on for about one minute. The manual defeat switch would also inhibit the scanner. This setup will allow you to use whichever repeater or simplex frequency is most convenient at the time, especially if your favorite repeater happens to be down just when you want to make the call. The decoder can be used in this way because it triggers almost instantly on the appropriate tone. Other single-tone decoders using the 567 chip require a prolonged tone to achieve freedom from falsing. A scanner would pass by too fast to decode the tone in this case. Other modifications will come to mind I'm sure. I hope you find this project useful and fun.

reference

1. Peter Stark, K2OAW, "741 Op Amp COR and Tone Decoder Circuits," 73, July, 1972, page 83.

ham radio

new FROM ALLIANCE!



HD-73 HEAVY-DUTY ROTATOR

with exclusive Dual-Speed Control!

For antennas up to 10.7 sq. ft. of wind load area. Mast support bracket design permits easy centering and offers a positive drive no-slip option. Automatic brake action cushions stops to reduce inertia stresses. Unique control unit features DUAL-SPEED rotation with one five-position switch. SPECIFICATIONS: Max. wind load bending moment—10,000 in.-lbs. (side-thrust overturning); Starting torque — 400 in.-lbs.; Hardened steel drive gears; Bearings — 100- $\frac{3}{8}$ " diameter (hardened); Meter — D'Arsonval, taut band (backlighted). There's much, much more — so get the whole story!

Mail this coupon for complete details!

YES! Send me complete details on the new HD-73!
 Give me the name of my nearest dealer!

NAME _____
ADDRESS _____
CITY _____
STATE _____ ZIP _____

 The **ALLIANCE** Manufacturing Co., Inc., Alliance, Ohio 44601
A NORTH AMERICAN PHILIPS COMPANY
Maker of the famous Antenna Rotator ... Alliance Tenna-Rotor® ... "TV's Better Color Getter!"
© 1978 The Alliance Mfg. Co., Inc.

When the FCC acted

we reported:



Important news **FAST** for all Amateurs.
If it's news about Amateur Radio,
HR Report brings it to you faster than
any other source!

SUBSCRIBE TODAY!



ORDER TOLL FREE
800-258-5353

hr

52 Weekly Issues \$20.00
Mailed First Class every Friday
REPORT
GREENVILLE, NH 03048

electronic bias switching

for the Henry 2K4 and 3KA linear amplifiers

Easy modifications
you can make
to these popular linears
to increase efficiency
in CW and ssb modes

Two excellent articles have appeared in the amateur literature dealing with electronic bias switching (EBS) for high-power linear amplifiers.^{1,2} Why electronic bias switching? It's a great saver of tube life. It reduces tube dissipation, ambient noise, and your power bill. EBS, in general, is a way to make your amplifier operate more efficiently in whatever mode you choose, ssb or CW.

The EBS method described here may be used by those amateurs interested in CW only operation or by those using ssb with or without signal processing. Using the basic circuits described in references 1 and 2, a very efficient EBS circuit can be built into the popular Henry 2K4 or 3KA linear amplifier. The circuit can be adapted to your home-brew linear with a little ingenuity.

Henry rf decks

First of all, for those not knowing it, the rf decks in the 2K4 and the 3KA amplifiers are almost identical. The only difference is the use of wider-spaced loading variable capacitors in the 3KA (two 350 pF instead of two 500 pF, plus three additional 100-pF, 5-

kV doorknob fixed capacitors). A 2K4 rf deck can easily be modified to a 3KA rf deck by simply changing these components. Of course, the 3KA uses higher plate voltage (3.6 instead of 2.8 kV). A 2K4 can be driven to 2 kW PEP with 100 watts rf, while the 3KA needs at least 150 watts of rf drive to run at its full rated output.

The EBS circuit will not be dealt with in detail. The referenced articles discuss the principles of operation of the circuit. The circuit components can be mounted on the aluminum panel covering the compartment that houses the swr bridge, zener diode, etc.

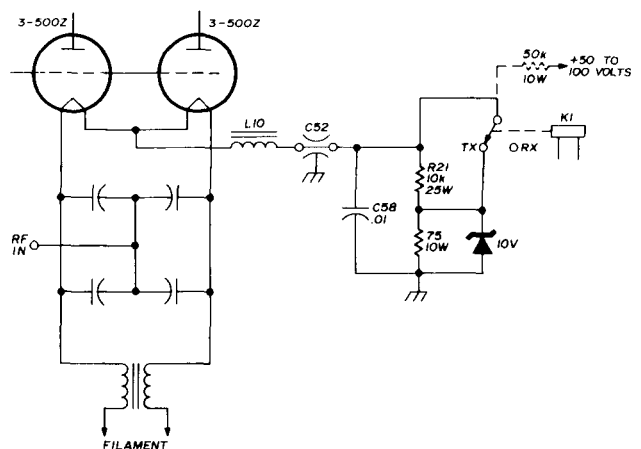

fig. 1. The bias and transmit-receive switching circuits in the Henry 2K4/3KA linear amplifiers. Dashed line (upper right) shows a 50k resistor added to the circuit through a +50-100-volt power supply to effect complete amplifier cutoff during receive mode.

Fig. 1 shows the original bias plus transmit/receive switching circuit as used in the 2K4 and 3KA amplifiers. During receive, R21 is switched into the cathode circuit, whereby the tube is biased to a point very near cutoff. Simply adding a 50-k resistor (fig. 1) and connecting it to a +100-volt supply (50-150 V) will improve the circuit; the tube will then be *completely* cut off during reception (+100 volts on the cathode).

By Michael James, W1C8Y

improved bias circuit

Fig. 2 shows the EBS circuit as developed especially for the 2K4 and 3KA linears. R1 through R4 are well over-dimensioned resistors (in wattage), where a parallel combination is used for added safety (if one resistor opens, the system will still function on the remaining resistor). These resistors can be mounted on the bottom side of the cover plate. The Darlington transistor and the thyristor can be bolted

dition; that is, without the EBS circuit. It also allows you to check tube idling current.

operation on ssb

Using signal processing. One general disadvantage of running a great amount of clipping (10-20 dB) is the objectionable background noise that may occur between words, especially if you have some noisy fans or if room acoustics are not the best.

First it's essential that, when using speech proces-

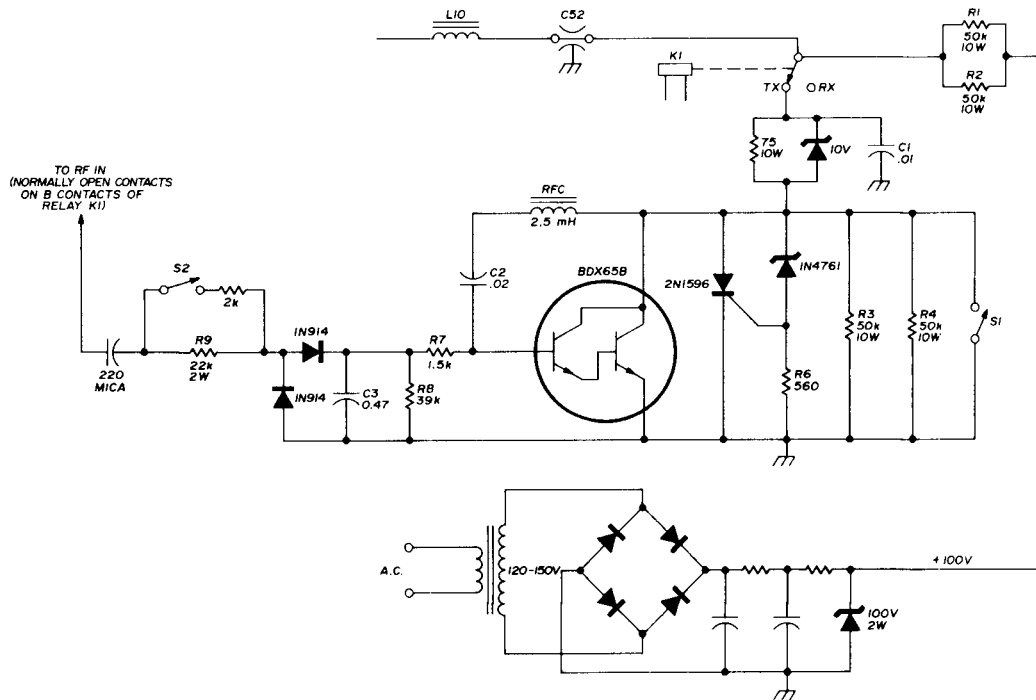

fig. 2. The electronic bias system circuit that can be added to the Henry 2K4/3KA linear amplifiers — an easy way to improve operation on CW or on ssb modes with or without signal processing.

to the plate using mica washers. All other components should be wired point-to-point on wiring strips. The rf choke (2.5 mH) in the integrator circuit between the Darlington transistor collector and base was necessary to prevent rf from getting into the base circuit and being rectified. This was the case with one particular unit in which the circuit functioned even without rf applied to the diode rectifier from the exciter input. Installing the rf choke cured the problem.

operation on cw

If you're a CW-only man, the time constants on the make and break side of the switch can be made much shorter. Change the 0.47- μ F capacitor to 0.047- μ F and the 20-nF to 2 nF. This will turn the amplifier on and off much faster and still further reduce tube dissipation between dots and dashes. Closing S1 allows you to run the amplifier in its original con-

dition; that is, without the EBS circuit. It also allows you to check tube idling current. When doing so the amount of clipping permissible with a processor such as the Magnum Six, Comdel, Vomax, DX engineering, or Datong, in a noisy shack, is determined by the acceptable signal-to-background noise ratio. An acceptable ratio is -25 dB. This means that, if your average power output with the processor, on a steady, stretched-out "Aaaa," is 1 kW (on your output meter), the background noise should be no more than 3.2 watts on the same output meter (that is, 25 dB down from 1000 watts). Adjustment procedure:

1. Switch off the EBS circuit by closing S1.
2. Tune up the amplifier in the normal way.
3. Adjust the clipping level in the prescribed way, but certainly no further than to the point where the background noise, as indicated on your

wattmeter, is at least 25 dB down from your steady "Aaa . . ." (3.2 watts versus 1000 watts).

4. Open S1, without changing any setting to your transmitter or processor. If the background noise (at -25 dB or better) trips the EBS circuit (meaning that if you see the background on the scope or output meter, or if your plate meter does not drop to zero) then the EBS-circuit input sensitivity is too high. Increase the value of the 22k resistor until you find a value where the background noise just does not trip the EBS circuit. This value should be such that a drive of a little higher than -25 dB (say 5 watts or -23 dB in our example) turns on the EBS circuit.

If, when first switching on the EBS circuit, your -25-dB background noise does not trip the EBS circuit, reduce the value of R9 (22k), and determine the value where a -25-dB signal will not trip the EBS circuit, while a -23 dB signal does.

Once you've determined the correct value of R9, you've not only installed a good working power saver but have achieved *total elimination of all bothersome background noise*, while running 15 or 20 dB of processing in a noisy environment. Nobody (especially the locals) will hear the blowers and accuse you of running excessive power!

Ssb using no signal processing. Using the EBS circuit with a value of R9 as determined above but driven by a nonprocessed ssb drive signal will result in too-low sensitivity of the input circuit. This will cause the circuit to switch on syllables. The result will be a distorted signal (similar to a vox dropping in and out while you talk because of too-short vox delay).

To work properly, the value of R9 must be decreased until switching does not occur between syllables. The best way to find out is to listen to your own signal using headphones and adjust R9 until the breaking up on syllables disappears. A value of 1.5 - 3.3k seems to be a good starting value.

If you want the EBS circuit to be fully flexible for both ssb modes (processed and nonprocessed ssb drive signals), a small switch (S2) or relay can be installed, which switches a second resistor in parallel with R9 to reduce its value when operating with a nonprocessed drive signal.

references

1. Marv Gonsior, W6VFR, "Electronic Bias Switching for Linear Amplifiers," *ham radio*, March, 1975, page 50.
2. J. A. Bryant, W4UX, "Electronic Bias Switching for RF Power Amplifiers," *QST*, May, 1974, page 36.

bibliography

1. John A. Devoldere, ON4UN, "Improved Performance from the Drake R4-B and T4XB," *CQ*, March, 1976.

ham radio

The Microwave Module line of linear transverters.

Use your present HF equipment on 144 or 432 MHz. These units are not the least expensive on the market . . . we believe they are the finest!

The standard IF is 28 to 30 MHz. However, we will provide 50 to 54 MHz or 144 to 148 MHz upon request. All units are covered by a full one year guarantee.

MMT 432/28S \$259.95
MMT 144/28S \$198.95

Receiving converters available for 2 meters, 432 and 1296 MHz. Write for complete catalog.

POWER SUPPLIES

28 Volt, 18 Amp Regulated Power Supplies (110V in) \$75.00
12 Volt, 18 Amp Regulated Power Supplies (110V in) \$85.00
Dual 300V D.C. 1 amp fully metered \$85.00

RECEIVERS

Collins 651F-1, 2 to 30 MHz in 100 cycle steps, digital tuning, USB/LSB/ISB. Stability: 1 part in 10⁸. Completely remote controlled, with all racks, connectors, control head. \$1400.00
R-388/51J — Collins 0.54 to 31 MHz \$375.00
R-390A — 0.54 to 31 MHz, overhauled complete \$595.00
Astrocom SR201, 30-300 MHz, all solid state \$450.00
RACAL Model 6217A, 980 kHz, 32 MHz, All Solid State, takes about 3 inches of rack space, digital tuning \$1600.00
LTV G111 Panoramic Recvr includes CRT display, 100-150 MHz with converters. Will make a fine spectrum analyzer. \$150.00



TMR-5 with front end plug-ins to cover 105-140 MHz and 200-260 MHz. \$250.00
2200 to 2300 MHz available.

We have complete documentation for all TMR-5 series including plug-ins.

CEI type 415, 60-250 MHz, all solid state, modular constr., xtal controlled, 4 channels. Incredible value. \$85.00

635V-1 Collins Preselector band pass Filters — They're back! 2 to 30 MHz. 1 kHz steps, with copy of manual and rack and connector. \$275.00

SX-115 Immaculate with speaker and manual. \$450.00

ANWRR2, 2-30 MHz, synthesized or continuous tuning, completely bench checked. \$600.00

TEST EQUIPMENT

URM-25H Sig. Gen., 10 kHz to 50 MHz calibrated attenuator. \$195.00

TS-419/U Sig. Gen. — 900 to 2200 MHz \$175.00

Jerrold 707P Sweep Gen. main frame with D51 detector. \$125.00

Bird 6835 Termination Wattmeter complete RF Assy. — NEW! 1.2 KW, 600 watts, 120 watts full scale. You add oil and meter. \$95.00

SPECIAL: Micromatch in-line wattmeters, complete guts, less meters, good to 500 MHz. You add 50µA meter. Removed from equipment. \$24.95

HP400DR Audio VTVM — NEW \$125.00

Solartron DA410 Transfer Function Analyzer with manual. \$475.00

Weinschel 693-1 Power Attenuators, 30 watt avg., 10KW peak. \$65.00

HP764D Dual directional coupler, 200-500 MHz. \$100.00

TRANSCEIVERS

Collins KWT6-6/URC32 — 2-30 MHz, 1 kHz steps, complete xcvr, 500 watt PEP output, 500 watt CW output, AM capability. Complete and running. \$1850.00

PRC 47 Transceiver, 2 to 11.999 MHz, synthesized, 1 kHz steps, 100 watts PEP, AM/CW/SSB/RTTY. Built-in antenna tuner. \$200.00

or with CV-2455 \$235.00

RTTY Converter CV-2455/PRC-47 Built-in loop supply (60 mA or 20 mA) — requires rcvr audio and 24 volts. It's also an AFSK Keyer. 850 Hz shift. \$65.00



Standard T/T pad mounted in a sturdy steel case incl. 2 volume pots & 1 push button labeled "Stereo". Also has 2 phone jacks for headphones, microphone, etc. Will make a fine control head. \$24.95

T/T to Pulse Converter — requires 12-24 VDC \$34.95

Wanted: Documentation for AN/WRR-2, plug-ins and IF Amplifiers for TMR-5.

DISC-CAP, 1434 REYNOLDS ST. AUGUSTA, GA. 30902 404-722-1121

Ga. Residents - add State Sales Tax. Unfortunately, Disc-Cap can only service U. S. customers.

DSI

DSI INSTRUMENTS INC.

Be the one who's on FREQUENCY!!

With your *DSI Counter*. . . save the shop cost of tweaking xtals. . . know your frequency. . . from 160 meters through 450 MHz. Now *DSI* offers *the most* counter for your dollar. Latest state-of-the-art technology. . . *DSI* advanced LSI design far exceeds outdated TTL. Go with the leader . . . buy a *DSI FREQUENCY* counter and **SAVE TIME & MONEY!!**



MODEL 3500 \$149.95
Includes TCXO ± 1 PPM

- **MADE IN USA**—Factory assembled—2 Hr. Burn-in Test & Calibration
- Built in 600MHz Prescaler with RF Preamp—Not an addon
- 7 Large Bright— $\frac{1}{2}$ inch LED Readouts
- Resolution—10Hz Non-Prescaled 100Hz Prescaled, .1 sec Gate
- **ACCURACY** ± 1 PPM \pm one count ± 1 PPM per six months from 65°F to 85°F
- **SENSITIVITY**—50 mVrms 150 to 250MHz 100mV @ 450MHz
- Gate Time Light—Automatic Decimal Point Placement
- Automatic Leading Zero Blanking When No Input Signal is Present
- No RF Connection Required with Supplied Antenna
- **S0239** Connectors Supplied for Direct Probe Input
- AC or DC Operation—115 VAC 50/60 Hz 8.5V to 13.5 VDC @ 300ma
- Comprehensive **Owners Manual** with Complete Schematics
- Size 2 7/8" H x 8" W x 5" Deep



MODEL 3600A \$199.95
Includes oven timebase $\pm .5$ PPM

- **MADE IN USA**—Factory Assembled—8 Hr. Burn-in Test & Calibration
- Built in 600MHz Prescaler & RF Preamp—Not an addon
- 8 Large Bright— $\frac{1}{2}$ inch LED Readouts
- Two Selectable Gate Times—.1 sec. & .1 sec. 100Hz to 600MHz
- **Accuracy** $\pm .5$ PPM \pm one count ± 1 PPM per six months from 50°F to 100°F
- **Sensitivity**—10mVrms 150 to 250MHz 50mV @ 450MHz
- Gate-time & Oven Light—Automatic Decimal Point Placement
- Automatic Leading Zero Blanking—When No Input Signal is present
- No Direct RF Connection Required—With Supplied Antenna
- **S0239** Hz input 50Hz to 75MHz—**S0239** Low ± 10 MHz to 600MHz
- AC or DC Operation 115 VAC 50/60 Hz, 8.5V to 13.5VDC @ 400ma
- 50Hz to 600MHz Sine or Square Wave Input
- **FCC Certifiable**—Designed for the Professional Service Technician
- Resolution 1 Hz Non-Prescaled 10Hz Prescaled @ .1 sec. Gate

PERFORMANCE YOU CAN COUNT ON

1. **PPM OVER TEMPERATURE RANGE** With a spec. of ± 1 PPM over 50°F to 100°F, your worst error over temperature would be ± 145 Hz, when measuring 145 MHz. This is the most important specification for any frequency counter because temperature variation of only a few degrees could have a drastic effect on the accuracy of your counter.
2. **PPM LONG TERM** With a spec. of ± 1 PPM per six months, your additional error would only be 145Hz when measuring 145MHz, six months after calibration.
3. **LAST DIGIT ERROR** All counters have an error in the last digit, if the last digit should read a 5 it could be a 4, 5 or 6. When you have 10 Hz resolution (last digit represents tens of Hz) your additional error will be ± 10 Hz.
4. **TOTAL ERROR** The overall error of a counter is the sum of the error due to temperature variation, last digit error and long term error. A simple ± 1 PPM spec. with no mention of temperature or ageing could conceal a much larger overall inaccuracy. Example: ± 1 PPM at 75°F is ± 145 Hz at 145MHz, but the same counter might be in error 1 KHz or more at only 85°F.

VISIT US AT YOUR NEXT HAMVENTION
Dallas, TX, June 17-18 • Greensboro, NC, July 29-30

See Your Local Dealer

or
Call Toll Free (800) 854-2049 *DSI Instruments Inc.*

• NO EXTRA COSTS •

FREE Shipping anywhere in U.S.A.

Name _____

Address _____

City _____ State _____ Zip Code _____

Please send more information on your full line of instruments

Check Enclosed C.O.D.

Please charge my: Bank Americard Visa Master Charge AE

Card # _____ Exp. Date _____

Signature _____

California Residents add 6% State Sales Tax and Call Collect (714) 565-8402

.....
: Strongest warranty in the counter field. :
: **ONE YEAR** Parts and Labor :
: Satisfaction Guaranteed. :
.....

Dennis Romack WA60Y1
VP Marketing, DSI

7914 Ronson Road No. G, San Diego, CA 92111

DSI**DSI INTRODUCES**

THE FIRST FULL LINE OF FREQUENCY COUNTER ACCESSORIES

Performance You Can Count On

DON'T SCRAP THAT OLD FREQUENCY COUNTER

**600 MHz PRESCALER ÷ BY 10
WITH BUILT IN PREAMP**

- 10 MV @ 150 MHz & 250 MHz
- 50 MV @ 450 MHz
- INCLUDES 115VAC SUPPLY
- OPERATES ON 8-12 VDC
- RUGGED CAST ALUMINUM CASE
- READY TO USE ON ANY COUNTER

**69⁹⁵**

MODEL PS-600

**SUPER PRE-AMP
15 DB PRE-AMPLIFIER
20 MHz TO 800 MHz**

- OUTSTANDING AS A PROBE AMPLIFIER
- INCREASE SENSITIVITY OF A COUNTER WITH 100 MV TO 12 MV TYP.
- INCLUDES 115VAC SUPPLY
- OPERATES ON 8.2-13.5 VDC
- RUGGED CAST ALUMINUM CASE

**69⁹⁵**

MODEL PA-800

**RTTY-PL-AUDIO
AUDIO SCALER**

- x10, x 100 MULTIPLIER
- .01 Hz RESOLUTION WITH 1 SEC GATE TIME
- 20 MV SENSITIVITY 10 Hz to 10 KHz
- HI Z INPUT 1 MEG OHM
- A MUST FOR PL REEDS, RTTY AND LOW AUDIO WORK WHERE ACCURACY IS MANDATORY

**49⁹⁵**

MODEL AS-100X

**PROTECT YOUR COUNTER
T-TAP
160 METERS TO 450 MHz**

- POWER LEVELS — 1 WATT TO 250 WATTS
- USE IN LINE WITH TRANSCEIVER
- LOW LOW LOSS
- PROVIDES LEVEL OUTPUT TO COUNTER AT ALL POWER LEVELS
- USE IN LINE WITH DUMMY LOAD OR ANTENNA
- RUGGED CAST ALUMINUM CASE

**32⁹⁵**

MODEL T-100

ALL UNITS ARE FACTORY ASSEMBLED, TESTED AND CARRY A FULL 1 YEAR WARRANTY.

SEE YOUR LOCAL DEALER

OR

CALL TOLL FREE (800) 854-2049

California Residents add 6% State Sales Tax and Call Collect (714) 565-8402

7914 Ronson Road No. G, San Diego, CA 92111

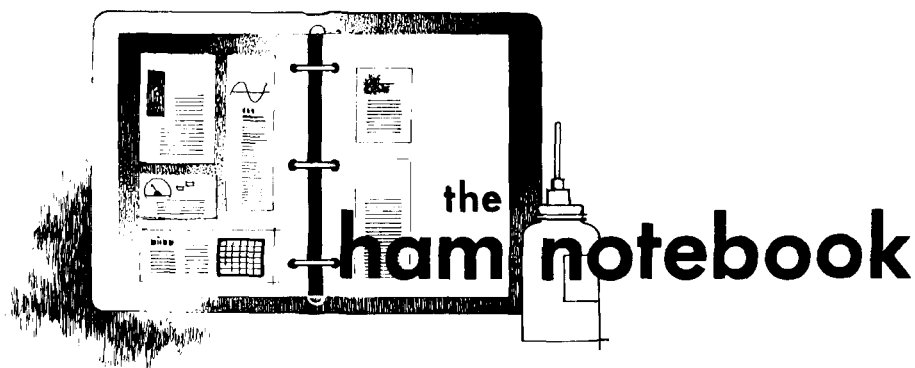

rejuvenating transmitting tubes with thoriated-tungsten filaments

Many amateur high-powered linear amplifiers are designed around the popular Eimac family of tubes, such as the 4-250A, 4-1000A, and the 3-500Z. All these tubes use thoriated-tungsten filaments. All other things *being equal*, the life of these tubes depends on the filament, which should be treated with care if you expect your tubes to last.

Filament emission is a complex process. As the chemical composition of the filament changes, the electron emission changes. As soon as the tube is turned on, it starts to lose electron emission, which finally drops below a value determined to be the "end-of-life" point. This process generally takes several thousand hours.

Once the end-of-life point is reached, the filament's chemical composition is so changed that nothing can be done by the user to restore the filament emission. The tube is then said to be "decarbured." The ditungsten carbide on the filament surface has thus evaporated or has combined with residual gas, and the carbide surface layer on the filament is gone.

Theoretically, it's estimated that a four per cent increase in filament voltage will result in a 20K increase in temperature, a 20 per cent increase in peak emission, and a 50 per cent decrease in life because of filament carbon loss. This, of course, also

works the other way. For a small decrease in temperature and peak emission, life of the filament carbide layer, and hence the tube, can be increased substantially.

For the Eimac 4-1000A and other tubes of this filament voltage, broadcast stations run the tube at 7.2 volts instead of 7.5 volts. The reason is extended life. The 3-500Z filament should be run at 4.8 volts instead of 5.0 volts, and so on. The filament voltage should be checked with a 1 per cent meter to achieve these values.

If the tube filament is contaminated, or if electron emission is otherwise inhibited (perhaps a grid has been overheated and has liberated gas, or filament chemistry has been upset by running the filament at a *very low* voltage), the tube can be rejuvenated by increasing the filament voltage by about 15 per cent and running it for a time at this overvoltage (filament power only; no other voltages on the tube elements). This filament overvoltage action will cause emission material in the filament to "boil" out from the filament interior and form a new emissive surface.

The "cooking" time depends on the filament condition — the time may be only a few minutes or it may be longer. The only way to tell is to test the tube at intervals for emission. If the tube has been cooked properly, and the filament is in the right condition chemically to begin with, normal electron emission will be restored.

If you have a power tetrode or triode tube that has lost filament-

emission (evidenced by decreased power output), it's certainly worth a try to get the tube back to near-new condition. Make sure that you meter the "cooking" circuit properly and that adequate cooling for the tube envelope and filament connectors is allowed.

These large tetrodes are expensive to replace, and you haven't anything to lose by cooking the filament of one that's lost emission. However, don't expect miracles. If your linear has used tubes, you probably don't know the history of the tube's operation and the cause of filament emission loss. It's worth a try, though, and you may be pleasantly surprised.

Alf Wilson, W6NIF

audio rolloff

Many people find that their external *Touch-Tone** encoder will not access some systems. Many times, this is not the fault of the radio or the encoder, but actually the interface between the two units. What often occurs is that the signal from the encoder is connected into the audio input. Most radios incorporate a small-value capacitor (0.001 to 0.0033 μF is typical) between the microphone input and the first audio IC. This capacitor rolls off the low frequencies from the *Touch-Tone* encoder, yet passes the high frequencies relatively unattenuated.

One possible solution to this problem is to change the value of the input capacitor to 0.1 μF . If this is not practical, another remedy would be to directly inject the signal from the encoder into the input of the first audio IC. In this case, connect a 0.01 μF capacitor between the encoder and the IC. The capacitor should be mounted as close to the circuit board as possible to preclude any problems with rf getting into the audio stage.

Joe Olivera

**Touch-Tone* is a registered trademark of the American Telephone and Telegraph Company.

tester for 6146 tubes

Since many popular exciters and transceivers use 6146 tubes, and since it is not easy to find a tube tester to accommodate this tube, there is a need for a simple tester to evaluate the condition of 6146 transmitting tubes. This is particularly important when speech processors are used — they tend to raise the average power input, thus shortening tube life. The circuit shown in **fig. 1** uses junk box parts, but will provide a very acceptable 6146 tube tester.

In this tester an ac bias for the grid is provided from the filament winding. It must be polarized. It must be

polarized properly, *i.e.*, the grid must be going positive as the plate is going positive. To check this, reverse the filament connections. Choose the

more as indicated on the meter. Note that this meter indication is the average of half-wave rectified current. Tubes providing 90 mA or less should

fig. 1. Simple tester for 6146 transmitting tubes is easily built from junk-box parts.

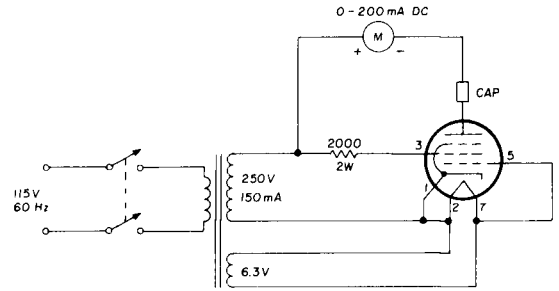

one which yields the greatest plate current. The tester is then ready for use.

A good tube will draw 115 mA or

be discarded or, at most, kept for emergency spares. The tester is also useful for balancing pairs of tubes.

Gary Liegel, W6KNE

programmable accessory for electronic keyers

Since completing the programmable accessory for electronic keyers, August, 1975, *ham radio*, I've struggled to get it operational with my WB4VVF keyer,¹ achieving only intermittent success. The problem has always centered around the memory address and the READ/WRITE control line.

As I've discovered, the READ/

Therefore, since it turned out that the clock pulse from Q2's collector will directly drive U9A, both U8 and U11A are no longer required. The READ/WRITE switching is still done with S3 as seen in **fig. 2**.

Another problem was that the output pulse from U11B was fast enough to feedthrough the first binary counter in U12 and trigger the second binary counter simultaneously. This prevented full address of the memories. Bypassing pin 4 of U11B with a 1000 pF capacitor cured the problem.

simple frequency counter

The frequency counter described by K4JIU in February, 1978, *ham radio*, page 30, has proven to be a simple, but useful, design. Unfortunately, after building the counter on the board supplied by Mr. Bordon, the counter wouldn't operate above about 30 MHz on the 50-MHz range, or above 300 MHz on the 500-MHz range. Discussions with the author indicated that the problem probably revolved around the waveform presented to the 7208. The Intersil data sheet stated that the optimum input waveform should have a 50 per cent duty cycle. This is the case in the 5-MHz range. But, when using the 74196 prescaler, the Q_D output has an 80 per cent duty cycle.

One possible cure is to use the Q_C output from the 74196 to drive the counter. This will give a duty cycle of 60 per cent. This change also requires that the nonscaled 5-MHz input be loaded through Data Input C instead of Data Input D. The change is accomplished by cutting the foil runs at pins 12 and 13 of U3 and using pieces of insulated wire to connect the foils to pins 2 and 3 respectively. After the change, there will be no connections to pins 12 or 13.

Carroll Hamlet, W2QBR

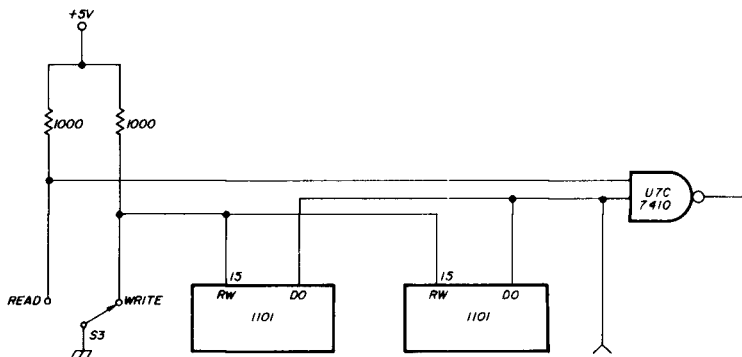

WRITE line of the memories does not have to be synchronously pulsed with the address locations, merely taking the R/W line to +5 volts during the READ is sufficient.

Since programmable memory address was not required, 7493s were substituted for 74193s. Additionally, sockets must be changed from 16 pin to 14 pin. The 7493 is somewhat cheaper and more available from suppliers.

John M. Korn, K9WGN/W0USL

1. James Garrett, WB4VVF, "The WB4VVF Accu-Keyer," *QST*, August, 1973, page 19.

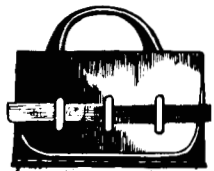

U.S. MAIL

comments

phasing networks

Dear HR:

In regard to VK2ZTB's article summarizing ssb phase shift networks in the January, 1978, issue, several comments are in order. First, a review of the many existing broadband audio phase-shift networks is fine, but the underlying theory *common* to each should also be presented.

In general, the type of networks employed are called all-pass filters (the attenuation is constant, and the phase changes monotonically with respect to frequency, over the entire frequency band of interest). All-pass filter characteristics:

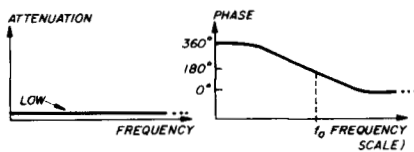

$$\frac{V_{output}}{V_{input}} = \frac{-\omega^2 - j\frac{\omega_0}{Q}\omega + \omega_0^2}{-\omega^2 + j\frac{\omega_0}{Q}\omega + \omega_0^2}$$

where $\omega = 2\pi f$ and ω_0 and Q are constants.

If two all-pass filters are constructed with the proper Q and ω_0 (for each), an audio phase shifter for ssb generation results. This is done as follows:

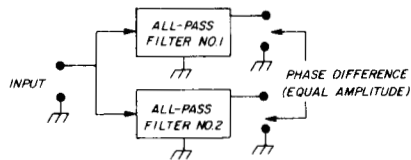

The Q of both filters is chosen to be 0.2252. ω_0 of all-pass filter 1 is 2π (428 Hz); ω_0 of all-pass filter 2 is 2π (2104 Hz).

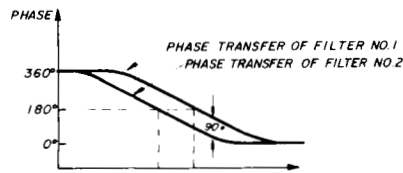

Note that even though the phase shift of each filter changes with frequency, the phase *difference* between the two outputs is 90 degrees over a wide band of frequencies.

No active filter examples were in-

cluded in the article (VK2ZTB's fig. 11 uses op amps, but there are no RC networks in the feedback path). Why not use the more state-of-the-art active filter approach? One realization of this type of circuit uses two Steffen all-pass filters.

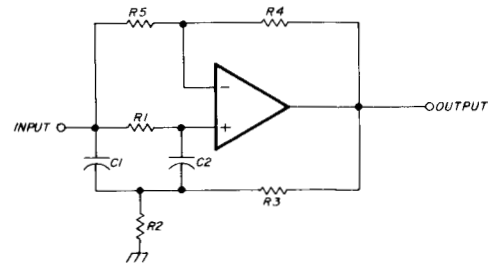

The general transfer function for the Steffen circuit is:

$$\frac{V_{out}}{V_{in}} = \frac{-\omega^2 - j\omega \left[\frac{R_4}{R_5} \left(\frac{1}{R_2} + \frac{1}{R_3} \right) \frac{1}{C_1} - \frac{1}{R_1 C_1} - \frac{1}{R_1 C_2} \right] + \frac{1}{R_1 C_1 C_2} \left(\frac{1}{R_2} + \frac{1}{R_3} \right)}{-\omega^2 + j\omega \left[\frac{1}{R_1 C_2} + \frac{1}{R_1 C_1} + \left(\frac{1}{R_2} + \frac{1}{R_3} \right) \frac{1}{C_1} - \frac{1}{R_3 C_1} \left(1 + \frac{R_4}{R_5} \right) \right] + \frac{1}{R_1 C_1 C_2} \left(\frac{1}{R_2} + \frac{1}{R_3} \right)}$$

tween the two outputs is 90 degrees over a wide band of frequencies.

The resulting audio phase shift network for ssb generation (300 to 3000 Hz) is as follows:

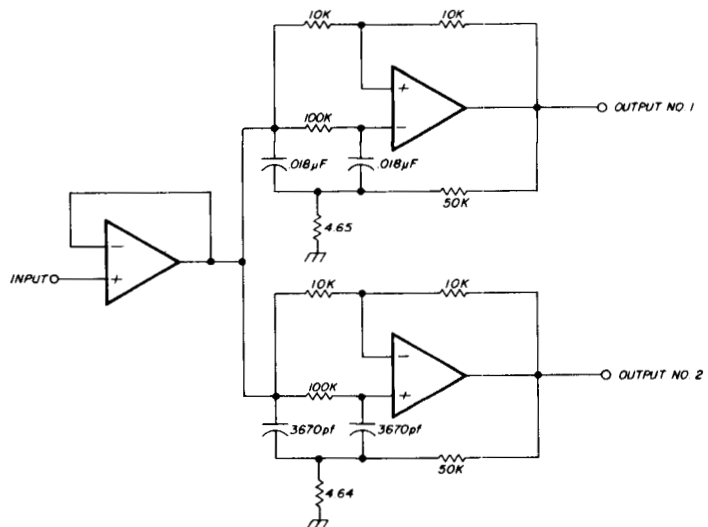

Tom Apel, WB9YEM
Madison, Wisconsin

What's on Your Mind???



Whether you're planning a complete new station or merely thinking about replacing some old coax cable, we at Clegg will be delighted to discuss it with you—at our expense!

We stock almost anything you're apt to need, whether you are equipping a station from scratch—or adding some crystals to your HT. Our lab and service facilities are second to none. And if you're shopping for price we offer a modest discount schedule based on your total purchase.

TOLL FREE
IN PA CALL COLLECT

1-(800)-233-0250
(717) 299-7221



Some of the product lines we stock in depth:

ICOM WILSON DRAKE KLM YAESU
MICROWAVE MODULES MFJ MOSLEY
HUSTLER ANTENNA SPECIALISTS B&W
DENTRON ALPHA (ETO) CDE MAGNUS
CLEGG

Call TOLL FREE for a copy of our Current Illustrated Catalog or just to discuss "What's on Your Mind"!

Clegg

Communications Corp.
1911 Olde Homestead Lane
Greenfield Industrial Park East
Lancaster, PA 17601





NEW products

For literature on any of the new products, use our *Check-Off* service on page 126.

EMI Power Purifier Pack

Now you can obtain a three-in-one package that will eliminate over 90 per cent of your mobile electrical-noise problems. Called the *Power Purifier Pack*, the kit from Marine Technology includes a power-line filter for use between the battery and your transceiver or other equipment; an alternator filter to reduce or eliminate alternator whine; and an ignition filter to clean up noise from that source.

The EMI-ACE, while not offered as part of the kit, can be obtained separately for use with fuel pumps, windshield wiper motors, cooling or heating blowers, and the like. The ACE may not be necessary in all cases.

For more information on the EMI *Power Purifier Pack* and other Marine Technology products, write to Marine Technology, 2780 Temple Avenue, Long Beach, California 90806; or use *ad check* on page

new Heath wattmeter

Heath Company, the world's largest manufacturer of electronic kits, has released a new wide-band Bi-directional Wattmeter. Called the IM-4190 (or SM-4190 in an assembled version), it is a self-contained unit that measures transmitted radio power up to 300 watts and reflected power up to 30 watts. It covers the 100-MHz to 1-GHz spectrum, and is an ideal tool for two-way radio serv-

ice and repair, or for the amateur-radio enthusiast.

The IM-4190 is capable of withstanding full power overloads on its lower scales without damage to the meter movement. A single 9-volt battery powers the IM-4190, so it may be used while portable. N-type coaxial connectors are used for low insertion loss. Adaptors are included for use with UHF-type connectors.

The IM-4190 kit retails for \$114.95 and the SM-4190 assembled version \$195.00 (mail order from Benton Harbor). For more information on the IM/SM-4190, write Heath Company, Department 350-630, Benton Harbor, Michigan 49022.

VIZ wattmeters



The Test Instruments Group of VIZ Manufacturing Company has introduced two new easy-to-use wattmeters that are ideal for testing vhf, fm, and even uhf transmitters as well as popular high-frequency and CB units.

The WV-551A dummy-load rf wattmeter has a broad frequency range — from 1.9 to 512 MHz. Its power range is 0.5 to 15 watts with full-scale accuracy better than 5 per cent. Input impedance is 50 ohms, and vswr is less than 1.15:1 at 500 MHz. It is simple to use: the transmitter output line is connected directly to the unit and readings are taken from the scale on a taut-band meter. The user price for the WV-551A is \$60.

The WV-552A in-line rf wattmeter is a dual unit used to measure both forward and reflected power — especially useful in matching and adjusting antennas, or for tuning transmitters for maximum output. Readings are taken from the two easy-to-read meters.

Measurements with the WV-552A are possible over three selectable frequency ranges: 20-40 MHz, 40-100 MHz, and 100-230 MHz. The meter's power ranges are 0-20 watts and 5-100 watts (forward), and 0-5 watts and 1-20 watts (reflected); full-scale accuracy is better than 5 per cent. The vswr is less than 1.15:1 over the entire frequency range, and input impedance is 50 ohms.

Both wattmeters are supplied with type M connectors; M-to-N and M-to-BNC adaptors are available.

The user-price is \$150. For further information and data sheets, contact Bob Liska, VIZ Test Instruments Group, VIZ Manufacturing Company, 335 East Price Street, Philadelphia, Pennsylvania 19144; telephone (215) 844-2626.

Palomar Electronics hand-held transceiver



The new Palomar Mini-I VHF-FM transceiver is about the same height as a dollar bill — yet it's a giant in performance. The transmitter output is one watt, with a total of 18 channels available in the 144-148-MHz band. The channels are obtained by using up-down split, down-up split, or simplex, all with only six crystals.

With the Auto-Patch option, the Palomar Mini-I can access a repeater and communicate through the telephone system as well.

Dimensions of the Palomar Mini-I are 152 mm high by 67 mm wide by 46 mm deep. Its compact size makes it exceptionally convenient as a means of portable communications.

For more information about the Palomar Mini-I VHF transceiver, write to Palomar Electronics, 655 Oppen Street, Escondido, California 92025.

Hamtronics converters

Hamtronics, Inc., announces a new series of low-cost vhf and uhf converters for use in receiving Oscar and other exciting signals on your present high-frequency receiver. At prices of \$34.95 for the kit (or \$54.95 wired and tested), they're quite a bargain for the enjoyment you'll get from listening to the ever-increasing activity on these bands.

The converters are small in size: only 7 x 11 x 2.5 cm (2-3/4 x 4-1/2 x 1 in). They can be constructed and tested in only a few hours. Built-in test points make alignment simple. The converters feature new high-Q coils, compartmental shielding, and ferrite-bead decoupling.

Any 2-MHz segment in the vhf and uhf range can be covered, using the 10-meter band on your existing receiver. Standard models are listed below, and other rf and i-f ranges are available on special order at the same price. An attractive extruded aluminum case kit is available as an option for \$12.95 additional.

standard converters for 28-30 MHz i-f

model	input range
C50	50-52 MHz
C144	144-146 MHz
C145	145-147 MHz
C146	146-148 MHz
C110	Any 2 MHz of aircraft band
C220	Any 2 MHz of 220-MHz band
C432-2	432-434 MHz
C432-5	435-437 MHz
C432-7	427.25 (61.25 MHz i-f)
C432-9	439.25 (61.25 MHz i-f)

To order, or to request a free 40-page catalog on vhf and uhf transmitters, receivers, preamps, and accessories, call 716-663-9254; or write Hamtronics, Inc., 182F Belmont Rd., Rochester, New York 14612.

CUSHCRAFT IS THE FM ANTENNA COMPANY.

Cushcraft manufactures the world's most complete line of quality antennas for amateur VHF-FM repeater service including high-gain multi-element vertical beams, stacked arrays, 5/8-wavelength mobile whips, half-wavelength Ringo[®] verticals, and the world-famous Ringo Ranger[®], which features stacked vertical half-wavelength elements for 4.5 dBd omnidirectional gain. Whether your favorite repeater is next door or across the state, Cushcraft has a VHF-FM antenna which is exactly engineered to your needs.

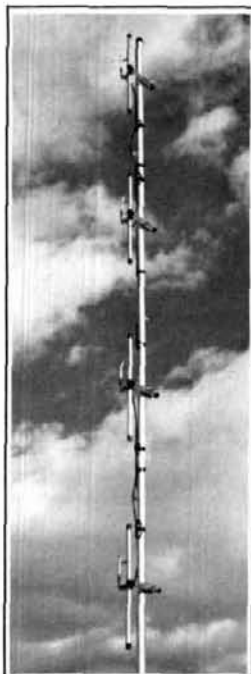

Four Pole

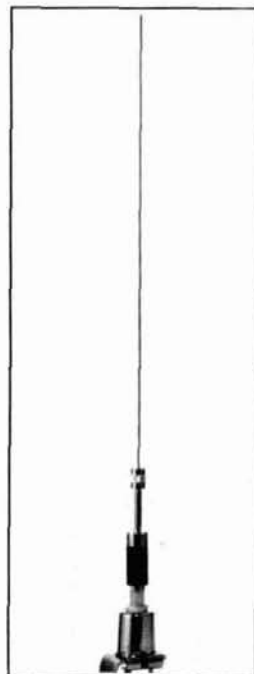

5/8 wave Mobile

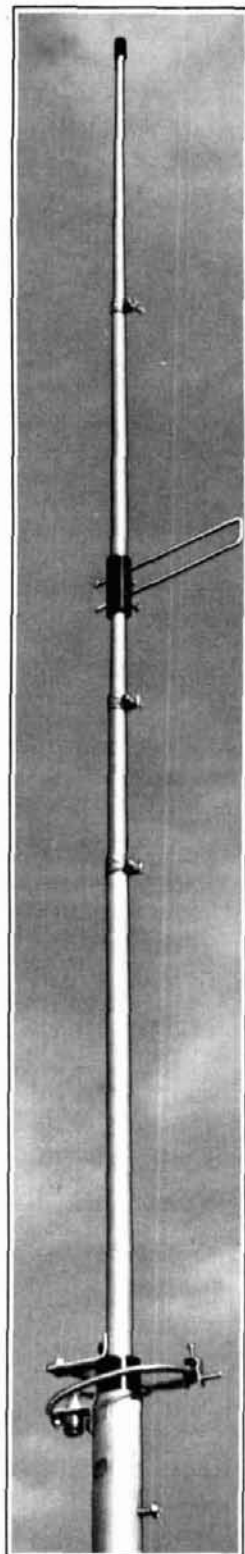

Ringo Ranger[®]



UPS SHIPPABLE
cushcraft
CORPORATION

In Stock With Dealers World Wide P.O. Box 4680, Manchester, N. H. 03108

R-X Noise Bridge

All Palomar Engineers products are made in U.S.A. Since 1965, manufacturers of Amateur Radio equipment only.



- Learn the truth about your antenna.
- Find its resonant frequency.
- Adjust it to your operating frequency quickly and easily.

If there is one place in your station where you cannot risk uncertain results it is in your antenna.

The Palomar Engineers R-X Noise Bridge tells you if your antenna is resonant or not and, if it is not, whether it is too long or too short. All this in one measurement reading. And it works just as well with ham-band-only receivers as with general coverage equipment because it gives perfect null readings even when the antenna is not resonant. It gives resistance and reactance readings on dipoles, inverted Vees, quads, beams multiband trap dipoles and verticals. No station is complete without this up-to-date instrument.

Why work in the dark? Your SWR meter or your resistance noise bridge tells you only half the story. Get the instrument that really works, the Palomar Engineers R-X Noise Bridge. Use it to check your antennas from 1 to 100 MHz. And use it in your shack to adjust resonant frequencies of both series and parallel tuned circuits. Works better than a dip meter and costs a lot less. Send for our free brochure.

The price is \$49.95 and we deliver postpaid anywhere in the U.S. and Canada. California residents add sales tax.

Italy write i2VTT, P.O. Box 37, 22063 Cantu. Elsewhere send \$52.00 (U.S.) for air parcel post delivery worldwide.

Fully guaranteed by the originator of the R-X Noise Bridge. ORDER YOURS NOW!

Palomar Engineers

Box 455, Escondido, CA. 92025 • Phone: [714] 747-3343

artwork transfer film for PC boards

Printed Circuit Products Company, of Helena, Montana, has produced a film that can be used to pick up artwork from printed pages and used for etching sensitized board. Called **PCP Type-A**, the film is easy to use. A protective backing is peeled off, then the clear film is pressed in place over the desired artwork. A blunt instrument is used to burnish the film into firm contact with the paper, and to remove all air bubbles. The combination is soaked in water until the paper softens and can be removed by rubbing, leaving the "print" on the film.

After the film has dried, the artwork is ready for use. Simply apply it over the surface of any sensitized pc board material in the normal manner, and expose, develop, and etch your own printed circuits.

The Type-A film eliminates the many photographic processes that usually accompany transferring artwork from the printed page to a form useful in etching boards. Note, however, that the artwork does not change form in the process — it remains either negative or positive, just as it is printed.

PCP Type-A film can also be used to create custom decals for your equipment, relabel meter faces, dials, or panels. For more information and prices, write to Printed Circuit Products Company, P.O. Box 4034, Helena, Montana 59601.

Touch-Call encoder

Standard Communications has announced the availability of their new TT-1A Touch-Call encoder which can be mounted on the front of SCC Model C146A, C730L, and C830L hand-held transceivers. The unit uses the dual-tone multiple frequency (DTMF) system to enable the user to place remote telephone calls, obtain access to repeater systems, activate decoders in other transceivers, or to

perform other remotely controlled operations.

The tones generated are compatible with both the Bell and RCC radiotelephone requirements. The unit is solid state and generates two simultaneous audio tones between 600 and 1700 Hz. The digitally synthesized frequencies generated are nonharmonic and provide high immunity to falsing. The TT-1A requires 7.5 to 15 Vdc for operation, which is obtained from the battery pack in the hand-helds. These encoders may be used with the commercial versions of SCC's hand-helds, which cover 450 to 512 MHz or 148 to 174 MHz and the amateur radio 144 to 148 MHz model. See your Standard dealer or write Standard Communications Corporation, P.O. Box 92151, Los Angeles, California 90009.

Multicore Solder products



Multicore Solders, a leading world-wide supplier to aerospace, electronic, and industrial manufacturers has introduced a line of selected, professional-quality solders and soldering accessories specifically packaged for the technician, service man, home owner, hobbyist, and do-it-yourselfer. Included in the product line are multiple-core wire solders in a variety of alloys and/or flux formulations, solid wire solder, solder creams, an emergency solder, flux pastes, and a line of desoldering wick.

CUSHCRAFT IS THE HF MULTIBAND ANTENNA COMPANY.

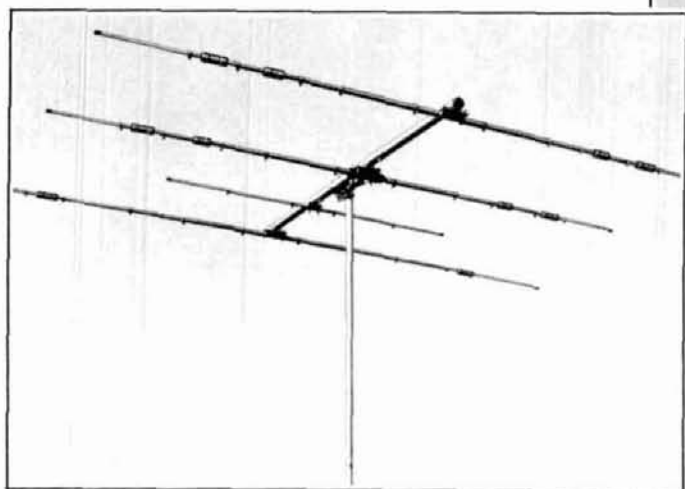

ATB-34, Three Band

Cushcraft manufactures a full range of high-frequency antennas which are performance engineered for the most discriminating amateur. For the amateur who demands top performance in a multiband Yagi beam there's the incomparable ATB-34 three-band beam for broadband, high-gain coverage on 10, 15 and 20 meters.

And for the Amateur with limited antenna space and budget who wants reliable, multiband radio communications there are three Cushcraft multiband verticals to choose from: the three-band ATV-3 for 10, 15 and 20; the four-band ATV-4 for 10, 15, 20 and 40 meters; and the ATV-5 for low VSWR five-band performance from 80 through 10 meters.

Cushcraft high-frequency antennas are quality engineered for top performance; they are often imitated, but never duplicated.

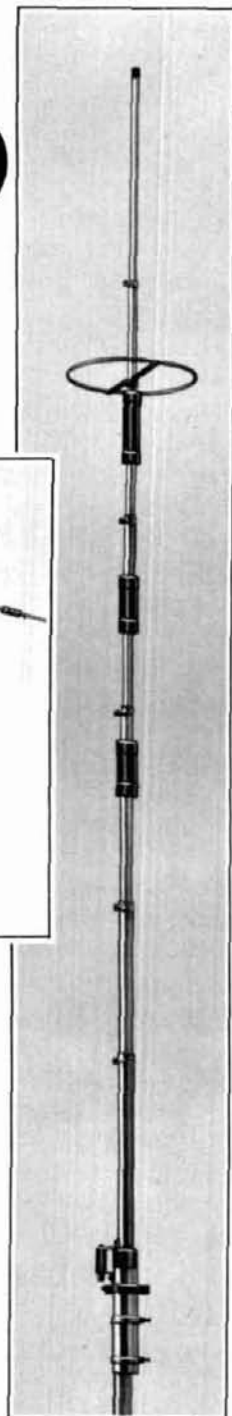

ATV-4, Four Band

 **UPS SHIPPABLE**
cushcraft
CORPORATION

In Stock With Dealers World Wide P.O. Box 4680, Manchester, N. H. 03108

We're Proud of Our Flock!



MODEL 43

BIRD

ALL MODELS AND TABLE ELEMENTS IN STOCK.
WE ALSO CARRY OTHER BIRD PRODUCTS... WRITE!

NEW PRICE \$125.00

AUTHORIZED BIRD DISTRIBUTOR — DEALER INQUIRIES INVITED.

We are also Dealers for:



YAESU

KLM electronics

Mosley



Wilson



ALL PREPAID & CREDIT CARD ORDERS SHIPPED NO CHARGE IN U.S.

SALES TAX 4% TO VIRGINIA RESIDENTS ONLY.

SPECIALISTS IN HANDLING FOREIGN ORDERS



ELECTRONIC EQUIPMENT BANK, INC.

516H MILL STREET, VIENNA, VA 22180

CALL COLLECT 703-938-3511

PUNCH UP



Your

Most Called Numbers with a Single Key Punch!

Now you can dial up to 18 complete 7 or 8-digit phone numbers by punching only one (or two) keys on your pad. The AD-1 Auto Dialer's 10 number capacity RAM can be completely programmed from its own pad in less than a minute. The optional field-installable factory-programmed PROM adds 8 more numbers for \$4.95. The AD-1 is ideal for mobile autopatches, home or business use. It features a unique MOS microprocessor which permits both tone duration and spacing to be programmed along with the numbers, adding versatility for repeater or similar control functions. Its crystal controlled tone generator assures high stability over a wide temperature range. The AD-1 is fully automatic and foolproof in operation. Coil cord provides convenient connection to your rig. Suggested Amateur net price \$129.95. A PROM order card is packed with each AD-1.

The AD-1 Auto Dialer is available at the finest amateur radio dealers and distributors everywhere.



Advanced Electronic Applications, Inc. P.O. Box 2160, Lynnwood, Washington 98036

Among the different solder alloys offered are those for electronic, general-purpose electrical, and a number of nonelectrical applications including sheet-metal work, plumbing, aluminum, and even a solder specifically formulated for stainless steel and silver jewelry.

The packaging for each of the products has been carefully designed to provide the user with a functional and practical choice, depending on the quantity he plans to use as well as storage requirements. All packaging is printed with complete application and instructional data, and is color coded according to alloy for quick identification. Complete information on all these products is available from Multicore Solders, Westbury, New York 11590.

Whitehouse parts catalog

A new catalog is available from G. R. Whitehouse & Co. of Amherst, New Hampshire. It lists many of the parts for amateur projects which have been described in *ham radio*, *Ham Radio Horizons*, and other amateur literature.

A scan through the pages reveals such items as a kit of parts for noise bridges, transmatches, and computing SWR indicators. There are several pages of individual component listings, such as toroid coils, ferrite beads and rods, and an assortment of cores for the experimenter.

A number of Barker & Williamson items are carried by Whitehouse, including coaxial switches, air-wound coils, multi-band plate circuits for high-power final amplifiers, and attenuators and filters.

The catalog shows a good selection of variable capacitors, including those made by E. F. Johnson, James Millen, and some Cardwell and Hammarlund types. Another section displays Jackson Brothers dials and drives, James Millen knobs and shaft couplers, and aluminum cases.

There is also a large section listing the J. W. Miller inductors and the Cushcraft line of antennas and accessories.

To obtain your copy of this free catalog, write to G. R. Whitehouse & Co., 16 Newbury Drive, Amherst, New Hampshire 03031.

MAX-100 frequency counter

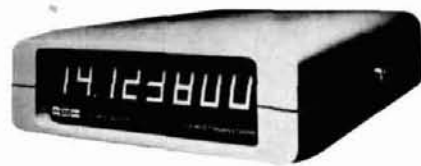

A new state-of-the-art LSI counting technology has enabled Continental Specialties Corporation to offer a competent frequency counter at a very good price. The counter, called MAX-100, delivers an accurate 8-digit display of frequencies from 20 Hz to 100 MHz. The crystal-controlled timebase features 3 ppm (parts per million) accuracy, and the counter updates the display every second.

The counter input includes a pre-amplifier which allows it to work with as little as 30 mV of signal. Diodes protect the input up to 200 Volts. Although it is a low-profile unit, the MAX-100 features large, bright, 15-mm (0.6-in.) digits. No range switch is necessary, because the least significant digit always represents 1 Hz. Leading zeroes are blanked, and over-range signals cause the most significant digit to flash.

The MAX-100 can be operated on internal alkaline or nickel-cadmium cells; or from automotive or 115-Vac power by using a battery charger or eliminator. All 8 digits flash to indicate a low battery condition, which permits extended battery life.

The input impedance of the counter is 1 megohm, shunted by 56 pF. Sine-wave sensitivity is rated at 30 mV RMS from 10 Hz to 50 MHz, 100 mV RMS to 80 MHz, and 300 mV RMS above. A number of accessories are

CUSHCRAFT IS THE VHF-UHF ANTENNA COMPANY.

Cushcraft precision engineered VHF/UHF Yagi beams have become the standard of comparison the world over for SSB and CW operation on 6 meters through 432 MHz. Built by skilled craftsmen from the best available materials, these beams represent that rare combination of high electrical performance, rugged construction, and durability.

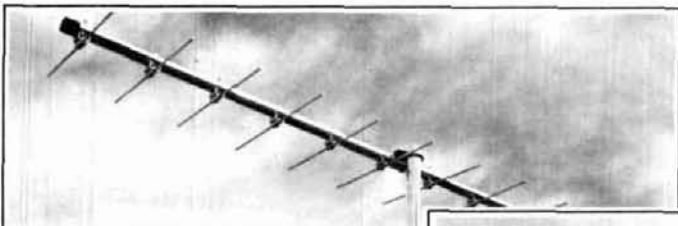

1 1/2-Meter Yagi

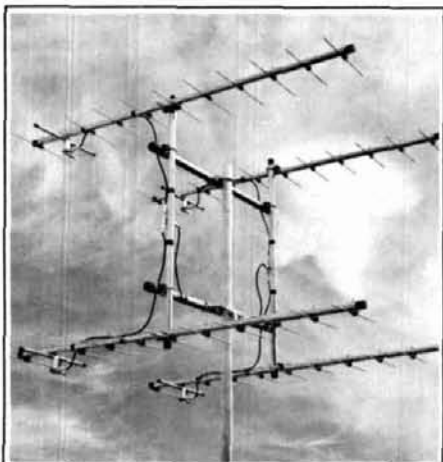

Quad Array

Cushcraft's Quad Arrays for 144, 220, and 432 MHz use four matched 11-element Cushcraft Yagis and are the ultimate in a high-performance Yagi array. These arrays have been carefully engineered for maximum forward gain, high front-to-back ratio, and broad frequency response. All antennas provide a low VSWR match to 50-ohm coaxial feedline.

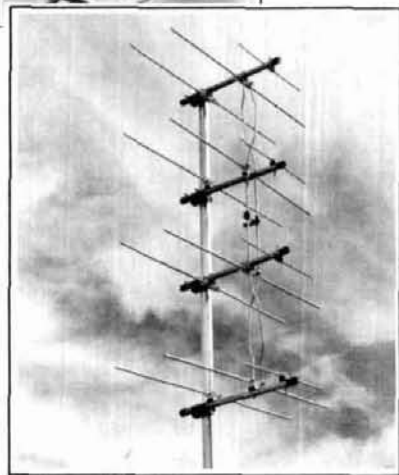

20 Element DX Array

Cushcraft's wide variety of VHF/UHF Beams includes an antenna for every amateur activity above 50 MHz, whether local ragchewing or long-haul over-the-horizon DX. All models have been carefully optimized for maximum forward gain with high front-to-back ratio. The heavy-wall bright hard-drawn aluminum booms and elements are combined with heavy formed aluminum brackets and plated mounting hardware for long operating life and survival in severe weather.



UPS SHIPPABLE
cushcraft
CORPORATION

In Stock With Dealers World Wide P.O. Box 4680, Manchester, N. H. 03108

This is easy- anyone can solder- WITH KESTER SOLDER

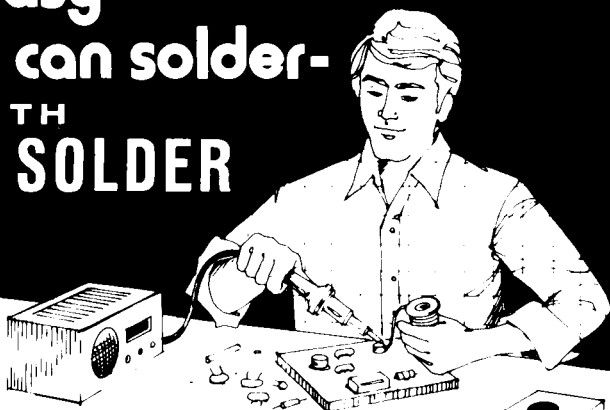

Handymen! Hobbyists! DO-IT-YOURSELFERS!

Let Kester Solder aid you in your home repairs or hobbies. For that household item that needs repairing — a radio, TV, model train, jewelry, appliances, minor electrical repairs, plumbing, etc. — Save money — repair it yourself. Soldering with Kester is a simple, inexpensive way to permanently join two metals.

When you Solder go "First Class" — use Kester Solder.

For valuable soldering information send self-addressed stamped envelope to Kester for a FREE Copy of "Soldering Simplified".



KESTER SOLDER
Litton 4201 WRIGHTWOOD AVENUE/CHICAGO, ILLINOIS 60639

Dentron BREAKS \$600 PRICE BARRIER

with the all-new

American-made DTR-1 hf transceiver

500 Hz & 1 kHz
Active Audio Filters

VOX and PTT...
Standard



Digital Readout...
Standard!

No Final Shutdown
works into any load!

Other Features

- 10 - 160M full coverage
- All Solid State
- Plug-in boards
- Semi-break-in CW with sidetone
- 2.3 kHz 8-pole SSB filter
- 9 MHz i-f
- RIT ± 5 kHz
- Noise blanker
- 25 kHz calibrator

\$599⁵⁰

ORDER NOW for August Delivery

AC Power Supply \$99⁰⁰

Hams Serving Hams Since 1939

ELECTRONIC DISTRIBUTORS, INC.

1960 PECK STREET
TELEPHONE (616) 726-3196

MUSKEGON, MICHIGAN 49441
TELEX 22-8411

available, including a battery charger/eliminator, tap-offs, a whip antenna, and a carrying case.

The MAX-100 is accurate enough for most professional field service applications; with a suggested price of \$134.95, it's economical enough for personal or educational use. For further information contact Continental Specialties Corporation, 44 Kendall Street, New Haven, Connecticut 06509.

ICOM programmable vhf marine radio

ICOM has announced a new addition to its Marine VHF radio line by introducing the ICOM M25D — similar in appearance and features to ICOM's popular 25-channel M25. A key advantage of the ICOM M25D is its 25-channel diode-programmable system. The diode matrix in the M25D can be "programmed and re-programmed" to any 25 of the commercial, pleasure, or international Marine VHF channels, thus eliminating the need to buy expensive crystals when additional channels are required.

ICOM enjoys an industry-wide reputation for producing one of the most thoroughly sealed and weather-protected Marine VHF units on the market. Like the M25, the M25D features a unique single-piece, molded-aluminum-base construction, incorporating a series of O-ring seals and gaskets around the switches and case covers to provide the maximum protection of the internal electrical components. The speaker is protected from rain and moisture by a tough, water-resistant membrane. The transceiver also features safety memory to channel 16, automatic start on 16, pushbutton selection for both weather and channel 16, a locking mounting system, a 5-watt audio system, an automatic nighttime dimmer system, and a provision for external speakers.

The ICOM M25D, like the M25, is FCC certified under both Parts 81

and 83, as well as Canadian DOC certified for pleasure vessels and compulsorily equipped commercial vessels. Learn more about the ICOM M25D by writing for a free brochure to: Icom-East, Suite 307, 3331 Towerwood, Dallas, Texas 75234; or in the western U.S., Icom-West, Inc., 13256 Northrup Way, Suite 3, Bellevue, Washington 98005.

CW speaker system



Skytec is offering a loudspeaker unit designed expressly for CW. Employing a unique, acoustic-chamber resonator, the Skytec CW-1 combines good single-frequency selectivity with a nice tone shaping characteristic.

By filtering right at the audio output, the unit suppresses hum, hiss, ringing, and miscellaneous noises left in the audio by most communications receivers. The CW-1 adds a remarkable degree of selectivity to any CW receiver, and it gives the best of receivers the most pleasant, "just right" bandpass for long contacts, net operating, and band scanning.

Priced at \$19.95, the 8.9 x 16.55 cm (3-1/2 x 6-1/2 inch), 0.9 kg (2 pound) unit is shipped with a connecting cable. A front switch provides for bypassing the audio to the regular station speaker for other than CW reception. Skytec's ordering address is Box 535, Talmage, California 95481, or for more information contact Jim Bowles, W6DLQ, at 707-462-6882.

Synthesizer II & Synthesizer 220



FEATURES

- T²L Logic
- Maximum offset versatility — easily programmed to any IF and transmitter offset between 100 KHz and 30 MHz in even 100 KHz increments.
- Jumper wire programmable for most common TX multiplying ratios
- All frequencies locked to one master crystal oscillator.
- 2 pole output filter on receive line.
- Virtually no measurable difference in spurious outputs from crystal.
- Lockup time typically 150 milliseconds.
- Easily interfaced to most rigs.
- Transmit offsets are digitally programmed on a diode matrix, and can range from 100 KHz to 10 MHz.
- No additional components are necessary!

SYNTHESIZER II

A 2 meter frequency synthesizer. Frequency is adjustable in 5 KHz steps from 140.00 MHz to 149.995 MHz with its digital readout thumb wheel switching.

SPECIFICATIONS

- Frequency: 140.000 — 149.995 MHz
- Transmit offsets: Simplex, +600 KHz, — 600 KHz plus 3 additional field programmable offsets.
- Output: 3 volts to a 50 load
- Input voltage: 11 — 18VDC at .900 amps
- Size: 8" long x 5 1/2" wide x 2 1/4" high
20.32CM x 13.97CM x 5.715CM
- Complete kit including all electronics, crystal, thumb wheel switch, cabinet, etc.

SYNTHESIZER 220

Comparable with virtually all 220 transceivers; Clegg, Midland, Cobra, etc..... Frequency is adjustable in 5 KHz steps from 220.00 MHz to 225.00 MHz with its digital readout thumb wheel switching.

SPECIFICATIONS

- Frequency: 220 — 225 MHz
- Transmit offsets: Simplex, +1.6 MHz, — 1.6 MHz plus 3 additional field programmable offsets.
- Output: 3 volts to a 50 load.
- Input voltage: 11 — 18 VDC at .900 amps
- Size: 8" long x 5 1/2" wide x 2 1/4" high
20.32CM x 13.97CM x 5.715CM
- Complete kit including all electronics, crystal, thumb wheel switch, cabinet, etc.

Shipping weight — 2 lb. 4 oz.

Price for either unit: Kit — \$169.95, Wired & tested — \$239.95

arma
smaller radio manufacturers' association

Vhf engineering

Division of Brownian Electronics Corp.

320 WATER STREET / BINGHAMTON, N.Y. 13901 / Phone 607-723-9574
Prices and specifications subject to change without notice. / Export prices slightly higher.



quantities of quality

SOMETHING TO MAKE LIFE EASY: We carry AP test clips for both 14 pin and 16 pin ICs. Gold plated wiping action; sturdy pins for scope probes; also removes ICs from sockets without damage. Model TC-14 (14 pin): \$4.50; Model TC-16 (16 pin): \$4.75. We also carry the A.C.E. 201K breadboarding kit (with 1,032 solderless plug-in tie point capacity) for only \$24.95.

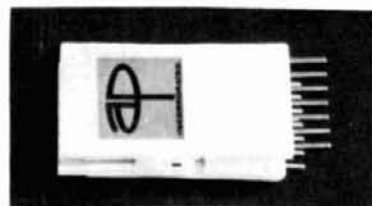

SEMICONDUCTORS FOR THE EXPERIMENTER

LM373	AM/FM/SSB IF detector (DIP)	\$1.95
LM566	Square/triangle oscillator (minidip)	\$1.75
LM567	PLL tone decoder (minidip)	\$1.85
uA706	DIP audio power amp	\$0.75
PET-1	Dual NJFET, VHF/UHF amp, package	3/\$1
FET-2	NJFET VHF/UHF amp similar to 2N4416	3/\$1
G103	Power transistor (equiv 2N3055)	\$0.75

RF TRANSISTORS

(All specs for the following taken at 25 degrees C at 2 GHz)

#2NRF1 (\$4.95) 2 GHz power transistor. Pd max 3.5W, Pout minimum 1.0W, Pin 310 mW, efficiency 30%. Similar to RCA 2N5470.

#2NRF2 (\$5.95) 2 GHz power transistor. Pd 8.7W, Pout 2.5W, Pin 300 mW, efficiency 33%. Similar to RCA TA8407.

#2NRF3 (\$6.95) 2 GHz power transistor. Pd 21W, Pout 5.5W, Pin 1.25W, efficiency 33%. Similar to RCA 2N6269.

#2NRF4 (\$7.95) 2 GHz power transistor. Pd 29W, Pout 7.5W, Pin 1.5W, efficiency 33%. Factory selected prime 2N6269.

UNELECTRONIC SPECIAL: LEATHER DICE CUP, \$2.50

It doesn't blink, flash, or communicate, but it's a beauty for dice players. Limited quantity. This is not a joke!

TRS-80 16K CONVERSION KIT

This kit contains 8 uPD416 1x16K dynamic memories and instructions on converting your 4K TRS-80 to a 16K machine. You could pay up to \$290 elsewhere, but our kit is only \$190!

TRIMMER CAPACITORS

CV2/8P	2 — 8 pF	5/\$2.00
CV2.5/11P	2.5 — 11 pF	5/\$2.00
CV3/15P	3 — 15 pF	4/\$2.00
CV3.5/14P	3.5 — 14 pF	4/\$2.00
CV4/12P	4 — 12 pF	4/\$2.00
CV5/25P	5 — 25 pF	4/\$2.00
CV5/30P	5 — 30 pF	4/\$2.00
CV5.5/18P	5.5 — 18 pF	4/\$2.00
CV6/30P	6 — 30 pF	4/\$2.00
CV7/25P	7 — 25 pF	4/\$2.00
CV8/50P	8 — 50 pF	3/\$2.00
CV9/35P	9 — 35 pF	3/\$2.00
CV9/45P	9 — 45 pF	3/\$2.00
CV15/60P	15 — 60 pF	3/\$2.00
CV/ASST.	10 assorted (no choice)	10/\$2.00

YES, WE HAVE COMPONENTS...not just some components, either, but a truly wide-range selection. From resistors to sophisticated ICs to experimenter and hobbyist items, before you do any shopping check with us... you'll be glad you did.

TERMS: Please allow up to 5% for shipping; excess refunded. Add \$1 handling for orders under \$10. Cal res add tax. COO OK with street address for UPS. For VISA®/Mastercharge® orders call our order desk (24 hrs) at (415) 562-0636. Prices good through cover month of magazine.

GODBOUT

BILL GODBOUT ELECTRONICS
BOX 2355, OAKLAND AIRPORT, CA 94614

uhf mobile antennas



A line of 5-dB gain uhf mobile antennas covering the 3/4 meter (420 MHz) frequency range and featuring simplified field tuning requirements has been introduced by Antenna Incorporated of Cleveland, Ohio.

Most 420 MHz antennas require the whip to be cut from the top and bottom for exact tuning. The Antenna Incorporated antennas feature a top sleeve which slides to adjust the upper portion of the whip, so only the bottom portion of the antenna needs to be cut for tuning.

These uhf antennas feature plated stainless-steel whips to make the antenna more conductive for reduced power loss, stainless-steel shock springs, and 17 feet (5 meters) of coaxial cable. They are available in 100- and 150-watt versions; the 150-watt models are supplied with Antenna Incorporated's high-power cable which has electrical characteristics similar to RG-8/U but in a size similar to RG-59/U.

These antennas are available in a variety of mounting configurations, including hole mount, trunk-lip mount, cowl mount, and a mount which adapts to existing Motorola mounts. The 100-watt versions also are available with a spring-clip gutter mount.

"The simplified tuning process means there is less chance for error

ATTENTION KENWOOD & YAESU OWNERS!!!

the W6TOG* RECEIVER MODIFICATION KIT

- INCREASES SELECTIVITY
 - IMPROVES SENSITIVITY
 - LOWERS INTERNAL NOISE
 - COMBATS BLOCKING FROM LOCAL SIGNAL
 - IMPROVES NOISE BLANKER OPERATION
- | | | |
|-------------------|-------|---------|
| TS-520 KIT | | \$27.50 |
| TS-520S KIT | | 32.50 |
| TS-820 & 820S KIT | .. | 34.50 |
| FT-101 SERIES KIT | .. | 32.50 |
| FR-101 SERIES KIT | .. | 34.50 |

EXPLICIT INSTRUCTIONS MAKE MODIFICATION A CINCH

*WELL KNOWN DXer WITH OVER 300 COUNTRIES CONFIRMED.

Order from

S-F AMATEUR RADIO SERVICES
4384 KEYSTONE AVE., CULVER CITY, CA. 90230
(213) 837-4870

IT'S MAGIC—IT'S "MAGICOM" PROCESSOR MODIFICATION KIT

IMPROVES AUDIO PUNCH • IMPROVES PROCESSED SPEECH QUALITY

Converts TS-820 speech processor from RF compressor to RF clipper

The "MAGICOM" RF processor module provides up to 6db increase in output with smooth, clean, non-distorted audio and more penetration for those pile-ups. Price \$27.50

ENDORSED BY W6TOG AND BIG GUN DXers WORLD WIDE

SATISFACTION GUARANTEED OR MONEY REFUNDED

All prices postpaid - in Calif. add 6% sales tax - Mastercharge & Visa accepted

when the antenna is field-cut to exact frequencies," sales manager Friedberg said. "Add to this the variety of mounting configurations we offer, and these antennas are the fastest and simplest antennas to install."

Further information on the new antennas, and the complete line of Antenna Incorporated communications antennas and accessories, is available from Antenna Incorporated, 26301 Richmond Road, Cleveland, Ohio 44146.

MFJ rf noise bridge

MFJ Enterprises has a new rf noise bridge, model MFJ-202, which allows quick adjustment, for maximum performance, of any antenna, whether a single or multiband dipole, inverted vee, beam, vertical mobile whip, or random-wire system. It indicates resonant frequency, radiation resistance, and reactance of these antennas, and also whether to shorten or lengthen the antenna for minimum swr over any portion of a band.

The MFJ rf noise bridge has a resistance range of 250 ohms and a wide capacitance range of ± 150 pF for reactance measurements. Included is a unique range-extender that shunts large unknown impedances down to within the measuring range of the noise bridge. In addition to measuring antenna characteristics, the noise bridge can be used to tune transmatches, adjust tuned circuits, and measure inductance and the rf impedance of amplifiers, baluns, transformers, and other rf circuits. It can also be used to determine electrical length, velocity factor, and impedance of coax cable. With a transmatch and dummy load, it can synthesize rf impedances for test purposes.

MFJ provides a 30-day money back trial period and a one year unconditional warranty.

The MFJ-202 RF Noise Bridge is available from MFJ Enterprises for \$49.95 plus \$2.00 shipping and handling. To order call toll free 800-647-8660 or mail order to MFJ Enterprises, P.O. Box 494, Mississippi State, Mississippi 39762.

Headquarters/USA for RSGB Publications

For years The Radio Society of Great Britain has been considered among the most prestigious organizations in Amateur Radio. This fine group has assembled what may well be the finest series of Amateur Radio publications ever issued by one publisher. Ham Radio's Communications Bookstore now offers you the opportunity to benefit from the RSGB's technical excellence and superior quality.

Whether it's your first taste of these great publications or another exciting addition to your RSGB library treat yourself today to the very best, an information-packed book from The Radio Society of Great Britain.



AMATEUR RADIO AWARDS Details over 90 international awards, including application instructions and valuable DX information. 185 pages. ©1973.
 RS-AW Softbound \$4.95

AMATEUR RADIO TECHNIQUES As an excellent idea and source book to help supplement handbook information, this new 6th edition contains 10% more pages and over 750 diagrams. 336 pages. ©1978.
 RS-RTC Softbound \$7.95

TEST EQUIPMENT FOR THE RADIO AMATEUR New chapters on wavemeters and power supplies make this completely updated version the finest test equipment book available anywhere. 135 pages. ©1978.
 RS-TRA Hardbound \$9.50

VHF-UHF MANUAL If it's above 30 MHz this book covers it — in super detail! Basics, space communications, microwaves, antennas, FM and plenty more. 400 pages. ©1976.
 RS-VH Hardbound \$13.95

RADIO DATA REFERENCE BOOK Both Amateurs and engineers will fully appreciate the excellent technical quality of this fine reference. 189 pages. ©1977.
 RS-DF Hardbound \$6.95

**ham radio's
communications
bookstore**

Available only from HRCB and selected dealers.

Greenville, NH 03048

NBFM MANUAL Here's FM theory and practice at its best along with many unique, useful circuits. 60 pages. ©1974. Softbound Regularly \$3.25.
 RS-FM Now \$2.50

TELEPRINTER HANDBOOK Most complete RTTY handbook ever published. Full information on popular page printers and auxiliary equipment, as well as theory, maintenance, adjustment and repair. 360 pages. ©1973.
 RS-TP Hardbound \$17.95

RADIO COMMUNICATIONS HANDBOOKS From tubes to semiconductors and propagation to power supplies, these handbooks are perhaps the most complete ever assembled.
Vol. 1, 460 pages. ©1976. Hardbound \$18.59
Vol. 2, 320 pages. ©1977. Hardbound \$16.50
 RS-RCH12 Both only \$29.95

OSCAR — AMATEUR RADIO SATELLITES Truly a worldwide best seller, this comprehensive book explains everything about OSCAR from concept to actual use. Charts, diagrams, and photos. 191 pages. ©1977.
 RS-O Softbound \$8.50

A GUIDE TO AMATEUR RADIO Provides Amateur Radio newcomers with basic information on receivers, transmitters, and antennas. It also explains how to obtain a British amateur license. 118 pages. ©1978.
 RS-GAR Softbound \$3.95

RSGB MEMBERSHIP AND RADIO COMMUNICATION (A monthly journal) Become a member of the famous Radio Society of Great Britain and you'll receive Radio Communication — a great magazine to stimulate your technical and construction interest. Also: reviews, propagation predictions, new products, unique advertisements and much more! 12 issues, (includes RSGB membership).
 RS-RC \$15.50

REPEATER USERS — Stay in Touch — with DSI

UNIVERSAL

TOUCH-TONE®

ENCODERS*

The Data Signal TTP Series of keyboard encoders is used to generate the standard 12 or 16 DTMF digits. The encoders provide fully automatic transmitter keying and feature a delayed Transmit Ready light, an interdigit timer, and a built-in audio monitor. Features also include all solid-state, crystal-controlled, digitally-synthesized tones and an optional internal mount Automatic Number Identifier (ANI).

TTP-1 (12-digit)
TTP-2 (16-digit)

\$59.00
\$69.00

MODEL DTM — Completely self-contained miniature encoder for hand-held portables. Only 5/16" thick. Three wire connection. Automatic PTT keying optional. With your choice of keyboards. Price DTM - \$39.00, DTM-PTT - \$49.00.

*Touch-Tone is a registered trade name of AT&T.

TTP-1



DTM



TTP-2



SUB-MINIATURE ENCODERS



MODEL SME — Smallest available Touch Tone Encoder. Thin, only .05" thick, keyboard mounts directly to front of hand-held portable, while sub-miniature tone module fits inside. This keyboard allows use of battery chargers. Price \$29.00, with your choice of keyboards. SME (less keyboard) \$24.00

AUTOPATCH — Ready to go!

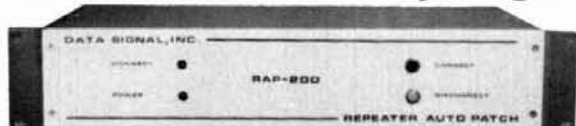

A Complete Autopatch facility that requires only a repeater and a telephone line. Features include single-digit access/disconnect, direct dialing from mobile or hand-held radios, adjustable amplifiers for transmitter and telephone audio, and tone-burst transponder for acknowledgement of patch disconnect.

RAP-200 P. C. Card
RAP-200R Rack Mount

\$199.50
\$249.50

DATA SIGNAL, INC.

2403 COMMERCE LANE

ALBANY, GEORGIA 31707, 912-883-4703



Be sure to ask about our new keyers and CW memory for CW buffs.

TPL 1/4 KILOWATT LINEAR AMPLIFIER

TPL proudly presents the first true power 1/4KW

SSB/AM, FM or CW solid state

2 meter linear amplifier

A remote control plug allows you to operate with the amplifier ON or OFF, or in SSB/AM, FM or CW from the dashboard.



The 2002 utilizes the latest state of the art engineering including micro-strip circuitry and modular construction. The three final transistors combine to produce 250W when driven by 15W or more at 13.8VDC.

POWER INPUT:

5-20W Carrier FM or CW
20W PEP maximum SSB or AM

HARMONIC ATTENUATION:

All Harmonics Attenuated
60 dB or Greater

POWER OUTPUT:

200-250W carrier FM or CW
300W PEP SSB or AM

CURRENT DRAIN:

FM-40 Amps @ 250W
SSB-30 Amps @ 300W PEP

FREQUENCY RANGE:

144 to 148 MHz*
will operate with slight degradation at 142-150 MHz.

DUTY CYCLE:

FM 50% @ 150W 33% @ 250W
SSB 60% @ 150W 50% @ 250W

Model 2002 \$479.00

can be ordered for repeater application for additional information contact

TPL COMMUNICATIONS INC.

1324 W. 135TH ST., GARDENA, CA 90247 (213) 538-9814

Canada: Lenbrook Industries, Ltd., 1145 Bellamy Rd., Scarborough, Ontario M1H 1H5
Export: EMEC Inc., 2350 South 30th Avenue, Hallandale, Florida 33009

You can't go wrong with a Mobile 2.

With 5/8 wave ready, all we left out was a high price.

Now available in both 5/8 and 1/4 wavelengths, the **Mobile 2** antennas are great for 2 meters, 220 MHz or 440 MHz bands.

The original **Mobile 2** mounts to your trunk lid. The **Mobile 2 magnetic** grabs on almost anywhere, and stays put. Even when passing big trucks.

Both antennas come with all cable, connectors and hardware in one package.

Either way, you can't go wrong with a **Kantronics Mobile 2**.



magnetic
\$19.95

trunk
\$11.95

KANTRONICS

The Lightweight Champs.

1202 East 23rd Street
Lawrence, Kansas 66044

Phone: 913-842-7745

We accept Visa, Master Charge, check and money orders.

600 MHZ. FREQUENCY COUNTER

±0.1 PPM TCXO

OPTO-8000.1

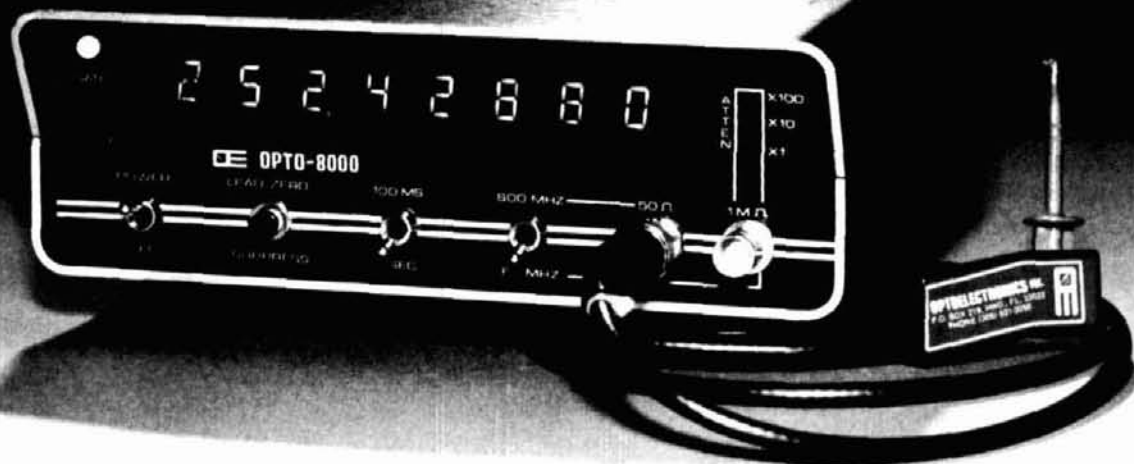

This new instrument has taken a giant step in front of the multitude of counters now available. The Opto-8000.1 boasts a combination of features and specifications not found in units costing several times its price. Accuracy of ± 0.1 PPM or better — *Guaranteed* — with a factory-adjusted, sealed TCXO (Temperature Compensated Xtal Oscillator). **Even kits require no adjustment for guaranteed accuracy!** Built-in, selectable-step attenuator, rugged and attractive, black anodized aluminum case (.090" thick aluminum) with tilt bail. 50 Ohm and 1 Megohm inputs, both with amplifier circuits for super sensitivity and both diode/overload protected. Front panel includes "Lead Zero Blanking Control" and a gate period indicator LED. AC and DC power cords with plugs included.

SPECIFICATIONS:

Time Base—TCXO ± 0.1 PPM GUARANTEED!
 Frequency Range—10 Hz to 600 MHz
 Resolution—1 Hz to 60 MHz; 10 Hz to 600 MHz
 Decimal Point—Automatic
 All IC's socketed (kits and factory-wired)
 Display—8 digit LED
 Gate Times—1 second and 1/10 second
 Selectable Input Attenuation—X1, X10, X100
 Input Connectors Type —BNC
 Approximate Size—3" h x 7½" w x 6½" d
 Approximate Weight—2½ pounds
 Cabinet—black anodized aluminum (.090" thickness)
 Input Power—9-15 VDC, 115 VAC 50/60 Hz
 or internal batteries
 OPTO-8000.1 Factory Wired **\$299.95**
 OPTO-8000.1K Kit **\$249.95**

ACCESSORIES:

Battery-Pack Option—Internal Ni-Cad Batteries and charging unit **\$19.95**
 Probes: P-100—DC Probe, may also be used with scope **\$13.95**
 P-101—LO-Pass Probe, very useful at audio frequencies **\$16.95**
 P-102—High Impedance Probe, ideal general purpose usage **\$16.95**
 VHF RF Pick-Up Antenna—Rubber Duck w/BNC #Duck-4H **\$12.50**
 Right Angle BNC adapter #RA-BNC **\$ 2.95**

FC-50 — Opto-8000 Conversion Kits:

Owners of FC-50 counters with #PSL-650 Prescaler can use this kit to convert their units to the Opto-8000 style case, including most of the features.

FC-50 — Opto-8000	Kit \$59.95
*FC-50 — Opto-8000F	Factory Update \$99.95
FC-50 — Opto-8000.1 (w/TCXO)	Kit \$109.95
*FC-50 — Opto-8000.1F	Factory Update \$149.95

*Units returned for factory update must be completely assembled and operational



OPTOELECTRONICS, INC.

5821 NE 14 Avenue
 Ft. Lauderdale, FL 33334
 Phones: (305) 771-2050 771-2051
 Phone orders accepted 6 days, until 7 p.m.



TERMS: Orders to U.S. and Canada, add 5% to maximum of \$10.00 per order for shipping, handling and insurance. To all other countries, add 10% of total order. Florida residents add 4% state tax. C.O.D. fee: \$1.00. Personal checks must clear before merchandise is shipped.



With purchase over \$50 you get 100',
buy under \$50, get 50'.

Columbia 1109 reg. \$20/c

1401 Blake St. Denver, Co. 80202



303-893-5525



 **cushcraft**

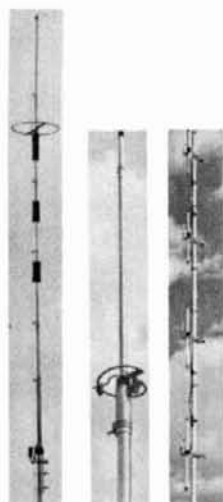

ARX 2	Ringo Ranger	\$36.95
AR 2	FM Ringo	\$24.95
AFM 4D	Four Pole	\$64.95
A147-4	4 element yagi	\$22.95
A147-11	11 element yagi	\$34.95
A147-20T	FM/SSB Twist	\$59.95
ATV 3	10/15/20 meter vertical	\$49.95
ATV 4	10/15/20/40 meter vertical	\$89.95
ATV 5	10/15/20/40/80 meter vertical	\$109.95
ATB 34	10/15/20 meter beam	\$259.95

Colo. residents add 3%

Twice as much for less.

HRCB's new LOG BOOK is here — and it is unquestionably the finest one you'll ever use. 80 big, **double-sided** pages of clear, legibly ruled stock, all spiralbound to lie flat for easy writing. More than 2000 entries give you twice the space for less money than the log book you are probably using now. Order yours today!

8-3/8" x 10-7/8", 80 pages.

ONLY \$1.50 each (plus 40¢ shipping)

Order 3 or more logs and we'll ship postpaid.



Send check, money order or charge card information:
**Ham Radio's Communications
Bookstore, Greenville, NH 03048**



LOG

\$1.50

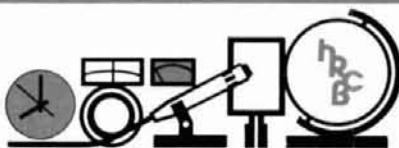

amateur radio station
number _____ from _____ to _____

ham
radio's
communications
bookstore

TEN-TEC CENTURY 21 GOES DIGITAL!

Century 21, the exciting 70-watt, 5-band CW transceiver that surprised everyone with its super performance and low cost, has another surprise for you. A second model with digital readout (and a mod kit for those who would like to convert their dial model). Both Models 570 and 574 have the same unique circuitry that has won raves from everyone — both have the same fine features:

- Direct Frequency Readout (Model 574: 5 red LED digits, 0.3" high, accurate to nearest 1 kHz. Model 570: marked in 5 kHz increments from 0-500 kHz, MHz markings for each band displayed, tuning rate typically 17 kHz per tuning knob turn.
- Full Break-In • Full Band Coverage on 3, 5, 7, 14, 21 MHz Bands, 1 MHz on 28 MHz Band • 70 Watts Input • Total Solid-State • Receives SSB and CW • Receiver Sensitivity 1 μ V • Instant Band Change, No Tune-up • Offset Receiver Tuning • 3-Position Selectivity • Adjustable Sidetone Level • Linear Crystal-Mixed VFO • Overload Protection • Built-In AC Power Supply • Black & Gray Styling • HWD: 6 $\frac{1}{2}$ " x 12 $\frac{1}{2}$ " x 12", 15 $\frac{1}{2}$ lbs. • Matching Accessories

THE RECEIVER. Double-Direct-Conversion. Easy tuning. Just select the frequency and set the audio level. Excellent cross-modulation characteristics. Offset tuning so you can tune either side of zero beat to reduce QRM. Front panel control selects one of 3 selectivity curves: 2.5 kHz for SSB reception, 1 kHz for normal CW, and 500 Hz for when the QRM gets rough. Plus separate AF and RF controls, headphone jack, and built-in speaker.

THE TRANSMITTER. Total solid-state. Push-pull Class C final amplifier. Individual low-pass filters are switched into the antenna line to reduce unwanted radiations, minimize TVI. No tune-up needed when changing frequencies or bands. And full break-in allows incoming signals to be heard between transmitted characters. Now CW is real conversation!

THE VFO. Common to receiver and transmitter. Permeability tuned. Linear scale on model 570; 5-5.5 MHz basic frequency is crystal-mixed to the desired frequency so bandwidth and stability are the same on all bands (crystals included for 3.5, 7, 14, 21, and 28-28.5 MHz segment of the 10 meter band).

THE POWER SUPPLY. Built-in, AC operated, and regulated. Monitors current demand, shuts down automatically when necessary for protection. Lighted input current meter shows proper Drive setting.

MATCHING ACCESSORIES. Model 277 Antenna Tuner/SWR Meter. Model 670 Electronic Keyer, 6-50 wpm, self-completing characters. Model 276 Calibrator for markers at every 25 and 100 kHz. Model 273 Crystal for 28.5-29 MHz. Model 1170 12 VDC Circuit Breaker for mobile operation of models 574 and 570.

574 Century 21 Digital Transceiver	\$399.00
570 Century 21 Non-Digital Transceiver	\$299.00
277 Antenna Tuner/SWR Meter	\$ 85.00
670 Century 21 Keyer	\$ 29.00
276 Century 21 Calibrator	\$ 29.00
273 Crystal for 28.5-29 MHz	\$ 5.00
274 Digital Mod. Kit for Model 570	\$ 90.00
1170 DC Circuit Breaker	\$ 8.75

See both Century 21 surprises at your TEN-TEC dealer — or write for full details.

arma

TEN-TEC, INC.
SEVIERVILLE, TENNESSEE 37862
EXPORT: 5715 LINCOLN AVE., CHICAGO, ILL. 60646

THE SECOND SURPRISE OF THE CENTURY: DIGITAL



ITS WHAT YOU CAN'T HEAR THAT MAKES YOUR QSO Q5

The Frequency-Agile FL-1 is totally unique in that it will automatically scan the 280 - 3,000 Hz audio spectrum, and when sensing interfering heterodynes, CW or RTTY signals, rejects them up to 40 DB!

NOTCH-MODE OPERATION

During your SSB/SSTV operations, the Frequency-Agile FL-1 AUTOMATICALLY scans, locks, and tracks interference within the 280-3000 Hz. spectrum, and in a second or two reduces QRM up to 40 db! For CW/RTTY usage, fully INDEPENDENT control of bandwidth

and center frequency provide rejection of interfering signals up to, or greater than 40 db.

PEAK-MODE OPERATION

The SSB/SSTV operator, using the fully INDEPENDENT controls of the FL-1, can precisely tailor the audio response; reducing or eliminating adjacent channel splatter or SSTV QRM. The CW/RTTY operator can adjust bandwidth down to 25 Hz rejecting virtually all interference to the desired signal. Often, the AUTOMATIC and AFC features of the FL-1 are desirable when in this mode.



\$179⁹⁵

including Pre-Paid shipping & full insurance

- Made in England
- Full 1 year warranty
- VISA-MASTERCHARGE accepted

GENERAL SPECIFICATIONS

- Size: 8"W, 3"H, 5.5"D
- Requires 9-16 VDC from either internal battery or external supply (not included)
- Installs easily in your audio line between your receiver and speaker
- Highest quality construction - 2 glass circuit boards, 8 I.C.s, 6 Transistors, 8 Diodes, 2 LEDs.

Dedicated to Excellence

AR Technical Products Corp.

(Exclusive Importers of DATONG FL-1's)

Box 62 Birmingham, Michigan 48010 Telephone 313/588-2288

'THE PROFESSIONALS''

NEW

MODEL CTR-2A • 500 MHz & 1 GHz

COUNTERS

NEW
Period Measurement

1 us to 1 sec.



NEW
Built-in Pre-Amp

10 mv @ 150 MHz

The New Model CTR-2A Series Counters are designed and built to the highest standards to fulfill the needs of commercial communications, engineering labs and serious experimenters. With an accuracy of + .00005% (oven option) the CTR-2A can handle the most critical measurements and is about half the cost of other commercial counters.

If you need a reliable counter at an affordable price, the CTR-2A is the answer.

- Built-in Pre-Amp 10 mv @ 150 MHz
- 8 Digit .3" LED Display
- High Stability TCXO Time Base
- Built-in VHF-UHF Prescaler
- Automatic Dp Placement
- TCXO Std. ± 2 ppm
- Period Measurement (Optional)
- Input Diode Protected
- 12V-DC Operation (Optional)
- Oven Controlled Crystal (Optional) $\pm .5$ ppm
- Selectible Gate Times - .1 & 1 sec.

500 MHz Kit CTR-2A-500K	\$249.95
500 MHz Assembled CTR-2A-500A	349.95
1GHz Kit CTR-2A-1000K	399.95
1GHz Assembled CTR-2A-1000A	549.95

OPTIONS

02) Oven Crystal	\$49.95	05) 10 sec. Time Base	\$ 5.00
03) .43" LED	10.00	06) Period	15.00
04) 12 V-DC	10.00	07) Handle	10.00

PROBES
Hi-Z
\$15.00
•
Low Pass
\$15.00

DAVIS



DAVIS ELECTRONICS 636 Sheridan Dr., Tona., N.Y. 14150 716/874-5848

GROTH-Type

COUNTS & DISPLAYS YOUR TURNS

- 99.99 Turns
- One Hole Panel Mount
- Handy Logging Area
- Spinner Handle Available

Case: 2x4"; shaft 1/4"x3"

PRICES	POST PAID	Model TC2: Skirt 2-1/8"; Knob 1-5/8"
TC 2	\$8.00	Model TC3: Skirt 3"; Knob 2-3/8"
TC 3	\$8.75	
Spinner (\$)	\$1.00	
Add \$0.75 for Air or UPS		

R. H. BAUMAN SALES

P.O. Box 122, Itasca, Ill. 60143

YOUR MARK II & MARK IV HEADQUARTERS!

MARK II 2.5-WATT
\$229⁹⁵
Plus Shipping

MARK IV 4-WATT
\$259⁹⁵
Plus Shipping

IN STOCK

THEY WORK AS GOOD AS THEY LOOK!

SHOWN WITH OPTIONAL TT PAD



SPECTRONICS, INC.
(312)848-6777 1009 GARFIELD ST. OAK PARK, ILL. 60304

WHERE RELIABILITY & ACCURACY COUNT

INTERNATIONAL CRYSTALS

70 KHz to 160 MHz

HOLDER TYPES

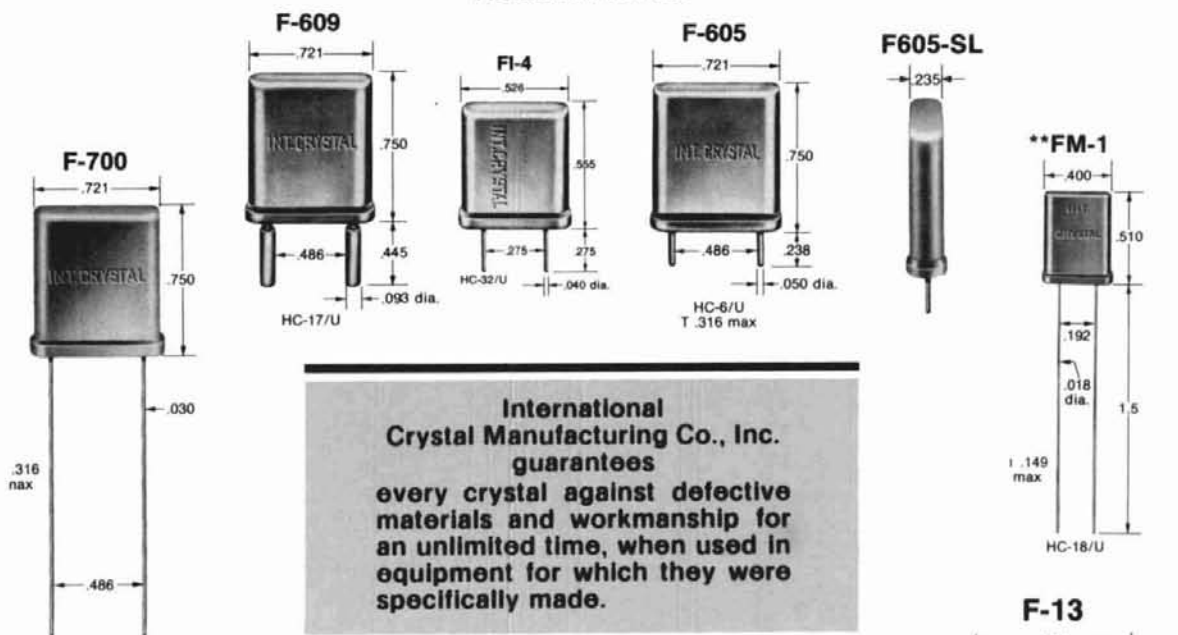

**International
Crystal Manufacturing Co., Inc.
guarantees
every crystal against defective
materials and workmanship for
an unlimited time, when used in
equipment for which they were
specifically made.**

CRYSTAL TYPES

(GP) for "General Purpose" applications
(CS) for "Commercial" equipment
(HA) for "High Accuracy" close temperature
tolerance requirements

International Crystals are available from 70
KHz to 160 MHz in a wide variety of holders.

WRITE FOR INFORMATION

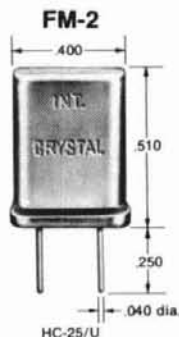

INTERNATIONAL CRYSTAL MFG. CO., INC.
10 North Lee, Oklahoma City, Oklahoma 73102
405/236-3741

MADISON ELECTRONICS SUPPLY, INC.

1508 McKINNEY
713/658-0268

HOUSTON, TEXAS 77002
Nites 713/497-5683

NEW! EXCITING! BREAKTHROUGH! DRAKE TR-7 TRANSCEIVER & ACC.



TR-7 **\$886.00**
TR-7 & DR-7 DIGITAL R/O **\$1072.00**
PS-7 POWER SUPPLY **\$166.00**

CALL FOR QUOTES ON:

YAESU	KENWOOD
FT901 DM	TS820S
FT625	TS520S
FT225	TR7400A
ALDA, AMCOMM, ETO ALPHA	
TEMPO VHF ONE PLUS	



ANTENNAS

MODEL OJA-146

TWO METER AMATEUR BAND 146-148MHz

- NO GROUND PLANE REQUIRED
- USE FIXED, MOBILE, OR PORTABLE
- 5dB GAIN OVER ISOTROPIC IN MOST MOBILE APPLICATIONS
- OVERALL LENGTH: LESS THAN 64 INCHES
- COLLAPSIBLE TO 22 INCHES. MAY BE PACKED IN SUITCASE FOR THOSE OUT-OF-TOWN TRIPS
- STEEL WHIP AND ADAPTER INCLUDED FOR MOBILE AND FIXED APPLICATIONS
- VSWR: LESS THAN 1.2:1

PRICE \$29.95 UPS Prepaid

220 MHz — \$27.95 450 MHz — \$27.95

AMATEUR BEAMS — in stock —

FINCO A62 6/2m **\$61.00**
TELREX TB5 EM **\$395.00**

CALL FOR FAST QUOTES SPECIAL ORDERS WELCOME

TERMS: All prices FOB Houston. Prices subject to change without notice. All Items Guaranteed. Some items subject to prior sale. Send letterhead for Amateur dealers price list. Texas residents add 5% tax. Please add postage estimate.

KLM: Antennas, Linears, Accessories All In Stock. **FREE** balun w/2 meter base antenna.
BIRD 43 Wattmeter plus slugs, in stock, prepaid freight.
BENCHER keyer paddles in stock **\$39.95**; chrome **\$49.95**
MIDLAND 23-136 dual meter, reads SWR and relative POWER handles 1 kW from 3-150 MHz **\$21.95**
DRAKE TR-7 **Call for Quote**
TELE-TOWER: 40' w/breakover **\$299**
 55' w/breakover **\$399**
MICROWAVE MODULES in stock
F9FT TONNA antennas: 144/16 el. **\$55.95**
 9/19 OSCAR **\$53.00**
JANEL Preamps in stock
TECHNICAL BOOKS: ARRL, Sams, TAB, TI, Rider, Radio Pub., Callbook, Cowan, TEPABCO, many others **call**
HAM X ROTOR (New Model) Turns 28 sq. ft. of antenna. List \$325. In stock. **Your Price \$249**
CDE HAM-III **\$129.00**
SWAN METERS: WM 6200 VHF Wattmeter **\$49.95**
 SWR 3 Mobile **\$9.95**
TELEX HEADSETS: in stock
CETRON 572B **\$27.95**
ADEL nibbling tool, \$6.45; punch \$3.50
CABLE 5/32", 6-strand, soft-drawn guy cable. For mast or light tower, **3¢ foot.**
BELDEN COAX CABLE: 9888 double shield RG8 foam coax, 100% braid, suitable for direct bury **39¢ ft.**, 8237 RG8 **21¢ ft.**, 8214 RG8 foam **25¢ ft.**, 8448 8-wire rotor cable **16¢ ft.**, 8210 72 ohm kw twinlead **\$19/100 ft.**, 8235 300 ohm kw twinlead **\$12/100 ft.**, Amphenol PL-259, silverplated **59¢**, UG175 adapter **19¢**, PL-258 dbl female **\$1.00**. BNC female chassis mount **59¢ ea**; MICRO RG-8/U same size as RG-59, 2 KW PEP @ 30 MHz **16¢ ft.**
BELDEN 14 gauge cop. stranded antenna wire. **\$5/100 ft.**
TIMES 1/2" foam hardline 60¢/ft. connectors **\$15 ea.**
KESTER SOLDER 1 lb. 60/40, .062 **\$6.50**
LEADER — Amateur Test Equip. — 10% off list.
MALLORY 2.5A/1000 PIV epoxy diode **19¢ ea.**
.001 MFD 20KV CAP. **\$1.95**
GE receiving tubes. **50% off list**
GE6146B, 8950 **\$7.95 ea.**

THIS MONTH'S SPECIAL

BEARCAT 210 **\$249**

SAY Electronic Power Supplies

Completely Regulated 13.8 to 20 volts dc, variable. Separate volt and amp meters. **Dual** protection against over voltage and over current.

4 amp	\$59.95
8 amp	\$109.95
20 amp	\$159.95

16 ELEMENTS — F9FT — 144 MHz

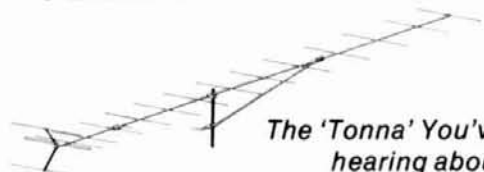

The 'Tonna' You've been hearing about

144/146 MHz	SWR ≤ 1.2:1
17.8 dBi	Wt. 4.4 kg.
50 ohms	Horiz./Vert.
length 6.4 m.	F/B ratio 22 dB
Side lobe attenuation >60 dB	
Horizontal aperture 2 x 16° (-3 dB)	
Vertical aperture 2 x 17° (-3 dB)	

\$55.95

MADISON ELECTRONICS SUPPLY, INC.

1508 McKINNEY
713/658-0268

HOUSTON, TEXAS 77002
Nites 713/497-5683

flea market



TELETYPEWRITER PARTS, gears, manuals, supplies, tools, toroids. SASE list. Typetronics, Box 8873, Ft. Lauderdale, FL, 33310. N4TT Buy parts, late machines.

EXCLUSIVELY HAM TELETYPE 24th year. RTTY Journal, articles, news, DX, VHF, classified ads. Sample 35¢. \$3.50 per year. 1155 Arden Drive, Encinitas, Calif. 92024.

MANUALS for most ham gear made 1937/1970. Send only 25¢ coin for list of manuals, postpaid. HI, Inc., Box H864, Council Bluffs, Iowa 51501.

QSL FORWARDING SERVICE — 30 cards per dollar. Write: QSL Express, 30 Lockwood Lane, West Chester, PA. 19380.

HAM RADIO HORIZONS, a super new magazine for the Beginner, the Novice and anyone interested in Amateur Radio... What it's all about, How to get started, The fun of ham radio. It's all here and just \$10.00 per year. **HURRY! HURRY!** Ham Radio HORIZONS, Greenville, NH 03048.

MOBILE IGNITION SHIELDING provides more range with no noise. Available most engines. Many other suppression accessories. Literature, Estes Engineering, 930 Marine Dr., Port Angeles, WA 93862.

HAPPY BIRTHDAY! Now ten years fighting TVI. The RSO low pass filter. For brochure write: Taylor Communications Manufacturing Company, Box 126, Agincourt, Ontario, Canada M1S 3B4.

DRAKE B LINE: T4XB, R4B, MS-4, AC-4 PS; Mint, with manuals. Sell as complete station only, \$750 firm. Prefer you examine and pick up, but will ship your cost. Jim Gray, W1XU, P.O. Box 186, Peterborough, N.H. 03458, or 603-924-6759 evenings.

WANTED: Davco DR-30 receiver, working or not. Please state price and condition in first letter. Also interested in accessory power supply/speaker unit for the DR-30. Jim Fisk, W1HR, 25 Main Street, Greenville, N.H. 03048.

WANTED: HF Transmitter, Drake preferred. Paul, WA3JXX, 3535 California Ave., Pgh., PA 15212.

HQ-140XA MINT 100KC Cal \$100. HT-32A New Tubes \$150. DenTron 80-10AT Tuner \$45. Half Done Accu-Memory \$15. Power Tubes 4-400, 4CX 250, 4X150, 2C39, Etc. 455 Kc Panoramic display \$40. B&K 2050 rf sig gen new \$50. Motor Driven Roller Inductor \$20. Stephen Johnson, N2FT, 2011 Ferry Ave., Apt. I-2, Camden, NJ 08104. (609)962-8418.

ATRONICS Code Reader, Model CR101, mint condition. First certified check or M.O. \$140 takes it. WDBMRC, 3960 N.M. — 30, Gladwin, Michigan 48624.

CERTIFICATE for proven two-way radio contacts with Amateurs in all ten USA call areas. Award suitable to frame and proven achievements added on request. SASE brings TAD data sheet from W6LS, 2814 Empire, Burbank, CA 91504.

CANADIANS: 1,000,000 surplus electronic parts. Hundreds of fantastic bargains! Good deals on Yaesu & Icom. Free catalog. ETCO-HR, 183G Hymus Blvd., Pointe Claire, Quebec H9R 1E9.

UNLIMITED VHF/UHF EQUIPMENT is at Radios Unlimited. From transverters to specialized transceivers, from mobile whips to E-M-E arrays. Plus all accessories. Authorized dealer for top manufacturers. (Also all your needs from 160 to 10) RUN in, write or phone — Radios Unlimited, 1760 Easton Avenue, Somerset, New Jersey 08873, 201-469-4599 — Hours 1 to 8 Mon-Fri; 10 to 8 Sat.

THE NEW RTTY Beginners Handbook now available, Box RY, Cardiff, CA 92024 \$4.50 postpaid.

HP-434A calorimeter, complete with cabinet, book. Inoperative \$130. Alden RJ4 19" weather-FAX machine, complete; cheaper than replacement parts, \$85. 30-300 MHz commercial antenna preamp (3 bands remotely switched) transistor with separate power supplies for each amplifier \$80. SELLERS, 4002 Columbus, Norfolk, VA 23504.

BUY-SELL-TRADE. Send \$1.00 for catalog. Give name, address and call letters. Complete stock of major brands new and reconditioned equipment. Call for best deals. We buy Collins, Drake, Swan, etc. SSB & FM. Associated Radio, 8012 Conser, Overland Park, KS 66204. 913-381-5900.

TELEONIC Slim Lowpass filter, 0.4 dB at 450 MHz; \$11 2/\$20 prepaid. Accurate 29.9 dB coupling signal sampler at 432 MHz, use two for FWD/REF power. Like micromatch 313N, 300-2000 MHz. \$15 each prepaid with data sheets. SELLERS, 4002 Columbus, Norfolk, VA 23504.

VFO WANTED. Prefer 5.0 to 5.5 mc. Stable, attractive, repairable. Yost, 70 Mt. Pleasant, Stratford, CT 06497.

NEW ITEMS

Sigma Relay — Factory new 18 ohm coil. 6 Vdc nominal coil voltage @ 60 mA. S.P.D.T. 3 amp contacts 115 Vac or 28 Vdc rating. We find this relay will pull-in as low as 1.5 volts. A real jewel. **\$1.25 ea.**

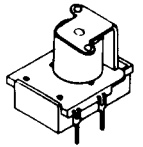

SMOKE DETECTOR



Protect your family — home — and business. These U.L. Approved, ALL METAL units were removed from large apartment complex being torn down. 115 Volt AC input. Sensitivity to smoke is 2% per ft. max. Paint may be scratched but all units tested before shipment. Buy now — Don't delay longer. **\$8.95 ea. ppd.**

Transformer: 115V AC Primary, Secondary 17-0-17V @ 7 Amps. We tested and find good for 10 Amps intermittent duty. Ideal for 2M rigs! \$8.00 ea. ppd.

High-gain 8 watt audio amp. 20 mV will drive it to 8 watts out. Rectifiers and filter cap on the board. Size approx. 3" x 4" x 3" high. All you need is 24-0-24 volts ac. Of course we supply schematic. \$3.25 ppd.

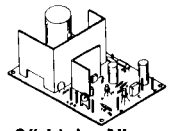

**S0239 Coax Fittings 50¢ ea.
PL259 Coax Fittings 50¢ ea.**

88 mHy unpotted toroids 5 for \$3.50

400 MW Zener diodes. Factory new — full leads. All 5% 3.3 volts, 5.1 volts, 9.1 volts, 11 volts. 10¢ ea. or 100 for \$8.00

1N914-1N4148 Type diodes — full leads. 10¢ ea. or 100 for \$8.00

Mini-Toggle. DPDT Cutler-Hammer wire-wrap terminals but can also be soldered. Gold plated. A very high quality unit. Hardware supplied. \$1.50 ea. ppd.

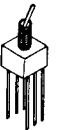

Computer Grade Capacitor. 5100 mfd @ 50 volts. Size: 2" dia. x 2-1/4" high. \$1.90 ea. ppd.

MA1003 Clock Module \$18.95

ALL ITEMS PPD USA
SEND STAMP FOR LIST OF BARGAINS
PA RESIDENTS ADD 6% SALES TAX
FONE 412-863-7006



RATES Non-commercial ads 10¢ per word; commercial ads 60¢ per word both payable in advance. No cash discounts or agency commissions allowed.

HAMFESTS Sponsored by non-profit organizations receive one free Flea Market ad (subject to our editing). Repeat insertions of hamfest ads pay the non-commercial rate.

COPY No special layout or arrangements available. Material should be typewritten or clearly printed (not all capitals) and must include full name and address. We reserve the right to reject unsuitable copy. **Ham Radio** cannot check each advertiser and thus cannot be held responsible for claims made. Liability for correctness of material limited to corrected ad in next available issue

DEADLINE 15th of second preceding month.

SEND MATERIAL TO: Flea Market, Ham Radio, Greenville, N.H. 03048.

CREATIVE QSL CARDS — New designs. Send 50¢, receive catalog, samples. WILKINS CREATIVE PRINTING, Box 787-2, Atascadero, CA 93422.

ELECTRONIC BARGAINS, CLOSEOUTS, SURPLUS! Parts, equipment, stereo, industrial, educational. Amazing values! Fascinating items unavailable in stores or catalogs anywhere. Unusual FREE catalog. ETCO-012, Box 782, Plattsburgh, N.Y. 12901. SURPLUS WANTED.

CUSTOM printed and photo QSL's, very economical; free samples. Stamp appreciated. Stu, K2RPZ, Box 412, Rocky Point, NY 11778. (516) 744-6260.

TELETYPE EQUIPMENT for beginners and experienced operators. RTTY machines, parts, supplies. Beginner's special: Model 15 Printer and demodulator \$139.00. Dozen black ribbons \$6.50; case 40 rolls 11/16 perf. tape \$17.50 FOB. Atlantic Surplus Sales, 3730 Nautilus Ave., Brooklyn, N.Y. 11224. Tel: (212) 372-0349.

THE "CADILLAC" of QSL's! Samples: \$1.00 (Refundable) — W5YI, Box #1171-D; Garland, Texas 75040.

Foreign Subscription Agents for Ham Radio Magazine

Ham Radio Austria
Karin Ueber
Postfach 2454
D-7850 Loerrach
West Germany

Ham Radio Holland
MRL Electronics
Postbus 88
NL-2204 Deilt
Holland

Ham Radio Belgium
Sterehouse
Brusselssesteenweg 416
B-9218 Gent
Belgium

Ham Radio Italy
STE, Via Maniago 15
I-20134 Milano
Italy

Ham Radio Canada
Box 114, Goderich
Ontario, Canada N7A 3Y5

Ham Radio Switzerland
Karin Ueber
Postfach 2454
D-7850 Loerrach
West Germany

Ham Radio Europe
Box 444
S-194 04 Upplands Vasby
Sweden

Ham Radio France
Christiane Michel
F-89117 Parly
France

Ham Radio UK
P.O. Box 83, Harrow
Middlesex HA3 6HS,
England

Ham Radio Germany
Karin Ueber
Postfach 2454
D-7850 Loerrach
West Germany

Holland Radio
143 Greenway
Greenside, Johannesburg
Republic of South Africa

flea market

REGULATORS	
LM304H	\$1.40
LM309K	.95
LM340-5	.95
7805	.75
7808	.85
7812	.85
7905	1.10
7912	1.10
7915	1.10
723 DIP	.65
723 TO3	.65



JOYSTICK
X-Y FUNCTION
10K LINEAR POTTS
\$3.95

toggle switch
P-C OR PANNEL
MOUNT MINI
SWITCH SPDT
\$1.00 10/\$8.



IN4007
PRIME
10c
1000 PIV 1 AMP.



HIGH VOLTAGE diode
3000PIV 250MA \$3.55
8000PIV 350MA \$1.25
6000PIV 750MA \$2.75
8000PIV 1000MA \$3.50

'Spectra Strip'
12 CONDUCTOR
22 AWG.
5 FT \$2.50
10 FT 4.00



CMOS

CHIP	\$	CHIP	\$
4000	.20	4027	.45
4001	.20	4028	.75
4002	.20	4030	.40
4006	1.10	4033	1.75
4007	.25	4035	.95
4008	.95	4040	1.15
4011	.20	4042	.75
4012	.20	4043	.85
4013	.60	4044	.85
4014	.90	4049	.50
4015	.90	4050	.50
4016	.35	4066	.90
4017	1.10	4068	.45
4018	1.25	4069	.40
4019	.70	4073	.70
4020	.90	4078	.28
4021	1.10	4516	1.00
4023	.20	4528	.98
4025	.30		

KIT
VARIABLE POWER SUPPLY
ALL PARTS INCLUDED
PS1 5-12 V \$5.95
PS2 12-28 V 5.95



T. TONE PAD HOUSING BLACK ONLY \$3.25



PHOTO CELL
C.P. CLARE NO. CL-703
\$.50 EA. 10/\$4.00



50 ohm COAX
RG 174 U
50 FT. \$2.75



CONNECTORS

BNC-M/UHF-F UG-255U \$3.00	BNC-F/UHF-M UG-273U \$2.50
N-F/BNC-M UG-349U \$3.75	N-F/UHF-M UG-83BU \$4.25
BNC-F/BNC-F UG-914U \$2.00	UHF-F/UHF-F PL-258 \$1.50
	RGB ADPT. UG 175 \$.25

NYLON CABLE TIES

4 INCH 100EA	\$1.50
6 INCH 100EA	\$2.50



50-239 65c
PL-259 65c
10/\$6.00 MIX/MATCH

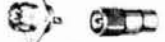

MOLEX PINS
200 EACH \$1.95
1000 EACH \$7.95



MJE3055
0 WATTS 60VCE
10 AMPS NPN
2/\$1.50



JUMBO RED LEDS
20 EA FOR \$1.00
100 EA FOR \$7.95



.1 ohm FIVE WATT RESISTOR
5/\$1.00



MARLIN P JONES & ASSOCIATES
PO BOX 9023
RIVIERA BEACH, FLORIDA 33404
(305) 848-8236

M	P
J	A

*FLA. RESIDENTS ADD 4% SALES TAX
*N.C. & VISA ACCEPTED
*ADD \$1.00 FOR ORDERS UNDER \$10.00
*USA ORDERS ADD \$8 FOR SHIPPING
*FOREIGN ORDERS PLEASE ALLOW SUFFICIENT POSTAGE

ELECTRONIC EQUIPMENT HOTLINE is a new classified advertising newsletter for buying and selling professional, industrial, and surplus electronic equipment. Subscriptions \$6/year, ads 50¢/word. Prepublication offer: \$1 off subscriptions and 20% off all ads postmarked by October 1, 1978. Electronic Equipment Hotline, P.O. Box 4768, Panorama City, CA 91402.

LORAN-C RF front-end & Preamp boards. See '73, May 1978, SASE: R. W. Burhans, 161 Grosvenor St., Athens, OH 45701.

WANTED: Hallicrafter SX115 and Heath CW/SSB filters. Andre, VE2BBT, 456 Route 138, St. Augustin, Quebec, Canada G0A 3E0.

PORTA PAK the accessory that makes your mobile really portable. \$67.50 and \$88.00. Dealer inquires invited. P.O. Box 67, Somers, Wisc. 53171.

RTTY — NS-1A PLL demodulator W/IT \$24.95 ppd. Price advance effective Sept. 1st. SASE for info. Nat Stinnette Electronics, Tavares, FL 32778.

HAM RADIO HORIZONS, a super new magazine for the Beginner, the Novice and anyone interested in Amateur Radio... What it's all about, How to get started, The fun of ham radio. It's all here and just \$10.00 per year. HURRY! HURRY! Ham Radio HOIRZONS, Greenville, NH 03048.

FREE CATALOG of new merchandise. Resistors, capacitors, IC's, semiconductors, and more. Send to: Key Electronics, Box 3506H, Schenectady, New York 12303.

WANTED: Measurements 59 grid dipper. Also interested in HF and UHF tuning heads. Jim Fisk, W1HR, Ham Radio, Greenville, NH 03048.

B&K TEST EQUIPMENT. Free catalog. Free shipping. Dinosaur discounts. Spacetron-CH, 948 Prospect, Elmhurst, IL 60126.

MOTOROLA HT220, HT200, and Pageboy service and modifications performed at reasonable rates. WA4FRV (804) 320-4439, evenings.

AUTHORIZED DEALER for DenTron, KLM, Larsen, Bearcat, etc., Big Catalog 201-962-4695 Narwid Electronics, 61 Bellot Road, Ringwood, N.J. 07456.

RECONDITIONED TEST EQUIPMENT for sale. Catalog \$5.00. Walter, 2697 Nickel, San Pablo, Ca. 94806.

TELETYPEWRITER PARTS WANTED: for all machines manufactured by: Klienschmidt Corp., Teletype Corp. and Mite. Any quantity, top prices paid send list for my quote. Phil Rickson, W4LWV, Rt. 6, Box 1103G2, Brooksville, FL 33512.

VERY In-ter-est-ing! Next 3 issues \$1. "The Ham Trader", Sycamore, IL 60178.

QSL CARDS 500/\$10. 400 illustrations, sample. Bowman Printing, Dept. HR, 743 Harvard, St. Louis, MO 63130.

HOME BREWERS: Stamp brings component list. CPO Surplus, Box 189, Braintree, Mass. 02184.

WE MAY NOT HAVE a toll-free number, but we'll save you more \$\$\$ in the long run! This month's special: CDE Ham-III Heavy-Duty rotor for only \$114.95, prepaid anywhere in the Continental United States! We are also factory-authorized dealers for Yaesu, Drake, Kenwood, Ten-Tec, ICOM, DenTron, and many more. For the best deal around on the HF or VHF gear of your choice, write or call us today for our low quote. Try our personal, friendly Hoosier service and become one of our many happy and satisfied customers. HOOSIER ELECTRONICS, P.O. Box 2001, Terre Haute, Indiana 47802. (812) 238-1456.

WANTED — Millen i-f's 455 kc and 1600 kc — #61455 #61160 several needed. Also schematic for Misers Dream Rec. Owen Laughlin, 1310 Pinecrest Dr., Ferndale, MI 48220.

AUTHORIZED DISTRIBUTOR F9FT Antennas, Microwave Modules, RIW Products' new tandem reflector, 19 element, 432 MHz Yagi — Radio Clinic — N2MB (formerly WA2BIT) 212-327-4952.

ANTENNA: All ham bands (80 thru 10) \$25 postpaid U.S.A. (CA residents add \$1.50 sales tax) Rudy Plak, P.O. Box 966, San Marcos, CA 92069.

SCANADAPTER — scan up to 10 channels of any receiver/transceiver, variable scan rate, manual advance, and 7 segment readout. Only \$29.95 wired. Pulse generators, high gain instrument amps, more. Free literature. Tek Devices, Box 19154, Honolulu, HI 96817.

GEM-QUAD FIBRE-GLASS ANTENNA FOR 10, 15, and 20 METERS

Two Elements \$139.00
Extra Elements \$99.00
Price is F.O.B. Transcona
INCLUDES U.S. Customs Duty



KIT COMPLETE WITH
*SPIDER
*ARMS
*WIRE
*BALUN KIT
*BOOM WHERE NEEDED

WINNER OF MANITOBA DESIGN INSTITUTE AWARD OF EXCELLENCE
Buy two elements now — a third and fourth may be added later with little effort.
Enjoy up to 8 db forward gain on DX, with a 25 db back to front ratio and excellent side discrimination.
Get maximum structural strength with low weight, using our "Tridetic" arms.

GEM QUAD PRODUCTS LTD.
Box 53
Transcona Manitoba
Canada R2C 2Z5
Tel. (204) 866-3338

WANTED FOR CASH



4CX150	4CX1000	4-65	4-250
4CX250	4CX1500	4-125A	4-400
4CX300A	4CX3000		4-1000
4CX350A	4CX5000		304TL
	4CX10,000		
	5CX1500		

Other tubes and Nixons also wanted.
See last month for other items available.

The Ted Dames Company
308 Hickory St. Arlington, N.J. 07032
(201) 998-4246 Evenings (201) 998-6475

TEST EQUIPMENT

All equipment listed is operational and unconditionally guaranteed. Money back if not satisfied. Prices listed are FOB Monroe.

HP120B 450kHz gen pur scope	\$215
HP170A (USM140) 30mHz scope with reg horiz, dual trace vert plugs	475
HP175A 50mHz scope with reg horiz, dual trace vert plugs	565
Quantech 303 Wave Anal	445
Tek565 Dual beam 10mHz scope less plug ins (3 series)	625
Tek585 80MHz gen pur scope less plugin	645
URM25 Stand Sig Gen 10kHz 50MHz calib atn	225

For complete list of all test equipment send stamped, self addressed envelope.

GRAY Electronics
P.O. Box 941, Monroe, Mich. 48161
Specializing in used test equipment.

CALL TOLL FREE

1-800-228-4097
Communications Center
 443 N 48th Street
 Lincoln, Nebraska 68504
 In Nebraska Call (402)466-8402

1-800-634-6227
Communications Center
West
 1072 N. Rancho Drive
 Las Vegas, Nevada 89106
 In Nevada Call (702)647-3114

Antenna Sale!

**CUSHCRAFT
 ATB-34**

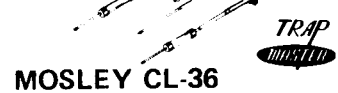
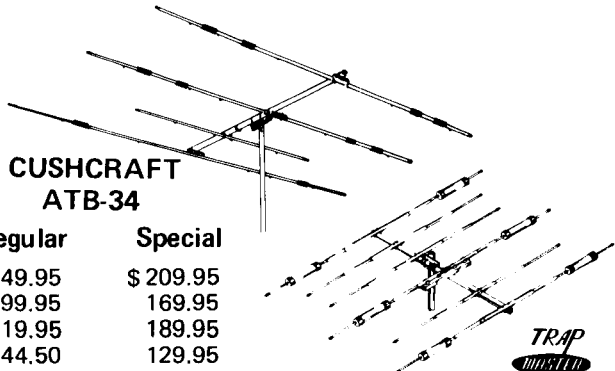

		Regular	Special
HY-GAIN			
TH6-DXX	Super Thunderbird	\$ 249.95	\$ 209.95
TH3-MK3	3 ele. 10, 15, 20 Mtr. beam	199.95	169.95
Hy-Quad	2 ele. Quad 10, 15, 20 Mtr.	219.95	189.95
TH3-Jr.	3 ele. 10, 15, 20 Mtr. beam	144.50	129.95
18 HT	Hy-Tower 10-80 Mtr. Vertical	279.95	239.95
14AVQ/WB	10-40 Mtr. Trap Vertical	67.00	57.00
18AVT/WB	10-80 Mtr. Trap Vertical	97.00	84.95
203	3 ele. 2 Mtr. beam	12.95	
205	5 ele. 2 Mtr. beam	16.95	
208	8 ele. 2 Mtr. beam	19.95	
214	14 ele. 2 Mtr. beam	26.95	

MOSLEY			
Classic 33	3 ele. 10, 15, 20 Mtr. beam	232.50	189.95
Classic 36	6 ele. 10, 15, 20 Mtr. beam	310.65	249.95
TA-33	3 ele. 10, 15, 20 Mtr. beam	206.50	169.95
TA-36	6 ele. 10, 15, 20 Mtr. beam	335.25	279.95
TA-33 Jr.	3 ele. 10, 15, 20 Mtr. beam	151.85	129.95
TA-40KR	40 Mtr. add on	92.25	74.95

CUSHCRAFT			
ATB-34	4 ele. 10, 15, 20 Mtr. beam	259.95	209.95
ARX-2	2 Mtr. Ringo Ranger	36.95	32.95
A147-20T	2 Mtr. Twist	59.95	52.95
A144-10T	10 ele. Twist 2 Mtr.	39.95	32.95
A144-20T	20 ele. Twist 2 Mtr.	59.95	52.95

HUSTLER			
4BTV	10-40 Mtr. Trap Vertical	99.95	82.95
RM-75	75 Meter Resonator	15.50	13.50
RM-75s	75 Meter Super Resonator	30.00	26.50
G6-144-A	6 db. 2 Mtr. Base Colinear	67.55	57.95

WILSON			
System One	5 ele. 10, 15, 20 Mtr. beam	274.95	239.95
System Two	4 ele. 10, 15, 20 Mtr. beam	219.95	189.95

CDE ROTORS	
Ham III	\$125.00
T2X Tail Twister	\$249.00
CD-44	\$105.00

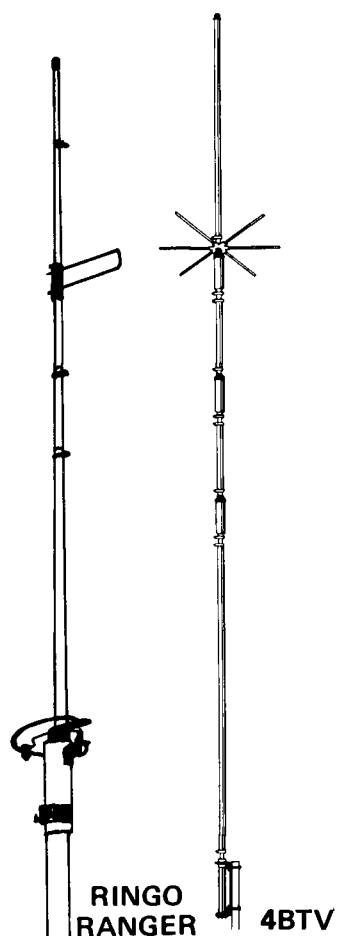

RINGO RANGER 4BTV



18HT

We carry all major brands of ham radios AT DISCOUNT PRICES

Yaesu — Kenwood — Drake — ICOM — Dentron —
 Ten-Tec — Swan — Tempo — Midland — E.T.O. — Wilson



Would You Like to Become One of the Hams at Heath?

For over two decades now, Heathkit amateur radio products have held a well-earned reputation for high quality at low cost, with serviceability built into the design. That reputation has been earned because every Heathkit amateur radio product is designed by RF engineers who are active in all facets of amateur radio. They know and understand the ham's need for high performance at affordable prices.

If you're a communications equipment design engineer, we have a rare opportunity for you to take on project responsibility designing major amateur radio products for your fellow hams. Along with good salary and benefits, it's a personally rewarding job. Ask any Heath Communications Group engineer...there's nothing quite like the satisfaction of having designed a piece of equipment that you know is being used by amateurs throughout the world.

If you'd like to become a member of our amateur radio design team, if you'd like to have the satisfaction of knowing you designed the rig that the OM on the other end of the QSO is so proud of — if you'd like to become one of the hams at Heath — then we'd like you to contact us. We're looking for graduate EE's who have specialized in HF and VHF Communications equipment design, with from one to four years of practical, proven design experience behind them. If this is the kind of opportunity you've been looking for, send your resume and salary history to Ken Smith, Professional Employment, at:

HEATH COMPANY
BENTON HARBOR, MICHIGAN 49022



An Equal Opportunity Employer M/F

flea market

RECEIVE PARTS LISTS regularly for \$4/yr. Surplus Parts, P.O. Box 7057, Norfolk, VA 23509.

WANT UP-TO-DATE INFORMATION? Radio-Hobbyist Newsletter issued every 2 weeks. Only \$5.00 year. W5Y1, Box 1171-D, Garland, Texas 75040.

EZ deals are the best! Try me and see for Yaesu, Drake, KLM, Swan, Cushcraft, DenTron, VHF Eng, ICOM, CDE, Hustler, Wilson and more. Call, see or write W0EZ, Bob Smith Electronics, RFD 3, Hwy 169 & 7, Fort Dodge, IA 50501. (515) 576-8886.

TRAVEL-PAK QSL KIT — Send call and 25¢; receive your call sample kit in return. Samco, Box 203, Wynantskill, NY 12198.

THE MEASUREMENT SHOP has used/reconditioned test equipment at sensible prices; catalog. 2 West 22nd St., Baltimore, MD 21218.

RADIO MUSEUM NOW OPEN. Free admission, 15,000 pieces of equipment from 1850 telegraph instruments to amateur and commercial transmitters of the 1920s. Amateur station W2AN. Write for information: Antique Wireless Assn., Main St., Holcomb, NY 14469.

AMATEUR MICROPROCESSOR EXPERIMENTERS: 10 MHz ± 20 ppm Coldweld crystals. 1 ppm/yr. 32 pF. C₀ 6 pF. \$4.25 ea. postpaid. Savoy Electronics, Inc., P.O. Box 5727, Ft. Lauderdale, FL 33310. 305-563-1333.

Coming Events

ALASKA: ARRL Convention, Anchorage. August 26, 27. Write: ARRL Alaska Convention 78, Anchorage ARC, PO Box 1987, Anchorage, AK 99510.

WIMU (Wyoming, Idaho, Montana, Utah) The 46th Annual WIMU Hamfest is scheduled for August 4, 5, and 6, 1978 at Mack's Inn, Idaho; 25 miles South of West Yellowstone, Montana. Talk-in 146.34/94 and 3935. Advance registration: \$6.00 for adults and \$2.00 for children, before July 25th, 1978. Late/regular registration: \$7.00 and \$2.50. SPECIAL PRIZE DRAWING FOR PRE-REGISTRATION. Please send pre-registration to: WIMU Hamfest, 3645 Vaughn Street, Idaho Falls, Idaho 83401. Phone (208) 522-9568.

ILLINOIS: Fox River Radio League Hamfest Sunday, August 27, 1978 Kane County Fairgrounds Exhibition Hall, St. Charles. 8:00 AM - 5:00 PM. Commercial exhibits & sales, used equipment market, raffle drawing; 1st prize: Kenwood TS-520 S Transceiver; 2nd prize: Midland 13-500 Transceiver. Door prizes. Motorhome camping. Admission — Raffle Tickets: \$1.50 advance; \$2.00 gate. For information & Tickets Contact: Don Berridge WB9PAC — 2303 Deerfield Way, Geneva, IL 60134. Telephone: (312) 232-0093. Talk-in frequency — 146.94 Simplex (7:00 AM to 3:00 PM).

NEW JERSEY — The 550 Amateur Radio Club annual flea market Saturday, August 26, 1978 9:00 AM to 5:00 PM American Legion Hall, Oak Street, Oakland, NJ. Admission \$1.00, tables \$3.00, tailgate \$2.00. Talk-in WR2AHD 147.49/146.49 or simplex 146.52. Dealers invited. Refreshments. For information or table reservations, write 550 ARC, P.O. Box 364, Oakland, NJ 07436, attention Mark Kirschner — WA2HLE (201) 337-3259.

IOWA: 75 Meter Net's annual Potluck picnic and hamfest Sunday, August 20, Riverside Park, Marshalltown. Awards and prizes. Lovelle Pedersen, WB0JFF Sec.

INDIANA: The Delaware Amateur Radio Association hamfest 8:00 AM until 5:00 PM., Saturday, August 12, Springwater Park, east of Muncie on Country Club Road. Hourly prize drawings from 10:00 AM until 4:00 PM, grand prize drawing at 4:00 PM. Flea market/no charge. Talk-in on 146.25-.85 or 146.52 simplex. Tickets \$1.50 advance, \$2.00 gate. Send check and SASE to: P.O. Box 3021, Muncie, IN 47302.

SPECIAL EVENT: Miss America Pageant, Atlantic City, N.J. Station K2BR. Dates: Sept. 1 to 10, 1978; Approx. frequencies: CW: 3555, 7055, 14055, 21055; Phone: 3935, 7235, 14280, 21380; Novice: 3730, 7130, 21130. QSL to K2BR. Operation from Atlantic City Convention Hall. Traffic to and from Contestants will be welcome. This station is sponsored by the Southern Counties Amateur Radio Association.

MICHIGAN: Hamfest! Aug. 6, Saline Fairgrounds — table and trunk sales, food, prizes. Talk-in 146.37/97 and 146.52. General info, advance tickets, table reservations — write Arrow, Box 1572, Ann Arbor, MI 48106.

DIPOLE HEADQUARTERS

Famous "W2AU" Balun



MODEL 1:1
or
MODEL 4:1 **\$14.95**

HANDLES FULL 2 KW PEP AND THEN SOME. Broad Banded 3 to 40 Mc. HELPS TRY PROBLEMS by Reducing Coax Line Radiation. NOW ALL STAINLESS STEEL HARDWARE. SO239 Double Silver Plated IMPROVES FIB RATIO by Reducing Coax Line Pick-Up. REPLACES CENTER INSULATOR. Withstands Antenna Pull of Over 600 Lbs. BUILT-IN LIGHTNING ARRESTER. Helps Protect Balun — Could Also Save Your Valuable Gear. BUILT-IN HAND-UP HOOD. Ideal for Inverted Vees, Multi Band Antennas, Dipoles, Beam and Quads.



MINIMUM ORDER

\$10.00

CABLE

BU FOAM, hi density braid, 50'	\$11.95
BU FOAM, hi density braid, 100'	22.90
RG58/U, stranded center, 100'	9.95
RG58, 2 ft. w/PL259 on each end,	3.05
RG58, 3 ft. w/PL259 on each end,	3.55
RG58, 5 ft. w/PL259 on each end,	3.85
RG58, 12 ft. w/PL259 on each end,	4.40
RG58, 50 ft. w/PL259 on each end,	7.45
GUY WIRE, steel/plastic, 100 ft.	4.95

COPPER WIRE

#14 STRANDED, 100' spool,	\$5.95
#14 SOLID, enameled, 100' spool,	5.95

INSULATORS

AIRPLANE style, porcelain ins., wt. 2 lb.	2/8 .99
DOG BONE style, porcelain ins., wt. 2 lb.	3/7 1.25
NAIL KNOB style, stand off ins., wt. 3 lb.	4/7 1.20
HY GAIN #155 center insulator, wt. 1.5 lb.	5.95
HY GAIN Cyclocac end ins. pair, wt. 1 lb.	3.95
MOBLEY dipole center insulator, wt. 1 lb.	4.25

CONNECTORS and ADAPTORs

PL259, UHF male conn.	2 for \$1.50
SO239, UHF female, chas. mig.69
U0175, Adaptor RG58 to PL259	2 for .59
U0176, Adaptor RG58 to PL259	2 for .69
PL259, UHF double female99
DM-8P, UHF double male conn.	1.89
M859, 90 deg. UHF elbow conn.	2.10
U088U, BNC male for RG58	1.49
U094, BNC female chassis mig.99
M854, UHF "T" connector	2.59
U0255, Adaptor UHF female to BNC male	2.49
U0273, Adaptor BNC female to UHF male	1.59



SPECTRONICS, INC.

1009 Garfield St. Oak Park, Illinois 60104

(312) 848-6777

SYNTHESIZERS

We have the worlds largest selection of synthesizers for receivers, transmitters and transceivers. For complete details see our 1/3 page ad in the April 1976 issue of this magazine or call or write for additional information. Phone orders accepted between 9 AM and 4 PM EDT. (212) 468-2720

VANGUARD LABS

196-23 JAMAICA AVENUE
HOLLIS, N. Y. 11423

MILITARY SURPLUS WANTED

WE NEED: ARC-34, ARC-51BX, ARC-92, ARC-94, ARC-102, ARC-109, ARC-115, ARC-116, ARC-131, ARC-134, ARC-164, ARN-82, ARN-83, ARN-84, ARA-48, ARA-50, APN-81, APN-123, APN-147, APX-64, APX-72, 618T, 490T-1, CU-1658A, CU-1669A, 807A, GRC-106, URC-9. TOP DOLLAR PAID OR TRADE FOR NEW AMATEUR GEAR. WRITE OR PHONE BILL SLEP, (704) 524-7519, SLEP ELECTRONICS COMPANY, HIGHWAY 441, OTTO, NORTH CAROLINA 28763.

Amateurs?

...WE ARE & WE AREN'T!

Yes, we are amateurs personally. But no, we're definitely not amateurs when it comes to engineering the most sophisticated, most dependable amateur transceivers, antennas and accessories available.

And now, as a division of Telex, the Hy-Gain trademark symbolizes an even more deeply committed approach to the electronics of amateur communication. As well as marine, professional, commercial, industrial and military systems sold worldwide.

Amateurs: we are and we're not. Stop by your nearest Hy-Gain amateur dealer today to see and hear what we mean for yourself.

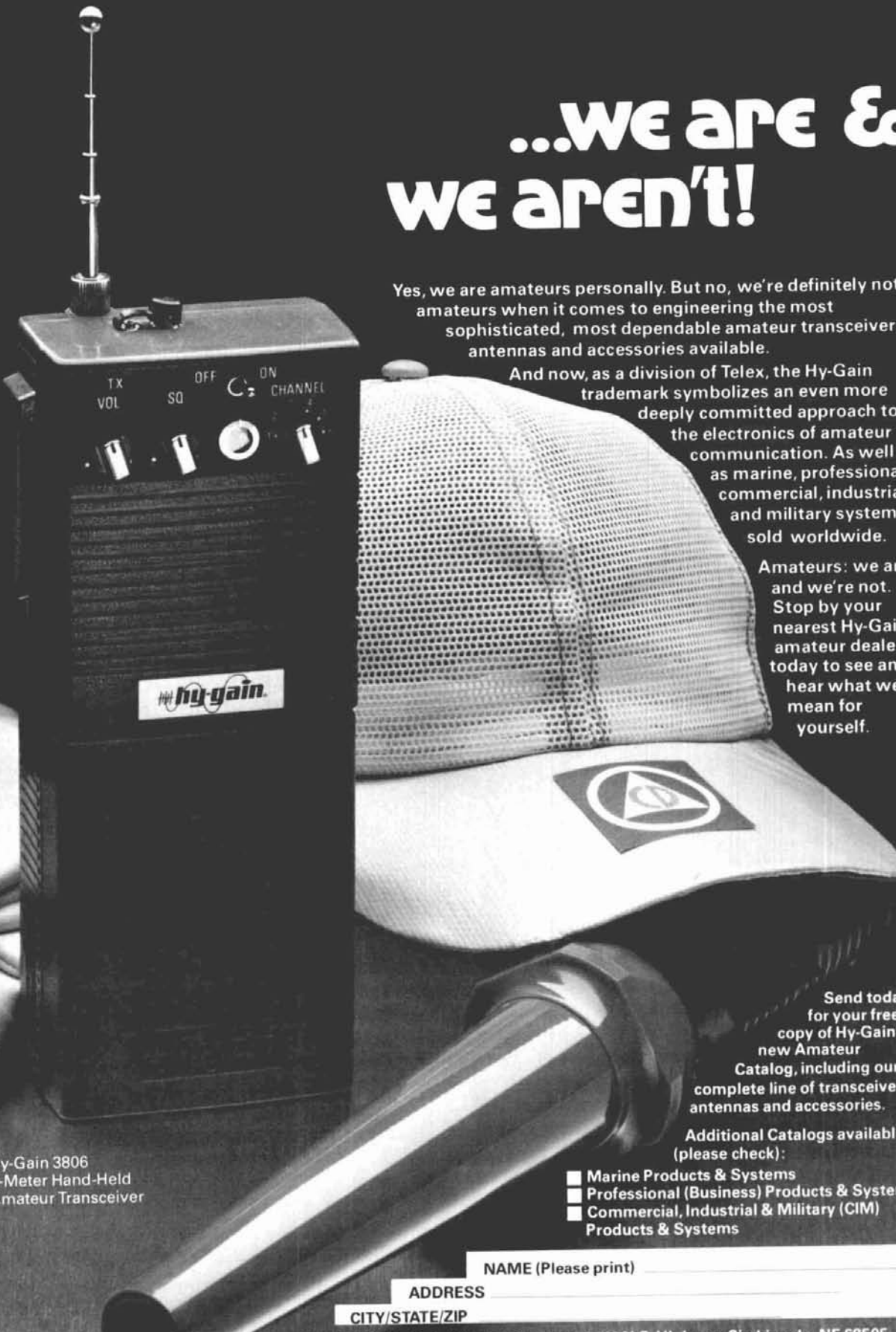

Hy-Gain 3806
2-Meter Hand-Held
Amateur Transceiver

Send today for your free copy of Hy-Gain's new Amateur Catalog, including our complete line of transceivers, antennas and accessories.

Additional Catalogs available (please check):

- Marine Products & Systems
- Professional (Business) Products & Systems
- Commercial, Industrial & Military (CIM) Products & Systems

NAME (Please print) _____

ADDRESS _____

CITY/STATE/ZIP _____

SEND TO: Hy-Gain Electronics Corp. 8601 N.E. Highway Six Lincoln, NE 68505
Phone (402) 467-5321 Telex 48-4324

& giant demo & clearance sale

FULL FACTORY WARRANTY!

WILSON:	SALE PRICE
M-66 (6 E1m 6 M)	\$ 79.95
M-68 (8 E1m 6 M)	104.95
M-420 (4 E1 20 M)	141.95
M-155 (5 E1 15 M)	134.95
WV-1 (40-10 Vert)	59.95
S Ys-1 Tri-bander	204.95
S Ys-2 Tri-bander	164.95
M 420 MTR	141.95
M 520	239.95
M 340	554.95

MOSLEY:	
S-402 2 E1 40 M	209.95
CL 36	233.95
CL 33	174.25

QUAD VIKING INSTRUMENTS:	
1322 2 E1 Quad 10-15-20 ...	202.95
1323 3 E1 Quad 10-15-20 ...	291.95

INFO TECH:	
Mod 300	450.00
100 C	391.95
75 A	287.95
93	212.95
200 C	439.95
150	259.95
75 B	289.95
30 C	289.95
200 A	419.95
10 B	269.95

**(DEALER FOR
DRAKE)... ALSO
WILSON MARK II IN
STOCK!**

WHILE THEY LAST!



**universal
amateur
radio inc**

1280 AIDA DRIVE
COLUMBUS, OHIO
(Reynoldsburg) 43068

(614)-866-HAMS

flea market

BYTE, Drink and be merry at the Tidewater Hamfest, Flea Market and Computer Show, Norfolk, Virginia, September 23-24. Over 60,000 sq. ft. of exhibit and flea market space. All indoors. All air-conditioned. Write TRCI, P.O. Box 9371, Norfolk, Virginia 23505.

FOX RIVER RADIO LEAGUE HAMFEST New Location: Indoors — Kane Co. Fairgrounds, St. Charles, IL. — Sunday, August 27th. Tickets: \$2.00 at gate — \$1.50 advance. Contact: Don Berridge WB9PAC, 2303 Deerfield Way — Geneva, IL 60134.

MANSFIELD, PA. — The Tioga County PA ARC Hamfest will be held Saturday, August 26th starting at 9:00 AM at the Tioga Co. Fair Grounds on Rt. 6 between Wellsboro and Mansfield, PA. The \$2 admission is good for all special programs and the XYL and children are free. In addition to the usual Flea Market and displays a bingo table and other items of interest will be available for the ladies and the PA Grand Canyon is within a short distance. Talk-in on 19/79, 52 Sim. and CB 5. For more information write to Denny Vorhees, WA3FWQ, RD #2 - Box 117A, Millerton, PA 16936.

TEXAS: Panhandle ARC's 4th Annual Golden Spread Amateur Radio Convention at Holiday Inn West, Amarillo. August 11, 12 and 13. Technical programs. Ladies programs. Free Bingo Saturday evening. Flea Market. Door prizes. Preregistration \$4.00. Door — \$6.00. For information: Golden Spread ARC, P.O. Box 10221, Amarillo, TX 79106.

CONN. WELI ARC 2nd Annual Flea Market & Auction Sunday, August 20 (rain date August 27) 10:00 AM - 4:00 PM Radio Towers Park, Benham St., Hamden, CT. Admission 50¢ Sellers \$5.00 ea. Info — Mike, WA1PXM (203) 943-1063 or Dave WA1ZWB (203) 467-3258.

NORTH ALABAMA HAMFEST. Sunday, August 20, 1978 at The Mall in Huntsville, AL. Prizes, large flea market, ARRL forum, MARS meetings, ladies' activities. Hamfest supper on Saturday night. For more information: N.A.H.A., P.O. Box 423, Huntsville, AL 35804.

MISSOURI: Annual Zero-Beaters ARC Hamfest Sunday, August 6, Washington City Park. Traders-row, displays, exhibitors, no extra charge. Refreshments. Ladies' activities. Prizes. For info write: WA0FYA, Dutzow, MO 63342.

INDIANA: LaPorte County Summer Hamfest, Sunday, August 27, LaPorte County Fairgrounds, LaPorte. Dealers 6:00 AM. Public 8:00 AM. 50 miles southeast of Chicago on Indiana #2. Talk-in on .01/61, .37/97 and .52 simplex. Donation \$2.00 at gate. For information: LPARC, P.O. Box 30, LaPorte, IN 46350.

PENNSYLVANIA: The Beaver Valley Amateur Radio Association's first annual hamfest Saturday, August 19, 9 AM to 5 PM at Brady's Run Park, 5 miles north of Rochester, PA on Route 51. Tickets: advance \$3.00 or 3/\$8.00. \$4.00 or 3/\$10.00 gate. Seller's fee \$1.00 your table. Flea market. Camping space, swimming, boating, fishing at park. Refreshments. Prizes: (1st) Kenwood TS-520S, (2nd) Midland 13-500 2 Meter FM Xcvr, (3rd) Den-Tron Super Tuner. Talk-in on 25/85, check-in on 52/52. For more info write Wayne R. Sphar WA3ZMS, Sec'y BVARA, 1200 Atlantic Ave., Monaca, PA 15061.

MISSOURI: SCARC Hamfest, August 27, Wentzville Community Club. Many prizes, refreshments, free bingo. Admission \$1.00 per car. Talk-in on 34-94 & 07-67. For information: SCARC, P.O. Box 1429, St. Charles, MO 63301.

PENNSYLVANIA: South Hills Brass Pounders and Modulators 41st Hamfest, August 6, noon to dusk, St. Clair Beach, Upper St. Clair Township on Route 19 South. Swap and Shop, picnicking and swimming. Mobile check-in on 29.0 MHz and 146.52 simplex. \$1.50 advance, \$2.00 door. For information: Bruce Banister, 5954 Leprechaun Dr., Bethel Park, PA 15102.

ELMIRA, NEW YORK HAMFEST — September 30th from 9-5. Door prizes, grand prize, Free Flea Market, tech talks, and more! Contact WA2-FJM, John Breese, 340 West Avenue, Horseheads, New York 14845 for tickets and info.

OHIO: 21st Annual Warren ARA Hamfest, Sunday, August 20, Trumbull KSU Campus, Ohio Rt. 45 at Warren outerbelt. 2 meter check-in. Dawn to dusk. Flea Market. Parks, lakes & family camping nearby.

ARKANSAS: Little Rock Ham-A-Rama, August 5-6, Arkansas State Fair Grounds, Little Rock. Air conditioned building. Flea market. Hourly door prizes, grand prize for \$1.00 registration. RV hookups. Talk-in on 146.52, 146.34/94 and 3995. For info call (501) 753-3450 or write CAREN, c/o Don Gephardt, WB5TSH, P.O. Box 2844, Little Rock, AR 72203.

JAN CRYSTALS HOLD THE FREQUENCY



- CB
- CB standard
- 2 meter
- Scanners
- Amateur Bands
- General Communication
- Industry
- Marine VHF
- Micro processor crystals

easy to charge

master charge THE INTERBANK CARD

BANKAMERICARD



Send 10¢ for our latest catalog
Write or phone for more details
2400 Crystal Drive
Ft. Myers, Florida 33901
all phones (813) 936-2397

TRANSFORMERS

American made, 115V Pri. All ppd.

12V 1.2 amp \$2.84 ea.

12V 3 amp \$4.48 ea.

12V 1/4 amp for P.C. \$1.66 ea.

36VCT, 1A; 14VCT, 400Ma \$4.20 ea.

44VCT, 1A; 6.3V 1/4 amp tap \$3.47 ea.

48VCT, 1A, 6.3V, 1/4 amp tap \$3.46 ea.

6.3V, 1 amp shielded \$1.80 ea.

UNPOTTED TOROIDS — Center tapped.

88 MHY - 5 oz. 5/\$2.95; 9 oz. - 5/\$3.49

44 MHY - 5/\$3.95

3000 MFD Capacitors. @ 30 Volts

1" Dia. x 3" — 90¢ ea. or 3/\$2.25

NEW — LINE CORDS — US — 7 AMP

6' — Blk — 50¢ ea. 4/\$1.50 ppd.

8' — Gray — 60¢ ea. 4/\$1.90 ppd.

EDGEVIEW METERS 250 µa 'S' METERS

NEW — \$2.65 ea. 3/\$7.25 ppd.

m. weinschenker

electronic specialties-BOX 353, IRWIN, PA 15642

DON'T KEEP A GOOD ANTENNA DOWN

put it up instead. Install the World-Record Breaking antenna that won W6TYP the QRP ARC 1,000,000 miles/watt award!

THE JOYSTICK VFA

(Variable freq. anti) gives low angle, omni-directional, harmonic free radiation on all bands 160 thru 10 (+MARS and receive on all BC & SW)

1000's of glowing reports in our files of the VFA in use, often in poor QTH and/or under QRP, contests, etc.

SYSTEM 'A' \$84.00

250W P.E.P. &/or Receiving only

SYSTEM 'J' \$110.00

500W P.E.P. &/or Improved Q Factor Receive

Air mail cost included (Each system 3 sections easily assembled to make unit 7' 6" long Matching ATU). Not only will you save space but you get better value per \$ if buying direct UK manu. Flush your order — Mastercharge, Visa, BankAmericard, or check, or ask for brochure —

PARTRIDGE (HR)

ELECTRONICS LTD

Broadstairs, Kent, England

Tel: 0843 62535

G3CED G3VFA

BULLET ELECTRONICS

P.O. Box 19442 Dallas, TX. 75219 (214)823-3240

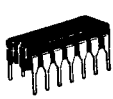

MC3301P HOUSE #
4 OP AMPS IN ONE PACKAGE. USES SINGLE SUPPLY. (4 to 28VDC). INTERNALLY COMPENSATED. SIMILAR TO MC3401, BUT HIGHER GAIN. **49¢**

MC1351P FM-IF AMP AND DISCRIMINATOR

USED IN FM & TV SOUND CIRCUITS. REQUIRES MINIMUM EXTERNAL COMPONENTS. 14 PIN DIP. DIRECT REPLACEMENT FOR HEPC 6060, ECG 748 and MANY OTHERS. HOUSE # **50¢** WITH SPECS

HOUSE #
LM3900 QUAD NORTON AMP

WE BOUGHT A LARGE QUANTITY OF THESE HOUSE NUMBERED PARTS AT A BARGAIN PRICE THAT ALLOWS US TO SELL THEM AT A LOW, LOW **39¢**

TIL312 COMMON ANODE READOUT



3" CHARACTER SIZE WITH PINOUT **.65** **6/3.00**

MC1437P DUAL 709 OP AMP
HIGH OPEN LOOP GAIN, LOW NOISE. 14 PIN DIP **3/1.00**

MPF131 N-CHANNEL DUAL GATE MOSFET



50¢

DESIGNED FOR AMPLIFIER AND MIXER APPLICATIONS TO 200 MHZ. PLASTIC CASE. UNITS ARE HOUSE NUMBERED WITH SPECS.

IL-1 OPTO ISOLATORS

BY LITRONIX 6 PIN DIP STANDARD PINOUT LED-TRANSISTOR COMBINATION. **50¢** WHILE THEY LAST!



SMALL SKIRTED BLACK INSTRUMENT KNOB.

FITS 1/4" SHAFT WITH SET SCREW.



5/1.00

MJ900 - MJ1000

COMPLIMENTARY PNP, NPN DARTINGTON POWER TRANSISTORS. 8 AMPS. WE SUPPLY A SCHEMATIC TO BUILD A HIGH POWER (35W) LOW DISTORTION AUDIO AMP WITH ONLY ONE ADDITIONAL TRANSISTOR AND A DOZEN INEXPENSIVE COMPONENTS! TO-3 CASE STYLE **BUY A PAIR FOR \$3.00!**

1N4148 DIODES

LEADS ARE TARNISHED BUT CLEAN UP EASILY. THE BOSS SAYS "DUMP 'EM"...SO CHECK THIS PRICE!

50/1.00

HOUSE # PNP POWER

TO-3

150 WATTS
80 VCEO
10 AMPS



IDENTICAL TO 2N3790 **1.00**

MC1469R POSITIVE VOLTAGE REGULATOR

1/2 AMP COMPLETE SPECS AND APPLICATIONS SHOW HOW TO BUILD FIXED OR VARIABLE POWER SUPPLIES FROM 3 TO 30VDC. DRIVE EXTERNAL SERIES PASS FOR CURRENT TO 20 AMPS!

1.25 EA.
10/10.00



HOUSE #

FANTASTIC SOUND EFFECTS CHIP

AVAILABLE ONLY FROM BULLET!

THIS 28 PIN MARVEL CONTAINS A LOW FREQUENCY OSCILLATOR, VCO, NOISE OSCILLATOR, ONE SHOT, MIXER AND ENVELOPE CONTROL. WITH 8 PAGE MANUAL. 5 to 9VDC **3.95**

ALL COMPONENTS 100% GUARANTEED

CA3011 WIDEBAND IF AMP w/specs **50¢**

2N3569 NPN EPOXY 1W **6/1.00**

741 OP AMP 8 PIN DIP **5/1.00**

723 VOLTAGE REG. 14 PIN DIP **50¢**

MPS6530 NPN HOUSE # **8/1.00**

725 OP AMP LOW NOISE HOUSE # **99¢**

7815 15V 1A REGULATOR HOUSE # **69¢**

LM340T-12 12V 1A VOLT. REG. w/specs **75¢**

TCA430 QUAD OSCILLATOR 1/specs **69¢**

2N4343 P CHANNEL J FET **4/1.00**

2N6111 PNP MED PWR 40W TO-220 **3/1.00**

2N6028 PROGRAMMABLE UNIJUNCTION w/specs **50¢**

TRIAC 200V 8A UNMARKED **3/1.00**

INCANDESCENT PANEL LAMP

WITH TINNEMAN NUT YOUR CHOICE OF RED, GREEN, YELLOW, WHITE 12-24VDC **15¢**

POWER SUPPLY METERS

Quality 3/4" meters for the P-S14. 0-15VDC & 0-25A. Matched set, individually packaged. **12.95/set** NOT SURPLUS!

CAPACITORS

SMALL SIZE!

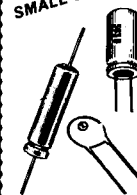

2200 MFD @ 16 VDC RADIAL **3/1.00**

500 MFD @ 35VDC **5/1.00** AXIAL

220 MFD @ 25VDC **7/1.00** AXIAL

.1 MFD @ 20VDC DISC CERAMIC **15/1.00**

FND510 69¢

COMMON ANODE READOUT 1/2" CHARACTER **LIMIT 24 PER CUSTOMER!**



Miniature 7K Pot w/water PC Mount or panel mount 1/8" shaft 49 Black plastic knob for above FREE

LIMITED QTY Computer Grade FILTER CAP Screw Terminals 2" x 5/8" 9500 mfd/75V 2.95 or 4/9.95

NEW!

➔ **ULTRASONIC SENDER RECEIVER KIT US-02** ➔
TOTAL SECURITY! Completely invisible ultrasonic (23KHZ) sound beam works like a photoelectric beam but is unaffected by light, heat or noise. Separate Transmitter and Receiver can be used from 6 inches to 25 feet! A solid object breaking the beam causes an output to go low that will sink up to 150 MA to Drive a Relay, TRIAC, etc. Complete electronics are provided. Works on 12VDC (unregulated) and draws less than 100 MA. Use it for burglar alarms, object counters, automatic door openers, automatic door bells, electronic rat traps! and more. Optional entry delay and Alarm Timeout Circuit will source or sink up to 200 MA DC. **3.96**
COMPLETE KIT LESS CASES **21.50**

LED'S JUMBO: RED 5/.89 GREEN 4/.89

MEDIUM: RED .15 MINI: GREEN .16 RED .10 YELLOW .16

1.5V 10-30 ma

POWER SUPPLY KIT PS-14

- Better than 200MV load and line regulation
 - Foldback Current Limiting
 - Short Circuit Protected
 - Thermal Shutdown
 - Adjustable Current Limiting
 - Less than 1% ripple.
 - 15 amps 11.5 to 14.5V
 - All parts supplied including heavy duty transformer.
 - Quality plated fiberglass PC board.
- Less Case, meters & jacks

39.95 UPS SHIPPING PAID!

OVERVOLTAGE PROTECTION KIT 6.95

Provides cheap insurance for your expensive equipment. Trip voltage is adjustable from 3 to 30 volts. Overvoltage instantly fires a 25A SCR and shorts the output to protect equipment. Should be used on units that are fused. Directly compatible with the PS-12 and PS-14. All electronics supplied. Drilled and plated PC board. (Order OVP-1)

Public Notice!

THE PS-14 HIGH CURRENT POWER SUPPLY KIT HAS BEEN SELLING LIKE HOT CAKES! WE WOULD LIKE TO GIVE OUR CUSTOMERS A CHANCE TO PURCHASE THE KIT AT THIS PRICE FOR 39.95 FOR OVER A YEAR. IN EXCESS OF ONE THOUSAND KITS BEFORE A SCHEDULED INCREASE TO 43.00 IN SEPTEMBER. **BUY IT NOW!**

MINI GRANDFATHER CLOCK KIT

- Chimes the hour (ie: 3 times for 3 O'clock)
 - Unique "swinging" LED pendulum
 - Tick tock sound matches pendulum swing.
 - Large 4 digit 5" LED readout
 - All CMOS construction
- Complete electronics including transformer & speaker; drilled and plated PC boards measure 4.5" x 6.5"

BEAUTIFUL SOLID WALNUT
Custom case for above kit. Over 9 1/2" tall. **19.95**

MK-03A CLOCK/TIMER KIT

Features 24 hour Zulu time and up to 24 hours of elapsed time on the same set of six digit LED readouts. Totally independent operation of both functions. Clock has presettable alarm with 10 minute snooze. Timer has reset, hold, and count functions. Full noise and overvoltage protection, 24 hour only. Readouts has dimmer feature or they can be turned off without disturbing the clock or timer. Timebase included (.01% accuracy). Because of the many options and mounting considerations the case and switches are not included. Switches are standard types. Will fit inside standard aircraft instrument case.

9-14VDC **28.95**

WARBLE ALARM Kit

A fun EASY kit to assemble that emits an ear piercing 10 watt dual tone scream. Resembles European siren sound. Great for alarms or toys. Operates from 5-12VDC up to 1 amp (using 12VDC 8 ohm speaker). Over five thousand have been sold. All parts including PC board, less speaker. **2.50** ORDER WB-02

2.50

- ★ NO C.O.D.'S
- ★ SEND CHECK M.O. OR CHARGE CARD NO.
- ★ PHONE ORDERS ACCEPTED ON VISA AND MASTERCARD ONLY.

- ★ ADD 5% FOR SHIPPING
- ★ TX. RES. ADD 5% STATE SALES TAX
- ★ ORDERS OF \$50. & OVER TAKE 10% DISCOUNT
- ★ FOREIGN ORDERS ADD 10% (20% AIRMAIL) U.S. FUNDS ONLY.

NEW FROM GLB

A complete line of **QUALITY 50 thru 450 MHz TRANSMITTER AND RECEIVER KITS**. Only two boards for a complete receiver. 4 pole crystal filter is standard. Use with our **CHANNELIZER** or your crystals. Priced from \$69.95. Matching transmitter strips. Easy construction, clean spectrum, **TWO WATTS** output, unsurpassed audio quality and built in **TONE PAD INTERFACE**. Priced from \$29.95.

SYNTHESIZER KITS from 50 to 450 MHz. Prices start at \$119.95.

Now available in **KIT FORM — GLB Model 200 MINI-SIZER**.

Fits any HT. Only 3.5 mA current drain. Kit price \$159.95 Wired and tested. \$239.95

Send for **FREE 16 page catalog**.

We welcome Mastercharge or VISA

GLB ELECTRONICS
1952 Clinton St., Buffalo, N. Y. 14206

Practical experience with Superior Quality Materials and Construction that's...

TOWER POWER

by **TRISTAO**

Tristao isn't just a trade name... it's a man called Lou, and he's been designing towers for hams all his life...the pioneer. That's why Tristao towers above all. And because he knows hams, he engineers quality at prices you can afford. From Mini-Masts to the giants, it's **TOWER POWER** all the way with Tristao.

WRITE RIGHT NOW FOR FULL SPECS and dealer nearest you. **PROMPT DELIVERY.**

TRISTAO TOWER

Division of Palmer Industries, Inc.
415 E. 5th St. - P.O. Box 115
Hanford, CA 93230 / Ph. (209)582-9016

flea market

NEW YORK: Mt. Beacon ARC 5th Annual Hamfest, Saturday, August 19th, 9AM to 5PM at Stewart Field, Newburgh. Talk-in 37/97 and 52. Admission, \$1; sellers, \$2; under 12 free. Additional information: Ron Perry, WA2CGA, RD 1, Glen Ave., Fishkill, N.Y. 12524.

VIRGINIA: 2nd Annual Bristol ARC Hamfest, August 19 and 20, New Washington County Fair Grounds, Route 11, Abingdon. Admission \$1.00, flea market \$2.00 extra. Talk-in 01-61 and 07-67. For info send SASE to WD4ECF Lowry Rouse, 77 Bordwine Rd., Bristol, VA 24201. (703) 669-3086.

OHIO: 42nd Annual Cincinnati Hamfest — Sunday, September 17, 1978 at Stricker's Grove on State Route 128, one mile west of Ross (Venice) Ohio. Exhibits, Prizes, Good Food, Refreshments, Flea Market (radio related products only) Music, Good Fellowship, Hidden Transmitter Hunt and Sensational Air Show. No increase in cost, same as last year — \$7.50 in advance. For further information: Lillian Abbott, K8CKI, 1424 Main Street, Cincinnati, Ohio 45210.

MINNESOTA: St. Cloud Radio Club Hamfest, Sunday, August 13, Sauk Rapids Municipal Park. Free camping and overnight parking at Lions Park, 1 mile from municipal park. Check in — 10:00 AM. Door prizes. Talk-in on 34/94 and 3925. For further info — Bill Zins, WA0OTO, Rt. #4, St. Cloud, MN 56301. (612) 253-3428.

PENNSYLVANIA: 23rd Annual York County Hamfest, September 3 U.S. 30 Dragway at Thomasville Airport, 10 miles west of York. 8:00 AM to 4:30 PM. Registration \$3.00. XYLs and children free. Tailgate 1.00 per space extra. Talk-in 146.37-97, 146.52-52, 147.93-33. Fly-ins to site. Self-contained campers. Display tables under roof by advance registration. Cafeteria. Contact Leroy Frey, K3POR, 170 S. Albemarle St., York, PA 17403. (717) 854-1203.

INDIANA: Tippecanoe ARA Hamfest, Sunday, August 20, Tippecanoe County Fairgrounds, Lafayette, 18th Street at Teal Road (Indiana Highway 25). Flea market setups after 6:00 PM Saturday, August 19. Camping on grounds, limited electricity, Friday through Sunday night. Major pre-registration and attendance prizes. Tickets \$2.00 — mail or gate. Talk-in 146.13-73 repeater and 146.94 simplex. SASE to Bill Bayley, WA9ZDI, 1021 Beck Lane, Lafayette, IN 47905 before August 10.

INDIANA: Tioga Amateur Radio Society's Ham Radio Cruise Day, Sunday, August 27. Lake Freeman, Monticello. Decks open at 1:00 PM. 2 Cruises — 2:00 PM and 4:00 PM. Marine Mobile. Special certificates and QSL's. Advance tickets \$2.00 — at dock \$2.50. SASE Byron Robbins, WD9EXI, Sec'y, 571 South Bluff St., Monticello, IN 47960.

KENTUCKY: The Lexington Bluegrass Amateur Radio Club Annual Hamfest Aug. 13th starting 8:00 AM, at the National Guard Armory near Bluegrass Field. Talk-in on .16/76. Large indoor exhibit area, paved outdoor fleamarket. Major prizes, forums, refreshments, free parking. Advance tickets \$2.50, \$3.00 at door. Fleamarket space \$1.00 extra. For information: Paul Heflin, WA4PAB, 434 Potomac Dr., Lexington, KY 40503. Phone: (606) 278-0646.

WEST VIRGINIA: Jackson County ARC's 2nd Annual Hamfest, West Virginia FFA-FHA Conference Center, Ripley, Sunday, August 13. Just off interstate 77 at Ripley. For information: Robert D. Morris, WB8CTO, JCARC, 628 Church St. South, Ripley, West Virginia 25271.

NEW JERSEY: South Jersey Radio Assn Hamfest is Sept. 10, 1978 rain or shine at Ellsberg Shopping Center, Cherry Hill N.J. at intersection of routes 41 and 70. Family registration \$2.00 Tailgating \$3.00. Flea market, auction, & activities. Many prizes. Talk-in 52. Contact K2KA, Box 2736, Cherry Hill, N.J. 08002. Tel: (609) 429-6032 for info.

HAMFESTERS 44TH ANNUAL PICNIC AND HAMFEST, Sunday, August 13, 1978 at Santa Fe Park, 91st and Wolf Road, Willow Springs, Illinois, Southwest suburb of Chicago. Exhibits for OM's and XYL's, FAMOUS SWAP-PERS ROW. Tickets at gate \$2.00, Advance \$1.50. For Hamfest info or Advance Tickets (send check or money order — SASE appreciated) to Bob Hayes W9KXW, 18931 Cedar Ave., Country Club Hills, IL 60477.

ILLINOIS: The Sangamon Valley Radio Club of Springfield, Third Annual Hamfest Sunday, September 24th, Sangamon County Fairgrounds in New Berlin, 16 miles west of Springfield. Hear Hugh Vandegrift WA4WME talk on the Clipperton DX-pedition! Various exhibits, kids activities and food. Camping. First Prize — Bearcat 210; Tickets: \$1.50 advance, \$2.00 at gate. Information — Al K9QFR; Tickets — Carole WB9QWR, write C/O 1025 S. Sixth, Springfield, Illinois 62703.

COLLINS & MORE

Ham Gear

Collins 180S1 Antenna tuner	\$295
Collins 312B4, Sta. Cntl., rd., exc.	\$250
Collins 312B5, Vfo Console, vy gd	\$495
Collins 312B5, Vfo Console, new, orig. box	\$795
Collins 32S3, Transmitter, rnd., exc.	\$850
Collins 75S3B, Ham receiver, vy gd	\$695
Collins 75A4, Ham receiver, vy gd	\$425
Collins 51S1, 2-30MHz rcvr	Special
Collins R-388/51J3 receiver, vy gd	\$425
Hammarlund SP-600JX, rcvr	\$395
Collins CP-1 Crystal Pack	\$195
Racal 6217E, .5-30MHz receiver	Special
New R390A, rcvr avail. Call for quote.	
Collins 32S3A Transmitter, rnd., new, orig. box	\$1495
Collins 312B4 Console, rnd., new, orig. box	\$325
Collins 30S1 Linear, wing, excellent	\$1695
Collins 30S1 Linear, round, excellent	\$1995
National NCL 2000, 2kW Linear, exc.	\$550

Test Gear

Boonton Radio 225A 10-500MHz sig. gen., like new	\$550
Boonton Electronics 91CA rf voltmeter, no probe	\$225
Gertsch FM-9 freq./dev. meter	\$795
HP-200CD wide-range oscillator	\$175
HP-202H 54-216MHz AM/FM sig. gen.	\$695
HP-608D 10-420MHz sig. gen.	\$550
Power Designs	
#605, 6VDC, 500mA, lab. p/s	\$60
#1210, 12VDC, 10A, lab. p/s	\$95
Measurements Mod. 65B, LF sig. gen.	\$325
260A Q-meter, exc.	\$450
Model 80, 2-400 MHz sig. gen.	\$350

We stock good, used equipment from Collins, Drake, Heath and other manufacturers. Hundreds of test items also available. Call for specific requirements, or

write for free catalog.

DAMES COMMUNICATION SYSTEMS

201-998-4256

10 SCHUYLER AVENUE

NORTH ARLINGTON, N. J. 07032

All equipment sold checked and realigned

Presenting THE A.R.O. UNITY RING



Your Prestige Your Pride

The unique, one of a kind, personalized "A.R.O. UNITY RING".

Your call letters. Your identity. Made just for you.

Group III, WB2LCL, WB2LCK and WB2LHC designed this beautiful 10 Karat Gold ring because of our pride in Amateur Radio. Wear this ring of distinction, personalized with your call letters and symbolizing the great and proud fraternity of Amateur Radio. We invite you to QSL for full color brochure and free reusable ring size.

Group III Sales Co.
Dept. 35 - P.O. Box 259
Little Neck, N.Y. 11362

Holiday Orders Must Be Received By October 23th

No Obligation

RADIO WORLD

CENTRAL NEW YORK'S FASTEST GROWING HAM DEALER



FT-101E ICOM IC-211

Featuring - Yaesu, ICOM, Drake, Atlas, Den-Tron, Ten-Tec, Swan, Regency, Standard, Tempo, KLM, Hy-Gain, Mosley, Larsen, Midland, Wilson, Southwest Tech Products. We service everything we sell! Write or call for quote. YOU WON'T BE DISAPPOINTED.

We are just a few minutes off the NYS Thruway (I-90) - Exit 32.

RADIO WORLD
ONEIDA COUNTY AIRPORT
TERMINAL BUILDING
ORISKANY, NY 13424
315-337-2622

Warren K21XN Bob WA2M5H

7400 TTL

Table listing various 7400 TTL integrated circuits with part numbers and prices.

BUGBOOK



Continuing Education Series... THE 555 TIMER APPLICATIONS... SOURCEBOOK WITH EXPERIMENTS...

BUGBOOK I & II

By Peter R. Rony, David G. Larson, MEd/MT... \$17.00 per set

BUGBOOK III... By David G. Larson, Peter R. Rony, Jonathan A. Titta... \$15.00

BUGBOOK IV & V... By Peter R. Rony, David G. Larson, MEd/MT, Jonathan A. Titta... \$19.00 per set

CMOS - V - DESIGNERS PRIMER AND HANDBOOK... \$9.50

COMPLETE MANUAL FOR DIGITAL CLOCKS... \$3.95

Discrete LEDs... 125 dia, 200 dia, 145 dia... Various part numbers and prices.

DISPLAY LEDS

Table listing various display LEDs with part numbers, prices, and specifications.

C/MOS

Table listing various C/MOS integrated circuits with part numbers and prices.

74C00

Table listing various 74C00 CMOS integrated circuits with part numbers and prices.

LICELAR

Table listing various LICELAR integrated circuits with part numbers and prices.

LICELAR

Table listing various LICELAR integrated circuits with part numbers and prices.

TYPE POLARITY HT PRICE

Table listing various types of LEDs with their polarities, heights, and prices.

TYPE POLARITY HT PRICE

Table listing various types of LEDs with their polarities, heights, and prices.

RCA LINEAR

Table listing various RCA linear integrated circuits with part numbers and prices.

CALCULATOR CHIPS AND DRIVER

Table listing various calculator chips and drivers with part numbers and prices.

CLOCK CHIPS

Table listing various clock chips with part numbers and prices.

IC SOLDERTAIL - LOW PROFILE (TIN) SOCKETS

Table listing various IC soldertail sockets with part numbers and prices.

SOLDERTAIL STANDARD (TIN)

Table listing various soldertail standard sockets with part numbers and prices.

SOLDERTAIL STANDARD (GOLD)

Table listing various soldertail standard sockets with part numbers and prices.

WIRE WRAP SOCKETS (GOLD) LEVEL #3

Table listing various wire wrap sockets with part numbers and prices.

50 PCS. RESISTOR ASSORTMENTS \$1.75 PER ASST.

Table listing various 50-piece resistor assortments with part numbers and prices.

WIRE-WRAP KIT - WK-2-W

WRAP • STRIP • UNWRAP... \$12.95

WIRE WRAP WIRE - 30 AWG

25 ft. min \$1.25 50 ft. \$1.95 100 ft. \$2.95 1000 ft. \$15.00

WIRE DISPENSER - WD-30

\$3.95 ea... \$1.96/spool

XR2206KA \$1.95

XR2206KA \$1.95... XR2242CP \$1.50

ZENERS - DIODES - RECTIFIERS

Table listing various Zener diodes, diodes, and rectifiers with part numbers and prices.

SCR AND FW BRIDGE RECTIFIERS

Table listing various SCR and FW bridge rectifiers with part numbers and prices.

TRANSISTORS

Table listing various transistors with part numbers and prices.

CAPACITOR

Table listing various capacitors with part numbers and prices.

Table listing various miniature aluminum electrolytic capacitors with part numbers and prices.

THIS IS IT



MODEL 4431 THRU LINE®

RF DIRECTIONAL WATTMETER
with VARIABLE RF
SIGNAL SAMPLER - BUILT IN

AUTHORIZED **BIRD** DISTRIBUTOR

Webster
associates

115 BELLARMINE
ROCHESTER, MI 48063
CALL TOLL FREE
800 - 521-2333
IN MICHIGAN 313 - 375 0420

flea market

FLORIDA: Five Flags ARA's Annual Ham-A-Rama, September 3, University of West Florida field house, Pensacola. Write: FFARA, P.O. Box 17343, Pensacola, FL 32522.

OHIO: Union County ARC Hamfest, Sunday, August 27, Plain City Fairgrounds, Plain City. Tickets: \$1.50 advance, \$2.00 at door. Refreshments, free flea market, free overnight camping Saturday, inside tables for dealers. Talk-in on 146.52. For info: Gene Kirby, W8BJN, Sec'y, 13813 U.S. 36, Marysville, OH 43040. SASE please.

MINNESOTA: Central States VHF Contest, August 17, 18, 19 and 20, 1978 at the Midway Motor Lodge, Rochester, Minnesota. Antenna gain measurements, speakers, entertainment, banquet, and prizes, plus much more that you cannot afford to miss! Send registration immediately to: Terry Van Benschoten, W0VB, 2326 NW 11th Avenue, Rochester, Minnesota 55901. For motel reservations call (507) 289-8866; for information, call Ed, (507) 288-3584 (home) or (507) 286-3090 (work); and Terry (507) 289-1496 (home) or (507) 286-5568 (work). Central States VHF NET Sunday night 8:30 Central time on 3818 kHz. Rochester repeater on 146.82/22.

FLORIDA: Jacksonville Hamfest, August 5th and 6th at the Jacksonville Beach Municipal Auditorium. Doors open 8:00 AM Advanced registration \$2.50, tables \$5.00. Ladies and children with registered amateur admitted free. Activities include commercial exhibits, ARRL forum, QCWA meeting, DX forum, antenna forum, microcomputer seminar and much more that you must see to believe! For more information, write: Jacksonville Hamfest Association, 911 Rio St. Johns Dr., Jacksonville, Florida 32211. Telephone (904) 744-9501.

ILLINOIS: Sixteenth Annual QSO Party, sponsored by RAMS; 1800Z August 5th to 2300Z August 6th, 1978 with a rest period from 0600 to 1200Z August 6th. Frequencies: CW - about 60 kHz from low end of each band; Phone - about 3975, 7275, 14275, 21375 and 28675. Novice: about 25 kHz from low end of each Novice band, especially on half hour. Write: RAMS - K9CJU, 3620 N. Oleander Ave., Chicago, Illinois 60634.

CALIFORNIANS: Microcomputer Net on WR6ACV (146.28/88) Mt. Oso, Sunday nights at 9:00. Listen for N6HF. Beginners welcome.

OHIO: Cleveland Hamfest; come for the fun on September 9th from 8:00 AM to 6:00 PM at County Fairgrounds, Berea, Ohio. Talk-in on 146.52 simplex. \$2 admission. Write to: Cleveland Hamfest Association, P.O. Box 27211, Cleveland, OH 44127.

LANSING, MI CMARC Swap-Shop. Oct. 1, 1978. Grand Ledge High School. Prizes - Food - Tables. CMARC Box 10073, Lansing, MI 48901.

MISSOURI: The Saint Charles Amateur Radio Club's Third Annual SCARC HAMFEST, August 27th, Wentzville Community Club, Wentzville, on Interstate 70, 25 miles West of Saint Louis. Talk-in on 34/94 and 07/67. Refreshments, kids games, FREE bingo, Prizes. Admission: \$1.00 per carload. For information contact: SCARC, P.O. Box 1429, Saint Charles, Missouri 63301.

ILLINOIS: Rockford ARA Hamfest and ARRL State Convention, September 10, 1978, Winnebago County Fairgrounds, Pecatonica, 10 miles west of Rockford on U.S. 20. Large inside and outside display areas; inside tables available \$3. Snack bar/free camping (electrical hookup \$4). Prizes, microcomputer seminar, ARRL technical discussion, OSCAR presentation, contest talk, Midwest Country Cousins meeting, many others. Come one, come all for FUN. Talk-in on 146.01/61 and 146.52 simplex. Tickets \$1.50 advance, \$2 at door. SASE to Rockford County Amateur Radio Association, P.O. Box 1744, Rockford, Illinois 61110.

Stolen Equipment

STOLEN FROM AIRLINE BAGGAGE, probably either in Minneapolis/St. Paul or San Francisco, Wilson WE-800 s/n 12521811 with 10 white "no brand" Ni-Cad batteries inside, flex antenna with UHF ell connector and UHF to BNC connector. Also homebuilt battery charger with 723 IC. Mitt Nodacker, WA7TFE, Box 2632, Pocatello, ID 83201.

STOLEN EQUIPMENT: 1. KLM 160 watt amplifier, no I.D. 2. Black Heath 2036 with Micoder and several obvious modifications: hi-low power selector on squelch knob, variable power on internal potentiometer, RCA plug replaced with SO-239, Social Security No. 350-30-1717 etched in foil on transmitter board. Darrel Dorsett, K9JKZ, Kankakee Area Career Center, Rt. 2, Road 100-W, Bourbonnais, IL 60914.

BARBER

STONE ENCODER

FEATURES:

- Crystal Controlled - Digitally Synthesized Tones.
- Low Current Drain CMOS Logic.
- RFI Immune
- 16-Button Tactile Feedback Keyboard.
- Will Interface to Transceivers Using Dynamic Microphones with Only Two Wires.
- Provisions for Three Wire Interface Are Provided.
- Gold-Plated Keyboard Contacts Provided for Maximum Reliability.
- Operating Voltage Range 9-18VDC.
- Size: 2.1" x 2.1" x .250" Without Case. 2.1" x 2.1" x .312" With Case.
- 2" Square Velcro Available for Convenient Mounting - Dashboard - Sun Visor - Radio - etc.



Tone Encoder \$46.00
Case \$ 2.00
Velcro \$.50

NEW! GOLDLINE AMP - 2M
1-4 Watts In, 7-25 Watts Out \$46.50

Ohio Residents Add 4.5% Sales Tax
Send Check or Money Order To:

WREN CO.
8630 WINTON RD.
CINCINNATI, OHIO 45231

432 Yagis by K2RIW

IF YOU'RE SERIOUS
ABOUT 432...

- 1st PLACE - EAST COAST VHF SOCIETY'S 1977 ANTENNA GAIN CONTEST
- 19 ELEMENTS, TANDEM-REFLECTOR*
- 12-MHz BANDWIDTH, 432-MHz CF
- INTEGRAL BALUN, 50 Ω TYPE N
- ALL ELEMENTS INSULATED FROM BOOM - NO GAIN LOSS FROM WEATHERING!
- HANDLES FULL KILOWATT CW
- 13-FT SELF-SUPPORTING BOOM
- SURVIVES 85-MPH WINDS
- WEIGHS ONLY 2-3/4 POUNDS!

*PATENT PENDING

MODEL \$49.95 PREPAID UPS IN
432-19 CONTINENTAL USA

QUANTITY DISCOUNTS AVAILABLE - WRITE

riw PRODUCTS
BOX 191, BABYLON, N.Y. 11702

MILITARY SURPLUS WANTED

Space buys more and pays more. Highest prices ever on U.S. Military surplus, especially on Collins equipment or parts. We pay freight. Call collect now for our high offer. 201 440-8787. SPACE ELECTRONICS CO. div. of Military Electronics Corp. 35 Ruta Court, S. Hackensack, N.J. 07606

K-ENTERPRISES

Frequency Counters
Prescalers
Marker & Peaking
Generators

Power Supplies
Amplifiers
Frequency
Standards

Write for Free Catalog
Box 410 (Pump Sta. Rd.) Fairland, OK 74343
Phone: 918-676-3752

RUBBER DUCKIES

- Model HM-4. Has 5/16"-32 thread. Fits Motorola HT's ICOM IC215 and Standard 146A \$7.00
- Model HM-5. Same as above, but with PL-259 connector \$7.00
- Model HM-226. Same. with TNC connector for Wilson 1405 \$16.00
- Model HM-227. Same. but with BNC connector termination \$11.00
- Model HM-228. With F connector for Wilson 1402 & Tempo \$10.00

HM-4

HM-5

ADD \$1.00 to each order for shipping.

SPECTRONICS, INC.
(312)848-6777 1009 GARFIELD ST
OAK PARK, ILL. 60304

Look closely at the new MT-3000A. You've never seen anything like it.

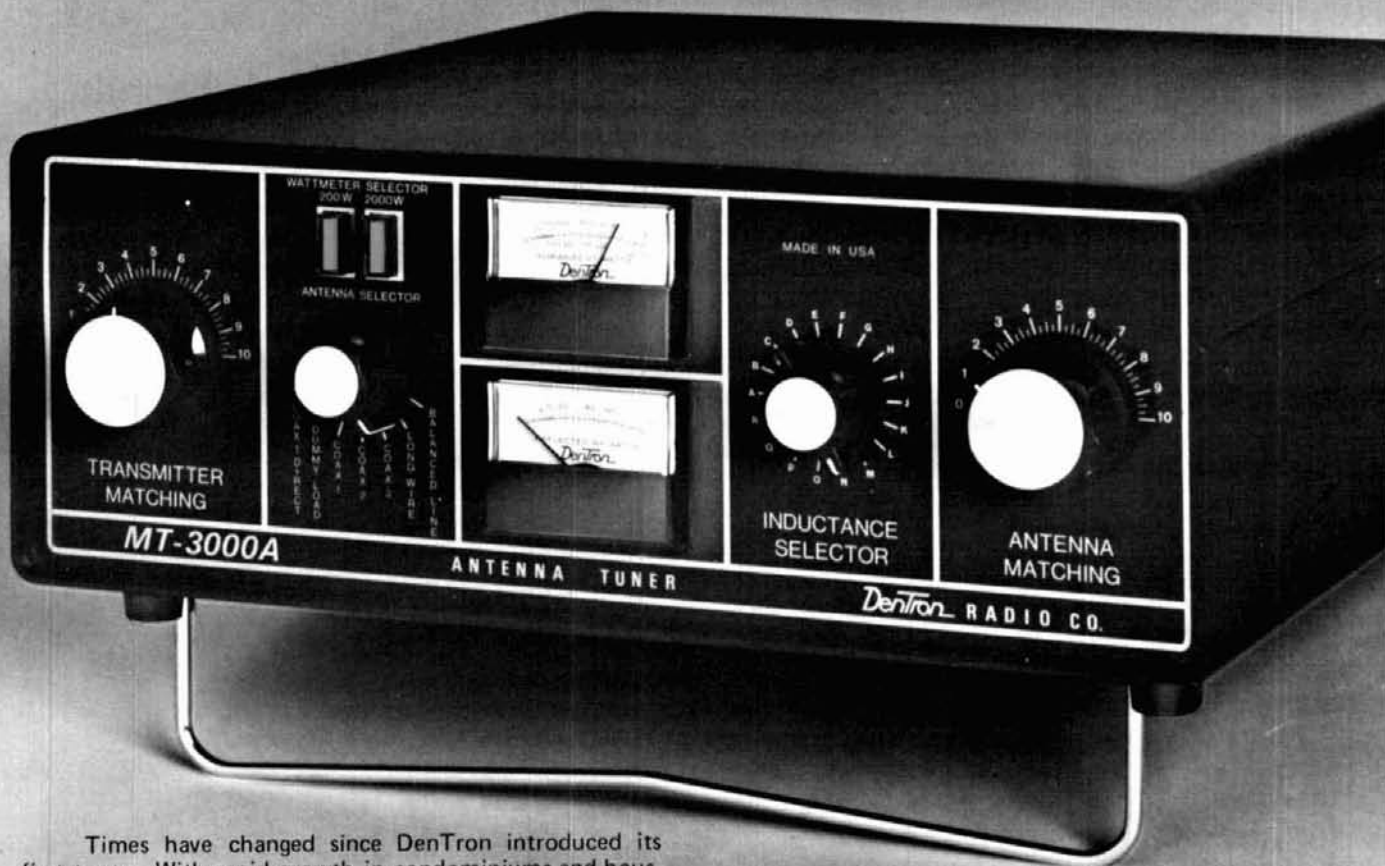

Times have changed since DenTron introduced its first tuner. With rapid growth in condominiums and housing developments, we have new problems that require new solutions.

DenTron decided to rethink the tuner and what its total capabilities should be.

The MT-3000A is a capsulized solution to many problems. It incorporates 4 unique features to give you the most versatile antenna tuner ever built.

First, as a rugged antenna tuner the MT-3000A easily handles a full 3KW pep. It is continuous tuning 1.8-30mc. It matches everything between 160 and 10 meters.

Second, the MT-3000A has built-in dual watt meters.

Third, it has a built-in 50 ohm dummy load for proper exciter adjustment.

Fourth, the antenna selector switch; (a) enables you to by-pass the tuner direct; (b) select the dummy load or 5 other antenna systems, including random wire or balanced feed.

The compact size alone of the MT-3000A (5½" x 14" x 14") makes it revolutionary. Combine that with its four built-in accessories and we're sure you'll agree that the MT-3000A is one of the most innovative and exciting instruments offered for amateur use.

At **\$349.50** the MT-3000A is not inexpensive. But it is less than you'd expect to pay for each of these accessories separately.

As unique as this tuner is, there are many things it shares with all DenTron products. It is built with the same meticulous attention to detail and American craftsmanship that is synonymous with DenTron.

After seeing the outstanding MT-3000A, wouldn't you rather have your problems solved by DenTron?

DenTron
Radio Co., Inc.

2100 Enterprise Parkway
Twinsburg, Ohio 44087
(216)425-3173

State
of the art



by
K.V.G.

CRYSTAL FILTERS and DISCRIMINATORS

9.0 MHz FILTERS

XF9-A	2.5 kHz	SSB TX	\$33.55
XF9-B	2.4 kHz	SSB RX/TX	\$47.75
XF9-C	3.75 kHz	AM	\$51.40
XF9-D	5.0 kHz	AM	\$51.40
XF9-E	12.0 kHz	NBFM	\$51.40
XF9-M	0.5 kHz	CW (4 pole)	\$35.95
XF9-NB	0.5 kHz	CW (8 pole)	\$63.95

Export
Inquiries
Invited

9.0 MHz CRYSTALS (Hc25/u)

XF900	9000.0 kHz	Carrier	\$4.15
XF901	8998.5 kHz	USB	\$4.15
XF902	9001.5 kHz	LSB	\$4.15
XF903	8999.0 kHz	BFO	\$4.15
F-05	Hc25/u	Socket Chassis	.50
F-06	Hc25/u	Socket P.C. Board	.50

Shipping
\$1.50
per filter

VARACTOR TRIPLERS

The low cost, easy way to operate on the 432 MHz and 1296 MHz bands. For OSCAR 7, mode B, drive the MMv432 family varactor tripler with your 2 meter transmitter. The wideband varactor triplers cover the full 2M/432 band without retuning. NO power supply required for varactor triplers; efficiency approximately 50%. Three models available at 432, two at 1296.

Model	Max Drive	
MMv432	30 W	\$65.95
MMv432M	50 W	\$85.95
MMv432H	70 W	\$125.95
MMv1296	20 W	\$75.95
MMv1296H	35 W	\$99.95



RECEIVE CONVERTERS



MODELS FOR ALL BANDS 50 MHz
THRU 1296 MHz. LOW NOISE OP-
TIONS AT 432 MHz.

Model	N. F.	Options	Shipping
MMc144	2.8 dB typ.	6M & 2M	\$2.50
MMc432	3.8 dB typ.		\$49.95
MMc438/ATV	Ch2 or Ch3 IF		\$59.95
MMc1296	8.5 dB typ.		\$79.95
			\$69.95

ANTENNAS (FOB CONCORD, VIA UPS)

144-148 MHz J-SLOTS

8 OVER 8 HORIZONTAL POL.	+12.3 dBd	D8/2M	\$45.95
8 BY 8 VERTICAL POL.		D8/2M-VERT.	\$53.95
8 + 8 TWIST 8XY/2M	\$47.65		



420-450 MHz
MULTIBEAMS

48 EL.	GAIN +15.7 dBd	70/MBM48	\$49.95
88 EL.	GAIN +18.5 dBd	70/MBM88	\$73.50

UHF LOOP YAGIS

26 LOOPS	GAIN +20 dBi	
1250-1340 MHz	1296-LY	\$56.95
1650-1750 MHz	1691-LY	\$63.95

Send 30¢ (2 stamps) for full details of KVG crystal products and all your VHF & UHF equipment requirements.

Pre-Selector Filters	Amplifiers	SSB Transverters
Varactor Triplers	Crystal Filters	FM Transverters
Decade Pre-Scalers	Frequency Meters	VHF Converters
Antennas	Oscillator Crystals	UHF Converters

si

Spectrum
International, Inc.
Post Office Box 1084
Concord, Mass. 01742, USA



GREGORY ELECTRONICS
The FM Used
Equipment People.

New Low Price!

2 Meter Portable
G.E. MASTR PR 36
132-150 MHz - 5 Watts
ALL SOLID STATE
with Ni-Cad Battery

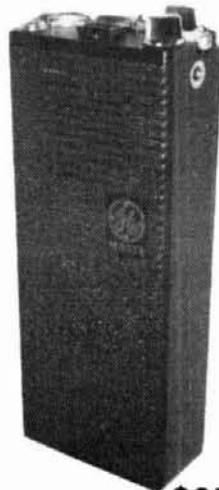

Reg.
~~\$228~~ **\$188.**
NOW

Vehicular Charger 4EP63A (sold only with unit) **\$25.**
A.C. Charger (subject to availability)..... **\$25.**
Speaker/Mike Type EM36 **\$15.**



GREGORY ELECTRONICS CORP.

245 Rt. 46, Saddle Brook, N.J. 07662
Phone: (201) 489-9000

Cleveland Hamfest!

SATURDAY

SEPT. 9th, 1978

8:00 AM to 6:00 PM

COUNTY FAIRGROUNDS

Berea, Ohio

Admission: \$2.00

Check-In on 146.52

For more info, Write to:
Cleveland Hamfest Assoc.

P.O. Box 27211
Cleveland, Ohio 44127

DIODES/ZENERS

1N914	100v	10mA	.05
1N4005	600v	1A	.08
1N4007	1000v	1A	.15
1N4148	75v	10mA	.05
1N4733	5.1v	1 W Zener	.25
1N753A	6.2v	500 mW Zener	.25
1N758A	10v	"	.25
1N759A	12v	"	.25
1N5243	13v	"	.25
1N5244B	14v	"	.25
1N5245B	15v	"	.25

SOCKETS/BRIDGES

8-pin	pcb	.20	ww	.35
14-pin	pcb	.20	ww	.40
16-pin	pcb	.20	ww	.40
18-pin	pcb	.25	ww	.75
22-pin	pcb	.35	ww	.95
24-pin	pcb	.35	ww	.95
28-pin	pcb	.45	ww	1.25
40-pin	pcb	.50	ww	1.25
Molex pins	.01	To-3 Sockets	.25	
2 Amp Bridge		100-prv	.95	
25 Amp Bridge		200-prv	1.95	

TRANSISTORS, LEDS, etc.

2N2222	NPN (2N2222 Plastic .10)	.15
2N2907	PNP	.15
2N3906	PNP (Plastic - Unmarked)	.10
2N3904	NPN (Plastic - Unmarked)	.10
2N3054	NPN	.35
2N3055	NPN 15A 60v	.50
T1P125	PNP Darlington	.35
LED Green, Red, Clear, Yellow		.15
D.L.747	7 seg 5/8" High com-anode	1.95
MAN72	7 seg com-anode (Red)	1.25
MAN3610	7 seg com-anode (Orange)	1.25
MAN82A	7 seg com-anode (Yellow)	1.25
MAN74A	7 seg com-cathode (Red)	1.50
FND359	7 seg com-cathode (Red)	1.25

C MOS

4000	.15	7400	.10
4001	.15	7401	.15
4002	.20	7402	.15
4004	3.95	7403	.15
4006	.95	7404	.10
4007	.20	7405	.25
4008	.75	7406	.25
4009	.35	7407	.55
4010	.35	7408	.15
4011	.20	7409	.15
4012	.20	7410	.15
4013	.40	7411	.25
4014	.75	7412	.25
4015	.75	7413	.25
4016	.35	7414	.75
4017	.75	7416	.25
4018	.75	7417	.40
4019	.35	7420	.15
4020	.85	7426	.25
4021	.75	7427	.25
4022	.75	7430	.15
4023	.20	7432	.20
4024	.75	7437	.20
4025	.20	7438	.20
4026	1.95	7440	.20
4027	.35	7441	1.15
4028	.75	7442	.45
4030	.35	7443	.45
4033	1.50	7444	.45
4034	2.45	7445	.65
4035	.75	7446	.70
4040	.75	7447	.70
4041	.69	7448	.50
4042	.65	7450	.25
4043	.50	7451	.25
4044	.65	7453	.20
4046	1.25	7454	.25
4049	.45	7460	.40
4050	.45	7470	.45
4066	.55	7472	.40

- T T L -

7473	.25	74176	.85	74H72	.35	74S133	.40
7474	.30	74180	.55	74H101	.75	74S140	.55
7475	.35	74181	2.25	74H103	.55	74S151	.30
7476	.40	74182	.75	74H106	.95	74S153	.35
7480	.55	74190	1.25			74S157	.75
7481	.75	74191	.95	74L00	.25	74S158	.30
7483	.75	74192	.75	74L02	.20	74S194	1.05
7485	.55	74193	.85	74L03	.25	74S257 (8123)	1.05
7486	.25	74194	.95	74L04	.30		
7489	1.05	74195	.95	74L10	.20	74LS00	.20
7490	.45	74196	.95	74L20	.35	74LS01	.20
7491	.70	74197	.95	74L30	.45	74LS02	.20
7492	.45	74198	1.45	74L47	1.95	74LS04	.20
7493	.35	74221	1.00	74L51	.45	74LS05	.25
7494	.75	74367	.75	74L55	.65	74LS08	.25
7495	.60			74L72	.45	74LS09	.25
7496	.80	75108A	.35	74L73	.40	74LS10	.25
74100	1.15	75491	.50	74L74	.45	74LS11	.25
74107	.25	75492	.50	74L75	.55	74LS20	.20
74121	.35			74L93	.55	74LS21	.25
74122	.55			74L123	.85	74LS22	.25
74123	.35	74H00	.15			74LS32	.25
74125	.45	74H01	.20	74S00	.35	74LS37	.25
74126	.35	74H04	.20	74S02	.35	74LS38	.35
74132	.75	74H05	.20	74S03	.25	74LS40	.30
74141	.90	74H08	.35	74S04	.25	74LS42	.65
74150	.85	74H10	.35	74S05	.35	74LS51	.35
74151	.65	74H11	.25	74S08	.35	74LS74	.35
74153	.75	74H15	.45	74S10	.35	74LS86	.35
74154	.95	74H20	.25	74S11	.35	74LS90	.55
74156	.70	74H21	.25	74S20	.25	74LS93	.55
74157	.65	74H22	.40	74S40	.20	74LS107	.40
74161	.55	74H30	.20	74S50	.20	74LS123	1.00
74163	.85	74H40	.25	74S51	.25	74LS151	.75
74164	.60	74H50	.25	74S64	.15	74LS153	.75
74165	1.10	74H51	.25	74S74	.35	74LS157	.75
74166	1.25	74H52	.15	74S112	.60	74LS164	1.00
74175	.80	74H53J	.25	74S114	.65	74LS193	.95
		74H55	.20			74LS367	.75
						74LS368	.65

4069/74C04

4071	.25
4081	.30
4082	.30
MC 14409	14.50
MC 14419	4.85
4511	.95
74C151	1.90

LINEARS, REGULATORS, etc.

MCT2	.95	LM320T5	1.65	LM340K15	1.25	LM723	.40
8038	3.95	LM320T12	1.65	LM340K18	1.25	LM725N	2.50
LM201	.75	LM320T15	1.65	LM340K24	1.25	LM739	1.50
LM301	.45	LM324N	1.25	78L05	.75	LM741 (8-14)	.25
LM308 (Mini)	.95	LM339	.75	78L12	.75	LM747	1.10
LM309H	.65	7805 (340T5)	.95	78L15	.75	LM1307	1.25
LM309K (340K-5)	.85	LM340T12	.95	78M05	.75	LM1458	.65
LM310	.85	LM340T15	.95	LM373	2.95	LM3900	.50
LM311D (Mini)	.75	LM340T18	.95	LM380 (8-14 PIN)	.95	LM75451	.65
LM318 (Mini)	1.75	LM340T24	.95	LM709 (8, 14 PIN)	.25	NE555	.35
LM320K5(7905)	1.65	LM340K12	1.25	LM711	.45	NE556	.85
LM320K12	1.65					NE565	.95

9000 SERIES

9301	.85	95H03	1.10
9309	.35	9601	.20
9322	.65	9602	.45

MICRO'S, RAMS, CPU'S, E-PROMS

74S188	3.00	8214	8.95
1702A	4.50	8224	3.25
MM5314	3.00	8228	6.00
MM5316	3.50	8251	8.50
2102-1	1.45	8255	10.50
2102L-1	1.75	8T13	1.50
2114	9.50	8T23	1.50
TR1602B	3.95	8T24	2.00
TMS 4044	9.95	8T97	1.00
		2107B-4	4.95
8080	8.95	2708	9.50
8212	2.95	Z80 PIO	8.50

INTEGRATED CIRCUITS UNLIMITED

7889 Clairemont Mesa Boulevard, San Diego, California 92111
(714) 278-4394 (Calif. Res.)

All orders shipped prepaid No minimum
Open accounts invited COD orders accepted

Discounts available at OEM Quantities California Residents add 6% Sales Tax

All IC's Prime/Guaranteed. All orders shipped same day received.

24 Hour Toll Free Phone 1-800-854-2211 American Express / BankAmericard / Visa / MasterCard

SPECIAL DISCOUNTS	
Total Order	Deduct
\$35 - \$99	10%
\$100 - \$300	15%
\$301 - \$1000	20%

**HOT
AUGUST
SPECIALS**

NEW TOLL FREE PHONE 800-528-1417

Now phone in your orders no charge (minimum phone order \$15.00)
Or mail in your order — no minimum on mail orders

NEW LOW PRICES - FOR FACTORY PRIME PARTS

We DO NOT sell surplus, retests or other low quality parts. Make up your order from this AD and our current catalog and phone it in today — Operators on duty 9 AM to 6 PM MST.

PRIME TTL	PRICE	CMOS	PRICE
7400	.14	CD 4001	.23
7402	.18	CD 4010	.45
7404	.18	CD 4011	.23
7410	.18	CD 4013	.39
7413	.30	CD 4016	.45
7420	.18	CD 4017	.70
7432	.25	CD 4020	.90
7441	.79	CD 4023	.23
7447	.59	CD 4024	.75
7473	.35	CD 4029	.90
7474	.35	CD 4044	.70
7485	.65	CD 4046	1.25
7490	.39	CD 4049	.45
7492	.39	CD 4050	.45
7493	.39	CD 4051	.70
74121	.35	CD 4069	.23
74123	.45	CD 4071	.23
74154	.79	CD 4081	.23
74161	.79	CD 4511	.95
74176	.70	CD 4518	.85
74177	.70	MC 14409	9.95
74192	.69	MC 14410	9.28
74193	.69	MC 14419	3.26

VOLTAGE REGULATORS

PRICE	
7805	.94
7806	.94
7808	.94
7812	.94
7815	.94
7824	.94
7905	.94
7906	.94
7908	.94
7912	.94
7915	.94
7924	.94

Mix or Match any
10 of above
for \$8.95

LM317T	only 2.75
Popular 723	.45
LM309K	1.25

LINEARS

PRICE	
LM 301AN	.35
LM 307N	.35
LM 311N	.75
LM 324N	.80
LM 380N	1.25
LM 381N	1.79
LM 386N	.99
NE/LM 566CN	.75
NE/LM 567	.99
LM 3900	.65
LM 3909	.75
.....	
NE555 TIMER	.35
.....	
741 OP AMP	.35

ASSORTED SPECIALS

PRICE	
40673	.99
MPF102	.35
95H90	9.50
11C90	15.50
7207A	5.75
7208	15.95
5.24288	
Crystal	6.95

SUPER BUY

TOUCH TONE ENCODER KIT
Only \$23.95

Includes:

- Digitran Keypad
- Integrated Circuit
- Crystal
- Circuit Board
- All Small Parts

CIRCUIT SPECIALISTS CO.
BOX 3047, SCOTTSDALE, AZ 85257

Please add 50¢ for shipping
Parts by phone — Call (1) 800-528-1417 It's FREE!
A special new number — for a special service.

8-POLE 350-Hz FILTER FOR SIGNAL/ONE TRANSCEIVERS \$120.00

Finally! Superior 8-Pole CW Selectivity for Drake TR-4, TR-4C, TR-4 Cw

350 Hz at -6db, 850 Hz at -60db. Cuts QRM. More selective than 6-pole CW filter in new TR-4Cw which is 500 Hz at -6db, and 2000 Hz at -60db. CF-350/B \$100.00. Switch and mounting kit \$10.00.

At Last! Superior 8-Pole CW Selectivity for Kenwood TS-820

MINIMAL LOSS IN SET. GOOD SIGNAL-TO-NOISE. 350 Hz at 6db, 850 Hz at -60db. Cuts QRM. More selective than standard YG-88C 6-pole CW filter which is 500 Hz at -6db, and 1800 Hz at -60db. CK-350/B \$100.00.

600 Hz 6-Pole First-IF Filter for Drake R-4C

Improve the early stage selectivity. Eliminate those high-pitched beeping notes from signals that leak around the switchable second IF filter. Minimize the chance of strong signals overloading the second mixer, causing intermodulation and desensitization. Both the existing filter and our CF-600/B can be mounted in the receiver and relay switched to retain phone capabilities. CF-600/B \$80.00. Relay switch kit \$33.00.

125 Hz 8-Pole Second-IF Filter for Drake R-4C

Still sharper available! 300 Hz at -60db! Cuts QRM. Ideal for DX and contest work. Unexcelled under crowded band conditions. Does what no audio filter can do. More selective than audio filters. Puts selectivity in AGC loop. Unlike with audio filters, receiver gain not reduced by QRM outside passband. Yet works well with an audio filter to improve receive performance. Plugs directly into an accessory filter socket of the R-4C. CF-125/B \$130.00.

CW Operators!
Attention:
These crystal filters are for you!

All filters contain specially-treated high-Q crystals.
Sherwood Engineering Inc.
1268 South Ogden St.
Denver, Colo. 80210
(303) 722-2257

Money back if not satisfied
Add \$3 per order shipping;
\$6 overseas air
Dealer Inquiries Welcome



COMPLAINTS?
... SEE FOR YOURSELF!

NATIONWIDE SPECTRUM-ANALYSIS SERVICE

FOR ALL LEGAL AMATEUR TRANSMITTERS.

Now you can get written proof of your unit's transmit from purity with spectrum analysis done on HP lab equipment. An entire analysis is just one required and shipped within 24 hrs. Send 25¢ of SASE for full details and authorization form.

PHOTOGRAPH OPTIONAL

MOST 6M up \$17.95
MOST HF \$25.00

SPECTRONICS, INC.
(312)848-6777 1009 GARFIELD ST. OAK PARK, ILL. 60304

solid state continuous coverage

THE COMM CENTER

The Drake TR-7

AREA CODE (301) WASHINGTON 953-9535 - BALTIMORE 792-0600
9624 FT. MEADE RD. LAUREL, MD. 20810

SST T-1 RANDOM WIRE ANTENNA TUNER

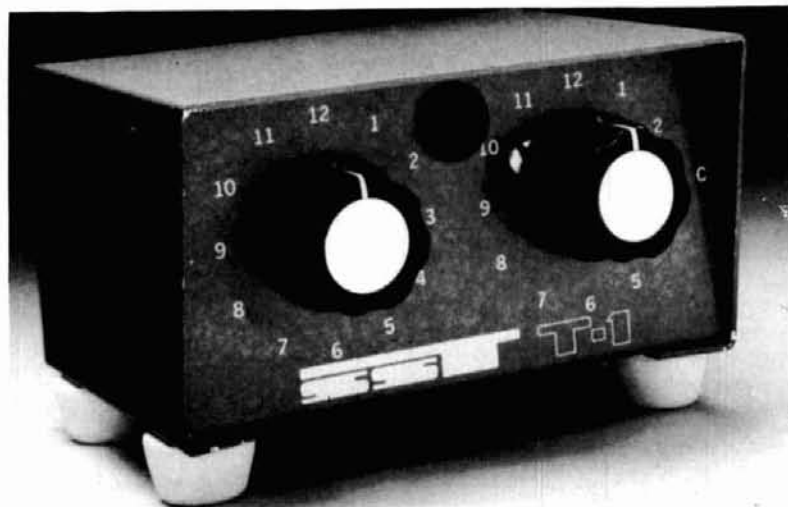

All band operation (160-10 meters) with any random length of wire. 200 watt output power capability—will work with virtually any transceiver. Ideal for portable or home operation. Great for apartments and hotel rooms—simply run a wire inside, out a window, or anyplace available. Efficient toroid inductor for small size: 4-1/4" x 2-3/8" x 3", and negligible loss. Built-in neon tune-up indicator. SO-239 connector. Attractive bronze finished enclosure.

only **\$29.95**

THE ORIGINAL Random Wire Antenna Tuner. . . in use by amateurs for 6 years.

SST T-2 ULTRA TUNER

Tunes out SWR on any coax fed antenna as well as random wires. Works great on all bands (80-10 meters) with any transceiver running up to 200 watts power output.

Increases usable bandwidth of any antenna. Tunes out SWR on mobile whips from inside your car.

Uses efficient toroid inductor and specially made capacitors for small size: 5-1/4" x 2-1/4" x 2-1/2". Rugged, yet compact. Negligible line loss. Attractive bronze finished enclosure. SO-239 coax connectors are used for transmitter input and coax fed antennas. Convenient binding posts are provided for random wire and ground connections.



only **\$39.95**

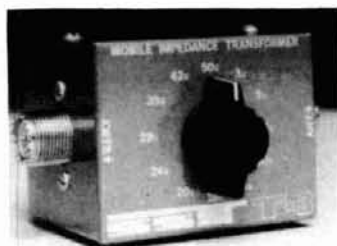

only **\$19.95**

SST T-3

Mobile Impedance Transformer

Matches 52 ohm coax to the lower impedance of a mobile whip or vertical. 12-position switch with taps spread between 3 and 52 ohms. Broadband from 1-30 Mhz. Will work with virtually any transceiver—300 watt output power capability. SO-239 connectors. Toroid inductor for small size: 2-3/4" x 2" x 2-1/4". Attractive bronze finish.

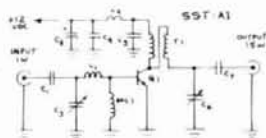

only **\$29.95**

\$49.95 wire and tested

SST A-1 VHF Amplifier Kit

1 watt input gives you 15 watts output across the entire 2 meter band without re-tuning. This easy-to-build kit (approx. 1/2 hr. assembly) includes everything you need for a complete amplifier. All top quality components. Compatible with all 1-3 watt 2-meter transceivers. Short and open protected—not damaged by high SWR.

Kit includes:

- Etched and drilled G-10 epoxy solder plated board.
- Heat sink and mounting hardware. All components—including pre-wound coils.
- Top quality TRW RF power transistor.
- Complete assembly instruction with details on a carrier operated T/R switch.



GUARANTEE



All SST products are guaranteed for 1 year. In addition, they may be returned within 10 days for a full refund (less shipping) if you are not satisfied for any reason. Please add \$2 for shipping and handling. Calif. residents, please add sales tax. COD orders OK by phone.



ELECTRONICS

P.O. BOX 1 LAWDALE, CALIF.
90260 (213) 376-5887

HAM MART

Ham Radio's guide to help you find your local

Alabama

LONG'S ELECTRONICS

2808 7TH AVENUE SOUTH
BIRMINGHAM, AL 35202
800-633-3410

Call us Toll Free to place your order

Alaska

RELIABLE ELECTRONICS

3306 COPE STREET
ANCHORAGE, AK 99503
907-279-5100
Kenwood, Yaesu, DenTron, Wilson,
Atlas, ICOM, Rohn, Tri-Ex.

Arizona

HAM SHACK

4506 A NORTH 16TH STREET
PHOENIX, AZ 85016
602-279-HAMS
Serving all amateurs from
beginner to expert.

KRYDER ELECTRONICS

5520 NORTH 7TH AVENUE
NORTH 7TH AVE. SHOPPING CTR.
PHOENIX, AZ 85013
602-249-3739
We service what we sell.

POWER COMMUNICATIONS

6012 NORTH 27th AVE.
PHOENIX, AZ 85017
602-242-6030
Arizona's #1 Ham Store.
Kenwood, Drake, ICOM & more.

QSA 599 AMATEUR RADIO CENTER

11 SOUTH MORRIS STREET
MESA, AZ 85202
602-833-8051
Eimac Distributor. New & Used
Equipment, Parts - Surplus too!

California

C & A ELECTRONIC ENTERPRISES

22010 S. WILMINGTON AVE.
SUITE 105
P. O. BOX 5232
CARSON, CA 90745
213-834-5868
Not the Biggest, but the Best —
since 1962.

HAM RADIO OUTLET

999 HOWARD AVENUE
BURLINGAME, CA 94010
415-342-5757

Visit our stores in Van Nuys
and Anaheim.

QUEMENT ELECTRONICS

1000 SO. BASCOM AVENUE
SAN JOSE, CA 95128
408-998-5900

Serving the world's Radio Amateurs
since 1933.

TOWER ELECTRONICS CORP.

24001 ALICIA PARKWAY
MISSION VIEJO, CA 92675
714-768-8900
Authorized Yaesu Sales & Service.
Mail orders welcome.

Colorado

MILE-HI COMMUNICATIONS, INC.

1970 SOUTH NAVAJO
DENVER, CO 80223
303-936-7108
Rocky Mountain's newest
ham store. Lee Tingle KØLT.

Connecticut

AUDIOTRONICS INC.

18 ISAAC STREET
NORWALK, CT 06850
203-838-4877
The Northeast's fastest growing
Ham Dept. dedicated to service.

Florida

AGL ELECTRONICS, INC.

1800-B DREW ST.
CLEARWATER, FL 33515
813-461-HAMS
West Coast's only full service
Amateur Radio Store.

AMATEUR RADIO CENTER, INC.

2805 N.E. 2ND AVENUE
MIAMI, FL 33137
305-573-8383
The place for great dependable
names in Ham Radio.

MARC'S

CENTRAL EQUIPMENT CO., INC.
18451 W. DIXIE HIGHWAY
NORTH MIAMI BEACH, FL 33160
305-932-1818
See Marc, WD4AAS, for complete
Amateur Sales & Service.

RAY'S AMATEUR RADIO

1590 US HIGHWAY 19 SO.
CLEARWATER, FL 33516
813-535-1416
West coast's only dealer:
Drake, Icom, Cushcraft, Hustler.

Illinois

AUREUS ELECTRONICS, INC.

1415 N. EAGLE STREET
NAPERVILLE, IL 60540
312-420-8629
"Amateur Excellence"

ERICKSON COMMUNICATIONS, INC.

5935 NORTH MILWAUKEE AVE.
CHICAGO, IL 60646
312-631-5181
Hours: 9:30-5:30 Mon, Tues, Wed,
Fri; 9:30-9:00 Thurs; 9:00-3:00 Sat.

SPECTRONICS, INC.

1009 GARFIELD STREET
OAK PARK, IL 60304
312-848-6777
Chicagoland's Amateur Radio
leader.

Indiana

HOOSIER ELECTRONICS, INC.

P. O. BOX 2001
TERRE HAUTE, IN 47802
812-238-1456
Ham Headquarters of the Midwest.
Store in Meadows Shopping Center.

KRYDER ELECTRONICS

GEORGETOWN NORTH
SHOPPING CENTER
2810 MAPLECREST RD.
FORT WAYNE, IN 46815
219-484-4946
We service what we sell. 10-9 T,
TH, F; 10-5 W, SAT.

Dealers - You should be here too! Contact Ham Radio today for complete details.

Amateur Radio Dealer

Iowa

BOB SMITH ELECTRONICS
RFD #3, HIGHWAY 169 and 7
FT. DODGE, IA 50501
515-576-3886
For an EZ deal.

Kansas

ASSOCIATED RADIO
8012 CONSER P. O. B. 4327
OVERLAND PARK, KS 66204
913-381-5901
Amateur Radio's Top Dealer.
Buy — Sell — Trade

Kentucky

COHOON AMATEUR SUPPLY
HIGHWAY 475
TRENTON, KY 42286
502-886-4535
Yaesu, Ten-Tec, Tempo, DenTron.
Our service is the BEST.

Maryland

THE COMM CENTER, INC.
9624 FT. MEADE ROAD
LAUREL PLAZA RT. 198
LAUREL, MD 20810
301-792-0600
R.L. Drake, Ten-Tec, Icom, Wilson,
Tempo, DenTron, Mosley, Cushcraft

**PROFESSIONAL
ELECTRONICS CO., INC.**
1710 JOAN AVENUE
BALTIMORE, MD 21234
301-661-2123
A professional place for amateurs.
Service-sales-design.

Massachusetts

TUFTS RADIO ELECTRONICS
209 MYSTIC AVENUE
MEDFORD, MA 02155
617-395-8280
New England's friendliest
ham store.

Michigan

ELECTRONIC DISTRIBUTORS
1960 PECK STREET
MUSKEGON, MI 49441
616-726-3196
Dealer for all major amateur
radio product lines.

RADIO SUPPLY & ENGINEERING
1207 WEST 14 MILE ROAD
CLAWSON, MI 48017
313-435-5660
10001 Chalmers, Detroit, MI
48213, 313-371-9050.

Minnesota

ELECTRONIC CENTER, INC.
127 THIRD AVENUE NORTH
MINNEAPOLIS, MN 55401
612-371-5240
ECI is still your best buy.

PAL ELECTRONICS INC.
3452 FREMONT AVE. NORTH
MINNEAPOLIS, MN 55412
612-521-4662
The Midwest's Fastest Growing
Ham Dealer.

Missouri

MIDCOM ELECTRONICS, INC.
2506 SO. BRENTWOOD BLVD.
ST. LOUIS, MO 63144
314-961-9990
At Midcom you can try before you
buy!

Nebraska

COMMUNICATIONS CENTER, INC.
443 NORTH 48 ST.
LINCOLN, NE 68504
800-228-4097
Kenwood, Yaesu, Drake and more
at discount prices.

Nevada

COMMUNICATIONS CENTER WEST
1072 RANCHO DRIVE
LAS VEGAS, NV 89106
800-634-6227
Kenwood, Yaesu, Drake and more
at discount prices.

New Hampshire

EVANS RADIO, INC.
BOX 893, RT. 3A BOW JUNCTION
CONCORD, NH 03301
603-224-9961
Icom, DenTron & Yaesu dealer.
We service what we sell.

New Jersey

ATKINSON & SMITH, INC.
17 LEWIS ST.
EATONTOWN, NJ 07724
201-542-2447
Ham supplies since "55".

RADIOS UNLIMITED
1760 EASTON AVENUE
SOMERSET, NJ 08873
201-469-4599
New Jersey's newest
complete Amateur Radio center

THE BARGAIN BROTHERS
216 SCOTCH ROAD
GLEN ROC SHOPPING CTR.
WEST TRENTON, NJ 06828
609-883-2050
A million parts - lowest prices
anywhere. Call us!

New Mexico

ELECTRONIC MODULE
601 N. TURNER
HOBBS, NM 88240
505-397-3012
Yaesu, Kenwood, Swan, DenTron,
Tempo, Atlas, Wilson, Cushcraft

New York

ADIRONDACK RADIO SUPPLY, INC.
185 W. MAIN STREET
AMSTERDAM, NY 12010
518-842-8350
Yaesu dealer for the Northeast.

GRAND CENTRAL RADIO
124 EAST 44 STREET
NEW YORK, NY 10017
212-682-3869
Drake, Atlas, Ten-Tec, Midland,
Hy-Gain, Mosley in stock

HAM-BONE RADIO
3206 ERIE BLVD. EAST
SYRACUSE, NY 13214
315-446-2266
We deal, we trade, all major brands!

RADIO WORLD
ONEIDA COUNTY AIRPORT
TERMINAL BLDG.
ORISKANY, NY 13424
315-337-2622
New & Used ham equipment.
See Warren K2IXN or Bob WA2MSH.

HAM MART

Ohio

AMATEUR RADIO SALES & SERVICE INC.
2187 E. LIVINGSTON AVE.
COLUMBUS, OH 43209
614-236-1625
Antennas for all services.

UNIVERSAL AMATEUR RADIO, INC.
1280 AIDA DRIVE
REYNOLDSBURG, (COLUMBUS) OH
43068
614-866-HAMS
Drake, Yaesu, Ten-Tec, KDK, Wilson,
DenTron, Tempo, Sigma.

Oklahoma

RADIO STORE, INC.
2102 SOUTHWEST 59th ST.
(AT 59th & S. PENNSYLVANIA)
OKLAHOMA CITY, OK 73119
405-682-2929
New and used equipment —
parts and supply.

Oregon

PORTLAND RADIO SUPPLY CO.
1234 S.W. STARK STREET
PORTLAND, OREGON 97205
503-228-8647
Second location, 1133 S. Riverside
Avenue, Medford, OR 97501.

Pennsylvania

ARTCO ELECTRONICS
302 WYOMING AVENUE
KINGSTON, PA 18704
717-288-8585
The largest variety of semiconduc-
tors in Northeastern Pennsylvania

ELECTRONIC EXCHANGE
136 N. MAIN STREET
SOUDERTON, PA 18964
215-723-1200
New & Used Amateur Radio
sales and service.

"HAM" BUERGER, INC.
68 N. YORK ROAD
WILLOW GROVE, PA 19090
215-659-5900
Delaware Valley's Fastest Growing
Amateur Radio Store

**HAMTRONICS, DIV. OF
TREVOS ELECT.**
4033 BROWNSVILLE ROAD
TREVOS, PA 19047
215-357-1400
Same location for 25 years.

Tennessee

GERMANTOWN AMATEUR SUPPLY
3203 SUMMER AVE.
MEMPHIS, TN 38112
800-238-6168
No monkey business. Call
Toll Free.

Texas

AGL ELECTRONICS
3068 FOREST LANE, SUITE 309
DALLAS, TX 75234
214-241-6414 (within Texas)
Out-of-State, Call our toll-free
number 800-527-7418.

HARDIN ELECTRONICS
5635 E. ROSEDALE
FT. WORTH, TX 76112
817-461-9761
Your Full Line Authorized
Yaesu Dealer.

Wisconsin

**AMATEUR
ELECTRONIC SUPPLY, INC.**
4828 WEST FOND du LAC AVENUE
MILWAUKEE, WI 53216
414-444-4200
Open Mon & Fri 9-9, Tues, Wed,
Thurs, 9-5:30, Sat, 9-3.

Washington

AMATEUR RADIO SUPPLY CO.
6213 13TH AVENUE SOUTH
SEATTLE, WA 98108
206-767-3222
First in Ham Radio in Washington
Northwest Bird Distributor

Dealers:

You should be
here too! Contact
HAM RADIO today
for complete details.

TOLL FREE 800-258-5353

ALUMA TOWERS

60 Ft.
Ham Crank-Up
Model T-60-H

40 Ft.
Crank-Up
Ham Model T-140

HIGHEST QUALITY

MADE IN ALUMINUM

- ★ TELESCOPING (CRANK UP)
- ★ GUYED
- ★ TILT OVER MODELS

QUALITY MADE

Excellent for

HAM COMMUNICATIONS

MANY MODELS MFG.

Towers to 100 feet. Specials
designed & made. See dealer
or send for free catalog.

ALUMA TOWER CO.
BOX 2806HR
VERO BEACH, FLA. 32960
PHONE (305) 567-3423

NEW ELECTRONIC PARTS
IC'S - TRANSISTORS - PROTOBOARDS - RESISTORS
CAPACITORS - DIODES - SWITCHES - CONNECTORS
VOLTAGE REGULATORS - CABINETS - HEAT SINKS
FUSES & MUCH MORE - STAMP BRINGS CATALOG

SPECIALS

KEYBOARD ENCLOSURES

TWO SIZES W	D	H	PRICE
14	8.3	3	\$15.20*
14	11.3	3	\$16.50*



BLUE BASE SPECIFY
WHITE OR BLACK TOP

BREADBOARD KIT \$10.75*

2" X 6"



BANKAMERICARD

*SHIPPING INCLUDED
NuData Electronics

104 N. EMERSON ST. MOUNT PROSPECT, ILLINOIS 60056

BIRD WATCHERS

Don't be absurd, buy a BIRD!
... from your Bird distributor

MODEL
43



\$120

ALL ITEMS AND ELEMENTS
ORDINARILY IN STOCK
Prepaid Shipment in Continental USA Only

**MADISON
ELECTRONICS SUPPLY, INC.**

1508 MCKINNEY HOUSTON, TEXAS 77002
713/658-0268 Nites 713/497-5683

sandarc

SAN DIEGO COUNTY AMATEUR RADIO COUNCIL, INC.
SPONSORS THE

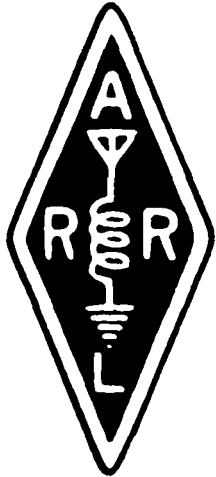
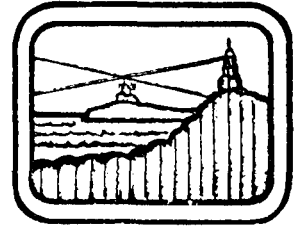

1978 ARRL NATIONAL

AND THE

QCWA NATIONAL CONVENTION

SAN DIEGO SEPTEMBER 22 - 23 - 24

TOWN & COUNTRY CONVENTION CENTER

1978 ARRL NATIONAL CONVENTION, SAN DIEGO, CALIF. SEPT. 22-24, 1978

REGISTRATION DATA FORM (Please print or type)

NAME CALL
STREET
CITY STATE..... ZIP

MAKE NAME BADGES AS BELOW

CALL	NAME	CITY
.....
.....

	Each Person—	Number
ADVANCE REGISTRATION WITH BANQUET (Ladies & Regular).....	\$19.00	<input type="checkbox"/>
ADVANCE REGISTRATION ONLY	\$ 6.00	<input type="checkbox"/>
ADVANCE REGISTRATION BANQUET ONLY	\$13.00	<input type="checkbox"/>
REGISTRATION ONLY—AFTER SEPT. 15, 1978	\$ 7.00	<input type="checkbox"/>
BANQUET ONLY—AFTER SEPT. 15, 1978	\$14.00	<input type="checkbox"/>
LADIES LUNCHEON (None sold at door; Minimum 200).....	\$ 8.00	<input type="checkbox"/>

CHECK/MONEY ORDER ENCLOSED FOR \$ IN PAYMENT FOR TOTAL OF ABOVE

MAKE PAYABLE TO: SANDARC
MAIL TO: SANDARC
P.O. BOX 563
POWAY, CA 92064

TALK { 3.900 MHZ }
IN: { 146.04-.64 MHZ }
 { 147.75-.15 MHZ }

HOTEL RESERVATIONS: CONTACT,
TOWN & COUNTRY HOTEL
500 HOTEL CIRCLE
SAN DIEGO, CA 92108 (714) 291-7131

NOTES: Only a limited number of banquet tickets will be sold at the door. Be sure to state you are attending the ARRL Convention when requesting hotel reservations. Cut off date for guaranteed reservations is Sept. 7, 1978. Please check your preference for breakfast Sunday, Sept. 24: DXQCWAWCARSFMMARSTRAFFICWPSS. Breakfast tickets will be sold Sat., Sept. 23 in the registration area. Breakfasts and prices will be controlled by the sponsoring group. Breakfasts held will depend on sponsors and your interest. Requests for refunds must be postmarked prior to Sept. 15, 1978.

GENERAL CHAIRMAN: Sam Dear, K6BWT, 13031 Papago Dr., Poway, CA 92064
(714) 566-7893

FREQUENCY COUNTERS

BY POPULAR DEMAND — we are continuing to offer

FREE with any purchase of \$99 or more from ad or flyer, a Fairchild clock module FCS-8100A (suggested retail price \$20).



Look at these Summer Specials

COMPLETE KITS: CONSISTING OF EVERY ESSENTIAL PART NEEDED TO MAKE YOUR COUNTER COMPLETE. **HAL-600A** 7-DIGIT COUNTER WITH FREQUENCY RANGE OF ZERO TO 600 MHz. FEATURES TWO INPUTS: ONE FOR LOW FREQUENCY AND ONE FOR HIGH FREQUENCY; AUTOMATIC ZERO SUPPRESSION. TIME BASE IS 1.0 SEC OR .1 SEC GATE WITH OPTIONAL 10 SEC GATE AVAILABLE. ACCURACY $\pm .001\%$. UTILIZES 10-MHz CRYSTAL 5 PPM.

COMPLETE KIT... ~~\$149~~... \$129

HAL-300A 7-DIGIT COUNTER WITH FREQUENCY RANGE OF ZERO TO 300 MHz. FEATURES TWO INPUTS: ONE FOR LOW FREQUENCY AND ONE FOR HIGH FREQUENCY; AUTOMATIC ZERO SUPPRESSION. TIME BASE IS 1.0 SEC OR .1 SEC GATE WITH OPTIONAL 10 SEC GATE AVAILABLE. ACCURACY $\pm .001\%$. UTILIZES 10-MHz CRYSTAL 5 PPM.

COMPLETE KIT... ~~\$124~~... \$109

HAL-50A 8-DIGIT COUNTER WITH FREQUENCY RANGE OF ZERO TO 50 MHz OR BETTER. AUTOMATIC DECIMAL POINT, ZERO SUPPRESSION UPON DEMAND. FEATURES TWO INPUTS: ONE FOR LOW FREQUENCY INPUT, AND ONE ON PANEL FOR USE WITH ANY INTERNALLY MOUNTED HALTRONIX PRE-SCALER FOR WHICH PROVISIONS HAVE ALREADY BEEN MADE. 1.0 SEC AND .1 SEC TIME GATES. ACCURACY $\pm .001\%$. UTILIZES 10-MHz CRYSTAL 5 PPM.

COMPLETE KIT... ~~\$124~~... \$109

ATTENTION RADIO CLUBS

For club or group projects, request FREE information about our DISCOUNTS on any of the HAL-TRONIX kits. Discounts range from 10-25%, depending upon the quantity needed.

We are experienced in supplying kits in volume quantities to schools, laboratories, clubs, and common-interest groups. Nobody beats HAL-TRONIX quality and price. Just try us and see for yourself.



FROM HAL-TRONIX DELUXE 12-BUTTON TOUCH-TONE ENCODER KIT

utilizing the new ICM 7206 chip. Provides both VISUAL AND AUDIO indications! Comes with its own two-tone anodized aluminum cabinet. Measures only 2 3/4 x 3 3/4". Complete with Touch-Tone pad, board, crystal, chip and all necessary components to finish the kit.

PRICED AT... \$29.95

For those who wish to mount the encoder in a hand-held unit, the PC board measures only 9/16" x 1 1/4". This partial kit with PC board, crystal, chip and components.

PRICED AT... \$14.95

PRE-SCALER KITS

HAL 300 PRE \$19.95
(Pre-drilled G10 board and all components)

HAL 300 A/PRE \$29.95
(Same as above but with preamp)

HAL 600 PRE \$34.95
(Pre-drilled G10 board and all components)

HAL 600 A/PRE \$39.95
(Same as above but with preamp)

PRE-BUILT COUNTERS AVAILABLE

HAL-600A \$229.00

HAL-300A \$199.00

HAL-50A \$199.00

ALLOW 4- TO 6-WEEK DELIVERY ON PRE-BUILT UNITS.

HAL-TRONIX

PO BOX 1101, SOUTHGATE, MI 48195

PHONE (313) 285-1782



"HAL"
HAROLD C. NOWLAND
W8ZXH

SHIPPING INFORMATION:

ORDERS OVER \$15.00 WILL BE SHIPPED POSTPAID EXCEPT ON ITEMS WHERE ADDITIONAL CHARGES ARE REQUESTED ON ORDERS LESS THAN \$15.00 PLEASE INCLUDE ADDITIONAL \$1.00 FOR HANDLING AND MAILING CHARGES. SEND SASE FOR FREE FLYER.

Freedom of Choice

In the past when your YAESU or KENWOOD dealer said the CW crystal filter for your set was optional you had a choice: Buy one of his standard units — or do without.

NO LONGER!

Now FOX-TANGO not only offers filters similar in bandwidth to those supplied by your set's manufacturer, but also sharp eight-pole, 250 Hz bandwidth filters with superior shape factors at an unbeatable price — some similar units are being advertised for \$100! And even so, they are not as sharp.

BUT THAT'S NOT ALL

Yaesu's CW filters for the FT-101, FR-101 and FT-301 Series have a bandwidth of 600 Hz. Most hams feel 600 Hz is too wide for today's conditions but that's not the only reason they find the going rough when the band is crowded: Not only are our filters 8-pole, but they have a superior shape factor and 500 Hz bandwidth. Wide enough for tuning ease, yet sharp and selective enough to cut through all but the heaviest QRM. And for the Kenwood CW enthusiast FOX-TANGO now offers, in addition to the sharp eight-pole 250 Hz units for the TS-520, R-599, and the TS-820 Series; new eight-pole 400 Hz filters with characteristics superior to those of the regular Kenwood 500 Hz units.

SOME REAL OPTIONS

But talk about FREEDOM OF CHOICE! Inexpensive, easily installed diode-switching boards are now available for all the above sets which permit the addition of up to two crystal filters in addition to those for which the manufacturer provides space. For example, if you have no CW filter at present or are just buying your set (which never comes with the filter factory-installed) you can select either of our superior units, secure in the knowledge that you can add the other later if you wish. Or if your rig already has a standard CW filter installed, you can add our sharp unit so that either can be switch-selected often using existing front panel controls. Just imagine! Nail your rare DX with the standard-type filter and cut out the crud and crowd with the flip of a switch. Now that's OPERATING!

HOW WE DO IT

Some hams have wondered how we can offer superior filters at such a low price. And they are superior, not only on the basis of laboratory tests but according to members of the International Fox-Tango Club who have used them in their rigs for many months. The answer to the "low price" question is that these filters are made for us in Japan by a concern with almost a quarter-century of experience in the design and production of these units, among others, for use in the best-known and most respected brands of both amateur and commercial gear. In the past their filters were sold exclusively to set manufacturers. Now they are being offered at retail for the first time — and at introductory prices — through our organization only.

GET YOURS NOW AND BEAT THE INFLATIONARY SPIRAL!

Our Filters are sold on a Money-back Guarantee Basis.

FOX-TANGO CORP.

Box 15944B, W. Palm Beach, FL 33406

DIODE SWITCHING BOARDS permit easy mounting (without drilling) of up to two crystal filters of any type in addition to those for which the manufacturer provides space. These boards will accommodate any of the filters listed below and other types planned for the future. They include one stage of amplification to compensate for filter insertion losses, if desired. Complete instructions. **SPECIFY Set with which board is to be used. \$15 with purchase of any filter. \$20 without filter.** Airmail Ppd. US & Canada. Overseas add \$1.

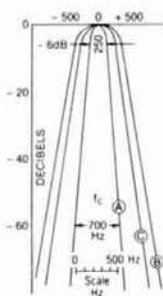

BANDWIDTH 6dB DOWN	TYPE NUMBERS FOR ORDERING
	CW FILTERS FOR YAESU
Hz TYPE	FT101 101 FT-301
250 (A)	YF31H250 YF89H250
500 (B)	YF31H500 YF89H500
	CW FILTERS FOR KENWOOD
Hz TYPE	TS-520/R599 TS-820
250 (A)	YF33H250 YF88H250
400 (B)	YF33H400 YF88H400

ALL TYPES

Only \$50

Airmail Ppd. US & Canada. Overseas add \$3 Circle type desired.

I enclose \$ _____ Check Money Order Cash
(Make checks payable to FTC)

I prefer to charge my

VISA Master Charge Name _____

Account No. _____ Address _____

Expiration date: _____ City _____

MC 4 digit no. _____ State _____ Zip _____

Florida residents add 4% Sales Tax.

THINKING ABOUT OSCAR?

Here are some helpful suggestions -

AT LAST! A 2 METER SSB TRANSVERTER

At a price you can afford

FAMOUS HAMTRONICS PREAMPS

let you hear the weak ones!

Great for OSCAR, SSB, FM, ATV. Over 10,000 in use throughout the world on all types of receivers.

P9 Kit \$12.95
P14 Wired \$24.95

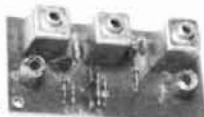

Deluxe vhf model for applications where space permits.

- 1-1/2 x 3" • Covers any 4 MHz band • 12 Vdc
- Ideal for OSCAR • Diode protection • 20dB gain

MODEL	RANGE
P9-LO	26-88 MHz
P9-HI	88-172 MHz
P9-220	172-230 MHz
P14 Wired	Give exact band



P8 Kit \$10.95
P16 Wired \$21.95

- Covers any 4 MHz band
 - 20 dB gain • 12 Vdc
- Miniature VHF model for tight spaces - size only 1/2 x 2-3/8 inches.

MODEL	RANGE
P8-LO	20-83 MHz
P8-HI	83-190 MHz
P8-220	220-230 MHz
P16 Wired	Give exact band

P15 Kit \$18.95
P35 Wired \$34.95



- Covers any 6 MHz band in UHF range of 380-520 MHz
- 20 dB gain • Low noise

FM/CW TRANSMITTER KITS

BUILD UP YOUR OWN GEAR FOR OSCAR CW OPERATION, FM REPEATERS, CONTROL LINKS

- Professional Sounding Audio • Free of Spurs
- Completely Stable • Built-in Testing Aids



T40 11 Channel 200 MW Exciter Kit for 2M or 6M band..... \$39.95
T20 Tripler/Driver Kit. Use with T40 for operation on 432-450 MHz band..... \$19.95

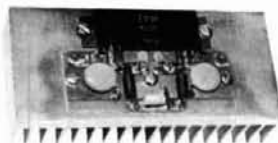

T80 RF POWER AMPLIFIER MODULES FOR ABOVE

- No tuning • VSWR Protected • Wired and Tested
 - Rated for Continuous Duty - Great for Repeaters
- T80-150: 140-175 MHz, 20-25W output \$79.95
T80-450: 430-470 MHz, 13-15W output \$79.95

Use inexpensive recycled 10 or 11 meter ssb exciter on 2 meters.

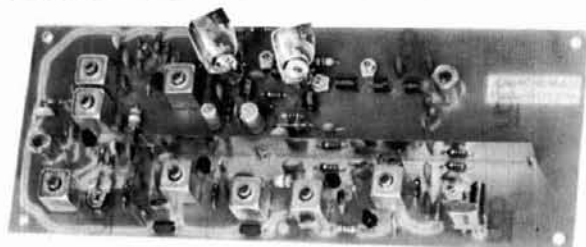

FEATURES:

- Linear Converter for SSB, CW, FM, etc.
- A fraction of the price of other units
- 2W p.e.p. output with 5 MW of drive
- Use low power tap on exciter or attenuator pad
- Easy to align with built-in test points

Frequency Schemes Available:

VX2-4	28-30 = 144-146	□ Other frequency ranges available on special order
VX2-5	28-29 = 145-146	□
VX2-6	26-28 = 144-146	□

2M LINEAR POWER AMPLIFIERS:

LPA 2-15 Kit	15 W p.e.p.	\$69.95
LPA 2-70 Kit	70 W p.e.p.	\$139.95

VX2-() TRANSVERTER KIT \$59.95
A25 Optional Cabinet for Xverter&PA \$20

New VHF&UHF Converter Kits

let you receive OSCAR signals and other exciting SSB, CW, & FM activity on your present HF receiver.

either one
- ONLY \$34.95
including crystal



MODEL	RF RANGE (MHZ)	I-F RANGE
C50	50-52	28-30
C144	144-146	28-30
C145	145-147 (OSCAR)	28-30
C146	146-148	28-30
C110	Aircraft	28-30
C220	220 band	28-30
Special	Other i-f & rf ranges available	

MODEL	RF RANGE (MHZ)	I-F RANGE
C432-2	432-434	28-30
C432-5	435-437 (OSCAR)	28-30
C432-7	427.25	61.25
C432-9	439.25	61.25
Special	Other i-f & rf ranges available	

A9 Extruded Alum Case/Connectors \$12.95

VHF/UHF FM RCVR KITS

- NEW GENERATION RECEIVERS
- MORE SENSITIVE • MORE SELECTIVE (70 or 100 dB)
- COMMERCIAL GRADE DESIGN
- EASY TO ALIGN WITH BUILT-IN TEST CKTS
- LOWER OVERALL COST THAN EVER BEFORE



R70 6-channel VHF Receiver Kit for 2M, 6M, 10M, 220 MHz, or com'l bands..... \$69.95
Optional xtal filter for 100 dB adj chan 10.00



R90 UHF Receiver Kit for any 2 MHz segment of 380-520 MHz band..... \$89.95

* FREE 1978 CATALOG *

40 PAGE CATALOG IS YOURS FOR THE ASKING!

IT'S EASY TO ORDER!

- CALL OR WRITE NOW FOR FREE CATALOG OR TO PLACE ORDER!
- PHONE 716-663-9254. (Answering service evenings and weekends for your convenience. Personal service 9-5 eastern time.)
- Use credit card, c.o.d., check, m.o.
- Add \$2.00 shipping & handling.

IN CANADA, send to Comtec; 5605 Westluka Ave; Montreal, Que H4W 2N3 or phone 514-482-2640. Add 28% to cover duty, tax, and exchange rate.

hamtronics, inc.

182-C Belmont Rd; Rochester, NY 14612

ALL-MODE VHF amplifiers

FOR BASE STATION & REPEATER USE



MODEL	INPUT	OUTPUT	PRICE
V70	10-20W	70-90W	\$298
V71	1-3W	70-90W	\$329
V130	25-40W	110-130W	\$389
V131	1-5W	110-130W	\$419
V135	5-10W	110-130W	\$419
V180	8-15W	180-200W	\$525
Universal 19" Rack Mount			\$25

* All units: Harmonics exceed -60 dB specification of FCC R&O 20777

- ☆ 143-149 MHz No Tuning
- ☆ AM - FM - CW - SSB
- ☆ Low Harmonics
- ☆ Heavy Duty
- ☆ No Power Supply Needed
- ☆ Illuminated Panel Meter
- ☆ +13.5V/3 Amp Socket
- ☆ 115 or 230V AC
- ☆ 60dB Spurious
- ☆ Fully Protected Output
- ☆ Internal T/R Switch
- ☆ U.S. Manufactured
- ☆ 19" Rack Panel Option
- ☆ Size 8-1/2 x 13 x 7" H

FCC type accepted models under Parts 89, 91, and 93 available.

Only two things are needed to put this power house on the air with your handy-talky or mobile transceiver: a two foot piece of coaxial cable and a 115 or 230 volt AC outlet. That's all. You do not need anything else. The mobile transceiver can be powered directly from the accessory socket located in the rear panel of the RFPL amplifier. It puts out +13.5 volts at 3 amperes. This is sufficient for powering most 15 watt transceivers.



DEALER INQUIRIES INVITED

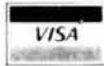

RF POWER LABS, INC.

11013-118th Place N.E. • Kirkland, Washington 98033 • Telephone: (206) 822-1251 • TELEX No. 32-1042

DIPOLE ANTENNA CONNECTOR



HYE-QUE (HQ-3) dipole connector has coax SO-239 socket molded into glass filled plastic body to accept coax PL-259 plug on feedline. Drip-cap keeps coax fittings dry. Instructions included. Guaranteed. At your dealers or \$4.95 postpaid. Companion insulators 2/\$.99.

BUDWIG MFG. Co. PO Box 97H, Ramona, CA 92065

FACSIMILE

COPY SATELLITE, PHOTOS, WEATHER MAPS, PRESS!

The Fax Are Clear — on our full size (18-1/2" wide) recorders. These commercial-military units now available at surplus prices. Learn how to copy with our FREE Fax Guide. Tel.: (212) 372-0349

ATLANTIC SURPLUS SALES
3730 NAUTILUS BROOKLYN, N.Y. 11224

The Ultimate IAMBIC PADDLE...

- Full range of adjustment in tension and contact spacing
- Self-adjusting nylon and brass needle bearings
- Solid silver contact points
- Precision-machined, chrome plated brass frames
- Heavy steel base has black, textured finish (chrome plated base optional)
- Non-skid feet



Write for literature

Available at selected dealers or send \$39.95 (\$49.95 for chrome model) plus \$2.00 shipping and handling. Money-back guarantee.



BENCHER, INC.

Dept. A, 333 W. Lake St., Chicago, IL 60606
(312) 263-1808



Radio Amateurs Reference Library of Maps and Atlas

WORLD PREFIX MAP — Full color, 40" x 28", shows prefixes on each country... DX zones, time zones, cities, cross referenced tables

\$1.25

RADIO AMATEURS GREAT CIRCLE CHART OF THE WORLD — from the center of the United States! Full color, 30" x 25", listing Great Circle bearings in degrees for six major U.S. cities: Boston, Washington, D.C., Miami, Seattle, San Francisco & Los Angeles.

\$1.25

RADIO AMATEURS MAP OF NORTH AMERICA! Full color, 30" x 25" — includes Central America and the Caribbean to the equator, showing call areas, zone boundaries, prefixes and time zones, FCC frequency chart, plus useful information on each of the 50 United States and other Countries

\$1.25

WORLD ATLAS — Only atlas compiled for radio amateurs. Packed with world-wide information — includes 11 maps, in 4 colors with zone boundaries and country prefixes on each map. Also includes a polar projection map of the world plus a map of the Antarctica — a complete set of maps of the world. 20 pages. Size 8 3/4" x 12"

\$2.50

Complete reference library of maps — set of 4 as listed above

\$3.75

See your favorite dealer or order direct.

Mail orders please include \$1.25 per order for shipping and handling.

RADIO AMATEUR

WRITE FOR FREE BROCHURE!



callbook INC.

Dept. E 925 Sherwood Drive
Lake Bluff, Ill. 60044

SUB-AUDIBLE GENERATOR for FM

THE CUBE

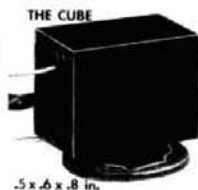

.5 x .6 x .8 in.

- Inexpensive multi tone encoder
- Compatible with PL-CG-QC
- Low distortion sinewave
- Input 8-18 VDC unregulated
- Rugged, plastic encased with leads
- Adjustable frequency (98-250 Hz), Lower available
- Excellent stability

Price \$19.95

Freq. set at factory \$5.00 extra

Calif. res. add 6%

Send for more info

lyle Products

Dept. hr P.O. Box 2083 Santa Clara, CA. 95051

IN STOCK FOR IMMEDIATE DELIVERY!



MODEL 43
\$125
Post Shipping



BROAD LINE OF BIRD PRODUCTS STOCKED IN DEPTH

AUTHORIZED DEALER/DISTRIBUTOR



SPECTRONICS, INC.

(312) 848-6777 1009 GARFIELD ST
OAK PARK, ILL. 60304

Here's an important new book from The Ham Radio Publishing Group. And to make it even more exciting, there is a very substantial pre-publication savings. "Radio Angels" depicts the heroic, glorious efforts of Amateurs around the world serving their fellow man during the times of distress. 160 pages of daring rescues, emergency assistance, and human compassion. Get your thrilling copy now!

New!

Often there are no signals operating out of the South Pole because of electrical storms and the aurora borealis. "Their winter will go on until September and there's no way of getting them out," said Guritz.

"... don't know our location," the voice said, "... suffering from complete mental, physical and nervous exhaustion ... adrift in high seas for three days."

Great Gift Idea!

Be thoughtful. Give your friends (non-Amateurs too!) a copy of this super new book.

ham
radio's
communications
bookstore

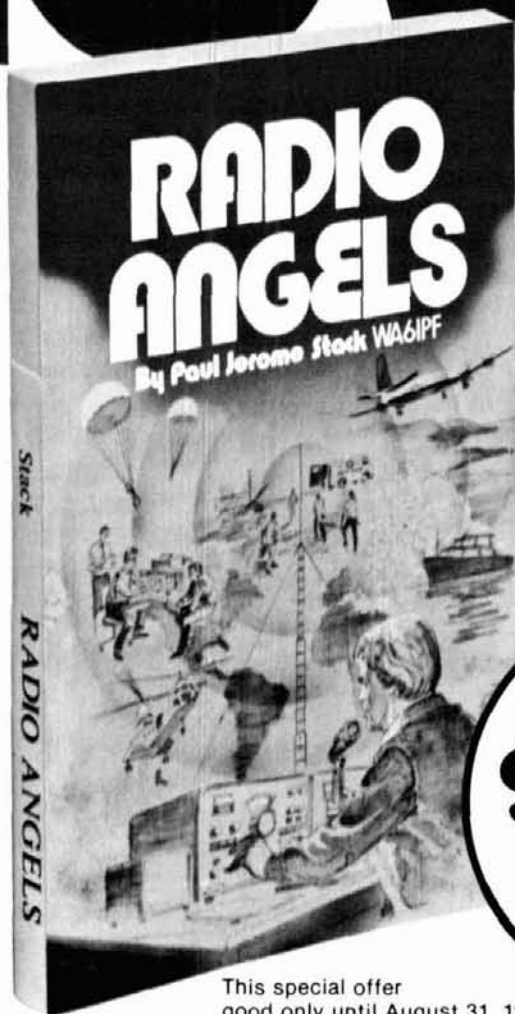

"It became necessary to transport the injured ... Radio Amateurs were dispatched quickly to area hospitals to form radio links with the command center. They later proceeded through downed trees and dangerous power lines to Cedarville to establish communications from there."

Get yours at
this special
reduced price

Pre-Publication
\$3.95 postpaid
SPECIAL
Regularly \$4.50

This special offer good only until August 31, 1978

Send check, money order, VISA or Master Charge



Ham Radio's Communications Bookstore

Greenville, New Hampshire 03048

RTTY for ALL Systems



ELECTROCOM® "SERIES 400" FREQUENCY SHIFT CONVERTERS

Professionally engineered for outstanding performance, stability, and reliability, the Electrocom® Models 400 and 402 add new dimensions of compatibility between radio and teletypewriter systems. Manufactured to highest quality standards—an Electrocom tradition for nearly two decades—these units are ideal for military, government, commercial, civil defense and amateur applications. The Model 400 front panel digital knob accurately selects shifts up to 1000 Hz., while two such knobs on the Model 402 independently set the mark and space frequencies. Both models may also be preset with any tone pair between 1000 and 3200 Hz.

Optimum performance with FSK or AFSK

systems is assured by matched filters, precision linear detectors, baud rate selector, bias compensation, and semi-diversity circuitry. Operation is enhanced by a CRT monitor, autostart with solid-state motor switching, antispaces, markhold, EIA/MIL output voltages, and a constant current loop supply. In addition, various options are available including rack mounting and polar current output.

Write or call us for complete product details and specifications. Learn why Electrocom® "400" Converters are designed not only for today's communication environment, but ultimately to fulfill RTTY requirements for years to come.

Electrocom® INDUSTRIES
1105 N. IRONWOOD DRIVE, SOUTH BEND, INDIANA 46615
Telephone: (219) 232-2743

PCP™ TYPE:A PATENT PENDING

SEE POPULAR ELECTRONICS
FEB '78 ISSUE!

FINALLY you can make HIGH QUALITY printed circuit boards directly from magazine construction articles! Can also be used to make specialized meter faces, front panel details, component placement details & others.
(Kits Available)

Small Pkg. 6pcs 4x6 \$5.49
Med. Pkg. 4pcs 6x9 \$6.95
Large Pkg. 3pcs 9x12 \$7.95

PCP

PRINTED CIRCUIT PRODUCTS CO.
P.O. BOX 1034
HELENA, MT 59601

BUILD-IT-YOURSELF AVIONICS FOR HAM PILOTS

Free catalogue describes high technology, low cost avionics and test equipment offered in kit form. Product line includes audio panel, aircraft band two-channel transceiver, digital chronometer, navigation and communications test equipment, bench power supply, and more. Shoot us the coupon for details.

Name _____
Address _____
City _____ State _____ Zip _____
(916) 272-2203
**Radio Systems
Technology, Inc.**
RR 5, GRASS VALLEY, CA 95945

7th ANNUAL HAMBURG INTERNATIONAL HAMFEST PRESENTS

HAM-O-RAMA "78"

SEPTEMBER 16th — 9 A.M. - 5 P.M.
ERIE COUNTY FAIRGROUNDS BUFFALO, N.Y.

Speakers — Big Prizes — Ladies' Programs — Major Manufacturers — R.V. Hookups — Indoor/
Outdoor Flea Markets — Talk In On 52 & 31/91 — Off N.Y.S. I-90 at Exit 57

Details: H.I.H. Committee, 10404 Cayuga Drive, Niagara Falls, N.Y. 14304 — Phone 716-297-0539 716-873-3984

"WAZYERBESPRIS?"

(607) 739-0187

YAESU

DRAKE

CALL US FOR OUR "CASH-AND-CARRY" PRICE

IN-STOCK ITEMS SHIPPED UPS WITHIN 24 HOURS

PHONE: TUES.-FRI. 10-5 WALK-IN: SATURDAYS ONLY 12-4

OTHER HOURS BY APPOINTMENT ONLY

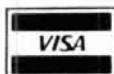

C F P COMMUNICATIONS

211 NORTH MAIN STREET
HORSEHEADS, N. Y. 14845
PHONE: 607-739-0187



MOVING? KEEP HAM RADIO COMING...

If possible let us know four to six weeks before you move and we will make sure your HAM RADIO Magazine arrives on schedule. Just remove the mailing label from this magazine and affix below. Then complete your new address (or any other corrections) in the space provided and we'll take care of the rest.

ham
radio
Magazine

Allow 4-6 weeks for
correction.

Greenville, NH 03048

Thanks for helping us to serve you better.

Here's my new address:

Name _____
Address _____
City _____ State _____ Zip _____

AFFIX
LABEL
HERE

1-800-432-1234

1-800-233-0250

Don't play the numbers!

Just call us... Toll Free!

1-800-325-3636

FOR NEW OR USED AMATEUR RADIO GEAR... we're specialists and carry *in stock* most of the famous-brand lines. Or, we will talk trade.

FOR FAST, DOOR-STEP DELIVERY... give us a call. You'll be amazed; for we guarantee we'll ship your equipment the same day. Plus, most shipments are **PRE-PAID**.

TO SAVE MONEY... join thousands of our satisfied customers who buy from us as easily as from their local supplier. So, remember your call is *Toll Free*.



We welcome your Master Charge or VISA/BankAmericard.

HAM RADIO CENTER

8340-42 Olive Blvd. P.O. Box 28271 St. Louis, MO 63132



Regency Scanner

BRINGS YOU THE NEWS WHILE ITS HAPPENING



10 channels covering all 5 bands. AC/DC operation.

SAVE \$40 **\$89.95**
LIST-\$129.95

1,000's OF CRYSTALS

- H25C Case Scanner Monitor
- 10.7 Amateur Ham
- 2 Meter, CB, Standard

1 to 9	10 to 49	50 and UP
\$3.70	\$3.00	\$2.50

CRYSTAL BANKING SERVICE
P.O. BOX 683
LYNNFIELD, MASS. 01940

ALL BAND TRAP ANTENNAS!



ALL 5 BAND OPERATION - ONLY ONE NEAT SMALL ANTENNA. FOR CONGESTED HOUSING AND APARTMENT DWELLERS! LIGHT, NEAT - ALMOST INVISIBLE!

FOR ALL MAKES AMATEUR HF TRANSMITTERS - TRANSCEIVERS - GUARANTEED FOR 2,000 WATTS PEP POWER. FOR NOVICE AND ALL CLASS AMATEURS!

COMPLETE Ready to put up with 30 ft. Dacron end support cords! Wt. 3 lbs., 1"X5" MOLDED RESONANT TRAPS - just switch your transmitter to desired band for EXCELLENT PERFORMANCE!

NO TUNERS OR BALUNS NEEDED! CAN BE USED IN ATTICS, TOPS OF BUILDINGS, INVERTED V; IN MINIMUM SPACE. NO CENTER SUPPORT NEEDED, NO HAYWIRE HOUSE APPEARANCE COMPLETELY ASSEMBLED. No tuning - cutting - soldering - measuring - JUST HANG IT, AND USE IT! SWR IS 1.2 AT RESONANCE THOUSANDS IN USE - EASIEST INSTALLATION!

80-40-20-15-10 meter bands---102 ft. with 90 ft. RG58U coax - connector - Model 998BU... \$49.95
40-20-15-10 meter bands---54 ft. with 90 ft. RG58U coax - connector - Model 1001BU... \$48.95
20-15-10 meter bands---26 ft. with 90 ft. RG58U coax - connector - Model 1007BU... \$47.95

Send only \$5.00 (cash, ck., mo.) and pay postman balance plus COD postage OR SEND FULL PRICE FOR POST PAID DEL. IN USA (Canada is \$5.00 extra) or order by MAIL OR PHONE with BankAmericard VISA - MASTER CHARGE - OR AM EXP. Give number and ex. date. Ph 1-308-236-5333 week days. We ship in 2-3 days. INFLATION? PRICES MAY INCREASE - SAVE - ORDER NOW! INFO. AVAILABLE FROM: WESTERN ELECTRONICS Dept. AH- 8 Kearney, Nebraska, 68847

NEW!

DAVIS ELECTRONICS

600 MHz Mini Counter

NOW...
• Completely PORTABLE with Ni-Cad Batteries
• Crystal Oven Available



General Purpose Low Cost Counter Without the Sacrifice of Basic Performance
"Check the features we have that some other low cost counters don't have."

- All Metal Cabinet
- Sensitivity 10 MV at 60 MHz
- Completely Auto Decimal Point
- 8 Digit 4" LED Display
- 115V or 12V Operation
- Selectable Gate Times (1 sec & .1 sec)
- Input Cable Included
- Push Button Controls
- Built-in Preamp (optional)
- 12V Input Jack
- Gate Light
- Crystal Time Base (1 ppm after cal.)

7208K 600 MHz Kit ... \$149.95 7208A Assembled ... \$199.95

OPTIONS ... 01) Portable w/Ni-Cad. Battery (Built in Charger) ... \$39.95
02) Crystal Oven (1 ppm: 0 to 60°C) \$39.95 03) Handle ... \$5.00
04) Built-in Preamp 10 MV @ 150 MHz ... \$10.00



DAVIS ELECTRONICS 636 Sheridan Dr., Tonawanda, NY 14150 716/874-5848

Pre-Amp PROBE
10-500 MHz
Only \$49.95



Advertisers check-off

... for literature, in a hurry — we'll rush your name to the companies whose names you "check-off"

Place your check mark in the space between name and number. Ex: Ham Radio 234

INDEX

AR Tech. _____ 687	Integ. Circuits _____ 518
Adv. Elect. _____	Int. Crystal _____ 066
Appl. _____ 677	Jameco _____ 333
Alliance _____ 700	Jan _____ 067
Aluma _____ 589	Jones _____ 626
Atlantic Surplus _____ 644	K-Enterprises _____ 071
Atlas _____ 198	Kantronics _____ 605
Bauman _____ 017	Kenwood * _____
Bencher _____ 629	Kester * _____
Budwig _____ 233	Larsen _____ 078
Bullet _____ 328	Long's _____ 468
CFP _____ 022	Lyle _____ 373
CW Elect. _____ 533	MFJ _____ 082
Circuit Spec. _____ 026	Madison * _____
Clegg _____ 027	Marine Tech. _____ 698
Cleveland _____	Multicore _____
Hamfest * _____	Solders _____ 703
Communications _____	NuData _____ 455
Center _____ 534	Optoelectronics _____ 352
Comm. Spec. _____ 330	Palomar Elec. _____ 673
Cont. Spec. _____ 348	Palomar Eng. _____ 093
Crystal Banking _____ 573	Partridge _____ 439
Cushcraft _____ 035	P.C.P. _____ 648
DSI _____ 656	RF Power Labs _____ 602
Dames Comm. _____ 551	RIW _____ 679
Dames, Ted _____ 324	Callbook _____ 100
Data Signal _____ 270	Radio Sys. Tech. _____ 422
Davis Elec. _____ 332	Radio World * _____
DenTron _____ 259	Ramsey _____ 442
Disc-Cap _____ 449	S-F A. R. S. _____ 640
Drake _____ 039	SST _____ 375
E.T.O. * _____	San Diego ARC * _____
Electrocom _____ 663	Sherwood _____ 435
Elec. Distr. _____ 044	Skytec _____ 704
Elec. Equip. _____	Slep _____ 232
Bank _____ 288	Space _____ 107
Fox-Tango _____ 657	Spectronics _____ 191
GLB _____ 552	Spectrum Int. _____ 108
Gem Quad _____ 295	Standard Comm. _____ 109
Godbout _____ 647	Swan _____ 111
Gray _____ 055	TPL _____ 240
Gregory _____	Ten-Tec * _____
Group III _____ 701	The Comm Center _____ 634
Gull _____ 635	Tristao _____ 118
Hal _____ 057	Universal A. R. S. _____ 653
Hal-Tronix _____ 254	VHF Eng. _____ 121
Hamburg Int. _____	VIZ _____ 696
Hamfest * _____	Vanguard * _____
Ham Center _____ 491	Varian _____ 043
HRCB _____ 150	Webster Assoc. _____ 423
HR Magazine _____ 150	Weinschenker _____ 122
HR Report _____ 206	Western * _____
Hamtronics _____ 246	Whitehouse _____ 378
Heath _____ 060	Wilson _____ 123
Henry _____ 062	Wren _____ 702
Hy-Gain _____ 064	Yaesu _____ 127
Icom _____ 065	

*Please contact this advertiser directly.

Limit 15 inquiries per request.

August, 1978

Please use before September 30, 1978

Tear off and mail to

HAM RADIO MAGAZINE — "check off"
Greenville, N. H. 03048

NAME

CALL

STREET

CITY

STATE ZIP



There's
nothing
like it !

RADIO AMATEUR
callbook

Respected worldwide as
the only complete authority
for radio amateur
QSL and QTH information.

The U.S. Callbook has over 300,000 W & K listings. It lists calls, license classes, names and addresses plus the many valuable back-up charts and references you come to expect from the Callbook.

Specialize in DX? Then you're looking for the **Foreign Callbook** with almost 300,000 calls, names and addresses of amateurs outside of the USA.

U.S. Callbook \$14.95

Foreign Callbook \$13.95

Order from your favorite electronics dealer or direct from the publisher. All direct orders add \$1.50 for shipping. Illinois residents add 5% Sales Tax.

RADIO AMATEUR
callbook INC.
Dept. E 925 Sherwood Drive
Lake Bluff, Ill. 60044

Advertisers Index

AR Technical Products, Inc.	98
Advanced Electronic Applications	88
Alliance Mfg. Company	73
Aluma Tower Co.	118
Atlantic Surplus Sales	122
Atlas Radio	69
R. H. Bauman Sales Co.	98
Bencher, Inc.	122
Budwig Mfg. Co.	122
Bullet	107
CFP Communications	124
CW Electronic Sales Company	96
Circuit Specialists	114
Clegg	83
Cleveland Hamfest	112
Communications Center	103
Communications Specialists	58, 59
Crystal Banking Service	125
Cushcraft	85, 87, 89
DSI Instruments	78, 79
Dames Communications Systems	108
Dames, Ted	102
Data Signal, Inc.	94
Davis Electronics	98, 125
DenTron Radio Company	7, 111
Disc-Cap	77
Drake Co., R. L.	38, 39
Ehrhorn Technological Operations	127
Electrocom Industries	124
Electronic Distributors	90
Electronic Equipment Bank	88
Fox-Tango Corporation	120
GLB	108
Gem Quad Products	102
Godbout Electronics	92
Gray Electronics	102
Gregory Electronics	112
Group III Sales Company	108
Gull Electronics	101
Hal Communications Corp.	23
Hal-Tronix	120
Hamburg International Hamfest	124
Ham Radio Center	125
Ham Radio's Communications Bookstore	93, 96, 119, 123
Ham Radio Magazine	124
Ham Radio Report	74
Hamtronics, Inc.	121
Heath Company	33, 104
Henry Radio Stores	Cover II
Hy-Gain Electronics	105
Icom	5
Integrated Circuits Unlimited	113
International Crystal	99
Jameco Electronics	109
Jan Crystals	106
Jones, Marlin P. & Assoc.	102
K-Enterprises	110
Kantronics	94
Trio-Kerwood Communications, Inc.	9, 64, 65
Kester Solder	90
Larsen Antennas	22
Long's Electronics	128
Lyle Products	122
MFJ Enterprises	2
Madison Electronic Supply	100, 118
NuData Electronics	118
Optoelectronics	96
Palomar Electronics Corp.	55
Palomar Engineers	86
Partridge (HR) Electronics	106
Printed Circuit Products	124
RF Power Labs	122
RIW Products	110
Radio Amateur Callbook	122, 126
Radio Systems Technology, Inc.	124
Radio World	108
Ramsey Electronics	71
S-F Amateur Radio Services	92
SST Electronics	115
San Diego ARC	66
Sherwood Engineering	114
Slep Electronics	104
Space Electronics	110
Spectronics	98, 104, 110, 114, 122
Spectrum International	112
Swan Electronics	1
TPL Communications	94
Ten-Tec	97
The Comm Center	114
Tristao Tower	108
Universal Amateur Radio Service, Inc.	106
VHF Engineering, Div. of Brownian	91
Vanguard Labs	104
Varian, Eimac Division	Cover IV
Webster Associates	110
Weinschenker	106
Western Electronics	125
Whitehouse, G. R. & Co.	16
Wilson Electronics	37
Wren Company	110
Yaesu Electronics Corp.	Cover III

THE NEW **ALPHAS** ARE HERE!

FOUR RUGGED NEW BEAUTIES . . . EACH IN A CLASS BY ITSELF!



MAXIMUM LEGAL POWER . . . ALPHA STYLE

There are lots of so-called "Maximum Legal Power" linear amplifiers on the market. Why is it that so many knowledgeable amateurs, after checking out (and often owning) the others, ultimately choose an ALPHA?

For one thing, "maximum legal power" doesn't begin to tell the whole story. Nearly all manufacturers' ratings implicitly assume an amateur service duty cycle much less than 100%. Even the terms "continuous" and "100%" duty have been so debased in recent years as to be meaningless unless explicitly defined. The consequence, too often, is a power transformer or tube going up in smoke during a long operating period.

Every ALPHA amplifier is unequivocally rated to run a full 1000 watts of continuous, average DC power input, in any mode, with No Time Limit (NTL). You could leave your ALPHA (any ALPHA) all day with a brick on the key, at a kilowatt input (or at 2KW PEP input, two tone SSB) without hurting it. In fact, you could leave it for weeks: last year we ran a standard ALPHA 76 keydown at a kilowatt for 18 days without ill effect. That's ALPHA POWER!

SIX TIMES THE WARRANTY!

To top it off, your new ALPHA is protected by ETO's exclusive 18 month factory warranty - six times as long as the industry-standard 90 days! Now that does tell a story.

EVEN BETTER THAN GREAT ALPHAS OF THE PAST!

These new ALPHAs are even better than their famed ALPHA 76/374 series predecessors . . . Believe it or not!

The pleasure of owning and using a new ALPHA is enhanced by the ruggedly handsome new metal work . . . refined metering and push-button control systems . . . improved bandpass circuits in the no-tune-up models. One version

combines the great conveniences of no-tune-up operation and full CW break-in. Another brings ALPHA POWER to 6 meters.

TRADITIONAL ALPHA ENGINEERING AND CRAFTSMANSHIP.

We've retained the robust components and basic circuitry that compiled such an amazing record of freedom from major failures in the ALPHA 76 and '374. Why tamper with success?

We think the new ALPHAs set a standard for style. But the real beauty of every ALPHA linear amplifier is inside the cabinet - where engineering and craftsmanship tell the whole story of ALPHA superiority.

The new ALPHA 76A series is FCC type-accepted and available now. For details, descriptive literature, and fast service on an even-greater new ALPHA, contact your dealer or write to ETO direct.

And ask for a copy of our free guide, "EVERYTHING YOU ALWAYS WANTED TO KNOW ABOUT (COMPARING) LINEARS . . . BUT DIDN'T KNOW WHOM TO ASK."



ALPHA / VOMAX

Speech processing in a class by itself . . . for "talk power", low distortion, and ease of use, it has no equal.

Shown with optional AC power adapter.

ALPHA - Sure you can buy a cheaper linear . . . But is that really what you want?

ETO

Ehrhorn Technological Operations, Inc.

P.O. Box 708 • Canon City, Colorado 81212 • (303) 275-1613

Call Toll Free For Swan 1-800-633-3410

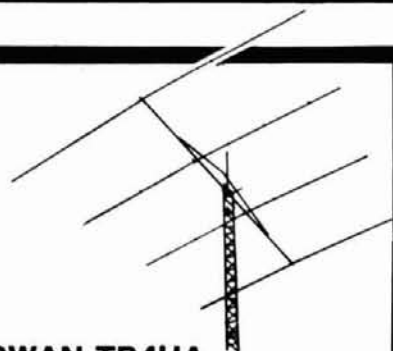
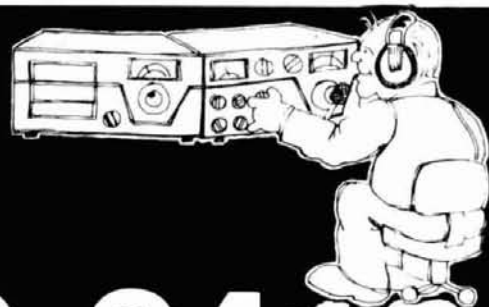

SWAN TB4HA 4 element tri-band beam

All four elements active on all three bands. The heavy duty TB4HA features: • Gain 9dB • Front to back 24-26 dB • Boom length 24' • Longest element 28 ft. 10 in. • Wind surface area 6 sq. ft. • 10-15-20 meters.

259.95 list price. Call for quote.

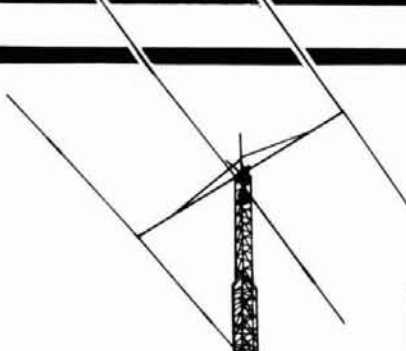

SWAN TB3HA 3 element tri-band beam

The heavy duty TB3HA features: Gain 8dB • Front to back 20-22 dB • Boom length 16' • Longest element 28'2" • Wind surface area 4 sq. ft. • 10-15-20 meters.

199.95 list price. Call for quote.

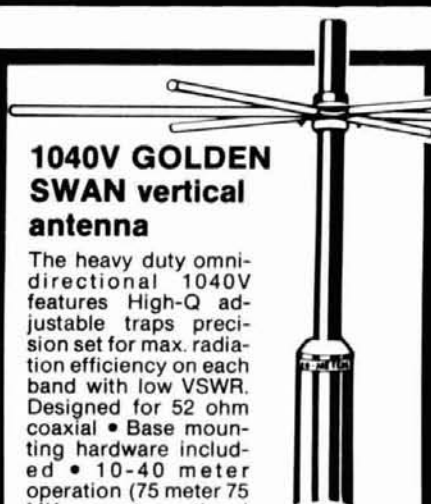

1040V GOLDEN SWAN vertical antenna

The heavy duty omni-directional 1040V features High-Q adjustable traps precision set for max. radiation efficiency on each band with low VSWR. Designed for 52 ohm coaxial • Base mounting hardware included • 10-40 meter operation (75 meter 75 MK resonator optional 39.95).

122.95 list price. Call for quote.

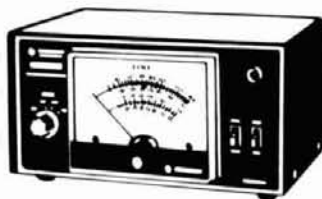

SWAN WM-3000 precision PEAK/RMS wattmeter

Read forward or reflected power with maximum accuracy from 3.5 to 30 MHz • RMS readings available with the flick of a switch • Four scales from 9 to 2000 watts. Requires 117V AC power source.

87.95 Call for yours today.



SWAN WMM200 SWR and power meter

Designed for mobile operation and illuminated for night operation • Directional coupler measuring method • Impedance 50 ohms • Power range: 0-20 watts and 200 watts in the second range • VSWR 1:1 - 3:1.

45.95 Call for yours today.

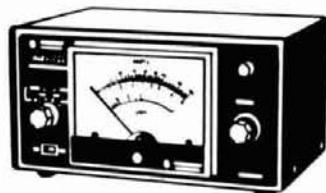

SWAN WM200A through-line wattmeter

Reads 20 and 200 watt scales • Includes expanded VSWR scale • Reads PEP or RMS values • Directional Coupler permits reading of forward or reflected power from 50-150 MHz • Requires 117 VAC in peak reading position.

87.95 Call for yours today.

Remember, you can call TOLL-FREE: 1-800-633-3410 in U.S.A. or call 1-800-292-8668 in Alabama to place your order. Store hours: 9:00 AM til 5:30 PM, Monday through Friday.



Long's Electronics



MAIL ORDERS: P.O. BOX 11347 BIRMINGHAM, AL 35202 • STREET ADDRESS: 2808 7TH AVENUE, SOUTH BIRMINGHAM, ALABAMA 35233

FT-225RD 2 METER TRANSCEIVER DIGITAL READOUT

ALL MODE SSB CW AM FM
SOLID STATE
PLUG IN MODULE



NEW ON 2 FROM YAESU

A compact versatile transceiver for the dedicated two-meter DXer, the built-in memory and twenty-five watt output puts the FT-225RD far ahead. See it at your dealers today, or write for our 1978 full line catalog.

SPECIFICATIONS:

General

Frequency Range: 144-145 MHz, 145-146 MHz, 146-147 MHz, 147-148 MHz

Frequency Readout: Digital readout to 100 Hz, analog display resolution better than 1 KHz.

Modes of Operation: LSB, USB, CW, AM, FM

Frequency Stability: Within 100 Hz during any 30 minute period after warmup. Not more than 20 Hz with 10% line voltage variation.

Intermediate Frequencies: 1st IF=10.7 MHz; 2nd IF=455 KHz.

Antenna Impedance: 50 ohms unbalanced

Repeater Split: 600 KHz installed, any split up to 1 MHz with optional crystal.

Power Requirements: AC 100/110/117/200/234 Volts

DC 13.8 Volts, negative ground

Power Consumption: AC Receive 30 VA

Transmit 160 VA at full output

DC Receive 1.2 Amps Transmit 6.5 Amps

Size: 280mm (W) x 125mm (H) x 315mm (D)

Weight: Approximately 9 kg

Receiver

Sensitivity: SSB/CW 0.3 uV for 10dB S/N

FM 0.35 uV for 20dB QS

AM 1.0 uV for 10dB S/N

Selectivity: SSB/CW/AM 2.3 KHz at 8dB down

4.1 KHz at 60dB down

FM 12 KHz at 6dB down 28 KHz at 60dB down

Image Response: Better than -60dB

Spurious Response: Better than 1 uV at antenna

Price And Specifications Subject To
Change Without Notice Or Obligation



YAESU
The radio.

YAESU ELECTRONICS CORP., 15954 Durney Ave., Paramount, CA 90723 (213) 633-4007
YAESU ELECTRONICS CORP., Eastern Service Ctr., 613 Redna Ter., Cincinnati, OH 45215

EIMAC tubes win a place in Rockwell-Collins' HF-80 systems.

Rockwell-Collins chooses EIMAC tubes again.

To power their new HF-80 family of 1 to 10 kW hf single sideband radio equipment, Rockwell-Collins needed tubes as well-constructed and reliable as the HF-80 system itself. That's why they went with EIMAC, the way they have for every hf system they've built since 1958.

The deciding factors— EIMAC's quality, backup, availability and customer acceptance.

The new HF-80 equipment ranges from operator-attended receivers and transmitters to fully automated, remotely located communications stations. The HF-80 is used worldwide in business, military and general government communications. So Rockwell-Collins needed tubes with worldwide availability and technical back-up. EIMAC's proven customer acceptance and well-established reliability were more pluses.

The HF-80 uses EIMAC's 4CX1500B at 1 kW, 4CX5000A at 3 kW, and 4CX15000A at 10 kW with EIMAC's 4CX350A as drivers.

For more information on what makes these and other EIMAC tubes so special, contact Varian, EIMAC Division, 301 Industrial Way, San Carlos, California 94070. Telephone (415) 592-1221. Or contact any of the more than 30 Varian Electron Device Group Sales Offices throughout the world.



FREE



Send for your copy of the world's largest selection of quality electronic products in easy-to-build, money-saving kit form! Nearly 400 kits in all — all with Heath's world-famous assembly manuals that take you step-by-step from unpacking to final plug-in.

fill in card and mail today

Please rush me my personal copy of the new Heathkit catalog.

I am not on your mailing list.

Name _____

Address _____

City _____ State _____

PC-126 _____ Zip _____

HAM RADIO _____ Dept. 122-430

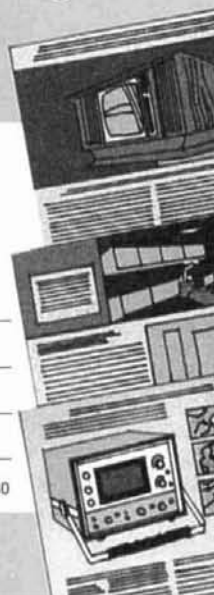

HEATH COMPANY
Benton Harbor MI 49022

FREE
HEATHKIT
CATALOG

**PLACE
STAMP
HERE**
The Post Office
will not deliver
mail without postage

Send for your
FREE
HEATHKIT CATALOG



Complete descriptions and
specifications of nearly 400
electronic kits

including:

stereo compo-
nents; auto,
marine and
aircraft acces-
sories; digital
clocks and
weather
instruments;
Amateur
Radio;
color TV;
personal
computers
and lots more!

