

75 cents

*hr*<sub>vr</sub>

focus  
on  
communications  
technology ...

# ham radio

magazine

AUGUST 1969

16-  
foot  
dish  
for  
UHF  
moon-  
bounce

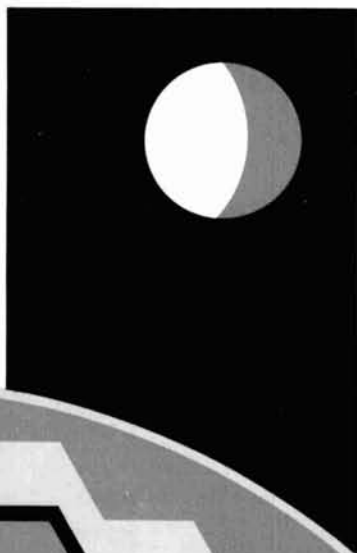

**HOMEBREW  
PARABOLIC  
REFLECTOR**

## *this month*

- solid-state Q5er 20
- frequency calibrator  
with mos IC's 30
- new multiband quad  
antenna 41
- troubleshooting  
with a scope 52



# SUITCASE SYSTEM

Slide a PM-2 Power Supply on the back of your KWM-2 and put them into a CC-2 Carrying Case. Slip the 30L-1 Linear Amplifier into another CC-2 and you're DXpedited. Plug in the antenna, microphone, and three patch cords and

you are on the air—anywhere—with a Collins quality kilowatt system.

COMMUNICATION / COMPUTATION / CONTROL





# Only Henry Radio offers this exciting beam antenna program

Any knowledgeable DX'er will tell you the secret is in the antenna. For over a year Henry Radio has provided an exciting beam antenna package program allowing the average amateur to own an efficient, and unbelievably economical antenna package . . . pre-engineered, pre-matched and pre-packaged to suit his pocketbook and requirements. NOW! This world famous antenna program moves forward. NOW! You can have the antenna of your choice at the same incredible saving.

## *HR-Junior Basic Antenna Package*

Tristao MM-35 "Mini-Mast"  
tubular tower--crank-up  
CDR AR-22R Rotator\*\*  
100 ft. RG-58 A/U Coax Cable  
100 ft. 4 Cond. rotor Cable

Complete with one of the following:

Hy-Gain TH2MK3	\$ 220.00
Hy-Gain TH3JR	225.00
Hy-Gain DB10-15A	225.00
Hy-Gain Hy-Quad	230.00
Hy-Gain 203BA	235.00
Hy-Gain TH3MK3	260.00

\*Free Standing Base: add \$29.95.

\*\*Optional (instead of AR-22R):

TR-44 rotator, add \$30.00

Illustrated: Tristao MM-35 "Mini-Mast"

## *HR-Standard Basic Antenna Package*

Tristao CZ-454 60 ft. crank-up  
tower w/mast\*  
CDR TR-44 rotator\*\*  
100 ft. RG-58 A/U Coax  
100 ft. Control cable

Complete with one of the following:

Hy-Gain DB10-15A	\$ 530.00
Hy-Gain Hy-Quad	540.00
Hy-Gain 204BA	570.00
Hy-Gain TH3MK3	570.00
Hy-Gain 402BA	580.00
Hy-Gain TH6DXX	595.00

\*Optional: Free-standing base, add \$10.00. \*\*HAM-M rotator, 8 cond. cable, RG-8/U Coax, add \$40.00.

Freight prepaid to your door in the Continental U.S.A. west of the Rockies. For shipment east of the Rockies add \$10.00.

Substitutions may be made . . . write for prices. And remember, you can buy on time. You can trade your used transmitter or receiver. You can rely on Henry Radio to supply the finest equipment and the best value.

**Henry Radio Stores**

CALL DIRECT . . . USE AREA CODE

11240 W. Olympic, Los Angeles, Calif., 90064	213 477-6701
931 N. Euclid, Anaheim, Calif., 92801	714 772-9200
Butler, Missouri, 64730	816 679-3127

"World's Largest Distributor of Amateur Radio Equipment"

# DRAKE 4 LINE Superior performance—versatility!



**R-4B**  
RECEIVER

Versatility ...  
Accuracy ...  
Dependability ...

- Linear permeability tuned VFO with 1 kc dial divisions. VFO and crystal frequencies pre-mixed for all-band stability
- Covers ham bands 80, 40, 20, 15 meters completely and 28.5 to 29.0 Mc of 10 meters with crystals furnished
- Any ten 500 kc ranges between 1.5 and 30 Mc can be covered with accessory crystals for 160 meters, MARS, etc. (5.0-6.0 Mc not recommended)
- Four bandwidths of selectivity, 0.4 kc, 1.2 kc, 2.4 kc and 4.8 kc
- Passband tuning gives sideband selection, without retuning
- Noise blander that works on CW, SSB, and AM is built-in
- Notch filter and 25 Kc crystal calibrator are built-in
- Product detector for SSB/CW, diode detector for AM
- Crystal Lattice Filter gives superior cross modulation and overload characteristics
- Solid State Permeability Tuned VFO • 10 tubes, 10 transistors, 17 diodes and 2 integrated circuits
- AVC for SSB or high-speed break-in CW
- Excellent Overload and Cross Modulation characteristics
- Dimensions: 5½"H, 10¾"W, 12¼"D. Wt.: 16 lbs.

**\$43000**



**T-4XB**  
TRANSMITTER

Use VFO of either R-4B or T-4XB for transceiving or separately.

- Covers ham bands 80, 40, 20, 15 meters completely and 28.5 to 29.0 Mc of 10 meters with crystals furnished; MARS and other frequencies with accessory crystals, except 2.3-3, 5-6, 10.5-12 Mc.
- Upper and Lower Sideband on all frequencies
- Automatic Transmit Receive Switching on CW (semi break-in)
- Controlled Carrier Modulation for AM is completely compatible with SSB linear amplifiers
- VOX or PTT on SSB and AM built-in
- Adjustable Pi-Network Output
- Two 8-pole Crystal-Lattice Filters for sideband selection, 2.4 kc bandwidth
- Transmitting AGC prevents flat topping
- Shaped Grid Block Keying with side tone output
- 200 Watts PEP Input on SSB—200 watts input CW
- Meter indicates plate current and relative output
- Compact size; rugged construction
- Solid State Permeability Tuned VFO with 1 kc divisions
- Solid State HF Crystal Oscillator
- 11 Tubes, 3 Transistors and 12 diodes
- Dimensions: 5½"H, 10¾"W, 12¼"D. Wt.: 14 lbs.

**\$44900**

HAMS SAY ... *"Best Receiver Buy since the 2-B!"*



**2-C**  
RECEIVER

*Excellent performance at low cost*

- Triple Conversion
- Crystal-controlled First Converter
- 500 kc ranges for 80, 40, 20, 15 and 10 Meters
- Also any 500 kc range between 3.0 mc and 30 mc by inserting an accessory Crystal
- Temperature-compensated VFO Tuning
- Selectable Sidebands without retuning
- Three Bandwidths—4, 2.4, 4.8 kc at 6 db
- Solid-state Audio, Product and AM Detectors, AVC Amp and Xtal Osc
- AVC Switch (Fast, Slow and Off)
- SSB, AM and CW with AVC and S-meter
- Works Break-in CW with 2-NT Xmttr
- 19 Tubes and Semi-Conductors
- Dimensions: 11½"W x 6¾"H x 9½"D. Wt.: 13½ lbs.

**\$22900**

Accessories available: 100 kc Calibrator, Q Multiplier, Matching Speaker, Noise Blander, Crystals for other ranges.

**CW TRANSMITTER**  
*For Novice thru Extra Class...*



**2-NT**  
CW  
TRANSMITTER

*Built-in essentials and accessories*

- 100 Watts Input (can be reduced to 75 watts for novice)
- Operates Break-in CW, Semi Break-in CW or Manual CW with Drake 2-C or other receivers
- Automatic Transmit Switching
- Side Tone Oscillator built in
- Antenna Change-over Relay built in
- Pi-Network output with fixed loading
- Lo Pass Filter against TVI built in
- Drop-out delay of change-over relay adjustable
- CW Coverage on 80, 40, 20, 15, 10 Meters
- Simplified Tuning
- Frequency Spotting without xmttr output
- Grid Block Keying
- Code Practice in stand-by position
- 13 Tubes and Semi-Conductors
- Dimensions: 9¾"W x 6¾"H x 9½"D. Wt.: 12½ lbs.

**\$14900**

Accessories available: Antenna Matching Network, and Crystals.

All prices are Amateur Net. Prices and specifications subject to change without notice.

Drake products are available at your distributor ... for a free brochure on any unit, write Dept. 489,

**R. L. DRAKE COMPANY • 540 Richard St., Miamisburg, Ohio 45342**



august 1969

volume 2, number 8

#### staff

editor

James R. Fisk, W1DTY

roving editor

Forest H. Belt

vhf editor

Nicholas D. Skeer, K1PSR

associate editors

A. Norman Into, Jr., W1CCZ

Alfred Wilson, W6NIF

James A. Harvey, WA6IAK

art director

Jean Frey

publisher

T. H. Tenney, Jr. W1NLB

#### offices

Greenville, New Hampshire  
03048

Telephone: 603-878-1441

ham radio magazine is published monthly by Communications Technology, Inc., Greenville, New Hampshire 03048. Subscription rates, world wide: one year, \$6.00, three years, \$12.00. Second class postage paid at Greenville, N.H. 03048 and at additional mailing offices.

Copyright 1969 © by Communications Technology, Inc. Title registered at U. S. Patent Office. Printed by Capital City Press, Inc. in Montpelier, Vermont 05602, U.S.A.

Microfilm copies of current and back issues are available from University Microfilms, 313 N. First Street, Ann Arbor, Michigan 48103.

Postmaster: Please send form 3579 to ham radio magazine, Greenville, New Hampshire 03048.

# contents

- 8 **16-foot parabolic reflector**  
Peter Laakmann, WB6IOM
- 20 **solid-state Q5er**  
Robert J. Grabowski, W5TKP
- 26 **distortion in fm detection**  
Carl C. Drumeller, W5JJ
- 30 **frequency divider calibrator using mos IC's**  
Henry D. Olson, W6GXN
- 36 **mobile installation**  
Robert L. Ruyle, W0FCH
- 41 **new multiband quad antenna**  
Dr. Werner Boldt, DJ4VM
- 46 **integrated-circuit cw monitor**  
John J. Schultz, W2EEY
- 48 **digital and burst encoder**  
David M. Stahley, K8AUH
- 52 **troubleshooting with an oscilloscope**  
Larry Allen
- 58 **ionospheric propagation**  
Victor R. Frank, WB6KAP
- 
- departments**
- |    |                   |    |                |
|----|-------------------|----|----------------|
| 4  | a second look     | 74 | new products   |
| 94 | advertisers index | 58 | propagation    |
| 83 | flea market       | 52 | repair bench   |
| 66 | ham notebook      | 80 | short circuits |

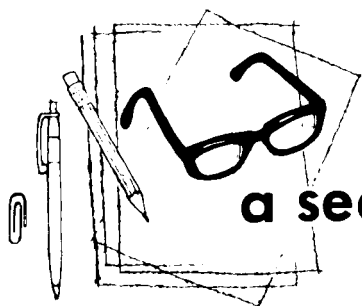

## a second look

by jim  
fisk

While I was researching some textbook material for an extensive article on vhf fm for the September issue of **ham radio**, I discovered a very curious fact: the standard textbooks did not agree on the differences between phase and frequency modulation. The textbooks that provided a mathematical treatment on the subject tended to be correct, while those that discussed it on a less technical level were usually in error.

There is a very simple difference between phase and frequency modulation: the frequency deviation of a frequency modulated wave is proportional to the peak **amplitude** of the modulating signal, and **independent** of the modulating frequency: frequency deviation in a phase-modulated wave is proportional to **both** the amplitude and frequency of the modulating signal. The difference is quite subtle, and since both phase and frequency modulation are forms of angular modulation, they are not essentially different, and one can be converted into the other.

This conversion from one to the other is important because although fm offers superior performance in terms of signal-to-noise ratios, phase modulators are more convenient to use with crystal-controlled transmitters. Since fm phase-modulated waves have greater deviation at the higher modulating signal frequencies than pure fm waves, an RC network that reduces the frequency response of the audio system on the higher modulating frequencies takes care of the conversion from pm to fm.

The important thing here is not this particular error, but the fact that errors do occasionally creep into textbooks. In this case, it was probably a case of the blind leading the blind—an early non-mathematical article on the subject was 180 degrees out of phase with the facts. Unfortunately, this article was used as the basis for several simple textbook discussions on fm; later textbook authors used these erroneous chapters as the basis for their words on the subject and the error was promulgated from one textbook to another, right up to the present day. Electronic-engineering textbooks, as I noted earlier, tend to present the matter correctly, particularly if the author has gone to the trouble to include the math.

When you run into a conflict in technical view, the question inevitably arises, who is **the** authority? Although there are dozens of excellent books on the subject of radio communications, there are two texts that stand out above all others: F. E. Terman's "Electronic and Radio Engineering" (McGraw-Hill, 1955), and Keith Henney's "Radio Engineering Handbook" (McGraw-Hill, 1959). If you don't have a copy of one of these at home, at work, or at your local public library, you should consider buying one volume or the other. Summer is a good time to buy too, since school is out, and used book stores near colleges and universities are often loaded up with books of this kind.

**Jim Fisk, W1DTY**  
editor

# Supertetrode Keeps its Super Cool.

Eimac's revolutionary 4CV50,000E 50-kW Wick-Cooled Tetrode combines the electrical features of the industry's first "Supertetrode" with a unique new vapor-cooling concept. This system replaces bulky anode cooling fins with a compact metal-mesh wick which dips into an integral boiler, and is permeated with water by capillary action.

The result is a dramatically smaller package. Tube plus boiler measure only 6½ inches in cross section, weigh 35 pounds. Water level is not critical. The unit will operate efficiently in a position up to 45° from vertical, ideal for mobile and marine installations.



And performance is truly superior. It betters comparable tetrodes in gain by 4 to 5 dB. It has greatly reduced cathode lead inductance and a unique re-entrant anode, permitting a shorter stem and only 310 pF input capacitance. Feedback capacitance is only 0.6 pF, making tube neutralization very much simpler. For data and application assistance on this or any Eimac tube, contact your nearest Varian/Eimac distributor or ask Information Operator for Varian Electron Tube and Device Group.

  
division  
of varian

# NOW...

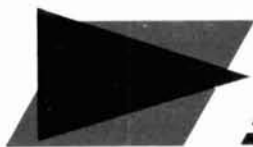

*"It Speaks for Itself"*

## **SIGNAL/ONE**

A Division of ECI (An NCR Subsidiary)

2200 Anvil Street N. St. Petersburg, Florida 33710



# ON THE WAY

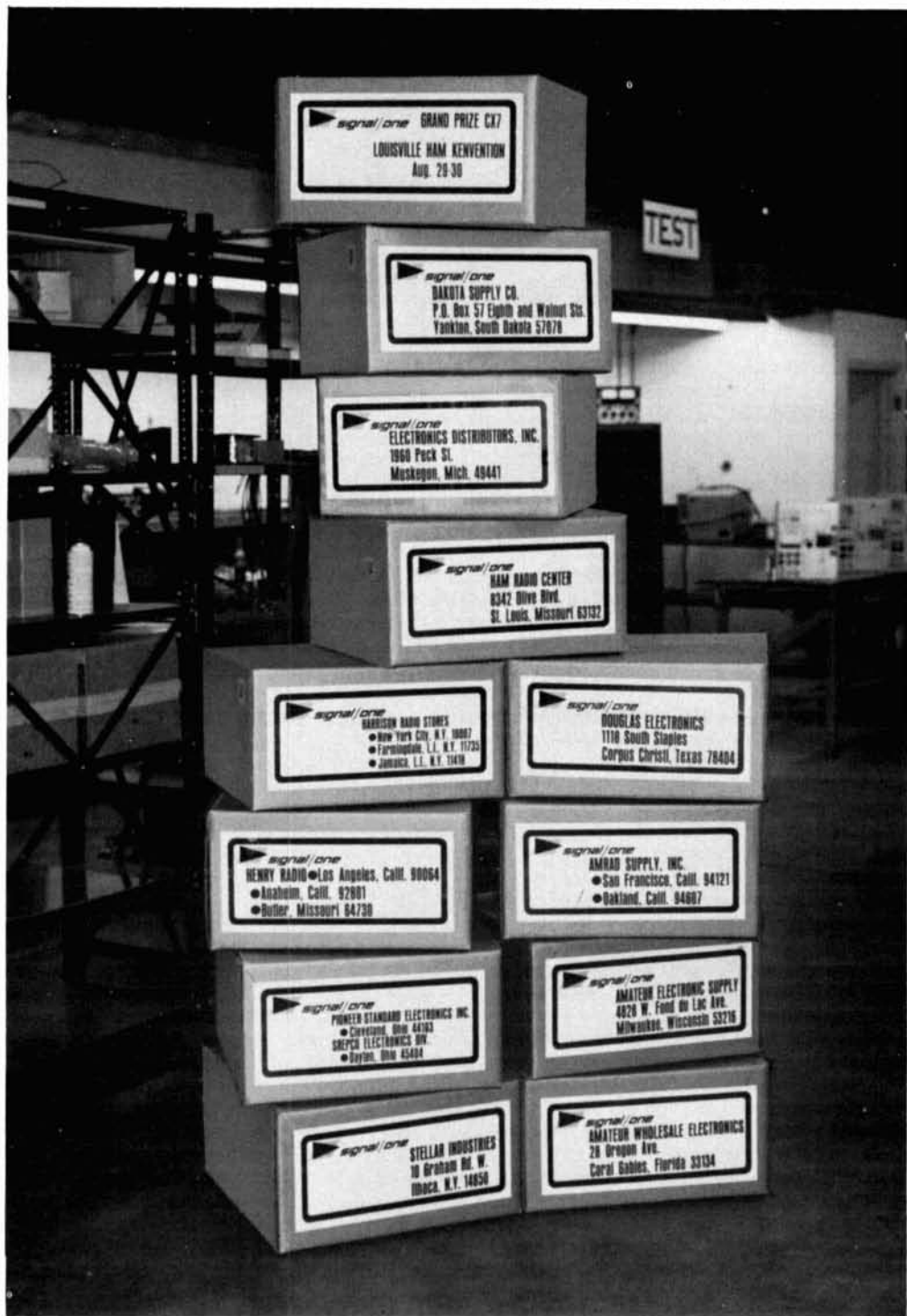

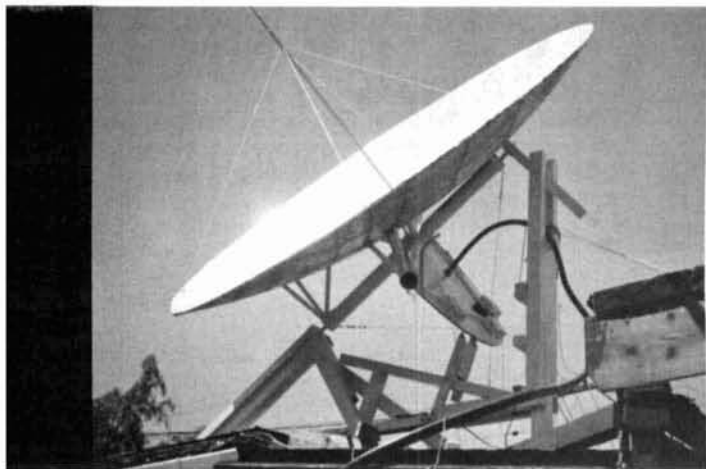

## a large homebrew parabolic reflector

Complete details  
for a 16-foot  
parabolic reflector  
using  
honeycomb sandwich  
construction

Peter Laakmann, WB6IOM, 8001 Airplane Avenue, Los Angeles, California

Constructing a large parabolic reflector with amateur means and budgets is by no means an easy job and requires hundreds of hours of effort before the dish is finished, installed, and ready to operate.

However, any serious uhf enthusiast will find out sooner or later that parasitic arrays will not do the job for EME work above 400 MHz. Commercial dishes which will perform as well as my homemade one are extremely expensive (\$5000 to \$10,000) so they are out of the average amateur's reach. The surplus market isn't much help either—supplies of large surplus parabolic reflectors are extremely limited.

For most uhf and microwave moonbounce enthusiasts the path to adequate system performance will include the construction of a large parabolic reflector. Although many amateurs have travelled this road successfully, even more have failed. Most failures apparently occurred because the builder underestimated rigidity and accuracy requirements for reflectors for the higher frequencies. Other failures occurred because operational pointing accuracy requirements were underestimated.

Errors in homemade reflectors are usually due to gross distortions that extend over a large portion of the dish surface (many wavelengths); these errors have the most effect on gain loss. To obtain full gain (within 1 dB of theoretical) surface errors must be less than 1/32 wavelength rms. At 1296 MHz this is a little more than one-quarter inch. There is no point in building a larger dish with less accuracy because it compounds the construction difficulties without producing any more gain than a smaller, accurately constructed dish.

## design

As dish size increases, aiming must be more accurate. A 10-foot dish for 1296-MHz moonbounce must be pointed with an accuracy of better than 1 degree or you will degrade moon echos more than 1 dB. On 1296-MHz I doubt that it is within amateur means to point a 30-foot dish accurately enough to take advantage of its full gain (20 minutes of error). These difficulties become even greater at 2300 MHz and higher.

I settled for a 16-foot parabolic for three reasons: it provides adequate system gain at 1296 and 2300 MHz, it can still be pointed accurately enough, and most of all, it is the largest size that could be built in my garage!

The  $f/d$  (focal length to diameter) ratio was chosen as 0.525 for a focal length of 8.4

feet. This is close to the optimum  $f/d$  for gain using simple feeds (0.40 to 0.50). The larger focal length allows later expansion to 20 feet and provides more latitude in pointing the dish over a small angle by moving the feed.

The dish is mounted on a polar mount with a fixed declination of plus 12 degrees. The feed is moveable over a range of plus and minus 16 degrees to cover all positive moon declinations. Gain losses due to feed steering are quite small.

## materials

The dish is constructed of aluminum honeycomb sandwich. This yields a solid surface with approximately twice as much wind resistance as a typical mesh surface. This is a disadvantage in high-wind areas but is not a factor in Los Angeles where the maximum recorded wind velocity has never been over 50 mph. City building code regulations call for the design of surfaces and support structures to withstand 15 pounds per square foot. At the "parking" angle of 22 degrees—the worst case—this only amounts to 1150 pounds loading.

All surface and attachment joints are made with epoxy. No bolts or welds were used anywhere on the dish or its rear frame structure. However, joints between the frame structure and the dish use fiberglass matting to assure better bonding in these high stress areas.

After the dish was placed on the gimbal on the roof of the house, 1/4-inch bolts were added to secure the rear frame to both the front and rear surfaces of the dish. These were epoxied in also. These bolts are probably not necessary, but I didn't want to find out during a windstorm. Epoxy joints are a tricky matter at best, particularly with aluminum; some turn out very well and some not so well—the difference is usually a result of cleanliness in construction.

One characteristic that makes honeycomb structures attractive for large reflectors is their fantastic rigidity relative to their weight. The dish and frame weighs approximately 230 pounds total. The frame is only attached to the dish at 5 points, yet applying 50 pounds force to the rim of the dish causes

Completed dish and polar mount. Co-axial feedline is 1-5/8" Heliax.



distortions of less than 1/4 inch.

Of the total weight, about 30 to 40 percent is nonstructural and due to the epoxy I used. More careful techniques of applying epoxy without waste could cut dish weight to less than 200 pounds. Dish weight is quite important because distortion due to gravity is usually more significant than windloading since gravity acts all of the time.

This article will dwell in detail on the construction of the dish using readily available materials. The dish is self-supporting when a **rigid** frame is attached to the center and four points about 5 feet from the center. The attachment area must cover at least 0.5 square foot for each point with fiberglass matting to provide uniform loading against the honeycomb sandwich.

I won't go into complete constructional details of my rear frame since I used materials that aren't easily obtained. It is made from four missile containers and honeycomb tubing that was originally intended to be a dissipative shock absorber for shock testing. The four cylindrical missile containers are epoxied together to form an X. A well thought out wood frame should work just as well. The missile containers are essentially 6-inch diameter fiberglass tubing sections with wall thickness of 0.02 to 0.03 inch and reinforced ends about 1/8-inch thick. The photograph on page 14 will clarify the attachment technique.

The materials used for the dish itself are fairly inexpensive; total cost is about \$250. Considering the performance of this reflector it is a good investment. Other costs are associated with the pattern on which the dish is constructed, chemicals, containers for cleaning and etching, countless pairs of rubber gloves, brick weights, rubber mats, and of course, the frame and gimbal for the finished dish.

A significant factor in the total cost is the amount of extra material which must be purchased when making only one dish. This must be done so sufficient material is always available to complete the job. Also, the honeycomb material and epoxy cannot be bought to the exact quantities required as it is shipped in standard increments. If a group of amateurs gets together to make several of

these dishes as a team project, a lot of money and tooling could be saved.

## honeycomb construction

A simple honeycomb sandwich consists of two faceplates and a core that looks like a bee's honeycomb. The core is joined to the faceplates by bonding or brazing. This constitutes a rigid sandwich that does not bend easily. Before bonding, the honeycomb core can be deformed to shape it to a **mildly** curved surface. When bending the honeycomb in one plane it naturally takes on a concave/convex "saddle" shape and resists the doubly concave or convex shape used in

Honeycomb sandwich used in the construction of the 16-foot dish.

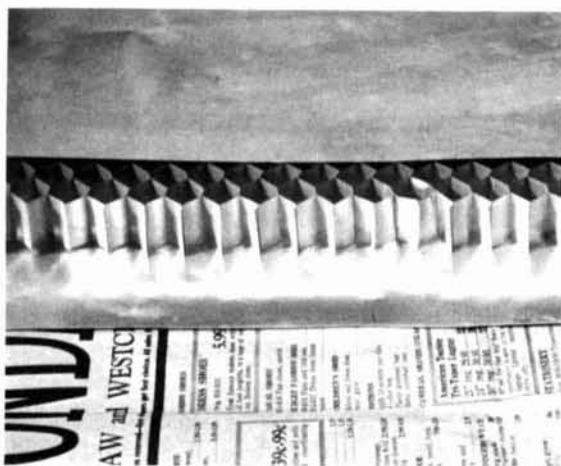

parabolic reflectors. With evenly applied pressure it will take on the desired shape if the curvature is mild, but when deformed beyond its limits it collapses.

The material used for the two faceplates does not have to be identical to the core material. The honeycomb core is available in paper, aluminum, epoxy fiberglass and steel. Rigidity is improved by increasing either faceplate thickness or cell height; rigidity is not affected by cell size or thickness of the core material. Cell size and core thickness affect compressive strength.

Honeycomb sandwiches can be tailored to the exact rigidity and strength require-

ments you need without overdesigning one to get the other. However, certain combinations of cell height and faceplate thickness result in a minimum-weight design for a stated rigidity. These combinations can't always be used, though, because the faceplate skin becomes excessively thin and the core is too high to bend very much.

The aluminum honeycomb I used for this dish has a cell size of  $\frac{3}{4}$  inch, a cell height of one inch and a wall thickness of 0.003 inches. The faceplates are 0.008-inch aluminum. Believe it or not, the compressive strength of this sandwich is 50 pounds per square inch!

**Honeycomb material takes on a saddle shape when deformed.**

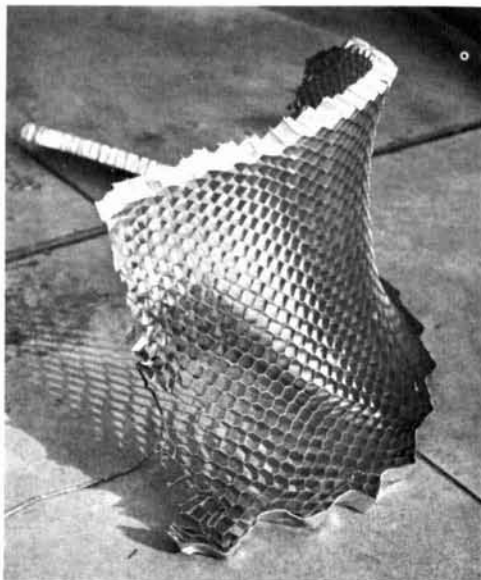

Core cost is about \$.35 a square foot. Total weight of the core material used in the dish is 30 pounds. The minimum weight sandwich would have consisted of honeycomb 2 inches high with 0.002-inch faceplates; the result would be 14 pounds lighter than my chosen design. However, 0.002-inch faceplates are impractical and too easily damaged. In addition, the 2-inch honeycomb would not conform to the dish curvature. The 8-mil faceplate material I used is quite

sturdy, and even permits walking on the surface without damage.

Bonding the honeycomb core to the faceplates is a simple process. The two pieces of sheet metal are coated with a thin coat of epoxy (about 10 mils) and the core is sandwiched in between. Uniform pressure is then applied, and the epoxy is allowed to set. The epoxy creeps up the walls by capillary action and forms a fillet that is higher than the coating thickness.

### **the epoxy**

Choice of epoxy for honeycomb bonding involves many factors: it must be a room-temperature curing type, it must have several hours of pot life, and it must be thixotropic\* to keep an adequate film on the sheets to be bonded. But above all it must be capable of achieving a structural bond to aluminum. Aluminum is probably the most difficult material to bond. The epoxy I used is the same as that used in the honeycomb construction<sup>2</sup> of the 60-foot reflector at Massachusetts Institute of Technology's Lincoln Laboratory and it does an excellent job of bonding aluminum.

Most of the other epoxies that I am familiar with do not achieve a true bond to aluminum; the aluminum can usually be peeled off the joint with very little force, leaving no trace on the aluminum of more than a superficial joint. The epoxy I used is General Adhesive and Chemical Company's type 88-110. This material apparently attacks the aluminum to create a structural bond. The force required to peel off the aluminum almost tears the metal before the epoxy gives. I strongly recommend that you not make any substitutions; also use the epoxy strictly in accordance with the manufacturer's instructions. Don't use any additives to prolong the pot life; I tried this with disastrous effects on bond strength.

The epoxy is quite reactive. Skin contact should be avoided as it can cause allergies in some people (generally true of all epoxies). Use rubber gloves all the time and

\* Thixotropic. Denotes a thick consistency that does not easily run off inclined surfaces. It is not quite the same as high viscosity as that term describes a phenomenon related to friction due to movement.

work only in well-ventilated areas.

The recommended ratio of resin to hardener is 7:1 by weight. It isn't too critical, however, so an ordinary household scale will weigh it accurately enough. In general, adding more hardener decreases both pot life and viscosity; neither effect is very desirable. However, when working with the material on cold days the ratio can be changed to 5:1 to maintain a viscosity that can be more easily worked. Pot life is increased by lower temperatures so two hours of pot life are still available.

The resin is sold in 5-gallon cans. Depending on how carefully it is used, anywhere from 5 to 7 gallons are required for the complete parabolic reflector. I recommend that you get an extra can of hardener since it seems to get used faster than the resin; the hardener is shipped in one gallon cans. Cost of the epoxy is \$9.62 per gallon.

## the pattern

The first step in the construction of any parabolic reflector is the creation of a pattern that is used as a reference surface. I made my pattern out of plywood, window screen and concrete as these are inexpensive. The pattern is hollow and the concrete is about one inch thick. About 5000 pounds of concrete are required (about 1 cubic yard), so it is best to buy it already mixed. I didn't realize how much was required and bought

it by the bag. This resulted in a lot of work and was actually much more expensive than it would have been if delivered ready-mixed from a truck.

The first step is to clear out a large flat area (I used my garage). Cast a 1½-inch diameter pipe in concrete in the center of the area. This is the minimum thickness pipe that can be used as the center of rotation for a parabolic ruler that is to define the parabolic surface. Thinner pipes bend too much. The pipe should be filled with concrete to stiffen it even more.

Partially finished pattern.



Next make a parabolic radius ruler from ¾-inch thick plywood. The curve can be generated numerically or by means of a string, using the definition that a parabola is equidistant from the focal point and a straight line (called the directrix) that lays behind the parabolic curve.

Attach the radius ruler to two bearings at least two feet apart; make sure the bearings fit the center pipe tightly. Also, make absolutely sure that the bearings are perpendicular to the radius ruler. When the ruler is attached to the center pipe, it should be stiff enough so it doesn't deflect more than 1/8 inch when a 10-pound force is applied to the end of it.

By rotating the radius ruler 180° around the pipe and taking height measurements against a true horizontal line, any errors from a non-parabolic curve can be found and corrected before further work is done. It's all right if the axis of rotation (the center pipe) is not

fig. 1. This sketch shows how you can generate a parabolic curve using a piece of string. In this drawing,  $A + A' = B + B' = C + C'$ , etc.

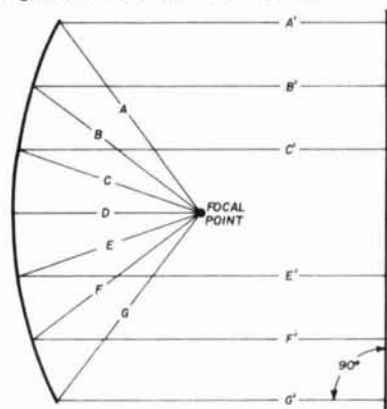

quite vertical, but it **must** be perpendicular to a tangent drawn to the parabolic curve in the center.

Next cut 32 plywood radius sections approximately parabolic in shape but about  $\frac{1}{2}$  inch less than the height to the radius ruler from the floor. Sixteen of these sections should be cut for the full radius of the dish; the other sixteen should be only half as long and are placed around the rim of the pattern as shown in the photo.

The  $\frac{1}{2}$ -inch height difference between the plywood pattern and the parabolic ruler is

**Friend Mike Mikalides smears concrete on the pattern while WB6IOM handles the ruler.**



adequate since the weight of the concrete causes some sagging between pattern sections and results in a mean concrete thickness of about 1 inch.

Anchor the plywood sections together with nails and short sections of 2x4's. Starting at the center, run steel wire around the pattern every 3 inches of radius and tighten by wrapping it around nails in the plywood. Cover the pattern with window screen and nail it to the plywood. Finish only about half of the total radius at this time so the center of the pattern is still accessible.

Starting from the center toward the outside, put wet concrete on the window screen and smooth it out with the radius ruler. Use gravel filled concrete for the initial pass and fine concrete for the top surface. Be careful not to produce excessive wear on the ruler by "grinding" with it. Stop when about one-third of the total radius is smooth; repeat the process on following weekends for the rest.

Add window screen and steel wire as you expand the concrete covered area toward the rim. After the concrete surface is finished, use plaster of Paris or similar materials to smooth out the concrete by hand and obtain a shiny surface without a sandy appearance. Remove the parabolic radius ruler. Now paint the pattern so it is dust free and smooth. It is now ready to be used.

### **etching the aluminum**

The aluminum used for the faceplates of the sandwich must be chemically etched to

**Closeup of the pattern showing plywood ribs and window screen.**



assure good quality bonds. The aluminum honeycomb should be etched also; however, the material delivered to me by Hexcel was found to be adequate for bonding without an etching process. The epoxy bond to the honeycomb is naturally stronger anyway because of larger area and edge roughness of the honeycomb. It's a good idea to make a couple of trial bonds with your material to check for any problem in this area.

The 1x2-foot aluminum sheets are etched in a chromic acid solution at a temperature of approximately 120° to 150° F. This size represents the largest faceplate that can be made to conform to the curvature of this reflector. If you plan to make a different size dish, or different f/d ratio, it would be a good idea to experiment with the size of the sheet on the pattern to determine the best size. The 1x2-foot size is not too large to be etched in a 32-gallon polyethylene trash can; in fact, up to three sheets can be etched at

one time. Two trash cans, one inside the other, are required for safety and rigidity.

Fill the trash can about half full with regular tap water and slowly add the sulfuric acid. Then dissolve the sodium dichromate. The heater for the solution is made from number 18 teflon hookup wire. The length of the wire is adjusted to absorb about 300 watts from a low-voltage filament transformer. Time to reach temperature equilibrium is about 8 hours, so power should be applied the evening before for use the next morning.

The chromic acid etching solution is not too dangerous but rubber gloves should be used while working with it. Safety goggles are a good idea too and at least regular eye glasses are required. The solution is about as potent as battery acid but it is poisonous due to the chromate content. Do not do any etching in an enclosed area.

The aluminum sheets should be immersed for about three minutes each, or until there is clear evidence of etching. There is some bubbling action but it is much milder than a caustic etch. Don't substitute a caustic etching process for the chromic acid; it does not leave a clean surface.

After etching, the aluminum sheets should be placed in a small children's swimming pool that is supplied with a continuous flow of tap water. After rinsing for a few minutes the sheets can be removed and hung up in a vertical position to dry. After drying the sheets may be stored for later use, but don't get any grease or fingerprints on them.

### **bonding the faceplates to the core**

Bonding between the three components is done on the plywood-concrete pattern. One side is bonded to the honeycomb core at each session. The top faceplate is bonded in place only after the bottom faceplate has had time to cure (about two days at 70° F. for full hardness). The maximum number of faceplates that can be worked in one session by a single worker is 8. It's a good idea to start out with fewer faceplates at first to gain experience so that the epoxy does not start to cure in the middle of a bonding session. The pot life of the epoxy is about two hours. Bonding 8 plates requires about 2 pounds of

epoxy.

The following explains the necessary procedures in detail. I highly recommend that this procedure be followed religiously as I cannot possibly cover all the possible pitfalls that might occur with another approach. The dish should be built up from the center toward the rim, and then expanded in both circumferential directions until the ends meet.

1. Place newspaper on pattern surface and tape together with masking tape. Tape ends

**Completed installation shows rear frame attachment points. This photo was taken before the feed was installed.**



of newspaper to pattern. Newspaper area must be slightly larger than area to be worked that day. The newspaper will act as a "mold release" so that the finished dish does not stick to the pattern.

2. Run masking tape down one side of the first faceplate sheet. Use tape at least one inch wide and center the edge of the sheet on the masking tape. Apply a thin coating of epoxy along the edge of the aluminum sheet (about 2 inches wide) with a putty knife. The epoxy is applied to the side that is to be face up; the masking tape is applied to the side facing the pattern. With experience you



can judge the thickness of the coating by the deep red color of the epoxy.

3. Take the second faceplate sheet and press it against the masking tape, allowing for a sheet overlap of approximately 1 inch. Continue to add faceplate sheets in this way until the area to be worked that day is finished.

4. Tape the aluminum sheets down against newspaper and the pattern in a few spots to prevent them from sliding.

5. Apply epoxy to the entire area.

6. Cut a piece of honeycomb that will leave the outer 2 inches of the aluminum sheet free. The honeycomb can be cut with ordinary household scissors.

7. Press the honeycomb against the aluminum sheet and move it back and forth about 1/4 inch to make sure the edge is well covered with epoxy.

8. Place bricks around the outside edge of honeycomb to apply pressure uniformly around the edge. This should result in compression throughout the area. If not, add bricks as required.

9. Remove all epoxy from the sheet metal not covered by honeycomb core (use a putty knife). A clean edge is required to facilitate bonding of the adjacent area. A particularly troublesome area is where the aluminum sheets overlap. After cleaning this area, place a small piece of masking tape over it to keep the sheets in compression.

10. Inspect the honeycomb fillets to make sure that the honeycomb is bonded throughout. The center is sometimes troublesome, but the edges cause the most problems. If the honeycomb is not in compression here it makes bonding of adjacent areas very difficult as there is a discontinuity in height of the sandwich. If any areas are found that do not have sufficient epoxy it can be added at this time.

11. Let the epoxy cure. Tools and hands can easily be cleaned with alcohol. However, fully cured epoxy cannot be dissolved with alcohol.

12. (At least two days later.) Remove bricks. Coat the appropriate number of faceplate sheets with epoxy and press them onto the honeycomb. Tape together with masking tape. Overlap between sheets should be approximately 1 inch. Leave approximately one inch of honeycomb around the periphery of the sandwich uncovered.

13. Tape the sandwich down to pattern to avoid sliding and cover it with newspaper. Place rubber mats over the entire honeycomb area and cover entire area with bricks (small ends down to get the most pressure per unit area). If necessary, tape the bricks down to avoid sliding.

14. (At least two days later.) Remove the rubber mats and newspaper and proceed to an adjacent area. Remove all masking tape under the new area to be worked and start at step 1.

**table 1. Materials and tools required for constructing a 16-foot reflector. Construction materials include ample reserve for normal waste. Pattern material and rear frame not included.**

**construction materials**

300 square feet 3/4-inch ACG aluminum honeycomb core, 1-inch high; Hexcel Products, Inc., Havre de Grace, Maryland

500 square feet .008-inch aluminum sheet, 1100H18 alloy cut into 1x2-foot pieces

10 gallons 88-110 epoxy, part A and B; General Adhesive and Chemical Company, Nashville, Tennessee

10 square feet of fiberglass mat for rear frame attachment

**tools and disposable materials**

5 gallons sulfuric acid

10 pounds sodium dichromate

100 standard 5 pound bricks

8 rubber mats, 1/4-inch thick, each 2 square feet

2 polyethylene trash cans, 32-gallon

1 small plastic children's swimming pool

denatured alcohol for cleaning tools and hands

scale for weighing epoxy (will be ruined sooner or later)

large metal shears

quantities of old newspapers

low voltage transformer (5 to 10 V), 300 W or more

100 feet number 18 teflon insulated wire

rubber gloves, masking tape and putty knives

When placing the top sheet of the sandwich over adjacent honeycomb areas (areas that were worked in two different days) sometimes the sheet will not lay flat because of height differences (see step 10 above). If this happens, the higher core material can be cut down until the faceplate sheet lies flat.

Adjacent honeycomb cores should be meshed as well as possible. There should never be a gap between sections. If a gap occurs accidentally, it can be filled by a small piece of honeycomb liberally coated with epoxy. The small piece can be compressed while cutting it to the height of adjacent sections. The honeycomb core sections should be placed in an irregular fashion on the pattern so that gaps between sections do not run the full length of the dish.

I cannot overemphasize the importance of using as little epoxy as possible to bond the faceplates. The weight of the epoxy is the largest single contributor to the final weight of the structure. The 10-mil coating applied to the faceplates weighs 60 pounds.

**Just after removing the 230-pound reflector from the pattern—now to put it on the roof!**



Any other unusual additions of epoxy to cover gaps between honeycomb areas, to finish the rim of the dish, etc., add to this.

The epoxy contributes very little additional rigidity to the structure and by its weight does more harm than good. It is also expensive. A coating as low as 5 mils is sufficient for bonding but it is difficult to achieve a sufficiently uniform coating at that thickness. I suggest you keep a running estimate of the total amount of epoxy used vs dish area covered to maintain control over dish weight and the epoxy necessary to finish the project.

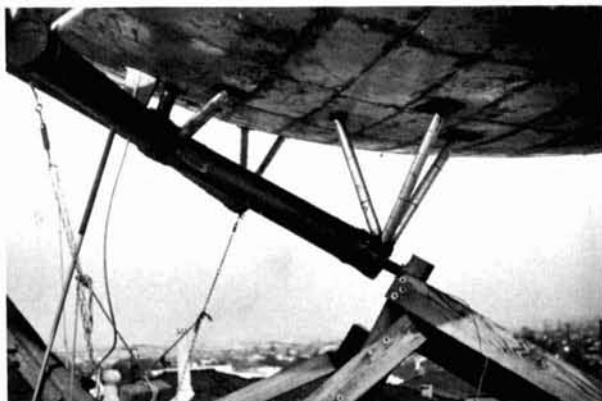

**Closeup of the x-shaped rear frame and lower gimbal bearing.**

### **the rear frame**

After the reflecting surface is finished the rear frame should be attached while the dish is still on the pattern. This defines the position of the attachment points with respect to the backup frame.

The frame should be rigid with respect to the forces to be expected from gravity and wind loading. For a 16-foot reflector, a 50-pound force applied to any end of the four-point frame should not cause more than 1/16-inch movement. The frame I used weighs about 40 pounds and meets the rigidity requirements.

Bearings made from standard plumbing components are attached to the ends of the fiberglass tube. On the reflector end these

consist of one-inch pipe flanges screwed into a wood plug that is epoxied to the fiberglass tube. On the gimbal end two-inch pipe flanges are used; six-inch long pipe nipples are screwed into these flanges. These nipples rest on the one-inch pipe flanges on the reflector frame. For safety, a two-inch-long one-inch nipple is screwed into each of the one-inch pipe flanges on the frame. This makes a crude but adequate bearing for the loads encountered.

The points of the dish used for attaching the frame should be well cleaned with coarse emery cloth just prior to bonding. To dis-

maintain access to the center hole for the steerable feed arrangement.

### removing the dish from the pattern

Four or five workers are required to lift the dish off the pattern. Pick it up at the rim. After removing it from the pattern you can remove all the newspaper still attached to the bottom. The dish is light enough to be placed onto the roof without the help of a crane. The high end of my gimbal is 23 feet above the ground but five people were able to mount it under winds of approximately 15 mph.

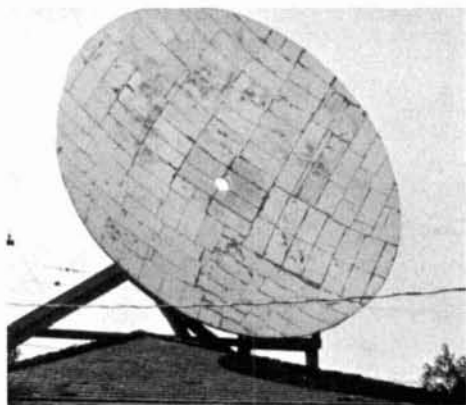

Homebrew 16-foot parabolic reflector sits in a polar mount on the garage roof.



Newly installed reflector with a temporary feed for sun noise measurements.

tribute the windloading forces, a minimum of 0.5 square feet is required for each of the attachment points. Each of the attachment points may be broken up into three smaller areas—I did this to use the two-inch diameter honeycomb tubing I had available.

Use a putty knife to apply a thin coat of epoxy to the frame and the dish surface. Then apply a thick layer of epoxy-coated fiberglass matting between the dish and the frame member and keep it under compression until the epoxy cures. You may want to add more epoxy to the top of the fiberglass (surrounding the frame member) to increase its stiffness.

I didn't attach the rear frame to the exact center of the dish because I wanted to

The dish should be painted a lusterless white to partially eliminate reflecting the sun into the feed. Since this dish has a solid shiny surface it could produce undesirable heating of the feeds in the daytime. Also, it could be hazardous working around the focal plane while making sun noise measurements.

Accuracy of the reflector appears to be better than  $1/8$ -inch rms. This is good enough for full gain use up to 3300 MHz, and the dish should still have considerable gain at X-band.

### the mount

The drive and counterbalance disk I use with the 16-foot reflector can be seen in the photographs of the completed system. The

disk is in the form of a half circle with a radius of 50 inches, and is made from 3/4-inch exterior grade plywood. The edge of the disk is lined with a deep metal channel, 3/4-inch wide. This channel guides a half-inch nylon rope (available at boating stores) around the circumference of the counterbalance disk. The nylon rope also runs once

widely spaced calibration points are very helpful.

Counterbalance for the reflector is provided by nine common red bricks. Six of these bricks are strapped to the center of the drive disk and three are mounted at the lower end of the fiberglass tube. These weights provide balance for all positions of the large reflector.

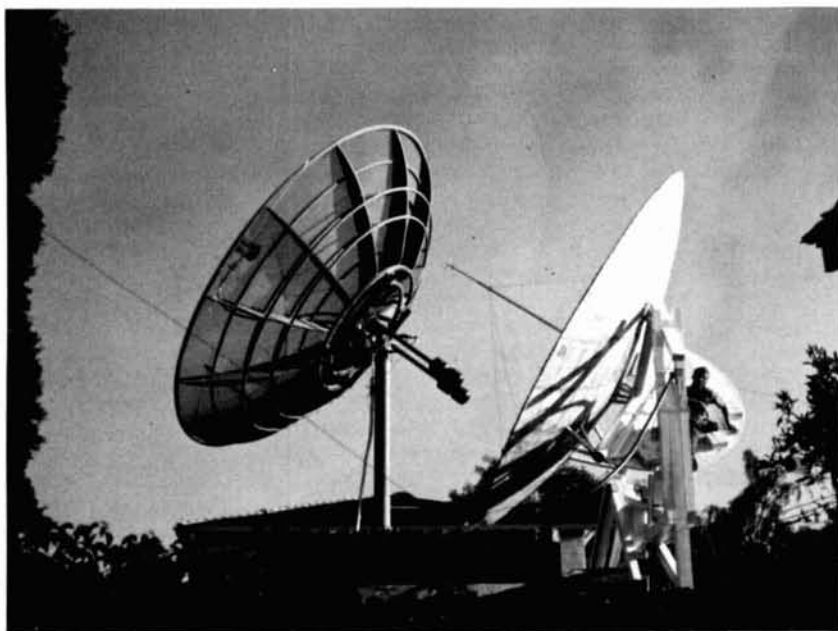

**Polar-mounted 16-foot parabolic reflector is to the right. The commercial 10-foot dish in the az-el mount to the left has been used for successful two-way moonbounce contacts with G3LTF and W2NFA.**

around a half-inch bolt—between two washers. When the washers are clamped together with a nut, the dish is locked into position. When the dish is “parked,” it is held by a safety chain since the nylon is not intended to lock the dish in high winds.

The drive disk is attached to one of the cross members of the reflector’s rear frame (see photo) and is held in the polar plane with guy wires. The edge of the drive disk is marked with hour-angle calibrations. The large circumference of the drive disk results in almost one inch per degree for these important calibration points. As I pointed out earlier, large reflectors must be pointed very accurately for maximum performance, so

All the structural members of the polar mount I used are either 6x6- or 4x6-inch Douglas fir timbers. Roof loading is minimal since the vertical members of the mount go through the roof to the floor of the garage.

#### references

1. S. Silver, “Microwave Antenna Theory and Design,” Dover Publications, New York, p. 488.
2. R. F. Latchaw, “Bonded Sandwich Construction for Parabolic Antennas,” *Adhesives Age*, July, 1964.
3. I. Skeist, “Epoxy Resins,” Reinhold Publishing Corporation, New York.
4. Hexcel Honeycomb Bibliography TSB 118-3, July, 1966.
5. Hexcel Bulletin TSB 120, second revision, January 1, 1966.
6. Hexcel Bulletin TSB 121, January, 1965.

**ham radio**

# a Great One from NRCI



## New 500-Watt 5-Bander from NRCI

You can't buy a more potent package than the new NRCI NCX-500 transceiver. This versatile 5-bander is packed with the performance extras that give you the sharpest signal on the band, plus an enviable collection of QSL's. Check it out!

- 500-Watt PEP input on SSB, grid-block keying on CW and compatible AM operation.
- Receive vernier, with tuning range greater than  $\pm 3$ kHz.
- Separate product and AM detection.
- Sidetone monitor, plus built-in code practice oscillator.
- Fast-attack slow-release AGC in all modes.
- Rugged heavy-duty 6LQ6's.
- Crystal-controlled pre-mixing with single VFO for effective frequency stability, plus identical calibration rate on all bands.
- Crystal lattice filter for high sideband suppression on transmit, and rejection of adjacent-channel QRM on receive . . . plus solid-state balanced modulator for "set-and-forget" carrier suppression.
- Universal mobile mount included.



AC-500 power supply available

Great things are happening at NRCI

**NATIONAL RADIO COMPANY, INC.**

**NRCI**

37 Washington St., Melrose, Mass. 02176  
617-662-7700 TWX: 617-665-5032



## solid-state Q5er

Replacing hot tubes  
with cool transistors  
makes this  
twenty-year-old veteran  
better than ever

Robert J. Grabowski, W5TKP, New Caney, Texas 77357

Large quantities of military surplus radio equipment became available shortly after World War II, and amateurs have made extensive use of the many high-quality pieces. Some of the equipment was used without conversion or modification, some was used as a source of excellent precision components, and some was altered for use in the amateur bands. One of the most popular pieces of military surplus is the low-frequency receiver designated BC-453 and commonly called the Q5er by many hams. Many articles on conversion and use of this receiver have appeared in radio magazines.

When the command receivers first appeared on the surplus market, the value of the BC-453 was not recognized. Some dealers offered this model as a free bonus with the purchase of one of the others in a set. However, when it was shown that it could be easily added to an amateur communica-



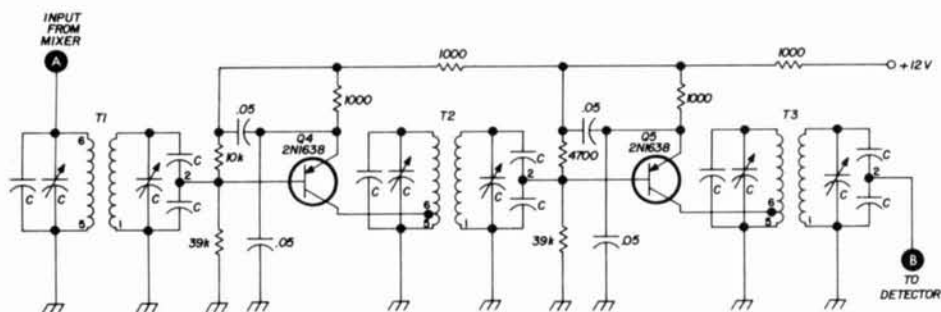
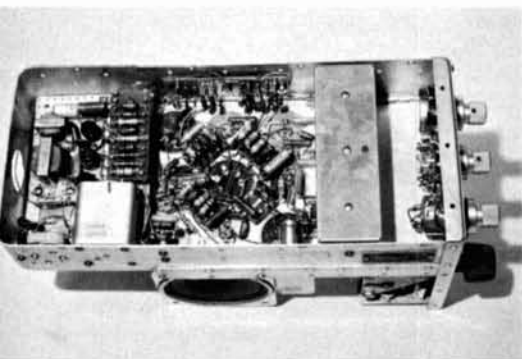

fig. 2. The i-f strip. A capacitor divider was added to the transformer secondaries (details and values for "C" are given in fig. 4.) T1, the first i-f can is coded red; T2, yellow and T3, blue.

## rf, mixer and oscillator

The rf-amplifier transistor is used in a grounded-base circuit (fig. 1), because neutralization is usually not required, and moderate gain is available. A ten-turn coil, wound on the form and positioned close to the

Under-chassis view of the Q5er; solid-state audio section is to the rear.



original input coil, provides the low-impedance source to drive the emitter of the input transistor, Q1. Another small coil (15 turns) added to the rf amplifier coil provides drive to the mixer, Q2.

The oscillator transistor is a 2N384. Other high-frequency types may be used, but I found that this transistor produces an excellent sine wave of nearly equal amplitude over the frequency range covered. A five-turn pick-up coil is added to provide drive coupling to the mixer emitter.

## i-f amplifier

The circuit for the i-f amplifier is shown in fig. 2. Modification of the i-f transformers is simple, and the same change is made in each unit. Addition of a 20-pF capacitor in parallel with the original (180 pF) and a 0.002-pF disc capacitor in series with the total 200 pF provides a convenient tap for the impedance match and retains the effective 180 pF required to tune each coil to 85 kHz. The modified coil circuit arrangement is shown in fig. 4. The three i-f transformers are identical, except that the primary and secondary of the first i-f can are not tapped.

## detector and bfo

The detector and bfo circuit is shown in fig. 3. The detector is a type suggested by

Top view of the Q5er shows the battery-pack power supply and transistor layout.

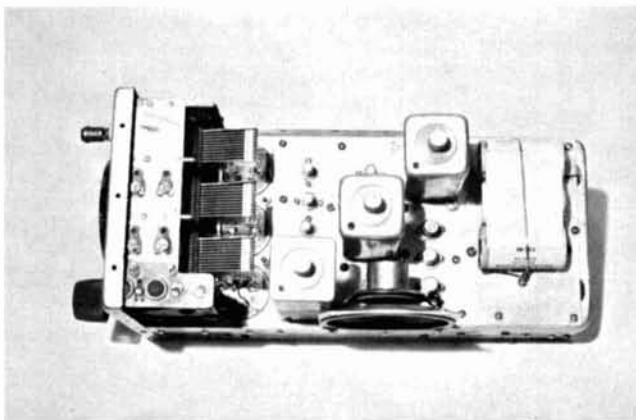



fig. 3. Bfo and detector. Sufficient signal is available to drive a simple two-stage audio amplifier. Parts marked with an asterisk are original BC-453 bfo components.

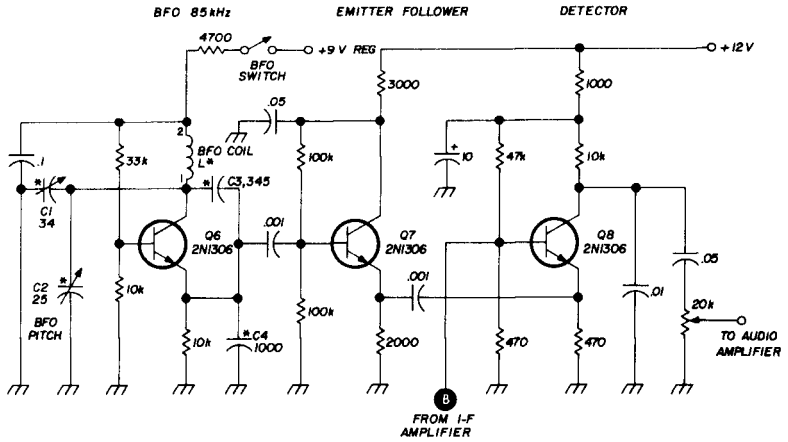
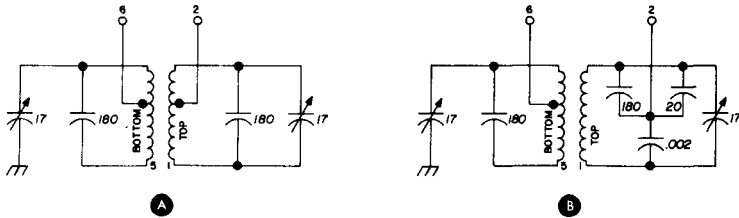

fig. 4. BC-453 i-f transformer detail. Original is shown in A. A series-parallel capacitor arrangement was added in B to provide an impedance match to following stages.



Stoner<sup>2</sup> and works well with a-m, cw and ssb. Detection of cw and ssb signals requires injection of a signal from the bfo.

The audio signal at the detector output is sufficient to drive a simple amplifier. A single voltage-amplifier stage followed by a power amplifier will provide adequate gain.

### an fet version

The availability of field effect transistors at prices competitive with bipolar transistors added new interest toward converting the BC-453 to complete solid-state. Since the fet is considered to be a solid-state counterpart of the vacuum tube, the possibility of mak-

fig. 5. Rf, mixer and local oscillator using fets. The BC-453 coils were used without change in this version. Coils L1 through L6 are original BC-453 coils.

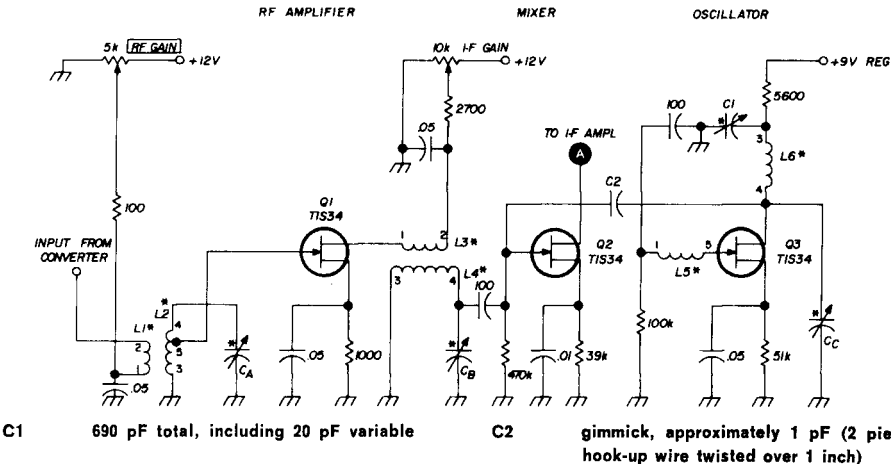

C1 690 pF total, including 20 pF variable

C2 gimmick, approximately 1 pF (2 pieces hook-up wire twisted over 1 inch)

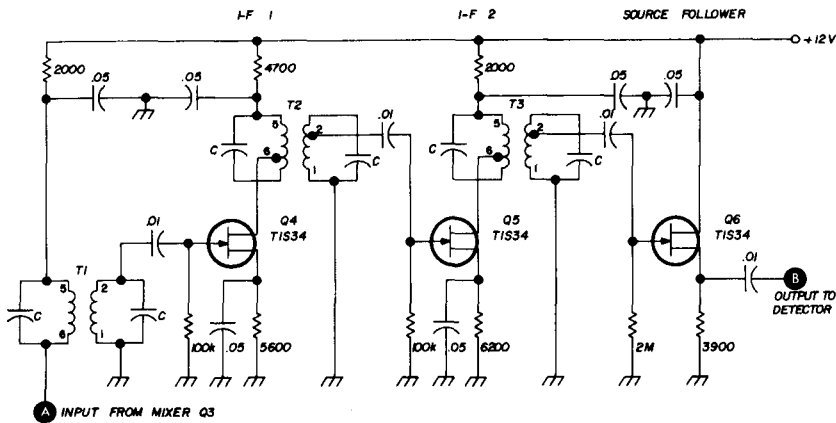

fig. 6. The fet i-f amplifier. T1, T2 and T3 are the original BC-453 85-kHz i-f transformers; capacitors labeled C are the 180-pF trimmers in the i-f cans.

ing the modification without coil alteration was investigated. Again, the conversion was easily made, and results were excellent. The fets are the one-dollar variety (TIS34). The circuits for the fet model are shown in figs. 5, 6 and 7. It should be noted that the original coils are used **without** alteration. Future plans include the addition of avc, noise limiter and a Q multiplier.

### mosfet converter

Fig. 8 is a schematic of a frequency converter for the 75- and 40-meter bands. This unit uses one of the new mosfets, and more than enough gain is available. Strong signals

are easily copied without an antenna (receiver case removed).

Some models of the BC-453 have an rf can containing only one winding, which is connected to the antenna post through an 11-pF coupling capacitor. In this case, the converter mixer drain load may be replaced with an rf choke and the mixer output taken from the drain side (conventional capacitive coupling).

The 3500-kHz crystal may be changed to suit individual needs or availability. A military surplus 3450-kHz crystal is a good substitute. With this crystal, the 75-meter phone band tunes from 350 to 550 kHz, and the

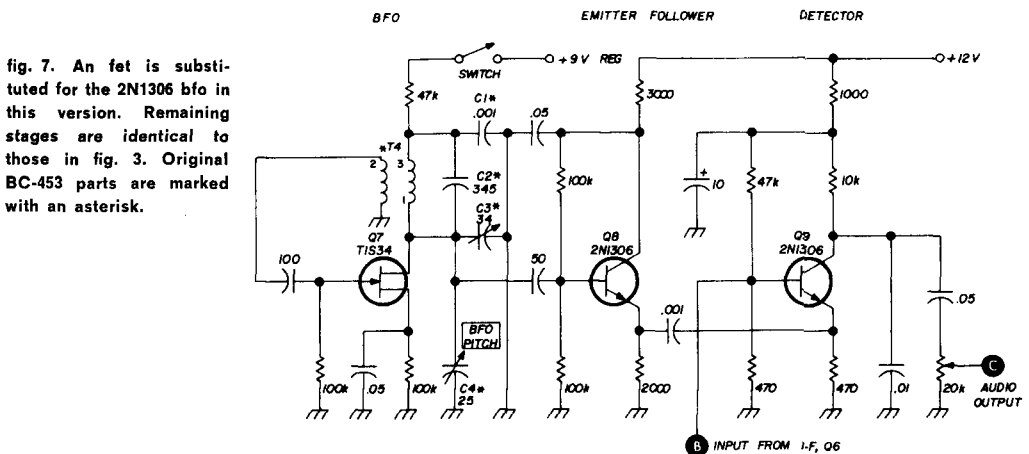
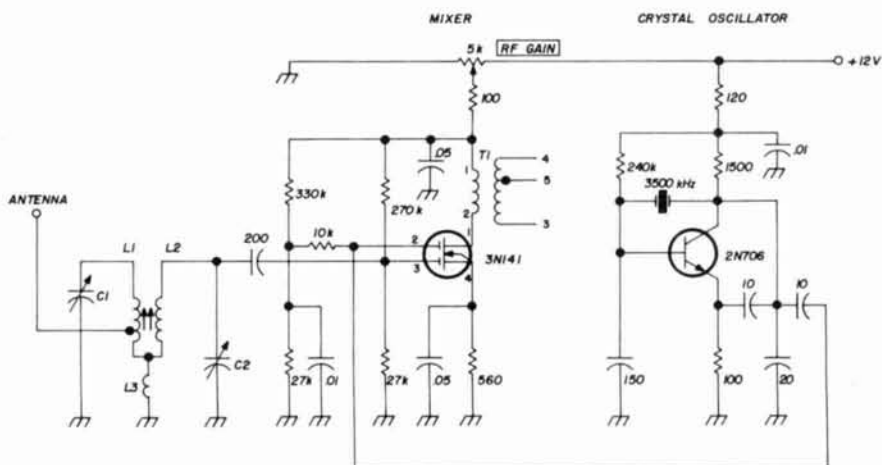

fig. 7. An fet is substituted for the 2N1306 bfo in this version. Remaining stages are identical to those in fig. 3. Original BC-453 parts are marked with an asterisk.



C1, C2 dual 365-pF variable

L1, L2 7  $\mu$ H. 26 turns no. 26 on 3/8" form, spaced 1 inch, antenna tap at 5 turns

L3 0.2  $\mu$ H. 10 turns no. 20 on 1 W resistor

T1 BC-453 antenna coil

fig. 8. Mosfet converter for 75 and 40 meters.

40-meter phone band tunes from 300 to 400 kHz. The crystal oscillator circuit produces many usable harmonics and has been used to provide a 144-MHz signal from an 8-MHz crystal for receiver tests.

Band changing is accomplished by merely adjusting the 365-pF tuning capacitor. With the coil values indicated, 75 meters peaks when the setting is approximately at

This repackaged version of the solid-state Q5er has a built-in 75- and 40-meter converter. A front view of this model is shown on page 20.

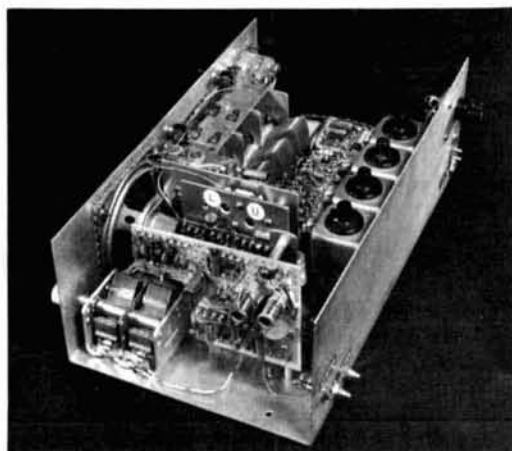

280 pF, and 40 meters is in tune at a setting of 75 pF. WWV signals at 10 MHz may be copied at 350 kHz on the dial if the capacity is decreased to about 20 pF (3450-kHz crystal in the converter).

### caution note

Extra precaution should be used when working with mosfets, since static charges can easily destroy some of the junctions. The units are sold with all leads in contact—usually held by a small eyelet. The mosfets may be handled without extreme caution if a fine strand of bare wire is wrapped around all the leads near the case before removing the eyelet. The wire may be removed after the unit is in the circuit.

I hope these conversion suggestions will stimulate new interest in the BC-453 and perhaps add life to the units considered part of the usual junk box. Use of integrated circuits in a fourth unit is currently in progress.

### references

1. Gordon E. White, "Command Set Receivers For All Frequencies—The Easy Way," *CQ*, January 1967, p. 21.
2. Stoner and Earnshaw, "The Transistor Radio Handbook," *Editors and Engineers, Ltd.*, 1963, Summerland, California.

ham radio

# distortion in fm systems

Adjustment of receiver  
and transmitter for  
optimum performance  
in the fm mode

Carl C. Drumeller, W5JL, 5824 N.W. 58th Street, Oklahoma City, Oklahoma 73122

There has been considerable interest recently in popularizing fm on the two- and six-meter bands. Commercial equipment, obsoleted by FCC rulings requiring narrower frequency deviation, has been adapted by some amateurs. Others have modified their a-m equipment for fm with varying degrees of success.

Adapting a-m transmitters for fm generally consists of frequency modulating a vfo and operating the following stages in class C. For receiving, slope detection is used, or a discriminator is substituted for the a-m detector.

Whether you use modified commercial equipment or adapt your a-m set for fm, there are some fundamental concepts that should be observed to avoid unsatisfactory performance when transmitting and receiving parameters haven't been standardized. The following is a review of causes of nonlinearities in fm systems, using both modified a-m receivers and discriminators. A discussion is also presented on adjusting frequency deviation in fm transmitters.

## slope detection

Consider first the use of an a-m receiver for the reception of fm signals. **Fig. 1** illustrates the principles. In the example shown, the receiver is tuned to a lower frequency than the received signal's resting frequency. (The receiver could have been tuned to a higher frequency.) The resting frequency is at the center of the linear portion of the receiver's rf/i-f selectivity curve. When the

transmitter is modulated, its carrier will shift above and below the resting frequency at a rate determined by the modulating frequency. This is known as frequency deviation.

If the modulation is sinusoidal, one complete cycle will appear as in **B** of **fig. 1**. A zero-center millivoltmeter connected across

the diode-detector load resistor of an a-m receiver tuned as in **fig. 1A** would indicate a pattern as shown in **fig. 1C** for the period of time depicted in **figs. 1B** and **C**. This corresponds to one complete cycle of the modulating frequency. Also, of course, it's the same as one complete cycle of the demodulated

**fig. 1.** The relationship between transmitter frequency deviation and the demodulated audio signal. Usable audio signal is a linear function of transmitter frequency deviation.

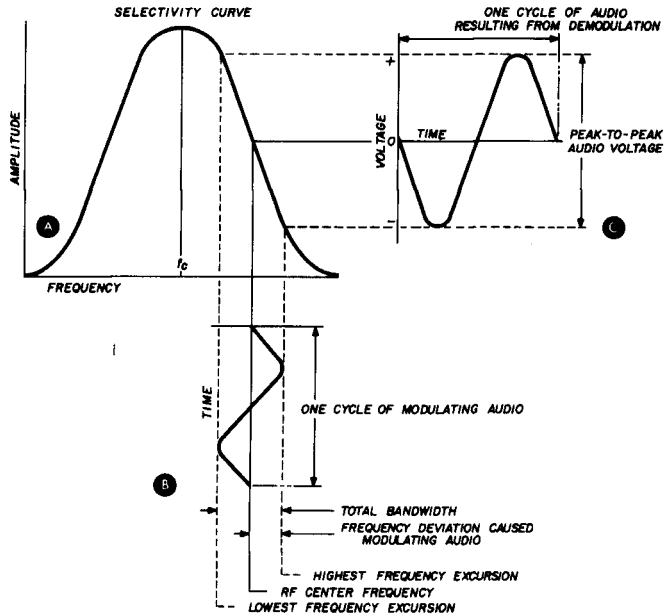

**fig. 2.** Effect of tuning the receiver to the center of the response curve. Note the flat top and extreme nonlinearity of the demodulated audio signal.

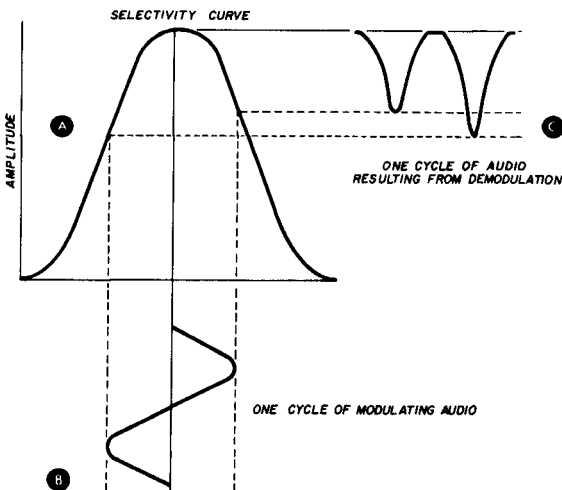

audio-frequency signal available at the receiver output.

If the input signal were redrawn to show only one-half the frequency deviation, the audio signal amplitude would be one-half its original value. From this you may draw the conclusion that an a-m receiver, correctly tuned and with a specific frequency response (selectivity) curve, will develop an undistorted audio signal that varies directly as the frequency deviation of the transmitted signal.

### incorrect tuning

Two cases of incorrect tuning are depicted in **figs. 2** and **3**. The first shows a signal tuned too far down on the slope of the response curve. This has two effects. One reduces the amplitude of the demodulated signal; the other introduces some distortion in the audio waveform. If you tuned in the other direction; that is, too close to the maxi-

mum-signal (rf) portion of the selectivity curve, **fig. 2** shows what happens. Not only is the audio amplitude quite reduced, but a distressing degree of distortion appears.

So far, we've dealt only with a receiver having a rather broad, gently-sloping selectivity curve. Very few presently manufactured receivers for amateurs fall into this classification. Most such receivers have selectivity curves resembling that of **fig. 4**, with many coming quite close to the ideal flat-nosed, vertical-sided curve. If the curve has a reasonable slope, very **narrow** frequency deviations can be received quite well, but any wide deviation or incorrect tuning will cause serious distortion.

### summing up

Slope-detection characteristics may be summarized as follows:

1. For other than narrowband fm, an a-m receiver selectivity curve should have a shallow slope. Its major portion should be free of abrupt change. Ideally, it should be straight.
2. If the receiver has a straight slope for a major portion of its selectivity curve, the receiver should be tuned so that the resting frequency of the incoming fm signal is in the center of the linear portion.
3. Thus tuned, the amplitude of the demodulated audio signal will vary directly as the deviation; the greater the deviation, the louder will be the audio.
4. Incorrect tuning (to either side of optimum) causes distortion.
5. Even with optimum tuning, excessive frequency deviation (for a given slope) will cause distortion.
6. For acceptable results, the transmitter frequency deviation must be compatible with the receiver slope characteristic. In other words, just any receiver will not be satisfactory with just any transmitter.
7. The more selective the a-m receiver (that is, the more nearly its selectivity curve ap-

proaches the flat-nosed, straight-sided shape) the less likely it will receive fm without distortion.

### the discriminator

Let's now consider the discriminator, which is one of the most common means of converting fm to audio. **Fig. 5A** is a plot of voltage developed across a load resistor in the output of a discriminator. An rf signal is introduced on the y axis, **fig. 5B**. If its frequency is constant, no voltage will be produced. If, however, you vary the frequency of the incoming signal, you'd find an output voltage whose magnitude and polarity are related to the deviation. The demodulated signal amplitude is **not** related to the amplitude of the incoming signal. Note that the curve is linear over a major portion, which is the useful part. The nonlinear part would result in distortion.

One important fact must be thoroughly understood at this point. The curve of **fig. 5** is the over-all rf performance characteristic. It is not the discriminator output versus discriminator input, but the **antenna input** versus discriminator output. The **total** receiver selectivity curve must be considered if dis-

**fig. 3.** What happens when the receiver is tuned too far down on the response curve slope. Amplitude is reduced and distortion is introduced.

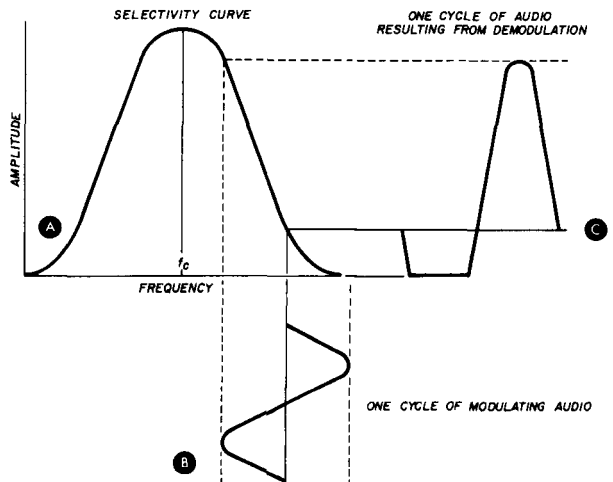

tortion is to be avoided. If the selectivity curve, up to the discriminator input, isn't flat-topped over a frequency range greater than that of the discriminator's linear portion, distortion will occur when the incoming signal has a bandwidth exceeding the flat-nosed part of the rf/i-f selectivity curve.

Most good a-m receivers must have their i-f strips broadened to receive fm for the reasons stated above. The exception to this is receiving narrowband fm. Most vhf fm doesn't fall into this category, however.

## the transmitter

For compatible fm, receiver and transmitter must be matched. The exact task is to design an fm transmitter that conforms to predetermined standards. These usually apply to frequency deviation and its linearity.

Deviation often depends on some arbitrary decision. For example, the FCC makes a ruling, a group of amateurs concur on a standard for their net, or a MARS director issues a bulletin. Once the parameter has been set, it's up to the amateur to conform. Unless you have a commercially built deviation meter, conformance can present a real problem. You might obtain the services of a specialist in the commercial fm field. Get him to adjust your transmitter, then leave the controls alone. Especially, don't take the advice of well-meaning hams who may not know all the answers.

fig. 4. Typical response curve of many commercially manufactured amateur receivers. Tuning is generally critical, however, if the fm signal has a rather large frequency deviation.

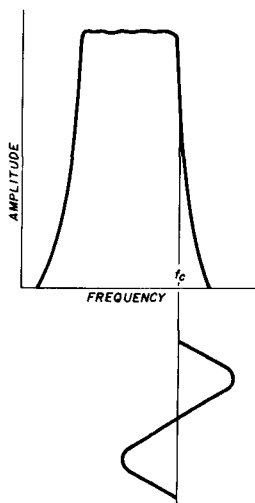

## dc method for deviation adjustment

To do this properly, you should have a peak-reading vtvm and a precision frequency meter. A steady voltage of one polarity is applied to the frequency-shifting circuit. The voltage is changed in small increments, the resulting frequency change is noted, and a plot is made of frequency deviation versus voltage. The polarity is reversed, and the procedure is repeated. The two plots should coincide exactly.

From these plots, the exact peak-to-peak input voltage is found that produces the

fig. 5. Typical fm discriminator curve. The demodulated af voltage amplitude is a function of the frequency deviation, not the amplitude of the input rf signal. Note the linearity, which gives undistorted output.

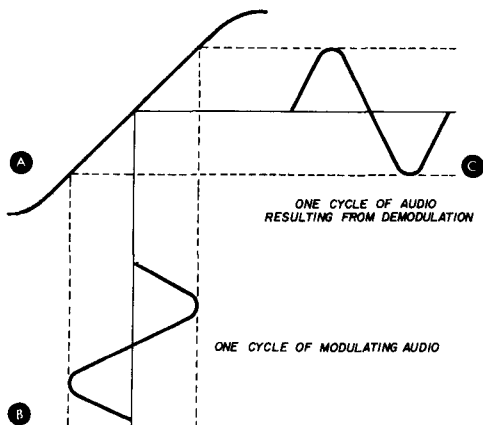

specified bandwidth. Then the audio circuit is adjusted for the same peak-to-peak voltage, and the control is locked. This procedure also takes care of the second standard: deviation linearity.

## closing note

A review of the amateur literature on converting to fm has, with few exceptions, overlooked the considerations treated in this article. I hope the ideas presented here will encourage a more straightforward approach to the adjustment and operation of fm equipment.

ham radio

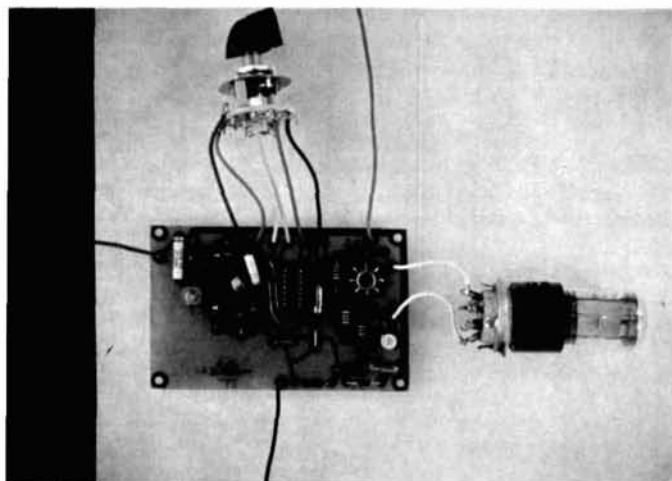

# simple frequency-divider calibrator using mos ic's

Mosfet's have been  
used in many amateur  
rf amplifier designs—  
here's a  
different application

Hank Olson, W6GXN, P. O. Box 339, Menlo Park, Calif.

The metal oxide silicon field-effect transistor (MOSFET), also called MOST, is now available at moderate cost after extensive development. One of its more common applications is in the computer field, where it is being used in large-scale integration (LSI) circuits. The development of LSI arrays has brought forth several varieties of the MOST. For example, you can now obtain a single-chip device with a 1024-bit memory storage.<sup>1</sup> Or you can buy a MOST chip as simple as a three-input gate in one TO-5 package.<sup>2</sup>

Amateur ingenuity has produced MOST converters and other receiver front-end designs.<sup>3-7</sup> This article is another contribution to amateur application of solid-state devices—a frequency calibrator using several MOST's to produce a 100-kHz signal plus four submultiples. Construction is not dif-



ful, but you should observe experience-proven techniques for handling and mounting the devices. Some tips on this are given in the following discussion.

### the oscillator-buffer section

A three-input NOR gate (Philco pL4GO4) is used in this circuit. It could be termed a MOS array, since it consists of three p-channel enhancement-mode MOST's on one chip. Its internal circuit is shown in fig. 1.

The gate and drain leads of each transistor are brought out separately on the eight-lead TO-5 package. The sources are common and are tied to pin 6. The remaining pin (8) is connected to the substrate. Since these MOST devices are p-channel types, the power supply ( $E_{DD}$ ) must be negative; -12 volts are used. Each MOST operates in the enhancement mode. This means that  $I_{DSS}$ , which is the drain current flowing when gate and source are connected, is nearly zero. Any gate must be negative with respect to its source before conduction begins. This is one of the nice features of enhancement-mode MOST's. They are self-biasing, like the zero-bias triodes that are so popular in amateur linear amplifiers.

Two of the MOST's in the pL4GO4 are wired as an astable multivibrator; a crystal and capacitor in series replace the usual cross-coupling capacitor. This crystal-controlled multivibrator then becomes our fre-

quency standard. The remaining MOST is used as an isolation amplifier.

### divider and shaping circuits

Following the oscillator-buffer is another MOST IC containing four binary divider stages and four inverting buffers (one for

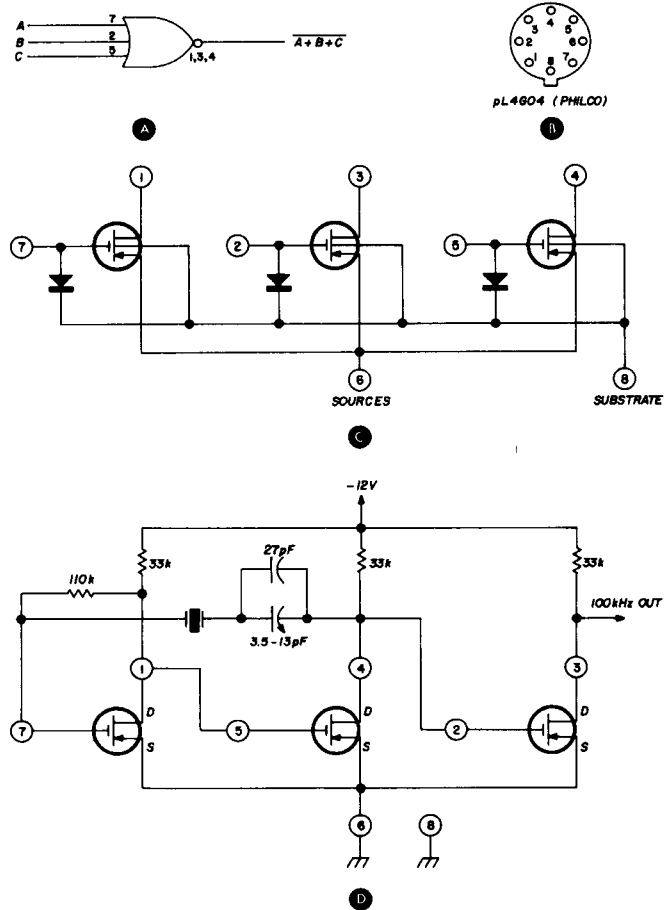

fig. 1. Three-input NOR gate used as the oscillator-buffer. Logic and pin diagrams are shown in (A) and (B). Internal circuit (C) shows protective snubbing diodes. The first two MOST's in (D) form the 100-kHz standard.

each divider), fig. 2. This IC is specifically designed for electronic organs, so its commercial price is low. A data sheet is available from Motorola.<sup>8</sup>

The desired output (100, 50, 25, 12.5 or 6.25 kHz) is applied to a Schmitt trigger. This circuit shapes the signal to a near-per-

fect square wave, thus increasing harmonic content.

Whereas the p-channel MOST's (pL4G04 and MC1124P) are relatively slow, the n-channel MOST and npn bipolar transistor in

## construction

Those who haven't used MOST's seem to be either completely unaware of their fragility or are afraid to touch one for fear of wrecking it. This is understandable, because

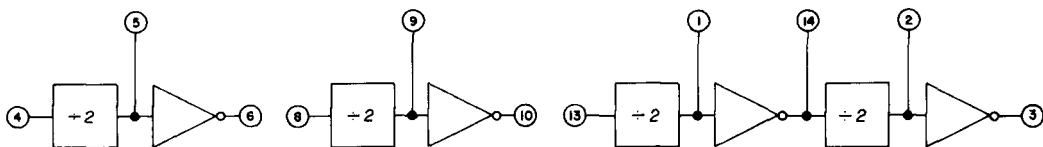

fig. 2. The MOST IC used as a frequency divider. Logic has been modified for this purpose to obtain the fundamental 100 kHz and four submultiples.

the Schmitt trigger will toggle above 100 MHz.

Solid-state Schmitt triggers ordinarily use two bipolar transistors; this one uses one MOST and one bipolar device. The MOST in the input of the Schmitt trigger allows it to be driven by the pL4G04 or MC1124P, which have high output impedances. The bipolar transistor on the output side has a much better saturation characteristic than a MOST, providing an output pulse approaching an ideal square wave. Thus by combining transistor types, one can achieve better performance characteristics than by using only one pair of either type.

early MOST's were indeed susceptible to gate burnout from electrostatic charges. This can occur from your body or from the polyfoam package material. However, most MOST IC's today have snubbing diodes between gate and source to prevent voltage buildup between these elements. The IC's in this article are of that type. The 3N128 in the Schmitt trigger is **not**, however, and it was handled by wrapping a fine wire around its leads. The wire was put on before the shorting collet was removed. The 3N128 was soldered into the circuit last, and the 110-kilohm gate-to-source resistor was soldered into the circuit before removing the short-

fig. 3. Complete calibrator circuit. The 3N128 should be handled with care to avoid static charges from building up between source and gate; see text.

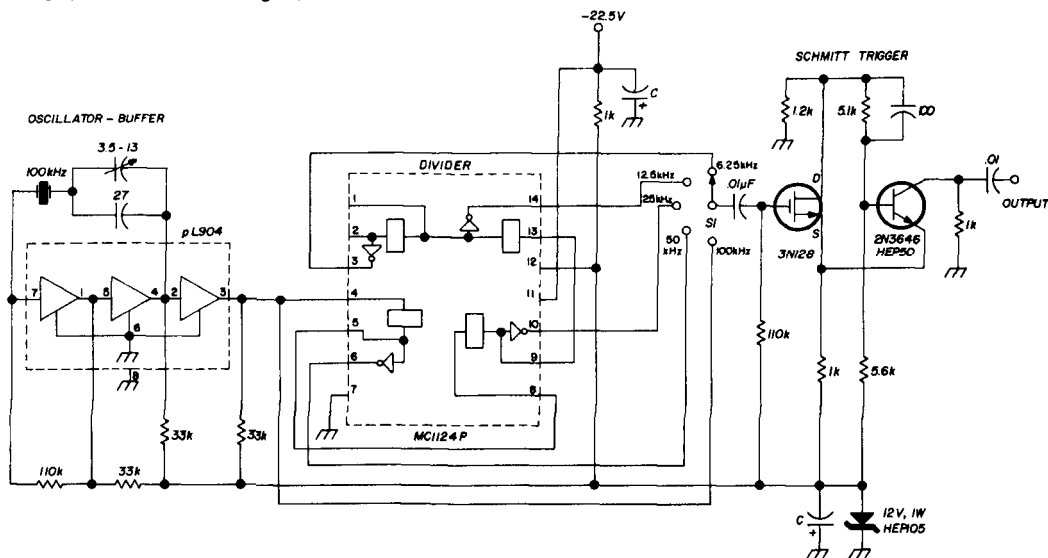

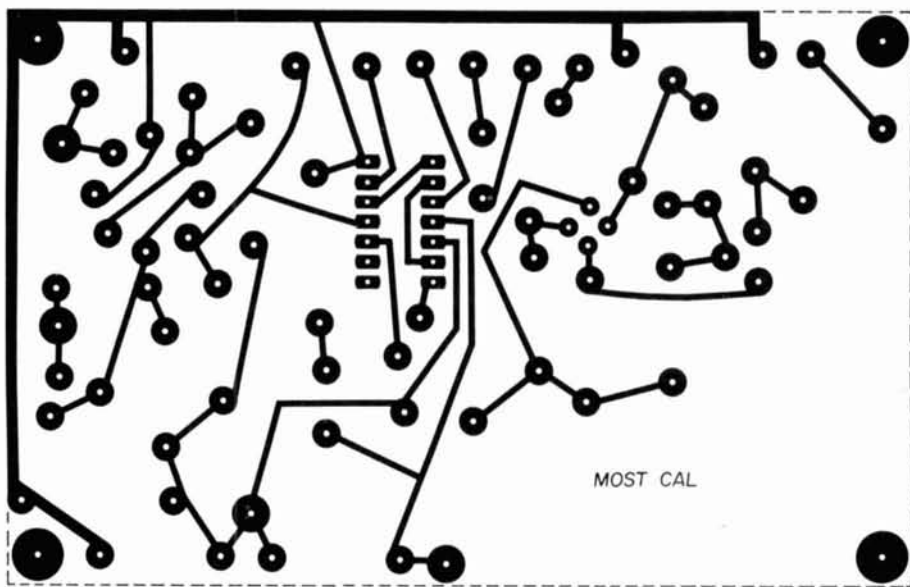

fig. 4. Etched circuit board for the frequency-divider calibrator.

ing wire.

The complete calibrator schematic is shown in fig. 3. The pL4G04 and MC1124P were mounted in sockets, but sockets aren't absolutely necessary. If you'd like to include this refinement, the sockets I used were

Nugent LP5178 and Methode M1141. The crystal is a Bliley glass-mounted type.\*

The frequency-adjusting capacitor is made by Trush, Inc., part number 75-TRIKO 02.

\* Bliley BG9D, available from Red Johnson Electronics, 440 Pepper Street, Palo Alto, California. Price \$5.00 pp.

Component layout.

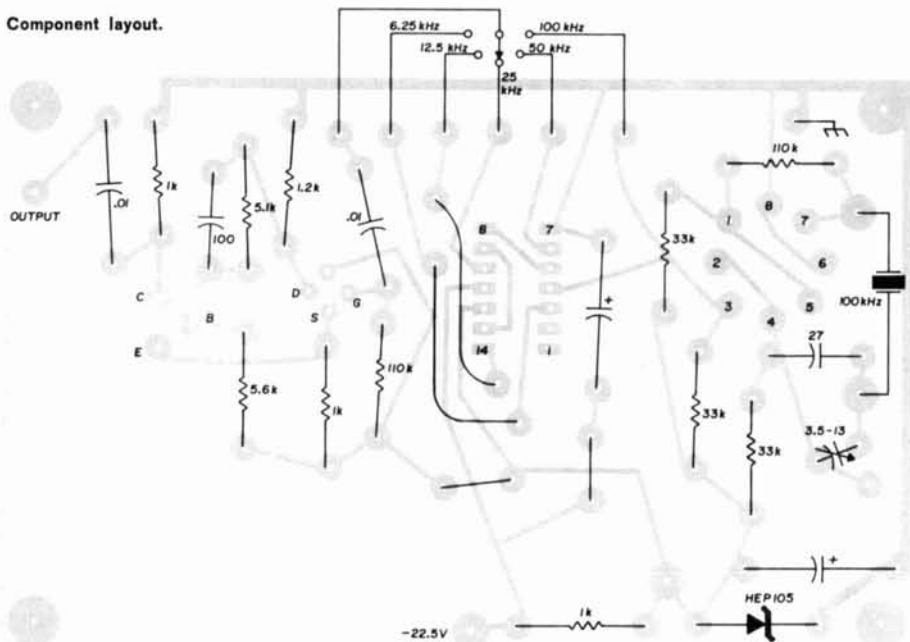

The circuit board, **fig. 4**, is designed especially to fit this particular capacitor. A ready-made board, complete with parts, can be obtained if you don't wish to make your own board.\*\*

A single-pole, 5-position wafer switch, S1, selects the desired frequency. A suggested source is Mallory, part number 3215J. The two bypass capacitors, identified as "C" in **fig. 3**, aren't critical. Tantalitic or Mylar low-voltage capacitors (0.1 to 20  $\mu$ F) will work fine.

A circuit for a regulated power supply is shown in **fig. 5**. The calibrator will operate for many hours on a battery supply, however. A Burgess number 4156 may be used.

### predictions for the future

The first cut at the calibrator design used a Philco pL4510 ten-input NOR gate, which has 22 leads on its small package. Only three of the ten gates were used. The complexity of such off-the-shelf IC's is an indication of how fast LSI components are becoming available to amateurs. The cost per gate of

\*\* Project Supply Company, P. O. Box 555, Tempe, Arizona 85281.

**Original version of the calibrator, using a Philco ten-input NOR gate. Only three gates were used for this application.**

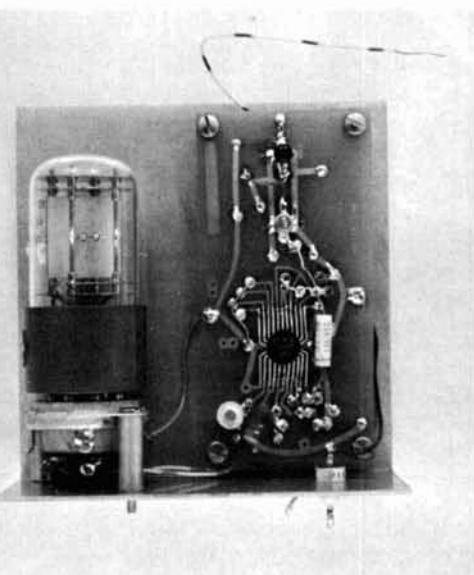

this device is lower than that of the pL4G04, even though the flat-pack styles are generally more expensive than the TO-5 package.

Prices of MOST integrated circuits should decrease as competition increases among manufacturers. The electronic organ industry indicates that something on the order of 40¢ per divide-by-two stage is the economic break point to justify the use of microcircuits. It's almost a certainty that this figure will be realized next year. This should make

**fig. 5. Suggested power supply for the frequency calibrator.**

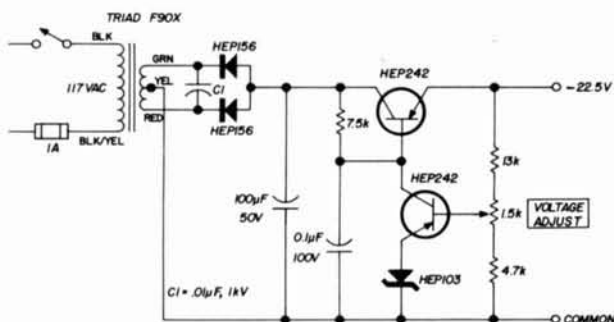

the price about 80¢ apiece for amateurs for 1 to 99 pieces. This should undercut the price of even the inexpensive RTL IC's, which have gained popularity among amateurs.<sup>9</sup>

### references

1. Data sheet for Fairchild 3501, 74-BR-0002-48, May, 1968, Fairchild Semiconductor, 313 Fairchild Drive, Mountain View, California.
2. Data sheet for Philco pL4G04, M-178, May, 1967, Philco Microelectronics, Blue Bell, Pennsylvania.
3. Mike Goldstein, VE3GFN, "Bandswitching FET Converter," *ham radio*, July, 1968, p. 6.
4. Don Nelson, "The WB2EGZ Six-Meter MOSFET Converter," *ham radio*, June, 1968, p. 22.
5. Don Nelson, WB2EGZ, "MOSFET Converter for Two Meters," *ham radio*, August, 1968, p. 22.
6. Don Nelson, WB2EGZ, "220-MHz MOSFET Converter," *ham radio*, January, 1969, p. 28.
7. Hank Cross, W1OOP, "Converting a Vacuum-Tube Receiver to Solid State," *ham radio*, February, 1969, p. 26.
8. Data sheet for Motorola MC1124P, PS-34, September, 1967, Motorola Semiconductors, Box 955, Phoenix, Arizona.
9. H. Olson, "Micrologic for Nonlogical Users," 73, June, 1967, p. 58.

**ham radio**

# SPEC-I-FI-'CA-TION

... A DETAILED, PRECISE PRESENTATION OF FACT—

## SEN-SI-'TIV-I-TY



BRAND NEW MODEL HQ200

The correct matching of the antenna to the tube input impedance is of great importance in securing an optimum signal to noise ratio. A reactive antenna will usually produce a detuning effect on the input R.F. circuit. A good way of overcoming this problem is to tune the circuit with a panel mounted antenna trimmer or with a variable capacitor ganged with the VFO tuning capacitor. (A Hammarlund Feature for Years!)

## SE-LEC-'TIV-I-TY

Maximum pre-mixer selectivity is a valuable aid in reducing spurious responses and such selectivity is most easily achieved with an R.F. stage. (See all Hammarlund receivers for this - -)

The ability of a receiver to separate stations on closely adjacent frequencies is a measurement of its selectivity. To compare receivers, look at their selectivity curves. The curves show the *nose figure*, which represents the bandwidth in KHz over which the signal will suffer little loss of strength; the other figure, the bandwidth over which a powerful signal is still audible, is termed the *skirt* performance. The ratio



MODEL HQ-180A

of the two is the *shape* factor of the receiver. The ideal would be a shape factor of one—but this is presently impractical. The inclusion of step selectivity by use of a mechanical or crystal filter or by changing LC circuit parameters can provide shape factors close to the ideal. (Check the front panel of any Hammarlund receiver!)



MODEL HQ-215

At Hammarlund, we believe in specifics—every one of our products meets published specifications—not just our engineering samples. Some of our receivers are still in daily use after thirty years and numerous owners! We'd like to tell you more about our radios—General Coverage—Ham Band—Commercial. Drop us a line at our sales office—20 Bridge Ave., Red Bank, New Jersey 07701—or see your favorite Hammarlund dealer.



Established 1910

The **HAMMARLUND**  
Manufacturing Company Incorporated

A subsidiary of Electronic Assistance Corporation  
73-88 Hammarlund Drive, Mars Hill, North Carolina 28754

These Facts Brought To You Straight From The Shoulder By The Hams At Hammarlund

Bill K4DZT Wayne K4HCS Bob W2HEU/4 "Mac" W4HHR Bob W4AEY Conell K4BHN Sw W4MVC/W2ERV Bill W4TYQ Don WB4LTL Henry W6NRT/4 Bill W9KPD/4



## putting together a mobile installation

A recipe  
for  
summer  
fun

Bob Ruyle, WØFCH, 420 Steinway Road, Lincoln, Nebraska, 68505

### ingredients:

- 1 Galaxy transceiver
- 1 mobile power supply
- 1 mobile mounting bracket and speaker
- 1 Antenna Specialist M3D body mount
- 1 Hustler foldover mast
- 1 Hustler resonator spring
- Waters loading coils and kilowatt tips

Route the power-supply cable from the mounting position of the transceiver to the area near the battery where you're going to mount the power supply. Keep the power supply away from areas that retain heat; I mounted mine up toward the front and even had to reposition the horn. Route the cable neatly through cable hangers.

Take the bottom plate off the power supply and connect the power cable as shown in the instruction manual. Check all connections before sealing the unit up again. Install the power supply in the spot you've chosen. Route the dc primary cables to the battery using the **shortest** path possible. Primary cables should be no longer than 4 feet. I ran mine in the cable channel between the radiator and air conditioner.



**Finishing the wire ends.**

Take a 20-foot length of good quality RG-58A/U coax (or RG-8A/U if you have the space) and route it from the front seat area to the back of the car where the antenna is to be mounted. You can remove paneling and covers to hide the coaxial cable—in the photo the cable is routed underneath the carpeting and behind the side panels. Be careful not to cut or pinch the cable when replacing the panels and protective covers.

Solder the uhf connector to the antenna lead; check the cable with an ohmmeter to make sure you haven't shorted it out.

Now lay out the pieces of the M3D antenna mount and attach the center conductors and ground lead. Remove all the hardware and mark the fender for drilling. A Greenlee punch is handy for the large round center cutout.

**Punching the antenna-mounting hole.**



**Above, mobile power supply and cable. Photo below shows routing of coaxial cable under side panels.**

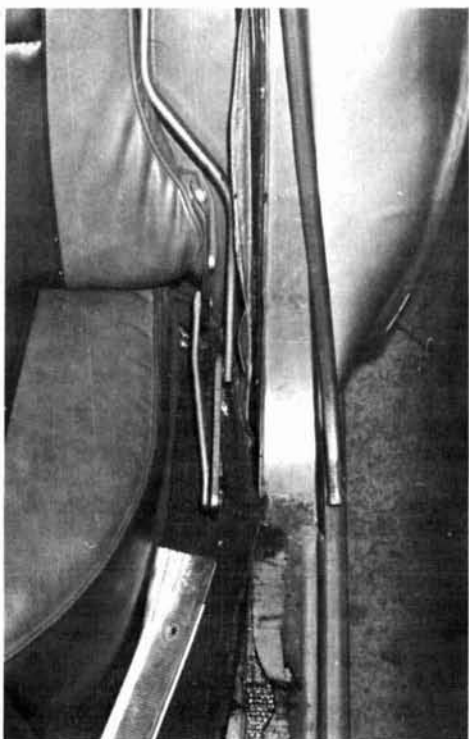



After the mounting hole is punched in the fender, put the mount together and screw in the mast, resonator spring, loading coil and tip.







**Install the mobile mount.**

Put the M3D antenna mount together, screw in the mast, resonator spring, loading coil and tip. Your mobile antenna is now ready for tuning.

Next, install the mobile mounting bracket. Be sure to try it out with the transceiver attached before marking any mounting holes—try all dials, switches, ash trays and the glove compartment door to make sure they don't interfere with the chosen transceiver location.

Connect the speaker, dc power cable and the antenna lead-in. Slip the transceiver into the mobile mount and run a ground line from the transceiver to the car body.

I mounted the speaker enclosure and the microphone to the bottom of the transceiver cabinet. This puts everything within easy reach when driving.

After tuning up the antenna, I fired up the installation and checked power output, swr and current drain under full load. Then I gave a call on 40 meters, and got a solid report from WØCUS near Colorado Springs. The recipe was complete. I would like to thank Galaxy electronics for their help in putting together the ingredients for this recipe.

**ham radio**

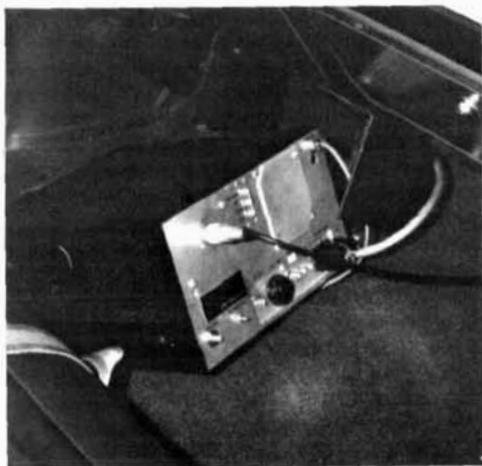

**Hook up all the cables.**



**The completed installation.**

# For The Experimenter!

## International EX Crystal & EX Kits

OSCILLATOR / RF MIXER / RF AMPLIFIER / POWER AMPLIFIER

### Type EX Crystal

Available from 3,000 KHz to 60,000 KHz. Supplied only in HC 6/U holder. Calibration is  $\pm .02\%$  when operated in International OX circuit or its equivalent. (Specify frequency)



# \$3.95



#### OX OSCILLATOR

Crystal controlled transistor type.  
Lo Kit 3,000 to 19,999 KHz  
Hi Kit 20,000 to 60,000 KHz  
(Specify when ordering)

# \$2.95

#### MXX-1 Transistor RF Mixer

**\$3.50**

A single tuned circuit intended for signal conversion in the 3 to 170 MHz range. Harmonics of the OX oscillator are used for injection in the 60 to 170 MHz range.

Lo Kit 3 to 20 MHz  
Hi Kit 20 to 170 MHz  
(Specify when ordering)



MXX-1



SAX-1

#### SAX-1 Transistor RF Amplifier

**\$3.50**

A small signal amplifier to drive MXX-1 mixer. Single tuned input and link output.

Lo Kit 3 to 20 MHz  
Hi Kit 20 to 170 MHz  
(Specify when ordering)

#### PAX-1 Transistor RF Power Amplifier

**\$3.75**

A single tuned output amplifier designed to follow the OX oscillator. Outputs up to 200 mw can be obtained depending on the frequency and voltage. Amplifier can be amplitude modulated for low power communication. Frequency range 3,000 to 30,000 KHz.

#### BAX-1 Broadband Amplifier

**\$3.75**

General purpose unit which may be used as a tuned or untuned amplifier in RF and audio applications 20 Hz to 150 MHz. Provides 6 to 30 db gain. Ideal for SWL, Experimenter or Amateur.



PAX-1



BAX-1

Write for complete catalog.



**CRYSTAL MFG. CO., INC.**

10 NO. LEE • OKLA. CITY, OKLA. 73102

# a new multiband quad antenna



This driven array  
features several  
improvements over  
conventional quads  
for  
three-band operation

Werner Boldt, PhD, DJ4VM, Am Zuckerberg 4773, Körbecke, West Germany

The cubical quad antenna has a reputation among amateurs for being an excellent DX antenna. Even after accounting for claims of over-enthusiastic quad users, the fact remains that the cubical quad is an excellent low-angle radiator, especially where height is limited.

Several ways to build multiband quads have been proposed. Some have proved to be practical and have become popular. All, however, are compromises in one way or another. Before describing the DJ4VM quad, which has been designed to exploit the best features of the quad antenna, I'll review the most popular designs and discuss their disadvantages.

## the multiband quad

The most popular multiband quad design consists of nested loop elements on a common supporting structure. Each antenna for each band is supposedly independent, and all are fed with a common transmission line using a gamma matching system or other tricks. The disadvantage here is that the size of the structure, which is determined by the lowest-frequency antenna, is not fully realized on the higher-frequency bands. In the common 20/15/10-meter antenna, for example, the 10-meter loop uses only about 25 percent of the available area.

fig. 1. Current distribution in conventional quad elements (cut for 20 meters). Note displacement of current loop with frequency.

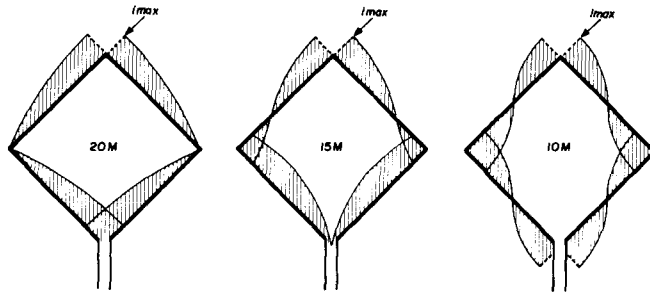

## forward field

The forward gain of each of the three antennas is expected to be the same as that of separate antennas of the same loop size. In concentric arrangements, however, the antennas interact. They exhibit spurious responses off the sides and to the rear. It is almost impossible to obtain more than 15 dB front-to-back ratio in the 15-meter antenna when loops are mounted concentrically with 10- and 20-meter loops.<sup>1</sup>

Investigations of single-loop arrangements have been made to simplify the antenna structure and take advantage of the given structure. The loop is usually fed in the lower-half portion; tuning and matching is achieved by stubs or lumped constants.<sup>2,3</sup>

If we consider the current distributions on different bands (fig. 1), we can draw the following conclusions:

1. On 20 meters, currents in the upper and lower halves of the loop are **in phase**. The loop thus acts as a broadside array, ensuring low-angle radiation in the desired direction.
2. On 10 meters, the currents in the upper and lower halves are **180 degrees out of phase**. The antenna performs as an end-fire array. Enhanced radiation is parallel to the plane of the loop (vertically in this case). This doesn't do much good in long-haul DX work.
3. In-phase current distribution prevails on the lowest-frequency band; rapid deterioration of performance occurs with increase in frequency.

By introducing stubs, lumped constants, and switching schemes, the proper phase relationships can be obtained on several

bands. On ten meters, for instance, the loop can be opened at the top corner, thus converting the antenna into a common bi-square, or so-called inverted rhombic.<sup>4</sup> These designs are feasible but not too practical.

## the center-fed loop

To overcome the disadvantages described above, I have developed a center-fed loop element as shown in fig. 2. Symmetrical current distribution with respect to the hori-

fig. 2. Current distribution in center-driven quad elements. Current loops are always symmetrical.

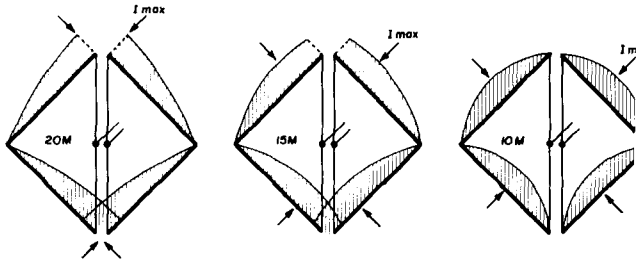

zontal axis is achieved on all three bands without switching or tuning the elements. Without introducing compromises, the leg length of one edge of the diamond may be between one-quarter and five-eighths wavelength. This will yield a usable frequency range of about 2.5:1 for a fixed loop. Exceeding the maximum length will result in spurious side lobes.

## leg length

The leg length can be less than one-quarter wavelength, but performance will be degraded, part of which is because the current loop is no longer located in the center of each leg. It should be possible to

correct this with loading capacitors, as shown in **fig. 3**. However, this means accepting losses introduced by the capacitors.

In general, leg length should be as long as possible, observing the 5/8-wavelength limit. Optimum leg length for a triband antenna would be 5/8 wavelength on 10 meters, or about 22 feet. However, a leg length of 17 feet (1/4-wavelength on 20 meter) would still be a good design, exhibiting only slightly less overall gain.

By settling for less than optimum gain, and sacrificing performance on 20 meters in particular, it is possible to get an element of this kind on a structure that would ordinarily support only a 15-meter quad element and obtain an antenna usable from 20 through 6 meters (12-foot leg length) with excellent performance on 6 meters.

**fig. 3. A miniquad element with loading capacitor at A and B.**

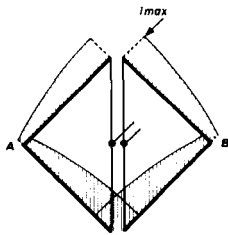

### the DJ4VM quad

The basic two-element arrangement is shown in **fig. 4**. Two designs were investigated: parasitic reflector and driven reflector. As shown later, the latter has definite advantages. The main one is the greatly reduced need for making a careful compromise in choosing the spacing between the two loops. This is achieved by carefully considering forward gain, front-to-back ratio and bandwidth on all three bands.

### the parasitic version

The tuning apparatus for this system is shown in **fig. 5**. Element spacing is 9 feet,

with 17 to 22 feet on a leg. The switching can be done either manually or remotely. If you use variable capacitors with a maximum capacity of 50 pF, the coils should have the following approximate dimensions:

- 20 meters: 10 turns, 1 1/2-inch diameter
- 15 meters: 8 turns, 1 1/2-inch diameter
- 10 meters: 8 turns, 1 1/4-inch diameter

**fig. 4. Basic two-element arrangement of the DJ4VM multiband quad.**

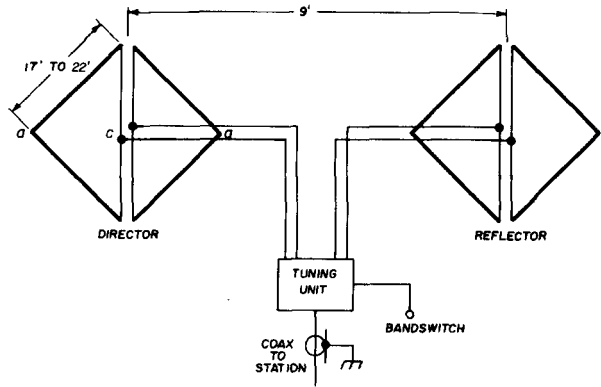

All are spacewound, of course, and preferably self-supporting. Instead of tapping the coils, the coaxial cable could be coupled with a link. Capacitor Ck should be used to tune out leakage inductance.

C1B should be adjusted for maximum front-to-back ratio. Thereafter the setting of C1A should be rechecked and corrected if necessary.

The tuning unit for the dual-driven antenna is shown in **fig. 6**, which is very similar to **fig. 5**. The two elements are driven out of phase by about 180 degrees. The lead length from the branch of the incoming coax to the switch contact, and from there to the coil taps, should be kept reasonably short to eliminate need for transformation. The tap point must be determined by using an swr meter. The approximate tap locations will be as follows (turns counted from the center tap):

- 20 meters: 2 turns
- 15 meters: 1 1/2 turns
- 10 meters: 1 turn

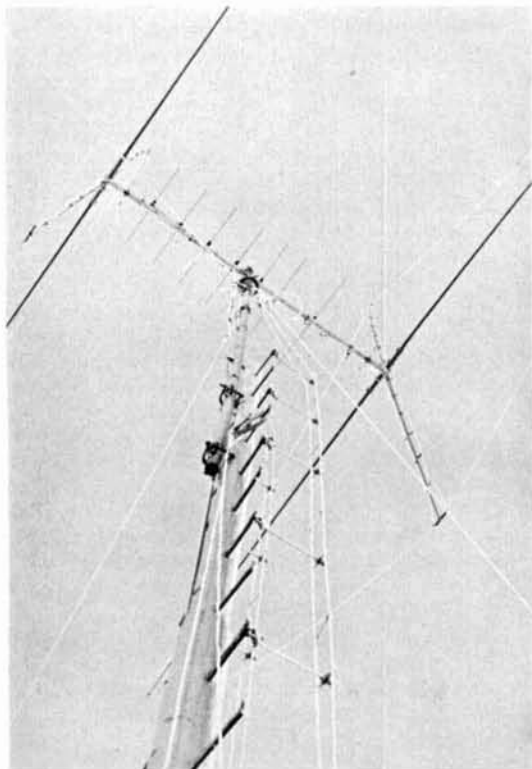

Multiband quad installation at DJ4VM.

For a better adjustment of front-to-back ratio, capacitor Ck can be used. If you do this, the feed point on the reflector coil will change to the opposite side of the center tap (Lb'). It will also be slightly farther away from the center.

Final tuning should be done with a field-strength meter and swr bridge while tuning C1B in, C1A out, and Ck for maximum attenuation to the rear. It's important to take the time and trouble to do this properly if you want to realize the best performance from this antenna.

Taps for the feed point should be chosen so that C1A and C1B resonate at about the same capacitance (with the transmission line connected and disconnected).

### field test results

I don't have any quantitative measurement figures on forward gain. Instead of unsubstantiated claims resulting from wishful

thinking, however, I'll give some field test results.

According to reference 5, the beamwidth of an antenna is an indication of forward gain. The half-power points of the antenna described were, from field tests:

- 20 meters: 50 degrees
- 15 meters: 40 degrees
- 10 meters: 30 degrees

Bear in mind this data was taken from my location and will not necessarily be the same for yours. Nevertheless, even under less-than-optimum local geometry, these beamwidths certainly are competitive with most 3-element Yagi antennas. The increased gain (narrower beamwidth) on the higher frequencies results from the larger radiator size, which is a direct consequence of the design principle.

The measured response on 15 meters is depicted in fig. 7. The front-to-back ratio was more than 40 dB. Without readjustments in the tuning unit, however, this value can be maintained over a relatively narrow frequency range. Fig. 8 shows swr, front-to-back ratio and relative gain for the 15-meter band.

fig. 5. Tuning circuit for the parasitic antenna. Switching can be either manual or remotely controlled. Capacitor Ck tunes out leakage inductance.

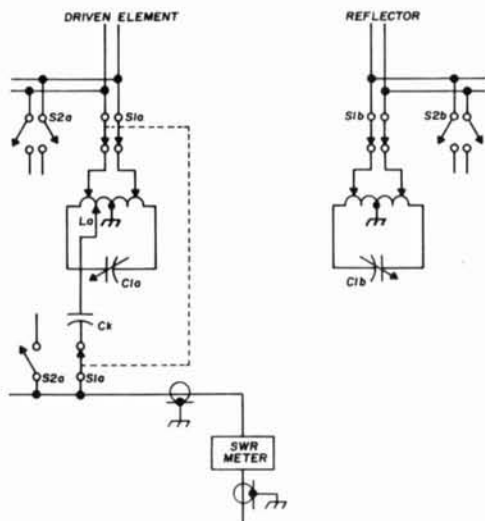

## advantages of the driven antenna

The main advantages of this antenna, compared with other beam antennas in general, are:

1. Utmost flexibility when scrambling for DX contest points.
2. No need to align antenna elements; all tuning is done remotely with the circuits in the tuning unit.
3. Lower angle of radiation for a given height.

fig. 7. Measured horizontal radiation pattern of the all-driven array. Design center is for the 15-meter band.

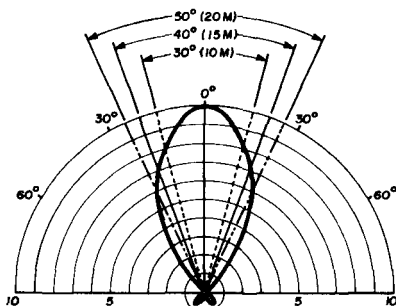
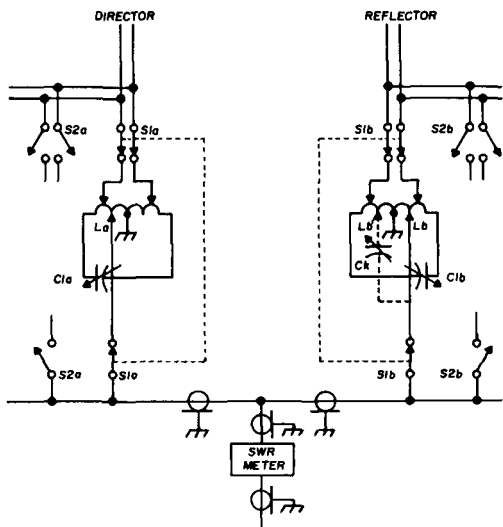

fig. 6. Tuning circuit for the all-driven array. Points La, Lb and Lb' are connected to the coax center conductor. The dashed line between Ck and the coil is an alternative.



4. Instant 180-degree switching of the beam degrees by switching off the reflector relays. (How long does it take to swing a Yagi from East to West?)
5. Less lateral space required than for a full-sized Yagi, colinear, long-wire and most other horizontally-oriented beams.

## a closing note

There's nothing secret about the diamond shape. It was chosen because the vertical feedlines could be easily attached to the

fig. 8. Standing-wave ratio, front-to-back ratio, and relative gain versus frequency. The data was taken on the 15-meter band.

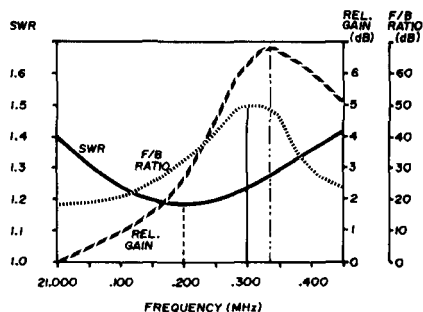

fiberglass poles. Other shapes such as squares, circles (for vhf), or the Swiss quad<sup>6</sup> could be adapted as centered, multiband quad elements.

The all-driven quad has been tested for some time and has given excellent results. Neither the antenna height (40 feet) nor the location (in a valley) can explain the performance it has given.

## references

1. W. I. Orr, W6SAI, "All About Cubical Quad Antennas," Radio Publications, Inc., Wilton, Conn., 1959, p. 50.
2. F. Kneitel, K2AES, "Antenna Roundup," Cowan Publishing Co., Vol. II, p. 44.
3. H. F. Rueckert, VK2AOU, "Dreiband-Eindraht-Cubical-Quad-Element," DL-QTC (Germany), 1968/4.
4. Byron Goodman, "Inverted Rhombics and Biconical Beams," QST, June, 1949, p. 42.
5. W. I. Orr, W6SAI, "Beam Antenna Handbook," Radio Publications, Inc., Wilton, Conn., 1955, p. 31.
6. R. Baumgartner, HB9CV, "Die Swiss-Quad-Antenne," DL-QTC (Germany) 1963/10, p. 454.

ham radio

# a new cw monitor

The versatile IC  
appears again—  
this time  
in an rf-actuated  
keying monitor  
featuring  
the low-cost  $\mu$ L914

**Rf-actuated keying monitors** certainly aren't new. They've been described in many articles, and there is even a commercial version available. However, the use of simple, inexpensive IC's, plus a different method of audio keying, make the monitor described here a worthwhile and interesting project.

The main advantage of rf-actuated monitors, of course, is that no direct connection to the transmitter is needed: the monitor uses internal battery power and is actuated by the rf field from the transmitter. Another advantage to such a monitor, which is less precisely explainable but nonetheless very real—as most users of such monitors will testify—is the clean keying that results. Clicks and other distortion present with most directly actuated monitors are completely eliminated.

## features

This rf-actuated monitor is unique in several respects. It uses only IC's and is a very simple project for anyone who would like to get acquainted with these devices. The IC is the Fairchild  $\mu$ L914. It is becoming one of the most versatile IC's any amateur can use. As its designation ( $\mu$ L for micrologic) implies, it was developed for digital logic circuits but it serves very well as a linear IC that will amplify continuously varying af or rf signals up to several megahertz. It's available from large mail-order supply houses for less than a dollar.

Another interesting feature of the monitor is that the transmitter rf field is not used to activate a transistor switch to turn on an audio oscillator, as is commonly done. The audio oscillator in this monitor runs continuously. The rf field controls a  $\mu$ L914 that is used as an enabling gate or switch. Audio passes through the gate only when the rf field closes or "enables" the circuit. The distortion and transients which occur when an audio oscillator is initially turned on with each transmitted keying character are thus avoided.

Particularly clean-sounding audio keying results from using this method. The audio oscillator shown in the circuit (another  $\mu$ L914) is of fixed frequency; but if you have another audio oscillator available, perhaps of variable frequency, it could be used in place of the oscillator shown simply by feeding it directly into the enabling gate. Exactly how this can be done is covered later.

## circuit description

The  $\mu$ L914 consists of a pair of dual grounded-emitter transistor stages. External connections determine how the stages are used in any particular circuit function. Physically, the  $\mu$ L914 appears as an ordinary epoxy-cased transistor, except it has eight leads. The numbering of these leads follows the scheme shown in **fig. 1**.

It's particularly important to note that the **index** flat on the  $\mu$ L914 case denotes the



**8th terminal lead.** Anyone who is used to working with tubes will probably regard the index mark as denoting the 1st terminal lead, as I frequently did when first working with the  $\mu$ L914. The result, of course, can very easily be ruined IC's.

The monitor circuit is shown in **fig. 1**. The first  $\mu$ L914 is connected as a free-running multivibrator. The oscillation frequency with the circuit components shown is approximately 1 kHz but the frequency may be changed over a wide range by varying either the value of both resistors or both capacitors.

For variations over a small range—if you

which can be placed anywhere in the vicinity of the transmitter power amplifier.

The last  $\mu$ L914, which is used as an audio amplifier stage, actually makes very poor use of the capability of the  $\mu$ L914. Only one transistor in the  $\mu$ L914 is active as an amplifier. A single audio transistor can be used for this unit if desired. Surprisingly enough, the cost will be about the same as that using the IC.

The amplifier stage output is sufficient to drive a medium-impedance (400- to 600-ohm) headset with adequate volume. If loudspeaker operation is preferred, the last  $\mu$ L914 can be followed by a transistor power

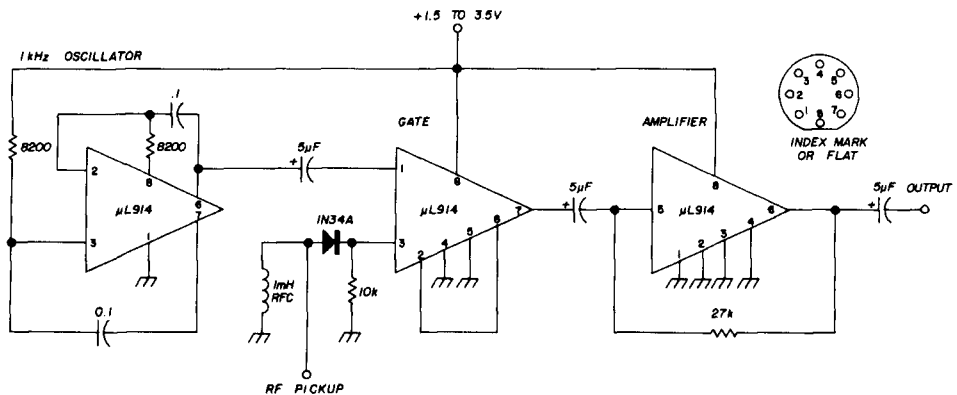

**fig. 1.** Schematic diagram of the integrated-circuit cw monitor.

can't get used to the idea of hearing the same tone all the time—you can replace one of the resistors with a 20k-ohm potentiometer.

The second  $\mu$ L914 is actually connected to perform a logic function. In this case, however, the result is as though an spst switch, connected between terminals 1 and 7, were controlled by a dc-control voltage on terminal 3 (generated by rectification of the transmitter rf field).

## operation

The 1N34A rectifies the rf pickup to produce a positive control voltage at terminal 3 of the second  $\mu$ L914. The rf pickup may be obtained by connecting a short piece of wire (about 1 foot) to the rf pickup terminal,

amplifier of conventional design.

No special precautions need be followed in construction, except perhaps to note that the leads concerned with the rf pickup circuit should be kept as short as possible. The circuit of **fig. 1** can be assembled on a 1-by-1½-inch piece of Vector board. The circuit can be mounted either inside a separate enclosure or inside the cabinet of your transmitter or transceiver.

The supply voltage is between 1.5 and 3.5 volts. The monitor will work well within this range, but at least 3 volts are necessary if the last  $\mu$ L914 drives a pair of headphones directly. The current drain is very low and can be handled for an extended period by two penlight cells in series.

**ham radio**

# a combined digital and burst encoder

Selective call and  
tone-burst signalling  
provide enhanced  
fm operation

**Sociologists tell us the world** is suffering from overpopulation. Anyone who tunes across the amateur bands will certainly agree, and the "fm frequencies" of 52.525 and 146.94 MHz are no exception. The availability of commercial fm equipment at moderate cost has no doubt contributed to this condition.

Efforts to minimize operating problems and retain the enjoyment of fm operation have produced the techniques of tone burst and selective call. A combination selective-call—tone-burst encoder is described in this article for fm enthusiasts interested in improving station versatility.

Selective call is used to alert another station to your traffic, allows remote control, and provides specific address for auto-start teletype. Tone-burst eliminates the need for constant monitoring of a crowded channel (by your wife, for example) to ensure receipt of traffic. It also allows more positive control of relay and repeater facilities.

## features

The encoder described here, which can be used for either mobile or base operation, provides two or more selectable control tones, burst or digital command, and acts as a microphone preamplifier and multi-rig station control.

David M. Stahley, K8AUH, 6401 Brookside Drive, Cleveland, Ohio 44144

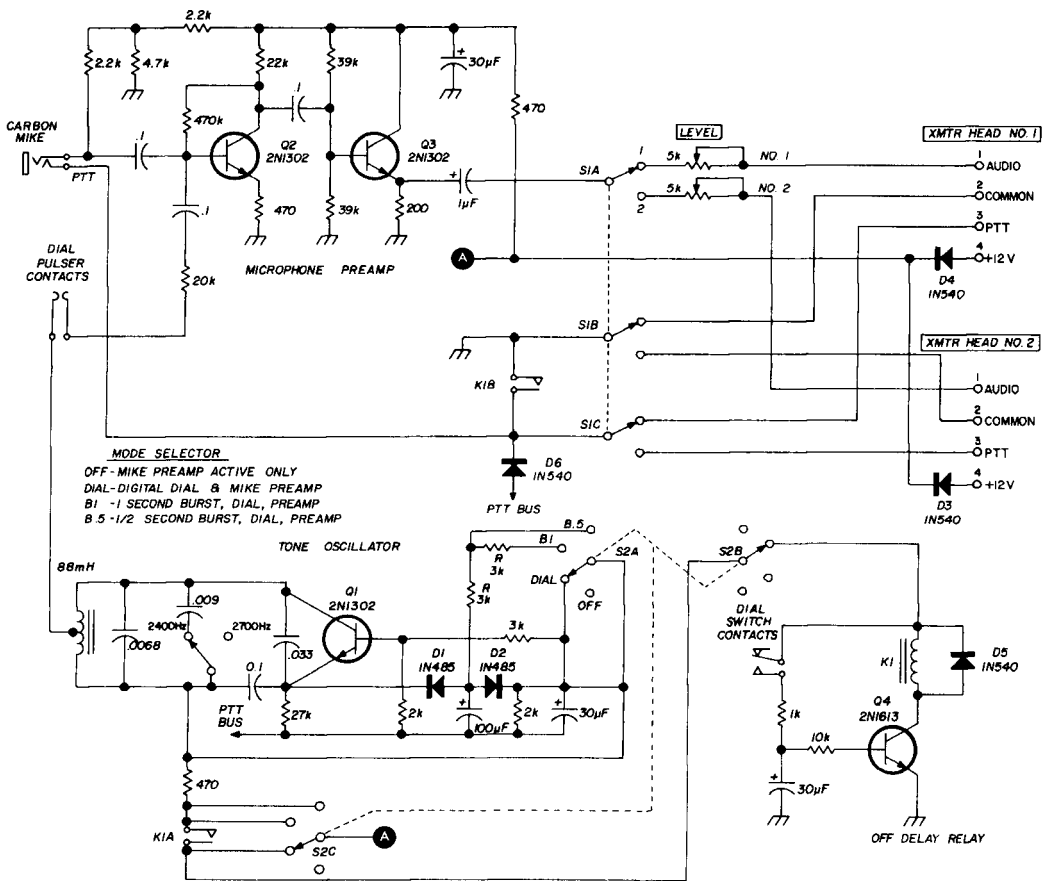

fig. 1. A schematic of a combined digital and burst encoder. K1 is a 12 Vdc relay.

A four-position selector switch provides:

1. A one-half-second tone burst at the beginning of each transmission.
2. A one-second tone burst as above.
3. Digital dial encoding and carrier-off delay.
4. Microphone preamp only.

The carrier-off delay feature (fig. 1) can be eliminated if you wish. You can then retain the dial-operated keying relay, and the selector can be left in the dial position without interfering with the push-to-talk (PTT) circuit.

### digital dialing

During dial operation, the normally

open contacts on the dial switch operate a relay that keys the transmitter and energizes a tone oscillator. If "off delay" is included, the carrier will remain on after the dial returns home. This allows operation of decoder alarms or other accessories.

The off-delay feature enhances multi-digit dialing. The dial-delay-off circuit can be any combination that will allow K1 to pull in immediately and drop out about 1 to 4 seconds after the dial returns home. This can be provided by a time-delay relay, a copper-slugged relay, capacitor and diode around the relay coil, or an RC-transistor timing circuit similar to that shown. K1 and Q4 comprise the delay-off circuit.

The digital circuit includes an oscillator

whose output is interrupted by a standard telephone dial. K1 provides the means by which the digital mode is enabled and allows automatic operation by simply dialing. No manual switching of audio lines or carrier switching is required.

### **the burst mode**

Burst operation must be selected and will provide a tone burst at the beginning of each transmission. This mode lends itself to burst entry of a base or repeater receiver, and provides relief from the need for constant monitoring. It also allows a more positive control of such facilities. The burst is accomplished by squelching off the oscillator with an RC network and switching diode D1.

Burst duration is determined by the value of R in the charging circuit. D2 provides a discharge path for C when the microphone is released at the end of the transmission. This circuit works very well with most fm and a-m transceivers; however, some problems were experienced with certain models where the voltage on the unkeyed PTT line prevented the timing capacitor from discharging. This, of course, affects the duration of the resultant burst, or whether you get a burst at all. The problem has been eliminated in most cases by the addition of blocking diode D6 in the PTT line.

### **tone frequencies**

The oscillator frequency is controlled by switching additional tuning capacitors across the 88-millihenry toroid. Available frequencies are limited only by switch size, room in the cabinet for tuning capacitors, and the low limit of the oscillator (approximately 1 Hz). If a progressively shorting switch is available, it will materially reduce the number of capacitors needed for multi-frequency operation. Adjustment for the various frequencies should begin with the highest frequency (lowest capacity) and progress to the lowest frequency (highest capacity).

### **transmitter control heads**

No changes are needed in the original

transceiver equipment to accommodate this encoder. One change is required in the control head of each unit to provide power for the encoder. Most control heads use a 4-pin microphone connector. The fourth pin is for receiver audio to be used with a handset. This should be removed and the fourth pin connected to switched 12 volts dc in the control head. A 4-pole double-throw switch transfers the appropriate lines from one control head to the other.

Interconnection between encoder and control heads is via jumper cables made with standard microphone plugs to mate with the microphone jacks on the control heads. It is suggested that the transmitter deviation/audio level be set for each rig in the normal fashion, with the microphone plugged into the appropriate control head. Then the microphone should be removed and the jumper cables from the encoder connected. The individual levels in the encoder can then be adjusted to provide the same deviation as before. This technique allows instant restoration of facilities should disaster strike the encoder, or should you change rigs.

The tone level relative to speech peaks is controlled by the resistor in series with the dial pulser contacts. The value shown will normally provide tone deviation of the same magnitude as the speech peaks. This relationship can be varied as the system demands. The sine-wave tone level into a 100-ohm load is approximately 300 mV rms, usually enough to provide full deviation in most equipment. Carbon microphone excitation is provided by the pre-amp circuit, and the normal excitation from the set is blocked by the coupling capacitor.

In working with remotely located equipment, care must be exercised to ensure that no ground loops exist in the system. Note the audio common is isolated from chassis ground and is switched, as are the PTT and audio lines. The frequency stability of this oscillator is quite good. It remains within approximately 1 percent of the set frequency with wide load, voltage and temperature variations.

**ham radio**

TOP OF THE YAESU



LINE



# THE FT<sub>DX</sub> 400 TRANSCEIVER

Conservatively rated at 500 watts PEP on all bands 80 through 10 the FT dx 400 combines high power with the hottest receiving section of any transceiver available today. In a few short months the Yaesu FT dx 400 has become the pace setter in the amateur field.

**FEATURES:** Built-in power supply • Built-in VOX • Built-in dual calibrators (25 and 100 KHz) • Built-in Clarifier (off-set tuning) • All crystals furnished 80 through the complete 10 meter band • Provision for 4 crystal-controlled channels within the amateur bands • Provision for 3 additional receive bands • Break-in CW with sidetone • Automatic dual acting noise limiter • and a sharp 2.3 KHz Crystal lattice filter with an optimum SSB shape factor of 1.66 to 1.

Design features include double conversion system for both transmit and receive functions resulting in, drift free operation, high sensitivity and image rejection • Switch selected metering • The FT dx 400 utilizes 18 tubes and 42 silicon semi-conductors in hybrid circuits designed to optimize the natural advantages of both tubes and transistors • Planetary gear tuning dial cover 500 KHz in 1 KHz increments • Glass-epoxy circuit boards • Final amplifier uses the popular 6KD6 tubes.

This imported desk top transceiver is beautifully styled with non-specular chrome front panel, back lighted dials, and heavy steel cabinet finished in functional blue-gray. The low cost, matching SP-400 Speaker is all that is needed to complete that professional station look.

**SPECIFICATIONS:** Maximum input: 500 W PEP SSB, 440 W CW, 125 W AM. **Sensitivity:** 0.5 uv, S/N 20 db. **Selectivity:** 2.3 KHz (6 db down), 3.7 KHz (55 db down). **Carrier suppression:** more than 40 db down. **Sideband suppression:** more than 50 db down at 1 KHz. **Frequency range:** 3.5 to 4, 7 to 7.5, 14 to 14.5, 21 to 21.5, 28 to 30 (megahertz). **Frequency stability:** Less than 100 Hz drift in any 30 minute period after warm up.

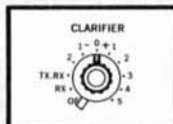

**CLARIFIER CONTROL**—Does the work of an external VFO—allows operator to vary receive frequency 10KHz from transmit frequency, or may be used as an extra VFO combining transmit and receive functions.

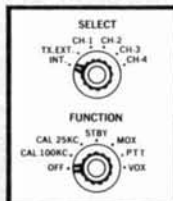

**SELECT CONTROL**—Offers option of internal or outboard VFO and crystal positions for convenient preset channel operation.

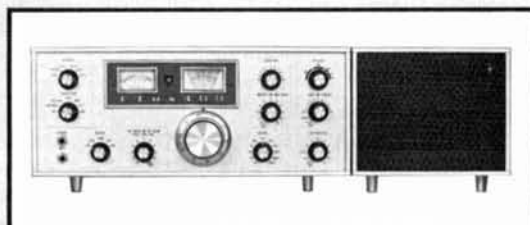

**FUNCTION CONTROL**—Selects crystal calibration marker frequency and desired transmit mode of operation.

FT DX 400 \$599.95 — SP-400 \$14.95



SPECTRONICS

BOX 356, LOS ALAMITOS, CALIFORNIA 90720

— PROFESSIONAL EQUIPMENT FOR THE AMATEUR —

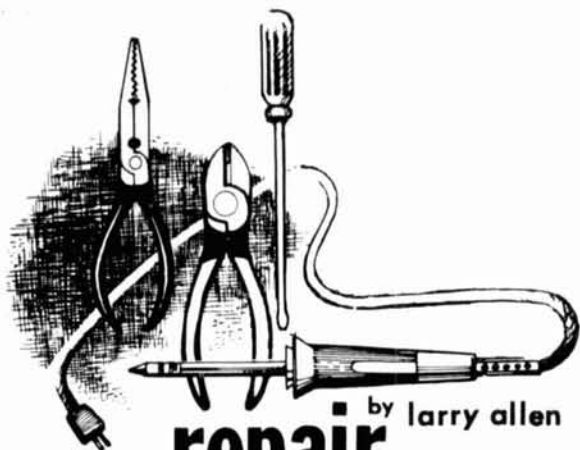

by Larry Allen

# the repair bench

## troubleshooting amateur gear with an oscilloscope

Well, guess I'd better begin where I left off. Before my spring sabbatical, I promised to tell you about oscilloscopes. And so I will.

A scope lets you look at a radio or audio signal. That's why it's so valuable as a tool for troubleshooting. It measures signal voltages, and at the same time shows the shape of the waveform. Thus, if distortion in an amplifier has fouled up a signal so it doesn't come through plain enough to understand, a scope can show you which stage makes it distorted. In those transistor-switching power supplies, you can look at the switching waveform and even track down troubles about to happen. You're probably familiar with the scope as a modulation monitor. And, if you are interested in amateur television, you simply have to know how to use a scope.

Most hams don't bother with a scope much because they don't really know how. Hooking one up as a modulation monitor is simple compared to twisting the knobs so you can view some of the strange-looking waveforms a serious ham runs into.

The scopes best suited for ham troubleshooting are the same kind used by radio and tv repair technicians. They should be wideband. You can buy them ready-made,

like the one in fig. 1. Or, there are scope kits; fig. 2 is one of those, in a compact size. The most common service-type models are recurrent-sweep scopes, called that to distinguish them from a more elaborate type called a triggered-sweep scope.

The dials and controls on the front of various brands and models differ only slightly. They're arranged in all sorts of positions, but the labels are always similar. Once you know one scope, you can quickly get acquainted with any of them.

### getting the scope fired up

There's a group of knobs, usually beside or just below the screen, that turn the scope on, light up the trace, and get it set up to show a display. They are the **intensity, focus,**

fig. 1. One scope that's popular with tv service technicians. Other well-known brands are listed in the box on page 57.



and **position** controls, and they're shown at the right in **fig. 3**.

The power switch may be on the **intensity** control. You turn it on, and turn the control all the way up. If the power switch is separate, turn the intensity up anyway. After a minute or so, either a dot or a line should show up on the screen.

Adjust the **focus** to make the dot or line as fine as possible. The top two photos of **fig. 3** show how a scope dot looks when it's out of focus and then when it's focused. The

bottom two show out-of-focus and in-focus line traces.

If the dot or line doesn't show up after 1½ minutes, the two **position** knobs may be set wrong. Move them slowly from one end to the other, first separately and then simultaneously. **Vertical position** moves the display up and down on the screen, and **horizontal position** moves it from side to side. When the scope first comes on, if a **position** knob is near one end of its rotation, the dot or line may be out of sight. Set the knobs to

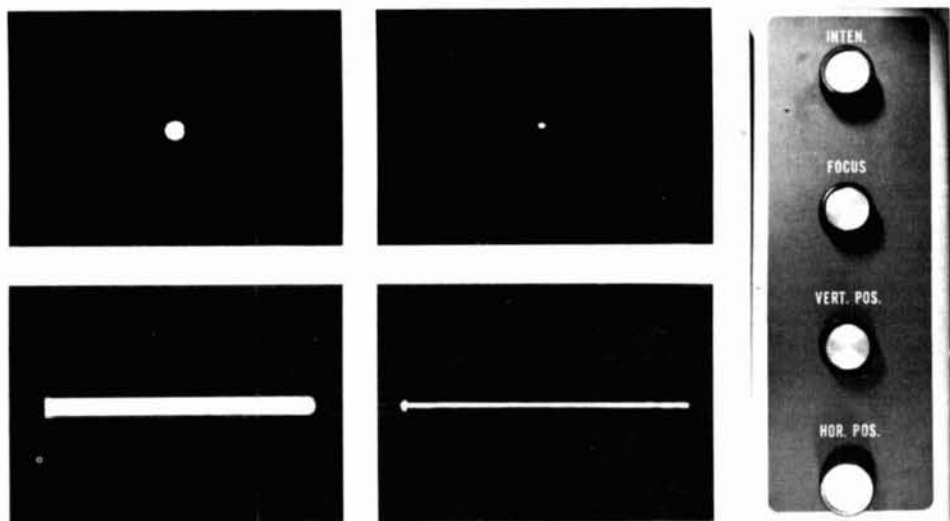

**fig. 3.** Scope dot or line when it's out-of-focus (large and fuzzy) and when it's in-focus (sharp and fine).

**fig. 2.** Compact, 3-inch scope you can build from a kit. Most kit-built scopes cost much less than comparable factory-built models.

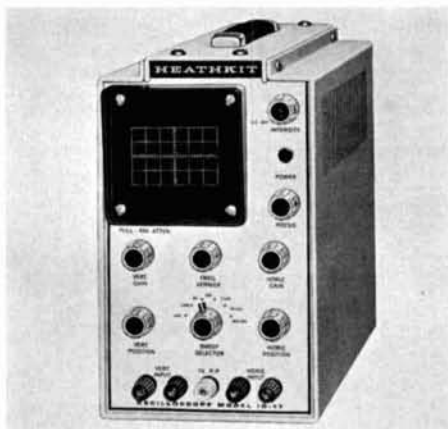

center the line or dot as well as you can.

To make a dot into a line, which you'll have to do to display waveforms, find the group of controls shown in **fig. 4**. The important ones for this are **horizontal frequency** and **horizontal gain**. On some scopes, the main frequency dial is labeled **sweep**. It controls the sawtooth generator that scans the beam (which makes the dot) rapidly from side to side. Turn the **horizontal frequency** switch to a position that makes the sawtooth generator sweep the beam back and forth 20 or 30 times a second. The switch in **fig. 4** is set between the 10 and 100 marks. That's close enough for now; later, with a waveform on the screen, you can refine the frequency of the scope's internal sweep generator with the lower left control.

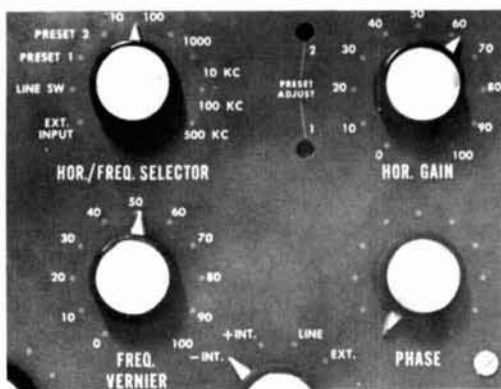

fig. 4. Frequency-control knobs on a kit-type servicing scope. Ignore phase knob at lower right.

There may still not be a line, or it may be very short. Turn up the **horizontal gain** until the line extends most of the way across the scope screen. The scope is ready now for you to display a waveform and learn how some of the other controls work.

### looking at an ac waveform

One handy waveform is the 60-Hz voltage from the power line. In fact, so much radiation from it is picked up by the capacitance

of your body, you can use that as a test signal. Just grab the tip of the probe with your fingers. Leave the ground clip dangling.

You'll have to set the **vertical input** controls (fig. 5) so the scope is sensitive enough to show the rather weak 60-Hz signal picked up by body capacitance. On the scope from which the fig. 5 photo was taken, the main input knob is set to X1, the most sensitive position. As you can see from the photo, the **vertical gain** doesn't need to be turned up much. (It may on some scopes, especially if



fig. 5. Vertical input knobs affect size of display on screen; on some scopes, they (along with graticule lines on the screen) help with voltage measurements.

fig. 6. Two top photos, and bottom left, show how the ac waveform may look before you adjust line frequency. Bottom right shows solidly locked three-full-cycle display.

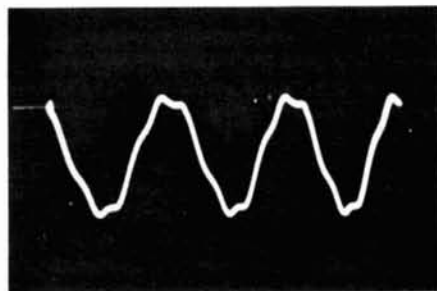
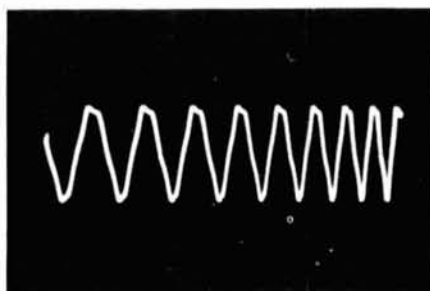
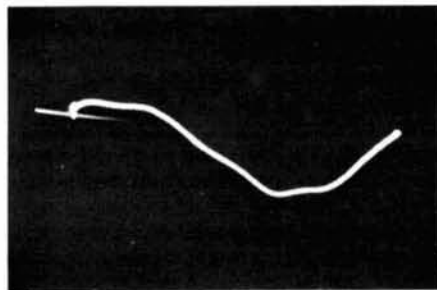
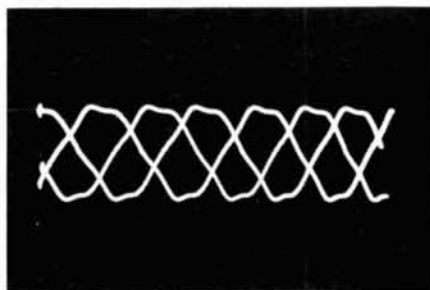



60-Hz radiation is mild around your shack or bench.)

The waveform display you see on the screen, if you set the **horizontal frequency** switch as I mentioned earlier, looks something like the top photos or the bottom left one in **fig. 6**. Best viewing is with two or three cycles of a waveform on the trace. You have to adjust the fine frequency control (labeled **frequency vernier** on the scope in **fig. 4**). Just turn it carefully back and forth

positive-going part of the signal; the **sync** switch is set at **+int.**

A scope with a control instead of a switch is synchronized much the same. The knob is usually marked with a center zero, and can be turned either way. One direction locks the signal on the negative slope, and the other locks it on the positive slope. If your scope has the control, notice once you get the display stopped how you can work the control back and forth slightly and shift the

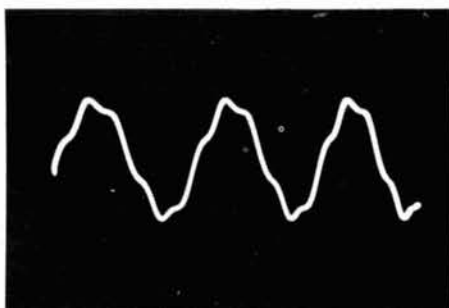
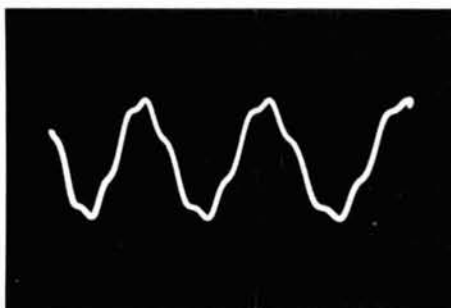

**fig. 7.** Ac waveforms locked, by sync switch, on negative slope (left) and positive slope (right). Irregular shape of sine ac is due to fluorescent-lamp radiation.

till you have only three waveforms on the screen—as in the bottom right photo in **fig. 6**.

The waveform may not snap into place quite that easily. It may appear to be running one way or the other, and you may not be able to stop it with the fine frequency control. Holding it in position solidly is the responsibility of a knob or switch labeled **sync**. In fact, you can adjust where the left side of the trace starts, merely by how you set **sync**.

In scopes that have only a **sync** switch, you have a choice of positive-going (+) or negative-going (-) internal sync, external sync, or sync from the scope's power transformer (line). You'll almost always use internal sync, and whether you choose + or - depends on the general shape of the waveform.

With the waveform at top left in **fig. 7**, the signal display is shown synchronized on the negative-going portion of the test waveform; the **sync** switch is at **-int.** In the top right photo, the waveform is synchronized on the

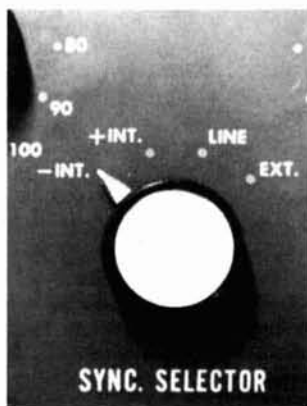

point on the slope where the trace starts. That isn't too important with an ordinary sine-wave display, but it is when you work with oddly shaped waveforms, like in amateur tv.

### looking at odd waveshapes

Sine waves are the most common type you'll look at when you use the scope on your repair bench. They're what you find in the power supply before the rectifier and filters get at the voltage. And you often in-

ject sine waves and then trace them to check out audio amplifiers, clippers and other speech stages.

But sine waves are far from being the only waveshape you'll see. The only problem you can have viewing the odd-shaped ones is making them stand still on the screen. But there are a couple of simple tricks for that. If you know what's important about a waveform, that's enough to let you sync it in tightly on the scope—every time.

As one example, look at the rounded sawtooth at the top in **fig. 8**. It's taken at the

**fig. 8.** To lock in unusual waveshapes, you need to know their approximate frequency and which direction the dominant slope goes. All of these were taken in a home-tv flying-spot scanner.

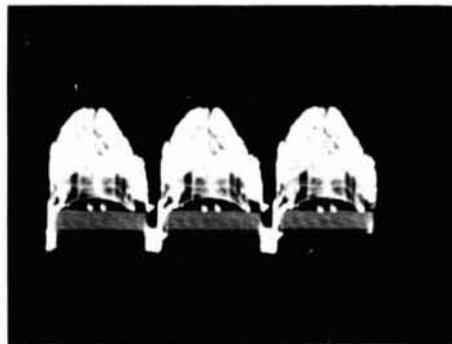

output of a rectifier, across the input filter. The important thing to notice is the steepest slope. That's always easiest to synchronize on. In this one, the steepest slope is upward, which means it goes in the positive direction. So, you set the **sync** switch to the + position. And, as you can see in the photo, the trace locks (and starts) on the upward slope.

You have to learn to recognize the dominant steep slope and which way it goes. Often the waveform can only be slowed down a little with the **frequency** control, and you have to see the waveshape "on the run." Once you're sure which way the steep slope goes, you can set the sync for the polarity that will lock easiest. Then you can

go back to the fine frequency control and slow the waveform down from running. When you get the scope sweep close enough to an exact multiple of the frequency of the signal you're viewing, the waveform locks in.

An example of locking in an odd-shaped waveform appears at the lower left in **fig. 8**. This is the video waveform from a flying-

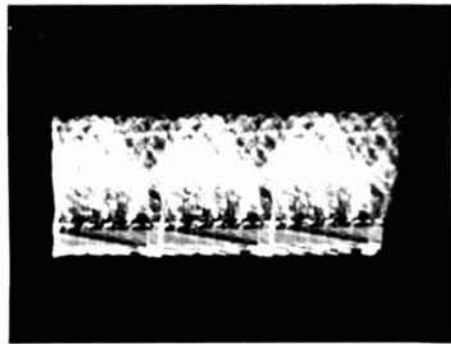
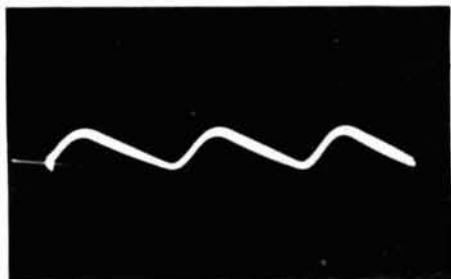

spot scanner such as you might build for ham tv. This display shows three cycles of video, which means the scope's sweep must be set to one-third the horizontal scanning rate of the tv set.

The horizontal sweep for commercial TV is 15,750 Hz. The scope, then, must be set to about 5,250 Hz. That way, the scope display has time to show three cycles during each scan of the scope beam. The **horizontal frequency** switch in **fig. 4** must be set between the **1000** and **10kc** (10 kHz) marks. Then the **frequency vernier** is turned slowly back and forth until you catch a glimpse of the shape of the waveform.

You'll see that its dominant slope is downward-going, meaning the waveshape is main-

ly negative. So, to lock it in solid, the sync switch is set on the -int mark.

With the sync switch inadvertently set wrong, the waveform can't be settled down much better than in the lower right picture in fig. 8. This photo was taken with the switch at +int. You can see only a vague outline of the waveshape, if you look close.

### using a scope for troubleshooting

Until you've used an oscilloscope for tracing faults in ham units, you can't appreciate how helpful it can be. And it's a mistake to try working on ham tv without one. Now that you know how to stabilize the waveforms on the screen, you can put a scope to work on your repair bench.

Next month, I'll tell you more about it. There are dozens of different tests you can make with it, and lots of ways to save time. I'll show you the waveforms you can expect to find in different kinds of equipment, how to measure them, and how to tell if they're not what they should be. And I'll tell you how to set the scope to look at each of them.

#### oscilloscope manufacturers

**B&K** Division, Dynascan Corporation, 1801 West Belle Plaine Avenue, Chicago, Illinois 60613

**EICO** Electrical Instrument Company, Inc., 283 Malta Street, Brooklyn, New York 11207

**Heath** Company, Benton Harbor, Michigan 49023

**Hickok** Electrical Instrument Company, Inc., 10523 DuPont Avenue, Cleveland, Ohio 44108

**Jackson** Electrical Instruments, 124 McDonough Street, Dayton, Ohio 45402

**Knight** Electronics Company, 100 North Western Avenue, Chicago, Illinois 60680

**Leader** Instruments Corporation, 24-20 Jackson Avenue, Long Island City, New York 11101

**RCA** Parts and Accessories, Deptford, New Jersey 08096

**Sencore**, Inc., 426 South Westgate Drive, Addison, Illinois 60101

**Tektronix**, Inc., P. O. Box 500, Beaverton, Oregon 97005

ham radio

# RCA has all-new FCC commercial license training

**Get your license—  
or your money back!**

Now RCA Institutes Home Study Training has the FCC License preparation material you've been looking for—all-new, both the training you need, and the up-to-date methods you use at home—at your own speed—to train for the license you want!

**2 Convenient Payment Plans**—You can pay for lessons as you order them, or take advantage of easy monthly payment plan. Choose the FCC License you're interested in—third, second or first phone. Take the course for the license you choose. If you need basic material first, apply for the complete License Training Program.

**SPECIAL TO AMATEURS.** This course is primarily for Commercial License qualifications. But it does cover some of the technical material that will help you prepare for the new Advanced and Amateur Extra class tickets. Check out the information the coupon will bring you.

Mail coupon today for full details and a 64-page booklet telling you how RCA Institutes Home Training can show you the way to a new career—higher income—and your FCC License.

# RCA

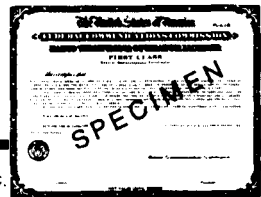

RCA INSTITUTES, INC.

Dept. HR-89

320 West 31st Street, New York, N.Y. 10001

Please rush me, without obligation, information on your all-new FCC Commercial License training.

Name \_\_\_\_\_

Address \_\_\_\_\_

City \_\_\_\_\_ State \_\_\_\_\_ Zip \_\_\_\_\_

# ionospheric propagation

**This month we will investigate** ionospheric propagation quantitatively using some of the most powerful aids available to the ionospheric physicist. The results will be far from general, but I hope they will be enlightening. We will need a model: a profile of ionospheric electron density vs height. We could get such a profile by direct measurement with a rocket probe but measurements can be made from earth-bound ionospheric sounders more conveniently and inexpensively.

The ionosonde is an upward-looking pulsed high-frequency radar whose frequency is swept in a predetermined manner (logarithmically on most ionosondes presently in use). Echoes are obtained from the overhead ionosphere, and from the variation of time delay between transmitted and received pulses vs frequency, a profile of electron density vs height can be determined.

A variety of echoes may be present. If we restrict our attention to those that involve only one passage from earth to ionosphere and return, there are, in general, two echoes returned at any given frequency below that which allows penetration of the ionosphere. The two echoes are from the ordinary and extraordinary waves. In order to explain the reflection process at vertical incidence I will describe the interaction between a radio wave and the free electrons in the ionosphere.

## properties of ionized media

High-frequency radio waves are propagated to great distances by virtue of the presence of free electrons in the ionosphere. The neutral particle density is small enough that collisions between particles are relatively infrequent and electrons are free to move in response to electric and magnetic fields. In addition to random thermal motions and large-scale drifts, electrons have orderly oscillatory motions in response to radio fre-

quency electromagnetic waves. The contributions of the positive ions may be neglected at high frequencies since these ions are much more massive than the electrons, and they do not acquire any significant velocity or displacement in response to the high-frequency fields.

A 1 kW transmitter at 14 MHz fed into a three element Yagi might produce the following electron motion in the E region:<sup>1</sup>

maximum displacement	$4 \times 10^{-6}$ cm
maximum velocity	350 cm/sec
number of cycles between collisions	140

For comparison, at 300° K (room temperature) in the E region, the displacement and velocity due to thermal motions are:

mean free path	100 cm
thermal velocity	$10^7$ cm/sec

The motion of an electron is a current flow, and a scattered field is radiated from each electron. The combined effect of trillions of free electrons moving in concert is the formation of weak scattered fields which are approximately 90° out of phase with the original field. The vector sum of the scattered and incident waves results in amplitude almost equal to the original field but with an advance in phase. The scattered fields add constructively only in the direction of propagation, while creating a large total advance in the phase of the electromagnetic wave relative to that which would occur in a vacuum.

We describe this modification of the wave by assigning an index of refraction to the medium. The behavior in an ionized medium is identical to that which would be expected in a dielectric whose index of refraction is less than unity. (Note that for dielectrics with

Victor R. Frank, WB6KAP, 12450 Skyline Boulevard, Woodside, California 94062

fig. 1. Ionograms taken by vertical-incidence sounder at Pt. Arguello, California (34.5° N. latitude) on August 14, 1968 at 2200 pst (A) and August 15, 1968 at 1100 pst (B).

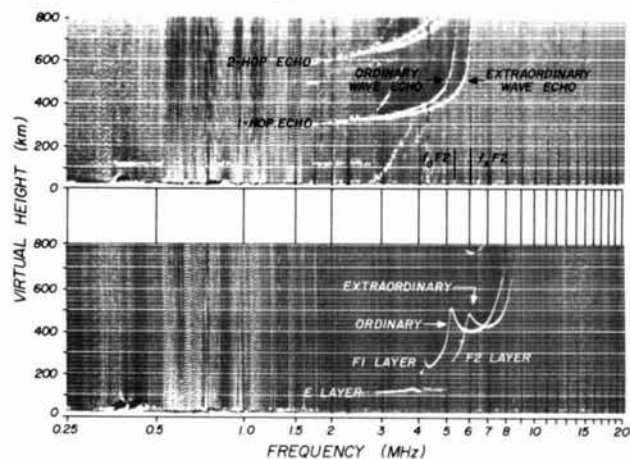

bound electrons, the resultant is a smaller decrease in phase and an index of refraction greater than unity). The index of refraction of the ionosphere depends not only on the electron density, but also on the frequency of the electromagnetic wave. Thus the ionosphere is a dispersive medium.

The index of refraction,  $\mu$ , for the ordinary wave is

$$\mu = \sqrt{1 - \frac{80.5N}{f^2}} = \sqrt{1 - \frac{fN^2}{f^2}}$$

fig. 2. True height profiles of electron density vs height derived from the ionograms of fig. 1.

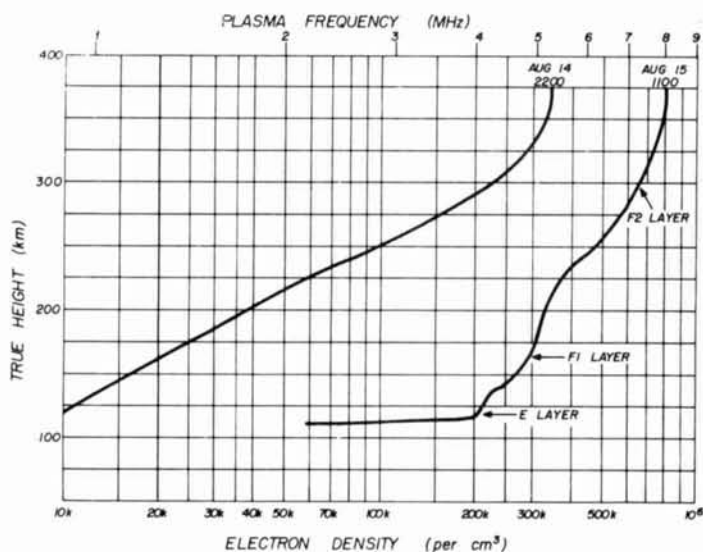

where  $N$  is the electron density per cubic centimeter and  $f$  is the radio frequency in kilohertz. At a radio frequency equal to the plasma frequency,  $fN$ , the index of refraction is zero for the ordinary wave. Propagation to regions of higher electron density is not possible and reflection occurs.

Fig. 1 shows two ionograms taken at Point Arguello, California on August 14, 1968 at 2200 pst and on August 15, 1968 at 1100 pst. The ionograms show traces of virtual height vs radio frequency from 250 kHz to 20 MHz. The virtual height is the time delay times the free-space velocity of light. The true height of reflection is less than the virtual height since the wave is retarded by its interaction with the electrons in the ionosphere. The group velocity,  $v_G$ , of the ordinary wave is approximately

$$v_G \cong \frac{c^2}{v_p} \cong \frac{c}{\mu}$$

where  $c$  is the velocity of light in a vacuum, and  $v_p$  is the phase velocity. Thus the wave is greatly retarded in regions where the refractive index is small over a wide range of heights (near the heights of maximum ionization).

There are preferred directions of electron motion due to the presence of the earth's magnetic field. This anisotropy\* results in multiple values of the refractive index and, in

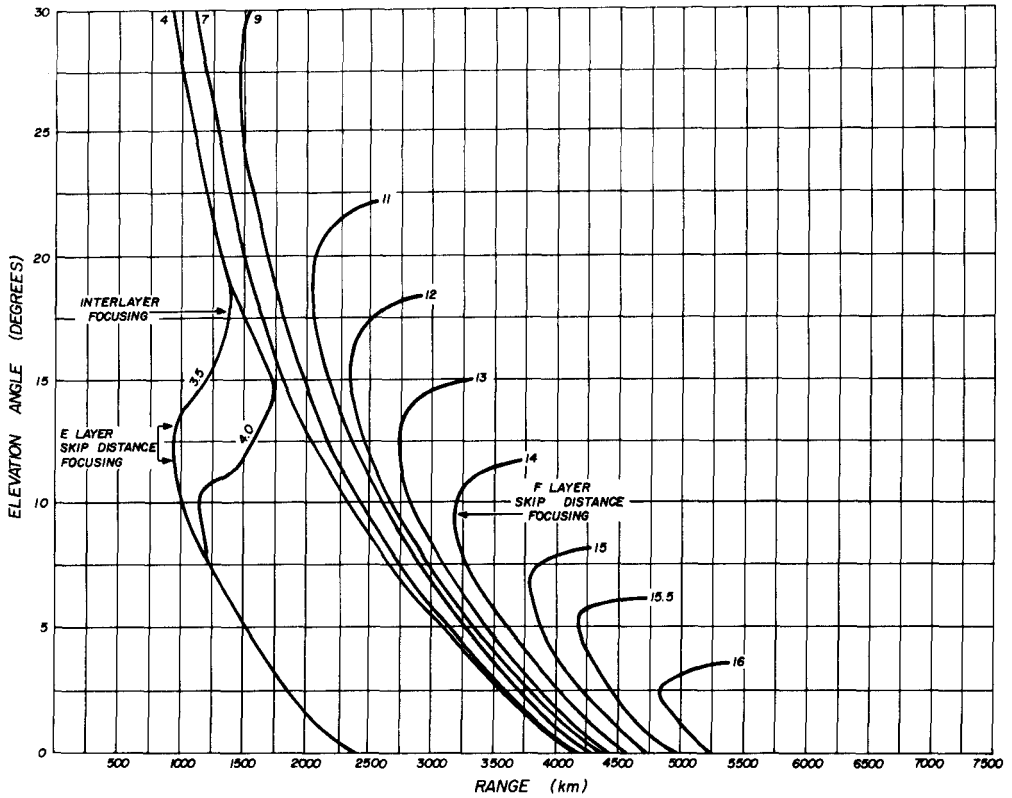

fig. 3. Range vs elevation angle plots for the ionogram of fig. 1A (2200 hours).

general, separation of a linear polarized wave into two counter-rotating elliptically-polarized characteristic waves which may travel over independent paths in the ionosphere. These characteristic waves are called the ordinary and extraordinary waves. Although the extraordinary-wave muf is higher than the ordinary-wave muf, it is dependent on the direction of propagation with respect to the magnetic field, and thus is more difficult to calculate. All of the calculations in this column are for the ordinary wave only.

There are approximate graphical aids for determining reflection heights, skip distances and penetration angles for oblique propagation from vertical-incidence ionograms. Ionogram scalings reported in past columns have used these transmission curves. For further information on transmission curves, you may want to consult references 2 and 3. This month I will show a more accurate (and expensive) technique that may be used if you have access to a digital computer.

First a model of the ionosphere is prepared from a vertical-incidence sounding (assumed to be taken at the path midpoint). A true height profile of electron density vs height is calculated.<sup>4</sup> The true height profiles (fig. 2) are, in general, not unique. They assume a monotonic increase of electron density with height; occasionally there are "valleys" between the E and F1 layers that are not directly measurable with ionospheric sounders. Another problem in creating models of the ionosphere is that the ionogram traces are seldom continuous. Absorption, interference and poor antennas frequently limit the low frequency coverage. However, the true height profiles obtained are probably as useful as any for predicting what the ionosphere may be like at mid-latitude United States near 1100 and 2200 local time during August 1969.

\* Anisotropy describes a medium that exhibits different properties when measured along axis in different directions.

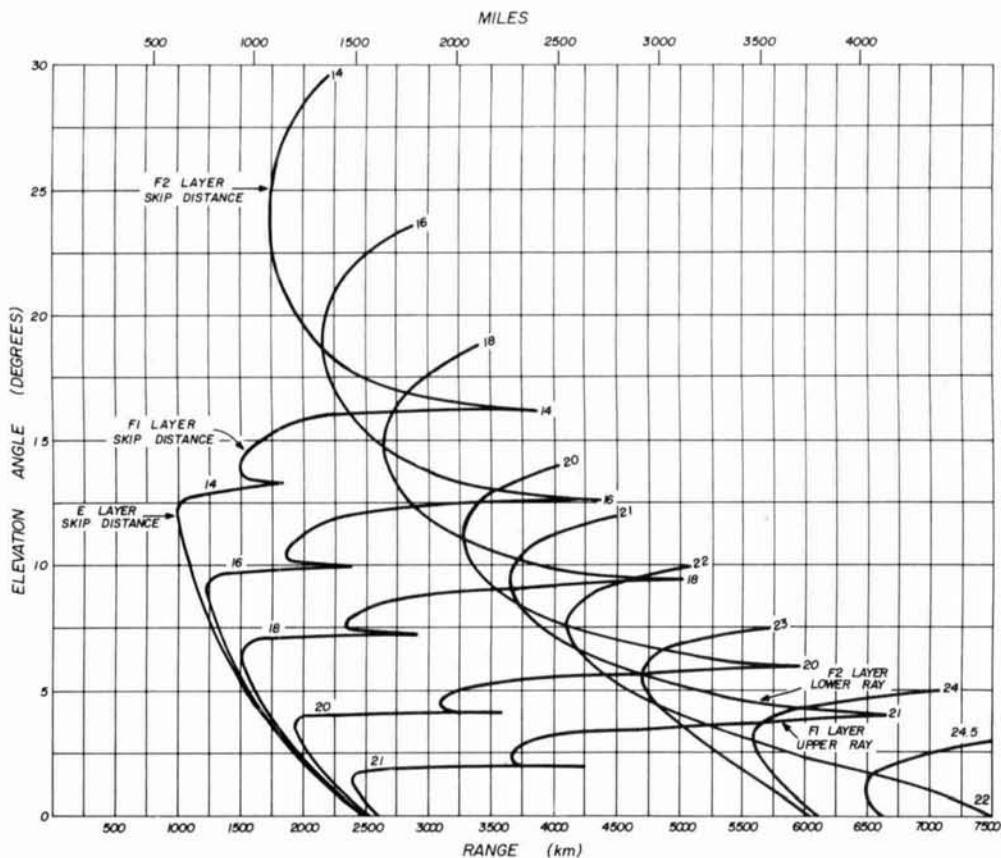

fig. 4. Range vs elevation angle plots for the ionogram of fig. 1B (1100 hours).

Given an ionospheric model, you can trace the path of a ray launched at a given angle at a given frequency. Using a program developed by Dr. T. A. Croft at Stanford. The following equation is solved in many steps

$$\mu r \sin \varnothing = K$$

where  $r$  is the distance from the center of the earth,  $\varnothing$  is the angle of incidence, and  $K$  is a constant for any given ray called the characteristic. (This is Bouger's rule, the

equivalent of Snell's Law for circular coordinates). These calculations produce propagation time delays, ground range and reflection height for rays of a given elevation angle at any particular frequency. For this column I have chosen to plot curves of ground range of single-hop propagation vs elevation angle for various radio frequencies. These curves are shown in figs. 3 and 4 for 2200 and 1100 local time, respectively.

Note from fig. 3 that at a given frequency

fig. 5. Range (delay time) vs time display of backscatter meteor echoes on a frequency of 25 MHz during last year's Perseids meteor shower.

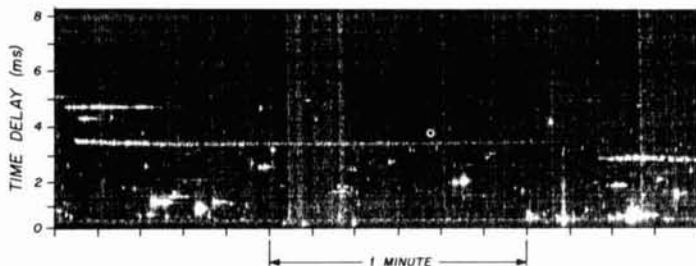

two rays may be returned to the same distance. The ray with the lowest elevation angle for a particular layer, called the lower ray, is usually strongest and occurs over the widest range of distances. The upper (or Pederson) ray is most frequently observed at frequencies just under the muf for that distance. For some ionospheric models and frequencies, the upper ray may be received at greater distances than the lower ray. If antennas with poor low-angle response are used and the distance is greater than 2500 miles or so, the maximum observed frequency may be propagated by single-hop upper rays.

Note from **fig. 4** that the situation is compounded during daylight hours by the possible presence of E- and F1-layer modes as well. The extraordinary waves (not computed) will almost match the ordinary waves, with the greatest separations at short distances and near the skip distances.

Curves of ground range vs elevation angle point up the focussing and defocussing that occur in the ionosphere. Focussing occurs at the skip distance where neighboring rays arrive very close to the same distance. The upper rays are defocussed at frequencies much below the muf (or distances much further than the skip distance) since neighboring rays are spread over a wide distance. The skip distance for frequencies near the absolute muf is much greater than the 2500 miles usually assumed for the maximum distance for one F2-layer hop. When considerable ioniza-

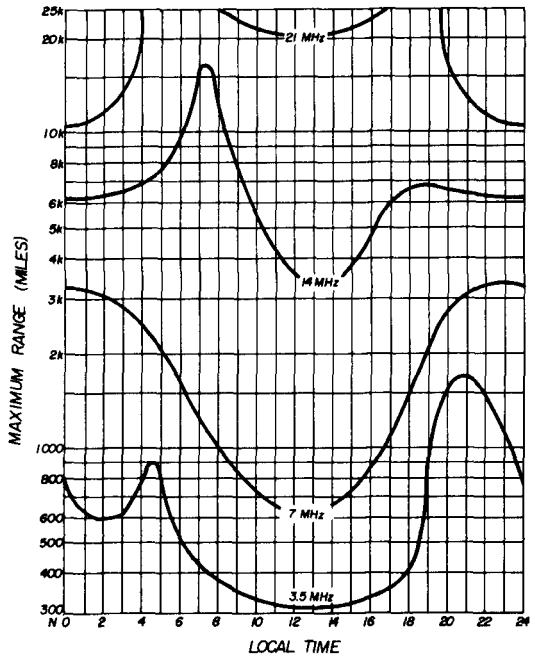
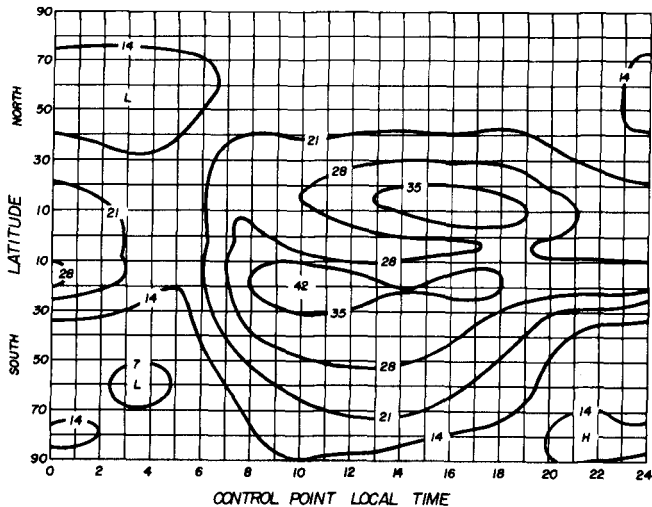

**fig. 7.** Maximum range to the north from 38° N. latitude as limited by absorption, atmospheric noise and system parameters (100 watts cw to typical antennas).

tion is present below the F2-layer, the maximum one-hop range may occur for elevation angles other than zero or just below the penetration angle (see curve for 21 MHz, 1100 hours).

However, predictions of extreme range upper rays should be viewed with some pessimism.

**fig. 6.** Time chart of muf(4000)F2, the median maximum usable frequency for a 2500-mile path predicted by ESSA for August 1969 based on 120° W. longitude.





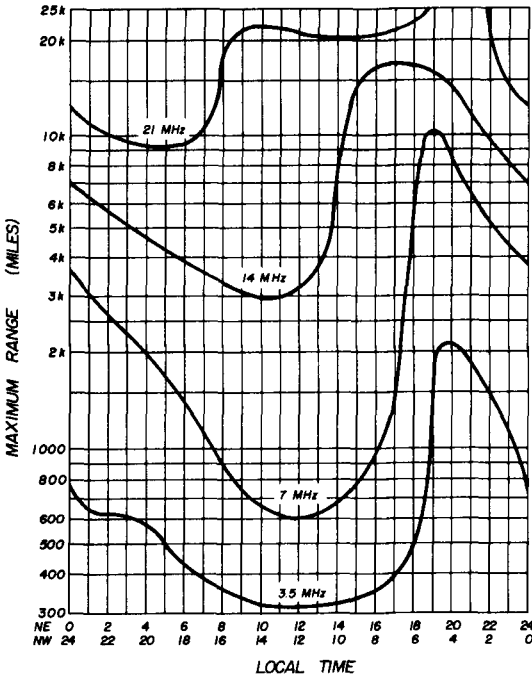

fig. 8. Maximum range to the northeast (top time scale) and the northwest (bottom time scale) from 38° N. latitude.

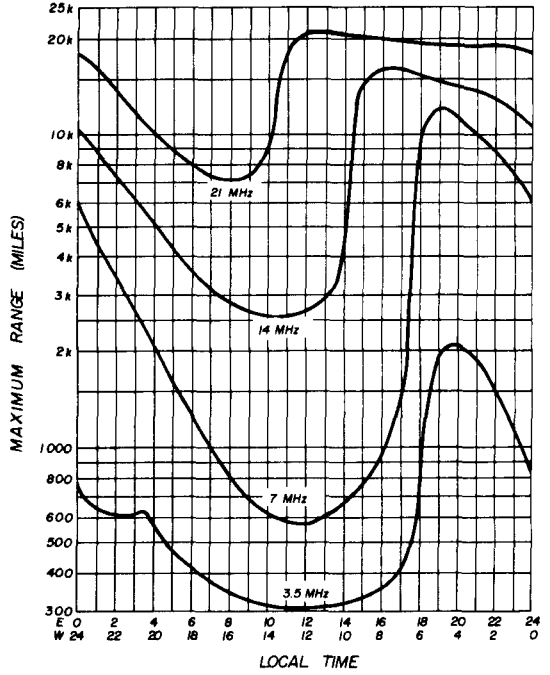

fig. 9. Maximum range to the east (top time scale) and to the west (bottom time scale) from 38° N. latitude.

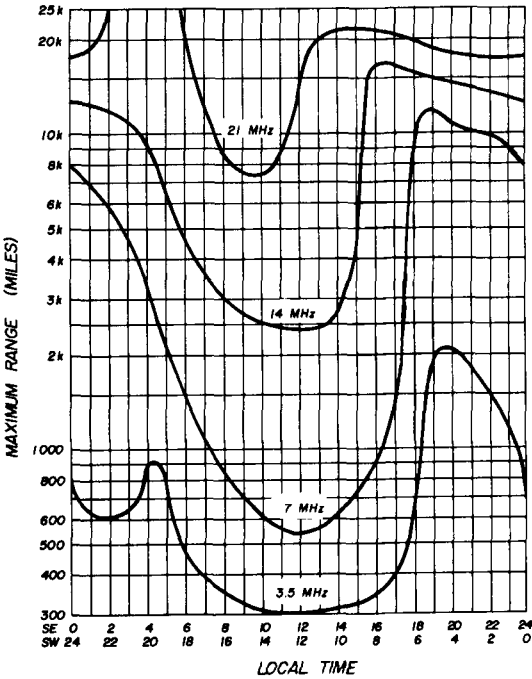

fig. 10. Maximum range to the southeast (top time scale) and the southwest (bottom time scale) from 38° N. latitude.

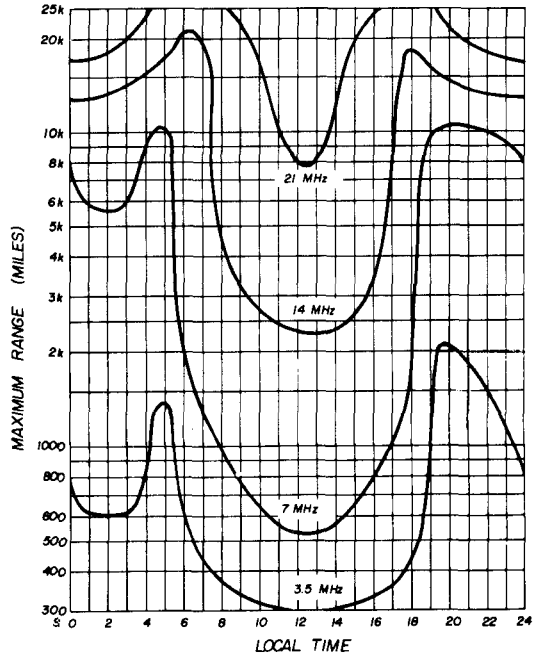

fig. 11. Maximum range to the south from 38° N. latitude.

mism as the ionospheric model was assumed to not vary with distance. This is a doubtful assumption for rays that remain in the ionosphere over such distances. Usually the rays will be returned to earth at shorter distances if the electron densities increase with distance—or will either penetrate the ionosphere or be trapped in ionosphere-ionosphere modes if the electron densities decrease with distance.

The exact characteristics of the transition region between modes depends critically on the shape of the ionosphere profile. When the layers are not well defined, the transition may occur as a turn instead of a cusp (3.5 and 4 MHz, **fig. 3**). In this case, another region of focussing occurs at the maximum of range for a single hop by the F2-layer.<sup>6,7</sup>

### meteors

August is a good month for meteors. The Perseids meteor shower (August 10 to 14) is responsible for many 144-MHz contacts over distances of about 500 to 1400 miles each year. Meteors by themselves are of little interest to the radio amateur; of interest is the ionized trail which results when the meteor enters the earth's atmosphere and is vaporized. Backscatter from meteor trails is also noticed at 50 MHz and lower frequencies.

**Fig. 5** is a record of reflections from many meteor trails observed near 25 MHz during last year's perseids meteor shower. The range to a meteor trail is about 150 km (93 miles) per millisecond delay. Some meteor trails were observed as far away as 800 km, but most were between 100 km and 600 km. Note the trail at 540 km (3.6 ms) that lasted two minutes. More frequent, of course, are the bursts of a second or less which are of limited use for ordinary radio amateur low-speed transmission.

Other meteor shows in August include the Cygnids (August 10 to August 20) and the Draconids (August 21 to August 31).

### vhf propagation during may

Reports of long distance vhf propagation during the first half of May are down from April, but lots of DX was worked on 50 MHz. As of May 20, ZK1AA had over 50 contacts in less than 2 months, all in the Northern Hemi-

sphere and over 2900 miles. His beacon is now operating daily from 1730-0930 gm. Trevor, 5W1AR, now has a beacon on 50.105 MHz operating 1900-2400 gm and 0400-0600 gm. Last I heard he was having tv problems with tv from American Samoa which comes on at 0600 gm. A chronological list of TE (transequatorial) contacts follows:

May 4, 0330-0500 gm, ZK1AA worked WB6YPF, WA6HXW, K6QEH, W6RUX, WA6GJU and W6NIT

May 6, ZK1AA worked KH6GRU; 2245 gm, W4GDS and WA4MHS

May 11, 0650 gm, ZK1AA worked WB6KAP; 0900 gm, ZK1AA worked KH6GRU; KH6GRU heard some VK's

May 18, 0630 gm, ZK1AA worked JA1AC and heard a Japanese broadcast station on 56 MHz; 0730 gm, ZK1AA heard KH6 fm stations to 95 MHz.

May 28, 0738-0823 gm, WB6KAP heard ZK1AA beacon

Note a shift in the times of TE occurrences as summer approached. The ZK1-to-KH6 path has been opening as late as 0700-1100 gm, and on May 28 this path was open only from 1000-1030 gm; these times are after midnight on the West Coast!

### propagation for august

Shortwave conditions this August should be very similar to those of last year. Comments made in last August's column are equally applicable. Summarizing, some improvement is expected over July in higher daytime muf's, lower absorption and lower noise levels. Sporadic-E activity is expected to decline while transequatorial openings are expected to reappear to the Southern States. There is the possibility of vhf aurora openings (or disturbances—depends on the band you're interested in) to the northern states.

The F2-layer muf chart for this month (**fig. 6**) is based on 120° W. longitude. The muf chart that appeared last year (for 75° W. longitude) is also still valid.

Note that all time scales are local solar time, which is within 30 minutes of local **standard**

## how to use these propagation charts

1. To find the maximum usable frequency for F2-layer propagation for distances of 2500 miles or more in any direction, find your control point and read the frequency from the F2-layer muf time chart. Your F2-layer control point is 1200 miles away from your station in the direction of propagation; this is about an 18-degree difference in latitude for a north-south path, or 1½ hours time difference for an east-west path.

2. To determine the path muf for a path under 2500 miles, the control point is at the path midpoint, and a correction factor is applied to the 2500 mile muf. These correction factors are plotted in fig. 7 of the August 1968 column.

3. During summer daytime, the path muf for a path shorter than 1200 miles may be set by E-layer propagation. To determine if this is so, refer to the E-layer muf time chart and the chart of muf reduction factor vs distance in this month's column. Note, however, that sporadic-E will probably result in zero skip distance on 7 MHz and skip distances under 400 miles on 14 MHz very frequently during daylight and evening hours.

4. The F2-layer will probably be effectively shielded by the E-layer for operating frequencies below 70 percent of the predicted E-layer muf.

5. Over any particular path involving more than one hop, the path muf is the lower of yours and the other station's control-point muf. The muf time charts may be treated as muf contour maps. (The F2-layer chart has significant errors outside the range of longitudes between 45°W. and 135°W.) As such, each hour is the equivalent of 15° of longitude. A map drawn to the same scale can be overlaid and positioned to the right or left to show the variation of the muf contour map with time. Curved lines may be drawn on the overlay representing great circle paths, as found from a globe or "Ionospheric Radio Propagation," printed by the U. S. Government Printing Office.

6. To find the maximum propagation distance as limited by ionospheric absorption and atmospheric noise, refer to the maximum range charts for the directions you wish to work. Note that the time scales are reversed for westward propagation. Also note that this month the noise curves have not been assumed to be symmetrical about local noon. Thus when the curves are used to predict propagation to the west they may be in error due to this lack of symmetry. These curves are based on a unity signal-to-noise ratio of a 6-kHz bandwidth with 100 watts output and antenna gains (over an isotrope) of 6 dB for 20 and 15 meters, 0 dB for 40 meters, and -6 dB for 80 meters at each station.

time, not daylight savings time. Also note that the muf contours of interest are those for the time and latitude of your control points, 1200 miles away in the direction of propagation.

### next month

Beginning with the September issue, Propagation predictions will no longer be included as a part of **ham radio**. Readers who are interested in propagation information may obtain a monthly propagation bulletin via first class mail by simply writing to the editor. This bulletin will provide you with the latest up-to-the-minute propagation forecasts.

**Note:** The formula for the maximum electron density of the E-region given in the May 1969 column on page 62 is incomplete. It should have been:

$$N = 10^4 (180 + 1.44R) \cos^{1/2} \chi$$

### references

1. J. A. Ratcliffe, "The Magneto-Ionic Theory and Its Application to the Ionosphere," Cambridge University Press, 1959.
2. NBS Circular 462, "Ionospheric Radio Propagation," U. S. Government Printing Office, Washington, D. C., 1948.
3. N. Smith, "The Relation of Radio Sky-Wave Transmission to Ionosphere Measurements," *Proceedings of the I.R.E.*, 27, p. 332, 1939.
4. K. G. Budden, "Radio Waves in the Ionosphere," Cambridge University Press, 1961.
5. T. A. Croft, "Methods and Applications of Computer Raytracing," Technical Report No. 112, Contract NONR 225(64), Radioscience Laboratory, Stanford University, January, 1969.
6. T. A. Croft, "HF Radio Focusing Caused By the Electron Distribution Between Ionospheric Layers," *Journal of Geophysical Research*, 72, May, 1967, p. 2343.
7. T. A. Croft and T. W. Washburn, "Comparison of Simultaneous Forward and Backscatter Soundings to Verify a Proposed Focusing Mechanism of HF Sky Waves," *Journal of Geophysical Research*, May, 1969, p. 2443.

# the ham notebook

## fet preamp for 432 MHz

If you're trying to get the most out of your receiving gear for 432 MHz, you should look into the new 2N5397 and 2N5398 field-effect transistors manufactured by Siliconix.\* These new devices are usable up to 800 MHz and their performance on 432 is nothing short of fantastic. Manufacturer's claims are many times on the optimistic side, but according to K6JYO and K6KV, the 2N5397 performs as advertised—at 450 MHz the

\*Siliconix Incorporated, 1140 West Evelyn Avenue, Sunnyvale, California 94088

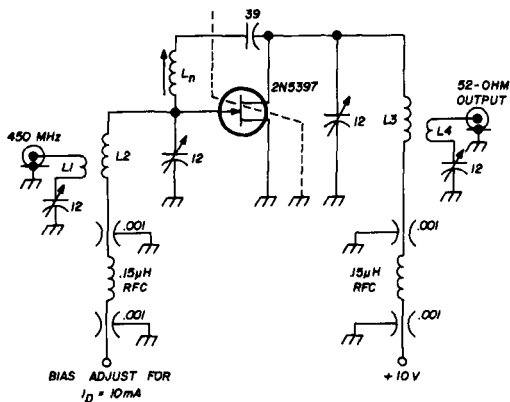

- L1 1.4" long piece of no. 22 enamelled, spaced 0.1" from L2
- L2 1.1" long piece of no. 16 solid copper
- L3 1.3" long piece of no. 16 solid copper
- L4 1.4" long piece of no. 22 enamelled, spaced 0.3" from L3
- Ln 3 turns no. 22 enamelled on 1/4" slug-tuned ceramic form, aluminum slug

fig. 1. 450-MHz common-source amplifier provides 18-dB gain.

noise figure is 2.5 dB typical (3.5 maximum), and power gain in the manufacturer's 450-MHz circuit in fig. 1 is 18 dB. The 2N5397 is \$8.50 and the 2N5398 is \$6.00.

In the common-source amplifier shown in fig. 1, the drain and gate leads should be shielded from each other to reduce

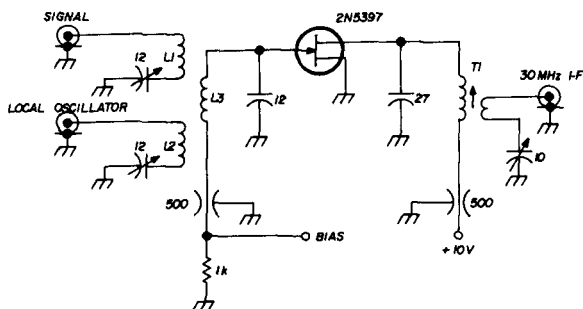

- L1 1.4" long piece of no. 22 enamelled, close coupled to L3
- L2 1.6" long piece of no. 22 enamelled, close coupled to L3
- L3 1.75" long piece of no. 18 copper
- T1 primary 13 turns no. 22 enamelled, close wound on 1/4" slug-tuned form; secondary is 3 turns no. 22 enamelled, close wound over primary

fig. 2. 450-MHz common-source mixer circuit.

feedback phase shift. The neutralizing coil should be low loss for best gain and noise figure. One other construction tip: tune patiently!

Another circuit for the 2N5397 is shown in fig. 2; this is a common-source mixer. When building this circuit, bypass the drain lead as close to the transistor case as possible. Maintain a high impedance at the intermediate frequency for maximum gain and maintain a signal ground on the source. Tune the tank circuit for best gain and noise figure.

Jim Fisk, W1OTY

## using Swan 350 and 400 equipment for rtty

I've received many inquiries from owners of Swan 350 and 400 transmitters on how to put this equipment to work in the rtty mode. Much correspondence resulted in the methods described here.

Once you've acquired the teletypewriter, you can add simple circuits for rtty operation. Two methods, afsk and fsk, were tried by WB2UCI and me with satisfactory results.

The afsk method involves feeding a sine-wave audio signal into the speech amplifier via the microphone jack. This shifts the modulating frequency, which produces frequency shift keying. In the fsk method, a keyer (circuit) inserts a small amount of capacitance into the vfo to vary its resonant frequency at the keyed rate.

The transmitter carrier is changed at an 850-Hz rate. This consists of two frequencies 850 Hz apart, called the space and mark frequencies. The standard frequencies for these are 2125 Hz for mark and 2975 Hz for space. The Swan 400 and 350, however, have an audio cutoff at 2450 Hz, so they won't pass 2975 Hz. The remedy for this is to change the space and mark frequencies to 2125 Hz and 1275 Hz, whose difference is still 850 Hz.

Essco teletype specialists offer the TU-7 unit which is already modified for the Swan transceivers at moderate cost. It's battery operated and also serves as a demodulator for receiving. Further information may be acquired by writing to Mr. J. S. Tessler.\*

The fsk method uses a keyer to add a small amount of capacitance into the emitter of the vfo oscillator transistor. The circuit that seems to work best with the Swan is shown in **fig. 3**. (The complete circuit appeared in the May 1965 issue of **QST**.) The keyer circuit is constructed on a three-lug terminal strip and is mounted inside the vfo. The lead from the trimmer capacitor to the emitter of the transistor should be as short as possible. Care must be taken when wiring this lead, since the transistor's lead is extremely short, and the printed circuit board

\* Essco, 324 Arch Street, Camden, New Jersey.

is very difficult to remove. The methods described work very well with both Swan units.

Outboard vfo's would make rtty much more enjoyable and less tedious. When using the transceiver alone, the transmitting and receiving frequency will not be the same, which may present a few problems. With another vfo the receiving and transmitting frequencies will be independent of each other.

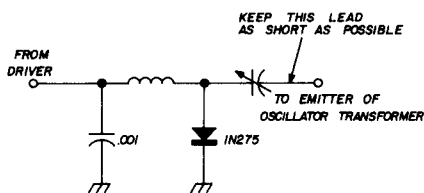

**fig. 3.** Circuit for fsk method in Swan 350 and 400. Mount it on a 3-lug tie point and install inside vfo section.

Tuning the Swan with these two methods is basically the same as in regular operation. When using afsk, tune the transmitter exactly as for ssb, making sure there's no carrier or other sideband present. If this occurs, afsk will be generated, which is illegal on the low bands.

With the keyer circuit, this is the same as for a-m and turn off the microphone gain. The Swan will now operate in F1 mode at 120 watts. This is adequate for cross-country contacts and occasional DX when the band opens.

**Joseph Boniakowski, WB2MIC**

## the indispensable glass

As age creeps on, one of the handiest gadgets in the ham shack is the old reliable magnifying glass. For example, if a DX station tells you to move up 2 kHz, and you find that your glasses have been left upstairs, the magnifying glass will let you easily read the spaces on your dial.

At the same time, a humorist will tell you that it's fine for enlarging the spirits when

you've just missed a rare DX station. Seriously though, a magnifying glass has a lot of uses, and I'll bet only a few amateurs even have one in the house.

With each issue of amateur radio magazines equipment seems to be smaller and smaller. Sometimes I think the people who put the equipment together must have magnifying eyeballs. Just look inside the gear and try to find the readings on a tiny transistor, a silicon diode, or even the colors on a small resistor without something to bring it up to a goodly size.

At one time, a magnifying glass was a handy device to start fires when the sun was bright. Now I use it to stop fires—to find out which resistor has started to burn up. There's so much packed into a modern piece of amateur gear, without a magnifying glass I don't believe anybody except a nearsighted old man could trace out the connections and components.

The other day I was having trouble with a rotary switch buried under a chassis. The naked eye couldn't tell what was wrong, but when I applied a glass to my eyes, I could see the corrosion on the ring and contact points. I also saw a cold solder joint at one connection.

Don't sell the magnifying glass short. Get one, but get a good one. By that I mean one made out of glass. There are cheap plastic varieties on the market. These aren't worth much, because they are easily scratched and can be marred by the slip of a soldering iron. I recommend one with a handle and a glass at least 2½ inches in diameter. I wouldn't be without one now.

**Gay E. Milius, Jr., W4NJF**

## **modifying the ART-13 for noiseless cw operation**

The ART-13 is an excellent cw transmitter, but many operators don't use it because of the noise made by the relays pulling in when operated on cw.

To silence the relays for cw operation with the ART-13 requires temporary removal of the red indicator light, I-101. It isn't neces-

sary to unsolder the wires of I-101; simply remove it from the mounting hole in the transmitter front panel so it can be pushed aside to remove wafer "emission" switch S-110. (This is labeled "off-voice-cw-mcw" on the front panel.) Do not disconnect the wires soldered to wafer switch S-110. Remove mounting screws and spacers between the two wafers. Replace the original spacers with spacers that are about half as long. Replace the wafers in their original position on the switch start.

Now, add more spacers the same length as the new shorter spacers you've already installed. This leaves the switch shaft long enough to accommodate an additional wafer. Select the contacts on the new wafer that will make when S-110 is in the cw position and will not make on any other position.

Ground one side of the new wafer contacts to the chassis, and connect the other side to the very tip end section of J-102 microphone jack. (When the emission switch is in the cw position the tip end section of J-102 is grounded, pulling in and holding all relays, which is the same thing that happens when the microphone push-to-talk button is energized.) Replace S-110 and I-101 on the front panel.

The transmitter is keyed when the emission switch is in the cw position, because vacuum relay K-102 grounds the cathode of the 837; thus the cathode lead to ground through the contacts of K-102 must be broken through the key jack. This may be accomplished by disconnecting the cathode lead from the ground side of R-131, a 350-ohm 10-watt resistor located on the bottom side of the transmitter in the center section directly behind the auto-tune motor. (One side of the resistor is connected to S-114, which is located on the bottom side of the transmitter directly behind the high-frequency knob" labeled "coarse A.") Make sure you disconnect the lead from the ground side of the resistor. This lead goes through vacuum switch K-102.

Now, isolate J-103 key jack above ground. This may be done by drilling the key jack hole in the chassis a little larger to accommodate insulating washers. Connect a lead from the ground side of R-131 to one side of J-103.

**ANNOUNCING**  
**a**  
**PHASED VERTICAL**  
**ANTENNA SYSTEM:**  
**the PHASAR-40<sup>tm</sup>**  
**BY**  
**Worthingham<sup>tm</sup>**

**BIG GAME HUNTERS:** Don't lose your quarry in the QRM - on 40 or 15 meters the Worthingham Phasar-40 is your big gun!

Imagine two 34' self-supporting aluminum radiators standing sentinel in your back yard — ready to reach out and snare that rare one. On versatile 40 meters the Phasar's high-gain bi-directional beam can be electronically rotated 90° to cover all compass points, or to null interfering foreign broadcast stations. On 15 meters, its low angle of radiation combined with narrow beam width provides superb performance on DX hunts. A remote phasing control allows instantaneous pattern selection with the turn of a switch.



The Phasar covers the entire 15 or 40 meter band with less than 2:1 SWR and negligible pattern distortion. The physical separation of the radiators (34 or 68 feet) results in diversity reception, lessening QSB.

Regardless of your game — ground wave contacts or long-haul DX — the Worthingham Phasar-40 is leading the way to new adventure in amateur radio.

**SPECIAL INTRODUCTORY PRICE: \$74.95**  
**FOB Factory — Expires August 30**  
**Shipping weight: 25 pounds**

Worthingham Electronics Co.  
P.O. Box 507  
Warren, Michigan 48090  
Dealer inquires invited



Connect another lead from the other side of J-103 to the original lead that was disconnected from the ground side of R-131. Insulate the connection.

Now the cathode of the 837 can be grounded through a key, when the emission switch is in the cw position, without the distracting noise of banging relays. **Note of cau-**

**tion:** Approximately 75 volts are on the key when keying the transmitter. I suggest you use a vacuum-tube keyer or an electronic keyer to eliminate the shock hazard.

To operate the ART-13 in the voice position with this modification, a shorted plug must be inserted in key jack J-103.

**Don Whitney, K5GKN**

## choosing fet's for 144 MHz converters

Here is some interesting information on jfets for two-meter converters. W6WSQ and I built a test jig (see fig. 4) for testing various jfets at 144 MHz. The test circuit is nothing more than a sensitive preamp which can be adjusted for different devices. A number of different fet's were tried in the circuit; gain was measured, and weak signal performance was compared to a good low-noise vacuum tube preamp—the results are listed in table 1. The interesting thing is that sensitivity is just about the same for each device regardless of type. The only exceptions are the "first generation" fet's (TIS34, 2N3823 and 2N2319), and their performance was only slightly lower than the best devices at 144 MHz.

**Bruce Clark, K6JYO**

table 1. Two-meter performance of various fet's.

type number	stable gain	weak signal source performance	manufacturer	price
2N5397	20-22 dB	note 1	Sil	\$8.50
2N4416	15-18 dB	note 1	UC, TI	5.00
TIS88	15-18 dB	note 1	TI	1.75
A-2734	15-18 dB	note 2	Amelco	1.25
UC-734	14-18 dB	note 2	UC	1.10
IT-108	12-15 dB	note 2	Intersil	.85
TIS34	10-15 dB	note 3	TI	1.10
2N3823	10-15 dB	note 3	TI	4.00
2N2319	10 dB	note 3	TI	—

note 1: 0.5 to 2 dB better than good 417A or 6CW4 units "normalized" at 3 dB noise figure

note 2: same or slightly better than comparison tube front ends

note 3: worse than comparison tube front ends; TIS34 to 1 to 2 dB worse, 2N3823 and 2N2319 3 to 4 dB worse

manufacturers: Sil, Siliconix; TI, Texas Instruments; UC, Union Carbide

fig. 4. Circuit of 144-MHz fet test jig. Reverse power supply voltage polarity for p-channel devices.

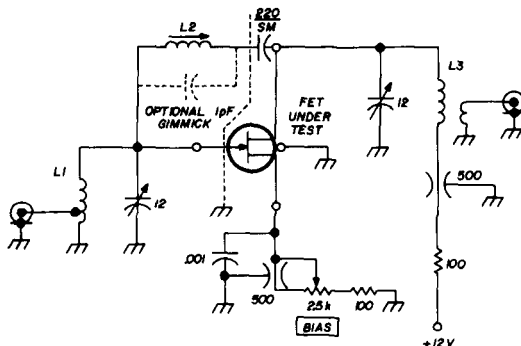

L1 5 turns no. 16, 3/8" diameter, 5/8" long, tapped at 1 1/2 turns

L2 15 turns no. 26 enamelled on 3/8" slug-tuned form; brass slug. Form must be insulated from chassis.

L3 7 turns no. 18, 3/8" diameter, 3/4" long, secondary is 1 1/2 turns no. 26 around cold end



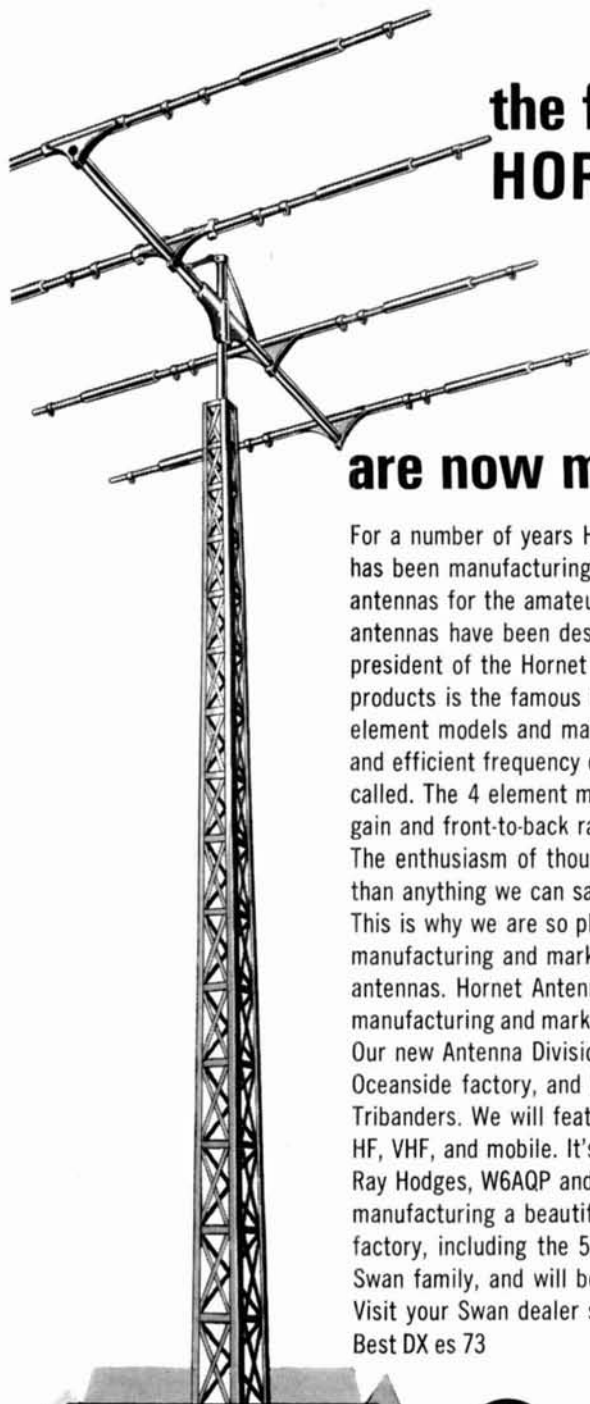

## the famous HORNET ANTENNAS

are now made by **SWAN**

For a number of years Hornet Antenna Products of Duncan, Oklahoma has been manufacturing a line of high quality, high performance antennas for the amateur bands as well as for other services. These antennas have been designed and manufactured by Jack Guest, W5AJZ, president of the Hornet company. Probably the best known of his products is the famous Hornet Tribander, made in both 3 and 4 element models and making use of Jack's patented, extremely rugged and efficient frequency dividers, or "traps" as they are commonly called. The 4 element model TB-1000-4 will equal or exceed the power gain and front-to-back ratio of any other beam built on a 24 foot boom. The enthusiasm of thousands of Hornet owners proves this better than anything we can say.

This is why we are so pleased to announce that Swan is now manufacturing and marketing the Hornet line of amateur band antennas. Hornet Antenna Products in Duncan, Oklahoma will continue manufacturing and marketing their line of Citizen's Band Antennas. Our new Antenna Division is a 10,000 square foot addition to our Oceanside factory, and is now in production on the Swan-Hornet Tribanders. We will feature a complete line of antenna products for HF, VHF, and mobile. It's a double pleasure to also announce that Ray Hodges, W6AQP and Fred Schnell, W6OZF, who have been manufacturing a beautiful line of mobile antennas at their Los Angeles factory, including the 5 band Swantennas, have recently joined the Swan family, and will be in charge of antenna production.

Visit your Swan dealer soon, or write for further details.

Best DX es 73

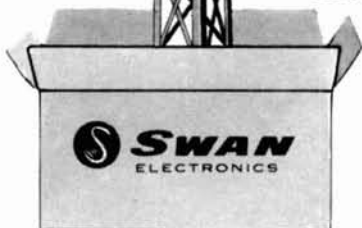

**SWAN**  
ELECTRONICS  
*For Better Ideas  
in Amateur Radio*

OCEANSIDE, CALIFORNIA • A subsidiary of Cubic Corporation

## mosfet transistors

In the cornucopia of mos field-effect transistors, I have selected a group which are most likely to be encountered by amateurs. A few types were omitted; perhaps a few were missed. In any event, the list should be an invaluable addition to your ham notebook. Because the emphasis in this grouping is on rf amplifier applications, all types are n-channel, depletion mode. This means their biasing and polarity are the same as vacuum tubes.

**Don Nelson, WB2EGZ**

## another use for coax relay coils

If you are using surplus coax relays with 24- or 28-volt dc coils, you might be able to use this idea. On a homebrew transmitter using push-pull 6AQ5's (the tubes could just as well have 6V6's), I found that the relay coil resistance was about the same resistance as the modulator cathode resistance should be. So I used the relay coil as the bias resistor. This worked okay, since the power supply B- was open on receive and grounded on transmit. Don't forget to bypass the coil with a 25-volt, 25  $\mu$ F capacitor.

**Bill Eslick, KØVQY**

**table 2. Performance characteristics of n-channel mosfet's suitable for rf circuits.**

type	gate	maximum freq (MHz)	application	200-MHz				Price
				trans- conductance ( $\mu$ mho)	power gain (dB)	noise figure (dB)	feedback capaci- tance (pF)	
3N128	single	250	rf amplifier, oscillator	7500	18	3.5	0.12	\$1.45
3N139	single	250	video, af, rf amplifier with 35-V $V_{dss}$	6000	17	4.0	0.18	2.89
3N140	dual	300	rf amplifier with agc capability	8000	19	3.5	0.02	1.62
3N141	dual	300	converter, product detector	10,000	18 <sup>1</sup>	—	0.02	1.55
3N142	single	175	rf amplifier, oscillator	7500	17 <sup>2</sup>	2.5 <sup>2</sup>	0.12	1.08
3N143	single	250	mixer, oscillator	7500	13.5 <sup>1</sup>	—	0.12	1.39
3N152	single	250	premium rf amplifier	7500	20	2.5	0.12	1.78
3N159	dual	300	premium rf amplifier with agc capability	10,000	20	2.5	0.02	2.18
40467A	single	220	general purpose rf amplifier and oscillator	7500	16	4.5	0.12	1.24
40468	single	125	rf amplifier	7500	17 <sup>2</sup>	3.5 <sup>2</sup>	0.12	.75
40559	single	125	mixer, oscillator	2800 <sup>3</sup>	21.5 <sup>1,2</sup>	—	0.12	.70
40600	dual	250	rf amplifier	11,000	17.5	3.5	0.02	2.24
40601	dual	250	mixer	2700 <sup>3</sup>	14 <sup>1</sup>	—	0.02	1.16
40602	dual	—	i-f amplifier	10,000	28 <sup>4</sup>	—	0.02	.83
40603	dual	150	rf amplifier	10,000	25 <sup>2</sup>	2.5 <sup>2</sup>	0.02	1.04
40604	dual	150	mixer	2800 <sup>3</sup>	20 <sup>4</sup>	—	0.02	.98
40673	gate-protected version of 3N140							2.22
MFE3006	dual	300	rf amplifier	15,000	24 <sup>2</sup>	3.0 <sup>2</sup>	0.02	1.50
MFE3007	dual	300	rf amplifier	14,000	24	3.0	0.02	1.65

1. Conversion gain  
2. At 100 MHz

3. Conversion transconductance  
4. At 44 MHz

# vhf-uhf manual

BY G.R.JESSOP, C.Eng., MIERE, G6JP

published by the Radio Society of Great Britain

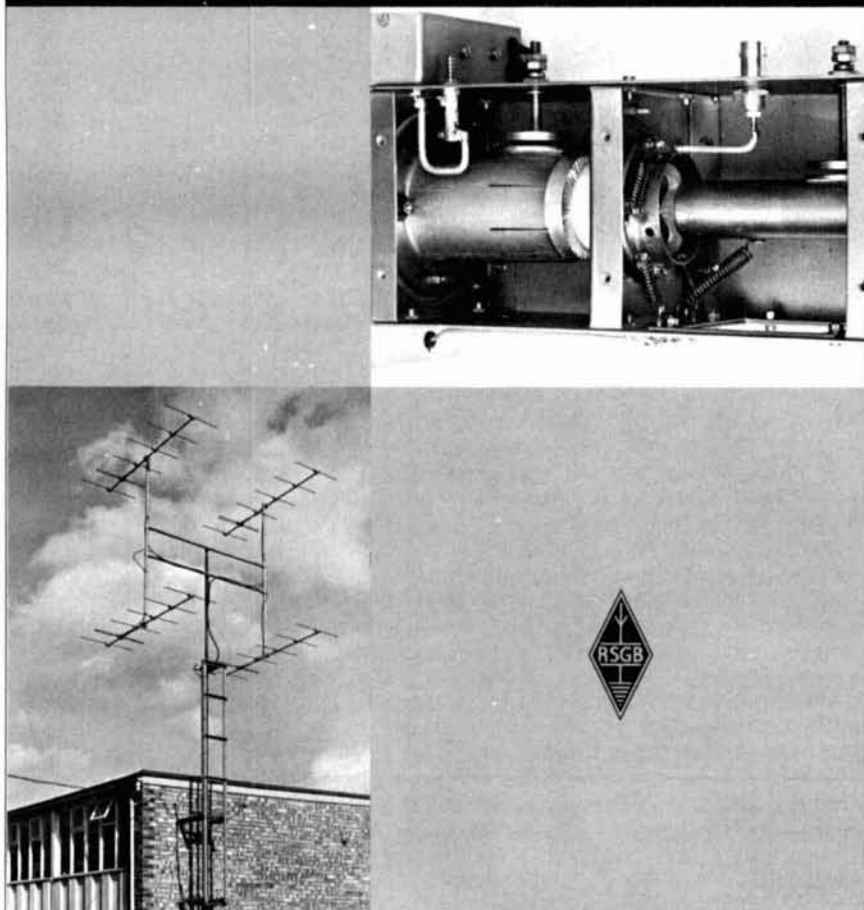

If you have any interest in the frequencies above 30 MHz then you need this book. It is probably the most comprehensive work of its kind ever produced, ranging from advanced material to simple circuits for the beginner to vhf. An attractive layout and clear style make the VHF/UHF Manual a most worthwhile addition to your library.

**3.75 postpaid**

book division

**comtec**

Box 592 • Amherst, New Hampshire 03031

"WE ARE THE EXCLUSIVE NORTH AMERICAN DISTRIBUTOR FOR RSGB PUBLICATIONS —  
DEALER INQUIRIES INVITED"

# new products

## mosley six-element tri-band beam



Mosley Electronics, Inc. has just announced their latest Trap-Master beam, the Classic 36, a six-element tri-band beam featuring the Classic feed system and balanced capacitive matching for efficient performance. The Classic 36 uses performance-proven Trap-Master traps for automatic bandswitching by means of high-impedance parallel-resonant tuned circuits. The new beam covers 10, 15 and 20 meters with an swr of 1.5:1 or better. Beam is power rated at 2 kW PEP ssb input to the final stage. If you already own a Mosley TA-36, you can obtain six-element tri-band operation with a TA36/CL36 conversion kit; kit includes an entire new radiating element. For more information write to Mosley Electronics, Inc., 4610 N. Lindbergh Boulevard, Bridgeton, Missouri 63042.

## dipole center insulator



O. Watson Greene, W1CPI, has just introduced a new dipole center insulator that is available with or without a broadband balun. The housing for the Greene insulator is a precision molding of hard-flow polystyrene material. When the two halves are cemented together, they are practically impossible to separate. Rain and moisture are kept out of the insulator and feedlines by the rain drip collar that is formed around the type-UHF coaxial connector on the bottom of the insulator. The hoist ring at top center makes the unit adaptable for either inverted-vees or horizontal dipoles. The antenna connectors are quarter-inch copper braid, six inches long with tensile strength of 500 pounds. The 1:1 52-ohm balun is wound on a ferrite rod and covers the range from 2.8 to 32 MHz. The manufacturer reports that this balun will take the full legal amateur power input without core saturation. The model GWB with balun is priced at \$10.00; the GNB without balun is \$6.00. Order from O. Watson Greene, Wakefield, Rhode Island 02880.

## noise blanker kit

The Drake 34-NB Noise Blanker Kit is designed for the Drake TR-3 and TR-4 transceivers. Unlike the noise clippers and limiters usually used in communications equipment, the 34-NB actually mutes the receiver for the duration of the noise pulse. Between noise pulses, full receiver gain is restored. The 34-NB is most effective on

strong, periodic noise impulses such as ignition noise and is least effective on random noise. However, impulse noise is the most troublesome, and loss of communications because of random noise is rare. According to the manufacturer, low-level signals that are completely masked by noise pulses without the noise blanker can be copied when it is used. This is a real boon to the mobile operator because he can blank ignition noise from trucks and other cars as well as his own car. \$129 from your local distributor, or write to the R. L. Drake Company, 540 Richard Street, Miamisburg, Ohio 45342.

## decade counter kit

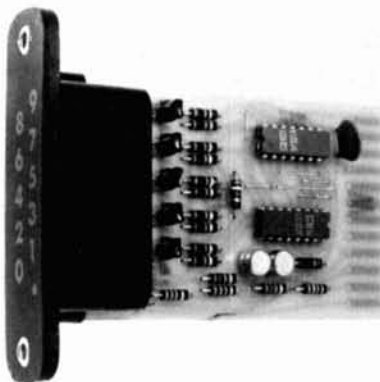

Display Electronics has announced a new decade counter kit for the electronics experimenter. With these new digital modules, you can build professional looking frequency counters, digital meters, precision clocks and many other projects. The counter module uses Signetics "Utilogic" integrated circuits for high noise immunity and a guaranteed 10-MHz clock rate. Eleven neon lamps illuminate the ten digits and decimal point on the readout face.

The model DC-10-1 decade counter is available in kit form for \$13.95 postpaid. The kit is easily assembled in a little over an hour and includes well written, easy-to-follow instructions. An assembled and tested version may be purchased for \$16.95. Data sheets are available from Display Electronics, P. O. Box 1044, Littleton, Colorado 80120.

# NOISE BLANKER FOR THE SWAN 250

The TNB-250 Noise Blanker effectively suppresses noise generated by auto ignitions, appliances, power lines, etc., permitting the recovery of weak DX and scatter signals normally lost in noise.

Features include modern solid state design techniques utilizing dual-gate MOS FET transistors and two stages of IF noise clipping for the efficient removal of impulse noise at the transmitter IF frequency. The use of MOS FETs and a special gain controlled amplifier circuit provide excellent cross-modulation characteristics in strong signal locations.



TNB-250 shown installed on a Swan 250 at accessory socket location.

Simplified installation requires twenty minutes.

TNB-250 \$29.95 ppd.  
TNB-250C (for Swan 250C) \$32.95 ppd.

**Model TNB Noise Blanker**, designed to operate with VHF converters by connecting in the coax between converter and receiver.



Choice of 14-20, 100-140, or 125-160 VDC, RCA phono or BNC connectors. Specify for 10 or 20 meter converter output.

Model TNB \$29.95 ppd.  
(For special frequencies add \$3.00)

Refer to the New Products column of the August '68 issue of Ham Radio Magazine for additional information on the TNB Noise Blanker or write for technical brochure.

Prepaid orders shipped postpaid. (For Air Mail add \$.80) C.O.D. orders accepted with \$5.00 deposit. California residents add sales tax.

All products are warranted for one year and offered on a satisfaction guaranteed or return basis.

**WESTCOM**  
ENGINEERING COMPANY

P. O. Box 1504 San Diego, Cal. 92112



a  
complete  
amateur radio station  
in one  
portable package

## SWAN *Cygnet*

A 5 BAND 260 WATT SSB TRANSCEIVER  
WITH BUILT-IN AC AND DC  
SUPPLY AND LOUDSPEAKER **Only**  
**\$435**

**WANTED — YOUR GOOD USED HAM GEAR**  
— We pay top prices for your ham gear —  
write us for quotations — trade your used  
gear in on new ham gear and get the BEST  
trades — new gear for delivery, Swan, Drake,  
Galaxy — mobile antennas, beams, Drake,  
Galaxy — tubes and small parts for the builder.

Used gear for sale or trade — all gear listed  
guaranteed for 90 days — subject to prior sale  
— all gear listed has been operated and is in  
excellent operating condition.

**B & W**  
5100 ..... \$ 65.00  
5100-B (Fair) ..... \$ 50.00

**COLLINS**  
32V3 (Vry gud) ..... \$195.00  
312B-5 (Like new) ..... \$299.50  
KWM-2, 30L-1, 516F-2, 312B-4 (Pkg. deal) —  
All less than two years old. Ser. #12,000's.

ALL MANUALS ..... \$1275.00

**HAMMARLUND**  
HQ-105TR ..... \$ 85.00  
HQ-145AC ..... \$165.00  
HQ-170 ..... \$180.00  
HQ-180 ..... \$199.95

**HALLICRAFTERS**  
HT-37 (Like new) ..... \$235.00  
SX-101 ..... \$125.00  
SX-111 ..... \$150.00

**HEATH**  
Warrior (4-UEW-572'B) ..... \$175.00  
HW-16 with HS-24 spkr.  
and headphones ..... \$125.00  
DX-60A ..... \$ 60.00

**GONSET**  
GSB-201 Linear ..... \$175.00

**GALAXY**  
Gal. 111 & AC/PS (Fair) ..... \$195.00  
Gal. V Mk3 & AC/PS (Near new) ..... \$420.00  
Del. Spkr. Console ..... \$ 65.00  
Special VFO ..... \$ 37.50

All gear listed F.O.B. Oklahoma City and  
subject to prior sale. Guaranteed 90 days.

*Bob's* **AMATEUR**  
**ELECTRONICS**

"THE COMPLETE HAM STORE"

Phone CE 5-6387

927 N.W. 1st Oklahoma City, Oklahoma 73106

"WE TAKE TRADE-INS ON ALL LINES OF NEW EQUIPMENT"  
TWO-WAY RADIOS — SALES • SERVICE • INSTALLATIONS

## regulated power supply

This new dc power supply features auto-  
matic overload and short-circuit protection  
and is useful to the experimenter and ser-  
viceman working with solid-state equipment.  
The supply features continuous variable dc  
voltage from 5 to 20 volts in two ranges;  
maximum rated load is 2 amperes. Ripple is  
less than 5 mV rms at full load, regulation  
is  $\pm 1\%$ , and output voltage and current are  
monitored with two meters. Input 115/230  
Vac, 50/60 Hz. \$39.95 from Lafayette Radio  
Electronics Corporation, 222 Jericho Turn-  
pike, Syosset, L.I., New York 11791. Order  
stock number 99-5077.

## low-cost volt-ohm-milliammeter



The first instrument new hams and elec-  
tronic experimenters buy is a volt-ohm-  
milliammeter. It is the **basic** electronics  
test instrument and is an invaluable aid  
to any electronics trouble shooting. Among  
the functions of the vom are signal tracing  
and alignment, and voltage, current and  
resistance measurements. A new depend-  
able pocket-size vom, the Knight-Kit model  
646, is available in kit form at a low  
enough price for anyone interested in elec-

tronics. This instrument features an easy-to-read two-color scale, 20,000 ohm-per-volt dc sensitivity (10,000 ohms per volt on ac) and accuracy of  $\pm 2\%$  full scale ac or dc.

The meter has five dc voltage ranges up to 1000 V, five ac ranges to 1000 V, three current ranges to 250 mA, three resistance ranges to 1 megohm, two dB scales plus scales for measuring large chokes and capacitors. Kit price is \$11.95 with all parts, test leads and battery from Allied Radio Corporation, 100 N. Western Avenue, Chicago, Illinois 60680.

### monolithic crystal filter



Tyco Laboratories has just announced a line of computer-designed high-frequency crystal filters with excellent performance characteristics. The center frequency range of these miniature filters is 5 to 22 MHz with fractional bandwidths from 0.01 to 0.4%. The new filters are currently available in a flat-pack metal can 1.54 inches long, 0.69 inch wide and 0.3 inch high. A typical eight-pole filter with a 10.7 MHz center frequency and 7 kHz bandwidth has a shape factor of 2:1 from 6 to 60 dB; stop-band rejection is more than 100 dB, and spurious responses are at least 90 dB down.

Applications for these filters include ssb, CW and narrow-band fm communications systems. It's expected that the monolithic construction will offer significant cost reductions over discrete filters. For more information, write to Mr. Kenneth Thomson, Crystal Products Group, Tyco Laboratories, Inc., 1510 McGee Street, Kansas City, Missouri 64108.

# FREE! ONE YEAR OF *ham radio*

A one year subscription is \$6.00. Take a three year subscription for \$12.00 and you get the last year for nothing.

Yes, I'd like the free year. Enclosed is \$12.00. Send 3 years of HAM RADIO.

HAM RADIO MAGAZINE  
GREENVILLE, N. H. 03048

Name ..... Call .....

Address .....

City ..... Zip .....

## GET MONEY

Guaranteed top money for any piece of surplus equipment. Payment in 24 hours. We also pay shipping, insurance. Call collect or send list for quick quote. SPACE ELECTRONICS CORP. 11 Summit Ave. East Paterson, New Jersey, (201) 791-5050

Another  
**NEW IDEA**  
from  
*ham*  
**radio**  
**MATCHING**  
**BINDERS and**  
**BOUND VOLUMES**

Keep your library always up to date — Past years in bound volumes — The current year in a binder. No missing or torn copies.

Both are covered in a handsome gold colored plastic impregnated buckram, set off with good looking artwork and printing. This is a tough cover, made to be abused. It can be washed — it won't wear out.

Make your HAM RADIO collection twice as useful — Send for your Bound Volumes and Binders today.

**BINDERS \$3.95**  
postpaid US & Canada

**BOUND VOLUMES \$14.95**  
postpaid US & Canada  
(All issues 1968 March - Dec.)

Order from  
**HAM RADIO MAGAZINE**  
GREENVILLE, N. H. 03048

## desoldering tool

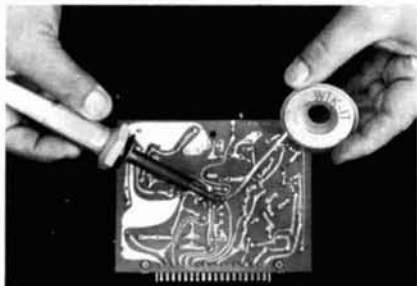

If you have ever tried to repair printed-circuit boards or tried to remove parts from them, here is a desoldering tool that should be of interest. Wik-It desoldering tool is a specially treated tinned braid that quickly draws up solder when heat is applied with an ordinary soldering iron. In addition to removing the solder, it acts as a heat sink to protect delicate components, and leaves the joint ready for re-soldering. It comes in various sizes and is sold in spools or as a service kit. See your local distributor or write to Wik-It Electronics Corporation, 2573 Spring Street, Redwood City, California 94063.

## meter expander



A new meter expander that increases the voltage and current sensitivity of a vom by as much as a thousand times has just been announced by Integrated Controls, Inc. The meter expander has selectable gain settings of 10, 100 and 1000 and is connected as a buffer amplifier between the test leads and the vom. The direct-coupled IC buffer amplifier produces a nominal full output of  $\pm 2.5$  volts and increases the voltage sensitivity of a vom up to 60 dB; input impedance is increased



to more than 1 megohm. It can also amplify current, multiplying the basic meter sensitivity up to 200 times. The gain-bandwidth product of the amplifier is 1 MHz. The unit is completely battery powered and its accuracy is compatible with most volt-ohm milliammeters. For more information, write to Integrated Controls, Inc., P. O. Box 17296, San Diego, California 92117.

## signal-injector kit



If you've ever done any troubleshooting, you know one of the handiest gadgets you can use is a signal injector. The new Knight-Kit KG-644 solid-state signal-injector kit is completely portable and self-contained and produces a signal rich in harmonics for tracing audio, rf and i-f circuits. The test probe is insulated for maximum safety, and the unit has a built-in battery-condition light. The kit is priced at \$4.95, complete with 4 penlight batteries, from Allied Radio Corporation, 100 N. Western, Chicago, Illinois 60680.

## varitronics correction

Unfortunately, two typographical errors crept into the new products writeup on the new FDFM-2S fm transceiver manufactured by the Inoue Communications Equipment Corporation. The power supply can vary between 12 and 14.5 Vdc, and frequency deviation is less than 15 kHz. Since the new products release that appeared in the June, 1969 issue of **ham radio**, the price of this transceiver has been increased to \$310. The unit is distributed by Varitronics, Inc., 3835 North 32nd Street, Suite 6, Phoenix, Arizona 85018.

## When it comes to antenna systems . . .

### IS YOURS

a space problem? a budget problem?  
an installation problem?  
an applications problem?  
or simply a problem of where to buy?

Your one-stop solution is  
*ANTENNAS, INC.*

*Exclusively specialists in radiating systems  
Complete systems or any component part*

Arrays — complete or in kit form, quads, yagis, dipole assemblies, verticals — fixed or mobile, towers, masts, rotors, guy and control cable, transmission line, coax relays and switches, connectors and adapters, test gear, technical publications, corrosion resistant hardware, corrosion proofing chemicals, insulators, installation and wiring hardware, aluminum tubing and plate, wire, and much, much more.

If your requirements are for a complete system, major components, or the smallest yet important piece of hardware — *ANTENNAS, INC.* has

AMPHENOL	HI-PAR
ANTENNA SPECIALISTS	E. F. JOHNSON
BELDEN	MILLEN
BILADA	MINI-PRODUCTS
BIRNBACH	MOR-GAIN
CALCON WIRE	MOSLEY
CDE ROTORS	NEWTRONICS
COMDEL	OMEGA-T
CUBEX	POLYGON PLASTICS
CUSHCRAFT	POMONA
DGP	ROHN
DPZ	SKYLANE
DOW-KEY	SWAN
EZ-WAY	TELREX
R. L. DRAKE	TIMES WIRE
HAM-KITS	TRI-EX
HY-GAIN	TRISTAO
GENERAL ELECTRIC	UNADILLA
GENTEC	VESTO
GOLDLINE	WATERS
GOHAM	

*ANTENNAS, INC.*

## Can be your one-stop, single-source

Write today for our catalog —  
no charge of course.

*ANTENNAS, INC.*

Dept. C, 512 McDonald Road  
Leavenworth, Kansas 66048

# short circuits

The schematic for K9MRL's integrated-circuit RTTY converter that appeared on page 41 of the May, 1968 issue was incorrectly drawn; the correct schematic is shown here.

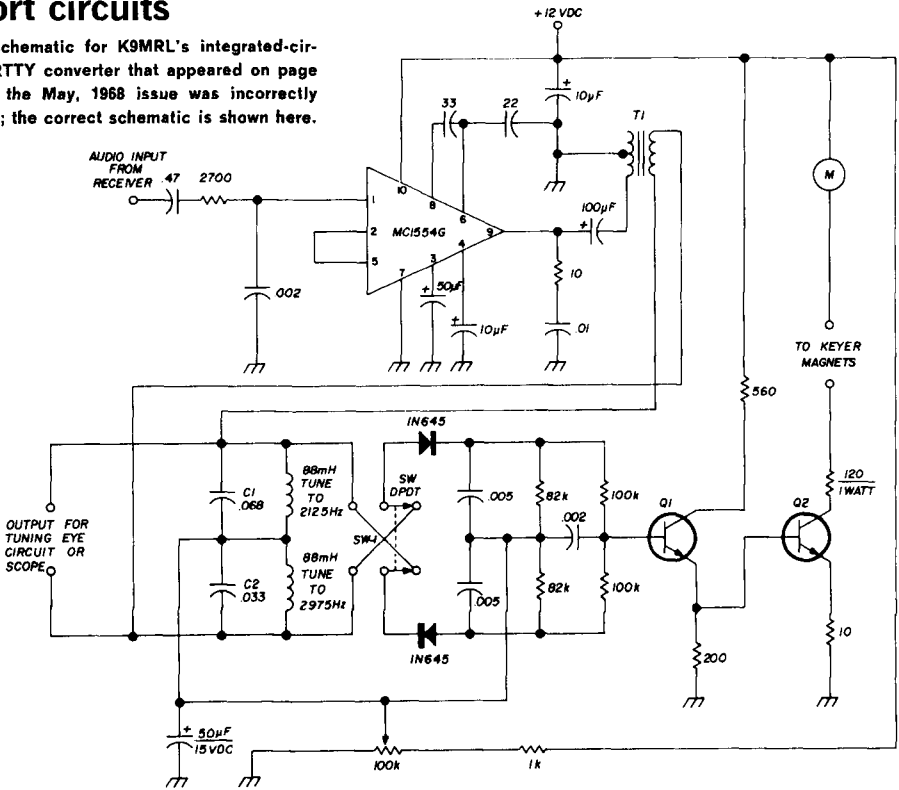

The schematic for W1OOP's slaved dual-voltage power supply that appeared in the ham notebook section of the April issue was in error—the collector circuit of the 2N2924 should be connected to the positive supply. Resistors R3 and R4 should be 1 percent resistors; any value from 2k to 22k.

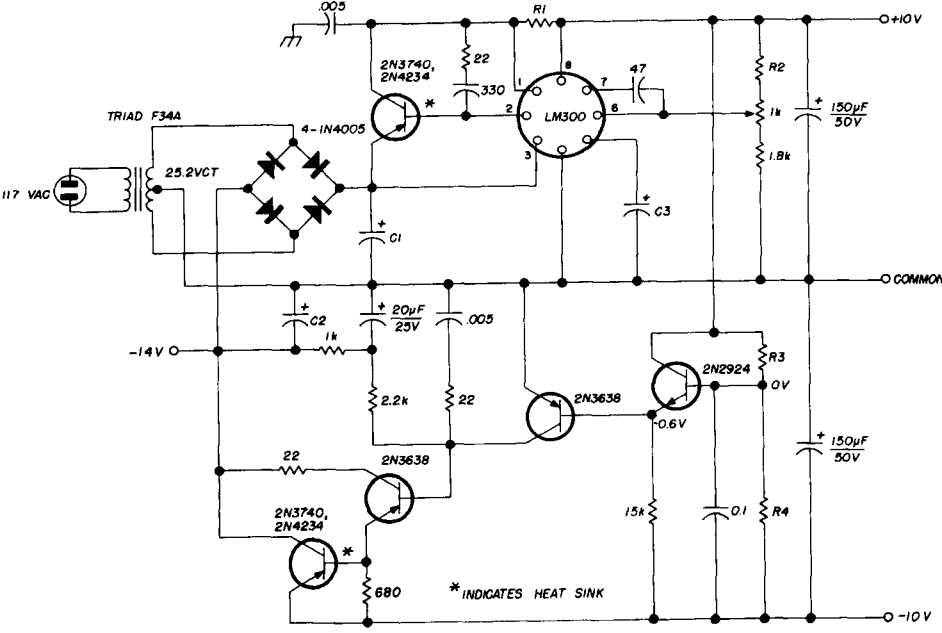

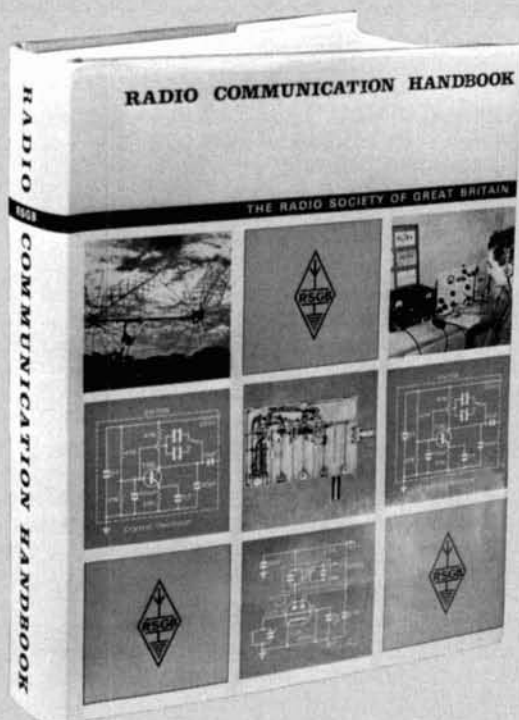

## HERE IS THE ANSWER

- |                          |   |
|--------------------------|---|
| BASIC PRINCIPLES         | RTTY                                    |
| TUBES                    | PROPAGATION                             |
| SEMICONDUCTORS           | HF ANTENNAS                             |
| HF RECEIVERS             | VHF and UHF ANTENNAS                    |
| VHF and UHF RECEIVERS    | NOISE                                   |
| HF TRANSMITTERS          | MOBILE EQUIPMENT                        |
| VHF and UHF TRANSMITTERS | POWER SUPPLIES                          |
| KEYING and BREAK-IN      | INTERFERENCE                            |
| MODULATION SYSTEMS       | MEASUREMENTS                            |
| SINGLE SIDEBAND          | OPERATING TECHNIQUE &<br>STATION LAYOUT |

The most complete handbook ever offered to the amateur  
Beautifully Printed — Handsomely Bound

### RADIO COMMUNICATION HANDBOOK

832 Pages

Only \$11.95 postpaid  
in USA & Canada

book division

**comtec**

Box 592 • Amherst, New Hampshire 03031  
DEALER INQUIRIES INVITED



**“I’m smiling about  
my great new FDFM-2S\*!”**

*\*Deluxe Solid-State 10-Watt, 2-Meter FM Transceiver. See it at your Dealer.*

*Dealer inquiries invited*

**VARITRONICS, INCORPORATED**

3835 N. 32nd St. • Suite 6 • Phoenix, Arizona 85018  
602/955-5610

# flea market



■ **RATES** Commercial Ads 25¢ per word; non-commercial ads 10¢ per word payable in advance. No cash discounts or agency commissions allowed.

■ **COPY** No special layout or arrangements available. Material should be typewritten or clearly printed and must include full name and address. We reserve the right to reject unsuitable copy. **Ham Radio** can not check out each advertiser and thus cannot be held responsible for claims made. Liability for correctness of material limited to corrected ad in next available issue. Deadline is 15th of second preceding month.

■ **SEND MATERIAL TO:** Flea Market, Ham Radio, Greenville, N. H. 03048.

**STOLEN** Collins 51S-1 #6312, Collins 51S-1 #6363, KWM-2 #15138, 312B-4 #59533, 516F-2 #58398. Also (2) 312B-3 Speakers, MM-1 & SM-1 Microphones plus cables and instruction books for above. Also Vibroplex "Deluxe Original" key, Telex Headsets HFR-91, HUP-01, HMV-2 and Kollsman Altimeter Type C-12 No. 671-BK010. Anyone having any information please contact Jim Gardner, Theft Bureau, Dallas Police Dept., Dallas, Texas 214-748-9711.

**THE EAST COAST VHF SOCIETY** is holding its Eleventh Annual Free outdoor Picnic-Hamfest on Sunday August 10, 1969 at Saddle Brook Park (Saddle River Road, Saddle Brook, N. J.), starting at 10:00 a.m. Games, Contests (including Antenna Measuring contest), Displays, Demonstrations and many other interesting events for all age groups have been planned. Food and Soft Drinks will be available. Bring your YL or XYL. Talk in stations will be on the air. For more information write: E. C. VHF Society, P. O. Box 1263, Paterson, N. J. See you at Saddle Brook!

**ORIGINAL EZ-IN DOUBLE HOLDERS** display 20 cards in plastic, 3 for \$1.00, 10 for \$3.00 prepaid. Guaranteed. Patented. Free sample to dealers. Tepabco, John KANMT, Box 198R, Gallatin, Tennessee 37066.

**WRL'S USED GEAR** has trial-terms-guarantee! KWM1 — \$249.95; HW 12 — \$89.95; Swan 250 — \$249.95; TR3 — \$369.95; Galaxy 5 — \$229.95; Galaxy 5mk2 — \$279.95; Galaxy 300 — \$139.95; SBE34 — \$299.95; R4A — \$319.95; Invader 200 — \$249.95; HQ180AC — \$349.95; CE100V — \$259.95; AF68 — \$49.95. Many more. Free "blue-book" list. WRL, Box 919, Council Bluffs, Iowa 51501.

**THE IOWA 75 METER PHONE NET** picnic will be held in Anson Park at Marshalltown, Iowa on August 17. All activities will begin around noon.

**HIGH-AMPERAGE** Low voltage 750VA Transformer 24/12 Volts 30/60 Amps from 115/230 \$10.00, Nicklecad Batteries 4AH — \$1.95, 8 AH \$2.50. Free Catalog With Order. Arrow Sales, 2534 S. Michigan, Chicago, Illinois 60616.

**THE ANNUAL HAMFEST FOR THE WASHINGTON, D.C., metropolitan area**, sponsored by the Foundation For Amateur Radio, will be held at the Gaithersburg Fairgrounds in nearby Gaithersburg, Maryland, on Sunday the 21st of September from 1000 until 1700 hours.

**SAVE.** On all makes of new and used equipment. Write or call Bob Grimes, 89 Aspen Road, Swampscott, Massachusetts, 617-598-2530 for the gear u want at the prices u want to pay.

**39th — ARRL WEST GULF Division Convention** August 15, 16 & 17, Amarillo, Texas. For an ideal summertime weekend of ideas, fellowship, entertainment, fun (and maybe good luck) you can't miss at \$10.50 for registration. W5WX Panhandle Amateur Radio Club, Box 5453, Amarillo, Texas 79107.

**THE LEBANESE AMATEUR RADIO ASSOCIATION** announces its 20th Anniversary DX contest. 0001 GMT Saturday, Oct. 4, 1969 to 2359 GMT Sunday, Oct. 12, 1969. Work as many different OD stations, on as many different bands as possible during the contest period. Phone or CW. Each OD station may be worked only once per band for credit, but the same station may be worked on additional bands for additional point credit. Contacts from North and South America, Oceania, and Antarctica count 2 points on 10, 15, and 20 meters; 4 points on 40 meters; and 6 points on 80 meters. Score is the total of the points on all bands. Logs: Submit list of contacts with date and time in GMT, band, and points claimed to: RAL P. O. B. 1217, Beirut, Lebanon. Mailing deadline is 1 November 1969. The over-all winner will receive two air tickets to Beirut from any point on the MEA route plus a free double room at the Cadmos Hotel for one week any time during the period 1 March through 31 August 1970. The high scorer on each continent will be awarded a silver cup. The high scorer in each country and U.S. call district will be awarded a special certificate.

**WANTED TO BORROW:** Instruction manual for Dumont 304H oscilloscope. Will return after I make a copy. W1DTY, Box 25, Rindge, N. H. 03461.

**FOR SALE: KWM-2 #12566** (latest series), 516F-2, \$850. 75A-4 (0.5 & 3.1 kcs, Noise Blanker), KWS-1 #1451, spkr, \$1000. 312B-4 (latest), \$140. 75S3-B #15066 (0.5, 2.1 kcs), \$525. 399C-1 (VFO/spkr for KWM-2), \$165. Henry 2K-2, spare 3-400-Z, \$575. HT-31-A, \$275. R4-A, T4X, AC-4, MS-4, \$625. Swan 350, 117-XC, 14-117 DC, \$400. HW-32-A, \$85. HP-13, \$50. Tektronix 514-D, \$175. 136B-2 Noise Blanker, \$70. Heath HD-15 "patch", \$16. Condel CSP-11 (new), \$95. Drake TV-1000-LP, \$10. Collins 70E-24 VFO (75A-4), \$20. Advance CB1C2C (115AC), \$15; CB1C2C (115DC), \$15. Powerstat, 115V/12 amp (new), \$19. Power supply: 115input/1800/300 reg/105 reg, excellent, \$30. Capacitors: 50 mf/3KV, \$20; 15 mf/1.5KV (new), \$3; 10 ea. 500 mf/310 VDC for \$19. **WANTED:** 30S-1, 30L-1, 312B-5. James W. Craig, W1FBG, 29 Sherburne Avenue, Portsmouth, N. H. 03801. Area Code 603 436-9062.

**WANTED — QST'S** Last four issues needed to complete 1916. Feb., May, June, July. Any reasonable price paid. K2EEK, 75-15 177th St., Flushing, N. Y.

**ROCHESTER, N. Y.** is again Hamfest, VHF meet and flea market headquarters for largest event in north-east, May 16, 1970. Write WNY Hamfest, P. O. Box 1388, Rochester, N. Y. 14603.

**HICKOK MODEL 121** Carmatic tube tester **PLUS** Adapter #CA-4, sell both for \$125.00 PPD. Or — swap for new RCA type 7102 photomultiplier tube. Write: R. W. Campbell, W4KAE, 316 Mariemont Drive, Lexington, Ky. 40505.

**GREENE** — center of dipole insulator with or without **BALUN** . . . see ad page 82, June 1969, Ham Radio.

**BRANDON AMATEUR RADIO SOCIETY** — Ham Camporee — August 22-23 — Royall Park Campground, Riverview, Florida. Write BARS, P. O. Box 828, Brandon, Florida 33511.

**DEALERS.** Do you carry R.S.G.B. publications? They are real best sellers. Interesting and well priced. For complete information write Comtec, Box 592, Amherst, N. H. 03031.

**TOURS, CRUISES, AIR AND STEAMSHIP TICKETS, DX-PEDITIONS, CONVENTIONS,** everything arranged by the ham's travel agent: Barber Travel Service, 711 Cottage Grove Road, Bloomfield, Connecticut 06002. Members A.S.T.A. Ruth K1IIF, Jack W1PRT. (203)242-2279

**DECADE COUNTER KITS** — \$13.95. Professional quality readout. Free information. Display Electronics, Dept. HR, Box 1044, Littleton, Colorado 80120.

# NEW! FREQUENCY MARKER



- KEEP YOUR RECEIVER CALIBRATED
- LOCATE THOSE SUB BANDS
- READOUTS AT  
5, 10, 25, 50, 100 kHz  
useful to 50 MHz

### SPECIFICATIONS

Glass epoxy board  
Adjustment to zero beat with WWV  
Uses 100 kHz crystal (not supplied)  
3 to 4 VDC at approx. 75 ma — 2 "D" Size Batteries  
Compact — 1.75 x 3.75 inches  
— Install Anywhere

Complete easy-to-assemble KIT \$15.00    Wired & Tested \$18.50

Prices are postpaid less crystal & batteries

**LAB 1**  
**THE RADIO SHOP**  
48 ELM STREET  
NEW CANAAN, CONN. 06840

**S-40 RECEIVER** Recently realigned, very clean, \$40. WIDHIZ, Box 185, Amherst, N. H. 03031. 603-673-4885.

**TOROIDS 44 and 88 mhy.** Unpotted. 5 for \$1.50 ppd. M. Weinschenker, Box 353, Irwin, Pa. 15642.

**FOR SALE: BC-610I** with control unit and speech amplifier. Exc. cond. \$100. T-90 w/AC gud cond. \$50. TS-413C signal generator 75kc to 40mc \$200 exc. cond. BC-639 with RA-42 \$50. HQ-160 \$125. SASE for list of meters, racks, etc. Jim Oshel, WA5SLZ, 165 Troy Avenue, Raton, N. Mex. 87740.

**73 MAGAZINE — COMPLETE COLLECTION.** 1st year bound volume, rest single issues. No splitting. Complete set only. K1PSR, Box 132, Amherst, NH 03031.

**QSL'S**, quality-fast. LJ Publications, Box 982, Lynwood, California 90262.

**RTTY — TERMINAL UNIT — Epoxy PC board** page 38 Junz HR \$10 postpaid. Cashion Electronics, Box 7307, Phoenix, Arizona 85011.

**3-D OFFICIAL MOON MAP** 53" x 48" in color \$2.25 for radio shacks, dens and offices. H. Morgan, 883-C Diana, Akron, Ohio 44307.

**SHAWNEE AMATEUR RADIO ASSOCIATION**, is holding a hamfest on Sunday, August 3, 1969, at the Herrin City Park, Illinois.

**QST'S WANTED:** December 1915, January to December 1916. Any unreasonable price paid! Ted Dames, 308 Hickory St., Arlington, N. J. 07032.

**TOROIDS. 88 & 44 mhy.**, Center-tapped, not potted, 5/\$2.00 POSTPAID. Model 32KSR latest page printer, excellent little used condition \$20. FRXD 14 typing reperforator-TD combination \$25. Deskfax #6500 facsimile transceiver \$20. Brand new Clegg 66'er, original box \$160. National NCX5 and NCXA like new \$400. Drake 2B&2BQ \$175. 11/16" reperforator tape \$3/box/10. B&W 51SB sideband adapter \$50. WANTED: Ham-M. Stamp for list. Van W2DLT, 302H Passaic Avenue, Stirling, N. J. 07980.

**THE CENTRAL COMMUNICATIONS REGION (AFCS)** will hold its fourth annual MARS conference, for Military and Civilian members, at the Sheraton-Jefferson Hotel in St. Louis, Mo., August 29, 30 and 31. Registration fee for the conference is \$11.50 and includes, among other things, the banquet on Saturday, 30 August, which will have Senator Barry Goldwater, AFA7UGA, as the primary speaker. For reservations and advance registration contact Mr. Eugene DePenelozza, AFB0AXU 6320 Wydown Blvd., Clayton, Mo. 63105.

**QSL'S — BROWNIE W3CJI** — 3111-B Lehigh, Allentown, Pa. 18103. Samples 10¢. Cut catalogue 25¢.

**MAGAZINES.** QST since March 1944. CQ since 1947. Sold as individual copies. What issues do you need? Write K1PSR, Box 132, Amherst, NH 03031.

**WANTED APRIL & JULY 1968** issues of Ham Radio. R. Atkins, KG6ASC, c/o NASA Tracking Station, Dan Dan, Guam 96910.

**WANTED METAL SHOP** to do precision metal work. Construction of parts for 1296 mc power amps. R. Atkins, KG6ASC, c/o NASA Tracking Station, Dan Dan, Guam 96910.

**NORTHERN CALIFORNIA Hams:** Best deals — new and reconditioned equipment. Write or stop for free estimate. The Wireless Shop, 1305 Tennessee, Vallejo, California 94590.

**MAKE MONEY!** Sell subscriptions to Ham Radio. Send for complete information. Ham Radio, Greenville, N. H. 03048.

**DALLAS AREA HAM-SWAP FEST** — Texas Instruments Activity Center — Sunday September 14, 1969 — 9 to 5 — Prizes: Swan 350C, TH-6, plus many more — Pre-registration prize — Register now — \$2/person — John Zagrodnick, 3823 Antigua Drive, Dallas, Texas, 75234.

**ANNUAL SOUTHWESTERN MICHIGAN VHF Picnic** — Allegan County Park — August 3rd. Sponsored by Van Buren County Amateur Radio Club Inc. — W8JUU Bangor, Michigan.

**THE ELECTRONIC MAIL ADVERTISER** published by WO Bargains Galore, is the fastest, most readable listing of electronic bargains. Twice a month, 6¢ a word when you subscribe. For a free sample send your QTH to Electronic Mail Advertiser, 1949 Van Reek Lane, St. Louis, Missouri 63131.

**YOUR AD** belongs here too. Commercial ads 25¢ per word, Non-commercial ads 10¢ per word. Commercial advertisers write for special discounts for standing ads not changed each month.

# radio amateur callbook

## GET YOUR NEW ISSUES NOW!

Over 290,000 QTHs in  
the U.S. edition \$6.95

Over 140,000 QTHs in  
the DX edition \$4.95

**NEW EDITION EVERY:**  
MARCH 1 — SEPT. 1  
JUNE 1 — DEC. 1

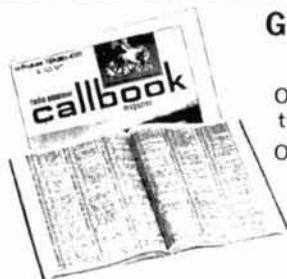

These valuable EXTRA features included in both editions!

- QSL Managers Around the World!
- Census of Radio Amateurs throughout the world!
- Radio Amateurs' License Class!
- World Prefix Map!
- International Radio Amateur Prefixes
- Radio Amateurs' Prefixes by Countries!
- A.R.R.L. Phonetic Alphabet!
- Where To Buy!
- Great Circle Bearings!
- International Postal Information!
- Plus much more!

See your favorite dealer or order direct (add 25¢ for mailing in U.S., Possessions & Canada. Elsewhere add 50¢).

**WRITE FOR  
FREE  
BROCHURE!**

RADIO AMATEUR



**callbook** INC.

Dept. E. 925 Sherwood Drive  
Lake Bluff, Ill. 60044

**VHF COMMUNICATIONS**, the international edition of the long-established German publication UKW-BERICHT, is an amateur radio quarterly concerned entirely with VHF, UHF and microwave technology.

**VHF COMMUNICATIONS** specializes in the publishing of complete and extensive construction data for transmitters, receivers, converters, transceivers, auxiliary and test equipment, antennas, etc. The latest advances in solid state, printed circuit, and electronic technology are reflected in the designs. Special components required for the assembly of the described equipment, such as printed-circuit boards, trimmers, coil forms, complex metal components as well as complete kits, are available.

**VHF COMMUNICATIONS** also features information regarding new developments in electronic equipment, test methods and general technology, useful to the amateur.

**VHF COMMUNICATIONS** is published in February, May, August and November. Each issue contains approximately sixty pages of technical information and articles.

Subscription rate US\$ 3.00 (\$4.00 airmail) per calendar year. Single issues US\$ 1.00.



## VHF COMMUNICATIONS

TOPSFIELD, MASSACHUSETTS 01983

### GEM-QUAD FIBRE — GLASS

ANTENNA FOR 10, 15, and 20 METERS.

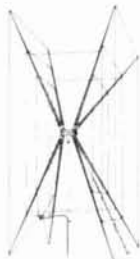

Two Elements \$77.73  
Extra Elements \$45.00 ea.  
Shipped Freight Collect  
INCLUDES U.S. Customs Duty

- KIT COMPLETE WITH**
- SPIDER
  - ARMS
  - WIRE
  - BALUN KIT
  - BOOM WHERE NEEDED

SEE OUR FULL PAGE IN JUNE ISSUE

Buy two elements now — a third and fourth may be added later with little effort.

Enjoy optimum forward gain on DX, with a maximum back to front ratio and excellent side discrimination.

Get a maximum structural strength with low weight, using our "Tridetic" arms.



MANITOBA DESIGN INSTITUTE  
AWARD WINNER

**Structural Glass**  
LIMITED

20 Burnett Avenue, Winnipeg 16, Manitoba, Canada

## LET US DO YOUR QSLing

We supply the QSLs — make out your QSLs — deliver your QSLs — all for the amazing price of 8¢ each.

This is how it works: On request we will send you free, a copy of our special log form, in duplicate. When you complete the first page of log you mark stations you wish to QSL to, send us copy of log, two copies of your QSL, and an order, paid in advance, for a minimum of 200 QSLs for \$16.00 or the bargain rate of 1000 QSLs for \$75.00. We print QSLs similar to yours, one side, two colors, and hold them for you. We transfer data, in your handwriting, from completed pages of your log to your QSLs, and mail to destination (any place in world), and send you additional log sheets.

### WORLD QSL BUREAU

5200 Panama Ave.

Richmond, Calif. U.S.A. 94804

PS: If you insist on the old fashioned way of supplying and filling out your own QSLs we will forward them for you to any place in the world for 4¢ each.

NOW, FOR THAT

## "Extra Class" 2 POWERFUL LINEARS



Built to Operate Dependably With Plenty of Reserve

- Dependable Operation
- Rugged Eimac 3-1000Z
- Instant Transmit • ALC
- Fast Band Switching
- Easy Load and Tune
- Real Signal Impact

**BTI LK-2000** ... For maximum legal amateur input ... 5SB, CW, RTTY.  
Price . . . . \$79500

**BTI LK-2000HD** ... For heavy duty applications such as MARS, high power RTTY and 5SB.  
Price . . . . \$89500

Listen for the hundreds of LK-2000 linears now on the air and judge for yourself. Write for free illustrated brochure or send \$1.00 for technical and instruction manual.

BTI AMATEUR DIVISION

**Hafstrom Technical Products**

4616 Santa Fe, San Diego, Ca. 92109



... THE BEST  
**2 METER  
CONVERTER**



Model 407  
**\$34.95**  
ppd.

144-146 MHz in. 28-30 MHz out  
or 146-148 MHz with a second crystal  
available for \$3.95 extra

A full description of this fantastic converter would fill this page, but you can take our word for it (or those of hundreds of satisfied users) that it's the best. The reason is simple — we use three RCA dual gate MOSFETs, one bipolar, and 3 diodes in the best circuit ever. Still not convinced? Then send for our free catalog and get the full description, plus photos and even the schematic.

Can't wait? Then send us a postal money order for \$34.95 and we'll rush the 407 out to you. NOTE: The Model 407 is also available in any frequency combination up to 450 MHz (some at higher prices) as listed in our catalog. New York City and State residents add local sales tax.

**VANGUARD LABS**

Dept. R, 196-23 Jamaica Ave., Hollis, N.Y. 11423

**Antennas Towers Rotators**  
**New Used Surplus**

We are a member of the Jennings Diode Bank.  
Contact us for any diode.

Service 1/2 amp to 1000 amp any voltage.

HY GAIN · HUSTLER · MOSLEY · EZ WAY  
TRI-EX · ROHN · VESTO · MYLAR  
ROPE · CDR, Etc.

One piece or a complete antenna system  
Also dealing in surplus  
Write for latest catalog

**ANTENNA MART**

BOX 7 · RIPPEY, IOWA 50235

**LARGEST SELECTION in United States  
AT LOWEST PRICES — 48 hr. delivery**



Thousands of frequencies in stock. Types include HC6/U, HC-18/U, FT-241, FT-243, FT-171, etc. SEND 10¢ for catalog with oscillator circuits. Refunded on first order.

2400H Crystal Drive  
Ft. Myers, Florida 33901

**CQ de W2KUW  
BEST OFFER!!**

Paid ..... for any piece of aircraft or ground radio units, also test equipment. All types of tubes. Particularly looking for 4-250 · 4-400 · 833A · 304TL · 4CX1000A · 4CX5000A et al. 17L · 51X · 390A · ARM · GRM · GRC · UPM · URM · USM units.  
TED DAMES CO., 308 Hickory St., Arlington, N.J. 07032

**EAST COAST VHF SOCIETY  
FREE!**

**11TH ANNUAL PICNIC - HAMFEST  
SUNDAY, AUGUST 10TH, 10 A.M.**

**SADDLE BROOK PARK !  
Saddle Brook, N. J.**

**GAMES — REFRESHMENTS  
PRIZES — CONTESTS — DISPLAYS**

**ELECTRONIC MAIL ADVERTISER**

published by WØ Bargains Galore, is the fastest, most readable listing of electronic bargains. Twice a month, 7¢ a word, based on 2 insertions. For a free sample send your QTH to ELECTRONIC MAIL ADVERTISER, 1949 Van Reek Lane, St. Louis, Mo. 63131.

**WHY**

YOU SHOULD HAVE

**W3KT**

**FORWARD YOUR QSLs TO DX STATIONS**

- W3KT** has over eight years of experience in operating an outgoing QSL service.
- W3KT** has forwarded well over a million QSLs during that time.
- W3KT** forwarded over 250,000 QSLs in 1968 alone.
- W3KT** personally has 345 countries confirmed.
- W3KT** offers you a **DELUXE** service. All you have to do is to fill in the card.
- W3KT** considers your QSL a personal message, and sends it out **PROMPTLY** by FIRST CLASS mail.
- W3KT** keeps up-to-date files of stateside QSL managers. When he sends cards to them he includes an SASE, and sends the replies to you via your QSL Bureau.
- W3KT** sends other cards to the proper QSL Bureaus, or, where necessary, direct.
- W3KT** sends out 30 **CARDS PER DOLLAR**, and it is not necessary to send these all at the same time, or if you prefer, he will forward your QSLs at **FOUR CENTS EACH**.
- W3KT** charges **NO MEMBERSHIP FEE**.

TRY THIS SERVICE!

CAN THOUSANDS OF USERS BE WRONG?

**W3KT QSL SERVICE**

RD 1, Valley Hill Road

Malvern, Pa. 19355





**MIDLAND  
SWR AND  
POWER  
METER**

Reads output and reflected power simultaneously. May be left in line up to 2000 watts. Low insertion loss. Size 5x2x2. Good to 175 Mhz. **PRICE \$15.95, FOB HOUSTON.**

**MADISON ELECTRONICS SUPPLY**  
1508 McKINNEY — HOUSTON, TEXAS 77002  
(713) 224-2668

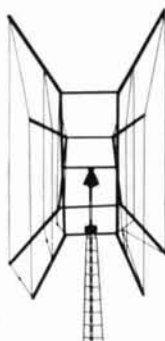

**2 Element  
QUAD**

FOR 10 - 15 - 20

The "JOGA QUAD" is rated at 1KW AM and 2KW PEP SSB. Features a single feed line. Enjoy maximum forward gain and very low SWR over the full bandwidth. The unique shape allows proper element spacing for all bands. It is easy to assemble and resists winds up to 100 MPH. It's lightweight with only a 4 1/2" boom length. A brochure with further information is free for the asking.

**PRODUCTOS JOGA**  
CALLE 50 X 45 NUM. 431  
MÉRIDA, YUC., MEX.



**RECEIVING  
CONVERTERS**

50 - 144 - 220 MHz

**\$17.95**

plus \$1.00 postage & handling



MODEL	INPUT MHz	OUTPUT MHz
512-2A	144-148	50-54
512-2B	144-145	6-1.6
512-2C	144-146	6-1.6
512-2D	144-147	28-18
512-2E	144-148	28-18
512-4A	50-51	6-1.6
512-4B	51-52	14-18
512-4C	50-54	14-18
512-4D	50-52	28-30
512-4E	50-54	28-30
512-4F	200-204	50-54
512-4G	220-222	28-30
512-4H	220-224	28-18

- Rugged fiberglass PC Board Construction
- Supplied with Quartz Crystal — Ready to operate
- Internal Battery Power
- SO-239 Connectors
- IBNC or N Connectors \$1.50 extra!

order from

**VHF Associates, Incorporated**  
P. O. BOX 22135, DENVER, COLO. 80222

**CONVERTER SALE**

RF Input Frequency 50-54 Mhz  
IF Output Frequency 14-18 Mhz  
Noise Figure 2.5 db nom.  
Conversion Gain 20 db nom.

These converters use three high quality UHF transistors as low noise RF amp, mixer, and local oscillator. The power requirement is only 9 to 15 volts at about 5 ma with either positive or negative ground. A power gate circuit is incorporated to protect the units against accidental application of reverse polarity power. Completely assembled and tested printed circuit board only 3" x 2 1/2" is ready for mounting. Available with either crystal or non-crystal local oscillator. Made in USA and guaranteed.

Crystal controlled, \$6 non-crystal, \$5  
SYNTELEX, 39 Lucille Ave., Dumont, N.J. 07628

**DIODES**

EVERY DIODE WE SELL IS CURVE TRACED ON A SPECIAL TESTER. THIS TESTER DRIVES 2 AMPS AVERAGE CURRENT THROUGH THE UNIT IN THE FORWARD DIRECTION WHILE THE REVERSE LEAKAGE IS MEASURED. (25 MICRO-AMPS). THE OPERATOR EXAMINES THE CURRENT-VOLTAGE PLOT OF EACH DIODE ON AN OSCILLOSCOPE SCREEN. WE FULLY GUARANTEE EVERY UNIT SOLD OR YOUR MONEY REFUNDED.

PIV	TOP-HAT		EPOXY		STUD-
	1.5 AMP	1.5 AMP	3 AMP	3 AMP	MOUNT
50	.04	.06	.12	.15	6 AMP
100	.06	.08	.16	.20	
200	.08	.10	.20	.25	
400	.12	.14	.28	.50	
600	.14	.16	.32	.58	
800	.17	.20	.40	.65	
1000	.20	.24	.48	.75	

**M. WEINSCHENKER K3DPJ**  
PO BOX 353  
IRWIN, PA. 15642



**Radio Amateurs  
Reference Library  
of Maps and Atlas**

**WORLD PREFIX MAP** — Full color, 40" x 28", shows prefix on each country . . . DX zones, time zones, cities, cross referenced tables . . . postpaid **\$1.00**

**RADIO AMATEURS GREAT CIRCLE CHART OF THE WORLD** — from the center of the United States! Full color, 30" x 25", listing Great Circle bearings in degrees for six major U.S. cities; Boston, Washington, D.C., Miami, Seattle, San Francisco & Los Angeles. . . . . postpaid **\$1.00**

**RADIO AMATEURS MAP OF NORTH AMERICA!** Full color, 30" x 25" — includes Central America and the Caribbean to the equator, showing call areas, zone boundaries, prefixes and time zones, FCC frequency chart, plus informative information on each of the 50 United States and other Countries. . . . . postpaid **\$1.00**

**WORLD ATLAS** — Only atlas compiled for radio amateurs. Packed with world-wide information — includes 11 maps, in 4 colors with zone boundaries and country prefixes on each map. Also includes a polar projection map of the world plus a map of the Antarctica — a complete set of maps of the world. 20 pages, size 8 1/4" x 12" . . . . . postpaid **\$2.00**

Complete reference library of maps — set of 4 as listed above . . . . . postpaid **\$3.00**  
See your favorite dealer or order direct.

**WRITE FOR  
FREE  
BROCHURE!**

RADIO AMATEUR



**callbook INC**  
Dept. E, 925 Sherwood Drive  
Lake Bluff, Ill. 60044

REVIEWED IN MARCH, 1968 HAM RADIO

## oscillator/monitor

- a sensitive broadband RF detector gives audible tone signal in the presence of any RF field from 10mw to 1 kw and 100kc to 1000mc.
- a CW monitor with positive "RF" switch uses only 8" pickup antenna and NO connection to rig or key
- a code practice oscillator with adjustable tone & built in speaker
- high gain 4 transistor circuit powered by long life AA pencil
- 16 gauge aluminum cabinet in white & black epoxy finish, 3 1/2" by 2 1/2" by 1 1/4", weight 8 ounces
- 100% US made and guaranteed



1295 (batt incl)  
ppd usa & can  
send cert ck or m.o.  
ny res add 5% tax

the James research company  
11 schermerhorn st., brooklyn n.y. 11201

WE PAY **HIGHEST**  
PRICES FOR ELECTRON  
TUBES AND SEMICONDUCTORS

## H & L ASSOCIATES

ELIZABETHPORT INDUSTRIAL PARK  
ELIZABETH, NEW JERSEY 07206  
(201) 351-4200

## SPACE AGE KEYS

Only  
\$67.50



- Planar epitaxial integrated circuits for reliability. No tubes—No separate transistors.
- Precision feather-touch key built-in.
- Fully digital—Dot-dash ratio always perfect.
- No polarity problems—Floating contacts switch  $\pm 300\text{-V}$  @ 100-ma.
- Rugged solid construction—will not walk.
- Send QSL or postcard for free brochure.

## PALOMAR ENGINEERS

BOX 455, ESCONDIDO, CAL. 92025

## ... THE BEST 6 METER CONVERTER



Model 407  
\$34.95  
ppd.

50-52 MHz In. 28-30 MHz out  
or 52-54 MHz with a second crystal  
available for \$3.95 extra

A full description of this fantastic converter would fill this page, but you can take our word for it (or those of hundreds of satisfied users) that it's the best. The reason is simple — we use three RCA dual gate MOSFETs, one bipolar, and 3 diodes in the best circuit ever. Still not convinced? Then send for our free catalog and get the full description, plus photos and even the schematic.

Can't wait? Then send us a postal money order for \$34.95 and we'll rush the 407 out to you. NOTE: The Model 407 is also available in any frequency combination up to 450 MHz (some at higher prices) as listed in our catalog. New York City and State residents add local sales tax.

## VANGUARD LABS

Dept. R, 196-23 Jamaica Ave., Hollis, N.Y. 11423

## W2AU BALUN LETS ENTIRE ANTENNA RADIATE!

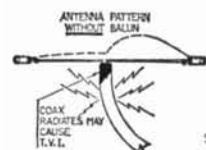
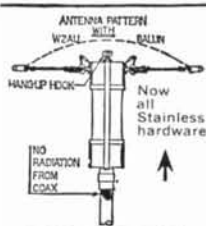

STOP WASTING YOUR SIGNAL!  
REMEMBER, YOUR ANTENNA  
IS THE MOST IMPORTANT  
PIECE OF GEAR YOU OWN.

- No Radiation from Coax
- No Center Insulator Needed
- Perfect for Inverted Vees (Use Hang-up Hook)
- Built-in Lightning arrester
- Broad Band 3 to 40 mc.
- Takes Legal Power Limit and then some
- Two Models:  
1:1 50 ohm coax to 50 ohm balanced  
4:1 75 ohm coax to 300 ohm balanced
- A must for Inverted Vees, Doublets, Quads, Yagis and Multiple Dipoles.

\$12.95 AMATEUR  
NET

See QST and May 73  
for more details

W2AU Complete pretuned Fiberglass Quad \$99.95  
W2AU Complete pretuned Vinyl Quad \$64.95

UNADILLA RADIATION PRODUCTS  
Unadilla, N. Y. 13849 607-369-2985

## LIBERTY PAYS MORE!!

WILL BUY FOR CASH — ALL TYPES  
Electron Tubes • Semiconductors • Test Equipment  
• Military Electronic Equipment

Wire, write, phone collect! We pay freight on all purchases!  
LIBERTY ELECTRONICS, INC.  
548 Broadway, New York, N. Y. 10012  
Phone: 212/925-6000



### DUAL TRANSISTOR IGNITION SYSTEM

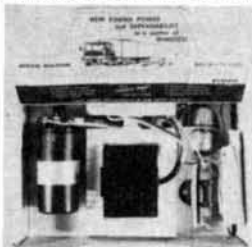

This system was made by Canadian Tire to sell for \$35.00. These are Brand New fully wired surplus, not rejects. The extra high voltage coil provides smoother running at high speeds and longer plug life, and the lower current through the points makes for longer point life and faster winter starts. Special connector allows instant change over to conventional ignition. Fully Guaranteed, with instructions ready to install for 6 or 12 volt negative ground car. CLOSE OUT SPECIAL DTI ..... \$10.00 p.p.

### POOR MAN'S HI FI HEADPHONES

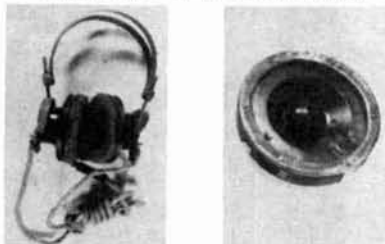

The Canadian Air Force has surplus also and we were fortunate to obtain over 500 headsets from them and are passing the savings on to you. They are unused and in the original cartons. The headphone elements are actually miniature speakers, as pictured, and this is the way Hi-Fi phones are constructed. Will give excellent fidelity with either voice or music. They have rubber pads with chamois-type covering, metal headband, cord and plug. 4 to 16 ohm impedance for use with any radio or TV, etc., by attaching to the speaker leads. May be converted to "stereo" by making connections at each ear phone. This is a real bargain for quality RCAFP head sets. RCAFP HP ..... \$3.00 p.p.

### GEIGER COUNTER - GOV'T SURPLUS



"CD" Type Radiation Survey Detectors are in like new condition, with instruction manual, and straps. Picture shows typical unit. Bright yellow plastic case, waterproofed. Meter readings may be made from 0.01r/hr to 50r/hr. Units are clean and are offered untested as is at a low price of \$10.00 less batteries, battery price about \$1.50. With life of 400 hrs. or intermittent operation. CD MD. No. 710 GC 710 ..... \$10.00 p.p.

### UNIVERSAL LOGIC CIRCUIT CARDS

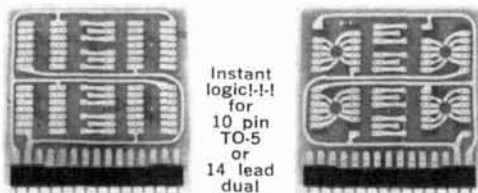

Instant logic!-I- for 10 pin TO-5 or 14 lead dual in-line

### INTEGRATED CIRCUITS

These boards are the most useful items we have ever offered for breadboarding with low cost integrated circuits. The cards are made from 1/16" G-10 Glass Epoxy, with pads for 14 lead dual in-line mounting pads on one side and 10 lead TO-5 pads on the other. 8 lead TO-5 cans will mount in the 10 lead TO-5 pads also. Discrete Transistors and components can be mounted in the locations between the I.C.'s, power supply leads are already routed around the board. Our competitors charge \$9.50 each for circuit card and mating connector. We give you a surplus, unused p.c. board with components on it (that you can keep for your junk box), a connector and its mate, and our great circuit card. You drill out the desired hole pattern, unsolder the connector from the surplus card and install it on the new card, wire in the I.C.'s and compute. A few minutes of your time, and you save over 80% of the cost of comparable p.c. cards. Get enough for your breadboarding needs now because these are going to go fast.

2 Cards & mating connectors	2 ICC	\$ 2.50 p.p.
10 Cards & mating connectors	10 ICC	\$10.00 p.p.
100 Cards & mating connectors	100 ICC	\$88.00 p.p.

### MAGNETIC MEMORY DRUM

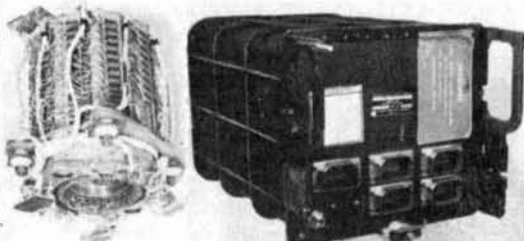

This Memory drum originally cost the government over \$6400.00, and is a truly fantastic piece of equipment. It was made by Hughes Aircraft Co. as part of an aircraft computer. The unit is completely sealed and therefore the drum surface is in excellent condition. It has 146 heads mounted in 11 columns, 12 are phase adjustable timing heads, the drive motor requires 115 VAC 400 cycle(Hz) 150 VA, and has a speed of 800 RPM. Sh. Wt. 50#. MMD-59 ..... \$100.00

SEND 25¢ FOR OUR LATEST, BEST CATALOG YET, JAM PACKED WITH ELECTRONIC BARGAINS . . . FREE WITH AN ORDER . . .

**B Enterprises**

P. O. BOX 44, HATHORNE, MASS. 01937

# BOOKS!

## Radio Society of Great Britain Publications RADIO COMMUNICATION HANDBOOK — Fourth Edition

A complete guide to virtually all technical aspects of amateur radio. Over 50% larger than previous editions. Prepared by the outstanding amateurs in Great Britain today. 832 pages. Hardbound \$11.95

## AMATEUR RADIO TECHNIQUES — Second Edition J. Pat Hawker, G3VA

Brand new edition — completely revised. A very complete collection of short articles and ideas covering many aspects of amateur radio. Includes new enlarged semiconductor section. 160 pages. Only \$2.50

## AMATEUR RADIO CIRCUITS BOOK

Completely revised — new edition. A very handy collection of many useful circuits for amateur use. Loaded with good ideas for that new converter, exciter or other project you are working on. Only \$2.00

## RADIO DATA REFERENCE BOOK — Second Edition — By G. K. Jessop, G6JP

Here in a 148 page book is one of the most complete compilations of radio and electronic charts, nomographs, formulas and design data available. Whether you design, build or operate, this is a book you must have. Only \$2.50

## WORLD AT THEIR FINGERTIPS — John Clarricoats, G6CL

A very interesting history of the RSGB and of amateur radio in Great Britain. It gives a great insight into the development of our hobby. Paper back edition \$2.50  
Deluxe edition \$6.50

### Other Important Volumes

#### RADIO HANDBOOK — 17th Edition

How to design, build and operate the latest types of amateur transmitters, receivers, transceivers and amplifiers. Provides extensive, simplified theory on practically every phase of radio. 848 pages. Only \$12.95

#### ALL ABOUT CUBICAL QUAD ANTENNAS by W6SAI

Construction and tuning data. Multi-band Quads. Charts, drawings and photos for your Quad. Full complete data on homemade Quad antennas. The new X-Q Quad. \$3.95

#### VHF HANDBOOK by Orr W6SAI & Johnson W6QKI

First complete Handbook covering the VHF spectrum! Many VHF construction projects. Design and construction of VHF transmitters, receivers and antennas! Make your VHF station work! \$3.75

#### THE CARE AND FEEDING OF POWER GRID TUBES by Robert Sutherland, W6UOV

Just as the title says, a very complete rundown on the use of power tubes. Be sure to read this before you start work on your new linear. Only \$3.95

#### BEAM ANTENNA HANDBOOK by William Orr, W6SAI

New edition. Theory, design, construction, and the installation of rotary beam antennas! SWR data! Multi-band beams, 40 meter beams, 20 meter DX beams! How to make your beam work! 200 pages. \$3.95

#### NOVICE & TECHNICIAN HANDBOOK by W6SAI and W6TNS

All about amateur radio in non-technical language! How to learn the code. How to assemble your ham station. Transmitters! Receivers! DX! How to get QSL cards. \$2.95

#### ELECTRONIC CONSTRUCTION HANDBOOK by Robert Lewis, W8MQU

All about design - construction - layout and testing of electronic equipment. Non-technical guide for kit-builders and your best key to better performance of your equipment! \$2.95

Postpaid in USA & Canada

**comtec**

Box 592 Amherst, New Hampshire 03031

# MAYDAY EMERGENCY MAYDAY HELP!

## DOCTOR'S ORDERS MUST QUIT BUSINESS

JUNK for sale, a large assortment of test sets, power supplies, amplifiers, medical electronics, originally bought for stripping purposes, but didn't get to do. CASH and CARRY only.

Sorry, NO Mail Orders accepted.

10¢ per pound, plus 10¢ each tube, and 50¢ each meter.

### SPECIAL DISCOUNTS

All items advertised since January 1968 in HAM RADIO and 73, and listed in my "GOODIE SHEET" for May 1968 and February 1969, except the above "JUNK", co-ax connectors, co-ax cable, and the few items previously reduced, from my already low prices:

#### FOR SALES OF

- \$10.00 and up a discount of 5%
- \$50.00 and up a discount of 7½%
- \$100.00 and up a discount of 10%

It may pay for a group to get together, or a club to pool their orders, shipment to one address only, no split shipments. to take advantage of the higher discount. Discounts only apply on mail orders, or sales at the store.

Sale ends on August 16. PLEASE include sufficient to cover postage, or other shipping charges. For heavier shipments, please specify routing — REA, motor freight, or bus express.

Sorry, NO more Hamfests.

### STORE HOURS

Monday thru Friday, 9:30 a.m.-4:30 p.m.  
Saturday, 9:30 a.m.-2:30 p.m.

### B C Electronics

Telephone 312 CALumet 5-2235  
2333 S. Michigan Ave. Chicago, Illinois 60616

## LOW PRICE, QUALITY, COAXIAL SWITCHES . . .



Don't pay for the 5th and 6th position. The average HAM rarely uses more than 4!

**SPECIFICATIONS:** Silvered Contacts. Write-on ERASABLE escutcheon plate. AVAILABLE EITHER 4 PST (COAX-9) OR LINEAR (COAX-LINEAR) IN-OUT VERSION. Handles 1000 W AM or 2000 W SSB. Insertion loss negligible to 160 Mc. VSWR: Less than 1.2 at 160 Mc. Size: 3/4" dia. x 1 1/4" overall. Single hole mount. SPECIFY MODEL. \$7.65 ea.

## COAXIAL LIGHTNING ARRESTORS



Zero power loss. No increase in SWR at 150 Mc. Does not alternate signals. Model 210 for 1000 W (AM) or 2000 W (SSB). Model 211 Electronic static arrester for 50 W (AM) or 100 W (SSB). SO-239 UHF type fittings. Other fittings available. Size approx. 3/4" x 1/4" dia. #210 \$3.15 ea. #211 \$4.65 ea. SPECIFY model #.

PRICES above are amateur net. Shipped ppd. in U.S.A. Send Check or M.O. (N.J. ADD 3% Sales Tax)

OTHER PRODUCTS: Feed thru capacitors. Tuned noise filters. Alternator, generator, low-pass and field filters. SEND FOR CATALOG.

**"COMMUNICATION ENGINEERED"**  
By "HAMMIE" RICHARDT-W2WIY

**ELECTRONIC APPLICATIONS CO.**  
ROUTE 46, Pine Brook, N. J. 07058

**BARRY  
PAYS  
CASH  
FAST**

You can be sure with Barry . . .  
Fair dealing since 1938

Send lists of your unused TUBES,  
Receivers, Semi-Conductors,  
Vac. Variables, Test Equipment, etc.

No Quantity too Small.  
No Quantity too Large.

Write or Call now . . . BARRY, W2LNI

**BARRY ELECTRONICS**  
512 BROADWAY • NEW YORK, N. Y. 10012  
212 - WA 5-7000

## GET IT from GOODHEART!

EVERYTHING UNCONDITIONALLY GUARANTEED

### REGUL. PWR SPLY FOR COMMAND, LM, ETC.:

PP-106/U: Metered. Knob-adjustable 90-270 v up to 80 ma dc; also select an AC of 6.3 v 5A, or 12.6 v 2 1/2 A or 28 v 2 1/2 A. With mating output plug & all tech. data. Shpg wt 50# **19.50**

### BARGAINS WHICH THE ABOVE WILL POWER:

LM-(\*) Freq. Meter: .125-20 MHz, .01%, CW or AM, with serial-matched calib. book, tech data, mating plug. Checked & grtd. **57.50**  
TS-323 Freq. Meter: Similar to above but 20-480 MHz, .001%. With data **169.50**  
A.R.C. R11A: Modern Q-5'er 190-550 KHz **12.95**  
A.R.C. R22: 540-1600 KHz w/tuning graph **17.95**  
A.R.C. R13B: 108-132 MHz w/tuning graph **27.50**

### ULTRA-WIDE-BAND RECEIVER:

AN/ALR-5: Late postwar AM/FM Countermeasures rcvr. Has S-Meter; variable IF Atten. & passband (0.2 or 2 MHz from 30 MHz center); AF. Video & Pan. outputs. New, modified for 120 v 60 Hz. Includes new (Method II pack) 4-band plug-in converter .038-1 GHz. 4 Type-N plugs automatically select correct ant. as bands are switched. Sensit. at -6 db setting: 6 1/2 uv thru 132 MHz. .13 thru 780 MHz & 45 1/2 at 1 GHz. BRAND NEW, with book & mating pwr-input plug, only **275.00**

### FOUND! A NEAT & COMPACT SCOPE XFRMR!

Freed 12691: DAS Loran Spares, supplied 5" CR, plates & hrs. Pri. 105-130v 50/60Hz. Sec's insul. 5 kv: 1490 & 1100 v, 5 ma; 390-0-390 v 100 ma; electrostatically-shielded 6.3 v, 0.8 A; two 2 1/2 v, 2 A. Sec's insul. 1 1/2 kv: two 6.3 v, 6 A; 5 v, 3 A; 2 1/2 v, 5A. Case 5 1/4 x 5 x 7 1/4. With diagram. **2.95**  
Shipped only by collect REA Express.

FAIRCHILD SOLID-STATE SCOPES all w/dual-trace plug-ins 25 & 50 MHz, w/delayed time-base plug-ins, w/books, overhauled & grtd. As low as **825.00**

### Versatile Plate & Filam. Transformer:

Depot Spares for SP-600-JX: Pri. 95/105/117/130/190/210/234/260 v 50/60 Hz. Sec. 1: 305-0-305 v, 150 ma. Sec. 2: 5 v 3A. Sec. 3: 6.3 v 5 A. Sec. 4: 7 1/2 v, 3/4 A. Sec. 5: 7 1/2 v, 1 1/4 A. Legend for pins is plainly marked. Herm. sealed. **2.95**

We probably have the best inventory of good lab test equipment in the country. But, please do not ask for catalog! Ask for specific items or kinds of items you need! We also buy! What do you have?

### R. E. GOODHEART CO. INC.

Box 1220-HR, Beverly Hills, Calif. 90213  
Tel: Area 213, office 272-5707, messages 275-5342

**WE PAY CASH FOR TUBES**  
**LEWISPAUL ELECTRONICS INC.**  
303 W. Crescent Avenue  
Allendale, New Jersey 07401

### ALL BAND TRAP ANTENNA !

Reduces Interference and Noise on ALL Makes Short Wave Receivers. Makes World-Wide Reception Stronger. Complete with 56 ft. 72 ohm feedline. Sealed resonant traps. For novice and class radio amateurs! Eliminates 5 separate antennas with better performance guaranteed. 50-40 20-10 meter bands. Complete 102 ft. \$19.95. 40-20-15-10 meter bands. 54 ft. (best for world-wide short wave reception) \$18.95. Send only \$3.00 (cash, c.k. m.o.) and pay postman balance C.O.D. plus postage on arrival or send full price for postpaid delivery. Complete instructions included!

WESTERN ELECTRONICS Dept. B Kearney, Nebr. 68847

## DECIMAL COUNTER



Electronic indicating decade, vacuum tube type, 4 tubes. Displays 0-9 counting input pulses. One unit may be used to drive another. Removed from equipment, w/tubes, w/ schematic. **\$8.00 each, 2/\$15.00, 10/\$60.00**



## COAX SWITCH

Unused coaxial switch, 12 volt coil, standard UHF fittings. Made by Allied Control. **\$5.00**

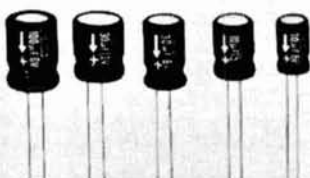

## TRANSISTOR CAPS

Volts	Mfd	Each	12
25	1	\$ .10	\$ 1.00
15	5	.10	1.00
15	10	.12	1.20
15	500	.20	2.00
12	15	.12	1.20
12	150	.15	1.50
8	300	.20	2.00
6	10	.09	.90
6	30	.10	1.00
6	50	.12	1.20
6	200	.15	1.50

Your choice of the above as listed . . . or . . . grab-bag our choice, **10 different \$1.10**

## CB CRYSTALS

The following CB crystals offered at 50¢ each, you pick 'em. Or, we will give a grab bag of

**6 different (no choice) \$1.50**

TRANSMIT: 1-2-3-4-5-6-7-8-9-10-11-12-13-14-17  
RECEIVE: 6-7-9-11-13-15-17-18-19

## 3400 VOLT CT XFMR 800 WATTS

Brute of a transformer, Arnold core. 115 volt 60 cycle input, output of 3400 VCT.

**\$10.00 each; 6 for \$50.00**

## IBM WIRED MEMORY FRAMES.

Removed from high priced computers. Exlnt condition.

4,000 Wired Core Plane	\$ 9.00
4,096 Wired Core Plane	\$12.50
8,000 Wired Core Plane	\$13.50
8,192 Wired Core Plane	\$15.00
16,384 Wired Core Plane	\$19.00

## LOW PASS FILTER

Brand new, w/UHF fittings, good for 100 watts, up to 30mc. 52 or 72 ohm line, attenuation min of 60 db from 35 mc thru FM & TV bands. **\$4.00**



## SLUG TUNED COILS

For PC board and one hole mount. Grab bag of 8 various types, ceramic, lucite, some with windings (easily removed to replace with your own). A good \$5.00 value for only **8 for \$1.00**

**50 for \$5.00**

## COMPUTER GRADE CAPS

for power supplies, photo strobe, linears  
**UNUSED**

600 MFD 450 V.	\$2.00—12/\$22.
6,000 MFD 75 V.	\$1.50—12/\$15.
110,000 MFD 15 V.	\$2.00—12/\$22.
0.5 MFD (OIL)7500 V	\$4.00—12/\$45.

## JOHN MESHNA JR.

19 ALLERTON ST., LYNN, MASS. 01904  
P. O. BOX 62, E. LYNN, MASS. 01904

# ABSOLUTELY

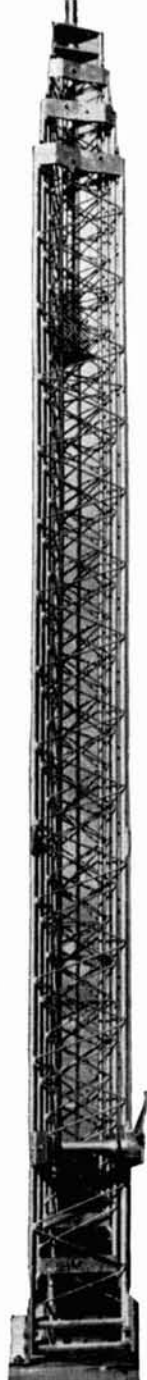

## TRI-EX

### FREE STANDING TOWER.

SUPPORTS 9 SQ. FT. OF ANTENNA.

Shown with internal Ham M rotator and 2" mast.

### INCLUDES

- FREE: RIGID BASE MOUNT
- PRE-DRILLED TOP PLATE — For TB-2 thrust bearing.
- HIGH STRENGTH STEEL TUBING LEGS. Solid rod, "W" bracing.
- EASY MAINTENANCE — No guys or house brackets needed.
- RISES TO 67 FT. — Nests down to 22 ft.
- HOT DIPPED GALVANIZED AFTER FABRICATION! All welding by certified welders.

### IMMEDIATE DELIVERY

FREIGHT PREPAID INSIDE CONTINENTAL U.S.A.

**Tri-Ex TOWER CORPORATION**  
7182 Rasmussen Ave., Visalia, Calif. 93277

# Advertisers iNdex

Aerotron, Inc.	Cover IV
Amateur Radio, Inc.	96
Antenna Mart	86
Antennas, Inc.	79
Arcturus Electronics Corp.	89
BC Electronics	91
B & F Enterprises	90
Barry Electronics	92
Bob's Amateur Electronics	76
Collins Radio Co.	Cover II
Columbia Electronics	89
Communications Technology	73, 81
Dames Co., Theodore E.	86
Drake Co., R. L.	2
East Coast VHF Society	86
Elmac Division of Varian	5
Electronic Applications Co.	92
Electronic Mail Advertiser	86
Goodheart Co., Inc., R. E.	92
Gordon Co., Herbert W.	Cover III
H & L Associates	88
Hafstrom Technical Products	85
Ham Radio Magazine	77, 78
Hammarlund Manufacturing Co.	35
Henry Radio	1
International Crystal Manufacturing Co., Inc.	40
James Research	88, 89
Jan Crystals	86
Joga, Products	87
Lewispaull Electronics, Inc.	92
Liberty Electronics	88
Madison Electronics Supply	87
Meshna, John, Jr.	93
National Radio Co., Inc.	19
Palomar Engineers	88
RCA Institutes, Inc.	57
Radio Amateur Callbook, Inc.	84, 87, 89
Radio Shop	84
Signal/One	6, 7
Space Electronics	77
Spectronics	51
Stellar Industries	95
Structural Glass, Ltd.	85
Swan Electronics	71
Syntelax	87
Telrex Communication Engineering Laboratory	89
Tri-Ex Tower Co.	94
Unadilla Radiation Products	88
VHF Associates	87
VHF Communications	85
Vanguard Labs	86, 88
Varitronics, Inc.	82
W3KT	86
Weinschenker, M.	87
Westcom Engineering Co.	75
Western Electronics	92
World QSL Bureau	85
Worthingham Electronics Co.	69



# GALAXY MAKES 'EM



# STELLAR SELLS 'EM

See GLEN FADDEN, W2CXX  
or a member of his staff at



**stellar industries**  
DIV. OF STELLAR I, Inc.  
SALES AND SERVICE

10 GRAHAM ROAD WEST, ITHACA, N. Y. 14850 · TELEPHONE 607-273-9333

Your Central New York headquarters for new and used ham gear

HOURS: 9:00 A.M. to 5:30 P.M. Monday through Friday 9:00 A.M. to 5:00 P. M. Saturday

# LOOKING FOR RESULTS ?

Then try a  
**HY-GAIN DOUBAND BEAM**  
from A. R. I.



The perfect answer for a winning antenna system, the Model DB-24B covers 20 and 40 meters while the Model DB 10-15A is designed for 10 and 15 meter operation. Built to offer the finest electrical and mechanical performance.

**Model DB-24B      \$189.95**

**Model DB 10-15A      89.95**

Shipped prepaid in the continental U. S. A.

FREE 100' of Alpha-Foam RG-8U Cable  
with each Hy-Gain Duoband during July

---

*A. R. I.* **AMATEUR RADIO INC.** *A. R. I.*  
TWO GREAT STORES TO SERVE YOU

---

**L. A. Amateur Radio Inc.**  
24214 CRENSHAW BLVD.  
TORRANCE, CALIF. 90505  
213-376-4455

**Evansville Amateur Radio Inc.**  
1311 N. FULTON AVENUE  
EVANSVILLE, INDIANA  
812-422-4551



## FM

Enhancing the ham world is the recently developed art of FM repeater operation for 2 meters and 6 meters which is now sweeping our country. There seems to be no limit to the usefulness of these small FM mobile and fixed devices. Their application defies the conventional thinker.

Here, in the North-East, a little tiny transceiver, mobile operated, can communicate by means of mountain top repeaters, with stations literally hundreds of miles away and, I am told, that such a set up exists in California and in many other parts of our country.

One of the cleverest and best thought out commercial products made to top this market is the Varitronics Inoue FDFM-2S, illustrated herewith. This all solid state device comes complete with microphone, speaker, mounting bracket, power cables, plugs and three crystals.

Channel 1 receives 146.94 and transmits on 146.34. Channel 2 is simplex on 146.94. Four additional crystal positions are provided and can be switched in at will. Complete squelch and metering is likewise furnished. Only 6½" wide x 3" high x 7½" deep and weighing but 4 pounds 4 ounces, the FDFM-2S is small and compact

enough to even fit a Porsche or other small compact foreign cars. Tiny rooftop antennas are available. Providing efficiency of up to 50% and operating with 10 watts input, these little gems make it entirely feasible to maintain reliable communications on a true FM noise free basis.

The receiving section is really hot with a sensitivity better than half a micro volt for 20 DB signal to noise. Spurious responses are downed at least 60 DB, and both units draw only 225 mils. When transmitting the FDFM-2S draws 1.5 amps, while for receiving, the FDFM-2S draws only 0.7 amps.

We stock both the 10 watt unit, described at \$310.00, and the 2 watt unit, which sells for only \$250.00. Both units are sold post-paid to United States and Canadian points and are 100% guaranteed for six months from date of purchase.

We endorse this fine product 100% and carry it in depth for immediate delivery. If you are thinking of something interesting this summer and want something different, yet a definite part of the ham radio picture, consider FM. It is exciting to those who own it and practical to those who use it and much more reliable than CB.

**HERBERT W. GORDON COMPANY**

Harvard, Massachusetts 01451 • Telephone 617 - 456 - 3548

*"Helping Hams to Help Themselves"*



# Just Getting Started In Ham Radio?

If your interest in ham radio has only recently developed you already know by now that there are hundreds of brands of equipment from which to choose, some costly . . . some not too costly. For years, Ameco equipment has appealed to the beginner because of its modest cost, yet with engineering and manufacturing quality you would expect to find in really expensive gear. Read about our All-Wave Receiver and Novice Transmitter below, then write for our new Ameco catalog to get complete specifications on these and other moderately priced items.

## Model R-5A Allwave Receiver



An exceptionally fine receiver for the short wave listener and beginning amateur operator. Fully transistorized-solid state. Covers .54 Mc through 54.0 Mc in five continuous bands. Includes standard broadcast band, all foreign broadcast bands, all amateur bands from 160 through 6 meters, all 27 Mc CB channels, all 2 way radio frequencies from 30 to 50 Mc including many police and fire departments. Controls include Beat Frequency Oscillator, Noise Limiter, Bandspeed. Provisions for external "Q" multiplier. Compare with tube-type units costing as much!

Wired and tested **\$99.95**  
 Battery adapter kit. (permits operation  
 from 12 VDC or eight "D" cells) **\$ 3.95**

## Model AC-1 Novice CW Transmitter Kit



The ideal kit for the beginner who requires a reliable TVI suppressed transmitter. Keying is clean and chirp-free. Crystal controlled, PI-network Output Circuit. Includes AC Power Supply. For 40 and 80 meters, CW. Fifteen watts input. Kit is simple to build and easy to operate.

Kit with coil for any 1 band, including tubes **\$23.95**  
 Extra coil kit for any 1 band, CK-1 **1.00**

## Ameco Books and Records

Radio Amateur Theory Course: Gives sufficient information to pass the FCC exams for the Novice, Technician, General and Conditional Classes of Amateur Licenses. The Ameco Theory Course is the shortest path to getting a ham ticket.

No. 102-01, Over 300 pages **\$3.95**

Radio Amateur License Guide: A study guide for those preparing for the Novice, Technician, Conditional and General Classes of Amateur licenses. Contains over 200 questions and answers.

No. 5-01, 32 pages **50¢**

Mastering the Morse Code: Teaches the beginner how to learn the International Morse Code.

No. 6-01, 32 pages **50¢**

Ameco Jr. Code Course: Fastest, simplest way to learn code. Contains 10 lessons and one 12" record in the 33 rpm series. Sample FCC-type exams included.

Complete Jr. Code Course (100 series) **\$3.95**



Division of Aerotron, Inc.  
 P. O. Box 6527 Raleigh, North Carolina 27608