

73 Amateur Radio Today

MAY 2003
ISSUE #510
USA \$3.95
CANADA \$4.95

**Tunable
Broadcast Band
Filter**

**Avoid
Disaster
Disasters**

**Wouff Hong
& Rettysnitch**

**Emergency
Power System**

**Madeira Hams
Pour It On**



*****AUTO**3-DIGIT 231
10938-9N ARO CAD3
JACK SPEER
BUCKMASTER PUBLISHING
6196 JEFFERSON HIGHWAY
MINERAL VA 23117-3425

83
115

05

0 74851 08725 1

ALINCO *Unleash The Power*

New



DR-620T VHF/UHF

Dual-Band Mobile/Base

**First Amateur Twin Band Mobile To Support
Optional Digital Voice Communications***

- RX-VHF 108-173.995 MHz, UHF 335-480 MHz
- TX-VHF 144-147.995 MHz, UHF 430-449.995 MHz
- Receives Airband and Wide FM
- Front control unit separation (optional EDS-9 kit required)
- Advanced 10F3 digital mode with speech compression technology (EJ-47U required)*
- 200 memory channels
- Advanced EJ-50U TNC (optional) supports digi-peet mode
- Remote control features including parameter setting and direct frequency entry through the microphone
- Dual-Band receiver with V/U, V/V, U/U capability
- CTCSS/DCS encode/decode and European Tone-bursts
- OUTPUT: H/M/L-50/10/5 watts VHF
- OUTPUT: H/M/L-35/10/5 watts UHF



DR-605TQ VHF/UHF

Dual-Band Mobile/Base

Full 2 Meter/440 Performance

- 100 memory channels, + a "call" channel for each band
- CTCSS encoded+decoded and tone scan
- Cross-band repeat and full duplex capability
- 9600 bps packet ready with dedicated terminals
- Internal duplexer - one easy antenna connection
- RX-VHF 136-173.995 MHz, UHF 420-449.994 MHz
- TX-VHF 144-147.995 MHz, UHF 430-449.994 MHz
- MARS capability (permit required)
- OUTPUT H/L - 50/5 watts VHF, 35/5 watts UHF
- Time-out timer (ideal for repeater and packet operation)

DJ-V5TH VHF/UHF

Dual-Band FM Transceiver

5 watts of output power, in a compact package.

- Alphanumeric Display, up to 6 characters
- TX-VHF 144-147.995 MHz, UHF 420-449.995 MHz
- 200 memory channels plus two call channels
- Full VHF + UHF Amateur Band Coverage
- Receive Range, (76 - 999MHz) includes Wide FM capability
- Up to 5 watts output, 3 output settings
- CTCSS encode+decode DTMF squelch and European Tone bursts
- 4 scan modes, 5 programmable scan banks
- MARS capability (permit required)



Ask your dealer
about the full line of
**Iron Horse antennas &
accessories!**



DJ-596T VHF/UHF Dual-Band HT with Digital Voice Option*

Loaded with features! The breakthrough design supports optional digital voice communications and you can easily switch the unit between analog and digital modes!

- Full 4.5 watts output VHF/4w UHF
- Powerful NiMH battery
- 100 memories in any combination of VHF or UHF channels
- Direct frequency input from keypad
- Each memory capable of "odd split" operation.
- Alphanumeric channel labels
- CTCSS/DCS encode+decode plus tone bursts
- Full 2m and 440 band coverage
- Accepts 6 to 16 VDC direct input
- Illuminated Keys and display
- Wide and narrow FM modes
- 10 autodial memories
- Theft alarm feature
- Optional EJ-40U Digital Voice Board!*
- Programming/Clone software available

Distributed in North America by Amateur Distributing LLC • 23 S. High St., Covington, OH 45318 • (937) 473-2840
Specifications subject to change without notice or obligation. *Digital communications require at least two similarly equipped transceivers.
Digital mode may not be legal in some countries. See FAQ on digital at www.alinco.com. Products intended for use by properly licensed operators.
Permits required for MARS use. Specifications subject to change without notice or obligation.

El Supremo & Founder
Wayne Green W2NSD/1

Associate Publisher
F. I. Marion

Executive Editor
Jack Burnett

Managing Editor
Joyce Sawtelle

Technical Editor
Hugh Wells W6WTU

Contributing Culprits
Mike Bryce WB8VGE
Jim Gray II
Jack Heller KB7NO
Chuck Houghton WB6IGP
Andy MacAllister W5ACM
Joe Moell K0OV
Steve Nowak KE8YN/0
Dr. Rick Olsen N6NR

Advertising Sales
Evelyn Garrison WS7A
21704 S.E. 35th St.
Issaquah WA 98029
425-557-9611
Fax: 425-557-9612

Circulation
Frances Hyvarinen

Data Entry & Other Stuff
Norman Marion

Business Office
Editorial - Advertising - Circulation
Feedback - Product Reviews
73 Amateur Radio Today Magazine
70 Hancock Rd.
Peterborough NH 03458-1107
603-924-0058
Fax: 603-924-8613

Reprints: \$3 per article
Back issues: \$5 each

Printed in the USA

73 Amateur Radio Today

TABLE OF CONTENTS

FEATURES

- 10 **Tunable Broadcast Band Filter — K8ZOA**
Another great project from K8ZOA.
- 22 **How to Avoid a Disaster Disaster — WB9YBM**
And how about putting the field back in Field Day?
- 23 **Ready, Set ... Don't Go? — AA2JZ**
The time for preparation to be a meaningful participant in the next emergency situation is before the event occurs.
- 24 **'Quaker Oaths — WA6ITF**
In 1989, the ARS came through ... is it still ready?
- 26 **Ham vs. Power Outage — WA9PYH**
Here's a solution that will warm your heart — as well as your wife's toes.
- 34 **Travels with Henryk — Part 12 — SM0JHF**
Have some Madeira, m' dear?
- 37 **How's That Thing Really Work, Anyway? — AA2JZ**
Part 2: Transmitters.
- 39 **The History of Ham Radio — W9CI**
— Part XV

DEPARTMENTS

- 42 **Above & Beyond — WB6IGP**
49 **Ad Index**
64 **Barter 'n' Buy**
56 **Calendar Events**
50 **The Digital Port — KB7NO**
44 **Hamsats — W5ACM**
53 **Homing In — K0OV**
8 **Letters**
4 **Never Say Die — W2NSD/1**
48 **New Products**
47 **On the Go — KE8YN/7**
60 **Propagation — Gray**
1 **QRX**
63 **Radio Bookshop**

E-Mail
design73@aol.com

Web Page
www.waynegreen.com

QRX...

Wouff Hong and Rettysnitch

a. "The Wouff-Hong is amateur radio's most sacred symbol and stands for the enforcement of law and order in amateur operation."

b. "The Rettysnitch ... is used to enforce the principles of decency in operating work."

— *The Radio Amateur's Handbook*, 1930, p. 11.

In 1930, the *Handbook* had pictures of both instruments of enforcement. By 1936, only the Wouff-Hong appeared, and by 1947, the *Handbook* had deleted both photos. Just when we needed traditions of law and order and of decency in amateur operations to

guide its growth in the post-World-War II explosion of technology and easier licensing, the symbols had disappeared from view.

Many of today's hams have no idea what a Wouff-Hong and a Rettysnitch look like. To rectify that gap in hamdom's essential history: The two main pieces appear to be wood banded by metal strapping and by heavy wire. What the sketches cannot convey is the darkness at the upper end of the longer wood piece, as if stained by blood or purified for its grave duties in the fires of purgatory — or both.

The Rettysnitch is an all-metal tool. Of the five teeth

Continued on page 6

Manuscripts: Contributions for possible publication are most welcome. We'll do the best we can to return anything you request, but we assume no responsibility for loss or damage. Payment for submitted articles will be made after publication. Please submit both a disk and a hard copy of your article [IBM (ok) or Mac (preferred) formats], carefully checked drawings and schematics, and the clearest, best focused and lighted photos you can manage. "How to write for 73" guidelines are available on request. US citizens, please include your Social Security number with submitted manuscripts so we can submit it to you know who.

73 Amateur Radio Today (ISSN 1052-2522) is published monthly by 73 Magazine, 70 Hancock Rd., Peterborough NH 03458-1107. The entire contents ©2003 by 73 Magazine. No part of this publication may be reproduced without written permission of the publisher, which is not all that difficult to get. The subscription rate is: one year \$24.97, two years \$44.97; Canada: one year \$34.21, two years \$57.75, including postage and 7% GST. Foreign postage: \$19 surface, \$42 airmail additional per year, payable in US funds on a US bank. Second class postage is paid at Peterborough, NH, and at additional mailing offices. Canadian second class mail registration #178101. Canadian GST registration #125393314. Microfilm edition: University Microfilm, Ann Arbor MI 48106. POSTMASTER: Send address changes to 73 Amateur Radio Today, 70 Hancock Rd., Peterborough NH 03458-1107. 73 Amateur Radio Today is owned by Shabromat Way Ltd. of Hancock NH.



...POWER ON WITH ASTRON

SWITCHING POWER SUPPLIES...



MODEL SS-10TK



MODEL SS-12IF



MODEL SS-18



MODEL SS-25M



MODEL SRM-30

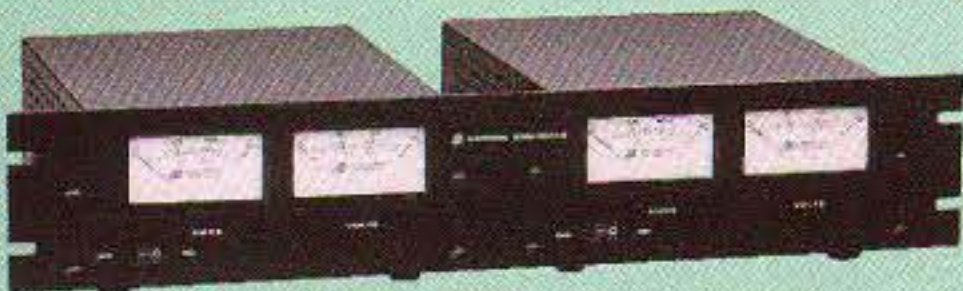

MODEL SRM-30M-2



MODEL SS-12SM/GTX



MODEL SS-10EFJ-98

SPECIAL FEATURES:

- HIGH EFFICIENCY SWITCHING TECHNOLOGY SPECIFICALLY FILTERED FOR USE WITH COMMUNICATIONS EQUIPMENT, FOR ALL FREQUENCIES INCLUDING HF
- HEAVY DUTY DESIGN
- LOW PROFILE, LIGHT WEIGHT PACKAGE
- EMI FILTER
- MEETS FCC CLASS B

PROTECTION FEATURES:

- CURRENT LIMITING
- OVERVOLTAGE PROTECTION
- FUSE PROTECTION.
- OVER TEMPERATURE SHUTDOWN

SPECIFICATIONS:

INPUT VOLTAGE: 115 VAC 50/60HZ
OR 220 VAC 50/60HZ
SWITCH SELECTABLE
OUTPUT VOLTAGE: 13.8VDC

AVAILABLE WITH THE FOLLOWING APPROVALS: UL, CUL, CE, TUV.

DESKTOP SWITCHING POWER SUPPLIES

MODEL	CONT. (Amps)	ICS	SIZE (inches)	Wt.(lbs.)
SS-10	7	10	1 1/2 x 6 x 9	3.2
SS-12	10	12	1 3/4 x 6 x 9	3.4
SS-18	15	18	1 3/4 x 6 x 9	3.6
SS-25	20	25	2 1/8 x 7 x 9 3/8	4.2
SS-30	25	30	3 3/4 x 7 x 9 3/8	5.0

DESKTOP SWITCHING POWER SUPPLIES WITH VOLT AND AMP METERS

MODEL	CONT. (Amps)	ICS	SIZE (inches)	Wt.(lbs.)
SS-25M*	20	25	2 1/8 x 7 x 9 3/8	4.2
SS-30M*	25	30	3 3/4 x 7 x 9 3/8	5.0

RACKMOUNT SWITCHING POWER SUPPLIES

MODEL	CONT. (Amps)	ICS	SIZE (inches)	Wt.(lbs.)
SRM-25	20	25	3 1/2 x 19 x 9 3/8	6.5
SRM-30	25	30	3 1/2 x 19 x 9 3/8	7.0

WITH SEPARATE VOLT & AMP METERS

MODEL	CONT. (Amps)	ICS	SIZE (inches)	Wt.(lbs.)
SRM-25M	20	25	3 1/2 x 19 x 9 3/8	6.5
SRM-30M	25	30	3 1/2 x 19 x 9 3/8	7.0

2 ea SWITCHING POWER SUPPLIES ON ONE RACK PANEL

MODEL	CONT. (Amps)	ICS	SIZE (inches)	Wt.(lbs.)
SRM-25-2	20	25	3 1/2 x 19 x 9 3/8	10.5
SRM-30-2	25	30	3 1/2 x 19 x 9 3/8	11.0

WITH SEPARATE VOLT & AMP METERS

MODEL	CONT. (Amps)	ICS	SIZE (inches)	Wt.(lbs.)
SRM-25M-2	20	25	3 1/2 x 19 x 9 3/8	10.5
SRM-30M-2	25	30	3 1/2 x 19 x 9 3/8	11.0

CUSTOM POWER SUPPLIES FOR RADIOS BELOW

- EF JOHNSON AVENGER GX-MC41
- EF JOHNSON AVENGER GX-MC42
- EF JOHNSON GT-ML81
- EF JOHNSON GT-ML83
- EF JOHNSON 9800 SERIES
- GE MARC SERIES
- GE MONOGRAM SERIES & MAXON SM-4000 SERIES
- ICOM IC-F11020 & IC-F2020
- KENWOOD TK760, 762, 840, 860, 940, 941
- KENWOOD TK760H, 762H
- MOTOROLA LOW POWER SM50, SM120, & GTX
- MOTOROLA HIGH POWER SM50, SM120, & GTX
- MOTOROLA RADIUS & GM 300
- MOTOROLA RADIUS & GM 300
- MOTOROLA RADIUS & GM 300
- UNIDEN SMH1525, SMU4525
- VERTEX — FTL-1011, FT-1011, FT-2011, FT-7011

NEW SWITCHING MODELS

- SS-10GX, SS-12GX
- SS-18GX
- SS-12EFJ
- SS-18EFJ
- SS-10-EFJ-98, SS-12-EFJ-98, SS-18-EFJ-98
- SS-12MC
- SS-10MG, SS-12MG
- SS-101F, SS-121F
- SS-10TK
- SS-12TK OR SS-18TK
- SS-10SM/GTX
- SS-10SM/GTX, SS-12SM/GTX, SS-18SM/GTX
- SS-10RA
- SS-12RA
- SS-18RA
- SS-10SMU, SS-12SMU, SS-18SMU
- SS-10V, SS-12V, SS-18V

Big Savings on Radio Scanners

Uniden®

SCANNERS

AOR



Bearcat® 785DGV APCO P-25 Digital Ready with free deluxe scanner headset
CEI on-line or phone special price \$339.95
 1,000 Channels • 27 bands • CTCSS/DCS • S Meter
 Size: 6^{15/16}" Wide x 6^{9/16}" Deep x 2^{3/8}" High

New Product. Scheduled for initial release January 10, 2003. Order now.
Frequency Coverage: 25.0000-512.0000 MHz., 806.000-823.9875MHz., 849.0125-868.9875 MHz., 894.0125-956.000, 1240.000-1300.000 MHz.

When you buy your Bearcat 785D state-of-the art Digital Capable Trunktracker III package deal from Communications Electronics, you get more. The GV means "Great Value." With your BC785D scanner purchase, you also get a **free deluxe scanner headphone** designed for home or race track use. The Bearcat 785D has 1,000 channels and the widest frequency coverage of any Bearcat scanner ever. When you order the optional **BCi25D, APCO Project 25 Digital Card** for \$299.95, when installed, you can monitor Public Safety Organizations who currently use conventional, trunked 3,600 baud and mixed mode APCO Project 25 systems. APCO project 25 is a modulation process where voice communications are converted into digital communications similar to digital mobile phones. You can also monitor Motorola, EDACS, EDACS SCAT, and EF Johnson systems. Many more features such as S.A.M.E. weather alert, full-frequency display and backlit controls, built-in CTCSS/DCS to assign analog and digital subaudible tone codes to a specific frequency in memory, PC Control with RS232 port, Beep Alert, Record function, VFO control, menu-driven design, total channel control and much more. Our CEI package deal includes telescopic antenna, AC adapter, cigarette lighter cord, DC cord, mobile mounting bracket with screws, owner's manual, trunking frequency guide and one-year limited Uniden factory warranty. For maximum scanning enjoyment, operate your scanner from your computer running Windows. Order Scancat Gold for Windows, part number **SGFW** for \$99.95 and magnetic mount antenna part number **ANTMMBNC** for \$29.95. Not compatible with 9,600 baud APCO digital control channel with digital voice, AGEIS, ASTRO or ESAS systems. For fastest delivery, order on-line at www.usascan.com.

Bearcat® 895XLT Trunk Tracker
 Manufacturer suggested list price \$499.95
Less -\$320 Instant Rebate / Special \$179.95
 300 Channels • 10 banks • Built-in CTCSS • S Meter
 Size: 10^{1/2}" Wide x 7^{1/2}" Deep x 3^{3/8}" High
Frequency Coverage: 29.000-54.000 MHz., 108.000-174 MHz., 216.000-512.000 MHz., 806.000-823.995 MHz., 849.0125-868.995 MHz., 894.0125-956.000 MHz.

The Bearcat 895XLT is superb for intercepting trunked analog communications transmissions with features like TurboScan™ to search VHF channels at 100 steps per second. This base and mobile scanner is also ideal for intelligence professionals because it has a Signal Strength Meter, RS232C Port to allow computer-control of your scanner via optional hardware and 30 trunking channel indicator annunciators to show you real-time trunking activity for an entire trunking system. Other features include Auto Store - Automatically stores all active frequencies within the specified bank(s). Auto Recording - Lets you record channel activity from the scanner onto a tape recorder. CTCSS Tone Board (Continuous Tone Control Squelch System) allows the squelch to be broken during scanning only when a correct CTCSS tone is received. For maximum scanning pleasure, order the following optional accessories: **PS001** Cigarette lighter power cord for temporary operation from your vehicle's cigarette lighter \$14.95; **PS002** DC power cord - enables permanent operation from your vehicle fuse box \$14.95; **MB001** Mobile mounting bracket \$14.95; **EX711** External speaker with mounting bracket & 10 feet of cable with plug attached \$19.95. **CAT895** Computer serial cable \$29.95. The BC895XLT comes with AC adapter, telescopic antenna, owner's manual and one year limited Uniden warranty. Not compatible with AGEIS, ASTRO, EDACS, ESAS or LTR systems.



Bearcat® 245XLT Trunk Tracker II

Mfg. suggested list price \$429.95/CEI price \$189.95

300 Channels • 10 banks • Trunk Scan and Scan Lists
 Trunk Lockout • Trunk Delay • Cloning Capability
 10 Priority Channels • Programmed Service Search
 Size: 2^{1/2}" Wide x 1^{3/4}" Deep x 6" High

Frequency Coverage:

29.000-54.000 MHz., 108-174 MHz., 406-512 MHz., 806-823.995 MHz., 849.0125-868.995 MHz., 894.0125-956.000 MHz.

Our Bearcat TrunkTracker BC245XLT is the world's first scanner designed to track Motorola Type I, Type II, Hybrid, SMARTNET, PRIVACY PLUS and EDACS® analog trunking systems on any band. Now, follow UHF High Band, UHF 800/900 MHz trunked public safety and public service systems just as if conventional two-way communications were used. Our scanner offers many new benefits such as Multi-Track - Track more than one trunking system at a time and scan conventional and trunked systems at the same time. 300 Channels - Program one frequency into each channel. 12 Bands, 10 Banks - Includes 12 bands, with aircraft and 800 MHz. 10 banks with 30 channels each are useful for storing similar frequencies to maintain faster scanning cycles or for storing all the frequencies of a trunked system. Smart Scanner - Automatically program your BC245XLT with all the frequencies and trunking talk groups for your local area by accessing the Bearcat national database with your PC. If you do not have a PC simply use an external modem. Turbo Search - Increases the search speed to 300 steps per second when monitoring frequency bands with 5 KHz. steps. 10 Priority Channels - You can assign one priority channel in each bank. Assigning a priority channel allows you to keep track of activity on your most important channels while monitoring other channels for transmissions. Preprogrammed Service (SVC) Search - Allows you to toggle through preprogrammed police, fire/emergency, railroad, aircraft, marine, and weather frequencies. Unique Data Skip - Allows your scanner to skip unwanted data transmissions and reduces unwanted birdies. Memory Backup - If the battery completely discharges or if power is disconnected, the frequencies programmed in your scanner are retained in memory. Manual Channel Access - Go directly to any channel. LCD Back Light - An LCD light remains on for 15 seconds when the back light key is pressed. Autolight - Automatically turns the backlight on when your scanner stops on a transmission. Battery Save - In manual mode, the BC245XLT automatically reduces its power requirements to extend the battery's charge. Attenuator - Reduces the signal strength to help prevent signal overload. The BC245XLT also works as a conventional scanner. Now it's easy to continuously monitor many radio conversations even though the message is switching frequencies. The BC245XLT comes with AC adapter, one rechargeable long life ni-cad battery pack, belt clip, flexible rubber antenna, earphone, RS232C cable, Trunk Tracker frequency guide, owner's manual and one year limited Uniden warranty. Not compatible with AGEIS, ASTRO, ESAS or LTR systems.



Hear more action on your radio scanner today. Order on-line at www.usascan.com for quick delivery. For maximum scanning satisfaction, control your Bearcat 245XLT from your computer running Windows. Order Scancat Gold for Windows, part number **SGFW** for \$99.95 or the surveillance enhanced version with audio recording part number **SGFWSE** for \$159.95.

More Radio Products

Save even more on radio scanners when purchased directly from CEI. Your CEI price after instant rebate is listed below:

Bearcat 895XLT 300 ch. Trunktracker I base/mobile scanner.....	\$179.95
Bearcat 785D 1,000 channel Trunktracker III base/mobile.....	\$339.95
Bearcat BCi25D APCO Project 25 digital software card.....	\$299.95
Bearcat 278CLT 100 ch. AM/FM/SAME WX alert scanner.....	\$139.95
Bearcat 245D 1,000 ch. Trunktracker III handheld scanner.....	\$339.95
Bearcat 245XLT 300 ch. Trunktracker II handheld scanner.....	\$189.95
Bearcat 248CLT 50 ch. base AM/FM/weather alert scanner.....	\$84.95
Bearcat Sportcat 200 alpha handheld sports scanner.....	\$159.95
Bearcat Sportcat 180B handheld sports scanner.....	\$139.95
Bearcat 80XLT 50 channel handheld scanner.....	\$99.95
Bearcat 60XLT 30 channel handheld scanner.....	\$74.95
Bearcat BCT7 information mobile scanner.....	\$139.95
AOR AR16BQ Wide Band scanner with quick charger.....	\$199.95
Sangean ATS909 306 memory shortwave receiver.....	\$209.95
Sangean ATS818 45 memory shortwave receiver.....	\$139.95
Uniden WX500 Weather Alert with S.A.M.E. feature.....	\$39.95

AOR® AR8200 Mark IIB Radio Scanner

AOR8200 Mark IIB-A wideband handheld scanner/SPECIAL \$539.95

1,000 Channels • 20 banks • 50 Select Scan Channels
 PASS channels: 50 per search bank + 50 for VFO search
 Frequency step programmable in multiples of 50 Hz.
 Size: 2^{1/2}" Wide x 1^{3/8}" Deep x 6^{1/8}" High

Frequency Coverage:

500 KHz to 823.995 MHz, 849.0125-868.995 MHz, 894.0125-2,040.000 MHz (Full coverage receivers available for export and FCC approved users.)



The AOR AR8200 Mark IIB is the ideal handheld radio scanner for communications professionals. It features all mode receive: WFM, NFM, SFM (Super Narrow FM), WAM, AM, NAM (wide, standard, narrow AM), USB, LSB & CW. Super narrow FM plus Wide and Narrow AM in addition to the standard modes. The AR8200 also has a versatile multifunctional band scope with save trace facility, twin frequency readout with bar signal meter, battery save feature with battery low legend, separate controls for volume and squelch, arrow four way side rocker with separate main tuning dial, user selectable keypad beep/illumination and LCD contrast, write protect and keypad lock, programmable scan and search including LINK, FREE, DELAY, AUDIO, LEVEL, MODE, computer socket fitted for control, clone and record, Flash-ROM no battery required memory, true carrier reinsertion in SSB modes, RF preselection of mid VHF bands, Detachable MW bar aerial. Tuning steps are programmable in multiples of 50 Hz in all modes, 8.33 KHz airband step correctly supported, Step-adjust, frequency offset, AFC, Noise limited & attenuator, Wide and Narrow AM in addition to the standard modes. For maximum scanning pleasure, you can add one of the following optional slot cards to this scanner: **CT8200** CTCSS squelch & search decoder \$89.95; **EM8200** External 4,000 channel backup memory, 160 search banks. \$69.95; **RU8200** about 20 seconds chip based recording and playback \$69.95; **TE8200** 256 step tone eliminator \$59.95. In addition, two leads are available for use with the option socket. **CC8200A** personal computer control lead \$109.95; **CR8200** tape recording lead \$59.95. Includes 4 1,000 mAh AA ni-cad batteries, charger, cigarette lighter adapter, whip aerial, MW bar antenna, belt hook, strap and one year limited AOR warranty. For fastest delivery, enter your order on-line at <http://www.usascan.com>.

Buy with Confidence

Order on-line and get big savings

For over 33 years, millions of communications specialists and enthusiasts worldwide have trusted Communications Electronics for their mission critical communications needs. It's easy to order. **For fastest delivery, order on-line at www.usascan.com**. Mail orders to: Communications Electronics Inc., P.O. Box 1045, Ann Arbor, Michigan 48106 USA. Add \$20.00 per radio receiver for UPS ground shipping, handling and insurance to the continental USA. Add \$15.00 shipping for all accessories and publications. For Canada, Puerto Rico, Hawaii, Alaska, Guam, P.O. Box or APO/FPO delivery, shipping charges are two times continental US rates. Michigan residents add sales tax. No COD's. Your satisfaction is guaranteed or return item in unused condition in original packaging within 61 days for refund, less shipping, handling and insurance charges. 10% surcharge for net 10 billing to qualified accounts. All sales are subject to availability, acceptance, verification and authentication. Prices, terms and specifications are subject to change without notice. We welcome your Discover, Visa, American Express, MasterCard, IMPAC and Eurocard. Call anytime 1-800-USA-SCAN or 800-872-7226 to order toll-free. Call +1-734-996-8888 if outside Canada or the USA. FAX anytime, dial +1-734-663-8888. Dealer and international inquiries invited. Order your radio products from CEI today at www.usascan.com.

For credit card orders call 1-800-USA-SCAN

e-mail: cei@usascan.com

www.usascan.com

PO Box 1045, Ann Arbor, Michigan 48106-1045 USA
 For information call 734-996-8888 or FAX 734-663-8888

Price schedule effective December 2, 2002 AD #120202 © 2002 Communications Electronics Inc.

COMMUNICATIONS ELECTRONICS INC.
 Emergency Operations Center

Visit WWW.USASCAN.COM • 1-800-USA-SCAN

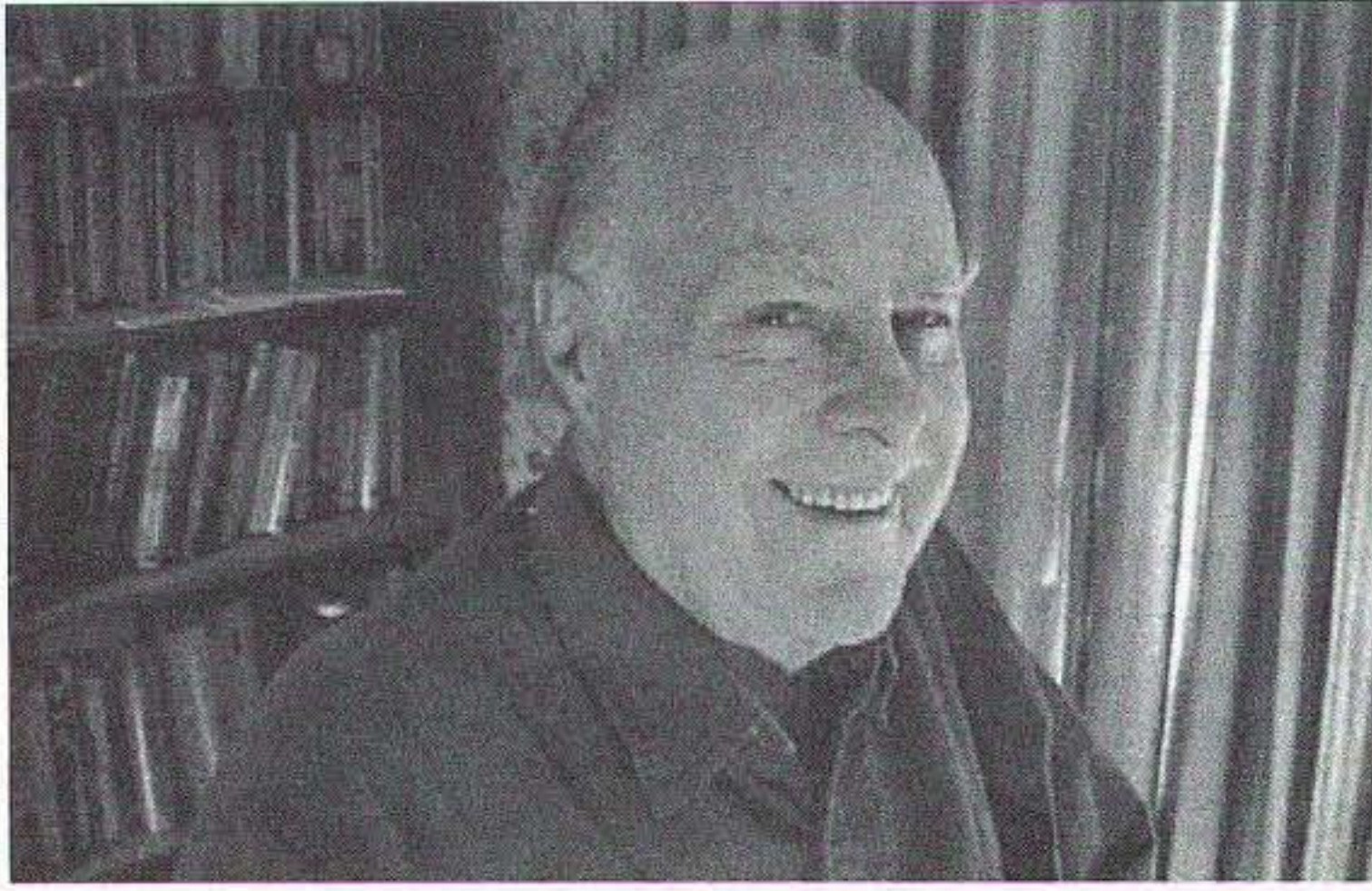

Wise Up & Beat the Odds

NEVER SAY DIE

Wayne Green W2NSD/1

w2nsd@aol.com

www.waynegreen.com

Afghanistan

Having been there and operated from Kabul as YA1NSD for a couple weeks a while back, I have a special interest in that messed up country. Here's a country with little infrastructure or government. There wasn't even any licensing authority when I was there so I picked my own call.

The country was a sitting duck for the Russians ... at least until the US started sending over billions in arms. I'm not sure what the Russians wanted with the place, nor why we sent arms to stop them. Maybe we just didn't like the idea of Russia trying to grab a country by force. The country is in the middle of nowhere and it's only natural resource was warring tribes led by local warlords.

When the war was over I predicted that Afghanistan would be in a terrible a mess if we didn't move in and help them put the country together. I explained that the warlords in each part of the country would be fighting each other again. And that's just what happened, with the Taliban eventually controlling most of the country ... thus guaranteeing to keep the country 1,500 years behind the rest of the world.

So here we are a second time, pulling out and leaving the country to the mujahedin to fight each other ... blowing a chance to help get the country organized. What a lousy example we're setting!

Here's a country with no exportable products other than opium. No industries. Few

paved roads. A few Muslim brainwashing schools where kids sit memorizing the Koran. Few towns with power, water supply, or sewage systems. Telephones, the Internet, TV, movies? Har-de-har.

My recipe for bailing the country out of the Middle Ages would be to install a network of radio and TV stations. Provide 'em with both local language and English programs so we can start them learning English. The French may hate it, but America's power has helped make English the language of world commerce. Set up a factory to make the cheapest cars possible ... like go-karts. Believe me, everyone in the world would like to get off their ass. Send a team to do a study to find out what raw materials are available, and then what markets there are for the products within easy shipping distance ... just like Singapore did when Malaysia didn't want that pest hole connected with their new country after the British pulled out.

Singapore went to Europe and got the funding to build high-rise apartments for their Chinese workers, who had been living in tin huts, and to build new factories. By 1966, when I first visited, the country was already one of the Asian tigers. When I last visited in the late '80s, cranes were busy building all around the city.

In New Caledonia, the French solved the warring tribes problem with television. The wars stopped while everyone made enough money

to get power and TV sets for their homes. Then they were busy making money to buy the advertised products. And that was the end of the tribal wars.

So, let's get busy and encourage our shortsighted government to help Afghanistan out of the past and at least into the 20th century.

My Advice ...

... which no one asked for and fewer will pay attention to. Yes, it has to do with Iraq. Been there. I even visited the ruins of King Nebuchadnezzar's palace. It was in June and the temperature was 120° in the shade. The only shade being an umbrella the taxi driver held for me. This place was so remote there weren't even any souvenir stands around.

Oh, yes, my advice. Have we gone into Iraq because of Saddam? Or Oil? Or, could it be political, because everytime we get into a war our economy booms ... and there's that little ol' election coming up next year? WWII was what finally bootstrapped us out of the 1930s depression. I'm not sure I understand how it works, but for some reason when our factories stop making consumer goods and turn out military hardware and bombs which are then destroyed, it's good for our economy.

Even though the Democratic Party is in total disarray, with the queue of presidential hopefuls getting longer every day, Bush Jr. could be worried about being re-elected if the economy stays stinko. Or

he may just feel a compulsion to make his dad feel better about him by finishing the job in Iraq B Senior left undone.

If you, despite my constant urging, are not taping the nightly *Coast-to-Coast AM* show and listening at your convenience, then you missed the March 6th Ed Dames interview. Tsk. Major Doms, as usual, had only the worst of predictions he and his group have remote viewed.

He says they looked into the near future and found that shortly after we got started attacking Iraq our good buddy Kim Son Il would send his hordes (he's got a million troops) across the DMZ into South Korea, using the many long tunnels they've been digging for the last 50 years.

And, if that isn't bad enough, once the 37,000 American troops based in South Korea get rushed to the DMZ in response to the invasion, Il's guys will hastily retreat and a nuke in one of the tunnels will be exploded. Pfft will go around 37,000 Americans. Hmm, what next? Nuke Pyongyang, where there is little but a few civilians?

And remember, the last time we were in Korea fighting we got the upper hand and were heading into North Korea when China sent down reinforcements and stopped us.

My advice? Close the PX and pull our troops out of Korea pronto. Then get South Korea to open the border and invite any North Koreans to come on down and resettle. We could offer to help pay the tab. And the offer would

also be open to any North Koreans who have fled to China to avoid starving. Bribery has always been a fact of life in Asia.

Last year NH Rep. Charles Bass showed photos of his recent visit to North Korea. He mentioned that we know there are many tunnels under the DMZ, we just don't know where they are. I tried to get him interested in having some expert dowsers dowse a map of the area and show exactly where they are. I got nowhere.

One of the Iraq inspection team members was on *Coast-to-Coast*, explaining how for years the team was prevented from inspecting one suspected site after another by the Iraq military. They flatly refused to let them see the sites.

Major Dooms also predicted that the stock market would crash. Permanently, this time. And as if all that good news wasn't enough, when George asked about all this Planet X stuff, he said his team had remote viewed it and that, as predicted by Mark Hazelwood, we'll be seeing a resulting pole shift, and that when it comes you sure don't want to be anywhere near an ocean. Ed explained that with remote viewing you can see events, but they can't be pinned down closely as to time. But I got a really big laugh when the first caller pointed out that none of Ed Dooms' past dire predictions had panned out. Maybe he needs to polish his crystal ball.

If I had any serious interest in surviving the pole shift I'd lay in a supply of ammunition, dig a hole with compacted earth and a domed roof for Sherry, me and my books, plus a good supply of seeds. Oh, and a low-powered ham transceiver.

Schools

Maybe you read where the New York City schools are spending \$11,000 per student per year. The kids ride on more buses than the city's transportation system. To what result? 60% will stay illiterate

or poor readers and never be able to make much money.

How can they get away with robbing millions of victims? Easy, the public school system is the biggest monopoly in America today. The government has made it mandatory for every child to go to school ... and for most kids that means public school. Why am I reminded of shopping in Russia under communism, where the clerks were seriously annoyed at having to serve customers. In the military it's called gold bricking ... figuring out how to get by with the least effort. Remember Sergeant Bilko?

So we have teachers who are virtually unfireable, who come from the bottom 20% of high school grads and go to teacher's ed school where almost nothing of any value is taught. I'm exaggerating? Read Rita Kramer's exposé, *Ed School Follies*. It's reviewed on page 11 of my *Secret Guide to Wisdom*. In case your memory is short, Thomas Sowell (*Inside American Education*) wrote that if he were elected president his first official act would be to issue a presidential order that all ed schools be immediately closed and all ed school professors be given \$1 million to never teach or write any books again.

How come kids are no longer learning to read? Prize-winning teacher John Taylor Gatto says reading can be taught in 100 hours. Today's ideology teaches that most children learn how to read naturally and any who aren't able are put in Special Education, which brings in more federal dollars for the school. Or, they're held back a year or two. Anyone who criticizes this is vilified as part of a right-wing conspiracy to teach phonics. The result has been a steady drop in American literacy.

Instead of teaching kids to sound out the syllables (a.k.a. phonics) so they'll be able to cope with bigger words, they're given books to read which have a restricted simple vocabulary. The next year a few dozen more words are added. Understandably, the

percentage who can't read at grade level has been going up each year.

The non-readers, to cover their humiliation when called on, become delinquent and disorderly. The school's solution to this is to put the disorderly on Ritalin or Prozac so they'll shut the hell up. If the parents object to their kid being drugged the child can be taken from them and put in a foster home.

I don't need any proof about American literacy. All I have to do is read the letters I get from people who've heard me on a talk show and have questions to ask. Many are beyond pathetic. It's unbelievable!

The solution to this mess is to totally revolutionize our educational system ... as I've been proposing.

1903

What will living in America be like in 3003? I say we don't have a clue.

A piece about how things were a hundred years ago turned up in my E-mail. That's when about 90% of Americans lived on farms; the average life expectancy was 47 years; pneumonia, flu and TB were the leading causes of death; 14% of homes had a bathtub; 8% had a telephone; there were only 8,000 cars, 144 miles of paved roads, and the city speed limit was 10 mph. 18% of homes had at least one full time domestic, and there were 230 reported murders in the entire country.

What a difference a century has made.

The above got me to thinking. Here we are in a world where most homes have not just a phone and radio, but TV and a computer ... probably with a DSL connection. And that led to my considering my part in where we are, and what I might contribute to where we'll be in twenty or fifty years from now.

Can you think of any one person who's had more of an influence on the development of cell phones, personal computers (and thus the Internet),

and compact discs than me? I've seen the future and helped make it happen.

Unless the medical industry, the food industry, the power industry, NASA, or the government has me killed, my biggest contribution, I hope, will be to help develop an educational industry that will totally change the world. Hey, why think small?

Anyone interested in helping? I should rephrase that. Is there anyone with \$1M who's interested in helping me change the world even more than I have already? That's all it'll take for us to do it. Yes, I have a business plan.

Seniors Conned Again

The February *AARP Bulletin* did a nice job of exposing how crooked many senior nonprofit groups are. Groups like United Seniors Association, The Seniors Coalition, and The 60-Plus Association are, it claims, little more than front organizations for the drug industry. That's where they get their funding, which pays for lobbyists and political advertising to promote candidates doing the drug industry's bidding. And negative ads to make sure those candidates not in the drug company pockets are defeated.

Gee, what a surprise!

As Frank Clemente, the director of Public Citizen's Congress Watch said, "This is an industry that's not only spending more on direct lobbying than any other industry but also more on front groups and related entities than any other industry."

Since it's one of the most profitable industries in the world, is that a surprise?

So, we suckers eat anything we want, eventually making ourselves sick, and the drug companies make hundreds of billions of dollars selling us stuff to ease or extend the pains. They sure don't want anyone rocking that golden barge.

Reading the *AARP Bulletin*, which is very pro prescriptions, I suspect that the

Continued on page 7

continued from page 1

around the disk near the pointed end, only three remain. According to tradition, the other two have done their work and perished in the effort. Again, my limited skills in describing the Rettysnitch rob the device of its terrible demeanor, and therefore of its force to ensure operating decency among amateurs.

Perhaps the last time the story of the Wouff-Hong and the Rettysnitch was told was in 1934. Rufus P. Turner — famous in the annals of electronics writings — recounted "Hamdom's Traditions: A Bedtime Story for Young Squirts." But even by Turner's time, the Rettysnitch was relegated to a paragraph on the story's continuation page in the back of the magazine, with no picture. Somehow, even then, folks had forgotten that you can never have law and order without first having decency. Some pessimists think that we now have neither.

I do not subscribe to the pessimist's view. Sure, the number of rotten operators has skyrocketed, but not their proportion to the main corps of good, legal, and decent operators, capable and courteous to a fault. We should not be troubled by the size of the job of curing amateur radio of its illegalities and indecencies, for we have more folks to help use the Wouff Hong and the Rettysnitch just where and how they ought to be used. No, not on others, but on ourselves — to make sure that we set a model for how amateur operations ought to be conducted.

Turner offers no prescription for using either device, but thought the Wouff Hong able to beat out King Kong's brains or easily plow up acres of Manhattan bedrock. That will tell you something of the power of these machines. But it won't tell you how they came to be.

Remember T.O.M. — The Old Man — who wrote in earliest days of "Rotten QRM"? His very first article in 1917 blasted concocted abbreviations just coming into use. Among the almost unintelligible gibberish in his headphones were words like "wouff hong" and "rettysnitch," surely instruments of terrifying punishment. By mid-1917, the ARRL was besieged by orders for these contraptions, orders that could not be

filled because the League staff had never seen either device.

In 1919, after World War I (then called simply the Great War since no one could imagine doing all that destruction and killing all over again), the League once more took up its work in earnest. At just this critical time, the directors received from The Old Man a package containing an authoritative and well-preserved specimen of Wouff Hong. Turner described the contents of the package as "the gruesome instrument of torture." By order of the directors, it was hung in the office of the Secretary-Editor, within easy reach. Its first portrait appeared in *QST* for July that year. At each board meeting, the Wouff-Hong stood on display, to the blanched looks of the humbled directors.

The Old Man also presented the world with its first glimpse of the Rettysnitch. In 1921, the monstrous machine was presented to the League traffic manager by the Washington, D.C., Radio Club, ostensibly after receiving it from T.O.M. Even at its first public appearance, two of its teeth were missing, suggesting a long history of necessary and effective use. However, to this day, the Rettysnitch has lost no other teeth. It was ordered to hang by its mate.

In the '20s and '30s, many a reproduction of both instruments, but especially the Wouff Hong, materialized across the country. A group of hams in Flint, Michigan, created the mystic society called the Royal Order of the Wouff Hong. The society endures to this day. The secret initiation ceremony takes place at midnight. And The Old Man has been given a name: Hiram Percy Maxim W1AW. At least, legend tells the story that way, perhaps based on the fact that T.O.M. glared at "Kitty" while reflecting on the "rotteness" of everything. Maxim did have a cat. However, true to feline nature, Maxim's cat never spilled the beans.

But what has become of the Wouff Hong and the Rettysnitch? More important, what has become of their power to enforce both decency and law and order on the ham bands? Hams used to cringe at the thought, let alone the sight, of these dreadful tools of enforcement. But, we do not hear of them much anymore. Oh, a tremor of curiosity every now and again brings out a ripple of questions and speculation. But not much more than a ripple.

You see, today, we have much more terrifying weapons, things like Oozies and H-booms and the like. They scare us in ways that seem to make the Wouff Hong and the Rettysnitch tame and toothless. However, even in Maxim's day, objectively more powerful weapons were used in France, like tanques and gas more poisonous than that made by Texas chili. Why were the Wouff Hong and the Rettysnitch so powerful to those early hams?

Because those hams cared about amateur radio in their hearts. They wanted what they knew they could never have: a perfectly law-abiding

and decent radio service that would inspire young and old alike to become hams or, lacking the inclination to electronics, to become admirers of hams. Every minute of on-the-air time was a chance to show how noble a pursuit amateur radio was and should always be. They feared the Wouff Hong and the Rettysnitch as instruments of their own consciences, as they strove to meet the standards they set for themselves.

And that is where today you will find both the Wouff Hong and the Rettysnitch — deep in your own conscience. If they seem to hold no power, then you know it is time once more to elevate your standards a notch higher, and then to strive to achieve them perfectly. Each of us has a secret and private office where no one else may go. Above the door, facing our individual operating tables, hang two instruments, one of law and order, the other of decency. However much the outside world may neglect the tradition of these terrible reminders of responsibility, each of us possesses our own Wouff Hong and Rettysnitch. May you never deserve their sting.

Like all legends, this one, too, must end with special words: Pass it on.

Thanks to WØPEA, via the Internet.

Ed. note: For more on the birth of the Wouff Hong (including illustration), see our October 2002 issue.

Pop! Goes Poptronics

Popular Electronics — better known as *Poptronics Magazine* — is the latest hobby electronics publication to fail. This, with the announcement that its publisher, Gernsback Publications, is no longer in operation.

Gernsback was in the publishing business for 94 years. The January 2003 issue was the last. Negotiations are reportedly under way to provide an alternative publication to *Popular Electronics'* current subscribers.

Thanks to W8H DU, via Newsline, Bill Pasternak WA6ITF, editor.

Shake, Rattle, and Roll

The job of monitoring earthquakes, from the tiniest temblor to the largest teeth-rattler, wherever and whenever they occur on the planet, goes to the US Geological Survey. All this data is then posted promptly on the U.S.G.S.'s National Earthquake Information Center Web site [<http://neic.usgs.gov>] for everyone to see. All data collected is posted from all over the world. Each occurrence is categorized and commented on, and has a map showing the epicenter, the depth of the quake, and its magnitude. Rock on, planet.

From The Modulator, the news and views of the Fort Myers Amateur Radio Club, Inc., Jan. 2003.

Subscriptions to 73 Magazine

Only \$24.97 — 1 year
\$44.97 — 2 years
\$65.00 — 3 years*

*best buy (54% off cover price!)

Call 800-274-7373

NEVER SAY DIE

continued from page 5

article may have been more aimed at hurting their competition for senior attention than enlightening the readers.

The AMA vs. Cancer

At an average of \$345,000 per patient, cancer is a huge business. If it has touched your life, either personally or through a family member or friend, isn't it worth spending a little time to learn more about it?

For instance, you'll learn that only about 7% of cancer patients achieve a remission. In 15% of the cases the patient's life is marginally prolonged. A "cure" is when a patient lives for five years.

With a 93% sentence of death, no wonder cancer scares the hell out of us.

When Dr. Richeard Eby, a well-known medical leader, went to the AMA and asked why they hadn't done any research on primitive societies where the people have no cancer, he was told by the AMA's chief counsel that the purpose of the AMA, if he'd read the by-laws, was to protect the income of its members. And since their biggest income

was from cancer patients, if ever a cure for cancer was found this could eliminate their main income. So, the AMA would make sure that no cancer cure was found or allowed to be recognized in America. Period. Further, donations (bribes) to Congress would make sure that the FDA supported the AMA policy.

And you thought I was a wacko for insisting that there's a simple no-drug cure for cancer that the AMA has been covering up. It's explained in my *Secret Guide to Health*.

Health Cost Strikes

The continually rising health care costs, now in double digit jumps, mainly caused by ever higher prescription prices, is increasing the cost of health care insurance by about \$500 this year. When General Electric balked, asking employees to pay a higher share, the workers went on strike.

I wonder what would happen if G.E. were to distribute my *Secret Guide to Health* to all their employees? I'll bet it would cost the company a lot less than a strike. I'll give 'em a special bulk discount.

Rotten Saddam

Can it be that we've been lied to? Again? By our own government? Say it isn't so!

If you missed the *Coast-to-Coast* show with Joyce Reilly interviewing one of the group of Americans who set the Kuwait oil well fires, you probably still believe that nasty rotten Saddam's guys did it. Nope, he says they were all set by our special forces to demonize Saddam. If so, it sure worked as planned.

And how about the reports leaking out that the poison gassing of the Kurd villages was actually done by the Iranians, complete with follow-up camera crews flown in to report on the atrocity.

Who knows what to believe? Well, one thing we do know: We can't believe our government or the media. So, where do we turn? Well, other than *Coast-to-Coast*?

I'm exaggerating? Then you haven't read *Into The Buzzsaw*, which documents one major cover-up after another. Like what actually happened to Flight 800.

No, Saddam is (was?) not a nice guy, but we've probably been suckered by the propaganda meisters again.

Continued on page 9

Smart Choice! Smartuner!

Do YOU want to be heard? *OF COURSE!* Then use the SGC Smartuner™ - the *Essential* link between your **HF transceiver** and **antenna**. Matching at the transceiver is good, but matching at the antenna is better. SGC Smartuners are designed to do just that. They operate completely independently to provide the best match between the feed line and the antenna, eliminating SWR problems completely.

SGC Smartuners are designed to work with *any* transceiver (including the ICOM 802) and *any* antenna. They are fully automated, intelligent enough to select the best match between feed line and antenna in seconds and remember it so it can recall that match in milliseconds. The Smartuner sets the standard. It is the original and still the best.



Illustration from the original SGC Marine SSB Facebook, 1974

Once you've learned how the Smartuner works, you won't want anything else!



SG-230



No Compromise Communications



SG-231

Visit www.sgeworld.com for more information on the entire line of Smartuners

SGC Inc. 13737 SE 26th St. Bellevue, WA 98005 USA Tel: 425-746-6310 Fax: 425-746-6384
sgc@sgeworld.com www.sgeworld.com

LETTERS

From the Ham Shack

Gene Collins KA2IWJ, Tonawanda NY. I agree 100% with the "immigrants" section of your March editorial! I've been complaining about this for many years — especially the "Afro-American" bit. Most of these people are no more African than I am. Anyway, I just wanted to let you know you've got the right combination of words there. Also, it annoys me that the US government will supply documents in Spanish. State ballots in Spanish also annoy me.

By the way, on your recommendation, I bought and read the book *Day of Deceit* by Robert B. Stinnett. I found it most interesting. It now resides in my very limited World War II library. I was only three years old when Pearl Harbor was attacked, but I remember rationing coupons, air wardens (drills with the lights out), and other assorted things.

Gene Blum KD5DGA. I was given about 5 years' worth of your 73 magazines from a friend of mine whose father has a subscription. The dates range from early part of 1997 to late part of 2001. I took them because of my interest in information about ham radio. I was so amused when I started looking through these magazines and saw the wealth of information that really blows away *CQ* and *QST*. I noticed that you cut away the bullshit and went for the meat and potatoes. I really enjoyed reading all the articles. I really was amazed about your editorials that you write. Who cares what the few say about what you have to say what is on your mind? I am, however, disappointed that 73 can't be found at any bookstore. I would like to start a subscription to 73 and enjoy (to me) the very best in ham radio publications.

Dan Clark W9VV. After reading the 7-page article in the March issue on how to build a telegraph key, I have to ask, What ever happened to radio? I don't believe many hams are going to rush to their basements to build a telegraph key from this article. How many hams have lathes, milling machines, drill presses and dial test indicators to build a key from an article like this?

The article is well done, and the key is a nice piece of work. However, I think a 7-page article like this would be better suited to *The Model Engineer* magazine or another publication dedicated to miniature machining.

If you are having difficulty getting articles

on subjects that are more related to radio communication, I have a suggestion. RECYCLE! Long ago, 73 had all kinds of great articles on the subject, many of which are still relevant today. With articles first published in the 1960s, consider that there have been two generations of hams who have never seen them. The older guys who did see them (like me) may not remember them. So to a large ham population, the articles will seem like brand new.

I don't suggest you reprint articles on vacuum tube technology, and I think we can rule out articles on surplus equipment conversion. However, there are many articles on easy-to-build transistor projects that could be recycled. Antennas haven't changed much in 40 years, and hams still build them, so how about reprinting some of those articles. Basic theory on how things work still can be useful to recent generations of hams. Cartoons and humor articles are other possibilities for recycling.

Reaching down towards the bottom of the pile, I came up with several issues of 73 from 1962. From March of that year there was a short article on checking transistors with an ohmmeter. The Zero Beatnik was an article on building a one-transistor oscillator that was used as a radiating BFO for receivers not equipped with one.

From April of there was The 40-meter ZL Special antenna made of twinlead. LCU's Michigan Long Wire was a temporary 75 meter antenna made of twinlead. The Universal Antenna article described a 70 ft. wire antenna loaded on several bands with an L network.

May had articles on a simple antenna mast for Field Day, an article on silicon rectifiers, and also a descriptive article on four-layer diodes (SCRs). Your competition has published basic articles on emitter follower amplifiers and also resistors and inductors in their March 2003 issues. So there must be some need for basic theory articles.

There appeared many short half-page articles on hints on how-to-do-it in past issues. Some were off the wall, but many were useful. Most all were interesting. Many of these could be reprinted. Who knows, some who read them might be inspired to contribute some new ones.

Many of the articles could be recycled with little or no editing to bring them up to date. I can suggest many possibilities to you if you have any interest. Just think, recycled articles are all paid for!

I believe that selectively recycling articles from long ago is not just a trip down memory lane, but it is something that could provide useful and interesting material to fill the pages of 73. What say, Wayne?

I say thanks for taking the time to write this letter. As a matter of fact and coincidence, there may be some 1975 log periodicals about to show up in your backyard. Now get back to that article you were writing, OK? And ... what do the rest of you want to see in 73? — Wayne.

From "Dave." I have been licensed and a subscriber for over a year. I note that you are interested in having more people in the hobby.

I do not have a radio yet because I have no idea what I should get as a beginner. I'm sure that there are others like me. How about an article on how to get started? I would like to have some idea about what is an appropriate rig for me to start with. Preferably something I can enlarge. Thanks!

So who out there is going to get off his duff and let us pay him (or her!) for the above mentioned article? — Wayne.

Frank Rumph KD4DZI. I built a bioelectrifier which works good for me. You've been saying to build a pulser to go along with it. I was looking for a flash unit and my son Donald N2LDY suggested I get one of those disposable cameras. I went to Walgreen's where they develop the pictures, and they had a garbage can full. I got several for free.

It's a simple matter to cut the land on the board and splice in the wire for the coil in series with the flash tube.

You can cut a hole in the back of the case to rotate the film sprocket and set the camera. Press the picture button and the flash goes off.

I don't get why Beck said to use such heavy wire (#14) for the coil.

Jack Botsford WØJAC. I just sent my renewal for 73 mag. Wayne, your editorials are the highlight of the month. I look forward to reading them first and I almost always agree with you — please keep it up.

Your accounts of WWII bring back a few things that I do not like to remember, like the radio room on a supply ship. At night it

Continued on page 62

NEVER SAY DIE

continued from page 7

Never Learning

The French seemingly learned nothing from their disaster in WWII. They "gave peace a chance" in 1938 when they violated their mutual defense treaty with Czechoslovakia and gave the western part of that country to Hitler at Munich.

Then, a year later, when they were formally at war, while Hitler was invading Poland, and France had a huge military superiority on its border with Germany, they sat there doing nothing for over six months. This gave Hitler time to move his army from the East back to the western front and attack France. France surrendered in only six weeks. Four years later Allied troops landed at Normandy and took their country back for them.

Now we see France dithering again, "giving peace a chance." What a bunch of losers! Their cheese stinks, too.

Let's Vote

What do you think was the greatest cover-up of the 20th century? My list of candidates includes (1) the discovery that any illness can be cured with no drugs; (2) the government's capturing crashed UFOs, communications with ETs, and the integration of some of their technology into ours; or (3) the faked Moon landings thirty years ago?

There are a host of lesser cover-ups ... like the fluoride in our water to make us docile, mercury poisoning from amalgam fillings, illnesses caused by root canals, vaccinations, the intentional depopulating of Africa with AIDS, President Roosevelt planning the Pearl Harbor attack, the downing of Flight 800 cover-up, who owns the major media, who controls Congress, and so on. It's a long list.

Okay, what, in your mind, was the most egregious cover-up of the 20th century?

Alzheimer's

The cover story in the March 15th issue of *Bottom Line* was on Alzheimer's. Since my mother had this terrible disease, I have a special interest in it.

Considering how awful (and expensive) this disease is, and that 10% of seniors are going this slow route to the grave, there's much to be said for not contributing early on to the disease. And that's when it starts.

So? The article says that the disease develops over decades and that diet seems to have a lot to do with it. Hey, gee, wow! — is that a big surprise. What's recommended? Lots of citrus

fruits, strawberries, tomatoes, vegetable oils, nuts. A raw food diet! By golly, that's just what I had for breakfast this morning! I had a grapefruit, strawberries, and orange. My mid-morning "snack" is an ounce of flax seed oil, a vitamin-mineral supplement mixed in apple juice, some cottage cheese and a glass of red grape juice. For lunch, I had melon, orange, and banana.

Since Alzheimer's patients brains are caked with aluminum, what's the harm in doing your best to keep your aluminum intake to a minimum? You shouldn't be eating any cooked food if you have much of an interest in having a healthy old age, but if you are still addicted to such poisons, at least don't cook the stuff in aluminum pans.

Then there are vaccinations, which are loaded with both mercury and aluminum. And deodorants (read the labels), which migrate aluminum through your skin and up to what's left of your brain.

Once you're an Alzheimer veggie you'll be sitting in a nursing home, strapped to a rocking chair so you won't wander off and get lost. You'll have no memory of anything recent, even from minutes ago. The only person my mother recognized was me. Not even my father. She did remember the address where she lived in Denver when she was eight years old, but very little more recent.

It's something to think about the next time you order a hamburger, fries and a diet Coke.

The Saudis

An E-mail pointing out that the Saudis are now boycotting American products

Continued on page 36

LOW PROFILE HF ANTENNAS

NO Radials • No Motors • MORE ANTENNA than just a Coil & Whip



ISOTRON

BILAL COMPANY

Call for a FREE Catalog

2003

is our
23rd year
in business!

719-687-0650

137 Manchester Dr.
Florissant, CO
81816

\$368.85

80, 40, 20, 15 & 10
60 inches tall &
32 inches across

www.isotronantennas.com

HOUSTON AMATEUR RADIO SUPPLY

267 Cypresswood Drive • Spring, TX 77388

800-471-7373

Local: 281-355-7373

email: houstonamateurradio@prodigy.net

COMPLETE SALES & SERVICE

Yaesu, Icom, ALinco, ADI, Hustler, Cushcraft

3 days.

•
Over 1600
exhibitors
& vendors.

•
It's time for the
ham radio event
of the year!

•
May 16, 17
& 18, 2003

•
Hara Arena

•
Dayton, Ohio

*Celebrating Youth
in Amateur Radio!*

HAMVENTION® 2003

Save \$5 on Advance Tickets!

1-937-276-6930 • www.hamvention.org

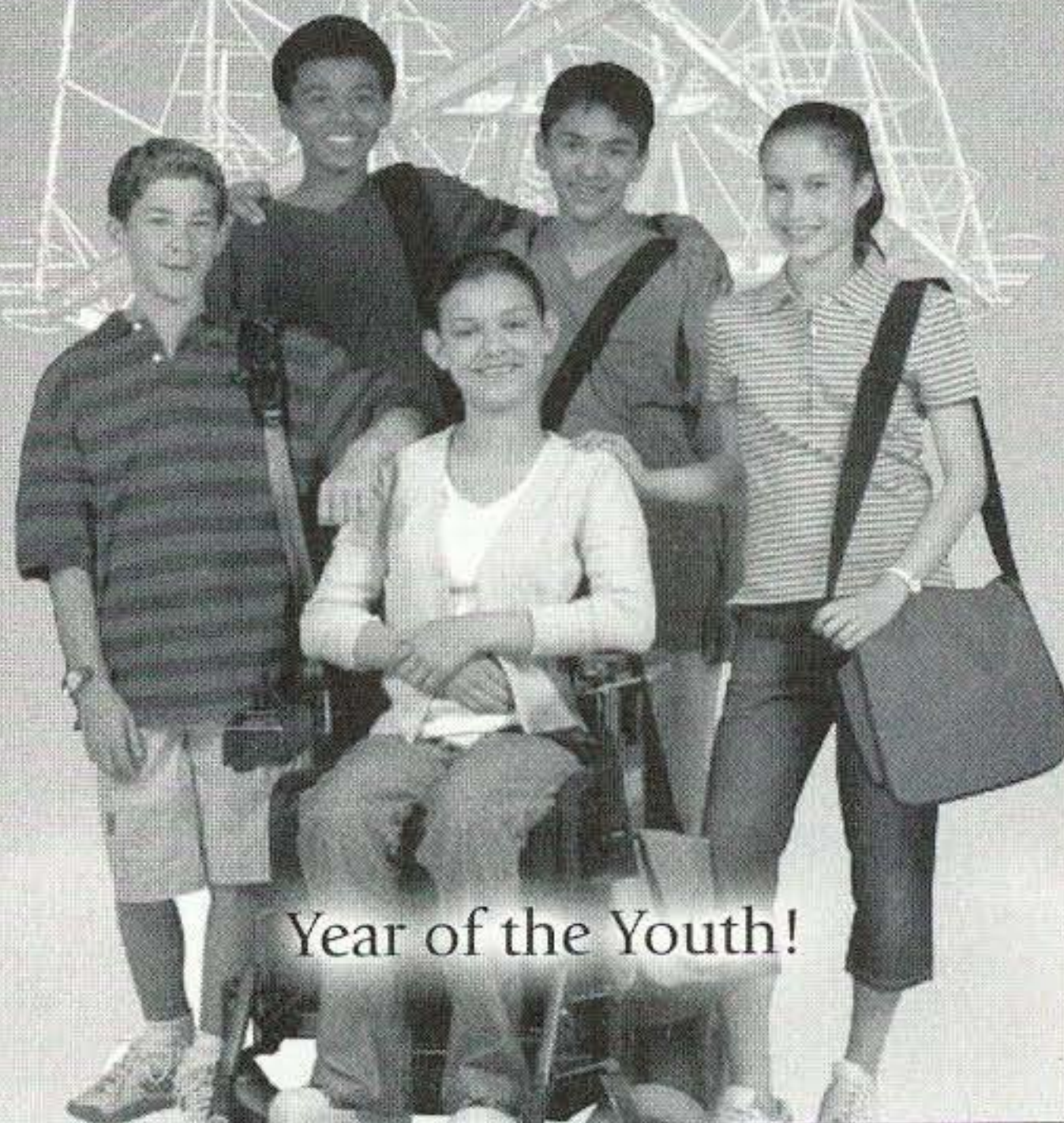

Year of the Youth!

Tunable Broadcast Band Filter

Another great project from K8ZOA.

I recently built a tunable bandpass filter for the AM broadcast band and learned a great deal about the quirks of tunable filters. The concepts and design philosophy behind my design are easily extensible to other frequencies using the techniques developed below.

Usually, filter design is approached with a set of design requirements in hand, such as passband width or required rejection attenuation at specified frequencies. Based on these requirements, the designer selects the mathematical model that governs the filter design — Butterworth, Chebychev, etc. — and determines the number of elements required to meet these requirements. The component values are then calculated. Or, these steps can be automated with computer software to completely design the filter, including a schematic, parts

values and simulated performance graphs.

My design proceeded in a bit of an inside-out direction — I had a 3-section variable capacitor and wanted to build a tunable broadcast band filter based around it. I had originally toyed with a permeability-tuned approach, with ferrite slugs moving in or out of coils, as implemented by Collins in its famous R390/390A general coverage receivers. A couple of test coils quickly convinced me that I couldn't wind coils that tracked closely enough.

Although my particular design was

for the broadcast band, it's easy to modify the design for other frequencies — for example, as a pre-selector for a 3.5–4 MHz direct conversion receiver. (A filter used between the antenna and receiver is sometimes called a “pre-selector.”)

It's possible to design a filter without pencil or paper; enter a few values into a filter design program and out comes a complete design. Although great timesavers, automatic design programs frequently hide critical details and design trade-offs. Hence, this article concentrates on a step-by-step manual design. Along the way, we will see that significant adjustments to theoretical designs are necessary.

Choice of coupled resonator filters

Recent ARRL handbooks devote a chapter to filters, including designing band-pass filters based upon a low-pass prototype. Unfortunately, a simple transform, as shown in Fig. 1 is difficult to implement as a tunable filter; if our tuning element is to be a variable capacitor one of its sections must float above ground. A standard multisection variable capacitor is therefore unusable, as each section has one grounded

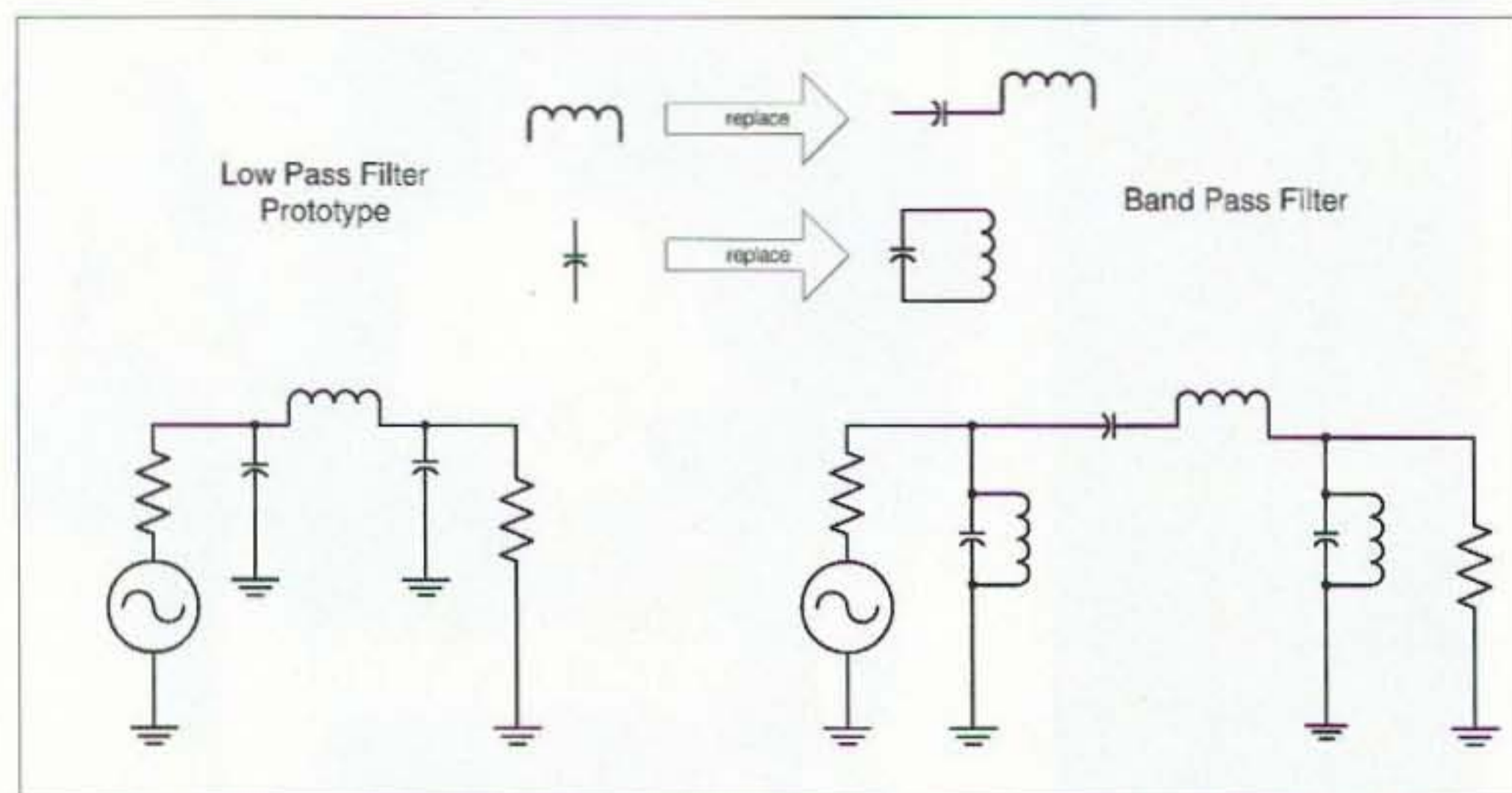

Fig. 1. Conventional transformation of low pass prototype to bandpass filter.

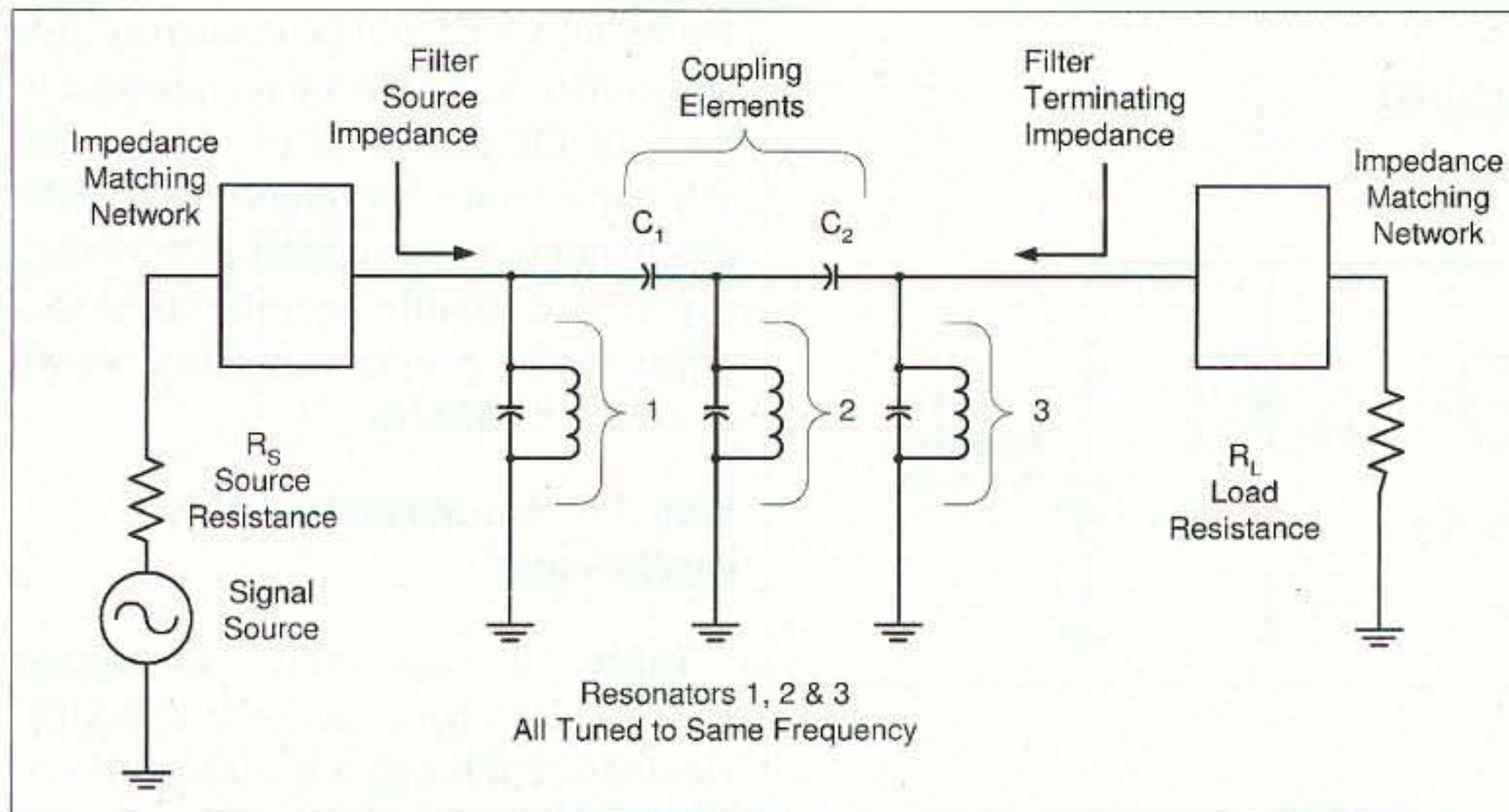

Fig. 2. Conceptual coupled resonator filter.

side. The floating inductor causes further implementation troubles, as stray capacitance to ground may be an issue. We've already ruled out variable inductance tuning, so an alternative topology is necessary.

A coupled resonator design, as shown conceptually at Fig. 2, solves many problems found in the design of Fig. 1; the main tuning capacitor elements have one side grounded as do all inductors. So far, so good. The most serious difficulty is that the coupling capacitors C_1 and C_2 must float above ground. Worse yet, as we will discover, both C_1 and C_2 must vary as well as the resonator tuning capacitors in a wide range tunable filter. Fortunately, these are small value capacitors and can be floated with only moderate difficulty. (A wonderful variety of alternative coupling possibilities exist, but for a variety of implementation issues, capacitive top coupling works the best for a wide range tunable design.)

Section 1 — Design

We'll design our tunable filter by looking at a series of designs for fixed frequencies throughout the tuning range. We'll find that our design will call for a number of compromises.

Our design requirements are to tune the AM broadcast band (535–1705 kHz) with reasonable selectivity, and an inductor Q that can be easily achieved in a home workshop. Limitations on inductor Q dictate our choice of a Butterworth prototype design.

We'll start our design at 550 kHz, near the bottom of our desired tuning range. At this frequency, we would like sufficient bandwidth to pass an AM broadcast signal without significant attenuation of the sidebands. We also can't make the filter bandwidth arbitrarily small without causing tracking and other problems. Accordingly, we'll use 20 kHz as our desired bandwidth.

Step 1 — Summary of design criteria

- 3 dB bandwidth at 550 kHz = 20 kHz (Upper 3 dB point is thus 560 kHz, lower 3 dB point is 540 kHz)
- Inductor Q_0 approximately 200
- Tuning capacitor range 375–14 pF (3 sections)
- Input & Output Impedance = 50 ohms
- Tuning range 540 kHz to 1700 kHz
- Filter design is Butterworth
- All capacitors are assumed lossless

Order	q1	q _n	k ₁₂	k ₂₃	k ₃₄	k ₄₅
2	1.4142	1.4142	0.7071	—	—	—
3	1.0000	1.0000	0.7071	0.7071	—	—
4	0.7654	0.7654	0.8409	0.5412	0.8409	—
5	0.6180	0.6180	1.0000	0.5559	0.5559	1.000

Table 1. Butterworth bandpass filter coefficients for orders 1 ... 5.

ALL ELECTRONICS CORPORATION

C O R P O R A T I O N

12 Vdc 1.25 amp Power Supply

DVE # DSA-0151-12
2.1mm I.D. coax power plug.
Center positive. UL, CSA.

CAT # PS-1215

\$7²⁵ each



10 for \$6.95 each • 100 for \$6.50 each

Neo-Cylinder Magnet

Shiny, nickel plated neodymium cylinder. 0.25" diameter x 0.2" long.

CAT # MAG-76

2 for \$1⁰⁰

50 for 35¢ each
100 for 25¢ each



SHOP OUR ONLINE STORE
www.allelectronics.com

LEDs (Light Emitting Diodes)

SUPER BRIGHT RED 6,000 mcd T-1 3/4
CAT# LED-94 75¢ each
100 for \$50.00 - 1,000 for \$350.00

BLUE - water-clear 1,500 mcd T-1 3/4
CAT# LED-74 \$1.75 each
100 for \$115.00 • 1,000 for \$950.00

WHITE - water-clear 3,000 mcd T-1 3/4
CAT# LED-75 \$2.00 each
100 for \$165.00 • 1,000 for \$1300.00



10 Compartment Plastic Storage box

Transparent hinged plastic box with 10 compartments. Great for parts storage or display of small items. Outside dimensions 7" x 3.4" x 1.25". Friction-lock lid with dual clasps. Each box individually wrapped in a cardboard sleeve. CAT # SB-10

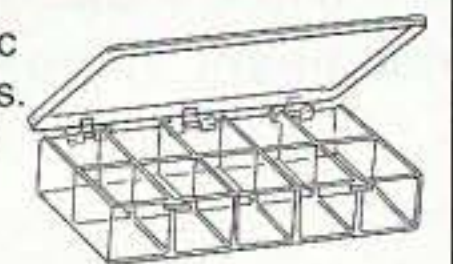

Case of 36 for \$30.60 (85¢ each)

\$1⁰⁰ each

ORDER TOLL FREE
1-800-826-5432
CHARGE ORDERS to Visa, Mastercard, American Express or Discover

TERMS: NO MINIMUM ORDER. Shipping and handling for the 48 continental U.S.A. \$6.00 per order. All others including AK, HI, PR or Canada must pay full shipping. All orders delivered in CALIFORNIA must include local state sales tax. Quantities Limited. NO COD. Prices subject to change without notice.

CALL, WRITE FAX or E-MAIL for our **FREE** 96 Page CATALOG Outside the U.S.A. send \$3.00 postage.

MAIL ORDERS TO:
ALL ELECTRONICS CORPORATION
P.O. Box 567
Van Nuys, CA 91408
FAX (818)781-2653

e-mail allcorp@allcorp.com

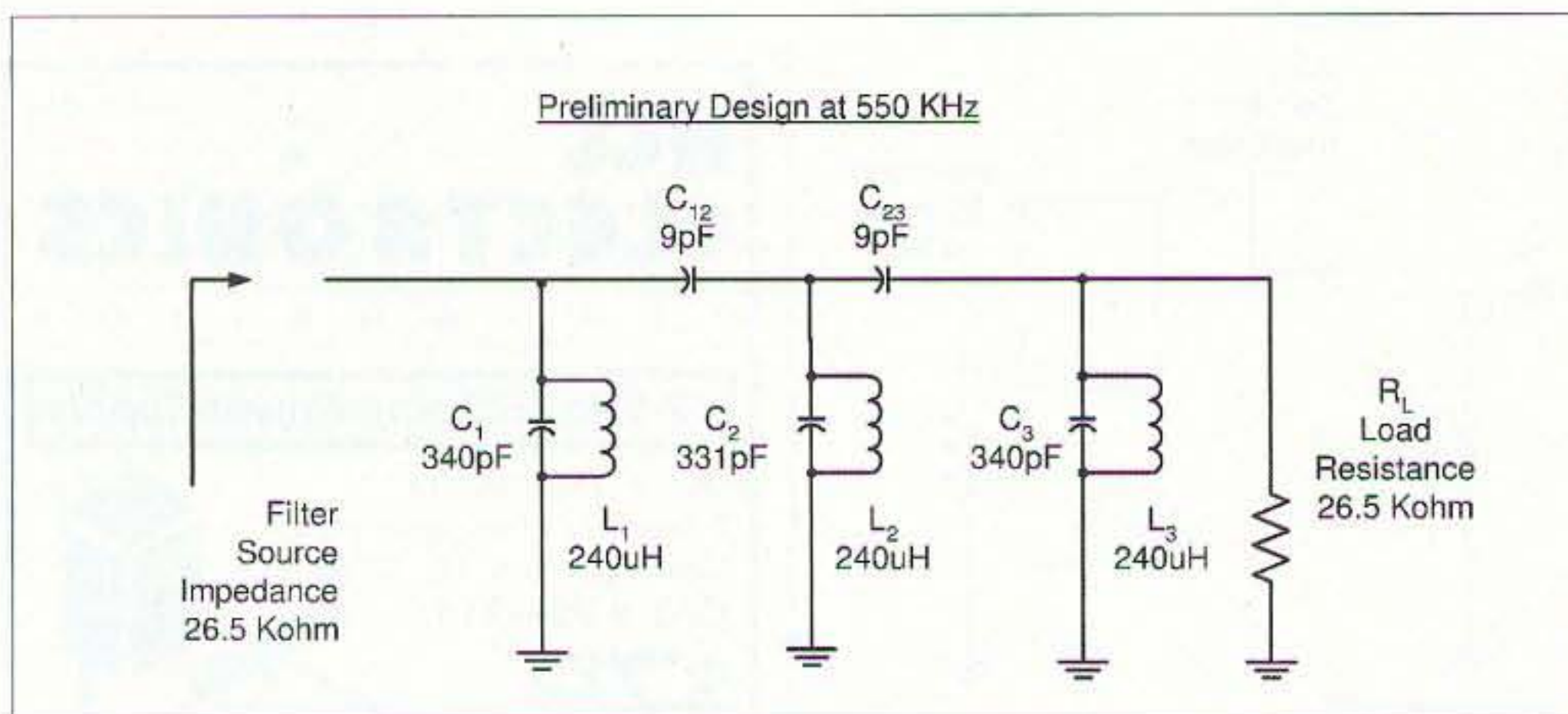

Fig. 3. Preliminary design at 550 kHz.

Step 2 — Calculate fractional bandwidth and resonator inductance

Fractional bandwidth, "a":

$$a = \frac{f_m}{\Delta f} = \frac{\sqrt{f_{3dBupper} \times f_{3dBlower}}}{f_{3dBupper} - f_{3dBlower}}$$

f_m is the geometric mean frequency, or

$$\sqrt{540 \text{ kHz} \times 560 \text{ kHz}} = 549.91 \text{ kHz.}$$

Since our filter is relatively narrow band, f_m is approximately the arithmetic center frequency, 550 kHz, and we'll use $f_m = 550$ kHz in our calculations.

Δf is the 3 dB bandwidth.

The fractional bandwidth is thus $a = 550 \text{ kHz} / 20 \text{ kHz} = 27.5$.

Now we will calculate the required resonator inductance based upon our maximum tuning capacitance, using

Parameter	Tuning Frequency		
	550 kHz	970 kHz	1700 kHz
Input impedance (k ohms)	26.5	46.6	81.5
Output impedance (k ohms)	26.5	46.6	81.5
"a" factor	27.5	27.5	27.5
Bandwidth (kHz)	20	35	62
$L_1, L_2, \& L_3$ (μH)	240	240	240
C_{12} (pF)	9	2.9	0.94
C_{21} (pF)	9	2.9	0.94
C_1 (pF)	340	109.3	35.6
C_2 (pF)	331	106.4	34.6
C_3 (pF)	340	109.3	35.6

Table 2. Preliminary design component values.

the standard formula for a resonant LC circuit. To ensure that we can tune down to the bottom of the broadcast band, we will assume that only 350 pF is available at 550 kHz, instead of the maximum 375 pF.

$$f = 1/2 \pi \sqrt{LC}, \text{ or, solving for } L, L = 1/(2\pi f)^2 C$$

Remembering that C is in farads and that 1 pF is 10^{-12} farads, f is in hertz, and 1 kHz = 1000 Hz, we determine the required resonating inductance L, in henrys:

$$L = 1/(2\pi \times 500 \times 10^3)^2 350 \times 10^{-12} = 1/11.94 \times 10^{12} \times 350 \times 10^{-12} = 239 \times 10^{-6} \text{H or } 239 \mu\text{H}$$

We will round L up to 240 μH .

We will now check whether our maximum frequency is achievable. We can assume that an air-wound solenoid form 240 μH inductor of reasonable size will have around 5 pF of distributed capacitance, and that wiring strays will add another 3 pF. We can also estimate the coupling capacitors as adding another 2 pF when set for 1700 kHz. Thus, our minimum capacitance is $14 \text{ pF} + 5 \text{ pF} + 3 \text{ pF} + 2 \text{ pF} = 24 \text{ pF}$. Using the LC resonance formula, we can determine the required C for resonance at 1700 kHz with 240 μH .

$$C = 1/(2\pi f)^2 L = 1/(2\pi \times 1700 \times 10^3)^2 \times 240 \times 10^{-6} = 36.5 \times 10^{-12} \text{ F or } 36.5 \text{ pF}$$

Our choice of 240 μH should work at 1700 kHz, with the tuning capacitor slightly less than fully unmeshed.

However, we should be concerned that strays and self-capacitance amount to 8 pF of the total 36.5 pF. Strays and self-capacitance are notoriously difficult to control and suggest that we may experience trouble keeping all nodes tuned to the proper frequency as we approach 1700 kHz.

Step 3 — Un-normalize filter coefficients

Table 1 has the normalized Butterworth bandpass filter coefficients for 2 through 5 resonator filters. (I calculated Table 1's values myself using the formulas provided in the sidebar "How to Make a Butterworth Low-Pass and Band-Pass Table." References [1] and [2] have similar tables.)

Table 1's values assume no losses, i.e., that our components have infinite Q. This is not the case, and we can either proceed with the understanding that our filter will not exactly meet our performance calculations, or we may use "predistorted" filter coefficients that take into account component losses. Compared with the infinite Q design, finite component Q increases the insertion loss, causes the shoulders of the pass-band to slump and reduces the stop-band loss. We will use the infinite Q table and accept any corresponding divergence between theory and design. References [01] and [02] provide both lossless and pre-distorted design tables, should the reader wish to pursue a more refined design. Both references provide similar tables for a variety of other filter responses, including Chebychev, Gaussian, linear phase, etc.

For a three-resonator design ($N = 3$), Table 1 provides the following normalized values:

$$\begin{aligned} q_1 &= 1.000 \\ q_n &= 1.000 \\ k_{12} &= 0.7071 \\ k_{23} &= 0.7071 \end{aligned}$$

These are "normalized" values, based upon $a = 1.000$. " q_1 " and " q_n " refer to the loaded Q of the input (first) and output (the "nth") resonators, k_{12} refers to the coupling between resonators 1 and 2, k_{23}

the coupling between the 2nd and 3rd resonators, etc. Our filter design has a $Q = 27.5$, so we must "de-normalize" the **Table 1** parameters. To de-normalize, q values are multiplied by a ; k values are divided by a :

$$Q_1 = aq_1 = 27.5 \times 1.000 = 27.5; Q_3 = aq_n = 27.5 \times 1.00 = 27.5$$

$$K_{12} = k_{12}/a = 0.7071/27.5 = 0.0257; K_{23} = k_{23}/a = 0.7071/27.5 = 0.0257$$

(We will refer to normalized values with lower case letters and de-normalized values with upper case.)

Step 4 — Calculate nodal capacitor, coupling capacitors, and tuning capacitors

At 550 kHz, our nominal 240 μ H inductors require 348.9 pF for resonance, determined by the standard resonance formula

$$C = 1/(2\pi f)^2 L$$

We now calculate the coupling capacitors. In our preliminary design, all inductors are 240 μ H, and therefore each of the three resonating nodal capacitances, C_N , is 348.9 pF.

The coupling capacitor between nodes j and k , C_{jk} , is equal to the product of C_N and K_{ij} .

$$C_{12} = C_N \times K_{12} = 348.9 \text{ pF} \times 0.02571 = 8.97 \text{ pF}$$

Likewise, we can calculate $C_{23} = 8.97 \text{ pF}$.

We can now calculate the tuning capacitors C_1 , C_2 , and C_3 needed for resonators 1, 2, and 3. To do this, we mentally short to ground the adjacent nodes and determine the total capacitance across the resonator.

Resonator 1 therefore "sees" its tuning capacitor C_1 , and coupling capacitor C_{12} . Resonator 2 "sees" its tuning capacitor C_2 , and two coupling capacitors, C_{12} and C_{23} . Resonator 3 "sees" its tuning capacitor C_3 and coupling capacitor C_{23} . We now can determine C_1 , C_2 and C_3 :

$$C_1 = C_N - C_{12} = 348.9 \text{ pF} - 8.97 \text{ pF} = 339.9 \text{ pF}$$

$$C_2 = C_N - C_{12} - C_{23} = 348.9 \text{ pF} - 8.97 \text{ pF} - 8.97 \text{ pF} = 331 \text{ pF}$$

$$C_3 = C_N - C_{23} = 348.9 \text{ pF} - 8.97 \text{ pF} = 339.9 \text{ pF}$$

Step 5 — Driving and load impedance

The final step in our preliminary design is to determine the filter's driving point impedance R_s and its load impedance R_L .

We have previously determined the de-normalized loaded Q_s , Q_1 and Q_3 , associated with the input and terminating resonators. We now can determine the equivalent parallel resistance, R_p , for the two end resonators, remembering that the Q of an inductor is given by

$$Q = R/X_L = R/2\pi fL,$$

where R is in parallel with the inductance. The input resonator's parallel loading resistor, R_{p1} is thus:

$$R_{p1} = 2\pi fLQ_1 = 2 \times 3.14159 \times 550 \times 10^3 \times 240 \times 10^{-6} \times 27.5 = 22.8 \text{ k}\Omega$$

R_{p1} actually consists of two parallel resistances: the driving-point resistance R_s and the parasitic resistance of the inductor, R_x , due to its finite Q .

$$R_x = 2\pi fLQ_1 = 2 \times 3.14159 \times 550 \times 10^3 \times 240 \times 10^{-6} \times 200 = 166 \text{ k}\Omega$$

Using the standard formula for parallel resistances, we know that

$$R_{p1} = (R_s \times R_x)/(R_s + R_x)$$

Solving for R_s :

$$R_s = (R_{p1} \times R_x)/(R_x - R_{p1}) = (166 \text{ k}\Omega \times 22.8 \text{ k}\Omega)/(166 \text{ k}\Omega - 22.8 \text{ k}\Omega) = 26.5 \text{ k}\Omega$$

Likewise, $R_L = 26.5 \text{ k}\Omega$.

Fig. 3 shows our completed preliminary design at 550 kHz. It will need substantial modification to be practicable.

Changes for constructability

Since we are building a *tunable* bandpass filter, we must know how all of the filter parameters vary with frequency. **Table 2** shows component values for the lowest and highest design frequencies and the geometrical midpoint frequency.

Note that we've kept "a" constant and allowed the bandwidth to increase

Smart Battery Charger

New & Improved



FOR GEL-CELLS or LEAD ACID BATTERIES.

Features: Precision temperature tracking voltage reference & three mode charging sequence. Standard kit is for 12V @ 1/2 or 1 Amp, user selectable. Can be connected to the battery indefinitely, will not overcharge. Weighs 2 pounds and measures 4"Wx5 1/2"Dx2 1/2"H. Finished enclosure included in kit.

Complete Kit Only	\$59.95
Assembled & Tested	\$79.95

CA Residents add 7.50% sales tax; S&H: \$6.50 (insured). Foreign orders add 20%.

For more info or price list go to a-engineering.com



A&A Engineering

2521 W. La Palma #K • Anaheim, CA 92801
(714) 952-2114 • FAX: (714) 952-3280



ICOM IC-756 Pro II



The impressive **IC-756 Pro II** covers HF plus 6 meters. The high resolution 5 inch TFT color display provides more operating information than ever, including a spectrum scope. The 32 bit floating point DSP provides crisp, clear reception with 41 built-in filters. The "Pro II" is the choice for serious DXers and contesters.

IC-746 Pro ✓ 160 to 2 Meters!



The **IC-746 Pro** covers 160-10 meters plus 6 and 2 meters with 100 watts on all bands. Call or visit our website for further details and pricing on this and other ICOM radios.



Universal Radio

6830 Americana Pkwy.
Reynoldsburg, OH 43068

◆ Orders: 800 431-3939
◆ Info: 614 866-4267
www.universal-radio.com

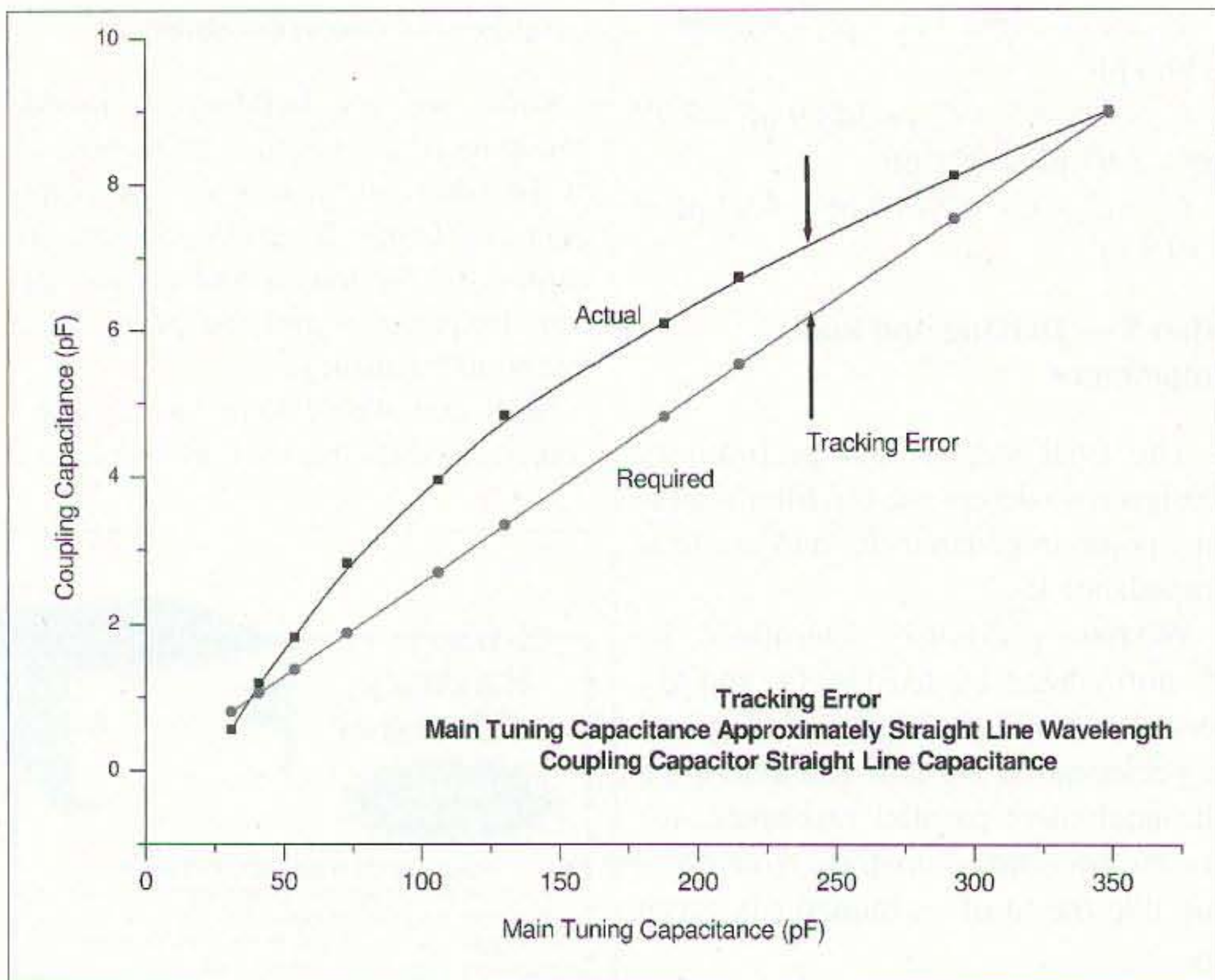

Fig. 4. Tracking error between main tuning and coupling capacitors.

with increasing frequency. If we try to maintain a constant bandwidth of 20 kHz at 1700 kHz, we quickly will find that we need a much higher Q inductor — on the order of 1000 or more — that C_{12} and C_{23} become a few tenths of pF and that the input and output impedances soar to hundreds of thousands of ohms. Hence, we will accept increasing bandwidth with frequency.

Four problems immediately spring to light in **Table 2**.

- How do we match to 50 ohms input/output?
- How do we deal with C_2 being smaller than C_1 and C_3 ?
- How do we vary the coupling capacitors in synchronization with C_1 , C_2 , and C_3 ?
- How do we make the coupling capacitors a more reasonable value?

Matching input and output

We desire the filter to have a 50 ohm input and output impedance; our design

shows the filter is a much higher impedance device. Hence, we must match both the input and output to 50 ohms. Since our filter tunes over a 3:1 range, we must immediately discard narrow-band matching. The classic reference *Single-Sideband Systems & Circuits* notes that input and output matching of a coupled resonator filter over a wide frequency range “can tax the ingenuity of the designer.” If anything, this is an understatement.

The most obvious matching method is to use the input and output inductors as autotransformers by tapping the feedpoint near the grounded side. If the inductor has N total turns, tapping n turns from the ground end produces an impedance step-up factor F of $F = (N/n)^2$, neglecting leakage flux. Since the impedance to be matched varies from 26.5 k-ohms to 81.5 k-ohms, a single tap point will cause a mismatch at some frequencies. We will design the tap for a match at the lowest impedance, accepting the consequences of a mismatch at other ranges. (This decision loads both the input and output resonators more heavily than our design calls for at higher frequencies, so we expect to see some additional bandwidth spreading.)

Accordingly, we need an impedance step-up factor of $26500/50 = 530$.

L1 and L3 have 75 turns, so $N = 75$. We now can find the tap point:

$$n = N/\sqrt{F} = 75/\sqrt{530} = 3.25$$

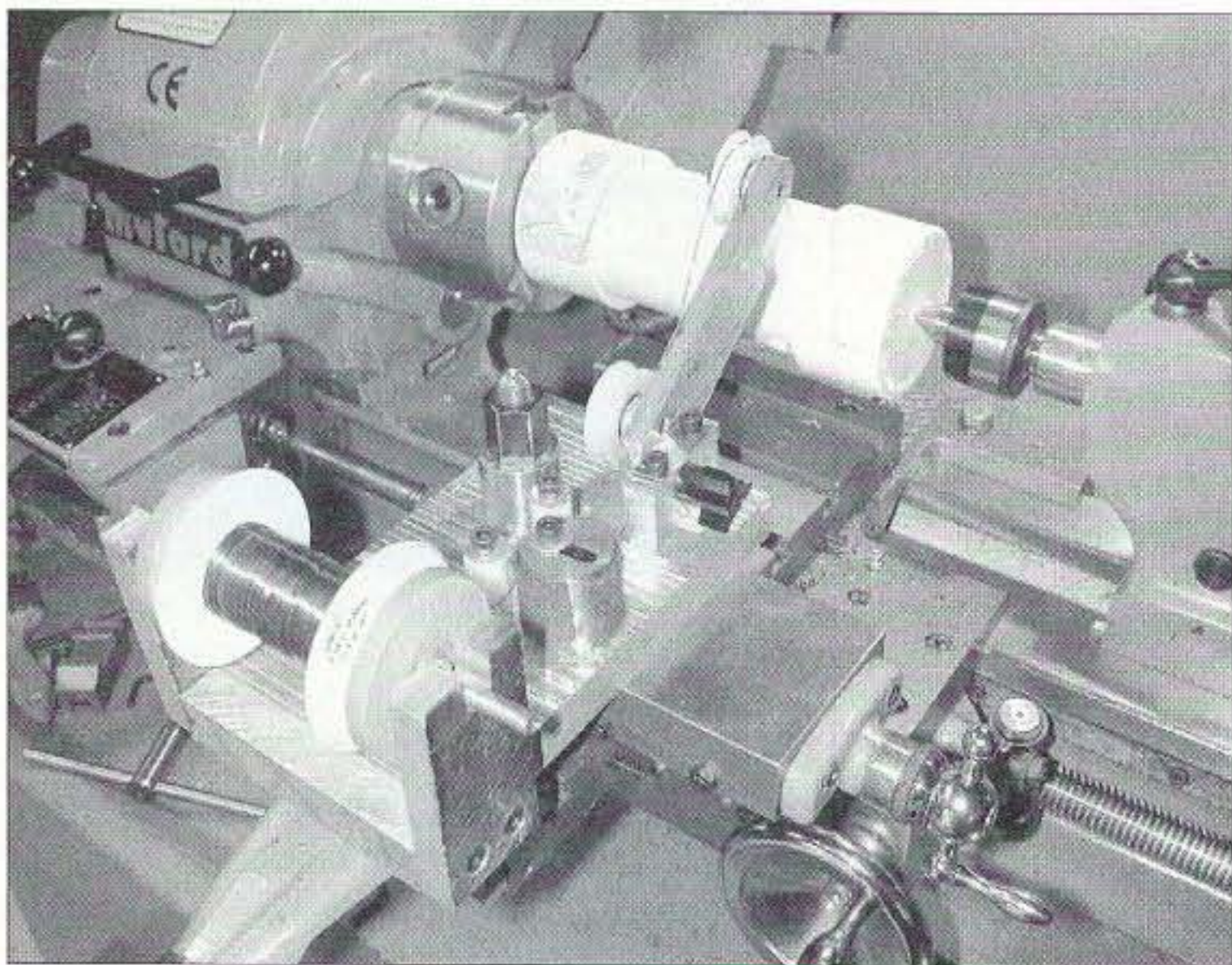

Photo A. I wound the coils on a lathe with a homemade winding adaptor.

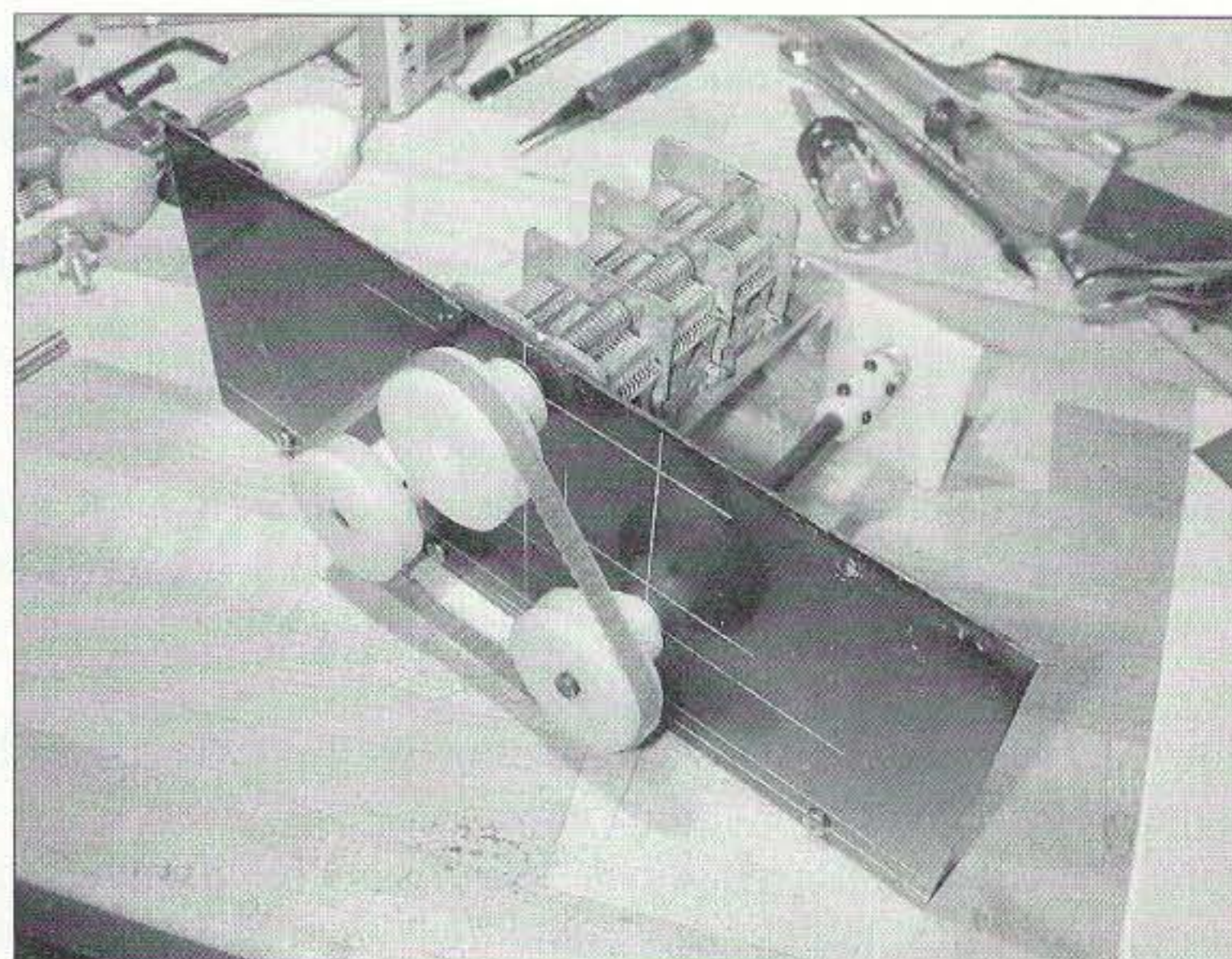

Photo B. The three variable capacitor shafts are ganged with a toothed belt and pulley arrangement.

We will tap at 3-1/4 turns from the ground end of L_1 and L_3 .

C_2 not equal to C_1 and C_3

C_2 is smaller than C_1 or C_3 by the coupling capacitor value. We could physically modify one section of the three-section tuning capacitor by bending a plate, or possibly even removing a plate. However, we note that C_2 is a constant percentage smaller than C_1 or C_3 through the tuning range. (C_2 is 97.35% of C_1 or C_3 .) This suggests that we can instead slightly reduce L_2 and use a uniform tuning capacitor where $C_1 = C_2 = C_3$. If we use a uniform tuning capacitor, C_2 will be 1/0.9753 too large. Since the resonant frequency of a tuned LC circuit is proportional to the product of L and C , we should reduce L_2 to 97.53% of L_1 or L_3 .

$$L_2 = 0.9753L_2 = 240 \mu\text{H} \times 0.9753 = 233.6 \mu\text{H}$$

Our new L_2 should be 234 μH .

How to vary C_{12} and C_{23} in concert with C_1 , C_2 and C_3

As we have determined, the coupling capacitance is directly proportional to the tuning capacitance, via K_{12} and K_{23} . Conceptually, therefore, we can mechanically link the shaft of the main tuning capacitor and two small variables. As the tuning capacitance is increased or decreased, therefore, a corresponding change is made to the coupling capacitors.

Here we run into another snag. Almost all small variables are "straight line capacitance," i.e., the capacitance varies linearly with shaft rotation. Most high-capacity broadcast receiver-type variables, such as the one we will use for tuning, are straight-line

A GREAT gift idea for yourself, your ham friend(s), or your child's school library

is a subscription to 73 Magazine ... only \$24.97!

Call 800-274-7373 or write to 70 Hancock Rd., Peterborough NH 03458

RIGrunner

Intelligent DC power panel

- Conveniently power your station with Anderson PowerPole® connectors.
- 40 Amps total, outlets to run all of your transceivers and accessories.
- Each and every outlet individually ATC fused with LED open fuse indicators.
- Precision LED and audio alert of safe, over or undervoltage, 4012 & 4008.
- No messy binding posts, frayed wires, black tape or short circuits.
- Safe, secure, hot connect, polarized, color keyed, unisex, connector system.
- Conforms to the ARES, RACES, RSGB recommended standard.
- Perfect for home, mobile, rover, portable, emergency and contest stations.

3 Models from \$49.95!



RIGblaster

Have more fun with your radio

The only no compromise sound card interfaces.

The easiest to set up, high quality, complete solution.

The best support too! Read our user comments!

Internet remote base linking with EchoLink!



NEW RIGblaster pro complete info on the web

<http://www.westmountainradio.com>

West Mountain Radio de N1ZZ and K1UHF
18 Sheehan Avenue, Norwalk, CT 06854 (203) 853 8080

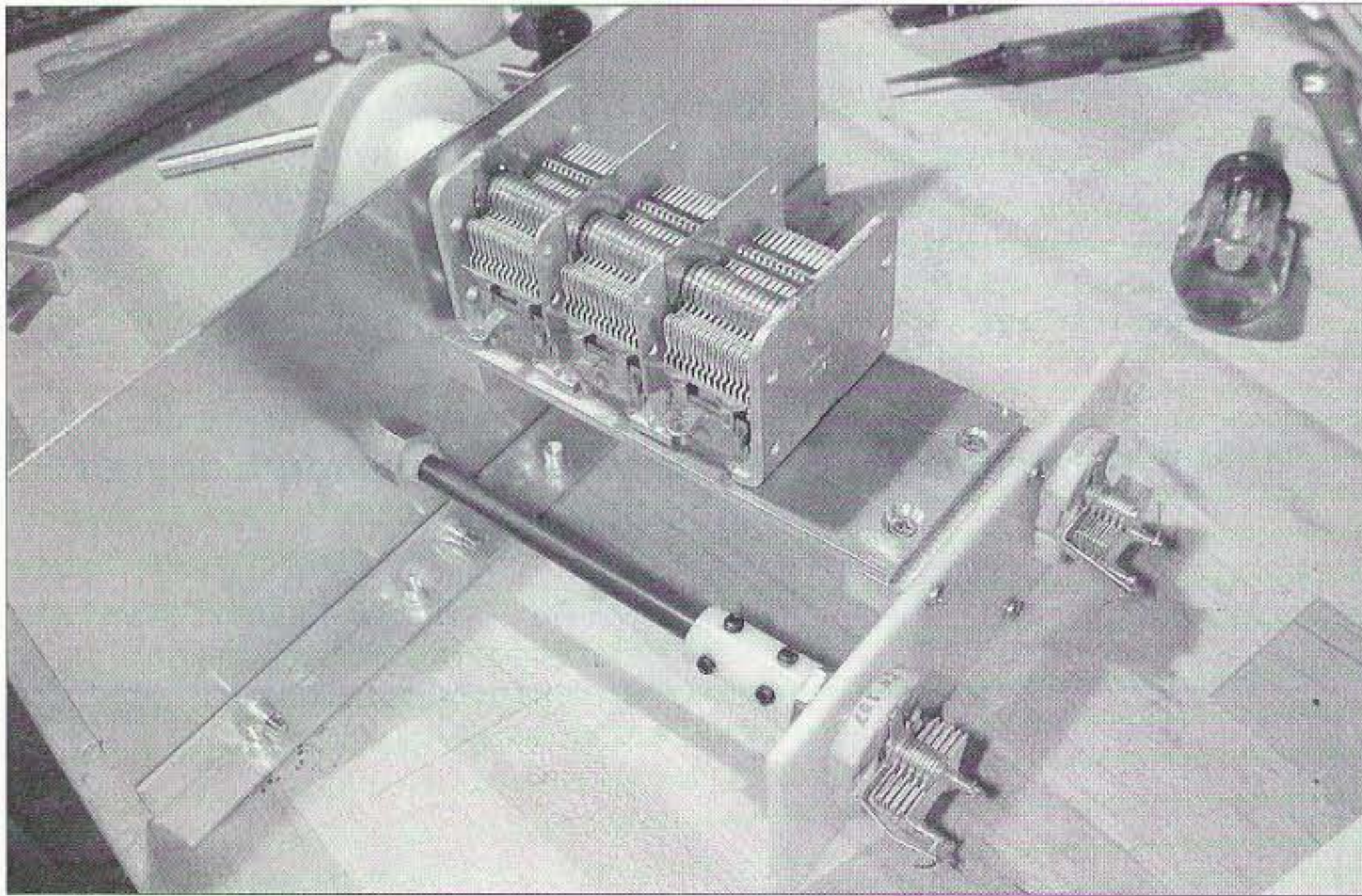

Photo C. Mount the variable coupling capacitors on an insulating plate as both sides are above ground.

wavelength. Hence, although we may be able to align the tuning and coupling capacitors at full mesh and open mesh, there will be a tracking error at intermediate points, as illustrated at **Fig. 4**. We could also reduce the mean error by shifting the actual capacitance curve downward, such as by adding a fixed series capacitor, thereby causing the error to be a mix of over- and undercoupling.

Unfortunately, there is no simple fix to the tracking error problem. What we

need are tuning and coupling variables with a similar tuning characteristic. Or, we might synthesize the desired tracking through a cam or other mechanical contrivance. Here, we will instead accept the tracking error. Since the coupling is heavier than desired, we anticipate that the filter bandwidth will exceed our design objectives in the midband.

The coupling capacitor complexity stems directly from our filter being tunable over nearly two octaves. If our

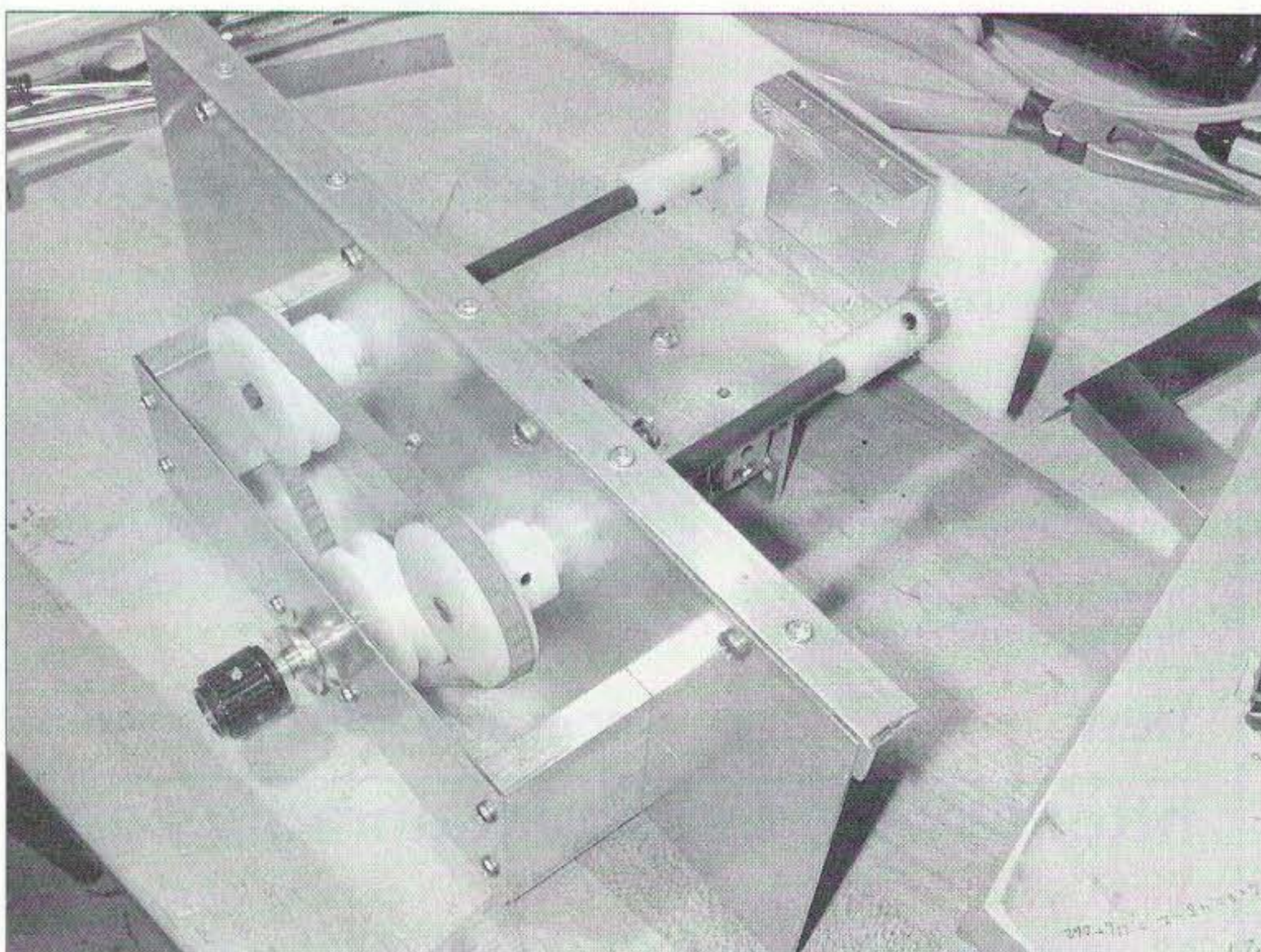

Photo D. The main shaft is driven with a 6:1 reduction vernier.

filter needed to cover only a single ham band, C_{12} and C_{23} could be fixed capacitors designed for the middle of the band. Only slight error would result at the band edges.

Making the coupling capacitors reasonable value

Although a 9 pF coupling capacitor at 550 kHz isn't an unreasonable value, there are obvious difficulties posed to provide 0.94 pF for 1700 kHz. Stray wiring capacitance, and the inevitable minimum capacitance of small variables, make realizing sub-pF capacitances difficult.

Fortunately, we can use the tapped inductor transformer to increase the required coupling capacitance. As illustrated in **Fig. 5**, a transformer will multiply (or divide) the effective capacitance by N^2 . If, instead of connecting the coupling capacitors to the top of the inductor, we connect to a tap at one-half the number of turns, we increase the required coupling capacitors by a factor of 4. Thus, we require two variables with $C_{max} = 36$ pF and $C_{min} = 3.6$ pF, much more reasonable values.

Fig. 6 shows our final "implementable" design.

Section 2 — Construction

It's unlikely that anyone would wish to exactly duplicate my mechanical configuration, so I won't provide detailed layout dimensions. But, the photographs should help you modify my ideas to work with your particular parts.

Winding the inductors

The resonator inductors must have reasonably high Q (preferably exceeding 200) and should be matched within 1% or so. (L_2 being matched as 97.5% of L_1 and L_2 .) The absolute value isn't nearly as critical and could vary $\pm 5\%$.

Although toroid inductors would save space, achieving our Q target would be difficult. Further, matching three toroid inductors to 1% would be difficult, as core-to-core variations of 20% are not uncommon.

I therefore decided to wind three single-layer solenoid coils. I used a

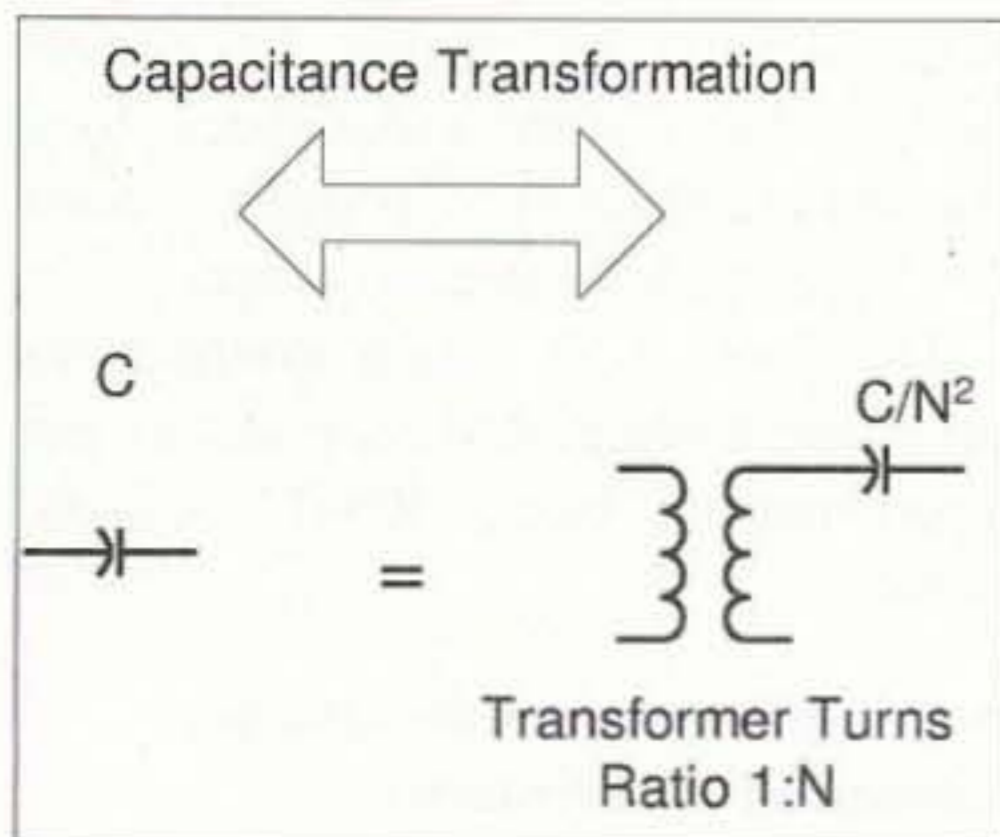

Fig. 5. A transformer can multiply or divide a capacitor's value.

homemade coil winding adapter and a lathe, but hand winding should be possible with reasonable care. My coils were wound on 5-1/2-inch lengths of 2-inch schedule 40 PVC pipe, with an outside diameter of 2-3/8 inch. I wound L_1 and L_2 with no. 24 AWG magnet wire, at 32 turns/inch. I used no. 22 AWG magnet wire for L_3 . The windings occupy about 2-3/8 inch of the core.

L_1 required 76 turns for 243 μH . L_2 required 72 turns for 236 μH . L_3 required 74 turns for 239 μH . In all cases, I wound the coils with 80 turns and removed a turn at a time until I reached the desired inductance.

These inductors have an indicated Q between 200 and 230. I measured the distributed capacitance of L_1 and L_2 at 2.5 pF and L_3 at 5.5 pF. This additional distributed capacitance is an offset for the slightly lower inductance of L_3 . (L_3 , being wound with larger wire, has closer turn-to-turn spacing resulting in increased distributed capacitance.)

A brief mention of distributed capacitance may be in order. Terman's *Electronic and Radio Engineering, 4th ed.*, succinctly states the cause of distributed capacitance in coils:

"In a coil there are small capacitances between adjacent turns, between turns that are not adjacent, between terminal leads, between turns and ground, etc. ... The total effect that the numerous small capacitances have can be represented to a high degree of accuracy by assuming that they can be replaced by a single capacitor of appropriate size shunted across the coil terminals."

Distributed capacitance sets a limit on the highest frequency at which a coil may be resonated; with no additional capacitance, the inductance and C_{dist} parallel resonate at some frequency, referred to as the "self-resonant frequency," or F_{self} .

Although I used an HP-4342A Q-meter to match my inductors, almost any method may be used, as we are chiefly looking for relative accuracy. For example, with a fixed 370 pF capacitor in parallel across L_1 , remove turns until a grid dip meter indicates resonance at 534 kHz. Move the 370 pF capacitor to L_3 and remove turns until a dip is seen at exactly the same dial point as observed for L_1 . Move the 370 pF to L_2 and parallel it with a 10 pF capacitor. Remove turns from L_2 until L_2 dips at the same dial point as seen with L_1 and L_3 . You can also squeeze the turns or spread them out to fine tune the inductance. (Since we are matching all inductors to the same dial mark, each inductor will be matched. If the grid dip meter dial is within 5%, the absolute value of the inductors will be close enough.)

I do not recommend using small pre-wound inductors, such as the 10 mm Toko or Coilcraft series, as their Q is well below minimum acceptable values for good performance.

Linking the variable capacitors

I mechanically ganged the main tuning capacitor and the two coupling

variables with a miniature toothed drive belt and pulleys. To slow down the tuning, I used a 6:1 vernier reduction drive. The vernier drive is connected to the main tuning capacitor with the two coupling variables being driven via the drive belt. The drive belt is approximately 12 inches in circumference.

Since both sides of the coupling capacitors float above ground, they must be mounted on an insulating material. I used 1/8-inch-thick Delrin® plastic. The shaft extension should also be insulated; I used 1/4-inch fiber rods.

I turned the pulleys on a lathe from 1-1/2-inch-diameter Delrin rod. I also made Delrin shaft bushings for the two 1/4-inch drive shafts.

The completed tuning assembly is reasonably smooth, but has a slight degree of "springiness" due mostly to flexing of the 1/4-inch shafts. The tuning feel could be improved — at the expense of considerable added mechanical complexity — by adding outboard bearings so that the shafts experience no significant bending moment. Some ultimate limit on tuning smoothness will be imposed by the drive belt stretch.

Because I wanted to use a large circular dial, it was necessary to elevate the main tuning capacitor with a bracket assembly. The mechanical assembly is further complicated by my desire to build and test the filter in

<ul style="list-style-type: none"> • DIP switch programmable • Miniature in size • 37 EIA tones, 27 non-standard tones from 33.0 to 254.1 Hz included • Reverse Burst built-in • Easy 3 wire hookup 		<ul style="list-style-type: none"> • Fully enclosed CTCSS encoder • All 32 EIA tones from 67.0 to 203.5 Hz included • Perfect for mobile / base applications 	
<p>SS-64 CTCSS Encoder .66" x 1.08" x .21"</p> <p>SS-64 DIP Switch Programmable CTCSS Encoder \$28.95</p>		<p>TE-32 5.25" x 3.3" x 1.7"</p> <p>TE-32 Multi-Tone CTCSS Encoder \$49.95</p>	
	<ul style="list-style-type: none"> • 51 CTCSS Tones • 106 DCS Codes • Supports 157 Repeater Subscribers • On-Line Computer Help • Repeater CW ID • Air Time Loading & Analysis Graphs • Signalling Formats: CTCSS, DCS & DTMF 		<ul style="list-style-type: none"> • Eight programmable, selectable messages • Fully field programmable via included keypad • Meets all FCC identification requirements
<p>TP-3200 Shared Repeater Tone Panel</p> <p>TP-3200D Table Top Version \$269.95 each</p> <p>TP-3200RM-A Single Rack Mount version \$279.95 each</p> <p>*TP-3200RM-B Triple Rack Mount version \$279.95 each</p> <p>*Holds up to three TP-3200s</p>		<p>ID-8 Automatic Morse Code Identifier 1.85" x 1.12" x .35"</p> <p>ID-8 Automatic Morse Station Identifier \$69.95</p>	
<p>Call or write to receive our full Product Catalog or visit our Web site for complete information at: http://www.com-spec.com</p>		<p>COMMUNICATIONS SPECIALISTS, INC. 426 WEST TAFT AVENUE • ORANGE, CA 92665-4296 (714) 998-3021 • FAX (714) 974-3420 Entire U.S.A. (800) 854-0547 • FAX (800) 850-0547 http://www.com-spec.com</p>	

sections. Thus, I made the capacitor tuning assembly as a stand-alone unit, for later installation into an enclosure. Some simplification would be possible if stand-alone testing was not desired.

If you wish to greatly simplify the mechanical portions of this project — and the mechanical elements represent 90% of the total effort — it isn't necessary to gang the main tuning with the coupling variables. Instead, tuning will require setting three knobs, not one. An additional side benefit is that the main tuning and coupling controls can be individually calibrated thereby removing tracking error.

Construction, layout, and wiring

I decided to make a completely homemade enclosure from sheet aluminum. The base is a 12" x 12" x 1/8" sheet. The front, back, and side panels are 12" x 8" x 0.050". The top is 12" x 12" x 0.050". All panels are held together with odds and ends of aluminum stock, mostly 1/2" x 1/2" bar stock and 1/2" angle. I painted the enclosure with primer and a finish coat of gloss dark gray.

The size of my enclosure was driven by the size of the coils and my desire not to have any inductor wiring one inch of the chassis in so far as possible, although I did not fully meet this objective in all cases.

I made the dial from a piece of 1/8-

inch white Lucite® plastic. I marked out a 6-inch-diameter circle with a compass and then rough cut it with a scroll saw. I then turned it to a perfect circle in the lathe. A lathe isn't necessary, as with some finishing with a file would have produced quite acceptable results if the scroll saw work were done carefully.

Start with a simple 0–100 scale taped to the dial and record the frequencies that corresponded to the major divisions. Then use a computer drawing program to prepare the scale and print it in reverse on a clear plastic sheet of the type used for an overhead projector. (I used Visio®.) Glue the scale to the Lucite backing with a transparent spray adhesive, such as Scotch® 77. By printing in reverse, the toner is protected from exposure to your hand while tuning. The result is a very professional-looking calibrated dial.

It's important to lay out the filter to minimize stray coupling. **Photo F** shows that each coil has its axis at right angles to the other coils. This minimizes unwanted inductive coupling. It's also a good idea to allow as much space as possible between the coils. I experimented with shielding between the coils but found it unnecessary.

I wired the filter with no. 16 AWG magnet wire and tried to keep each wire at least a half-inch from neighboring wires and from the chassis and

other structural elements. It's important to keep stray capacitance to a minimum. Wherever possible, don't run wires parallel to each other.

The input and output connections are made through BNC connectors and short internal runs of RG-174 coaxial cable.

Section 3 — Adjustments and measured performance

When first assembled, I found poor performance above 1000 kHz. Between 1000 and 1700 kHz, the pass-band had multiple peaks and poor roll-off, both evidence of over-coupling. While I expected problems with overcoupling arising from the tracking error, the result was far worse than envisioned.

Resonance at 1700 kHz corresponds to a node tuning capacitance of 35.6 pF that is achieved, allowing for strays and distributed capacitance, with around 27 pF or so of main tuning capacitance. Fully unmeshed — 180 degrees of shaft rotation — my main tuning variable only had 14 pF, corresponding to a center frequency near 2200 kHz. 1700 kHz occurred at 150 degrees of main tuning capacitor shaft rotation.

Our design assumed that the coupling variable would be at its minimum capacitance — 180 degrees of shaft rotation — at 1700 kHz. Since I had synchronized the coupling variables to achieve minimum capacitance at the same shaft rotation angle as the main tuning capacitor's minimum capacitance, I clearly had too much coupling capacitance at 150 degrees rotation. To reduce the coupling at 1700 kHz, I set the coupling variables to be fully open when the main tuning variable was peaked at 1700 kHz. Thus, the main tuning variable and the two coupling variables are out-of-synchronization by 30 degrees.

This significantly, but not completely, improved the response above 1000 kHz. The downside is that at lower frequencies, the resonators will be undercoupled, as when the main tuning capacitor is fully meshed, the coupling capacitors are short of full mesh.

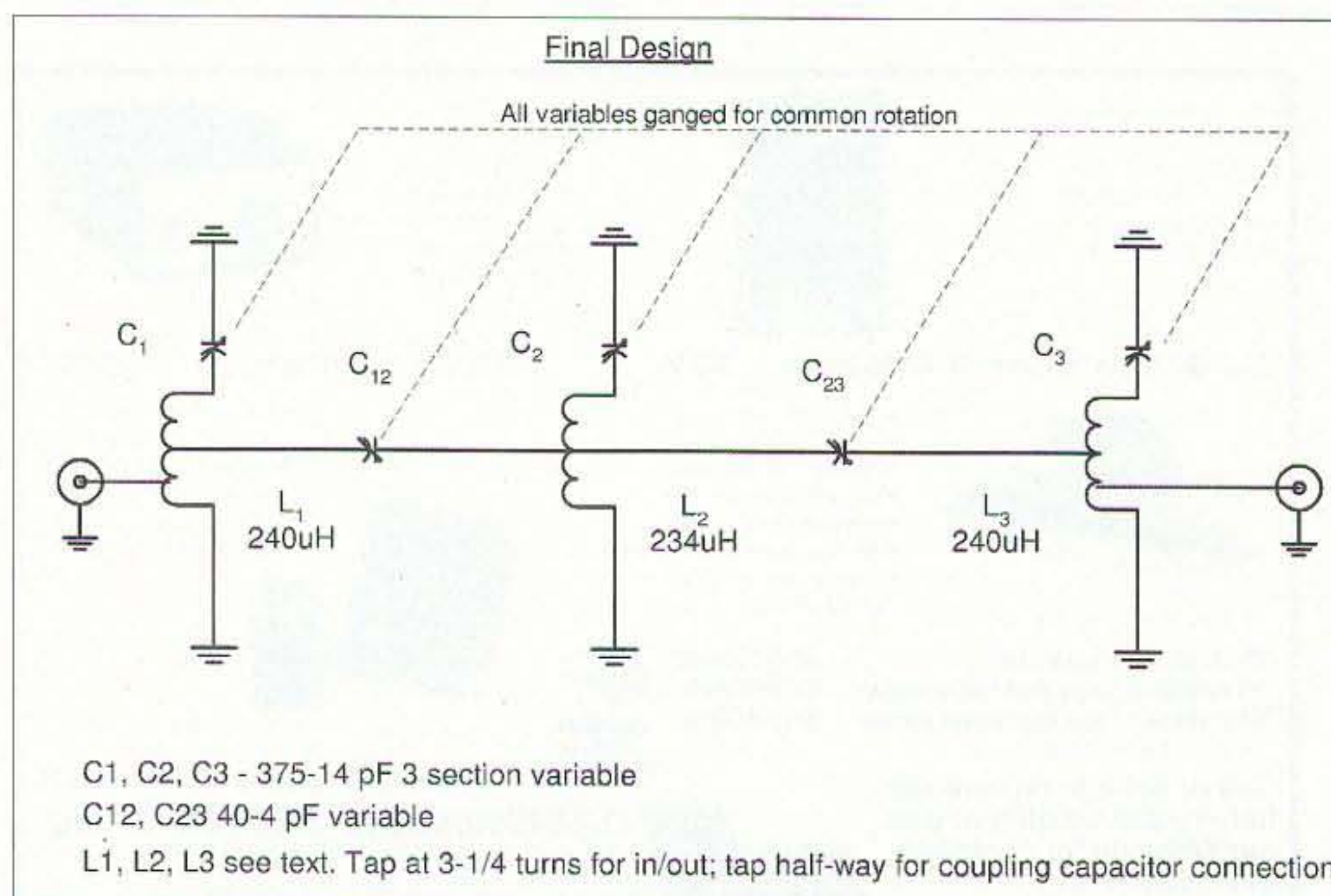

Fig. 6. Final design.

Although much improved, the frequency response at 1700 kHz still showed signs of multiple peaks. Driving the filter with a signal generator at 1700 kHz, I measured the voltage across each resonator with an oscilloscope and an X10 probe. All oscilloscope probes introduce some shunt capacitance that detunes the resonator being measured. Hence, we have to look for relative shifts between the resonators.

As I slightly moved the tuning control, I saw that one resonator peaked at a higher dial frequency than the other two. Upon reflection, the problem was obvious; the out-of-resonance circuit involved L_1 , which was wound with no. 24 AWG, resulting in about 3 pF less distributed capacitance than its counterpart L_3 wound with no. 22 AWG wire. This small difference in total capacitance shifted the resonant point enough to disturb the passband response. A 3 pF silver mica added across L_1 brought all three inductors into synchronization and removed the separate passband peak. (At lower frequencies, a difference of 3 pF becomes negligible; at 1700 kHz, 3 pF is 8% of the total resonating capacitance!)

Fig. 7 shows the passband response of the completed filter, after making these two alterations. In general, it conforms to our design, except for narrower-than-predicted bandpass at 550 kHz and a wider-than-expected bandpass at both 970 kHz and 1700 kHz. In addition, the passband isn't as flat as might be desired. One predicted result of finite-Q inductors is passband tilt.

As with any filter, far-out-of-band rejection may be of concern due to self-resonance of inductors and stray coupling. To examine this, I looked at the response from 3 MHz to 50 MHz with an HP 8754A network analyzer. **Photo E** shows the response 4–50 MHz, at 10 dB/division. (The filter was tuned to 600 kHz, but its passband is below the 4 MHz minimum frequency of the network analyzer.) Spurious responses around 6 and 11 MHz appear to be associated with the self-resonant frequencies of the resonator inductors, whilst the higher frequency responses

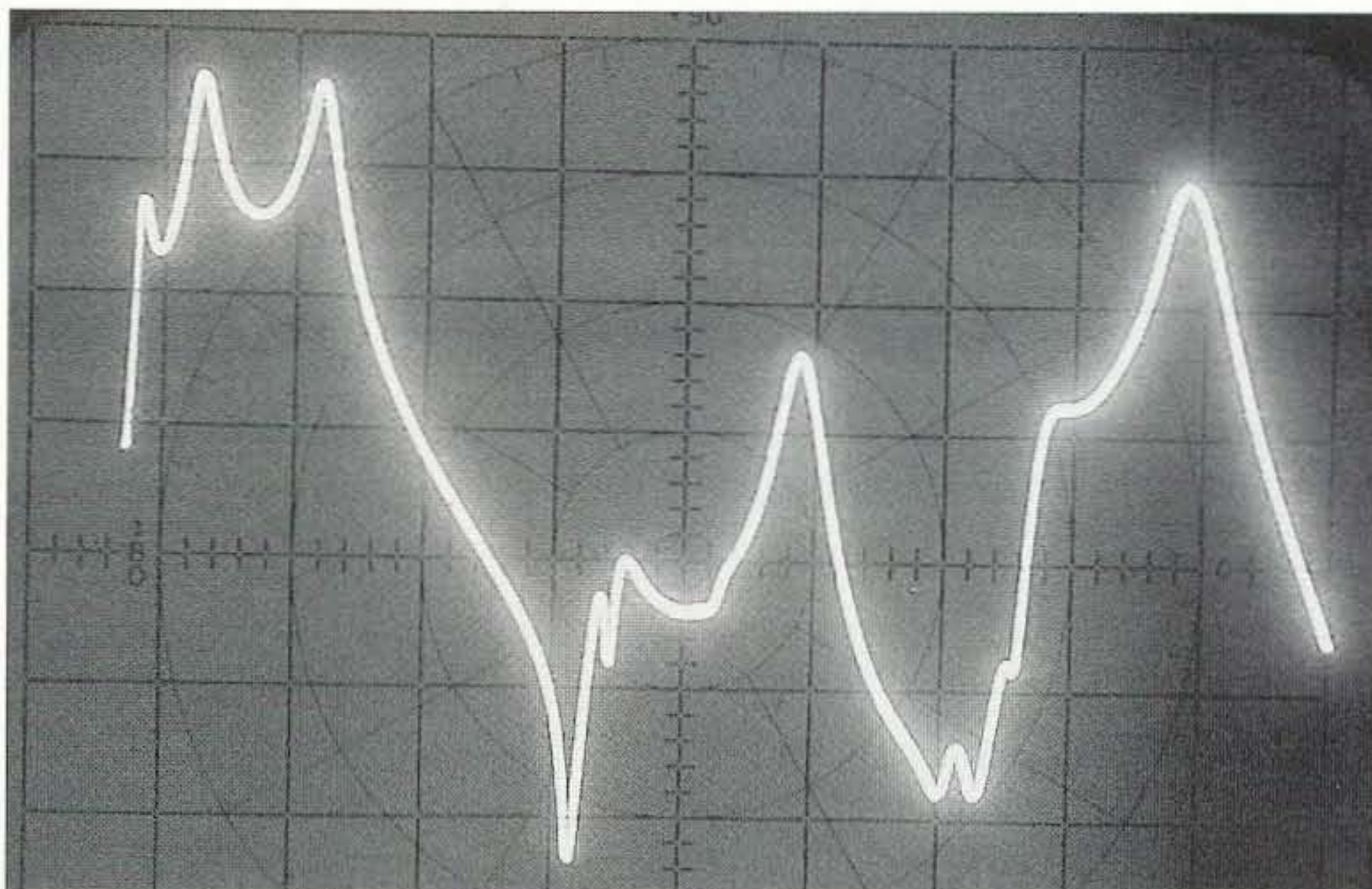

Photo E. The filter has high frequency spurious responses (5 MHz/div. & 10 dB/div.).

likely result from stray inductance and capacitance in the connecting wiring. If far-out-of-band attenuation is a concern, a simple low pass filter with a cut-off of, say, 2.5 MHz could be added.

References

A.I. Zverev, *Handbook of Filter Synthesis* (Wiley, 1967). Zverev's book is still in print 35 years after initial publication and should be in the library of anyone seriously interested in filter design. If the breathtaking price of a

new copy is difficult to justify, ask your local public library for a copy via interlibrary loan.

A.B. Williams and F.J. Taylor, eds. *Electronic Filter Design Handbook, Third Edition* (McGraw Hill, 1995). Out of print, but available from used bookstores and via interlibrary loan. Includes good active filter section and reproduces some of Zverev's most important tables and graphs.

W.E. Sabin and E. O. Schoenike, eds. *Single-Sideband Systems & Circuits*, (McGraw Hill, 1987), or the revised edition, originally published as

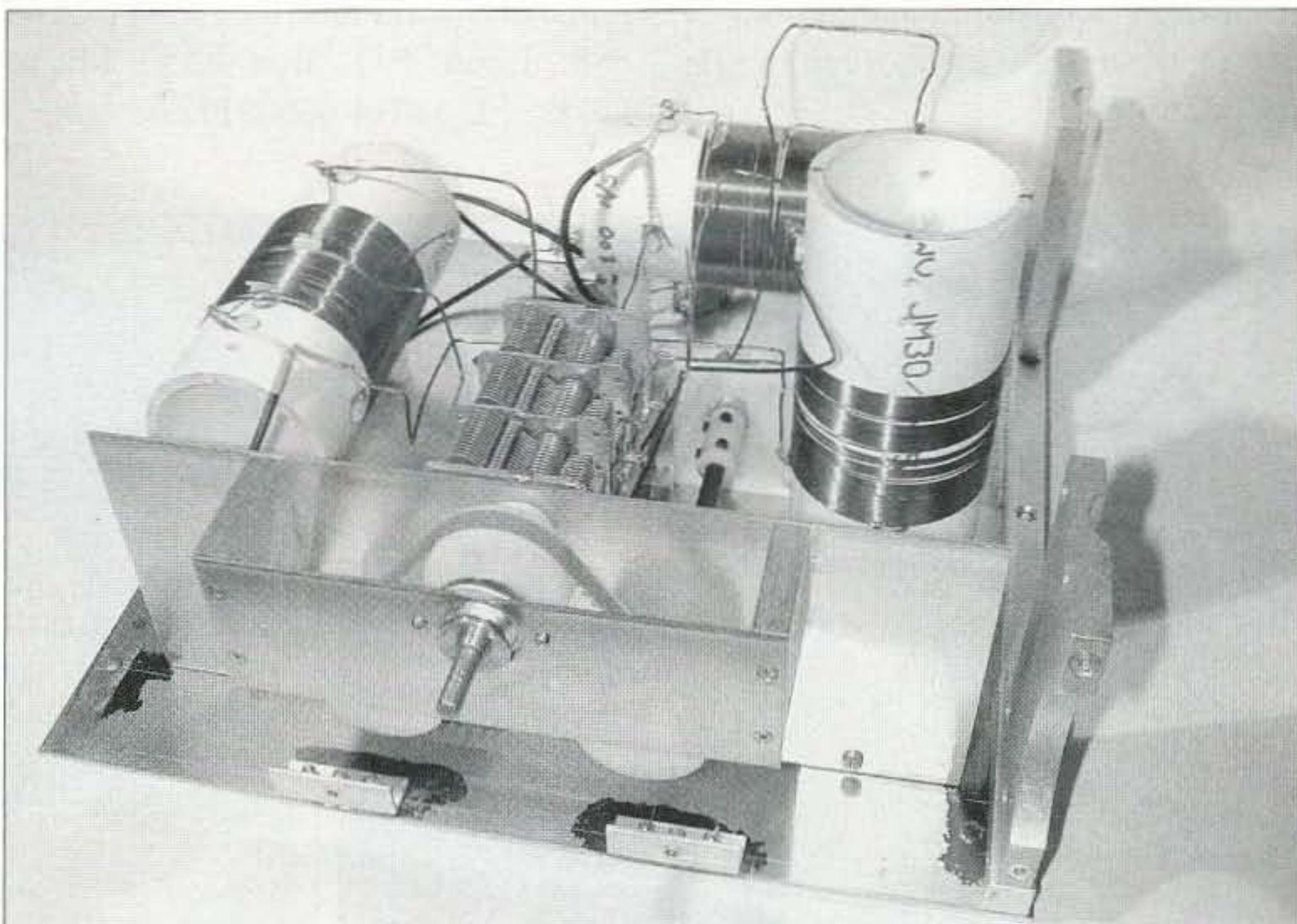

Photo F. Mount the coils so that each is at right angles to the others.

Scrambling News

915 NW First Ave., Suite 2902, Miami FL, 33136
305-372-9427
www.scramblingnews.com

Pay TV and Satellite Descrambling 2002 - NEW! - satellite and cable. Includes latest information. \$19.95 plus \$1.75 shipping.
Hacking Digital Satellite Systems Video 2002 - New! - \$29.95 plus \$3.50 shipping.
Scrambling News Online - Online service for those interested in satellite television news. \$59.95/year. \$59.95/yr.
Pay TV and Satellite Descrambling Series CD-Rom - all 13 volumes over 300 pages, \$59.95 plus \$3.50 shipping.
Best Deal - Everything listed above for only \$99.95 plus \$3.50 shipping.

Surplus Microwave Parts & Test Equipment
dudleylab.com
Visa/MC/Discover
732-240-6895
Toms River, NJ 08757

Single-Sideband Systems & Circuits, 2nd Ed. (McGraw Hill, 1995), reprinted as *HF Radio Systems & Circuits* (Noble Publishing Corp., 1998). Both the first and second editions devote a complete chapter to preselector design, and offer many theoretical and practical suggestions.

F.E. Terman, *Electronic and Radio Engineering, 4th ed.* (McGraw Hill, New York, 1955). The classic radio engineering textbook, readily available from used bookstores and should be in the library of every technically inclined ham.

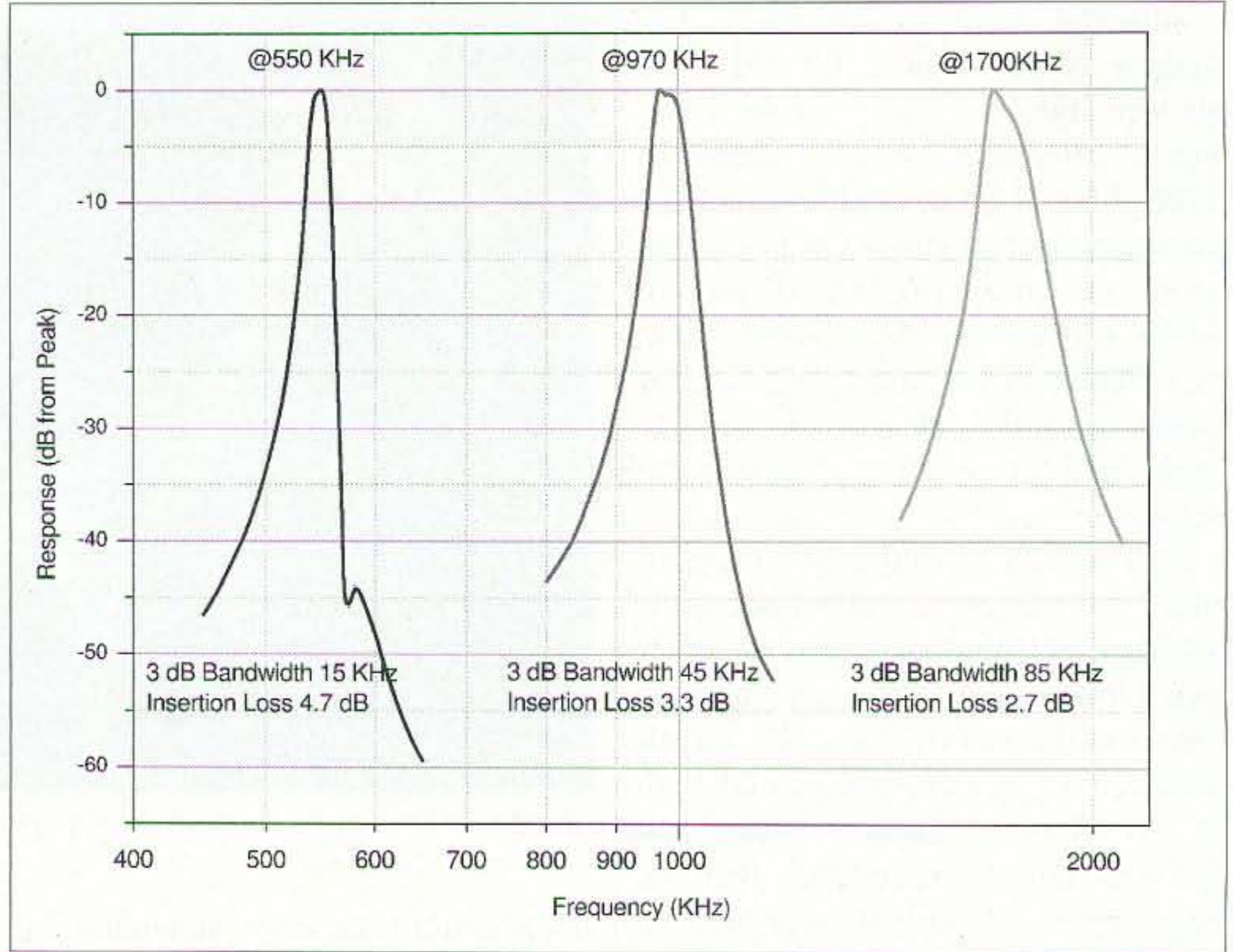

Fig. 7. Passband plot.

Parts sources

One source of vernier reduction drives and variable capacitors, including three-section broadcast variables, is Ocean State Electronics, 6 Industrial Drive, P.O. Box 1458, Westerly, RI 02891; phone: 401-596-3080; (fax) 401-596-3590. Web site: [http://www.oselectronics.com].

Mechanical parts, including miniature drive belts and pulleys, can be found at Small Parts, Inc., 13980 N.W. 58th Court P.O. Box 4650 Miami Lakes, FL 33014-0650, Phone orders:

1-800-220-4242. Web site: [http://www.smallparts.com]. Another possible source of similar products is SDP/SI, 2101 Jericho Turnpike Box 5416, New Hyde Park, NY 11042-5416. Web site: [http://www.sdp-si.com/index.asp].

I bought many of the mechanical parts and material stock from MSC Industrial Supply Co., via their Internet ordering site: [http://www.msdirect.com].

Say You Saw it In 73!

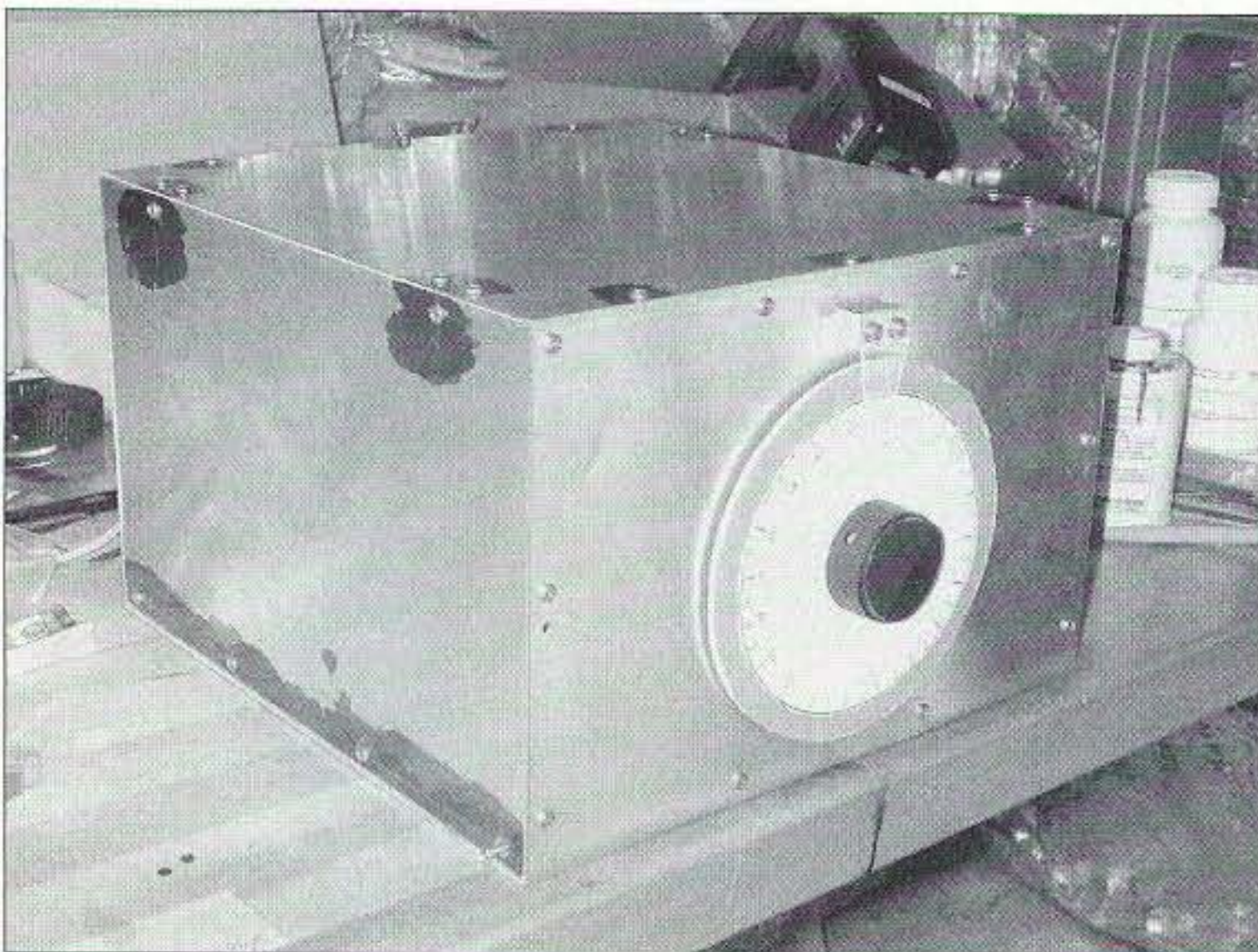

Photo G. Test assembly of the cabinet and dial, before painting.

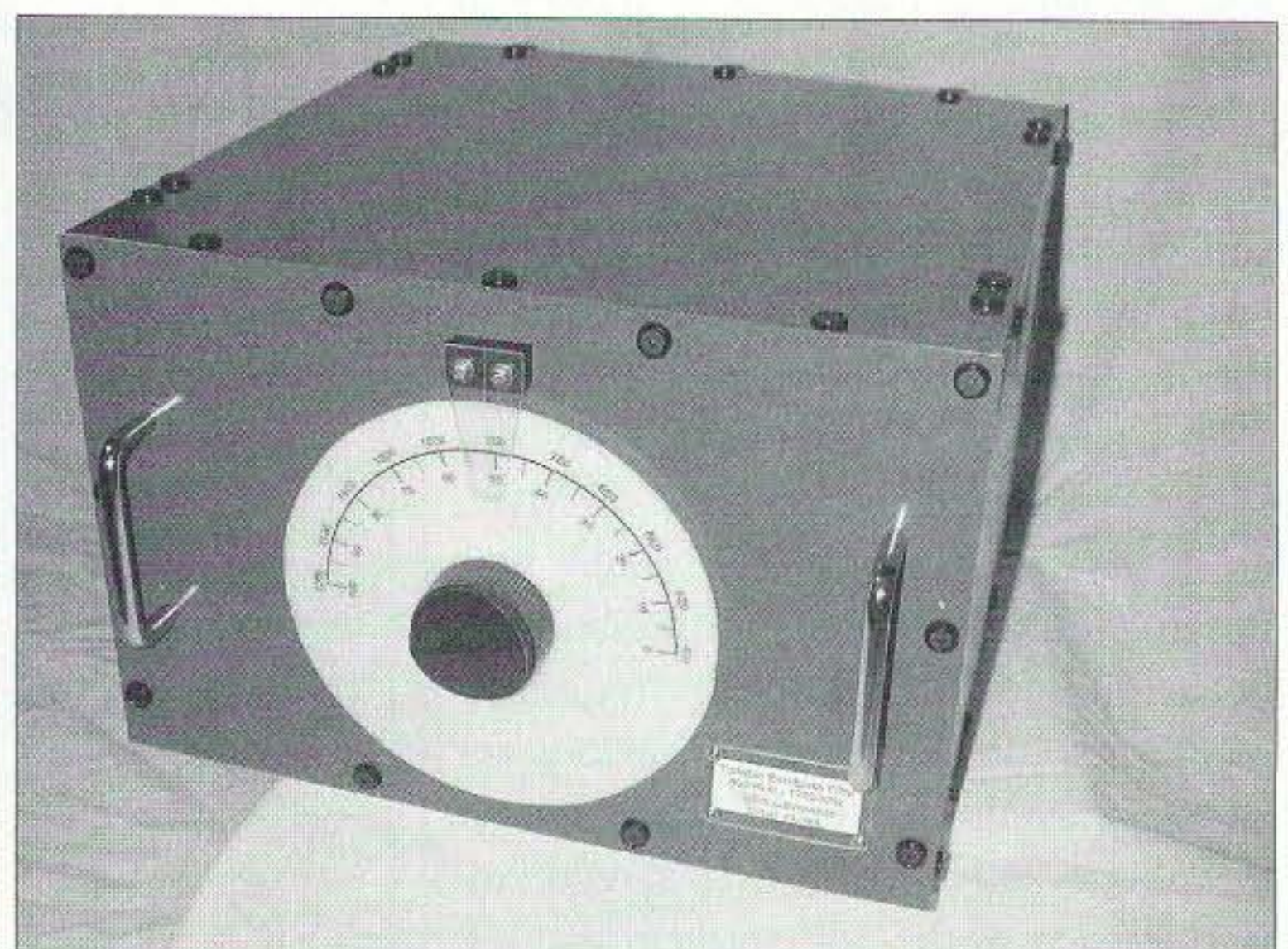

Photo H. Completed filter.

How to Make a Butterworth Low Pass and Bandpass Table

Low Pass Prototype

The Butterworth prototype low pass g-values for infinite Q can be calculated very easily with a spreadsheet program, such as Excel®, or a scientific calculator. The key equations are:

$$g(n) = 2\sin[\pi(2n - 1)/2N]n = 1, 2, \dots, N$$

$$g(N + 1) = 1$$

N is the order of the filter. One point to remember is that the argument for the sine function is expected to be in radians. So, if your calculator is set for degrees, a conversion is necessary. Excel assumes radians, so no conversion is necessary if you set up a spreadsheet.

Let's go through a couple of examples. **Table S1**, for Butterworth low pass prototypes, can be found in many references, including recent ARRL handbooks.

For a 4th-order filter (N = 4), we will calculate g(0) through g(5). We'll use $\pi = 3.14159$ as accurate enough for our calculations.

g(0) — We can either calculate it, or note that g(0) always is 1.000.

g(1) — Plug in N = 4 and n = 1 into the g(n) formula.

$$g(1) = 2\sin[3.14159 \times (2 \times 1 - 1)/2 \times 4] = 2\sin(3.14159 \times 1/8) = 2\sin(.3927) = 2 \times 0.3827 = 0.7654$$

If your calculator expects the argument for sin(x) to be in degrees, multiply 0.3927 radians by 57.30 degrees/radians. $0.3927 \times 57.30 = 22.50$ degrees. $\sin(22.50 \text{ degrees}) = 0.3827$.

g(2) — Plug in N = 4, n = 2 into the g(n) formula.

$$g(2) = 2\sin[3.14159 \times (2 \times 2 - 1)/2 \times 4] = 2\sin(3.14159 \times 3/8) = 2\sin(1.1781) = 2 \times 0.9239 = 1.8478$$

g(3) — We can either calculate g(3), or note that the Butterworth coefficients exhibit symmetry about the midpoint, such that $g(n) = g(N - n + 1)$. In this case, n = 3, N = 4 so $g(3) = g(4 - 3 + 1) = g(2)$. We know $g(2) = 1.8478$, so $g(3) = 1.8478$ as well.

g(4) — Likewise, we can use the symmetry relationship and simplify the calculation. $g(4) = g(4 - 4 + 1) = g(1)$. We know $g(1) = 0.7654$, so $g(4) = 0.7654$ as well.

g(5) — Now, n = N + 1, so we have to use the special formula, $g(N + 1) = 1.000$. Hence, $g(5) = 1.0000$.

By repeating these calculations, we can complete the Butterworth low pass filter table for any order that we wish.

Convert to bandpass table

Our converted bandpass table will contain two data elements; normalized Q values and normalized coupling coefficients.

Normalized Q values are q_1 and q_n , where q_1 is with respect to the first resonator and q_n is with respect to the last (nth) element. For a particular filter of order N, the q values are very simply related to the g parameters of the low pass filter prototype of order N:

$$q_1 = g(1)$$

And, since Butterworth filters are symmetrical, $q_n = q_1$.

The normalized coupling coefficients are expressed as k_{12} , k_{23} , etc., where k_{12} is the coupling coefficient between resonators 1 and 2, k_{23} is the coupling coefficient between resonators 2 and 3. k_{ij} is the coupling coefficient between nodes i and j. The relationship between the coupling coefficients and g values is given by:

$$k_{ij} = 1/\sqrt{g(i)g(j)}$$

Table S2 is a bandpass table corresponding to the low pass table in **Table S1**.

Now, let's see how these values were calculated. We'll again look at the N = 4 values.

q₁ — Determining q_1 is easy. $q_1 = g(1)$, or 0.7654.

q_n — Since $q_n = q_1$, $q_n = 0.7654$.

k₁₂ — We previously found that $g(1) = 0.7654$ and $g(2) = 1.8478$. We now use these values to calculate k_{12} :

$$k_{12} = 1/\sqrt{g(1)g(2)} = 1/\sqrt{0.7654 \times 1.8478} = 1/\sqrt{1.414} = 1/1.1892 = 0.8409$$

k₂₃ — We calculate k_{23} the same way, noting that $g(2) = 1.8478$ and $g(3) = 1.8478$:

$$k_{23} = 1/\sqrt{g(2)g(3)} = 1/\sqrt{1.8478 \times 1.8478} = 1/\sqrt{3.414} = 1/1.8478 = 0.5412$$

k₃₄ — Again, we can calculate k_{34} using the approach shown for k_{12} and k_{23} , or we can again take advantage of symmetry and save a calculation. Symmetry requires $k_{ij} = k_{(N-i)(N-j+2)}$. Since for our sample N = 4, $k_{34} = k_{(4-3)(4-4+2)} = k_{12}$ or k_{12} . Accordingly, $k_{34} = 0.8409$. 73

	n					
	0	1	2	3	4	5
N	g(0)	g(1)	g(2)	g(3)	g(4)	g(5)
2	1.0000	1.4142	1.4142	1.0000	—	—
3	1.0000	1.0000	2.0000	1.0000	1.0000	—
4	1.0000	0.7654	1.8478	1.8478	0.7654	1.0000

Table S1.

N	q1	qn	k12	k23	k34
2	1.4142	1.4142	0.7071	—	—
3	1.0000	1.0000	0.7071	0.7071	—
4	0.7654	0.7654	0.8409	0.5412	0.8409

Table S2.

How to Avoid a Disaster Disaster

And how about putting the field back in Field Day?

What do Field Day and disaster communications have in common? Before Field Day turned into a beer-guzzling barbecue party, it was intended to test our preparedness for communicating in disasters, and other emergencies. While some clubs still actually bring radios and antennas out to their Field Day parties, I've found it unfortunate that the primary concern discussed on local repeaters is, "Who's bringing the potato chips?", instead of, "Who's got the emergency generator?"

Returning to the original intent of Field Day, it should be identical to disaster and emergency communications, minus the body bags. A good way to tell if you, or your club is ready for either is to imagine the following scenario: Your club president (or other ham official) calls you at three o'clock in the morning to chase you out of bed. You have to grab your emergency radio kit and get to point "X," ready to jump in with ham communications.

Are you ready? The most common mistake I've seen made is that people bite off more than they can chew: They think that they have to bring their entire ham shack, and set it up. In reality, though, face it: You don't operate everything at once while you're at home, even under the best of conditions.

No one expects you to do that under the extremes of disaster communications, either. Focus on what you're good at. For example, if you're an avid off-road enthusiast complete with an appropriate vehicle, consider a mobile "command vehicle" that you can take right up to the site (or as far as the police or fire officials will allow — be prepared to show identification if asked).

You can then help coordinate communications in and out of the site. Are you an avid hiker? Then you might be the perfect candidate to tag along with the command vehicle, and be prepared to hike the last stretch to the emergency site. Emergencies do not always take place in areas that are accessible by vehicle, and the last stretch may have to be taken on foot. Duffel bags are built a bit more ruggedly than backpacks, and come equipped with backpack-like straps to allow hands-free carrying. You might want to consider one of those to carry your equipment the last stretch. Emergency supplies like blankets can serve as protection from radio equipment getting banged up along the way. You won't need high-power equipment, either; all you'll need is a minimum of equipment, since all you need to reach is the command vehicle. That vehicle, with its engine-driven power supply, makes for an ideal relay station to the outside world.

The most neglected aspect I've noticed in emergency communications is the repeater. Very few have backup power supplies that can sustain emergency communications, even in low power. If you or your club can't afford

a large back-up power source, consider extending the life of a smaller source and toggle off the amplifier. Even low-power repeaters, through their exceptionally good antenna height, have better coverage than mobiles and portables. Remember: You're not out to work repeater DX — just get a message out of the emergency site. Police departments have been using repeaters, called mobile extenders, in their squad cars for years, and they work well even with the low antennas. Again, they're not out to work DX — just to get their hand-helds' signal from where they are back to a central dispatch center.

For these applications, it's a good idea to have a second repeater that can be used for a backup in case the first one goes down. Not everyone has the technical ability to fix their own repeaters (unfortunate but true), and in the middle of an emergency you can't put things on hold for two months while you send the repeater back to the manufacturer for repair. The only other option is to have enough spares for your repeater lying around to get things back on the air with a parts

Continued on page 58

Ready, Set ... Don't Go?

The time for preparation to be a meaningful participant in the next emergency situation is before the event occurs.

Not that we're looking forward to catastrophes, but to be prepared to operate effectively and efficiently in such times makes planning and training essential ingredients for success.

When the catastrophe of September 11th struck New York City, the call went out for volunteers to provide a multitude of needed services. Amateur radio operators and their portable equipment were but one of the services desperately needed in the city during the initial days following the disaster.

One of my fellow radio amateurs and a few of his friends rallied round the kitchen table that evening and decided that they were able to "get away" for a few days. Filled with good thoughts and ambition, they answered the "call."

But guess what?!!

They were politely denied the opportunity to serve, because "they" didn't know who my friends were!

They hadn't taken the preparedness course! Therefore, they weren't registered volunteers in the Red Cross databank!

Identification

"They" would have been glad to have had my friends' services had they only attended the required orientation course necessary of all volunteers, and possessed the Red Cross identification

badge. Other amateur operators who had attended the orientation course were promptly assigned duty positions and put to work.

"They" weren't able to let my friends provide a service as amateur radio operators at a time when communications were desperately needed, because they hadn't made the necessary preparatory steps to be qualified volunteers when the need arose! Without the prior training and identification, they could have become a liability to the effort!

You've got to understand the atmosphere of the moment. When the need for volunteers went out to the amateur radio community, hams from a number of places responded to the need. To coordinate the use and positioning of these people and their equipment, other volunteers manned posts designed to track people and know where they are. The effectiveness of the relief effort is vastly improved when the volunteers being managed are all familiar with the organization providing the overall relief effort.

Well, my friends weren't some of those "qualified individuals," and the disaster has long since become history.

Hopefully, there won't be another event like that one, but I wonder: What does "being qualified" really mean?

You've already become licensed as an amateur radio operator and you've equipped yourself with some really nice radios. But what possibly could be the reasons for not using your talents?

Volunteer orientation course

Organizations like the American Red Cross rely on volunteers to provide wide-scale activities at major disaster locations. These workers have access to data files that provide them with information needed to perform their function. One of these files is an "Identification File." In it are contained the names, addresses, telephone numbers, etc., and what the volunteer's particular specialty is, if any. The information for the "identification file" was gathered from documents completed at a "volunteer orientation course."

Mother Nature seems to take particular delight in testing our resolve. So, because my "crystal ball" for the perfect world is often cloudy and I haven't any idea of when the next disaster will

Continued on page 58

'Quaker Oaths

In 1989, the ARS came through ... is it still ready?

Within minutes of the October 17, 1989, San Francisco earthquake, hundreds, maybe thousands, of amateur radio operators responded statewide and nationwide. While Pacific Bell Telephone suffered little damage, the lines into and out of San Francisco were jammed. According to a telephone company spokesman on the ABC news, some 25,000,000 callers attempted to reach San Francisco almost instantly.

The number of callers continued unabated for three days. For the average citizen trying to find out about his loved ones or friends, there was only amateur radio to turn to.

Thousands of "health and welfare" messages flowed into and out of San Francisco and areas to the south. The hours of preparedness drills paid off for those who devote themselves to emergency communications. Statewide nets responded almost instantly, with long-haul nets close behind.

Digipeating packeteers

According to Lew Jenkins N6VV, president of the Northern California Packet Radio Association, digital, rather than analog, communications prevailed. "We had it coming in on AMTOR; on packet via HF nets; and it could be easily warehoused in the devastated area, then worked [delivered] at the convenience of the folks there."

Jenkins added that the ability to "digipeat" by every ham running

packet offered many advantages over conventional voice repeaters with traffic on VHF and UHF: "No other mode gave that form of audit trail and trackability. And the adaptive nature of the networks — not having to rely on one repeater — let us switch [work around it] when we lost one of our major nodes down at Crystal Peak; we just brought up additional nodes. We were able to create a new path into areas where we needed to get traffic ..."

Digital-analog cooperation

One of the long-running bones of contention between digital and analog amateur communications has been the self-imposed isolation between the two. The ARRL has tried to remedy this by asking voice repeater coordinators to take on packet and digipeater coordination, but virtually all have declined. This has led to even further isolation. But in California, this isolation ended when the quake began to rumble.

N6VV seems to feel things have changed: "The combination of the automatic routing capability of packet and the appropriate use of the FM

networks ... made it work. When we got word [via packet] of emergency relief supplies from Los Angeles, the first thing we did was to get on 2 meters [FM voice] and contact the E.O.C. in Santa Cruz, which passed that traffic on the Loma Prieta machine ... Meanwhile, 'health and welfare' traffic was flowing [on packet] all of the time that the [voice] conversation was going on."

But there were some reports of packet-oriented hams being a bit too zealous about proving the importance of their favorite mode at a time when they should only have been worrying about getting messages through. Several apparently showed up at disaster coordination sites armed with radios and TNCs, but no microphones. They insisted that packet was better than voice for "tactical" amateur radio communications from the streets.

Jenkins thinks this was a pretty bad idea: "... The general reaction up here was that talking keyboard-to-keyboard in an emergency situation was not that effective. There may be some isolated cases where we will see that it worked. But what we did was to try to get some people with portable packet gear into

the affected areas to take 'health and welfare' outbound traffic ..."

The lifeline for the city

The quake's epicenter was near the once-picturesque town of Santa Cruz some 50 miles away. Santa Cruz was devastated and cut off. Also hard hit was the city of Hollister. A day after the quake, NBC Network News producer Alan Kaul W6RCL visited the Red Cross Evacuation Center in Hollister with a camera crew for Nightly News. Alan and crew came across an amateur radio station that was literally the lifeline for the city. Al was very moved by what he saw, and called Amateur Radio Newline with the following story:

"One of the Red Cross Centers was at the San Andreas High School in Hollister, California, about 30 miles east of the earthquake epicenter. Hollister is the so-called 'earthquake capital of the world' because it is at the junction of three of California's most active faults — the Calaveras, the Hayward, and the San Andreas. Officials here were ready for a quake. They had rehearsed just three months before.

"RACES member Al Romeo N6OJO of San Jose was one of the volunteers who ran the amateur station at the San Andreas school. Forty families whose homes were now unsafe had moved into the shelter. N6OJO, N6RCO, N6DDM and WA6BWT took turns providing coordination. Much of the effort involved keeping the shelter in contact with Red Cross headquarters about fifty miles away near San Jose. They had a packet radio system and were prepared to handle health and welfare messages on HF and VHF radio.

"The amateur radio operation was manned around the clock for about forty hours until power and telephone links were restored. And what type of messages do radio amateurs handle during an emergency like the quake? One order via 2-meter radio in San Francisco was to a drugstore for the purchase of three hundred desperately needed baby bottles."

Alkaline batteries last longer

What did N6OJO learn from his

experiences in the quake? Not to rely on NiCd batteries. There was no good way to charge them when the power was off for so many hours. He said that dry-cell, alkaline batteries last much longer, and he suggests that anyone preparing for an emergency stock up on them.

The Condor Connection

Given the 220 MHz controversy, it's ironic that the statewide backbone of amateur radio emergency communication was not HF, but rather the 220 MHz statewide open interlink called the Condor Connection. Designed and built by Mark Gilmore WB6RHQ and the late W6TLG, the Condor Connection covers the state from San Francisco/Sacramento to the US-Mexican border, and east to Arizona and Nevada. This open system functions as a three-state super-repeater with the ability to handle massive amounts of voice traffic free of the kinds of natural and manmade interference often hampering HF links. WB6RHQ had engineered Condor to withstand a quake of this magnitude or greater, and on October 17 this attention to detail paid off. Condor withstood the test and went on to handle a traffic load that would boggle the mind of anyone listening in.

There is no way to establish the message count handled by those using Condor, but it has to be in the thousands. Unfortunately, the Condor Connection is slated for oblivion. The FCC recently reallocated the spectrum between 220–222 MHz to Land Mobile Services.

What about the next time?

In the crowded amateur bands of California, there is no place left to relocate the Condor Connection. As vital as it is, there appears to be no way to convince repeater owners of 2 meters, 220 MHz and 450 MHz to vacate channels for Condor.

As I am writing this only hours since the emergency began, information pertaining to amateur radio involvement is still scarce. Some of it, regarding organized malicious interference, is

dismaying. I enjoy writing about the triumphs of those in our hobby/service who, like Al Romeo N6OJO, Frank Collins N6TAF, Lew Jenkins N6VV, Mark Gilmore WB6RHQ, and countless others whose names we may never know, are providing the kind of community support indicative of what we hams are supposed to be.

The San Francisco quake brought many hams closer than ever before. It proved the importance of the new digital modes and their ability to handle volumes of traffic quickly and effectively. It has also opened up a new dialogue between the analog and digital worlds that will definitely lead to more interaction and cooperation between the two.

CBers not to blame

But the quake also pointed out that we have among our ranks psychotics holding amateur radio operator licenses. We cannot excuse the organized jamming of the emergency communications. We can't blame it on "CBers with stolen rigs." Hams did it. People who studied for their licenses. Who took a test of Morse Code and amateur radio theory. Human beings who probably shelled out several thousand dollars to set up a ham station, and what for? To destroy!

In the late 1970s and early 1980s, California had a master legal tactician who devoted himself to putting the sickies off the air. He was able to reduce the amount of malicious interference to almost zero. The Dayton Amateur Radio Association recognized his work and awarded him its Specific Achievement Award. His solving the jamming problem also almost cost him his life when he suffered a massive heart attack as a result. Joe Merdler N6AHU, where are you when we need you! 73

SAVE 47%!

on 12 months of **73**

Only \$24.97

Call 800-274-7373

Ham vs. Power Outage

Here's a solution that will warm your heart — as well as your wife's toes.

Have you ever experienced a long power outage? I don't mean a few hours. I mean days on end! Here in South Bend, Indiana, we had a severe ice storm that, according to our newspaper, knocked out the power to 100,500 customers.

It all began Wednesday night, January 30, 2002. I was watching The Weather Channel late in the evening, and I saw the warning roll across the bottom of the screen: "Sleet and freezing rain." The temperature was going to hover around freezing through the night, accompanied by precipitation. I put my HT on charge, and checked all the flashlights in the house (just in case). Then I went to bed.

I got up the next morning as usual at 5:30 and looked out the windows.

Everything was coated with at least 1/4 inch of ice! I noticed that the trees were moving — uh-oh! Wind! I noticed that there were flashes of light coming from all directions. The flashes looked like lightning, but there was no thunder.

At 5:45 the power went out in our neighborhood. With the street lights and yard lights out now, I could see the flashes more clearly. The flashes were different colors: red, yellow, green, blue. What the heck is going on? Then I figured it out. The flashes were the

sparks from the power lines arcing. The flashes continued.

I muttered to myself: "This is gonna be bad ... really bad ..."

I fixed a quick breakfast and listened to a few local radio stations on my battery-powered radio. Power was out in many areas of town.

Luckily, I had prepared for this exact situation. We have hot water heat in most areas of our house and a forced air system in the back of the house. The hot water heat lines run around the perimeter of the inside of the house. I

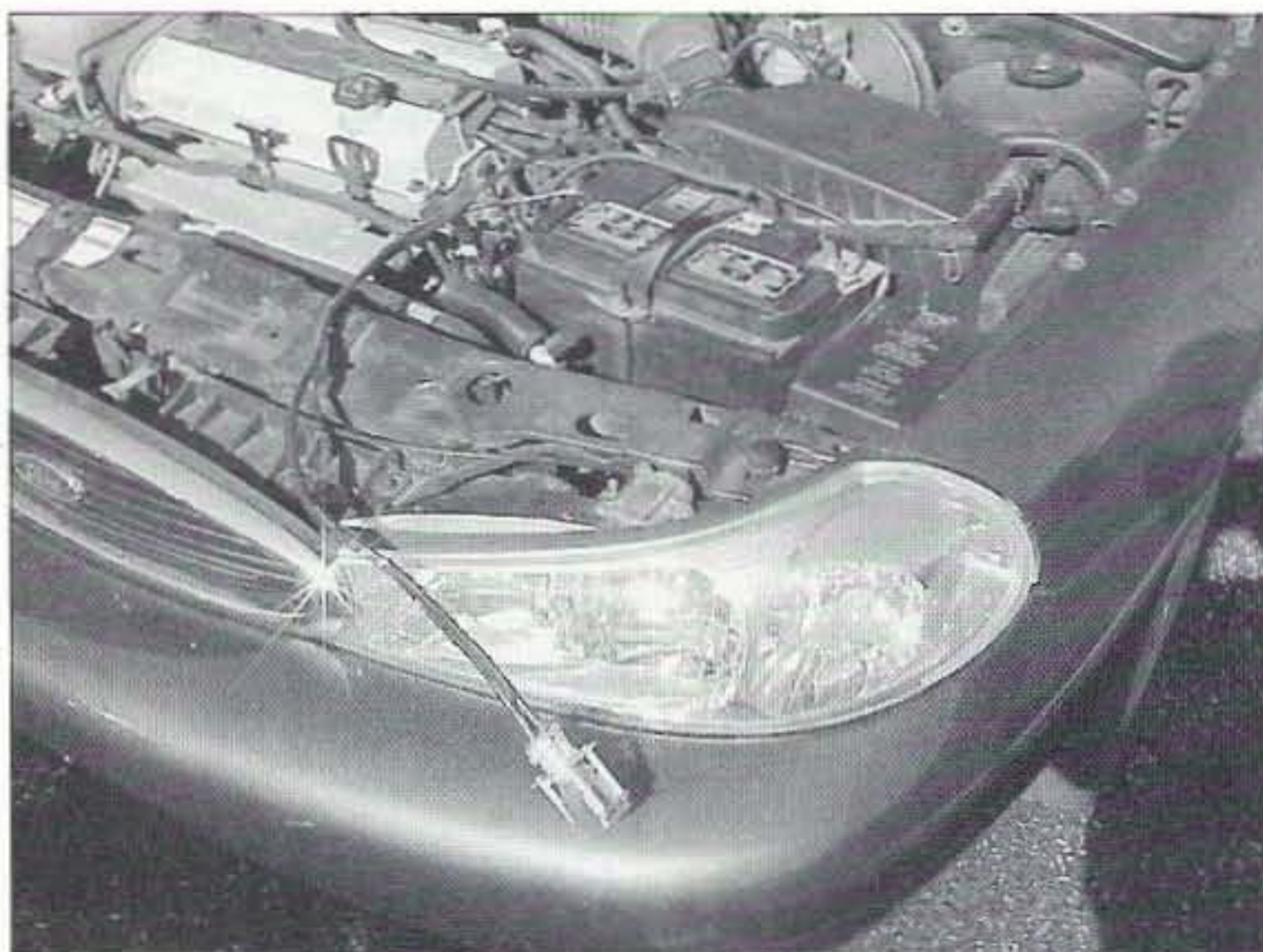

Photo A. Female connector and #6 cables connected to car battery.



Photo B. Close-up of connector on battery cable. Note homemade backshell consisting of metal stand offs conduit fitting and bathtub sealer.

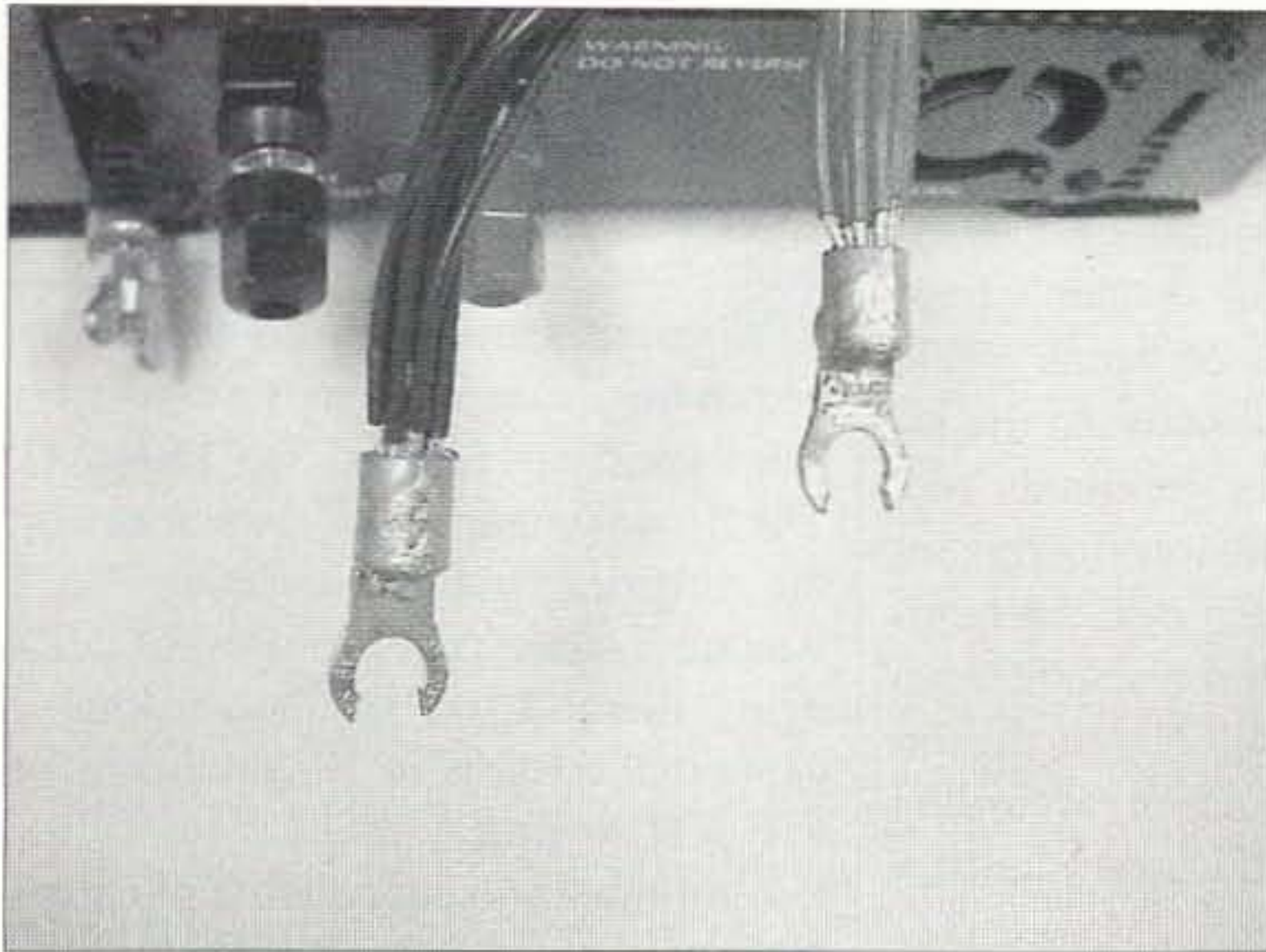

Photo C. This shows the connectors that fit the inverter input terminals. Part of the ring must be removed to allow it to attach to the 5-way binding posts.

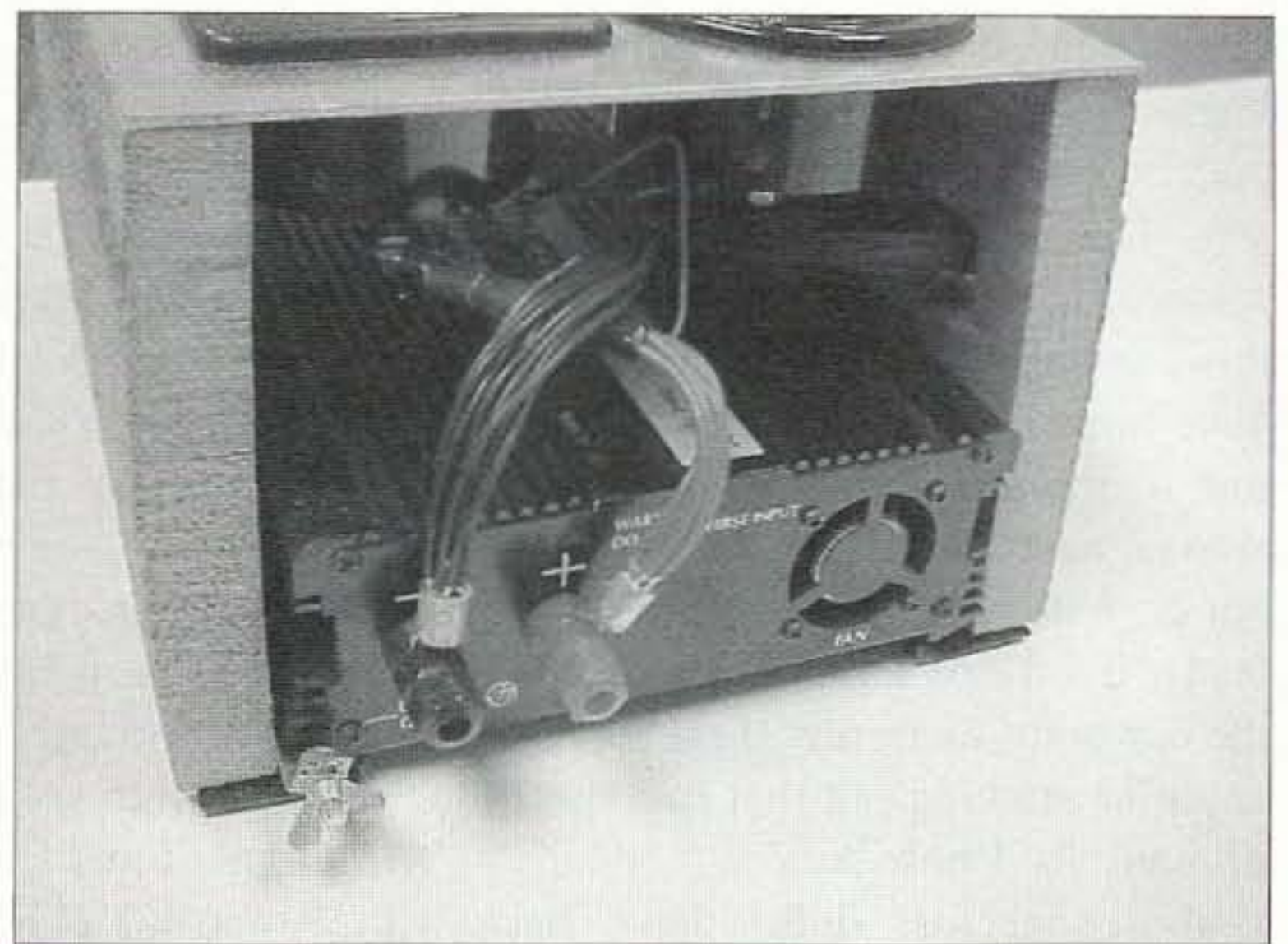

Photo D. The flexible leads are shown attached to the inverter input terminals. I used black and red wires for the negative and positive leads (respectively).

knew that if the power went out for a long time in winter, the house could get so cold that the water lines would be the first to freeze and then burst. This would be followed by the rest of the water lines in the house. If the lines burst we would have a royal mess on our hands.

To heat our house, a minimal backup power system needs to run only the blower on a small furnace in part of our house and a small water pump to circulate the hot water in the rest of the house. Both furnaces use natural gas as a source of heat.

Back when Y2K was a big deal, I thought about what we would need to get by at our house if the power went out. That's when I decided against

buying a generator and instead bought an inverter — a device that converts the 12 VDC from your car battery to 120 VAC. Of course Y2K was a big fizzle, and I never heard of any power failures. The heck with Y2K, Mother Nature was going to see to it that we would be put in the dark!

In the remainder of this article, I'll tell you what I do to keep our house warm in the winter when there is a power failure, and how to do the same for yours! I know you're wondering: How much time did I spend and how much did it cost? Well, I spent about 10 hours making wiring changes, fabricating some cables, and doing a small amount of metalwork. The inverter I bought cost \$130, the optional meters

cost \$10 at a hamfest, and the electrical boxes cost a few dollars. 10 hours and \$147 — not bad for keeping our house warm in the middle of winter.

Overview

To use the inverter, you will need to change the furnace's power wiring, add two large cables and a connector to your car's battery, and make up a cable with connectors to attach to the inverter.

Wiring changes to your car

I obtained two 3-foot lengths of #6 stranded insulated wire from an electrical supply store. It is labeled "oil and gasoline resistant" on the insulation.



Photo E. This shows the front end of the inverter assembly. Wood screws attach the inverter mounting brackets to the wood sides.

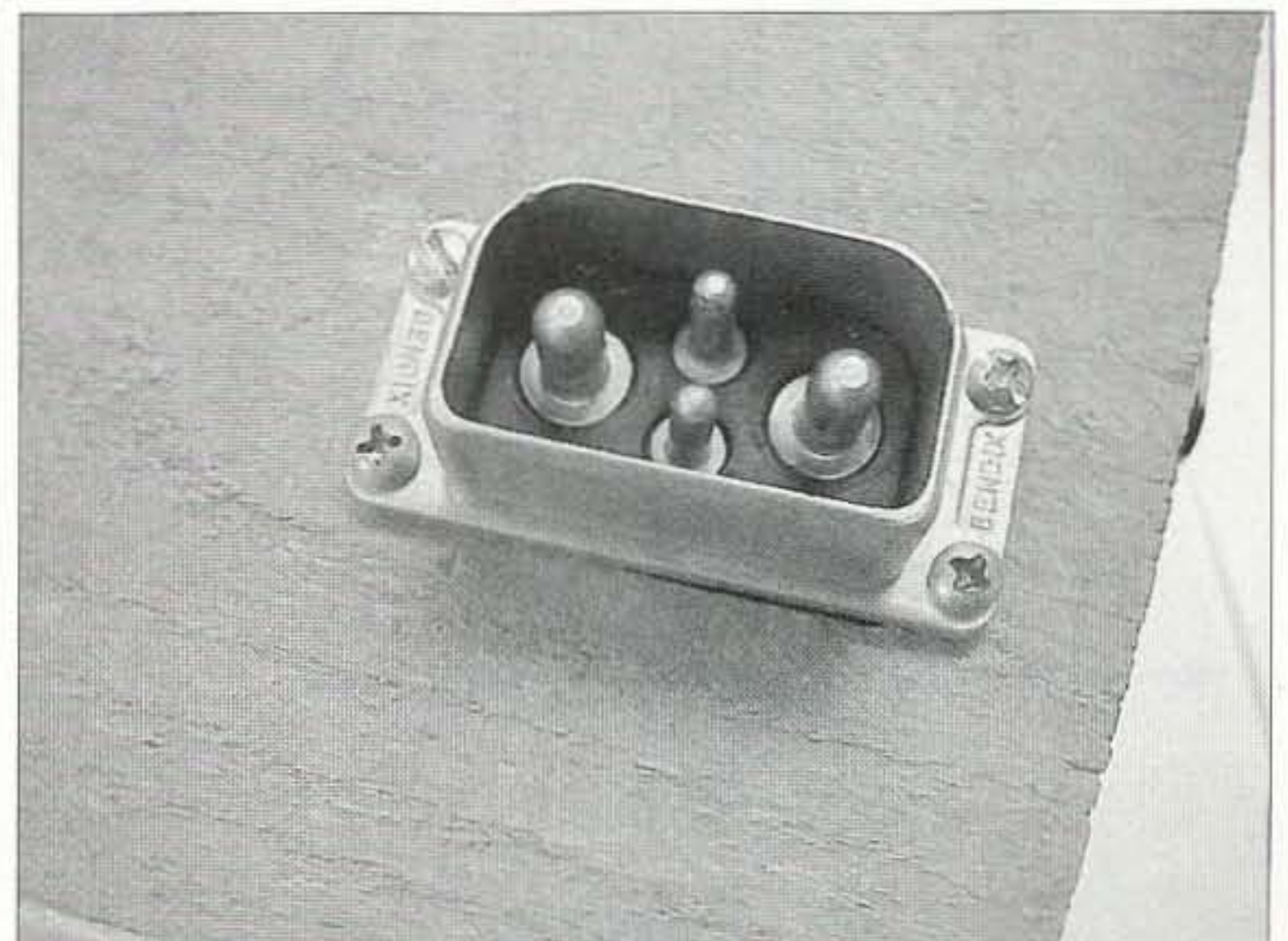

Photo F. The male connector mounted on the side of the inverter assembly.

On one end of each wire I soldered a lug with a hole to match the size of the bolt on each terminal of my car battery. The other end of both cables is soldered to a female connector. I found this connector in my junk box. It must have large contacts to carry high current — more on this later. You will, of course, need the mate to it. Be sure to put the female connector on the battery leads. If it flops around and gets near the car body or frame, there won't be any pins sticking out that can short to ground. See **Photo A**.

My connectors didn't have backshells when I found them at the hamfest. (You can't have everything!) I made my own from four standoffs, an aluminum plate, and a conduit fitting. The conduit fitting holds the cables securely to the connector so that the soldered connection isn't strained. After soldering and securing the cables with the conduit fittings, I put some bathtub sealer all around where the wires are soldered to the connector. This keeps water out and prevents a short to ground in the engine compartment when the connector is not in use. See **Photo B**. When it's not in use, I wrap the car connector in two ziplock bags to keep out water and dirt.

I knew that the current drawn from the battery would be 40 to 50 amps, since the inverter must pull 600 watts from the battery if it supplies 600 watts to the motor. (According to Ohm's Law, $P = EI$, so $12 \text{ VDC} \times 50 \text{ amps} = 600 \text{ watts}$.) Any resistance between the inverter and the battery terminals will drop the voltage available to the inverter. As an example, with 50 amps current draw, a $1/4$ ohm resistance can drop the voltage available to the inverter by 1.25 volts. (Again, according to Ohm's Law, $E = IR$, so $50 \text{ amps} \times 0.25 \text{ ohm} = 1.25 \text{ volts}$.)

Why worry about a voltage drop? It turns out that the inverter will shut itself off if the input voltage drops below 10.5 VDC. I assume it was designed that way to avoid damaging a battery if the voltage drops too low. If there is a 1.25 volt drop across a connection and the battery voltage goes below 11.75 volts the inverter shuts itself off and your furnace won't start.

I measured the resistance of the connector contacts in my unit with a milliohmmeter and found it to be 0.001 ohm. That works out to about a 0.05 volt drop at 50 amps current draw — very nice!

Power inverter and mating connector

Next, you will need to fabricate a cable that connects the inverter 12 VDC input terminals to a male connector that is the mate to the connector from your car battery. See **Photo C**. The 5-way binding post connectors on the inverter are a bit flimsy — I wanted a strain relief to prevent damaging them. I did this by making a cable that consists of 12 conductors of #16 Teflon wire.

A minimal system consists of cables and connectors only. I chose to add metering to monitor the battery voltage and the battery current drawn by the inverter. To do this, I mounted my inverter on two pieces of wood and placed an aluminum plate atop the wood pieces to hold the meters. See **Photos D and E**. (As you can see, there are actually four meters in my setup. Two of the meters monitor the incoming 12 VDC current and voltage. The other two were intended to monitor the output 120 VAC voltage and current. I mounted all four meters but then couldn't figure out a way to get the AC lines to the meters and then back inside the inverter. This will be a project for the summer — not winter,

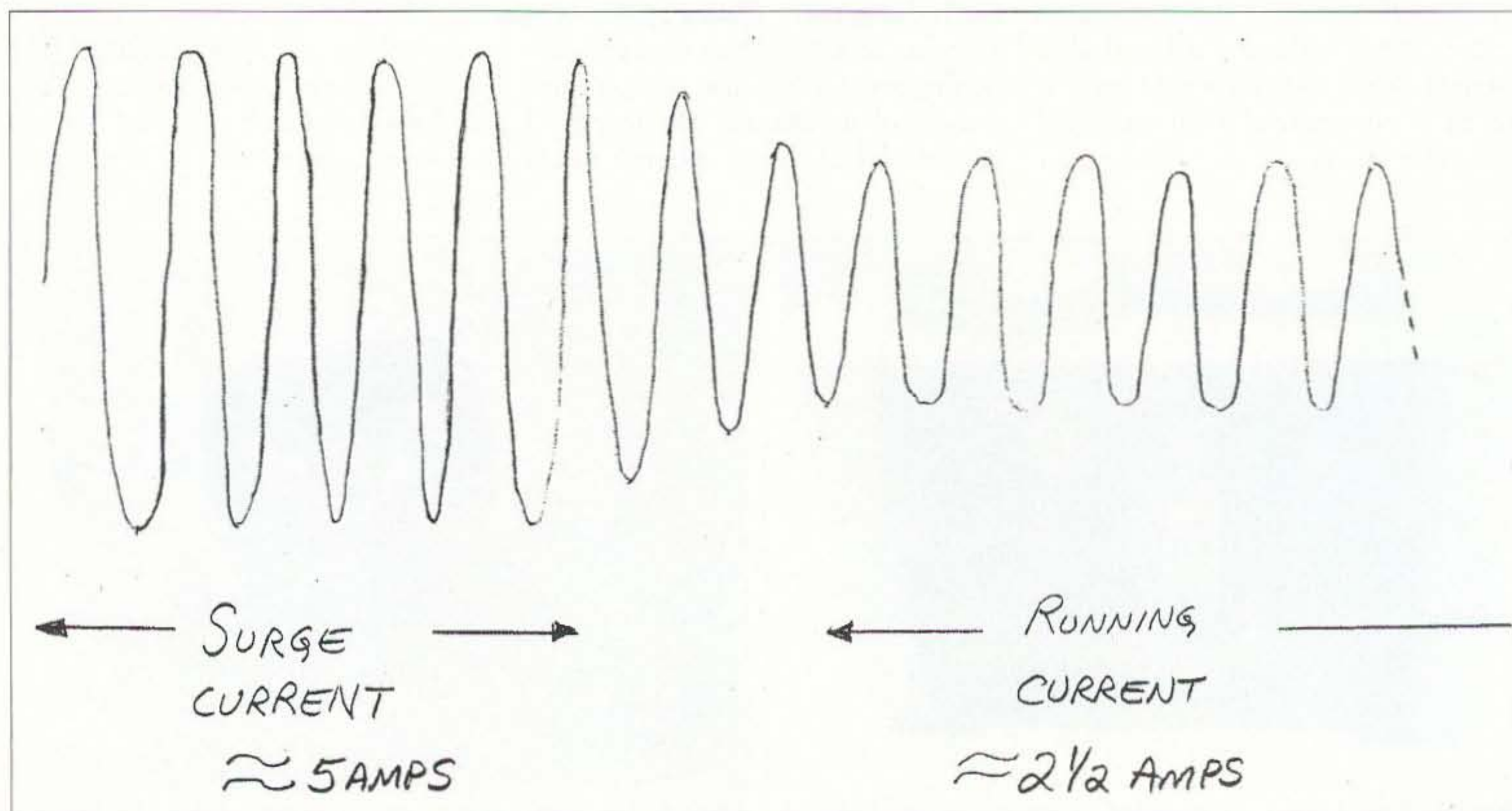

Fig. 1. Current display on a storage oscilloscope.

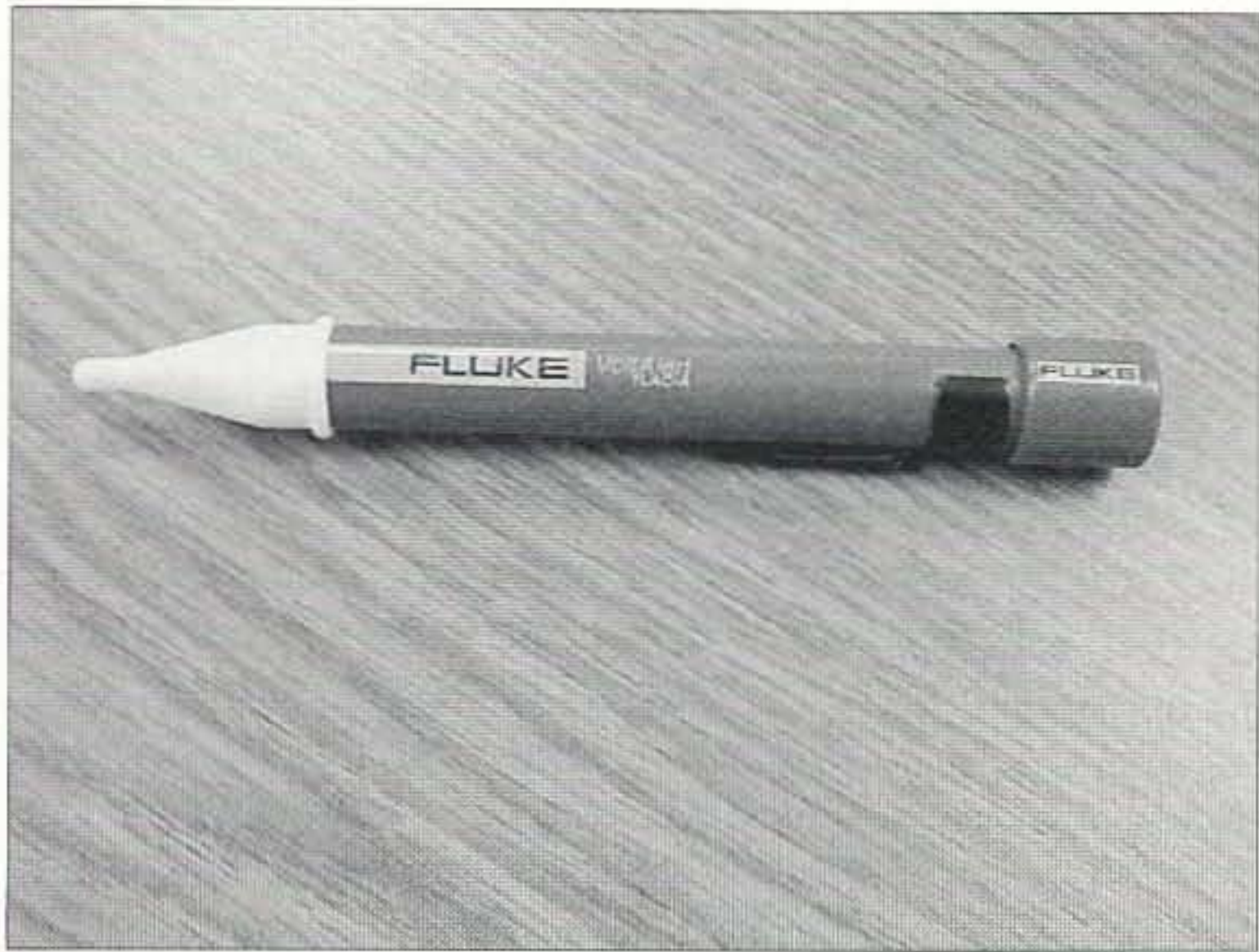

Photo G. The Fluke "VoltAlert" voltage sensor I used to make sure the power is turned off.

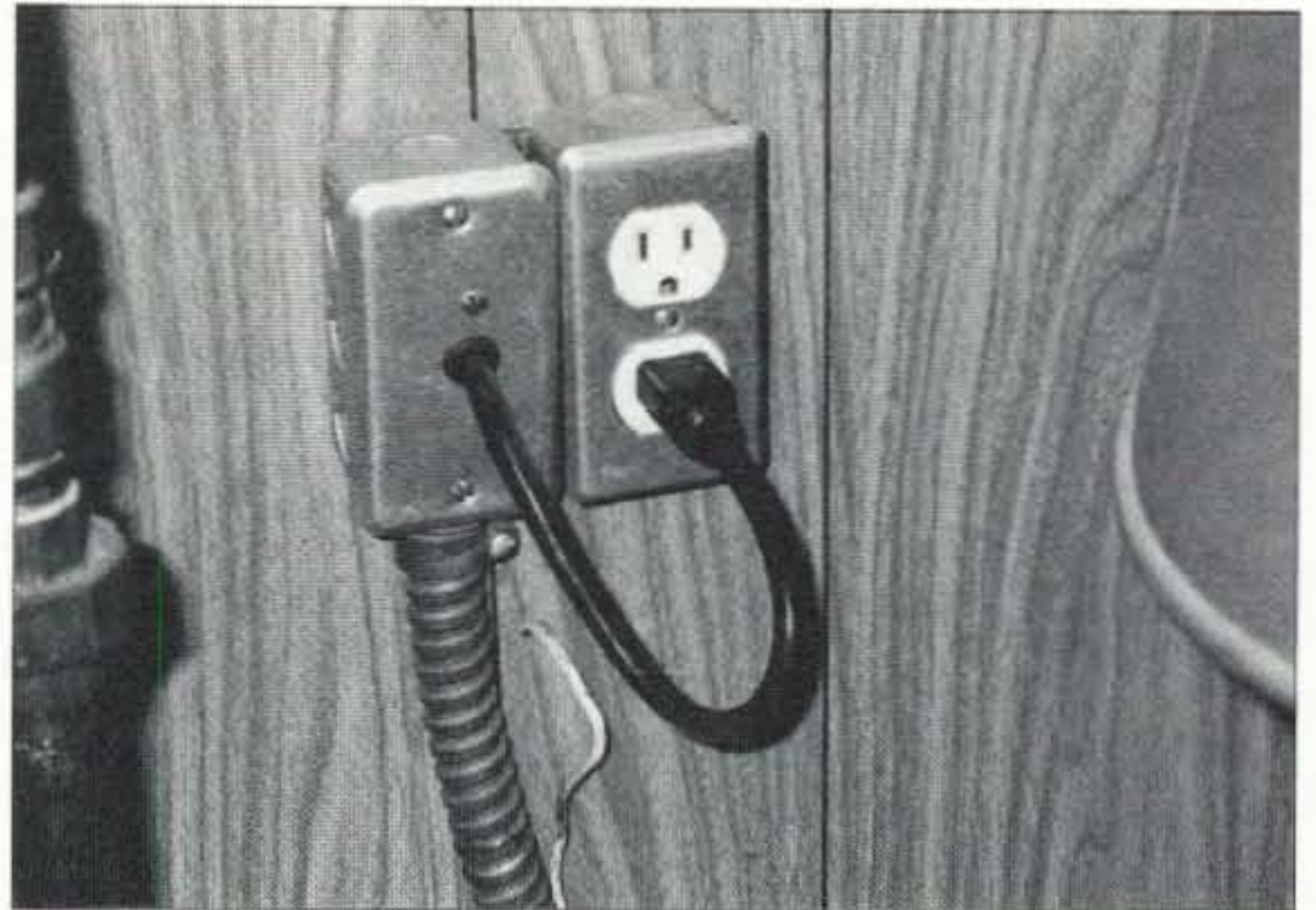

Photo H. The new furnace wiring. The box and duplex outlet on the right is wired to house power. The box on the left contains the wiring that connects the furnace to the 3-prong plug.

when I might need the inverter at any moment!) The short, very flexible cables serve as a strain relief for the meter terminals. The wire runs were quite short between the meter and terminals so that routing and bending of the rigid #6 wire was difficult. I mounted the mating male connector on the side of the wood panel. See **Photo F**.

Determining the inverter size for your application

If the motor in the furnace has a nameplate, look for the current rating in amps. To determine power simply multiply this amp rating by 120 volts to get running watts. This is the power the motor consumes when it is running. The starting current is higher but lasts only a very short time. My motors pulled the surge current for approximately 100 milliseconds. The motor in my hot water heat system pulls 1.7 amps (200 watts) surge and 0.8 amps (96 watts) running. The motor in my forced air heat system pulls 5.4 amps (648 watts) surge and 3.8 amps (456 watts) running. I used a clamp-on ammeter to make the readings.

The surge is of such short duration that you may not be able to obtain a meaningful reading by just looking at the display. You'll need a faster-responding display such as a clamp-on ammeter that has connections for coupling the sensed current to an external device such as a storage oscilloscope. A storage oscilloscope will allow you

to view the instantaneous sensed current if you set it to trigger on an incoming signal. If you don't have access to a clamp-on ammeter with terminals and storage oscilloscope you can estimate the surge current by simply multiplying the nameplate current by 120 VAC then multiplying it by 2. (This method assumes that the surge current is at most double the running current.) If you are fortunate enough to have access to a clamp-on ammeter and storage oscilloscope here's how to measure the current:

Step 1. You must first calibrate your scope by measuring the current drawn by a known load. I used a small room heater that was rated at 1200 watts. Pass either lead through the ammeter clamp and then turn on the device. In

my case the ammeter read approximately 10 amps. Since the current is AC it will appear as a 60 Hz sine wave on the oscilloscope screen. Adjust the vertical gain on the oscilloscope so that the waveform peaks reach the top and bottom graticules of the screen. Using the setting above, if the load you attach (such as your furnace blower motor) produces a waveform that only goes halfway above and below the center line, the motor is pulling 5 amps. If it goes 3/10 of the way above and below the centerline, the motor is pulling 3 amps.

Step 2. Set the triggering such that the sweep begins when you start the motor (when the motor begins to pull current). Set the sweep speed

Continued on page 30

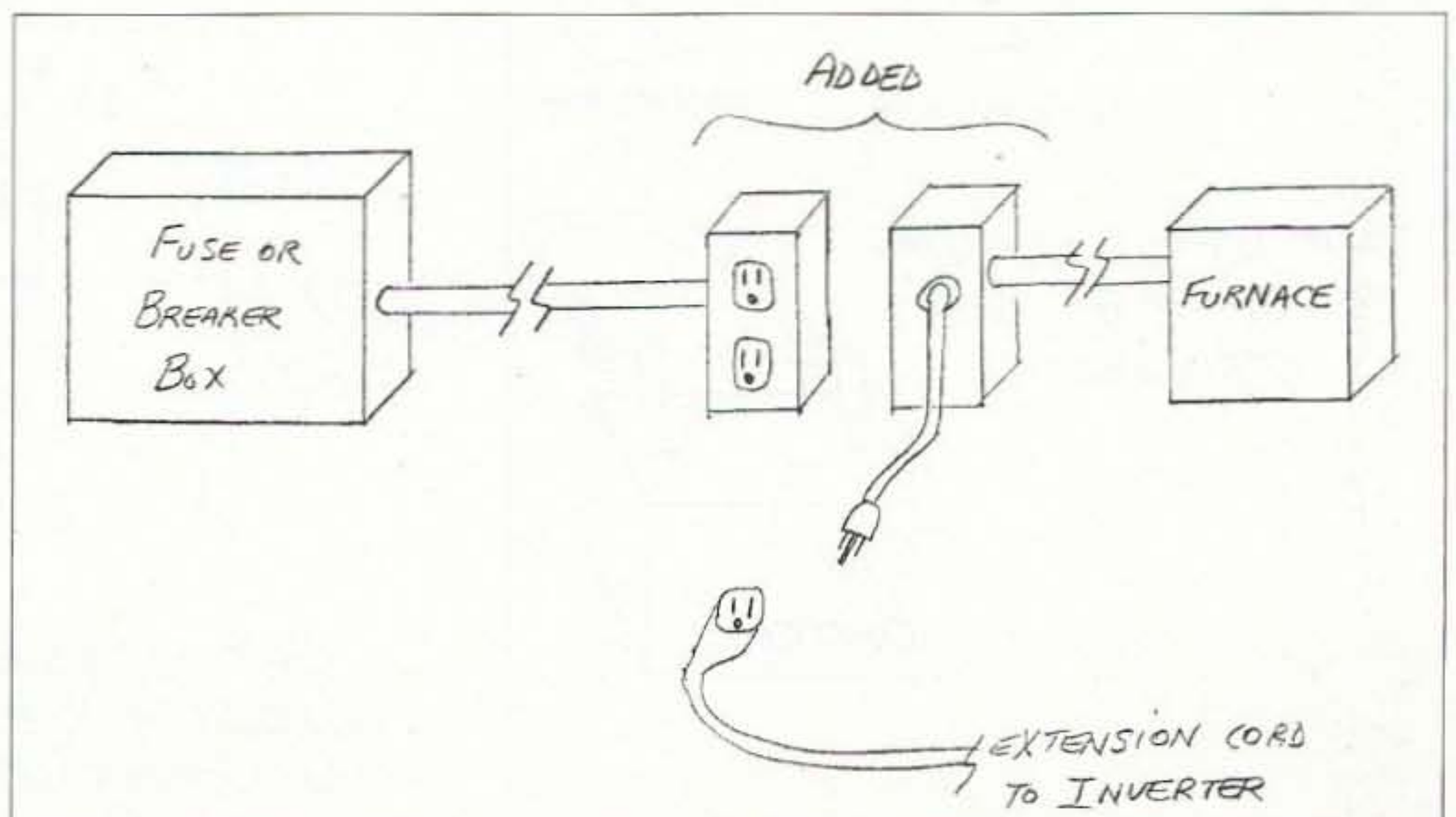

Fig. 2. Modified furnace power wiring.

Ham vs. Power Outage

continued from page 29

for approximately 50 milliseconds per square on the screen.

Step 3. Start the motor again, allowing the trace to complete one sweep. The waveform should look something like **Fig 1**. Note that the waveform is higher in amplitude at the extreme left of the screen and quickly settles to a lower value for the rest of the sweep. The higher amplitude is the starting current and the lower amplitude is the running current.

Step 4. Multiply each of the two currents by 120 VAC to get the starting and running power in watts.

The surge power capacity ratings of the inverters available from Hosfelt are roughly twice the running power capacity ratings for 1/10 second. The 1/10 second is about the duration of the surge current drawn by the motor. In my case the forced air furnace has the higher current rating of the two systems, so I

selected an inverter with 600 watts continuous/1200 watts surge. Select an inverter with a surge and running capacity higher than your motor ratings.

Using the meters on the input and the clamp-on ammeter on the output I was able to verify that the input power and output power are nearly equal. This is also proved by the fact that the heatsinks on the side of the inverter stay very cool to the touch. If it wasted any energy, the heatsinks would be warm. The power consumed isn't based on the size of the inverter. It is based on the load.

Don't scrimp on the size of the inverter. Remember, you're trying to heat your house (and maybe be a "hero" in your family). You can't do that if the inverter fails!

Rewiring your furnace

Next, you must make a simple change to the power wiring to your furnace. The furnace power is usually

hardwired to 120 VAC lines. I inserted a plug and duplex outlet "in series" with the normal wiring. This way you can either plug the furnace into the commercial power, or if the power fails, you can plug the furnace into an extension cord that connects to the inverter near your car.

First, think SAFETY! Turn off power to your furnace. Then use one of the new power sensors like the Fluke "VoltAlert" to make sure that the power is turned off. It is a priceless tool that can save your life if you do any work around 120 V power wiring. The tip glows red if you get it near any live circuit. I bought mine for less than \$20 from Newark Electronics. See **Photo G**. They are also available at any home improvement store.

Here are the changes you need to make to your furnace:

Step 1. Check to make sure the power is shut off.

Step 2. Locate where the power enters your furnace.

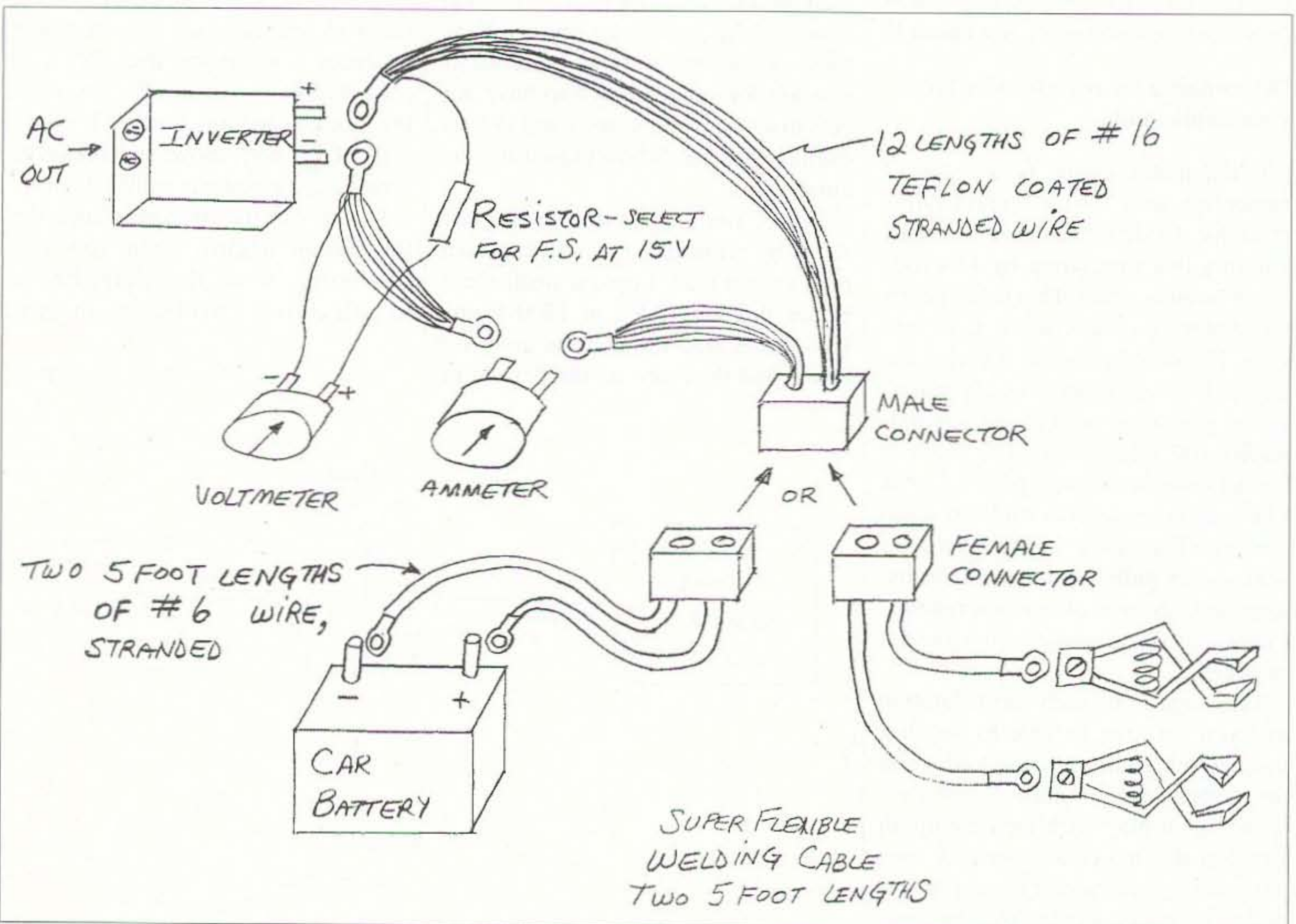

Fig. 3. 12 VDC inverter wiring.

Step 3. Cut this wire and run the wiring from the furnace into a metal electrical box mounted close to where the extension cord from the inverter ends.

Step 4. Attach a 3-conductor cord with a plug on the end to the furnace motor and furnace transformer wiring and pass it through a grommet mounted in a hole in a cover plate attached to the box in step 3.

Step 5. Mount a second metal box beside the first box. Install a duplex outlet in this second box and connect the wiring from the fuse/breaker box to the duplex outlet.

The final configuration of the work done in Steps 1–5 above can be seen in **Photo H** and is diagrammed in **Fig 2**. The break in the line that you create should be as close to your car as possible so that you can use a short extension cord.

Meters — the deluxe system

I wanted to monitor battery voltage and current draw while the system is in use. The voltmeter is used to check the general health of the battery and that the charging system is replacing the power my two furnaces draw from the battery. The ammeter is used to monitor how much current the furnace is drawing — just to make sure that everything is working as it should. (I have a little note attached to the inverter listing the current drawn when powering my furnaces — I know that during a power failure I won't remember the current each furnace pulls.)

Adding the meters will require a little more work when constructing your system, but I feel that it's worth it. You will need a voltmeter that reads at least 15 VDC full scale and a DC ammeter with a full-scale rating of at least 50 amps. I was lucky to find both at a hamfest for \$5 each.

Adapting meters of other ranges is beyond the scope of this article. An excellent article on this can be found in the October 2002 issue of *QST*, page 69. The *ARRL Handbook* also covers extending the range of meters, converting milliamp meters to voltmeters, etc. Also, see the "Test Procedures" section of any recent *ARRL Handbook*.

All soldering was done using a propane torch to heat up the terminals. Make sure all parts to be soldered are clean and use a little soldering paste or flux to help the solder bond with all parts. After the soldered junction has cooled, clean it with alcohol and a stiff brush. A diagram showing all the inverter wiring is shown in **Fig. 3**.

To monitor the AC parameters in the system, I was going to add an AC voltmeter and AC ammeter to the output of the inverter. You can see that the meters are in place but are not wired in. The AC meter can simply plug into one of the two 115 VAC outlets. The AC ammeter is a different issue. To monitor current, I couldn't find a meter that could be wired directly in series with the output. The meter I found requires a 2-ohm shunt resistor. This requires bringing the 115 VAC outside the inverter chassis so the shunt resistor can be attached to the aluminum meter panel that will act as a heatsink for the shunt resistor. I tried the shunt and meter connected with clip leads and it worked perfectly. Now that winter's almost here again I don't want to risk damaging any part of the system when we may need it at any time. Maybe next summer!

Parts: where to obtain them

The duplex outlet, electrical boxes, and conduit fittings can be purchased at any hardware or home improvement store. The 3-prong plug/cable assembly that connects to each furnace came from some computer power cables. I cut off the end that usually goes to the PC and attached it to the furnace wiring with wire nuts.

I purchased my inverters from Hosfelt Electronics. They had many units to choose from. Continuous power output ratings are: 75, 140, 300, 600, 800, 1000, and 1500 watts.

The wire can be purchased at an electrical supply house. The connectors I used came from a hamfest. If you can't find anything suitable there, try an automotive supply store.

The meters I used also came from a hamfest. The DC voltmeter should be easy to find. The 50-amp DC meter may be harder to locate. This too may

The New Pools!

Examination Test
Questions & Answers

The exact questions, multiple choices and answers for the Technician Class, General Class, and Extra Class operator's license.

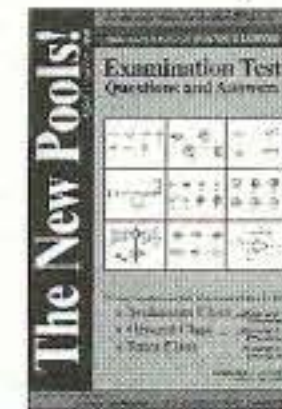

Only
\$9.95
Plus \$3.50 S&H

Omega Sales

P.O. Box 376

Jaffrey, NH 03452

800-467-7237



A Division of Milestone Technologies, Inc.

*Everything for the
Morse Enthusiast!*

Keys, Bugs, Paddles, Keyers,
Books, Kits, Tools, Software....

Free Catalog!

www.MorseX.com

(303) 752-3382

HamCall™ CD-ROM
World Wide - Over 1.7 million listings



If you are a "Ham" you are in HamCall.
The most complete callsign CD-ROM available.

Latest Features

- Choose font and color of data display.
- Displays flag and map for each country.
- Shows CQ, ITU zone, and continent.
- History list shows each callsign entered.
- Print labels in a variety of formats.
- View & search interests of 44,000 hams.
- Search for club, military, vanity, silent keys, name, address, and more.

Over 1,700,000 listings world wide, 136,000 e-mail addresses, 4,300 photos and QSL cards, 42,000 vanity calls, and 24,000 references to QSL managers.

Shows path distance & bearing.
Precise latitude/longitude for over 90%+ of addresses.
HamCall is \$50.00, included is 6 months free access to our HamCall Internet Service - request when ordering.

New HCLog logging program - \$19.95.

\$5.00 shipping (\$8 int'l) per order. Your satisfaction guaranteed!

BUCKMASTER
6196 Jefferson Highway • Mineral, VA 23117 USA
e-mail: info@buck.com
540-894-5777 • 800-282-5628 • 540-894-9141 (fax)

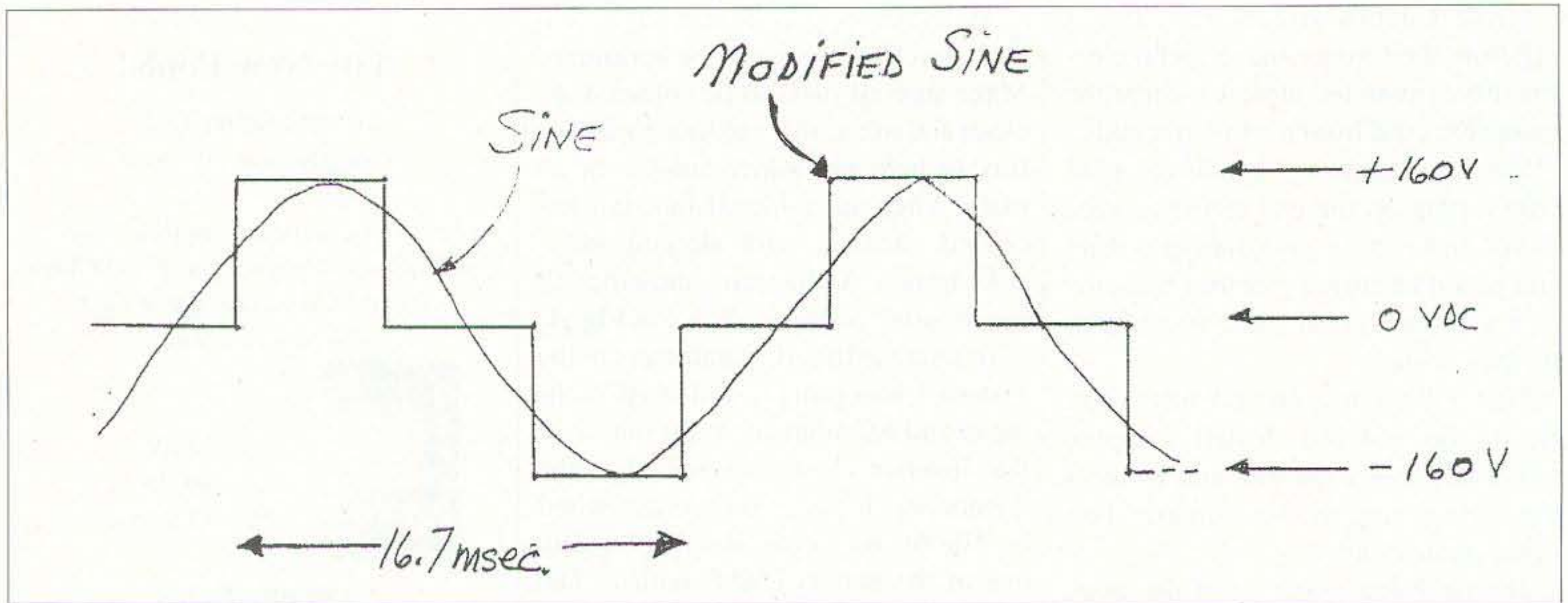

Fig. 4. Modified sine wave vs. normal sine wave.

be available at an automotive parts store. The meters aren't absolutely necessary — the system will work without them.

A diagram showing the 12 VDC input portion of my system is shown in Fig. 3.

The proof is in the pudding

So how does it work? Great! I used the system nonstop for five days during our ice storm. It kept the furnaces running and the house toasty warm. One night the temperature dipped to 18°F.

When the inverter is called into service, it's a simple matter of plugging

the connector from the car battery into the inverter, running the extension cords from the garage to the furnaces, and, finally, plugging both furnaces into the extension cords. In my house it takes me about 3 minutes to run the extension cord from each of the furnaces to the garage.

This past summer we had another power failure during a lightning storm. The power was out for about 2 hours. During that time my wife wanted to watch a certain TV show. I had the inverter up and running in about 5 minutes, she got to see her show, and when the power came back on I put the inverter back on the shelf for next time. I

also tried using a VCR powered by the inverter and it worked fine, too. I thought there might be some problem with the VCR and TV running on a modified sine wave but they worked perfectly. (More on the waveform later.) While we were watching TV, our neighbor across the street spent half an hour trying to get his generator started. He finally got it started just before the power came back on! So much for gasoline-powered generators! My inverter started right away. During the ice storm our neighbor had his generator running in the front yard. We had to listen to its dull roar all day and all night. No one could hear my inverter running.

Other information

Be aware that the extension cord carries 120 VAC power and can injure and kill just as easily as regular house power. Just because a car battery is the source of power, that doesn't mean that it's as safe as the 12 VDC from the battery! The inverter supplies many amps of current at 120 VAC.

The only difference I noticed when using the inverter instead of regular house current was that the 24 V transformer in the furnace buzzed very slightly. I believe the buzzing is caused by the shape of the output waveform from the inverter. The hot water furnace in our house is over 35 years old and the motor runs fine even after running on the modified sine wave for five



Photo 1. This cable plugs into the inverter assembly and can be connected to any 12-volt battery. The small clamps below came with the inverter.

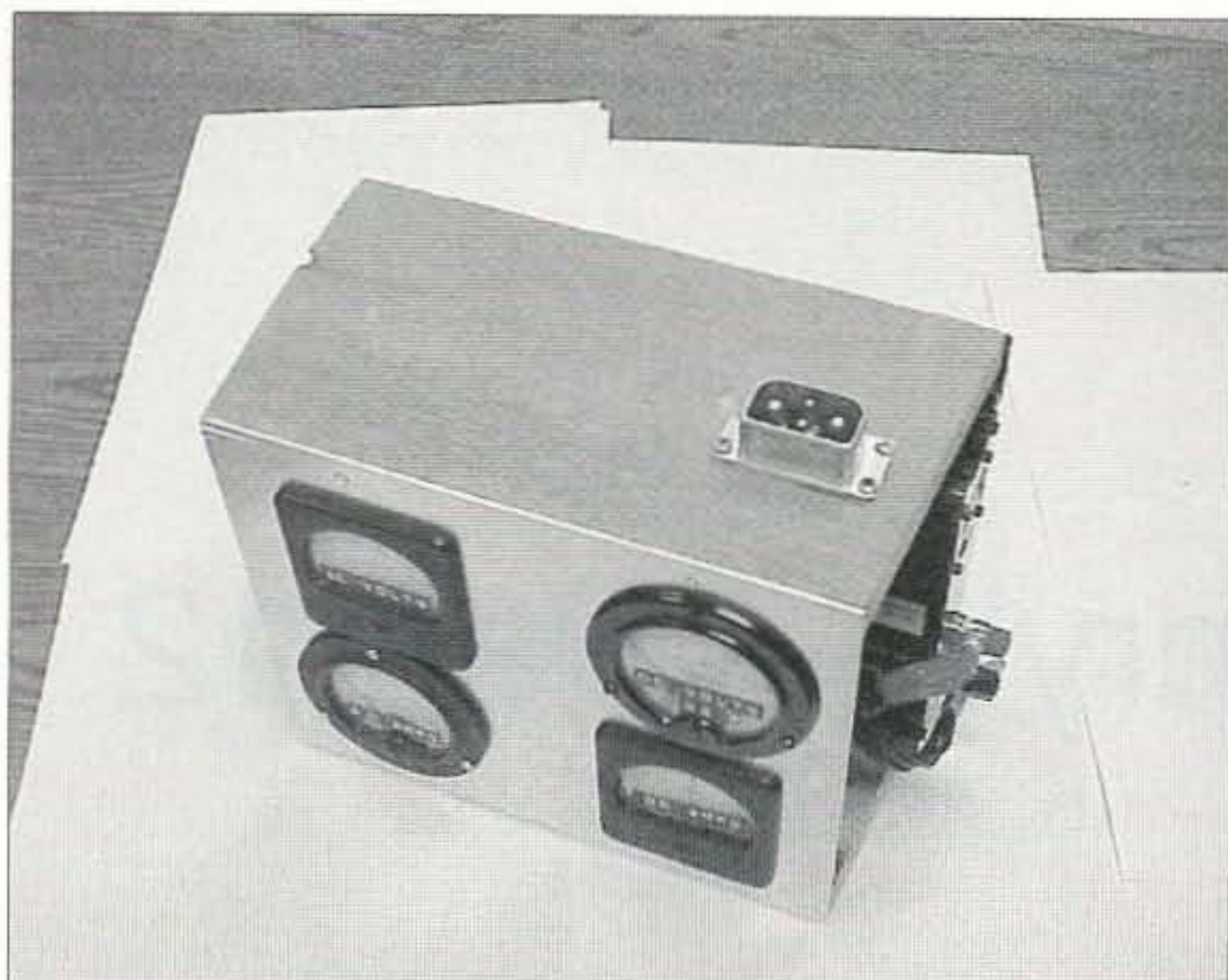

Photo J. The complete inverter assembly.

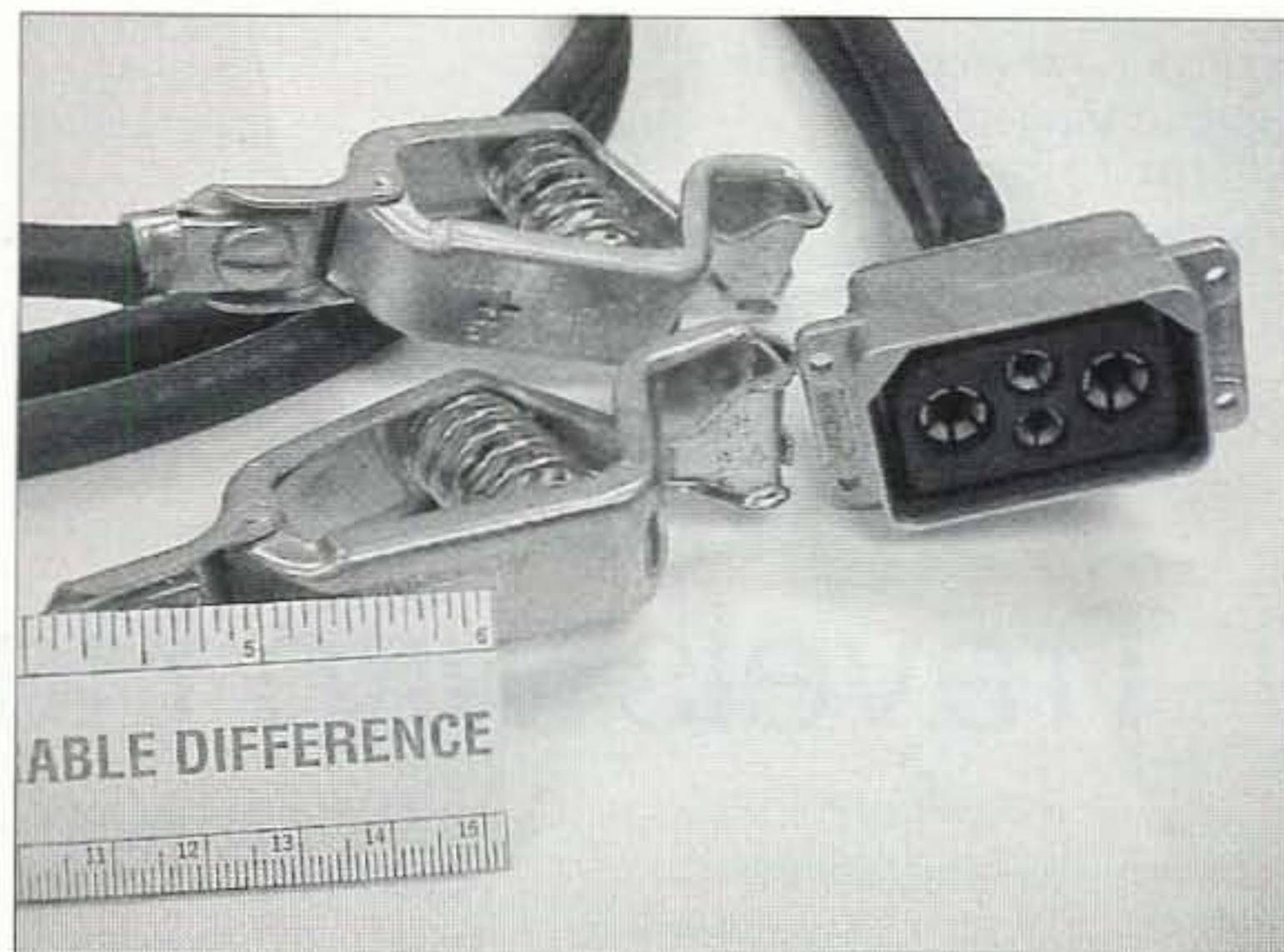

Photo K. A close-up of the clamps and connector. Note that the large connector pins are approximately 3/16-inch diameter.

days. Apparently the modified sine wave caused no damage. **Fig. 4** shows what the modified sine wave looks like on an oscilloscope. I used a 100:1 voltage divider to bump the signal down to a level suitable for viewing on an oscilloscope.

If you use a gasoline-powered generator you must refuel it every few hours, based on the size of the fuel tank. It also makes noise and smoke. The oil should be changed periodically, too. How many people remember to change the oil so the engine is in good shape for the next power failure? How many people start it once a month to make sure it will start when needed? How much space does a gasoline-powered generator take up in your garage? This inverter measures 8" x 12" x 6", makes no noise, and requires no maintenance. A gasoline-powered generator takes a lot of room in your garage or tool shed. When I need it I pull it down from the shelf. When I'm done it goes back on the shelf — totally out of the way! The car engine gets started nearly every day, I get the oil changed per the recommended schedule, and I buy the best battery available for the car — just so I'm never caught with a weak battery. Normal maintenance on your car is all that's needed for this inverter.

I built an extra set of cables so that if needed, I could attach my inverter to ANY car anywhere. These cables consist of a female connector on one end and a large set of alligator clips on the

other end. For the wire I used two 5-foot lengths of welding cable. It's very flexible and its insulation is very rugged and thick. I got it for the asking at a local welding shop. Be sure to mark the positive and negative terminals very clearly. During a power failure it's easy to get confused. This extra cable and the clamps that came with my inverter are shown in **Photo I**. They have very weak springs. I didn't feel that they would grip the battery terminals very tightly, so I replaced them with larger ones that have heavier springs.

The completed inverter assembly is shown in **Photo J**. **Photo K** shows the size of the connector and heavy-duty clamps.

Note that the connectors I used have two small and two large pins/sockets. Although one pin/socket per conductor would probably have provided a sufficiently low contact resistance, using two pins/sockets per conductor provides an even lower resistance. I jumpered the large and small pins/sockets together by wrapping thick copper straps around the solder cups then soldered them.

The downside of inverters

There were two problems we had when powering our house with an inverter. First, we couldn't run our water pump or any other large-load appliances. Second, I had to recharge the battery every 5 to 6 hours. (*We would also add that determining how long*

your car battery can be discharged before being unable to restart your car depends on many variables, and may not necessarily be 5 to 6 hours. Caveat dischargeor. — ed.)

I measured our water pump current draw at 8.5 amps surge and 7.3 amps running at 220 VAC. None of the inverters I found can supply 220 VAC or 1600 watts of power. If you're on city water, you're in luck. Flushing the toilets was a hassle because we had to drive 5 miles to my dad's house to fill up lots of old milk cartons with water. Each flush took about 1-1/2 gallons.

After several trips to my dad's house I got to talking to our neighbor, who was also without power. (A tree fell on the power line running to his house and ripped a large piece of the wall from the side of his house.) He has a swimming pool in his backyard and in the daylight the snow on the pool cover melted. This was convenient because then we only had to go next door to get all the water we needed for flushing. About the second day into the power blackout, my wife noticed that there was a nearly endless supply of very clean water from the snow and ice melting on our roof that ran out the downspouts during the daytime. For drinking water we refilled gallon jugs that originally contained drinking water from a local grocery store. (Don't use old milk jugs for drinking water.

Continued on page 59

Travels with Henryk — Part 12

Have some Madeira, m' dear?

I have been to this floating garden a few times. And I know I will go there again. Madeira, an autonomous region of Portugal located in the Atlantic Ocean west of Morocco, is extremely attractive from my point of view. It has a variety of micro climates; abundance of fruit, flower, and fish; frequent and easy flight connections from many European cities; very active ham community; and ... it counts as Africa in amateur radio contests.

I am not the only one attracted to Madeira, and almost each week a visitor or two gets on the air “portable CT3.” Some of the local hams are very active, too.

The president of the local radio society, Luis CT3DL, is regularly on all bands, all modes, contests, DX cluster, and even on DXpeditions. I did not have a chance to visit his station, but I

visited the local radio society, ARRM. It has at least 200 members, and last time I was there I met about 10 of them (Photo A). The office is spacious — there is a meeting room, a QSL bureau, a few operating positions, and even a couple of antique radio items (Photo B).

The tradition of amateur radio in Madeira is old. I met Henrique

CT3AB (Photo C), whose father was a radio pioneer in the 1920s and was the original CT3AB. Henrique received his late father’s callsign in the ’70s and even managed to get his nephew Filipe interested in radio. Filipe is CT3KB now, and I met him in the club. He is



Photo A. Some members of the local radio society (ARRM), in front of their club headquarters in Funchal, Madeira.



Photo B. A well-kept vintage transmitter is displayed inside the ARRM Radio Club headquarters.

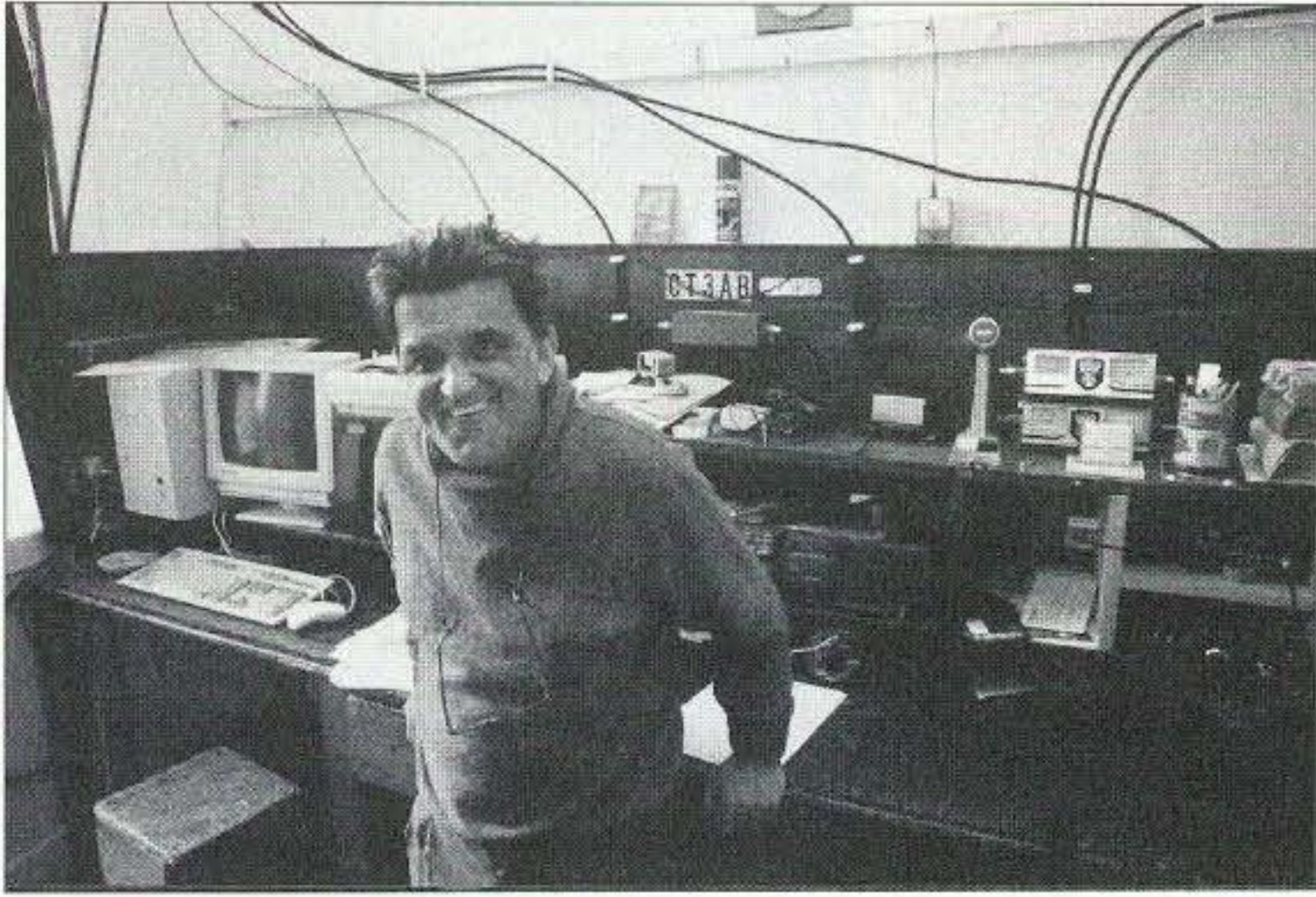

Photo C. Henrique CT3AB in his radio room.

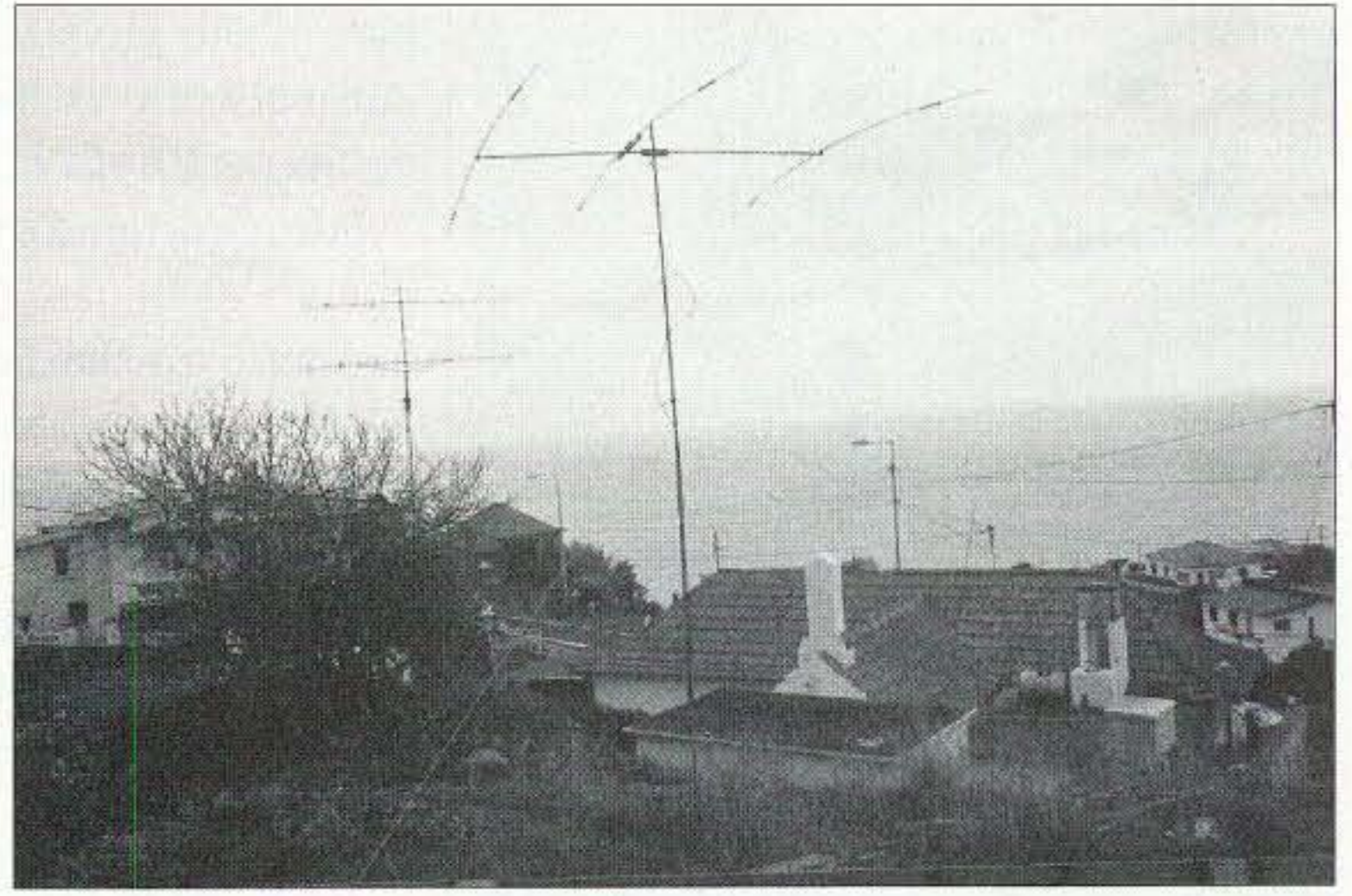

Photo D. The antennas of Duarte CT3HF.



Photo E. CT3HG in his well-equipped radio room.

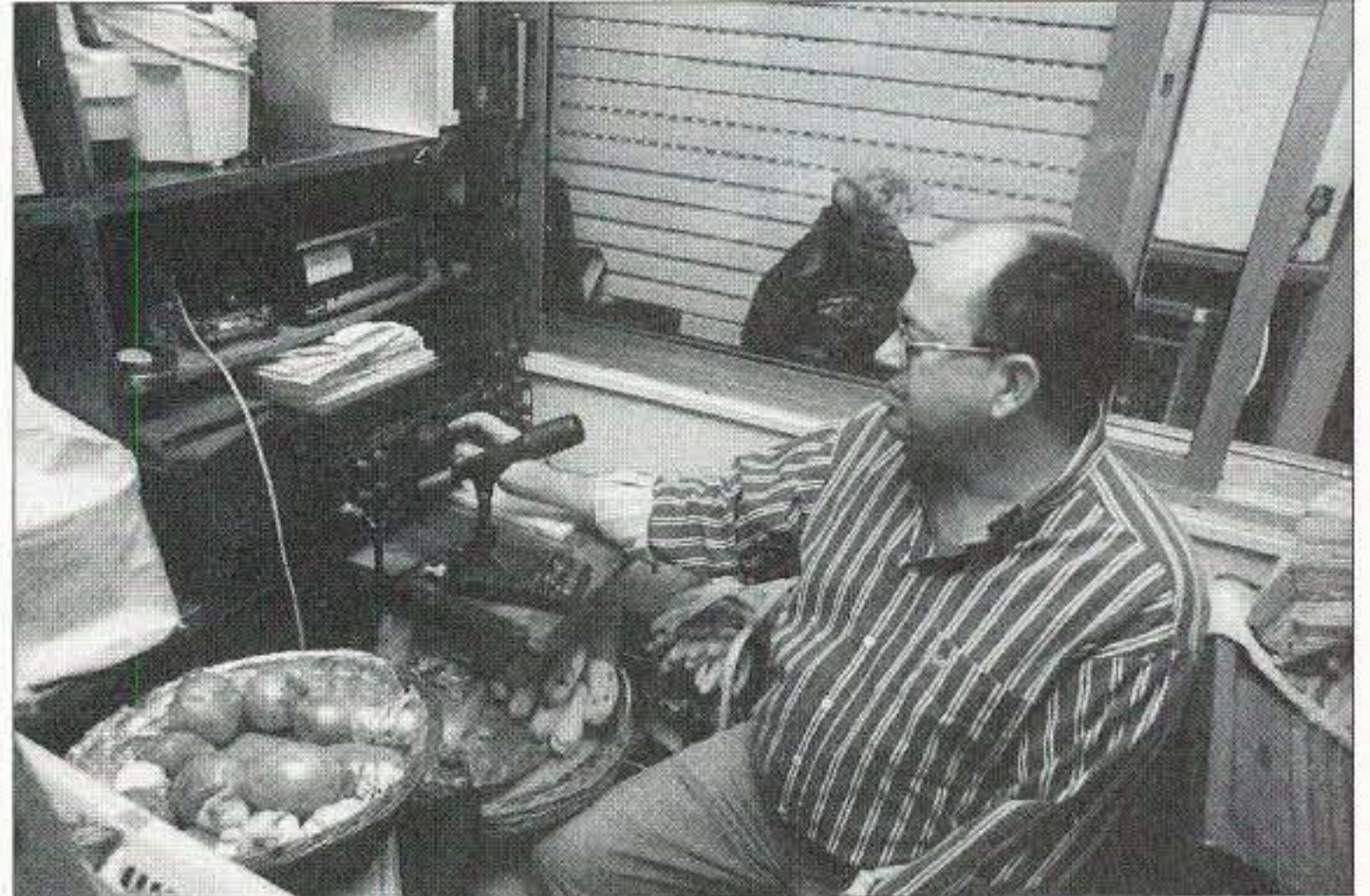

Photo F. Joao Carlos CT3IJ, of Funchal, has his rig and operating desk in the kitchen.

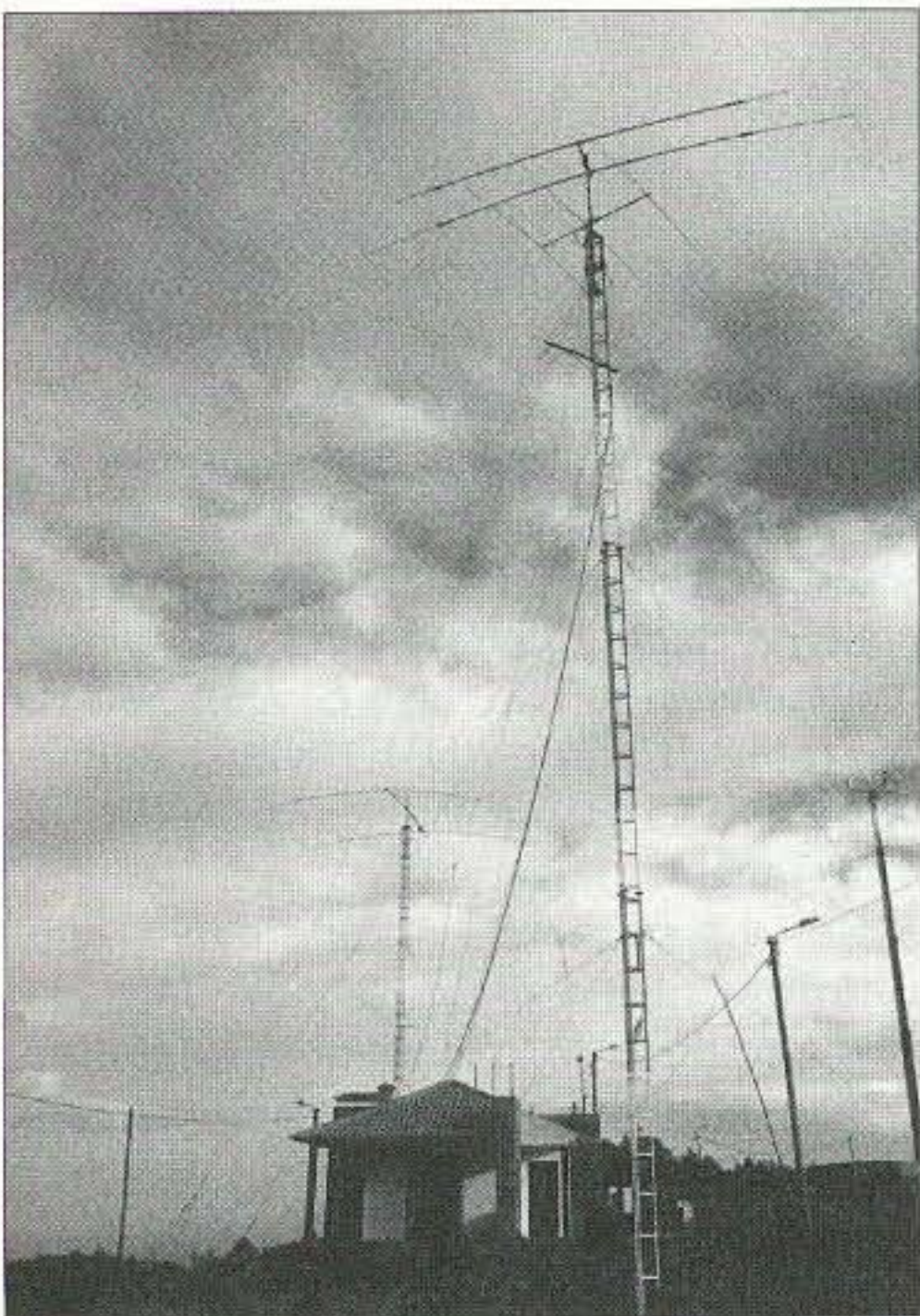

Photo G. Have you heard CT9M and CQ9K contesting from windy Santo da Serra? Here are some of their more weather-resistant antennas at the contest site — close to 2,000 feet above sea level.

second from right in **Photo A**, next to Ricardo CT3KN, first from right. Ricardo is a newcomer, too. His father used to be PY1BHJ in Brazil. Second from left is Duarte CT3HF. He is quite active and actually helped Ricardo to get involved in ham radio.

I passed by Duarte's home one afternoon and took a picture of the antennas (**Photo D**), but he was not at home so there are no photos of the radio shack. I was more lucky when I saw the large antenna tower of Jose Alves CT3HG. His station is fully furnished for HF and VHF (**Photo E**), and he has a whole room dedicated to radio.

Joao CT3IJ, who lives downtown in the capital city of Funchal, keeps his radio in the kitchen, among onions and bananas (**Photo F**). He has a decent tribander on the roof, but surrounded by TV receiving antennas.

Serious contesting in Madeira is

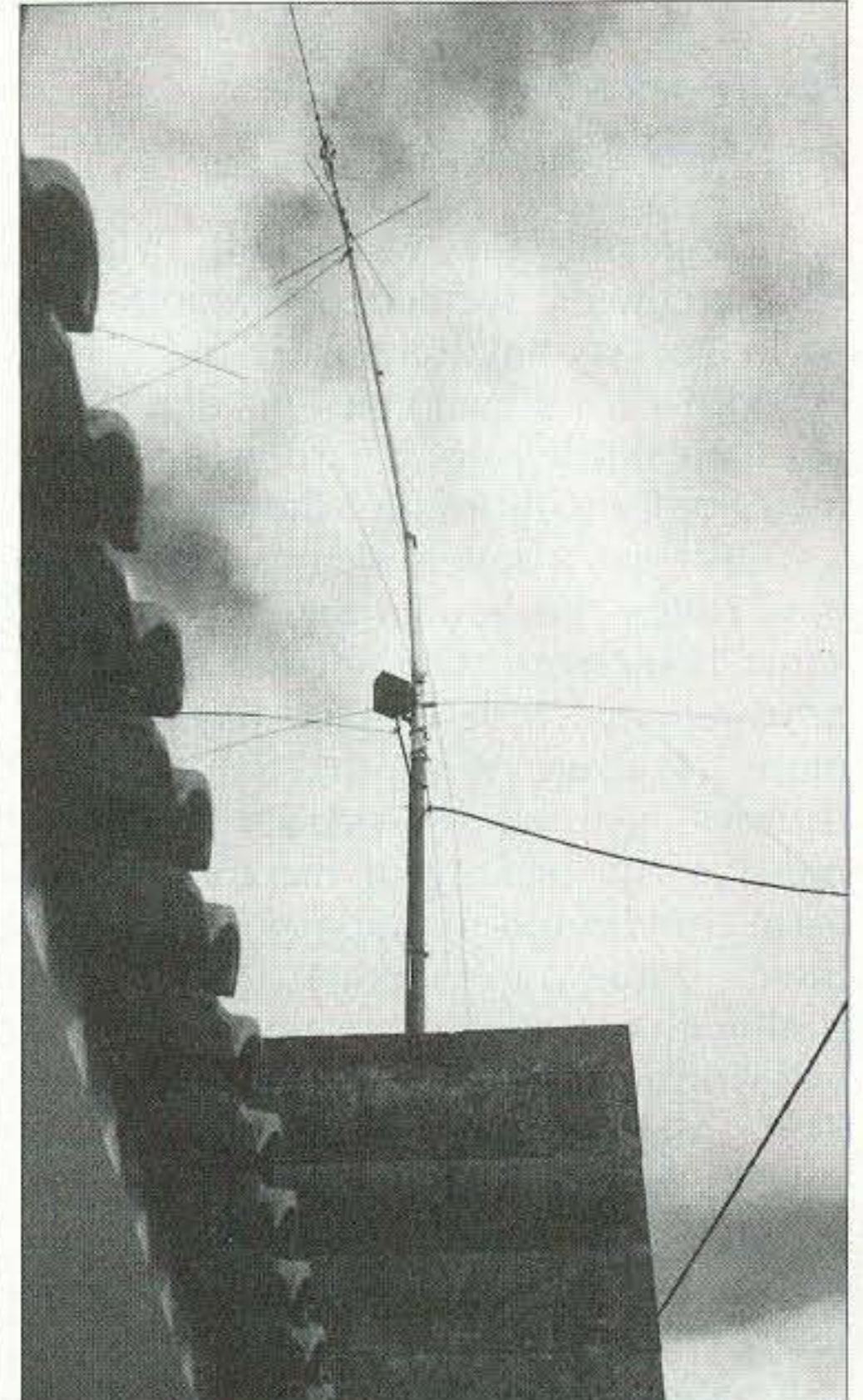

Photo H. The CS3B beacon antenna.



Photo I. The antennas of Joao CT3FU in Santana, Madeira.

done up the country. In Santo da Serra, about 2,000 feet above sea level, the local contest group, using calls CT9M and CQ9K, has a few permanent antennas which are shown in **Photo G**. They do erect more towers before large contests, but storms do too much damage to maintain a permanent antenna farm. The HF beacon CS3B, a

part of the global NCDXF/IARU beacon network, is located here in Santo da Serra (**Photo H**).

I drove around the island and spotted many antennas. For example, in Santana, on the northern coast of the island, I found an impressive set of yagis and a dish owned by Joao CT3FU (**Photo I**). Porto Santo, another inhabited island about 30 miles northeast of the main one, belongs to the Madeira Archipelago. The local population is only 5,000, but radio activity is high. This island is flat and not haunted by winter storms, so amateur radio antennas stay put longer. One example is the huge array of Antonio CT3BY (**Photo J**).

Better known from the air are Cedric CT3FT and Hernani CT3BX. Cedric retired to Porto Santo from the United Kingdom and is regularly on the air. Hernani is a busy person and is not often on the air but has large towers here. He became tired of perpetual damage caused by winds in the main island and moved his contesting setup to Porto Santo.

The main town of Madeira is Funchal, located on the southern coast. It is sunlit and protected from northern winds by a 6,000-foot mountain range. Of



Photo J. Impressive antennas of Antonio CT3BY.

course, this very choice location is very densely populated. Many local hams live here, and most tourists stay here.

The local government of Madeira supports amateur radio in many ways. The majority of present hams were originally CB operators who have upgraded in the recent years. There is a feeling of hope for amateur radio in Madeira. 73

NEVER SAY DIE

continued from page 9

and suggesting that we should, in turn, boycott theirs, seemed reasonable. I'll no longer buy anything at Herrod's. Not even their ice cream bar. Plus don't forget their not letting our troops mass on their border with Iraq for the war.

You'll get a much clearer picture of how rotten the Saudis are if you'll do some homework. Our media, as usual, have reported little on this subject. One more cover-up. Well, the Saudis have trillions invested in American companies, so any leaking of the truth about them could result in massive advertising losses. Money talks much louder than truth with our media.

If you're interested in what living in Saudi Arabia is like, invest \$13 in *Princess*, by Jean Sasson. It makes fascinating reading. I predict that you don't even have a hint as to how awful the Saudis really are. And their country.

Keep in mind that the Saudis have been major financiers of terrorist groups.

They're the money power house behind the spread of fundamentalist Islam. This is the religion that teaches children from birth that it is their duty to kill all infidels. An infidel is anyone who doesn't believe in Islam.

Whether we like it or not, while oil may be important in the Iraq war, there are over a billion Moslems who are totally convinced that this is just another step in our war against Islam.

If you take the trouble to read the Koran and the writings of Mohammed, you'll be amazed at the calls to kill. Kill all infidels. Kill any Moslem who even questions the Koran. And this brainwashing has spread all through the Arab countries, across to Indonesia, Malaysia and to the Philippines. Plus, how many mosques are there here in America?

If you'd like to boycott Middle Eastern oil, stick to buying Citgo, Sunoco, Conoco, Sinclair, BP/Phillips and Hess.

But be sure to read *Princess*. And, after that, the two follow-up books, *Princess Sultana's Daughters*, and *Princess Sultana's Circle*. They're both \$13 and worth reading.

So what's the answer to a billion Moslems taught from birth to hate us? They want to kill us, so should we reciprocate? My preference is to outsmart them instead of trying to out-kill them.

The key is education. If we can make an alternative education available for their youngsters, we might be able to screw up Islam fundamentalism. I propose producing entertaining (and game) programs which are also educational via the Internet and on DVD which will be seductively fascinating and blindside their fanatic clergy.

Right now there's no alternative education available to Moslem youngsters. They've no way to learn about freedom, self-determination, or religious choices. It's Islam or death.

Coffee vs. Cancer

With 90% of Americans enjoying the wake-up punch of a cup of coffee, and with Starbucks shops every few blocks

Continued on page 41

How's That Thing Really Work, Anyway?

Part 2: Transmitters.

This time we'll take a look at the basic workings of the transmitter section. Receiving is half of the fun, so now we want to generate a signal and "talk" with AB2F on 80 meters.

Previously, the block diagram showed a logical path through a typical receiver circuit, using mathematics to describe how sections function in relation with each other,

producing an audio output. Using like techniques, transmitter signals are generated, amplified, and sent to the antenna.

This time, the receiver portion of

the block diagram in **Fig. 1** has been shaded, while the new transmitter section is not. Some portions of the receiver section will be used for both transmit and receive; the VFO, audio

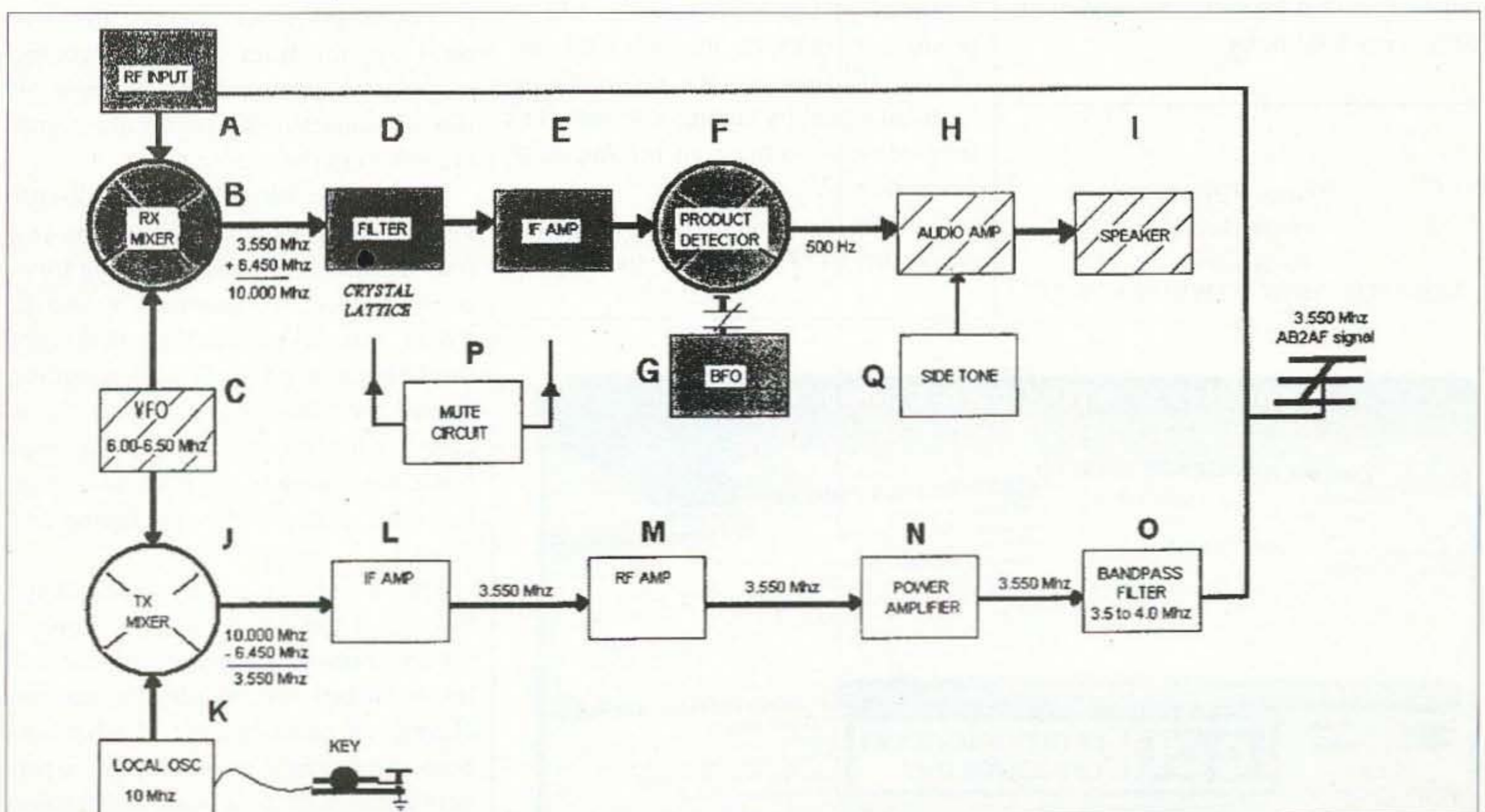

Fig. 1. A typical QRP transceiver circuit. Arrows indicate signal direction, while block "P" is used to provide DC voltage to activate the "mute" circuit.

amplifier, and speaker have lines marked across them. Using the control on the VFO (C), we have "tuned in" a signal to convert to audio. In the receiving process, the VFO and MIXER (B) used "up conversion" to mix the incoming signal with the VFO to produce a 10 MHz signal for the converting process.

The receiver must be "muted" to avoid "over amplification," and possible damage to the audio amplifier section. The receive function continues until the Morse code key contacts are closed and portions of the transmitter section are enabled. An RF signal is generated for transmission, and DC voltage circuits are added to portions of the receiver to disable the audio amplification process, (MUTE CIRCUIT) (P). At the same time another DC voltage path is allowed to enable transmitter sections. This DC voltage being allowed to act upon the transmitter and receiver circuits is often called "KEYED DC." The "switching of voltages" is needed to have the transceiver function properly. Unless the receive portion becomes "muted," the sections designed to process very low signal levels would attempt to amplify this already large signal and be erratic — not to mention provide our ears with some very loud noise.

We have disabled only that portion of the receive section that is used to process the incoming signal. Another section has been enabled, SIDETONE (Q), which will enable us to hear what we are sending. With the "front end" (blocks A, B, D, E, F, and G) of the receiver section disabled, the sidetone circuitry and audio output circuits function similarly to a "code practice oscillator."

Sound confusing? Just follow along with the block diagram as you read, remembering that new circuits have been energized while others have been blocked, and the functions to be described should become apparent to you.

Closing the key contacts makes our first dot or dash of code. The receiver is disabled and the signal from the VFO is now routed to the transmit mixer (J) for processing. We know from before that a mixer circuit processes two signals and produces a predetermined output. This second signal comes from the LOCAL OSCILLATOR (K), which has been activated by the closing of the key and activation of DC circuits.

The signal output from the LO is 10 MHz, but now we'll use the "difference" of the VFO and the LO to produce a signal on the 80-meter frequency. Previously, we changed the received signal by adding it to the VFO frequency to produce an *Intermediate Frequency (IF)* of 10 MHz.

Now the process is slightly altered to allow the VFO frequency to *subtract*

from the LOCAL OSCILLATOR FREQUENCY to produce a signal on 80 meters. This is called the *difference* method of frequency generation because the transmit mixer circuit is tuned to provide the difference between the VFO signal and the LOCAL OSCILLATOR signal, which will provide an output between 3.500 MHz and 4.000 MHz.

This weak RF signal is passed through tuned circuits to the IF AMPLIFIER (L) where it is amplified. How much amplification of the newly generated signal is a design requirement? QRP gear needs fewer stages of amplification than does a high-powered QRO rig. Sections M and N are RF AMPLIFIERS, and are there to boost the RF signal up to an acceptable level. Here we're talking basics, and because QRP is my desire, we will use only two stages of RF amplification to build the signal up to the 5 watt level for QRP operation.

Section O, the BANDPASS FILTER, has a special purpose. Its job is to pass only frequencies between 3.500 MHz and 4.000 MHz, and eliminate all others. Inductors and capacitors are arranged to electrically create a filter designed to pass only frequencies in the 80-meter band for this QRP rig. Using this filter at the output of the transmitter section removes most of the harmonic energy before the signal is applied to the antenna.

I hope this "block diagram" discussion of transmitter circuits helps you to understand the basic operating functions needed to generate a signal. "Why" circuits in your rig function are the beginning phase of understanding "how" they function. Knowing "basically" what the circuit is to accomplish, the design of the particular stage becomes a task with a beginning and an end.

This has been a very basic "trip" through a QRP transceiver's transmit section. There have been many schematics published for building equipment. Having an understanding of what sections are required to accomplish a particular task will make your construction adventures more enjoyable.

Good luck! And keep building! 73

We pay \$CASH\$
(well, check)
for articles!

SEND FOR "HOW TO WRITE FOR 73"

Amplifiers, ATU Down Converters & Hard to Find Parts

<p>LINEAR AMPLIFIERS</p> <p>HF Amplifiers PC board and complete parts list for HF amplifiers described in the Motorola Application Notes and Engineering Bulletins:</p> <table style="width: 100%;"> <tr><td>AN779H (20W)</td><td>AN 758 (300W)</td></tr> <tr><td>AN779L (20W)</td><td>AR313 (300W)</td></tr> <tr><td>AN 762 (140W)</td><td>EB27A (300W)</td></tr> <tr><td>EB63 (140W)</td><td>EB104 (600W)</td></tr> <tr><td>AR305 (380W)</td><td>AR347 (1000W)</td></tr> </table>	AN779H (20W)	AN 758 (300W)	AN779L (20W)	AR313 (300W)	AN 762 (140W)	EB27A (300W)	EB63 (140W)	EB104 (600W)	AR305 (380W)	AR347 (1000W)	<p>2 Meter Amplifiers (144-148 MHz) (Kit or Wired and Tested)</p> <p>35W - Model 335A, \$79.95/\$109.95</p> <p>75W - Model 875A, \$119.95/\$159.95</p>	<p>HARD TO FIND PARTS</p> <ul style="list-style-type: none"> • RF Power Transistors • Broadband HF Transformers • Chip Caps - Kemet/ATC • Metalclad Mica Caps - Unelco/Semco • ARCO/SPRAGUE Trimmer Capacitors <p>We can get you virtually any RF transistor! Call us for "strange" hard to find parts!</p> <p>DIGITAL FREQUENCY READOUT For older analog transceivers TK-1 (Wired and Tested) \$149.95</p>
AN779H (20W)	AN 758 (300W)											
AN779L (20W)	AR313 (300W)											
AN 762 (140W)	EB27A (300W)											
EB63 (140W)	EB104 (600W)											
AR305 (380W)	AR347 (1000W)											

ATU Down Converters
(Kit or Wired and Tested)

Model ATV-3 (420-450)
(Ga AS - FET) \$49.95/\$69.95

Model ATV-4 (902-926)
(GaAS - FET) \$59.95/\$79.95

ADDITIONAL ITEMS

Heat Sink Material

Model 99 Heat Sink (6.5" x 12" x 1.6"), \$24

CHS-8 Copper Spreader (8" x 6" x 3/8"), \$24

Low Pass Filters (up to 300W) for harmonics \$12.95

Specify 10M, 15M, 20M, 40M, 80M or 160M

HF Splitters and Combiners up to 2KW

For detailed information and prices call or write for our free catalog!

Phone
(937) 426-8600

FAX
(937) 429-3811

CCI Communication Concepts Inc.

508 Millstone Drive • Beavercreek, Ohio 45434-5840

e-mail: cci.dayton@pobox.com

www.communication-concepts.com

The History of Ham Radio

— part XV

There had been no changes in radio legislation in 14 years, and by 1926 there were over 700 applications on file with the Department of Commerce for radio broadcast station licenses and about 16,000 licensed radio amateurs operating in the United States.

Of special interest to all was the allocation of frequencies above 200 kc decided upon by the Fourth National Radio Conference. (See **Table 1**.)

Broadcasters had 95 available frequencies with 10-kc separation, with six reserved exclusively for Canada.

Mounting listener resentment

The listening audiences generally agreed that there were too many high-powered broadcast stations operating in the lower wavebands with too little information and entertainment of high-class value. In addition, the problem of regenerative whistles from neighboring radio sets was a bugaboo. The receivers on the market in 1926 lacked good design and circuitry development, so they oscillated and produced spurious signals. By 8 p.m. every night, when the squealers and howlers started, the time for receiver shutoffs had arrived.

Reprinted from *73 Magazine for Radio Amateurs*, June 1981, where this was originally reprinted from *QCC News*, a publication of the Chicago Area Chapter of the QCWA.

Enjoyment of radio listening began to wane.

License and frequency assignments for radio broadcasting, as well as all other associated regulation, still rested with the Department of Commerce, with Secretary Hoover in charge. As more conflicts arose, the Department's authority was seriously questioned. Several broadcasters, notably WJAZ in

Chicago, challenged the legality of the regulations pertaining to "time on the air" assignments. They asserted that The Freedom of the Air gave everyone the right to choose ... where and when he operated ... that the people of the country were the ones who had The Freedom of the Air. In consequence, the division of time among the powerful stations, known as

Kilocycles	Meters	Service
500-550	545-600	CW, ICW, phone, aircraft
550-1,500	200-545	Broadcast
1,500-2,000	150-200	Amateur phone, CW, ICW
2,000-3,500	85.7-105	Aircraft, point-to-point, mobile relay
3,500-4,000	75-85.7	Amateur, army mobile, navy vessels with aircraft
4,000-7,000	42.8-75	Public toll, mobile, point-to-point, relay
7,000-8,000	37.5-42.8	Amateur, army mobile
8,000-14,000	21.4-37.5	Point-to-point, relay
14,000-16,000	18.7-21.4	Amateur
16,000-56,000	5.35-18.7	Public toll, mobile, government, point-to-point, experimental
56,000-64,000	4.69-5.35	Amateur
64,000-400,000	.7496-4.69	Experimental
400,000-401,000	.7477-.7496	Amateur

Table 1. 1926 frequency allocations.

Class B stations, was challenged and legal action resulted.

The new radio bills

The radio legislative situation in Congress brought about important stipulations through the enactment of two long-overdue bills. The House's White Bill, H.R. 9971, one of many previously considered by committee, was finally voted on favorably March 15, 1926, placing the control of radio in the Department of Commerce. In the Senate, the Dill Bill, S.4027 (Fig. 1), introduced April 19, 1926, provided for an independent regulatory commission. These two bills went to a joint compromise conference committee, but were not acted upon until the 70th Session. The new law emerged in final form February 23, 1927, after being signed by President Calvin Coolidge and designated *The Radio Act of 1927*.

Henceforth, available licenses were granted to license-seekers on request

on the basis of priority of demand. The new Radio Act provided for dividing the United States into five radio zones to facilitate parceling out available radio channels as applications for licenses and renewals were received. It was implied that the Secretary of Commerce should make an equitable distribution of frequencies and power among the zones and issue licenses accordingly. Also provided for in the Act was the appointment of a five-member commission, one member for each zone, to constitute an advisory body to aid the Secretary in the designation of channels, etc. President Coolidge made the committee appointments on March 1, 1927.

With radio and other associated regulations still in the hands of the Department of Commerce, Senator Dill had the following remarks to contribute:

The question has arisen during consideration of the bill as to whether the regulation of radio should be entrusted to the Secretary of Commerce, or to

any other one man. It is my belief that at the present stage of development the details of administration should remain with the Department of Commerce, but that a nonpartisan commission should be established with authority to pass finally upon questions which may be referred to it by the Secretary of Commerce or anyone else. The decision of this commission should, of course, be subject to review by the courts.

In all the 14 years of radio control under Secretary Hoover, no serious criticism was aimed at his method of administration ... referred to in a passing remark by Dill. During the debate in Congress, there emerged criticism concerning one-man control with the observation that "such arrangement would give the president the final say while political opposition would be deprived the use of the ether! Control must be nonpartisan!!"

The several committees, in their long

Continued on page 59

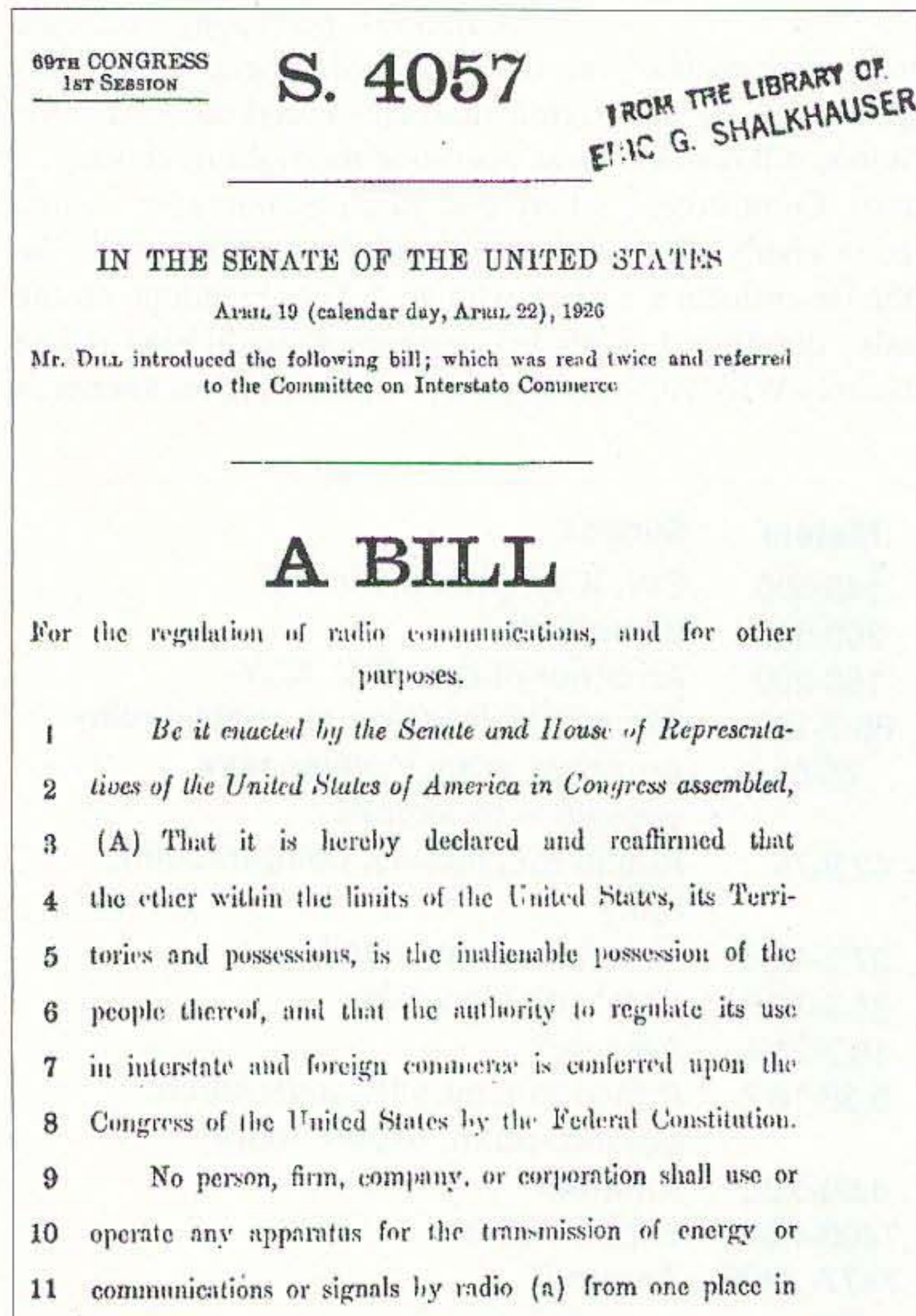

Fig. 1. First page of Dill Bill S. 4057.

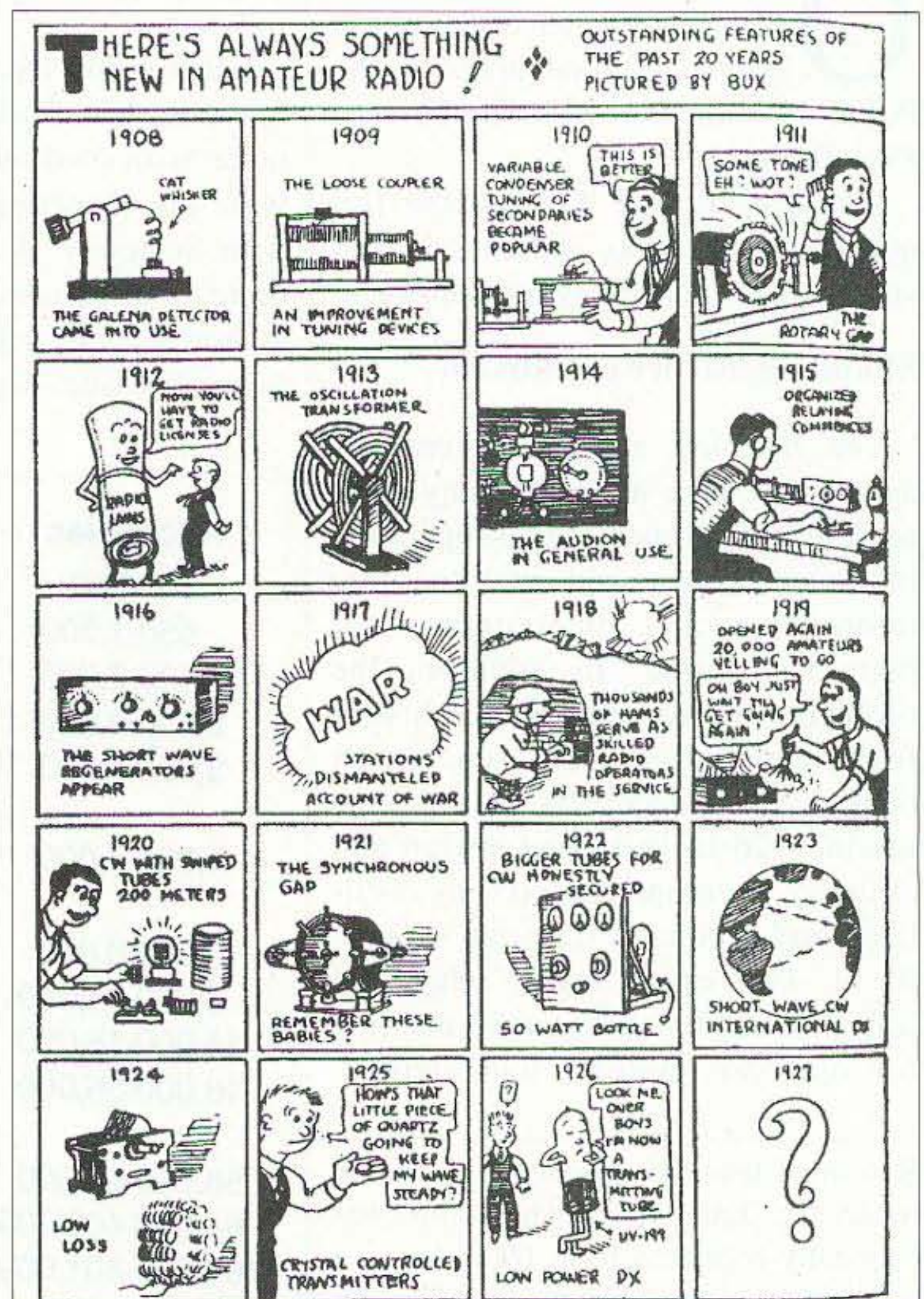

Fig. 2. Cartoon history, 1908-1926.

NEVER SAY DIE

continued from page 36

in our cities, let's keep it quiet that cancer researcher Dr. Bruce Ames says that coffee is the number two cause of cancer today.

Coffee is a mind-altering stimulant that produces a surge of nervous energy ... and then leaves you exhausted, depressed, irritable and short tempered. Caffeine stimulates the brain cortex, causing poor memory, poor balance, fatigue, anxiety, hand tremors, hostility, headaches and dehydration. Researchers claim that it takes two or three cups of water to overcome the dehydration caused by one cup of coffee.

There's also a proven link between coffee and osteoporosis, breast cancer, miscarriages, high blood pressure and raised blood sugar levels.

Those are just the short-term problems. Another chemical in coffee (methylxanthines) permanently alters your genes. Mutation damage of the chromosomes that will be reflected in a lowering of your children's IQs. Thus this national habit is permanently weakening our entire country and messing up our gene pool.

Ham TV on the Web

An article by G3ZHI in *Amateur Television Quarterly* on linking ham TVers and ham TV repeaters via the Internet got my interest. Alas, it was Windows-oriented, making a Mac person ready to retch.

I'd sure like to see an article submitted on how I might be able to interconnect with ham TVers and ham TV repeaters via the Web ... using my eMac and my digital Sony camera.

Picabo

Here's another chuckle from my E-mail. The famous Olympic skier Picabo (Peek-a-boo) Street is a nurse as well as an athlete. She currently works at the Intensive Care Unit of a large metropolitan hospital. She is not permitted to answer the phone because she caused too much confusion when she was answering, saying ... "Picabo, ICU."

Mature Worker Glut

Mature, meaning over 45 these days ... and workers over 45 are an increasing problem.

In 2000, there were 61 million Americans 45 to 64. By 2010, there will be 79 million ... unless more people wise up and stop poisoning themselves, in which case there'll be a lot more.

In 1960, 78% of men from 60 to 64

were in the labor force, as were 31% of those 65 and over. By 2000, it was down to 55% and 18%!

Older workers are usually much more expensive, after years of raises and increasing costly health problems, so management tends to replace them with lower-cost younger workers. I've always preferred to hire youngsters and train them. On every occasion where I've hired older workers, hoping to benefit from their experience, I've come to regret it.

So what can an older worker do?

With unskilled and blue-collar jobs moving to lower wage countries and white collar jobs being replaced by information systems, looking to large companies for jobs isn't going to make it. The answer is to start planning ahead for an early retirement where you're running your own business. This is a safety cushion in case your investments for your retirement have gone down a Tyco toilet.

My *Secret Guide to Wealth* goes into detail on how to get someone else to pay you learn everything you need to know to be a successful entrepreneur ... and how to pick a product or service for your business.

Our country could use a couple million more small businesses and fewer giants.

Drug Promotions

For the few of you who may have wondered at how high drug prices are, it may help you to know that promotional spending on drugs is currently \$19 billion. That's with a B ... for golf outings, ski trips, dinners at posh restaurants, and so on. Does all this influence prescription writing? You bet your sweet bippy it does.

Prescription costs have risen at twice the inflation rate for the last five years.

In Vermont, Medicaid spending for prescription drugs went from \$40 million in 1998 to \$115 million last year.

My mantra is simple: Stop poisoning your body and you won't need a doctor or medications.

Last fall, TAP Pharmaceutical settled charges of kickbacks and lavish gifts to push Lupron by paying an \$875 million fine.

AIDS Deaths

George Will recently wrote in *Newsweek* about the world's AIDS situation. He said that 25 million have died so far, and 65 million are currently HIV-positive. He didn't mention anything about how AIDS got started. A book by Dr. William Douglass puts the epidemic at the hands of the Center of Disease Control in Maryland, where he says it was developed. It was then deployed with vaccinations in sub-Saharan Africa

to counter their huge birth rate and among the American gay community for some other reason.

Please, if you know of any way to reach George Will, let him know that the AMA, and probably the FDA and NIH, have been covering up an inexpensive no-drug cure for AIDS for over ten years. One that was granted a patent in record time. This is a cure that could save those 65 million lives and would have cost less than a dollar a life.

Dr. Bruno Comby discovered another cure for AIDS as described in his book, *Maximize Immunity*, which was published in 1994. More recently, Dr. Lorraine Day rediscovered the Comby approach.

Why all the cover-up? Money. Drug company profits.

TV Advertising

Though cable, satellite, movie rentals and DVDs may be luring viewers from the networks, they're doing just fine. NBC had \$2.7 billion in ad revenue for last spring's season. The six-networks total for the season was \$8.2 billion.

Yes, there are more ads. Ten years ago the non-program time for prime-time network shows was 13-1/2 minutes. Now it's over 16-18 minutes! That's why it's taking me longer to fast-forward through all those commercials. I watch nothing live, so I watch *60 Minutes* in 42 minutes, and watch the Nexium and car ads endlessly whiz by.

In 1980, the three networks shared 90% of the viewers. Today the six networks are sharing only 56%.

If I'm able to get the word to the public about changing our lifestyles, the loss of drug and food advertising could just about wipe out the networks. Gee, what a loss!

Meanwhile at present an ad on *Friends* runs about a half a million dollars. *CSI* is a quarter million, and *8 Simple Rules* an eighth of a million.

The IQ Mystique

As a founder of American Mensa I can write with some authority about Mensans. I've known hundreds of 'em and met thousands. For the most part, what a bunch of ignorant losers!

When a journalist asked a New England Mensa official to suggest a successful Mensa member he could interview, the official was stumped.

Just as a high speed computer with lots of memory is useless without data, so are our brains. Reading the sports pages and watching ball games (base, basket, foot, soccer, golf, tennis, bowling)

Continued on page 62

Putting 24-Volt Microwave Devices to Use

Since the September 2002 column covering microwave relays, I have received a few questions on adapting 24-volt microwave relays to use with 12-volt-powered systems. This seems to be a common problem in that 24-volt relays seem to be popping up at swapmeets in increasing numbers.

While several dealers have the advertised 24-volt relays for a pretty good price, their 12-volt counterparts are even more costly, straining the experimenter's budget. In that regard, pick up those inexpensive swapmeet 24-volt miniature SMA relays and use them on your upper microwave frequencies. They exhibit great isolation and will handle moderate power for many transceivers, even the likes of my 10 watt TWT amplifier for 10 GHz.

There are several versions of miniature SMA relays, from the basic SPDT switch, which seems to be most common, to the more exotic latching type of relay. The difference between them externally is almost nothing. Internally, the difference is quite a bit. In an SPDT type, there is only one relay coil internal and the normally make

contacts are common to one side of the relay with the coil not energized. When energized the relay switches from common to the other side of the switch and stays in this position until the relay coil power is removed.

In a latching relay, common is tied to one side in a make condition and this side depends on which set of coils were toggled first. It has two internal coils and they, when powered individually, put the switch in position 1 to common or position 2 to common depending which coil is powered. Power (current) flows momentarily, as when the coil is powered to latch the selected position a cutoff switch internal opens the coil from power and no further current flows in the circuit. The second coil in the scenario makes its previously open coil

closed to the power pin on the relay body and awaits the application of DC power to reactivate the second coil to make condition.

The switching of a latching relay is simple. It actually just requires two power leads, one for receive and one for transmit. In receive, common and left (1) contact is made in receive, and when transmit DC is applied to the second coil, the relay switches to the transmit common part of the switch, making the receive contact open from common.

But now the major problem to be discussed here is how to use 24-volt relays from 12-volt DC sources like in mobile or remote Field Day operations. Of course, you could power your equipment from a 24-volt battery source, but that requires carrying an extra battery for operations.

Electrically speaking, what can be done to accommodate this power problem, allowing utilization of surplus/used 24-volt microwave relays to adapt them to 12-volt power systems? There are two solutions. One requires construction of a bucking voltage doubler, or you can add a miniature surplus switching power supply on top of the 12-volt control switching relay power line. In actual operations, the latter is simple if you can obtain such a power supply. In surplus scrap yards that break down computer and other electronics, they have been found in reasonable quantities, allowing for use in such an application.

These switching power supplies are quite common and might have been overlooked for many applications. They are quite small, being about the size of two postage stamps and one quarter of an inch high. While there are many that are rated for various voltage inputs and outputs, the ones that seem to be just what we desire are the ones that operate from +12 volts input and deliver +5 volts

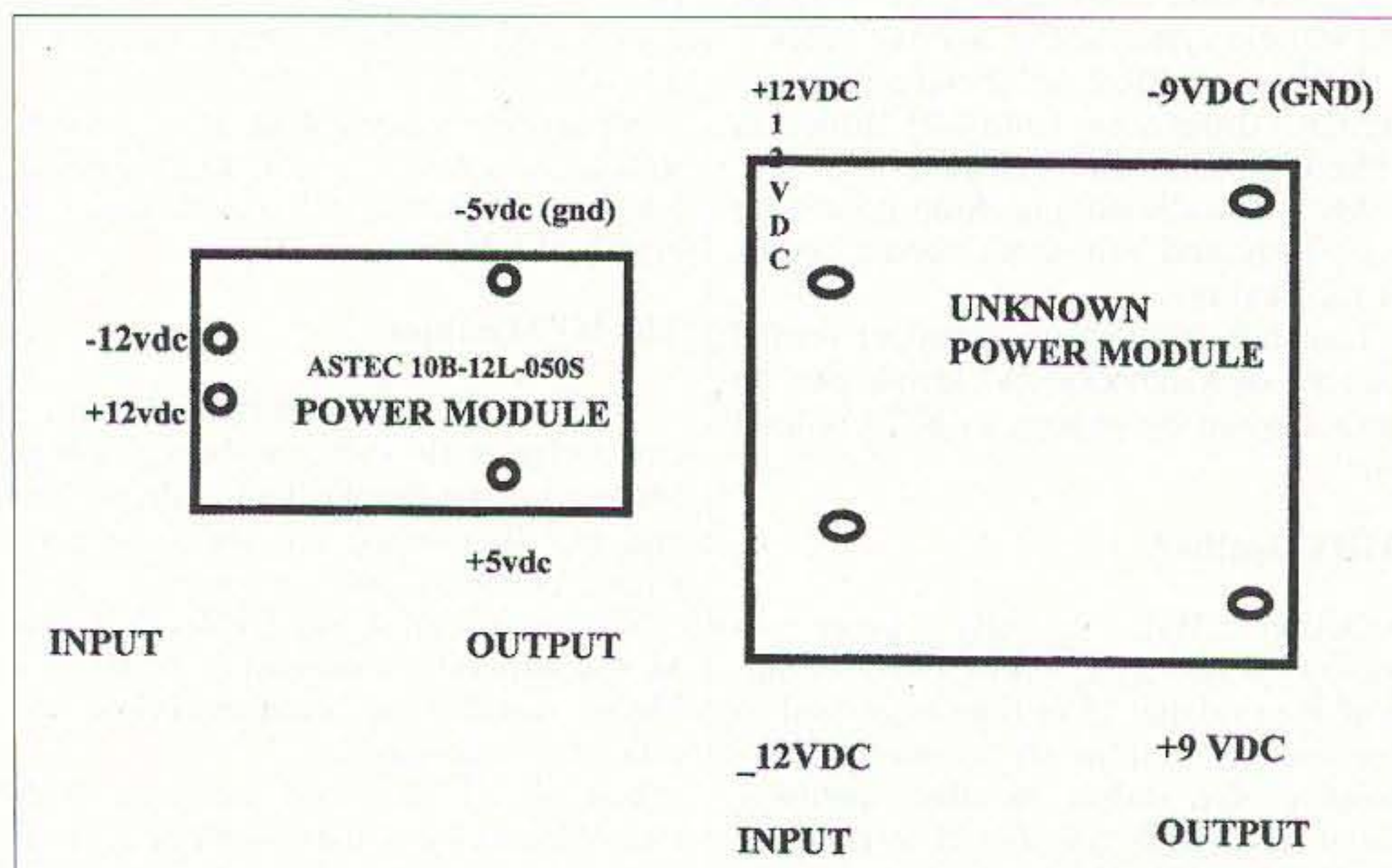

Fig. 1. Top view of power supply modules showing pinout connections for both the Astec 5-volt isolated supply and the unknown 9-volt isolated switching power supply modules. NOTE: Both modules use input pins spaced closer together than the output pins, possibly a standard configuration.

output. Most of these can handle at least 5 watts of power output at 5 volts and can be used normally or inverted for negative power requirements.

That is because the output is not just a voltage regulator internally but a complete switching power supply whose input is totally isolated from its output. This is what allows powering up the primary to ground and +12 volts and taking the negative 5 volts and making a direct connection to the +12-volt DC lead. Now at the positive 5-volt lead you have +17 volts available. Connecting two of these in series gives you 22 volts. That's 12 volts from the primary power source, and with two 5-volt isolated power supplies in series each adding 5 volts to the picture, now a total of 22 volts. With mobile operations with a charging 12-volt battery source, it will up the voltage on these connections to 24 volts as the charging 12-volt battery nominal is now +13.9 or so.

Why 5-volt switching power supplies? Well, they're the most common to provide +5 volts DC for logic power on PC boards. While there are other voltages that fill the bill, the 5-volt switchers seem to be the most plentiful. One other possibility that I located quite some time ago was +12-volt input and 9-volt isolated output switching power supply in a square package. There was no label, but you could be sure it's a switcher as it had only 4 leads internal to the sealed epoxy package and resided on the DC power supply shelf of the scrap PC board it was harvested from. Once I recognized it for what it was, many more were obtained, as I knew what to look for, label or not.

Most part number schemes seem complex, while some are not. Take, for example, a surplus Astec power switcher with a label of "AA10B-12L-050S". While I don't know the total information on this unit, it has been observed that it's +12 volts input and 5 volts isolated output. I have stacked one power module on top of a 12-volt DC line, and with the 17 volts have been able to use with assurance many 24-volt relays without further modification.

Another great application is the generation capabilities of using this power module in an inverted power connection for FET bias supplies. This allows you to use lower voltage DC positive drain power source and

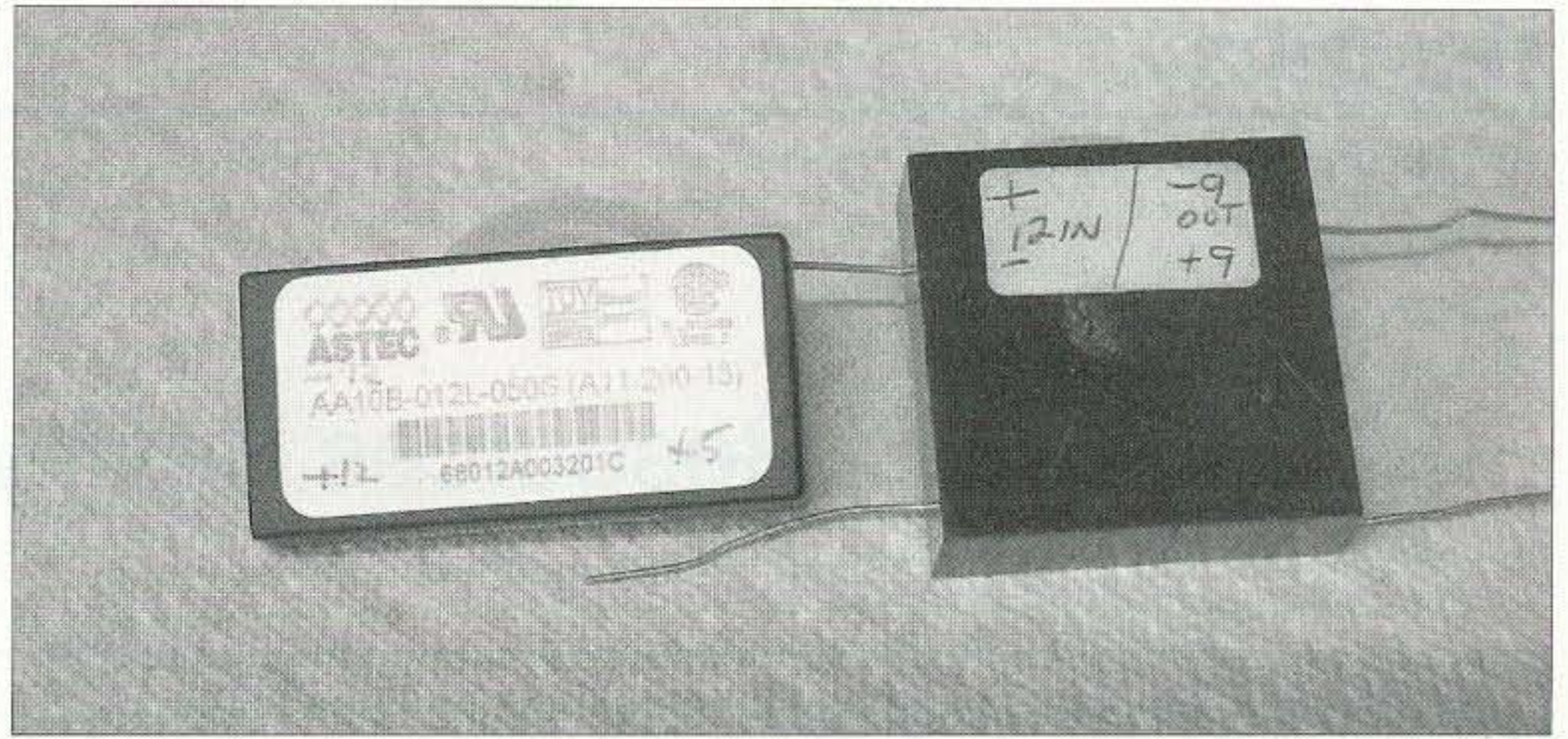

Photo A. Shows both the Astec 12-volt to 5-volt isolated power module and the unlabeled 12-volt to 9-volt output power module I was able to find for use in powering 24-volt relays from 12-volt supplies.

a negative 5-volt supply from the switcher for gate FET bias. Of course, further circuitry is necessary in any FET power supply circuitry, but the basics are there for both positive- and negative-generated voltages for operations.

Testing the power module that did not have a label and put out 9 volts isolated on the secondary of the switcher, I found that with a 75-ohm load it was still loafing along at 125 mA draw. Testing it with a 24-volt relay that drew 95 mA, the unloaded power supply was 22 volts and did not change a tenth of a volt when power was applied to the 24-volt relay. It operated quite well on 22 volts, as I was watching contact closure for relay operation with a simple LED-driven test circuit I use for coax relay contact testing.

That's just another simple project for testing miniature SMA relays that is constructed out of some scraps of SMA connectorized coax cable and tied to two LEDs operating

on low voltage for watching contact closure of the relay. I built it as, being a scrounger and finding a relay that was defective, I could use this simple tester to verify if and when I obtained contact closure and repair on a few relays. It was easier to use this simple test setup than to hold a VOM set of test leads. Most relays I have found defective had dirty contacts internal to the relay. If you can pry the cover off without destroying the relay, through some simple maintenance repair you too might get lucky in the salvage of a defective SMA microwave relay.

Well, that's it for this month's tip of the day. Don't scowl on the next batch of SMA microwave relays just because they're marked 24 volts only. Take advantage of these 24-volt relays, be they an SPDT or latching or even the harder-to-find transfer (four-contact) relays. As always, if there is any question please address me at my e-mail address and I will answer your question ASAP. Best 73, Chuck WB6IGP. 73

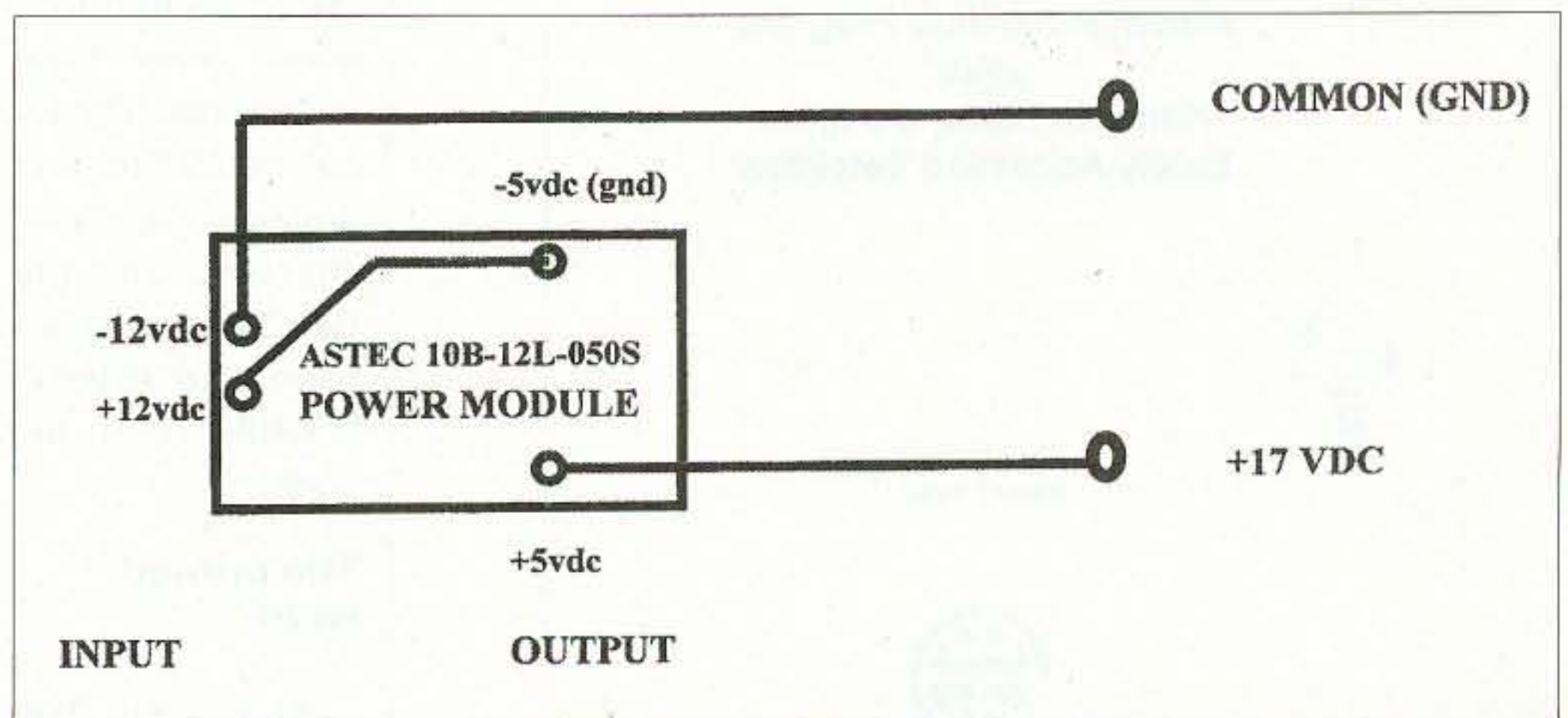

Fig. 2. Application of switching power supplies added in series to input 12-volt positive supply to generate higher voltage allowing use of 24-volt microwave relay operation from simple 12-volt power sources. Be it the 5-volt addition to the 12-volt supply or 9-volt secondary outputs, both worked well on 24-volt relays I tested in my junk box.

SAVE 47%!
on 12 months of **73**
Only \$24.97
Call 800-274-7373

Resources Review

Last month we asked some questions: "How many satellites can you keep up with?" and "How many can you work in a day?" We've come a long way from the days of, "Have you been on the satellite lately?" Now you hear: "Been on SO-50 this week?"

The answer might be, "What's SO-50?" There are so many hamsats and modes, that even among a local satellite group, members could be extremely active via the amateur radio satellites, but never make contacts with each other. Rather than getting stuck on one satellite or mode, investigate the others. You will be surprised at what's out there waiting for you.

Info sources

Even with the Internet, it's still a challenge to gather all of the information needed to explore a new satellite or mode. If your

focus has been FM contacts via UoSAT-OSCAR-14 (UO-14), getting on a 9600-baud digital hamsat might seem daunting. You may have an understanding of orbital mechanics, at least enough to guess when UO-14 will be around tomorrow, but the last time you listened to a 9600-baud satellite, all you heard was a bump in the noise on the FM downlink. What about SSB (single sideband) contacts via the Fuji satellites, or SSTV (slow scan television) via the S-band downlink on AMSAT-OSCAR-40 (AO-40)? Your satellite "Elmer" may have gotten you started, but it's up to you to explore new horizons.

patches and stickers, but the booklets and books looked like the same thing I had seen a year earlier. I asked about this, and got an answer that caused me to buy almost one of each of everything on the table. AMSAT has made it a policy to study the status of all of their publications every year. They look for things that have changed and new topics that need coverage. The authors provide updates and the new version of an old favorite is ready to go for the Dayton Hamvention in May. All AMSAT items are available via the Web site, [www.amsat.org]. Near the bottom of the front page is the link to "AMSAT Catalog." From there you will find the current offerings and prices with differentiation for domestic and foreign shipping.

Working the Easy Sats

This is an introductory booklet by Gary Rogers WA4YMZ. At 33 pages, Gary's guide is inexpensive (\$6.00), but invaluable for first-time hamsat chasers. Gary's reason for writing this material for AMSAT was simple: He simply wanted to share his experiences of getting on the air via satellite with others. "I did it. You can, too. Come join the fun!" Contents range from a description of the types of amateur-radio satellites, definitions of terms, and special considerations, to how to set up a station and achieve success. Gary also includes sections on what to do after the QSO, expanding to other satellites, further resources, and final thoughts. If you are just getting started, this is the place.

The Analog Satellites Operating Guide

G. Gould Smith WA4SXM has been a strong AMSAT supporter for decades. His analog satellite guide is an in-depth

After the initial Internet "Google" search for everything you ever wanted to know about a particular satellite or mode, you may realize that there are holes in the data, or it makes too many assumptions about your base knowledge. The local satellite net doesn't mention anything and the magazines are off on some other tangent. It's time to hit the books.

The printed word

At a recent ham convention, I checked out the offerings at the AMSAT booth. I saw some new

WORKING THE EASY SATS



An Informal Introduction to the
Amateur Satellite Program
plus
Hints on Using the More
Easily Accessed Satellites



by
GARY B. ROGERS, WA4YMZ
AMSAT 16961



Photo A. For newcomers: Working the Easy Sats.

The Analog Satellites Operating Guide

UO-14, AO-27, SO-41, RS-12/13, RS-15,
FO-20, FO-29, AO-10, AO-40 and ISS

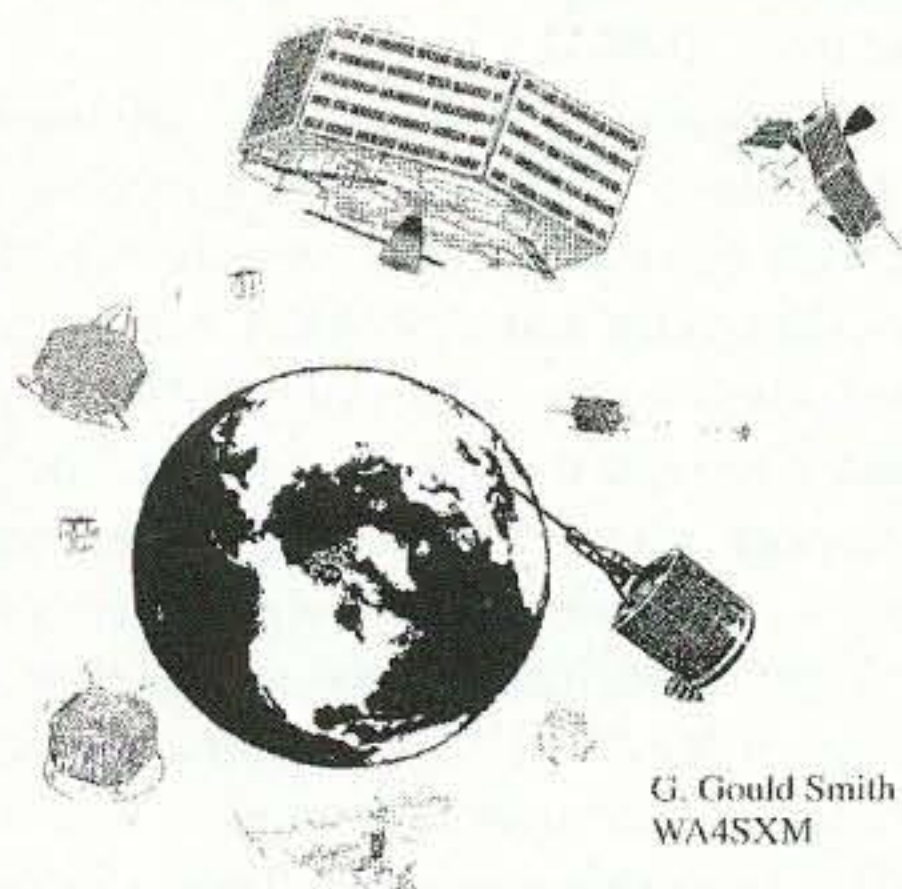

Photo B. Analog satellites for everyone.

information source for anyone who wants to check out analog modes (FM, SSB, CW, etc.) via the hamsats. According to Gould, there is a three-tier amateur satellite upgrade path. On the analog side, it starts with FM voice via satellites like UO-14, but also includes voice communications with the International Space Station. Level two adds SSB/CW communications through satellites such as Fuji-OSCAR-29 (FO-29), while the top level includes AMSAT-OSCAR-40 (AO-40) work with its 70-cm (Mode U) and 23-cm (Mode L) uplinks in conjunction with the 13-cm (Mode S) downlink. With this 100-page book, you will get satellite profiles with frequencies of operation, telemetry information, operating guidelines, and information about tracking software. At \$15, it's an excellent resource.

The AMSAT-NA Digital Satellite Guide

WA4SXM isn't just a master of the analog satellites. His interest in telemetry, which is usually quite digital, has led him to expert status via the digital hamsats. He once again applies a three-tier upgrade path for the digital enthusiast. Beginning with two-meter FM packet and advancing through ISS, Gould explains equipment requirements and how to achieve digital

success. Level two goes further with 1200-baud UoSAT-OSCAR-11 (UO-11) telemetry decoding, 1200-baud AMSAT-OSCAR-16 (AO-16) communications, and details on 9600-baud FM work through such satellites as UoSAT-OSCAR-22 (UO-22). For the dedicated few wishing to go further, there's level three with UoSAT-OSCAR-36 (UO-36) transmissions at 38.4 kbaud and the RUDAK digital system via AO-40. Gould goes into great detail on how to use available digital-communications software like WiSP (Windows Satellite Program) by Chris Jackson ZL2TPO/G7UPN, and provides further insights for tracking systems, including unattended automatic operation. This is another excellent resource, and with 100-plus pages, well worth the \$15 from AMSAT.

Mode S — The Book

Some folks aren't satisfied with off-the-shelf, plug-and-play radio systems. Ed Krome K9EK is one. His *Mode S* book has been updated to include many experiments and options for those pursuing the 2400 MHz downlink signals from AO-40. Useful *Mode S* made its debut on AMSAT-OSCAR-13 (AO-13) many years ago. It was surprisingly easy to make contacts even though the downlink gear on the satellite

The AMSAT-NA Digital Satellite Guide

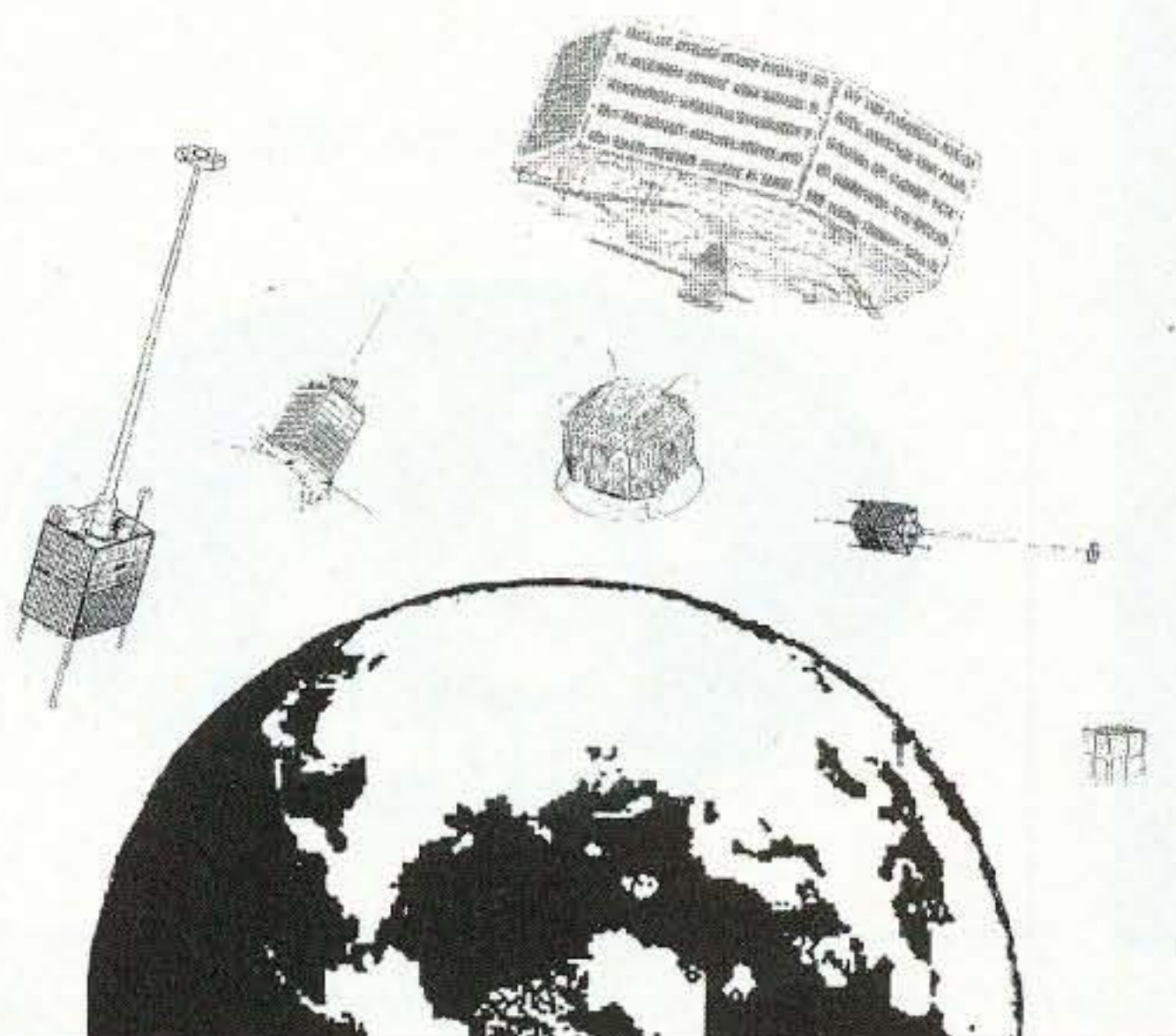

Photo C. Digital hamsat info from simple packet to high-speed satellite communications.

was low power and used only a small helix antenna. Ed has been building S-band receivers, downconverters, and antennas ever since. His 134-page book includes examples, photos, schematics, circuit board layouts, and parts lists for his most successful projects. It's like a catalog of things to try and devices to build for better AO-40 communications, both analog and digital. It's \$15 from AMSAT.

December 1974 AMSAT Newsletter

For \$5, you can get a copy of the best source of data about AMSAT's oldest operational satellite, AMSAT-OSCAR-7. The December 1974 *AMSAT Newsletter* was printed just after a successful launch from Vandenberg, California, on November 15, 1974. The newsletter is a 36-page small-format (8" x 5.5") "zine" full of historical AMSAT material in addition to details about the spacecraft. It's not mentioned on the Web site, but AMSAT has copies at their main office for those who ask.

Other books from AMSAT

Every year AMSAT, compiles the proceedings from their space symposium. Those who attend get a copy. AMSAT usually has a number of extras that are made

Mode S

- The Book -

2001 AO-40 Update

The complete guide to operating
Satellite S-Band

by Ed Krome K9EK

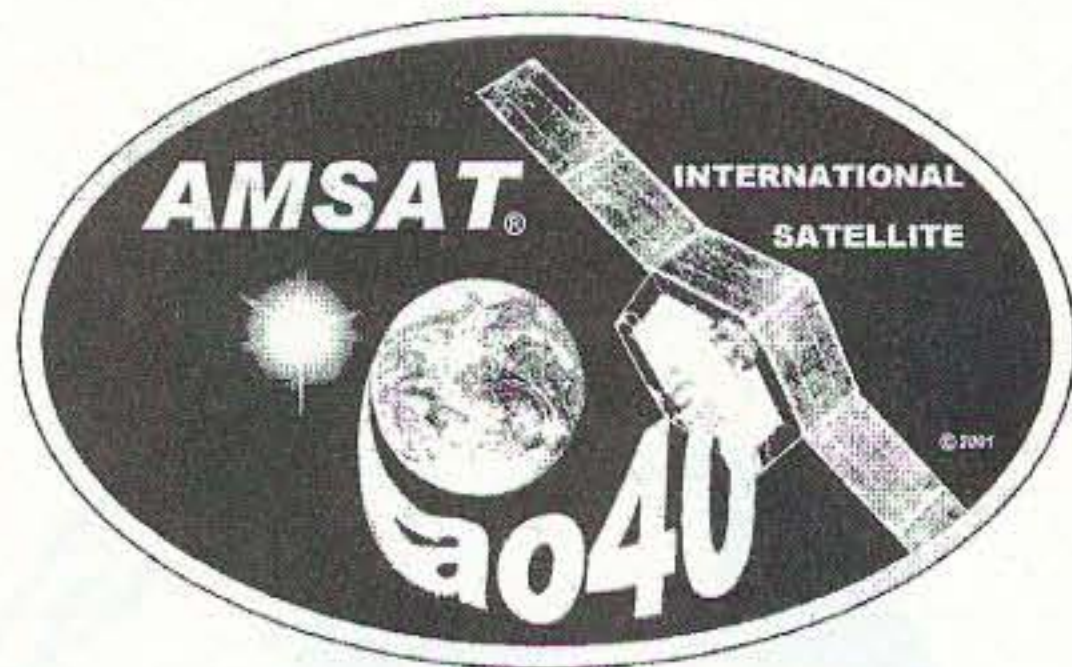

Photo D. Everything you can imagine about hardware for 2400 MHz satellite reception.



AMSAT

Affiliated with



NEWSLETTER

PRICE
50¢

Issued quarterly by the Radio Amateur Satellite Corporation

Volume 71

Number 4

December 1974

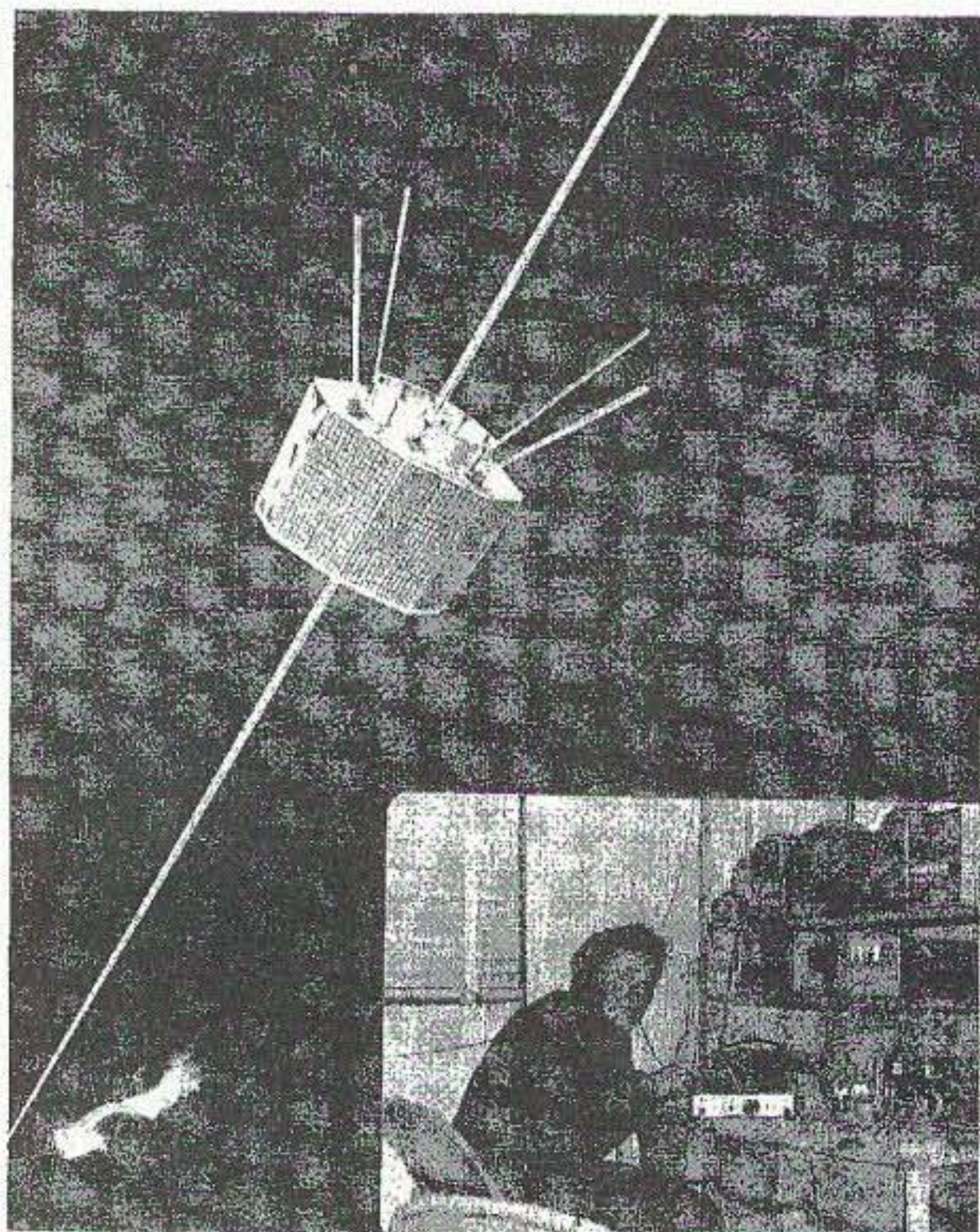

Photo E. The AMSAT Newsletter from December 1974 tells all for AO-7 activity.

available via the main office and Web site. As publisher, the American Radio Relay League (ARRL), also has copies for sale. It is an excellent source of information about new project proposals, studies on current experiments, and other appropriate topics. Length is typically 120–160 pages; it is professionally bound, and sells for \$20.

Although not an AMSAT book, *The Radio Amateur's Satellite Handbook* by longtime AMSAT member and supporter Martin Davidoff K2UBC is considered the best all-around source of information about amateur-radio satellite efforts. Last updated in 1998, it sports 370 pages of information and retails for \$22 (\$25 postpaid from AMSAT).

For those who are new to amateur radio satellites, the introductory section provides a nicely detailed view of the program's history starting with a perspective on *Sputnik 1*. Schematics of the first *Explorer*, *Vanguard* and *OSCAR 1* beacon transmitters are included. The complete chronology of the OSCARs, and the many volunteer hams who built them, is fascinating. The book continues with operating notes on satellite activities, information resources, descriptions of international organizations, conferences, the AMSAT local area coordinators network, satellite schedules, and the involvement of the ARRL. The two final chapters of the book describe various satellite onboard systems, and what it takes to actually build a ham radio satellite. Topics include propulsion motors, power sources, onboard computers, radio links, thermal concerns, mechanical considerations, and launch opportunities. This handbook brings hamsat information and operating practices together with an insight into the history of OSCAR and possibilities for the future. It's a good investment.

Other books

The ARRL has two other books of interest including *The ARRL Satellite Anthology* and of course *The ARRL Handbook*. The *Satellite Anthology* is a compilation of articles from the ARRL's magazine, *QST*, from the 1990s. Hamsat information in *The ARRL Handbook* is updated yearly to ensure that it is current and useful. While many of the best items have already been publicized via AMSAT, there are also offerings that have been developed by ARRL authors and staff [www.arrl.org]. Another book of note is the *Space Radio Handbook* by John Branegan GM4IHJ, produced by the Radio Society of Great Britain. Although published in 1991, this book has many sections of timeless material dealing with the physics of satellite orbits, meteor scatter, moonbounce, asteroid and comet signal reflections, radio astronomy, and even lunar beacons. Finding a copy may be difficult since it is no longer in print, but it will be worth it if a copy can be located [www.rsgb.org]. AMSAT-UK (United Kingdom) recently published an updated version of their own *Guide to OSCAR Operating*. Although the focus is mainly for newcomers, the color illustrations and detailed charts make it useful for everyone [www.amsat-uk.org].

More information

Don't forget magazines. The Hamsats column has been continuously supported by *73* since January, 1987. Other periodicals like *QST*, *CQ*, *World Radio*, and others have had their own versions of satellite columns and article support. One of the best hamsat periodicals is *The AMSAT Journal*. It is published bimonthly by AMSAT for current members. Membership is \$36 per year for U.S. residents, \$41 for Canada and Mexico, and \$45 elsewhere. As the organization's communications link with their membership, the

Continued on page 59

D700 Keyboard Interface for the Kenwood TMD-700A

One of the most interesting aspects of ham radio is the fact that you can start with a great product with great features, but soon some ham will figure out a way to make it much better. The Kenwood TMD-700A is one such great product, and the D700 Keyboard Interface from John Hansen W2FS makes it even easier to use.

Kenwood's TMD-700A offers a dual-band radio with a built-in TNC. Not only does this make packet radio possible, but also the built-in software makes APRS (Automatic Position Reporting System) a natural.

Generally, this tends to be somewhat of a one way street. I know that people can spot my location as I travel, and I do see other APRS stations pop up on the display. However, it is impractical to watch the screen while driving, and totally impossible to send a message. The TMD-700A has limited controls, so sending a message involves either punching in the text with the microphone or using the front panel display. While both methods are possible, each is somewhat time consuming. The microphone method utilizes each key for several letters, so you must press a key repeatedly. To enter the "@" sign, integral to every e-mail address, it takes 18 presses of a button. The control panel method is like an old labelmaker: Spin the dial until you get to the correct letter, then press a key. As the old expression goes, "There must be a better way!"

The D700 keyboard interface makes operation of the radio in packet or APRS quick and easy. Since the D700 uses DTMF tones to transmit a letter from the microphone to the radio, John decided that it should be possible to build an interface that would allow a standard computer keyboard to be connected to the radio utilizing the microphone port. By generating the correct tones, it would be possible to convert the alphanumeric keystroke to the DTMF tone that would enter the correct letter into the radio. Of course, converting a theory to a practical use is more than just coming up with the idea. The trick was to determine how to

emulate the signals generated by the microphone. Fortunately, Kenwood was very helpful in providing John with information to make this possible.

The keyboard interface can be purchased either as a kit or assembled and tested. There are only about 35 components, including the connectors, so construction should not present a challenge for most hams and will save you a few dollars. Of course, if you have small children who insist on participating in your every endeavor as I do, you may prefer to purchase the unit complete.

If you do decide to build the kit, a few of the usual recommendations are in order. Check the circuit board carefully for broken traces or solder bridges before you begin; it's much easier to replace the board before you start construction than after. For those of us who haven't had laser eye surgery, a magnifying glass may be a useful tool.

As always, check to make sure you have all the parts. An empty egg carton can be very useful for sorting parts, although some people use a corrugated box for some components like resistors. Place one lead into the honeycomb of the cardboard edge and write the component value just below.

Before beginning to construct the interface, a few decisions must be made. It is possible to install a switch and LED on the circuit board. If you are planning on installing the circuit board into a case, you may want to install these on the case itself rather than on the circuit board. The switch and LED are optional, depending upon how you plan on using the device. If they are used, the unit will power itself down after three minutes with no activity. If you plan on powering this from a 9-volt battery, this feature is

Continued on page 59

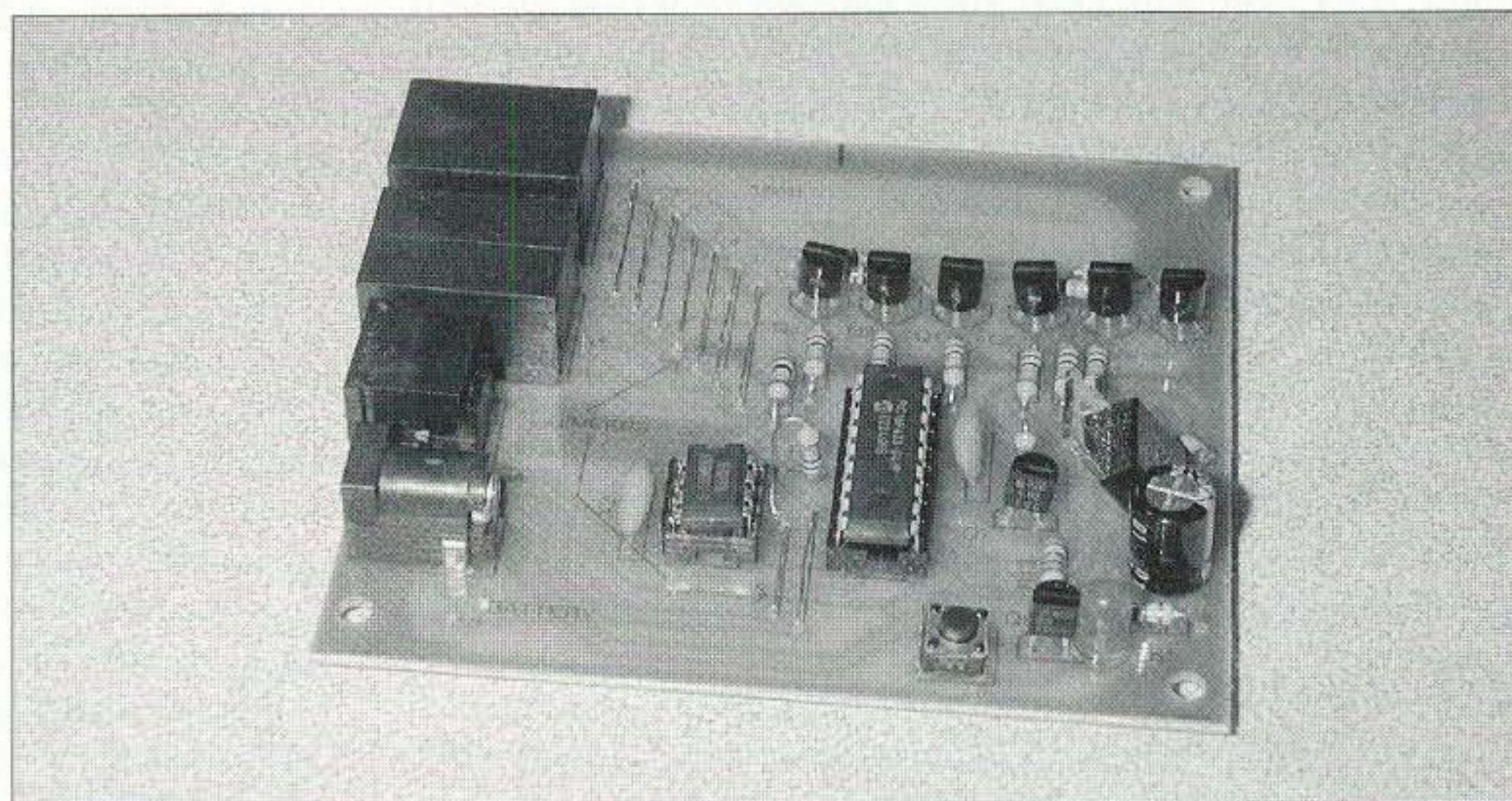
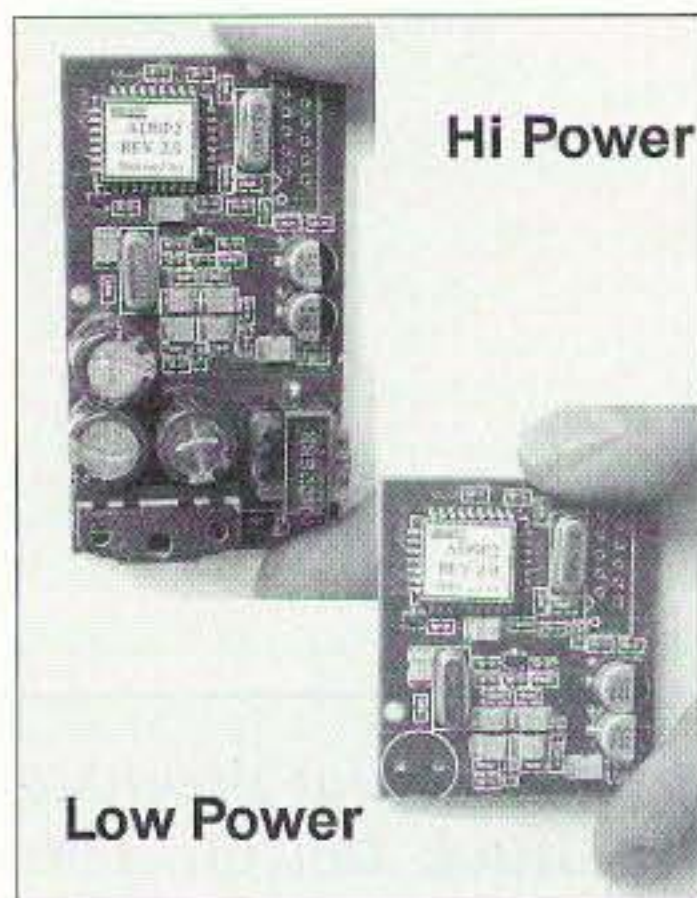

Photo A. Want to be able to easily send text messages on APRS with your Kenwood TMD700A? With the D700 interface you can connect a PS/2 keyboard.



SGC Announces ADSP²

SGC Inc. is pleased to announce ADSP², an unprecedented improvement in Automatic Digital Signal

Processing. Beginning on March 1st, SGC has made available ADSP² for its own SG-2020 Transceiver and as an add-on for nearly any transceiver — old or new — that meets minimal specifications for the receiver audio circuits.

SGC pioneered Automatic Digital Signal Processing (ADSP) more than 10 years ago. ADSP² pushes ADSP performance to the extreme performance limits of modern DSP processing technology. Internal IF-based DSP is incapable of matching the performance of ADSP² because it must devote some processor time to other

tasks. ADSP² devotes all of its time to spectral noise reduction, yielding unprecedented performance exceeding that available in top-of-the-line transceivers.

SGC has tested the ADSP² in many popular transceivers, including small portable units, and found significant improvements in noise rejection on every unit evaluated. The ADSP² board adds two levels of ADSP processing and three narrowband filters, giving the user significant flexibility in choosing the processing most appropriate to the conditions.

ADSP² is supplied ready for

installation with only a few simple connections and full instructions for various transceivers. It can be installed by the user, by a dealer, or returned to SGC for installation. Retail cost for the ADSP² board is \$180 with a \$49.95 charge for installation when done by SGC. SG-2020 owners may upgrade the ADSP² for \$120 until 30 June 2003, after which the cost will be \$180. All SG-2020 upgrades will be done at the factory.

Additional information is available at the SGC Web site at [www.sgeworld.com] or by phone at 1-800-259-7331.

New Technician Class Book Reorganizes Everything

Gordon West WB6NOA has announced his new Element 2 Technician class study guide valid from July 1, 2003, through June 30, 2007. This new book reflects all 511 Element 2 Technician class questions and answers released by the National Conference of Volunteer Examination Coordinators Question Pool Committee. Every question and answer is followed by "Gordo's" unique and upbeat description of the correct answer.

West explains that one of the most important features of this new book to better help new ham applicants study questions in a more logical progression:

"When the 4-member Question Pool Committee revised the old Technician class question pool, many of the subject areas were separated and moved out of place from a logical teaching plan. The QPC question pool jumps right into questions about privileges and radio bands, yet the applicant won't see questions on what an actual radio wave is until nearly halfway through the pool. If someone were just to study the question pool in the order of how the 511 questions appear from the QPC, they are simply memorizing how to pass the test and missing the important aspects of how that particular test question works into the real world of operating ham radio." West is well known for his teaching methods through his weekend amateur radio training classes offered throughout the country.

The new Gordon West Technician class book has completely reorganized the entire question pool for Technician class in a logical progression for learning and teaching amateur radio in both the classroom as well as home study. Chapters:

- What is ham radio? (6 Q & A's)
- What it takes to earn a Technician class license (over a dozen Q & A's)
- All about Technician class callsigns (a dozen Q & A's)
- Where you may operate your new ham radio (almost a dozen Q & A's)
- The responsibility of being a control operator (a dozen Q & A's)

- Allowing a third party to talk on your radio (almost a dozen questions)
- All those no-code privileges (a dozen questions)
- The excitement of operating repeaters (over 2 dozen Q & A's)
- More line-of-sight excitement, including space, moon, data, and radio control (a couple dozen Q & A's)
- Understanding wavelength and frequencies (a couple dozen questions)
- Procedures for going on the air, and rules (a dozen questions)
- In an emergency ... (a dozen questions)
- Going on the air with your new license (many questions)
- Technician added privileges with code (more than a dozen Q & A's)
- Understanding propagation from beacons (a couple questions)
- Basic understanding of volts, amps, resistance, and watts (lots of questions)
- Circuits within your new radio (lots of questions)
- Understanding bandwidth (a dozen questions)
- Stay away from TVI (a dozen questions)
- Low PEP works fine (less than a dozen questions)
- Understanding antennas like the dipole and beam (many questions)
- Know your SWR (less than a dozen questions)
- Putting up your mast and tower safely (a dozen questions)
- Staying safe around radio frequency energy (many questions)

The new Gordon West Technician class Element 2 class and home-study training book is available from all amateur radio dealers, and also available in single copies or in quantities at a discount for amateur radio instructors through the W5YI Group (800-669-9594).

The book is part of a series of amateur radio and commercial communication electronics books published by Master Publishing in Lincolnwood, Illinois [www.masterpublishing.com]. Master Publishing Editor Peter Trotter KB9SMG is the book editor. Gordon West, with his wife Suzy West N6GLF, were proud to take an enormous 511-question pool and rearrange it so that applicants are truly learning the material as opposed to simply memorizing questions to get through the test. 73

ADVERTISERS' INDEX

R.S.#	page	R.S.#	page	R.S.#	page	R.S.#	page	
• A & A Engineering	13	99	Communication Concepts	38	• M ²	58	• Radio Book Shop	43
• Alinco	CV2	• Communications		• Milestone Technologies	31	• Radio Book Shop	55	
• Alinco	CV3	• Electronics, Inc.	3	• Omega Sales	31	• Radio Book Shop	58	
• All Electronics Corp.	11	10	Communications	• Omega Sales	49	• Radio Book Shop	61	
16 Astron Corporation	2		Specialists, Inc.	17	• Omega Sales	55	• Radio Book Shop	63
• ATOC Amateur		13	Doppler Systems	55	• Radcomm Radio	49	• RLS	15
Distributing Corp.	CV2	• Dudley Lab	20	• Radio Book Shop	6	• Scrambling News	20	
• ATOC Amateur		• Hamvention	9	• Radio Book Shop	15	• SGC	7	
Distributing Corp	CV3	• Houston Amateur		• Radio Book Shop	20	• Universal Radio	13	
42 Bilal Company	9	• Radio Supply	9	• Radio Book Shop	25	• West Mountain Radio	15	
168 Buckmaster Publishing	31	42	Isotron	9	• Radio Book Shop	38	• Yaesu	CV4

When you buy products from these advertisers, please tell them that you saw their ads in 73.
 Subscribe to 73 right now...call 800-274-7373 (9-5 Monday-Friday EST).

Reprints
 of
73 Magazine Articles
 Only \$3.00 Each!
 Call 800-274-7373

SAVE 47%!
 on 12 months of **73**
Only \$24.97
 Call 800-274-7373

Back Issues
 of
73 Magazine
 Only \$5.00 Each!
 Call 800-274-7373

The Gordon West Study Guides

Examination Test Questions & Answers for General Class and Extra Class with explanations of the answers



General Class
 \$12.95
 Plus \$3.50 S&H

Extra Class
 \$14.95
 Plus \$3.50 S&H

Omega Sales

P.O. Box 376
 Jaffrey, NH 03452
 800-467-7237



• MFJ • Kantronics • Daiwa • Comet • ARRL • Pryme • Iron Horse Antennas •

CALL FOR DETAILS

IC-W32
Rugged, 2m/
440MHz Handheld

IC-V8000
75W, 2 meter mobile

IC-756 Pro II
160-6 meter,
100 watts

IC-706 MK II G
HF-6m-2m-70cm
Compact Multi-Band

IC-746 PRO
HF-6m-2m 32bit IF-DSP

IC-T90
6m/2m/
440 MHz HT

IC-2720H
2m/70cm Mobile

NEW (multiple instances)

3300 82nd St. #E, Lubbock, TX 79423
 Hours: 10-6 M-F 1-5 Sat Central Time
1-800-588-2426
 806-792-3669 FAX 806-785-3699
www.rad-comm.com

Iron Horse Antennas • MFJ • Kantronics • Daiwa • Comet • ARRL • Pryme •

Real Helps for Morse Code (for Free!)

Even with the relaxed requirements for Morse Code proficiency and the increased interest in digital soundcard modes, many hams are drawn to the Brasspounders Society (and that is not to be taken as BS).

The reasons are many, but the main one is that it is still a part of ham radio, plus it is a dependable method for communicating under adverse conditions, and equal to just about any mode available, even in this advanced age of technology.

This month, I have two programs that may easily interest many of you who have an interest in CW. The first is a program developed by Ed AC3L that approaches learning the code in a rather unique way. He takes you from ground zero through a series of painless hoops, and the process makes sense right from the beginning.

Some of us, who feel secure in our code proficiency, tend to hesitate when we first see a program such as the International Morse Code Trainer (IMCT) for beginner's software. My opinion was that it wasted some time getting started. I was quickly proved wrong on this, and will explain how I learned the error of my ways.

I could see I was in need of an attitude adjustment, so I had to see this program through someone else's eyes. It was not necessary to look very far to find the right person to run a short experiment for me. Janet, the other half of this household, is a confirmed nonham who is absolutely convinced she could never master the Morse Code.

So I approached her in what I felt was one of her weak moments and she consented to give this software a short test run. That was an eye-opener. She came back in about a half hour explaining how interesting the introductory explanations about the code and its uses in ham radio were to her.

This information had not appeared that engaging to me, and I had almost pushed her right past those to "get down to the meat" of the program. That showed how little I understood about the teaching process that

Ed has utilized so well in this program. This was going well.

Then she explained further how there seemed to be a need for a change in the sequence when first learning the sounds of the characters. I had her show me what she meant and it even made sense to me. I sent off a message to Ed and he set about to make that little change. No problem. He even sent a shot of the new screen format which I added to my existing image. Hence, a little fuzz crept in.

It became more apparent how much real value there is in this piece of software as I looked through the many features. There is real user interaction at every level. I think most users who seriously wish to learn the Morse Code will find this to be an enthusiasm-building process. As you learn, passing from one phase to the next, you will feel good about yourself, and gain appreciation for the utility of this excellent mode of communication.

Installation

Here is where we, as spoiled Windows users, may find a bit of a surprise. IMCT may not as a rule install on your computer as easily and painlessly as programs such as DigiPan. At least, that was the case with me, but it turned my thinking around a bit as to how out-of-date my Win98se platform was at the time.

As I recall my experience in the beginning, it just refused to install after the download. Something was amiss. I went back to the Web site [http://www.qth.com/antenna/] and did a little reading. I also communicated with the author of the software. Obviously, I was behind the times and in need of enlightenment.

Ed explained where my problems were and directed me back to his Web site, and

in the end, via links provided at Ed's site, I downloaded three vital tools from Microsoft's library that were missing from my Win98se install. They were, I believe, developments that came along after the release of my version of Win98, so I am now as up-to-the-minute as it gets. Well, this is true counting the 30 or so other updates installed along the way.

With all this in place, and I should explain that Microsoft makes the installation of these items absolutely painless, the IMCT software installed properly and performs like a million. What I am saying is, if I could struggle through the process, just about anyone can, and it is worth the effort. Not only is the IMCT package a real winner, but one day you will find that these tools will be critical for some other applications.

One final note: This should become a standard tool for clubs, or anyone in the Elmer position to assist those wishing to learn the Morse Code. There have been a lot of methods appearing over the years, and this one is about as good as it gets. It might be good to add that the program is strictly for learning at minimal speed (no high-speed practice), but once this is under a person's belt, it is not much of an effort to pass off five words per minute.

Now to the rest of the CW story

I have mentioned enough times in days past that I am one of those folks who actually enjoys the use of CW. I don't know if that is a macho ham attitude or simply what some would term masochism.

So it follows that I have always held a certain disdain for software that imitated the CW-mode. However, I am softening. Some of you will recall a recent column on CwGet (February 2003). And I am not alone. There were quite a few responses and sincere

interest in that software which, I have to agree with many, is about as good as it gets for receiving and decoding Morse Code.

It just so happens that I ran across a real contender in a piece of software for Morse Code that I was totally unaware existed. It is ET_Morse written by Patrick F6CTE. It can be downloaded from the G3VFP Web site, which you can get to by clicking on line 30 of *The Chart* on my Web site.

This is a full-featured TX-RX program with just about all the bells and whistles I could imagine to receive and transmit CW. And the good part? It really works!

You will notice in the screenshot the near-perfect copy of machine-sent text. That is one real time test. You will find that CW decoding programs will all have difficulty with hand-sent CW (electronic keyers included) because of certain variations. It seems impossible for the best of programmers to write a one-size-fits-all algorithm to decode Morse Code from every source.

However, I spent quite a bit of time tuning to different signals and some that seemed perfectly readable to my ear were totally indecipherable by the software. Then there were some which were obviously paddle-induced and the copy was so good that if the mistakes formed a character, it was printed on the screen.

I was monitoring a QSO between two obvious old hands, really good "fists," and the print was so perfect I had to listen closely to read between the lines that they were sending with paddles. I was, to say the least, impressed both by the hams' skill and the program's decoding ability.

I attempted to answer a few 100%-copy CQ calls and was not answered, so I began to wonder if I had something wrong in my settings. So I picked out a fairly wide space in between signals and called CQ and got an answer. Wouldn't you know, the returning signal was one that I had to copy by ear, while thinking about entering information in little boxes in an unfamiliar program.

At least I knew then that the software was transmitting on the same frequency as the receive frequency and the output was legible Morse Code. The lesson learned to pass on is to use caution when making contacts with any CW software. Be ready to copy the old-fashioned way when you get a reply. But it is fun to play.

Feature list

There is a very adequate Help File. As a matter of fact, there are two, one in English and one in French. Regular Windows-style layout and helpful.

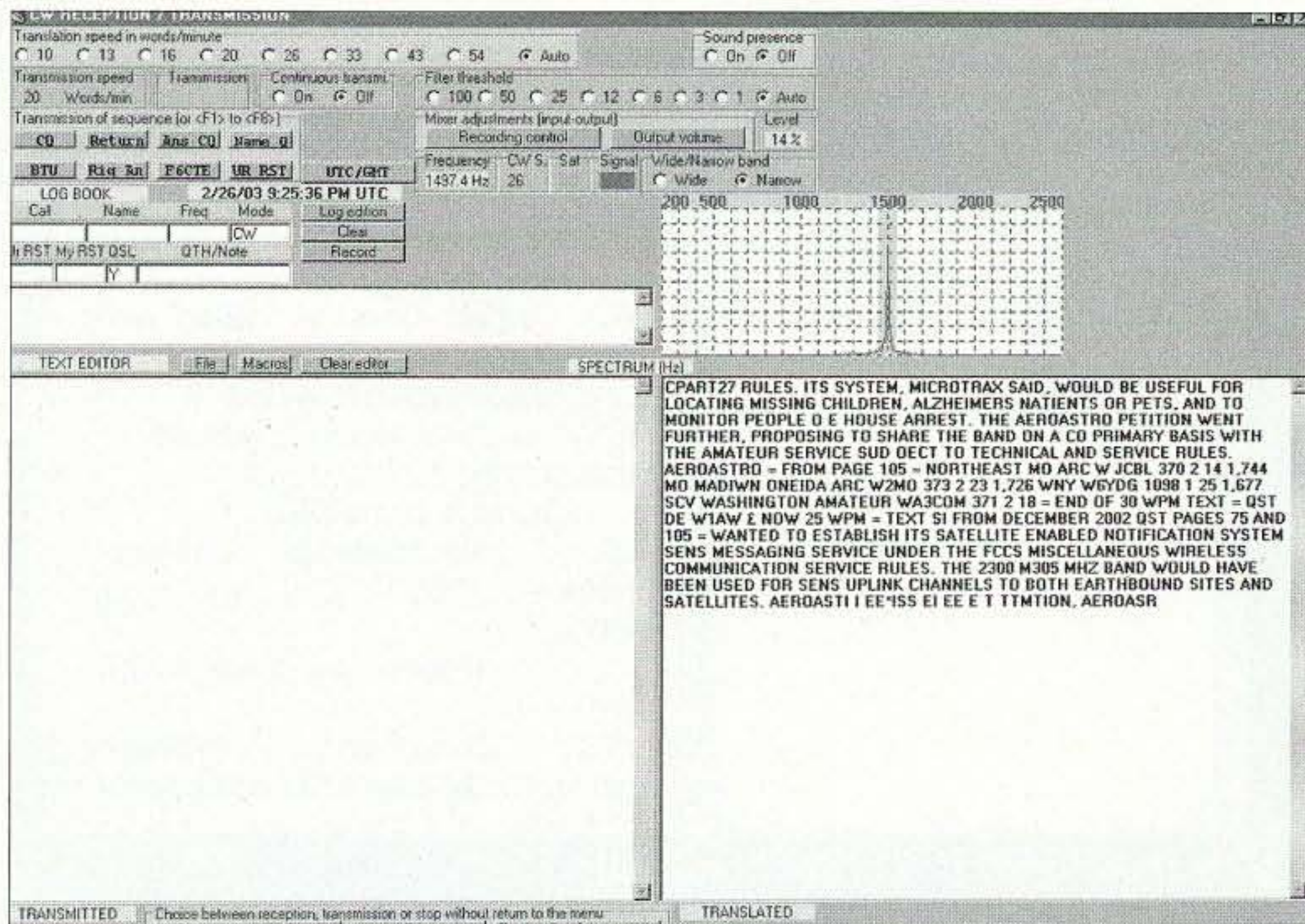

Fig. 1. ET_Morse screenshot. A first rate RX-TX CW program with just about every bell and whistle you can ask for. The text received panel is half-filled with copy from near-perfect computer generated CW transmission. I found hams sending with paddles that printed this well (see text). And I found some hams sending CW that was perfect copy "between the ears" but decoded poorly by the program. However, a lot of that happens with CW software. This one is way above average in every respect. It has macros and logging, and the grid above the receive pane is the spectral display with two choices for filtering. Clicking on a signal tunes ready for receive. A truly great work. Very usable and intuitive. PTT supported along with audio settings from the screen. And it is FREE!

Macro building is about as simple as it gets. You will find a pull-down menu in the Main screen where you can write and edit eight macros and put names on the macro buttons. There is a separate menu where you enter personal information such as your callsign and name, and the macros draw information from that file automatically. But the really nifty part I liked was that within the macro editor, there are automated buttons to insert strings such as MYCALL and HIS NAME. Click the button and it is typed in place.

One of the great features we have come to expect these days is log capability. You will find a built-in log that answers most every need for casual ragchewing, plus it goes a step further. You can not only edit and delete files in the log, but you can also export them in ADIF or text format. This means that you can transport your CW log file with a few mouse clicks from ET_Morse to your log program of choice.

Also, for some of us who complain about the wee-dinky text panel fonts, there are font size options available. I stumbled on this as I was clicking the pull-down menus on the opening screen. There is one labeled "Police." That is the one. Police? Well, I looked in my French-English dictionary and that

translates directly to "Font." See how we learn?

Really, just about everything you read on-screen within this program is in understandable English format or becomes obvious immediately. What I am saying is this is a very intuitive program. The "police" word so surprised me, I had to pass it on. That was the only mildly confusing item I recall.

Little differences

One other small item, I must bring to your attention. When you go to install the etmorse.zip file, you will unzip it, and there is no "Setup" file as we are used to using for installation. Unzip will result in 26 files that you need to put into a subdirectory you create and name. You may then either start the program by double-clicking the ET_MORSE.exe file or create a shortcut to do it for you. If you are impatient as most of us are, you will double-click the file the first few times. Anyway, the story is that the program is installed once you have the files in their own little directory, and it will run.

I noticed a small problem worth mention. And I have seen this with other software. I get so used to using the Function

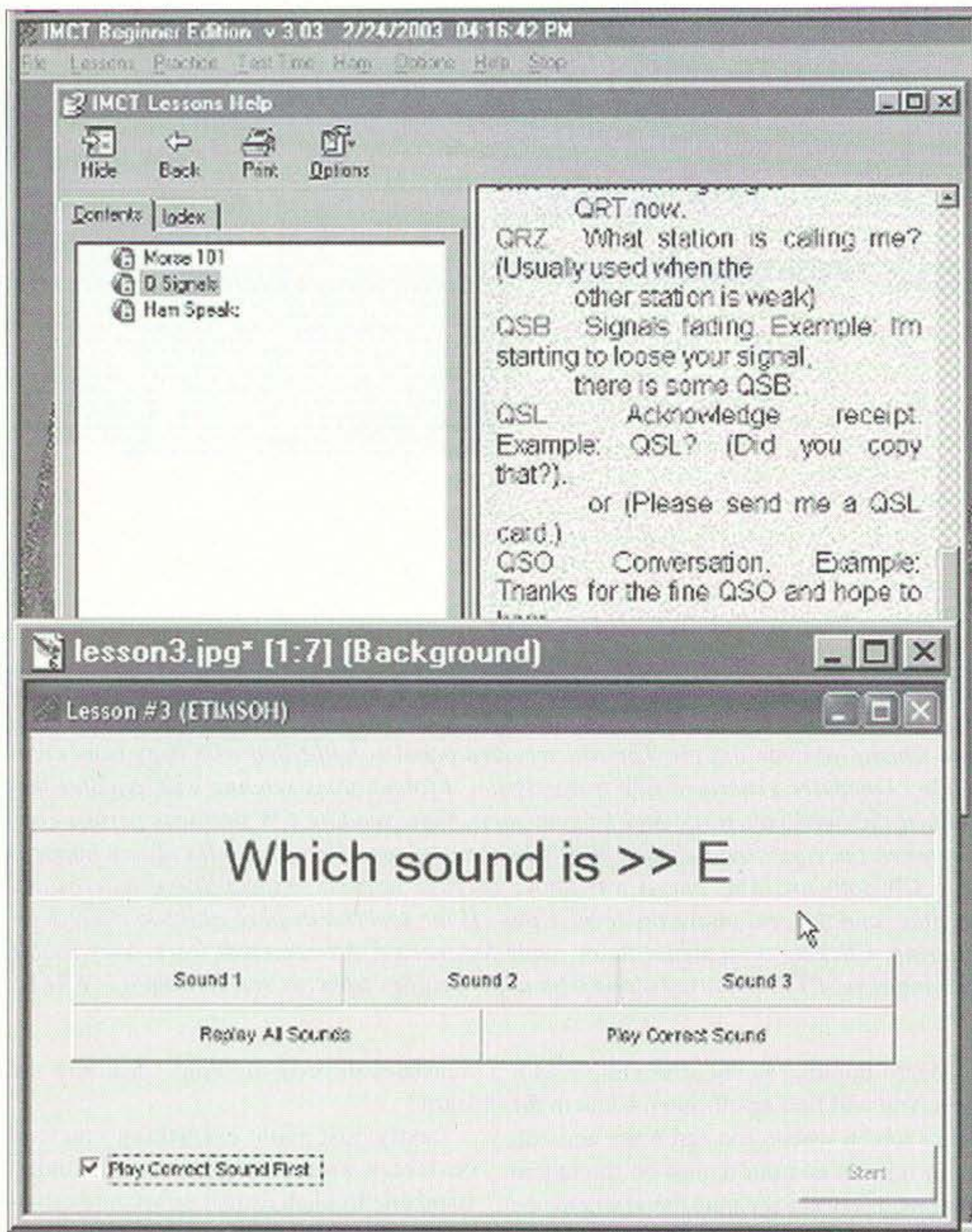

Fig. 2. IMCT screenshot. This gives just a glimpse of the depth within the Morse code training software. The shot is a composite that started just a bit clearer in the pane explaining Q-signals. This got redone when the program's author sent me a revised shot of the lower pane where he had added a requested revision (see text). The program teaches a group of character sounds at a time and interacts with the user to repeat as often as necessary or simply move on. The user advances at his own pace to a point where he is working with QSO-type messages. The student will find much information in addition to the file shown that will help him to understand how hams use the Morse code. A very effective training scheme, and it is FREE!

keys to activate macros that I take the process for granted. I found that this did not work dependably with ET_Morse. However, I have been advised in the past by some programmers that this is at least partially a Windows problem. So, not to condemn, but I advise you to use your mouse to activate macros in this software unless your particular system cooperates.

All in all, this was a very good experience as CW software goes. This is right up there with the best of them, and I definitely recommend a look-see.

Another program includes MFSK

MFSK has gotten a lot of attention lately, especially with the addition of the image capability included in the MixW2 release. For a time, it was becoming difficult to find a space to play. In the midst of all this, Sergei, the creator of TrueTTY (available from the DXSoft Web site), added the MFSK mode to TrueTTY.

I have only had a few minutes to take a short look at it, but it tunes and works very well. One noticeable plus is that the aggressive AFC in TrueTTY clamps right onto the

MFSK signal. Along with that, it seemed, sometimes, to jump off track while receiving. I think there is adjustment for AFC sensitivity, but I took an easy way and disabled AFC once copy was established, and it decoded just great. One thing to keep in mind is that the only MFSK software that will do images is MixW2. But there are now, by quick count, at least four software packages including this great mode. MFSK, in case you are not aware, has some real advantages in adverse conditions, such as multipath, high noise, and especially, pole flutter as compared to BPSK31. A little aside: I find a lot of hams are not aware that use of QPSK31 instead of BPSK31 levels the playing field in many of those instances mentioned above.

The image debacle

Suddenly, just as a lot of us were getting our acts together in the MFSK image fun, it was discovered that the country (US of A) where there is a huge interest in MFSK images has statutes that make these modes of transmission illegal where we were doing it. I won't go into the details, but after the word got out, the 14.080-14.083 image activity area went blank.

So now, before we can resume our fun and games, the FCC will have to make a ruling with either temporary or permanent changes to allow us to play. I hope it is in the form of a temporary waiver. Watching the wheels of government move on anything they consider "permanent" is worse, by far, than watching grass grow.

Perfect OS just about died

I guess I bragged a bit too much about the virtues of Win98se and, sure enough, it began to spit up hairballs recently. I think it was a product of way too many pieces of software and attendant data files with no

Continued on page 61

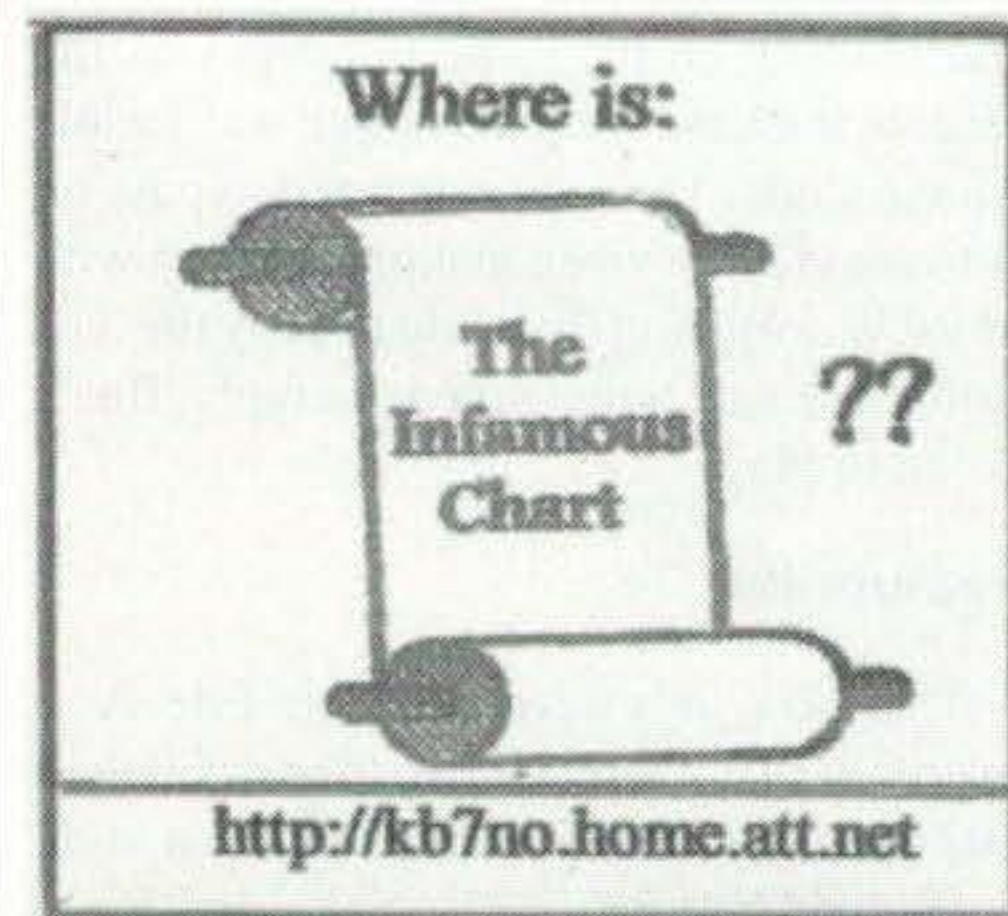

Dim Sum, Dayton, and Doppler Calibration

"We did everything wrong!" That's what one new hidden transmitter hunter wrote in an e-mail that I received two days ago. He and his friends had learned some radio direction finding (RDF) lessons from the proverbial School of Hard Knocks as they tried to locate an intruder on the OSCAR two-meter subband.

They took longer than experienced transmitter hunters might have, but their efforts were successful and they can be proud of the result.

I had corresponded with Michael Weldon KB2UMJ of Stratford, New Jersey, seven years ago when he was constructing a Doppler RDF kit. Together, we solved some problems he was having with the display unit, but he never got around to building the antenna set. "The rest of life took over, two kids, a job and honey-do's," he wrote.

"This past week I had a rekindling of my RDF spirit," Michael continued. "A good friend, Patrick Guilfooy AB2HM, told me of a 'stuck mike' he found on 145.835 MHz. The signal was S9 at my home and S9 + 30 dB at his. The really strange part is that it sounded like a Chinese restaurant! The background sounds were that of a commercial take-out kitchen.

"I got out my 'RDF bible'¹ and looked for the easiest thing I could whip up in a hurry. In about 15 minutes I had constructed a 2-meter loop out of a broomstick and 12-gauge Romex wire. I took some towels from the linen closet (my wife Colleen KB2UJW is still miffed at that), connected the loop to the receiver through a homemade switchable attenuator, and propped it up through the moonroof of my '99 Maxima. AB2HM and another friend, Rich Nicolella KC2GIB met me, we took a bearing on the carrier, and went hunting.

"What should have taken ten minutes ended up at an hour and a half. The loop gave us a 50-50 chance on the direction of the transmitter and we kept picking the wrong one.² With 40 dB of attenuation, the meter was back to S9 + 30 dB as we were on top of small bridge over a creek. A Chinese take-out restaurant was directly

opposite the bridge on the other side of the creek.

"KC2GIB and I got out and looked around for any sign of an external antenna. Not finding anything and being hungry, we went inside and ordered some food while checking out the interior. Nothing seemed to point at a ham radio station or any other radio installation. We grabbed a menu that listed the street address and left with our food.

"The three of us decided that whatever these people were doing, it wasn't in our best interest to tell them to stop. The following day, KC2GIB contacted the local FCC staff and informed them of what we had found. They went out and tracked the signal themselves a day later. The FCC later contacted Rich to tell him that the transmitter was part of an illegally imported high-power cordless phone. The restaurant had been previously warned about its use, so this time it was confiscated."

Michael concluded his letter by exclaiming, "Now I really want to finish that Doppler!" He also asked a good question about antenna switcher construction. It fits right in with the "Homing In" Doppler series, so I'll include it in a future column.

Congratulations to Michael, Pat, and Rich for your resourcefulness and for being willing to take on this challenge. Your experience points out the advantages of building and thoroughly testing your RDF gear before an urgent need for it arises. Fortunately, it's easy and fun to do that in areas where there are regular competitive transmitter hunts. Mobile RDF contests, usually called foxhunts or T-hunts, continue to gain in popularity. The "Homing In" Web site has links to over 50 local T-hunt group sites around the country, plus E-mail addresses for group contacts in almost 20 more localities.

The most recent T-hunting hot spot to be added is Sacramento, California, where the North Hills Radio Club and the River City ARC have gotten together to put on monthly hunts just for beginners. Richard Hill NU6T has accepted the task of T-Hunt Coordinator and has gotten plenty of help from experienced hunters in the nearby Bay area, who are acting as Elmers.

Great Hamfest Hunts

If you don't have transmitter hunts in your hometown yet, or even if you do, you'll want to take part in the ones at hamfests and conventions you attend. They range from simple to very difficult and could be mobile, on foot, or both.

World-class mobile T-hunting is a tradition at the annual Orlando Hamfest, and it has become a tradition for "Homing In" to receive a report on it, with photos, from John Munsey KB3GK of Ormond Beach, Florida. He and Bill Thomas KE4HIX from Daytona Beach made up one of the seven teams that signed up for the Orlando hunt on February 9, 2003. They were destined for a very interesting afternoon, trying to find three foxes deployed by Pat Eckenrode AC4QM and Arthur Byrnes KA4WDK.

Pat and Arthur were winners in 2002. Their professed goal for this year was to stump the renowned KB3GK/KE4HIX team, and all the others in the process. They enlisted help from Howard Hersholt KC4ZYC and the trio decided that each of them would plan and hide one difficult fox, with no coordination before the hunt. All transmitters were on different frequencies the hunters were required to find them in order. Transmissions were approximately one minute with two minutes off.

"Fox #1 was in an older community next

to a large lake," John wrote. "The streets do not run in any orderly pattern and many, if not most, go to dead ends. Even KC4ZYC got lost trying to find his spot on hunt day. Using both a mobile transceiver and an HT, Howard varied power from 50 watts to just a few milliwatts. Between transmissions, he changed antennas from beams to rubber duckies and varied his frequency as much as 12.5 kHz on either side of the announced spot. It all proved useless, as we bagged this one in about twenty minutes, no more than five minutes over driving time. One other team found this one, Jeff Mathews KG4DHZ and Fred Villers K8FV. Jim Korenz N8PXW got to a block away but could not navigate into the dead end street where it was located.

"KA4WDK hid fox #2 next to another lake," KB3GK continued. "This was a 5-watt rig into a dipole mounted twenty inches off the ground with the ends pointed in the direction that the hunters had to come from." Lakes and rivers sometimes act like RF conduits, leading RDF teams to make mistakes in determining from which bank the signal is coming. When John and Bill got to the lake, they decided to split, one going on each side. That was a good strategy, because Bill picked the right direction and spotted the fox in just a few minutes. No other team found this one.

AC4QM's fox #3 was a simplex repeater, listening on the hunt frequency and re-transmitting the audio it heard every few seconds. Pat put it on the northeast side of a very large park, several hundred feet into a very thick wooded area. Armed with their Australian-made portable two-element

HB9CV-type antennas (**Photo A**), Bill and John beat the bushes and uncovered this one — the only team to do so. They also give credit to their new "Sniffer 4" receivers.³

Next stop for everyone was a local Steak and Ale for the traditional after-hunt party, where John and Bill were awarded the hunt prize, a new handie-talkie (**Photo B**). How will you split that, gents? Now it's time for them to start planning how they will hide this hamfest hunt in 2004.

What About Dayton?

"A mobile hunt at the Dayton Hamvention wouldn't be well attended because so many of the attendees don't have vehicles," says Dick Arnett WB4SUV. "They fly in and get around on the shuttle buses. We had a successful on-foot hunt at a nearby schoolground for a few years,⁴ but we don't have access to that property any more and there's no other suitable area close by."

Nevertheless, there will be plenty of opportunities to meet other T-hunters and learn about the sport at this year's Hamvention, May 16-18. Once again, WB4SUV will team up with Bob Frey WA6EZV to put on a two-hour Foxhunt Forum that will cover many aspects of RDF contesting, including equipment and techniques.

Bob and Dick will be the main forum speakers this year, because they have much to tell about the Third USA ARDF Championships. They are co-chairs of the organizing committee for this event, which takes place in nearby Cincinnati from July 30 through August 3. Terry Hudson KT9V will talk about his adventures in tracking radio-collared bobcats for

the Indiana Department of Natural Resources.⁵ Mobile transmitter hunting will also be covered.

"Usually we have had our Foxhunt Forum on Saturday beginning about 10 a.m., says Dick. "This year they have us scheduled for Friday morning, a much less desirable time. I have sent messages requesting a change to Saturday morning, and I'm still hopeful." Dick will keep me informed on progress, and I'll post updates on this Foxhunt Forum time in the "Homing In" Web site.

According to WB4SUV, "We had a full house last year, about 130 people, and they were there from the moment we started right up to the end. I sure hope we can repeat this year. But if folks can't get to the forum, they can stop by the OH-KY-IN Radio Club booth at the flea market and we'll give them the handouts and information about upcoming events."

Calibrating Your Doppler

This year marks the 200th anniversary of the birth of Austrian physicist Christian Doppler. "Homing In" is celebrating with a multipart series on Doppler RDF sets, which utilize Christian's discovery that the perceived frequencies of waves undergo changes when source and receiver are in relative motion. There's just enough column space left this month for a few paragraphs on calibration of Doppler sets.

In the first two installments, you learned how the simulated movement of a vertical or dipole antenna in a circular track at hundreds of revolutions per second induces a narrowband FM tone into the received



Photo A. Ready to track down any and all two-meter fox transmitters are Bill Thomas KE4HIX (left) and John Munsey KB3GK. (Photo by Anne Marie Elais)



Photo B. KE4HIX and KB3GK receive their Orlando Hamfest T-hunt prize from David Flagg N4BGH of the Orlando Amateur Radio Club. (Photo by Anne Marie Elais)

audio. The phase of this tone is a function of the azimuth of the incoming signal. A Doppler RDF set has a circuit to detect the phase of this sine wave, usually by determining the timing of its zero-crossings. A calibration function in hardware or software establishes which zero-crossing times correspond to straight ahead, left, right, behind, and so forth.

Before you take your new Doppler set out on a hidden transmitter hunt, you'll need to set the calibration. You should also verify that display indications are correct for signals from all directions, proving that the antenna control lines are wired correctly. Re-calibration should be done each time you change receivers, vehicles, or ham bands, but it is not required when you QSY within a band.

The intuitive way to check calibration would be to take a quick walk around the vehicle with a transmitting hand-held, watching the LED display to see if it follows along. But this is not a reliable method. A perfectly good antenna system is likely to give bad results, for two reasons. First, the display electronics and switcher diode currents may be upset by the intense RF field from the HT.

Second, a Doppler array is designed to work with a "planar" wavefront in the "far field," to use some terms that \$100-an-hour antenna engineers like to toss around. Put more simply, the wavefront coming off your HT's "duddy" is a circle that expands outward. It's just like the ring of ripples you get when you toss a rock into a still pond. When the transmitter is very close to the receiver (in the "near field"), the part of the wavefront that strikes the receiving antenna has a lot of curvature to it. When it is many wavelengths away ("far field"), the wave-front circle has become so big that the segment reaching the receiver has very little curvature and appears to be planar.

Another factor to consider is that Doppler accuracy can be degraded by proximity to anything that disrupts the planar characteristic of the incoming wavefront. Other communications antennas on your car may "pull" the Doppler indication in their direction. The effect is most detrimental when whips are in front of the Doppler array, or when you have a rotatable beam mounted on the car.

For the most accurate calibration, you need a steady signal that's in a known direction, as you travel on a street to average the local multipath effects. Some hams have a friend drive in front of them at the same speed, a couple of blocks ahead. That works, but it's not convenient for frequent or prolonged testing.

The "standard course" that I use here in Fullerton is a city street that runs radially from a two-meter repeater at an aerospace facility. While the repeater is active, I tune to the output and drive directly toward it on a half-mile section of this street that is about 2 miles away. To verify indication of other directions, I drive circles in an open parking lot next to this street.

The repeater is mostly line-of-sight from this test course, but there are urban features to provide some signal bounces (multipath). I can readily compare multipath performance between antenna systems and display models. I can also make checks before T-hunts to make sure that the calibration is still good and that the antenna system is working properly. One day I observed that the display did not track the repeater as usual. It just bounced around in one quadrant of the display, no matter which way the car was traveling. I checked the DC whip voltages and noticed that one was different from the others. Sure enough, a resistor lead in one antenna base was poorly soldered (oops!) and had lost contact, keeping the two PIN diodes in series with that whip from conducting.

If the Doppler under test has serial bearing output that can be

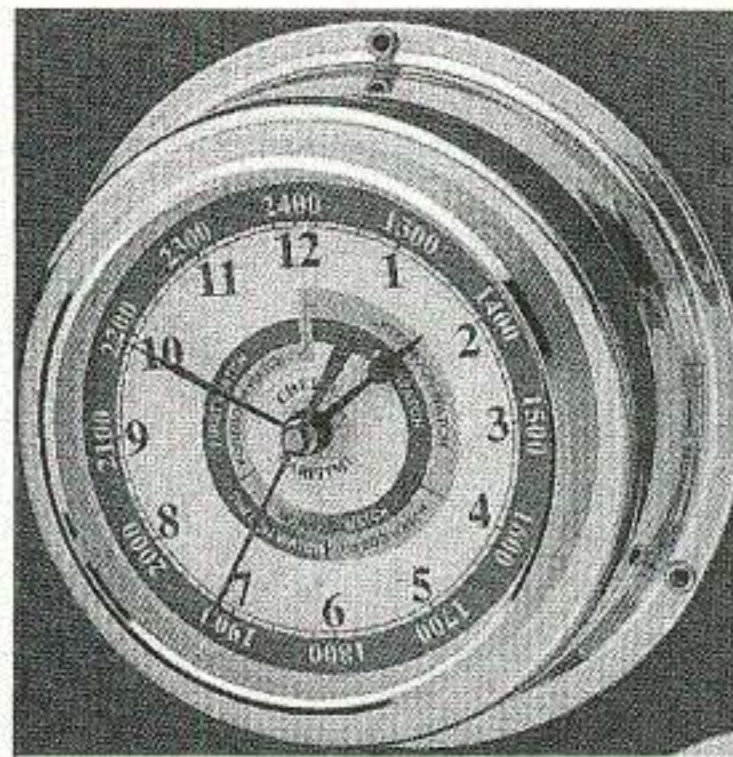

Chelsea Clock

Clockmakers since 1897
The choice of The Coast
Guard Foundation.

Quartz Clock

4" Dial

Beautifully hand-polished.

Stamped brass case and bezel.

Curved glass crystal.

Wall or bulkhead mounting.

Made so well they last from generation to generation!

Order this month and save \$20!

Your price \$75

Omega Sales

P.O. Box 376

Jaffrey NH 03452

1-800-467-7237

If you're a No-Code Tech, and you're having fun operating, tell us about it! Other No-Code Techs will enjoy reading about your adventures in ham radio—and we'll pay you for your articles. Yes, lots of nice clear photos, please. Call Joyce Sawtelle at 800-274-7373 to get a copy of "How to Write for 73 Magazine."

TRANSMITTER LOCATION

New fixed site direction finders provide 2 degree accuracy, and include software for triangulation from a central control site. Mobile versions also available covering 50MHz to 1 GHz

Doppler Systems Inc.

PO Box 2780 Carefree, AZ 85377
Tel: (480) 488-9755 Fax: (480) 488-1295
www.dopsys.com

European Marketing Director Denis Egan
PO Box 2, Seaton, Devon EX12 2YS England
Tel & Fax: 44 1297 62 56 90



Continued on page 61

CALENDAR EVENTS

Listings are free of charge as space permits. Please send us your Calendar Event two months in advance of the issue you want it to appear in. For example, if you want it to appear in the August issue, we should receive it by May 31. Provide a clear, concise summary of the essential details about your Calendar Event.

MAY 3

CADILLAC, MI The Wexaukee ARC will hold their Annual Amateur Radio and Computer Swap Meet on Saturday, May 3rd, from 8 a.m. to 1 p.m. at the Cadillac Jr. High School in Cadillac MI. VE exams at 10:30 a.m. You must pre-register for testing starting at 8:30 a.m. Limit 50. Free parking. Admission is \$5. 8 ft. tables are \$8 each. For tables, call Brian Polk KC8TXT at 231-743-6860, or E-mail [bandb@netonecom.net]. For general info please write to Wexaukee ARC, P.O. Box 163, Cadillac MI 49601. Talk-in on 146.98 rptr.

MAY 3, 4

ABILENE, TX The Key City ARC will sponsor the ARRL West Texas Section Convention and its 18th annual Hamfest at the Abilene Civic Center, 1100 N 6th St., from 8 a.m. to 5 p.m. Saturday, and from 9 a.m. to 2 p.m. Sunday. Free parking. VE exams. Wheelchair access. Limited RV parking for a nominal fee. Tables \$7 each. Pre-registration \$7, must be received by April 29th; \$8 at the door. Talk-in on 146.160/.760. For reservations and info, contact Peg Richard KA4UPA, 1442 Lakeside Dr., Abilene TX 79602; phone 915-672-8889. E-mail to [ka4upa@arrl.net].

MAY 10

FREDERICKSBURG, PA The Appalachian Amateur Radio Group Inc. will hold their AARG Hamfest at Fredericksburg Fireman's Park, located on Route 343, 1.3 miles south of Route 22, north of Lebanon. Talk-in on the AA3RG rptr. 146.640(-600). Admission is \$5 for sellers and buyers. Anyone under the age of 16 will be admitted free. Breakfast and lunch will be available. Setup for sellers is at 6 a.m. Special arrangements to set up Friday evening can be arranged in advance by contacting AARG. Anyone arriving between 10 p.m. Friday and 6 a.m. Saturday will not be allowed in the tailgate/pavilion area. Overnight security will be provided. Buyers admitted at 8 a.m. on Saturday. 10' x 10' tailgate space \$5, plus admission fee. 8' tables in the pavilion are \$15 each, plus admission. Electric available. Additional info is available on the AARG Web site at [www.aa3rg.org]. E-mail to [info@aa3rg.org], or call Dick Wise K3MIK at 717-534-2945, or Neil Shatto N3JQM at 717-469-7357. No electronic equipment is allowed to be left as trash — please take these items with you.

RENO, NV The Reno Area Metro Simplex ARC will sponsor the Reno Spring Ham Swap 2003 at the Salvation Army Headquarters, 1931 Sutro St., Reno, 7 a.m. to 1 p.m. Talk-in at 147.060(+123) on the RAMS rptr. system. Ham swappers bring your own table. Large outdoor parking lot available. A raffle, coffee, doughnuts, VE session and other activities are being planned. A map can be found at [http://www.cvrcc.net/images/SACenterMap.gif]. Contact Gary Grant K7VY by E-mail at [k7vy@netzero.net]. For info about the VE exams, E-mail Don Freeman W7FD at [donald_freeman@sbcglobal.net], or call 775-851-1176. Exams start at 11 a.m.

MAY 18

CAMBRIDGE, MA The FLEA at MIT, sponsored by the MIT Radio Society and the Harvard Wireless Club, will be held in the Albany Street Garage at Albany and Main Streets in Cambridge, from 9 a.m. to 2 p.m. Sellers setup at 7 a.m. Covered space is available for all sellers in the event of rain. Talk-in on 145.23(-) PL 88.5 and 449.725/444.725 PL 114.8. For more details contact Nick KA1MQX at 617-253-3776, 9 to 5 M-F, or visit the Web site at [http://web.mit.edu/w1mx/www/swapfest.html]. This event is also being held on the following dates: June 15th, July 20th, August 17th, Sept. 21st and Oct. 19th.

MAY 24

WINTERVILLE, NC The East Carolina Antique Radio Club Annual Swapfest will be held 8 a.m. to 3 p.m. at Kiwanis Club, 177 Forelines Rd., Winterville NC 28590. Free admission. Inside tables \$15, outside tailgate \$10, bring your own table/chairs. Setup will begin at 7 a.m. Drinks and hot dogs will be available. Contact Herman Schnur K4CTG, 3205 Brick Kiln Rd., Greenville NC 27858; phone 252-752-2264. E-mail [hschnur@cox.net]. Or contact William Engstrom, 218 Bent Creek Dr., Greenville NC 27834; phone 252-355-8732. E-mail [Wengstrom@vol.com].

GREENVILLE, NC Annual Swapfest 8:00 a.m. to 3:00 p.m. Sponsor: ECARC, Kiwanis Club, 177 Forelines Rod, Winterville, NC 28590. Admission: free. Inside tables: \$15.00; outside tailgate: \$10.00. Contact: Herman Schnur K4CTG, 3205 Brick Kiln Road, Greenville, NC 27858; phone: 252-752-2264; E-mail: [hschnur@cox.net].

MAY 25

WEST FRIENDSHIP MD The MFMA Hamfest will be held on May 25 from 8 a.m. to 2:20 p.m. Sponsor: Maryland FM Association. Location: Howard Co. Fairgrounds, I-70 to Rte. 32, south to Rte. 144, turn right, go west on Rte. 144 approx. one mile to fairgrounds. TI: 146.76, 224.76, 444.00. Donation: \$5. Tables in adv., \$25; door, \$30; tailgate \$5 (per space). Reservations: MFMA, P.O. Box 351, Hanover MD 21076. Phone: 301-641-5313 from 6 p.m. to 10 p.m.

MAY 31

WASHINGTON TOWNSHIP, NJ The Bergen ARA will sponsor its Annual Spring Hamfest on Saturday, May 31st, at the Westwood Regional Jr./Sr. High School, 701 Ridgewood Rd., Washington Township NJ. The location is approximately 15 minutes from the GW Bridge and 5 minutes from Paramus NJ. Talk-in on 146.19/.79. Vendors setup at 6 a.m. General admission 8 a.m. to 2 p.m. VE exams 8 a.m. to 10 a.m. only. DXCC card checking. Indoor and outdoor spaces are available. Lots of parking for tailgating. Admission is a \$5 donation (non-ham family members free). Vendors \$15 per space. Rest room facilities and refreshments available. For more info check the BARA Web site at [www.bara.org], or contact Jim Joyce K2ZO at [K2ZO@arrl.net], or call 201-664-6725.

SPRINGFIELD, IL The Sangamon Valley Radio Club's annual Hamfest will be held May 31st at the Illinois State Fairgrounds Cooperative Extension Bldg. in Springfield IL. Directions: Interstate I-55 to exit 100B, go west on Sangamon Ave. 3 miles to the fairgrounds. Watch for signs. Enter Gate 11 at 8th St., off Sangamon Ave. GPS coordinates: Lat N 39 50.16364 Lon W 89 38.73376. Talk-in on 146.685(-). The flea market pavilion opens at 6 a.m., commercial exhibits open at 8 a.m. Tickets \$5 each. No additional charge for flea market space. Bring your own tables. Commercial dealers, contact us for information about Friday indoor setup. VE exams, no pre-registration necessary. Testing begins at 9 a.m., last registration is at 10 a.m. Those wishing to take exams need \$12 testing fee, photocopy of license (if you are upgrading), Social Security number, two IDs, one of which must be a photo ID, and any applicable CSCE.

Contact Ed Gaffney, 13997 Frazee Rd., Box 14A, Divernon IL 62530. Call 217-628-3697, or E-mail [egaffney@family-net.net].

JUNE 7

BANGOR, ME Bangor Hamfest at Hermon High School, Hermon, Me. Time: 8 a.m. to 1 p.m. Admission, \$5.00. Tailgaters, \$5.00. Directions: Interstate 95 to Exit 44 North to Rte #2, left on Rte #2 West for 1-1/2 miles to High School. From Newport, East on Rte #2 to Hermon Corner, then 1/2 mile east on Rte #2 to High School. Talk-in Freq. 146.34/94. Simplex 146.52. Grand Prize drawing At NOON. Must be present to win. Programs: ATV, APRS, ARES/RACES DEMO, TRAFFIC HANDLING, PSK 31, VINTAGE RADIO, ECHO LINK, FOX HUNT, GEOCACHING. Club Web site: [www.n1me.com]. Contact Person: Roger W. Dole, 207-848-3846; E-mail: [rdole@hermon.net].

WINSTON-SALEM, NC Set up Fri. night or 6 a.m. Sat.; gates open 6 a.m. to 1 p.m. Sponsor: Forsyth Amateur Radio Club. Dixie Classic Fairgrounds; I-40 to US52 to Akron Dr. follow signs to fairgrounds, enter Gate 5 off Deacon Blvd. Fleamarket, tailgating, VE Session. Camping hookups available for Friday night. Talk-In: 146.64 (145.47 B/U). Admission: \$5.00; tables: \$15.00. Raymond Taber KG4NTC, 336-786-8241 or 336-723-7388. E-mail for info: [kg4ntc@yahoo.com]. General info: [http://www.w4nc.com].

JUNE 14

MIDLAND, MI The Midland Amateur Radio Club (M.A.R.C.) will sponsor its 26th annual Hamfest on Saturday June 14, 2003, from 8:00 a.m. until 1:00 p.m. at the Midland County Fairgrounds. Admission is \$4.00 per person, advanced table reservations are available for \$6.00 per 8 foot section, and trunk sale space for \$5.00 per space plus admission. FCC exams will be administered, food will be available. (Friday night camping is available on the fairgrounds.) Location: Gerstacker Fair Center on the Midland County Fairgrounds. Use Entrance off Airport Road. For further information and table reservations: M.A.R.C. Hamfest, P.O. Box 1049, Midland MI 48641-1049, or Bill AB8JF, 989-835-5562; E-mail: [ab8jf@arrl.net]. Also: Lee KC8ITI, 989-652-6213.

MONUMENT, CO Pikes Peak Amateur Association Swapfest will be held on June 14, 2003, at the Lewis-Palmer High School, 1300 Higby Road, Monument, Colorado (just east of I-25 between exits 158 and 161). Prizes include Yaesu FT-817, Yaesu 8900R, Yaesu VX-1R. Forums, VE session, junk auction. Admission is \$5.00. Contact Dennis N0ABC, n0abc@arrl.net. Additional information: Kate Muniz, kcegi@aol.com. Doors open 8:00 a.m. (0600 for sellers).

JUNE 21

PISCATAWAY, NJ W2QW, the Raritan Valley Radio Club, will hold "Hamfest 2003" at Piscataway NJ High School (NEW LOCATION), near intersection of Old New Brunswick and Behmer Roads. Sellers 6:00 a.m., Buyers 7:00 a.m. - 2:00 p.m. Admission: Buyers \$5.00, Sellers \$5.00 (\$5.00 each additional space). Talk-in 146.625(r), 447.250(r), tone 141.3, 146.520(s). Contact person: Marty Ficke KD2QK@aol.com, 725-968-6911, or Fred Werner KB2HZO, 732-968-7789 before 8 p.m. Raritan Valley Radio Club W2QW Web site: [www.w2qw.org].

JULY 26

CINCINNATI, OH West Side - Saturday, July 26, 2002, Flea market 6 a.m. - 1 p.m. Air-conditioned inside vendor area 8 a.m. - 1 p.m. Sponsor: OH KY IN Amateur Radio Society. Location: Diamond Oaks Career Development Campus, 6375 Harrison Avenue, Cincinnati, OH (handicapped accessible). This large facility is located just east of I-275 and I-74. Take I-74 to the Rybolt Road/Harrison Avenue Exit (Exit #11). Go east on Harrison Avenue. Diamond Oaks is located on the right (south side) of Harrison Avenue, less than one mile from the I-74 exit. Special seminars, transmitter hunts, indoor vendors, large outdoor flea market, door prizes, VE exams (8 a.m., walk-ins accepted), refreshments, free parking, handicapped parking available. ARRL-approved! Talk-in: 146.670(-) repeater. Admission: Adv. \$5, gate \$6., age 12 and under free. Indoor vendor tables (6 ft. with free electricity) \$10 ea. Outdoor flea market, \$1 per space. Contact Lynn Ernst WD8JAW, 10650 Aspen Place, Union KY 41091-7665; 859-657-6161, E-mail [wd8jaw@arrl.net]. Web: [www.ohkyin.org].

AUG 2

ALFARATA, PA Juniata Valley ARC Hamfest, 6:30 a.m. General admission, 8:00 a.m. Morning and noon food items available. Admission \$2.00 donation, XYL and children free. Tailgating \$5.00 donation, includes admission. Indoor tables, \$10.00 donation per table. Space is limited. Vendors responsible to collect PA sales tax. Electricity, \$2.00 additional. Please bring your own power cords. Directions: The Decatur Fire Co. is located along US Route 522 North, 8 miles east of Lewistown, PA in the town of Alfarata, PA. Look for signs. Talk-in on 146.910 MHz. For more info, contact JVARC, PO Box 73 Yeagertown PA 17099, or contact Cliff Bell WB3IVX, 717-248-2616.

SEP 25-28

SEATTLE WA Microwave Update 2003 organizers and the Pacific Northwest VHF Society are joining forces to host a joint conference in the Seattle WA area on September 25-28, 2003. Registrations for the joint conference will be accepted beginning

April 1st. Cost of the registration will be \$40 prior to September 12th, and covers all three days. Single day or single event registrations are not available. Late registrations, including at the door, will be \$50. Registration forms can be downloaded at [www.microwaveupdate.org] or send an SASE to John Price N7MWV, 12026 81st Ave. NE, Kirkland WA 98034, and a form will be mailed to you. Completed registration forms and payment should be sent to the same address. Make checks payable to Microwave Update 2003. Joint conference sessions and the Saturday evening banquet will be held at the Everett Holiday Inn and Conference Center, a short drive north of downtown Seattle. Special rates have been arranged with the hotel for conference participants. Rooms are \$69 per night plus tax, a real bargain for the Seattle area! It is suggested that early reservations be made directly with the hotel at 425-337-2900. Be sure to mention "Microwave Update" to get this rate. Reservations must be made by August 21st for this rate.

"White papers" are currently being solicited from potential authors and speakers for publication in the 2003 conference proceedings. Topics specifically of interest to Microwave Update attendees, as well as those on VHF and UHF subjects usually associated with the annual Pacific Northwest VHF Conference are being solicited. Papers will be accepted until July 1st, 2003, to allow enough time for printing. White papers should be sent directly to Jim Christiansen K7ND, via E-mail at [k7nd@att.net]. MS Word format is preferred. Microwave Update 2003 and the Pacific Northwest VHF Society respectively, will be the sole judges of whether presentation requests and white papers are accepted.

If you are interested in making a session presentation at one of the Microwave Update 2003 sessions, please respond to NU7Z [nu7z@aol.com]. For presentations at the Pacific Northwest VHF Conference sessions, contact N7CFO at [n7cfo@ix.netcom.com]. LCD projection equipment will be available for those using PowerPoint presentations. Slides and video presentations can be accommodated with advance notice.

SPECIAL EVENTS, ETC.

MAY 2-4

MARTHA'S VINEYARD, MA The Fall River ARC will be having its 10th Annual Martha's Vineyard Gay Head Lighthouse DXpedition (IOTA NA-046) starting 14:00 UTC May 2nd and ending 17:00 UTC May 4th. Listen for W1ACT on 14.260, 21.260, 28.460 and 146.550. SASE for a QSL card via Roland Daignault N1JOY, 19 Davis Rd., Westport MA 02790. He can be reached by E-mail at [n1joy@arrl.net].

Continued on page 58

CALENDAR EVENTS

continued from page 57

MAY 10, 11

KANSAS The Kurt N. Sterba Strange Antenna Challenge will start Saturday, May 10th at 10 a.m. Central (15:00 UTC) and end Sunday, May 11th at 7 p.m. Central (01:00 UTC). Main freq: 28.500± 20 kHz as per the QST listing. For more info check the Web at [<http://www.leafwerks.net/nOew/StrangeAntennas/kOs.html>]. What are strange antennas? Metal folding chairs, ladders, painting easels ... anything except wires or pipes.

MAY 24-26

FORT WAYNE IN Memorial Day Special Event. HF bands. We will try to list the frequencies with Midcars 7258. The Veterans National Memorial Shrine (VNMS) of Fort Wayne, 21220 O'Day Road, Fort Wayne IN 46818. Sponsored by the Fort Wayne Radio Club and other volunteer amateurs. For info, contact Robert Hilton N9SJV, 5809 Heatherview, Ft. Wayne IN 46818. 73

73 Ad Sales

Call
1-800-677-8838

M²

**EXTRA, EXTRA!
M2 BUILDS
TRIBANDER**

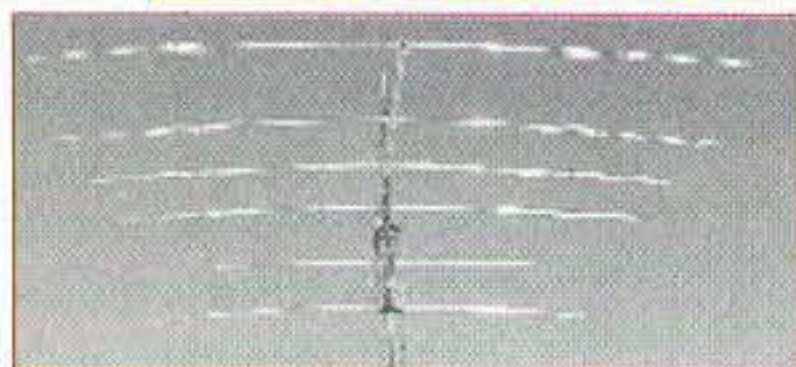

The tried and true KT34 series antennas have been made better using the latest computer modeling and mechanical design techniques to provide you with the best tribander performer available today. Just take a look!

**INCREASED FRONT TO BACK
INCREASED GAIN
MECHANICALLY SUPERIOR
ELECTRICALLY SUPERIOR
LOWER WIND LOAD THAN COMPETITORS
LESS WEIGHT THAN COMPETITORS
RATED AT 100 MPH WIND SURVIVAL
AND OF COURSE, NO POP RIVETS**

Contact us for our new catalog of
ALL the goodies!!
Can't wait? Visit our Website
@m2inc.com



4402 N. Selland, Fresno, CA 93722
559-432-8873 Fax 559-432-3059
E-Mail: wyatt@m2inc.com
Website: www.m2inc.com



How to Avoid a Disaster Disaster

continued from page 22

swap. What I've seen most often for maintenance is that people will hang on to a part (like a transmit module or the controller) after it's been exchanged for an upgrade. Don't get rid of the old parts!

The lesson here is to stay focused on what it is that you're actually trying to accomplish. When it comes right down to it, the people you're trying to help in a disaster area would probably think more favorably of extra bandages than counting knobs on your ultra-deluxe chrome-plated gadgets. 73

Ready, Set ... Don't Go?

continued from page 23

arise, I decided to attend an orientation course. I attended to satisfy my curiosity and to prepare myself for volunteering at some future date should it become necessary. I would be just as happy to remain sitting in my operator's chair, working DX and building QRP rigs, and not ever having to be called into service as a volunteer. But that would be in the "perfect world."

The orientation course I attended was hosted by the American Red Cross of Greater New York, Sullivan County Chapter, which is located about 90 miles north of New York City. Arrangements for attending had been made prior to the scheduled date to ensure that all those who wished to volunteer were aware of the location, date, and time. About three hours of your time will be required to complete the course. During that time you will be asked to complete paperwork, watch videos about Red Cross history and goals, and participate in programs and training available to all volunteers. Refreshments were provided during the orientation, and every effort was afforded to have you feel comfortable and needed.

It's a non-pressure meeting. By that I mean that you don't have to volunteer if you really don't want to. Of course, the volunteers presenting the course would like for you to become their newest volunteer, but the commitment is *entirely up to you*.

They will explain their role in the volunteer scheme of things, the courses offered to volunteers covering a variety of subjects, and a host of other subjects. It's a good thing they provided me with a package of literature describing all of that which is offered — it was too much to be remembered!

For those who decide to begin their volunteer activity, a temporary non-photo ID form is completed and shipped off to other volunteers who process your paperwork. Receipt of the ID is dependent upon the volunteers' workload. Mine was in the mail in about a month from attending the seminar. This temporary ID will be replaced with a photo ID once the initial trial period is complete.

Training

Training is provided on a request basis. That is, you "request" that you attend training from a schedule of subjects. Your Office of Affiliation will then help your request be accomplished. Classes are scheduled to provide the most benefit to all members and to meet the needs of the organization.

There you have it! I'm not an aficionado of any one volunteer organization. I find that they all provide an invaluable service in times of need, and each has its share of benefits and quirks. I attended the Red Cross orientation course because it is the most visible organization of this nature in my area.

The American Red Cross can be contacted by telephone; their number is listed in the white pages of most telephone directories. The number for the Greater New York chapter is 212-787-1000. I'm sure they can provide you with other numbers applicable to your location.

You never know when Mother Nature will "do it to you" in your area, or those other folks will again try to impress us with their beliefs. Give some thought to becoming a registered volunteer. Explore those agencies in your area that you often pass on your way to work, but haven't yet visited to find out just what they're all about.

You may be glad you did! 73

Ham vs. Power Outage

continued from page 33

I've read that even after a good cleaning there is still the chance of having some contaminants in the jugs.)

I didn't try powering our refrigerator with the inverter. It was cold enough outside that we could store all the food in baskets in the garage.

The car engine has to be started and run at idle for approximately 20 minutes every 5 to 6 hours to recharge the battery. This is something you must do. The inverter instructions say not to start a car engine with the inverter running. I suspect that a voltage spike from the starter motor could do permanent damage to the electronics in the inverter. To be safe, I removed the connector from the battery so the inverter was disconnected when I started the car engine. I don't know if simply shutting off the inverter at its switch would keep the spikes out of the inverter, but I didn't want to find out during the ice storm

Memories of the ice storm

Memories of all that happens during an event like this tend to fade. Even so, I'll never forget seeing the flashes of light reflected from the clouds. It's hard to explain the feeling of isolation you get when you're in the garage running the car engine to recharge the battery at 3 in the morning. But, I saw our neighbor refueling his generator at the same time one morning. The feeling of isolation was especially bad when I could see the next neighborhood over all lit up — they had power and we didn't — and they're only a block away. But, we did have heat!

If you don't feel comfortable working with the power wiring going to your furnace you should call an electrician to make the needed modifications. The rest you can do yourself.

If you build this system, please write me and let me know how it works for you. I had fun building it and a real sense of accomplishment when I had to use it in a real emergency. Many thanks to my wife Yvonne for proofreading this article and noticing the source of clean water from our roof. 73

The History of Ham Radio

continued from page 40

debates before reaching compromises, recognized the need for extension of broadcast into the higher frequencies, but did not want to encroach upon the major bands used by the amateurs. The extensive progress continuously made by amateur and experimental "wireless" was clearly exemplified in the assignments made to the frequency bands for amateur use. 73

HAMSATS

continued from page 46

Journal always has the latest updates on current and future projects, in addition to construction articles and details on new hamsats from around the world. AMSAT can be contacted by mail at AMSAT-NA, 850 Sligo Avenue, Suite 600, Silver Spring MD 20910-4703. The phone number for information is 301-589-6062, and for orders or to join, 888-322-6728. 73

ON THE GO

continued from page 47

very beneficial. However, with so many TMD-700A transceivers being used as mobile rigs, you may want to power it from the car's electrical system. In that case, you may want to be able to turn the unit on and leave it on as long as the car and radio are operating,

There's no particular order for installing the components, but as always, orientation of semiconductors and electrolytic capacitors is critical. When you are finished, take a few minutes to double check the installed components and inspect the circuit board for solder bridges or cold solder joints. If you decide to use a case, John recommends the Pac-Tec HP9VB.

In order to operate the unit, it must be connected to the radio, keyboard and power supply. There are four jacks on one end of the circuit board. There is a coaxial connector that can be used to provide 12 volts to the circuit. The next connector is used to connect a PS/2 keyboard. If you have a number of keyboards in your junk box, this is the keyboard with the smaller connector. While you can use an adapter, most adapters are built in such a way as to exert enough leverage on the board to damage it over time. I strongly recommend using the correct

keyboard. These can be found at office supply stores for less than \$20, and if you're lucky, sometimes the chains will have them for about \$10 with a \$10 rebate.

The microphone from the Kenwood TMD-700A is unplugged from the radio and plugged into one of the RJ-45 jacks on the interface. A "straight through" jumper is then plugged between the radio and the interface board. Don't worry which item is plugged into which connector on the interface board. They are wired in parallel, so it doesn't matter.

There are a few commands that must be given to the Kenwood radio before you're ready to go. These set several of the function keys on the keyboard to allow the most features to be handled from the keyboard. If you switch on the interface now, the red LED should light and the keyboard will probably do a quick self-test. With most keyboards, this is evident by the three green LEDs above the numeric keypad flashing three times. You are now ready to use the keyboard.

The main purpose of this interface is to allow you to send text messages easily. If you press the F2 button it will immediately take you to the "Send Message" screen. Enter the callsign of the station you wish to contact and press ENTER. Type your message and again press ENTER. You're done and your message is sent. The F3 button will take you to the recently-heard-stations list. Since the up and down arrows on the keyboard function like the up and down buttons on the microphone, scrolling through the list is easy.

The D700 interface can't quite do everything. If you are a world class touch typist, it won't keep up with you. Remember the fact that to get an "@" sign you would have had to press 18 keystrokes? You may only press one key, but the interface translates this into the required 18, so there may be a very slight delay. There are a few errors that may occur when the radio is in a different mode where the command you are typing means something else. In most cases, you can get out of difficulty by either pressing the ENTER key, or pressing the ESCAPE key twice.

This product is intended for APRS use, and APRS is a very specialized method of digital communications. Most of the time the information sent by APRS is position sensitive as opposed to message sensitive. However, there are times when sending a message is helpful.

Most of the time the messages sent by

Continued on page 61

Fairly Fair

The sun is expected to be mildly unsettled this month, so my overall forecast is for Fair (F) conditions to prevail.

The period from the 4th through 11th will be relatively uneventful and should allow decent propagation despite numerous minor flares. The end of May and early June should be noticeably free from solar disturbances, however, and could provide some excellent opportunities, but by then we will have entered the so-called "summer doldrums," so openings on the lower bands will be rather limited.

The two-week stretch from the 13th to the 25th will probably be most frustrating for DXers because of coronal hole effects and an overall increase in the magnitude of solar flares. I expect the 22nd, 23rd, or 24th to yield one or more strong disturbances and possibly a major proton event, but this is the only period where my charts indicate that such an occurrence is likely.

While late spring in the middle latitudes marks the beginning of the "summer doldrums" (bringing lower MUFs, higher noise levels, and daytime over-ionization), it is also the season where "sporadic-E" propagation can turn otherwise dead or declining bands around.

During daylight hours, electron density (a measure of the ionization potential) can reach very high levels, creating localized patches or "clouds" in the E region of the ionosphere. Once formed, these electron clouds generally drift from east to west and have been shown to move at roughly 110 mph. They sometimes persist well into the night even though direct ionization from the sun has ceased.

Sporadic-E can significantly affect radio wave propagation, and typically produces single-skip distances of between 500 and 1,500 miles. Double-hop and even triple-hop propagation has been noted when sporadic-E is widespread. These unpredictable E-clouds can

EASTERN UNITED STATES TO:												
GMT:	00	02	04	06	08	10	12	14	16	18	20	22
Central America	15-20	(15-40)	20 (40)	20 (40)	(20)	(20)	(15-20)	15 (20)	15 (20)	15 (20)	10-20	(12) 20
South America	15-20	(15)	(15) 20	(20-30)	x	(20)	(15-20)	(15)	(15)	(10-15)	10 (20)	(10) 20
Western Europe	20 (40)	20-40	(20-40)	(20-40)	20	(20)	(15-17)	(15)	x	(15-20)	(15) 20	(17) 20
Southern Africa	(40)	(40)	20	20	x	x	x	(12) 15	(15)	(20)	(20)	x
Eastern Europe	20 (30)	20 (40)	(20-30)	x	x	x	x	x	x	(15-20)	(12) 20	(17) 20
Middle East	20 (40)	20 (40)	(20-30)	x	x	(20)	x	x	(15)	(15-20)	15-20	(15) 20
India/Pakistan	(15-20)	(20)	x	x	(20)	x	x	x	x	x	x	(15)
Far East/ Japan	x	x	x	x	x	(20)	(20)	x	x	x	x	(15)
Southeast Asia	(15-20)	x	(20)	x	x	(20)	x	x	x	x	x	(15-20)
Australia	15	(15)	15 (20)	20 (30)	(20-40)	(20)	(17) 20	(20)	x	x	x	(15)
Alaska	(15)	(20)	(20)	(20)	(20)	(20)	(20)	x	x	x	(15)	(15)
Hawaii	15 (20)	(15) 20	20 (30)	20 (30)	20 (30)	(20-30)	(20)	x	x	x	(15)	(10-15)
Western USA	(12) 20	(12) 40	(20) 40	(30) 40	(30) 40	(30) 40	(40)	x	(17) 20	(12) 20	(10) 20	(10) 20
CENTRAL UNITED STATES TO:												
Central America	15-20	(15) 20	20 (40)	20 (40)	(20)	20 (40)	20	(15) 20	15 (20)	(10-20)	10 (20)	(10) 20
South America	10-20	(12) 20	(15-40)	(20-40)	x	(20)	(20)	(15)	x	(10-12)	(10-15)	10 (20)
Western Europe	(17) 20	20 (30)	20 (40)	(40)	x	(20)	(20)	x	x	x	x	(15) 20
Southern Africa	x	x	(30-40)	(20)	x	x	x	(15)	(15)	(20)	(20)	x
Eastern Europe	20	20 (40)	(20-30)	(20)	x	(20)	(20)	x	x	(15)	(15-20)	(20)
Middle East	(17) 20	20 (40)	(20-30)	x	x	x	(20)	x	x	x	(15)	(15-20)
India/Pakistan	(15-20)	(15-20)	(20)	(20)	(20)	(20)	(20)	x	x	x	x	x
Far East/ Japan	(15)	(15)	(15)	x	(20)	(20-40)	20 (30)	(17) 20	(20)	x	x	x
Southeast Asia	(15)	(15)	(20)	(20)	(20)	(20)	(20)	(20)	x	x	x	x
Australia	(15)	15	(15-20)	20 (30)	20 (40)	(20-40)	20 (40)	20	x	x	(15)	x
Alaska	(15-17)	15 (17)	(15) 17	(20)	(20-30)	(20-40)	20 (30)	(20)	x	x	(15)	x
Hawaii	(10-20)	15 (20)	(15) 20	20	20 (40)	(20-40)	20 (30)	(20)	x	x	(15)	x
WESTERN UNITED STATES TO:												
Central America	(12) 20	(15) 20	20 (30)	20 (40)	(20-30)	(20-40)	(20-30)	20	(15-20)	(10-17)	(10-17)	(10-20)
South America	12 (20)	(12) 20	(15) 20	(17) 20	(20-40)	(20)	(20-30)	(15-20)	x	x	(10-15)	(10-15)
Western Europe	(17) 20	20	20	(20)	x	x	x	(20)	(15-17)	(15)	x	(15-17)
Southern Africa	x	x	x	(20)	(20)	x	x	(20)	(17-20)	(15-17)	x	x
Eastern Europe	x	x	20 (30)	(20)	x	x	x	x	x	x	x	x
Middle East	(20)	(20)	(17) 20	(20)	x	x	x	x	x	(15)	x	x
India/Pakistan	x	x	(15)	x	x	x	(20)	(20)	(20)	(15-17)	x	x
Far East/ Japan	(15)	x	(20)	(17) 20	20	20 (40)	(20-40)	20 (30)	(17) 20	(15-20)	x	15
Southeast Asia	x	x	(15)	x	(20)	(20-30)	(20-30)	20 (30)	(17) 20	(17-20)	x	x
Australia	(10-15)	(10) 15	(12) 15	(15-20)	20	20 (40)	20-40	(17) 20	(17) 20	x	x	(12-15)
Alaska	(12-15)	(12-15)	(15-20)	(17-20)	20 (30)	(20-30)	(20-40)	20 (30)	(20)	(17)	x	(15)
Hawaii	(10-15)	(10) 15	(12) 15	(15-20)	20-40	(20) 40	(20) 40	20 (30)	(20)	x	x	(15)
Eastern USA	(12) 20	(12) 40	(20) 40	(30) 40	(30) 40	(30) 40	(40)	x	(17) 20	(12) 20	(10) 20	(10) 20

Table 1. Band, time, country chart. Plain numerals indicate bands which should be workable on Fair to Good (F-G) and Good (G) days. Numbers in parentheses indicate bands usually workable on Good (G) days only. Dual numbers indicate that the intervening bands should also be usable. When one number appears in parentheses, that end of the range will probably be open on Good (G) days only.

May 2003						
SUN	MON	TUE	WED	THU	FRI	SAT
				1 F	2 F-P	3 F
4 F	5 F-G	6 F-G	7 F	8 F-G	9 F-G	10 F-G
11 F-G	12 F	13 F-P	14 F	15 F	16 F-P	17 F-P
18 F	19 F-G	20 F	21 F-P	22 P	23 P	24 P
25 F-P	26 F-P	27 F	28 F	29 G	30 G	31 G

produce strong openings that might last only a few minutes, but on occasion the effects may linger for several hours.

For an in-depth look at the sporadic-E phenomenon, I suggest that you read "Mid-Latitude Sporadic-E" by Michael Hawk. This article can be found on the Internet on The AM and FM DXers Resource propagation page, at [www.amfmdx.net/propagation/].

73 and happy hunting!

Band-by-band forecast

10-12 meters. Ten and twelve are now in "summer mode" and openings are limited. There should still be some good opportunities into the Caribbean and Latin or South America from midafternoon through early evening, but not much else will be available on a regular basis. Try Eastern Europe or the Middle East just after sunrise, and Japan, Australia, or the Far East in the early evening. Daytime short-skip can range from 1,000 to about 2,000 miles.

15-17 meters. Fairly decent worldwide opportunities are still available on Fair-to-Good (FG) and Good (G) days. Openings will begin about an hour after sunrise and should last until nearly midnight. Central and South America will be quite reliable for a good part of the day, while the western Pacific, from the Aleutians down to Australia, should supply regular openings around midevening. Short-skip will average between 1,000 and 2,000 miles.

20 meters. Around-the-clock opportunities will be available on Good (G) days. Decent opportunities will often be found right after sunrise and late in the afternoon, but the evening hours after sunset will be the best time for strong propagation. Supertime through late evening should support regular pipelines to Europe and the Middle East, but you'll only find "night owls" awake over there at those hours. If you find yourself awake between midnight and sunrise, try working the Central or Western Pacific where openings should be regular and strong. Short-skip will fluctuate between 500 and 2,200 miles.

30-40 meters. Atmospheric noise due to convective storms will play the major role in daily conditions, but there should be lots of activity here during the quieter periods. Good opportunities to Europe, the Middle East, and Africa will be available to stations located in the eastern U.S., while Australia, Japan, and the Far East will be open to those in the western states. If you live in the central U.S., then all of these regions should be available to you at some time during the month. As usual, Central and South America

and the Caribbean will be open to everyone on most days. Short-skip at night will range from 500 to 2,500 miles but will be well under 1,000 miles during the day.

80-160 meters. Propagation on these bands will be spotty due to high QRN levels, but decent opportunities can still be found at night during the quieter periods. Let forty meters be your guide. Eighty and one-sixty are pretty much nighttime-only bands, with short-skip ranging from 1,000 to 2,000 miles, but daytime multiskip is possible into the Caribbean and northern South America. Noise levels are bound to be very high on most days, however, and daytime short-skip will typically fall under 300 miles. 73

ON THE GO

continued from page 59

APRS are very short. The most common ones I see are those telling another station how they can reach you by voice. This is where one of the neatest features of the D700 interface comes into play. It is possible to store text messages up to 31 characters each into function keys F5 through F8. It is handy to load them with your favorite voice frequencies and such messages as "Monitoring 146.52 simplex" or "Call me on 147.39 +." In this way, you can quickly connect up with a station for a more prolonged conversation.

I find that this interface would be very beneficial in a disaster situation. With a Kenwood TMD-700A in the car, I could park in a strategic location and be able to handle short text messages. While this may not be ideal for health and welfare traffic with long lists of victims, it would be very helpful for tactical traffic. This really is far more efficient than using the built-in methods. As I said earlier, there's a real benefit in taking a good product, such as the Kenwood TMD-700A, and making it better. The D700 keyboard interface does just that.

If you're interested, check out the Web page at [www.john.hansen.net].

John is available to answer questions at john@hansen.net or for snail mail use John Hansen W2FS, 49 Maple Avenue, Fredonia NY 14063.

You can order on-line using PayPal. The kit is available for \$40, and the assembled circuit for \$75. The Pac-Tec enclosure is also available at the same location. 73

THE DIGITAL PORT

continued from page 52

concerted effort toward organization. There are about 6 gigabytes worth of stuff on this hard drive, and that is a bunch.

The computer got the notion that it had enough and came up in "Safe mode." Not a good sign, folks. I ran Scandisk, starting in the middle of the afternoon, which took it to a little after sun-up the next day. Then it would play in Normal mode but it looked weak.

Installation of Norton Utilities made the "fix" possible, but it was time consuming. A search for problems in the system with the Norton package revealed about 40 or so, which included a fix similar to Microsoft's defragmentation. That last was about the same length as the Scandisk operation, but it cleaned up and works like a million again and, per Norton claims, the system actually runs noticeably faster. Probably the end of the hairball dilemma, I hope.

That's about it for this session. Hang in there and keep those digital fires burning. I'll look for the shacks with the porch lights on. 73, Jack, KB7NO@att.net. 73

HOMING IN

continued from page 55

connected to a computer, the accuracy and multipath performance comparisons can be documented. In an upcoming column, I'll tell you about a ham who has done just that, with very interesting results.

Notes

1. Moell and Curlee, *Transmitter Hunting — Radio Direction Finding Simplified*, published by TAB McGraw-Hill, ISBN 0-8306-2701-4. A simple two-meter RDF loop is on page 26.

2. Loop plans in the book include an added "sense" element to resolve the bearing ambiguity. Try that next time!

3. Moell, Joe, "Homing In: Two New Tools for T-Hunting," *73 Magazine*, April 2003.

4. Moell, Joe, "Homing In: Dayton Does DF," *73 Magazine*, September 1999.

5. Moell, Joe, "Homing In: Wildlife Tracking Update — Burrowing Owls Found, Saw-whets Sought," *73 Magazine*, October 2001. 73

Ad Sales Call 800-677-8838

Say You Saw it In 73!

LETTERS

continued from page 8

would be blacked out, all portholes closed, no light of any kind on deck, with all the filaments on so the transmitter could be put on the air very quickly. As if that were not enough, there were four men sleeping in a tier of bunks, and the air became very foul and stuffy to say the least.

There was one good thing: Tokyo Rose, good music, and propaganda that was so "corny" it sent us into fits of laughter.

Don Schulke KF6XF, donsschulke@juno.com. Wayne, I'm an investor and resident of China in the oil business. I've known you, and of you, since the end of WWII, and reading your NSD columns in the 2002 Christmas 73 edition, I find you haven't changed a bit! Poor ole ARRL still gets it both barrels. But here's another shot!

Like you, I'm not trashing the League. But for a short time, I have had an opportunity that will never come again. This is to buy and create a ham ship as described here.

Why me? Because I was an early investor in China. And in recognition of my endurance through the years from socialism to market economy, it is an unofficial gesture that if I buy it and take it out of China, as I have proposed, it becomes my blessing! Otherwise, it will go to salvage; trashed. And this will happen unless action is taken soon.

Once paid for, registration under new ownership, and flying another flag, the ship may return to China to engage in commerce, same as any other foreign vessel. This ship, I recognize as ideal for China seas trade in petrochemicals, the area and the business best known to me for over 40 years. These many islands and countries of different cultures will continue to be exciting and welcome visitors and traders alike.

My call KF6XF is authorized in China. China television filmed our ham club through summer and winter for a two-segment half-hour TV program. Most important was a field trip by train to a high school where students in club T-shirts showed their CW and phone skills. It's on a VCD for China and overseas views. One Canadian reported seeing it, at least. I can send a copy.

Since China has its own League and logo similar to the ARRL, I telephoned my hamship idea to ARRL headquarters. I didn't get past the first person, i.e., the League is not connected with China, doesn't have this kind of interest, and my history relates more to ex-military organizations. This short shrift deflation diverted League as primary interest. The ship is a valid self-supporting business operation as I know it.

Investors, however, want to retain ownership, rather than the short-term operator status I propose of selling stock for buy-back by hams as a seagoing ham shack.

The immediate initial investment for ownership is US \$100,000 of which I personally will put up half, at 0% interest. The gap of \$50,000 remaining requires 500 hams buying 1 share @ \$100 per share covering the purchase. [This is not a prospectus or stock offering. — ed.]

An additional US \$50,000 for shipyard haul-out and repaint financed from additional stock sales will then apply.

The ship may be viewed now in Shanghai. With ownership we will accept volunteer labor contributions.

I can supply more info via my stateside contact info: 1575 Howard Ave., San Ysidro CA 92173-1209; 619-428-1500; fax 619-428-1600. 73

NEVER SAY DIE

continued from page 41

don't add much to the data files. It doesn't take a lot of brains to learn to read. The problem is that most people, including Mensans, stop reading very much shortly after almost learning how, so they never build up knowledge for their brains to work with.

My mother read to me from my earliest days, so I took to reading as soon as I learned how. My grandfather used to take me in his lap and read to me after dinner.

The average schoolteacher reads one book a year. Probably a novel. Figures.

What I enjoy about books is that I'm able to get information directly from the top experts and brains of the world through their books. I read with my Magic Marker at hand, highlighting key data. And then, if I have some questions, I get in touch with the authors and talk with them.

The big problem, of course, is finding the best books to read. My *Secret Guide to Wisdom* is a review of about a hundred truly outstanding books I've found.

I had high hopes when I founded Mensa in 1960. I envisioned Mensa think tank groups helping businesses and the government to solve problems. I organized New Hampshire Mensa members into such a group and got them together with Senator Humphrey. He posed the question of how to get government bureaus and departments to stop spending wildly at the end of their fiscal year as a way to make sure that the next year's budget would be increased. The Mensa group came up with a beautiful solution.

I've described this in my past editorials and in my *Improving State Governments* booklet.

We have unlimited memory capabilities. What most people are not doing is providing their memories with information for their brains to use.

Prozac

Didja miss the Prozac article in the July *Discover*? It covered the benefits and drawbacks of the serotonin enhancers such as Prozac, Zoloft, Paxil, Valium, and Effexor. These are the drugs children with attention deficit disorder (ADD), hyperactivity and depression are being given ... and often forced to take.

The article listed the common known side effects alphabetically: abnormal thinking, allergic reaction, anxiety, chest pain, chills, cough, diarrhea, dizziness, drowsiness, dry mouth, flu symptoms, frequent urination, hay fever, headache, inability to fall or stay asleep, increased appetite, indigestion, joint pain, nausea, sore throat, stomach/intestinal disorder, sweating, tremors, weakness, weight loss. Somewhat less common are abnormal ejaculation, abnormal gait, amnesia, antisocial behavior, apathy, confusion, convulsions, decreased sex drive, extreme muscle tension, fluttery heartbeat, hair loss, hallucinations, hostility, paranoid reaction, slurred speech, stupor, suicidal thoughts, temporary cessation of breathing, twitching, weight gain.

Well, I suppose it's easier to put up with those side effects than to stop feeding a child sugar.

Puberty

For thousands of years boys and girls reached puberty at eighteen. A recent study showed that today the average age for boys and girls is around ten! Clearly something has changed radically. And it has changed even more for black girls, where the average age is nine — with 50% reaching it at eight, and (amazingly) 3% "maturing" at three years old! Welcome to the Pepsi generation — the fast food fans.

I know it's a lousy thing to do to cute little creatures like rats, but I'd sure like to see some research reports on what happens to rat puberty for groups fed burgers, fries, and cola vs. those on a raw food diet. You know, burgers made out of growth hormone and antibiotic-laced beef (well done, to make sure it takes a very long time to be digested), plus a bun made from white flour (which has zero nutritive value), fries (made from genetically engineered potatoes

Continued on page 64

Wise Up!

Here are some of my books which can change your life (if you'll let 'em). If the idea of being healthy, wealthy and wise interests you, start reading. Yes, you can be all that, but only when you know the secrets which I've spent a lifetime uncovering.

.....Wayne

The Secret Guide to Health: Yes, there really is a secret to regaining your health and adding 30 to 60 years of healthy living to your life. The answer is simple, but it means making some serious lifestyle changes. Will you be skiing the slopes of Aspen with me when you're 90 or doddering around a nursing home? Or pushing up daisies? No, I'm not selling any health products, but I can help you cure yourself of cancer, heart trouble, or any other illness. Get this new, 2002 expanded edition (160p). \$10 (#04)

The Secret Guide to Wealth: Just as with health, you'll find that you have been suckered by "the system" into a pattern of life that will keep you from ever making much money and having the freedom to travel and do what you want. I explain how anyone can get a dream job with no college, no résumé, and even without any experience. I explain how you can get someone to happily pay you to learn what you need to know to start your own business. \$5 (#03)

The Secret Guide to Wisdom: This is a review of around a hundred books that will boggle your mind and help you change your life. No, I don't sell these books. They're on a wide range of subjects and will help to make you a very interesting person. Wait'll you see some of the gems you've missed reading. You'll have plenty of fascinating stuff to talk about on the air. \$5 (#02)

My WWII Submarine Adventures: Yes, I spent from 1943-1945 on a submarine, right in the middle of the war with Japan. We almost got sunk several times, and twice I was in the right place at the right time to save the boat. What's it really like to be depth charged? And what's the daily life aboard a submarine like? How about the Amelia Earhart inside story? If you're near Mobile, please visit the Drum. \$5 (#10)

Travel Diaries: You can travel amazingly inexpensively - once you know the ropes. Enjoy Sherry and my budget visits to Europe, Russia, and a bunch of other interesting places. How about a first class flight to Munich, a rented Audi, driving to visit Vienna, Krakow

in Poland (and the famous salt mines), Prague, back to Munich, and the first class flight home for two, all for under \$1,000? Yes, when you know how you can travel inexpensively, and still stay in first class hotels. \$5 (#11)

Writer's Guide: It's easy, fun, can pad your résumé, and impress the hell out of your friends. \$0 (#78)

Wayne's Caribbean Adventures: My super budget travel stories - where I visit the hams and scuba dive most of the islands of the Caribbean. You'll love the special Liat fare which let me visit 11 countries in 21 days, diving all but one of the islands, Guadeloupe, where the hams kept me too busy with parties. \$5 (#12)

Cold Fusion Overview: This is both a brief history of cold fusion, which I predict will be one of the largest industries in the world in the 21st century, plus a simple explanation of how and why it works. This new field is going to generate a whole new bunch of billionaires, just as the personal computer industry did. \$5 (#20)

Improving State Government: Here are 24 ways that state governments can cut expenses enormously, while providing far better service. I explain how any government bureau or department can cut its expenses by at least 50% in three years and do it cooperatively and enthusiastically. I explain how, by applying a new technology, the state can make it possible to provide all needed services without having to levy any taxes at all! Read the book, run for your legislature, and let's get busy making this country work like its founders wanted it to. Don't leave this for "someone else" to do. \$5 (#30)

Mankind's Extinction Predictions: If any one of the experts who have written books predicting a soon-to-come catastrophe which will virtually wipe most of us out are right, we're in trouble. In this book I explain about the various disaster scenarios, like that of Nostradamus, who says the poles will soon shift (as they have several times in the past), wiping out 97% of mankind. Okay, so he's made a long string of past lucky guesses. The worst part of these predictions is the accuracy record of some of the experts. Will it be a pole shift, a new ice age, a massive solar flare, a comet or asteroid, a bioterrorist attack? I'm getting ready, how about you? \$5 (#31)

Moondoggle: After reading René's book, *NASA Mooned America*, I read everything I could find on our Moon landings. I watched the NASA videos, looked carefully at the photos, read the astronaut's biographies, and talked with some readers who worked for NASA. This book cites 45 good reasons I believe the whole Apollo program had to have been faked. \$5 (#32)

Classical Music Guide: A list of 100 CDs which will provide you with an outstanding collection of the finest classical music ever written. This is what you need to help you reduce stress. Classical music also raises youngsters' IQs, helps plants grow faster, and will make you healthier. Just wait'll you hear some of Gotschalk's fabulous music! \$5 (#33)

The Radar Coverup: Is police radar dangerous? Ross Adey K6UI, a world authority, confirms the dangers of radio and magnetic fields, including our HTs and cell phones. \$3 (#34)

Three Gatto Talks: A prize-winning teacher explains what's wrong with American schools and why our kids are not being educated. Why are Swedish youngsters, who start school at 7 years of age, leaving our kids in the dust? Our kids are intentionally being dumbed down by our school system - the least effective and most expensive in the world. \$5 (#35)

Aspartame: a.k.a. NutraSweet, the stuff in diet drinks, etc., can cause all kinds of serious health problems. Multiple sclerosis, for one. Read all about it, two pamphlets for a buck. (#38)

\$1 Million Sales Video: The secret of how you can generate an extra million dollars in sales just by using PR. This will be one of the best investments you or your business will ever make. \$40 (#52)

Reprints of My Editorials from 7 3. Very few things in this world are as we've been taught, and as they appear. As an iconoclast I blow the whistle on the scams around us, such as the health care, our school system, our money, the drug war, a college education, sugar, the food giants, our unhealthy food, fluorides, EMFs, NutraSweet, etc.

- 1996 100 Editorial Essays: \$5 (#72)
- 1997 157 Editorial Essays: \$8 (#74)
- 1998 192 Editorial Essays: \$10 (#75)
- 1999 165 Editorial Essays: \$8 (#76)
- 2000 101 Editorial Essays: \$5 (#77)
- 2001 104 Editorial Essays: \$5 (#78)

Silver Wire: With two 5-in. pieces of heavy pure silver wire + three 9V batteries you can make a thousand dollars worth of silver colloid. What do you do with it? It does what the antibiotics do, but germs can't adapt to it. Use it to get rid of germs on food, for skin fungus, warts, and even to drink. Read some books on the uses of silver colloid, it's like magic. \$15 (#80)

Colloid Reprint. April 97 article on a silver colloid maker, history, and how to use the stuff. \$5 (#98)

Colloid Clips. Three 9V battery clips, 2 alligator clips & instructions. \$5 (#99)

AC-powered Colloid Kit: 12V power supply, silver wires, reprint, including priority mail shipment. \$37 (#82)

Four Small Booklets Combo: Super Organic Food: a trillion dollar new industry; Schools in 2020: another \$ trillion industry. Anthrax, a simple cure. Dowsing: why and how it works. \$3 (#86)

My 1992 We The People Declare War! On Our Lousy Government book—360 pages and packed with ideas that'll get you all excited. Was \$13. While they last \$10. Just a few left, found in the warehouse. Last chance for this classic. (#06)

Stuff I didn't write, but you need:

NASA Mooned America: René makes an air-tight case that NASA faked the Moon landings. This book will convince even you. \$30 (#90)

Last Skeptic of Science: This is René's book where he debunks a bunch of accepted scientific beliefs - such as the ice ages, the Earth being a magnet, the Moon causing the tides, etc. \$30 (#91)

Dark Moon: 568 pages of carefully researched proof that the Apollo Moon landings were a hoax—a capping blow for René's skeptics. \$25 (#92)

1982 General Class License Study Guides. Teaches the fundamentals of radio & electricity. Was \$7. I found a few in the warehouse. \$3, while they last. Great book! (#83)

Radio Bookshop

Box 416, Hancock NH 03449

Name _____ Call _____

Address _____

City-State-Zip _____

Use the numbers in the brackets or copy page and mark the books you want. Add \$3 s/h per total order in US (\$7 priority mail), \$6 Can, \$10 foreign. _____

Order total: US\$ _____ Phone (for CC orders) _____

MC/Visa for orders over \$10. # _____ Expire _____

www.waynegreen.com • phone orders: 603-588-0107 • fax: 603-588-3205 • w2nsd@aol.com

Yes! Put me down for a year of 73 for only \$25 (a steal). Canada US\$32. Foreign US\$44 by sea.

I need some industrial strength stress reduction so send me your Adventures In Music CD catalog. Allow 4 weeks for delivery except foreign, though we try to get most orders shipped in a day or two.

Your e-mail address: _____

Barter 'n' Buy

Turn your old ham and computer gear into cash now. Sure, you can wait for a hamfest to try and dump it, but you know you'll get a far more realistic price if you have it out where 100,000 active ham potential buyers can see it, rather than the few hundred local hams who come by a flea market table. Check your attic, garage, cellar and closet shelves and get cash for your ham and computer gear before it's too old to sell. You know you're not going to use it again, so why leave it for your widow to throw out? That stuff isn't getting any younger!

The 73 Flea Market, Barter 'n' Buy, costs you peanuts (almost) — comes to 35 cents a word for individual (noncommercial!) ads and \$1.00 a word for commercial ads. Don't plan on telling a long story. Use abbreviations, cram it in. But be honest. There are plenty of hams who love to fix things, so if it doesn't work, say so.

Make your list, count the words, including your call, address and phone number. Include a check or your credit card number and expiration. If you're placing a commercial ad, include an additional phone number, separate from your ad.

This is a monthly magazine, not a daily newspaper, so figure a couple months before the action starts; then be prepared. If you get too many calls, you priced it low. If you don't get many calls, too high.

So get busy. Blow the dust off, check everything out, make sure it still works right and maybe you can help make a ham newcomer or retired old timer happy with that rig you're not using now. Or you might get busy on your computer and put together a list of small gear/parts to send to those interested?

Send your ads and payment to: 73 Magazine, Barter 'n' Buy, 70 Hancock Rd., Peterborough NH 03458 and get set for the phone calls. The deadline for the July 2003 classified ad section is May 10, 2003.

220 MHz Award; see W9CYT on WWW.QRZ.COM for information. BNB645

K8CX HAM GALLERY [<http://hamgallery.com>]. BNB620

TELEGRAPH COLLECTOR'S PRICE GUIDE: 250 pictures/prices. \$12 postpaid. **ARTIFAX BOOKS**, Box 88, Maynard MA 01754. Telegraph Museum: [<http://wltpl.com>]. BNB113

New miniature oscillator modules are now available ... all under \$20 ... plus our great reference book is still for sale. Write to **RMT Engineering**, 6863 Buffham Road, Seville OH 44273 or see our Web site at [www.ohio.net/~rtormet/index.html]. BNB640

RF TRANSISTORS TUBES 2SC2879, 2SC1971, 2SC1972, MRF247, MRF455, MB8719, 2SC1307, 2SC2029, MRF454, 2SC3133, 4CX250B, 12DQ6, 6KG6A, etc. **WESTGATE**, 1-800-213-4563. BNB6000

METHOD TO LEARN MORSE CODE FAST AND WITHOUT HANGUPS Johan N3RF. Send \$1.00 & SASE. SVANHOLM RESEARCH LABORATORIES, P.O. Box 81, Washington DC 20044 USA. BNB421

Cash for Collins: Buy any Collins Equipment. **Leo KJ6HI**. Tel./FAX (310) 670-6969. [radioleo@earthlink.net]. BNB425

Browse our Web site and check out the "Monthly Special." TDL Technology, Inc. [www.zianet.com/tdl]. BNB500

MAHLON LOOMIS, INVENTOR OF RADIO, by Thomas Appleby (copyright 1967). Second printing available from **JOHAN K.V. SVANHOLM N3RF**, SVANHOLM RESEARCH LABORATORIES, P.O. Box 81, Washington DC 20044. Please send \$25.00 donation with \$5.00 for S&H. BNB420

Ham Radio Repair, Quality workmanship. All Brands, Fast Service. **Affordable Electronics**, 7110 E. Thomas Rd., Scottsdale, AZ 85251. Call 480-970-0963, or E-mail [HAM_SERVICE@AOL.COM]. BNB427

SATELLITE TV — Large selection of items at reasonable prices. We specialize in Big Dish TVRO C & Ku Band equipment. Check us out at [www.daveswebshop.com]. BNB646

HEATHKIT COMPANY is selling photocopies of most Heathkit manuals. Only authorized source for copyright manuals. **Phone:** (616) 925-5899, 8-4 ET. BNB964

WANTED: USED ROTORS, controls, CD-44, Ham-M, 2, 3, 4, T2X, or larger. Call C.A.T.S., 1-800-3ROTORS BNB662

Electricity, Magnetism, Gravity, The Big Bang. New explanation of basic forces of nature in this 91-page book covering early scientific theories and exploring latest controversial conclusions on their relationship to a unified field theory. To order, send check or money order for \$16.95 to: American Science Innovations, P.O. Box 155, Clarington OH 43915. Web site for other products [http://www.asi_2000.com]. BNB100

COLLOIDAL SILVER GENERATOR! Why buy a "box of batteries" for hundreds of dollars? Current regulated, AC powered, fully assembled with #12 AWG silver electrodes, \$74.50. Same, but DC powered, \$54.50. Add \$2.50 shipping. **Thomas Miller**, 216 East 10th St., Ashland OH 44805. Web address [www.bioelectrifier.com]. BNB342

ANTENNA SCIENCE: Why do antennas radiate electromagnetic waves? Learn for yourself from this enlightening paper by **MAX RESEARCH**. Gain an understanding of the radiation mechanism of antennas! Written in a clear style for radio hobbyists, inquisitive amateurs and experimenters. \$4.95 ... ppd. Order from **MAX RESEARCH**, P.O. Box 1306, East Northport NY 11731. BNB426

WANTED: ANY MODEL Collins, working or not, including speakers, filters, options, 1-piece or collection. Bob, 651-354-5345 days: 651-345-3600 eves. E-Mail: rkemp@mr.net. BNB661

FREE!! HAM Radio and other CD-Roms and Disk catalog. **MOM 'N' POP'S SOFTWARE**, P.O. Box 15003-TH, Springhill, FL 34604-0111, 1-352-688-9108, visit: <http://www.momnpopsware.com> BNB660

SMART BATTERY CHARGERS and more, [www.a-engineering.com] BNB653

GET MORE OUT OF HAM RADIO! Books on all topics. Up to 15% off. Quality Technical Books. [<http://qtb.com/hamradio/>]. BNB665

Alinco DX-70 \$350. Astron SS-30 \$125. Heathkit HTX-24 HT with NiCads - alkaline pack - charger - case/holster - Spkr/mic \$250. All manuals — All perfect working-order. You pay S&H. Cashiers checks ONLY. Contact W9CGI@arrl.net.

NEVER SAY DIE

continued from page 62

which have never been tested for long-term side effects on humans) cooked in (rape seed) oil, and cola with 12 teaspoons of sugar per can (plus dissolved aluminum from the can). If the average child's junk food diet doesn't kill the rats before they reach puberty, or they don't kill each other, I'll be surprised if their age at puberty doesn't drop. Oh, lace their water with fluorides and chlorine, right out of your kitchen faucet.

Since there obviously will be no government or industry funding for this research, maybe you can get some kids who can do it as a science fair project. I'll bet *The New Yorker* will be interested in publishing the result and that none of the medical journals will touch it. 73

73 Ad Sales

Call
1-800-677-8838

Alinco Delivers HF Adventure!

Alinco's HF Transceivers Deliver Incredible Performance at a Tiny Price

You're only a few hundred dollars away from a brand new Alinco HF Transceiver. That's right! Just a few hundred dollars gets you on the air with a big 100-watt signal, great audio and an easy-to-operate package that's perfect for base, portable or mobile operations. The Alinco DX-70 and DX-77 make it easy for everyone to enjoy HF with a dependable transceiver that's backed by Alinco's 1 year warranty.

The world of HF is calling. What are you waiting for?



Alinco DX-70TH Base/Mobile/Portable HF + 6 Meter Transceiver

- 100 watts SSB, FM & CW, 40 watts AM
- Continuous coverage HF receiver + full 6 meter coverage
- 100 memory channels
- Speech compressor
- Great CW rig, full QSK, semi or automatic break-in
- Standard narrow filter fights QRM on SSB, CW or AM
- Two VFO's and easy "split" operation
- Removable face for remote mounting.
- RIT / TXIT, IF shift
- Multi function control for easy operation

Alinco DX-77T Desktop HF Transceiver

- 100 watts SSB, FM & CW, 40 watts AM
- General coverage receiver 150 KHz ~ 30 MHz
- Two VFO's; easy "split" operation
- Standard speech processor
- Front panel speaker provides loud, clear audio
- Built-in electronic keyer 6 ~ 60 wpm
- Full QSK, 7-step semi break-in or auto break-in
- Enhanced Direct Digital Synthesis (DDS) eliminates need for SSB Narrow Filter
- Front panel connections for mic, key, speaker & phones



Options

- EDX-2 automatic wire antenna tuner
- EMS-14 desktop microphone
- DM-330 MVT switching power supply
- DM-340 MVT regulated power supply



Iron Horse Mobile HF antennas for Alinco and other HF transceivers

Order the Iron Horse IHF5S package from your dealer and go mobile fast!

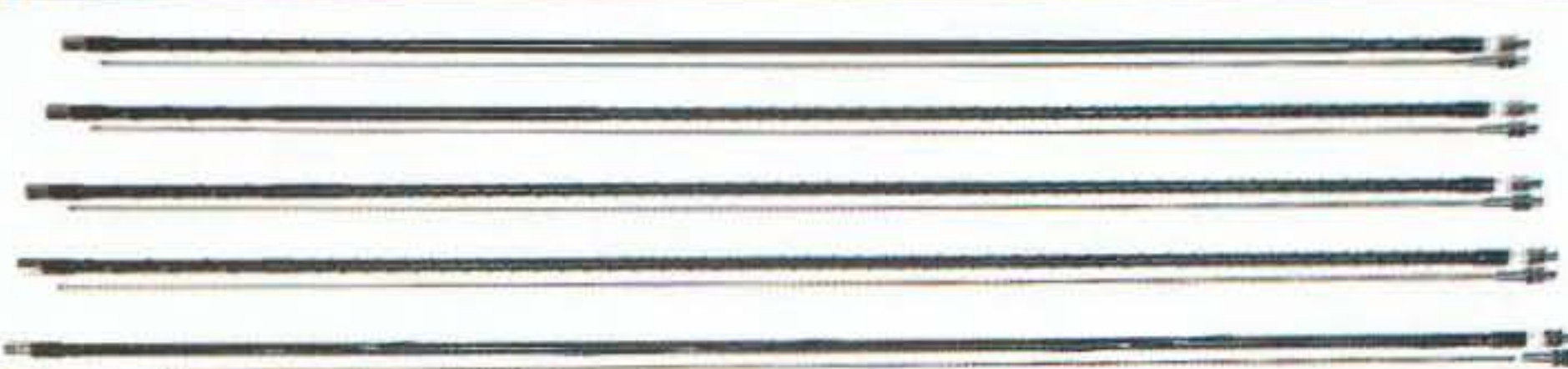

IHF5S Mobile HF Antennas

IHTH-1
Optional
Trailer Hitch Mount



You get a package of 5 rugged, easily tuned antennas for 10, 15, 20, 40 & 75 meters from Iron Horse, a name recognized for its strength and dependability. Each has 3/8 x 24 threads and is rated for 500 watts. Order the IHKD3S 5 antenna quick disconnect mounting kit to make changing bands a quick and easy operation, just push, turn & go!

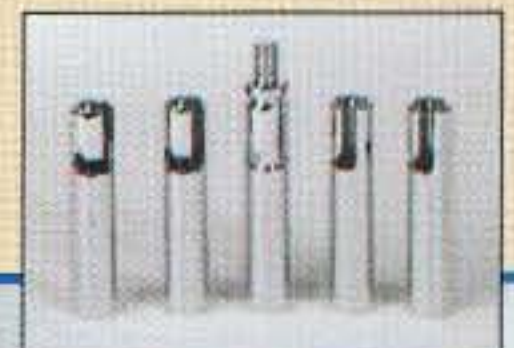

IHKD3S Quick
Disconnect Kit



www.ALINCO.com

Distributed in North America by ATOC Amateur Distributing LLC • 23 S. High St., Covington, OH 45318 • (937) 473-2840
Specifications subject to change without notice or obligation.

Products intended for use by properly licensed operators. Permits required for MARS/CAP use. Specifications subject to change without notice or obligation. All trademarks remain the property of their respective owners.

ULTRA-RUGGED, SUBMERSIBLE TRI-BAND MAGNESIUM HANDIE

Own the brightest star in the Ham Radio Galaxy! The exciting new YAESU VX-7R sets new standards in ruggedness, water resistance, and versatility, and its memory capacity is unparalleled. Own the VX-7R, and you'll own the best.

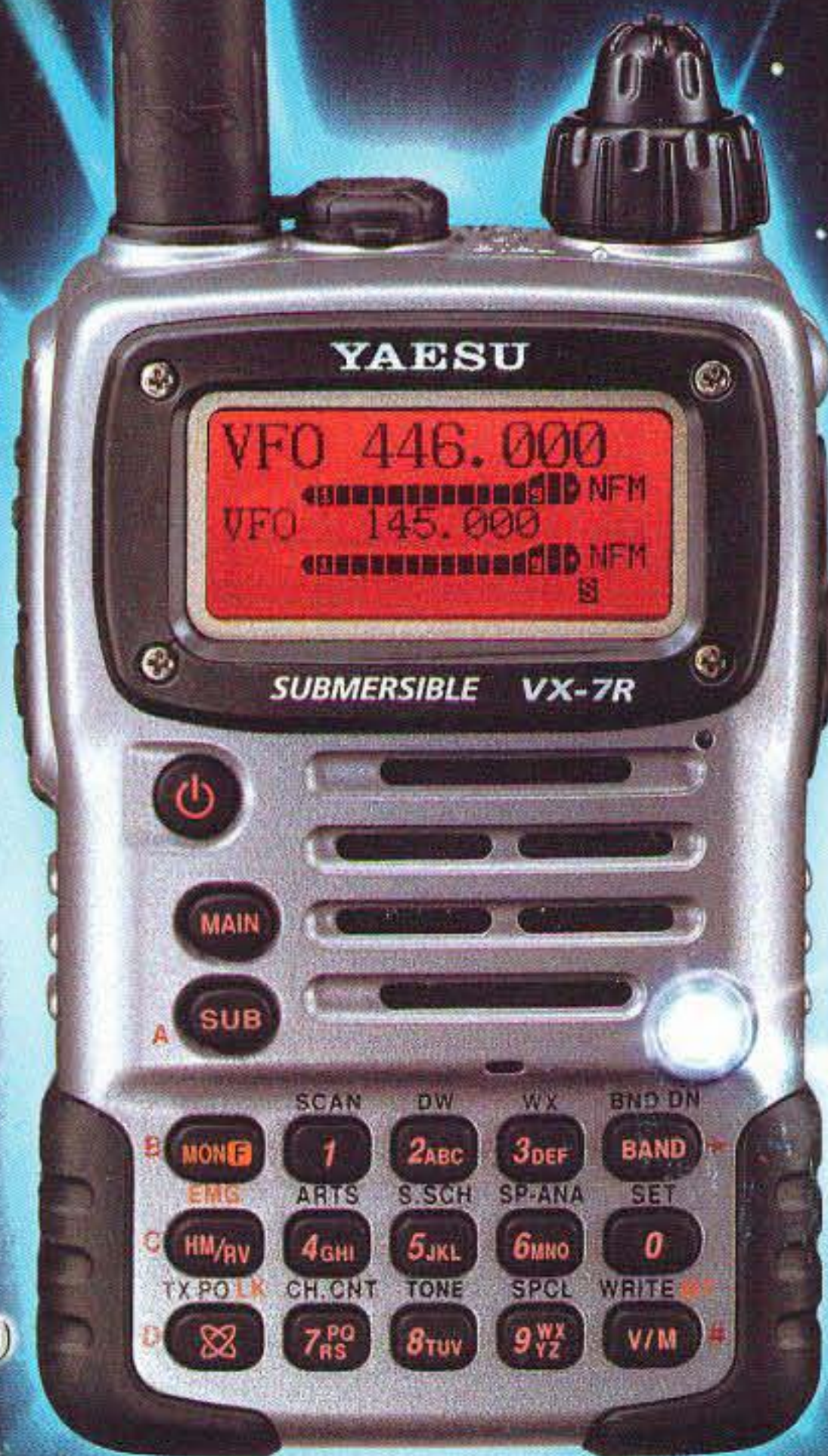

**TRUE DUAL RECEIVE
(V+V/U+U/V+U/HAM+GEN)**

WIDE-RANGE RECEIVER

MAGNESIUM CASE

**SUBMERSIBLE
(3 feet for 30 minutes)**

**OVER 500 MEMORY
CHANNELS**

**MIXED TONE (CTCSS/DCS)
CAPABILITY**

INTERNET KEY FOR ACCESS TO

WIRES

Wide-Coverage Internet Repeater Enhancement System

**SHORTWAVE BROADCAST
MEMORY BANK**

**WEATHER BROADCAST MEMORY
BANK WITH "SEVERE WEATHER"
ALERT**

MARINE BAND MEMORY BANK

MULTI-COLOR STROBE LED

**LOW-POWER 222 MHz TX
(U.S. version)**

RUBBER CASE PROTECTOR

VX-7R

50/144/430 MHz 5W FM Transceiver

Actual Size

For the latest Yaesu news, visit us on the Internet:
<http://www.vxstdusa.com>

Specifications subject to change without notice. Some accessories and/or options may be standard in certain areas. Frequency coverage may differ in some countries. Check with your local Yaesu Dealer for specific details.

YAESU
Choice of the World's Top DX'ers

Vertex Standard
US Headquarters
10900 Walker Street
Cypress, CA 90630 (714)827-7600