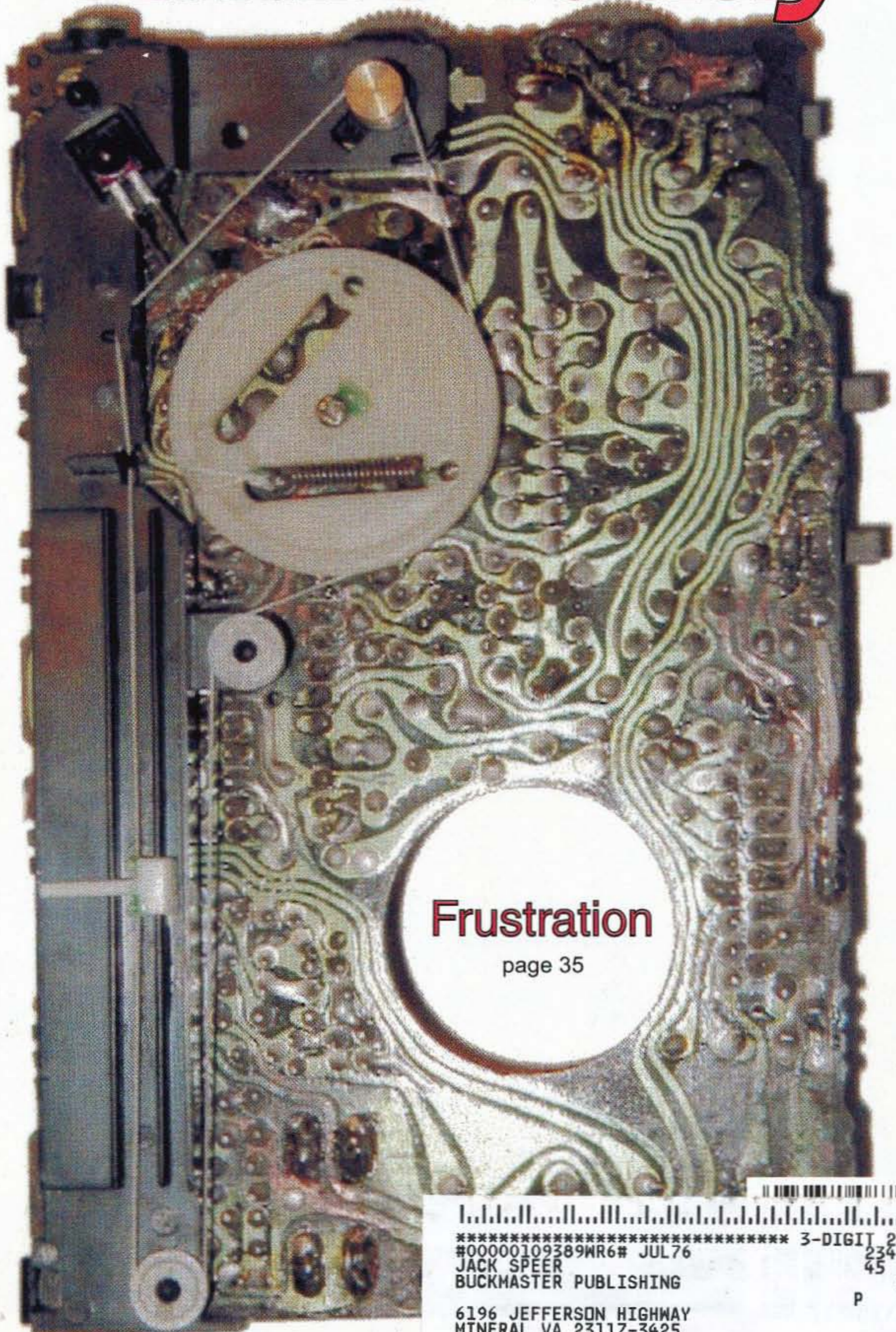


# 73 Amateur Radio Today

MARCH 2003  
ISSUE #508  
USA \$3.95  
CANADA \$4.95



**Frustration**

page 35

\*\*\*\*\*3-DIGIT 231  
#00000109389WR6# JUL76 234  
JACK SPEER 45  
BUCKMASTER PUBLISHING 3  
P

6196 JEFFERSON HIGHWAY  
MINERAL VA 23117-3425

03

# ALINCO *Unleash The Power*

**New**



## **DR-620T VHF/UHF**

### **Dual-Band Mobile/Base**

**First Amateur Twin Band Mobile To Support Optional Digital Voice Communications\***

- RX-VHF 108-173.995 MHz, UHF 335-480 MHz
- TX-VHF 144-147.995 MHz, UHF 430-449.995 MHz
- Receives Airband and Wide FM
- Front control unit separation (optional EDS-9 kit required)
- Advanced 10F3 digital mode with speech compression technology (EJ-47U required)\*
- 200 memory channels
- Advanced EJ-50U TNC (optional) supports digi-peet mode
- Remote control features including parameter setting and direct frequency entry through the microphone
- Dual-Band receiver with V/U, V/V, U/U capability
- CTCSS/DCS encode/decode and European Tone-bursts
- OUTPUT: H/M/L-50/10/5 watts VHF
- OUTPUT: H/M/L-35/10/5 watts UHF



## **DR-605TQ VHF/UHF**

### **Dual-Band Mobile/Base**

**Full 2 Meter/440 Performance**

- 100 memory channels, + a "call" channel for each band
- CTCSS encoded+decoded and tone scan
- Cross-band repeat and full duplex capability
- 9600 bps packet ready with dedicated terminals
- Internal duplexer - one easy antenna connection
- RX-VHF 136-173.995 MHz, UHF 420-449.994 MHz
- TX-VHF 144-147.995 MHz, UHF 430-449.994 MHz
- MARS capability (permit required)
- OUTPUT H/L - 50/5 watts VHF, 35/5 watts UHF
- Time-out timer (ideal for repeater and packet operation)

## **DJ-V5TH VHF/UHF**

### **Dual-Band FM Transceiver**

**5 watts of output power, in a compact package.**

- Alphanumeric Display, up to 6 characters
- TX-VHF 144-147.995 MHz, UHF 420-449.995 MHz
- 200 memory channels plus two call channels
- Full VHF + UHF Amateur Band Coverage
- Receive Range, (76 - 999MHz) includes Wide FM capability
- Up to 5 watts output, 3 output settings
- CTCSS encode+decode DTMF squelch and European Tone bursts
- 4 scan modes, 5 programmable scan banks
- MARS capability (permit required)



Ask your dealer  
about the full line of  
**Iron Horse antennas &  
accessories!**



## **DJ-596T VHF/UHF Dual-Band HT with Digital Voice Option\***

**Loaded with features! The breakthrough design supports optional digital voice communications and you can easily switch the unit between analog and digital modes!**

- Full 4.5 watts output VHF/4w UHF
- Powerful NiMH battery
- 100 memories in any combination of VHF or UHF channels
- Direct frequency input from keypad
- Each memory capable of "odd split" operation.
- Alphanumeric channel labels
- CTCSS/DCS encode+decode plus tone bursts
- Full 2m and 440 band coverage
- Accepts 6 to 16 VDC direct input
- Illuminated Keys and display
- Wide and narrow FM modes
- 10 autodial memories
- Theft alarm feature
- Optional EJ-40U Digital Voice Board!\*
- Programming/Clone software available



Distributed in North America by Amateur Distributing LLC • 23 S. High St., Covington, OH 45318 • (937) 473-2840  
Specifications subject to change without notice or obligation. \*Digital communications require at least two similarly equipped transceivers. Digital mode may not be legal in some countries. See FAQ on digital at [www.alinco.com](http://www.alinco.com). Products intended for use by properly licensed operators. Permits required for MARS use. Specifications subject to change without notice or obligation.

**El Supremo & Founder**  
Wayne Green W2NSD/1

**Associate Publisher**  
F. I. Marion

**Executive Editor**  
Jack Burnett

**Managing Editor**  
Joyce Sawtelle

**Technical Editor**  
Larry Antonuk WB9RRT

**Contributing Culprits**  
Mike Bryce WB8VGE  
Jim Gray II  
Jack Heller KB7NO  
Chuck Houghton WB6IGP  
Andy MacAllister W5ACM  
Joe Moell K0OV  
Steve Nowak KE8YN/0  
Dr. Rick Olsen N6NR

**Advertising Sales**  
Evelyn Garrison WS7A  
21704 S.E. 35th St.  
Issaquah WA 98029  
425-557-9611  
Fax: 425-557-9612

**Circulation**  
Frances Hyvarinen

**Data Entry & Other Stuff**  
Norman Marion

**Business Office**  
Editorial - Advertising - Circulation  
Feedback - Product Reviews  
73 Amateur Radio Today Magazine  
70 Hancock Rd.  
Peterborough NH 03458-1107  
603-924-0058  
Fax: 603-924-8613

Reprints: \$3 per article  
Back issues: \$5 each

Printed in the USA

# 73 Amateur Radio Today

## TABLE OF CONTENTS

### FEATURES

- 10 Build Your DREAM Antenna — AC3L**  
*As in "Dual-suspension, Removable, Easy-to-build, Amateur-radio, Multiple-band, 10-meter mobile antenna system."*
- 14 All Keyed Up — K8ZOA**  
*Over this neat project.*
- 21 Junkbox Telephone Recording Adapter — KC5MFY**  
*Caught on tape.*
- 23 Meter Made — N2DCH**  
*Here's how to recycle those VU meters in old stereos.*
- 26 Autobiography of Everyham — Part 1 — WB9YBM**  
*How many times do you see yourself in this story?*
- 35 All About Electronics Frustration — W6WTU**  
*Or, What to do when neighborly theory meets neighborly reality.*
- 38 Travels with Henryk — Part 10 — SMØJHF**  
*Lithuania: "elementary essence of our hobby."*
- 40 Front and Center — AA2JZ**  
*How to use your computer to make personalized front panels.*

### DEPARTMENTS

- 49 Ad Index  
64 Barter 'n' Buy  
44 Calendar Events  
53 The Digital Port — KB7NO  
50 Homing In — K0OV  
8 Letters  
4 Never Say Die — W2NSD/1  
48 New Products  
45 On the Go — KE8YN/7  
60 Propagation — Gray  
46 QRP — WB8VGE  
1 QRX  
63 Radio Bookshop

**E-Mail**  
[design73@aol.com](mailto:design73@aol.com)

**Web Page**  
[www.waynegreen.com](http://www.waynegreen.com)

## QRX . . .

### Why Computers Crash

If a packet hits a pocket on a socket on a port,  
And the bus is interrupted at a very last resort,  
And the access of the memory makes your floppy  
disk abort,  
Then the socket packet pocket has an error to report.

If your cursor finds a menu item followed by a dash,

And the double-clicking icon puts your window in  
the trash,

And your data is corrupted 'cause the index doesn't  
hash,

Then your situation's hopeless and your system's  
gonna crash!

If the label on the cable on the table at your house,

*Continued on page 6*

**Manuscripts:** Contributions for possible publication are most welcome. We'll do the best we can to return anything you request, but we assume no responsibility for loss or damage. Payment for submitted articles will be made after publication. Please submit both a disk and a hard copy of your article [IBM (ok) or Mac (preferred) formats], carefully checked drawings and schematics, and the clearest, best focused and lighted photos you can manage. "How to write for 73" guidelines are available on request. US citizens, please include your Social Security number with submitted manuscripts so we can submit it to you know who.

**73 Amateur Radio Today** (ISSN 1052-2522) is published monthly by 73 Magazine, 70 Hancock Rd., Peterborough NH 03458-1107. The entire contents ©2003 by 73 Magazine. No part of this publication may be reproduced without written permission of the publisher, which is not all that difficult to get. The subscription rate is: one year \$24.97, two years \$44.97; Canada: one year \$34.21, two years \$57.75, including postage and 7% GST. Foreign postage: \$19 surface, \$42 airmail additional per year, payable in US funds on a US bank. Second class postage is paid at Peterborough, NH, and at additional mailing offices. Canadian second class mail registration #178101. Canadian GST registration #125393314. Microfilm edition: University Microfilm, Ann Arbor MI 48106. POSTMASTER: Send address changes to 73 Amateur Radio Today, 70 Hancock Rd., Peterborough NH 03458-1107. 73 Amateur Radio Today is owned by Shabromat Way Ltd. of Hancock NH.



# ...POWER ON WITH ASTRON

SWITCHING POWER SUPPLIES...



MODEL SS-10TK



MODEL SS-12IF



MODEL SS-18



MODEL SS-25M



MODEL SRM-30



MODEL SRM-30M-2



MODEL SS-12SM/GTX



MODEL SS-10EFJ-98

### SPECIAL FEATURES:

- HIGH EFFICIENCY SWITCHING TECHNOLOGY SPECIFICALLY FILTERED FOR USE WITH COMMUNICATIONS EQUIPMENT, FOR ALL FREQUENCIES INCLUDING HF
- HEAVY DUTY DESIGN
- LOW PROFILE, LIGHT WEIGHT PACKAGE
- EMI FILTER
- MEETS FCC CLASS B

### PROTECTION FEATURES:

- CURRENT LIMITING
- OVERVOLTAGE PROTECTION
- FUSE PROTECTION
- OVER TEMPERATURE SHUTDOWN

### SPECIFICATIONS:

INPUT VOLTAGE: 115 VAC 50/60HZ  
OR 220 VAC 50/60HZ  
SWITCH SELECTABLE  
OUTPUT VOLTAGE: 13.8VDC

AVAILABLE WITH THE FOLLOWING APPROVALS: UL, CUL, CE, TUV.

### DESKTOP SWITCHING POWER SUPPLIES

MODEL	CONT. (Amps)	ICS	SIZE (inches)	Wt.(lbs.)
SS-10	7	10	1 1/4 x 6 x 9	3.2
SS-12	10	12	1 1/4 x 6 x 9	3.4
SS-18	15	18	1 1/4 x 6 x 9	3.6
SS-25	20	25	2 1/4 x 7 x 9 1/2	4.2
SS-30	25	30	3 1/4 x 7 x 9 1/2	5.0

### DESKTOP SWITCHING POWER SUPPLIES WITH VOLT AND AMP METERS

MODEL	CONT. (Amps)	ICS	SIZE (inches)	Wt.(lbs.)
SS-25M*	20	25	2 1/4 x 7 x 9 1/2	4.2
SS-30M*	25	30	3 1/4 x 7 x 9 1/2	5.0

### RACKMOUNT SWITCHING POWER SUPPLIES

MODEL	CONT. (Amps)	ICS	SIZE (inches)	Wt.(lbs.)
SRM-25	20	25	3 1/2 x 19 x 9 1/2	6.5
SRM-30	25	30	3 1/2 x 19 x 9 1/2	7.0

### WITH SEPARATE VOLT & AMP METERS

MODEL	CONT. (Amps)	ICS	SIZE (inches)	Wt.(lbs.)
SRM-25M	20	25	3 1/2 x 19 x 9 1/2	6.5
SRM-30M	25	30	3 1/2 x 19 x 9 1/2	7.0

### 2 ea SWITCHING POWER SUPPLIES ON ONE RACK PANEL

MODEL	CONT. (Amps)	ICS	SIZE (inches)	Wt.(lbs.)
SRM-25-2	20	25	3 1/2 x 19 x 9 1/2	10.5
SRM-30-2	25	30	3 1/2 x 19 x 9 1/2	11.0

### WITH SEPARATE VOLT & AMP METERS

MODEL	CONT. (Amps)	ICS	SIZE (inches)	Wt.(lbs.)
SRM-25M-2	20	25	3 1/2 x 19 x 9 1/2	10.5
SRM-30M-2	25	30	3 1/2 x 19 x 9 1/2	11.0

### CUSTOM POWER SUPPLIES FOR RADIOS BELOW

EF JOHNSON AVENGER GX-MC41  
EF JOHNSON AVENGER GX-MC42  
EF JOHNSON GT-ML81  
EF JOHNSON GT-ML83  
EF JOHNSON 9800 SERIES  
GE MARC SERIES  
GE MONOGRAM SERIES & MAXON SM-4000 SERIES  
ICOM IC-F11020 & IC-F2020  
KENWOOD TK760, 762, 840, 860, 940, 941  
KENWOOD TK760H, 762H  
MOTOROLA LOW POWER SM50, SM120, & GTX  
MOTOROLA HIGH POWER SM50, SM120, & GTX  
MOTOROLA RADIUS & GM 300  
MOTOROLA RADIUS & GM 300  
MOTOROLA RADIUS & GM 300  
UNIDEN SMH1525, SMU4525  
VERTEX — FTL-1011, FT-1011, FT-2011, FT-7011

### NEW SWITCHING MODELS

SS-10GX, SS-12GX  
SS-18GX  
SS-12EFJ  
SS-18EFJ  
SS-10-EFJ-98, SS-12-EFJ-98, SS-18-EFJ-98  
SS-12MC  
SS-10MG, SS-12MG  
SS-101F, SS-121F  
SS-10TK  
SS-12TK OR SS-18TK  
SS-10SM/GTX  
SS-10SM/GTX, SS-12SM/GTX, SS-18SM/GTX  
SS-10RA  
SS-12RA  
SS-18RA  
SS-10SMU, SS-12SMU, SS-18SMU  
SS-10V, SS-12V, SS-18V

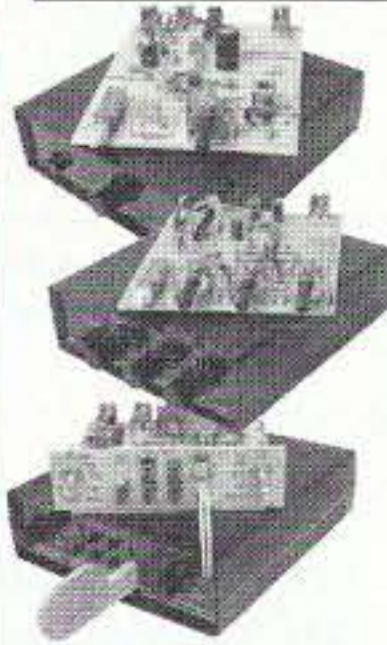
# RAMSEY

**GET THE NEW CATALOG TODAY!**

New Kits, New LPFM, New Cameras  
[www.ramseykits.com](http://www.ramseykits.com)



**WORK THE WORLD WITH A WATT...FOR ONLY \$99!**



### QRP TRANSMITTER

Available in 20, 30, or 40 Meters, these neat little transmitters put out 1 Watt!

### HR RECEIVER

Available in 20, 30, or 40 Meters, 1.0 uV sensitivity rivals the big rigs...at a fraction of the price!

### CW700 KEYER

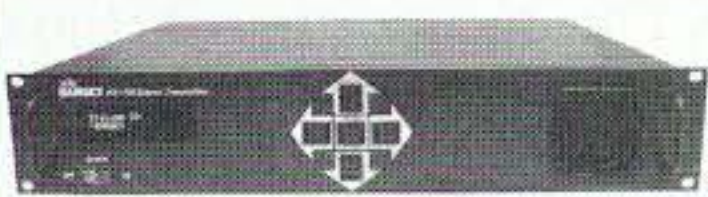
With adjustable pitch & speed from 3-60 wpm, features true iambic keying and EPROM memory!

**\$99 COMPLETE!**

**\$155 Sold Separately**  
 Visit [www.ramseykits.com/qrp](http://www.ramseykits.com/qrp) to order this special deal!

\$99 price includes QRP Transmitter kit, HR Receiver kit, and CW700 Micro-Memory Keyer kit, all the matching case & knob sets shown. Visit [www.ramseykits.com/qrp](http://www.ramseykits.com/qrp) to order this special deal!

### 35 WATT LPFM STEREO TRANSMITTER



- ✓ 35W RF output, VSWR protected
- ✓ Automatic audio & power controls
- ✓ Digital synthesized PLL
- ✓ Full front panel control
- ✓ 110/220VAC, 12VDC operation

Whether your application is export or LPFM, the PX1 has you covered. From the over-rated continuous duty power supply & power amplifier to the 2 line vacuum fluorescent display, your station will be the easiest to setup and the most reliable for continuous operation. Full microprocessor controls provide a "virtual engineer". Check out [www.highpowerfm](http://www.highpowerfm) for full details.

PX1 35W Professional FM Stereo Transmitter \$1,795.95

### TOUCH-TONE TONE GRABBER



- ✓ New-built-in RJ11 phone jack
  - ✓ Large memory holds over 500 numbers
  - ✓ Big bold 8 digit display, auto insertion of dashes
  - ✓ New-output latch jack
- Dialed phone numbers on the radio, repeater codes, control codes, anywhere touch-tones are used, you can read and store them!

All new design for 2002. Capture those tones with the TG2!  
 TG2 Tone Grabber Tone Reader Kit \$59.95  
 CTG2 Matching Case & Knob Set \$14.95  
 AC125 110 VAC Power Adapter \$9.95

### ELECTROCARDIOGRAM HEART MONITOR



- ✓ Visible and audible display of your heart rhythm
  - ✓ Re-usable sensors included; just like visiting the hospital!
  - ✓ Bright LED "beat" indicator
  - ✓ Monitor output for oscilloscope display
- Enjoy learning about the inner workings of the heart while covering the stage by stage electronic circuit theory of ECG/EKG systems. Be heart smart and learn at the same time!

ECG1 Electrocardiogram Heart Monitor Kit \$34.95  
 CECG Matching Case & Knob Set \$14.95  
 AC125 110 VAC Power Adapter \$9.95  
 ECGP10 Replacement Reusable Probe Patches (10-Pack) \$7.95

### XLR TO RCA AUDIO CONVERTER



- ✓ Connect consumer outputs to XLR inputs
  - ✓ Left & right audio gain adjustments
- So you're trying to connect consumer audio outputs with RCA connectors (unbalanced) to XLR (balanced) inputs. Always a problem...Not anymore with the R2XL1!

R2XL1 Unbalanced to Balanced Audio Converter Kit \$49.95  
 CR2XL Matching Case & Knob Set \$14.95  
 PWR25 12VAC Power Adapter \$9.95

### GIVEAWAYS & SPECIALS EVERY MONTH!

Register to receive our E-Mail specials and you will automatically be entered in our monthly drawing! New deals, new specials, new giveaways every month!

**Register TODAY**

[www.ramseykits.com/specials](http://www.ramseykits.com/specials)

### PROFESSIONAL FM STEREO RADIO STATION



- ✓ Synthesized 88 to 108 MHz with no drift!
- ✓ Built-in mixer - 2 line inputs and one microphone input!
- ✓ High power module available for export use
- ✓ Low pass filter for great audio response

Our FM100 is used all over the world by serious hobbyists as well as churches, drive-in theaters, and schools. Frequency synthesized PLL assures drift-free operation with simple front panel frequency selection. Built-in audio mixer features LED bargraph meters to make setting audio a breeze. The kit includes metal case, whip antenna and built-in 110 volt AC power supply.

FM100 Super-Pro FM Stereo Radio Station Kit \$249.95  
 FM100WT 1 Watt, Wired Export Version \$399.95

### SYNTHESIZED FM STEREO TRANSMITTER



- ✓ All new design & features for 2002!
  - ✓ Fully adjustable RF output
- Our #1 kit for years has just gotten better for 2002! Totally redesigned, the FM25B has all the features you've asked for. From variable RF output, F connector RF output jack, line input, loop output, and more.

Includes case, power supply, whip antenna, audio cables.  
 FM25B Synthesized FM Stereo Transmitter Kit \$129.95

### AUTOMATIC COLOR/BW IR CAMERA



- ✓ Color during the day, IR B&W at night!
  - ✓ Automatically turns on IR Illumination!
  - ✓ Waterproof to IP57 standards!
  - ✓ Black anodized housing with universal mount
- Best of both worlds! This video camera is a waterproof COLOR camera during the day. When the light level drops, it automatically changes to B&W and turns on its built-in IR illumination, with 10 IR LEDs. Powered by 12VDC and terminated with a professional BNC connector. B&W only model also available if color is not needed.

Both in heavy anodized black housing.  
 CCD309 Color/B&W IR Waterproof Bullet Camera \$169.95  
 CCD308 B&W IR Waterproof Bullet Camera \$109.95  
 AC125 110 VAC Power Adapter \$9.95

### MINI B&W CAMERA WITH IR ILLUMINATION



- ✓ Built in IR illumination!
  - ✓ Sees in total darkness!
- What a deal! This miniature B&W video camera has 6 high power IR LEDs built into it to provide illumination in total darkness! No need for external IR illuminators. Attractive black aluminum housing easily mounts at any angle with the built-in swivel bracket. Runs on 12VDC, and includes professional BNC output plug-in harness.

CCD303 Mini B&W IR Illuminated Camera \$59.95  
 AC125 110 VAC Power Adapter \$9.95

Check out all our other new cameras at [www.ramseykits.com](http://www.ramseykits.com)



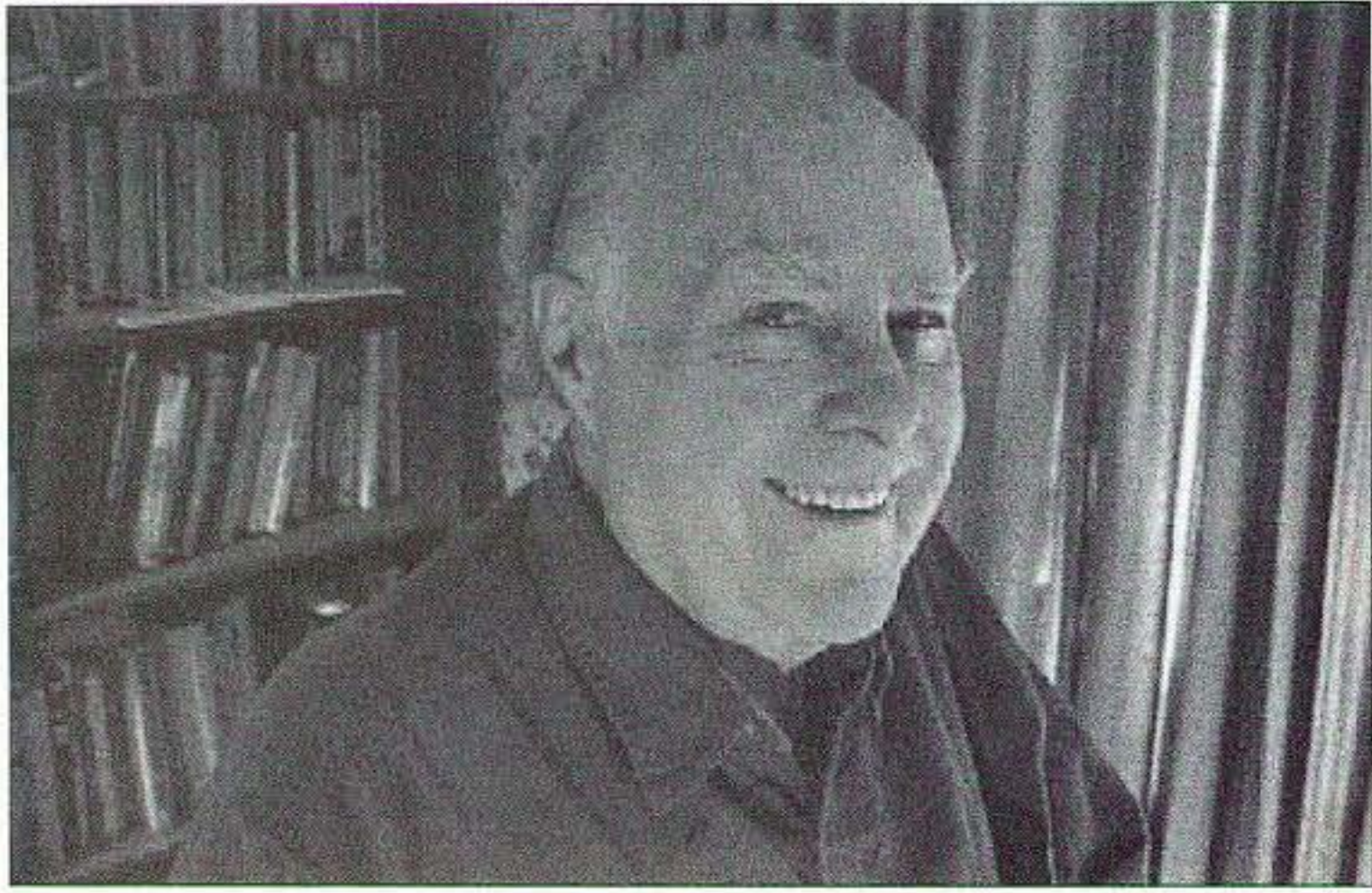
**RAMSEY ELECTRONICS, INC.**

793 Canning Parkway  
 Victor, NY 14564  
 716-924-4560  
[sales@ramseykits.com](mailto:sales@ramseykits.com)



**Order Today! 800-446-2295**

[www.ramseykits.com](http://www.ramseykits.com)



## Wise Up & Beat the Odds

### NEVER SAY DIE

Wayne Green W2NSD/1

w2nsd@aol.com

www.waynegr.com

#### X Again

Have you got your QRP gear in good shape yet? How about emergency power for it? Well, hold tight...I may have more news on Planet X next month.

I've been talking with the experts ... trying to find out who's real and who's bogus when it comes to Planet X. Like Nancy Lieder [www.zetataalk.com], who's been on the talk shows giving us a May 15th date for a pole shift. Now I'm hearing that she may just be a shill for NASA and the sneaky plan is for May 15th to go by with nothing happening...thus blowing up all the Planet X stuff as baloney. Whew! Darn, just when I thought the world as we know it was about to end.

Could Nostradamus, Scallion and the other doomsayers have it wrong?

Nancy's story, that she got her info about Planet X psychically from the Zeta Reticulans does not inspire my confidence. But, on the other hand, I see the events predicted by Mark Hazelwood in *Blindsided* And Jim McCanney in *Planet-X* happening right on schedule. Like our having weird weather. Like more volcanoes and earthquakes than in recorded history. Like both Mars and Pluto heating up. Like the weirdest sun spots in history. Hey, something is going on.

You can join the fun via [www.zetataalk.com], [www.jmccanneyscience.com], and [www.planetxvideo.com].

You can get copies of the two books from Radio

Bookshop, \$15 each, items #94 (Hazelwood) and #95 (McCanney), and scare yourself into getting a good QRP rig working.

#### Iraq

If you are reading this before we attack Iraq, fine. Nobody has asked, but naturally I have some advice for our military commanders. My advice? Drop everything and read *Black Hawk Down* or watch the movie. Wise up and don't get our troops involved with fighting in the cities. Learn from the mess you got into in Somalia.

The alternative? Go back a few hundred years when castles were being attacked. The dumb (military) way was to throw big stones with catapults, use battering rams, ladders to get over the walls, and so on. This killed a lot of the invading army, which probably wasn't a bad thing. The more economical way was to surround the castle and wait for the people inside to run out of food.

Then there's the Genghis Khan approach. When he and his horde started on their campaign they came to the first village on the road and gave them an ultimatum: surrender or be killed. The village fought back. And lost. The invaders proceeded to level the village totally, killing every living thing in it. Men, women, children, and even the chickens.

From then on they never had another problem with villages and towns.

No, I'm not suggesting we

obliterate an Iraqi village as a demo. When our armies come to a city I suggest they circle it and wait for the food to run out. It won't take long before the inhabitants get hungry and will begin to be interested in an alternative to street by street fighting. Let's see videos of long lines of Iraqis surrendering their guns and then sitting around having their first good meal in weeks with our army as hosts. No, let's not be mean and serve them pork pies.

The Iraqis obviously learned from our super botched Somalia. If you watched the segment on "50 Minutes" you saw men, women and children all being given guns and ammunition in Baghdad so that every one of 'em could take out as many Americans as they could. And I'll bet this is happening in every city, town and village in the country.

But, what about a few die-hard snipers who stay in the village, waiting for our soldiers to come into the evacuated town? Hmm, we could be sure the villagers are kept upwind and fumigate the place with poison gas. Or we could, at the first shot, level the town à la Khan, and move on, leaving the villagers to start rebuilding.

But no one asked.

#### Silver Canteens

During WWI the German soldiers used silver canteens. This allowed them to drink the local water as they moved around without getting dysentery,

an illness that debilitated many of the Allied troops.

The ability of silver to kill germs was known long before doctors stopped denying that there was such a thing as germs. A silver dollar was put into milk to keep it from spoiling. Of course, that was back when silver dollars were actually made of silver. And guess what the wealthier people ate with? Silverware. The hoi polloi ate with their hands ... and got sick.

I've been doing a very brisk business selling silver colloid kits. They're item #82 from Radio Bookshop, and consist of an AC power supply, two #10 pure silver wires, instructions, a reprint of an article on making silver colloid, and priority mail shipping ... all for \$37.

If any of this bioterrorism materializes, this stuff could help.

Meanwhile, I've been hearing from a lot of people who have been downing a few teaspoons of 10 ppm every day without turning gray, and reporting no more colds or flu.

#### Immigrants

I don't care where anyone or their parent (or grandparents) came from ... they came to American because it offered a better life than their home country did. What I wish to hell all of 'em would do is accept our language, speak it, accept our culture ... and live it.

I don't want to hear any

Continued on page 8

# Big Savings on Radio Scanners

## Uniden®

## SCANNERS

## AOR



**Bearcat® 785DGV APCO P-25 Digital Ready with free deluxe scanner headset**  
**CEI on-line or phone special price \$339.95**  
 1,000 Channels • 27 bands • CTCSS/DCS • S Meter  
 Size: 6<sup>15</sup>/<sub>16</sub>" Wide x 6<sup>3</sup>/<sub>16</sub>" Deep x 2<sup>3</sup>/<sub>8</sub>" High

New Product. Scheduled for initial release January 10, 2003. Order now.  
**Frequency Coverage:** 25.000-512.000 MHz., 806.000-823.9875MHz., 849.0125-868.9875 MHz., 894.0125-956.000, 1240.000-1300.000 MHz.

When you buy your Bearcat 785D state-of-the art Digital Capable Trunktracker III package deal from Communications Electronics, you get more. The GV means "Great Value." With your BC785D scanner purchase, you also get a free deluxe scanner headphone designed for home or race track use. The Bearcat 785D has 1,000 channels and the widest frequency coverage of any Bearcat scanner ever. When you order the optional **BCi25D, APCO Project 25 Digital Card** for \$299.95, when installed, you can monitor Public Safety Organizations who currently use conventional, trunked 3,600 baud and mixed mode APCO Project 25 systems. APCO project 25 is a modulation process where voice communications are converted into digital communications similar to digital mobile phones. You can also monitor Motorola, EDACS, EDACS SCAT, and EF Johnson systems. Many more features such as S.A.M.E. weather alert, full-frequency display and backlit controls, built-in CTCSS/DCS to assign analog and digital subaudible tone codes to a specific frequency in memory, PC Control with RS232 port, Beep Alert, Record function, VFO control, menu-driven design, total channel control and much more. Our CEI package deal includes telescopic antenna, AC adapter, cigarette lighter cord, DC cord, mobile mounting bracket with screws, owner's manual, trunking frequency guide and one-year limited Uniden factory warranty. For maximum scanning enjoyment, operate your scanner from your computer running Windows. Order Scancat Gold for Windows, part number **SGFW** for \$99.95 and magnetic mount antenna part number **ANTMMBNC** for \$29.95. Not compatible with 9,600 baud APCO digital control channel with digital voice, AGEIS, ASTRO or ESAS systems. For fastest delivery, order on-line at [www.usascan.com](http://www.usascan.com).

**Bearcat® 895XLT Trunk Tracker**  
 Manufacturer suggested list price \$499.95  
**Less -\$320 Instant Rebate / Special \$179.95**  
 300 Channels • 10 banks • Built-in CTCSS • S Meter  
 Size: 10<sup>1</sup>/<sub>2</sub>" Wide x 7<sup>1</sup>/<sub>2</sub>" Deep x 3<sup>3</sup>/<sub>8</sub>" High  
**Frequency Coverage:** 29.000-54.000 MHz., 108.000-174 MHz., 216.000-512.000 MHz., 806.000-823.995 MHz., 849.0125-868.995 MHz., 894.0125-956.000 MHz.

The Bearcat 895XLT is superb for intercepting trunked analog communications transmissions with features like TurboScan™ to search VHF channels at 100 steps per second. This base and mobile scanner is also ideal for intelligence professionals because it has a Signal Strength Meter, RS232C Port to allow computer-control of your scanner via optional hardware and 30 trunking channel indicator annunciators to show you real-time trunking activity for an entire trunking system. Other features include Auto Store - Automatically stores all active frequencies within the specified bank(s). Auto Recording - Lets you record channel activity from the scanner onto a tape recorder. CTCSS Tone Board (Continuous Tone Control Squelch System) allows the squelch to be broken during scanning only when a correct CTCSS tone is received. For maximum scanning pleasure, order the following optional accessories: **PS001** Cigarette lighter power cord for temporary operation from your vehicle's cigarette lighter \$14.95; **PS002** DC power cord - enables permanent operation from your vehicle fuse box \$14.95; **MB001** Mobile mounting bracket \$14.95; **EX711** External speaker with mounting bracket & 10 feet of cable with plug attached \$19.95. **CAT895** Computer serial cable \$29.95. The BC895XLT comes with AC adapter, telescopic antenna, owner's manual and one year limited Uniden warranty. Not compatible with AGEIS, ASTRO, EDACS, ESAS or LTR systems.



### Bearcat® 245XLT Trunk Tracker II

Mfg. suggested list price \$429.95/CEI price \$189.95  
 300 Channels • 10 banks • Trunk Scan and Scan Lists  
 Trunk Lockout • Trunk Delay • Cloning Capability  
 10 Priority Channels • Programmed Service Search  
 Size: 2<sup>1</sup>/<sub>2</sub>" Wide x 1<sup>3</sup>/<sub>4</sub>" Deep x 6" High  
**Frequency Coverage:**  
 29.000-54.000 MHz., 108-174 MHz., 406-512 MHz., 806-823.995 MHz., 849.0125-868.995 MHz., 894.0125-956.000 MHz.

Our Bearcat TrunkTracker BC245XLT is the world's first scanner designed to track Motorola Type I, Type II, Hybrid, SMARTNET, PRIVACY PLUS and EDACS® analog trunking systems on any band. Now, follow UHF High Band, UHF 800/900 MHz trunked public safety and public service systems just as if conventional two-way communications were used. Our scanner offers many new benefits such as Multi-Track - Track more than one trunking system at a time and scan conventional and trunked systems at the same time. 300 Channels - Program one frequency into each channel. 12 Bands, 10 Banks - Includes 12 bands, with aircraft and 800 MHz. 10 banks with 30 channels each are useful for storing similar frequencies to maintain faster scanning cycles or for storing all the frequencies of a trunked system. Smart Scanner - Automatically program your BC245XLT with all the frequencies and trunking talk groups for your local area by accessing the Bearcat national database with your PC. If you do not have a PC simply use an external modem. Turbo Search - Increases the search speed to 300 steps per second when monitoring frequency bands with 5 KHz. steps. 10 Priority Channels - You can assign one priority channel in each bank. Assigning a priority channel allows you to keep track of activity on your most important channels while monitoring other channels for transmissions. Preprogrammed Service (SVC) Search - Allows you to toggle through preprogrammed police, fire/emergency, railroad, aircraft, marine, and weather frequencies. Unique Data Skip - Allows your scanner to skip unwanted data transmissions and reduces unwanted birdies. Memory Backup - If the battery completely discharges or if power is disconnected, the frequencies programmed in your scanner are retained in memory. Manual Channel Access - Go directly to any channel. LCD Back Light - An LCD light remains on for 15 seconds when the back light key is pressed. Autolight - Automatically turns the backlight on when your scanner stops on a transmission. Battery Save - In manual mode, the BC245XLT automatically reduces its power requirements to extend the battery's charge. Attenuator - Reduces the signal strength to help prevent signal overload. The BC245XLT also works as a conventional scanner. Now it's easy to continuously monitor many radio conversations even though the message is switching frequencies. The BC245XLT comes with AC adapter, one rechargeable long life ni-cad battery pack, belt clip, flexible rubber antenna, earphone, RS232C cable, Trunk Tracker frequency guide, owner's manual and one year limited Uniden warranty. Not compatible with AGEIS, ASTRO, ESAS or LTR systems.

Hear more action on your radio scanner today. Order on-line at [www.usascan.com](http://www.usascan.com) for quick delivery. For maximum scanning satisfaction, control your Bearcat 245XLT from your computer running Windows. Order Scancat Gold for Windows, part number **SGFW** for \$99.95 or the surveillance enhanced version with audio recording part number **SGFWSE** for \$159.95.

### More Radio Products

Save even more on radio scanners when purchased directly from CEI. Your CEI price after instant rebate is listed below:

Bearcat 895XLT 300 ch. Trunktracker I base/mobile scanner.....	\$179.95
Bearcat 785D 1,000 channel Trunktracker III base/mobile.....	\$339.95
Bearcat BCi25D APCO Project 25 digital software card.....	\$299.95
Bearcat 278CLT 100 ch. AM/FM/SAME WX alert scanner.....	\$139.95
Bearcat 250D 1,000 ch. Trunktracker III handheld scanner.....	\$339.95
Bearcat 245XLT 300 ch. Trunktracker II handheld scanner.....	\$189.95
Bearcat 248CLT 50 ch. base AM/FM/weather alert scanner.....	\$84.95
Bearcat Sportcat 200 alpha handheld sports scanner.....	\$159.95
Bearcat Sportcat 180B handheld sports scanner.....	\$139.95
Bearcat 80XLT 50 channel handheld scanner.....	\$99.95
Bearcat 60XLT 30 channel handheld scanner.....	\$74.95
Bearcat BCT7 information mobile scanner.....	\$139.95
AOR AR16BQ Wide Band scanner with quick charger.....	\$199.95
Sangean ATS909 306 memory shortwave receiver.....	\$209.95
Sangean ATS818 45 memory shortwave receiver.....	\$139.95
Uniden WX500 Weather Alert with S.A.M.E. feature.....	\$39.95

### AOR® AR8200 Mark IIB Radio Scanner

AOR8200 Mark IIB-A wideband handheld scanner/SPECIAL \$539.95  
 1,000 Channels • 20 banks • 50 Select Scan Channels  
 PASS channels: 50 per search bank + 50 for VFO search  
 Frequency step programmable in multiples of 50 Hz.  
 Size: 2<sup>1</sup>/<sub>2</sub>" Wide x 1<sup>3</sup>/<sub>8</sub>" Deep x 6<sup>1</sup>/<sub>8</sub>" High  
**Frequency Coverage:**  
 500 KHz to 823.995 MHz, 849.0125-868.995 MHz, 894.0125-2,040.000 MHz  
 (Full coverage receivers available for export and FCC approved users.)



The AOR AR8200 Mark IIB is the ideal handheld radio scanner for communications professionals. It features all mode receive: WFM, NFM, SFM (Super Narrow FM), WAM, AM, NAM (wide, standard, narrow AM), USB, LSB & CW. Super narrow FM plus Wide and Narrow AM in addition to the standard modes. The AR8200 also has a versatile multifunctional band scope with save trace facility, twin frequency readout with bar signal meter, battery save feature with battery low legend, separate controls for volume and squelch, arrow four way side rocker with separate main tuning dial, user selectable keypad beep/illumination and LCD contrast, write protect and keypad lock, programmable scan and search including LINK, FREE, DELAY, AUDIO, LEVEL, MODE, computer socket fitted for control, clone and record, Flash-ROM no battery required memory, true carrier reinsertion in SSB modes, RF preselection of mid VHF bands, Detachable MW bar aerial. Tuning steps are programmable in multiples of 50 Hz in all modes, 8.33 KHz airband step correctly supported, Step-adjust, frequency offset, AFC, Noise limited & attenuator, Wide and Narrow AM in addition to the standard modes. For maximum scanning pleasure, you can add one of the following optional slot cards to this scanner: **CT8200** CTCSS squelch & search decoder \$89.95; **EM8200** External 4,000 channel backup memory, 160 search banks. \$69.95; **RU8200** about 20 seconds chip based recording and playback \$69.95; **TE8200** 256 step tone eliminator \$59.95. In addition, two leads are available for use with the option socket. **CC8200A** personal computer control lead \$109.95; **CR8200** tape recording lead \$59.95. Includes 4 1,000 mAh AA ni-cad batteries, charger, cigarette lighter adapter, whip aerial, MW bar antenna, belt hook, strap and one year limited AOR warranty. For fastest delivery, enter your order on-line at <http://www.usascan.com>.

### Buy with Confidence

#### Order on-line and get big savings

For over 33 years, millions of communications specialists and enthusiasts worldwide have trusted Communications Electronics for their mission critical communications needs. It's easy to order. For fastest delivery, order on-line at [www.usascan.com](http://www.usascan.com). Mail orders to: Communications Electronics Inc., P.O. Box 1045, Ann Arbor, Michigan 48106 USA. Add \$20.00 per radio receiver for UPS ground shipping, handling and insurance to the continental USA. Add \$15.00 shipping for all accessories and publications. For Canada, Puerto Rico, Hawaii, Alaska, Guam, P.O. Box or APO/FPO delivery, shipping charges are two times continental US rates. Michigan residents add sales tax. No COD's. Your satisfaction is guaranteed or return item in unused condition in original packaging within 61 days for refund, less shipping, handling and insurance charges. 10% surcharge for net 10 billing to qualified accounts. All sales are subject to availability, acceptance, verification and authentication. Prices, terms and specifications are subject to change without notice. We welcome your Discover, Visa, American Express, MasterCard, IMPAC and Eurocard. Call anytime 1-800-USA-SCAN or 800-872-7226 to order toll-free. Call +1-734-996-8888 if outside Canada or the USA. FAX anytime, dial +1-734-663-8888. Dealer and international inquiries invited. Order your radio products from CEI today at [www.usascan.com](http://www.usascan.com).

For credit card orders call  
**1-800-USA-SCAN**

e-mail: [cei@usascan.com](mailto:cei@usascan.com)

[www.usascan.com](http://www.usascan.com)

PO Box 1045, Ann Arbor, Michigan 48106-1045 USA  
 For information call 734-996-8888 or FAX 734-663-8888  
 Price schedule effective December 2, 2002 AD #120202 © 2002 Communications Electronics Inc.

**COMMUNICATIONS ELECTRONICS INC.**  
 Emergency Operations Center

Visit [WWW.USASCAN.COM](http://WWW.USASCAN.COM) • 1-800-USA-SCAN

continued from page 1

Says the network is connected to the button on your mouse,

But your packets want to tunnel to another protocol,

That's repeatedly rejected by the printer down the hall,

And your screen is all distorted by the side effects of gauss,

So your icons in the window are as wavy as a souse,

Then you may as well reboot and go out with a bang,

'Cause sure as I'm a poet, the sucker's gonna hang!

Thus when the copy of your floppy's getting sloppy in the disk,

And the macro code instructions cause unnecessary risk,

Then you'll have to flash the memory and you'll want to RAM your ROM,

Then quickly turn off the computer — and be sure to tell your mom!

Thanks to unknown author, from the Internet, Dec. 2002.

## Down Under Update

The Wireless Institute of Australia has recently updated its Web site. All those who wish to apply for Wireless Institute of Australia awards certificates should immediately check out their new Web site data at [<http://www.wia.org.au>], and use the following address: Malcolm K. Johnson VK6LC, Wireless Institute of Australia, Federal Awards Manager, P.O. Box 196, Cannington 6987, Western Australia, Australia; [[awards@wia.org.au](mailto:awards@wia.org.au)].

Thanks to VK6LC.

## Element Two Technician Question Pool Revised

The FCC question pool for Element 2, the Technician written exam, has been revised. The new 511-item pool will take effect on July 1, 2003. The older pool contains 385 items. The new question pool can be viewed via [[www.arrl.org/arrlvec/pools.html](http://www.arrl.org/arrlvec/pools.html)].

Thanks to Balanced Modulator, Jan.–Feb. 2003.

## Here's Lookin' at the REAL Ya!

In more news from Venus, we've learned that our source for last month's item on the canals had ITS source wrong, so we hasten to credit Bob Gonsett and his *CGC Communicator* for that eye-opener.

## Dog Days of Winter

An inter-species communications apparatus — as in a dog-to-person translator — was one of the winners of the 2002 Ig Noble awards.

What are the Ig Noble awards, you ask? They are a spoof of the famed Nobel Awards ceremony and are given annually at Harvard University to recognize achievements that cannot or should not ever be reproduced.

Winners are selected by a secret committee from thousands of nominations. Actual Nobel laureates present the Ig Nobles at a ceremony where the winners are hailed with cheers and a flurry of paper airplanes. And if a recipient feels insulted or slighted by the award, it is withdrawn.

For 2002, those victorious included the people behind the definitive study on belly-button lint, and an inquiry into what arouses ostriches. But by far the dog-to-person translator was one of the most popular. It works by listening to the tone of a dog's bark, converting that data into an interpretation of the dog's mood.

The device is already on the market in Japan. An English language version called Bow-Wow-Lingual — nope, we are not kidding — Bow-Wow-Lingual — may be on the market here in the USA in about a year. And we thought that you'd want to know.

For more about the Ig Noble awards, see [[www.improb.com/ig/ig-top.html](http://www.improb.com/ig/ig-top.html)].

Thanks to Science Frontiers, via Newline, Bill Pasternak, editor, with special mention to his dog, Daisy.

## Beam Me Up

As incredible as it may seem, a Star Trek-like transporter may be a step closer to reality. This, after physicists in Denmark make two samples of trillions of atoms interact at some distance.

The experiment involved a science called quantum entanglement. This is a mysterious theory of a controlled spiraling of two or more particles without any physical contact. Scientists say that these entangled states are needed for quantum computing and for teleportation.

Before the team at the University of Aarhus made its breakthrough, other scientists had successfully developed entangled states of a few atoms. But the scientists in Denmark have now done it with very large numbers.

At the moment, nobody is about to teleport anyone, anywhere. But the research, which was reported in the science magazine *Nature*, makes the idea of instantly transporting an object from one place to another less far-fetched.

If all goes well, maybe the term "Beam me up, Scotty" will be reality in our great, great, great grandchildren's lifetime. The only question is whether a 5 word-per-minute Code test will still be required to "communicate" using that rather exotic mode.

Thanks to Future Technology, via Newline, Bill Pasternak WA6ITF, editor.

## Zero Gravity

When NASA first started sending up astronauts, they quickly discovered that ballpoint pens would not work in zero gravity. To combat this problem, NASA scientists spent a decade and \$12 billion developing a pen that writes in zero gravity, upside down, underwater, on almost any surface, including glass, and at temperatures ranging from below freezing to over 300 degrees C.

The Russians used a pencil.

Thanks to The Tuned Circuit, November 2002.

## Dumb Newspaper Headlines

- Include Your Children When Baking Cookies
  - Something Went Wrong in Jet Crash, Experts Say
  - Police Begin Campaign to Run Down Jaywalkers
  - Drunks Get Nine Months in Violin Case
  - Iraqi Head Seeks Arms
  - Is There a Ring of Debris Around Uranus?
  - Prostitutes Appeal to Pope
  - Panda Mating Fails; Veterinarian Takes Over
  - British Left Waffles on Falkland Islands
  - Teacher Strikes Idle Kids
  - Clinton Wins Budget; More Lies Ahead
  - Plane Too Close to Ground, Crash Probe Told
  - Miners Refuse to Work After Death
  - Juvenile Court to Try Shooting Defendant
  - Stolen Painting Found by Tree
  - Two Sisters Reunited After 18 Years in Checkout Counter
  - War Dims Hope for Peace
  - If Strike Isn't Settled Quickly, It May Last a While
  - Couple Slain; Police Suspect Homicide
  - Man Struck by Lightning Faces Battery Charge
  - New Study of Obesity Looks for Larger Test Group
  - Astronaut Takes Blame for Gas in Space
  - Kids Make Nutritious Snacks
  - Local High School Dropouts Cut in Half
  - Typhoon Rips Through Cemetery; Hundreds Dead
- Thanks to the "Giggle Hertz" section of Radio Flyer, the *UBET ARC newsletter*, April 2002.

## Hot Air

Well, another would-be tallest man-made structure could soon be towering over the Australian outback. This, as part of a plan to capitalize on the global push for greater use of renewable energy.



By 2006, the Australian power company EnviroMission Ltd. hopes to build a 3,300-foot-high solar tower in southwest New South Wales state. The 200 megawatt solar generating station will cost nearly \$563 million dollars to build and will be the width of a football field.

The technology behind its operation is very simple. The sun heats air under the tower's glass roof. As the hot air rises, a powerful updraft is also created by the tower that allows air to be continually sucked through 32 turbines, which spin to generate power.

EnviroMission hopes to begin construction on the solar tower before the end of the year. It says that it plans on generating enough electricity to supply 200,000 homes around the beginning of 2006.

Currently, the world's tallest free-standing structure is the Canadian National Tower in Toronto. It's about 1,650 feet high.

Thanks to W8HDU, via Newsline, Bill Pasternak WA6ITF, editor.

## W6OBB Retires

Art Bell W6OBB bid a final farewell to his "Coast-to-Coast A.M." radio show as 2002 gave way to 2003. Over the 15 years he hosted the show, Bell took it to the very top of the ratings

peak. It was on over 450 radio stations in North America and heard worldwide over the Internet, and had an audience estimated in the tens of millions.

Bell had departed the show once before due to a family situation that needed his full time and attention. The show did not do well under the substitute hosts. Bell returned the following year and rebuilt the program to its powerhouse position on the Premiere Radio Network. Often, after the program, Bell could be found on 75 meters chatting with his friends.

In saying good-bye to his listeners, W6OBB explained that this is not the end of his career in radio. Actually, it's a new beginning.

Bell says that he and his wife have made one of their dreams come true. They built their own radio station — KNYE — located in Pahrump, Nevada — and it's now on the air. Bell says that building KNYE into the station he wants it to become will be the next challenge in his broadcasting career.

Meantime, you can still hear — and talk to — Art Bell, but only if your signal can be heard in Pahrump, Nevada. Just listen on or near 3.840 MHz for the callsign W6OBB. If you hear Art, please say hello, and you might add, "Thanks for the ride..."

Thanks to Newsline, Bill Pasternak WA6ITF, editor.

## Words That Don't Exist, But Should

**AQUADEXTROUS** (ak wa DEKS trus), adj. Possessing the ability to turn the bathtub tap on and off with your toes.

**CARPERPETUATION** (KAR pur pet u AY shun), n. The act, when vacuuming, of running over a string or a piece of lint at least a dozen times, reaching over and picking it up, examining it, then putting it back down to give the vacuum one more chance.

**DISCONFECT** (dis kon FEKT), v. To sterilize the piece of confection (lollipop) you dropped on the floor by blowing on it, assuming this will somehow "remove" all the germs.

**ELBONICS** (el BON iks), n. The actions of two people maneuvering for one armrest in a movie theater.

**FRUST** (frust), n. The small line of debris that refuses to be swept onto the dust pan and keeps backing a person across the room until he finally decides to give up and sweep it under the rug.

**LACTOMANGULATION** (LAK toe man gyu LAY shun), n. Manhandling the "open here" spout on a milk container so badly that one has to resort to the "illegal" side.

Continued on page 61

# Smart Choice! Smartuner!

Do YOU want to be heard? *OF COURSE!* Then use the SGC Smartuner™ - the *Essential* link between your **HF transceiver** and **antenna**. Matching at the transceiver is good, but matching at the antenna is better. SGC Smartuners are designed to do just that. They operate completely independently to provide the best match between the feed line and the antenna, eliminating SWR problems completely.

SGC Smartuners are designed to work with *any* transceiver (including the ICOM 802) and *any* antenna. They are fully automated, intelligent enough to select the best match between feed line and antenna in seconds and remember it so it can recall that match in milliseconds. The Smartuner sets the standard. It is the original and still the best.



Illustration from the original SGC Marine SSB Facebook, 1974

Once you've learned how the Smartuner works, you won't want anything else!



SG-230



No Compromise Communications



SG-231

Visit [www.sgeworld.com](http://www.sgeworld.com) for more information on the entire line of Smartuners

SGC Inc. 13737 SE 26th St. Bellevue, WA 98005 USA Tel: 425-746-6310 Fax: 425-746-6384  
[sgc@sgeworld.com](mailto:sgc@sgeworld.com) [www.sgeworld.com](http://www.sgeworld.com)

# LETTERS

## From the Ham Shack

**Herman KN5GRK.** I read "Never Say Die" in the November issue of *73 Amateur Radio Today*. Your column brings out how important a mobile emergency communications vehicle will be in time of a disaster such as the ones you mention in this article. I don't subscribe to *73* but was referred to your article by a fellow ham who realized it had a bearing on our club project.

Our club purchased a 1987 Chevrolet step van, and we are currently getting it ready to make a "mobile operations center" — some of the reasons we feel we need this van are mentioned in your article. We are in the process of obtaining letters of recommendation from local emergency agencies, police, sheriff, fire, mayors, school board, etc., in order to obtain a federal grant from the FDA to purchase the equipment to be used in this project.

I would also like to have your permission to use this article or portions of your article in our next newsletter and as a reference to some of these agencies to get our point across. Credit will be given to you and *73* magazine.

I see that you would like to have a report and pictures of these emergency mobile communications vehicles. I have added a photo gallery on our van project with a link to "Scope of Project" that explains what we plan to do with our van. We have a long road to travel, but I think the waiting and work will pay off, plus provide a lot of fun and education in amateur radio for our club.

If you would like to see our pictures, just go to: [<http://www.w5ddl.org/clubsite/vanproject.htm>].

*Permission granted, for this worthy*

*project, OM ... but please be sure to include subscription information in the reprints, in case anybody who has been too cheap to subscribe thus far feels so inclined ... if you know what we mean. Good luck, and keep up the good work! — ed.*

**Tracy Markham N4LGH.** I just want to say thank you, heartily, thank you, for the QRX article on Dollar Power in the Jan 2003 issue.

I understand a lot of the symbolism that Ben Franklin and Thomas Jefferson and their "gang" built into our insignias and other marks. But I never looked at the dollar, and the symbols on it, like I have since I read that article.

Thank you for finding it — I know you're not sure of the author, and perhaps it's best that way really. Again, thank you ...

**Clinton Peebles VE7KNL.** It's a sad fact, but there are dishonest hams out there. At least they call themselves amateur radio operators, but in my opinion they are nowhere close. I have recently had the unfortunate opportunity to deal with one. I purchased a Kenwood TMD-700A radio, serial number 30100018, from K.A. in Edmonton. It's now been 6 months and I still haven't seen the radio, nor do I expect to. Like a fool, I trusted him and sent him a money order. Never do this! C.O.D. charges are small compared to what you will lose. I know of at least one other ham who was also taken in by this thief for the same radio. Don't count on help from the R.C.M.P. — you won't get it.

There is a group on [[www.yahogroups.com](http://www.yahogroups.com)] called BADHAM. If you are planning on a private purchase, it's a good idea to use this group. If you've been ripped off, please list the culprit there so others don't get ripped off by the same crook.

**Ray J. Howes G4OWY.** Wow, "440 home-brewed projects" ("Letters," January 2003). KC6WZK, I salute you! This man puts me to shame — and how many others, too, I wonder? And what's even better, he's a QRPer as well!

Yes, as Dain rightly implies, home-brewing ham equipment (not kits), especially transceivers, is now unfortunately a minority interest amongst hams. No doubt this is due in part to many things — commercialization of our hobby and a lack of a willingness to just get on and do it, to name just two.

Anyhow, I'm sure that anyone reading KC6WZK's letter (and seeing his station photograph) can't fail to be fired up to try to emulate, if only in part, this particular ham's obvious love of rolling your own! Here's to many more constructive years of home-brewing and QRPing, Dain!

**Edwin Olsen W4GES.** My most recent lipid panel results are beautiful, and this without Liptor or Zocor, or any other cholesterol-lowering drugs. I attribute this to following your dietary guidelines. Each of these drugs had had a very adverse effect on my liver. In the case of Zocor, it took months before my liver enzymes went back to normal. Thank you for your pioneering efforts in promoting good health.

## NEVER SAY DIE

*continued from page 4*

more crap about Irish-Americans, German-Americans, African-Americans, Italian-Americans, and so on. Look, guys, you're here, and if you plan to stay get rid of that crummy hyphen and start thinking of yourselves as Americans. Accept and live our culture. Please don't continue to try to keep the "old country" culture alive here. You left that for something better.

Yes, a bunch of Americans have different skin colors. Get over it.

It's about damned time for blacks to forget Africa. I'll be glad to start

taking up a collection to pay blacks their fare to any country in Africa they'd like to move to and give them a stake to get them started there.

It won't take much of a collection because I doubt I'll have any takers. I've been to a bunch of African countries (10 so far) and there isn't one I'd want to live in. No American black would either, if they'd ever visited any of 'em.

Let's stop this destructive nonsense of school classes for non-American-speaking children. Government forms should be in American, and not in any other languages. Let's even get rid of American newspapers published in

foreign languages. America, love it or, dammit, leave it!

Foreigners coming here should accept our American heritage and forget the one they left behind. Our heritage is a combo of English, Scotch, Irish, Italian, German, Russian, Jewish, American Indian, and so on. No, I have no problem with Chinese, German, and so on restaurants. The more foreign food restaurants, the better. Well, that's as long as you insist on poisoning your body with cooked food and shortening your life. Bon appetite. Bon obesity, diabetes, and heart attacks.

*Continued on page 42*

## LOW NOISE PREAMPS

### LNY-( ) ECONOMY PREAMP

ONLY \$29/w&t

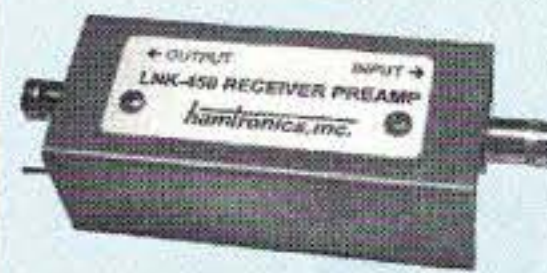
- Miniature MOSFET Preamp.
- Low noise figure.
- Available for various bands from 28 to 450 MHz.



### LNK-( ) PREAMP

ONLY \$59/w&t

Low noise preamp in alum case w/ BNC jacks.

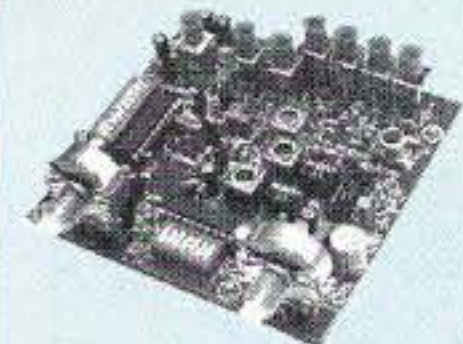


### LNP-( ) PRESELECTION ONLY \$49/w&t

- Eliminate intermod!
- Sharp 3-section filter
- Low noise preamp
- Available for bands from 137 to 170 MHz.



## R121 AVIATION RECEIVER



- AM receiver for the 118-137 MHz aircraft band.
- Allows pilot control of runway lighting.
- ELT monitor to detect and locate downed aircraft.
- Used at small airports across the country.

- Dip switch frequency selection.
- Superior sensitivity and selectivity.

R121 Receiver module wired/tested .....\$209  
 R121 Receiver in cabinet (see website).....\$299

## WEATHER FAX RECEIVER

Join the fun. Get striking images directly from the weather satellites!

A very sensitive wideband fm receiver optimized for NOAA APT & Russian Meteor weather fax on the 137MHz band.



Covers all 5 satellite channels. Scanner circuit & recorder control allow you to automatically capture signals as satellites pass overhead, even while away from home.

- R139 Receiver Kit less case .....\$159
- R139 Receiver Kit with case and ac power adapter.....\$189
- R139 Receiver w/t in case with ac power adapter.....\$239
- Turnstile Antenna .....\$135

## WEATHER ALERT RECEIVER



A sensitive and selective professional grade receiver to monitor critical NOAA weather broadcasts. Good reception even at distances of 70 miles or more with suitable antenna. No comparison with ordinary consumer radios!

Automatic mode provides storm watch, alerting you by unmuting receiver and providing an output to trip remote equipment when an alert tone is broadcast. Crystal controlled for accuracy; all 7 channels (162.40 to 162.55).

- RWX Rcvr kit, PCB only .....\$79
- RWX Rcvr kit with cabinet, spkr, & ac adapter .....\$109
- RWX Rcvr w/t in cabinet with spkr & adapter.....\$149

## WWV RECEIVER

Get time & frequency checks without buying multiband hf rcvr. Hear solar activity reports affecting radio propagation.

Very sensitive and selective crystal controlled superhet, dedicated to listening to WWV on 10 MHz. Performance rivals the most expensive rcvrs.



- RWWV Rcvr kit, PCB only .....\$69
- RWWV Rcvr kit with cabt, spkr, & ac adapter .....\$109
- RWWV Rcvr w/t in cabt with spkr & adapter .....\$149

## HIGH PERFORMANCE VHF & UHF EXCITER & RECEIVER MODULES

### FM EXCITERS:

2W continuous duty output.

#### T301 Synthesized VHF Exciter:

for various bands 139-174 MHz, 216-226 MHz. Dip switch freq. setting. TCXO freq stability.

- Kit 2M only (TCXO option \$40).....\$109
- Wired/tested, incl TCXO .....\$189

#### T304 Synthesized UHF Exciter:

for various bands 400-470 MHz.

- Kit (440-450 ham band only) incl TCXO .....\$149
- Wired/tested .....\$189

#### CRYSTAL CONTROLLED:

- TA51: for 6M, 2M, 220 MHz ..... kit \$99, w/t \$169
- TA451: for 420-475 MHz. .... kit \$99, w/t \$169
- TA901: for 902-928 MHz, (0.5W out)..... w/t \$169



### VHF & UHF POWER AMPLIFIERS:

Output levels from 10W to 100W..... Starting at \$99

### FM RECEIVERS:

Very sensitive, 0.2µV.

Superb selectivity, >100 dB down at ±12 kHz, best available anywhere, flutter-proof squelch.

#### R301 Synthesized VHF Receiver:

various bands 139-174MHz, 216-226 MHz. Dip switch freq. setting. TCXO freq stability.

- Kit 2m only (TCXO option \$40) ..... only \$139
- Wired/tested (incl TCXO) ..... \$209

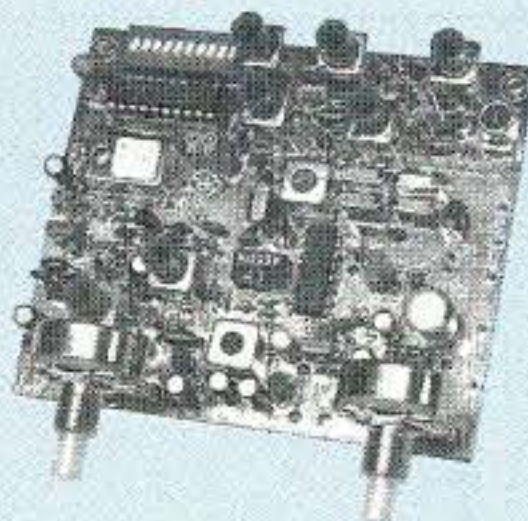
#### R304 Synthesized UHF Receiver:

various bands 400-470MHz.

- Kit 440-450 only (incl TCXO) ..... \$179
- Wired/tested ..... \$209

#### CRYSTAL CONTROLLED:

- R100 for 46-54, 72-76, 140-175, or 216-225 MHz. .... kit \$129, w/t \$189
- R451 for 420-475 MHz. .... kit \$129, w/t \$189
- R901 for 902-928MHz ..... kit \$159, w/t \$219



## CTCSS TONE ENCODER/DECODER



Access all your favorite repeaters!

- Encodes all standard subaudible tones with crystal accuracy and DIP switch tone selection.

• Decoder can be used to mute receive audio and is optimized for installation in repeaters to provide closed access. High pass filter gets rid of annoying rcvr buzz.

- TD-5 CTCSS Encoder/Decoder Kit .....\$39
- TD-5 CTCSS Encoder/Decoder Wired/tested .....\$59

## TRANSMITTING & RECEIVING CONVERTERS

No need to spend thousands on new transceivers for each band!

- Convert vhf and uhf signals to & from 10M.

• Receiving converters available for various segments of 2M and 432 MHz bands.

- Rcvg Conv Kits from \$49, wired/tested units only \$99.



- Transmitting converters for 2M.
- Kits only \$89. • Power amplifiers up to 50W.

## Get more features for your dollar with our REP-200 REPEATER

A microprocessor-controlled repeater with full autopatch and many versatile dtmf remote control features at less than you might pay for a bare bones repeater or controller alone!

There are more REP-200's on the air than any other repeater in the world.



- kit still only \$1095
- factory assembled still only \$1295

50-54, 143-174, 213-233, 420-475 MHz.

( FCC type accepted for commercial service in 150 & 450 MHz bands.)

**Digital Voice Recorder Option.** Allows message up to 20 sec. to be remotely recorded off the air. Play back at user request by DTMF command, or as a periodic voice id, or both. **Great for making club announcements!** .....only \$100

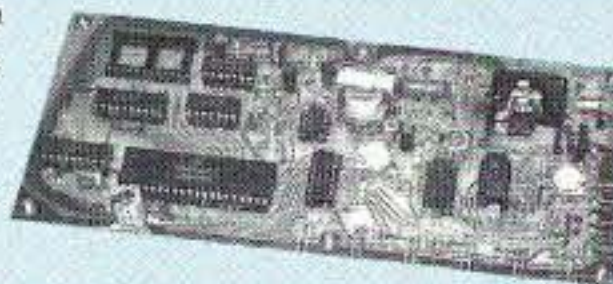
**REP-200C Economy Repeater.** Real-voice ID, no dtmf or autopatch. .... Kit only \$795, w&t \$1195

**REP-200N Repeater.** Without controller so you can use your own. .... Kit only \$695, w&t \$995

## You'll KICK Yourself If You Build a Repeater

Without Checking Out Our Website First!

Hamtronics has the most complete line of modules for making repeaters. In addition to exciters, pa's, and receivers, we offer the following controllers.



**COR-3.** Inexpensive, flexible COR module with timers, courtesy beep, audio mixer. ....only \$49/kit, \$79 w/t

**CWID-2.** Eeprom-controlled ID'er.....only \$54/kit, \$79 w/t

**DVR-1.** Record your own voice up to 20 sec. For voice id or playing club announcements. ....\$59/kit, \$99 w/t

**COR-4.** Complete COR and CWID all on one board. ID in eeprom. Low power CMOS .....only \$99/kit, \$149 w/t

**COR-6.** COR with recorded-voice id. Low power CMOS, non-volatile memory. .... kit only \$99, w/t only \$149

**COR-5.** Microprocessor controller with autopatch, reverse ap, telephone remote control, lots of DTMF control functions, all on one board, as used in REP-200 Repeater. ....\$379 w/t

**AP-3.** Repeater autopatch, reverse autopatch, phone line remote control. Use with TD-2. .... kit \$89

**TD-2.** Four-digit DTMF decoder/controller. Five latching on-off functions, toll call restrictor. .... kit \$79, w/t \$129

## HANDY FREQUENCY COUNTERS

Pocket sized, but lab quality! 3GHz bandwidth, 1ppm accuracy, very affordable. NiCd battery, ac adapter/charger, rugged black anodized aluminum case. Telescoping whip antenna and great sensitivity allow measurements even from a distance.

Two models with prices from \$149. Both go up to 3 GHz; one goes down to 10 Hz with noise filters and other advanced features. See our website for details.



## Hamtronics, Inc.

65 Moul Rd; Hilton NY 14468-9535

Ph: 585-392-9430; Email: sales@hamtronics.com

See special offers and view complete catalog on our web site -

**hamtronics.com**

# Build Your DREAM Antenna

*As in "Dual-suspension, Removable, Easy-to-build, Amateur-radio, Multiple-band, 10-meter mobile antenna system.*

*Take a couple of hours, mix in a little creativity, and you can change that boring commute to work every day into hours of glowing reports and solid contacts.*

**T**his article describes an effective, efficient, broadband, 10-meter DX mobile antenna. Now, don't let poor past experiences with mobile signals put you off — you'll be surprised at the difference a full-size quarter wave antenna makes, especially if you're used to dealing with magnetic-mount antennas. The best mobile signal reports I've ever received were from 102-inch steel whips that were cut down to the 10-meter band.

Let's quickly review some of the problems with using a short antenna. You already know they're inefficient because of their size and use of coils, not to mention the narrow SWR bandwidths. And hey, get just a little bit of dirt or grit under the magnet and you get this interesting circle of annoying scratch marks right on the top of your car. On the other hand, quarter wave antennas are efficient and broadbanded, and this design does not cause any damage to the car! Plus, since we'll be using a standard antenna mount, if you ever get tired of 10 meters (can't happen, by the way!), you can just swap the whip for one of the many other antennas on the market.

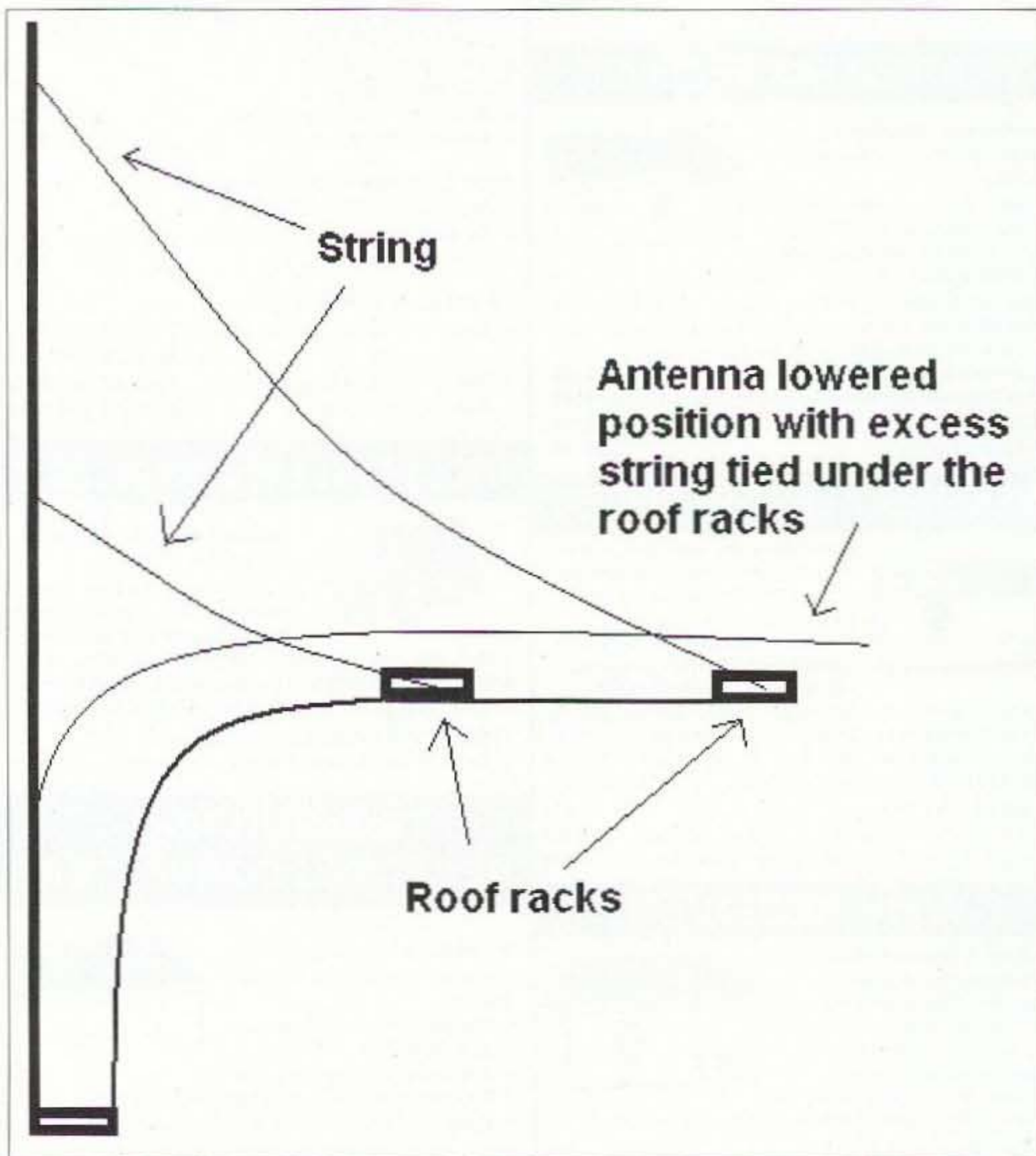


Fig. 1. Dual suspension.

Even with all these reasons to do this project, that doesn't mean there aren't any drawbacks to having an 8-foot monster antenna tacked onto the back of your vehicle. One problem to watch out for is the low-hanging trees in the neighborhood. I've whacked many a branch, so be on the lookout. And what about the fast food drive-through or even garages? Height limits are a problem there as well. Don't worry. My patented (yeah, right) design will solve these problems for you. To see how, let's start by taking a look at the promise of the article title.

### Dual-suspension (Fig. 1)

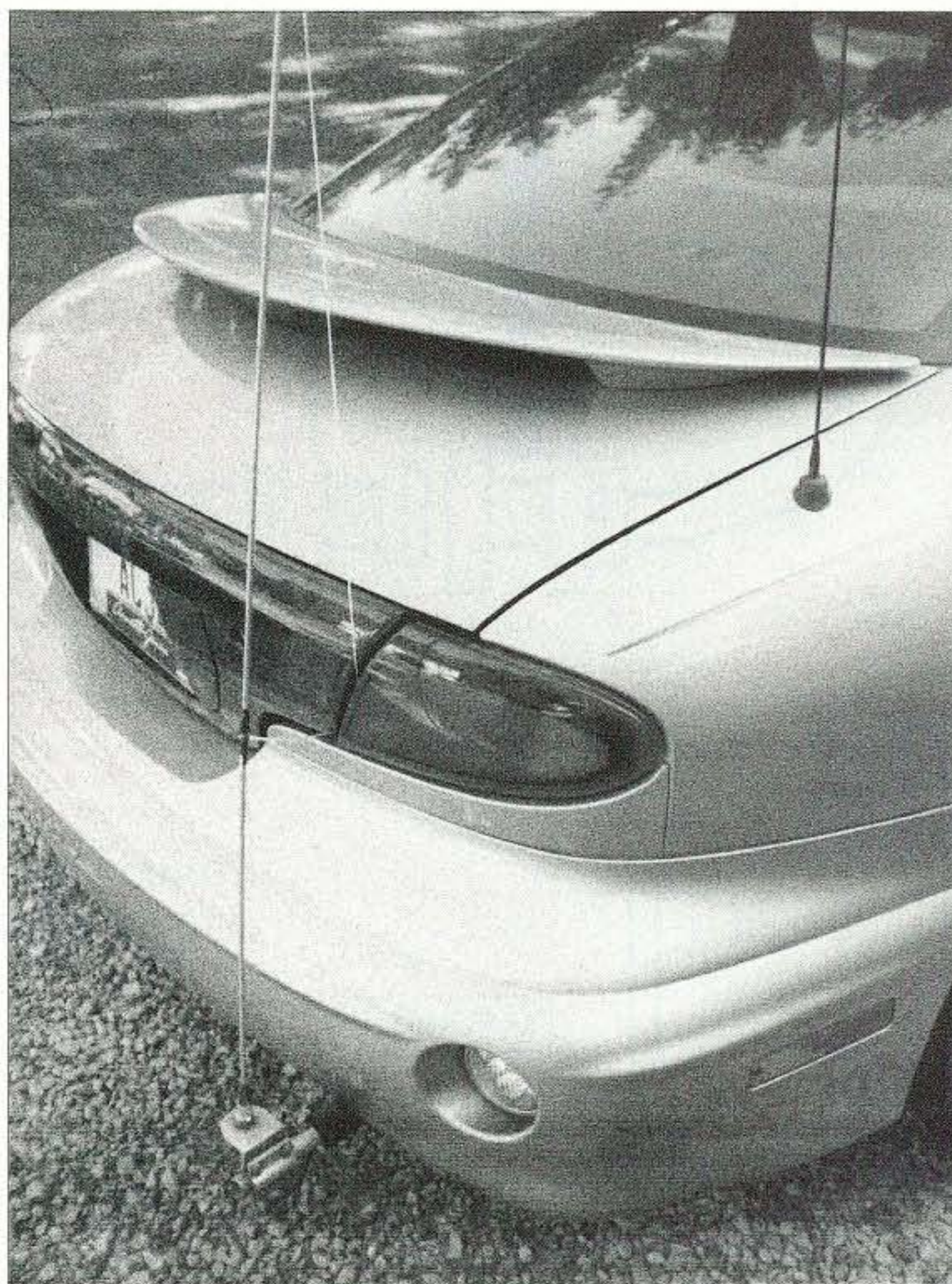
Okay, so the dual suspension is just two pieces of string, but this very simple system is extremely effective. It's great for times when you are entering places with low overhead clearances. It solves these problems by allowing you to bend the top of the whip down to the roof of the car. If you are lucky enough to have a roof rack available (**Fig. 1**), one end can be tied near the top of the antenna with the other tied off to the roof rack nearest the front of the vehicle. Plus, if the roof rack is adjustable (with the ability to slide back and forth), there will probably be some sort of latch that opens. Just open the latch, pull the top string and antenna down toward the car, and wrap the excess line under it. And when you are ready to put it back up, all you have to do is just release the latch. If there is just no place to tie the top part down, you might want to try another setup I've used (**Photo A**) to at least control the sway of the antenna.

### Removable

My goal was to put together an antenna system that does no damage to the vehicle at all. That way, when it comes time to buy a new vehicle, you don't have to just leave the mount on the old car and buy all new parts for your next car. It's non-invasive since no drilling (at least externally visible drilling) is needed. That way you don't have to worry about any loss in the price of the car. Even the cable and ground wires can be removed easily.

### Easy-to-build

Besides the antenna whip and coax, there is only one other key component to this system. That is the antenna mount itself. It's actually a mirror mount (see the parts list), and it installs on the end of the 1/4" tubing (**Photo B**) that is used as the mounting support. Although it's easy to build (it generally just takes a few U-bolts and clamps), remember that I mentioned you'll need a little creativity? I wish I could just give one method of connecting up the antenna that would work for all cases, but if you take a quick look underneath various vehicles, you'll see that each is different and you'll need to come up with some possibilities for your particular instance. See the section on putting it all together later in the article for information and some ideas to get you started on this.



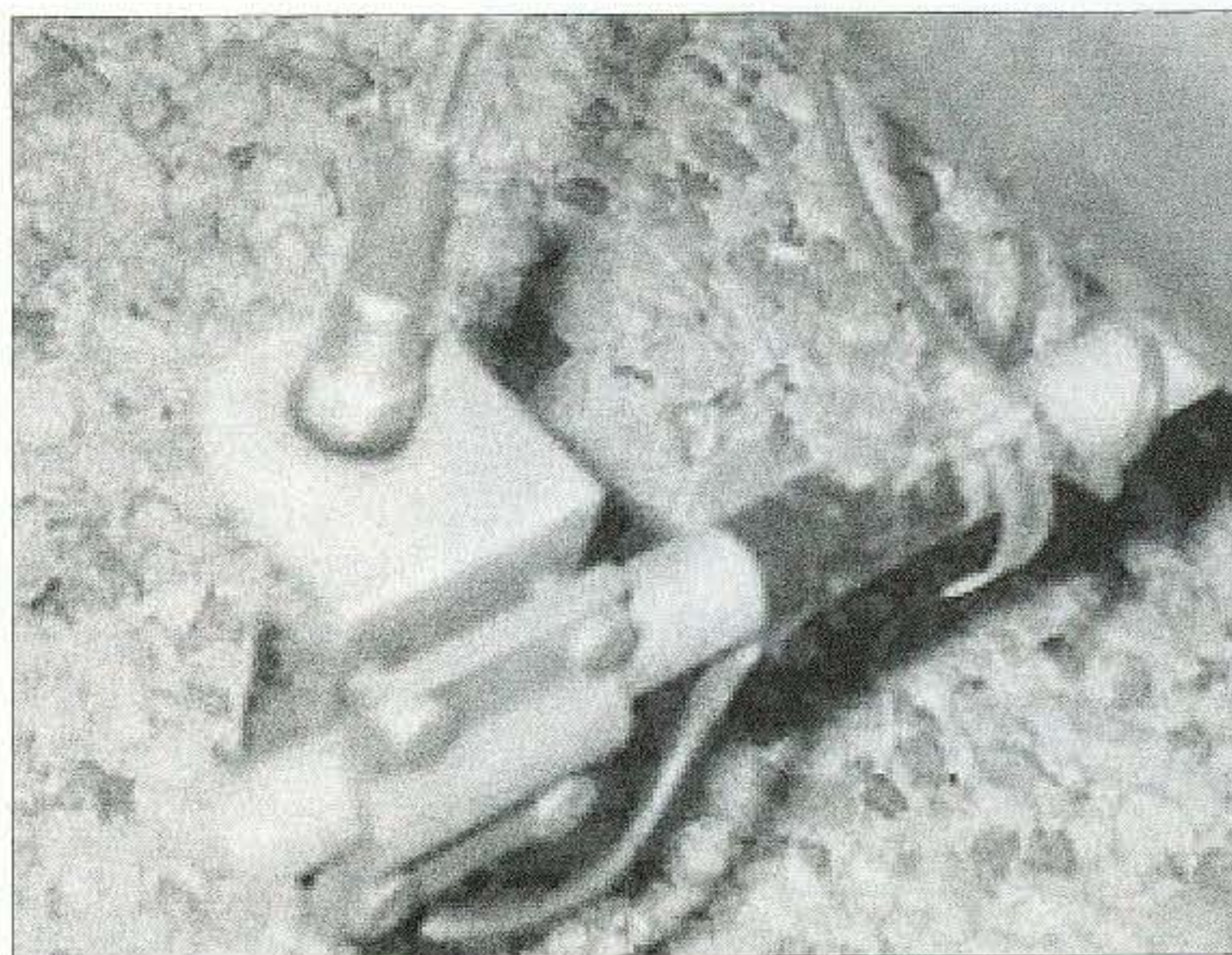
*Photo A. Stabilizer tie-up.*

### Amateur-radio

Well ... No dah!! Or, should that be "No dit"?

### Multiple-band

This one may surprise you. A quarter wave antenna is very broadbanded. In fact, after you get the entire system working perfectly on 10 meters, switch down to the 12-meter band and try a signal there. You can do this either through a



*Photo B. 1/4" tubing supporting the mirror mount.*

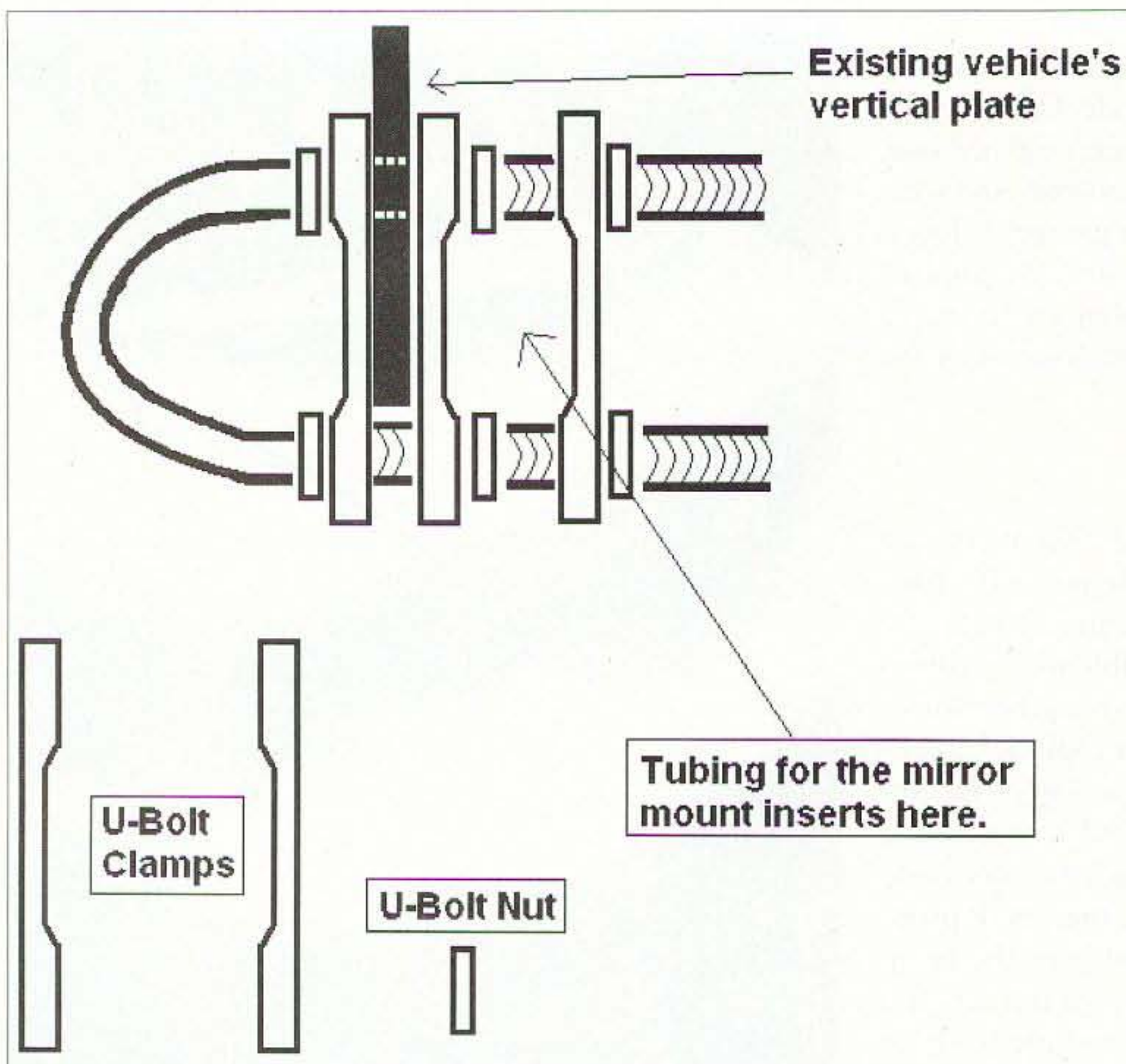


Fig. 2. Bolt and clamp assembly.

mobile antenna matcher or do what I do and just run it direct. If your radio has built in SWR protection, it will cut back the power to a safe level and you'll end up running 12 meters at low

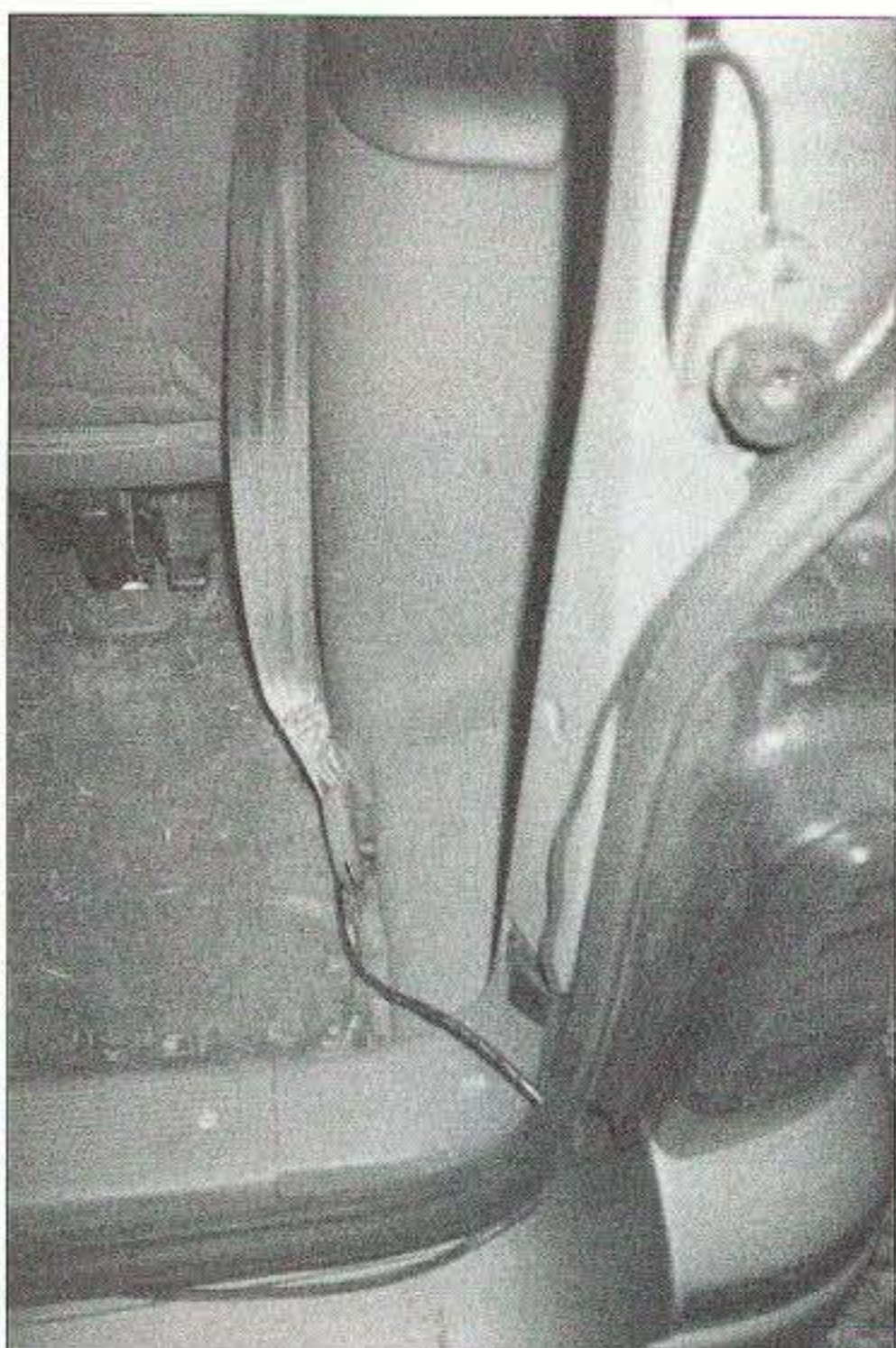


Photo C. Slip the cable into the trunk through the water seal if there are no water holes that you can use.

power. Sure it's reduced power, but hey, QRP can be a lot of fun. Plus, the band isn't crowded so it doesn't take much to get a signal through. The antenna is pretty efficient at least down to 12 meters. Beyond that, you'll spend a lot of time yelling and screaming before making any contacts.

### Putting it all together

Start the whole process by crawling under the back of the vehicle to decide on a mounting design to connect the two feet or so of the 1/4" tubing to the underside of the car. The length of the tubing will depend on just how far back under the car you need to go in order to find a place to attach it. Trying to figure out how to mount the tubing is going to be the hardest part of this project. You'll need to find at least two support spots. One will just support the weight of the mount and antenna; the second keeps the whole thing from swaying back and forth. Search for holes under the car that can be used as an attachment point for the U-bolts. Look for potential spots in the frame

up above where the tubing will be positioned or perhaps even horizontal to the tubing. Another option is to look for any existing bolts in the frame that may be extending out enough to be useful. If you find one long enough you can just lay the U-bolt over it and use that as the support. The best thing to do though is to draw a quick picture of what you see under there and then take a trip to the hardware stores, auto parts stores, and even plumbing supply stores to come up with some ideas. Some things that might work for you are toggle bolts, turnbuckles, and Milford hangers.

I did come up with a way (Fig. 2) of combining a few U-bolt and clamp parts together that you'll likely be able to use one way or another, so I'll take the time to describe it here.

In my case, my van happened to be a 1993 voyager. It had a vertical plate with some holes already drilled through it. Actually, one hole is all you need, that is, if it is near the bottom of the plate. This is because you can use the free space below the plate to act as the second hole. You'll end up running one of the U-bolt rods through the existing hole and the other bolt will hang below the plate.

You're going to need 3 sets of the U-bolts with clamps to do this, plus one extra set of nuts. Start with one of the U-bolts and screw on the two nuts. Take them all the way to the end of the threads nearest the U. This will provide a stopping point for the 1st clamp. Next, place the 1st clamp on with the "teeth" end going in first. It will stop at the nuts you've just put on. This makes the flat end available as a stopping point against the metal plate. Run the U-bolt through the hole(s) in the plate of the vehicle and the whole thing will stop against the plate.

Next, we need another clamp to brace against the other side of the car's plate. Push it on with the flat side first this time, to butt up against the plate. Now screw on another set of nuts and tighten them so the whole thing doesn't move at all. We're almost done now.

Next, put on a third clamp and slide it in toward the last one. This time "teeth" first. This provides us with a

space now between the two sets of teeth to grab the antenna mount tubing. Don't press it all the way in, because you'll do that once the tubing is ready to be connected up. Again put on two nuts. This will hold the outside clamp in place against the tubing when you are ready to attach it. And last, put on a final set of nuts. This last set will help keep the outside two from unscrewing over time due to the vibrations of the car.

Okay, now take the remaining U-bolts into your back yard. Drive a peg into the ground and start practicing horseshoe throwing — because they are of no use to the rest of this project!

Once you've got a mounting system plan ready, the hard part is out of the way. Before you actually mount the tubing to the vehicle, first take the tubing, and attach the mirror mount (Photo B). That way you can gauge when there will be enough room for the antenna to clear the back of the car. At this time you can also get the whole thing aligned correctly too, so the antenna is going to be vertical and not off on some angle. Be sure to place some tube pipe insulation around the antenna mount tubing to keep it from rubbing up against the bottom of the bumper. We don't want to do any damage there either. Besides, I think it looks cool. Tighten everything up and then screw in the 102-inch whip. Now you're ready to run the cable.

Part	Description
Steel whip	102 inch, Radio Shack #21-903
U-bolt with clamp	3 or 4 sets, RS #15-826
RG-58 cable	50 ohm, 20 ft.
Mirror and luggage rack mount	RS #21-937
1/4 inch tubing	2 to 3 ft., for use in mounting the mirror mount
Ground wire	4 ft., enough to find suitable connection points
Hose clamp	To attach the ground wire to 1/4 inch tubing
Tube pipe insulation	—
Optional	
Cigarette lighter adapter	12 V power adapter, 10 A, RS #270-1521
Banana jack binding posts and adapters	RS #274-718, #274-716

Table 1. Parts list.

## Routing the cables and ground wires

Notice that I've listed RG-58 (the thin stuff) as the coax to use. We need to be able to route the cable from the outside of the car to the inside of the trunk area. First check to see if you have any rubber water plugs in the trunk that will give you access from below the trunk to the inside. If so, this hole must be at least big enough to pass the diameter of the cable through or better yet, the diameter of the PL-259 connector. If the size isn't big enough or if there are no water plugs there, you'll need to cut off the connector from one of the ends of the cable. With no hole available what we're going to have to do is to sneak the cable in through the water seal that runs along the lip of the trunk (Photo C). I've usually seen this seal with holes predrilled on one side of the seal. By putting one on the opposite side too, you can slip the RG-58 and even a ground wire through the seal.

Start by connecting the PL-259 end of the cable to the mirror mount connector and run the cable up and under the bumper or other path that works for your car. Open the trunk and route the cable up and through the water seal holes. Once through, you can use those handy dandy quick connect crimp-style connectors to easily attach the male connector to the end of the cable which is going to the radio. Attach a ground wire around the antenna mount tubing and secure it via hose clamps. Run that wire up along the coax and through the same hole, or another, if the size is a problem. Connect the other end of the wire to any convenient ground screw you can find.

This is one of the two grounds you'll want to have in the system. (Note: I've found that some ground spots are better than others, so you might want to check with an ohmmeter to see that you've got a good short to the main body of the car.) The second connection should be a ground wire from the radio to a ground screw near the radio at the front of the car.

## SWR

I typically start with the full 102"

whip and cut down from there. Before you start cutting anything off of the whip, check the SWR as is. Depending on the type of vehicle (van, car, truck, etc.) and how close the antenna is to it, as well as how much of the antenna runs along side the vehicle, the length for a good match will vary. If you do need to shorten the antenna, only snip off 1/8"–1/4" pieces at a time. Decide ahead of time which portion of the band you'll be spending most of your time and go for the 1:1 match there. Note: Most of the voice SSB activity exists from 28.3–28.5 MHz.

If you plan to bring the rig into the house nightly, you should take care to install easy disconnect connectors of some sort. I won't go into all of the possibilities here, but I ended up using banana plug binding posts and that worked nicely. If you plan on just running QRP you can get away with running direct to a cigarette lighter

Continued on page 56



The impressive IC-756 Pro II covers HF plus 6 meters. The high resolution 5 inch TFT color display provides more operating information than ever, including a spectrum scope. The 32 bit floating point DSP provides crisp, clear reception with 41 built-in filters. The "Pro II" is the choice for serious DXers and contesters.

## IC-746 Pro ✓ 160 to 2 Meters!



The IC-746 Pro covers 160-10 meters plus 6 and 2 meters with 100 watts on all bands. Call or visit our website for further details and pricing on this and other ICOM radios.



**Universal Radio**  
6830 Americana Pkwy.  
Reynoldsburg, OH 43068  
◆ Orders: 800 431-3939  
◆ Info: 614 866-4267  
[www.universal-radio.com](http://www.universal-radio.com)

# All Keyed Up

*Over this neat project.*

*Hand-sent Morse is enjoying a renaissance. A variety of straight keys are available for purchase by Morse aficionados, including some that tip the price scale near \$200. Although my surplus J38 is still functional 40 plus years after I bought it, I decided to design and build my own straight key.*

I used a milling machine, lathe, and metal-cutting bandsaw to make my key. With a bit of redesign and a lot more work, you could build a similar design using only a drill press and normal hand tools.

## A note on materials

I've made aluminum, brass, and stainless steel versions of my design. Aluminum and brass are much easier to work than stainless steel and should be used if you only have simple tools. Brass has a nice color, polishes up easily, and is the traditional construction material for "brass pounding." It can be lacquered to retain its sheen. If you use stainless steel, I suggest drilling all tapped holes one or two drill sizes larger than normally recommended. There isn't much mechanical stress in the key, and oversized holes will reduce the risk of tap breakage in stainless steel without impairing performance.

## Bearing block

I made the bearing block (**Fig. 1**) from a 1" length of 1" square bar stock. In my design, the armature is restrained from side-to-side movement only by the clearance in the bearing

block slot. Mill the slot for the armature, making it slightly oversize so as to permit the armature free rotation, but without excessive side-to-side play. I found about 0.005" of excess width worked well. If the slot is too wide you may use shim washers to control excess side play. If you don't have a milling machine, it should be possible to make the bearing block by drilling and filing. In this case, aluminum or brass is a much more practical material than stainless steel.

The armature rotates in Oilite® bearings. (Oilite is a porous bronze material, with oil trapped in its interstices.) The bearings are a press fit into the bearing block. Oilite bearings are not strictly necessary, and a plain bronze bearing would likely work. An even simpler design would omit press-in bearings and instead use the bearing block itself.

For the bearings to fit, the 0.375" mounting holes should be drilled slightly undersize using a "U" drill and reamed to final size with a 0.375" reamer. Press or drive the bearings in place.

The bearings and their mounting holes must be accurately aligned, or else the armature may bind. Drill and ream in one pass from one side, rather than separately from each side.

I made the inner diameter of the Oilite bearing slightly oversize with a 0.252" reamer to ease the fit with the 0.250" axle shaft. (Passing a drill or reamer through an Oilite bearing closes up the pores and may tear the bearing surface. This would be inadvisable if the bearing were to be used at high speed, but is acceptable for a hand key.) I reamed to 0.252" after pressing the bearings into the bearing holder, taking care to align the reamer to the bearing hole. Alternatively, the axle shaft could be reduced a couple thousandths of an inch in diameter with sandpaper and the Oilite bearings kept as-is.

## Armature

The armature (**Fig. 2**) is made from a 4-1/2" length of 1/2" x 1/2" bar stock. I milled the knob end of the armature to 1/4" to give me a better grip on the knob, but this is a personal preference item. If a milling machine isn't available, the thickness reduction could be accomplished with a hacksaw, or a file.

It's important that the axle shaft hole is made at right angles to the armature as accurately as possible, as any angular error may cause the armature to bind in the bearing block slot.



I drilled the axle shaft hole with a 1/4" drill and reamed with a 0.252" reamer. If you instead decide to reduce the axle shaft to a couple thousandths below 0.250", the 0.252" ream isn't necessary.

My design uses an upper spring adjustment washer with a hub that when fully retracted fits into a pocket milled into the armature. I used a 3/8" end mill to produce a flat-bottomed pocket.

The spacing adjustment screw can work loose as the key is used, so I added a 6-32 locking screw at the end of the armature.

### Base plate

The base plate (Fig. 3) is made from a 5-1/4" length of 3" x 1/2" cold rolled steel bar stock. I like a heavy base, and this substantial block of steel meets my desires.

The bearing block and the ground connection post are mounted to the base plate with 6-32 screws. I used socket head cap screws, and used a counterbore to recess the heads of the SHCS screws to be flush with the bottom of the base plate. Alternatively, 6-32 flat head screws could be used and flush countersunk.

It's important that the screw holes that

attach the bearing block be accurately located so that the armature is centered and parallel with the long axis of the base plate.

I didn't want the spacing adjustment screw to contact the base plate, as it would, over time, chip away the paint. To give the adjustment screw a safe contact point, I drilled and tapped the base plate for a 1/4-20 thread and screwed in a 1/4-20 x 1/2" stainless steel

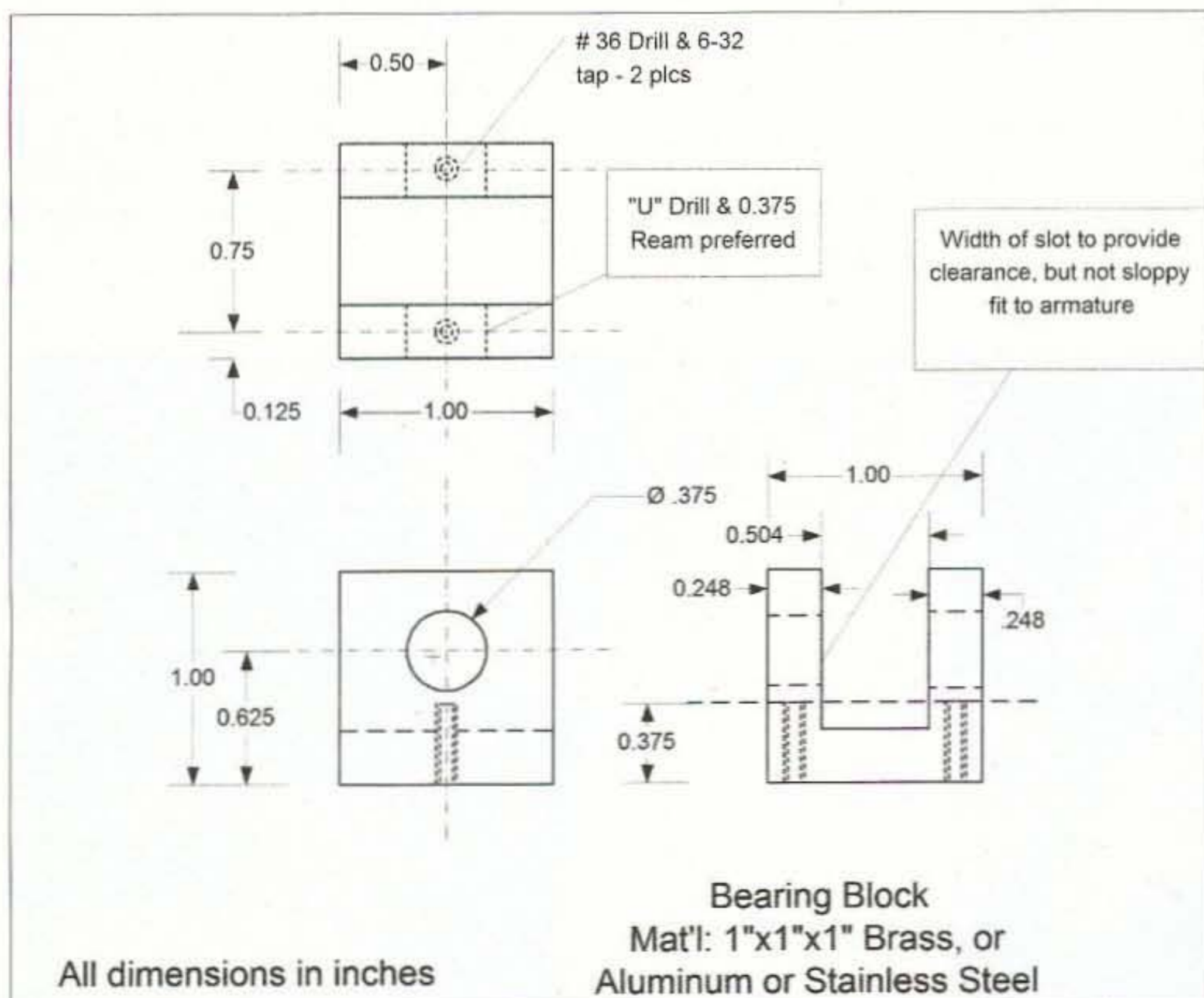


Fig. 1. Bearing block.

- DIP switch programmable
- Miniature in size
- 37 EIA tones, 27 non-standard tones from 33.0 to 254.1 Hz included
- Reverse Burst built-in
- Easy 3 wire hookup

SS-64 CTCSS Encoder  
66" x 1.08" x 21"

**SS-64 DIP Switch Programmable CTCSS Encoder \$28.95**



- Fully enclosed CTCSS encoder
- All 32 EIA tones from 67.0 to 203.5 Hz included
- Perfect for mobile / base applications

TE-32  
5.25" x 3.3" x 1.7"

**TE-32 Multi-Tone CTCSS Encoder \$49.95**



- 51 CTCSS Tones
- 106 DCS Codes
- Supports 157 Repeater Subscribers
- On-Line Computer Help
- Repeater CW ID
- Air Time Loading & Analysis Graphs
- Signalling Formats: CTCSS, DCS & DTMF

TP-3200 Shared Repeater Tone Panel

TP-3200D Table Top Version \$269.95 each

TP-3200RM-A Single Rack Mount version \$279.95 each

\*TP-3200RM-B Triple Rack Mount version \$279.95 each

\*Holds up to three TP-3200s

Call or write to receive our full Product Catalog or visit our Web site for complete information at:  
<http://www.com-spec.com>

- Eight programmable, selectable messages
- Fully field programmable via included keypad
- Meets all FCC identification requirements

ID-8 Automatic Morse Code Identifier  
1.85" x 1.12" x .35"

ID-8 Automatic Morse Station Identifier \$69.95






**COMMUNICATIONS SPECIALISTS, INC.**  
426 WEST TAFT AVENUE • ORANGE, CA 92665-4296  
(714) 998-3021 • FAX (714) 974-3420  
Entire U.S.A. (800) 854-0547 • FAX (800) 850-0547  
<http://www.com-spec.com>

Qty.	Description
1	1x1x1 in. material for bearing block, brass/aluminum/stainless steel
1	1/2x1/2x4/5 in. armature, brass/aluminum/stainless steel
2	Oillite bronze bearings, 3/8 in. OD 0.25 in. ID x 0.25 in.
1	baseplate, 1/2x3x5-1/4 in. cold rolled steel
2	3/8 in. diam. x 1 in. long drill rod for connection posts
3	1/2 in. OD x 1/8 in. thick Delrin washer, clearance hole for 6-32 screw
1	1/2 in. OD x 1/8 in thick Delrin washer, 0.25 in. clearance hole
1	0.250 in. diam. x 1 in. long drill rod for axle
1	6-32 hex key head set screw x 3/8 in. long, cone point, stainless steel
1	1/4-20 x 1-1/2 in. stainless steel bolt, cut down for fixed contact
1	1/4-20 x 1/2 in. stainless steel bolt, for fixed space contact surface
2	8-32x3/8 in. hex key set screws
2	6-32x1/2 in. socket head cap screws
4	6-32x1/2 in. socket head cap screws
1	6-32 hex key set screw x 3/8 in. long black oxide cup point
1	6-32 hex key set screw x 1/4 in. long black oxide cup point
1	lower spring support from 1/2 in. steel rod
1	upper spring support from 3/4 in. steel rod
1	spring, 12T 0.021 in. wire 1 in. long 0.26 in. ID
1	knob, plastic or ceramic drawer pull
4	felt or plastic feet, self-adhesive
1	6-32x3/8 in. socket head cap screws

Table 1. Parts list.

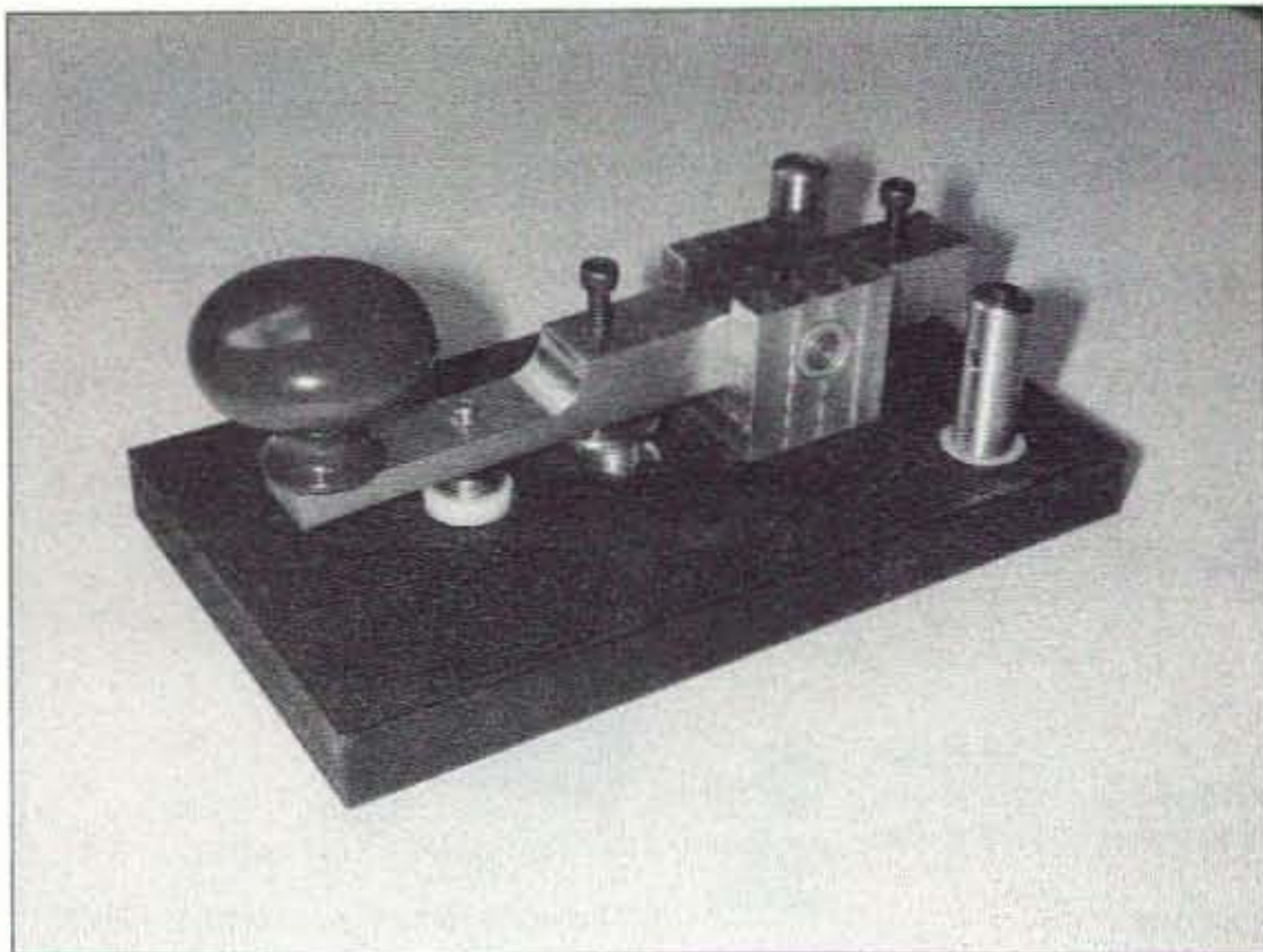


Photo A. Completed key.

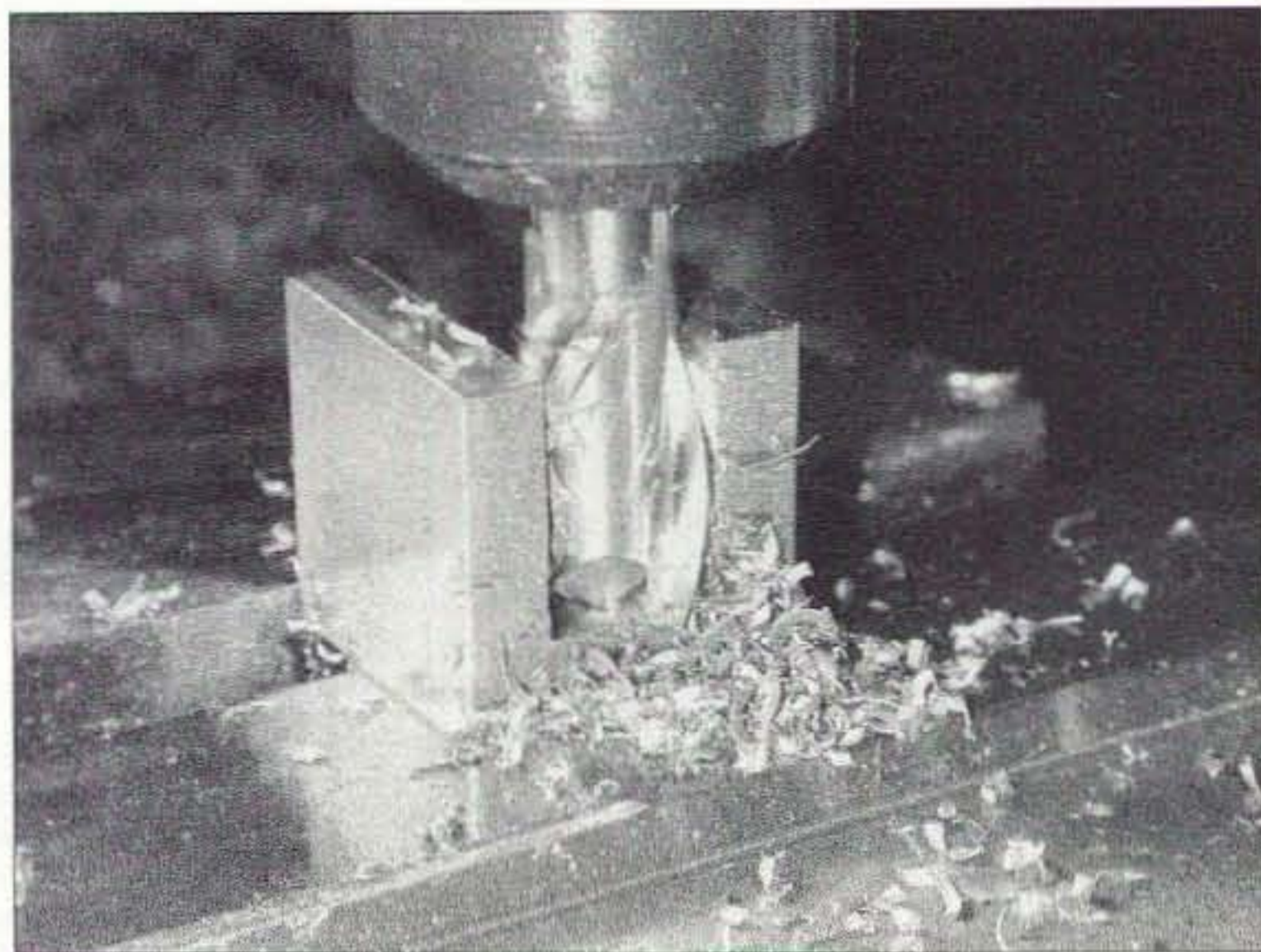


Photo B. Milling the bearing block.

bolt, positioned so that the adjustment screw strikes the bolt head. To dress up the striking point, I surfaced the hex bolt head and turned the head round. The appearance is of a smooth cylindrical pin. The round-headed bolt can be turned in finger tight and then final tightened with padded jaws pliers.

I also wanted the bottom of the spring to not contact the painted base plate. I milled a 1/2" diameter pocket 1/16" deep to hold the lower spring retainer.

The hot side connection post and the fixed contact must be insulated from the base plate. I made insulating washers from a 1/2" diameter Delrin rod. Nylon or other similar plastics would work as well. The base plate has flat-bottomed pockets to accommodate the washers. The pockets are milled 1/4" deep to permit the screw heads to be flush with the bottom of the base plate.

In addition, I milled a 1/4" wide slot between the hot side connection post and the fixed contact to contain a connecting wire. I insulated the lugs with heat shrink tubing to prevent shorting against the base plate.

#### Miscellaneous parts and assembly

Fig. 4 details the remaining custom parts required for the key. The drawings are self-explanatory. Since many of these parts are visible, try for good-quality workmanship — chamfer edges and polish out any nicks or scratches. When drilling and taping the connection posts, soft jaws on the lathe may reduce marring.

I use a standard drawer pull, available at any hardware store, for a knob. I've used both plastic and ceramic pulls. If you use a ceramic pull you may find it

necessary to go to a heavier spring to offset its increased weight.

I found a suitable spring at the hardware store. It is wound from 0.021" diameter wire, 12 turns/inch, with an inner diameter of 0.26 inches. The spring was two inches long, and I cut it in half for my key. Spring tension is a personal preference, and I like a small spacing, soft tension key. A good hardware store will have a selection of springs, so experiment until you find one to your liking.

The armature contact is a 6-32 x 3/8" stainless steel cone tip set screw, adjusted to have the cone part of the tip protrude below the bottom of the armature. This results in a stainless-steel-to-stainless-steel contact, which has proven satisfactory. If you can't find the cone tip set screw, you can grind the tip of a standard stainless steel set screw into a cone shape. To

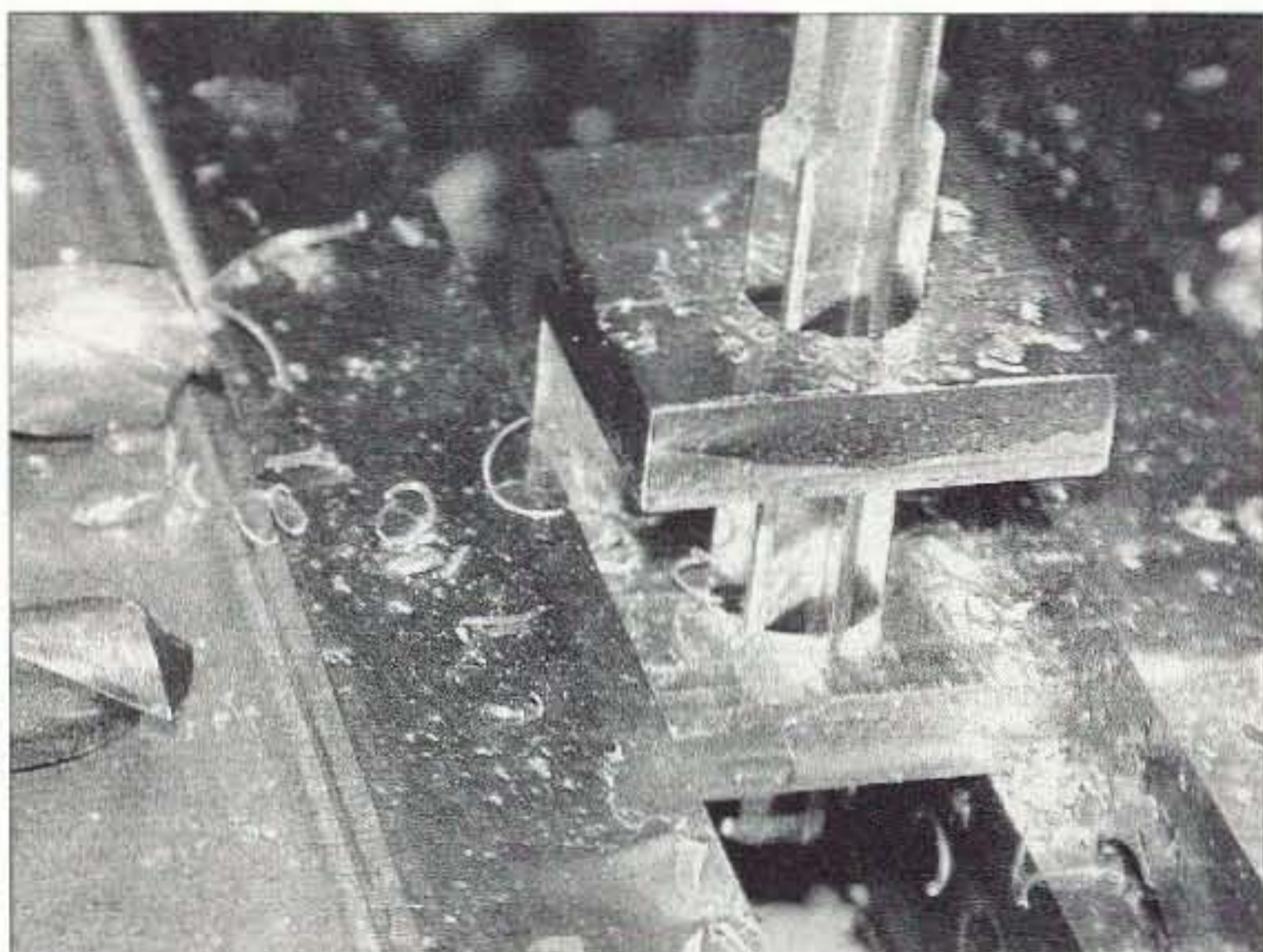


Photo C. Ream the 0.375" hole for the bearings.



Photo D. Milling the reduced part of the armature.

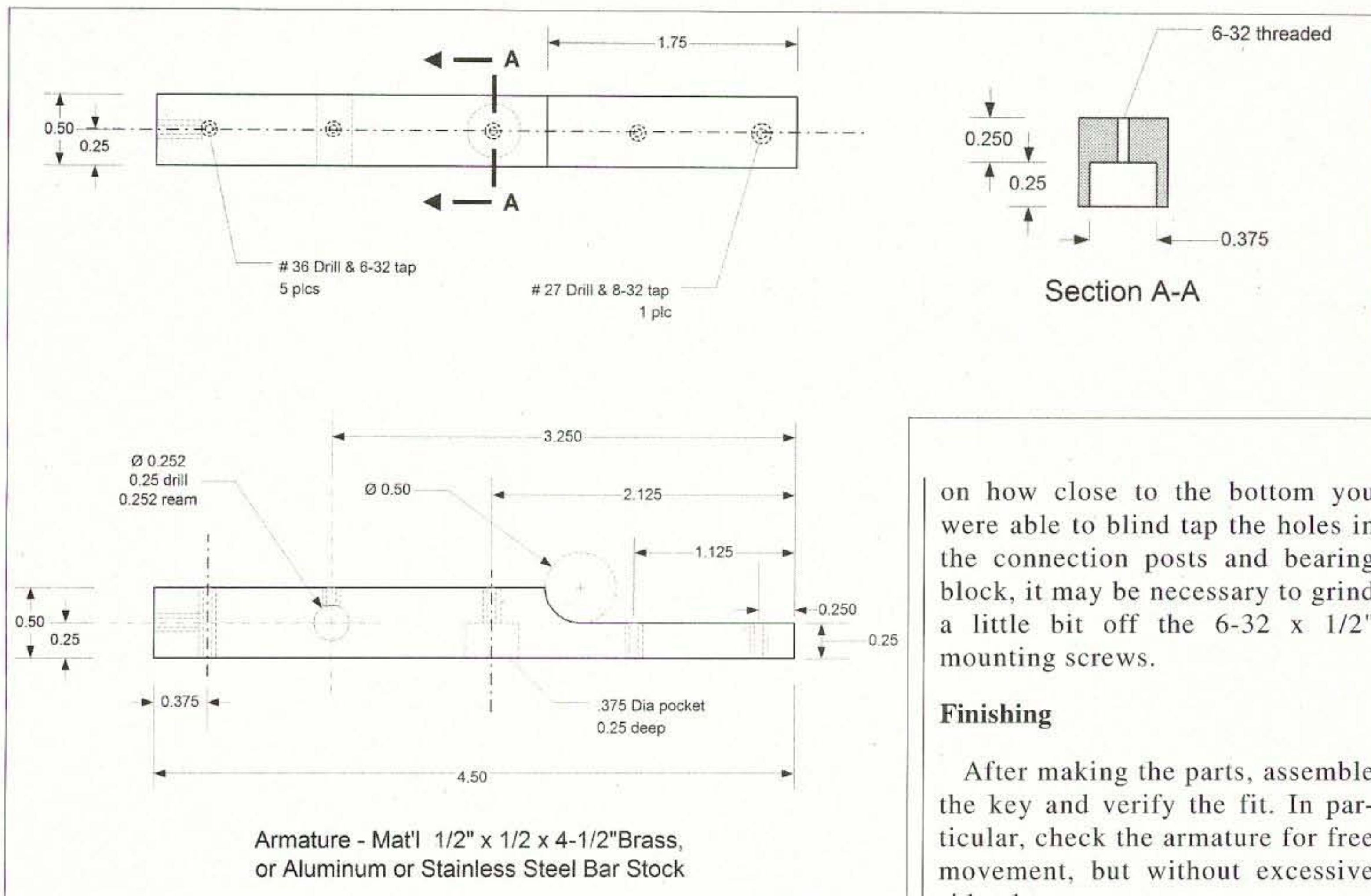


Fig. 2. Armature.

retain the set screw contact in the armature, I used Loctite 222 small thread locking compound. Fingernail polish would likely work just as well.

The spring tension retaining screw and the spacing adjustment screw are 6-32 x 1" SHCS screws. I used black oxide screws to provide color contrast, but you may prefer stainless steel.

Use a 6-32 x 1/4" set screw to hold

the axle shaft to the armature. A 6-32 x 3/8" set screw locks the spacing adjustment screw in place. Again, I used black oxide set screws, but stainless steel would provide a different appearance.

The connection posts and the bearing block are held in place by 6-32 x 1/2" SHCS. I used 8-32 set screws in the top of the connection posts, but you may prefer 8-32 thumb screws. Depending

on how close to the bottom you were able to blind tap the holes in the connection posts and bearing block, it may be necessary to grind a little bit off the 6-32 x 1/2" mounting screws.

### Finishing

After making the parts, assemble the key and verify the fit. In particular, check the armature for free movement, but without excessive side play.

When you are satisfied, disassemble and prepare the key for painting and polishing.

After degreasing the parts, I sanded the base plate with a medium-grit emery paper and then painted it with a bare metal primer coat, followed with a finish coat of Krylon "Black Wrinkle." I like a wrinkle finish because it covers up minor blemishes in the base plate that might not have been removed with the sanding. Install

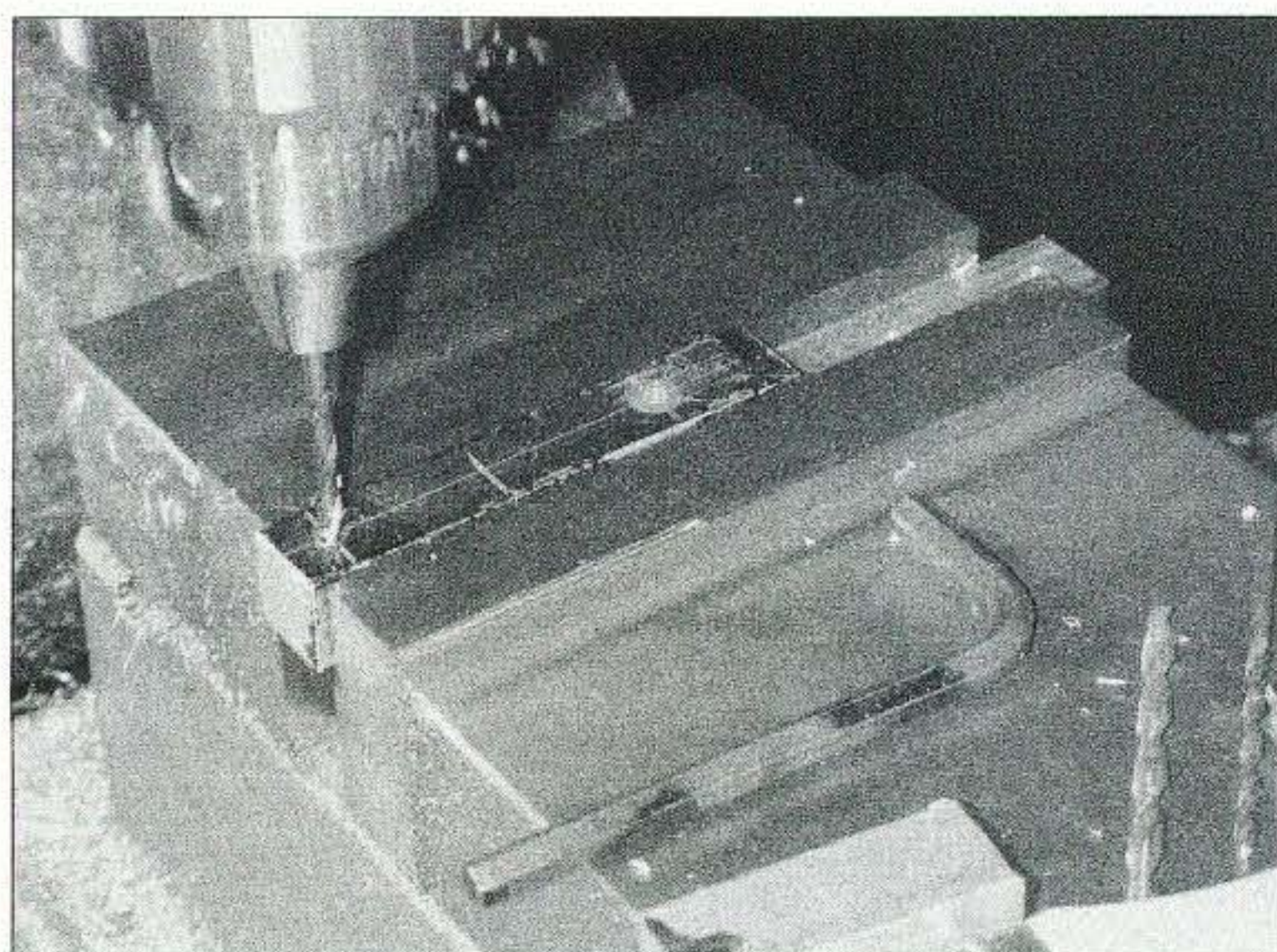


Photo E. Drilling the armature.

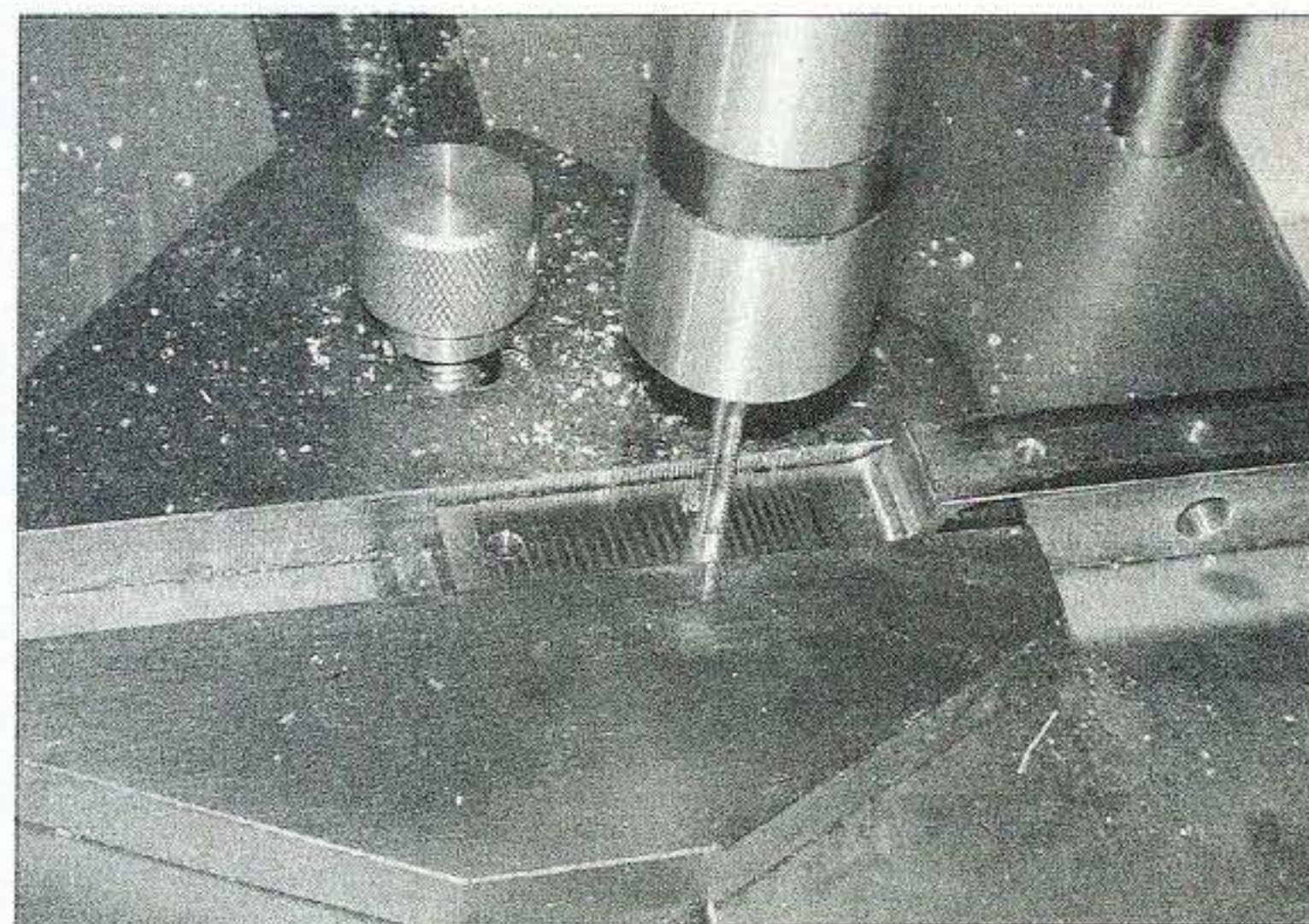


Photo F. Using a hand tapping machine to tap the threaded holes in the armature.

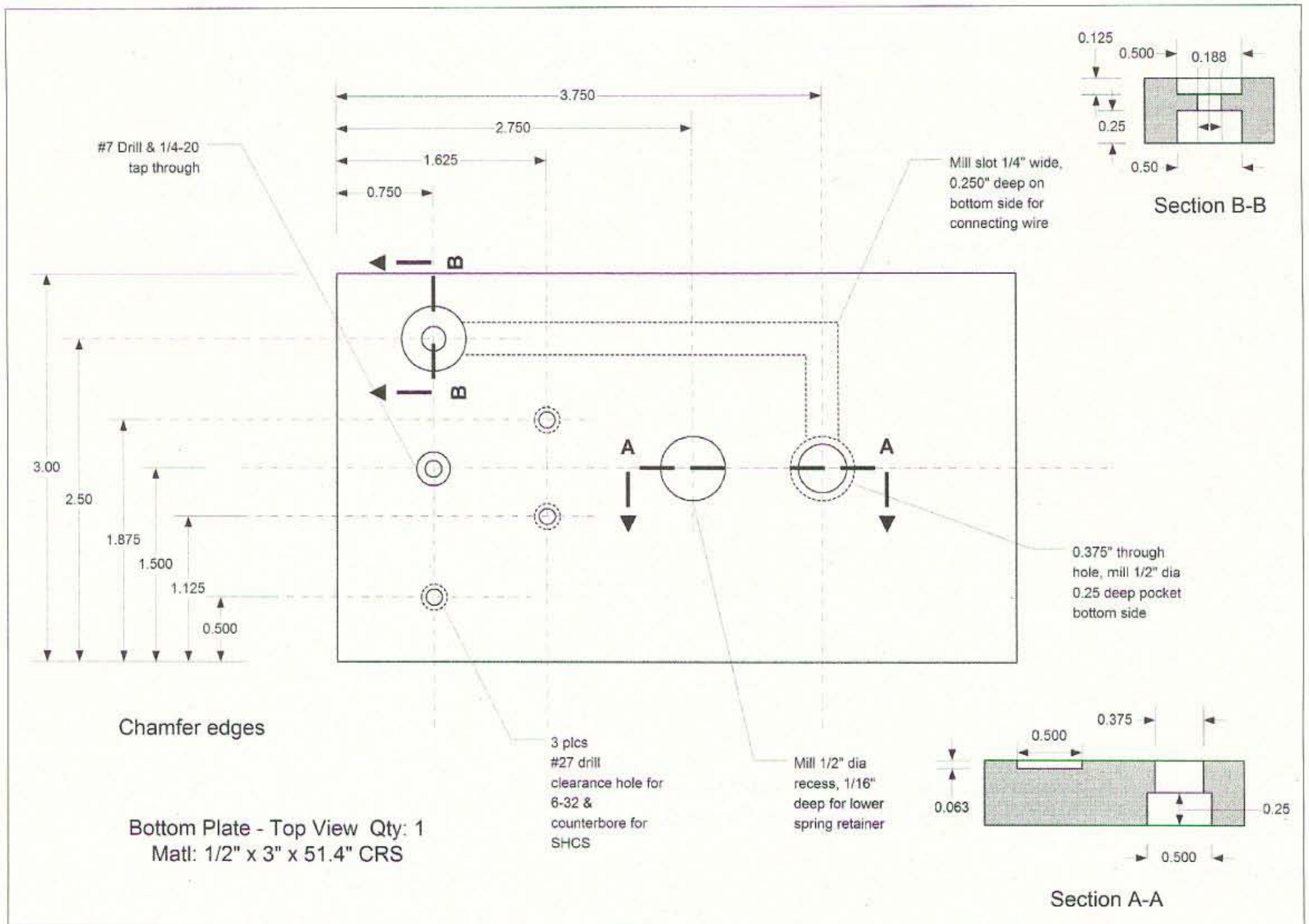
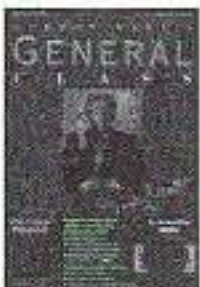


Fig. 3. Base plate.

Say You Saw it In 73!

### The Gordon West Study Guides

Examination Test Questions & Answers for General Class and Extra Class with explanations of the answers



General Class  
\$12.95  
Plus \$3.50 S&H



Extra Class  
\$14.95  
Plus \$3.50 S&H

**Omega Sales**

P.O. Box 376  
Jaffrey, NH 03452  
800-467-7237



self-adhesive felt or rubber pads at the four corners of the base plate to stop the key from sliding or marring your desk.

I finished the armature and bearing block with fine-grit emery paper, followed by an automobile "scratch and swirl remover." This produced a



Photo G. Marking the base plate using a height gauge.

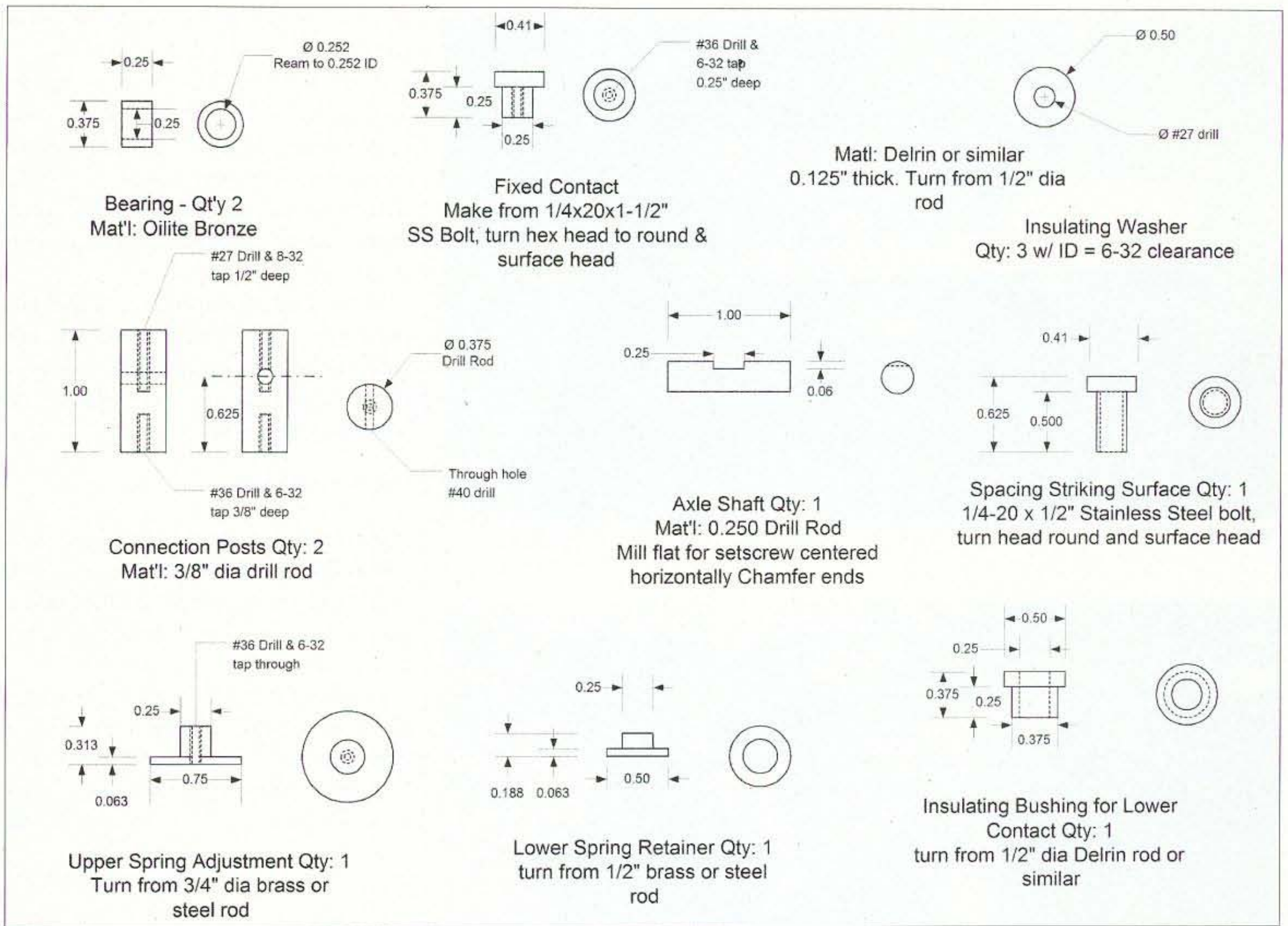


Fig. 4. Miscellaneous parts.

nice luster when applied to brass and aluminum. After polishing, you can treat the armature and bearing block with clear lacquer if you

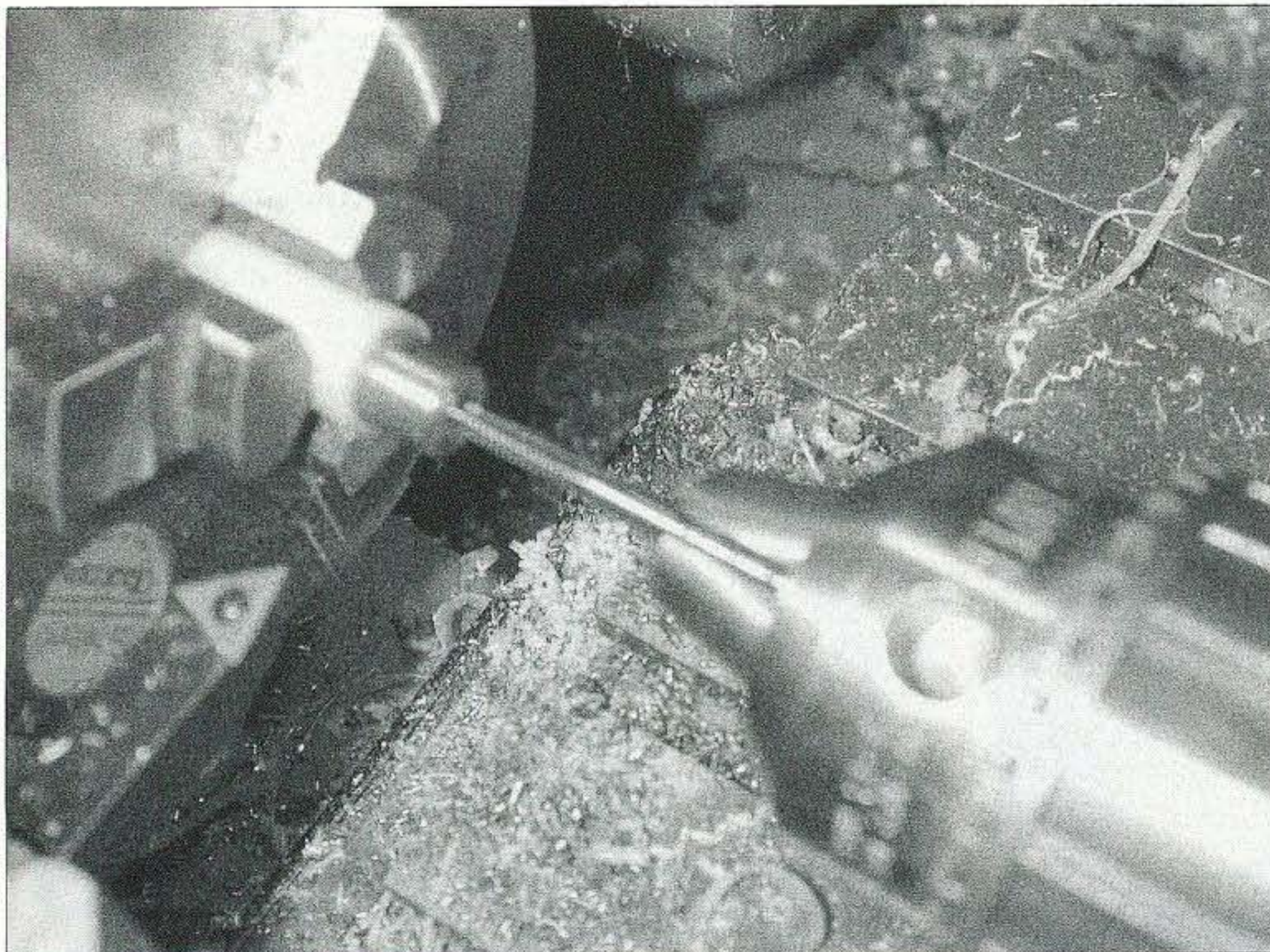


Photo H. Use a plastic bushing to prevent marking the connection posts while drilling and tapping.

Reprints  
of  
73 Magazine articles  
Only \$3.00 Each!  
Call 800-274-7373

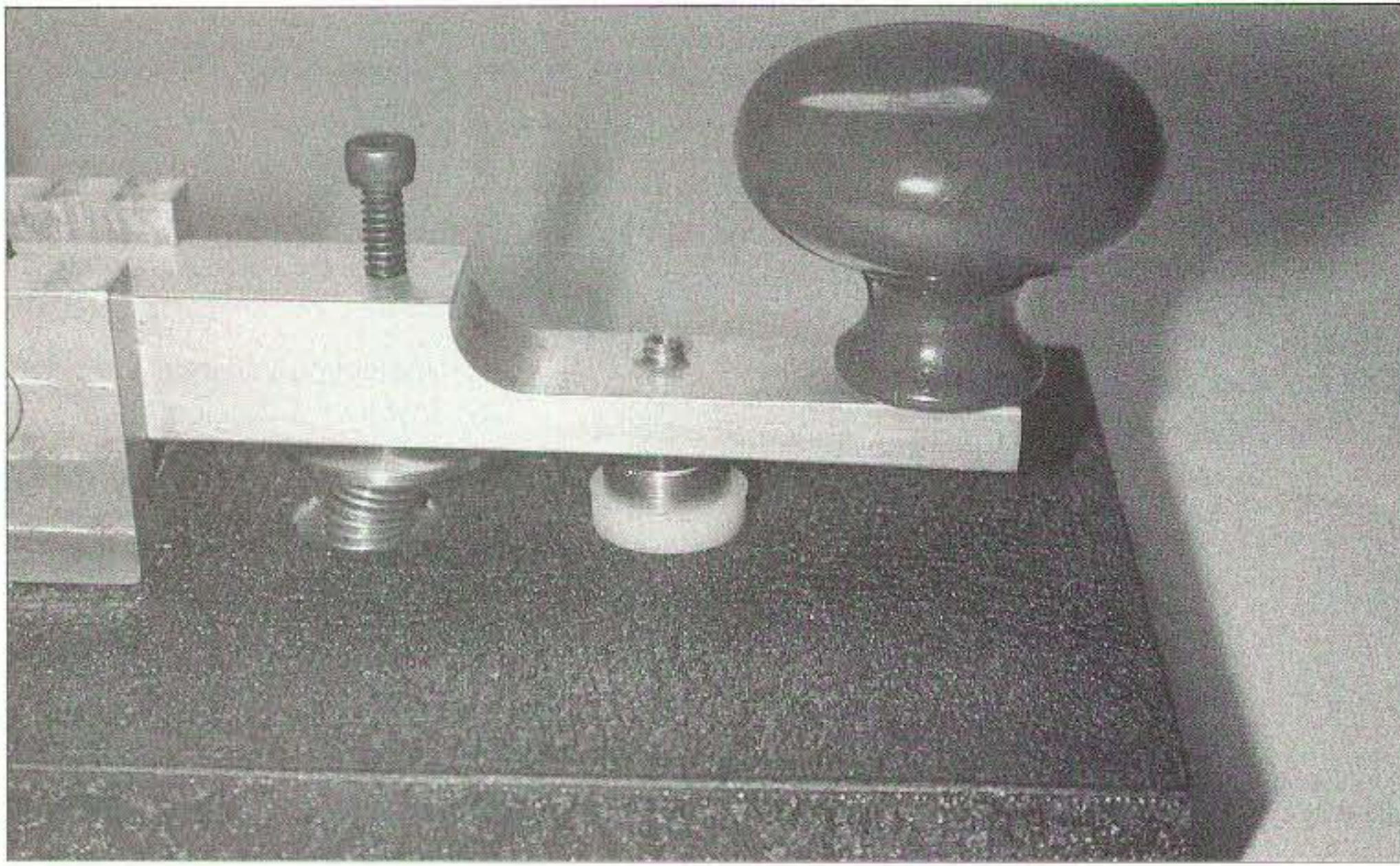
**good deals on what you want**

- Keeping the FUN in Ham Radio is what we're all about! Since 1980!
- Great prices & customer care on today's major brands, including:

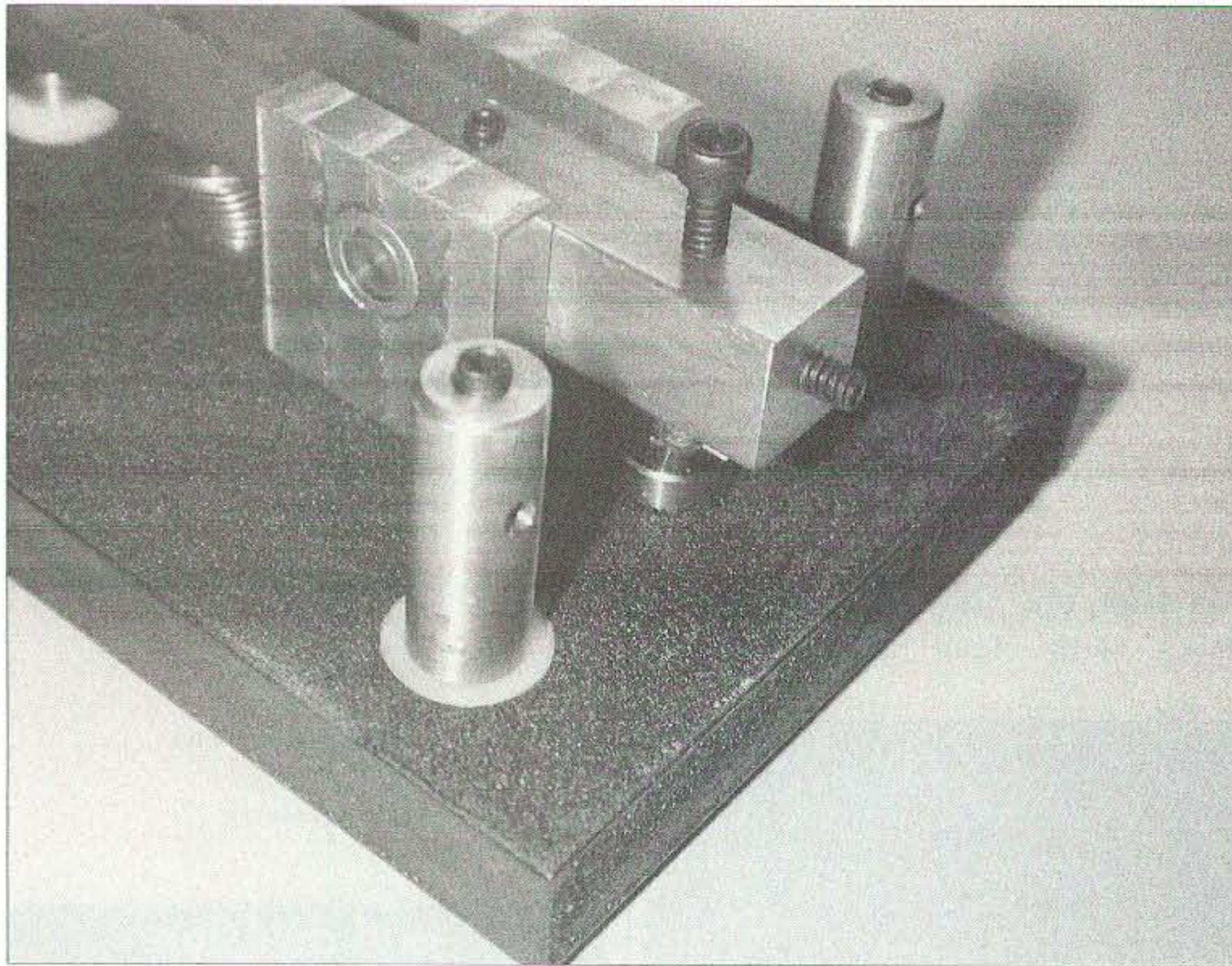
- |             |              |           |
|-------------|--------------|-----------|
| MFJ         | DIAMOND      | MAHA      |
| QRZ         | BATTERY TECH | Heil      |
| GORDON WEST | ARRL         | PATCOMM   |
| PROCOMM     | TRANSEL      | RAMSEY    |
| CALLBOOK    | W4RT ELECT.  | POWERPORT |
| IRON HORSE  | AND MORE!    | MIRACLE   |
| LDG ELECT.  |              | ANTENNA   |

Call Today  
**217-352-1725**  
"Our name says it all!"

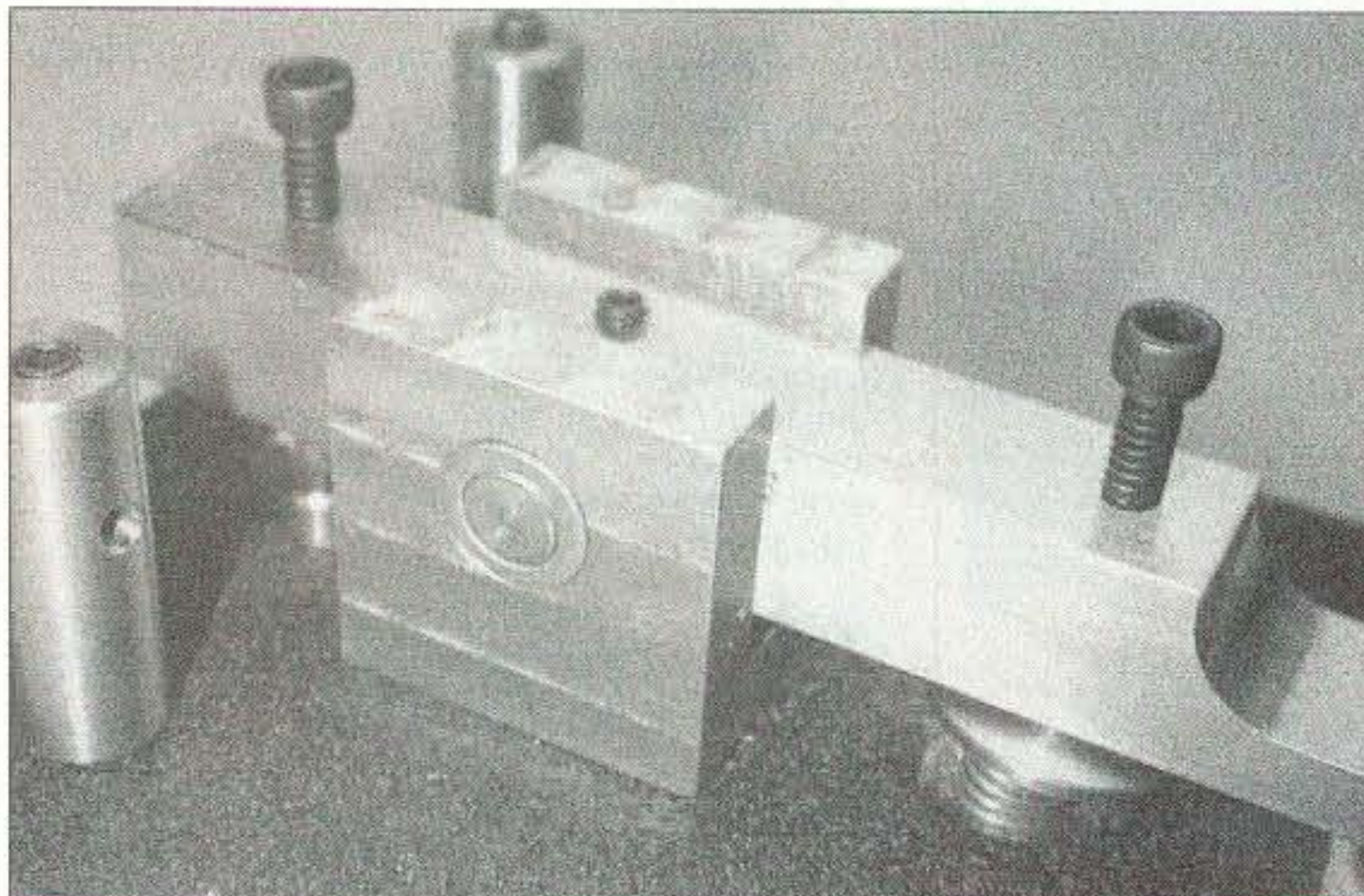
**Amateur Accessories** P.O. Box 7333, Champaign, IL 61826  
www.amateuraccessories.com  
kr4s@msn.com



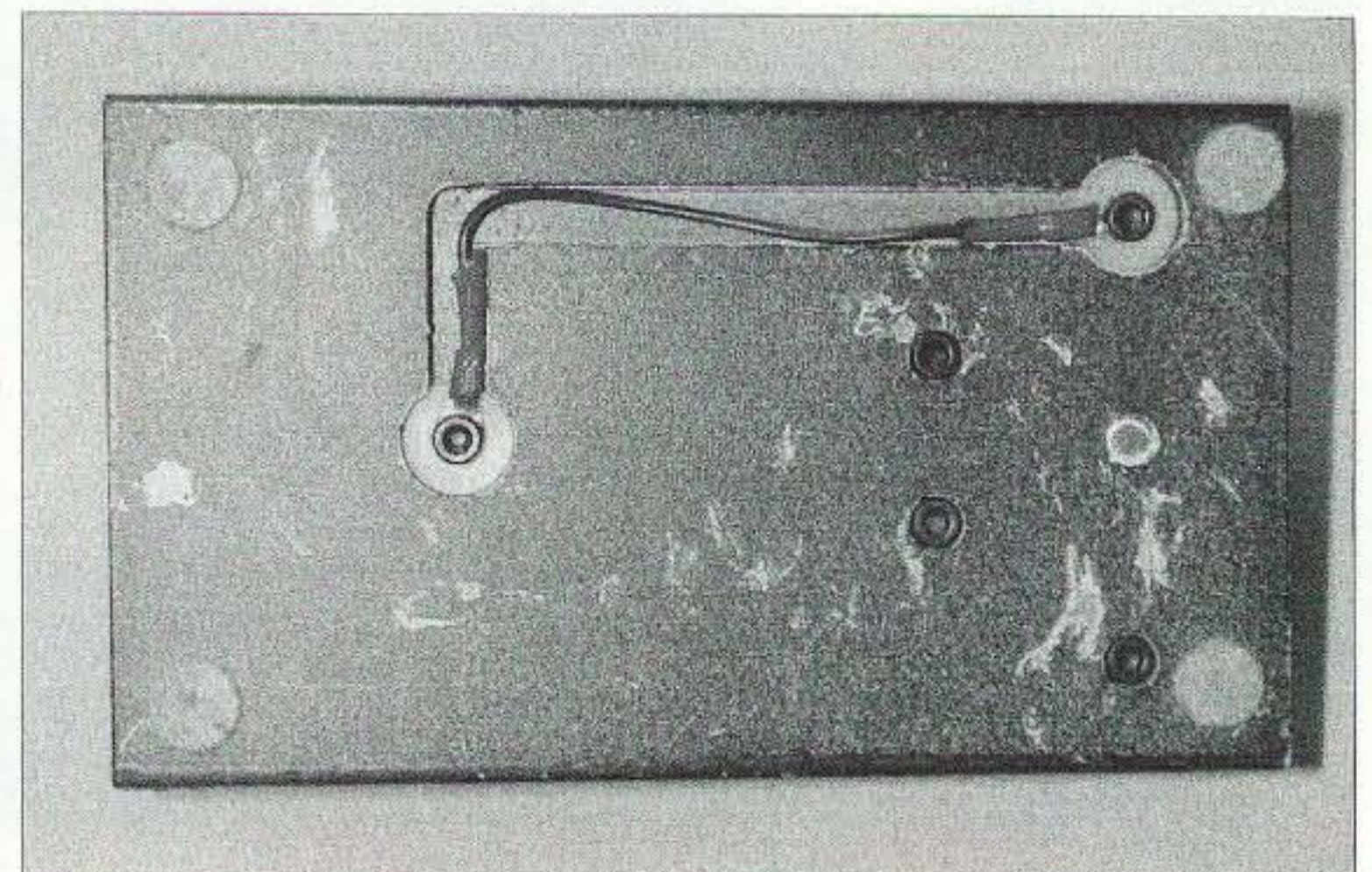
*Photo I. The knob is a drawer pull. The upper contact is a cone-pointed set screw.*



*Photo J. The space adjusting screw is locked in place with a set screw.*



*Photo K. Oilite bearings fit into the bearing block.*



*Photo L. Route the connecting wire through a milled channel.*

wish to preserve the color in brass or aluminum.

After painting the base plate, go back in with the counterbore tool and remove any paint that may have found its way into the three 6-32 SHCS holes, as these screws must make good electrical contact with the base plate.

Make a short connecting jumper between the fixed contact and the hot side connection post, using ring lugs on both ends of the wire. Route the wire through the milled slot.

#### Parts availability

Buying small quantities of metal is often difficult. I ordered the bar stock and base plate stock from Online Metals, at Web site [<http://www.onlinemetals.com/>].

I ordered small hardware and plastic stock from MSC Industrial Supply, at Web site [<http://www.mscdirect.com/>].

Neither company has a minimum order quantity. 73

**SAVE 47%!**

on 12 months of **73**

**Only \$24.97**

Call 800-274-7373

**73 Ad Sales**

Call

**1-800-677-8838**

# Junkbox Telephone Recording Adapter

*Caught on tape.*

*Before using this device, be sure to check with your local authorities to find out if it is legal.*

**M**any times it may be necessary to record telephone calls. The circuit in **Fig. 1** will allow the user to automatically record incoming and outgoing calls. In order to do this, the tape recorder must have "REMOTE" and "MIC" inputs. The Telephone Recording Adapter (TRA) connects to the "REMOTE" of the tape recorder. This allows the adapter to start and stop the recording process. The device also connects to the "MIC" input of the recorder. The telephone line is plugged into the TRA and power is supplied to the unit from a wall transformer. If there is no unused telephone jack to connect to the TRA, a one-to-two-telephone jack adapter is required. This will allow the TRA and a telephone to be plugged into the same telephone jack.

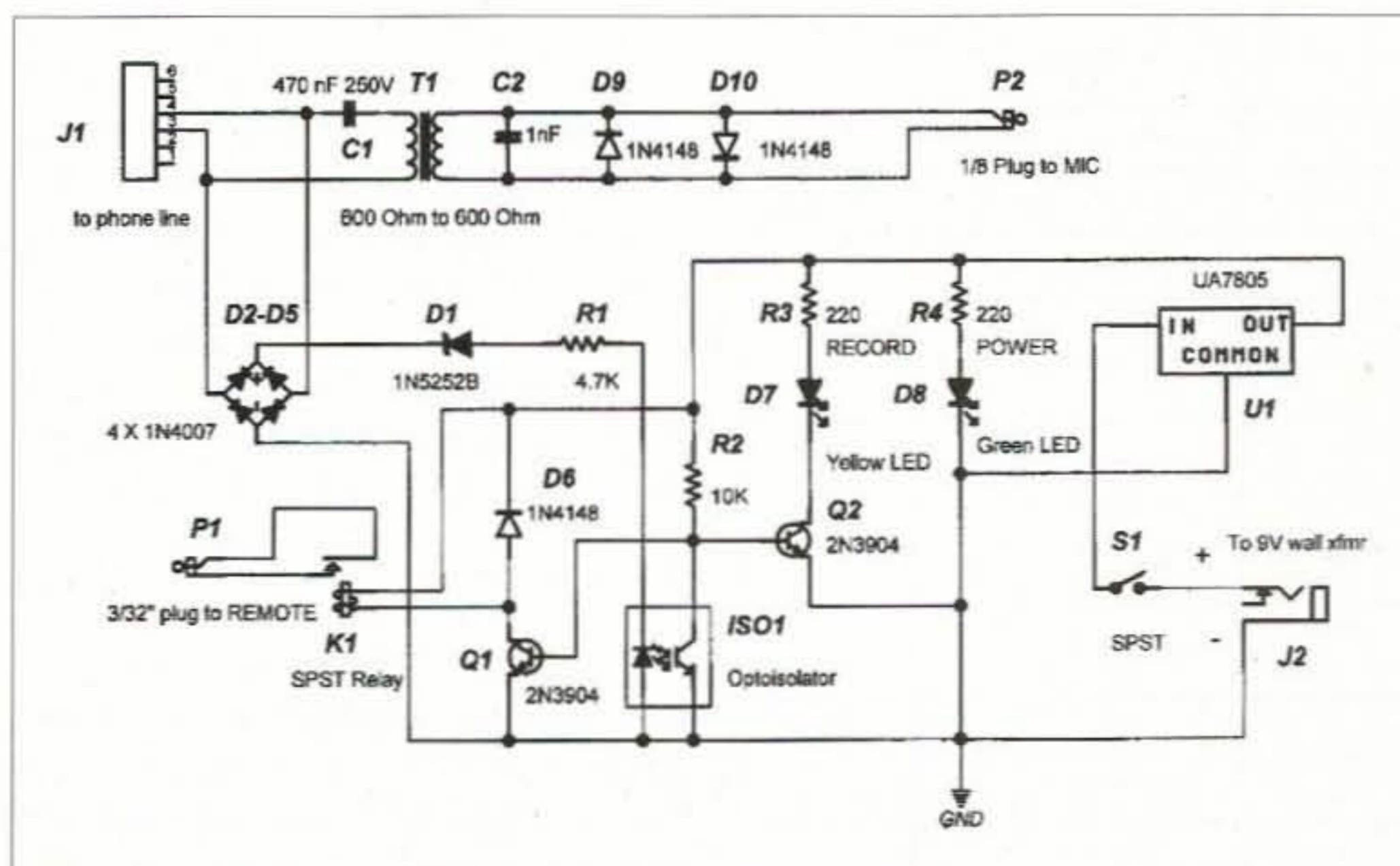
Once all of the connections are made, the tape recorder is put into record mode. For an outgoing call, the TRA will begin recording the conversation when any handset on the monitored line is lifted. If there is an incoming call the device will also record the conversation once a handset is lifted.

## Circuit description

The TRA is connected to the phone line at J1. The "on-hook" voltage at J1 is -48V. D2 through D5 form a full-wave bridge rectifier. Positive 48 volts is connected to D1 (a 24 V zener diode). When all the telephones on the monitored line are "on-hook," the voltage at the anode of D1 is 24 volts. This turns on the LED in the optoisolator through current-limiting

resistor R1. When the LED in ISO1 is on, it causes the transistor in ISO1 to turn on. When the transistor in ISO1 is on, Q1 and Q2 are off.

However, if the line has a telephone that is "off-hook," the line voltage is much less than 24 volts. Therefore, the LED in ISO1 is off, causing the transistor in the optoisolator to be high-impedance. R2 then pulls up the base of Q1 and Q2. Q2 turns on D7 (the yellow LED), denoting the "off-hook"



**Fig. 1.** Schematic of a Telephone Recording Adapter.

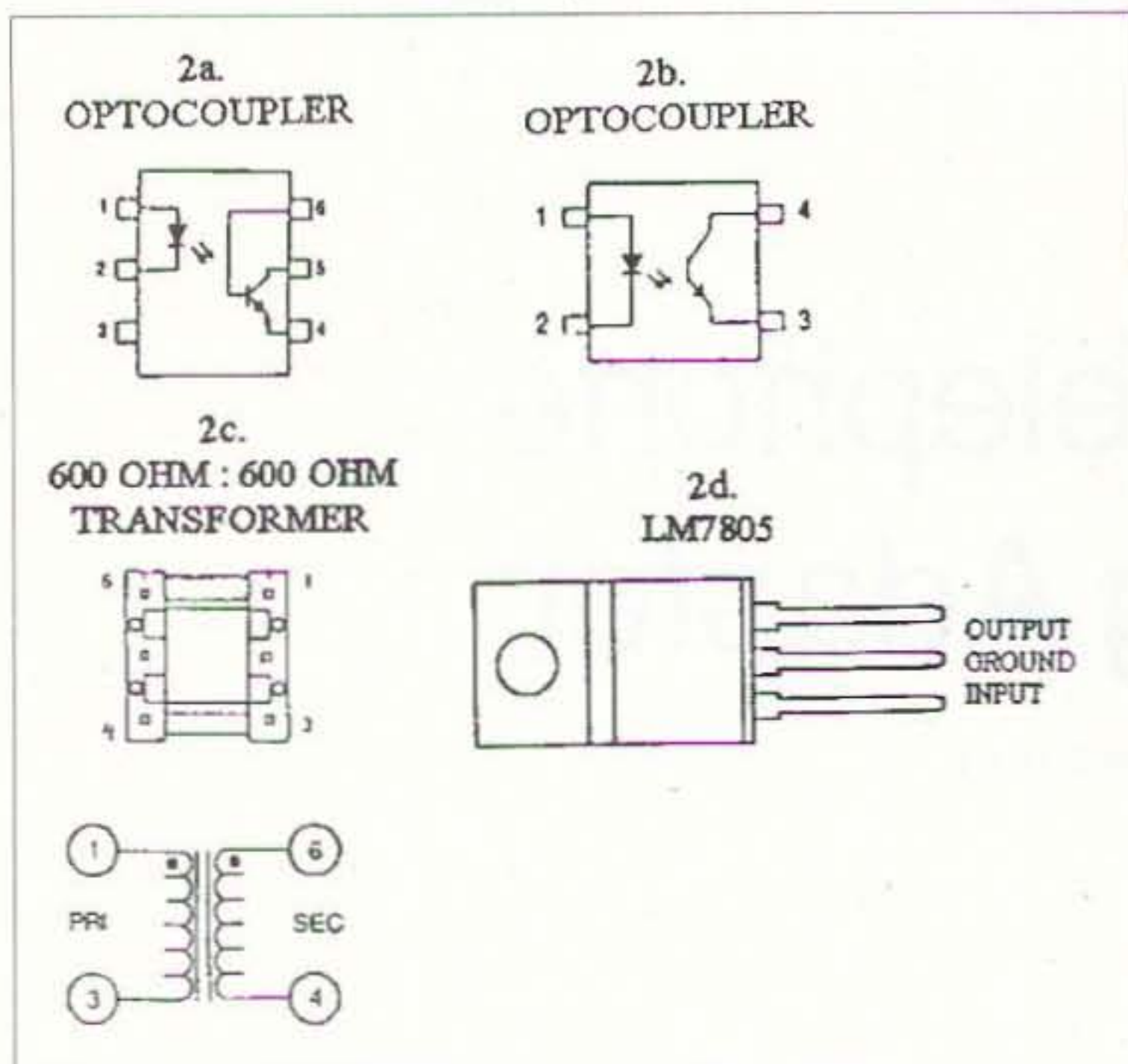


Fig. 2. Component pinouts.

Part	Description	Source
R1	4.7k 5% 1/4W	—
R2	10k 5% 1/4W	—
R3, R4	220 ohms 5% 1/4W	—
C1	470 nF 250V	Salvaged
C2	1 nF	—
Q1, Q2	2N3904	—
U1	UA7805	Salvaged
D1	1N5252B	—
D2-D5	1N4007	—
D6, D9, D10	1N4148	—
D7	Yellow LED	—
D8	Green LED	—
ISO1	Optoisolator	Salvaged
T1	600 ohm to 600 ohm transformer	Salvaged
K1	5V SPST N.O reed relay	Salvaged
J1	Telephone jack	Salvaged
J2	1/8-inch jack	—
P1	3/32-inch plug	Radio Shack #274-289C
P2	1/8-inch plug	Radio Shack #276-286
S1	SPST toggle switch	—
Wall transformer	9V 200 mA transformer	Salvaged
Perfboard	—	Radio Shack #276-1688
Hookup wire	—	—

Table 1. Parts list.

When the tape recorder is in the RECORD mode, the contact closure of K1 starts the recording process. The 600 ohm primary of T1 is connected to the phone line through C1. The 600 ohm secondary has its output clamped at  $\pm 700$  mV by D9 and D10 to protect the recorder input during telephone rings. This clamped voltage is connected to the tape recorder "MIC" input.

Because the ring voltage oscillates below 24 volts, the yellow LED will flash during telephone rings. Similarly, K1 will open and close its contacts at 20 Hz during the ring. Depending on the tape recorder, this may cause clicks or tones to be recorded on the tape before the handset is lifted on an incoming phone call. U1 (7805) provides 5V to power the TRA from 9 VDC at J2.

In this design, a heat sink is not required for U1. S1 is used to turn the recording adapter on and off. D8, a green LED, glows to indicate power to the device is on. Turning off S1 will disable the recording function when it is not needed (during modem communications, for example).

### Construction

This design uses several components which can be salvaged from a defunct cordless phone or out-of-date modem card. Some of the components that can be salvaged are U1, C2, ISO1, T1, K1, J1, and the 9 VDC wall transformer.

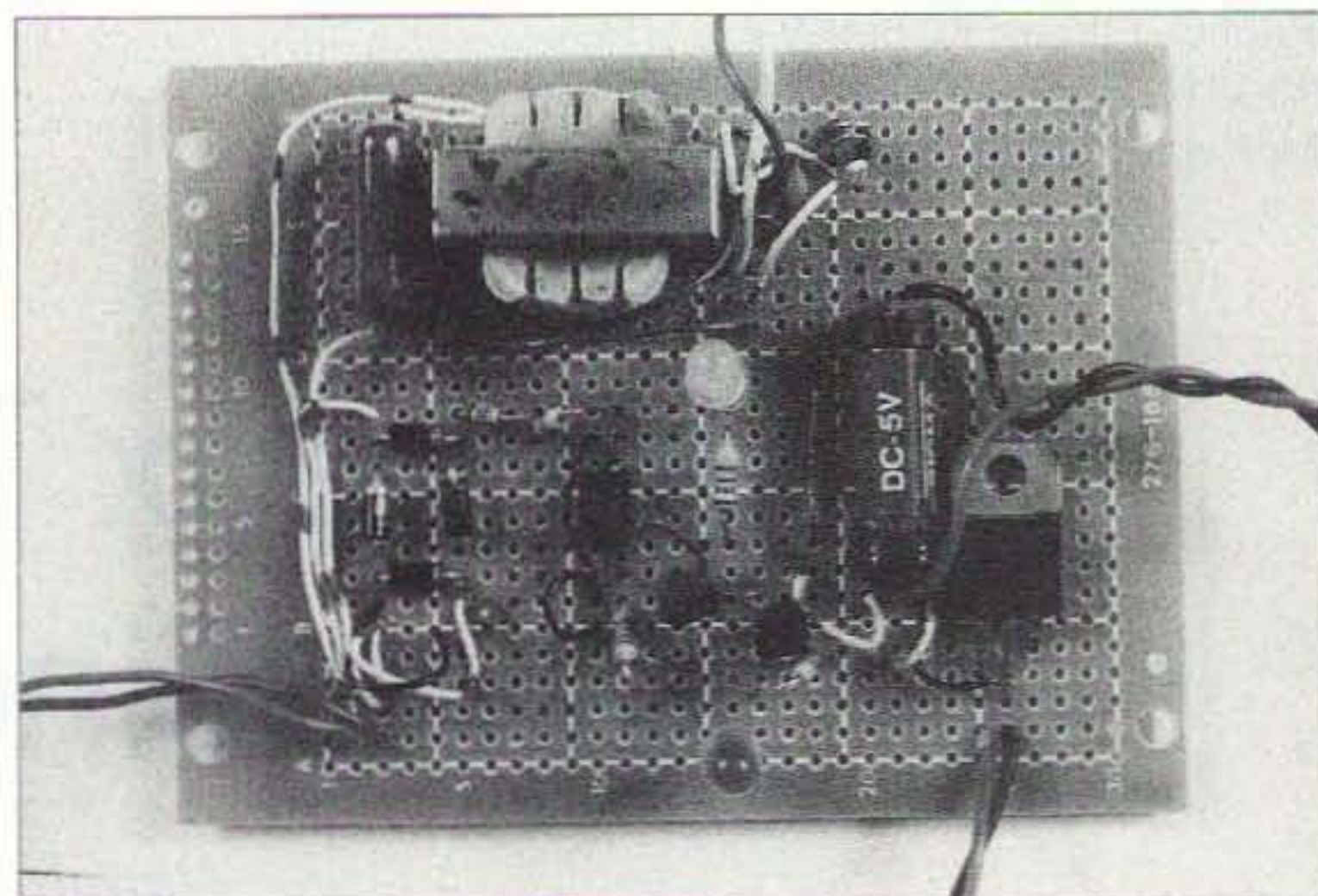


Photo A. Telephone Recording Adapter.

(Record) condition. Q1 turns on K1 (which is connected to the tape recorder "REMOTE" input).

Examine the cordless phone or modem circuit board and remove these components (refer to Fig. 2 and Table 1).

If any of these parts cannot be located, they can be purchased new. A salvaged optoisolator is most likely to have a pinout shown in Fig. 2a or Fig. 2b. An example of a 600 ohm to 600 ohm transformer is shown in Fig. 2c. The primary and secondary may be center-tapped or the secondary windings may have two 600 ohm windings. Note that the impedance of T1 at audio frequencies is 600 ohms, but the DC resistance for a 600 ohm winding impedance is usually between 75 and 200 ohms. The primary and secondary windings may have the same impedance without having the same DC resistance.

Once these windings have been determined, use a permanent marker to label the location of the windings terminals on the transformer. K1 is a 5 V N.O. reed relay. To verify the coil terminals, use an ohmmeter to look for a resistance of a few hundred ohms. When the coil pins are determined, use the ohmmeter to check contact resistance with 5 V applied to the relay coil. The contact resistance should be approximately zero. When the coil voltage is removed, the contacts should be open circuit. When connecting J1 to the Adapter, only the two center terminals out of the six are used.

Assemble the circuit on a piece of perfboard using point-to-point wiring. A printed circuit board is not given

Continued on page 56



# Meter Made

*Here's how to recycle those VU meters in old stereos.*

*Meters from discarded stereos can be used in many ham radio projects. This article shows how to measure their characteristics and put them to use as ammeters and voltmeters.*

A typical stereo set, such as the Realistic 13-1198 originally sold by Radio Shack, will have two VU meters on the front panel as shown in **Photo A**. This meter is 1.5 inches square and it has a white pointer with a black background.

Another stereo rescued from the trash man, a Superscope Imperial Model C-5060, is shown in **Photo B**. This one had a bonanza of five meters. They are 1.9 inches square. Two had a level scale (VU) shown in **Photo C** and two had a watts scale.

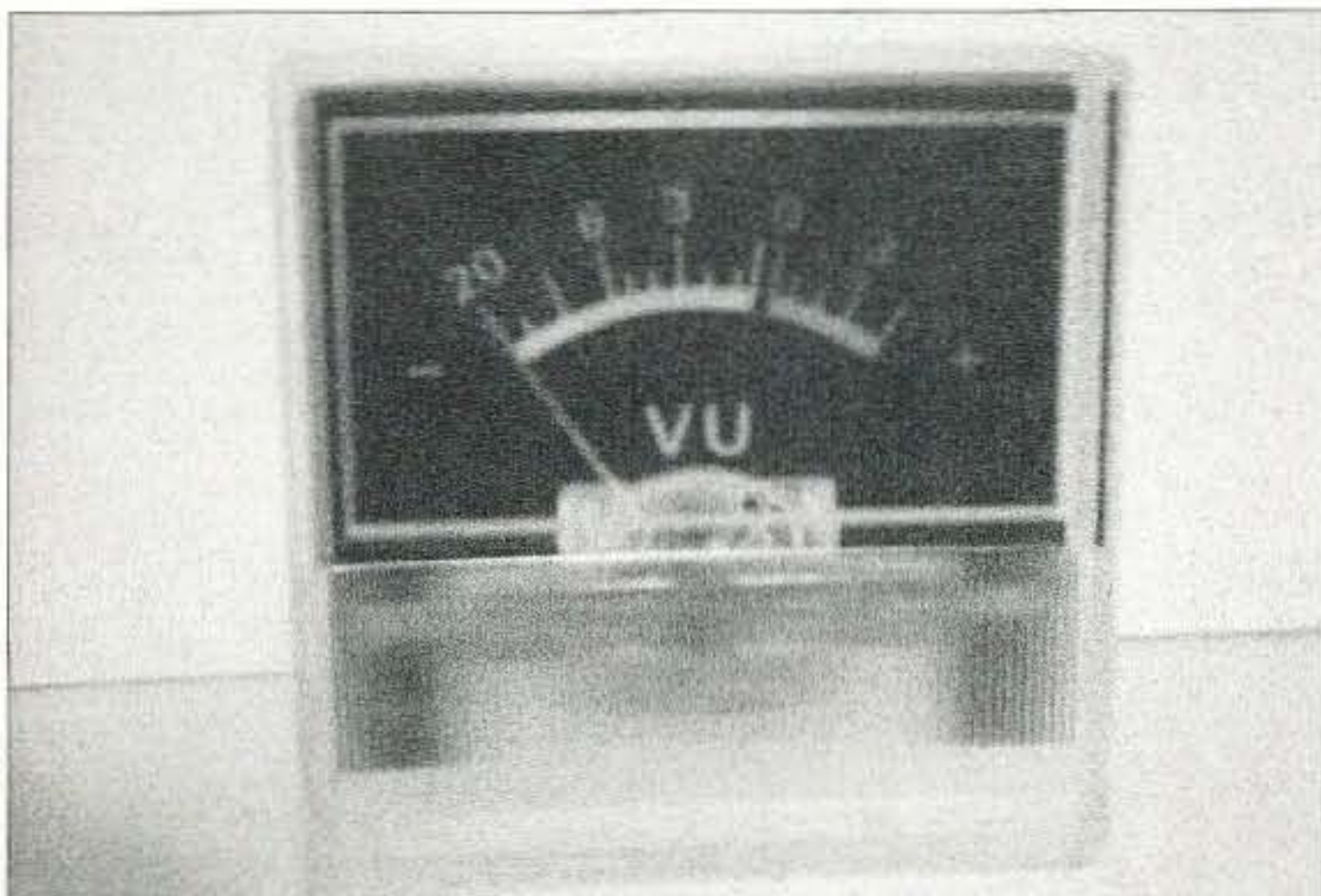
The fifth meter has a tuning scale. All five have a black pointer with a silver background.

Radio amateurs should have no difficulty in locating an endless supply of similar meters from discarded stereo sets. Check out neighborhoods where renters are frequently moving in and out, especially college students. The meters are easily removed from the sets. There may also be other parts of use to the radio amateur such as a power transformer, heat sink, variable capacitor, switches, potentiometer, etc.

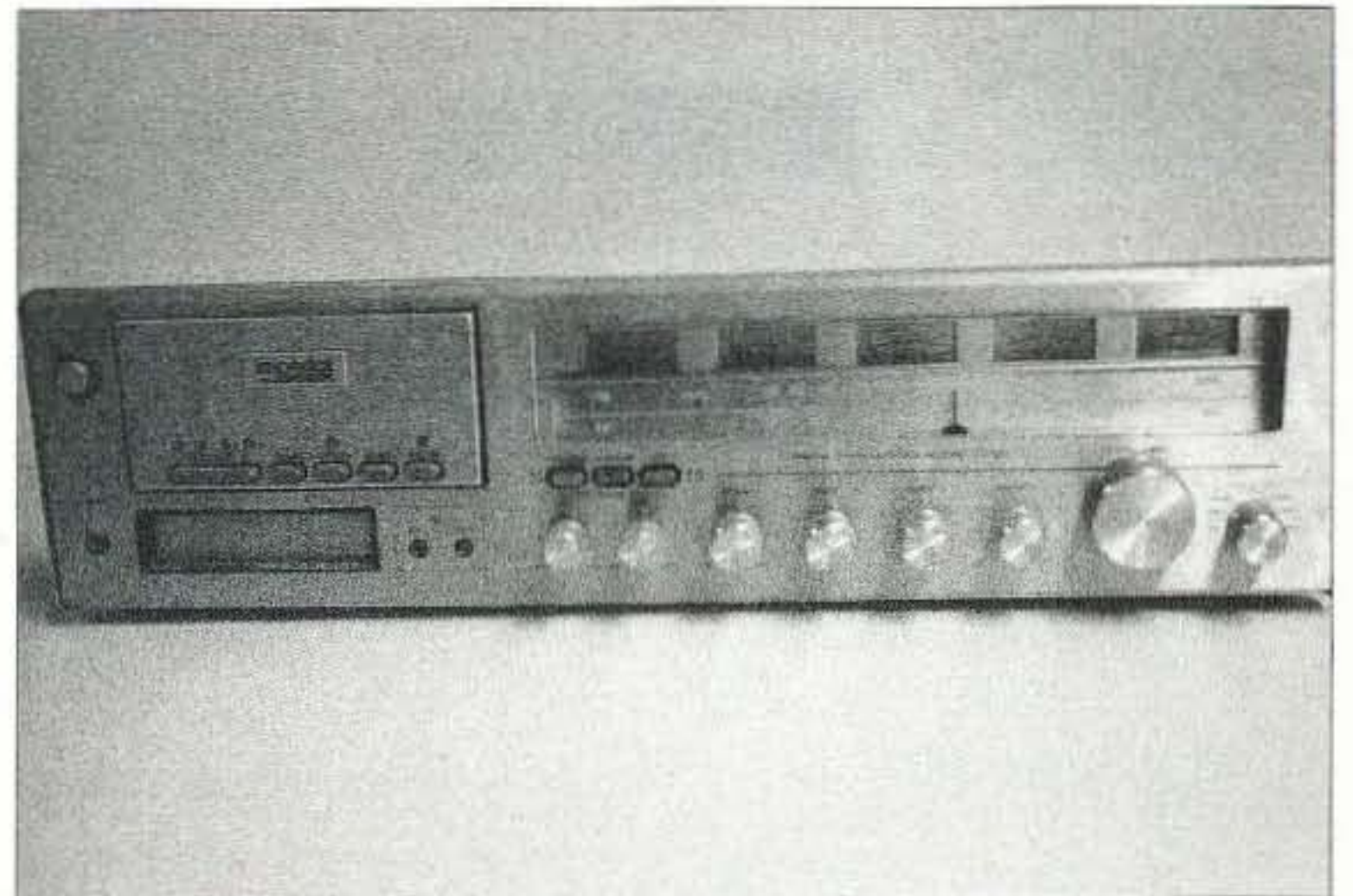
## Measuring the meter's characteristics

A meter can be characterized by the current level required to drive it to a full-scale reading and by its internal resistance. One way to measure these characteristics is to set up a circuit shown in **Fig. 1**. A 1.5-volt "D" cell and 10k ohm potentiometer are connected in series with the meter. Adjust the potentiometer for a full-scale reading on the meter as shown in **Photo D**.

Now measure the voltage of the "D" cell with a digital voltmeter. I



**Photo A.** VU meter from Realistic 13-1198.



**Photo B.** Superscope Imperial C-5060 AM/FM stereo.

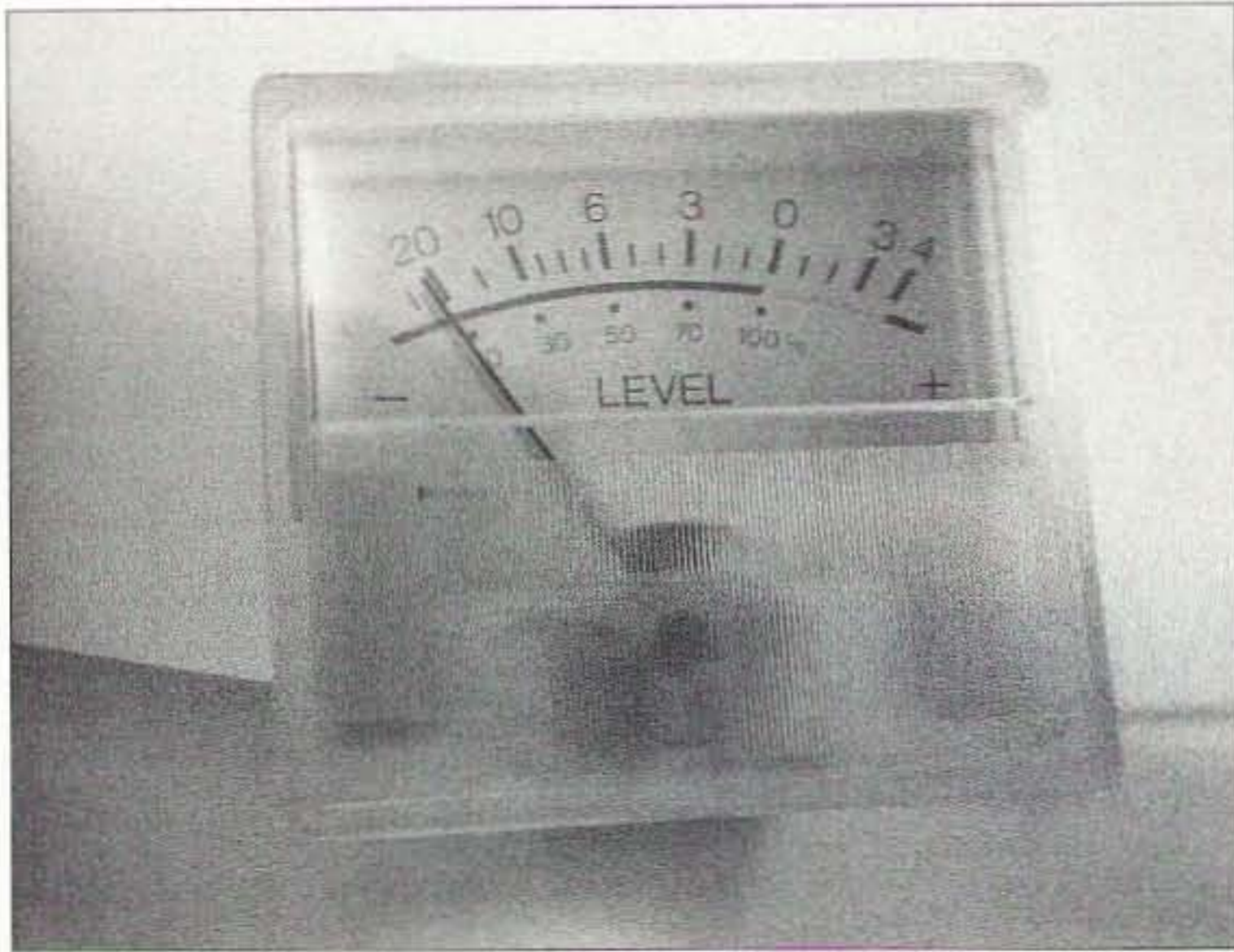


Photo C. Level meter from Superscope set.

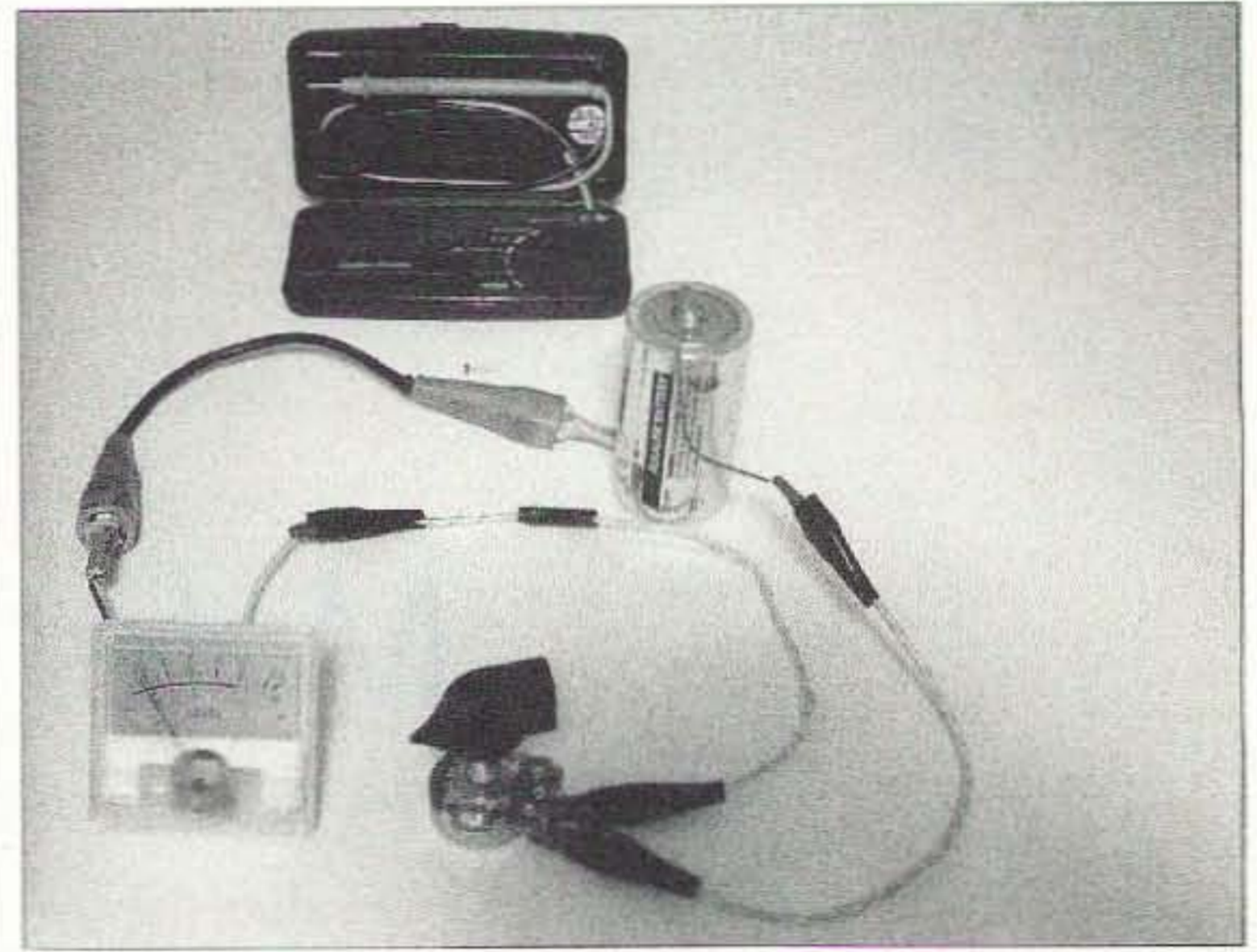


Photo D. Measuring meter characteristics.

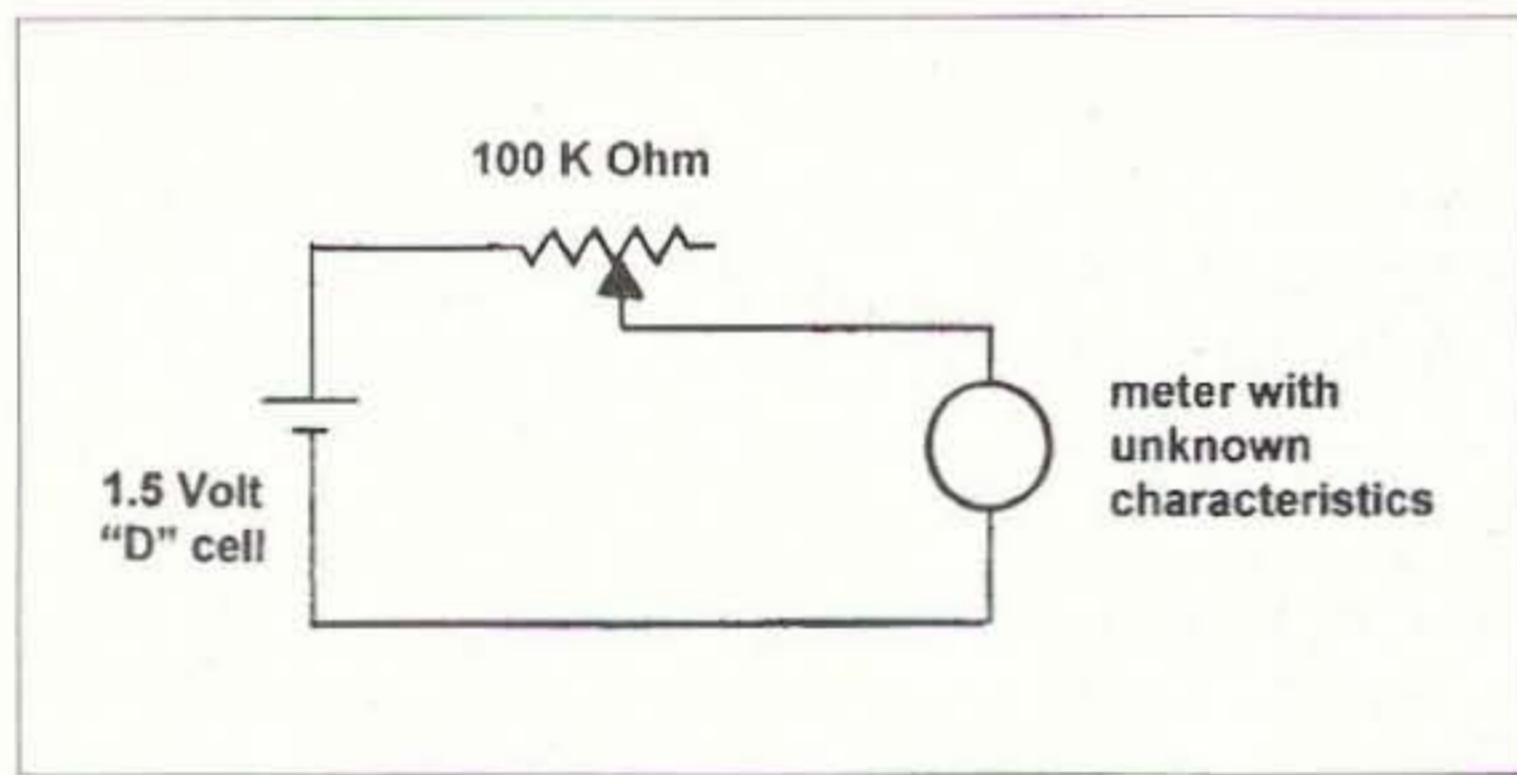


Fig. 1. Circuit for measuring meter characteristics.

Meter	Current ( $\mu\text{A}$ )	Resistance ( $\Omega$ )
Level 1	280	649
Level 2	258	639
Tuning	250	674
Watts 1	237	675
Watts 2	264	654

Table 1. Meter characteristics, Superscope Imperial C-5060 AM/FM stereo.

Desired Full-Scale Volts	Series Resistance ( $\Omega$ )
5	17.0k
20	71.2k
100	360.0k
200	1721.0k

Table 2. Series resistors.

used the inexpensive Radio Shack pocket digital multimeter shown in Photo D. Then measure the voltage across the meter. There should be no drop in the full-scale reading on the

meter when this measurement is taken. If there is, then your digital voltmeter is drawing too much current and the measurement will not be accurate. The pocket digital multimeter has a high enough input impedance so

there is absolutely no movement of the needle pointer when this reading is taken.

Desired Current	Resistance ( $\Omega$ )
1 mA	388
10 mA	28.9
100 mA	2.81
1 A	0.28
5 A	0.056

Table 3. Shunt resistor values.

Remove the potentiometer from the circuit and measure its resistance with the digital multimeter. Then, using formulas 1 and 2 below, calculate the meter's characteristics.

$$(1) \text{ Full-scale current} = (V_{\text{batt}} - V_{\text{meter}}) / R_{\text{pot}}$$

$$(2) \text{ Internal resistance} = V_{\text{meter}} / \text{Full-scale current}$$

For example, the Realistic meters measured: Full-scale current = 277  $\mu\text{A}$ , Internal resistance = 1013 ohms. Table 1 gives the measurements for all five of the Superscope's meters. The average is 258  $\mu\text{A}$  and 658 ohms.

### Use as a voltmeter

A resistor placed in series with a meter allows it to be used as a voltmeter. The series resistor value is given by formula 3.

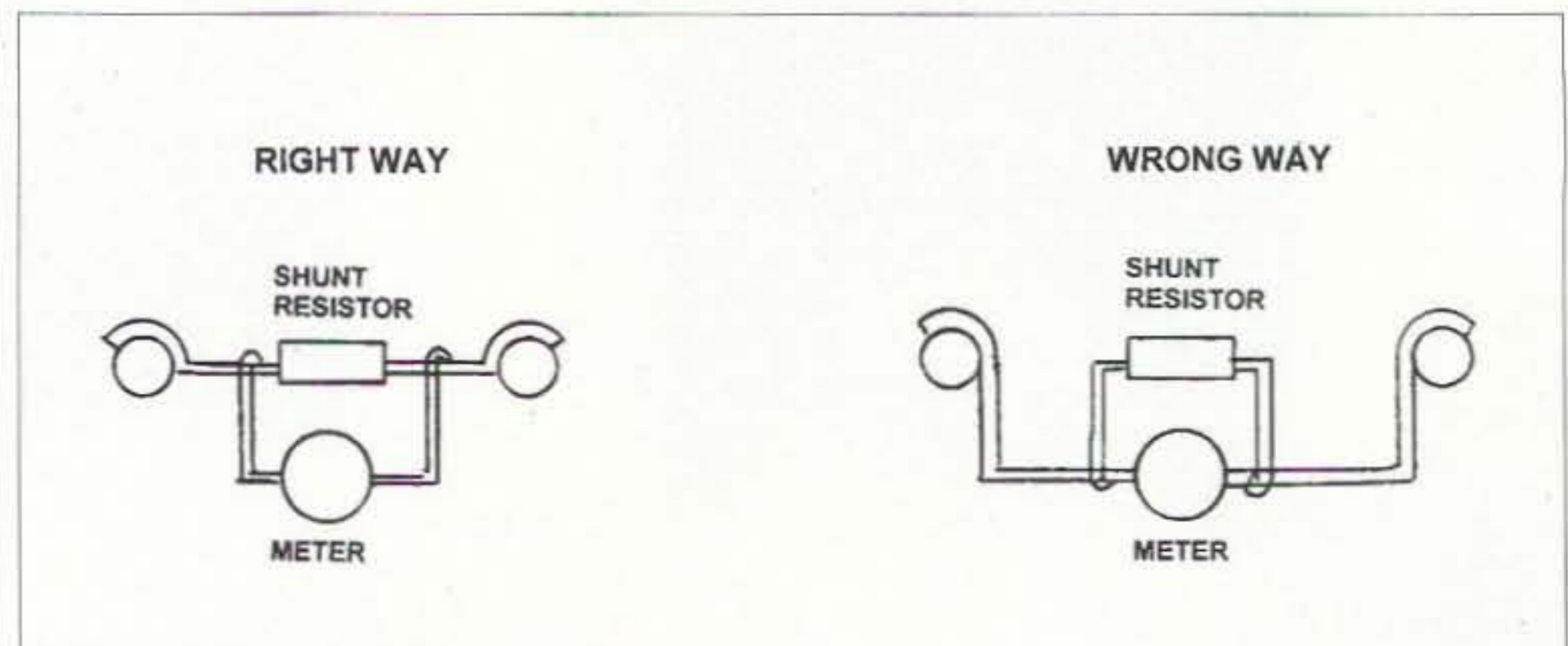
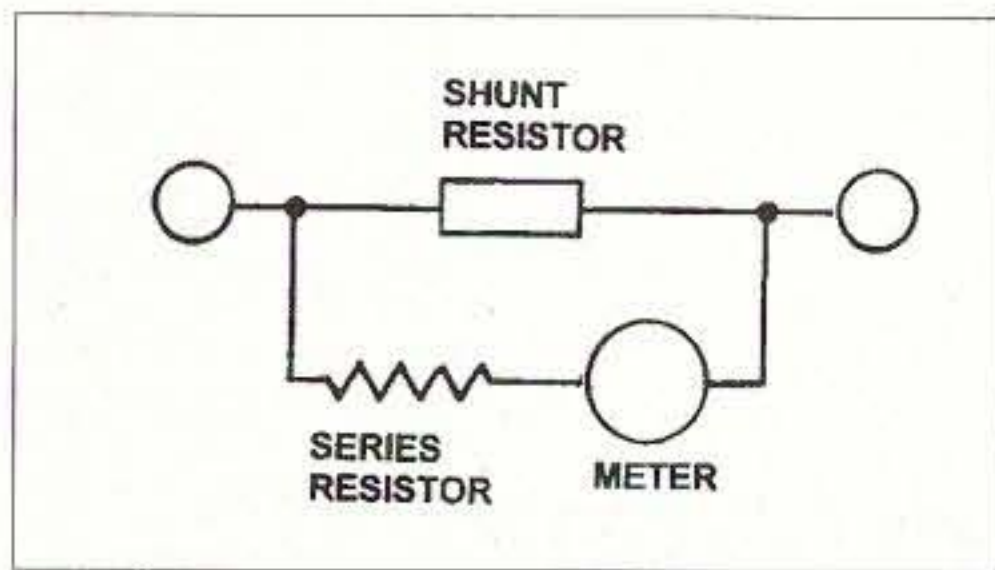


Fig. 2. Proper way to connect meter in parallel with a low-value shunt resistor.



**Fig. 3.** Use of a standard value shunt resistor by adding a resistor in series with the meter.

$$(3) R_{series} = (\text{Desired full-scale volts} / \text{Full-scale current}) - \text{Internal resistance}$$

See **Table 2.** The closest 1% resistor can be used, or two or more 5% resistors can be combined in series or parallel to provide the necessary value.

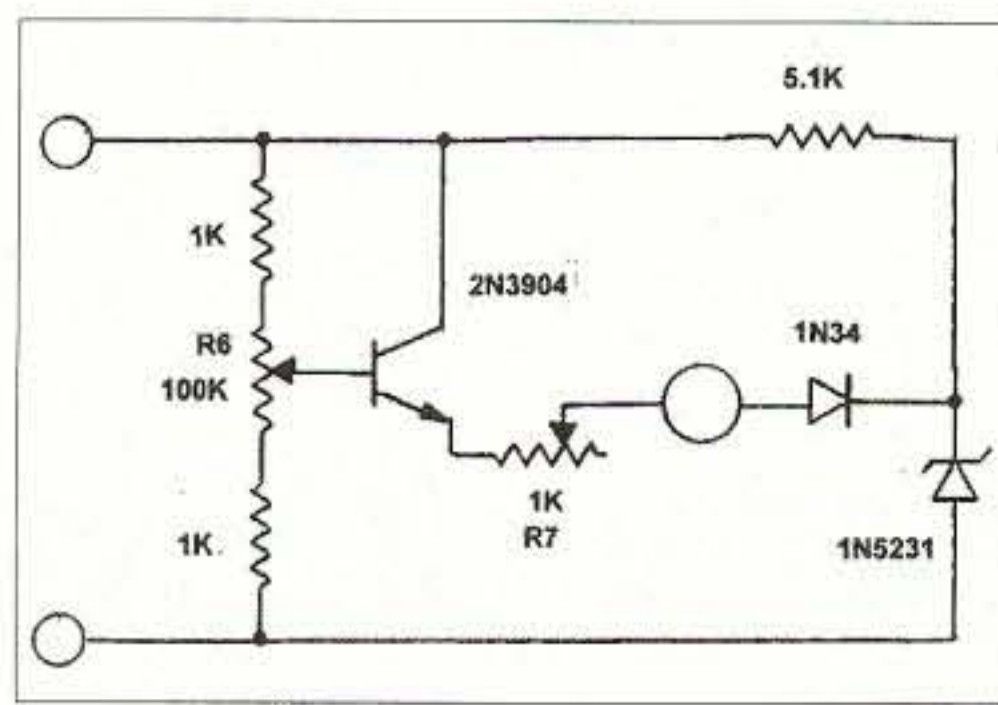
### Use as an ammeter

A resistor placed in parallel or shunt with the meter allows it to be used to measure current in milliamperes or amperes. The required shunt value is given by formula 4. The values will be in the low ohms range.

$$(4) R_{shunt} = \text{Full-scale current} \times \text{Internal resistance} / (\text{Desired current} - \text{Full-scale current})$$

**Table 3** gives some typical values for the Realistic meter.

Two or more standard-value resistors can be combined in series or parallel to provide these odd values. For low values below one ohm, it is important to connect the meter across the



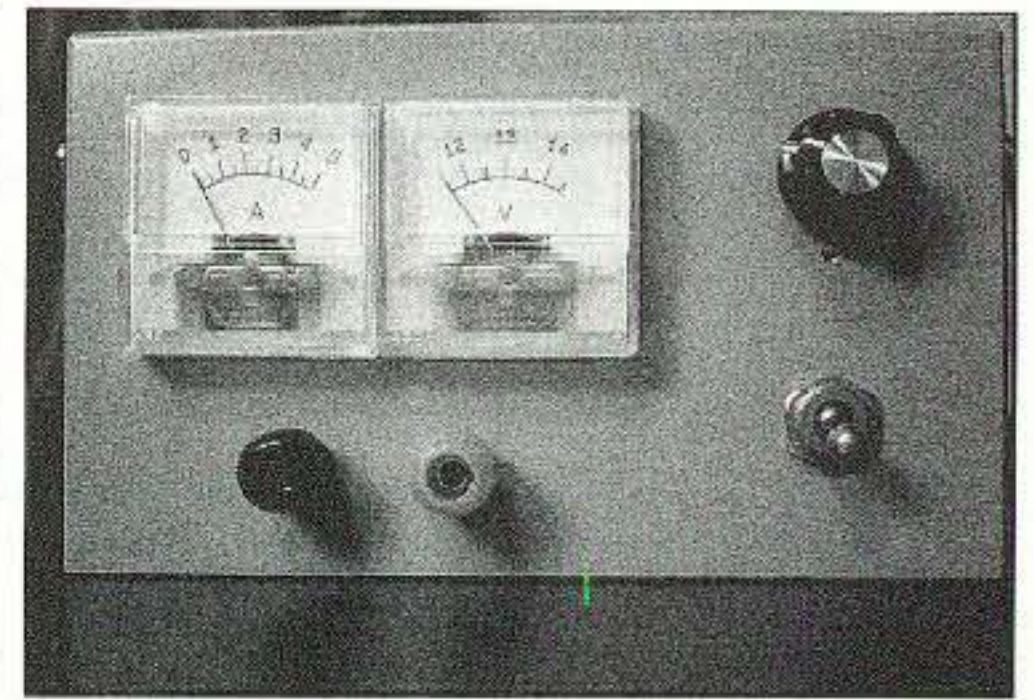
**Fig. 4.** Expanded scale voltmeter circuit.

shunt properly to minimize the effect of resistance in the connections. See **Fig. 2** for details.

The selection of low-value resistors available to the experimenter is very limited. If a particular low-value resistor is available, it may be possible to use it in the circuit shown in **Fig. 3.** A resistor is placed in series with the meter. The series resistor is calculated from formula 5.

$$(5) R_{series} = [(R_{shunt} \times \text{Desired current}) / \text{Full-scale current}] - R_{shunt} - \text{Internal resistance}$$

Of course, if the calculated value of  $R_{series}$  comes out to be negative with this formula, then the circuit of **Fig. 3** cannot be used with that shunt resistor. A higher-value shunt resistor must be selected. Note that the circuit of **Fig. 3** will also have a larger (but still small) voltage drop across the terminals than the direct shunt circuit of **Fig. 2.**



**Photo E.** 12-volt adjustable power supply.

### Use of meter as a suppressed-zero (expanded-scale) voltmeter

In some applications, such as the 12-volt power supply described later in this article, it is desirable to have an expanded voltage scale. A circuit developed for the battery fuel gauge from *Electronics Now*, April 1997, pages 58-59, 74 can be used. See **Fig. 4.**

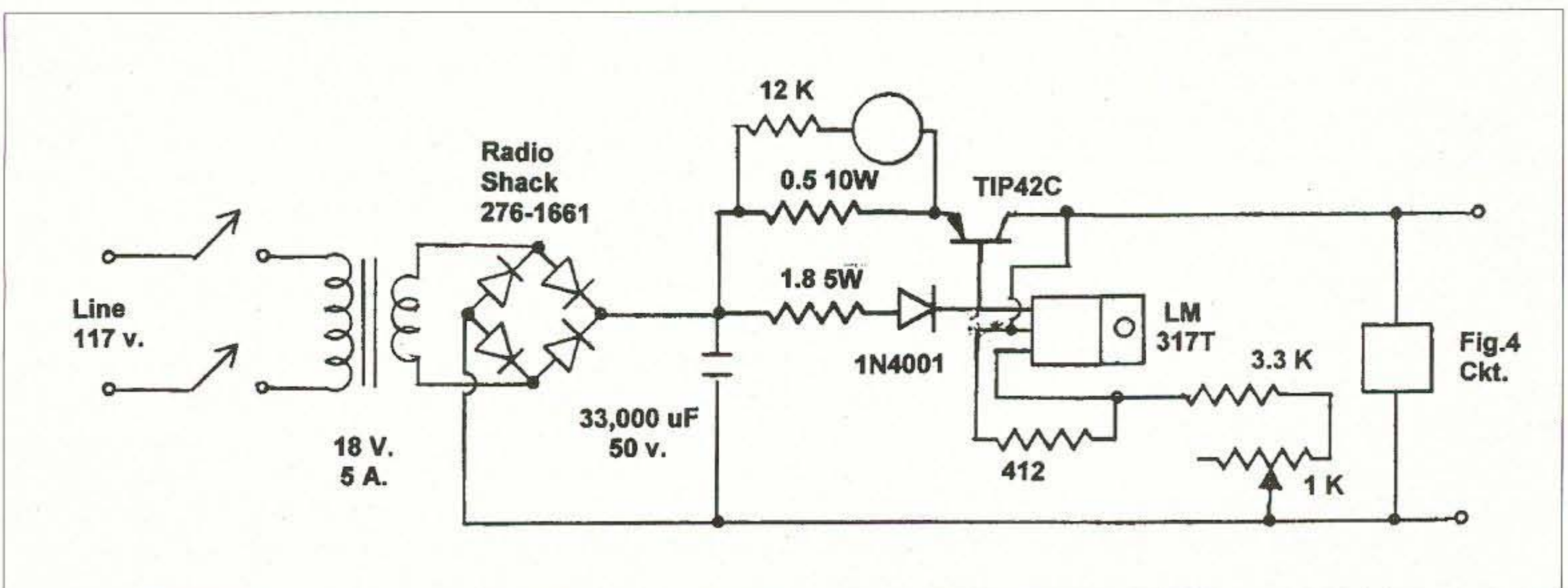
A percentage of the incoming voltage, set by R6, is compared to a fixed voltage set by a zener diode D1. Only when the voltage exceeds this value does the meter start to indicate. The left and right ends of the meter scale can be set by adjustment of R6 and R7 respectively.

Circuit boards for the fuel gauge, as well as full kits, are still available from Unicorn Electronics at 1-800-221-9454 or [www.unicornelex.com].

### Variable power supply using recycled meters

You can use recycled meters to read

*Continued on page 57*



**Fig. 5.** Adjustable power supply circuit diagram.

# Autobiography of Everyham — Part 1

*How many times do you see yourself in this story?*

*Amateur radio has, for many decades, been one of the more undervalued contributions to our communities. Having begun as a group of experimenters before the term “engineer” was used for much more than the guy driving a locomotive, these early pioneers helped develop radio communication as we know it.*

**D**uring the evolution of radio, these experimenters were pushing the envelope with the development of new transmission modes, transmitters, and, well, basically anything radio.

As technology progressed, it developed complexities that could no longer be dealt with effectively (and developed further) without the aid of an electronics laboratory, or at the very least, someone with scientific training and access to appropriate tools. This led to the lament that the modern amateur radio operator was no more than an “appliance operator” — one who buys his equipment ready-made, and is either not inclined or not trained to repair it. Combined with certain antisocial habits exhibited by a minority of operators, it has often been asked, “What’s the future of amateur radio?”

To give credit where credit is due, there are a few remaining operators out there who realize that amateur radio is, indeed, a service (the rules and regulations published by the Federal Communications Commission state that very clearly). When conventional communications systems are overloaded during emergencies, there are

still amateur radio operators who will jump in and volunteer their services. During special events, special service clubs often contribute their communications skills to keep things running smoothly. A certain minority still even use amateur radio as a “test bed” for their experimental circuit development; learn about the propagation characteristics of various frequency bands, or of antenna types, or indulge in other learning processes that add to either their own knowledge pool or the accumulation of knowledge for the amateur radio community as a whole.

Whether these contributions will suffice to convince the FCC that we are allowed to maintain our access to valuable frequency spectrum, and for how long, remains to be seen. The only thing for certain is that demands for more radio spectrum will continue to increase (brought by pressures from the cellular telephone industry and the public service sectors, especially in larger metropolitan areas where there are many such services requiring an ever increasing amount of “elbow room”).

My amateur career is rather unique in that it began at the cusp, between the age of experimenters and the era of

the “appliance operator.” Having one foot firmly planted in each epoch has given me insights into, and the best of, both worlds. For those who share this unique position (or those I met on the way who came along for the ride), the experiences have, for the most part, been interesting at the very least, if not memorable. Having received my first license in 1976, I have had the longevity in the service that has given me the opportunity to not only be part of many unique experiences and historical events (such as having been active on the first 220 MHz repeater in Illinois), but to have also provided the chance at reflection and introspection over several decades.

The longer I am around, the more newcomers seem to ask me what it was like, either in amateur radio in general, or on their favorite band. At other times, one of the twists and turns that commonly take place in a longer conversation spark a memory of a certain event in history that lead to an interesting or otherwise useful anecdote. While I don’t mind rehashing some of the more poignant or humorous events (especially when suitably bribed with beer), I am as susceptible as anyone else to the foibles of memory, especially

as the years advance. To minimize these pitfalls in memory, a written version seems in order.

### Early years

The majority of amateur radio operators I met in my early years — and this happens to a more limited extent today — earned their licenses as an off-shoot of their employment: maritime radiomen wanting to extend their interest to other services; radio engineers who thought it would be the fun thing to do; or military radio operators wanting a place they could carry on with what they enjoyed doing but in a more leisurely environment.

From them, I learned many good operating practices (most led by example), or in the case of the engineers, got help in developing my first insights into what it takes to put together a good radio setup (and other technical advice).

But, as far as the actual licensing is concerned, I was a bit of the "odd man out"; I was too young to be a shipboard "sparks" (my dream job that I've never been able to get — born too late!), and it was too early in my schooling to be considered anything even remotely resembling an engineer. Instead, I had developed my interests in radio by other means. The first exposure to radio was gained via an old shortwave receiver I found in my grandmother's closet when I was very young. They had bought the radio when they first emigrated to America: it was about the size of a small suitcase and was a tube radio — the early version of a Zenith Transoceanic. One thing I always enjoyed about the old tube radios are their ambiance: the soft glow of the tubes (unfortunately not visible on the Transoceanic, but on subsequent radios I had, they made a unique night light!), the subtle hum of the power transformer, and after having been on a while, the smell of the oil used to machine the metal parts (a residue always seemed to be on the chassis). Too bad even the best modern technology can't find a way to recreate that kind of nostalgia!

After establishing my initial fascination with hearing all those interesting

signals from far-off lands, it didn't seem all that long afterwards until, a few years later in junior high school, I came across a fictional book in the library (even back then I was an avid reader) whose main character got his "ham" license.

This sparked my curiosity even further, and one coincidence led to another (the first being that I had found that book in the school library to begin with). Shortly after I finished the book, the junior high school's vice principal started an amateur radio club. Thinking it had been established for those who already had a license, I missed the first meeting, but after mentioning the interest to my parents, I was encouraged to attend subsequent meetings. Fortunately, my first assumption had been wrong; the club had been set up for those who wanted to learn to get their license. This was back in 1976, the day when the basic beginner license was the Novice class: Slow Morse code speed and technical knowledge were both required for the test; licensees were still given the unique prefix of "WN" to denote their status; license terms were still two years, and; a single person holding a General class or higher-level license could still administer the FCC theory test, after sending in paperwork stating the student had successfully passed the Morse code requirements. This was still the case when I was in college in the early 1980s, and I administered the test to a few people at the college I was attending.

My dad (an electronics engineer at that time) built my first code-practice oscillator, and helped with tutoring outside the junior high school club environment. Of about ten members, approximately half survived the code test; of those, only two of us passed the written test to get our licenses. Back then, there didn't seem to be all that many school clubs. Either they had gone defunct (like, as I learned later, my high school club had), or they had not gotten the word out as successfully as clubs seem to do today. Relatively recently I even read in a ham magazine that there was a Special Event day where school clubs tried to work as

# ALL ELECTRONICS CORPORATION

## 12 Vdc 1.25 amp Power Supply

DVE # DSA-0151-12  
2.1mm I.D. coax power plug.  
Center positive. UL, CSA.

CAT # PS-1215

**\$7<sup>25</sup>**  
each



10 for \$6.95 each • 100 for \$6.50 each

## Neo-Cylinder Magnet

Shiny, nickel plated neodymium cylinder. 0.25" diameter x 0.2" long.

CAT # MAG-76

**2 for \$1<sup>00</sup>**

50 for 35¢ each  
100 for 25¢ each



SHOP OUR ONLINE STORE  
[www.allelectronics.com](http://www.allelectronics.com)

## LEDs (Light Emitting Diodes)

SUPER BRIGHT RED 6,000 mcd T-1 3/4  
CAT# LED-94 75¢ each  
100 for \$50.00 - 1,000 for \$350.00

BLUE - water-clear 1,500 mcd T-1 3/4  
CAT# LED-74 \$1.75 each  
100 for \$115.00 • 1,000 for \$950.00

WHITE - water-clear 3,000 mcd T-1 3/4  
CAT# LED-75 \$2.00 each  
100 for \$165.00 • 1,000 for \$1300.00



## 10 Compartment Plastic Storage box

Transparent hinged plastic box with 10 compartments. Great for parts storage or display of small items. Outside dimensions 7" x 3.4" x 1.25". Friction-lock lid with dual clasps. Each box individually wrapped in a cardboard sleeve. CAT # SB-10

Case of 36 for \$30.60  
(85¢ each)

**\$1<sup>00</sup>**  
each



ORDER TOLL FREE  
**1-800-826-5432**

CHARGE ORDERS to Visa, Mastercard,  
American Express or Discover

TERMS: NO MINIMUM ORDER. Shipping and handling for the 48 continental U.S.A. \$6.00 per order. All others including AK, HI, PR or Canada must pay full shipping. All orders delivered in CALIFORNIA must include local state sales tax. Quantities Limited. NO COD. Prices subject to change without notice.

CALL, WRITE  
FAX or E-MAIL  
for our FREE  
96 Page  
CATALOG  
Outside the U.S.A.  
send \$3.00 postage.

MAIL ORDERS TO:  
ALL ELECTRONICS  
CORPORATION  
P.O. Box 567  
Van Nuys, CA 91408  
FAX (818)781-2653

e-mail [allcorp@allcorp.com](mailto:allcorp@allcorp.com)

many stations as they could, garnishing extra points for working other clubs. Although we had discussed putting together a school radio station in my junior high, it unfortunately never came to pass.

Even the process of getting licensed provided its entertaining aspects. Although I may not have been the "perfect" student, I was able to avoid more serious trouble. When the school's intercom paged me to the vice principal's office (he was responsible for looking after the troublesome students, among other things), my esteem in the eyes of the tougher kids went up a notch. Keeping the actual reason for the page a mystery enhanced my status; having been one of the students singled out for being "picked on" by other kids, the status as an imperfect student encouraged others to look elsewhere for whom they picked on. Fortunately (as an additional benefit), these calls to the vice principal's office were related to urgent club business, typically a last minute schedule change for our meetings. Getting out of what I thought to be a boring class didn't hurt, either!

### A surprise from the FCC

The early days of my amateur career also provided my first scare. My dad

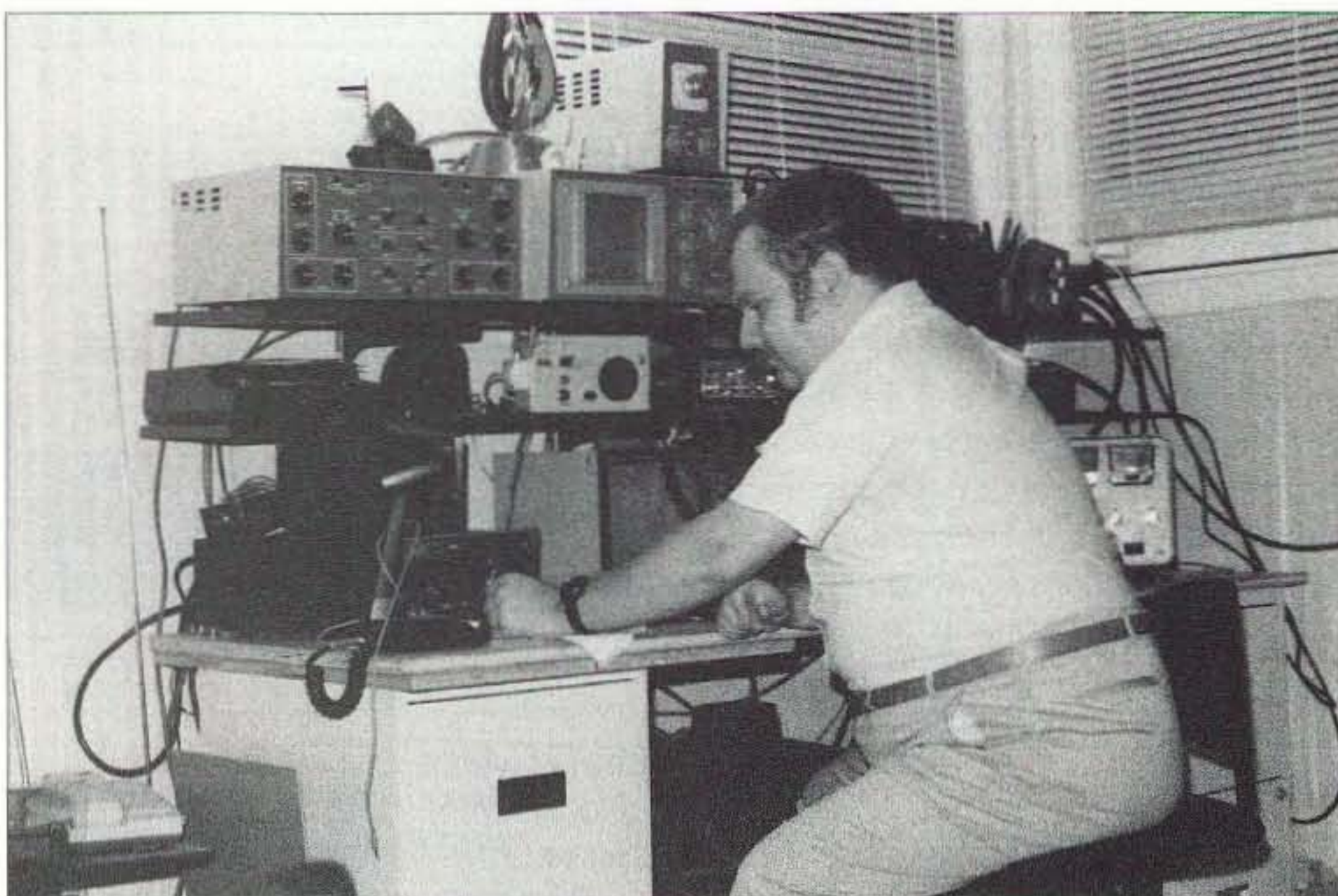
and Mr. Panczyk, the school's vice principal, put up a 40-meter inverted "V" on the house; the old tube radio I had (a Drake TR-3) would tune it on 40 and 15 meters (a solid state radio I upgraded to many years later, a Drake TR-7, proved to be more fussy and I needed a separate antenna for 15). I had barely any time at all to get on the air (the first time was with Mr. Panczyk; we spent more time on the telephone than on the air), when I received a letter from the FCC. It put me into shock; realizing my inexperience on the air, I had always used above-average caution to avoid problems. Besides, I hadn't even been on the air long enough to get into trouble! Fortunately, it turned out to be a pleasant surprise. I had received my license at the point where the FCC dropped the rule of giving Novice class operators distinctive callsigns. Typically novices who were licensed before then had to upgrade to the next higher class to lose that prefix, but since I was pretty much right on the dividing line between the two, they had given me an updated call without my having to do anything.

Trying to get on the air in the first place can present its own set of problems, as a test of the determination of the licensee. After a pleasant Saturday morning outing to a ham store about

75 miles away during beautiful weather, going through some very enjoyable Wisconsin scenery, we got back to within two miles of home, only to have a car accident (fortunately, no injuries). Shortly thereafter, the one and only family car was stolen (a 1968 Ford Galaxy — a car I was hoping to learn how to drive in, and buy from my dad at the appropriate time). Although my dad was a help initially in getting licensed and on the air, it wouldn't be for a few more years that any mobile radio work would be done. This was approximately 1977, when my dad installed a CB in a used 1974 Mercury Comet, a car I would learn how to drive in, and use as my car for almost a decade afterwards.

Just like today, the best bargain and best way to get on the air was with used equipment. Back in those days when I first got licensed, that still meant manually tuned tube equipment; the operator would pick an operating frequency, and through the turning of several controls in a given sequence specified by the radio's owner's manual (usually read three or four times through) would tune the radio. The radio was then tuned to a certain operating frequency, give or take a few tens of kilocycles either way. The operators who could afford to buy the parts typically did most of their tuning with the radio switched to a dummy load, and then tweaked the tuning on the antenna afterwards. This was the politer, and probably more legal, way of doing things. More creative operators would calculate how many light bulbs were required to handle the output power of a radio, taking into account the "on" impedance of light bulbs. Some of these operators reported surprising results with light bulbs, typically in the form of working another station a few states over with their "light bulb antenna," to the astonishment of both parties involved. The rest of us just tuned up right on the air, after listening for a clear spot on the dial.

The actual act of tuning a radio, in itself, was not that big of a problem to anyone who could understand the radio's owner's manual and have a bit



*Photo A. Inner sanctum: Klaus WB9YBM at his operating position. Hidden from view on the center shelf is a 220 MHz radio and 10m all-mode transceiver. To the left, next to the cordless telephone (on the shelf), is his SWL receiver and scanner, conveniently located next to his bed.*

of decent dexterity and eye-hand coordination, since tuning involved watching a meter while twirling knobs. The challenge was in the technique of tuning. Even when owner's manuals provided pre-sets of the tuning controls, these were typically just rough estimates used as a starting point, with variations being caused by exactly where in a given band it was that the operator was tuning, how well the antenna was matched in its tuning point, and variations in all the myriad components in the transmitter. It was not unknown for an operator to blow out expensive transmit tubes because key-down times during tuning were too long, or the pauses between transmissions were too short to allow component cool-down.

At the very minimum, the clumsy operator would cause damage to components just short of total failure, leaving him to wonder why things like transmit finals didn't last as long as they did for other operators. Usually the more astute operator would add listening as a positive attribute to properly tuning a radio — danger signs like arcing between the tuning plates of the air variable capacitors could be heard in the early stages of improper tuning, as could the smell of ozone in the more severe cases. A good operator knew to have eyes in two places at once — the tuning meter, and looking through the cooling slots of his radio, backing off the power when the cherry red glow of the tubes' plate got a bit too bright. It's unfortunate that these techniques aren't being properly passed down from one generation to the next; inevitably, there are always going to be hams out there interested in antique radios who need to know these tuning techniques, and to this day I haven't seen them mentioned in any manuals, nor have I heard too many teachers pass these things along to their students.

Since actual transmit tubes were either unavailable or too expensive for the ham community, most early radios used television sweep tubes (two or three in parallel) for finals. Just like their transistor counterparts, they had to be replaced in, and bought as,

matched sets. Even adding a fan to a transmitter didn't seem to extend the tube life all too much longer, especially when the modulation mode used increased the duty cycle, as with RTTY.

### Rule changes

During my high school years, being too busy with school studies, I had little time left to think about upgrading my ham license. Fortunately, during this time the FCC came to my assistance with two rule changes. First, the two-year license became renewable, and when I went to renew, they had changed it from a two-year to a five-year license. Luckily, I enjoyed Morse-code operations, and took every chance I could to operate. This stood me in good stead when I upgraded to General class a few years later (code speed requirements were still 13 wpm back then). During summer breaks I studied for my upgrades, first to Technician class in March of 1981 (this was when exams were still given at the Federal Building in Chicago); this was probably one of the more unique graduation gifts anyone could receive, since I graduated from high school in June of that year. I earned my General class license in March of 1982, when the exams were no longer at the Federal building, and the FCC was renting

meeting halls in hotels in suburbs to administer them. Further upgrades seemed a long way off, since I was now allowed to operate everywhere, and with every mode, that interested me.

This was the time when there were still two further license classes to go: Advanced and Extra. The benefit of working up from license class to license class during the period licenses were structured like this was that it was like going up a ladder rung by rung: You weren't overwhelmed by needing to take theory and code at the same time, except for the Novice and Extra exams. Since my upgrades were spaced apart a good amount due to my school obligations, my voice communications was limited to listening to shortwave. To help me avoid frustration at not being able to join in that aspect more directly, my dad got us started on citizens band during my high school years, initially getting a license for his business. I would later get my own CB license when I was of legal age to do so. We lived two miles away from an expressway, so I did my share of community service by helping the truck drivers find their destinations in and around our suburb, and steer them towards restaurants where truck parking was allowed. During bad weather, I'd listen to the emergency channel and provide help there (too

• MFJ • Kantronics • Daiwa • Comet • ARRL • Pryme • Iron Horse Antennas •

**CALL FOR DETAILS**

**IC-W32**  
Rugged, 2m/  
440MHz Handheld

**IC-V8000**  
75W, 2 meter mobile



**IC-756 Pro II**  
160-6 meter,  
100 watts

**IC-706 MK II G**  
HF-6m-2m-70cm  
Compact Multi-Band

**IC-746 PRO**  
HF-6m-2m 32bit IF-DSP

**IC-T90**  
6m/2m/  
440 MHz HT

**IC-2720H**  
2m/70cm Mobile

**NEW**



**NEW**



**NEW**



**RADCOMM RADIO**

3300 82nd St. #E, Lubbock, TX 79423  
Hours: 10-6 M-F 1-5 Sat Central Time  
**1-800-588-2426**  
806-792-3669 FAX 806-785-3699  
[www.rad-comm.com](http://www.rad-comm.com)

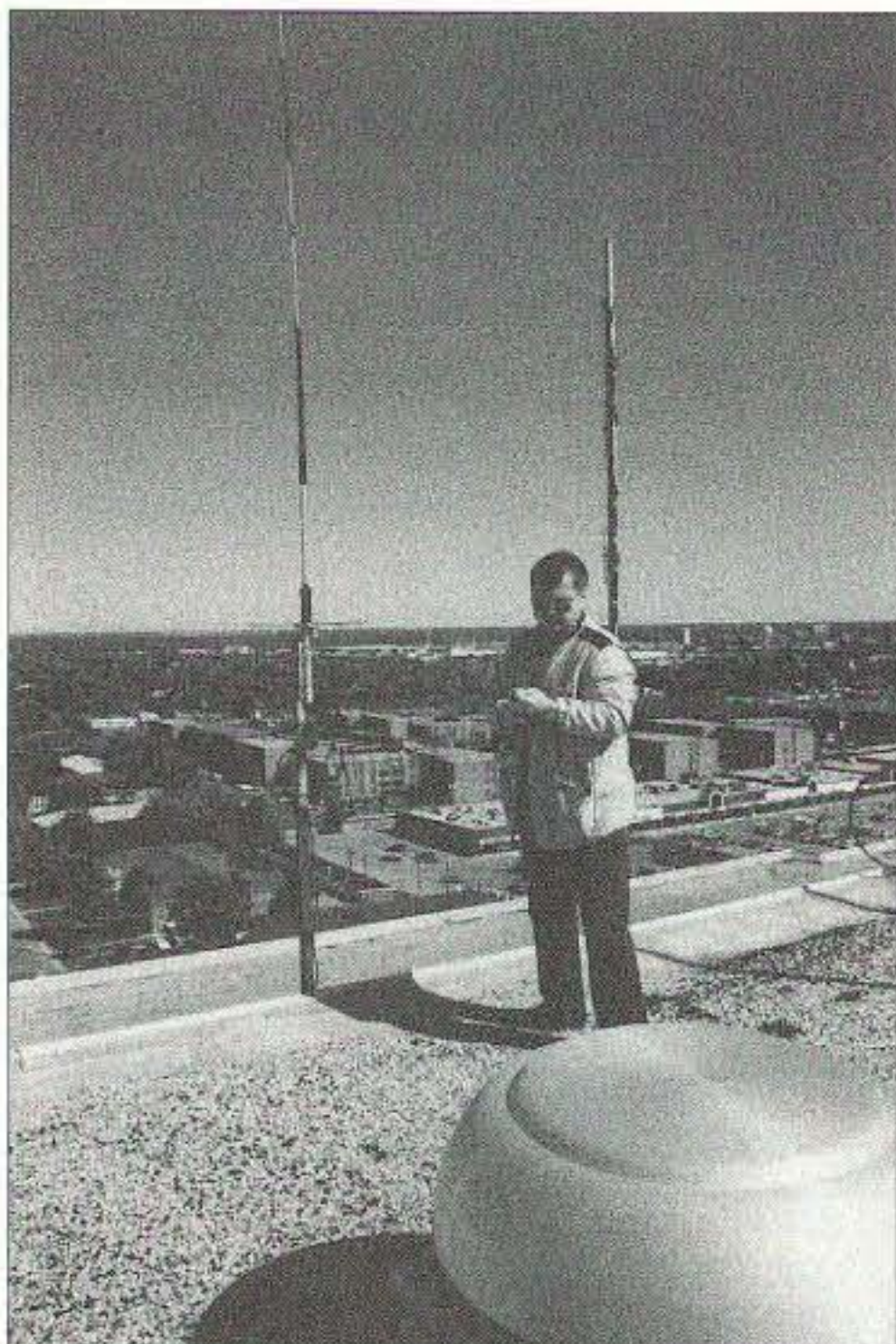
• Iron Horse Antennas • MFJ • Kantronics • Daiwa • Comet • ARRL • Pryme •



*Photo B. Joe W9CYT/SK, long-time Elmer and friend, shown operating 220 MHz. Note the 160m AM Collins cabinet in the background; and home-brewed coffee-can duplexers for 220 MHz standing on a stack of magazines next to the Collins.*

bad the amateurs have never decided on any one frequency as an emergency frequency; it has its uses!).

Although now I live too far from an expressway to be of much use to the professional drivers out there (and this



*Photo C. Joe WA9ZMY, providing a tutorial on repeater maintenance on the 224.78 MHz repeater site.*

might change in the future, but for other reasons), I still find CB a useful tool when driving long distances, especially on the highway. I've never understood the reason for some hams having a snobbish attitude towards CBers. There have definitely been several instances (and these have not been isolated cases) where I received more courteous treatment from CBers than I did from some hams.

Getting on voice the first time on the ham bands — and for me that was on forty meters — was a real treat, in that communication went at a better clip than what could be done with code. I could finally get a much better first-hand glimpse of far-off places than previously. The main drawback I saw firsthand (I had heard others discuss it before, but up until then it was only a theory to me) was that voice gets clobbered real quick with noise, and on forty that meant (especially at night) fighting all those shortwave broadcasters sharing the band back then. Since that time, there has been a bit of re-shuffling of the voice subband on forty, and due to budget cuts many shortwave broadcasters have left the air (or as a minimum drastically cut back on their transmitting schedule and frequencies).

Of course, this did not mean forgetting the code entirely. Whenever my parents went on vacation, there was a strong possibility that another antenna would find its way to the roof. Since I was studying electronics throughout high school and college, the primary equipment was financially subsidized until I was eighteen, since my dad felt he should help with my education. Subsidies were typically limited to 50% and to primary gear (not the "extras"), because I was also using the station for enjoyment. So, the extra antennas were something I could afford on my own money, and did not need to ask for extra cash. After my dad's initial screaming that his house was starting to look like a porcupine, I reminded him how important he thought education was and this was, when all was said and done, part of my education. Wire antennas were, fortunately, not very obtrusive especially when

kept in the rear of the property and covered by several trees in the front and side yards. All that passers-by saw were a few masts rising up and vanishing into nowhere.

One of these new additions (a dipole for eighty meters) led to a memorable QSO. It was late in the evening (which may be part of the reason that the band was as empty as it was), and the band seemed reasonably open; I heard one or two stations, very faintly, coming in from some far off land. After scanning the band, I was surprised at how underutilized it seemed. After not finding anyone to call, I decided to call "CQ" on my own. A station in southwest Wisconsin answered my call, coming in about S-2 to S-3, with almost S-0 noise levels. We were pounding brass (me with a home-made keyer I had built for a high school electronics project, him with a straight key) for about two hours. At this point, he begged off, claiming his fist was getting tired. Although it's been many years since this happened, I'm still curious how long we could've continued — we were deeply involved in an interesting discussion, and who knows where it would have led. Even more phenomenal is that during the entire time we had no interference, no detrimental signal fluctuations, and no one chased us off of "their" frequency.

### **Chasing paper — NOT!**

I've never been a "paper chaser"; if I happen to qualify for an award somewhere along the way, fine, but I refuse to break my neck in the process. If a DX station doesn't acknowledge me on my third or fourth try, to heck with it; I'll wait either for another DX station, or until I catch the same station but without the pile-up. I'm probably the only station that took an entire seven years to complete the Worked All States award (would've been a year or three earlier if Wyoming would've shown up sooner. As it was, I caught it more by a bit of luck than actual intent). Of all the places to find Wyoming, it was on 75-meter phone (the last place I expected to hear that state). Thanks to a bit of insomnia, I was up to the unholy hour of eleven in



the evening, tuning across 75/80 meters. I stumbled across a net, and checked in. Although I finally got tired, managed to stay awake when I very faintly heard a station mention he was in Wyoming. Although he signed off, his XYL picked up the microphone during the last portion of the net, in order to finish things up. After the net closed down for the night, I tried giving her a call, but she didn't hear me. Fortunately, the net control station was still around and offered to relay any messages that I might have. I explained the situation to him, and thanks to him encouraging the Wyoming station to crank up her volume control and to "listen real careful," I was able to make the contact. She included a very nice hand-written note with her QSL card (which I've kept along with my QSL card collection), wishing me luck with the WAS award. That award might've taken longer than usual, but unique contacts like this made the journey a lot more interesting. What good is an award, if there isn't an interesting story to go with it? (Like the time I got my Worked All Continents award; when I realized all I needed was Africa and I heard a station from that continent the first time, he must've thought I was going nuts by the way I was begging him for a contact — "yes, yes, OM, I know your dinner's getting cold; with profound apologies to your wife, just a quick contact puh-leeeeeze!" — by this time, both of us were chuckling; more importantly, I got the QSL card.) Would've helped having an antenna farm mounted on a ridiculously high tower and running a nuclear-powered amplifier into meltdown conditions, but what's the point to an award if it's that easy? Did it all with inverted "V" or dipole antennas, running legal limit power only when necessary (it isn't as necessary as often as one might think); otherwise I made do with 200 watts.

By this time I managed to jump on the 2-meter bandwagon. It was a big thrill being able to put up an actual gain antenna, because at those frequencies even a gain antenna is a lot more reasonable in height than the HF equivalent. With this in mind, I still

have a hard time figuring out what possesses someone to put a 1/4-wave antenna up, especially for 440 MHz. Even though I was not talking with far-away places on two meters, it had its own type of perks — like getting the chance to actually meet the faces behind the voices (have you ever noticed how seldom people look the way they sound?). Given the type of operating going on, on two meters, especially in the crowded, big-city environment, it did not take long for me to want to escape to new frontiers in VHF or UHF operation. Six meters — the only band (except for the remaining UHF frequencies) that I had not explored yet — was out of the question, since it's a neighbor of television channel 2 which is in active use in the Chicago area, and I was creating enough QRM already. Besides, the things called "cable television" and "satellite television" hadn't even been heard of in the early days of my ham radio operations — people were still using antennas to receive their television signals.

Good fortune once again intervened, and just at the right time. One of my uncles, who at that time was a car mechanic, knew a tow-truck driver who was an avid CB enthusiast — the type of CBer who was perpetually looking for a radio with more channels, more power, more this, more that. Somehow, someone sold him a Midland 13-509, and then realized that he (after a few tries) couldn't use it. He couldn't figure out why and was at the point where he was frustrated enough

## EVERY ISSUE OF 73 Amateur Radio Today on Microfiche!

The entire run of **73** from October 1960 through last year is now available. Over 800 fiche!

You can have access to the treasures of **73** without several hundred pounds of bulky back issues. Our 24x microfiche have 98 pages each and will fit in a card file on your desk.

We offer a battery operated hand held viewer for \$150, and a desk model for \$260. Libraries have these readers.

The collection of microfiche, is available as an entire set, (no partial sets) for \$325, plus \$10 shipping (USA). Annual updates available for \$10, plus \$3 shipping/handling. Satisfaction guaranteed or money back!

**BUCKMASTER**  
6196 Jefferson Highway  
Mineral, Virginia 23117 USA  
540:894-5777 • 800:282-5628  
Fax 540:894-9141  
e-mail: info@buck.com

## Subscriptions to 73 Magazine

Only \$24.97 — 1 year  
\$44.97 — 2 years  
\$65.00 — 3 years\*

\*best buy (54% off cover price!)

Call 800-274-7373

## Amplifiers, ATU Down Converters & Hard to Find Parts

### LINEAR AMPLIFIERS

HF Amplifiers  
PC board and complete parts list for HF amplifiers described in the Motorola Application Notes and Engineering Bulletins:

AN779H (20W)	AN 758 (300W)
AN779L (20W)	AR313 (300W)
AN 762 (140W)	EB27A (300W)
EB63 (140W)	EB104 (600W)
AR305 (300W)	AR347 (1000W)

2 Meter Amplifiers  
(144-148 MHz)  
(Kit or Wired and Tested)

35W - Model 335A	\$79.95/\$109.95
75W - Model 875A	\$119.95/\$159.95

### HARD TO FIND PARTS

- RF Power Transistors
- Broadband HF Transformers
- Chip Caps - Kermet/ATC
- Metalclad Mica Caps - Unelco/Semco
- ARCO/SPRAGUE Trimmer Capacitors

We can get you virtually any RF transistor!  
Call us for "strange" hard to find parts!  
**DIGITAL FREQUENCY READOUT**  
For older analog transceivers  
TK-1 (Wired and Tested) \$149.95

### ATU Down Converters

(Kit or Wired and Tested)  
Model ATV-3 (420-450)  
(Ga AS - FET) \$49.95/\$69.95  
Model ATV-4 (902-926)  
(GaAS - FET) \$59.95/\$79.95

For detailed information and prices call or write for our free catalog!

Phone  
(937) 426-8600  
FAX  
(937) 429-3811

**CCI Communication Concepts Inc.**  
508 Millstone Drive • Beavercreek, Ohio 45434-5840  
e-mail: cci.dayton@pobox.com  
www.communication-concepts.com

### ADDITIONAL ITEMS

Heat Sink Material  
Model 99 Heat Sink (6.5" x 12" x 1.6"), \$24  
CHS-8 Copper Spreader (8" x 6" x 3/8"), \$24  
Low Pass Filters (up to 300W)  
for harmonics \$12.95  
Specify 10M, 15M, 20M, 40M, 80M or 160M  
HF Splitters and Combiners up to 2KW

to toss the radio out, and my uncle mentioned to him that his nephew (meaning me) was into radios, and there might be a chance I could use the radio for something or another.

Sometimes the most unique flashes of opportunity produce the most interesting results, and this was one of those times. The Midland 13-509, a rock-bound twelve-channel 220 MHz radio, was built in the early to mid-1970s; several other manufacturers such as Cobra and Clegg marketed identical radios but with different face plates, making them the default standard types of radios for 220 MHz operation. The 2-meter versions of these radios were practically identical, except that one of the frequency triplers in the power amplifier stages was replaced with a doubler. These radios were built in an era before manufacturers were over-cautious with part numbers; all the parts found in the Midland Radios were labeled with the generic part numbers found in parts stores, making repairs easy. Back then, the idea of shrinking radios as far as possible had not been thought of, leaving plenty of room in them for maintenance, and even adding small little circuits a home-brewer would think of in order to add little "extras" to the radio. These radios were also designed with everything on a separate printed circuit board, making the receivers or transmitters

easy to remove for use in home-made repeaters.

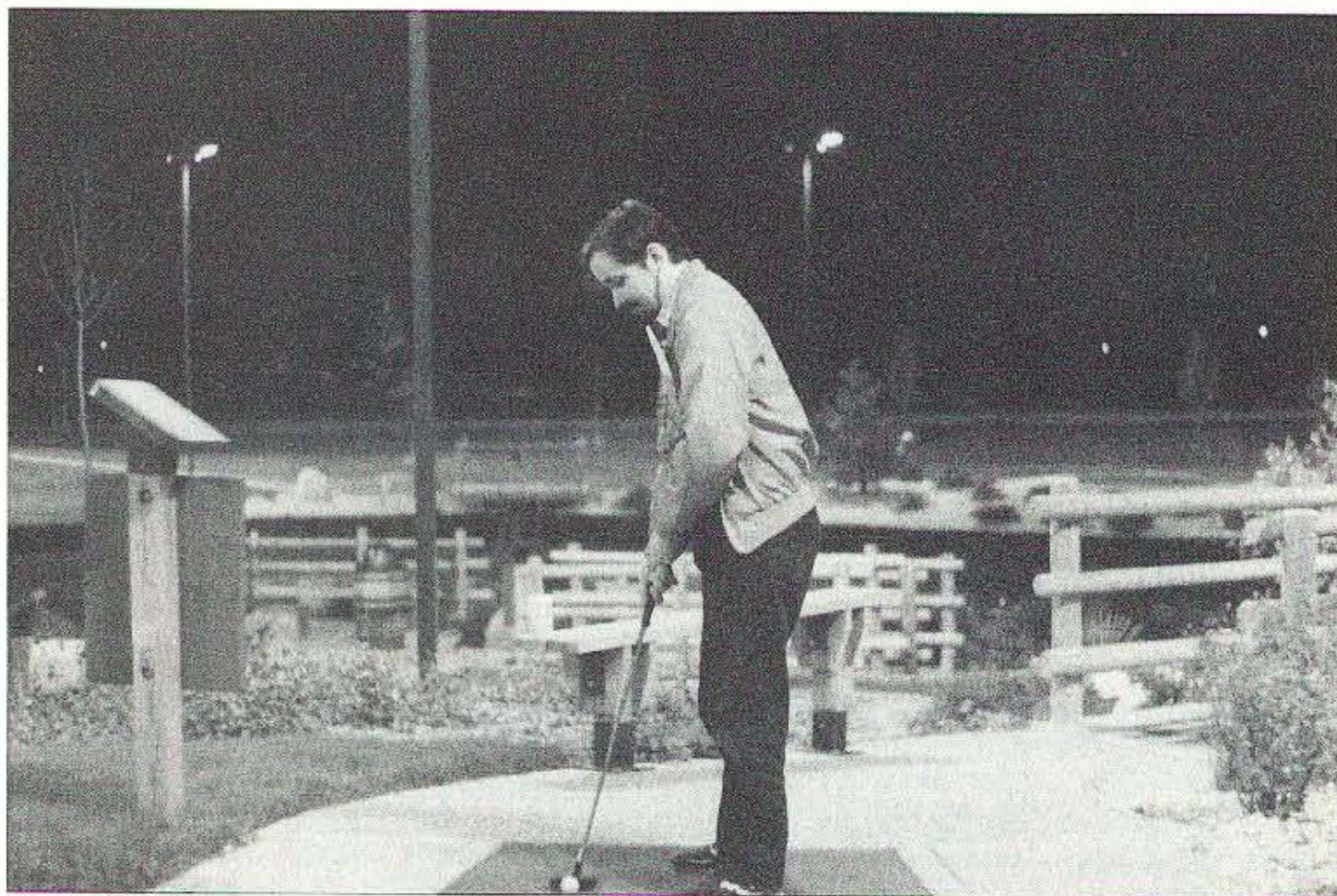
Although I had a radio with only two frequencies — the national simplex calling frequency and one major Chicago repeater — I was soon led to one or two other frequencies by the "regulars" on that band, found a few additional frequencies to try on my own, and quickly got hooked on 220 MHz. The operations on that band certainly seemed a lot more relaxed and polite than I had seen on 2 meters, so I had fewer qualms about investing money in the band. By this time, I was through college and on my way to the working world, making equipment purchases easier. My interests in 220 had gotten to the point where I wanted a synthesized rig, but since I had my trusty 509 as a mobile and base radio, I decided on an HT.

The big rage at the time were the Icom-series HTs; the selling point was that they had shrunk a radio to the height and width of a dollar bill (without the battery pack), although they were still relatively thick. It would be a trusted companion for many years, even in the mobile (with a variety of amplifiers for mobile operation, ranging from 15 to 25 watts). 220 MHz operation brought new friends, and a better class of operation. It was the first VHF band where rag-chewing on repeaters was actually not only allowed

but encouraged, something that had been unheard of during my 2 meter days. It got to the point where a friend of mine and I not only played chess games on a repeater, but the gentleman we received permission from for that rag-chewing even kibitzed, and my chess playing certainly needs the help!

Even during periods of high activity on that band, people could be found rag-chewing on the national simplex calling frequency; if someone else needed the frequency, things were sociable enough so that there was never any problem letting them in or having them join in the conversation. I became part of a group that boasted being the first 220 MHz-only repeater club in Illinois (maybe even over a larger region). Luminaries like Bill Halligan, founder of Hallicrafters Radio, had been a member of that group before I came along. I regret having missed him, although plenty of interesting others made up for that along the way. That repeater was unique to the point where even several years after the repeater had gone off the air, people were still talking about it. That led me to research the repeater and assemble a history for it; copies went out to all the past members that I could find. Subsequently, it was published in a more official manner by *QST*, in their "FM" column — page 112 of their November 1995 issue. Unfortunately, my friend Joe W9CYT passed away in September of that year; he missed seeing the advanced copy I received from the ARRL by a matter of only a few weeks. Having stayed in touch with his widow Emma, I made sure to drop off a copy with her, along with an 11 x 14 picture of Joe in his ham shack.

Although declined somewhat from its initial splendor, 220 had always been known as the "gentleman's gentleman band," so any problems on that band were typically handled in a polite way. Over many years of operation, there were two or three of us with quite the talent for being able to rag-chew for long periods of time; three to five hours were often typical. One operator in particular I met on the calling frequency was a local, only about five miles away from me, living in Chicago.

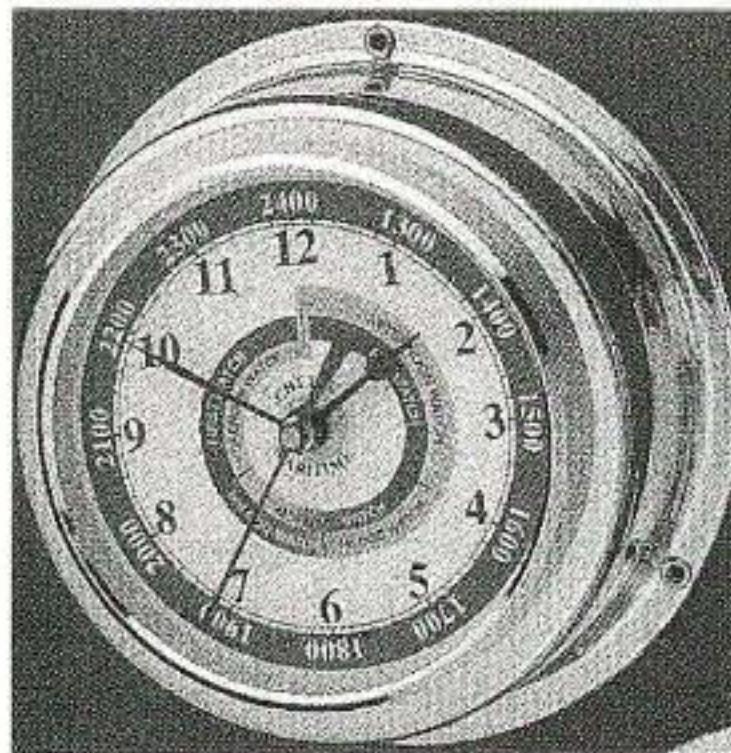


*Photo D.* Fellow home-brewer Ken N9HXD, unwinding after a long day of discussing projects.

Close in age, we shared many common interests which included science fiction and a wide range of technical topics, fuel for our rag-chews. He is a bit of an unusual character, and unconventional attitudes and thinking (to a certain extent on both our parts) led to interesting topics of discussion, and provided good "brain exercise." Years later, his mother commented to me that she was glad her son had a friend like me; I guess she considered me to be the most "normal" individual that her son socialized with. After we shared common laments about the things we put up with from him, she asked how we ever put up with him; my comment was, "Everyone else is too normal!" I'm glad we got the chance to share a laugh — I guess sometimes the truth can be as funny as the best joke.

Another noteworthy individual I met through my VHF activities was Roy W9FHS (who passed away in 1998). Both he and Joe had worked for Motorola as far back as World War II (Joe having retired in '76), and had the chance to be involved with, or at least be witness to, many of the developments in radio communications throughout those years. At one point, Roy sent two pictures of him — one as he was working on a test bench, and the other while he and Joe were about to take some amateur radio equipment for aeronautical mobile tests in what looked like a Piper Cub; the equipment they were testing was for 2-1/2 meters, then available to amateur radio operators. These were two other individuals I shared many long and interesting QSOs with, although seldom with the variety of topics being discussed as with my friend in Chicago. The unusual point about Roy was that he never wanted to be seen; whenever a ham offered to give him a ride to a hamfest, or to play chauffeur for whatever errands Roy needed run, or just to drop by for a social call, Roy always demurred. Roy was also known as "Mr. HT." Every time he spoke with someone, it seemed as though he would mention a new HT he had recently acquired; it was also general knowledge that Roy only used HTs.

Joe was active with tinkering after one fashion or another, well past his retirement in '76. He kept track of 220 MHz propagation, worked DX when it was available, in spite of having only indoor antennas, and was frequency coordinator for over ten years. Thanks at least in part to his efforts, 220 MHz operation in the Chicago area stayed as well organized (and some say as civilized) as it has been, even several years after he retired from active coordination. Several people helped Joe with coordination, since we had our outdoor antennas; initially, I think it was Ken (KA9BTJ/N9HDX); then, as Ken became less active, I helped out (even retyping the list on a computer, and distributing it on an as-requested basis), as did Dave KA9KWR, (another friend and fellow rag-chewer I met on 220, although Dave became active on 220 a few years after I had become established on the band). During his latter years, when his eyesight became less than ideal and hands weren't as steady as they used to be, Joe's home-brewing dealt mainly with the larger things that were easy to see and handle, like a dual-band 220 MHz and 440 MHz 5-element



### Chelsea Clock

Clockmakers since 1897  
The choice of The Coast  
Guard Foundation.

Quartz Clock  
4" Dial

Beautifully hand-polished.  
Stamped brass case and  
bezel.  
Curved glass crystal.  
Wall or bulkhead mounting.  
Made so well they last from  
generation to generation!  
Order this month and save  
\$20!

**Your price \$75**

**Omega Sales**

**P.O. Box 376**

**Jaffrey NH 03452**

**1-800-467-7237**

If you're a No-Code Tech, and you're having fun operating, tell us about it! Other No-Code Techs will enjoy reading about your adventures in ham radio—and we'll pay you for your articles. Yes, lots of nice clear photos, please. Call Joyce Sawtelle at 800-274-7373 to get a copy of "How to Write for 73 Magazine."

## TRANSMITTER LOCATION

New fixed site direction finders provide 2 degree accuracy, and include software for triangulation from a central control site. Mobile versions also available covering 50MHz to 1 GHz

### Doppler Systems Inc.

PO Box 2780 Carefree, AZ 85377  
Tel: (480) 488-9755 Fax: (480) 488-1295  
www.dopsys.com

European Marketing Director Denis Egan  
PO Box 2, Seaton, Devon EX12 2YS England  
Tel & Fax: 44 1297 62 56 90



loop antenna and home-made duplexers for his repeater, made from coffee cans.

For smaller things like fixing microphone connectors, I was always glad to help out. In spite of the difference in our age, we became friends. He was very much like a favorite uncle until he passed away. Although our discussions usually centered on amateur radio, we had the chance for lunch get-togethers, trips to the odd hamfest, and barbecues at my parents' place. My mom and Joe's wife Emma became friends during that period of time. After Joe's passing, until her passing in March 2001, I was sure to always send flowers to Emma at Christmas, even through those years when my visits were infrequent.

There don't seem to be all that many hams left (if any!) willing to go to that extent for their home-brew projects as Joe did with his coffee can duplexers, although a few of us came close. In the early days of our friendship, Ken wanted to take along 220 MHz gear in the 1974 Mercury Comet I drove; all I was set up for was two meters and CB. I wanted to donate some World War II aircraft radios to an aircraft museum I had heard about in Michigan, as well as stop by a winery on the way back (in Paw Paw, Michigan) to pick up a few bottles to take home. We thought it would be the ideal time to test the range of a few of the Chicago repeaters out towards the east/southeast, a direction we didn't drive in too often, and if we got lucky even meet up with another well-known 220 MHz user and friend, Dennis KA8BND.

So, here's a rusty '74 Comet, already bristling with antennas for 144 MHz, 28 MHz, and the FM stereo (they were still external back in those days, instead of in the windshield — that came about five to ten years later), and Ken adds a 1/4-wave for 220. Ken's antenna consisted of the stiff household wiring used in the walls for household power, soldered to a bulkhead (SO-239) connector, and wedged in the passengers' side window. Whenever we accidentally keyed up 11 meters and 220 MHz at the same time, an underrated fuse would blow under the dash.

Fortunately I knew which fuse, so all it cost us was a side trip to a Radio Shack. All those antennas on something that was obviously not an official test vehicle by any stretch of the imagination makes it surprising we didn't look suspicious enough to get pulled over.

Unfortunately we missed Dennis, but did get a tour of the 224.30 repeater site near Niles, Michigan, by "Doc," the system's owner, and had a pleasant visit with this 220 regular whom we didn't get the chance to talk to all that often. This took place at the beginning of a time when we would go on trips at the slightest excuse; Ken shared my interest in studying the range of our favorite repeaters (I was to continue this later, in a time when it became increasingly hard to gain Ken's participation in much of anything, due to his health situation). Either with a group of others or on our own, we would make trips to sites within a day's drive of Chicago (like the Oshkosh Aircraft Museum, and the architectural museum in Spring Green, Wisconsin). It was the one of few friendships in amateur radio that developed to include interests other than strictly radio communications, and extended to such diverse things as Halloween parties and laser-tag competitions at the local laser-tag establishment (which has since gone out of business, at least in this area).

The mention of road trips brings back memories of a business trip my dad took with our two meter portable (for those who might remember the old antique radios, it was an Icom IC-2AT). He favored 2-meter operation longer than I did, mostly from a practical standpoint way back then; there were still more repeaters on two meters than there were on 220 MHz, and he did a lot of traveling for business. He usually did more listening than talking, since he was never sure what to talk about on the radio, although in one particular trip when he was driving I had actually been able to convince him to transmit a bit. I was at the home station, and he was providing a commentary about his location, traffic, when he'd be back, and such, when his signals started to get noisy. In

order to keep talking for a few more miles, he ended up placing the HT on the roof of the car (both to get the ducky antenna outside of the shielding of the car's metal body, as well as to get a decent ground plane effect from the car's roof), using the speaker/microphone with his other hand, and steering the car with his left knee; all while doing the speed limit on the expressway. For a half hour or so following my dad signing out, all that the hams on that repeater could talk about was "the nut with the HT." (At least for a short time, this resulted in my not getting the standard lecture about what dumb stunts kids do.)

Some of the friendships in amateur radio can be considered unusual, in their consistency (longevity) or lack thereof. On the HF bands, due to the variabilities of propagation, it is often difficult to meet the same person twice with any consistent regularity, making the development of friendships at least mildly challenging. On VHF and UHF bands, though, much time is spent driving to and from work with basically the same group of people riding along with you, via radio. This usually happens long enough (and usually longer) to have acquaintances turn into at least mild friendships. Yet, people seem to come and go (some switching jobs, work times, or frequency bands; others move out of the area, or retire) without keeping in touch with friends left behind. By the time this phenomena had developed from a curiosity into some kind of cosmic ritual, I pointed this out to Dave (KA9KWR), mentioning that the situation seemed like we were the "regulars" on a television show and we're watching the comings and goings of the "guest stars." Some would even go so far as to say our antics qualified this as a comedy show, but more on that later. Maybe I'm being too sentimental or nostalgic, but occasionally it seems a bit sad to think a lot of the voices and conversations of the past long gone; the sentimentalist in me wishes that, way back when, when these conversations took place, I would've had the foresight to capture at least a few on tape.

Next time: Fun times, bedsprings, and flagpoles. 73

# All About Electronics Frustration

*Or, what to do when neighborly theory meets neighborly reality.*

*Hams get involved in some interesting and sometimes weird electronic projects. Have you ever had a neighbor walk up your driveway and hand you something electronic and ask you to repair it? Because hams are involved with electronic theory, techniques, and hardware, they're liable to be asked to repair most anything, but does it matter what the application might be for the device that's to be repaired?*

One of my neighbors asked me to look at and repair, if possible, a pocket Panasonic RF-455 AM/FM broadcast radio as shown in **Photos A** and **B**. Normally the time required to diagnose and repair such a radio is very short, and of course believing that, I accepted the task.

Guess what? As you perhaps have already guessed, the task turned out to

be very time consuming. It wasn't that the circuit was too complicated, but the AAA cells had leaked inside of the case, causing corrosion and damage to the board circuit traces. At this point most hams in their right mind would return the radio as "not repairable." Well, either I'm gullible, out of my mind, or just curious about the challenge of a somewhat common circuit; I decided to see how far I could go in sorting out the problems. You see, it's always been my philosophy that if a device once worked, that it should be capable of working again.

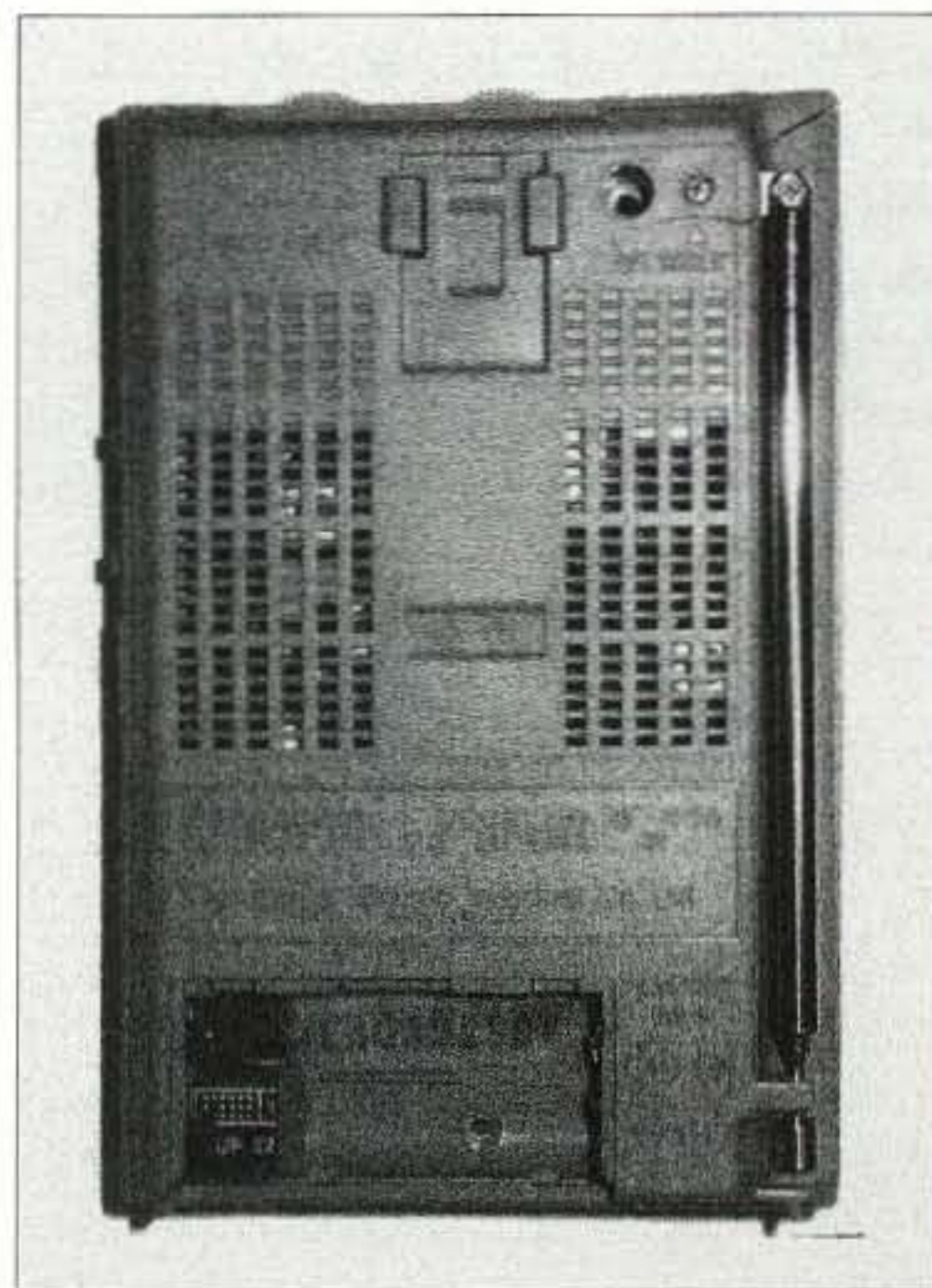
Since the battery leakage had dried and was left as hard corrosion, chipping it off with an X-acto knife worked quite well. Once the board had been cleaned up, power was applied, and as expected, the radio failed to play. Originally, the circuit board had been coated with a green solder mask, but some had been undermined by the battery fluid, causing black corrosion along portions of the trace. Scraping the circuit trace lines with the knife revealed two obvious circuit breaks. These breaks were repaired by bridging them with wire jumpers soldered across the gaps. **Photos C** and **D**, respectively,

show the top and bottom sides of the printed circuit board. **Fig. 1** shows the parts placement and identification for the major parts on the board.

Applying power again to the radio created a new set of circumstances that led me down a serious troubleshooting path. With 3 volts applied, the radio failed to play. However, after decreasing the voltage to 1.7V, the AM radio



**Photo A.** Shown is the front face of a Panasonic model RF-455 broadcast AM/FM/FM-STEREO pocket radio.



**Photo B.** Shown is the backside of the Panasonic broadcast radio.

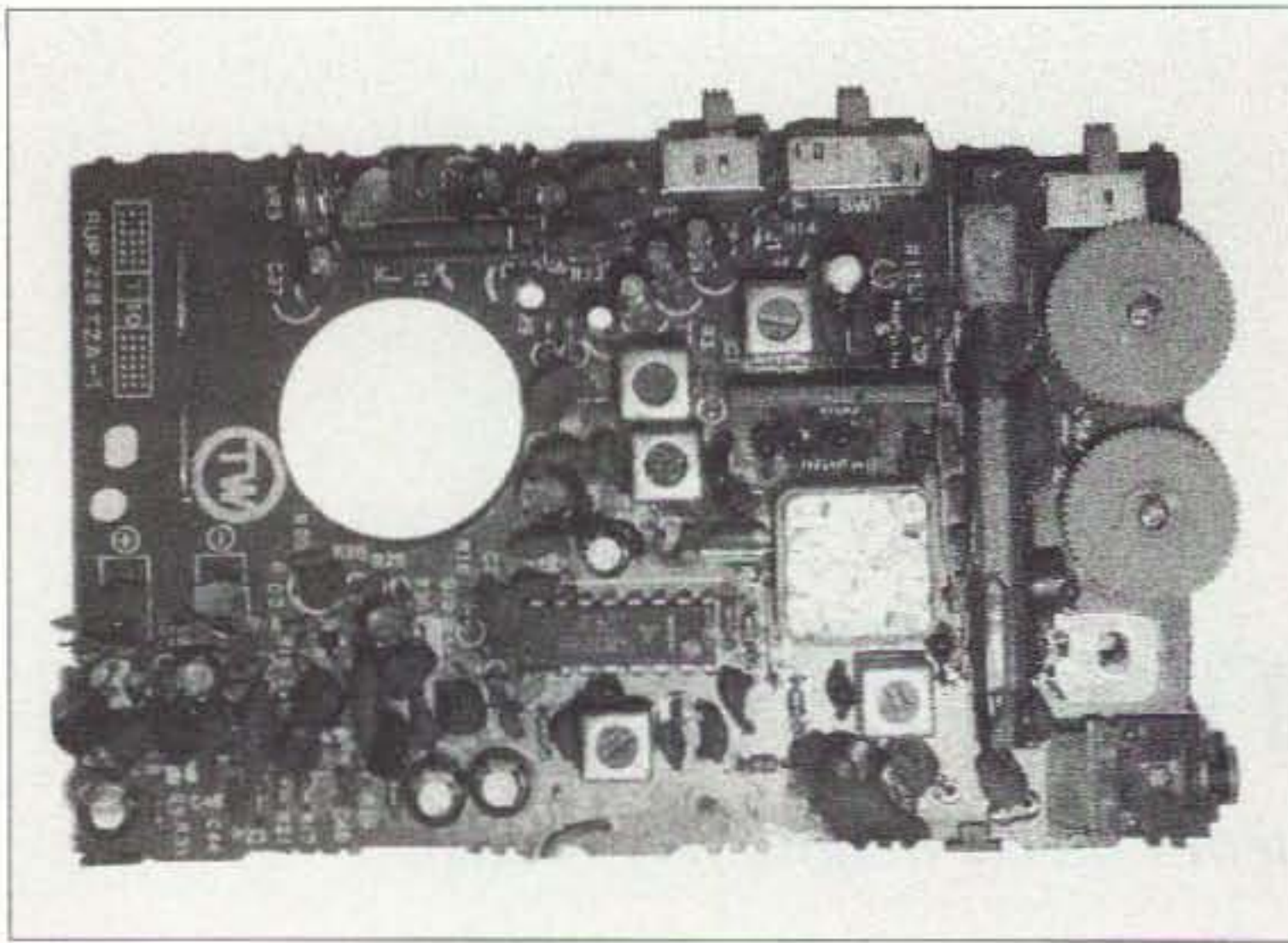


Photo C. The component side view of the printed circuit board.

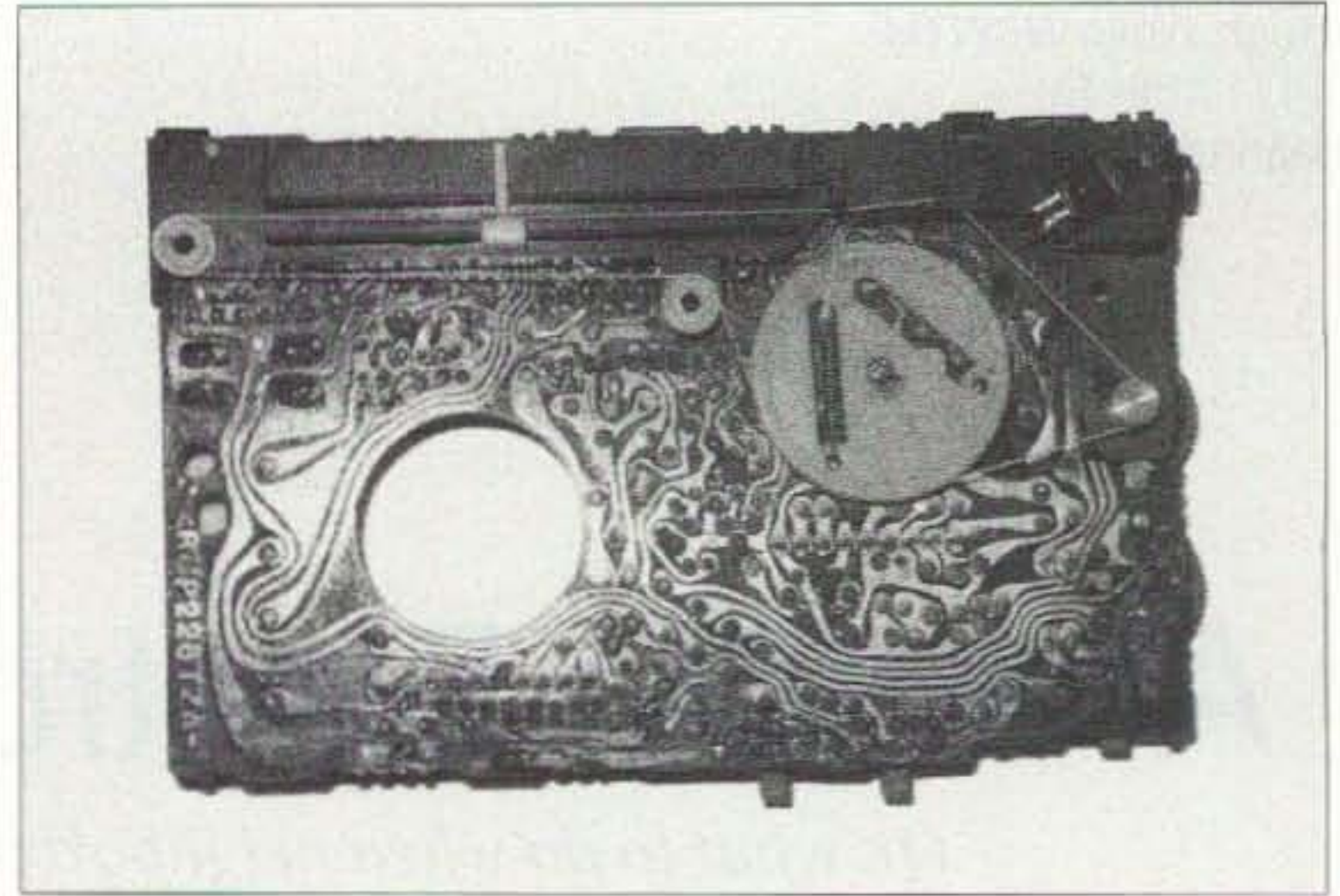


Photo D. The bottom side of the circuit board. Circuit traces were damaged by leaking battery electrolyte.

showed signs of life, though poor. After operating for a while, the sound would fade away as if the supply voltage was being reduced. Raising the voltage above 1.7V caused the sound to stop as well — so where to go next?

At this point I concluded that I needed to know more details about the circuit than what I could view by looking directly at the circuit board. Correct, I wasn't familiar with the ICs used on the board, so they provided a level of unknown. Therefore, some logical troubleshooting technique was warranted. This step required a schematic, but where does one get a schematic? After an Internet search for either a schematic or data on the ICs used, the only thing available was data on one of the three ICs. Believe it or not, that's the one IC that appeared to be working properly. Therefore, the only avenue left open to me was to trace the circuit and draw out a schematic. Tracing and drawing the circuit took some time, but a sufficient amount of the circuit was developed to

enable my understanding of what was going on in order to troubleshoot the circuit.

Since IC data except for one chip was unavailable, pin functions for the two unknown chips left a lot to be desired. The signal path information developed through the circuit tracing allowed me to assume circuit path functions for most of the IC pins. From my circuit tracing, the combined block and schematic diagram was developed and is shown in Fig. 2. Circuitwise, the radio is made up into sections, with IC1 being the FM mixer/oscillator feeding a 10.7 MHz signal through a ceramic filter into IC2. IC2 is a complex device in that it contains the AM oscillator and mixer in addition to the 10.7 MHz IF and FM quadrature detector. A detected DC voltage level from the detector circuit is used to

drive a varactor diode used for AFC of the FM oscillator.

The detected audio output, which also contains the FM multiplex signal, is routed to IC3. IC3 is made up of the stereo multiplexer, two preamp audio channels and the stereo lamp driver. Output audio from each preamp is fed through individual volume controls mounted on a common shaft to drive two individual discrete transistor amplifiers. One path is used for both AM and monaural FM audio, and the second path is used for the second audio channel during a stereo broadcast. Because of the interesting design used in the two audio amplifiers, I've shown them in Fig. 3. There are slight differences between the two circuits, and both are shown instead of one to represent both. These amplifiers operate from a 3-volt battery and provide an

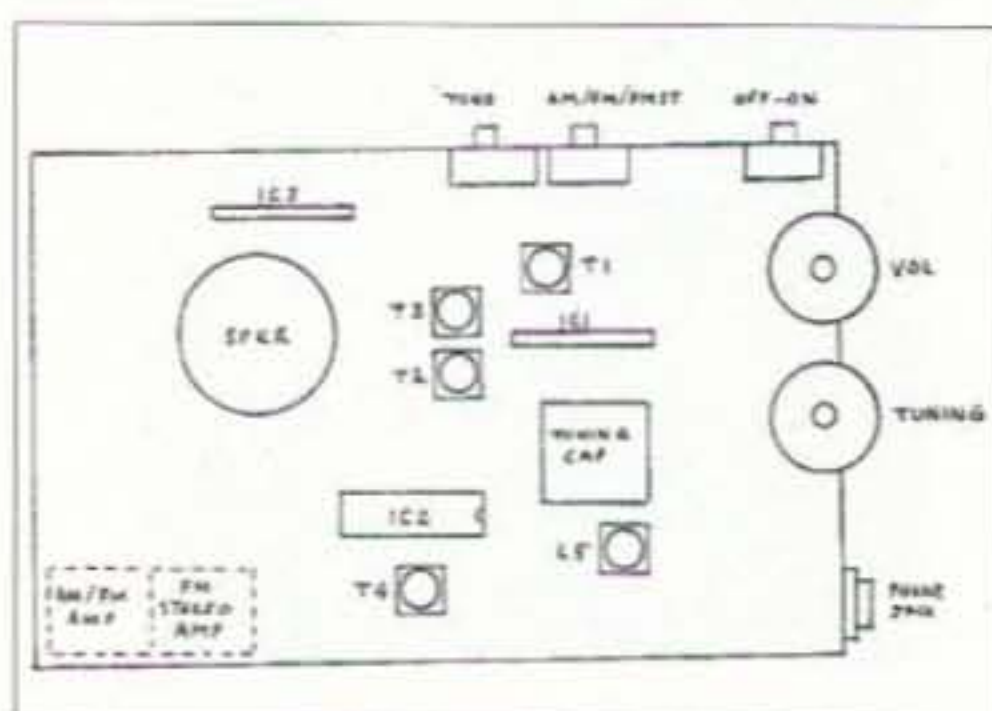


Fig. 1. A drawing showing the placement and identification of the major components.

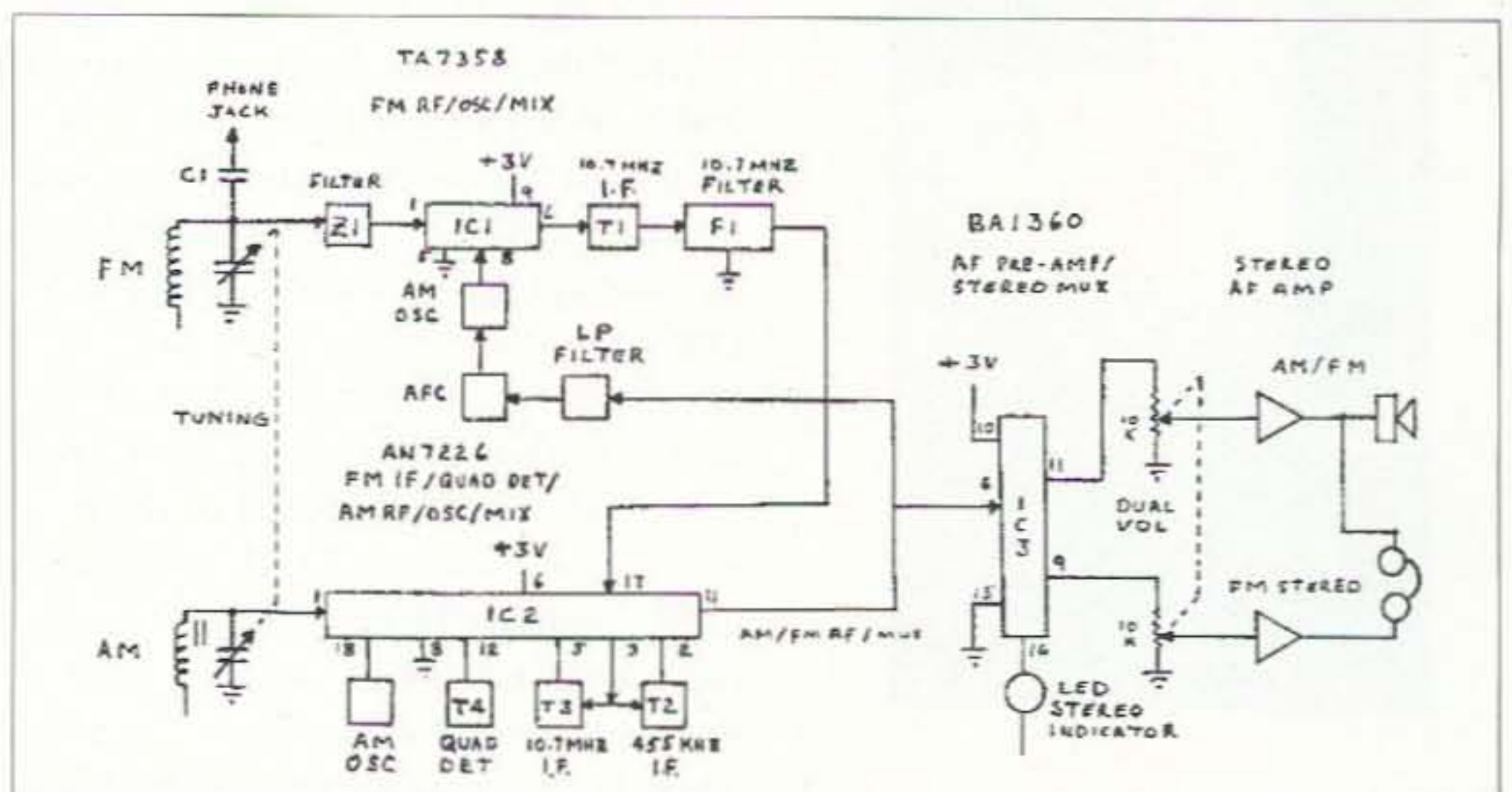


Fig. 2. This is a combination signal path diagram and partial schematic with IC pin numbers identified.

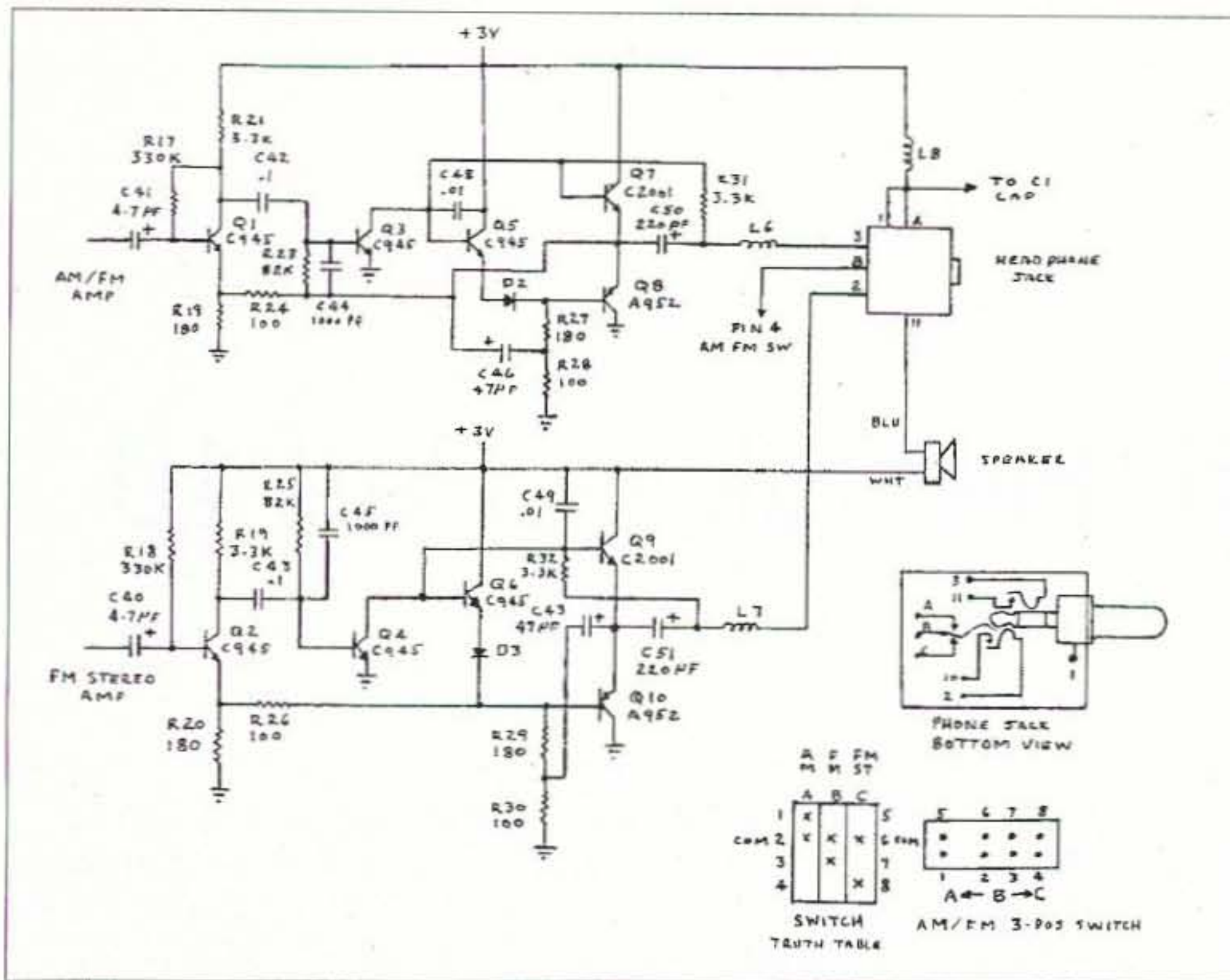


Fig. 3. Shown is the schematic diagram of the discrete audio amplifiers. Included is a pictorial view of the phone jack and internal switching arrangement. Also shown is a truth table identifying switch pin positions for the dual three-position AM/FM selector switch.

audible signal level that seems to be quite adequate for a small handheld radio. I would have to conclude that the power drawn from the battery is minimal but varies directly with the desired volume level. At least with my hearing capability, there is no detectable distortion in the audio until the speaker cone strikes a travel limit.

Of importance during troubleshooting is the identified signal path and the associated IC pin. To obtain a reasonably accurate schematic, it was necessary to remove the dial assembly, AM/FM selector switch, and the stereo headphone jack. Detailed information on both the switch and headphone jack is

shown in Fig. 3. The stereo headphone jack was interesting in that I hadn't seen one previously that contained three switches and the only way I had of interrogating it was to remove it from the board. You'll note that the AM/FM switch is a dual three-position selector switch, with pins 2 and 6 being independent common wiper pins.

The slide-rule dial assembly had to be removed to obtain access to the bottom side of the circuit board, otherwise it would have been better to leave it in-place. On a cautionary note, a Circlip (or "E" clip) is used to hold the dial's tuning shaft in place. The clip must be captured during removal or it

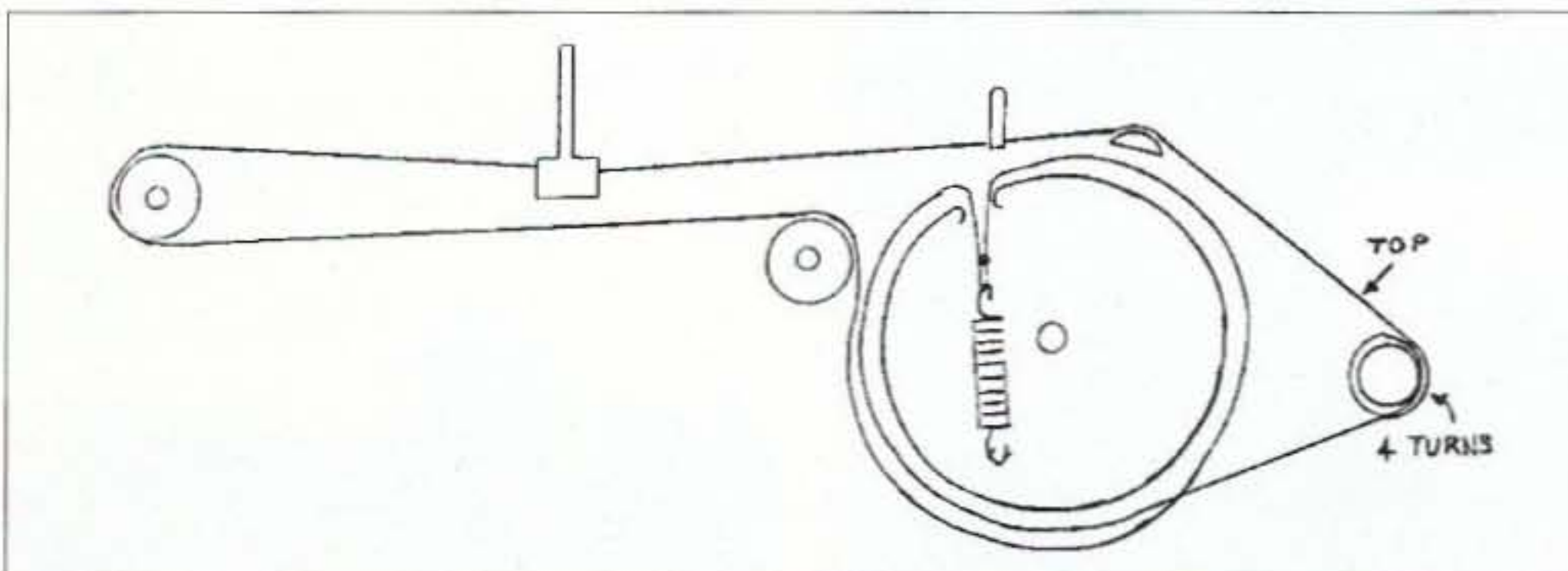


Fig. 4. This is a drawing showing the dial cord routing including the correct orientation of the tuning capacitor's pulley.

will be lost forever (biblical terms are usually expressed as the clip goes flying away). Fig. 4 shows the dial string configuration. Yes, I certainly needed the diagram during the re-assembly process.

Equipment required for troubleshooting is: a voltmeter, signal generator, and a receiver tuned to 10.7 MHz. The first step in troubleshooting was to check the FM mixer-oscillator to determine if signals were passing into the IF path. The receiver was connected to the output of the 10.7 MHz IF ceramic filter, and signals were present and tunable indicating the front end was operating correctly. With the front end operating, the next step was to determine if the 10.7 MHz IF and quadrature detector were operating. At this step I ran into an interesting set of circumstances. At first, the IF/detector failed to operate. However, after raising the generator's signal output

Continued on page 57

Pin #	TA7358	AN7226		BA1360
	IC1	IC2		IC3
		AM	FM	
1	0.71	3.0	0.52	1.01
2	1.45	3.0	0.52	0.04
3	2.9	3.0	0.52	0.04
4	1.41	0.71	0.55	0
5	0	2.5	2.67	0
6	3.0	2.55	2.81	0
7	2.16	2.20	2.80	1.36
8	2.88	0	0	3.0
9	3.0	1.67	2.28	1.41
10	—	1.28	0.39	1.07
11	—	0.01	0.01	1.38
12	—	2.36	2.31	1.0
13	—	2.33	2.0	0.05
14	—	0	0	1.01
15	—	2.51	2.64	0
16	—	2.51	2.62	1.37
17	—	2.51	2.63	—
18	—	3.0	0.52	—

Table 1. Shown are the voltage readings taken at each IC pin using a high impedance digital voltmeter. At the time of measurement the supply voltage was 3.0V.

# Travels with Henryk — Part 10

*Lithuania: “elementary essence of our hobby.”*

*It is a small country, exactly in the middle of Europe, at least according to the French Geographical Society. Tucked away on the eastern coast of the Baltic Sea, between the Russian province of Kaliningrad (UA2F), Poland, Belarus, and Latvia. Lithuania is similar to Ireland in respect to land area and population figures. It is also a green, agriculture-dominated country. But amateur radio activity is definitely higher in Lithuania. There are also tens of active radio clubs in LY-land. I visited two of them.*

**T**he capital city is Vilnius, and there I found a well-equipped club in The Youth Technical Creativity Center. The callsign is LY1BZB but sometimes they use the shorter contest callsign LY8X. The shack is prepared for multi-operator efforts (**Photo A**). The roof, from which I had an impressive view over the whole city, is armed with HF and

VHF radiating arrays (**Photo B**). Maintenance of some of these antennas is not easy (**Photo C**), as the building is more than 100 ft. high and balancing on the edge is risky. The larger part of the club's equipment and measuring instruments is bulky and obsolete (**Photo D**), but they do have a few modern-technology items. However, an average income is still low here and

new equipment is not affordable by everyone. This club welcomes mainly younger people who are attracted by our hobby. There are other departments in this Creativity Center, covering most technical hobbies like building aircraft models, go-carts, or computers.

On a more advanced level of technical knowledge and of more mature age are the members of the radio club at the

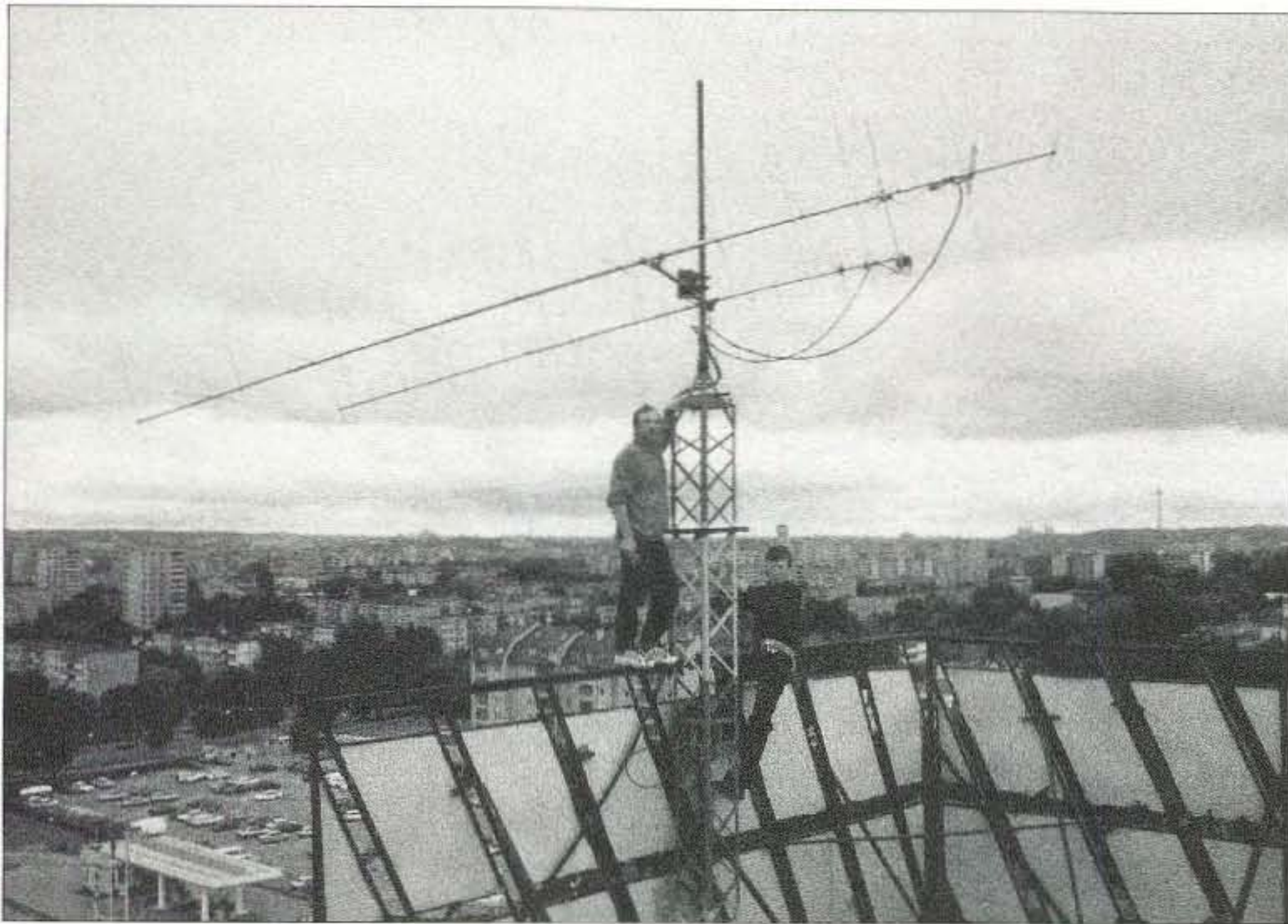


**Photo A.** The radio room at LY1BZB club. From left: Viaceslav LY1FF, Ernest LY3PH, Roy LY2BKF. (Photos by Henryk Kotowski SMØJHF)

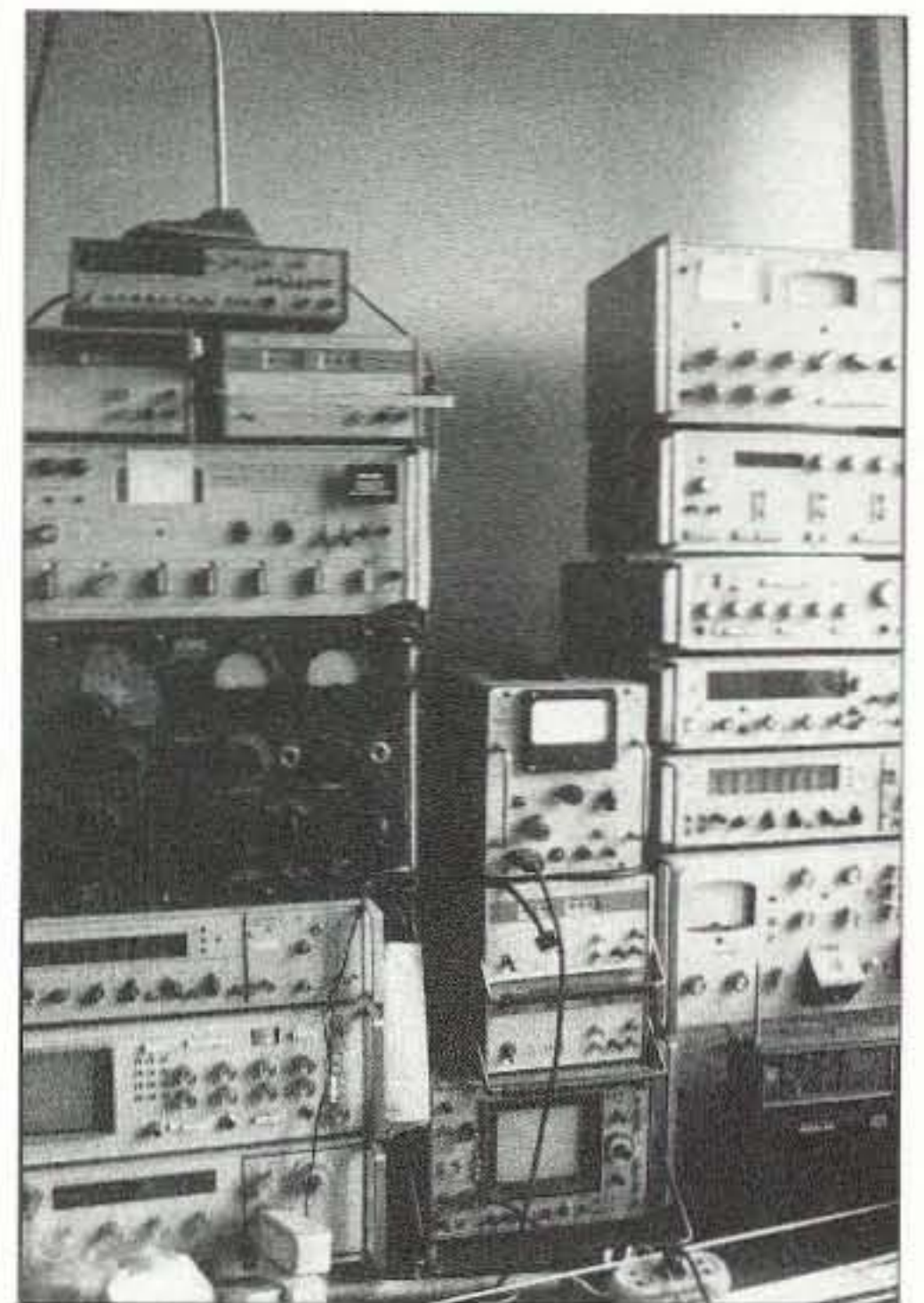


**Photo B.** The roof of LY1BZB club with HF antennas up front.





**Photo C.** At the roof of LY1BZB radio club in Vilnius, Roy LY2BKF, and lower, Ernest LY3PH.



**Photo D.** Some measuring instruments of LY1BZB radio club.

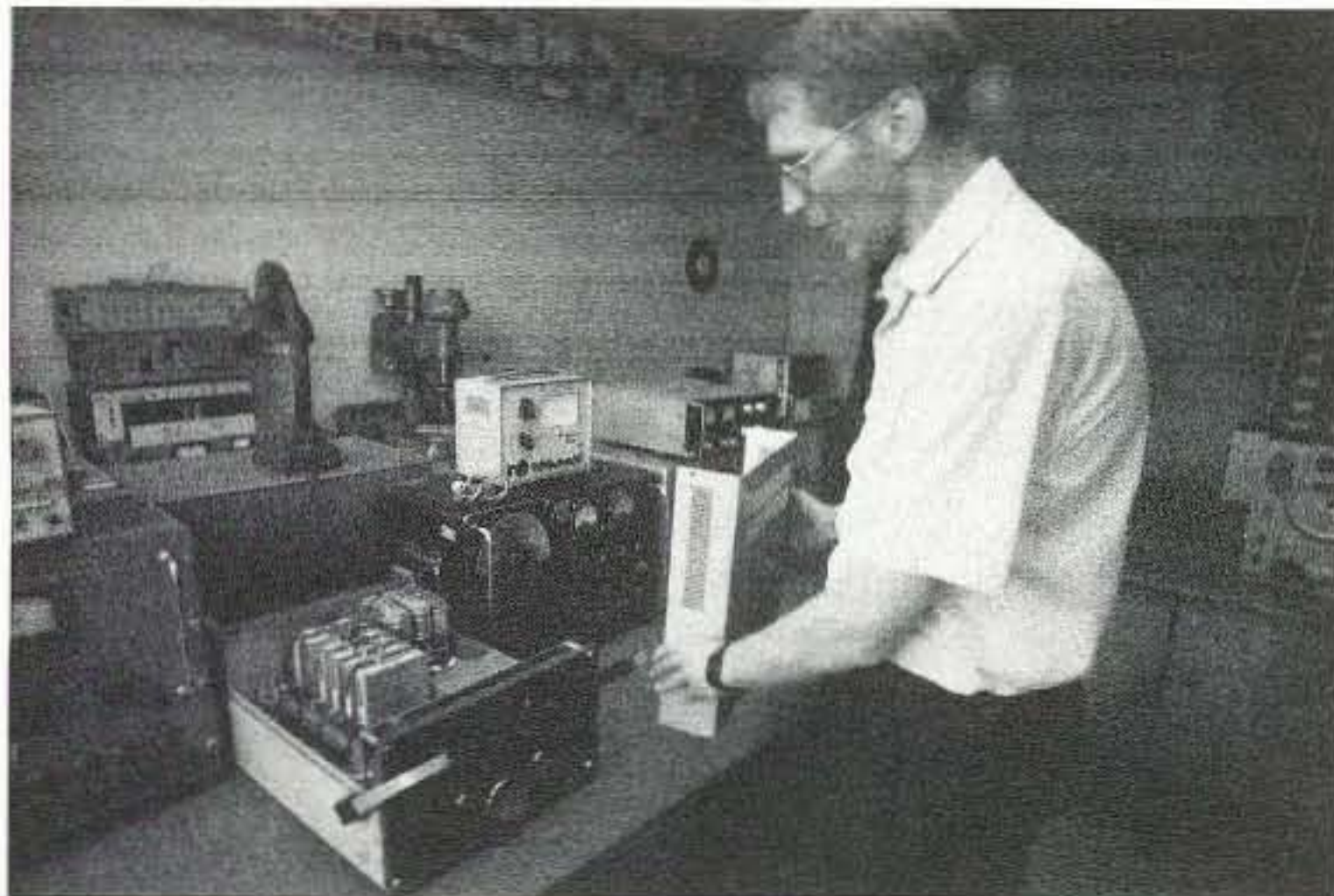
Kaunas University of Technology. Their Web site is at [<http://www.ktu.lt/radio/>]. Out of nearly 100 members,

students and graduates, teachers, and researchers, I met only two.

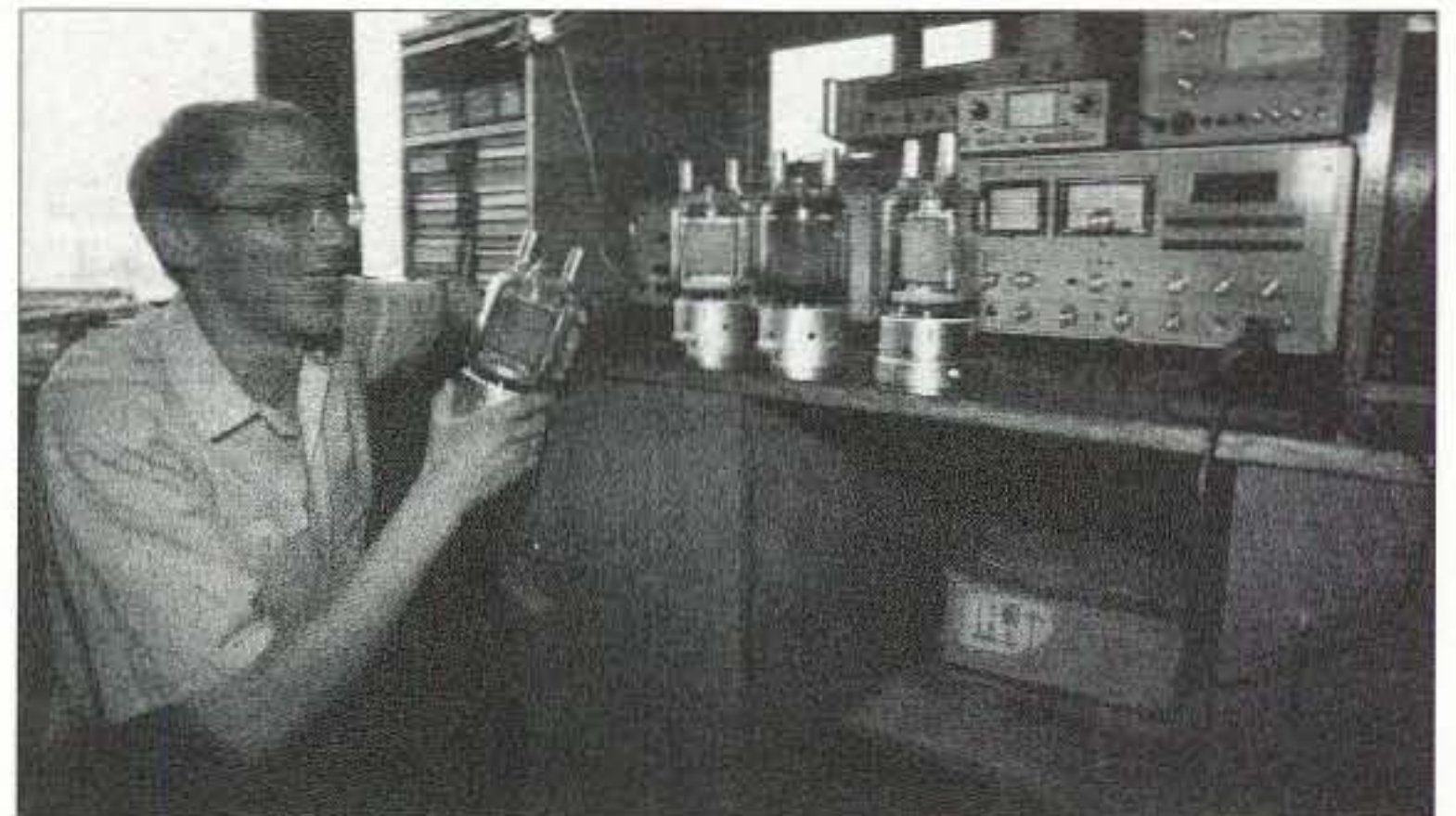
When I met Ricardas LY2FN, who

lives in Kaunas, second-largest city of

*Continued on page 58*



**Photo E.** Ricardas LY2FN shows his homemade HF transceiver.



**Photo F.** Ricardas LY2FN at the club LY2ZO displays power tubes commonly used by amateur radio operators in this part of the world.



**Photo G.** Algis LY2NK in the Kaunas University of Technology radio club LY2ZO.



**Photo H.** Algis LY2NK at one of the contest operating positions out of town at the LY7A site.

# Front and Center

*How to use your computer to make personalized front panels.*

*By using a "word processing" approach, you can personalize your next project and have it "stand out from the crowd." Using readily available technology and a little imagination, you will be able to create a distinctive "panel cover" to complement your next creation!*

There's always a project brewing on my bench, and as often as not, I'm anxious to "see" what the final appearance will be. This is usually the case long before all the "bugs" are worked out of the design. How many times have you placed a control on the front panel only to find it is in an *impossible location* when it comes time for labeling the front

panel? The style and size of control knobs play a big part in where the labels are placed, what size they should be, etc. Wouldn't it be nice to be able to add "special effects" to have your project be more appealing to look at? It is my goal to create projects that not only work as required, but are pleasing to look at.

The outer dimensions of projects

today are generally smaller than in days gone by. This size difference can be a problem! The "tape writer" or "rub-on" lettering isn't the correct size, and is often difficult if not impossible to apply. It sometimes just doesn't look good when you're finished. Today's computer technology has given us a way to create front panel "labels" that are easy to create, look great, and can be reproduced either in whole or part for future projects.

My computer uses Microsoft Word 2002<sup>®</sup> as its word processing software with Microsoft XP Professional. For those of you who are less computer-literate than I (and there aren't many of those around anymore!), you will need to "turn on" the following options if they aren't activated already. Located in the top menu bar, click on "View," then click on "Rulers." This will activate rulers on the top and side of your screen. Next click on "View" again and select "Standard, and Drawing" tool bars. The *Standard* toolbar is located at the top of your screen and displays icons such as "print, save ABC, etc." The *Draw* toolbar is at the bottom of the screen and has "AutoShapes,

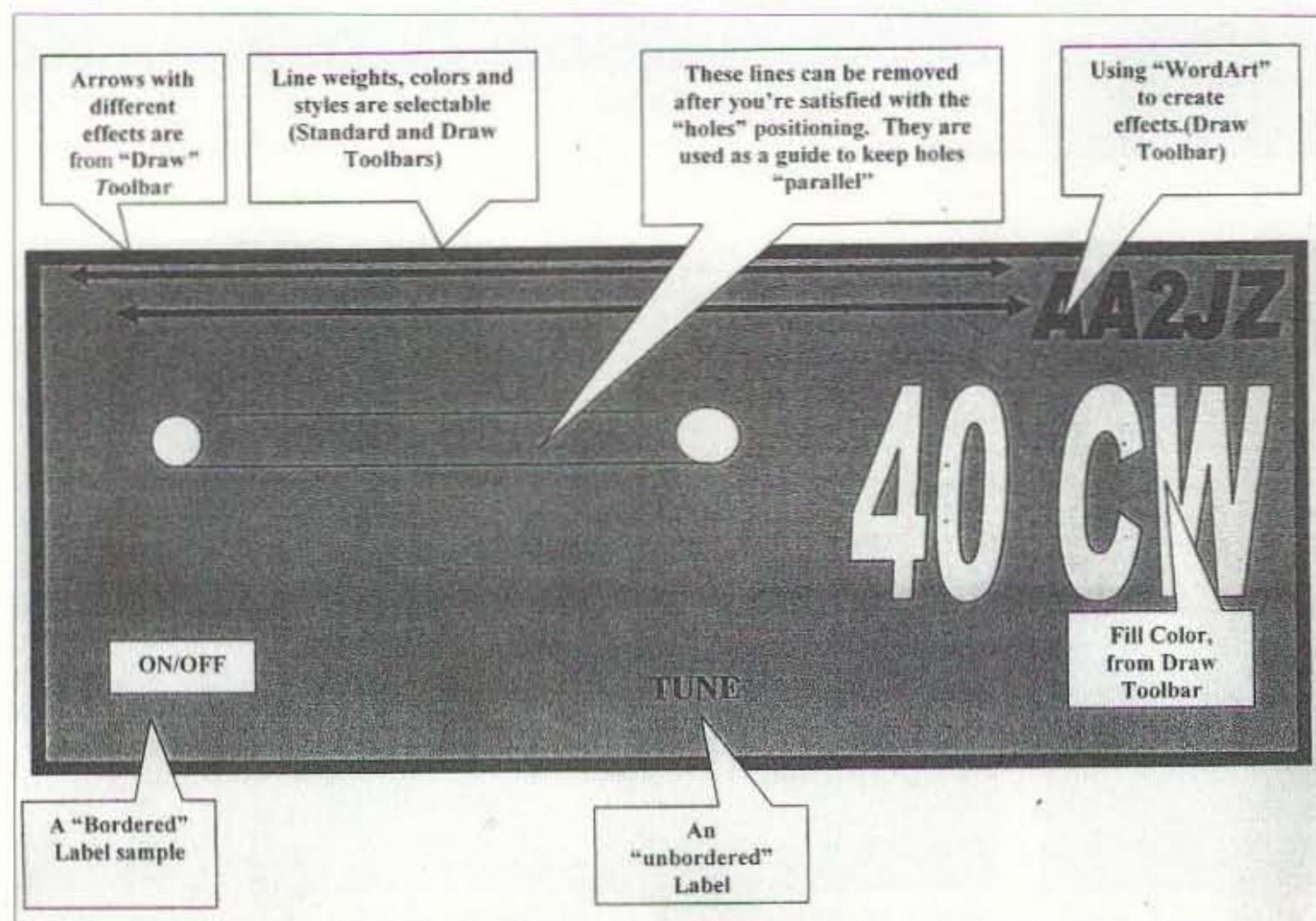


Fig. 1. Typical Word layout face plate.

lines, arrows, etc.," located on it. Either of these toolbars can be moved to other locations you may find more convenient. I happen to work with them in these locations.

Begin by measuring the face plate material, make note of the length and width. Don't forget to measure where needed holes are to be drilled. A rough, hand-drawn picture on scrap paper will suffice at this point. Then, on a blank, open "Word" document, create a "Text Box" from the "Draw" toolbar by clicking on the "page" icon (a square with lines on it representing a printed page). Make the rectangle slightly larger than the measurements of the blank face plate. Use the Ruler at the top and side of the screen as a guide. The excess paper will be trimmed away later when the finished print is adhered to the face plate material.

### Now the fun begins!

Select the "slanted A" (WordArt) from the Draw toolbar, choose the first example in the upper left corner of the menu, set the type size to 18, and type your call. When you're done, select OK. The open-faced capital letters should have appeared somewhere on your Word document. It can be moved to your beginning panel by left clicking on the WordArt to bring up the "handles" (little squares) and dragging the WordArt to where you desire it. Those handles allow the work to be stretched, skewed, moved, rotated, etc. If you aren't pleased with what you've added, on the Standard toolbar are two curved, pointed arrows. Click on the left one and your last attempt is removed, while clicking on the right one will put it back. Key strokes can be removed or replaced in the order in which they were created, until the file is saved. What you've created should resemble the drawing in Fig. 1, with your call sign of course!

The neat thing about using a Word program to design a front panel face is that none of it is permanent until you want it to be. Go ahead, move things around, try different lines and shapes! The file you create is limited in design only by what you try. Having trouble

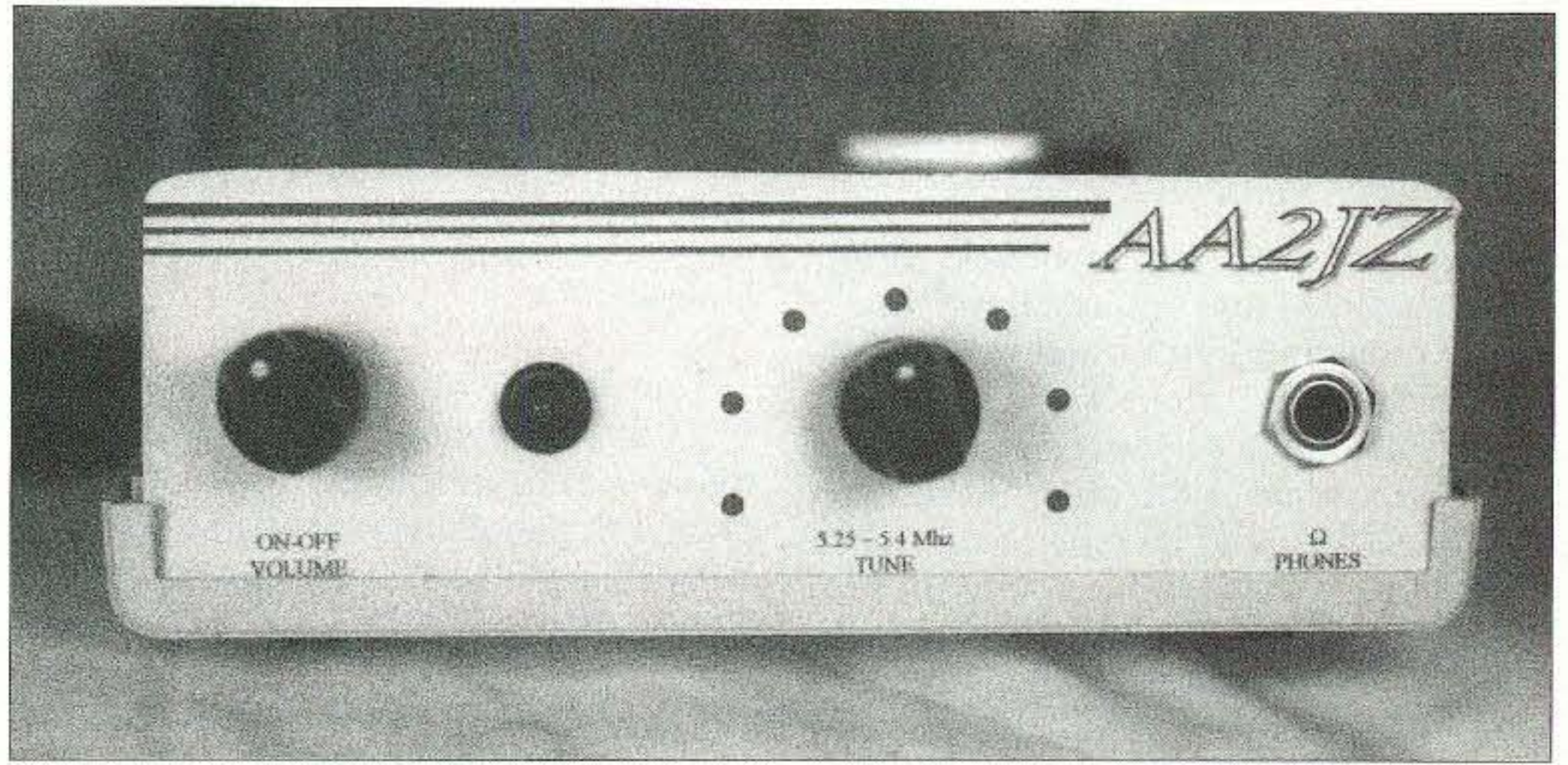


Photo A. 5.25–5.4 MHz receiver project. The case is a "left over" computer item. The word processing approach to faceplate design dresses it up just right.

making the "holes" for the controls line up? Draw guide lines using the "lines" option from the Draw toolbar. They can be deleted later. Fill color can be added to different portions of the drawing using the "spilling paint can" command from the Draw toolbar. Lettering colors can be changed by using the Font color command from the Drawing toolbar. There are many things that can be controlled from the toolbars: centering the lettering, changing the border line colors, etc. The manual that came with the computer will list them. Unless of course, your computer is like mine and is minus the manual. In this case, you just have to play (design) and try things out!

Let's assume that you've put together

a design you find attractive for your project. Print a copy of your design. Now, while holding it against the blank face plate, make sure that the layout is correct. By this, I mean that the hole locations are where they should be, that the lettering will fall in the proper place. I said to make the overall size of the print slightly larger than the measurements of the blank face plate. I do this to ensure that the design I created will fill the entire length and width of the plate, and that the call sign or other design will have some space at the end and not run off the end of the plate.

Printing the first few tries on plain

Continued on page 58

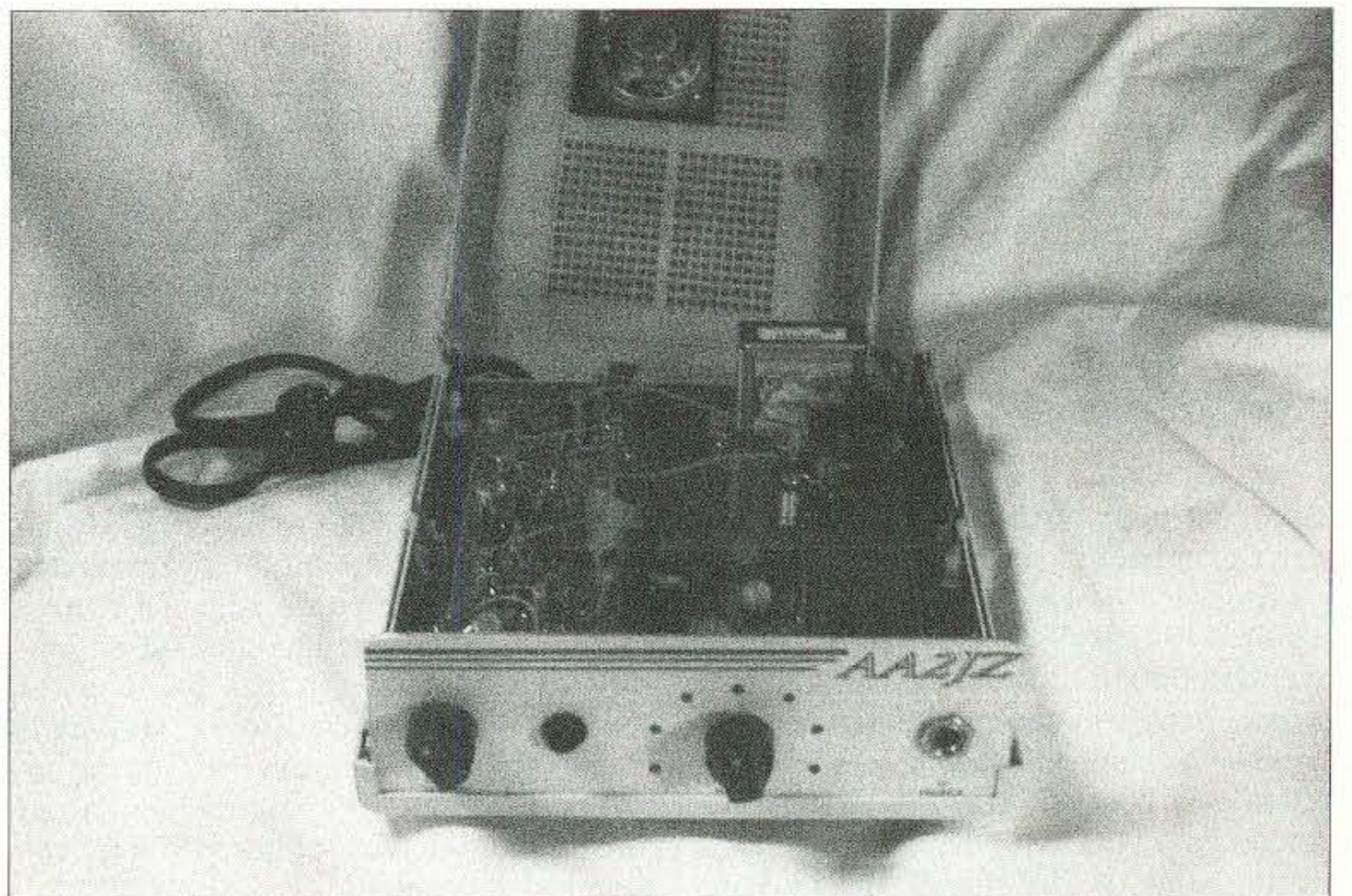


Photo B. The panel slips into slots and the top snaps over it all to keep it together.

## NEVER SAY DIE

Continued from page 8

### Van Allen

The Van Allen radiation belt, originally predicted and described by Nikola Tesla, protects us from high energy radiation from the Sun. Okay, so what's the big deal? We're shooting astronauts into Earth orbit all the time. Some even stay there for quite a while in the space stations.

The big deal is that all of this activity is going on hundreds of miles up, not thousands, where they'd have to deal with the intense radiation in the Van Allen Belt.

One mission did get up around a thousand miles, where the Van Allen Belt is just barely starting, but they reported seeing intense light flashes in their heads resulting from the radiation and had to quickly be brought down to a lower altitude.

Bart Sibrel reported on the C2C show that he asked one of the men who supposedly went to the Moon about seeing this phenomenon while passing through the Belt. No, he'd seen nothing like that. None of the Apollo astronauts reported anything like that. This further convinced Bart that the Moon missions had been faked.

Bart's the guy who got socked in the jaw when he asked Buzz Aldrin to swear on the Bible that he'd actually been to the Moon.

### More Moon

A ham friend who worked for NASA in the '70s explained why the engineers at NASA during the Apollo missions had to use slide rules for their orbital calculations. The computers NASA used in the Apollo days were surplus fire control computers—30 bit machines with 32 kb of memory. That's kilobytes, not gigabytes.

What fantastic luck to be able to get all those missions to the Moon and back safely with slide rules and a black board for calculations.

### WA6VPS Rides the Airways Again?

One of our most famous brethren, Kevin Mitnick WA6VPS, is getting his ham ticket back!

Mitnick, "the most wanted computer criminal in U.S. history," says he's spent over \$16,000 in legal fees to get his ham license back. He claims this is the most expensive ham license in the world. When you hear him on the air be sure you do your best to give him his money's worth. None of this stupid "the rig here is..." crap. Ask him about himself.

Kev was on with Art Bell W6OBB on one of Art's final C2C broadcasts. It was nice hearing from the subject of so much furor. I only wish the interview had been more interesting. Zzzz.

### Ooops!

Your friendly drug companies and the FDA goofed again, killing a lot of customers. This time all drugs containing phenylpropanolamine are being recalled. Seems the stuff has been causing strokes and seizure in children and in particular with women in the 18-49 group.

The stuff is in Acutrim, Alka-Seltzer, BC, Comtrex, Contac, Dexatrim, Dimetapp, Robitussin, and Triaminic products, so check the fine print on the labels carefully. You can probably get a refund.

If you'd keep your immune system in shape you wouldn't need any of this junk anyway. Remember, every drug has side effects, it's just that most aren't this serious. Or they haven't found out that they are yet.

### Oklahoma

A letter from a reader says he talked to a nearby seismograph operator a few days after the bombing. He said there were two distinct tremors recorded about nine seconds apart. The government explanation was that the second tremor was from the impact of the building coming down. Later, when the remaining building was brought down by a controlled detonation there was no tremor recorded, even though there was about five times the tonnage this time.

I've copies of the TV news broadcasts of the bombing available for \$10 (Radio Bookshop item #53). It shows interviews with several of the building's occupants testifying that the first explosion was inside the building, and the truck bomb went off a few seconds later. It also shows bomb squads removing two unexploded bombs from the building.

There are suggestions that McVeigh wasn't really executed, but is living comfortably somewhere with a new identity.

### Money Talks

One of the biggest mysteries in Washington is who inserted a two paragraph rider in the homeland security bill which confers virtual immunity to drug makers against any vaccination suits. The suspected culprit is the mercury-based preservative used in vaccines for diseases such as mumps and measles. Hundreds of parents have sued the drug manufacturers for including mercury in their vaccines after their children have been diagnosed as autistic.

I read that in 2002 Eli Lilly alone gave

\$1.6 million, mostly in cash, to GOP political candidates. Their investment clearly paid off. The Democrats failed their biggest contributors ... trial lawyers.

### The Warming Crock

The ignorant and misinformed are still making a stink about global warming. They're anxious to implement the Kyoto Protocol, which would cost us at least \$500 billion a year and virtually destroy many third world nations.

Warming? Historically today's temperatures are cooler than their average during the human era. The record shows that the world was several degrees warmer 1000, 3000 and 6000 years ago, long before we started burning coal and oil.

Hmm, 3000 and 6000 years ago were when Planet X may have swished by. That should warm things up for sure.

I've been pooh-poohing global warming for years and until I see some reliable evidence to the contrary I'm going to keep at it.

### Older Workers

As an employer my experience with hiring older workers was that it wasn't worth it. The lure is that they've experience and therefore should be able to do a better job. The reality was that in the businesses I've been in things were constantly changing and older workers resisted change. I did far better when I hired young people and trained them.

Kids are taught to get an education, get a job that will provide security, and eventually retire ... life's earned vacation. Few youngsters even consider any other route.

More and more companies are beginning to wise up that older workers have gold bricking down to a science and, when revenues start dropping, early retiring them. This gets rid of the employees who've built up salaries through yearly raises. Workers over 45 are discovering that there are very few jobs open for them.

My recommendation: even if you totally believe in a job and job security, give some thought to developing some sort of home-run business on the side. Maybe a mail order business. Then you'll have a cushion if your employer downsizes or goes out of business.

### Indian Casinos

*Time* did a 13-page article on the Indian casino scam. Let me quote: "Imagine, if you will, Congress passing a bill to make Indian tribes more self-sufficient that gives billions of dollars to the white backers of Indian businesses —

and nothing to hundreds of thousands of Native Americans living in poverty. Or a bill that gives hundreds of millions of dollars to one Indian tribe with a few dozen members — and not a penny to a tribe with hundreds of thousands of members. Or a bill that allows select Indian tribes to create businesses that reap millions of dollars in profits and pay no federal income tax — at the same time that tribes collect millions in aid from American taxpayers. Can't imagine Congress passing such a bill? It did."

And we're the patsies paying for all this. A tax cut? Har-de-har.

## Cancer!

Si-i-i-igh. A five-page article in *Business Week* on cancer was all about traditional treatment. Well, they're certainly not going to take even a slight chance of offending the pharmaceutical industry. There was no hint of what's causing cancer. No hint that there are any treatment alternatives.

Since no consumer publication dares to challenge the medical industry, FDA, drug industry, HMOs, and the parasitic sickness insurance industry, the only way the word is going to get out is for you to tell anyone who will listen that cancer is easy to cure. Any cancer. And with no drugs. No chemo. No radiation. No surgery. And I mean cure, not remission!

This veil of secrecy has been killing millions of people.

No, I'm not an MD. Hell, if I was I wouldn't dare make such a statement ... I'd lose my license in a wink. But I do believe in the work of Drs. Lorraine Day, Bruno Comby, Henry Bieler, and a bunch of others who are never mentioned in the medical schools or medical press.

It's all explained in my *Secret Guide to Health*.

Over half a million Americans are dying every year of cancer. And when cancer strikes, the victims learn soon enough that it's incurable ... that the best they can hope for is remission. What a crock! But not one in ten or a hundred thousand will ever make any effort to look into the situation and do any research. The public's belief in doctors is almost total.

If any cancer victims you meet don't even want to look at my book, maybe you can get them to call 800-574-2437 and get Dr. Day's video, "Cancer Doesn't Scare Me Anymore!" Yes, she's a "real" doctor.

With the medical cabal making an average of \$345,000 per cancer case, news of how easy it is to totally cure any cancer with no drugs could cost the industry hundreds of billions.

Didja see the "50 Minutes" segment

where an AIDS patient was spending \$6,000 a month for a drug that made her feel better? I sure wish someone would clue her in that AIDS is as easy to cure as cancer. Dr. Comby in Paris has been doing it for years using the same raw food approach as Dr. Day, as explained in my book.

## The American Cancer Society

One of the guests on the Art Bell show pointed out that of the \$400 million they get a year, less than 5% goes to patient care. 61%, he said, goes for salaries and perks. Further, they've never made one single advance in the treatment of cancer.

We have the spectacle of Dr. Lorraine Day easily curing her "incurable" cancer. Ditto Dr. Bruno Comby and a few other renegades. And Dr. Henry Bieler curing one child with "incurable" leukemia after another.

A hundred years ago cancer was almost unknown in America, but the American diet then was totally different. We were a country of farmers, eating home grown potatoes, tomatoes, grain, raw milk, free range chickens and eggs, and almost no sugar by today's norm.

Cancer has gone from a rarity to causing one out of three deaths by 1985, one out of two now, and it's projected to reach everyone by 2020.

Maybe you can start getting the word out about how easy cancer is to cure as long as people don't fall for the medical industry \$345,000 chemotherapy or radiation to death routes — and how easy it is to prevent in the first place with a saner diet.

## Mercury

Dentists who have been using dental amalgam for fillings were found to have four times the normal level of mercury in their bodies by researchers at the Glasgow Royal Infirmary. They also had more kidney disorders and memory problems. My dentist, who helped load my mouth with mercury (since removed), died of Alzheimer's.

And this is the stuff that, as a child, I played with and used to coat dimes. It turns out that its vapors are easily inhaled, and it also migrates through the skin to your brain. It takes from 15 to 30 years for half of it to leave your body.

It's been found to cause Alzheimer's, kidney dysfunction, multiple sclerosis, food allergies, impaired immune system, fatigue, poor memory, and psychological disorders. Mothers with mercury poisoning can expect birth defects in their children.

Yet, with all this becoming common knowledge, many dentists are still using amalgam fillings and denying the long range health danger.

If you still have any amalgam fillings, get 'em replaced with plastic as soon as you can.

## Tora Bora

Wow, we're semi-famous! D'ja see the report of a copy of 73 being found in one of the Taliban caves in Tora Bora, Afghanistan? Gee, I wonder if our guys killed my subscriber?

## Senior Hams

Well, if we can't attract the kids, then how about going after the geriatric generation?

Maybe you've read that older people are stressed by their isolation. If I had to depend on friends my age around here, I'd be stressed too. Most of my old friends are dead. John Peterson, who I used to go hunting and skiing with, died last year.

When you have a ham station you definitely are not isolated. All I have to

*Continued on page 62*

## Scrambling News

915 NW First Ave., Suite 2902, Miami FL, 33136  
305-372-9427

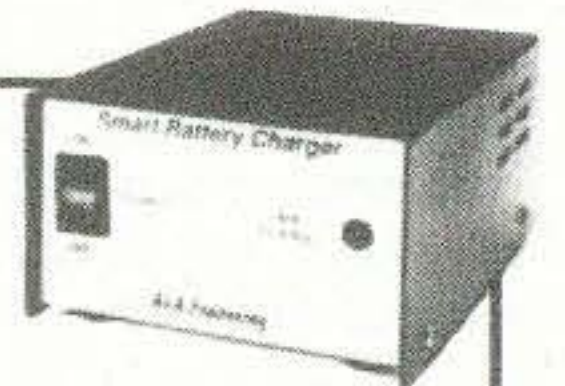
[www.scramblingnews.com](http://www.scramblingnews.com)

**Pay TV and Satellite Descrambling 2002** - NEW! - satellite and cable. Includes latest information. \$19.95 plus \$1.75 shipping.  
**Hacking Digital Satellite Systems Video 2002** - New! - \$29.95 plus \$3.50 shipping.  
**Scrambling News Online** - Online service for those interested in satellite television news. \$59.95/year. \$59.95/yr.  
**Pay TV and Satellite Descrambling Series CD-Rom** - all 13 volumes over 300 pages, \$59.95 plus \$3.50 shipping.  
**Best Deal** - Everything listed above for only \$99.95 plus \$3.50 shipping.

Say You Saw it In 73!

## Smart Battery Charger

New & Improved



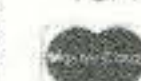
FOR GEL-CELLS or LEAD ACID BATTERIES.

Features: Precision temperature tracking voltage reference & three mode charging sequence. Standard kit is for 12V @ 1/2 or 1 Amp. user selectable. Can be connected to the battery indefinitely, will not overcharge. Weighs 2 pounds and measures 4"Wx5 1/2"Dx2 1/2"H. Finished enclosure included in kit.

Complete Kit Only ..... \$59.95  
Assembled & Tested ..... \$79.95

CA Residents add 7.50% sales tax; S&H: \$6.50 (insured).  
Foreign orders add 20%.

For more info or price list go to [a-engineering.com](http://a-engineering.com)



**A&A Engineering**



2521 W. La Palma #K • Anaheim, CA 92801  
(714) 952-2114 • FAX: (714) 952-3280

# CALENDAR EVENTS

Listings are free of charge as space permits. Please send us your Calendar Event two months in advance of the issue you want it to appear in. For example, if you want it to appear in the June issue, we should receive it by March 31. Provide a clear, concise summary of the essential details about your Calendar Event.

## MAR 1

**KNOXVILLE, TN** The Shriners of Kerbela ARS will sponsor their annual Kerbela Hamfest at Kerbela Temple, 315 Mimosa Ave., Knoxville TN. Admission is \$5. Indoor vendor tables are \$8 each plus admission of \$5. Setup Friday from 4 to 8 p.m., and Saturday from 5 to 8 a.m. Overnight security will be provided. Talk-in on 145.43 (-600), or 146.52 simplex. Smoking indoors is permitted in designated area only. Contact *Paul Baird K3PB, 1500 Coulter Shoals Cir., Lenoir City TN 37772. Phone 865-986-9562.*

## MAR 8, 9

**CHARLOTTE, NC** The Mecklenburg ARS proudly announces the 2003 Charlotte Hamfest and Computerfair. It will be held at the Charlotte Merchandise Mart, 2500 E. Independence Blvd. (US 74), Charlotte NC, on March 8th and 9th. Commercial dealers will be in Freedom Hall. The flea market will be in Independence Hall. Doors open 8:30 a.m. to 5 p.m. Saturday, and 8:30 a.m. to 2 p.m. Sunday. All the top manufacturers will be represented. Major equipment dealers, tons of great prizes, VE exams, ladies' programs, forums, new and used radio and computer equipment. Meet FCC's Riley Hollingsworth and a NASA shuttle astronaut. Tickets are \$8 at the door for both days, \$6 in advance or for just Sunday. Kids 12 and under admitted free. Flea market tables at \$22 each are good for both days. Pre-paid parking \$3, good for both days. Talk-in on 145.29 W4BFB rptr. For more details check the Web site at [[www.w4bfb.org](http://www.w4bfb.org)], or call *Tom Hunt KA3VVJ, 704-948-7373. Dealers may E-mail to [[dealers@w4bfb.org](mailto:dealers@w4bfb.org)]. For table reservations E-mail to [[fleamarket@w4bfb.org](mailto:fleamarket@w4bfb.org)]. Pre-registration tickets and table orders may be sent to *Charlotte Hamfest, P.O. Box 669, Cornelius NC 28031-0669. Be sure to include an SASE!**

## MAR 9

**AMHERST, MA** The M.T.A.R.A. 18th Annual Amateur Radio Hamfest will be held Sunday, March 9th at Amherst Regional Middle School, 170 Chestnut St., Amherst MA. Directions: From Mass Pike Exit 4: take Rte. 91 North to Exit 19, Rte. 9. Take Rte. 9 to Amherst Center. At the light in Amherst Center take a left. Proceed through several lights, pass Bank on right (just past the bank). Turn right on

Chestnut St. (not Chestnut Court), and proceed to Amherst Regional Middle School on the left. There will be help unloading and loading. Tailgating, no stairs, handicapped parking, a snack bar, and 120 VAC available. Doors open 7 a.m. for vendors, 9 a.m. for bargain hunters. Admission \$5 for adults, children under 12 free. Tailgating \$5, 8 ft. tables \$15 each. VE exams at 10 a.m. Space limited, pre-registration strongly recommended. To register, contact *Dave Cote WA1DC, [[wa1dc@arrl.net](mailto:wa1dc@arrl.net)]*. Bring two forms of positive ID, with originals and photocopies of any CSCE's you hold. If licensed, bring your original license and a photocopy. Walk-ins will be accepted, but only as seating permits! For commercial license testing, GROL, GMDSS-O/M, ship radar, etc., contact *Steve N1SR at 413-593-6554. Leave name, phone number, and desired license. Talk-in on the 146.940 MHz Mt. Tom rptr. and KD1XP's rptr. 145.130 MHz PL 123.0 Hz.*

## MAR 15

**SCOTTSDALE, AZ** The Scottsdale ARC will sponsor a hamfest starting at 6 a.m. on March 15th at Scottsdale Community College, 101 North - exit Chaparral Rd., 9000 E. Chaparral Rd., Scottsdale AZ. Parking \$2. Tables \$10. Self contained RV parking. VE exams. Refreshments. Talk-in on 147.18. Contact *Ed Nickerson WU7S, 902 North 73rd Place, Scottsdale AZ 85257. Phone 480-949-5162. E-mail to [[enickerson427@aol.com](mailto:enickerson427@aol.com)].*

## MAR 16

**JEFFERSON, WI** The Tri-County ARC will host "Hamfest 2003", Sunday, March 16th, at the Jefferson County Fairgrounds Activity Center, Hwy. 18 West, Jefferson WI. Open to the public from 8 a.m. until 1 p.m. VE exams start at 9 a.m. Vendors will be admitted at 7 a.m. Vendors-only parking will be provided for unloading. Food and beverages will be available. Talk-in on the 145.49 rptr. Admission \$4, 8 ft. table space @ \$6 each. Reserve your space early! Contact *TCARC, 213 Frederick St., Fort Atkinson WI 53538. Call 920-563-6381 evenings. Fax 920-563-9551. E-mail [[tricityarc@globaldialog.com](mailto:tricityarc@globaldialog.com)]. The Web site is at [[www.cmdline.com/tcarc/](http://www.cmdline.com/tcarc/)].*

## MAR 22

**BRAMPTON, ON, CANADA** The Peel ARC

and Mississauga ARC will host a hamfest on March 22nd at the Brampton Fall Fairgrounds. Take Hwy. 410 north until it becomes Heart Lake Rd. just past Bovaird Dr. Continue northward 7.5 km (4.6 mi) to Old School Rd. The fairgrounds are on the southwest corner. This event will feature amateur radio equipment manufacturers, major commercial vendors, new and used radio/computer electronics equipment and parts, VE exams, DXCC card checking, seminars, exhibits and demonstrations. There will also be a gala banquet and prizes. Guest speaker will be Jim Dean, VP, Radio Amateurs of Canada. Doors open to vendors at 7 a.m., and to the public flea market 9 a.m. to 1 p.m. Exhibits, demonstrations and seminars will be presented 9 a.m. to 5 p.m. Admission \$C 6; vendor tables \$C 25 and \$C 30 (6 ft. and 8 ft.). Includes one free admission per table. Talk-in on VE3PRC 146.880(-) and VE3MIS 145.430(-). Check the Web site at [<http://www.peelarc.org>] for more info. E-mail to [[ham-ex@sympatico.ca](mailto:ham-ex@sympatico.ca)]. Phone *Victoria 905-846-0822.*

## MAR 23

**MADISON, OH** The Lake County ARA will be holding it's 25th annual Hamfest/Computerfest on March 23rd, from 8 a.m. until 2 p.m. at the Madison High School, 3100 Burns Rd., Madison OH. Great bargains on new and used amateur radio equipment, computer and various other types of electronic equipment. There will also be hourly door prize drawings, craft demonstrations and VE exams. Admission tickets are \$5 and may be purchased at the door. Tables are \$8 each for 6 ft. or \$15 for two 6 ft tables; \$10 for an 8 ft. table. Call Roxanne at 440-209-8953 for table reservations, or E-mail her at [[roxanne@lcara.org](mailto:roxanne@lcara.org)] for any other questions.

## MAR 29

**ST. PAUL, MN** The Robbinsdale ARC, Inc. will hold their Midwinter Madness® Hobby Electronics Show Saturday March 29th from 7:30 a.m. to 1 p.m. at Ganglehoff Center, 235 Hamline Ave., on the Concordia University Campus in St. Paul MN. Concordia University is located off Interstate 94 near Hamline and Marshall. Midwinter Madness has commercial vendors selling new items in the line of

*Continued on page 59*

# Continuing Education: Emergency Communications on the Go

*In many professions, there is a requirement to participate in continuing education in order to maintain your certification or license. In amateur radio we are also engaged in a dynamic technology, and there are certain benefits to continuing our education in our hobby as well.*

**M**y professional field is in radiology, and although I have been in the management end as opposed to the clinical arena for many years, I keep my license and national registration current in both radiography and magnetic resonance imaging. This means that I must complete a minimum 24 hours of approved continuing education every two years to be able to maintain my status as a Radiologic Technologist. (Trivia note: Since the early 1950s the correct title has been Radiologic Technologist. People who refer to X-Ray Technicians are over a half century out of date.) On one hand, it might be argued that with nearly thirty years in the field my experience should be fairly extensive and I should have a pretty good understanding of it. On the other hand, during my career, healthcare has added Computerized Tomography (CT or CAT Scan), Magnetic Resonance Imaging (MRI), and Positron Emission Tomography (PET Scan). The requirement for continuing education has ensured that I stay up-to-date in my own clinical areas, as well as learn about the new and emerging technologies.

Amateur radio is also a technologically oriented field with many enhancements over the twenty years that I've been licensed. While the International Morse Code hasn't changed, we've added many new modes, particularly in the digital realm. The brick-size handie-talkie that my Elmer used has given way to much smaller multiband computerized HTs with more features than I could have imagined back in the early '80s. I remember amazing people by bringing up a phone patch with my first HT. Today that would only rate a yawn, but only if I could get the other person to put their cell phone down for a minute or two. The world and our hobby have changed phenomenally, and that's why we're beginning to see a

movement toward continuing education in amateur radio.

The American Radio Relay League is the driving force behind this movement. Whether you love the League or hate it, you have to admit that they have given the hobby some tools that we otherwise would never have enjoyed. Continuing education is one such offering. While many hams read voraciously to keep up on the great new technology (known to our spouses as toys), there is something to be said for a structured approach to learning. A structured educational process attempts to ensure that certain topics are presented in a certain way so that the learner acquires certain skills or concepts that may not have been present before. Pilot's training, for example, is geared to teaching the student all the skills essential for a safe flight under routine conditions. It also provides a framework so that others engaged in the same endeavors have a reasonable idea as to what others' level of training is. It kind of lets you know what to expect when dealing with someone new if you know what training they've had.

With the state of the world today, one of the key sets of skills that amateur radio operators can be expected to have are those relating to emergency communications. With as near and dear as this topic is to my heart, I think it was an excellent idea for the ARRL to offer this as a continuing education course.

There are actually three courses on emergency communications that the ARRL offers. The first course is aimed at amateur radio operators who expect to be called upon to provide communications in an emergency. The Level II course develops net management skills for those who want to participate as net control stations and net managers. The third level is aimed

at those who manage emergency communications at all levels.

I had the opportunity to take the Amateur Radio Emergency Communications Level I over the past few weeks. The course is handled on line through the Connecticut Distance Learning Consortium, and is kind of like going to school over the Web. To enroll in a course, you can go to the League's home page [<http://www.arrl.org>] and search for AREC. Or you can go directly to [<http://www.arrl.org/cce/courses.html>], which will give you a description of each course and enrollment information. There is a cost associated with the courses, although all materials are provided via the Web. Each level of the course costs \$45 for ARRL members and \$75 for nonmembers. Upon submission of your application and fees, you'll receive instructions by E-mail on how to access the Web site and how to start the course.

Each student is assigned a mentor who will help him through the course. Mine, Jim Stalzer WJØS, provided guidance, insight, and encouragement during the process. In my case the course began in mid-November, and radiology has a major weeklong trade show that starts the weekend after Thanksgiving. When he didn't see the activity that would be expected, he gave me a gentle nudge to make sure that I was on schedule. The mentor is a key element to this course and its success, acting more as a guide and sounding board than an instructor.

There are twenty learning units. Each is the equivalent of about five to ten pages and covers key concepts of emergency communications. There are significant references listed at the end of each unit from such sources as the Federal Emergency

*Continued on page 61*

# Geriatric Care for the Argonaut

*It's hard not to mention the Ten-Tec Argonaut 509 when talking about QRP. For years it's been the standard by which other radios have been judged.*

**B**ut the 509 is getting old. Some of the early models are approaching 25-years-old. If you own a 509, you'll find this installment of the QRP column your cup of tea!

### What goes wrong?

Besides the usual problems of dried out capacitors and carbon resistors changing values, there's no one single problem that appears to be common to the 509.

One problem you will see in all of the older Argonaut-series QRP transceivers is loose or broken dial strings. Replacing the dial string is not hard, but getting to it can be a challenge. You must completely strip the radio down to get to the subpanel that houses the dial string. It's not hard to do, but I must warn those with weak hearts, it can be overwhelming!

Before you get started tearing into the 509, call Ten-Tec and order a dial string

rebuild kit. It contains everything you need to restring the transceiver. As a matter of fact, they're not very expensive — order two and keep one in the junk box.

And although I'll be talking about the Ten-Tec 509, the same procedure holds true for the Ten-Tec 505 QRP transceiver and the Ten-Tec 515 transceiver. As a matter of fact, even the Ten-Tec Century 22 and the original Ten-Tec Argosy use the same basic steps in dial string replacement.

The first step in getting to that dial string is to remove all the front knobs. Make sure you have the right tools to get the knobs off. Some have set screws, others have Allen screws, and then some knobs push on. After you have all the knobs removed, place them in a warm bath of mild soap and water. Let 'em soak for an hour or so to remove the dirt and crud. Wash them off with clear water and towel dry. You'll be amazed how much dirt can accumulate on those knobs!

Now, remove the two end pieces. There are several screws holding each into the aluminum chassis. Before you can remove the two end panels, there is an aluminum brace bar that runs from one panel to the other. This guy is located at the very top of the radio. You'll need a long screwdriver to reach the single screw on either side.

Once you have

the end pieces removed, place them down on a soft cloth. This will prevent them from picking up scratches to the walnut inlays.

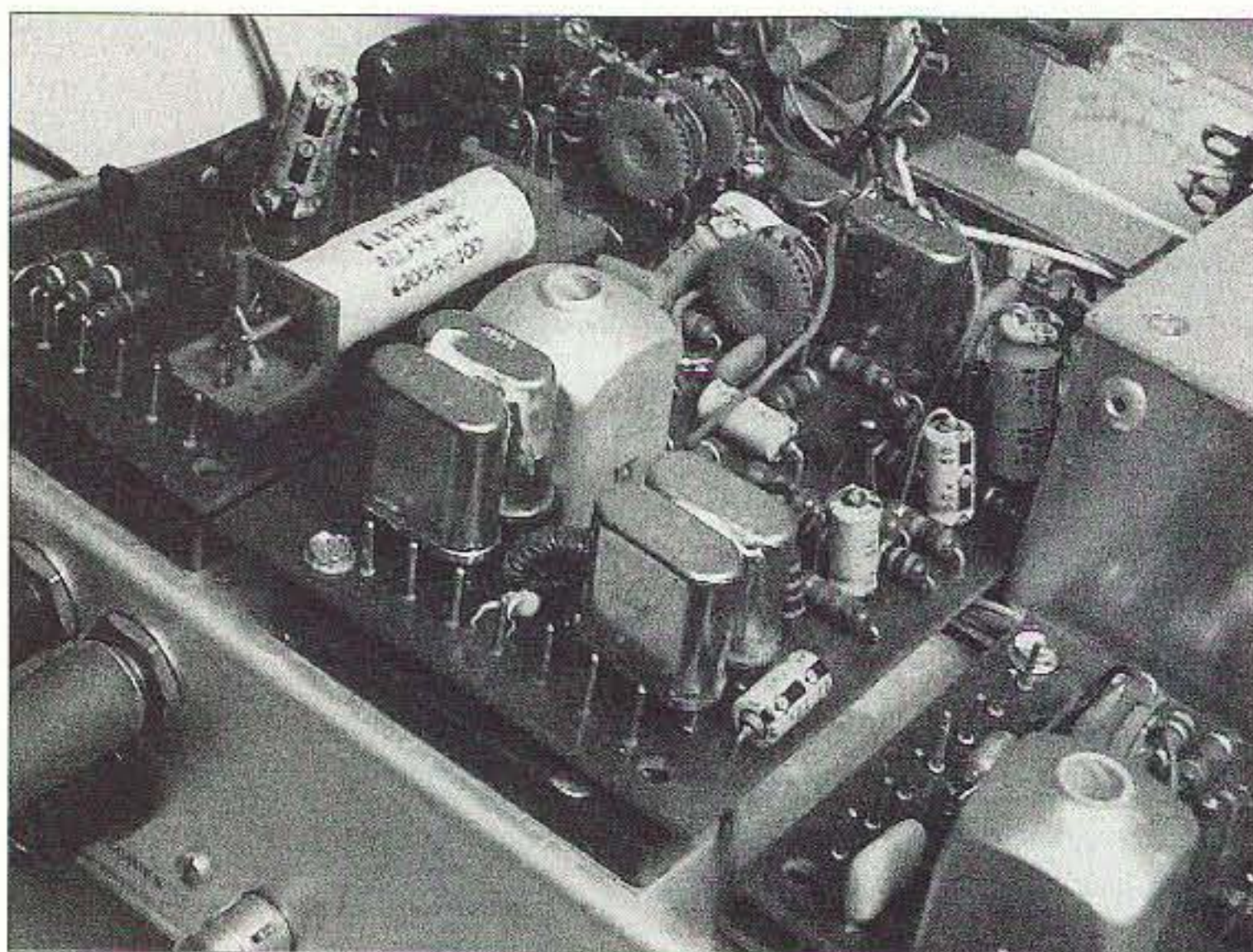
With the end panels off, there are but a few more screws holding the front panel on. To get the front panel off, break out the hollow shaft nut drivers and remove the hardware around the controls. For goodness' sake, use the nut drivers and not a pair of pliers to remove the nuts. A slip of the pliers will send a scratch across the panel, leaving a deep gouge in its wake. Use the correct tools!

Carefully remove the front panel. Now, if you're lucky, the dial string will simply be worn out and not broken. The elastic cord routes over and under the pulleys. The elastic cord is fastened down via a solder lug just about under the main VFO tuning shaft.

It's almost always the elastic cord that causes the problems with the dial on the 509. The elastic cord loses elasticity and the pointer droops when you tune towards the low end of the band. Sometimes the droop is so bad the pointer falls down.

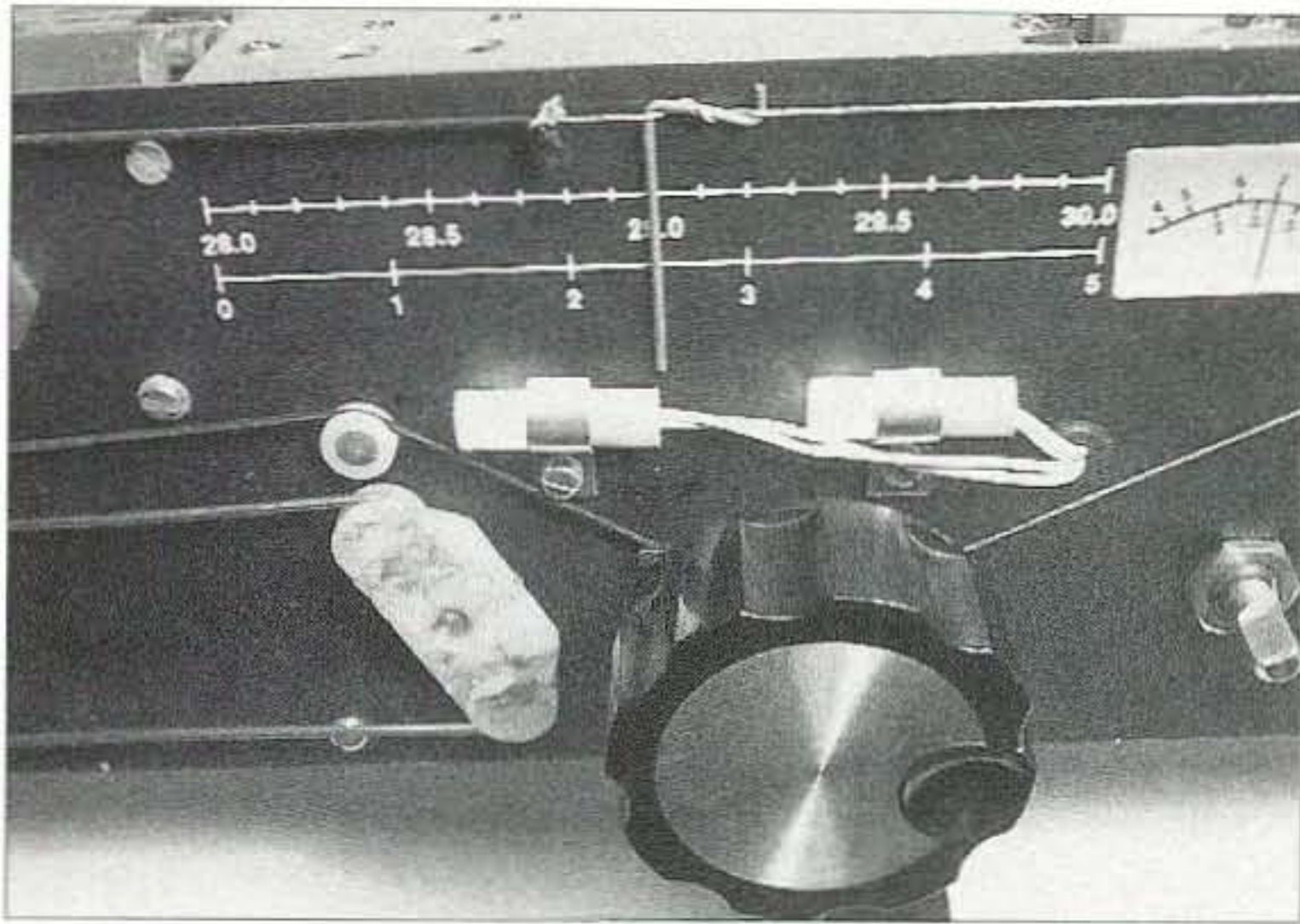
When I replace the elastic cord, I normally don't mess with the dial string. The elastic cord is fastened to the slide pointer using a granny knot. The dial string is left alone. Now, having said that, if you have purchased the restring kit from Ten-Tec, you might as well install a new dial string along with a new elastic cord.

Before you start removing the elastic cord and string, make a drawing of how the string and cord wrap around the various pulleys. This simple step can save you hours and hours of work later on.

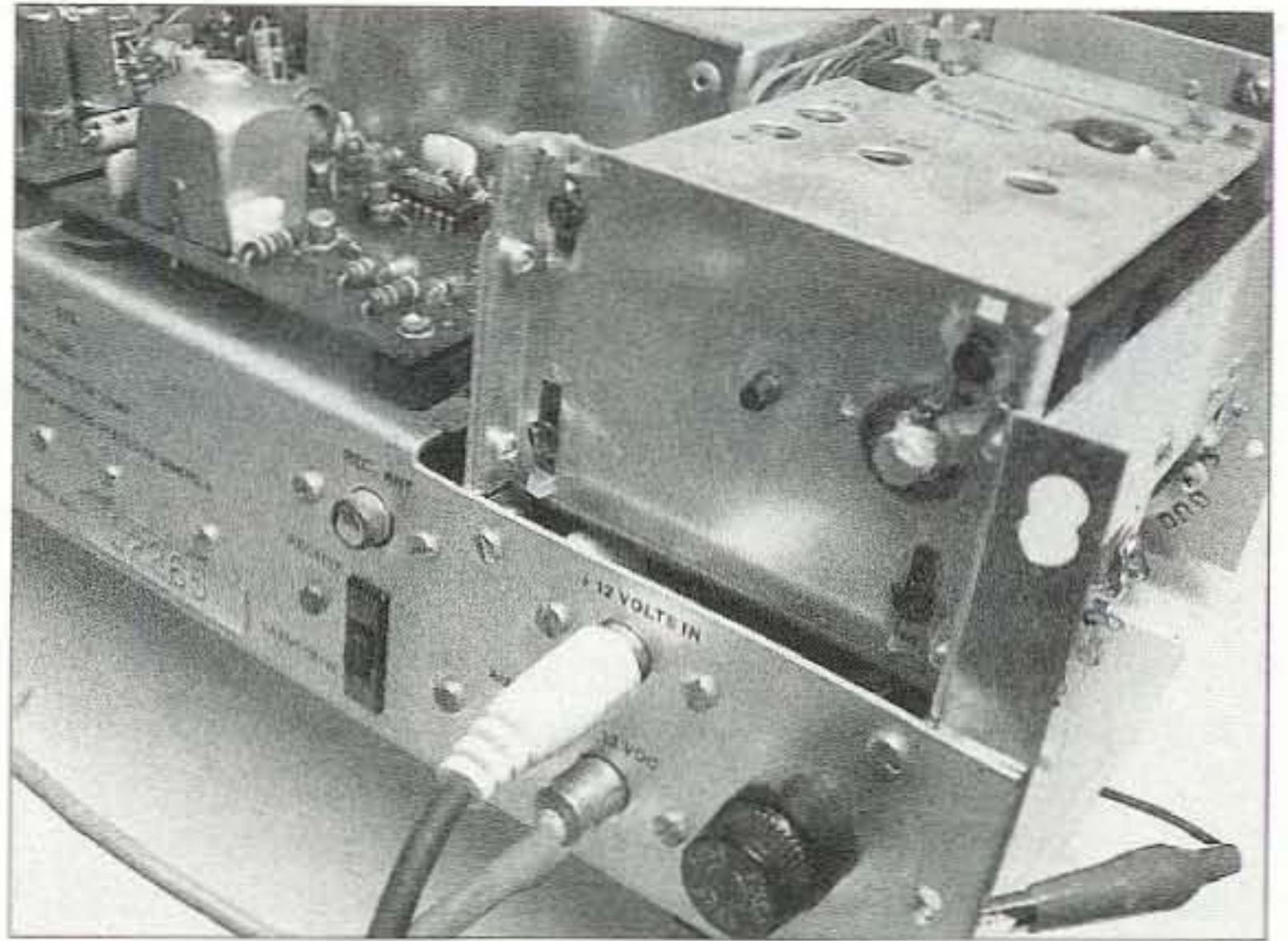


*Photo A. The crystal filter used by the 509 is shown here.*





**Photo B.** The main tuning knob has been installed. Notice the lamps are on and the S-meter is working. I was working with the rig in this condition.



**Photo C.** The main resonate rack. Just a dab of grease on the area that moves up and down.

Since you now have the front panel off, carefully power up the radio and verify that the two dial lamps are working. If not, then replace them.

#### Some other tidbits before you reassemble the radio

Before you reinstall the front panel and end panels, flip the radio over so you can see the rear end. The front end tuning rack is now fully exposed. Check the front and rear bushing for grease. If your unit is dry, apply ever so slight a dab of multipurpose grease. I use bicycle grease. Radio Shack sells some multipurpose electronic grease, too. Remember, and this is very important, only a very, very small amount is needed. Too much will really muck up the works.

#### Some last minute touch-ups

Since you already have the radio torn

apart, take some time and remove, one at a time, the plug-in boards. All you want to do is remove the two screws holding the board down. Then carefully pry up the board. Next, reset the board back down into its socket. This breaks up any oxidation on the pins and sockets. Pay attention to how the board goes into the socket. You can easily get it turned 180 degrees around and then you've really had it!

There is no need to use contact cleaner here. You should not even think of using any cleaner with solvents in it on the chassis.

After you have reset the PC boards, it's time to reassemble the 509. Just reverse the process you used to tear it apart and you should have no trouble.

You may have noticed, in some of the photographs of the front panel of my 509, that the meter is reading S7. Well,

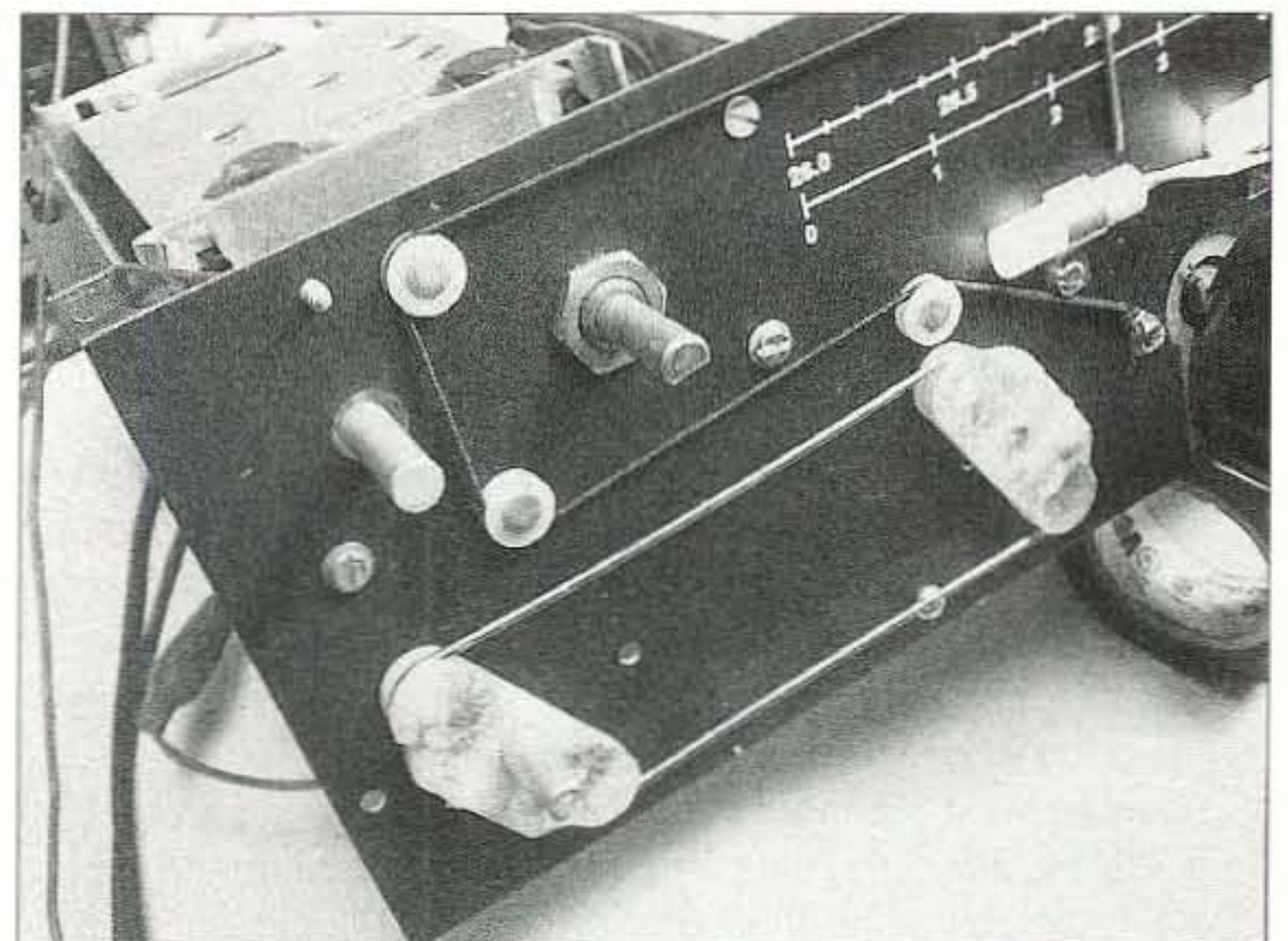
as I was replacing the dial string on my radio I had it setting on the MIDCARS frequency of 7.258. Of course I had to check into the service, and was given a S9+ report. Not bad for QRP and a radio spread all over the workbench! 73

**Surplus Microwave Parts & Test  
Equipment**  
dudleylab.com  
Visa/MC/Discover  
732-240-6895  
Toms River, NJ 08757

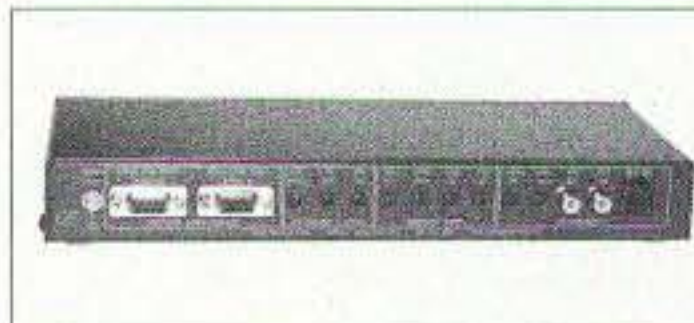
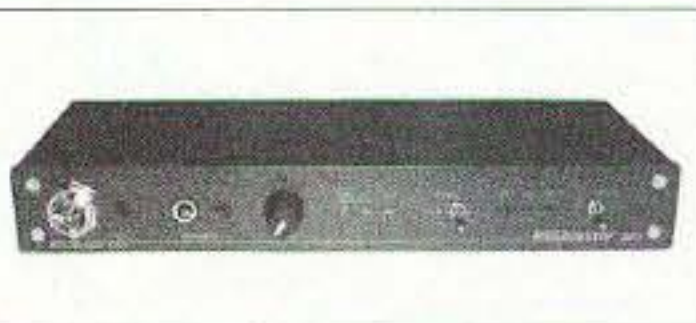
**Back Issues**  
of  
*73 Magazine*  
Only \$5.00 Each!  
Call 800-274-7373



**Photo D.** Notice how the string is run between the two pulleys.



**Photo E.** Internal gang switches for the band switch.



## New RIGblaster Pro from West Mountain Radio

The new RIGblaster Pro model from West Mountain Radio is the fourth in a series of RIGblasters. West Mountain radio was the first to offer sound card interfaces. Their new Pro model represents a revolutionary advancement in computer-to-radio interfaces. It is not only a sound card interface, but also a complete computer interface that will do everything you can do with a computer and a radio — even functions that have never been done before.

The Pro, like all other RIGblasters, supports operation with almost 100 different ham radio sound card programs that transmit and receive, with over 20 distinctly different modes. In addition to functioning as a sound card interface, the Pro also has a built-in rig control interface for most radios. Having both sound card and rig control in a single unit allows operation with a single serial port! HamScope (freeware), MixW, WriteLog, and other multimode amateur radio programs support using a single port.

The new RIGblaster Pro has two separate keying circuits, one for CW and one for FSK. A configurable secondary serial port provides compatibility with a wide choice of software.

Another new feature innovation is the ability to bridge your station mic to the computer as well as a radio. You can do digital recording of both sides of a QSO or perform high-performance transmit speech processing. With software off the Web, equalization, compression and noise reduction during phone operation is possible. West Mountain Radio is developing a special ham radio program optimized for phone operation.

New features unique to the RIGblaster Pro, include: front panel LED status indicators for PTT, CW, FSK, audio source, and audio level, making software setup easy; transmit computer speaker muting; front panel audio drive level control; electret mic bias; aux. plug-in headset mic jack; dual headphone jacks; dual PTT jacks, for foot switch or sequencing; radio and computer speaker loop through; and a power switch.

A RIGblaster Pro, a computer, and appropriate software can replace a mic equalizer/processor, rig control interface, multimode TNC, Internet remote link, contest digital voice keyer, DSP receive filter, receive enhancer, DX beacon clock that receives, and of course a sound card interface. You have all of this in one integrated package, for \$299.95.

The RIGblaster Pro is compatible with any sound-capable computer and any radio that has an 8-pin screw on or RJ45 mic jack. Accessory 4-pin screw on and RJ22 adapters are available. Some radios will work but their mics will not, only if they use RJ22 plugs or digital PTT buttons. The RIGblaster Pro comes supplied with the West Mountain CD, 12 VDC power supply, and all the cables you need to get on the air.

Contact West Mountain Radio at 18 Sheehan Ave., Norwalk, CT 06854; 203-853-8080; or go to [westmountainradio.com] for full details and on-line ordering.

## Octavia Announces New Release of Visual Callsign Database

Octavia is pleased to announce the new release of Visual Callsign Database 3.0 ESD, a most comprehensive source of the Commonwealth of Independent States (CIS) callsign information.

First released in 1990 as R&R Callsign Database, VCD is designed to assist hams in successfully QSLing the CIS countries of the old Soviet Union. The updated version offers more photographs and most accurate and updated listings.

It covers all over the CIS (Armenia, Azerbaijan, Belarus, Georgia, Kazakhstan, Kyrgyzstan, Moldova, Russia, Ukraine, Uzbekistan, Tajikistan, and Turkmenistan) and provides instant access to over 81,568 database entries.

VCD provides a wide range of features:

- Instant access to 81,568 entries, including current, contest, special-event callsigns, radio clubs, and silent keys.
- Data converted into their English language equivalents and presented in a form which will be recognizable by both International and Russian (Ukrainian, etc.) postal workers.
- 23,495 cross-references from old to new calls.
- 1,592 personal photographs and QSL card images. Slide show facility. All images are scanned and color-corrected by Octavia. Limited feature in unregistered version.
- DXpeditions with photos.
- 986 e-mail and amateur radio packet radio addresses, WWW URLs, and ICQ #.
- Over 5,500 home telephone numbers with area codes.
- Club membership information.
- Full date of birth and year first licensed.
- WW grid locator.
- Advisor utility. Marks incorrect/suspicious addresses.
- Powerful advanced searching capabilities: look up by callsign, name, address, postal code, ex- and special event call, region, WW grid loc., clubs membership, old calls, etc.
- QSL bureau listing.
- Data export into the clipboard/label printing.

Some of the VCD screen shots can be viewed at [www.octavia.com/callsignserver/vcd.htm].

A 30-day trial version is free to download from Octavia Web site at [www.octavia.com/vcd/download.asp].

Unlimited license can be purchased securely on-line or via postal mail for US\$20.00. All major credit cards accepted. Registered users will get the entire image library (100 Mb) to make their program fully functional, and one year of free updates.

Product options: The fully functional CD-ROM version is priced at US\$30.00. A CD-ROM subscription is also available. One year subscription includes 6 fully functional CDs delivered bi-monthly by mail. The regular price is US\$50.00.

## About Octavia

Octavia Company, Ltd., has been developing Visual Callsign Database since 1989, and specializes in delivering design, print, and Web solutions for hams, small businesses, and companies.

Octavia is a family-owned company based in Maykop, Russia, with a Web site at [www.octavia.com].

Please contact Octavia at [info@octavia.com] with any comments and/or questions relating to this program/product. For further information, contact Valery Kharchenko RA6YR at the same address.

# ADVERTISERS' INDEX

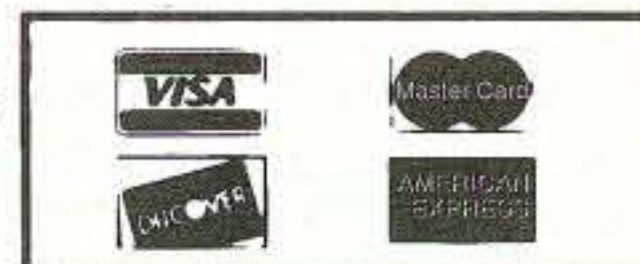
R.S.#	page	R.S.#	page	R.S.#	page	R.S.#	page
• A & A Engineering .....	43	56 Buckmaster Publishing .....	59	42 Isotron .....	59	• Radio Book Shop .....	33
• Alinco .....	CV2	99 Communication Concepts .....	31	• M <sup>2</sup> .....	58	• Radio Book Shop .....	43
• Alinco .....	CV3	• Communications		• Michigan Radio .....	49	• Radio Book Shop .....	47
• All Electronics Corp. ....	27	Electronics, Inc. ....	5	• Milestone Technologies ....	51	• Radio Book Shop .....	51
• Amateur Accessories .....	19	10 Communications		• Omega Sales .....	18	• Radio Book Shop .....	63
16 Astron Corporation .....	2	Specialists, Inc. ....	15	• Omega Sales .....	33	34 Ramsey Electronics .....	3
• ATOC Amateur		Doppler Systems .....	33	• Omega Sales .....	59	• RLS .....	55
Distributing Corp. ....	CV2	• Dudley Lab .....	47	• Radcomm Radio .....	29	• Scrambling News .....	43
• ATOC Amateur		• Fair Radio Sales .....	51	• Radio Book Shop .....	18	• SGC .....	7
Distributing Corp. ....	CV3	• Hamtronics, Inc. ....	9	• Radio Book Shop .....	19	• Universal Radio .....	13
42 Bilal Company .....	59	• Houston Amateur		• Radio Book Shop .....	20	• West Mountain Radio .....	55
168 Buckmaster Publishing .....	31	Radio Supply .....	51	• Radio Book Shop .....	31	• Yaesu .....	CV4

When you buy products from these advertisers, please tell them that you saw their ads in 73.  
 Subscribe to 73 right now...call 800-274-7373 (9-5 Monday-Friday EST).

**WE SHIP WORLDWIDE**  
**Michigan Radio**  
 SALES SERVICE

Local & Tech 1-810-771-4711, Service 1-810-771-4712, Fax Service 1-810-771-6546

OPEN  
 TUES, WED, THUR 10-6  
 FRI 11-8  
 SAT 10-3  
 CLOSED SUN & MON



Terms do not include shipping. Price and availability subject to change without notice. Most orders shipped same day. COD's welcome (\$5.50 & shipping).

26014 Groesbeck, Warren, MI 48089  
**1-800-TRU-HAMM** (orders only)  
 (800-878-4266)

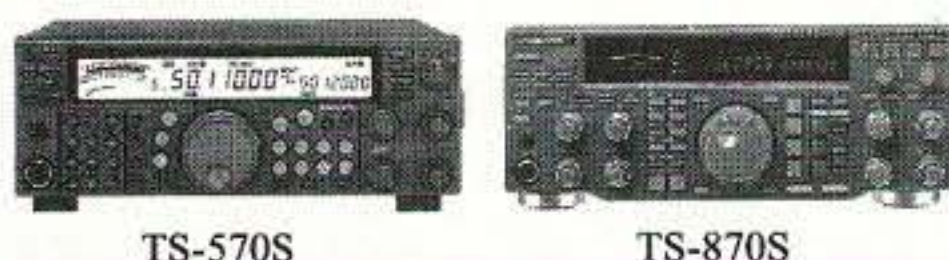
Now on the World Wide Web

<http://michiganradio.com>

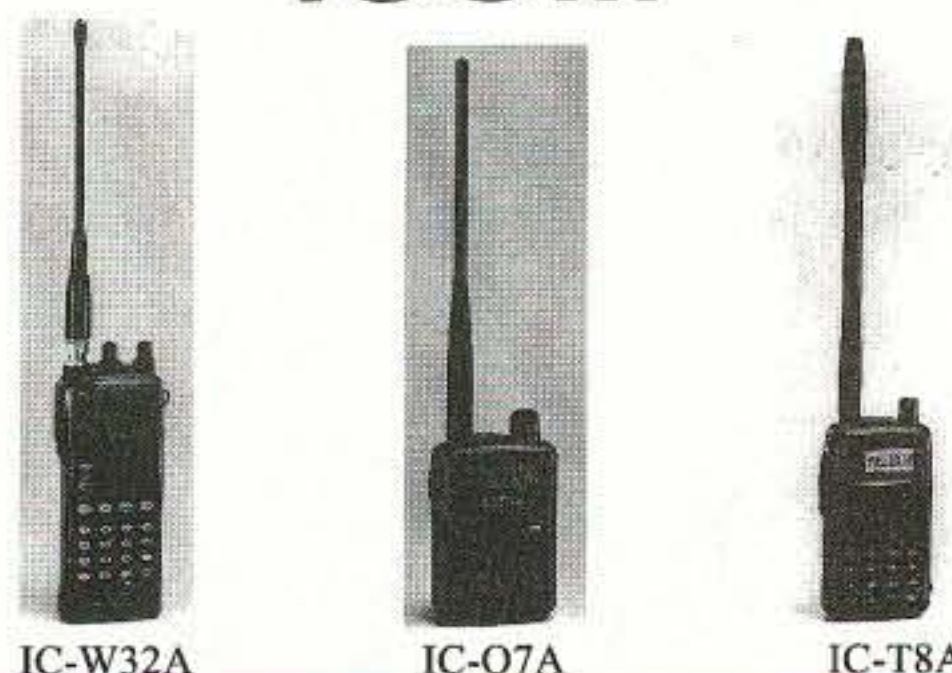
E-mail [mirad@mich.com](mailto:mirad@mich.com)



**KENWOOD**



**ICOM**



**YAESU**



Convert Excess Equipment to CASH • We buy good, clean, used equipment • Estate Sales

# True Dopplers and Comical T-Hunting

Last month's "Homing In" took you on a journey that started with Christian Doppler's birth almost exactly two centuries ago. While trying to understand color changes in double stars, this astronomer/physicist was the first to document the apparent frequency shift of waves when source and observer are in relative motion.

Doppler radio direction finding (RDF) sets for ham radio came along in 1978, adapted from a spinning antenna scheme that was first proposed just after the Second World War. This month, we'll clear up

some misconceptions about antennas that produce Doppler shift without physical motion.

In a typical VHF/UHF Doppler RDF antenna unit, three or more whips or vertical dipoles are equally spaced along the circumference of an imaginary horizontal circle.

An electronic switch connects them to the receiver one at a time in sequence, for equal periods of time. This simulates a single whip moving along the imaginary circle at a physically impossible high rate of speed, sufficient to provide periodic Doppler frequency shifts in all incoming signals.

Many hams confuse the rotation frequency, the Doppler tone frequency, and the tone's frequency deviation, all of which are stated in Hertz (Hz). The array rotation rate (number of times that each whip is sequenced on in a second) is always the same as the fundamental frequency of the induced Doppler tone. Typical rotation rates range

from 300 to 1000 Hz, corresponding to the audio passband of narrowband FM voice receivers. Higher rates are avoided because they produce audio harmonics that may be interpreted as noise by the receiver's squelch circuit.

Peak FM deviation of the Doppler tone is given by the formula in Fig. 1. For best performance, deviation must be high enough that the tone can be easily detected and its phase determined when the signal isn't full-quieting and when voice or other modulation is present. A four-element set with whips in an 18-inch square, switched at 500 revolutions per second, produces peak Doppler tone deviation of about 0.5 kHz.

The bottom of Fig. 1 illustrates the sinusoidal waveform that would be produced in an FM receiver discriminator by a single moving vertical antenna. Fig. 2 is an oscilloscope trace of the audio output of the FM receiver in a typical four-whip Doppler setup. Signal wavefront phase changes that are presented to the receiver as the antenna elements are sequentially switched show up here as periodic pulses. All of the information necessary to determine signal bearing is contained in the amplitude, polarity, and timing of these pulses. The rise and fall slopes of the pulses and the "tilt" between them are functions of the frequency response of the audio stages, and are inconsequential. Note the large pulses of opposite polarity when switching to antennas #1 and #3, and the very small jumps at #2 and #4. From this, we can tell that the incoming signal direction is approximately perpendicular to an imaginary line through antennas #1 and #2.

A frequency domain analysis of the audio of Fig. 2 looks like Fig. 3. The fundamental frequency (474 Hz in this case, same

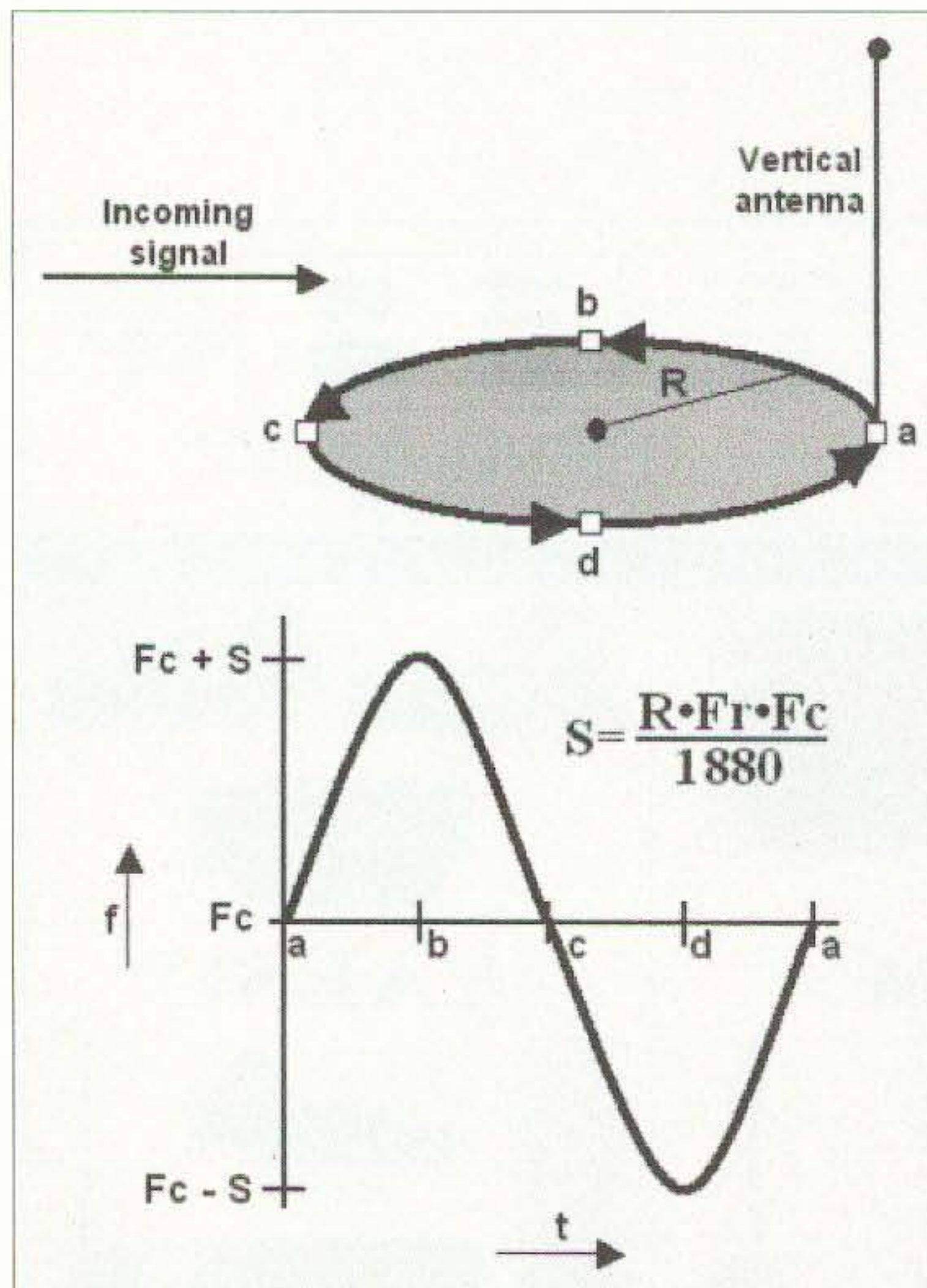


Fig. 1. As a vertical antenna element moves rapidly on a circular track, the Doppler shift imposes an FM tone on received signals. Peak FM deviation of the tone ( $S$  in Hz) is a function of signal frequency ( $F_c$  in MHz), circular rotation rate ( $F_r$  in Hz), and radius of the circular track ( $R$  in inches), according to the formula.

as the rotation rate) is the only component of interest for bearing determination. The array of harmonics comes about because of the switching steps of the audio. If you have encountered Fourier series in a math class, you'll recognize the characteristic decreasing harmonic values. Note that only odd-numbered harmonics are present (1422 Hz, 2370 Hz, 3318 Hz, and so forth). Changing the number of evenly spaced whips will change the relative levels of the odd harmonics, but will not add any even harmonics to the tone spectrum. This is important, as we will see in a later installment of this series.

In a practical Doppler set, a very narrow audio bandpass filter (as low as 2 Hz bandwidth) is synchronized to the antenna rotation rate. Because it is locked to the fundamental frequency of the Fourier series, this filter strips out the upper harmonics as well as the unwanted noise and modulation on the incoming signal. The output is a sine wave (like Fig. 1) with just the RDF information we want (relative phase) on it. It's nearly indistinguishable from what would be achieved with an infinite number of whips, which explains why it's possible to have high bearing accuracy with just three or four whip antennas.

### Just like the movies

Despite the above explanation and the good performance of Doppler RDF sets, some hams have trouble accepting the concept of a few sequenced vertical antennas taking the place of a single vertical antenna moving in a circular pattern. This was the topic of considerable debate on an Internet discussion group for transmitter hunters about six years ago. Some writers claimed that it is impossible for switched verticals to produce "true Doppler" response. But no matter what you choose to call them, they do indeed follow Doppler's principle and the equations derived from it.

For those having trouble thinking this through, I suggested an intermediate step. Consider the theoretical case of an infinite number of individual whips and a perfect switching system in place of the single moving whip. This is the same piecewise approximation technique used in the calculus. There are tiny phase steps added to the received signal every time the switch operates, creating an infinite-step sinusoidal Doppler-induced carrier shift in the receiver discriminator output, identical to the physically rotating whip case. Doppler's frequency shift prediction still exactly describes the frequency changes that the receiver perceives.

Now reduce the number of whips from infinity to a practical number. This reduces the number of pieces in the piecewise approximation of one rotation from infinity to the number of whips. The receiver's discriminator output still includes phase jumps corresponding to antenna switching steps, but they are fewer in number and greater in amplitude. The phase information necessary to determine our RDF bearing is still present in the fundamental frequency term of this series. The harmonic content is greater and more filtering is required than in a million-whip array, but our narrow bandpass filter strips all the harmonics out.

Some members of the Internet discussion group were still troubled about all the simulated antenna movement being encoded in very brief phase jumps, while the rest of the time one antenna is connected to the receiver. But the important thing to remember is that it's the combination of both the jumps and plateaus (switching and sitting times) that simulates the motion. When you watch a movie, you are seeing a series of still photos (frames) that snap from one to another with rapid transitions. It is the combination of transitions and still frames that the viewer perceives as smooth motion. The eye and brain act as a filter, just as the filtering in the Doppler set. If you were to eliminate either the still frames or the transitions, then the simulation of smooth motion on the screen would be lost. Similarly, the combination of both the phase steps and the plateaus in between creates the waveform that the narrowband filter uses to extract the Doppler data with high accuracy.

With this explanation, almost everyone in the group was convinced. Then one writer pointed out that the peak amplitudes of phase jumps in the receiver output are not affected by the array rotation rate. Amplitudes remain the same because the phase steps are a function of the number of elements and direction of signal only. They remain the same number of electrical degrees when the rate changes. This appears contrary to the Doppler equation of Fig. 1, from which increasing the rotation rate ( $F_r$ ) should always cause increases in the deviation amplitude ( $S$ ). Does that mean that it isn't a true Doppler after all?

This writer's incorrect conclusion came about because he confused phase modulation (PM) with frequency modulation (FM). They are similar forms of angular modulation, related mathematically but not identical. An FM signal's deviation is a function of only the amplitude of its modulating waveform, and is independent of the modulation frequency. PM deviation is a function of both



A Division of Milestone Technologies, Inc.

## Everything for the Morse Enthusiast!

Keys, Bugs, Paddles, Keyers, Books, Kits, Tools, Software....

Free Catalog!

[www.MorseX.com](http://www.MorseX.com)

(303) 752-3382

### HOUSTON AMATEUR RADIO SUPPLY

267 Cypresswood Drive • Spring, TX 77388

800-471-7373

Local: 281-355-7373

email: [houstonamateurradio@prodigy.net](mailto:houstonamateurradio@prodigy.net)

COMPLETE SALES & SERVICE

Yaesu, Icom, ALinco, ADI, Hustler, Cushcraft

### WANTED

Fun, easy-to-build projects for publication in 73.

For more info, write to:

Joyce Sawtelle,  
73 Amateur Radio Today,  
70 Hancock Road  
Peterborough NH 03458.

Say You Saw it In 73!

**FAIR RADIO SALES**  
ELECTRONIC MILITARY SURPLUS

Capacitors - Motors - Relays - Power Supplies - Test Equipment

### 12 FOOT MAST KIT



12 foot Fiberglass Mast Kit 3/47"x 1 3/8" Dia fiberglass mast sections, 8" top mast section for two 28 inch dipole elements and 16 feet of RG-58 coax with BNC connectors, one guy ring with ropes, three 9" stainless steel stakes, one 27" long mast base which is pushed into the ground, and O.D. green carrying bag with handle. Excellent for field day or other portable antenna use. 12 lbs sh. #MK-12, \$59.50 each; 2 for \$99.50 plus shpg.

Radios - Antennas - Roller Inductors - Transformers - Wire - Tubes

### 30 Foot Mast Kit

30 Foot Mast Kit. Twelve AB-35 33" aluminum mast sections, AB-154 mast base, 6/ guy ropes, 2/ guy rings, 3/guy stakes, and a heavy duty nylon carrying bag various colors - sorry no choice. 32 lbs sh. All items listed above are in used condition except the mast sections and the bag which are unused. #ANT-KIT-30, \$145.00 plus shpg.

WEBSITE: [fairradio.com](http://fairradio.com)  
E-MAIL: [fairradio@fairradio.com](mailto:fairradio@fairradio.com)  
PHONE: 419-227-6573 - FAX: 419-227-1313  
2395 St Johns RD - Box 1105 Lima, OH 45802  
VISA, MASTERCARD, DISCOVER accepted  
Write for latest Catalog - Address Dept. 73

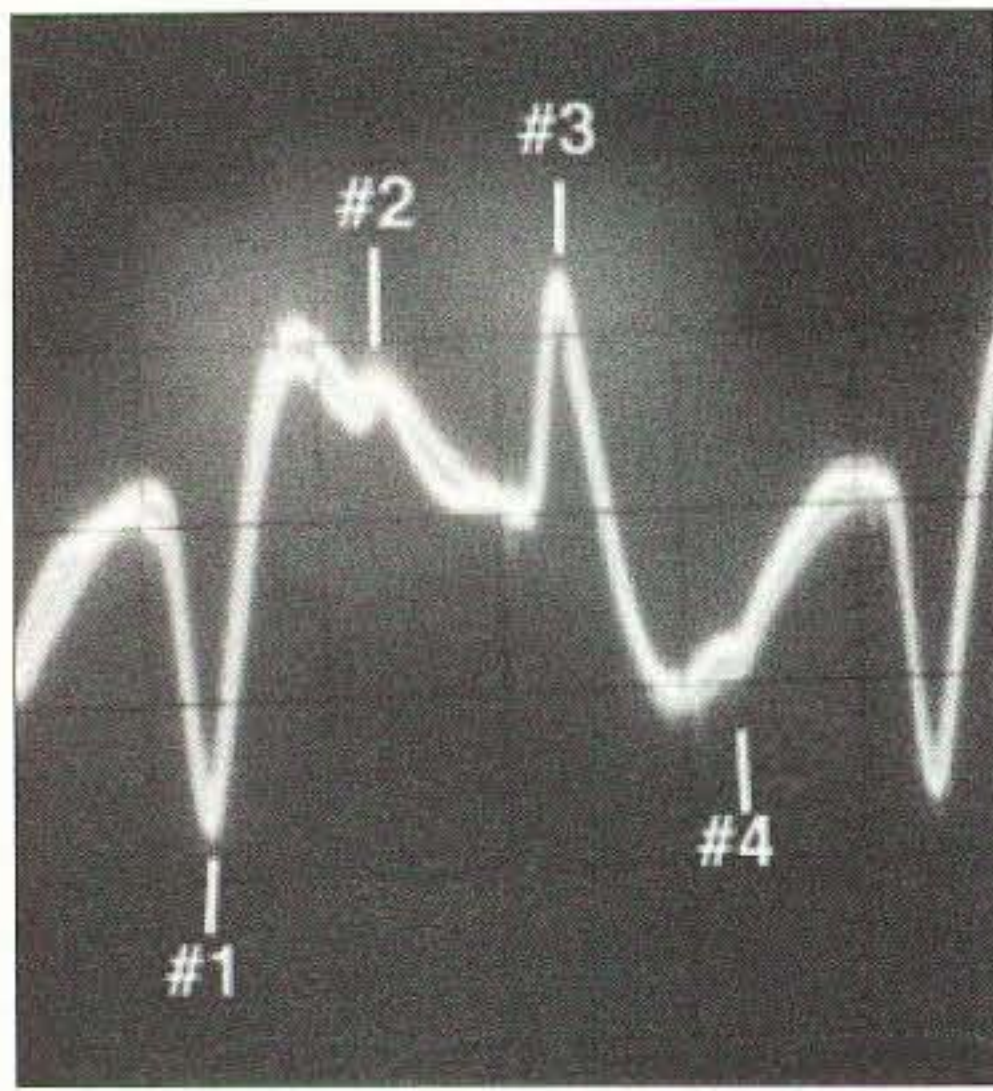


Fig. 2. Audio output waveform of a receiver with a typical four-whip Doppler set in operation.

the amplitude and frequency of the modulating waveform. In PM, the higher the modulating wave's amplitude and/or frequency, the greater the deviation.

A quick bit of history: In 1936, before phase-locked loops and other modern direct-FM producing techniques, it wasn't possible to achieve distortion-free high deviation in stable oscillators. So Edwin Armstrong

invented an indirect method of transmitting VHF-FM. A crystal oscillator was followed by a "serrasoid" phase modulator, and then by several doubler and tripler stages that also conveniently multiplied the deviation.

Armstrong's method directly varied the phase of the RF signal, which indirectly varied the frequency. By shaping the audio to be transmitted prior to applying it to the phase modulation stage (increasing the levels of low frequencies at a 6 dB per octave slope), his transmitter's output was indistinguishable from that of a direct-FM transmitter. Phase modulators with audio processing to achieve FM were standard for many years. These circuits were in the transmitter of the FM broadcast station that I tended in college and in the VHF/UHF business-band rigs that we converted to ham frequencies in those days.

If we increase the switching speed of a Doppler array, the phase changes and thus the voltage peaks in the discriminator output do indeed remain the same for each jump in a cycle of rotation. The induced PM level on the signal has not changed. But since we have increased the rotation frequency and hence increased the frequency of all tone components coming out of the discriminator, the equivalent FM signal being detected

does indeed have proportionally greater deviation. So the Doppler equation is indeed being followed, and we do have a true Doppler RDF set after all.

### How many whips?

No matter how many vertical elements in your Doppler array, the adjacent elements along the rotation circle must not be more than 1/2 free-space wavelength apart, to avoid ambiguous bearings due to phase steps of greater than 180 degrees. Furthermore, adjacent element spacings of greater than 1/4 wavelength will produce phase steps of more than 90 degrees, lowering the level of the recovered audio tone and worsening the signal-to-noise ratio. With that in mind, the optimum spacing for a four-whip "square" mobile array for VHF or UHF is slightly less than 1/4 wavelength on a side at the highest frequency to be used. For two meters, that is about 18 inches on a side.

Would eight elements be an improvement? It would reduce the harmonic content of the recovered Doppler tone, but that wouldn't be noticed with a good 2 Hz bandpass filter. More whips in the same size array would mean closer spacing and thus more RF coupling between them. That would be detrimental to performance in areas of high signal reflections, as we'll see in a future installment. So in practice, the difference in performance between four-whip and eight-whip Dopplers of the same array size usually isn't significant.

On the other hand, for a fixed installation such as your home rooftop where plenty of space is available, or for a car-top array at UHF or microwaves, the added complexity of more elements in a larger array allows you to improve performance by increasing the overall array size (aperture). Consider a two-meter eight-whip array in an octagon pattern of 18 inches per side (i.e., the same adjacent whip spacing as the typical four-whip Doppler). Radius of rotation is more than double that of the four-whip set, giving over 1 kHz Doppler tone deviation at the same rotation rate. The array aperture is more than doubled, which improves performance in multipath.

The downside is that this array has a diameter of almost 4-1/2 feet, so it won't fit on most vehicles. Furthermore, you would need 7-1/2 feet total diameter to provide ground plane under the whips. But a similar size (in wavelengths) array for the 70 cm band (440 MHz) would be only 2-1/2 feet diameter, which is practical.

A final caution: The equal spacing of

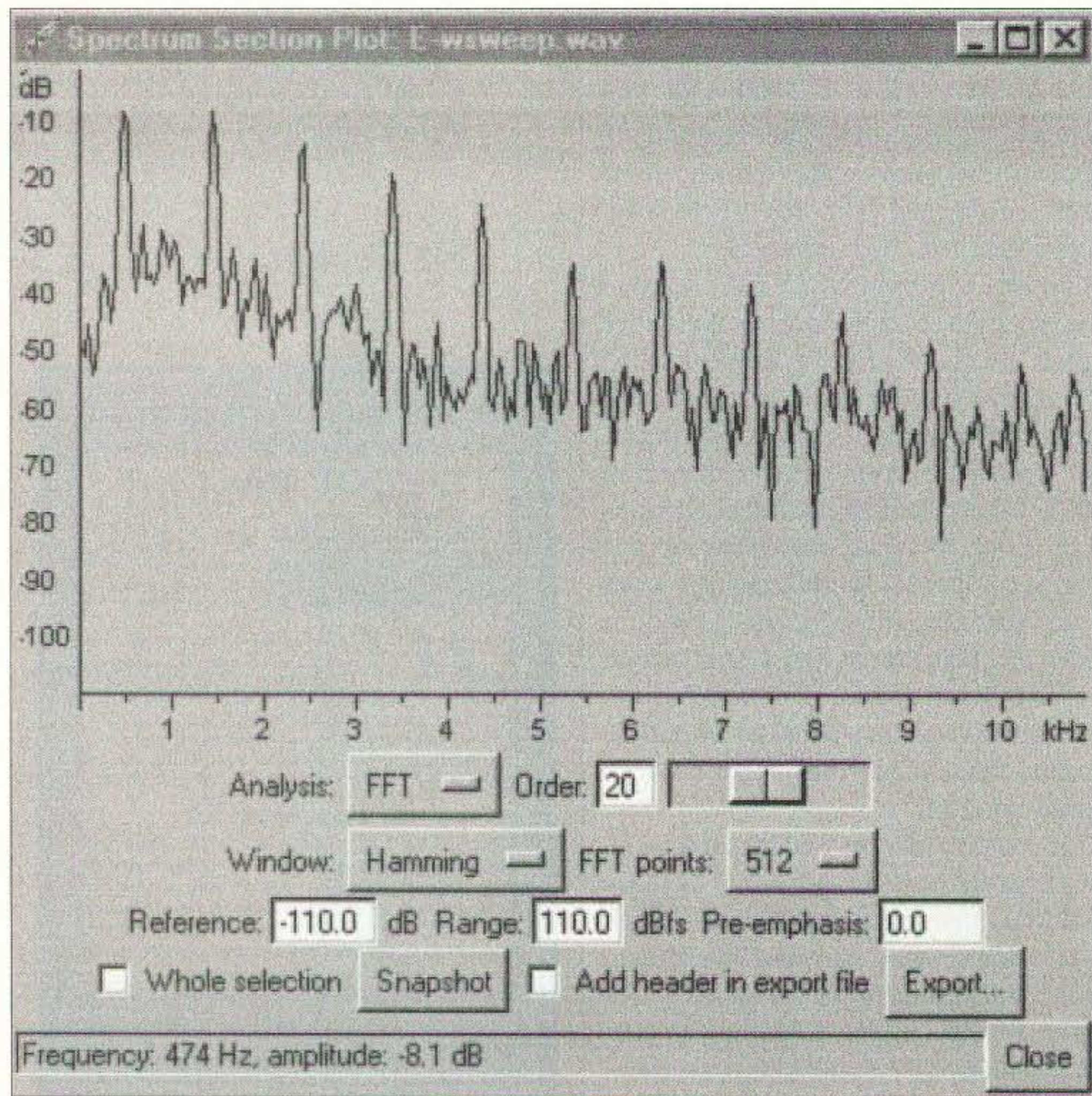


Fig. 3. Frequency components in the audio output of a typical four-whip Doppler.

## A New Definition for "Narrow": SSTV within MFSK!

*Advances in the digital art are surfacing rapidly. By the time you read this the narrowband SSTV described here will have been added upon to such a degree that this article will take on the appearance of a Stone Age review. But, you can always say you saw it here first.*

This is being written just after Christmas 2002. There are two reasons to mention the timing. First, there was an interesting Subject Line on the MixW message reflector where this new mode was introduced that announced, "Merry Christmas." It was well timed as a "gift" from Nick UT2UZ. The second is, as I mentioned, that the information in this article will be pretty much out of date in a very short few months.

To get right to the point, we now have a narrowband SSTV mode that is legal in the digital portions of the ham bands, at least as far as has been interpreted. The only clutter that will result is that there are going to be so many users, we will soon be standing in line for a turn to transmit. Well, that is an exaggeration I am sure, but I found it quite easy to initiate my first two contacts to experiment with the mode.

What is needed is the latest version of the MixW software, starting with the beta package MixW2.06xj, which was the release on Christmas Day. It has a cost, but it is the same as it ever has been, \$50 US. To explain, if you paid once, you have paid for all the updates with that one-time charge. One other quick point for those unaware: The noncrippled demo version can be had for a free download.

I have read complaints that JPEG files would not work and, as of this early usage, I had four JPEG files and four bitmap files and the only success was with the bitmap files. Someone offered the opinion that this was because of some system abnormality. The image shown in the screenshot here was claimed to be a JPEG. So there is somewhat of a learning curve as yet. We will have to watch and see how this plays out. There was an early rumor there would soon be a color version.

What is important is that it works.

Whatever bugs that surface will be dealt with as usual. The other interesting thing is the mode hit the streets and suddenly everyone seemed to know how to use it. The strange part about that is up until this writing and after using it myself, I have not seen any color-by-the-numbers for setting up for the mode.

That means the process is easy and intuitive. I got some hints from the reflector about a <PIC> macro and some suggestions about which was the best way to use it. Then I looked in the list of macro commands that come in the program and <PIC> wasn't listed. Of course I tried it anyway and it works.

I think everyone else who was fascinated by the idea followed similar steps. There was mention on the MixW reflector about approximate dimensions and that the images needed to be in black and white. Quite a few of us have graphics software to facilitate these conversions from regular digital images we have stored.

So, this was really easy. In my case, there was no outlay of cash to get into the MFSK picture-sending frenzy and have some fun. That is what I did. I realized after making the screenshot that my log demonstrated this to be my second venture into the mode. If you read it carefully, you will discover there were at least two days between those two contacts.

Some of the time was devoted to other real-time projects (somewhat related), and a portion of the delay was caused as I went through images and organized a few and assigned them to individual macro buttons. The result was to see what the difference was between the JPEG and the bitmap formats, and I could choose them on the fly. This did not cure all my clumsiness, but saves other operators from waiting for me to find images.

### I did it the Hard Way first

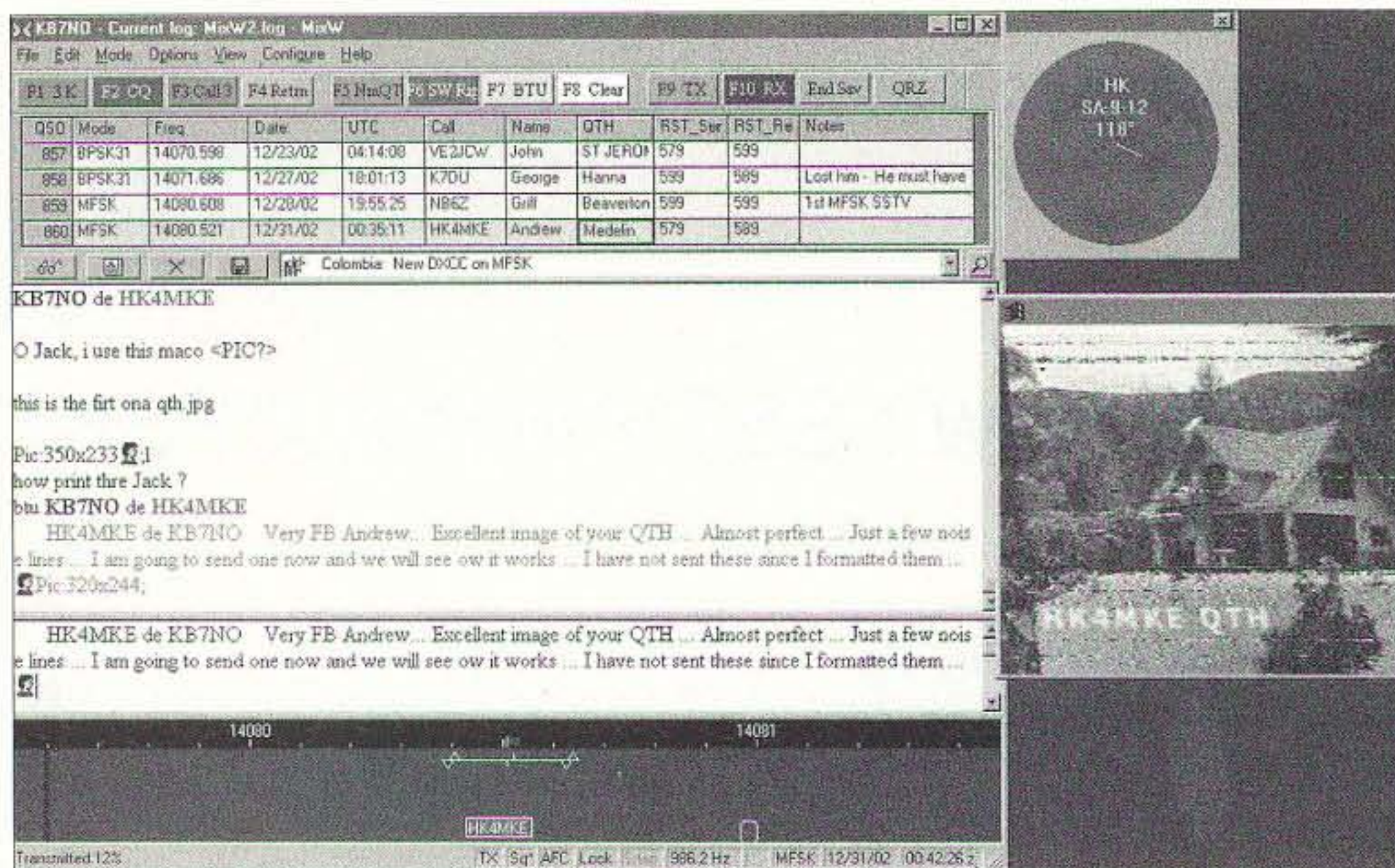
There are other issues, such as another way to use the <PIC> macro. I went with the straightforward method of writing a macro to fetch a specific file from a specific directory (folder). That is, I made a directory, C:\NarSSTVimag, with the doctored images residing within. So, the first macro I wrote was <PIC:\NarSSTVimag\V&TinCC.jpg>

You can see why I chose to write separate macros for each image (length — hard to do this on the fly). Incidentally, this macro is written correctly but would not transmit, but the macro in the button next to it is the same image in bitmap form, extender .bmp, and it flies just fine.

### I learned to "go with the flow"

In the end, at least at this writing (it keeps evolving as I write), the newest and easiest to use macro is <PIC?N>. With this macro in place, all you do is evoke it and the main MixW directory is displayed with only the graphics files. To be clear, this means you must store your images in the MixW directory (folder) to use this method. This allows you to click on any file and a thumbnail is displayed so you are sure of content; then double click and it is in place to transmit.

As this is being written, I checked and already someone had found the reason why the above JPEG file type would not transmit. It was a converted file using the Paint Shop Pro software to convert from color to gray scale which appears as black and white. The author of the fix I just found said he had discovered the working solution is to "decolorize" the pictures using the same program. He gave an explanation, but I will leave that to those who enjoy discussing technicalities.



**Fig. 1. NBSSTV over MFSK!** Some real fun with images where you never expected to use them. The frequency was at 14.080.5. The mode is MFSK, but the difference is the black and white image to the right of the screenshot — under the world map — was received using this mode. This was one of the first few QSOs I had in this mode and it was learning time, but it was working and with no real instructions. The method is fairly simple, see the text. Note the little icons in the text fields. These appear as you load an image and when it begins to transmit. At the time of this shot, I was sending an image. If you will look to the bottom left corner you will see the message, “Transmitted 12%.” It takes about the same amount of time to send an image in this mode as by regular SSTV. All you need is for both stations to have the same software, and there are plenty of hams in the action already at this writing. You won’t have a problem finding someone to try it out on. And if you do not already have a copy of MixW, the 15 day noncrippled download is free. When you try it, you are hooked!

Speaking of the learning curve, the users are the best source of information. During the QSO shown in the screenshot, Andrew sent back one of my images and I mentioned I had no idea how to save the image for return as he had. He explained simply all that was necessary was to click the little emblem in the upper left corner of the SSTV screen and follow the directions. From there it is automatically saved to the MixW file by default. Things a guy can learn if he will but ask.

In the regular SSTV software there are opportunities to save images in a similar and

usually automated manner. In this MixW method, you can gather images or not bother with them, your choice. The only real problem with saving them is remembering to delete them before sheer clutter sets in.

All in all, I must say this is the regular ham way to have fun. Spend a minimum of bucks, if any, and jump into the middle of the action. No one is upset if you blow a few transmissions. Other users will do their best to help you get it right the next time, hopefully before the end of the QSO.

### The other end of the SSTV spectrum

There is another new mode out that I have not as yet had the time to experience. I stuck in the little heading about the other end of the spectrum after having given the Narrowband SSTV a plug that included low cost. You are not to believe this next item is pricey by contrast. It is the idea of, believe this (it is difficult to think about), High Definition SSTV, and it is freeware.

Whew! That becomes a mind twister when you think of it in the terms of ham modes we are accustomed to using. If you want to see some truly great, about as flawless as you can imagine images, take a look

at [<http://home.att.net/~ronchap/hamhdtv/hdsstv1.htm>].

These images easily equal the quality of prints you see in the best slick magazines.

The software for this is, as stated, free for the download. I downloaded and installed this program. It can be found at the Web site where you download the SSTV-PAL and other such programs that you can link to from *The Chart* on my Web site. And there are others available from links to the above referenced URL. Even a Linux version is available. The only drawback I can read into the literature concerning this program is they say you should have a 2 GHz CPU for best results. Mine is a bit slower but when I find someone willing, I will make the test run. It is really worth a look and appears very simple to use.

### I got into too much of a rush

And speaking of SSTV, I mentioned last month that it looked like the creators of ChromaPIX, Silicon Pixels, had packed their tent. Just after that message got sent to the magazine, I received word from an alert reader there is a new Web site, which I edited into *The Chart*. So the link has been ready for some time before you read this and all is well. Another great software, often referred to as the benchmark for SSTV software, is still with us.

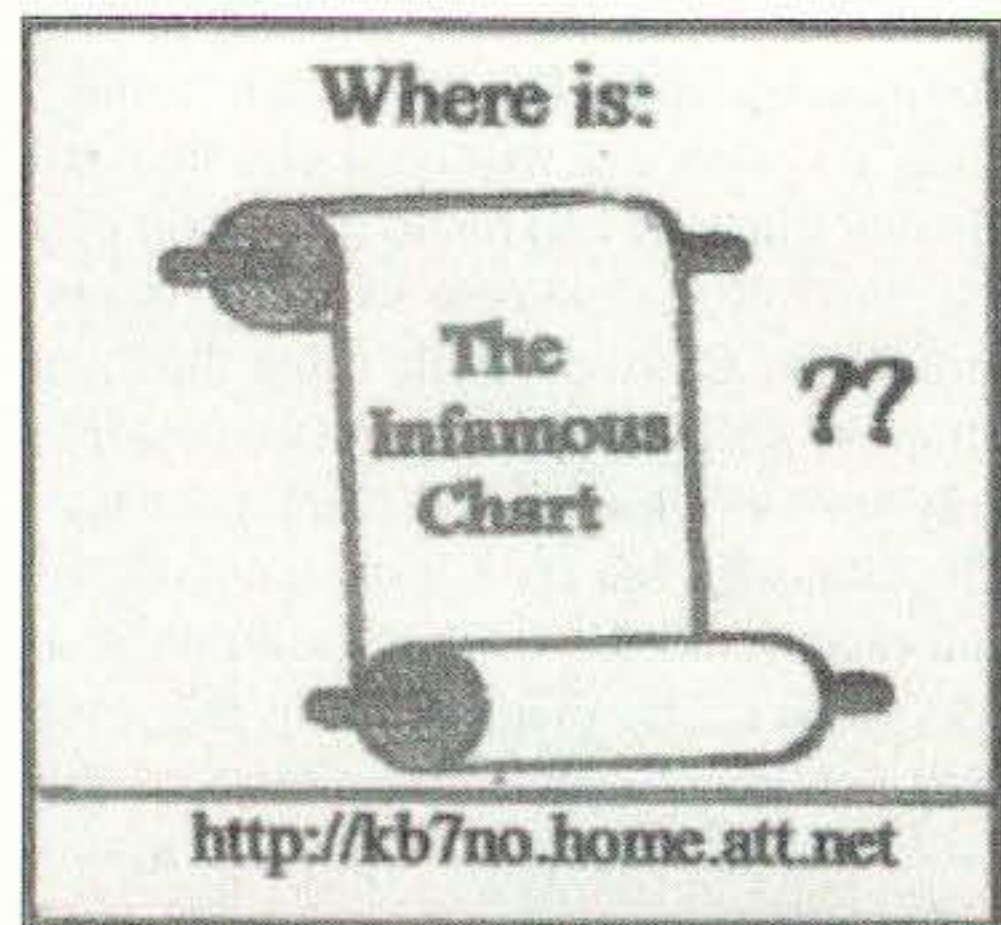
### The Linux Project

This one really stretches the imagination. I have been working, or reporting that I am working, at getting a Linux work station up and running with ham software in place. Been a rough go and many of you have been very sympathetic toward the cause. I have received a lot of encouragement and that is appreciated.

The latest is that it is getting closer to fruition. At long last, I put a page on my Web site about the Linux experience. It is not complete as yet because this thing is really testing my stick-to-it-ive-ness.

But the progress at this point in time is that I have successfully gotten all the ducks in a row as far as installing an “off-brand” (I think all Linux software is considered off-brand by those not involved) hamware named KPSK. A bit more configuring and it may just fly by the time the last of the snow is shoveled around these parts.

There have been some interesting learning opportunities as this adventure has unfolded. A lot of this centers on support for different operating systems. Linux can be tough to get all the square pegs in the assorted matching holes, but so can a lot of







Arkansas's Communication Store

1710 East Parkway  
Russellville, AR 72801  
Phone 479-967-8315  
Fax 479-967-8317  
1-888-315-7388

Kenwood, Icom, Alinco, ADI,  
Police & Fire Communications Equipment,  
Surveillance Electronics (Installed).  
We sell amateur & commercial band radios.

www.rlselectronics.com

the technology we see these days. Some of the marketers make quite a point of telling you about support, then when you call for help you are asked to ante up for each session. I have to be seriously desperate to succumb to this blood letting, but I go along on occasion.

As for the matter of the Lindows operating system, that turned out to be a definite pay-for-play adventure, and that is okay for some because that company appears to be providing what they charge for. I have no regrets. They were definitely part of my education in the Linux vein. I was glad that some other avenues were open that I have been following.

Currently, I am working with an early release of Red Hat, and a ham suggested I join the Red Hat Network. This is a freebie where updates are available for the download. Another education awaited me. They have this all set up to automatically probe the system that connects to them — yours or mine — and tell us what updates are available and provide the download. Once the files are in place the installation is extremely simple. Even for me.

I understand that the Mandrake package for Linux has a similar offering. So here are two major players in the Linux field offering automated support to help make these things run.

Alas, this does not solve all the little problems of getting everything sorted out, but there are also a lot of folks, in our case Linux using hams, who are very understanding of the problems that beset us when we attempt to make these crazy machines work. And that is another source.

Now, just a little side glance in defense of the folks at Microsoft. They do similar things. Many of you are aware of this. Recently, I had occasion to stop by their update area on the Internet to download a file I did not have, and found a number of updates not in this Win98se. So I downloaded the whole bunch of them, and when the files were downloaded the system automatically installed them for me. Pretty good. Lots of pros and cons to discuss there but it is

Continued on page 56

**A GREAT gift idea for yourself, your ham friend(s), or your child's school library**

is a subscription to 73 Magazine ... only \$24.97!

Call 800-274-7373 or write to 70 Hancock Rd., Peterborough NH 03458

# RIGrunner

## Intelligent DC power panel

- Conveniently power your station with Anderson PowerPole® connectors.
- 40 Amps total, outlets to run all of your transceivers and accessories.
- Each and every outlet individually ATC fused with LED open fuse indicators.
- Precision LED and audio alert of safe, over or undervoltage, 4012 & 4008.
- No messy binding posts, frayed wires, black tape or short circuits.
- Safe, secure, hot connect, polarized, color keyed, unisex, connector system.
- Conforms to the ARES, RACES, RSGB recommended standard.
- Perfect for home, mobile, rover, portable, emergency and contest stations.

**3 Models from  
\$49.95!**



# RIGblaster

## Have more fun with your radio

The only no compromise sound card interfaces.

The easiest to set up, high quality, complete solution.

The best support too!  
Read our user comments!

See our new **RIGblaster pro** elsewhere in this QST

**RIGblasters: Pro, Plus, M8 and Nomic**

<http://www.westmountainradio.com>

**West Mountain Radio** de N1ZZ and K1UHF

18 Sheehan Avenue, Norwalk, CT 06854 (203) 853 8080



## THE DIGITAL PORT

*continued from page 55*

definitely a service as good as any that we don't hear much about.

### A little in the form of editorializing

What I am saying is that there are some real advantages to getting a Linux system up and running. I feel I am a pretty frugal person when it comes to money spent on computers as I sit here with this machine that once cost over \$1,500. And if I were to update the operating system to the latest and greatest according to Microsoft, it would be faster but I would then have to buy new software to replace the stuff that is already working.

There is a bit more to the story. The previous machine ran with updates for about eight years before retirement and had somewhere between \$2,500 and \$3,000 dollars invested in original outlay and "improvements." This allows me to make a conservative estimate that I have spent in excess of \$4,500 in ten years to play the "keep up with the Jones'" computer game.

What is the point? This is a way better method to acquire income than when razor companies sold cheap razors that needed expensive blades replaced every couple of days. All that is necessary to get us to spend more on these Windows systems is to come up with irresistible games and toys that will only run on newer systems that require everything else to be replaced for more expense. That is why I have found a kind of ground zero with Win98se and attempt to make it do everything I want.

Now, the idea of the Linux workstation is to assemble a machine that never has an expensive major update. In the project I am working on, I have not as yet finished buying hardware because I am still dancing around the iffy getting-it-going phase. When I see the light at the end of the tunnel I will have to go for a decent monitor and a few small items, but I expect to get this thing all together doing almost every essential word processing, graphics, and ham-oriented procedure that I do with this Windows machine, with a total outlay of under \$700, and never need a major update! Quite a contrast.

The problem? Nothing about this system thus far has been plug-it-in-and-turn-it-on and start to use it. It is a slow tinkering process. Sometimes I really have negative thoughts about the folks who build all these little packages of software for the Linux system that don't seem to communicate with each other. And you know what? I don't think that bothers those folks. They seem

to say to us, "If you want the advantages of the system, you gotta learn to play our way."

To tell the truth, I don't mind that as much as it appears. What I want to do is get the ham community I can reach to take a look at this stuff. My real hope is that I can tell you a complete enough story so that you can bypass some of the problems I have encountered and get into this system and enjoy the advantages yourself.

That's it for this month. Keep those digital fires burning. 73, Jack, [KB7NO@att.net].

### Build Your DREAM Antenna

*continued from page 13*

plug or to an accessory outlet — watch the current maximums allowed here. They may be a lot lower than you expect, so read your owner's manual! Otherwise to run high power, run your power lines directly to the battery with fused lines. Be sure to run that second ground wire I mentioned earlier from the ground lug on the rig and use some sort of quick connect plugs to attach/detach to the ground wire for ease of removing the radio each day.

[By the way, if you own a 5-door vehicle and getting into the hatch is going to be an issue for you (I just don't use it), check out some of the sites I've listed for special mounts to handle this.]

As a last step, take a little time to arrange the cable neatly from the back of the vehicle all the way to the radio. Try to keep it out of tripping distance by tucking it under molding or carpet where possible. I've found that especially near the doors, it's easy to unscrew the molding, place the cable down and screw the molding back in place all in just minutes. It will save you a lot of aggravation later.

### Testing it out — swinging the beam

Find an empty parking lot somewhere — up on a hill if possible — and scan the band for a decent signal. It's important to know this, so listen up. This is a directional antenna. Try pointing the front end (diagonally opposite to the side you have the antenna mounted) toward the incoming signal. While the station is talking, slowly

turn the car away from the signal and then back again — you've got a mobile beam! When the signals are down, take advantage of this fact, it does help! I've logged many hours of fun with this type of antenna system and you can, too. It's a great DX antenna and you'll see the best results on those long hops.

Is this antenna system for everyone? Of course not! But for me, it's a "DREAM" come true!

### Special swivel antenna mount pages

[[www.firestik.com/Catalog/MK-SB18.htm](http://www.firestik.com/Catalog/MK-SB18.htm)]

[[www.firestik.com/Catalog/dvsb.htm](http://www.firestik.com/Catalog/dvsb.htm)]

[[www.alfenterprises.com/mobile1.htm](http://www.alfenterprises.com/mobile1.htm)]

[[www.shakespeare-marine.com/antennas/mounts/swivel-81-s.htm](http://www.shakespeare-marine.com/antennas/mounts/swivel-81-s.htm)]

[[www.soft.donbass.com/igor/YACHTA1/shakespeare\\_mounts.htm](http://www.soft.donbass.com/igor/YACHTA1/shakespeare_mounts.htm)] **73**

### Junkbox Telephone Recording Adapter

*continued from page 22*

because of the variety of pinouts of the salvaged components. P1 and P2 are each connected to the perfboard using about 1 foot of twisted pair wire each.

Twisted pair wire can easily be made with a variable speed drill. Simply put the ends of the two wires in the drill chuck and tighten. Hold the other end of the wires taught while running the drill at a slow speed. Turn the wires until the pair has about two turns per inch. Remove the wires from the chuck, trim, strip, and tin the ends.

The J2 ring connection (-) is connected to ground with a 6 inch piece of wire. The J2 tip (+) connection is wired to one side of switch S1. The other side of S1 is connected to the IN terminal of voltage regulator U1. Refer to **Fig. 2d** for U1's pinout. I will leave it up to you to be able to mount the Telephone Recording Adapter assembly into a suitable enclosure.

### Testing

Plug in the 9 VDC wall transformer.

Insert the wall transformer plug into J2. Turn on S1. The green LED (D8) should glow. The yellow LED (D7) should also glow, indicating an input voltage at J1 of less than 24 volts. If D7 and D8 are not on, check for proper installation of these LEDs. Measure continuity at P1, tip to ring. The reading should be a short circuit. Next, plug the phone line into J1. With all of the phones on the line "on-hook," the yellow LED should be off. If this is not the case, check for proper installation of D1 through D5.

## Use

Obtain a tape recorder with "MIC" and "REMOTE" inputs. The MIC input is a 1/8 inch (3.5mm) jack, while the REMOTE input is a 3/32 inch (2.5mm) jack. Plug the power cord of the recorder into the wall and insert a blank tape (it should be rewound completely) into the machine.

Make sure the 9 VDC transformer is plugged into the wall and its output connected to J2. Verify that S1 is off. Ensure that J1 is connected to the phone line. Next, plug P2 into the MIC input and plug P1 into the REMOTE input of the tape recorder. Put the tape recorder in the RECORD mode (this is usually accomplished by pressing the PLAY and RECORD buttons simultaneously).

Then, turn on S1. The green LED should glow. The yellow LED will glow if any telephone on the line is "off-hook." When the yellow LED is on, the phone conversation is being recorded. As mentioned earlier, turn off S1 to disable the Telephone Recording Adapter. 73

## Meter Made

*continued from page 25*

the voltage and current in an adjustable power supply. **Fig. 5** shows a 12-volt, 5-amp circuit diagram built around an LM317T adjustable regulator IC. A PNP "wraparound" power transistor increased the current capability from 1.5 amps for the LM317T to 5 amps. The voltage is adjustable from 11.5 to 14.5 volts. This is the

range of voltages normally seen in equipment powered by an automobile electrical system.

The voltmeter uses the expanded-scale circuit of **Fig. 4** with expanded-scale markings on the face. The ammeter uses the circuit of **Fig. 3** and is placed in the input of the regulator circuit. This placement eliminates the effect of any voltage drop across the meter shunt resistor from affecting the output voltage. With this placement, current drawn by the regulator circuit itself is included in the meter reading. However, the regulator circuit draws less than 5 mA, a negligible amount on a 5-amp meter scale.

## Other uses

There are many other uses for recycled meters. An SWR bridge requires two meters. If purchased new, the cost would be prohibitive. With recycled meters, the cost is zero! Recycled meters can also be used in a dipper instrument, or as an S-meter in a home-built receiver. Other test instruments are described in the new book *Test Equipment* by Guido Silva I2EO, which is available from Barnes and Noble and also from Amazon on the World Wide Web [[www.amazon.com](http://www.amazon.com)].

## Drawing the new meter scales

New meter scales are best drawn on bright white paper with black ink. If the original meter needle is white, you can make it black with a black felt-tip marker. Those with artistic talent can envision many other possibilities. I used a pen plotter to draw the scales for the meters on the 12-volt power supply as seen in the photos.

I hope to see many projects described in this journal using recycled meters. It's great fun to build your own instruments and gear. 73

## All About Electronics Frustration

*continued from page 37*

level, the detector became alive and the FM radio played in a manner that appeared to be normal. Of course, after

dropping the power, then restoring it, the FM radio was DEAD again. Repeating the signal generator injection again worked, but only periodically. During the time the FM portion was working, the AM portion worked as well. OK, where do I go from here? The problem appeared to be around IC2 — was the chip good or bad? And, if it was bad, what then?

So how do I proceed to troubleshoot a chip that has no published available data? The first step during this part of the process was to examine the board under a magnifying glass to see if any bad solder joints or broken traces were visible. As you might expect, everything looked good and no obvious problems were detected.

Studying the schematic regarding the part surrounding and connecting to IC2 suggested that checking the parts should be the next logical step. Each capacitor and resistor was removed individually from the board, checked, and then returned. No problem was found. The next thought I entertained was that perhaps one of the IC pins wasn't properly soldered even though it passed a visual inspection. Each pin of IC2 was resoldered, but that process failed to repair the problem.

What fixed the problem? Even though the IC pins appeared to be soldered, I had to assume that there was a hairline crack in the circuit trace connected to one of the IC pins. Though each trace appeared to be OK by visual inspection, I chose to clean off the solder mask on a small section of the trace adjacent to each pin of IC2. Each trace section was then chased with solder that functioned as a bridge. Obviously this had to be the cure because the radio, with power applied, operated as expected. Even varying the supply voltage from 1.5 to 3.2 volts failed to disrupt the normal operation — absolutely unlike previous tests. With the radio now operating, more data was desired for future reference. A voltage chart for each IC pin was developed and is shown in **Table 1**.

## Conclusion

For a "simple AM/FM broadcast radio," this Panasonic is sure packed

with a lot of electronic features for its physical size. As a result it was far more complex to troubleshoot than anticipated from looking at the exterior of the box.

You will always ask the question "Should I tackle this repair task?" when the neighbor approaches with a project in hand. Although the AM/FM BC radio isn't ham-related, the electronic portion and the troubleshooting techniques involved certainly relate directly to any ham-related piece of equipment. Learning the skills for troubleshooting problems can pay off in the long run. So why not practice on the neighbors' simpler equipment before tackling a ham rig? 73

## Travels with Henryk — Part 10

*continued from page 39*

Lithuania, I could see that the spirit of homebrewing is still high there (**Photo E**). Ricardas is not very active from his

apartment due to limited living space and antenna restrictions. So he spends quite some time at the club station which has the callsign of LY2ZO. There is more space ... and provisions for running more power (**Photo F**). These Russian power tubes can deliver much more than the official limit of 200 watts!

The LY2ZO club is probably the most successful contest club in this part of Europe. This is a result of many years of improving the skills, antennas, and equipment. The man behind this achievement is Algis LY2NK (**Photo G**). He has spent the last 40 years, against all odds, building antennas and equipment, encouraging others, going on contest expeditions, winning contests, and so on. His efforts have been recognized internationally, and Algis LY2NK was elected to the Contest Hall Of Fame, Number 37. The contest station of LY2ZO club is out of town, with separate operating positions for each band (**Photo H**) and an impressive homegrown antenna farm. More pictures can be seen at the club's Web site. For contest purposes, the club usually uses its shorter contest callsign, LY7A.

I have often wondered why in some places, without technological tradition and appropriate industrial infrastructure, amateur radio activity is high. What is driving people to devote so much time and energy, overcome obstacles, deploy and develop ingenuity, all not for profit? Maybe this is the elementary essence of our hobby — to learn and improve the skills, go forward. The more difficult it is, the more fun and satisfaction it gives. Lithuanian radio clubs, and there are many more of them than these two that I visited, can serve as evidence of my point. 73

## Front and Center

*continued from page 41*

white paper is less expensive than using colored paper. I use the colored paper for the background. My printer, an inexpensive inkjet type, doesn't "fill" background well, and I like the total color of the colored paper. Having

made a final copy on the chosen colored paper stock, it's time to adhere the print to the face plate. Using contact cement, coat the face plate evenly using a soft brush or foam applicator. Now carefully place the print on the prepared plate. Ensure that the holes line up, the lettering and designs aren't beyond the ends of the plate. It sometimes helps to hold the plate with the paper attached up to the light, to be better able to see where the placement is. Be careful not to have excess cement find its way to the surface of the paper. It will be impossible to remove and will be a "blemish" on your work. Once you're satisfied with the placement of the print, and the cement has had time to cure, use "Krystal-clear" wide transparent adhesive tape (*misspelled, but that's what it says on the roll*) to coat the surface of the panel. Using clear tape provides protection for the paper from absorbing oils from fingers, and a measure of resistance to wear.

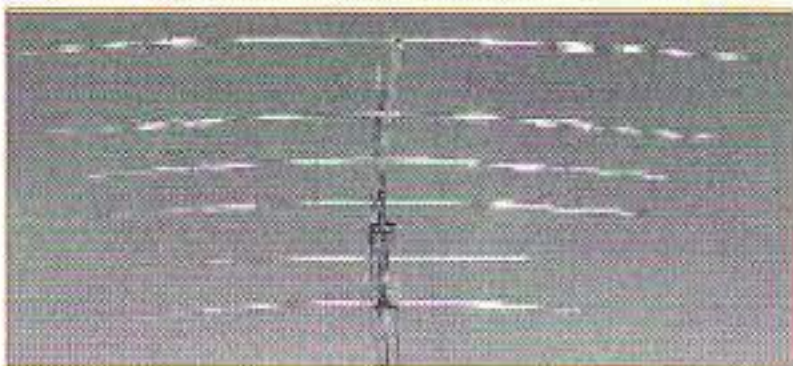
Now that the print is adhered to the surface, has a layer of clear tape protecting it, and you're happy with the results, it's time to remove the excess paper from around the borders of the panel. Using a razor knife or single-edged razor blade, trim the excess from the panel. Use the edges of the panel as a guide, being careful to cut only the paper and tape and not your fingers! The edge of the panel provides a solid rest for the blade, enabling it to produce a clean, sharp cut. If you began with ten fingers and have ten remaining, then the operation was a success!

The key to this project is "learning what's already in your word processing program." Panels that are attractive and distinctive and personalize the project you've worked on are easy to create in "Word." **Photos A and B** are of a 5.25 MHz to 5.4 MHz receiver project I've been working on. The case of the project was a "left over" computer item. The panel slips into slots and the top snaps over it all to keep it together.

Play a little bit! (*They ... call it playing, but we can call it "designing."*) You've nothing to lose but some time and paper. Who knows, you may even be delighted with the results! 73

**M<sup>2</sup>**

**EXTRA, EXTRA!  
M2 BUILDS  
TRIBANDER**



The tried and true KT34 series antennas have been made better using the latest computer modeling and mechanical design techniques to provide you with the best tribander performer available today. Just take a look!

**INCREASED FRONT TO BACK  
INCREASED GAIN  
MECHANICALLY SUPERIOR  
ELECTRICALLY SUPERIOR  
LOWER WIND LOAD THAN COMPETITORS  
LESS WEIGHT THAN COMPETITORS  
RATED AT 100 MPH WIND SURVIVAL  
AND OF COURSE, NO POP RIVETS**

Contact us for our new catalog of  
**ALL the goodies!!**  
Can't wait? Visit our Website  
@m2inc.com



4402 N. Selland, Fresno, CA 93722  
559-432-8873 Fax 559-432-3059  
E-Mail: wyatt@m2inc.com  
Website: www.m2inc.com



## CALENDAR EVENTS

continued from page 44

computers, software, peripherals, hardware, amateur radios, and components of all kinds. There will also be flea market tables selling used equipment in any of the areas listed, and more that would attract the electronics hobby enthusiast. Friday evening setup details will be sent with table registration. Admission is \$6 in advance or \$8 at the door, with people 15-years-old and under admitted free. Advance discount tickets are available at Amateur & Antique Radio Consignment Center, Pavek Museum, and Radio City. For further info call 763-537-1722, or visit [<http://www.køltc.org>]. Send E-mail to [[køltc@visi.com](mailto:køltc@visi.com)]. **Advance prices:** All electricity paid in advance is \$15 extra, charged once per vendor. 8 ft. swap table \$25 each. Table in Club Corral \$15 each. Commercial booth \$125 each. VE exams registration required. NO walk-ins. For info, contact *Denny Ackerman* by E-mail at [[kbøoqq@arrl.net](mailto:kbøoqq@arrl.net)], or call 651-769-0358. VE fee is \$12. Please plan ahead and bring copies of all your documentation. The site is handicap accessible. Send a check payable to RARC (no cash please) and mail by March 15th to *Robbinsdale Amateur Radio Club, P.O. Box 22613, Robbinsdale MN 55422*. You must include a legal size SASE. Requests received without an SASE, or after March 15th, will be held for pickup at "Will Call." **After March 15th**, swap tables are \$35 (add \$30 for electricity) subject to availability. Club tables \$18. Commercial booth \$135, electricity \$30 extra. Swap table confirmation will be mailed after March 8th.

### LATE MARCH

**ST. LOUIS COUNTY, MO, AREA** Severe weather "SKYWARN" training is being scheduled. Volunteer observers are sought in the St. Louis County area. There is no cost for the training and it is offered numerous times during the month of March to accommodate as many trainees as possible. Reservations are not required. There is ample space and parking is free. Participants from out of the area are also welcomed. The training is being sponsored by the St. Louis County SKYWARN Program. Level 1 (basic) and Level 2 (advanced) training is being offered, as well as a Severe Weather Safety & Preparedness Class, and a Disaster Damage Assessment Class. For those wishing to become amateur radio operators, an eight week class is offered beginning in late March. For the schedule of events, call 314-615-7857, or check the Internet at [<http://www.stlouisco-skywarn.org/>] or [<http://dlw.hispeed.com/sabre/Skywarn.html>]. If you are in the local area, please check into the monthly SKYWARN net on the first Thursday of each month at 7 p.m. on the 146.940 rptr. For more info contact *Michael Redman* at 314-615-5362 or at [[Mredman@stlouisco.com](mailto:Mredman@stlouisco.com)].

### APR 13

**STOUGHTON, WI** The Madison Area Repeater Assoc. will host the Madison Swapfest on Sunday, April 13th, at Mandt Community Center, Stoughton Junior Fair Grounds, on South Fourth St. Doors open at 8 a.m. Talk-in on 147.15. For more info contact *Madison Area Repeater Assoc., P.O. Box 8890, Madison WI 53708-8890*. Phone 608-245-8890. For fast access to more info, check the Web site at [<http://www.qsl.net/mara/>].

### APR 27

**GALVA, IL** The 4th annual W9YPS/AA9RO Hamfest will be hosted by the Area Amateur Radio Operators Club, 8 a.m. to 1 p.m. at the Galva IL National Guard Armory on 150 Morgan Rd. Advance 3-stub tickets \$5, 1-stub tickets \$7 at the door. 6 ft. tables \$10. Reserved tables not paid for by April 15th may be reassigned. Breakfast and lunch will be available. Talk-in on 145.490 - 88.5 PL. There is a large outdoor flea market area with handicap parking and the building is handicap accessible. Some electricity is available, first come first served. Bring your own extension cords. Please contact [[wd9hcf@arrl.net](mailto:wd9hcf@arrl.net)] for details about VE exams. For more info contact *Mat Bullock W9SIX, 419 College St., Kewanee IL 61443, [mailto:mbullock@theramp.net]*; *Phil Imes WD9IRE, 908 Zang Ave., Kewanee IL 61443, [mailto:kewphil@cin.net]*; or *Bill Anderson WA9BA, 920 W Division St., Galva IL 61434, [mailto:wa9ba@arrl.net]*.

### SEP 25-28

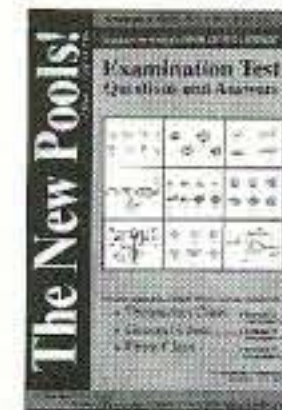
**SEATTLE WA** Microwave Update 2003 organizers and the Pacific Northwest VHF Society are joining forces to host a joint conference in the Seattle WA area on September 25-28, 2003. Registrations for the joint conference will be accepted beginning April 1st. Cost of the registration will be \$40 prior to September 12th, and covers all three days. Single day or single event registrations are not available. Late registrations, including at the door, will be \$50. Registration forms can be downloaded at [[www.microwaveupdate.org](http://www.microwaveupdate.org)] or send an SASE to *John Price N7MWV, 12026 81st Ave. NE, Kirkland WA 98034*, and a form will be mailed to you. Completed registration forms and payment should be sent to the same address. Make checks payable to *Microwave Update 2003*. Joint conference sessions and the Saturday evening banquet will be held at the Everett Holiday Inn and Conference Center, a short drive north of downtown Seattle. Special rates have been arranged with the hotel for conference participants. Rooms are \$69 per night plus tax, a real bargain for the Seattle area! It is suggested that early reservations be made directly with the hotel at 425-337-2900. Be sure to mention "Microwave Update" to get this rate.

Continued on page 61

## The New Pools!

Examination Test  
Questions & Answers

The exact questions, multiple choices and answers for the Technician Class, General Class, and Extra Class operator's license.



Only  
\$9.95  
Plus \$3.50 S&H

Omega Sales

P.O. Box 376  
Jaffrey, NH 03452  
800-467-7237

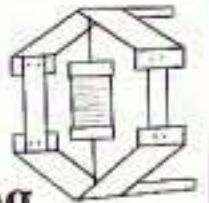


## LOW PROFILE HF ANTENNAS

NO Radials • No Motors • MORE ANTENNA than just a Coil & Whip



**ISOTRON**  
BILAL COMPANY



Call for a FREE Catalog

2003 is our 23rd year in business!  
2003 is our 23rd year in business!  
719-687-0650 \$368.85  
137 Manchester Dr. 80, 40, 20, 15 & 10  
Florissant, CO 60 inches tall &  
81816 32 inches across

[www.rayfield.net/isotron](http://www.rayfield.net/isotron)

### 73 Ad Sales

Call  
1-800-677-8838

**HamCall™ CD-ROM**  
U.S. & International - Over 1.63 million listings



We make a new HamCall every month! Clearly, the most current and complete CD-ROM available.

#### Latest Features

- Choose font and color of data display.
- Displays flag and map for each country.
- Shows CQ, ITU zone, and continent.
- History list shows each callsign entered. Print labels in a variety of formats.
- View & search interests of 39,000 hams.
- Search for club, military, vanity, silent keys, name, address, and more.

Over 1,631,000 U.S. and International listings, 128,000 e-mail addresses, 4,000 photos and QSL cards, 37,000 vanity calls, and 20,000 references to QSL managers.

Shows path distance & bearing.  
Precise latitude/longitude for over 90% of addresses.  
HamCall is \$50.00, included is 6 months free access to our HamCall Internet Service - request when ordering.

HamCall Mousepad, with morse code reference, 7.5" x 8", blue with yellow letters. \$5.00 + \$3 shipping.

\$5.00 shipping (\$8 Intl) per order. Your satisfaction guaranteed!



**BUCKMASTER**

6196 Jefferson Highway • Mineral, VA 23117 USA  
e-mail: [info@buck.com](mailto:info@buck.com)  
540-894-5777 • 800-282-5628 • 540-894-9141 (fax)



## The Good, the Bad, ...

*The first half of March should bring a welcome improvement in DXing conditions, something that we haven't experienced in a while. However, the latter half of the month will be rocky, with a particularly poor stretch from the 14th to the 24th.*

Look for a major flare or large CME around the equinox, followed within a day or so (if Earth-directed) by a strong geomagnetic storm. Good propagation will not return again until early April, but by then we should have a long stretch of decent conditions to look forward to.

This month marks the 100th anniversary of the first transatlantic daily "sked." On the 20th of March 1903, in concert with the London Times, Guglielmo Marconi established the first transatlantic news service between Glace Bay in Nova Scotia, Canada, and Poldhu in Cornwall, England. This ambitious project came only two and a half months after the first successful transatlantic radio message was transmitted, and just nine years after Marconi began experimenting with "wireless" telegraphy.

That first "commercial" broadcast station on Cape Breton was impressive, even by modern standards. The antenna array included four 200-foot wooden towers supporting miles of copper cables that covered approximately 500 acres. The crude "spark" transmitter was relatively powerful at 75 kilowatts, and the entire station was powered by its own coal-burning generating plant! In addition to the transmitter "shack," there was a home for the station manager and his family, plus several outbuildings to house various pieces of equipment. In size at least, Marconi's station was something any dyed-in-the-wool ham could fantasize about.

Unfortunately, Marconi's early attempt at establishing a regular international broadcast schedule was short-lived. Only three weeks later, on April 6, an ice storm brought down the huge antenna array. Although it was rebuilt, this event and other technical difficulties

March 2003						
SUN	MON	TUE	WED	THU	FRI	SAT
						1 F-P
2 F	3 G	4 F-G	5 F-G	6 F-G	7 G	8 G
9 F-G	10 F	11 F-G	12 G	13 G	14 F-P	15 P
16 F	17 F-P	18 P	19 F-P	20 F-P	21 P	22 VP
23 F-P	24 F-P	25 F	26 F-P	27 F	28 F	29 F-G
30 F-P	31 F-P					

EASTERN UNITED STATES TO:												
GMT:	00	02	04	06	08	10	12	14	16	18	20	22
Central America	(15) 20	(15) 20	20 (40)	x	x	x	(10)	(10)	(10-15)	10 (17)	10-15	12-20
South America	(17) 20	20 (40)	20 (40)	(20-40)	x	x	x	(10)	(10)	(10-15)	10-15	10 (20)
Western Europe	(20-40)	(30-40)	(30-40)	(40)	x	x	(15-20)	(10-20)	(10) 17	15-20	(15) 20	(20)
Southern Africa	(17) 20	(20-40)	(20)	(20)	x	x	x	x	(10)	10 (15)	12 (17)	(15-20)
Eastern Europe	x	(30-40)	(20-40)	(17-20)	(20)	x	x	(10-15)	(15)	(17-20)	(20)	(20)
Middle East	x	(20)	20	(20-40)	(40)	x	x	x	(10-15)	15	(17-20)	(20)
India/Pakistan	(17-20)	x	x	x	x	x	x	(15-17)	x	x	x	x
Far East/Japan	(17-20)	(20)	x	x	x	x	x	x	x	x	x	(15)
Southeast Asia	(17-20)	x	x	x	x	x	(17-20)	(10-15)	x	x	x	x
Australia	(15)	(17-20)	x	x	x	x	(20-40)	(20)	(10)	x	x	x
Alaska	(15) 20	(20)	(20-30)	(30-40)	(40)	x	x	x	(15-20)	(10-20)	(10) 17	15-20
Hawaii	(15) 20	20	(20-40)	(20-40)	(40)	x	x	x	(15-20)	(10-20)	(10-20)	15-20
Western USA	15-20	20 (40)	20 (40)	(20) 40	(30-40)	x	x	(10-20)	10 (20)	10 (20)	10 (20)	(15) 20

CENTRAL UNITED STATES TO:												
GMT:	00	02	04	06	08	10	12	14	16	18	20	22
Central America	(15-20)	20 (40)	20-40	20-40	(20-40)	x	(10-20)	10-20	10-20	10 (20)	10 (20)	10-20
South America	(15) 20	17-30	20 (40)	20 (40)	x	x	x	(10-20)	10 (20)	10 (15)	(10-20)	12 (20)
Western Europe	(20)	(40)	(40)	x	x	x	x	(15)	(15-17)	(15-20)	(17-20)	(20)
Southern Africa	20	(20)	(20)	(20)	x	x	x	x	(10)	(10-15)	(10-17)	(15-20)
Eastern Europe	(20)	(20)	x	x	x	x	x	(15)	(15-17)	(17-20)	(20)	(20)
Middle East	x	x	x	x	x	x	x	x	(15)	(15)	(20)	(20)
India/Pakistan	(17-20)	(15-20)	x	x	x	x	x	(15-20)	x	x	x	x
Far East/Japan	(17-20)	(20)	x	x	x	x	x	x	x	x	x	(15)
Southeast Asia	(15-20)	x	x	x	x	x	x	(20)	(10-20)	x	x	x
Australia	(15-20)	(20)	x	x	x	x	x	(15-20)	(15-20)	15	15	15 (20)
Alaska	15-20	(15) 20	20	20 (30)	(30-40)	(40)	x	x	x	(10-20)	10-20	10 (20)
Hawaii	15-20	(15) 20	20 (40)	(30-40)	(40)	x	x	x	x	(10) 12	10-15	(10) 17

WESTERN UNITED STATES TO:												
GMT:	00	02	04	06	08	10	12	14	16	18	20	22
Central America	10-20	15-20	15-30	(14) 40	20-40	(30-40)	x	(15-20)	10 (20)	10 (20)	10 (20)	10 (20)
South America	(10) 20	(15) 20	20 (40)	20 (40)	x	x	x	(10-20)	10 (20)	(10-15)	10 (15)	10 (20)
Western Europe	x	x	x	x	x	x	x	x	(15-17)	(15-17)	(17-20)	(17-20)
Southern Africa	(20)	(20)	(20)	(20)	(20)	x	x	x	x	(10-12)	(12) 17	(15-20)
Eastern Europe	x	x	x	(17-20)	(17-20)	x	x	(15)	(15)	(15-17)	(17-20)	(20)
Middle East	x	(20)	(20)	x	x	x	x	x	(15-17)	(20)	(20)	(20)
India/Pakistan	x	(17-20)	x	x	x	x	x	x	(15-17)	x	x	x
Far East/Japan	10-20	(20)	x	x	x	(40)	(40)	x	x	x	x	(10-20)
Southeast Asia	(10-15)	(10-15)	x	x	x	x	x	x	x	(15-20)	(15-20)	(10-15)
Australia	(10-15)	(15)	(17-20)	x	x	x	x	x	(15) 20	(15-20)	(15)	(10)
Alaska	(10) 20	(15) 20	20 (40)	(20) 40	(30-40)	(40)	(40)	(40)	x	(10-15)	10-15	10-20
Hawaii	(15) 20	20	(20-40)	(20) 40	(30-40)	(40)	(40)	x	x	x	(10-20)	(10) 20
Eastern USA	15-20	20 (40)	20 (40)	(20) 40	(30-40)	x	x	(10-20)	10 (20)	10 (20)	10 (20)	(15) 20

**Table 1.** Band, time, country chart. Plain numerals indicate bands which should be workable on Fair to Good (F-G) and Good (G) days. Numbers in parentheses indicate bands usually workable on Good (G) days only. Dual numbers indicate that the intervening bands should also be usable. When one number appears in parentheses, that end of the range will probably be open on Good (G) days only.

brought an end to the first commercial radio venture. Another six years elapsed before daily transatlantic radio communication became a reality.

In retrospect, it is amazing that Marconi met any success at all. Those early messages often took hours to complete successfully and had to be repeated many times. Reception was extremely variable, and although Marconi had at least discovered that his transatlantic transmissions worked better at night, the reason why was not understood. Solar effects were also unappreciated at the time, and to make matters worse, those first transatlantic broadcasts took place during the sunspot minimum at the end of Cycle 13. So, if you find yourself grumbling about propagation conditions later this month, think back on the incredible patience and tenacity of our first "DXer," and perhaps you will be inspired to hang in there.

### Band-by-Band Forecast

#### 10-12 meters

Good openings into Europe should be available before noon, and into Africa or the South Pacific after noon. The strongest "pipelines" will be to Central and South America from shortly after noon through early evening. Daytime short-skip will range from 1,000 to approximately 2,300 miles.

#### 15-17 meters

Excellent worldwide propagation will be available to most areas of the globe from sunrise through mid-evening. Europe will open before noon and the rest of the world will be workable after noon. South America and Australasia may stay open until midnight during the best periods. Short-skip will average from 1,000 to 2,200 miles.

#### 20 meters

Expect excellent daytime propagation but only fair conditions after dark. All areas of the globe should be workable on Good (G) days with peak periods coming for about two hours after sunrise and another few hours in the late afternoon or early evening. Europe should be particularly good from the eastern U.S. and the South Pacific, and Australia will offer excellent openings to operators in the western U.S. Short-skip can fluctuate between 500 and 2,300 miles.

#### 30-40 meters

Good to excellent worldwide opportunities should be available from sunset to sunrise

despite rising atmospheric static. The Caribbean, Central America, and the northern half of South America will be particularly good, with New Zealand and Australia offering other decent opportunities. Short-skip at night will range from 500 to 2,500 miles but will be under 1,000 miles during the day.

#### 80-160 meters

Fairly good worldwide DXing should be available from sunset through sunrise, but will be limited by atmospheric static. 80 meters will be substantially better than 160 except during the very quietest periods. Daytime skip will be very short — under 250 miles — but nighttime short-skip can range from 1,000 to 2,000 miles. 73

### CALENDAR EVENTS

*continued from page 59*

Reservations must be made by August 21st for this rate.

"White papers" are currently being solicited from potential authors and speakers for publication in the 2003 conference proceedings. Topics specifically of interest to Microwave Update attendees, as well as those on VHF and UHF subjects usually associated with the annual Pacific Northwest VHF Conference are being solicited. Papers will be accepted until July 1st, 2003, to allow enough time for printing. White papers should be sent directly to *Jim Christiansen K7ND*, via E-mail at [[k7nd@att.net](mailto:k7nd@att.net)]. MS Word format is preferred. Microwave Update 2003 and the Pacific Northwest VHF Society respectively, will be the sole judges of whether presentation requests and white papers are accepted.

If you are interested in making a session presentation at one of the Microwave Update 2003 sessions, please respond to *NU7Z* [[nu7z@aol.com](mailto:nu7z@aol.com)]. For presentations at the Pacific Northwest VHF Conference sessions, contact *N7CFO* at [[n7cfo@ix.netcom.com](mailto:n7cfo@ix.netcom.com)]. LCD projection equipment will be available for those using PowerPoint presentations. Slides and video presentations can be accommodated with advance notice.

### SPECIAL EVENTS, ETC.

#### MAR 22-23

**OKLAHOMA QSO PARTY** The Oklahoma DX Assn. will host the Oklahoma QSO Party, beginning at 1300 UTC on 22 March, and ending at 1300 UTC 23 March. All entries may operate 18 hours of the 24-hour time frame. Plaques awarded for high score(s). Certificates are available. For rules and info go to [[www.qsl.net/okdxa](http://www.qsl.net/okdxa)]. 73

### ON THE GO

*continued from page 45*

Management Agency, the Red Cross, and the League itself. These references are all available on-line so you can check on a particular topic during the lesson and then jump back to the lesson itself. You can print out the learning units if you prefer to highlight key sections, or if your eyesight prefers paper and ink to a CRT. Once you are comfortable with the material, there is a student activity wherein you are given one or more questions or situations and asked to share your response with your mentor. I'd E-mail my responses and normally have a response back in just a few days. This activity sort of takes the place of a class discussion in a virtual world and fleshes out the material. After completing the student activity you can then move on to a series of questions to check your understanding of the material. Answer each question, then press a button under the multiple choice answers to check your answer.

When you finish all the learning units, you then can take the final assessment, which is a twenty-five-question multiple-choice test that reviews the entire course. I found it interesting that the material stressed focused as much on the people skills as the technical skills. This only makes sense because people tend to melt down in a crisis more frequently than equipment does. There are also sections devoted to net operations, message handling, and equipment choices. The course spends time on preparation for deployment, activation, and initial operations as well as how to shut the operation down. They even have a section on the importance of your own family and how to make sure they're provided for if and when you go. The material was useful, down to earth, and well presented.

Some suggestions if you decide to take this course. If you've been out of school for a while (and many of us have), get organized before you start. I chose to print the materials and keep them in a three-ring binder. If so, you may want to have space for your own notes, as well. Also, with exceptional reference materials available for download, you may want to either print them out for future reference or else burn them onto a CD-ROM and include it with your other emergency supplies. Most laptop or notebook computers now have CD-ROM drives, so this is an easy way to have reference materials readily available if you have to pack up and go.

This course was well worth the time and effort. If you plan on doing public service or emergency communications, you should give serious thought to taking this course. As I mentioned earlier, you may not always agree with the League, but they do provide some unique benefits. 73

## HOMING IN

*continued from page 52*

elements along the imaginary circle of movement is critical. A four-whip array must form a perfect square; an eight-whip array must form a perfect octagon, and so forth. Any error in element placement can cause significant bearing errors at some angles. If you use magnetic-mounts instead of a single fixed array-on-a-plate, be sure to use a template or make careful measurements when putting the mag-mounts on top of your vehicle.

That's enough theory for this month. In the next installment, I'll delve into practical Doppler antenna switching schemes. There are lots of circuits out there and some work much better than others. I'll explain why and describe some simple things you can do that may improve the performance of the one you're using now.

### Duke City comics

Annually around New Year's Day, hams from all over southern California gather for a party in front of multiple TV sets, viewing stacks of videos they have taken at T-hunts of the past year. J. Scott Bovitz N6MI hosted this year's film-fest and the video I brought was a big hit, even though it wasn't about a local hunt. Here's why:

Our strange mobile RDF setups and hidden transmitter hunt rules seem comical to many non-hams, including news reporters. Some years ago, I took a columnist for our local newspaper on a hunt ride-along. The story she wrote made it clear that the humorous aspects of the event made a much greater impression on her than my explanations of T-hunting's serious enforcement and search/rescue value.

The T-hunters of Albuquerque have had similar media encounters, so they decided that if it is something to joke about, they might as well make the most of it. When comedian Dave Attell came to Duke City last June to videotape the city's nightlife for his weekly show on Comedy Central cable/satellite channel, they put on a special late-night T-hunt.

As a result, Attell's "Insomniac" Albuquerque episode includes a hilarious segment on mobile T-hunting, as Dave rides along with Mike Pendley K5ATM and Debbie Pendley KD5LOK in their Doppler-equipped van. Waiting for the hunters on a mesa above Petroglyph National Monument beside his T-in-a-bush is Jerry Boyd WB8WFK. It first aired last December and is expected to be repeated in the coming months (check listings at [www.comedycentral.com]).

Congratulations to the T-hunters of Albuquerque for showing the humorous side of our sport to the whole country. What publicity has your club gotten for RDF contesting in your area? Send E-mail or postal mail to the addresses at the beginning of this article and tell me about it. 73

## QRX

*continued from page 7*

PHONESIA (fo NEE zhuh), n. The affliction of dialing a phone number and forgetting whom you were calling just as they answer.

*Thanks to the UBET ARC newsletter Radio Flyer, April 2002.*

And then there's MUSTURD (MUSS terd), n. That hard little cap of old stuff that forms at the top of a squeeze bottle of mustard. — ed. 73

## NEVER SAY DIE

*continued from page 43*

do is turn on a switch and the whole world is my oyster. I turn off the switch and I'm alone to read, think and write. But if I get lonely, I've got a bunch of friends all around the world waiting there for me.

Okay, how can we get the grays into our hobby? That's easy. Start writing articles about the fun you're having on the ham bands for your local shopper paper. Tell 'em how easy it is to get a ticket these days and how little it costs to get a used ham rig. Invite 'em to a club meeting. Offer to help 'em put up an antenna.

If we can't get the kids, let's go for their grandparents.

### Danger — Blasting

We've all seen the signs asking us to turn off radio transmitters when passing blasting areas. Well, a reader sent me a download from newsmax.com of an article recommending that Israel set up narrow passages at every checkpoint with sandbags to absorb any explosions and UHF transmitters which would detonate any blasting caps Palestinians might walk or drive through with. That would get rid of suicide bombers in short order.

If we set up a system like that at airline check-ins we might blow the feet off some shoe bombers.

That got me to thinking — and I can prove it.

How about using a psychological approach? I'd set up a series of radio and TV broadcasts in Arabic of psychics interviewing dead suicide bombers who

are screaming that they are roasting in hell and that all that crap about they're having 73 virgins and living in paradise are just terrible lies. Allah is furious with them and has put a curse on their families.

I've always felt it's far better to out-smart enemies rather than to try and outfight them. It's cheaper and saves a lot of lives.

### Rife = Bunk

If you haven't read Barry Lynes' *The Cancer Cure That Worked*, the book about the work of Dr. Royal Raymond Rife, you've missed a fascinating story.

Rife is the guy who, back in the 1920s, invented a super powerful microscope. Like Béchamp before him, he heterodyned two ultra-violet lights to produce a visible light magnification that allowed him to watch live bacteria in action. But he made the serious mistake of curing some of his patients of cancer. For this error he was arrested, his microscopes destroyed and he was put in prison. It's the good old American way. At least, he didn't die there as did Dr. Wilhelm Reich—whose equipment was also destroyed.

So where's the bunk?

Rife was using a radio frequency generator, which he supposedly "tuned" to frequencies which blew bacteria apart, with each requiring a different frequency. So today we have so-called Rife frequency generators which are selling in the multi-kilobuck range.

So what's wrong with that? Why do I think this is bunk?

Firstly, I've read everything I could find about Rife's work, looking futilely for some hint as to the frequencies he was using. Plus, it seems to me that if one is going to blow up a bacteria one is going to have to use one heck of a high frequency to get a half-wavelength down to microbe size. With 1920s technology? When I got started building radios in 1937 the ham ten-meter band was considered an ultra-high frequency experimental band.

The second problem was stability. You either used a crystal in an oven to generate a stabilized frequency or your signal wandered around as your coil heated up and cooled. Even temperature-controlled ovens were crude by today's digital generator standards. So how could Rife have known and achieved a frequency accuracy which targeted a specific pathogen?

Third, this was way before accurate frequency counters. There was no way to accurately measure frequency.

Fourth, cancer isn't caused by bacteria anyway. It's caused by faultily reproduced cells not being trashed by the immune system and thus being allowed to

*Continued on page 64*



# Wise Up!

Here are some of my books which can change your life (if you'll let 'em). If the idea of being healthy, wealthy and wise interests you, start reading. Yes, you can be all that, but only when you know the secrets which I've spent a lifetime uncovering.

.....Wayne

**The Secret Guide to Health:** Yes, there really is a secret to regaining your health and adding 30 to 60 years of healthy living to your life. The answer is simple, but it means making some serious lifestyle changes. Will you be skiing the slopes of Aspen with me when you're 90 or doddering around a nursing home? Or pushing up daisies? No, I'm not selling any health products, but I can help you cure yourself of cancer, heart trouble, or any other illness. Get this new, 2002 expanded edition (160p). \$10 (#04)

**The Secret Guide to Wealth:** Just as with health, you'll find that you have been suckered by "the system" into a pattern of life that will keep you from ever making much money and having the freedom to travel and do what you want. I explain how anyone can get a dream job with no college, no résumé, and even without any experience. I explain how you can get someone to happily pay you to learn what you need to know to start your own business. \$5 (#03)

**The Secret Guide to Wisdom:** This is a review of around a hundred books that will boggle your mind and help you change your life. No, I don't sell these books. They're on a wide range of subjects and will help to make you a very interesting person. Wait'll you see some of the gems you've missed reading. You'll have plenty of fascinating stuff to talk about on the air. \$5 (#02)

**My WWII Submarine Adventures:** Yes, I spent from 1943-1945 on a submarine, right in the middle of the war with Japan. We almost got sunk several times, and twice I was in the right place at the right time to save the boat. What's it really like to be depth charged? And what's the daily life aboard a submarine like? How about the Amelia Earhart inside story? If you're near Mobile, please visit the Drum. \$5 (#10)

**Travel Diaries:** You can travel amazingly inexpensively – once you know the ropes. Enjoy Sherry and my budget visits to Europe, Russia, and a bunch of other interesting places. How about a first class flight to Munich, a rented Audi, driving to visit Vienna, Krakow

in Poland (and the famous salt mines), Prague, back to Munich, and the first class flight home for two, all for under \$1,000? Yes, when you know how you can travel inexpensively, and still stay in first class hotels. \$5 (#11)

**Writer's Guide:** It's easy, fun, can pad your résumé, and impress the hell out of your friends. \$0 (#78)

**Wayne's Caribbean Adventures:** My super budget travel stories – where I visit the hams and scuba dive most of the islands of the Caribbean. You'll love the special Liat fare which let me visit 11 countries in 21 days, diving all but one of the islands, Guadeloupe, where the hams kept me too busy with parties. \$5 (#12)

**Cold Fusion Overview:** This is both a brief history of cold fusion, which I predict will be one of the largest industries in the world in the 21st century, plus a simple explanation of how and why it works. This new field is going to generate a whole new bunch of billionaires, just as the personal computer industry did. \$5 (#20)

**Improving State Government:** Here are 24 ways that state governments can cut expenses enormously, while providing far better service. I explain how any government bureau or department can cut its expenses by at least 50% in three years and do it cooperatively and enthusiastically. I explain how, by applying a new technology, the state can make it possible to provide all needed services without having to levy *any* taxes at all! Read the book, run for your legislature, and let's get busy making this country work like its founders wanted it to. Don't leave this for "someone else" to do. \$5 (#30)

**Mankind's Extinction Predictions:** If any one of the experts who have written books predicting a soon-to-come catastrophe which will virtually wipe most of us out are right, we're in trouble. In this book I explain about the various disaster scenarios, like that of Nostradamus, who says the poles will soon shift (as they have several times in the past), wiping out 97% of mankind. Okay, so he's made a long string of past lucky guesses. The worst part of these predictions is the accuracy record of some of the experts. Will it be a pole shift, a new ice age, a massive solar flare, a comet or asteroid, a bioterrorist attack? I'm getting ready, how about you? \$5 (#31)

**Moondoggle:** After reading René's book, *NASA Mooned America*, I read everything I could find on our Moon landings. I watched the NASA videos, looked carefully at the photos, read the astronaut's biographies, and talked with some readers who worked for NASA. This book cites 45 good reasons I believe the whole Apollo program had to have been faked. \$5 (#32)

**Classical Music Guide:** A list of 100 CDs which will provide you with an outstanding collection of the finest classical music ever written. This is what you need to help you reduce stress. Classical music also raises youngsters' IQs, helps plants grow faster, and will make you healthier. Just wait'll you hear some of Gotschalk's fabulous music! \$5 (#33)

**The Radar Coverup:** Is police radar dangerous? Ross Adey K6UI, a world authority, confirms the dangers of radio and magnetic fields, including our HTs and cell phones. \$3 (#34)

**Three Gatto Talks:** A prize-winning teacher explains what's wrong with American schools and why our kids are not being educated. Why are Swedish youngsters, who start school at 7 years of age, leaving our kids in the dust? Our kids are intentionally being dumbed down by our school system – the least effective and most expensive in the world. \$5 (#35)

**Aspartame:** a.k.a. NutraSweet, the stuff in diet drinks, etc., can cause all kinds of serious health problems. Multiple sclerosis, for one. Read all about it, two pamphlets for a buck. (#38)

**\$1 Million Sales Video:** The secret of how you can generate an extra million dollars in sales just by using PR. This will be one of the best investments you or your business will ever make. \$40 (#52)

**Reprints of My Editorials from 73.** Very few things in this world are as we've been taught, and as they appear. As an iconoclast I blow the whistle on the scams around us, such as the health care, our school system, our money, the drug war, a college education, sugar, the food giants, our unhealthy food, fluorides, EMFs, NutraSweet, etc.

**1996 100 Editorial Essays:** \$5 (#72)

**1997 157 Editorial Essays:** \$8 (#74)

**1998 192 Editorial Essays:** \$10 (#75)

**1999 165 Editorial Essays:** \$8 (#76)

**2000 101 Editorial Essays:** \$5 (#77)

**2001 104 Editorial Essays:** \$5 (#78)

**Silver Wire:** With two 5-in. pieces of heavy pure silver wire + three 9V batteries you can make a thousand dollars worth of silver colloid. What do you do with it? It does what the antibiotics do, but germs can't adapt to it. Use it to get rid of germs on food, for skin fungus, warts, and even to drink. Read some books on the uses of silver colloid, it's like magic. \$15 (#80)

**Colloid Reprint.** April 97 article on a silver colloid maker, history, and how to use the stuff. \$5 (#98)

**Colloid Clips.** Three 9V battery clips, 2 alligator clips & instructions. \$5 (#99)

**AC-powered Colloid Kit:** 12V power supply, silver wires, reprint, including priority mail shipment. \$37 (#82)

**Four Small Booklets Combo:** Super Organic Food: a trillion dollar new industry; Schools in 2020: another \$ trillion industry. Anthrax, a simple cure. Dowsing: why and how it works. \$3 (#86)

**My 1992 We The People Declare War! On Our Lousy Government** book—360 pages and packed with ideas that'll get you all excited. Was \$13. While they last \$10. Just a few left, found in the warehouse. Last chance for this classic. (#06)

**Stuff I didn't write, but you need:**

**NASA Mooned America:** René makes an air-tight case that NASA faked the Moon landings. This book will convince even you. \$30 (#90)

**Last Skeptic of Science:** This is René's book where he debunks a bunch of accepted scientific beliefs – such as the ice ages, the Earth being a magnet, the Moon causing the tides, etc. \$30 (#91)

**Dark Moon:** 568 pages of carefully researched proof that the Apollo Moon landings were a hoax—a capping blow for René's skeptics. \$25 (#92)

**1982 General Class License Study Guides.** Teaches the fundamentals of radio & electricity. Was \$7. I found a few in the warehouse. \$3, while they last. Great book! (#83)

## Radio Bookshop

Box 416, Hancock NH 03449

Name \_\_\_\_\_ Call \_\_\_\_\_

Address \_\_\_\_\_

City-State-Zip \_\_\_\_\_

Use the numbers in the brackets or copy page and mark the books you want. Add \$3 s/h per total order in US (\$7 priority mail), \$6 Can, \$10 foreign.

Order total: US\$ \_\_\_\_\_ Phone (for CC orders) \_\_\_\_\_

MC/Visa for orders over \$10. # \_\_\_\_\_ Expire \_\_\_\_\_

www.waynecgreen.com • phone orders: 603-588-0107 • fax: 603-588-3205 • w2nsd@aol.com

Yes! Put me down for a year of 73 for only \$25 (a steal). Canada US\$32. Foreign US\$44 by sea.

I need some industrial strength stress reduction so send me your Adventures In Music CD catalog

Allow 4 weeks for delivery except foreign, though we try to get most orders shipped in a day or two.

Your e-mail address: \_\_\_\_\_

# Barter 'n' Buy

Turn your old ham and computer gear into cash now. Sure, you can wait for a hamfest to try and dump it, but you know you'll get a far more realistic price if you have it out where 100,000 active ham potential buyers can see it, rather than the few hundred local hams who come by a flea market table. Check your attic, garage, cellar and closet shelves and get cash for your ham and computer gear before it's too old to sell. You know you're not going to use it again, so why leave it for your widow to throw out? That stuff isn't getting any younger!

The 73 Flea Market, Barter 'n' Buy, costs you peanuts (almost) — comes to 35 cents a word for individual (noncommercial!) ads and \$1.00 a word for commercial ads. Don't plan on telling a long story. Use abbreviations, cram it in. But be honest. There are plenty of hams who love to fix things, so if it doesn't work, say so.

Make your list, count the words, including your call, address and phone number. Include a check or your credit card number and expiration. If you're placing a commercial ad, include an additional phone number, separate from your ad.

This is a monthly magazine, not a daily newspaper, so figure a couple months before the action starts; then be prepared. If you get too many calls, you priced it low. If you don't get many calls, too high.

So get busy. Blow the dust off, check everything out, make sure it still works right and maybe you can help make a ham newcomer or retired old timer happy with that rig you're not using now. Or you might get busy on your computer and put together a list of small gear/parts to send to those interested?

**Send your ads and payment to: 73 Magazine, Barter 'n' Buy, 70 Hancock Rd., Peterborough NH 03458 and get set for the phone calls.** The deadline for the May 2003 classified ad section is March 10, 2003.

**220 MHz Award;** see W9CYT on [WWW.QRZ.COM](http://WWW.QRZ.COM) for information. BNB645

**K8CX HAM GALLERY** [<http://hamgallery.com>]. BNB620

**TELEGRAPH COLLECTOR'S PRICE GUIDE:** 250 pictures/prices. \$12 postpaid. **ARTIFAX BOOKS**, Box 88, Maynard MA 01754. Telegraph Museum: [<http://wltip.com>]. BNB113

New miniature oscillator modules are now available ... all under \$20 ... plus our great reference book is still for sale. Write to **RMT Engineering**, 6863 Buffham Road, Seville OH 44273 or see our Web site at [[www.ohio.net/~rtormet/index.html](http://www.ohio.net/~rtormet/index.html)]. BNB640

**RF TRANSISTORS TUBES** 2SC2879, 2SC1971, 2SC1972, MRF247, MRF455, MB8719, 2SC1307, 2SC2029, MRF454, 2SC3133, 4CX250B, 12DQ6, 6KG6A, etc. **WESTGATE**, 1-800-213-4563. BNB6000

**METHOD TO LEARN MORSE CODE FAST AND WITHOUT HANGUPS** Johan N3RF. Send \$1.00 & SASE. **SVANHOLM RESEARCH LABORATORIES**, P.O. Box 81, Washington DC 20044 USA. BNB421

**Cash for Collins:** Buy any Collins Equipment. **Leo KJ6HI**. Tel./FAX (310) 670-6969. [[radioleo@earthlink.net](mailto:radioleo@earthlink.net)]. BNB425

**Browse** our Web site and check out the "Monthly Special." TDL Technology, Inc. [[www.zianet.com/tdl](http://www.zianet.com/tdl)]. BNB500

**MAHLON LOOMIS, INVENTOR OF RADIO**, by Thomas Appleby (copyright 1967). Second printing available from **JOHAN K.V. SVANHOLM N3RF**, SVANHOLM RESEARCH LABORATORIES, P.O. Box 81, Washington DC 20044. Please send \$25.00 donation with \$5.00 for S&H. BNB420

**Ham Radio Repair**, Quality workmanship. All Brands, Fast Service. **Affordable Electronics**, 7110 E. Thomas Rd., Scottsdale, AZ 85251. Call 480-970-0963, or E-mail [[HAM\\_SERVICE@AOL.COM](mailto:HAM_SERVICE@AOL.COM)]. BNB427

**SATELLITE TV** — Large selection of items at reasonable prices. We specialize in Big Dish TVRO C & Ku Band equipment. Check us out at [[www.daveswebshop.com](http://www.daveswebshop.com)]. BNB646

**HEATHKIT COMPANY** is selling photocopies of most Heathkit manuals. Only authorized source for copyright manuals. **Phone:** (616) 925-5899, 8-4 ET. BNB964

**WANTED: USED ROTORS**, controls, CD-44, Ham-M, 2, 3, 4, T2X, or larger. Call C.A.T.S., 1-800-3ROTORS BNB662

**Electricity, Magnetism, Gravity, The Big Bang.** New explanation of basic forces of nature in this 91-page book covering early scientific theories and exploring latest controversial conclusions on their relationship to a unified field theory. To order, send check or money order for \$16.95 to: American Science Innovations, P.O. Box 155, Clarington OH 43915. Web site for other products [[http://www.asi\\_2000.com](http://www.asi_2000.com)]. BNB100

**COLLOIDAL SILVER GENERATOR!** Why buy a "box of batteries" for hundreds of dollars? Current regulated, AC powered, fully assembled with #12 AWG silver electrodes, \$74.50. Same, but DC powered, \$54.50. Add \$2.50 shipping. **Thomas Miller**, 216 East 10th St., Ashland OH 44805. Web address [[www.bioelectrifier.com](http://www.bioelectrifier.com)]. BNB342

**ANTENNA SCIENCE:** Why do antennas radiate electromagnetic waves? Learn for yourself from this enlightening paper by **MAX RESEARCH**. Gain an understanding of the radiation mechanism of antennas! Written in a clear style for radio hobbyists, inquisitive amateurs and experimenters. \$4.95 ... ppd. Order from **MAX RESEARCH**, P.O. Box 1306, East Northport NY 11731. BNB426

**WANTED: ANY MODEL** Collins, working or not, including speakers, filters, options, 1-piece or collection. Bob, 651-354-5345 days: 651-345-3600 eves. E-Mail: [rkemp@mr.net](mailto:rkemp@mr.net). BNB661

**FREE!! HAM** Radio and other CD-Roms and Disk catalog. **MOM 'N' POP'S SOFTWARE**, P.O. Box 15003-TH, Springhill, FL 34604-0111, 1-352-688-9108, visit: <http://www.momnpopsware.com> BNB660

**SMART BATTERY CHARGERS** and more, [[www.a-aengineering.com](http://www.a-aengineering.com)] BNB653

**GET MORE OUT OF HAM RADIO!** Books on all topics. Up to 15% off. Quality Technical Books. [<http://qtb.com/hamradio/>]. BNB665

## NEVER SAY DIE

*continued from page 62*

grow out of control. With around 24 billion cells having to be replaced every day, an impaired immune system can miss trashing a few reproduction errors — and the result can be deadly. The only practical cure I see for cancer is to rebuild one's immune system. This is the route promoted by Drs. Day, Comby, Bieler, me and a few others.

So, as far as I can see, those expensive so-called Rife frequency generators are just one more alternative health fraud.

## Writing

I lucked into a wonderful book at one of those New Hampshire yard sales. It's *Write From the Start* by Donald Graves, a 1985 paperback. One of the best quarters I've ever spent.

The idea is to encourage young children to start writing. Give 'em a pencil and paper and see what happens. Young? Many kids get started writing at three or four, even before they've learned to read, and they love it. A group of teachers at some New Hampshire schools let their children write about anything they wanted, and never mind marks for spelling, grammar or punctuation — or anything else. They're encouraged to do it because it's fun. 73

# Alinco Delivers HF Adventure!

## Alinco's HF Transceivers Deliver Incredible Performance at a Tiny Price

You're only a few hundred dollars away from a brand new Alinco HF Transceiver. That's right! Just a few hundred dollars gets you on the air with a big 100-watt signal, great audio and an easy-to-operate package that's perfect for base, portable or mobile operations. The Alinco DX-70 and DX-77 make it easy for everyone to enjoy HF with a dependable transceiver that's backed by Alinco's 1 year warranty.

**The world of HF is calling. What are you waiting for?**



### Alinco DX-70TH Base/Mobile/Portable HF + 6 Meter Transceiver

- 100 watts SSB, FM & CW, 40 watts AM
- Continuous coverage HF receiver + full 6 meter coverage
- 100 memory channels
- Speech compressor
- Great CW rig, full QSK, semi or automatic break-in
- Standard narrow filter fights QRM on SSB, CW or AM
- Two VFO's and easy "split" operation
- Removable face for remote mounting.
- RIT / TXIT, IF shift
- Multi function control for easy operation

### Alinco DX-77T Desktop HF Transceiver

- 100 watts SSB, FM & CW, 40 watts AM
- General coverage receiver 150 KHz ~ 30 MHz
- Two VFO's; easy "split" operation
- Standard speech processor
- Front panel speaker provides loud, clear audio
- Built-in electronic keyer 6 ~ 60 wpm
- Full QSK, 7-step semi break-in or auto break-in
- Enhanced Direct Digital Synthesis (DDS) eliminates need for SSB Narrow Filter
- Front panel connections for mic, key, speaker & phones



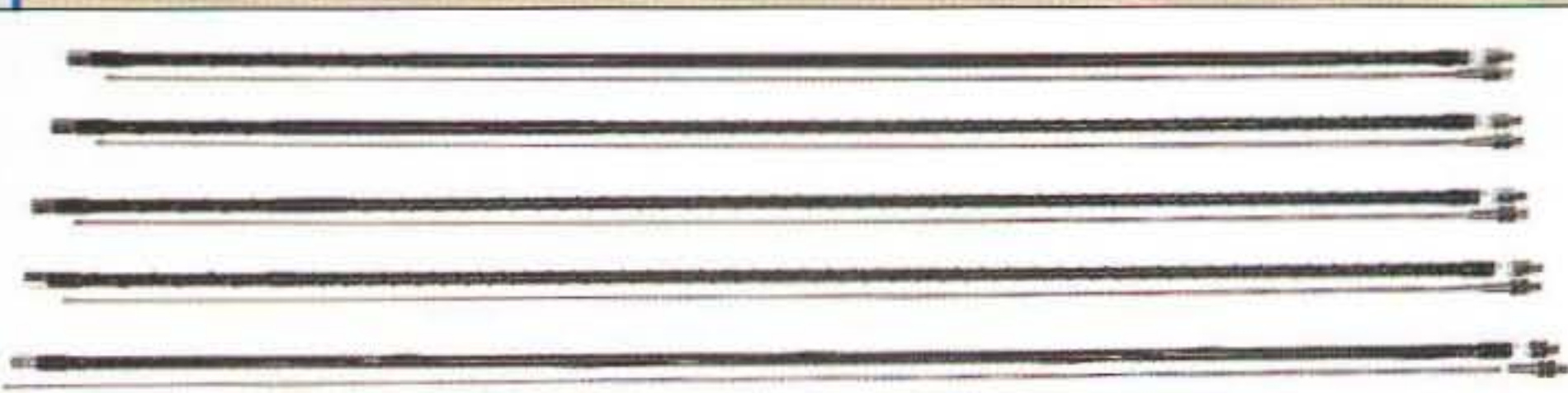
#### Options

- EDX-2 automatic wire antenna tuner
- EMS-14 desktop microphone
- DM-330 MVT switching power supply
- DM-340 MVT regulated power supply



### Iron Horse Mobile HF antennas for Alinco and other HF transceivers

*Order the Iron Horse IHF5S package from your dealer and go mobile fast!*

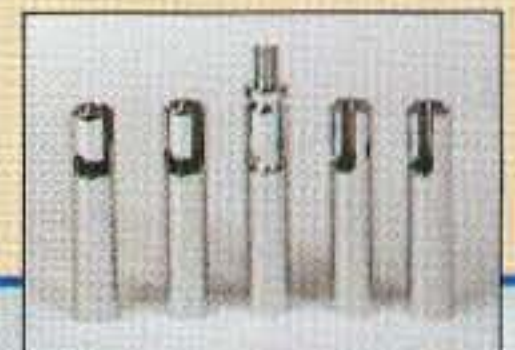


IHF5S Mobile HF Antennas

IHTH-1  
Optional  
Trailer Hitch Mount



You get a package of 5 rugged, easily tuned antennas for 10, 15, 20, 40 & 75 meters from Iron Horse, a name recognized for its strength and dependability. Each has 3/8 x 24 threads and is rated for 500 watts. Order the IHKD3S 5 antenna quick disconnect mounting kit to make changing bands a quick and easy operation, just push, turn & go!



IHKD3S Quick  
Disconnect Kit



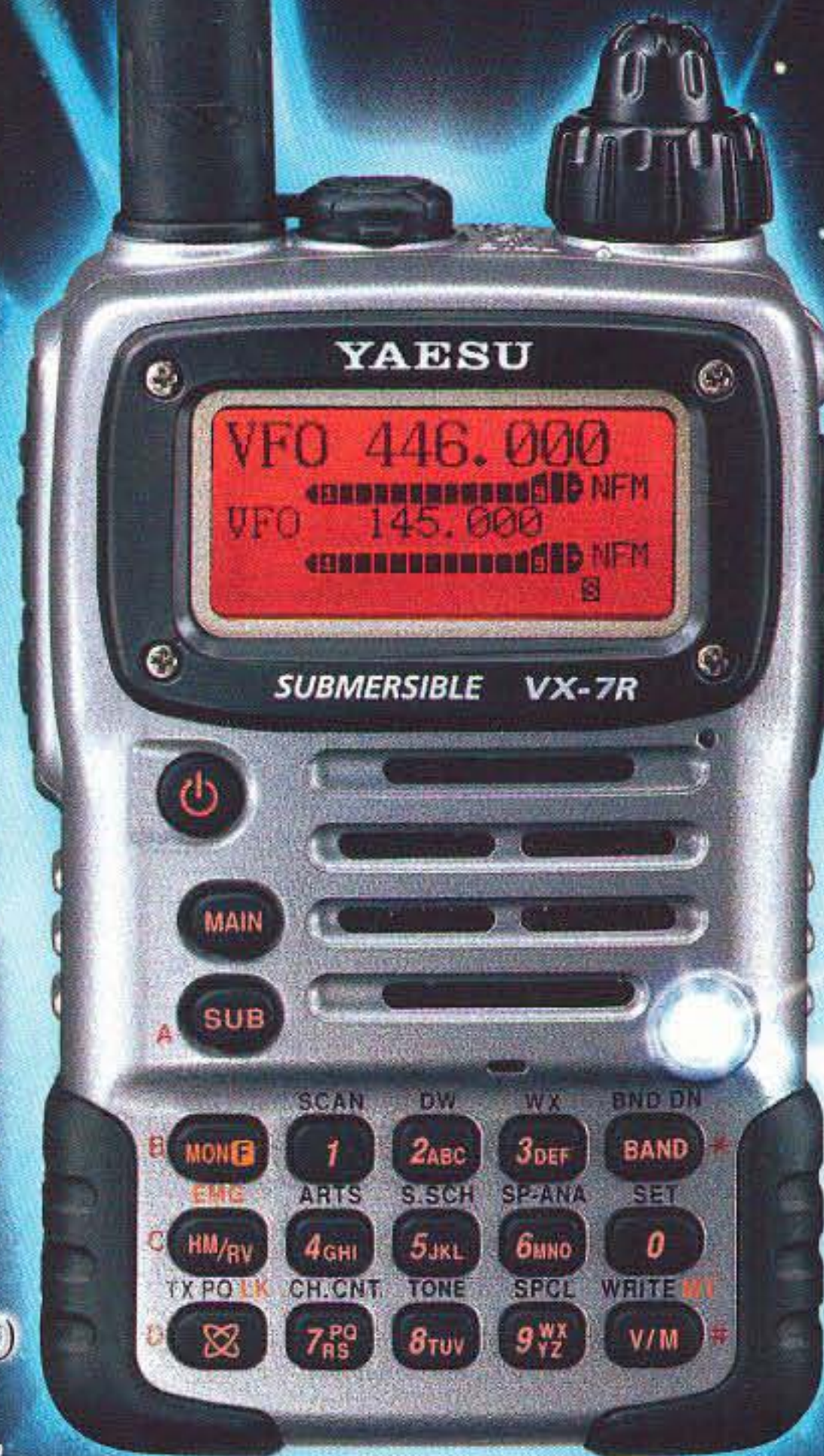
[www.ALINCO.com](http://www.ALINCO.com)

Distributed in North America by ATOC Amateur Distributing LLC • 23 S. High St., Covington, OH 45318 • (937) 473-2840  
Specifications subject to change without notice or obligation.

Products intended for use by properly licensed operators. Permits required for MARS/CAP use. Specifications subject to change without notice or obligation. All trademarks remain the property of their respective owners.

# ULTRA-RUGGED, SUBMERSIBLE TRI-BAND MAGNESIUM HANDIE

Own the brightest star in the Ham Radio Galaxy! The exciting new YAESU VX-7R sets new standards in ruggedness, water resistance, and versatility, and its memory capacity is unparalleled. Own the VX-7R, and you'll own the best.



**TRUE DUAL RECEIVE  
(V+V/U+U/V+U/HAM+GEN)**

**WIDE-RANGE RECEIVER**

**MAGNESIUM CASE**

**SUBMERSIBLE  
(3 feet for 30 minutes)**

**OVER 500 MEMORY  
CHANNELS**

**MIXED TONE (CTCSS/DCS)  
CAPABILITY**

**INTERNET KEY FOR ACCESS TO**

**WIRES**

*Wide-Coverage Internet Repeater Enhancement System*

**SHORTWAVE BROADCAST  
MEMORY BANK**

**WEATHER BROADCAST MEMORY  
BANK WITH "SEVERE WEATHER"  
ALERT**

**MARINE BAND MEMORY BANK**

**MULTI-COLOR STROBE LED**

**LOW-POWER 222 MHz TX  
(U.S. version)**

**RUBBER CASE PROTECTOR**

## VX-7R

50/144/430 MHz 5W FM Transceiver

Actual Size

For the latest Yaesu news, visit us on the Internet:  
<http://www.vxstdusa.com>

Specifications subject to change without notice. Some accessories and/or options may be standard in certain areas. Frequency coverage may differ in some countries. Check with your local Yaesu Dealer for specific details.

**YAESU**  
*Choice of the World's Top DX'ers*

Vertex Standard  
US Headquarters  
10900 Walker Street  
Cypress, CA 90630 (714)827-7600