

THE NEW! **Amateur**  
**73 Radio Today**

MARCH 2001  
ISSUE #484  
USA \$3.95  
CANADA \$4.95

**Rocket  
Tracker  
Antenna**

**Weird QRP Spree**

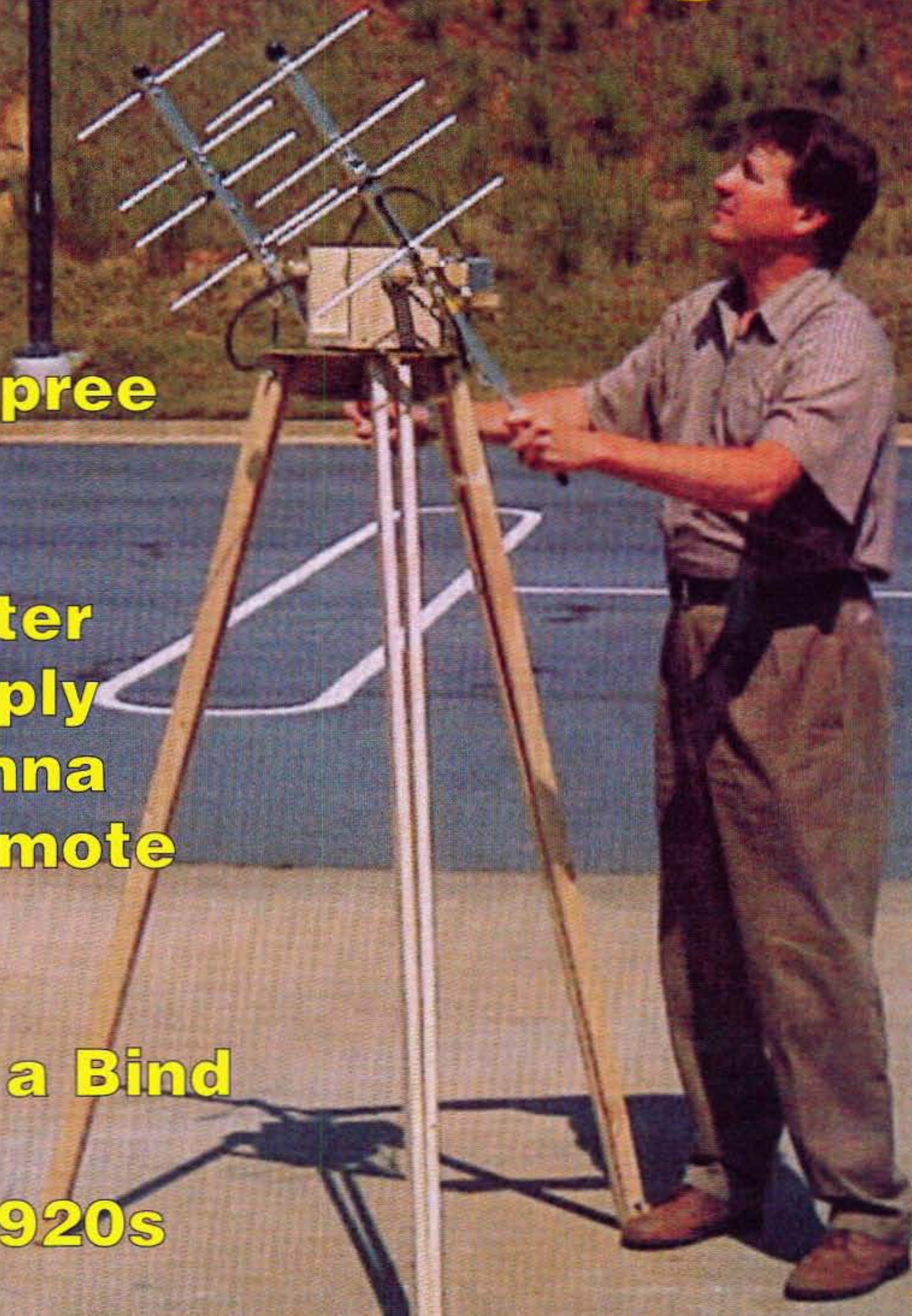
**Build:**

- **Beam Pointer**
- **Variac Supply**
- **NVIS Antenna**
- **Nifty IR Remote Tester**

**Getting Into a Bind**

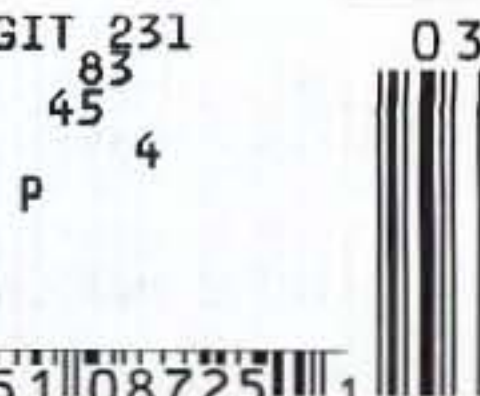
**ARS in the 1920s**

**Mysteries of RMS**



\*\*\*\*\*3-DIGIT 231  
#00000109389WR6# JUL76 83  
JACK SPEER 45  
BUCKMASTER PUBLISHING 4

6196 JEFFERSON HIGHWAY  
MINERAL VA 23117-3425



0 74851 08725 1



# Now There Are Three!

Alinco Wide-Range Receivers with Features  
You Won't Find Elsewhere!

*Listening adventures come alive with this family of Alinco receivers!*

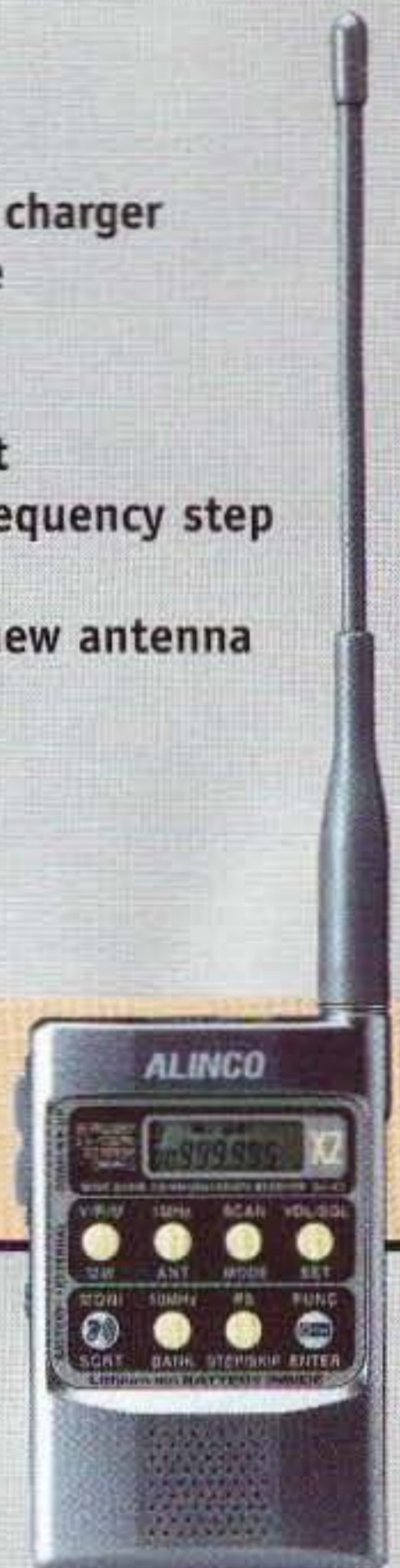


## New Alinco DJ-X2000 Wide-Range Intelligent Receiver™

- 100 KHz ~ 2.150 GHz coverage\*
- 2000 memory channels
- Advanced "on board" help feature
- Computer programmable
- Alphanumeric channel labels
- Flash Tune™ locks onto local signals \*\*
- Transweeper™ searches for "bugs" \*\*
- RF Frequency Counter
- Digital TXCO 1 ppm stability
- AM, NFM, WFM, FM Stereo\*\*\*, CW, LSB, USB Modes
- Ni-Cd battery & quick charger
- CTCSS search & decode
- Digital Recorder
- Two-stage Attenuator
- Direct Frequency input
- User-programmable frequency step
- ChannelScope™
- Super-wide coverage new antenna
- Much more!

## New Alinco DJ-X2 Pocket Communications Receiver

- "Credit Card" size
- 700 memory channels
- Internal Lithium Ion battery
- Snap-on charger and dry cell pack
- RF "sniffer" searches for bugs\*\*
- 522 KHz ~ 1 GHz Range\*
- AM, FM, WFM modes
- Clone Feature
- Three antenna modes
- Preset memory and VFO modes
- Free downloadable software on [www.alinco.com](http://www.alinco.com)



## DJ-X10 Wide-Range Communications Receiver

- 100 KHz ~ 2 GHz Range\*
- 1200 memory channels
- ChannelScope™ Display
- AM, WFM, NFM, USB, LSB CW modes
- On-board HELP messages
- Superb sensitivity
- "Beginner" and "Expert" modes
- Alphanumeric channel labels
- Automatic Memory Write feature
- Cloning Feature
- Attenuator
- Excellent audio



[www.ALINCO.com](http://www.ALINCO.com)

U.S.A. Alinco Branch: 438 Amapola Ave. • Suite 130 • Torrance, CA 90501  
Specifications subject to change without notice or obligation.

\* Cellular blocked in USA models. Unblocked versions available for export and authorized use. \*\* Patent applied for. \*\*\*Accessory stereo headphones or speakers required.



# THE TEAM

MARCH 2001  
ISSUE #484

**El Supremo & Founder**  
Wayne Green W2NSD/1

**Associate Publisher**  
F. I. Marion

**Executive Editor**  
Jack Burnett

**Managing Editor**  
Joyce Sawtelle

**Technical Editor**  
Larry Antonuk WB9RRT

**Contributing Culprits**  
Mike Bryce WB8VGE  
Jim Gray II  
Jack Heller KB7NO  
Chuck Houghton WB6IGP  
Andy MacAllister W5ACM  
Joe Moell K0OV  
Steve Nowak KE8YN/5  
Dr. Rick Olsen N6NR

**Advertising Sales**  
Evelyn Garrison WS7A  
21704 S.E. 35th St.  
Issaquah WA 98029  
425-557-9611  
Fax: 425-557-9612

**Circulation**  
Frances Hyvarinen

**Data Entry & Other Stuff**  
Norman Marion

**Business Office**  
Editorial - Advertising - Circulation  
Feedback - Product Reviews  
73 Amateur Radio Today Magazine  
70 Hancock Rd.  
Peterborough NH 03458-1107  
603-924-0058  
Fax: 603-924-8613

Reprints: \$3 per article  
Back issues: \$5 each

Printed in the USA

# THE NEW! 73 Amateur Radio Today

## TABLE OF CONTENTS

### FEATURES

- 10 Way Cool Rocket Project: Part 2 — N4XVF**  
*This 70cm rocketborne radio telemetry system is strictly for kids — NOT!*
- 18 Build Yourself an NVIS — VE2EQL**  
*If you want to talk to the guy in the next county on HF, of course.*
- 19 Inside Digital TV/VCR Tuners — W6WTU**  
*Part 7: Conclusion.*
- 23 Build This Variable AC Bench Supply — K8IHQ**  
*If you can find a Variac transformer, that is.*
- 26 \$5 Infrared Remote Tester — WA9PYH**  
*Build this and look like a hero.*
- 28 QRP Drives Ham Nuts — NY9D**  
*Buys "critical mass" of parts and then goes on bizarre building spree.*
- 31 Bookbind THIS! — Part 1 — W6WTU**  
*Get organized, and save money, too.*
- 34 Guessless Beam Pointing — W9PJF**  
*This has been around for years, but for you newcomers ...*
- 53 The History of Ham Radio — W9CI**  
*Part 4: The early 1920s.*
- 56 Read All About It! — K8JWR**  
*Part 5 of good stuff from The Hertzian Herald.*

### DEPARTMENTS

- 49 Ad Index  
64 Barter 'n' Buy  
37 Calendar Events  
50 The Digital Port — KB7NO  
46 Hamsats — W5ACM  
39 Homing In — K0OV  
4 Never Say Die — W2NSD/1  
48 New Products  
38 On the Go — KE8YN/4  
60 Propagation — Gray  
43 QRP  
1 QRX  
63 Radio Bookshop

#### E-Mail

design73@aol.com

#### Web Page

www.waynegr.com

## QRX . . .

### ARISS

There's a bright new star in the sky. The International Space Station is up and running, and so is the ARISS amateur radio station on board.

While solar wings were being deployed and brought on line to provide power to the station, the international team that set up ARISS met at NASA's Goddard Space Flight Center to pin down rules and

regulations and set up the plans for operating the station now and into the future.

Delegates from the United States and Russia were joined by their counterparts representing a consortium of European nations, Canada, and Japan. They elected Frank Bauer KA3HDO to chair the Administrative Group for the next two years. That's the

*Continued on page 6*

**Manuscripts:** Contributions for possible publication are most welcome. We'll do the best we can to return anything you request, but we assume no responsibility for loss or damage. Payment for submitted articles will be made after publication. Please submit both a disk and a hard copy of your article [IBM (ok) or Mac (preferred) formats], carefully checked drawings and schematics, and the clearest, best focused and lighted photos you can manage. "How to write for 73" guidelines are available on request. US citizens, please include your Social Security number with submitted manuscripts so we can submit it to you know who.

**73 Amateur Radio Today** (ISSN 1052-2522) is published monthly by 73 Magazine, 70 Hancock Rd., Peterborough NH 03458-1107. The entire contents ©2001 by 73 Magazine. No part of this publication may be reproduced without written permission of the publisher, which is not all that difficult to get. The subscription rate is: one year \$24.97, two years \$44.97; Canada: one year \$34.21, two years \$57.75, including postage and 7% GST. Foreign postage: \$19 surface, \$42 airmail additional per year, payable in US funds on a US bank. Second class postage is paid at Peterborough, NH, and at additional mailing offices. Canadian second class mail registration #178101. Canadian GST registration #125393314. Microfilm edition: University Microfilm, Ann Arbor MI 48106. POSTMASTER: Send address changes to 73 Amateur Radio Today, 70 Hancock Rd., Peterborough NH 03458-1107. 73 Amateur Radio Today is owned by Shabromat Way Ltd. of Hancock NH.





# ...POWER ON WITH ASTRON

SWITCHING POWER SUPPLIES...

**SPECIAL FEATURES:**

- HIGH EFFICIENCY SWITCHING TECHNOLOGY SPECIFICALLY FILTERED FOR USE WITH COMMUNICATIONS EQUIPMENT, FOR ALL FREQUENCIES INCLUDING HF
- HEAVY DUTY DESIGN
- LOW PROFILE, LIGHT WEIGHT PACKAGE
- EMI FILTER
- MEETS FCC CLASS B

**PROTECTION FEATURES:**

- CURRENT LIMITING
- OVERVOLTAGE PROTECTION
- FUSE PROTECTION
- OVER TEMPERATURE SHUTDOWN

**SPECIFICATIONS:**

INPUT VOLTAGE: 115 VAC 50/60HZ  
OR 220 VAC 50/60HZ  
SWITCH SELECTABLE

OUTPUT VOLTAGE: 13.8VDC

AVAILABLE WITH THE FOLLOWING APPROVALS: UL, CUL, CE, TUV.



MODEL SS-10TK



MODEL SS-12IF



MODEL SS-18

**DESKTOP SWITCHING POWER SUPPLIES**

MODEL	CONT. (Amps)	ICS	SIZE (inches)	Wt.(lbs.)
SS-10	7	10	1 1/2 x 6 x 9	3.2
SS-12	10	12	1 1/2 x 6 x 9	3.4
SS-18	15	18	1 1/2 x 6 x 9	3.6
SS-25	20	25	2 1/2 x 7 x 9 1/2	4.2
SS-30	25	30	3 1/4 x 7 x 9 1/2	5.0



MODEL SS-25M

**DESKTOP SWITCHING POWER SUPPLIES WITH VOLT AND AMP METERS**

MODEL	CONT. (Amps)	ICS	SIZE (inches)	Wt.(lbs.)
SS-25M*	20	25	2 1/2 x 7 x 9 1/2	4.2
SS-30M*	25	30	3 1/4 x 7 x 9 1/2	5.0



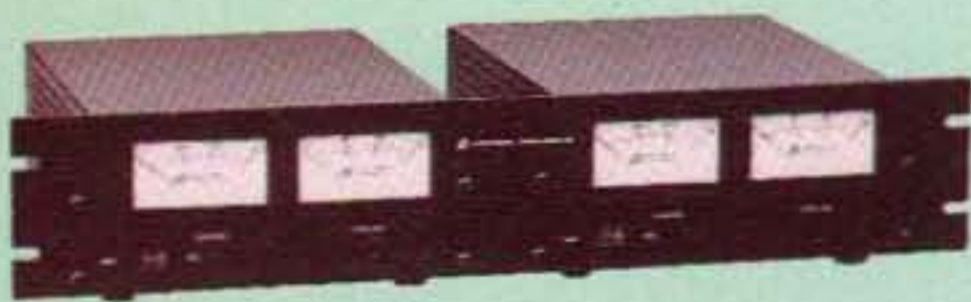
MODEL SRM-30

**RACKMOUNT SWITCHING POWER SUPPLIES**

MODEL	CONT. (Amps)	ICS	SIZE (inches)	Wt.(lbs.)
SRM-25	20	25	3 1/2 x 19 x 9 1/2	6.5
SRM-30	25	30	3 1/2 x 19 x 9 1/2	7.0

**WITH SEPARATE VOLT & AMP METERS**

MODEL	CONT. (Amps)	ICS	SIZE (inches)	Wt.(lbs.)
SRM-25M	20	25	3 1/2 x 19 x 9 1/2	6.5
SRM-30M	25	30	3 1/2 x 19 x 9 1/2	7.0



MODEL SRM-30M-2

**2 ea SWITCHING POWER SUPPLIES ON ONE RACK PANEL**

MODEL	CONT. (Amps)	ICS	SIZE (inches)	Wt.(lbs.)
SRM-25-2	20	25	3 1/2 x 19 x 9 1/2	10.5
SRM-30-2	25	30	3 1/2 x 19 x 9 1/2	11.0

**WITH SEPARATE VOLT & AMP METERS**

MODEL	CONT. (Amps)	ICS	SIZE (inches)	Wt.(lbs.)
SRM-25M-2	20	25	3 1/2 x 19 x 9 1/2	10.5
SRM-30M-2	25	30	3 1/2 x 19 x 9 1/2	11.0



MODEL SS-12SM/GTX



MODEL SS-10EFJ-98

**CUSTOM POWER SUPPLIES FOR RADIOS BELOW**

- EF JOHNSON AVENGER GX-MC41
- EF JOHNSON AVENGER GX-MC42
- EF JOHNSON GT-ML81
- EF JOHNSON GT-ML83
- EF JOHNSON 9800 SERIES
- GE MARC SERIES
- GE MONOGRAM SERIES & MAXON SM-4000 SERIES
- ICOM IC-F11020 & IC-F2020
- KENWOOD TK760, 762, 840, 860, 940, 941
- KENWOOD TK760H, 762H
- MOTOROLA LOW POWER SM50, SM120, & GTX
- MOTOROLA HIGH POWER SM50, SM120, & GTX
- MOTOROLA RADIUS & GM 300
- MOTOROLA RADIUS & GM 300
- MOTOROLA RADIUS & GM 300
- UNIDEN SMH1525, SMU4525
- VERTEX — FTL-1011, FT-1011, FT-2011, FT-7011

**NEW SWITCHING MODELS**

- SS-10GX, SS-12GX
- SS-18GX
- SS-12EFJ
- SS-18EFJ
- SS-10-EFJ-98, SS-12-EFJ-98, SS-18-EFJ-98
- SS-12MC
- SS-10MG, SS-12MG
- SS-101F, SS-121F
- SS-10TK
- SS-12TK OR SS-18TK
- SS-10SM/GTX
- SS-10SM/GTX, SS-12SM/GTX, SS-18SM/GTX
- SS-10RA
- SS-12RA
- SS-18RA
- SS-10SMU, SS-12SMU, SS-18SMU
- SS-10V, SS-12V, SS-18V



# RAMSEY

## Doppler Direction Finder

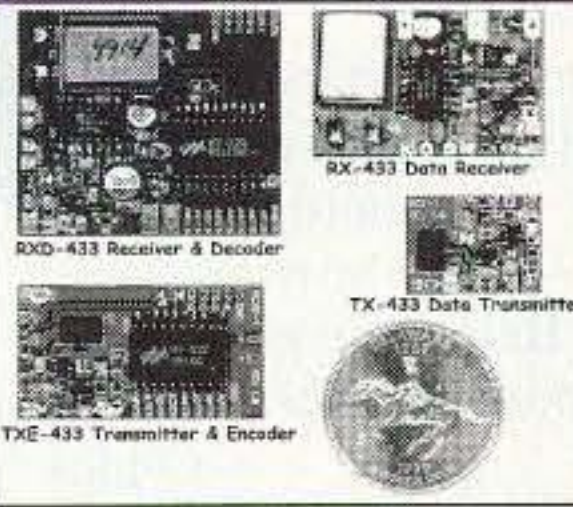
Track down jammers and hidden transmitters with ease! This is the famous WA2EBY DF'er featured in April 99 QST. Shows direct bearing to transmitter on compass style LED display, easy to hook up to any FM receiver. The transmitter - the object of your DF'ing - need not be FM, it can be AM, FM or CW. Easily connects to receiver's speaker jack and antenna, unit runs on 12 VDC. We even include 4 handy home-brew "mag mount" antennas and cable for quick set up and operation! Whips can be cut and optimized for any frequency from 130-1000 MHz. Track down that jammer, win that fox hunt, zero in on that downed Cessna - this is an easy to build, reliable kit that compares most favorably to commercial units costing upwards of \$1000.00! This is a neat kit!!

DDF-1, Doppler Direction Finder Kit ..... \$149.95

## Wireless RF Data Link Modules

RF link boards are perfect for any wireless control application; alarms, data transmission, electronic monitoring...you name it. Very stable SAW resonator transmitter, crystal controlled receiver - no frequency drift! Range up to 600 feet, license free 433 MHz band. Encoder/decoder units have 12 bit Holtek HT-12 series chips allowing multiple units all individually addressable, see web site for full details. Super small size - that's a quarter in the picture! Run on 3-12 VDC. Fully wired and tested, ready to go and easy to use!

RX-433 Data Receiver..... \$16.95 TX-433 Data Transmitter..... \$14.95  
RXD-433 Receiver/Decoder..... \$21.95 TXE-433 Transmitter/Encoder..... \$19.95



## World's Smallest TV Transmitters



We call them the 'Cubes'.... Perfect video transmission from a transmitter you can hide under a quarter and only as thick as a stack of four pennies - that's a nickel in the picture! Transmits color or B&W with fantastic quality - almost like a direct wired connection to any TV tuned to cable channel 59. Crystal controlled for no frequency

drift with performance that equals models that cost hundreds more! Basic 20 mW model transmits up to 300' while the high power 100 mW unit goes up to 1/4 mile. Their very light weight and size make them ideal for balloon and rocket launches, R/C models, robots - you name it! Units run on 9 volts and hook-up to most any CCD camera or standard video source. In fact, all of our cameras have been tested to mate perfectly with our Cubes and work great. Fully assembled - just hook-up power and you're on the air! One customer even put one on his dog!

C-2000, Basic Video Transmitter.....\$89.95 C-2001, High Power Video Transmitter...\$179.95

## CCD Video Cameras



Top quality Japanese Class 'A' CCD array, over 440 line line resolution, not the off-spec arrays that are found on many other cameras. Don't be fooled by the cheap CMOS single chip cameras which have 1/2 the resolution, 1/4 the light sensitivity and draw over twice the current! The black & white models are also super IR (Infra-Red) sensitive. Add our invisible to the eye, IR-1 illuminator kit to see in the dark! Color camera has Auto gain, white balance, Back Light Compensation and DSP! Available with Wide-angle (80°) or super slim Pin-hole style lens. Run on 9 VDC, standard 1 volt p-p video. Use our transmitters for wireless transmission to TV set, or add our IB-1 Interface board kit for super easy direct wire hook-up to any Video monitor, VCR or TV with A/V input. Fully assembled, with pre-wired connector.

CCDWA-2, B&W CCD Camera, wide-angle lens ..... \$69.95  
CCDPH-2, B&W CCD Camera, slim fit pin-hole lens. . \$69.95  
CCDCC-1, Color CCD Camera, wide-angle lens .... \$129.95  
IR-1, IR Illuminator Kit for B&W cameras ..... \$24.95  
IB-1, Interface Board Kit ..... \$14.95

## AM Radio Transmitter



Operates in standard AM broadcast band. Pro version, AM-25, is synthesized for stable, no-drift frequency and is settable for high power output where regulations allow, typical range of 1-2 miles. Entry-level AM-1 is tunable, runs FCC maximum 100 mW, range 1/4 mile. Both accept line-level inputs from tape decks, CD players or mike mixers, run on 12 volts DC. Pro AM-25 includes AC power adapter, matching case and bottom loaded wire antenna. Entry-level AM-1 has an available matching case and knob set that dresses up the unit. Great sound, easy to build - you can be on the air in an evening!

AM-25, Professional AM Transmitter Kit. .... \$129.95  
AM-1, Entry level AM Radio Transmitter Kit. . . \$29.95  
CAM, Matching Case Set for AM-1..... \$14.95

## Mini Radio Receivers



Imagine the fun of tuning into aircraft a hundred miles away, the local police/fire department, ham operators, or how about Radio Moscow or the BBC in London? Now imagine doing this on a little radio you built yourself - in just an evening! These popular little receivers are the nuts for catching all the action on the local ham, aircraft, standard FM broadcast radio, shortwave or WWV National Time Standard radio bands. Pick the receiver of your choice, each easy to build, sensitive receiver has plenty of crystal clear audio to drive any speaker or earphone. Easy one evening assembly, run on 9 volt battery, all have squelch except for shortwave and FM broadcast receiver which has subcarrier output for hook-up to our SCA adapter. The SCA-1 will tune in commercial-free music and other 'hidden' special services when connected to FM receiver. Add our snazzy matching case and knob set for that smart finished look!

AR-1, Airband 108-136 MHz Kit..... \$29.95 FR-6, 6 Meter FM Ham Band Kit ..... \$34.95  
HFRC-1, WWV 10 MHz (crystal controlled) Kit ..... \$34.95 FR-10, 10 Meter FM Ham Band Kit..... \$34.95  
FR-1, FM Broadcast Band 88-108 MHz Kit ..... \$24.95 FR-146, 2 Meter FM Ham Band Kit..... \$34.95  
SR-1, Shortwave 4-11 MHz Band Kit ..... \$29.95 FR-220, 220 MHz FM Ham Band Kit..... \$34.95  
SCA-1 SCA Subcarrier Adapter kit for FM radio .... \$27.95 Matching Case Set (specify for which kit) .... \$14.95

## PIC-Pro Pic Chip Programmer

Easy to use programmer for the PIC16C84, 16F84, 16F83 microcontrollers by Microchip. All software - editor, assembler, run and program - as well as free updates available on Ramsey download site! This is the popular unit designed by Michael Covington and featured in Electronics Now, September 1998. Connects to your parallel port and includes the great looking matching case, knob set and AC power supply. Start programming those really neat microcontrollers now...order your PICPRO today!

PIC-1, PICPRO PIC Chip Programmer Kit ..... \$59.95



## 1 GHz RF Signal Generator



A super price on a full featured RF signal generator! Covers 100 KHz to 999.99999 MHz in 10 Hz steps. Tons of features; calibrated AM and FM modulation, 90 front panel memories, built-in RS-232 interface, +10 to -130 dBm output and more! Fast and easy to use, its

big bright vacuum florescent display can be read from anywhere on the bench and the handy 'smart-knob' has great analog feel and is intelligently enabled when entering or changing parameters in any field - a real time saver! All functions can be continuously varied without the need for a shift or second function key. In short, this is the generator you'll want on your bench, you won't find a harder working RF signal generator - and you'll save almost \$3,000 over competitive units!

RSG-1000B RF Signal Generator ..... \$1995.00

## Super Pro FM Stereo Transmitter



Professional synthesized FM Stereo station in easy to use, handsome cabinet. Most radio stations require a whole equipment rack to hold all the features we've packed into the FM-100. Set freq with Up/Down buttons, big LED display. Input low pass filter gives great sound (no more squeals or swishing from cheap CD inputs!) Limiters for max 'punch' in audio - without over mod, LED meters to easily set audio levels, built-in mixer with mike, line level inputs. Churches, drive-ins, schools, colleges find the FM-100 the answer to their transmitting needs, you will too. Great features, great price! Kit includes cabinet, whip antenna, 120 VAC supply. We also offer a high power export version of the FM-100 fully assembled with one watt of RF power, for miles of program coverage. The export version can only be shipped if accompanied by a signed statement that the unit will be exported.

FM-100, Pro FM Stereo Transmitter Kit ..... \$249.95  
FM-100WT, Fully Wired High Power FM-100..... \$399.95

## FM Stereo Radio Transmitters



No drift, microprocessor synthesized! Great audio quality, connect to CD player, tape deck or mike mixer and you're on-the-air. Strapable for high or low power! Runs on 12 VDC or 120 VAC. Kit includes snazzy case, whip antenna, 120 VAC power adapter - easy one evening assembly.

FM-25, Synthesized Stereo Transmitter Kit ..... \$129.95

Lower cost alternative to our high performance transmitters. Great value, easily tunable, fun to build. Manual goes into great detail about antennas, range and FCC rules. Handy for sending music thru house and yard, ideal for school projects too - you'll be amazed at the exceptional audio quality! Runs on 9V battery or 5 to 15 VDC. Add matching case and whip antenna set for nice 'pro' look.

FM-10A, Tunable FM Stereo Transmitter Kit..... \$34.95  
CFM, Matching Case and Antenna Set ..... \$14.95  
FMAC, 12 Volt DC Wall Plug Adapter..... \$9.95

## RF Power Booster



Add muscle to your signal, boost power up to 1 watt over a freq range of 100 KHz to over 1000 MHz! Use as a lab amp for signal generators, plus many foreign users employ the LPA-1 to boost the power of their FM transmitters, providing radio service through an entire town. Runs on 12 VDC. For a neat finished look, add the nice matching case set. Outdoor unit attaches right at the antenna for best signal - receiving or transmitting, weatherproof, too!

LPA-1, Power Booster Amplifier Kit ..... \$39.95  
CLPA, Matching Case Set for LPA-1 Kit ..... \$14.95  
LPA-1WT, Fully Wired LPA-1 with Case ..... \$99.95  
FMBA-1, Outdoor Mast Mount Version of LPA-1 ..... \$59.95

## FM Station Antennas

For maximum performance, a good antenna is needed. Choose our very popular dipole kit or the Comet, a factory made 5/8 wave colinear model with 3.4 dB gain. Both work great with any FM receiver or transmitter.

TM-100, FM Antenna Kit ..... \$39.95  
FMA-200, Vertical Antenna ..... \$114.95



Order Toll-free: 800-446-2295

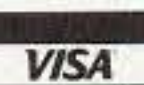
Sorry, no tech info, or order status at 800 number

For Technical Info, Order Status  
Call Factory direct: 716-924-4560

RAMSEY ELECTRONICS, INC.  
793 Canning Parkway Victor, NY 14564

See our complete catalog and order  
on-line with our secure server at:

www.ramseyelectronics.com



ORDERING INFO: Satisfaction Guaranteed. Examine for 10 days, if not pleased, return in original form for refund. Add \$6.95 for shipping, handling and insurance. Orders under \$20, add \$3.00. NY residents add 7% sales tax. Sorry, no CODs. Foreign orders, add 20% for surface mail or use credit card and specify shipping method.



# NEVER SAY DIE

Wayne Green W2NSD/1

w2nsd@aol.com  
www.waynegr.com



## Dayton 2001

In cleaning out my files for the new century, I ran across a four-year-old letter from a Dayton Hamvention assistant chairman asking for suggestions. Of course I offered a bunch. Far's I know, none of 'em were ever implemented.

For instance, I suggested they do a survey of their attendees to find out what they enjoyed the most and liked the least about the Hamvention — just as manufacturers survey customers on their products. Did they attend any talks? How would they rate them? What did they buy? About how much did they spend? A survey of the exhibitors would ask what they liked best and what least, and how the Hamvention might be made better for them. How did they do? The flea market exhibitors should also be surveyed.

These surveys would enable the convention committee to improve the product, plus give 'em added ammunition to convince more companies to exhibit.

I suggested that the Hamvention could be used as a sales pitch for the hobby — promoting their show in the local newspapers, TV, and radio shows, aimed at youngsters, and encouraging local ham groups to set up displays which would demonstrate our various special interests such as repeaters, DXing, slow-scan, packet, hamsats, and so on. We've got a ton of excitement and adventure to sell, but we've been keeping it a secret.

How about several tethered balloon rides so attendees could take pictures from two or three hundred feet up?

Most of the ham superstars have died recently — Barry Goldwater, Jean Shepherd, King Hussein — but how about getting Art Bell to give a talk? How about Walter Cronkite?

Something needs to be done by committees to make their hamfests more exciting so they'll be better attended. PR takes work but, unlike advertising, it's free. Where I've been asked to give hamfest talks I've offered to get there a couple of days early and help with radio and TV talk shows. Having been a radio DJ and a TV producer-director, I have no problem with these media. You can get a free sample by listening to archive recordings of my guest appearances on the Coast To Coast AM radio show via [www.coasttocoast.com] and Real Audio.

Hamfests and ham conventions have to be kept in tune with the times, like any other product or service. Alas, in my experience, hamfests have changed little in the last 60 years.

## Transfusions

Doctors are doing millions of blood transfusions every year, and I'll bet you're completely convinced that this is a good, lifesaving procedure. My advice? Do everything you can to avoid one!

I used to work in an office on 43rd Street in Manhattan. On the floor below our publishing offices was a blood bank, so I got a good look at their clientele over the five years I worked there — and it was mostly homeless winos, getting enough money for another bottle of the cheapest wine they could find.

As I've mentioned, every cell in your body, and that includes every cell in your blood, is in constant contact with every other cell, even when separated from you by thousands of miles. When you get a transfusion of someone else's blood, you're getting a part of them integrated into your mind/body system, and not just your body. You'll also get a good collection of any poisons they were carrying around, such as alcohol, nicotine, caffeine, and any other drugs, viruses, microbes, parasites, fungi, or yeasts in their blood. And maybe some toxic metals, too.

If you think I'm exaggerating, you haven't bothered to read *The Secret Life of Your Cells* yet. I've reviewed it in my editorial, and in my *Secret Guide to Wisdom*.

Even though the new blood is the same type as yours, it is from another person and your immune system will get busy eliminating the invader. That's just what you need at a time when you need all of the strength your immune system can muster to help you recover from whatever caused the doctors to give you the transfusion.

If you have made any effort to develop your psychic ability, once you've had a transfusion you'll be able to pick up many of the thoughts and feelings of the person from whom you've received the blood. One woman wrote a book about an organ transplant where she was able to sense the name of the donor and feel his feelings. And thousands of people have reported

weird things resulting from blood transfusions. A recent lab test with cells from an athlete's heart beat exactly in pace with his heart as he walked and ran, even though he was miles away.

## School Report

In Virginia, reformers, in an effort to improve their schools, required that at least 70% of the students pass the state exams or a school would lose its accreditation. When only 7% passed the exams, the requirement was quietly thrown out.

In Arizona, its requirements were withdrawn when only 10% of high school sophomores passed a new math exam. And Wisconsin had to cancel a test students were supposed to pass before they could graduate.

Our public schools are getting worse and worse.

The education establishment is being run by educators who don't know how to educate, and teachers who don't know how or what to teach. As long as school-teachers and administrators are coming from the bottom 20% of high school students, have union-guaranteed tenure, and pay that has no connection to their performance, nothing is going to change — other than our kids are going to continue to get poorer and poorer educations.

This is a cancer which is slowly making America less and less competitive in a world where lowering communications

Continued on page 8



# Big Savings on Radio Scanners

## Uniden® NEW!



### Bearcat® 780XLT Trunk Tracker III

Mfg. suggested list price \$529.95

**Less -\$190 Instant Rebate / Special \$339.95**

500 Channels • 10 banks • CTCSS/DCS • S Meter

Size: 7<sup>5/8</sup>" Wide x 6<sup>15/16</sup>" Deep x 2<sup>13/16</sup>" High

Frequency Coverage: 25.0000-512.0000 MHz., 806.000-

823.9875MHz., 849.0125-868.9875 MHz., 894.0125-1300.000 MHz.

The Bearcat 780XLT has 500 channels and the widest frequency coverage of any Bearcat scanner ever. Packed with features such as Trunktracker III to cover EDACS, Motorola and EF Johnson systems, control channel only mode to allow you to automatically trunk certain systems by simply programming the control channel, S.A.M.E. weather alert, full-frequency display & backlit controls, built-in CTCSS/DCS to assign analog and digital subaudible tone codes to a specific frequency in memory, PC Control with RS232 port, Beep Alert, Record function, VFO control, menu-driven design, total channel control and much more. Our CEI package deal includes telescopic antenna, AC adapter, cigarette lighter cord, DC cord, mobile mounting bracket with screws, owner's manual, trunking frequency guide and one-year limited Uniden factory warranty. For maximum scanning enjoyment, order magnetic mount antenna part number ANTMMBNC for \$29.95; The BC780XLT comes with AC adapter, telescopic antenna, owner's manual and one year limited Uniden warranty. Not compatible with AGEIS, ASTRO or ESAS systems. For fastest delivery, order on-line at [www.usascan.com](http://www.usascan.com).

### Bearcat® 895XLT Trunk Tracker

Mfg. suggested list price \$499.95

**Less -\$320 Instant Rebate / Special \$179.95**

300 Channels • 10 banks • Built-in CTCSS • S Meter

Size: 10<sup>1/2</sup>" Wide x 7<sup>1/2</sup>" Deep x 3<sup>3/8</sup>" High

Frequency Coverage: 29.000-54.000 MHz., 108.000-174

MHz., 216.000-512.000 MHz., 806.000-823.995 MHz., 849.0125-

868.995 MHz., 894.0125-956.000 MHz.

The Bearcat 895XLT is superb for intercepting trunked communications transmissions with features like TurboScan™ to search VHF channels at 100 steps per second. This base and mobile scanner is also ideal for intelligence professionals because it has a Signal Strength Meter, RS232C Port to allow computer-control of your scanner via optional hardware and 30 trunking channel indicator annunciators to show you real-time trunking activity for an entire trunking system. Other features include Auto Store - Automatically stores all active frequencies within the specified bank(s). Auto Recording - Lets you record channel activity from the scanner onto a tape recorder. CTCSS Tone Board (Continuous Tone Control Squelch System) allows the squelch to be broken during scanning only when a correct CTCSS tone is received. For maximum scanning enjoyment, order the following optional accessories: PS001 Cigarette lighter power cord for temporary operation from your vehicle's cigarette lighter \$14.95; PS002 DC power cord - enables permanent operation from your vehicle's fuse box \$14.95; MB001 Mobile mounting bracket \$14.95; EX711 External speaker with mounting bracket & 10 feet of cable with plug attached \$19.95. The BC895XLT comes with AC adapter, telescopic antenna, owner's manual and one year limited Uniden warranty. Not compatible with AGEIS, ASTRO, EDACS, ESAS or LTR systems.



## SCANNERS

### Bearcat® 245XLT Trunk Tracker II

Mfg. suggested list price \$429.95/CEI price \$189.95

300 Channels • 10 banks • Trunk Scan and Scan Lists

Trunk Lockout • Trunk Delay • Cloning Capability

10 Priority Channels • Programmed Service Search

Size: 2<sup>1/2</sup>" Wide x 1<sup>3/4</sup>" Deep x 6" High

Frequency Coverage:

29.000-54.000 MHz., 108-174 MHz., 406-512 MHz., 806-823.995

MHz., 849.0125-868.995 MHz., 894.0125-956.000 MHz.

Our Bearcat TrunkTracker BC245XLT, is the world's first scanner designed to track Motorola Type I, Type II, Hybrid, SMARTNET, PRIVACY PLUS and EDACS® analog trunking systems on any band. Now, follow UHF High Band, UHF 800/900 MHz trunked public safety and public service systems just as if conventional two-way communications were used. Our scanner offers many new benefits such as Multi-Track - Track more than one trunking system at a time and scan conventional and trunked systems at the same time. 300 Channels - Program one frequency into each channel. 12 Bands, 10 Banks - Includes 12 bands, with Aircraft and 800 MHz. 10 banks with 30 channels each are useful for storing similar frequencies to maintain faster scanning cycles or for storing all the frequencies of a trunked system. Smart Scanner - Automatically program your BC245XLT with all the frequencies and trunking talk groups for your local area by accessing the Bearcat national database with your PC. If you do not have a PC simply use an external modem. Turbo Search - Increases the search speed to 300 steps per second when monitoring frequency bands with 5 KHz. steps. 10 Priority Channels - You can assign one priority channel in each bank. Assigning a priority channel allows you to keep track of activity on your most important channels while monitoring other channels for transmissions. Preprogrammed Service (SVC) Search - Allows you to toggle through preprogrammed police, fire/emergency, railroad, aircraft, marine, and weather frequencies. Unique Data Skip - Allows your scanner to skip unwanted data transmissions and reduces unwanted birdies. Memory Backup - If the battery completely discharges or if power is disconnected, the frequencies programmed in your scanner are retained in memory. Manual Channel Access - Go directly to any channel. LCD Back Light - An LCD light remains on for 15 seconds when the back light key is pressed. Autolight - Automatically turns the backlight on when your scanner stops on a transmission. Battery Save - In manual mode, the BC245XLT automatically reduces its power requirements to extend the battery's charge. Attenuator - Reduces the signal strength to help prevent signal overload. The BC245XLT also works as a conventional scanner. Now it's easy to continuously monitor many radio conversations even though the message is switching frequencies. The BC245XLT comes

with AC adapter, one rechargeable long life ni-cad battery pack, belt clip, flexible rubber antenna, earphone, RS232C cable, Trunk Tracker frequency guide, owner's manual and one year limited Uniden warranty. Not compatible with AGEIS, ASTRO, ESAS or LTR systems. Hear more action on your radio scanner today. Order on-line at [www.usascan.com](http://www.usascan.com) for quick delivery.



with AC adapter, one rechargeable long life ni-cad battery pack, belt clip, flexible rubber antenna, earphone, RS232C cable, Trunk Tracker frequency guide, owner's manual and one year limited Uniden warranty. Not compatible with AGEIS, ASTRO, ESAS or LTR systems. Hear more action on your radio scanner today. Order on-line at [www.usascan.com](http://www.usascan.com) for quick delivery.

### More Radio Products

Save even more on radio scanners when purchased directly from CEI. Your CEI price after instant rebate is listed below:

Bearcat 895XLT 300 ch. Trunktracker I base/mobile scanner.....	\$179.95
Bearcat 780XLT 500 ch. Trunktracker III base/mobile.....	\$339.95
Bearcat 278CLT 100 ch. AM/FM/SAME WX alert scanner.....	\$159.95
Bearcat 245XLT 300 ch. Trunktracker II handheld scanner.....	\$189.95
Bearcat 248CLT 50 ch. base AM/FM/weather alert scanner.....	\$89.95
Bearcat Sportcat 200 alpha handheld sports scanner.....	\$169.95
Bearcat Sportcat 180B handheld sports scanner.....	\$149.95
Bearcat 80XLT 50 channel handheld scanner.....	\$99.95
Bearcat 60XLT 30 channel handheld scanner.....	\$74.95
Bearcat BCT7 information mobile scanner.....	\$139.95
AOR AR8200 Mark II Wide Band handheld scanner.....	\$539.95
AOR AR16BQ Wide Band scanner with quick charger.....	\$209.95
ICOM ICR8500 wideband communications receiver.....	\$1,469.95
ICOM PCR1000 computer communications receiver.....	\$379.95
ICOM R10 handheld wideband communications receiver.....	\$279.95
Uniden WX100 Weather Alert with S.A.M.E. feature.....	\$49.95

## AOR

### AOR® AR8200 Mark IIB Radio Scanner

AOR8200 Mark IIB-A wideband handheld scanner/SPECIAL \$539.95

1,000 Channels • 20 banks • 50 Select Scan Channels

PASS channels: 50 per search bank + 50 for VFO search

Frequency step programmable in multiples of 50 Hz.

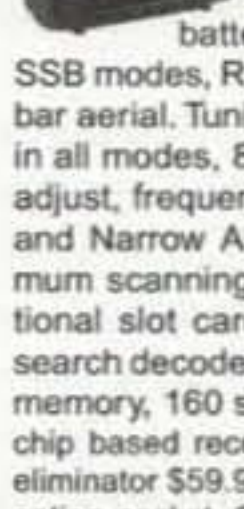
Size: 2<sup>1/2</sup>" Wide x 1<sup>3/8</sup>" Deep x 6<sup>1/8</sup>" High

Frequency Coverage:

500 KHz to 823.995 MHz, 849.0125-868.995 MHz, 894.0125-2,040.000 MHz

(Full coverage receivers available for export and FCC approved users.)

The AOR AR8200 Mark IIB is the ideal handheld radio scanner for communications professionals. It features all mode receive: WFM, NFM, SFM (Super Narrow FM), WAM, AM, NAM (wide, standard, narrow AM), USB, LSB & CW. Super narrow FM plus Wide and Narrow AM in addition to the standard modes. The AR8200 also has a versatile multi-function band scope with save trace facility, twin frequency readout with bar signal meter, battery save feature with battery low legend, separate controls for volume and squelch, arrow four way side rocker with separate main tuning dial, configurable keypad beep/illumination and LCD contrast, write protect and keypad lock, programmable scan and search including LINK, FREE, DELAY, AUDIO, LEVEL, MODE, computer socket fitted for control, clone and record, Flash-ROM no battery required memory, true carrier re-insertion in SSB modes, RF preselection of mid VHF bands, Detachable MW bar aerial. Tuning steps are programmable in multiples of 50 Hz in all modes. 8.33 KHz airband step correctly supported, Step-adjust, frequency offset, AFC, Noise limited & attenuator, Wide and Narrow AM in addition to the standard modes. For maximum scanning pleasure, you can add one of the following optional slot cards to this scanner: CT8200 CTCSS squelch & search decoder \$89.95; EM8200 External 4,000 channel backup memory, 160 search banks. \$69.95; RU8200 about 20 seconds chip based recording and playback \$69.95; TE8200 256 step tone eliminator \$59.95. In addition, two leads are available for use with the option socket. CC8200 PC control lead with CD Rom programming software \$109.95; CR8200 tape recording lead \$59.95. Includes 4 1,000 mAh AA ni-cad batteries, charger, cigar lead, whip aerial, MW bar antenna, belt hook, strap and one year limited AOR warranty. Enter your order now at <http://www.usascan.com>.



### Buy with Confidence

#### Order on-line and get big savings

For over 32 years, millions of communications specialists and enthusiasts worldwide have trusted Communications Electronics for their mission critical communications needs. It's easy to order. For fastest delivery, order on-line at [www.usascan.com](http://www.usascan.com). Mail orders to: Communications Electronics Inc., P.O. Box 1045, Ann Arbor, Michigan 48106 USA. Add \$20.00 per radio transceiver for UPS ground shipping, handling and insurance to the continental USA. Add \$13.00 shipping for all accessories and publications. For Canada, Puerto Rico, Hawaii, Alaska, Guam, P.O. Box or APO/FPO delivery, shipping charges are two times continental US rates. Michigan residents add sales tax. No COD's. Your satisfaction is guaranteed or return item in unused condition in original packaging within 61 days for refund, less shipping, handling and insurance charges. 10% surcharge for net 10 billing to qualified accounts. All sales are subject to availability, acceptance and verification. Prices, terms and specifications are subject to change without notice. We welcome your Discover, Visa, American Express, MasterCard, IMPAC or Eurocard. Call anytime 1-800-USA-SCAN or 800-872-7226 to order toll-free. Call 734-996-8888 if outside Canada or the USA. FAX anytime, dial 734-663-8888. Dealer and international inquiries invited. Order your radio scanners from Communications Electronics Inc. today at [www.usascan.com](http://www.usascan.com).

For credit card orders call  
**1-800-USA-SCAN**

e-mail: [cei@usascan.com](mailto:cei@usascan.com)

[www.usascan.com](http://www.usascan.com)

PO Box 1045, Ann Arbor, Michigan 48106-1045 USA

For information call 734-996-8888 or FAX 734-663-8888

Price schedule effective March 2, 2001 AD #03020173 © 2001 Communications Electronics Inc.



**COMMUNICATIONS  
ELECTRONICS INC.**

Emergency Operations Center

Visit [WWW.USASCAN.COM](http://WWW.USASCAN.COM) • 1-800-USA-SCAN



continued from page 1

group that runs ARISS. Frank will be joined by Gaston Bertels ON4WF as Vice Chair and Rosalie White K1STO as Secretary-Treasurer. Those names should sound familiar. Frank is a Vice President of AMSAT and Rosalie is an executive at the ARRL; both were key players in SAREX, the Space Amateur Radio Experiment that led to the formation of ARISS.

In final, approved form, the ARISS station will continue on the air with the present equipment and antenna in the FGB section of ISS *Alpha*. The crew currently is using voice on 2 meters. They plan to fire up packet operation in the next week or so.

Frequencies for public contacts are 145.800 packet and voice downlink and 145.990 packet uplink. Other uplinks can be found in the ARISS Web page. Call letters are NA1SS and RZ3DZR. The Russians are trying to change the latter to RSØISS.

Russia's Chief Delegate, Sergej Samburov RV3DR, was given approval to send up another station next spring, using upgraded *MIR* hardware to be installed in the Service Module. Slow Scan TV, being developed in the U.S. by a team led by Miles Mann WF1F, with hardware support from Lou McFadin W5DID, also should be activated at that time.

Future plans involving the Habitation Module and a remote station in an Express Pallet on the outside of the ISS were channeled to member nations for processing and evolution.

There was much discussion of school contacts and third-party traffic. It was agreed that this is one of the most important aspects of ARISS. The first school contact was to be set up as soon as possible. ARISS hopes that the astronauts'/cosmonauts' busy schedule may accommodate a school contact a week, once the station settles into routine operation.

The delegates even agreed on a QSL card. It's a beauty, complete with a cover picture of the International Space Station, the permanent home in space for amateur radio.

Thanks to Roy Neal K6DUE, via Newsline, Bill Pasternak WA6ITF, editor.

---

## Eye in the Sky: Your QTH from Space

Ever wonder what your home QTH would look like if you were trying to view it from Earth orbit? Well, now you can find out without ever leaving your hamshack, if it has a connection to the Internet.

All you have to do is take your Web browser over to [www.globexplorer.com]. Globexplorer is one word. Then click in the word explore and enter your complete address in the area provided. Click the go button, and in less than a minute you will be looking at your neighborhood from

space. And if you are not satisfied with what you see, you can zoom in or slew the picture in just about any direction. And some of the photos are so good that large antenna systems are visible.

Thanks to Jim Damron N8TMW, via Newsline, Bill Pasternak WA6ITF, editor.

---

## FAR Scholarships

The Foundation for Amateur Radio, Inc., a nonprofit organization with headquarters in Washington, DC, plans to administer 67 scholarships for the academic year 2001-2002 to assist licensed radio amateurs. The Foundation, composed of over 75 local area amateur radio clubs, fully funds 10 of these scholarships with the income from grants and its annual hamfest. The remaining 57 are administered by the Foundation without cost to the various donors.

Licensed radio amateurs may compete for these awards if they plan to pursue a full-time course of studies beyond high school and are enrolled in or have been accepted for enrollment at an accredited university, college, or technical school. The awards range from \$500 to \$2,500 with preference given in some cases to residents of specified geographical areas or the pursuit of certain study programs. Clubs, especially those in Delaware, Florida, Maryland, Ohio, Pennsylvania, Texas, Virginia, and Wisconsin, are encouraged to announce these opportunities at their meetings, in their club newsletters, during training classes, on their nets, and on their World Wide Web home pages.

Additional information and an application form may be requested by letter or QSL card, postmarked prior to April 30, 2001, from FAR Scholarships, P.O. Box 831, Riverdale MD 20738.

The Foundation for Amateur Radio, incorporated in the District of Columbia, is an exempt organization under Section 501(C)(3) of the Internal Revenue Code of 1954. It is devoted exclusively to promoting the interests of amateur radio and those scientific, literary, and educational pursuits that advance the purposes of the Amateur Radio Service.

Thanks to FAR for this news item as well as all their efforts.

---

## The Many Lives of Iridium

Motorola's seemingly doomed constellation of Iridium low Earth orbiting telecommunications satellites has gotten a new lease on life. This, as the U.S. Department of Defense signs a two year 72 million dollar contract with the newly formed Iridium Satellite LLC to keep the satellites in orbit and functional.

Under the agreement, Iridium Satellite has contracted with Boeing to take over operation of the 66-satellite cluster from Motorola. Iridium Satellite LLC will then market their services to

commercial users as well as to the U.S. military and other government users. The State Department already owns 2,000 Iridium handsets for use in remote spots on humanitarian missions.

Thanks to Newsline, Bill Pasternak WA6ITF, editor.

---

## Ham-Palm

Thanks to Jeff Davis N9AVG, you can now catch up on the latest ham radio news over your PalmPilot. All you need do is visit [www.callingcq.org] and subscribe to the new AvantGO channel titled "CALLING CQ." Then, each time you sync your Palm OS or Win CE device, you'll receive the most comprehensive news and information available for amateur radio enthusiasts.

Thanks to N9AVG, via Newsline, Bill Pasternak WA6ITF, editor.

---

## DARA Scholarships

The Dayton Amateur Radio Association is now accepting requests for their annual scholarships. These scholarships are awarded in varying amounts up to \$2,000. An applicant for a DARA scholarship must be a graduating high school senior in 2001 and must also hold a valid United States-issued FCC amateur license. To find out more or obtain an application, please send a self-addressed stamped envelope to DARA Scholarships, 45 Cinnamon Court, Springboro OH 45066. Completed applications must be postmarked no later than June 1st, 2001.

Thanks to DARA, via Newsline, Bill Pasternak WA6ITF, editor.

---

## CQ de CO2KK

On the international scene, famed Cuban VHF DXer and *CQ Magazine* writer Arnie Coro CO2KK continues to host a radio program called CQ DX Unlimited. Arnie's show is broadcast in English over Radio Havana Cuba and is aimed mainly at shortwave listeners and beginners in amateur radio. CQ DX Unlimited is broadcast on Tuesdays at 2115 to 2130 UTC on 13.750 MHz AM and on 13.660 MHz SSB. Be sure to listen in.

Thanks to G4NJH, via Newsline, Bill Pasternak WA6ITF, editor.

---

## Ham Radio History Remailer

The Ham Radio History E-mail reflector was founded in September of 1998 in an effort to research and preserve as much of ham radio's past

Continued on page 61



# MFJ TUNERS

## MFJ-989C Legal Limit Antenna Tuner

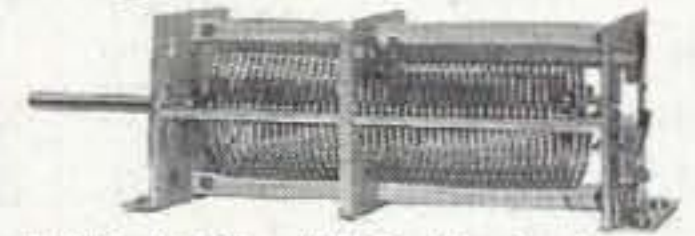
MFJ uses super heavy duty components to make the world's finest legal limit tuner

MFJ uses super heavy duty components -- roller inductor, variable capacitors, antenna switch and balun -- to build the world's most popular high power antenna tuner.

The rugged world famous MFJ-989C handles 3 KW PEP SSB amplifier input power (1500 Watts PEP SSB output power). Covers 1.8 to 30 MHz, including MARS and WARC bands.

MFJ's AirCore™ roller inductor, new gear-driven turns counter and weighted spinner knob gives you exact inductance control for absolute minimum SWR.

You can match dipoles, verticals, inverted vees, random wires, beams, mobile whips,



MFJ AirCore™ Roller Inductor gives high-Q, low loss, high efficiency and high power handling.

MFJ's exclusive Self-Resonance Killer™ keeps damaging self-resonances away from your operating frequency.

Large, self-cleaning wiping contact gives good low-resistance connection. Solid 1/4 inch brass shaft, self-align bearings give smooth non-binding rotation.

MFJ No Matter What™ Warranty

MFJ will repair or replace your MFJ-989C (at our option) no matter what for one year.

shortwave -- nearly any antenna. Use coax, random wire or balanced lines.

You get everything you've ever wanted in a high power, full featured antenna tuner -- widest matching range, lighted Cross-

MFJ-989C  
**\$359<sup>95</sup>** Needle SWR/Wattmeter, massive transmitting variable capacitors, ceramic antenna switch, built-in dummy load, TrueCurrent™ Balun, scratch-proof Lexan front panel -- all in a sleek compact cabinet (10 3/4"Wx4 1/2"Hx15"D in).

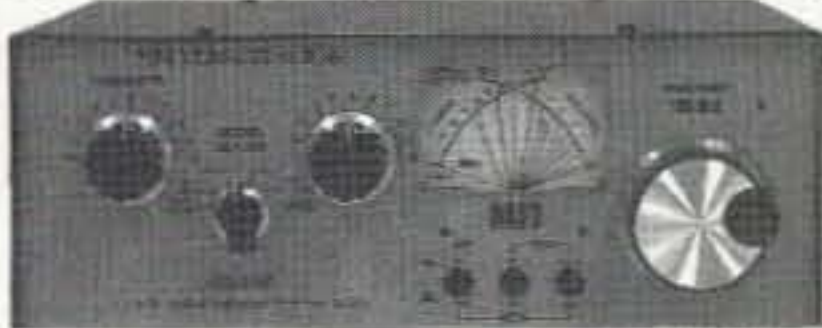
**More hams use MFJ tuners than all other tuners in the world!**

### MFJ-986 Two knob Differential-T™



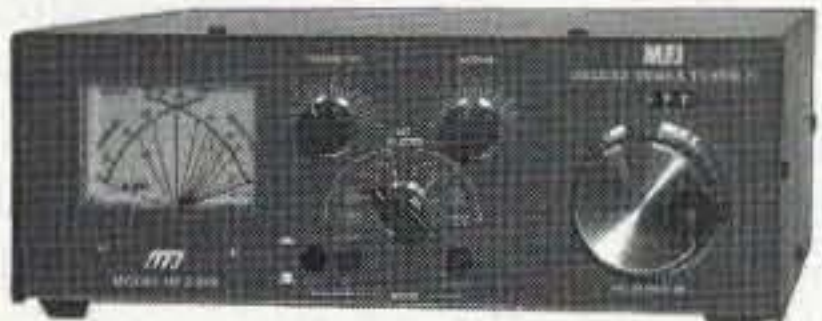
Two knob tuning (differential capacitor and AirCore™ roller inductor) makes tuning foolproof and easier than ever. Gives minimum SWR at only one setting. Handles 3 KW PEP SSB amplifier input power (1.5 KW output). Gear-driven turns counter, lighted peak/average Cross-Needle SWR/Wattmeter, antenna switch, balun. 1.8 to 30 MHz. 10 3/4"Wx4 1/2"Hx15 in.

### MFJ-962D compact Tuner for Amps



A few more dollars steps you up to a KW tuner for an amp later. Handles 1.5 KW PEP SSB amplifier input power (800W output). Ideal for Ameritron's AL-811H! AirCore™ roller inductor, gear-driven turns counter, pk/avg lighted Cross-Needle SWR/Wattmeter, antenna switch, balun, Lexan front, 1.8-30MHz. 10 3/4"Wx4 1/2"Hx10 7/8 in.

### MFJ-969 300W Roller Inductor Tuner



Superb AirCore™ Roller Inductor tuning. Covers 6 Meters thru 160 Meters! 300 Watts PEP SSB. Active true peak reading lighted Cross-Needle SWR Wattmeter, QRM-Free PreTune™, antenna switch, dummy load, 4:1 balun, Lexan front panel. 3 1/2"Hx10 1/2"Wx9 1/2"D inches.

### MFJ-949E deluxe 300 Watt Tuner

More hams use MFJ-949s than any other antenna tuner in the world! Handles 300 Watts. Full 1.8 to 30 MHz coverage, 48 position Precision48™ inductor, 1000 Volt tuning capacitors, full size peak/average lighted Cross-Needle SWR/Wattmeter, 8 position antenna switch, dummy load, QRM-Free PreTune™, scratch proof Lexan front panel. 3 1/2"Hx10 3/8"Wx7"D inches.

MFJ-948, \$129.95. Economy version of MFJ-949E, less dummy load, Lexan front panel.

### MFJ-941E super value Tuner

The most for your money! Handles 300 Watts PEP, covers 1.8-30 MHz, lighted Cross-Needle SWR/Wattmeter, 8 position antenna switch, 4:1 balun, 1000 volt capacitors, Lexan front panel. Sleek 10 1/2"Wx2 1/2"Hx7"D in.

### MFJ-945E HF+6 Meter mobile Tuner

Extends your mobile antenna bandwidth so you don't have to stop, go outside and adjust your antenna. Tiny 8x2x6 in. Lighted Cross-Needle SWR/Wattmeter. Lamp and bypass switches. Covers 1.8-30 MHz and 6 Meters. 300 Watts PEP. MFJ-20, \$4.95, mobile mount.

### MFJ-971 portable/QRP Tuner

Tunes coax, balanced lines, random wire 1.8-30 MHz. Cross-Needle Meter. SWR, 30/300 or 6 Watt QRP ranges. Matches popular MFJ transceivers. Tiny 6x6 1/2"x2 1/2" inches.

### MFJ-901B smallest Versa Tuner

MFJ's smallest (5x2x6 in.) and most affordable wide range 200 Watt PEP Versa tuner. Covers 1.8 to 30 MHz. Great for matching solid state rigs to linear amps.

### MFJ-16010 random wire Tuner

Operate all bands anywhere with MFJ's reversible L-network. Turns random wire into powerful transmitting antenna. 1.8-30 MHz. 200 Watts PEP. Tiny 2x3x4 in.

### MFJ-906/903 6 Meter Tuners

MFJ-906 has lighted Cross-Needle SWR/Wattmeter, bypass switch. Handles 100 W FM, 200W SSB. MFJ-903, \$49.95, Like MFJ-906, less SWR/Wattmeter, bypass switch.

### MFJ-921/924 VHF/UHF Tuners

MFJ-921 covers 2 Meters/220 MHz. MFJ-924 covers 440 MHz. SWR/Wattmeter. 8x2 1/2"x3 inches. Simple 2-knob tuning for mobile or base.

### MFJ-922 144/440 MHz Tuner

Ultra tiny 4x2 1/2"x1 1/4 inch tuner covers VHF 136-175 MHz and UHF 420-460 MHz. SWR/Wattmeter reads 60/150 Watts.

### MFJ-931 artificial RF Ground

Creates artificial RF ground. Also electrically places a far away RF ground directly at your rig by tuning out reactance of connecting wire. Eliminates RF hot spots, RF feedback, TVI/RFI, weak signals caused by poor RF grounding. MFJ-934, \$169.95, Artificial ground/300 Watt Tuner/Cross-Needle SWR/Wattmeter.

## Free MFJ Catalog

and Nearest Dealer . . . 800-647-1800

<http://www.mfjenterprises.com>

1 Year No Matter What™ warranty 30 day money back guarantee (less s/h) on orders from MFJ ENTERPRISES, INC. Box 494, Miss. State, MS 39762 (662) 323-5869; 8-4:30 CST, Mon.-Fri. FAX: (662) 323-6551; Add s/h Tech Help: (662) 323-0549

Prices and specifications subject to change. (c) 2000 MFJ Enterprises, Inc.



## NEVER SAY DIE

continued from page 6

and transportation costs are moving hundreds of thousands of jobs to lower-wage countries, which provide far-better-educated workforces.

The teachers' unions have rejected every effort to even test the teaching systems which have been producing amazing results in some experimental schools. Hmm, why does that remind me of the medical establishment refusing to allow tests of therapies which have been shown to have great promise?

But, hey, as long as you don't care what the schools are doing to your kids, nothing is going to change. No, there will be change, but it will be, as in the past, change for the worse.

Rome distracted its citizens with games while their civilization was crumbling. We're busy with ball games, TV talk shows, and the political rhetoric of election campaigns. Let's get more Christians and lions into the arenas.

Maybe you read about the dozens of New York City teachers and principals who were found to be helping students to cheat on tests in order to make their schools look better?

### Yes, More Aspartame News

One young woman had been paralyzed from the waist down by a car accident. But as a regular drinker of "Diet Coke" or Pepsi with aspartame (NutraSweet) in it, she was soon paralyzed from the neck down. Then there was a young boy who had become brain damaged by diet sodas containing aspartame. Not everyone becomes brain damaged or semi-paralyzed to the extent that it's immediately and dramatically noticeable — we all have different susceptibilities, different detoxing capabilities — but why knowingly put a proven poison in your body? We unknowingly put in enough as it is. The damage can well be cumulative and show up later.

## Boners

Our politicians have pulled some incredible boners during the 20th century. Like what? Like rent control, for instance. This socialist dream has done more to ruin cities than poverty or drugs. It's destroyed much of the Bronx, Paris, and other cities around the world. The president of Vietnam said that low rents had done more damage to Hanoi than all of the American bombing.

Like price controls, which in every instance have resulted in prices skyrocketing. When manufacturers find their profits on a product are falling, they "improve" the product and bring it out at a higher price.

Like prohibition, which brought us the Mafia and organized crime, which is flourishing just fine today, thank you, and in all sorts of businesses. I found them a controlling force in newsstand distribution and making sure the bigger radio stations only played the music of the major labels.

Then there's the so-called War on Poverty. What a joke. And the War on Drugs, which has built a new group of wealthy criminals, plus billions for the bribery of tens of thousands of police, attorneys, judges, and customs agents.

I'm open for your nominations for other worst ideas of the 20th century. Get your word processor going and snail- or E-mail me at w2nsd@aol.com.

### Buying Radios

If you or a friend are in the market for a shortwave receiver, you want to make an educated buy, so you won't get hornswoggled. There seems to be an unlimited supply of hornswogglers, so you need to approach the situation not too information-challenged.

I don't know about you, but I keep a radio which includes shortwave coverage at my bedside, so I can check out a couple of the more interesting shortwave stations, check the CHU time ticks, and see who

Coast-To-Coast AM has on for a guest. My instrument of choice for this is the Sony ICF-SW1. It's 3x5x1 inches, weighs a half a pound, and covers BC-SW-FM — 150–30,000 kHz, 76–108 MHz. Of course, it goes with me on trips.

So, when you're shopping the flea markets, the ham rag classifieds, or the WWW, you need Fred Osterman's N8EKU *Buying a Used Shortwave Receiver* book. It's \$6 (+\$2 s/h), 78 pages, and gives a description of 100 of the most popular radios, complete with used prices. If you can't find the book at your local radio store, write Universal Radio, 6830 Americana Pkwy, Reynoldsburg OH 43068. You might even splurge another \$2 for their 108-page catalog. It's a beaut.

### Prayer Works

Yep, they've double-blind-proven it scientifically. Read Robert Miller's *Miracles In The Making*, Ariel Press, 289 South Main Street #205, Alpharetta GA 30201, 128pp., \$10. I watched a video of one of the experiments described in this book at a Subtle Energies conference in Monterey (CA). That's where Olga Worrall, the noted psychic, lowered the surface tension of a jar of water just by putting her hands near it. Then, she was shown repeating this from over a thousand miles away while the camera ran.

This book is packed with the proof of prayer's power. In one experiment with a large group of people with high blood pressure, psychics were able to pray for half of them and substantially lower their blood pressure. No one in the group knew which of them were being prayed for and which weren't, so it wasn't any placebo effect.

I've reviewed several other books which prove that just wishing for something can make it happen, so this proof of the power of prayer isn't a big stretch.

This takes me back to Neil Slade's book, where he explains how simple it is to

manipulate clouds with your mind. You don't have to pray to God, to Jesus, to Allah, or to Mohammed. And it works just as well for atheists as the devout of any commercial religion.

### My Books

I hope you'll read my *Secret Guide to Health* and start changing your lifestyle so you'll be able to enjoy robust health. Then I hope that you'll do your best to get the word to people you care about, so they can regain their health. My editorials in 73 are a tiny lever, but with your help we can make thousands, and then millions of people healthier and wealthier. This business of spending a lifetime working at jobs — being a "worker" — is just one more way we've all been bamboozled. Send an SASE for a catalog of my publications to Wayne Green, Hancock NH 03449.

### We Wuz Robbed

Several of the books reviewed in my *Secret Guide to Wisdom* have to do with how bad our school system is, and how it got that way. In my "spare time" (har-de-har) I've been working on a book which has as its core my editorial essays on the subject, plus relevant material from my now-sold-out *Declare War!* book.

Our school system is both by far the most expensive in the world, and the worst, at least in the developed world. Our kids come in at the bottom on international tests.

I've complained that one result of this dumbing down process has been a lack of geniuses. I've noticed this particularly in the music field. When I turn to a classical music station I know almost immediately who the composer is, even if I'm not familiar with the piece. Beethoven, Wagner, Copland, and so on, all have their stamp on their music. It turns out that I'm not the only person to notice this phenomenon.

Continued on page 62



## HIGH QUALITY VHF & UHF EXCITER & RECEIVER MODULES

### FM EXCITERS:

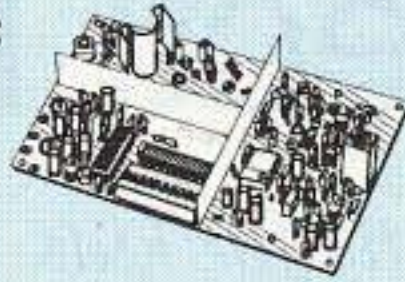
Rated for continuous duty, 2W continuous duty output.

**T301 Synthesized VHF Exciter:** for various bands 139-174MHz, 216-226 MHz. Dip switch freq. setting.

- Kit (ham bands only) ...\$109 (TCXO option \$40)
- Wired/tested, incl TCXO...\$189

**T304 Synthesized UHF Exciter:** various bands 400-470 MHz.

- Kit (440-450 ham band only) incl TCXO ...\$149
- Wired/tested...\$189



### CRYSTAL CONTROLLED:

- TA51: for 6M, 2M, 220 MHz ..... kit \$99, w/t \$169
- TA451: for 420-475 MHz. .... kit \$99, w/t \$169
- TA901: for 902-928 MHz, (0.5W out) ..... w/t \$169

### VHF & UHF POWER AMPLIFIERS.

Output levels from 10W to 100W..... Starting at \$99

### FM RECEIVERS:

Very sensitive - 0.2µV.

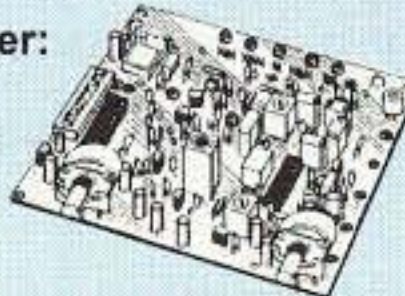
Superb selectivity, >100 dB down at ±12 kHz, best available anywhere, flutter-proof squelch.

**R301 Synthesized VHF Receiver:** various bands 139-174MHz, 216-226 MHz.

- Kit (ham bands only) ...only \$139 (TCXO option \$40)
- Wired/tested ...\$209 (includes TCXO)

**R304 Synthesized UHF Receiver:** various bands 400-470MHz.

- Kit (440-450 ham band only) incl TCXO ...\$179
- Wired/tested...\$209



### CRYSTAL CONTROLLED:

- R100 RCVR. For 46-54, 72-76, 140-175, or 216-225 MHz. .... kit \$129, w/t \$189
- R144 RCVR. Like R100, for 2M, with helical resonator in front end..... kit \$159, w/t \$219
- R451 RCVR, for 420-475 MHz. Similar to R100 above. .... kit \$129, w/t \$189
- R901 RCVR, 902-928MHz ..... kit \$159, w/t \$219

### SUBAUDIBLE TONE ENCODER/DECODER



Access all your favorite closed repeaters!

- Encodes all standard CTCSS tones with crystal accuracy and convenient DIP switch selection.

• Decoder can be used to mute receive audio and is optimized for installation in repeaters to provide closed access. High pass filter gets rid of annoying rcvr buzz.

- TD-5 CTCSS Encoder/Decoder Kit .....now only \$39
- TD-5 CTCSS Encoder/Decoder Wired/tested.....\$59

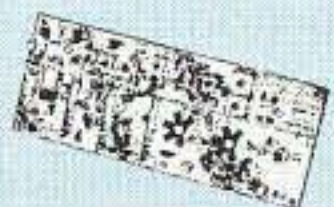
### TRANSMITTING & RECEIVING CONVERTERS

No need to spend thousands on new transceivers for each band!



- Convert vhf and uhf signals to & from 10M.
- Even if you don't have a 10M rig, you can pick up very good used xmtrs & rcvrs for next to nothing.
- Receiving converters (shown above) available for various segments of 6M, 2M, 220, and 432 MHz.
- Rcvg Conv Kits from \$49, wired/tested units only \$99.

- Transmitting converters for 2M, 432 MHz.
- Kits only \$89 vhf or \$99 uhf.
- Power amplifiers up to 50W.



Buy at low, factory-direct net prices and save!  
For complete info, call or write for complete catalog.  
Order by mail, email, or phone (9-12, 1-5 eastern time).  
Min. \$6 S&H charge for 1" lb. plus add'l weight & insurance.  
Use Visa, MC, Discover, check, or UPS C.O.D.

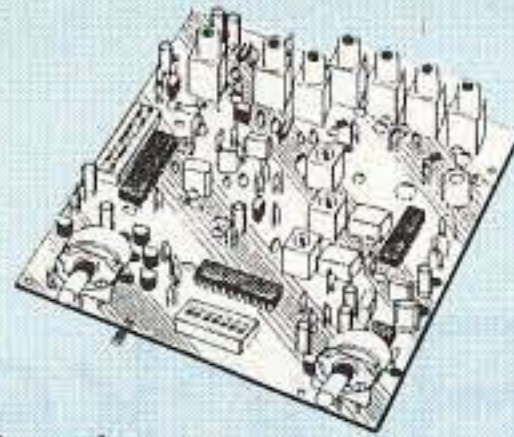
## R121 AVIATION RECEIVER



Exciting new AM receiver for the 118-137 MHz aircraft band.

- Ideal for monitoring at small airports.
- Allows pilot control of runway lighting.
- High-quality ELT monitor to detect and locate downed aircraft.
- Dip switch frequency selection.
- Superior sensitivity and selectivity.

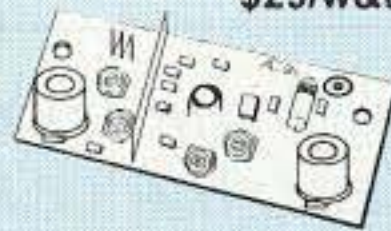
R121 Receiver module wired/tested .....\$209  
R121 Receiver in A87 cabinet .....\$299



### LOW NOISE RECEIVER PREAMPS

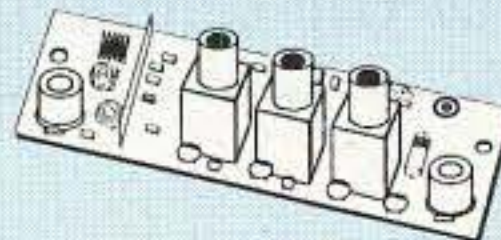
#### LNY-( ) ECONOMY PREAMP ONLY \$29/w&t

- Miniature MOSFET Preamp.
- Low noise figure.
- Available for various bands from 28 to 450 MHz.



#### LNP-( ) PRESELECTOR ONLY \$39/w&t

- Eliminate intermod!
- Low noise preamp
- Sharp 3-section filter
- Available for bands from 137 to 170 MHz.



#### LNG-( ) GAAs FET PREAMP

STILL ONLY \$59, wired/tested

Available for 28-30, 46-56, 137-152, 152-172, 210-230, 400-470, and 800-960 MHz bands.

### WEATHER FAX RECEIVER

Join the fun. Get striking images directly from the weather satellites!

A very sensitive wideband fm receiver optimized for NOAA APT & Russian Meteor weather fax on the 137MHz band.

Covers all 5 satellite channels. Scanner circuit & recorder control allow you to automatically capture signals as satellites pass overhead, even while away from home.

See product review with actual satellite pictures in June 1999 QST, along with info on software and antennas.

- R139 Receiver Kit less case .....\$159
- R139 Receiver Kit with case and AC power adapter \$189
- R139 Receiver w/t in case with AC power adapter ...\$239
- Internal PC Demodulator Board & Imaging Software \$289
- Turnstile Antenna .....\$135
- Weather Satellite Handbook .....\$20



### WWW RECEIVER

Get time & frequency checks without buying multiband hf rcvr. Hear solar activity reports affecting radio propagation.

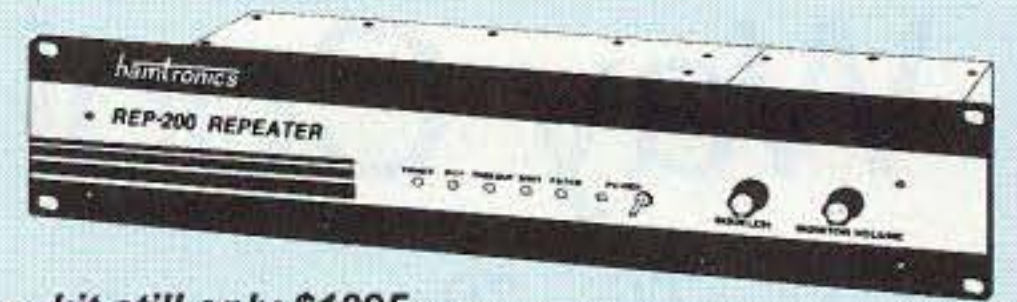
Very sensitive and selective crystal controlled superhet, dedicated to listening to WWW on 10 MHz. Performance rivals the most expensive rcvrs.

- RWWV Rcvr kit, PCB only .....\$59
- RWWV Rcvr kit with cabt, spkr, & 12Vdc adapter .....\$89
- RWWV Rcvr w/t in cabt with spkr & adapter .....\$129



## Get more features for your dollar with our REP-200 REPEATER

A microprocessor-controlled repeater with full autopatch and many versatile dtmf remote control features at less than you might pay for a bare bones repeater or controller alone!



- kit still only \$1095
- factory assembled still only \$1295

50-54, 143-174, 213-233, 420-475 MHz.

FCC type accepted for commercial service in 150 & 450 MHz bands.

Digital Voice Recorder Option. Allows message up to 20 sec. to be remotely recorded off the air. Play back at user request by DTMF command, or as a periodical voice id, or both. Great for making club announcements! .....only \$100

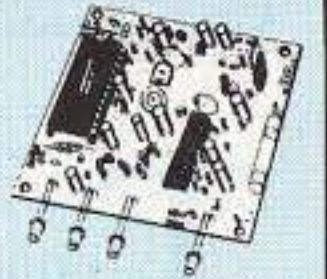
REP-200C Economy Repeater. Real-voice ID, no dtmf or autopatch. .... Kit only \$795, w&t \$1195

REP-200N Repeater. Without controller so you can use your own. .... Kit only \$695, w&t \$995

### You'll KICK Yourself If You Build a Repeater

Without Checking Out Our Catalog First!

Hamtronics has the world's most complete line of modules for making repeaters. In addition to exciters, pa's, and receivers, we offer the following controllers.



COR-3. Inexpensive, flexible COR module with timers, courtesy beep, audio mixer. .... only \$49/kit, \$79 w/t

CWID-2. Eeprom-controlled ID'er..... only \$54/kit, \$79 w/t

DVR-1. Record your own voice up to 20 sec. For voice id or playing club announcements. ....\$59/kit, \$99 w/t

COR-4. Complete COR and CWID all on one board. ID in eeprom. Low power CMOS. .... only \$99/kit, \$149 w/t

COR-6. COR with real-voice id. Low power CMOS, non-volatile memory. .... kit only \$99, w/t only \$149

COR-5. µP controller with autopatch, reverse ap, phone remote control, lots of DTMF control functions, all on one board, as used in REP-200 Repeater. ....\$379 w/t

AP-3. Repeater autopatch, reverse autopatch, phone line remote control. Use with TD-2. .... kit \$89

TD-2. Four-digit DTMF decoder/controller. Five latching on-off functions, toll call restrictor. .... kit \$79, w/t \$129

TD-4. DTMF controller as above except one on-off function and no toll call restrictor..... w/t \$89

### WEATHER ALERT RECEIVER

A sensitive and selective professional grade receiver to monitor critical NOAA weather broadcasts. Good reception even at distances of 70 miles or more with suitable antenna. No comparison with ordinary consumer radios!

Automatic mode provides storm watch, alerting you by unmuting receiver and providing an output to trip remote equipment when an alert tone is broadcast. Crystal controlled for accuracy; all 7 channels (162.40 to 162.55).

Buy just the receiver pcb module in kit form or buy the kit with an attractive metal cabinet, AC power adapter, and built-in speaker. Also available factory wired and tested.

- RWX Rcvr kit, PCB only .....\$79
- RWX Rcvr kit with cabinet, speaker, & AC adapter .....\$99
- RWX Rcvr wired/tested in cabinet with speaker & adapter .....\$139



See SPECIAL OFFERS and view complete catalog on our web site:  
[www.hamtronics.com](http://www.hamtronics.com)  
email: [jv@hamtronics.com](mailto:jv@hamtronics.com)

Our 38<sup>th</sup> Year  
**hamtronics, inc.**  
65-D Moul Rd; Hilton NY 14468-9535  
Phone/fax: 716-392-9430



# Way Cool Rocket Project: Part 2

*This 70cm rocketborne radio telemetry system is strictly for kids — NOT!*

*Part one of this series described the construction of a 433 MHz telemetry transmitter and receiver. Part two will describe construction of a 433 MHz telemetry receiving antenna and integration of the telemetry transmitter into the rocket payload section. Let's begin with construction of the telemetry receive antenna.*

The telemetry receive antenna consists of two Astron Corporation Model 400-4 yagi antenna kits cut for 433 MHz operation, stacked vertically, and fed in phase. The Astron Model 400-4 kit can be purchased directly from Astron Corporation or from Ramsey Electronics as Ramsey #400-4. Specifications for the 4-element yagi indicate a forward gain of 7 dB, with a half-power beamwidth

of about 30 degrees. With two antennas stacked for vertical polarization and fed in phase, the forward gain becomes 9.5 dB, with the vertical half power beamwidth reduced to about 15 degrees. In addition, the vertical capture area of the antenna is doubled. With only 80 milliwatts from the transmitter, we need all the gain and capture area that we can get to ensure solid copy of the telemetry signal. Vertical

polarization of the receive antennas was selected to match the vertical polarization of the rocket-mounted transmit antenna. Because the rocket is in motion, the receive antenna must be able to follow the flight path to ensure positive reception of telemetry data. To accomplish this I created a fully steerable alt-azimuth antenna mount. **Photo A** shows the completed antenna array in tracking mode.

Building the antenna array begins with construction of the two 4-element yagi antennas. The Astron Model 400-4 is supplied as an un-drilled aluminum boom with four sets of aluminum element material. (The driven element is preassembled but not cut to length.) Element mounting hardware is also supplied. Each element must be cut for the operating frequency. A chart is supplied with the kit that gives element dimensions and element spacing for specific frequencies. In addition to drilling the boom for the antenna elements, the boom must also be drilled for the mounting hardware and for an antenna counterweight. **Fig. 1** is a drawing of the antenna dimensions that I used in building the yagis for 433 MHz.



**Photo A.** Completed antenna array in tracking mode.



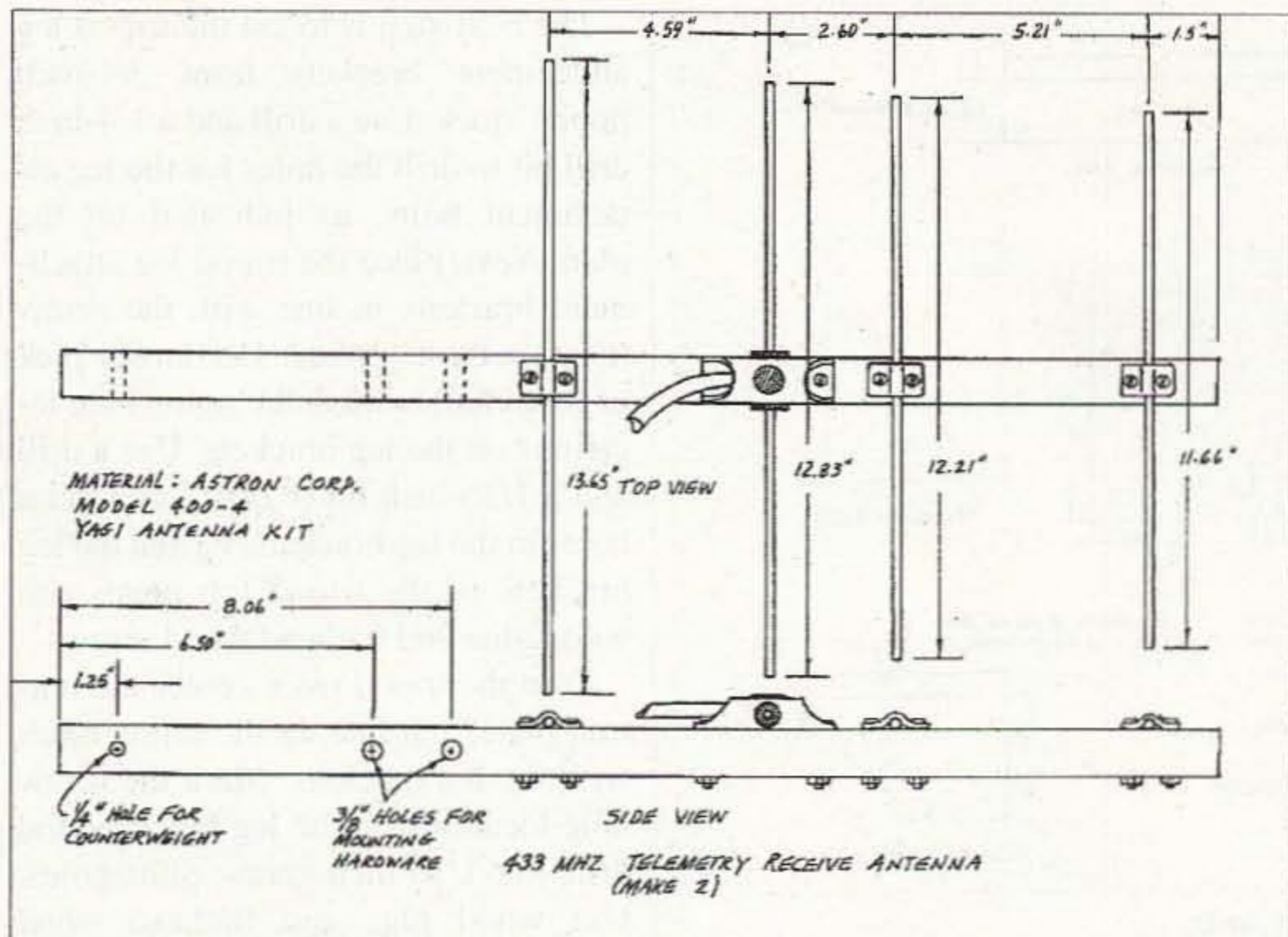


Fig. 1. Tracking antenna.

The antenna counterweights are 6-inch lengths of 1/2-inch-diameter soft steel rod. The counterweights are installed after the antennas are assembled and mounted. As a safety measure, these counterweight rods are wrapped with fluorescent red tape to prevent them being an eye hazard. Now that you have the two antennas assembled and drilled, set them aside and begin construction on the antenna mount.

### The antenna mount

Three sub-assemblies are combined together to form the antenna mount. These three subassemblies are the tripod legs, tripod head, and elevation bearing box and azimuth bearing.

The tripod legs and tripod head are built first. Fig. 2 is a dimensioned drawing of the tripod parts.

Cut six lengths of 1-1/2- x 3/4-inch clear pine to sixty inches (5 ft.). Each

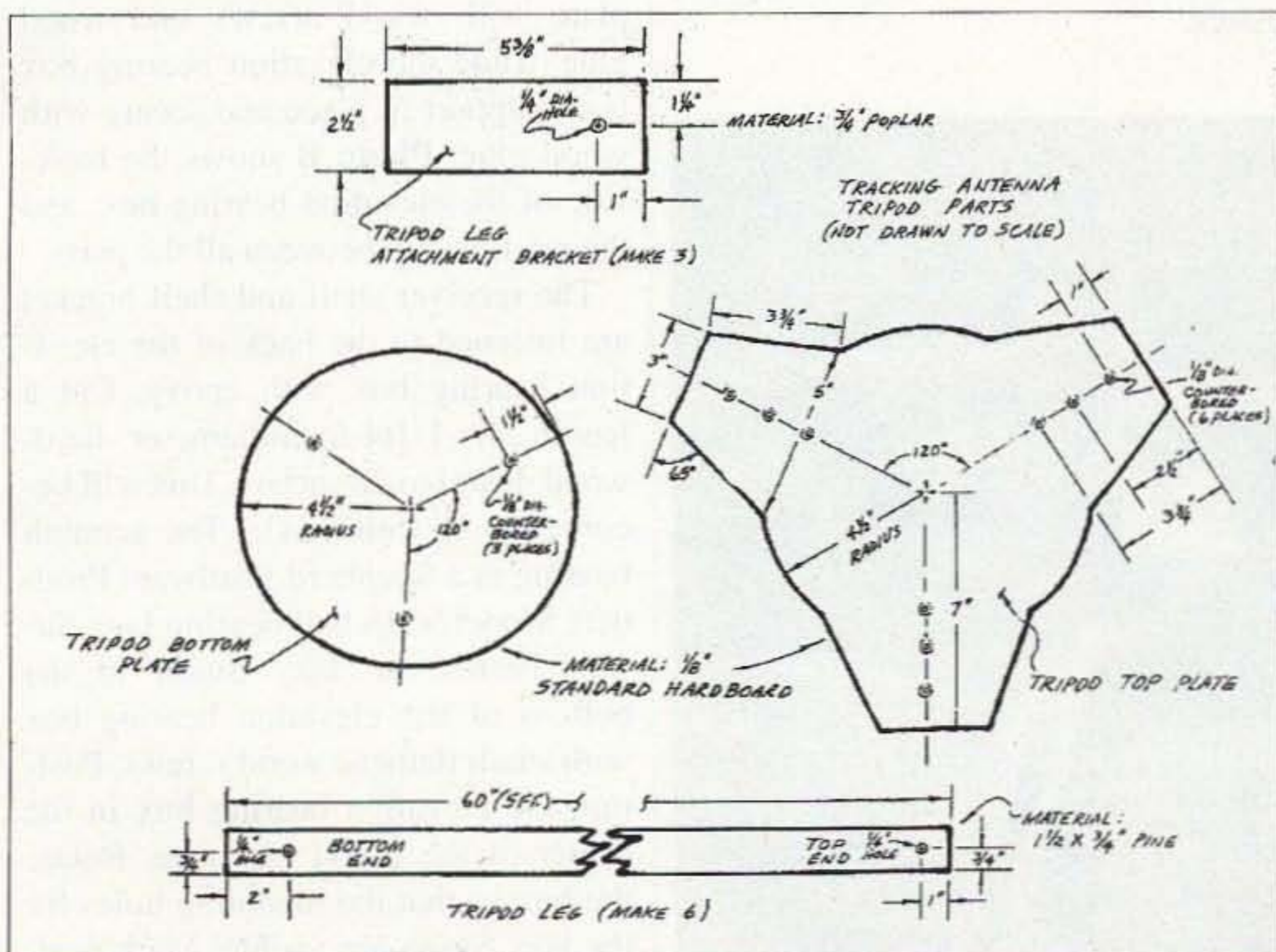


Fig. 2. Tracking antenna tripod parts.

# ALL ELECTRONICS CORPORATION

## Small Solar Cells

### Silicon photovoltaic cells.

Approximate output:  
0.45 Volts @ 100 mA.  
0.79" x 0.79" (20mm x 20mm) square.  
0.01" thick.  
CAT # SPL-22 **75¢** each **10 for \$5.00**

Approximate output:  
0.45 Volts @ 50 mA.  
0.79" x 0.4" (20mm x 10mm).  
0.01" thick.  
CAT # SPL-12 **3 for \$1.00**

## 16 Character X 2 Line LCD with Backlight

Daewoo # 16216L-5-VSO  
5 x 7 dot format. 2.56" x 0.54" viewing area.  
3.15" x 1.41" module size.  
LED backlight. Includes hook-up/spec sheet.  
CAT # LCD-53

**\$7.50** each **10 for \$6.50 each**  
**100 for \$5.00 each**

## Nickel-Metal Hydride AA "Flat-Top" Cells

Panasonic # HHR-11AA0. 1.2 Volt, 1100 mAh "flat-top" rechargeable AA cells. These cells are designed for use in battery packs; they do not have the raised button found on most replaceable batteries. 0.55" diameter X 1.95" long. Large quantity available. Two styles:

**REGULAR-FLAT TOP**  
CAT # NMH-110  
**\$1.50** each **40pcs \$1.25 • 120pcs \$1.00**  
**800pcs 85¢ each**

**SOLDER-TABBED**  
CAT # NMH-110T  
**\$1.75** each **40pcs \$1.50 • 120pcs \$1.25**  
**800+ \$1.00 each**

ORDER TOLL FREE  
**1-800-826-5432**  
SHOP OUR ONLINE STORE  
[www.allelectronics.com](http://www.allelectronics.com)  
CHARGE ORDERS to Visa, Mastercard, American Express or Discover

TERMS: NO MINIMUM ORDER. Shipping and handling for the 48 continental U.S.A. \$5.00 per order. All others including AK, HI, PR or Canada must pay full shipping. All orders delivered in CALIFORNIA must include local state sales tax. Quantities Limited. NO COD. Prices subject to change without notice.

CALL, WRITE FAX or E-MAIL for our **FREE** 96 Page CATALOG Outside the U.S.A. send \$3.00 postage.

MAIL ORDERS TO:  
**ALL ELECTRONICS CORPORATION**  
P.O. Box 567  
Van Nuys, CA 91408  
FAX (818)781-2653

e-mail [allcorp@allcorp.com](mailto:allcorp@allcorp.com)



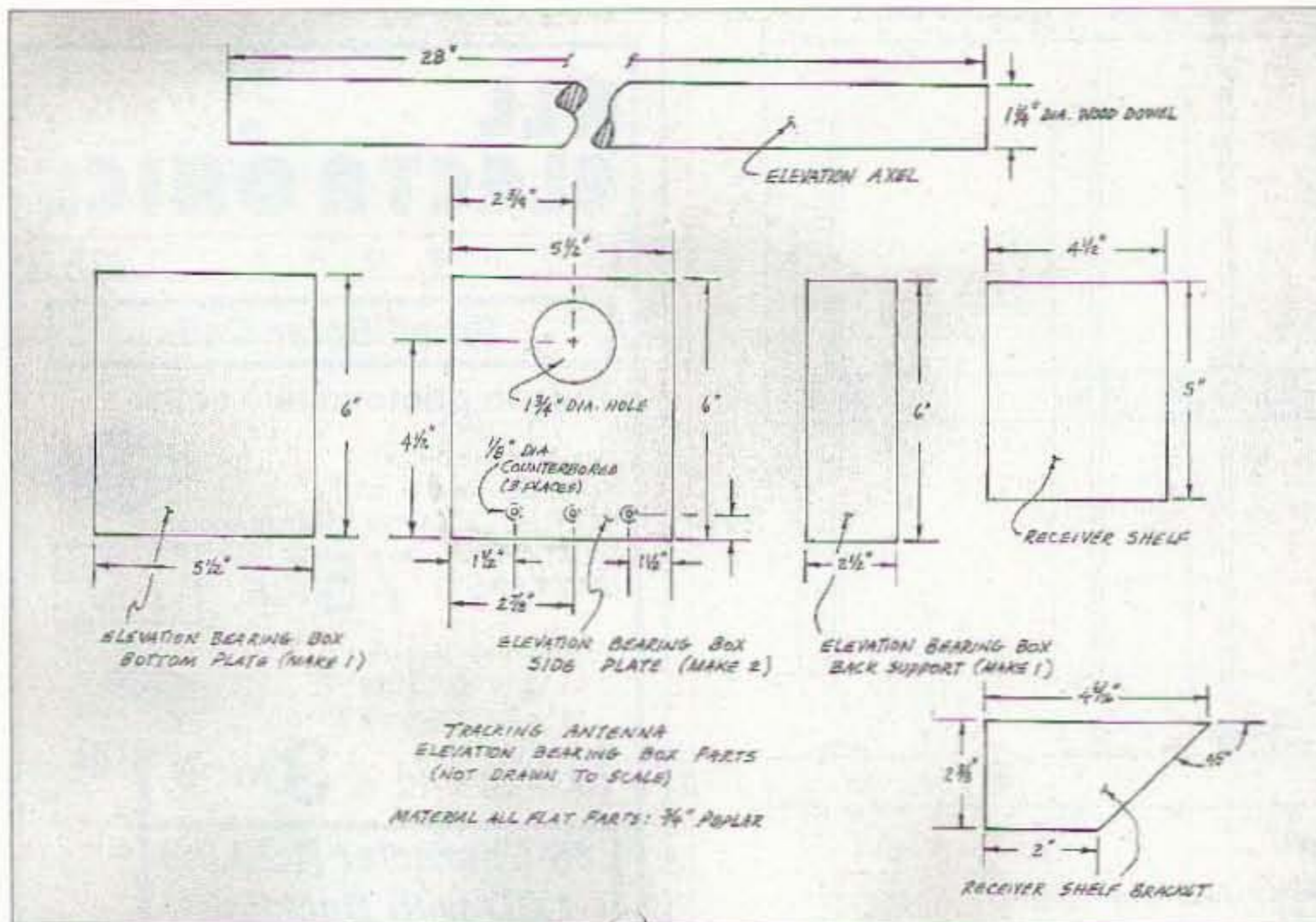


Fig. 3. Tracking antenna elevation bearing box parts.

tripod leg is made up of two of these five-foot members. Using the dimensioned drawing as a guide, mark the locations of the 1/4-inch holes on each end of the legs. Drill 1/4-inch holes at the top and bottom ends of each tripod leg at the measured locations. Fasten the bottom two members of each leg together with a 1/4-inch x 3-inch bolt. Loosely fasten the nut on each of the three bolts.

I elected to use 1/8-inch-thick standard hardboard as the material for the top and bottom plates on the tripod head. This material is inexpensive and

easily worked. You can find this material at most home improvement centers. Once the top and bottom plates are cut to shape, use the dimensioned drawing to mark locations for the screw holes. Using a drill and a 1/8-inch drill bit, drill the nine screw holes in the tripod top plate and the three screw holes in the tripod bottom plate. Use a countersink bit to slightly counter bore these screw holes. This will ensure that the flathead wood screws to be used later will rest flat with the surface of the top and bottom plates.

The next step is to cut the tripod leg attachment brackets from 3/4-inch poplar stock. Use a drill and a 1/4-inch drill bit to drill the holes for the leg attachment bolts, as indicated on the plan. Next, place the tripod leg attachment brackets in line with the screw holes in the top plate. Use an ice pick or small nail to mark the screw hole locations on the leg brackets. Use a drill and a 1/16-inch bit to drill screw pilot holes in the leg brackets. Fasten the leg brackets to the tripod top plate with wood glue and flathead wood screws.

Turn the tripod over, center the bottom plate, and line up the screw holes with the leg brackets. Mark the screw hole locations on the leg brackets and drill the 1/16-inch screw pilot holes. Use wood glue and flathead wood screws to fasten the bottom plate to the tripod leg brackets. Set this assembly aside to dry.

The elevation bearing box is the next component of the antenna mount. Fig. 3 is a dimensioned drawing of the parts for the elevation bearing box.

Start by cutting all the pieces for the bearing box. Make sure to make two of the side plates. I used 3/4-inch poplar for the bearing box, although the type of material is not critical. Mark and drill the holes in the side plates using information from the plans. Fasten the bearing box side plates to the bottom plate with wood screws and wood glue. Slide the elevation bearing box back support in place and secure with wood glue. Photo B shows the back-side of the elevation bearing box, and the relationship between all the parts.

The receiver shelf and shelf bracket are fastened to the back of the elevation bearing box with epoxy. Cut a length of 1-1/4-inch-diameter hardwood dowel to 28 inches. This will become the elevation axle. The azimuth bearing is a Shepherd Hardware Products Model 9548 ball bearing lazy Susan. Fasten the lazy Susan to the bottom of the elevation bearing box with small flathead wood screws. Position the elevation bearing box in the center of the tripod top plate. Rotate the box so that the mounting holes for the lazy Susan are visible. Mark position of the lazy Susan mounting holes

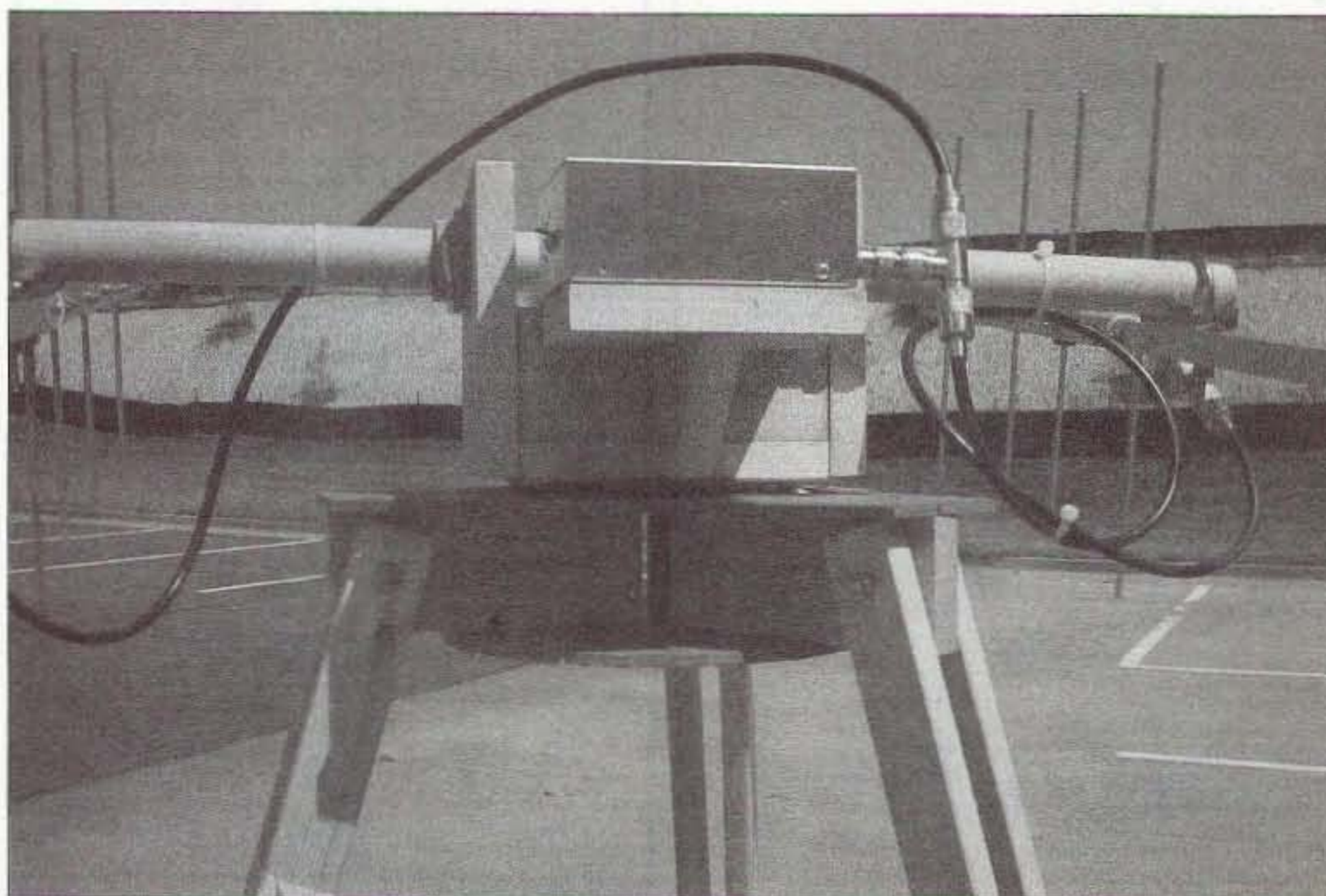


Photo B. Elevation bearing box, rear view.



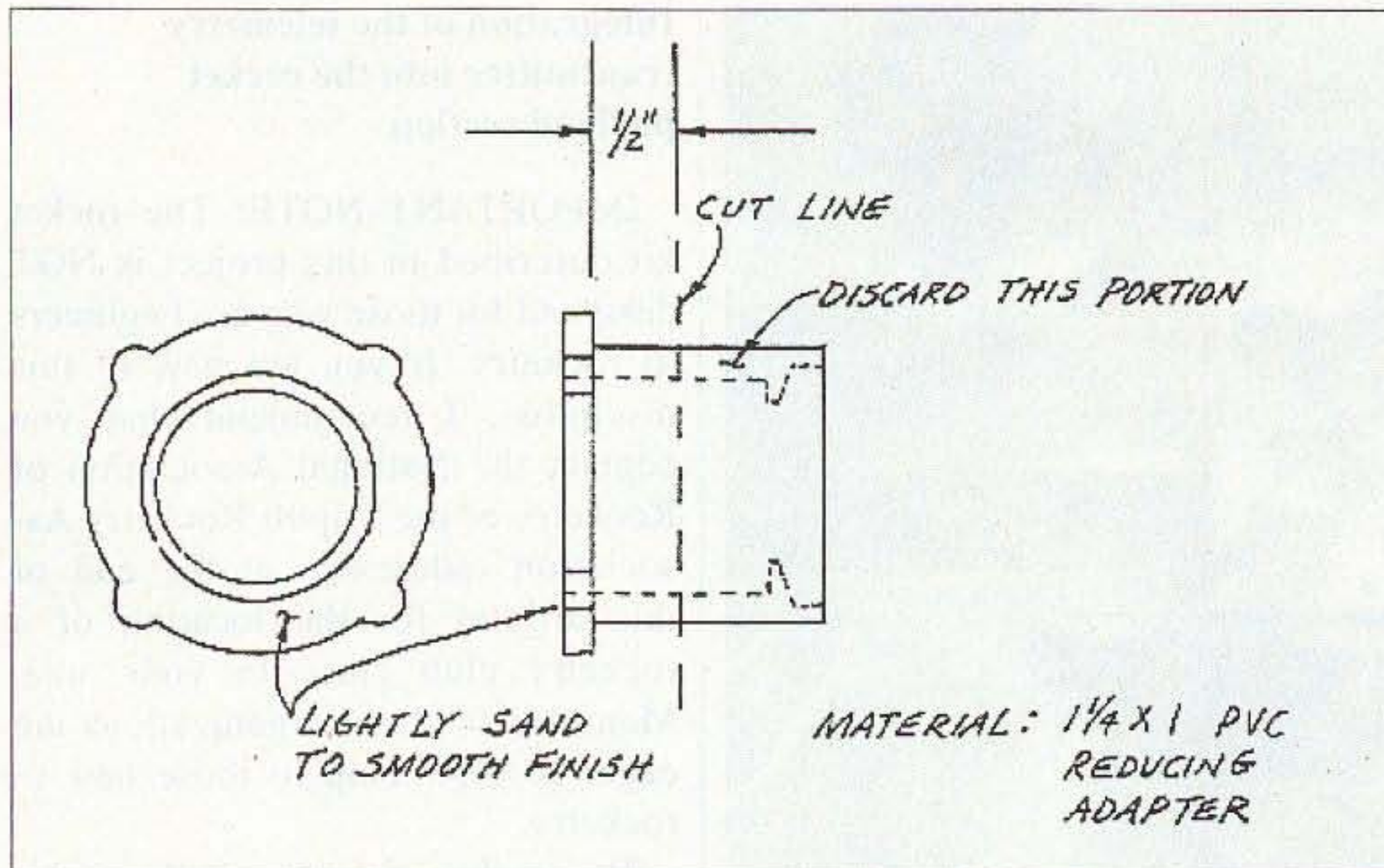


Fig. 4. Elevation bearing detail.

on the tripod top plate. You will find that one of the four lazy Susan mounting holes will line up with the position of a tripod leg bracket. A flathead wood screw should be used at this position. The remaining three mounting holes will use 6-32 x 1-inch machine screws and nuts.

Modified 1-1/4- x 1-inch PVC reducer adapters are used as bearings for the elevation axle. Fig. 4 is a drawing showing the modifications of the PVC adapters. You will need to make four of the modified adapters.

As shown in Fig. 4, the shank of each PVC adapter is cut down to a length of 1/2-inch. Make sure to remove any burrs with a small knife. The outside diameter of the PVC adapter is a little less than the 1-3/4-inch-diameter hole. Take two of the cut-down adapters and wrap masking tape around the outside surface of the 1/2-inch-long shank until it just fits into the 1-3/4-inch-diameter hole in the elevation bearing box side plate. Coat the inside surface of the 1-3/4-inch-diameter hole and the outside surface of the tape on the adapter with 5-minute epoxy and fit in place. Use care to not get any of the epoxy on the inside surface of the adapter. After the epoxy has set, slide the elevation axle into the PVC adapter bearings and center it with respect to the elevation bearing box. Slide one of the remaining prepared PVC adapters over one end of

the elevation axle and bring up tight to the mounted bearing. Refer to Photo B to see this relationship between the bearing surfaces. While holding the prepared PVC adapter in place, use a drill and a 3/16-inch drill bit and drill through the PVC adapter and the axle. Slide a 5/32 x 2-1/2-inch cotter pin into the hole to hold the bearing in place. Repeat this procedure on the other end of the elevation axle. At this point, attach the leg assemblies to the leg brackets with 4-inch x 1/4-inch carriage bolts and nuts. Spread the tripod legs out so that the elevation bearing box is at a comfortable working height. The next step is to mount the antennas to the elevation axle.

### Mounting the antennas

Radio Shack #15-826 U-bolt and clamp assemblies are used to mount the prepared antennas to the elevation axle. Photo C shows how the antenna is mounted to the elevation axle.

Make sure the driven element is directed outward (as shown in the photograph) and that the element is aligned with the end of the elevation axle. This will ensure proper spacing of the two antennas. Next, move the antennas so the booms are horizontal and insert the previously prepared lengths of steel rod into the rear open end of the boom. Adjust position of the steel rods until the antennas are balanced on the elevation axle. Mark this position on the

## Repeaters

6 & 2 m & 440 On your frequency

\$399.95 & \$499.95

## Repeater Controllers

RC-1000V \$259.95 / RC-100 \$129.95

## Micro Computer Concepts

8849 Gum Tree Ave

New Port Richey, FL 34653

727-376-6575 10 AM-10 PM

e-mail n9ee@akos.net

http://mcc.stormfan.com

## LOW PROFILE HF ANTENNAS THAT REALLY WORK!

"Work the World Without Working Up the Neighborhood"

## ISOTRON

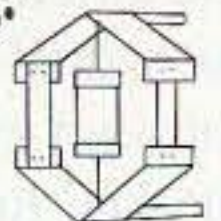
BILAL COMPANY

Call for a FREE Catalog:

719/687-0650

137 Manchester Dr.  
Florissant, CO 80816

www.rayfield.net/isotron



The impressive IC-756 Pro covers HF plus 6 meters. The high resolution 5 inch TFT color display provides more operating information than ever, including a spectrum scope. The 32 bit floating point DSP provides crisp, clear reception with 41 built-in filters. The "Pro" is the choice for serious DXers and contesters.



The IC-746 covers 160-10 meters plus 6 and 2 meters with 100 watts on all bands. Call or visit our website for further details and pricing on this and other ICOM radios.



## Universal Radio

6830 Americana Pkwy.  
Reynoldsburg, OH 43068

◆ Orders: 800 431-3939

◆ Info: 614 866-4267

www.universal-radio.com



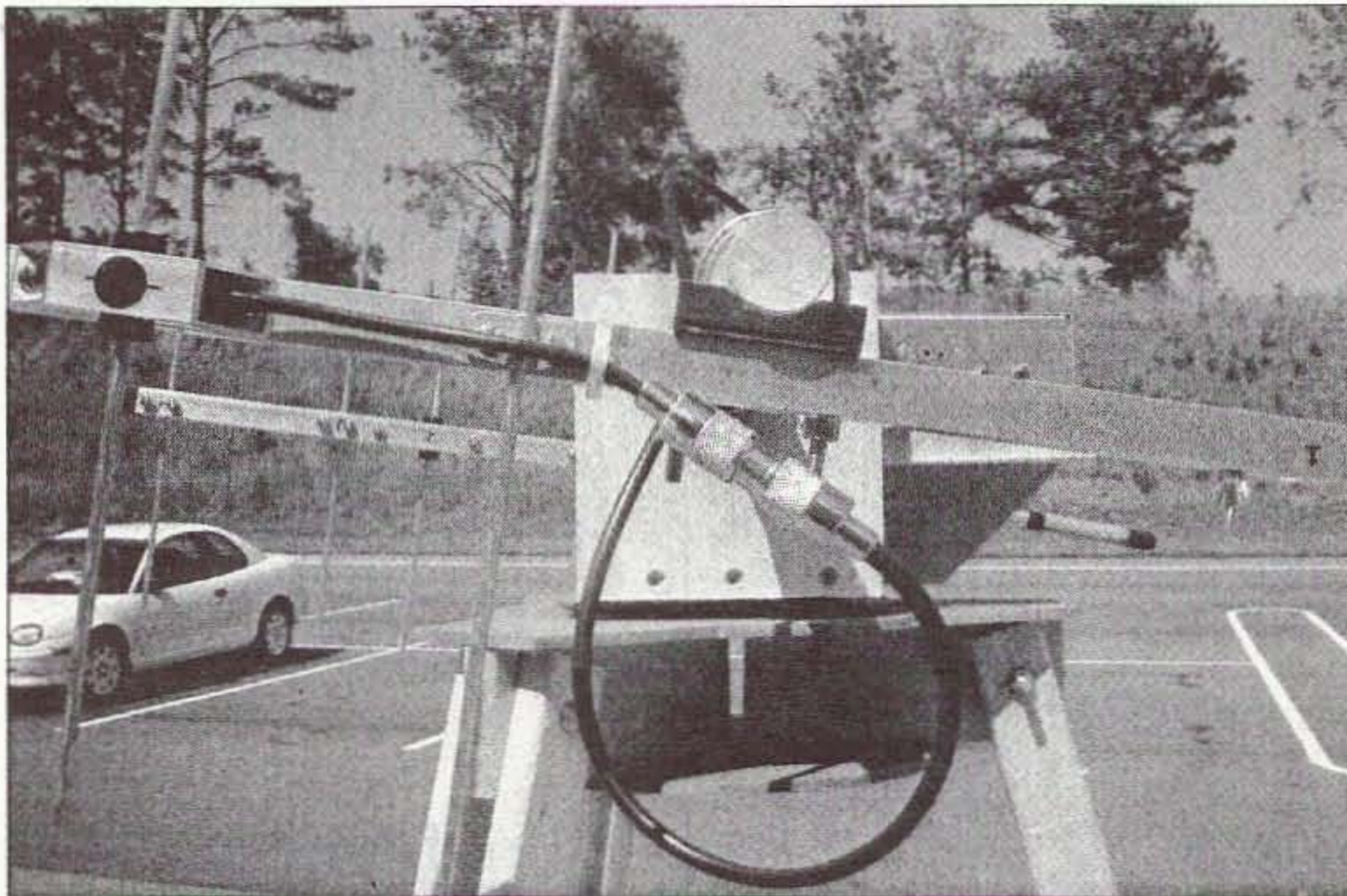


Photo C. Antenna mounted to elevation axle.

steel rod through the hole in the end of the antenna boom. Use a drill and 1/4-inch drill bit to drill a mounting hole through each of the steel rods at the marked locations. Install the steel rods into the rear end of the antenna booms with a 1/4-inch x 2-inch bolt and wing

nut. The remaining step in antenna construction is fabrication of the coaxial cable phasing harness.

#### Building the phasing harness

Fig. 5 is a dimensioned drawing of the coaxial phasing harness.

The harness uses two sections of RG-6 75-ohm coax, each leg 37 inches in length. The first step, however is to attach a connector to the short length of coax from the antenna driven element. Cut this length of coax to 6 inches and attach a male coaxial connector. A coaxial barrel connector is used to join the phasing harness to each of the driven element connectors.

The photographs in this article show the details of mounting the phasing harness. This completes construction of the telemetry receive antenna array.

#### Integration of the telemetry transmitter into the rocket payload section

**IMPORTANT NOTE:** The rocket kit described in this project is NOT designed for those who are beginners to rocketry. If you are new to this discipline, I recommend that you contact the National Association of Rocketry or the Tripoli Rocketry Association (addresses at the end of this article) for the location of a rocketry club close to your area. Members of these organizations are eager to offer help to those new to rocketry.

The rocket airframe used in this project is the Vaughn Brothers Extreme 38 rocket kit. Construction of the rocket airframe is outside of the scope of this article. The kit should be built according to the instructions supplied with the kit with the exceptions detailed below. Fig. 6 is a dimensioned drawing highlighting the modifications made to the payload section of the rocket kit.

The first modification to be made is to the nose cone. As detailed in Fig. 6, the rear portion of the nose cone is removed and discarded. With a 1/16-inch drill bit, drill two small holes 1/2-inch from the shoulder of the nose cone. This is the point at which the thermistor will be mounted. Insert the thermistor leads into the two small holes in the nose cone. Ensure a 1/32-inch air gap between the bottom of the thermistor and the nose cone surface. Place a small dab of epoxy over the thermistor leads on the inside of the nose cone to fix the thermistor in place.

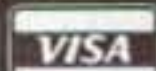
#### EVERY ISSUE OF **73** Amateur Radio Today on Microfiche!

The entire run of **73** from October 1960 through last year is now available. Over 800 fiche!

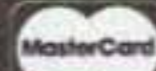
You can have access to the treasures of **73** without several hundred pounds of bulky back issues. Our 24x fiche have 98 pages each and will fit in a card file on your desk.

We offer a battery operated hand held viewer for \$150, and a desk model for \$260. Libraries have these readers.

The collection of microfiche, is available as an entire set, (no partial sets) for \$325, plus \$10 shipping (USA). Annual updates available for \$10, plus \$3 shipping/handling. Satisfaction guaranteed or money back!



**BUCKMASTER**



6196 Jefferson Highway  
Mineral, Virginia 23117 USA  
540:894-5777 • 800:282-5628  
Fax 540:894-9141  
e-mail: info@buck.com

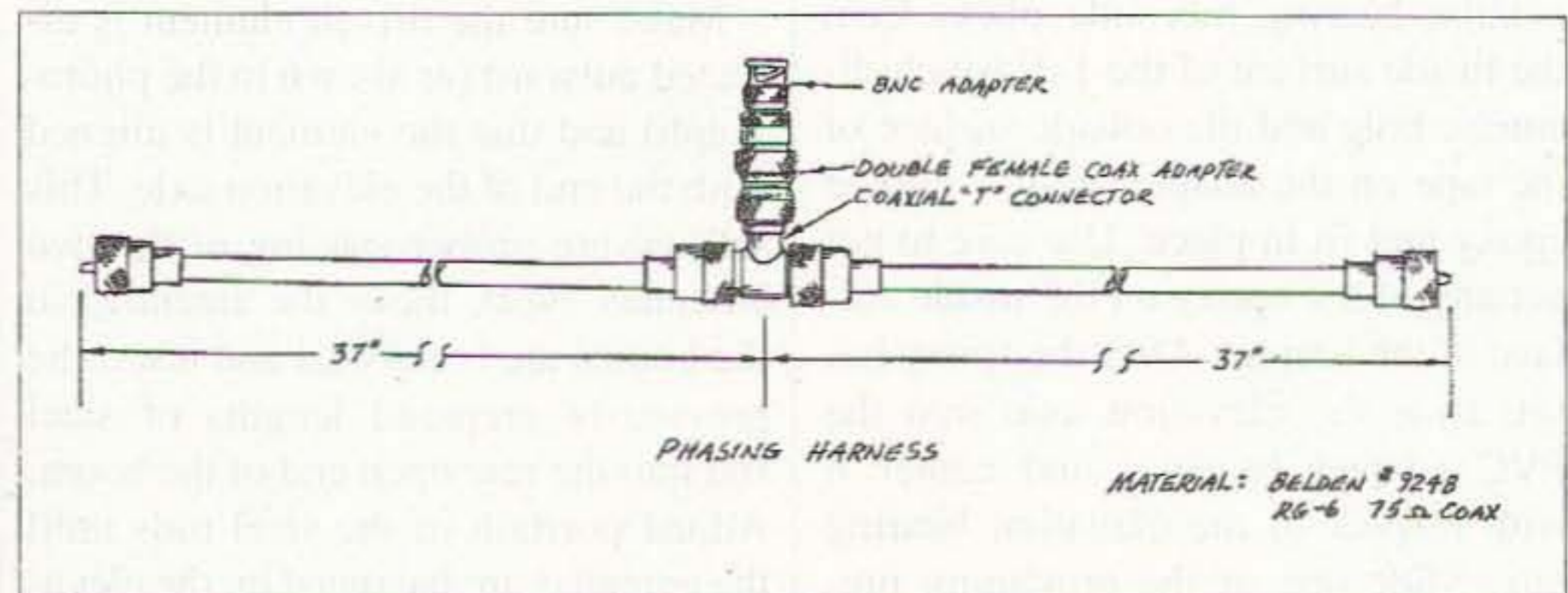


Fig. 5. Phasing harness.



Use the drawing in Fig. 6 as a guide, and cut the thermistor shroud from a small sheet of .005-inch brass. Prepare three one-inch lengths of tinned number 22 solid copper wire. Solder these three wires to the brass shroud as shown in Fig. 6. Temporarily bend these wires out from the shroud and form the shroud over the thermistor. Make sure that the brass shroud will not touch the thermistor. Mark the three locations where the bent out wires touch the nose cone surface. Use a 1/32-inch drill bit to drill holes at the marked locations on the nose cone. Bend the shroud wires so they are pointing down and away from the shroud. Insert the shroud wires into the three holes. Bend the wires down from the inside of the nose cone to hold the shroud in place. Fix each shroud wire in place with a small dab of epoxy over each wire. Lay in an epoxy fillet at the shroud nose cone boundary. The shroud is used both to shield the thermistor from the sun and to protect it from flight-generated aerodynamic forces.

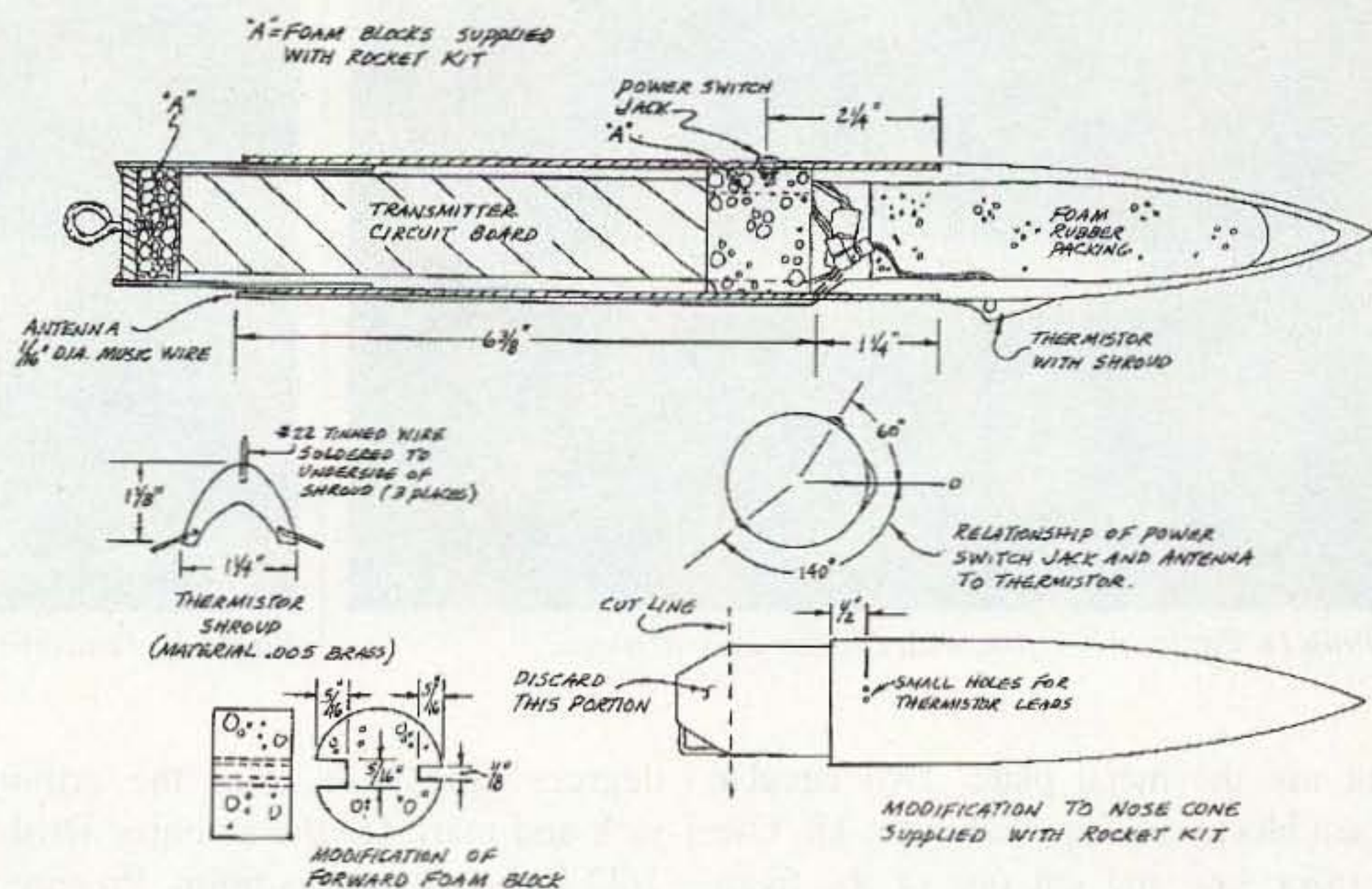


Fig. 6. Rocket assembly.

Prepare two lengths of stranded hookup wire, each 3 inches in length. Twist the two wires together. Solder a 2-pin Dean's connector to one end of the prepared two wires. Solder the free

end of the wires to the thermistor leads inside the nose cone.

The Vaughn Brothers rocket kit is supplied with a mounting bracket and plate for an altimeter circuit. You will

Celebrating **50** Shows

# Hamvention®

## 2001

The World's Largest  
Amateur Radio Gathering

DAYTON HARA ARENA

DAYTON, OHIO

MAY 18, 19 & 20

Please watch  
your mailbox for  
pre-show mailers!

www.hamvention.org





*Photo D. Payload section, with arming jack in place.*



*Photo E. Transmit antenna installed on the payload section.*

not use the metal plate. Two circular foam blocks are supplied in the kit. Use a razor saw and cut one of the foam blocks in half. Modify the remaining foam block as shown in **Fig. 6**.

Build the payload section as detailed in the rocket kit instructions. When all the epoxy adhesive has fully set, push the one-half foam block you cut earlier to the bottom of the payload section. Measure 2-1/4 inches from the front edge of the payload section and mark the position of the mounting hole for the arming jack. Use the sharp point of a modeling knife to cut a 3/16-inch-diameter hole at the point marked for the arming jack. To make installation of the transmitter easier, I placed a two-conductor connector in series with the wires from the arming jack to the transmitter battery. **Photo D** shows the payload section with the arming jack in place.

Measure 1-1/4-inch from the front of the payload section at a point 200

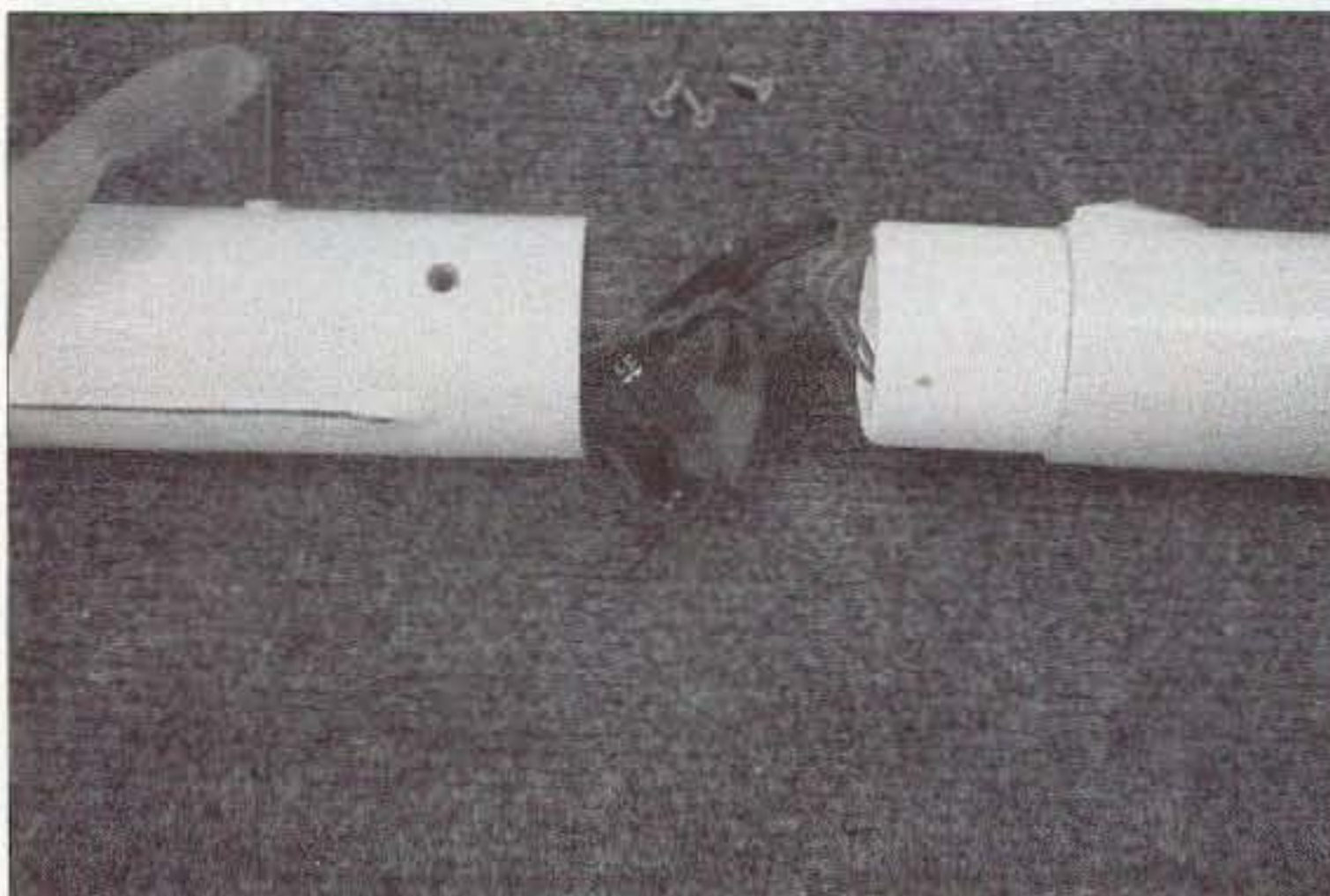
degrees clockwise from the arming jack and mark for the antenna. Drill a 1/32-inch hole at this point. Prepare a two-inch length of stranded hookup wire by stripping 1/4-inch from each end and tinning the wire with solder. Next, cut a 6-3/4-inch length of 1/16-inch music wire. Use fine sandpaper and burnish 2 inches of one end of the music wire. Measure 3/8-inch from the burnished end of the wire. Use pliers to put a 40-degree bend in the wire at this point. Push the prepared music wire into the antenna hole in the payload section so that you have access to the short bent section of wire. Solder one end of the two-inch wire you prepared earlier to the bent section of music wire.

Push the music wire back through the antenna mounting hole so the 6-3/8-inch length lies alongside the payload section. Use a short length of masking tape to hold the antenna in place while you lay in epoxy fillets on

each side of the wire to hold it in place. You may find it helpful to tack the antenna to the payload section with cyanoacrylate adhesive before using the epoxy. **Photo E** shows the transmit antenna installed on the payload section.

Solder a 2-pin Dean's connector to the free end of the 2-inch antenna wire. The next step is to install the transmitter circuit board into the payload section.

Insert the transmitter circuit board, battery end first, into the payload section. Use care to position the circuit board to clear the arming jack as you slide the circuit board into position. Slide the prepared forward foam block into place. The 5/16-inch slot in the foam block should just clear the arming jack. Dress the remaining wires from the transmitter circuit board through the 1/8-inch slot in the foam block. I used an additional piece of foam rubber as a forward block inside the nose cone. This ensures that, once the nose cone is fastened in place, the



*Photo F. Antenna, thermistor, and arming jack connectors.*



*Photo G. Completed airframe in primer coat white.*



Qty.	Part
2	Astron 400-4 or Ramsey Electronics 400-4 yagi antenna kits
6	5 ft. lengths of 1-1/2 x 3/4 inch clear pine lumber
1	3 ft. x 3 ft. square piece of 1/8 inch standard hardboard
1	4 ft. section 5-1/2 x 3/4 inch poplar lumber
1	3 ft. section 3 x 3/4 inch poplar lumber
1	30 inch length 1-1/4 inch diam. hardwood dowel
3	3 inch x 1/4 inch carriage bolts with nuts
3	4 inch x 1/4 inch carriage bolts with nuts
3	6-32 machine screws with nuts
10	1-1/2 inch flathead wood screws
2	Radio Shack #15-826 U-bolt clamps
1	12 inch length 1/2 inch diam soft steel rod
4	1-1/4 inch x 1 inch PVC reducer adapter
1	8 ft. length Belden #9248 RG-6 75 ohm coaxial cable
6	UHF male coax cable connectors
2	UHF barrel double female coax connectors
1	UHF coax tee connector
1	UHF double female coax connector
1	UHF male-to-BNC male coax adapter

Table 1. Tracking antenna parts list.

transmitter circuit board will not shift under flight G-forces.

Connect the thermistor, antenna, and arming jack connectors, and then fasten the nose cone in place with the

Qty.	Part
1	Vaughn Brothers Extreme 38 rocket kit
1	8 inch length 1/16 inch music wire
1	12 inch x 12 inch square section R/C packing foam rubber (available from hobby shops)
1	2 inch x 2 inch square sheet 0.005 brass (available from hobby shops)
1	6 inch length #22 tinned solid wire
1	Dean's Ultra Plug 2-pin power connector (available from hobby shops)
2	Dean's standard 2-pin connector (available from hobby shops)

Table 2. Airframe parts list.

screws supplied in the rocket kit. Note: You may find it necessary to notch the bottom edge of the nose cone to clear the antenna wire on the inside of the payload section. I recommend placing an index mark on the junction between nose cone and payload section so proper alignment can be achieved later. **Photo F** shows the antenna, thermistor, and arming jack connectors.

Test the transmitter installation by turning on the receiver and then pulling the arming plug from the jack. If everything is working OK, you should hear tone pulses from the receiver. Reinstall the arming plug to turn off the transmitter. **Photo G** is a photograph of the completed airframe in primer coat white. The next article in this series will describe calibration of the thermistor temperature sensor, finishing the sounding rocket airframe, flight operations, data recovery, and implementation of the project with schools and youth groups.

**ROCKET CONSTRUCTION NOTE:** The rocket airframe has been built for

launch from a tower, so no launch lugs have been installed. If you will be launching from a rod-type launcher, launch lugs will need to be installed on the airframe.

#### Addresses

Vaughn Brothers Rocketry, 4575 Ross Drive, Paso Robles CA 93446; tel.: (805) 239-3818; fax: (805) 239-0292.

Astron Corporation, 22560 Glenn Drive, Suite 114, Sterling VA 20164; tel.: (703) 450-5517; fax: (703) 450-9753.

National Association of Rocketry, 1311 Edgewood Drive, Altoona WI 54720; [www.nar.org].

Tripoli Rocketry Association, Inc., P.O. Box 280, Bessemer AL 35021-0280; tel.: (205) 424-8357. 73

Back Issues  
of  
**73 Magazine**  
Only \$5.00 Each!  
Call 800-274-7373

**www.amcominc.com**

**Toll Free Orders: 1-888-803-5823**

**Am-Com, Inc. ClearSpeech® Speaker**



5.5" X 4.3" X 2.5"

**\$149<sup>95</sup>**  
plus S&H  
(Reg. Price \$179.95)

This easy-to-use DSP speaker activates automatically and filters 95% background noise, static and other interference.

- Improves clarity & intelligibility
- Continuous, adaptive removal of background noise
- Listen with less fatigue & greater concentration
- Improves signal to noise ratio
- Engineered for use with amateur radios
- Speaker output jack

**Am-Com, Inc. ClearSpeech® Base**

You asked for it. The unique digital noise canceling technology of the popular ClearSpeech® Speaker, but without the internal speaker. Removes up to 95% of noise from received audio.

Use in-line with your favorite base station or mobile speaker.



3"X1"X5.5"

**\$149<sup>95</sup>**  
plus S&H  
(Reg. Price \$179.95)

**Your One Source Amateur Radio Dealer.**

**Best Icom Radio Prices**

**Guaranteed.**




Email: [amcom@digisys.net](mailto:amcom@digisys.net)

Mail Orders To: Am-Com, Inc., 100 Bierney Rd., Suite C, Lakeside, Montana 59922




ADI

ALINCO

AMERITRON

MFI

ICOM

MIRAGE COMMUNICATIONS EQUIPMENT

QRMST

LA CROSSE TECHNOLOGY

YAESU THE HIGHEST LEVEL

hy-gain



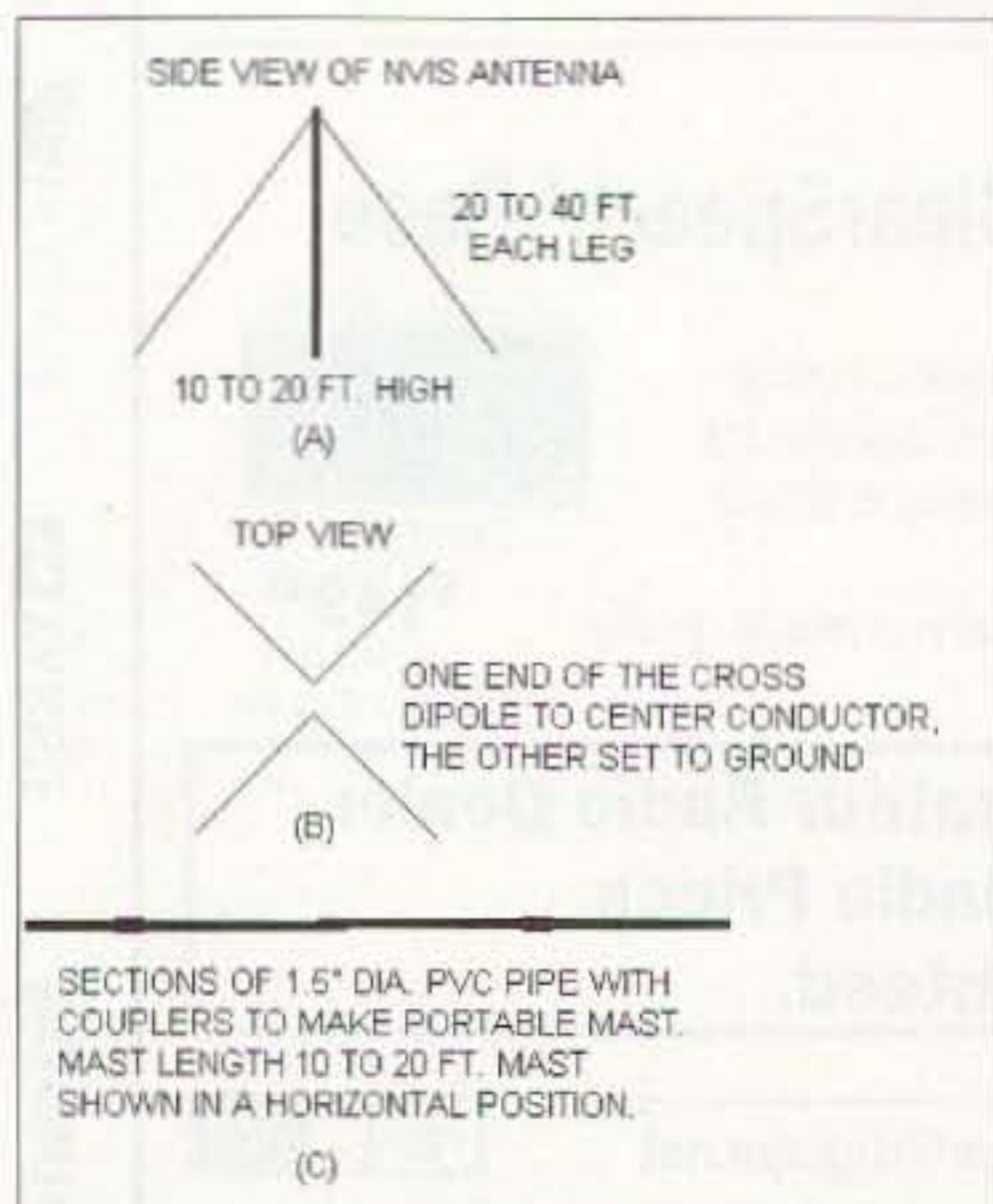
# Build Yourself an NVIS

*If you want to talk to the guy in the next county on HF, of course.*

*We have all experimented with antennas. At one time or other we played with dipoles, verticals, quads, yagis, and variations of wire antennas. All for the desire of a low-angle signal, which will help us snag DX stations. There have been numerous articles and books on antennas, making us very familiar with the above antenna names. But have you ever heard of the Australian "District Antenna," or the Russian "Zenith Radiation," or what our military calls NVIS (Near Vertical Incidence Skywave)?*

**T**his antenna has been around since World War II. The reason most hams have not heard about it is their desire to work faraway stations. When it comes to local communications, VHF/UHF is more common. But there are many cases where the range of VHF is limited, and reliable communications are needed on HF.

In many population centers, there is the desire of many hams to communicate within a 100- to 300-mile radius.



**Fig. 1.** NVIS antenna details.

In those cases, the known popular antennas might not provide a reliable link. Our military had the same problems, and they found that producing a high angle skywave provided a reliable link, less subject to fading. With a high angle, the surrounding terrain is not an issue.

## How to experiment with NVIS

There are many ways an antenna can be made to work in an NVIS mode. The easiest is to run a wire fed with a tuner a few feet from the ground. In most cases, a high-angle skywave will be produced. Stations nearby will be able to communicate.

Another approach is to take your HF mobile antenna and place it in a horizontal position parallel to the ground. You could experiment with the distance between the ground and horizontal antenna. A distance of 3 to 9 feet will work.

When experimenting with NVIS, 80, 40, and 30 meters seem to work best. I tried frequencies between 3.5 and 30 MHz. The factors of working frequencies below the MUF (Maximum Usable Frequency) play a very important role. Power levels of QRP to 100 watts have been used.

## Building a simple NVIS antenna

A very simple NVIS antenna can be built, for fixed or portable use. (Please refer to **Fig. 1**.) The basic NVIS antenna is nothing more than two crossed dipoles mounted anywhere from 10 to 20 feet high. The legs of the dipole are sloped and secured to the ground. The crossed dipoles are fed with 50-ohm coax. A tuner, manual or automatic, is required.

A fixed NVIS antenna can be a wooden pole, PVC pipe, or metal mast. The lengths of the wire elements can be anywhere from 20 to 40 feet. For a portable NVIS antenna, a mast could be made from 1.5"-diameter PVC tubing mating with PVC couplers. A piece of coax fed through the mast then feeds the crossed dipoles.

Please make sure that safety concerns are taken into consideration. You do not want anyone to run into the sloping wires, which will be a few feet off the ground. This type of antenna has been made commercially by Telex. It is called the NVIS Antenna, with a model number of AS-2259/1990.

*Continued on page 58*



# Inside Digital TV/VCR Tuners

## Part 7: Conclusion.

*The previous section described how the printed circuit boards for the data transmitter and receiver are prepared for processing. This section will complete the process steps, beginning with marking the board.*

It is desirable to have some identification markings on the board indicating voltage values, polarity, IC pin and transistor lead identifiers, etc. Prior to etching, a sharp instrument like a scribe may be used to scratch through the fingernail polish, exposing the copper as shown in **Photo A**. The scratch marks in the form of letters and symbols will be etched into the copper as shown in **Photo B**.

Many of the black ink etch-resist marking pens contain a water-repellent ink that is sometimes used for marking the bare copper prior to etching. Unfortunately, the ink does break down

somewhat in the etchant, so that it isn't always satisfactory for making a reliable etch-resist for trace patterns. After etching, the marking pen is more suitable for marking the component placement, orientation, polarity, etc., information on the top side of the board.

### Etching the board

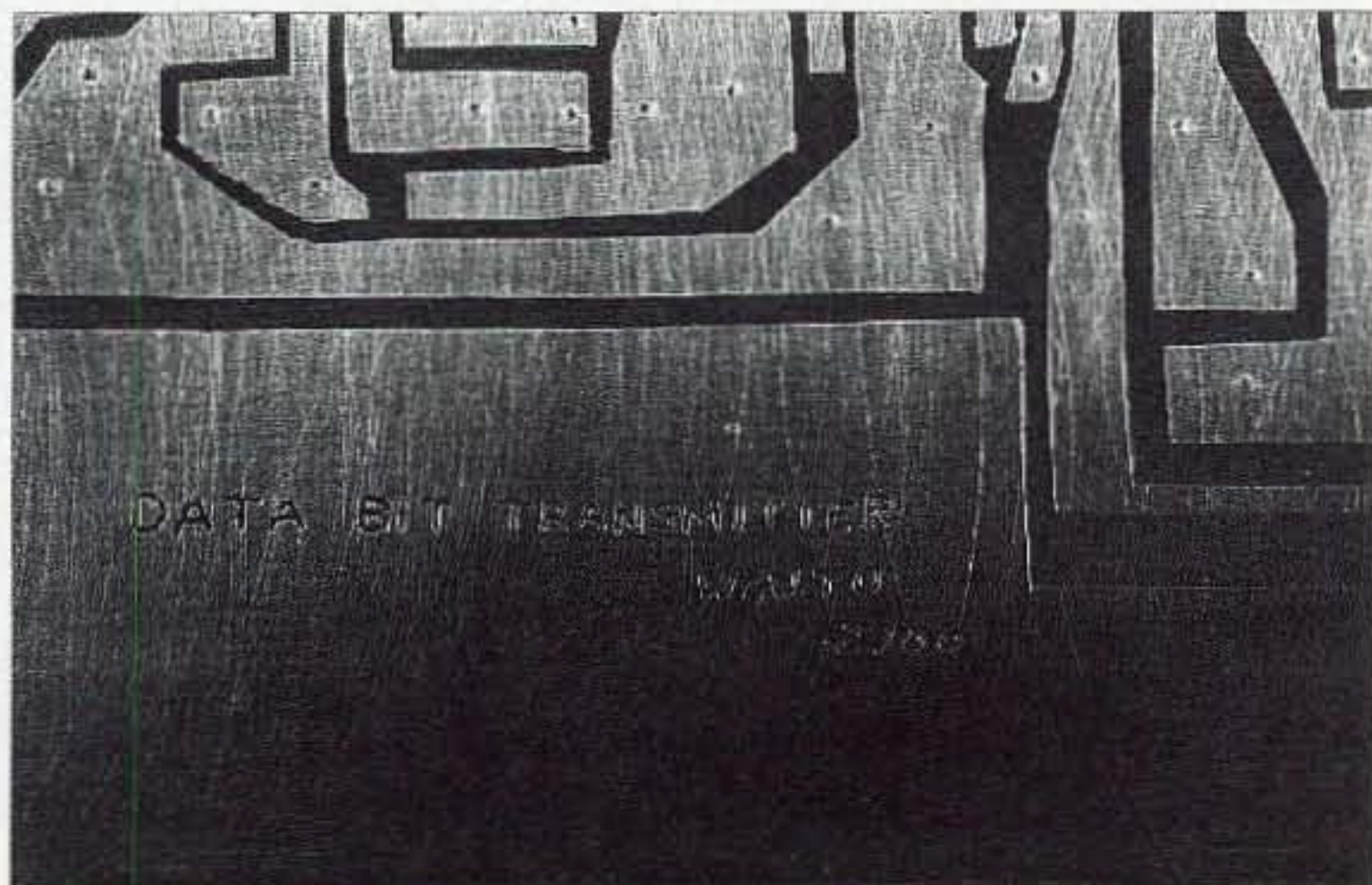
Ferric chloride is the most common etchant available and perhaps the easiest and safest to use. The major caution with it is that it is dark in color and will severely stain cloth, so care

must be taken to prevent spills and splashes.

The board will be ready to etch after the nail polish has dried — usually 30 minutes to an hour is a proper waiting period. There are many methods suitable for etching a board, but the one most suitable to your needs is the one that you should use. A simple and easy method is to pour the etchant to a depth of 1/8–1/4-inch into a flat glass or plastic dish. Float the board copper side down on the surface of the etchant. It will be necessary to lift the board periodically after about 30 minutes to assess the progress of etching



**Photo A.** A scribe is being used to scratch through the nail polish for marking/identifying the board.



**Photo B.** The board marking that remains after etching.





**Photo C.** The circuit board floating on the etchant. A stick is used to lift the board momentarily to purge bubbles.

as shown in **Photo C**. A stick or tongue depressor works well for lifting the board. Also, lifting the board, then lowering it slowly, will allow the trapped bubbles to be purged.

When the etching process appears to be complete, remove the board, wash it with tap water, and dry it with a paper towel. The board can now be inspected for completion. Some areas, specifically where bubbles were trapped, will not etch very fast. Scraping those areas with a knife blade or scribe to scratch the copper will allow the copper to be etched a little faster, as shown in **Photo D**. Return the board to the etch and allow the etching process to continue. When wide trace patterns are used, overetching is usually not a problem.

During a cold environment, the etchant works very slowly. Adding a little heat to the process will speed it up considerably. Placing a small light

bulb close to the etchant will warm the surrounding air. Also, placing a small cardboard box over the lamp and etchant tray will raise the temperature sufficiently to speed the etching process.

An alternate method for etching boards is to use a zipper-style plastic bag as an etch container. After the board is placed into the bag, about one inch of etchant is poured into the bag. Because some bags have a tendency to leak, it's a good idea to slide the first bag containing the board into another bag for drip protection.

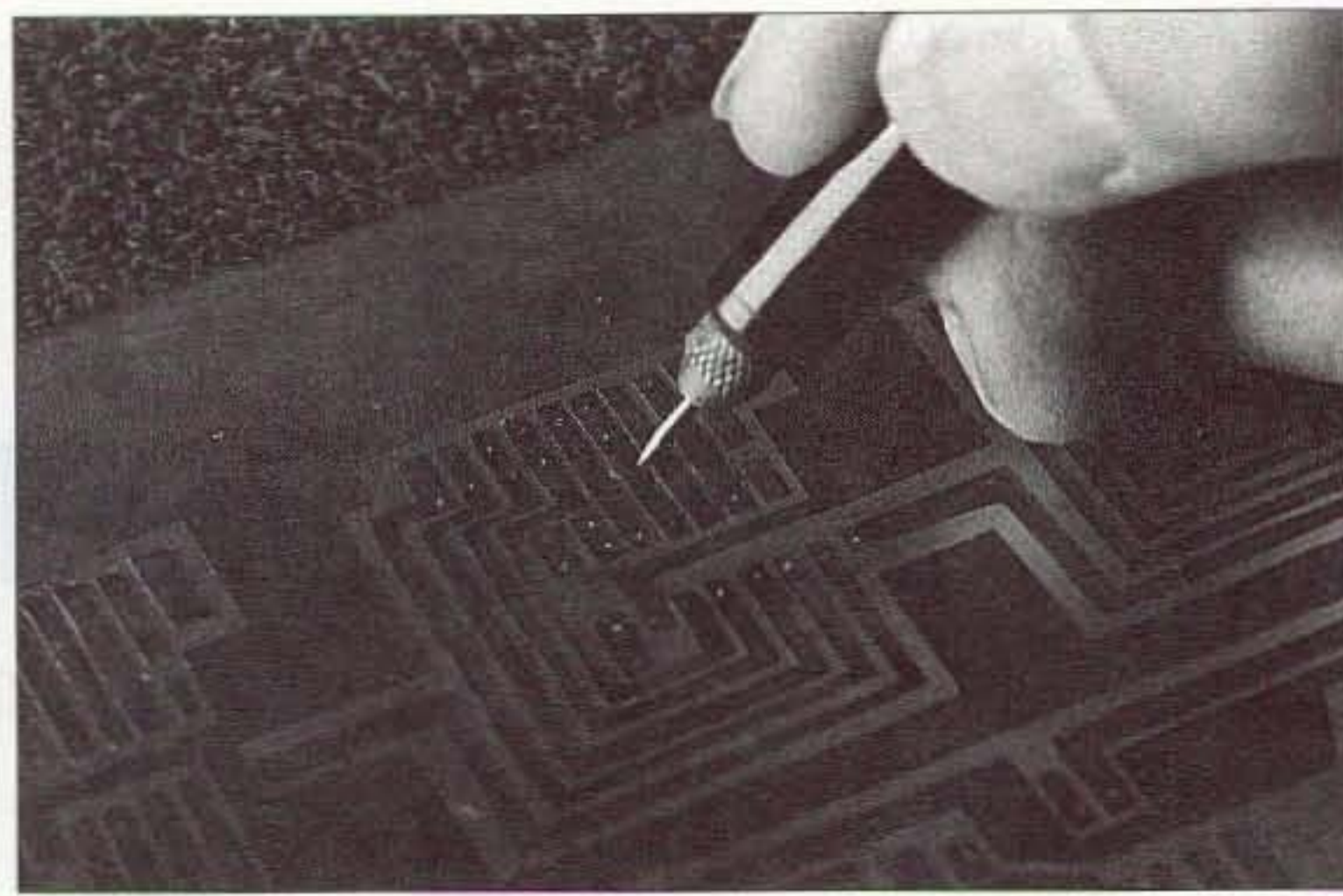
After sealing the bag(s), the board is positioned flat with the copper down. Because the bag is transparent, the etching process can be observed through the bag. Handling the board and bag with care is OK, but excess handling should be avoided to prevent accidental spills caused by bag tears.

### After etching

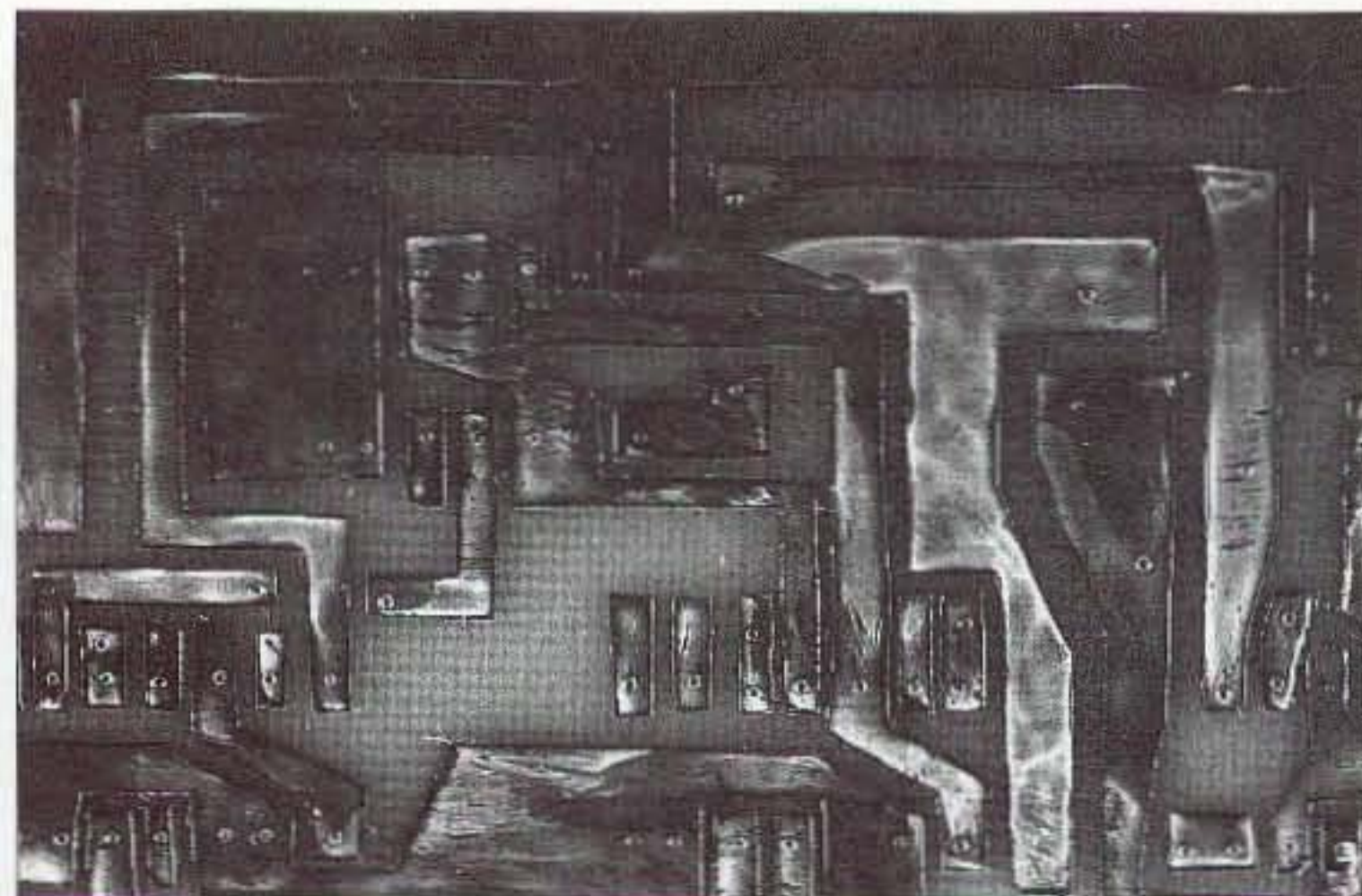
Upon completion, the board must be washed with tap water to remove the etchant. If the board is to be a single-sided board, then the nail polish can be removed with lacquer thinner or acetone. A small amount of solvent on a paper tissue works well as a wiper. An etched board with nail polish is shown in **Photo E**.

Following an inspection of the trace pattern for copper bridges and other possible minor defects, the board is ready for drilling (**Photo F**). Hole sizes are a personal choice, but drill sizes from #57 to #62 work well for most applications.

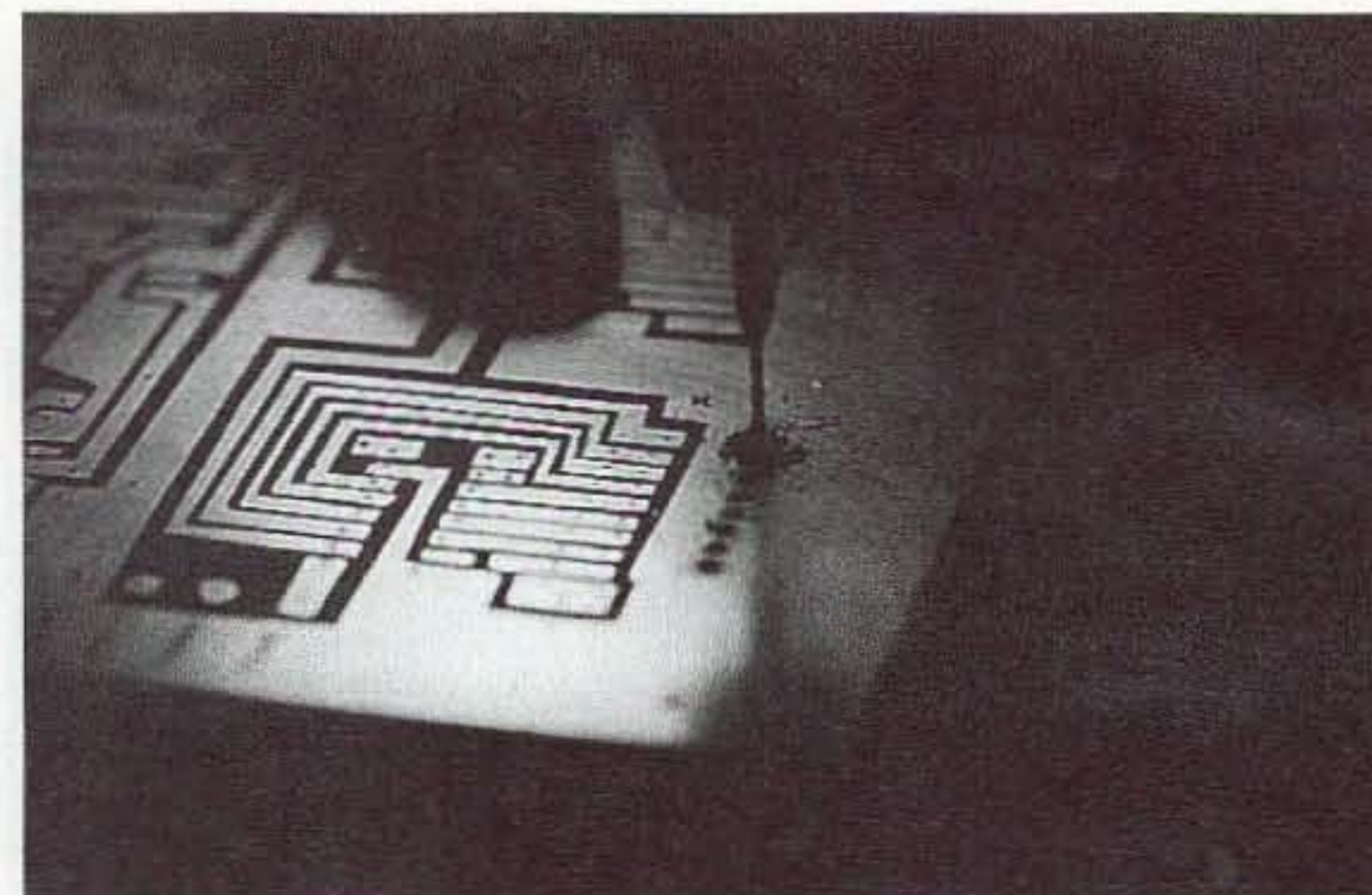
Solder-coating the copper is an optional process, but it does help reduce oxide development on the surface of the copper. The advantages of solder coating are better part solderability and uniform appearance, in addition to



**Photo D.** A scribe is used to scratch unetched copper bridges before returning the board to the etch.



**Photo E.** This is the etched board after being washed, but before the nail polish has been removed.



**Photo F.** Drill sizes from #57 to #62 work well for drilling the holes.



the reduction in copper oxide formation. The involved steps begin with cleaning the copper with fine steel wool followed with a solvent rinse. The objective is to remove all traces of nail polish, oxides, and oil.

The procedure for solder coating the board is as follows:

1) Coat the surface of the copper with a very thin coating of solder flux.

2) Place a small drop of solder on the tip of a 25-30 watt soldering iron.

3) Touch the solder to the copper and draw the iron along the copper. A solder trail will be left as the iron moves. Solder may be added as necessary to continue the process.

4) Continue the solder coating process until all of the copper is coated. It will be necessary to move the iron reasonably fast across the copper to reduce the possibility of burning the adhesive below the copper.

5) Clean the coated board with alcohol, lacquer thinner, or acetone to remove the flux.

### Double-sided boards

Making double-sided boards is a little more difficult than the process outlined above. However, the same steps are repeated except for drilling. Drilling is done from the bottom side (most complex trace pattern side) of the board.

During the etching process, the side opposite the pattern being etched must be protected from etching. Coating the "protected" side with nail polish or with a couple of layers of plastic spray is sufficient. After the first side is etched, it is sprayed with plastic or the exposed areas of copper are coated with nail polish to prevent further etching of those areas. Care must be taken so that the "protected" side is not scratched during handling. Coating the "protected" side a few minutes before etching is best.

Preparing the second side of the board follows the same steps as the first, but orientation of the trace pattern is a little tricky. It is best to have the majority of holes drilled before the second side is started, as the holes are

Continued on page 22

### LED FLASHLIGHTS (and more!)



Colors: white, blue, red, and green

**D & L Antenna Supply Co.**

Secure Ordering On Line at

[www.wavehunter.com](http://www.wavehunter.com)

1-800-965-8880

Prices from \$4.95 to \$59.95

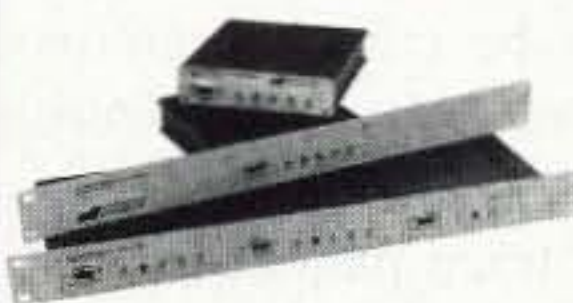
- Lasts 4 times longer than regular flashlights
- Lifetime warranty including LED lights
- Shockproof
- Features 4 high intensity LED lights
- Powered by 3 AA alkaline batteries

After continuously being turned on for 14 days (336 hours), it was possible to read a newspaper using only the output from this amazing system. This item sold out at Dayton!

- DIP switch programmable
- Miniature in size
- 37 EIA tones, 27 non-standard tones from 33.0 to 254.1 Hz included
- Reverse Burst built-in
- Easy 3 wire hookup

SS-64 CTCSS Encoder  
.66" x 1.08" x .21"

SS-64 DIP Switch Programmable CTCSS Encoder \$28.95



TP-3200 Shared Repeater Tone Panel

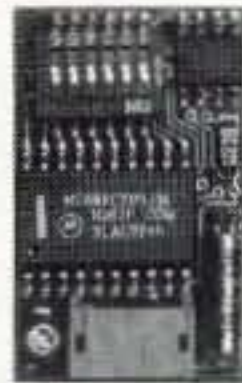
TP-3200D Table Top Version

TP-3200RM-A Single Rack Mount version

\*TP-3200RM-B Triple Rack Mount version

\*Holds up to three TP-3200s

Call or write to receive our full Product Catalog or visit our Web site for complete information at:  
<http://www.com-spec.com>

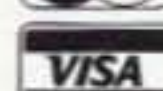


- 51 CTCSS Tones
- 106 DCS Codes
- Supports 157 Repeater Subscribers
- On-Line Computer Help
- Repeater CW ID
- Air Time Loading & Analysis Graphs
- Signalling Formats: CTCSS DCS & DTMF

\$269.95 each

\$279.95 each

\$279.95 each



- Fully enclosed CTCSS encoder
- All 32 EIA tones from 67.0 to 203.5 Hz included
- Perfect for mobile / base applications



TE-32  
5.25" x 3.3" x 1.7"

TE-32 Multi-Tone CTCSS Encoder \$49.95



- Eight programmable, selectable messages
- Fully field programmable via included keypad
- Meets all FCC identification requirements

ID-8 Automatic Morse Code Identifier  
1.85" x 1.12" x .35"

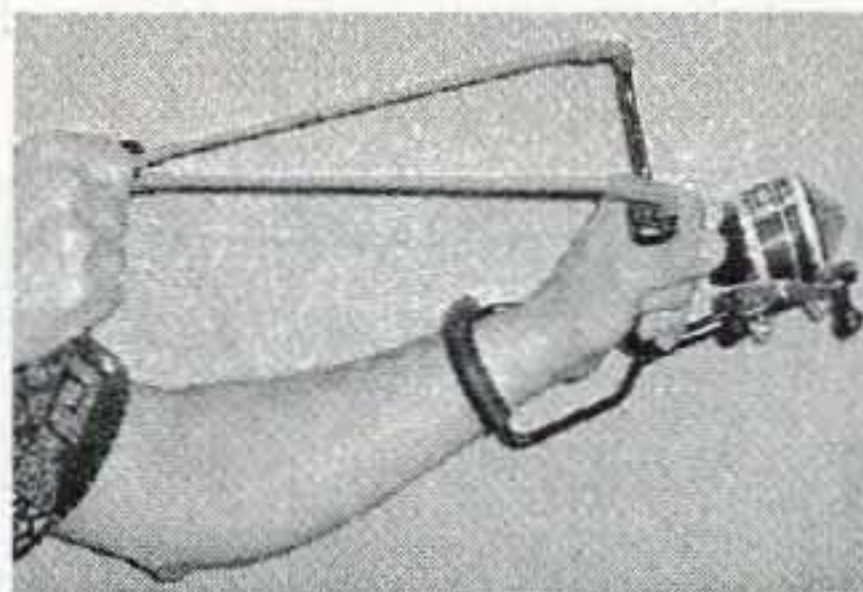
ID-8 Automatic Morse Station Identifier \$69.95



**COMMUNICATIONS SPECIALISTS, INC.**

426 WEST TAFT AVENUE • ORANGE, CA 92665-4296  
(714) 998-3021 • FAX (714) 974-3420  
Entire U.S.A. (800) 854-0547 • FAX (800) 850-0547  
<http://www.com-spec.com>

## HANG YOUR NEXT WIRE ANTENNA THE EZ HANG WAY



Everything you need; the original EZ Hang, the EZ Winder intermediate line dispenser and five extra weights:

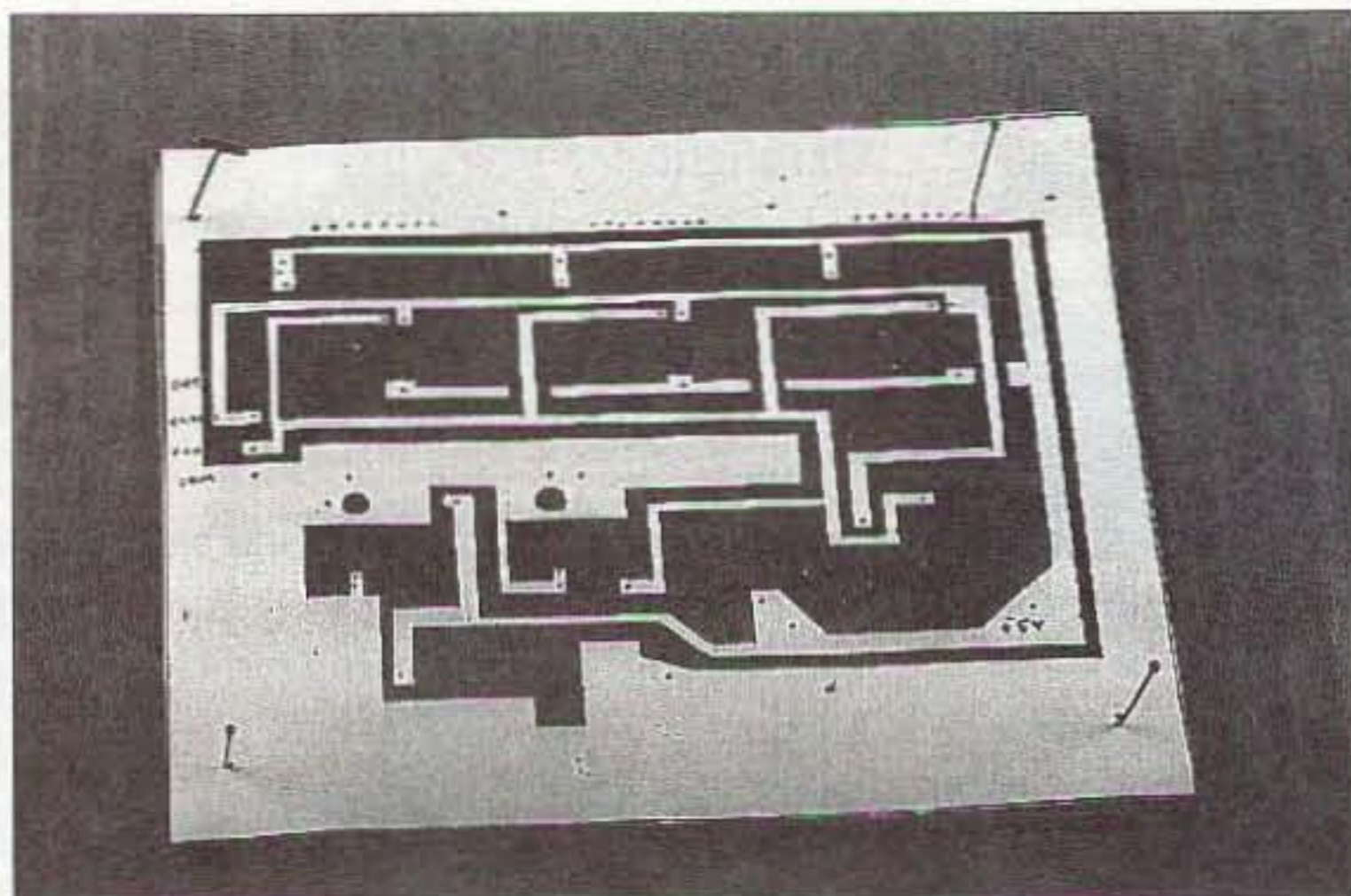
\$62.95 + \$7.95 (US) S&H

EZ Hang, Code 7, 8645 Tower Dr, Laurel, MD 20723

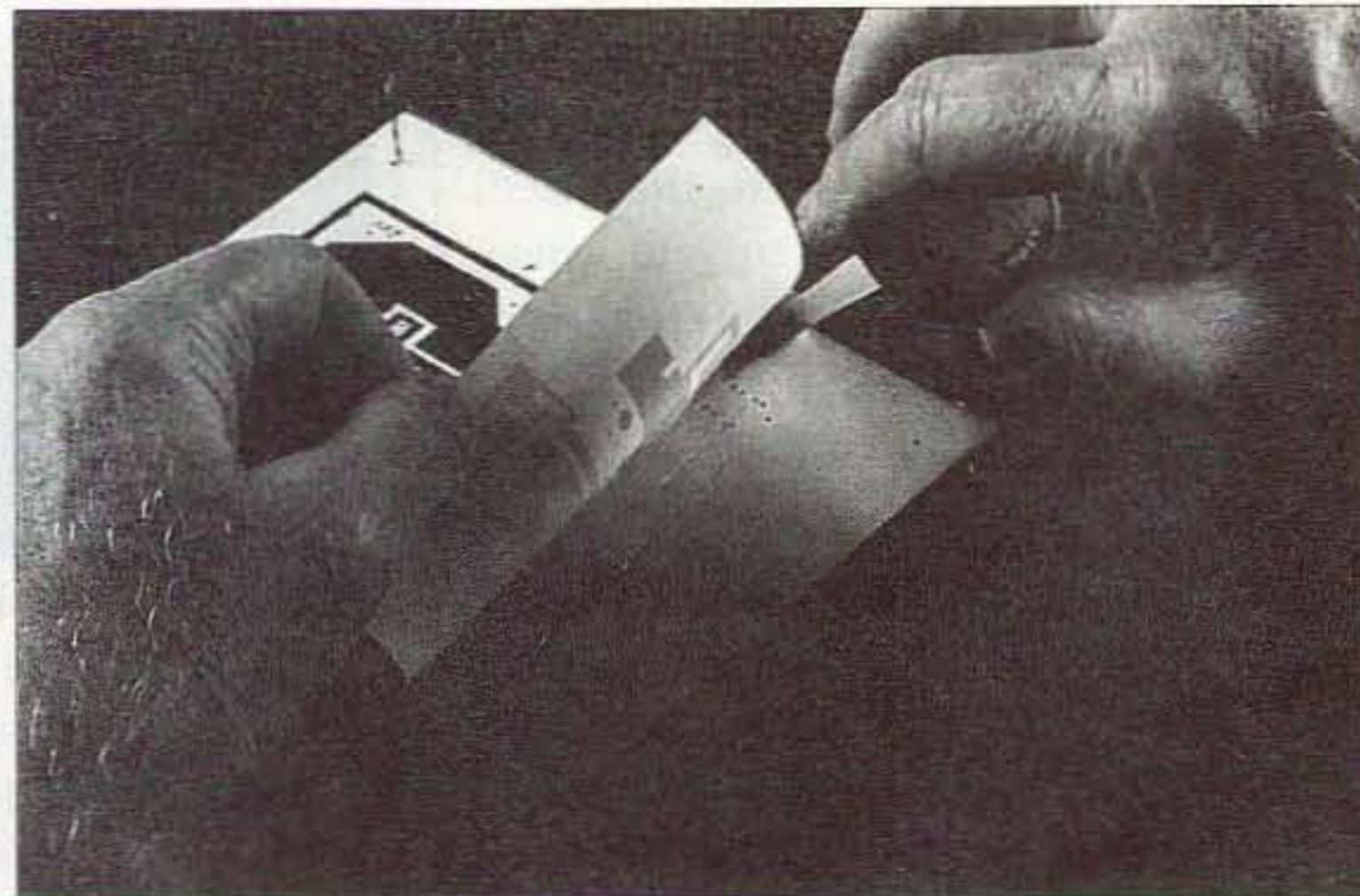
540-286-0176

[www.ezhang.com](http://www.ezhang.com)





**Photo G.** The second side paper mask is positioned prior to being cemented.



**Photo H.** The first half of the paper mask has been aligned and cemented, while the second half is being cemented.

## Inside Digital TV/VCR Tuners

*continued from page 21*

used as a guide for placing the paper mask.

In preparation for placing the paper mask onto the second side, the following steps are recommended:

1) Place the mask on the board without cement and orient the pattern to match the drilled holes.

2) For an alignment check, hold the board up to a light and observe the light passing through the holes. View the board from the topside pattern.

3) Push two or more straight pins through the corresponding mask "holes" into the board holes and note the proper trace orientation as shown in **Photo G**.

4) When satisfied that the orientation is correct, coat the copper and the paper mask with rubber cement.

5) With the straight pins pushed through the paper mask, use the pins as

alignment guides while dropping the paper onto the copper as shown in **Photo H**.

6) Remove the pins and rub out the bubbles and excess cement.

With the mask in place, the trace pattern may be cut and removed, as was done for the first side. During the mask removal process, any misalignment of the trace pattern may be corrected as the process is performed, while using the mask lines as a cutting guide. Deviating from the drawn pattern may be necessary to correctly pick up the drilled holes.

Double-sided boards made commercially usually have plated-through holes. Unfortunately, the plating process required for making the plated holes may be outside of the reach of the average ham, so the data transmitter and receiver boards have been laid out for "Z"-wires as was shown in part 6, Fig. 5. The objective of the "Z"-wire

is to connect the circuit trace on one side of the board to the trace on the other side. On the project boards, the solder pads have been extended away from the IC pin or transistor lead far enough for a wire to be passed through the board. Where "Z"-wires are used, component leads need to be soldered

only to the bottom side of the board, as the "Z"-wire will transfer the connection between board sides.

Some bypass capacitors and the filter capacitors will require soldering onto the upper surface traces, because holes have not been provided. Placement of the capacitors is at the user's option. As an example, the 100-500  $\mu$ F filter capacitor(s) may be placed anywhere on the board where the +5 volt trace runs close by the ground trace.

**Photo I** shows the completed prototype boards for the data transmitter and receiver. Trace pattern errors found in the prototypes have been corrected for the patterns provided herein.

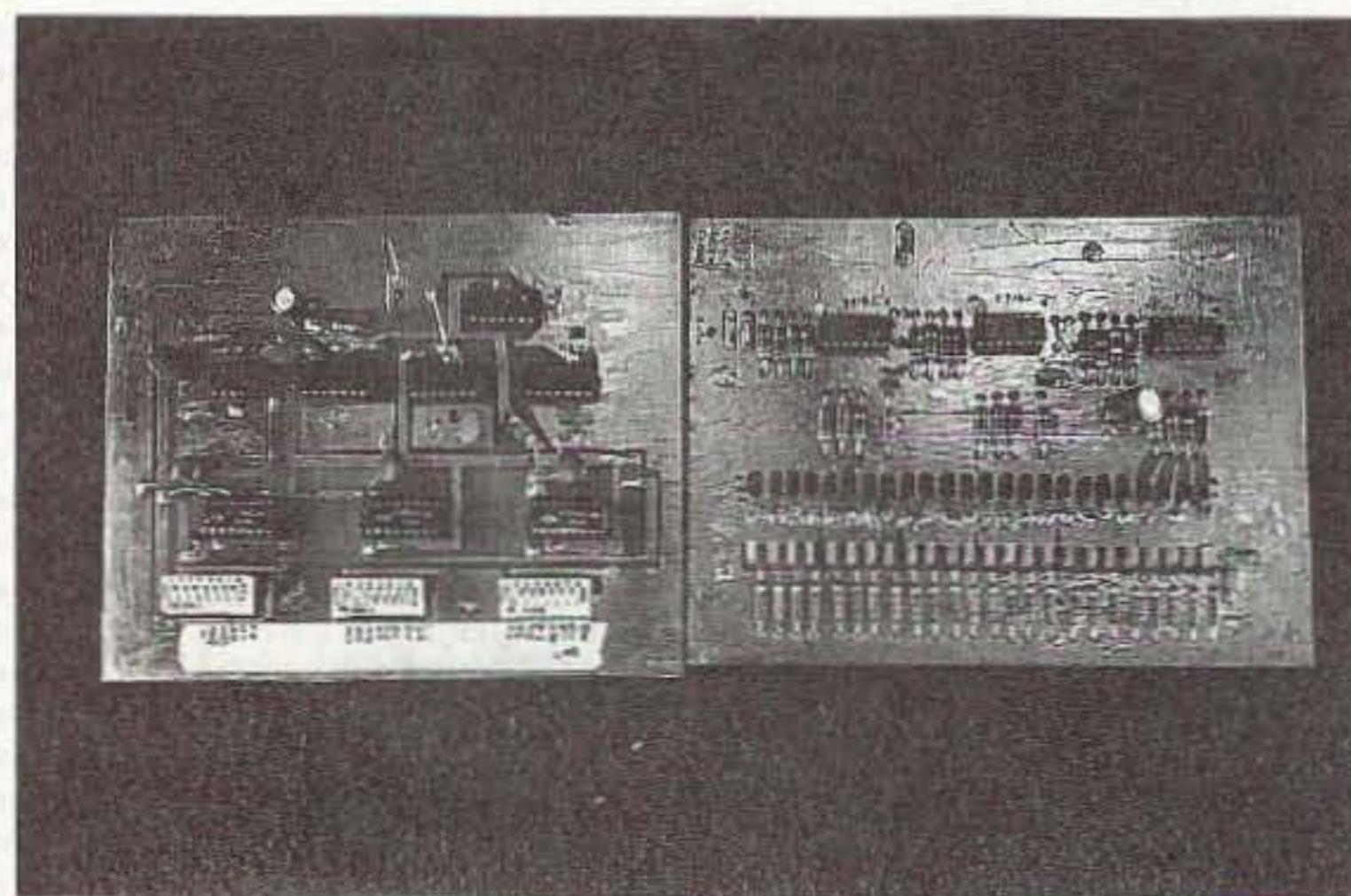
I've been using the fingernail polish resist method for making printed circuit boards for a great many years, and can attest to the reliability of the process. I hope that you will see the merit in the simple process steps involved and will give it a try.

### Alternate boardmaking techniques

Because of the wide variety of printed circuit board processing techniques available, some alternate methods can be found on the Internet. The techniques indicated below utilize the plastic toner used in copy machines and laser printers as an etch-resist.

Here are four good URLs:

- [<http://geocities.com/pdmtr>]
- [<http://www.techniks.com/press-n-peel.html>]
- [<http://www.qsl.net/ei9gq/pcb.html>]
- [<http://www.nordicdx.com/dxlab/makepcb2.html>].



**Photo I.** This photo shows the operational prototypes of the data receiver (right) and the data transmitter (left).



# Build This Variable AC Bench Supply

*If you can find a Variac transformer, that is.*

How many times have you home-brew folks had the need for a variable 120 VAC power supply? Well, at least several. We know that working with 12 volt DC on the bench is certainly no problem. If a mistake is made, you might lose an IC or two, but no fires erupt. With AC — well, things can get lethal before the fuse blows, and this is especially true when using 120 VAC. We have all done those dumb things that have jump-started our heart from time to time. This "Variac" variable supply will prove safe on those start-ups of those questionable home-brew circuits that require AC supplies.

Let's look at the central component, which is called a Variac transformer. This is also known as an autotransformer in some circles. A certain ham who has tried to declare himself to be the authority in this field has also called the "autotransformer" a current transformer when it is used in RF impedance matching devices called baluns.

Well, it is particularly a variable secondary winding transformer that allows a continuously variable primary-to-secondary ratio, thus providing a continuously variable AC voltage from zero to 130 VAC. These devices have become very expensive when purchased

new, and are usually in the \$130 range for the 3 A models. I do not recommend the purchase of a new Variac transformer.

Now, look at the list of local hamfest flea market supply get-togethers. Usually a five dollar entry fee will get you into one of these events. They take place usually on Sunday mornings from 9 a.m. to 1 p.m. You can look into *QST*, *CQ*, or *73* magazines under the "coming hamfests" section to determine the location and date of each event. You can also check into your local two meter repeaters and someone can help you, since nearly all of the events are sponsored by repeater

groups. Anyway, look for a Variac under the vendors' tables since they do not seem to have a high dollar value or a large demand these days. I found mine for a price of fifteen dollars. I did not even try to bargain or dicker, since the condition was very good. Try to ensure that the knob is with it, since the completed unit with knob will look more professional. Finding a replacement knob can become a real problem, so do your best.

The next item is some type of voltage indicator. It is possible to use a digital voltmeter and do calibration on the front panel, but a nice analog AC voltmeter is best since the AC line

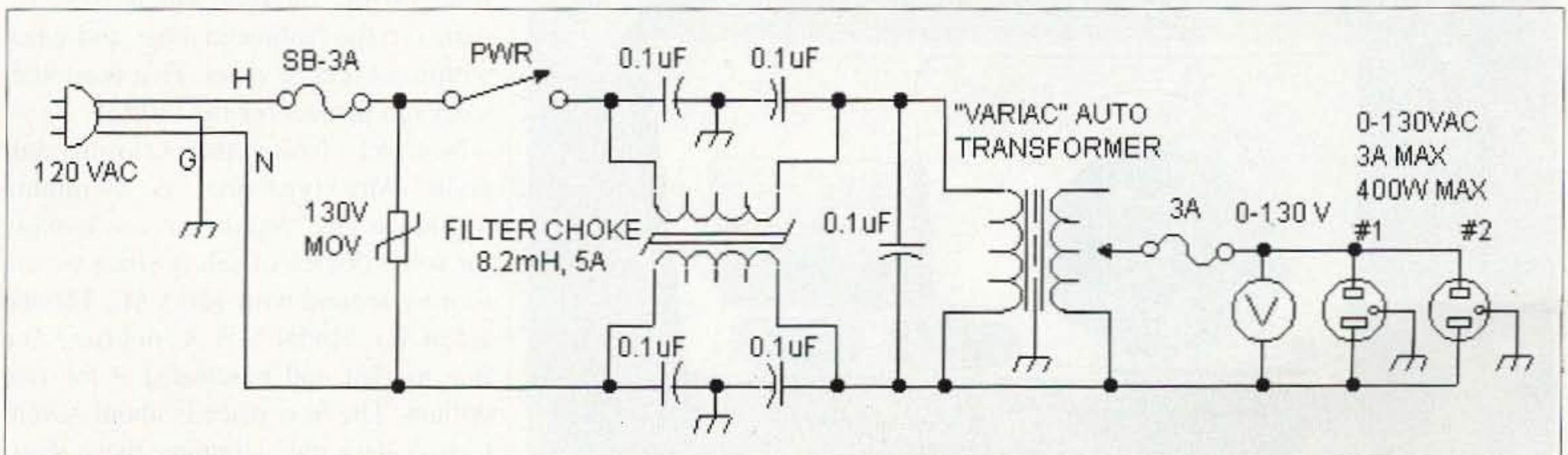


Fig. 1. Supply schematic.



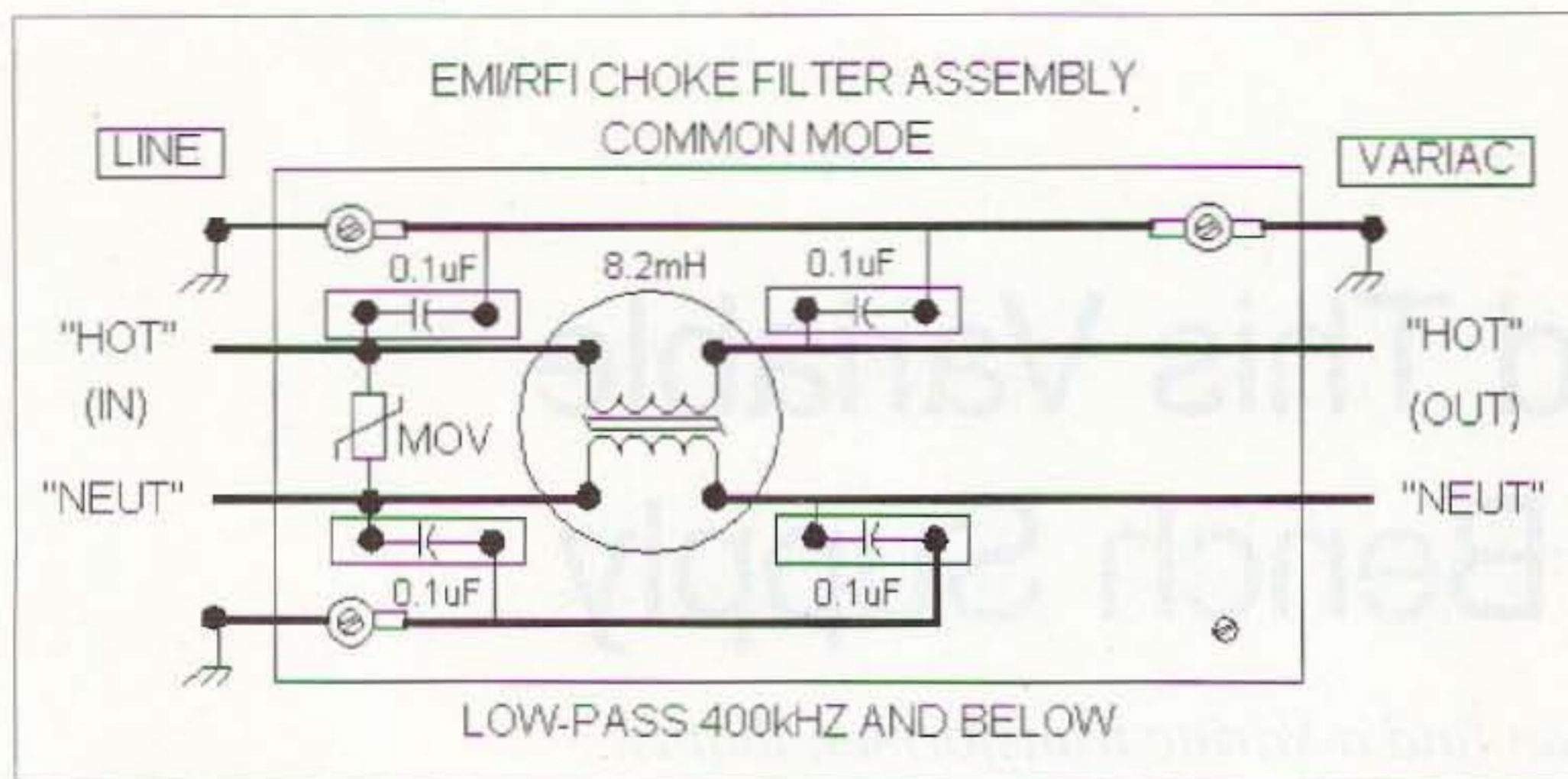


Fig. 2. EMI/RFI choke filter assembly. Mount using 0.25-inch aluminum standoffs.

voltage may vary at your location. I found an old Lafayette model #99-51161 0-250VAC type. The vendor wanted one dollar, so I smiled and paid the man and thanked him. It's that old story of one man's junk is another man's gold. He also had several new, boxed Heathkit 200  $\mu$ A meters for one dollar each. No, you do not have to ask me! The plastic covers snap off and two screws hold the metal scale plate in place, so reversing the plate and drawing a new scale is not a problem on these meters. With a shunt resistor, the meters can be used for nearly any DC application. A trimpot in series will adjust the scale in the voltage mode. For AC, you can use a bridge rectifier and adjust. All this "stuff" is in your *ARRL Handbook* and many other good books. Be creative, spend

one buck, and have some fun. If you feel you just have to purchase a new, good-looking meter, you can go to your local Radio Shack and order one (RS #22-412) at about thirteen dollars a pop!

For safety's sake, we want to double fuse the little box. Use a 3 A slo-blo 3AG fuse on the primary side and a 3 A fast blow 3AG on the secondary side. This is all the protection that is needed. That expensive Variac needs primary and secondary protection for sure!

When working on electronic projects, it is always nice to filter the 120 VAC line to keep garbage noise out of the circuits being tested or developed. An inexpensive low pass (common-mode) filter is employed on this project, and can be seen in Fig. 1.

Something like an electric motor appliance putting common-mode noise on the line will give you nightmares. An inexpensive common mode filter is installed, which all but eliminates noises from appearing on the primary or secondary of the Variac transformer. Working with digital circuits using a DC wall transformer for power can move tremendous hash and noise to the 120 VAC line and get unbelievable noise from the folks you live with. The 8.2 mH filter is rated at 5 AC amps (RMS) so the 3 A requirement is well covered. The 0.1  $\mu$ F capacitors and 130 VAC MOV take care of any large peak voltage spikes very well. This is nice insurance in case a transient tries to get to the filter circuit. The MOV or metal oxide varistor device is for those unexpected current slugs that the electric utility ignores. It will clamp off at the 150 V level, figuring in the variable voltage to variable time factors. This device is rated at 130 VAC but is just not very fast.

The line cord must be a three conductor (NEMAL) type preferably in the AWG #14 wire size. The green ground wire, when attached to the aluminum enclosure, will ensure safe operation no matter the situation. It is required these days by NEC (code), so it is a good idea to use it. Another note on the source of AC power which should be covered is the problem of GFI (ground fault) devices. If you use one of these safety devices to supply your power to the workbench be aware of all the Triac/SCR noise that they produce. The common-mode filter will take care of that nasty little item. I have considered using this filter as a filter on the devices which NEC requires in the bathroom areas and when within six feet of water. That is another weekend project for the future!

Now, let's look at the enclosure situation. Any type that is aluminum would be OK. Again, we are looking for some degree of safety since we are fooling around with 120 VAC. I found a Ten-Tec Model MW-8 enclosure at a flea market and purchased it for five dollars. The new price is about seventeen dollars plus shipping these days. Just be creative!

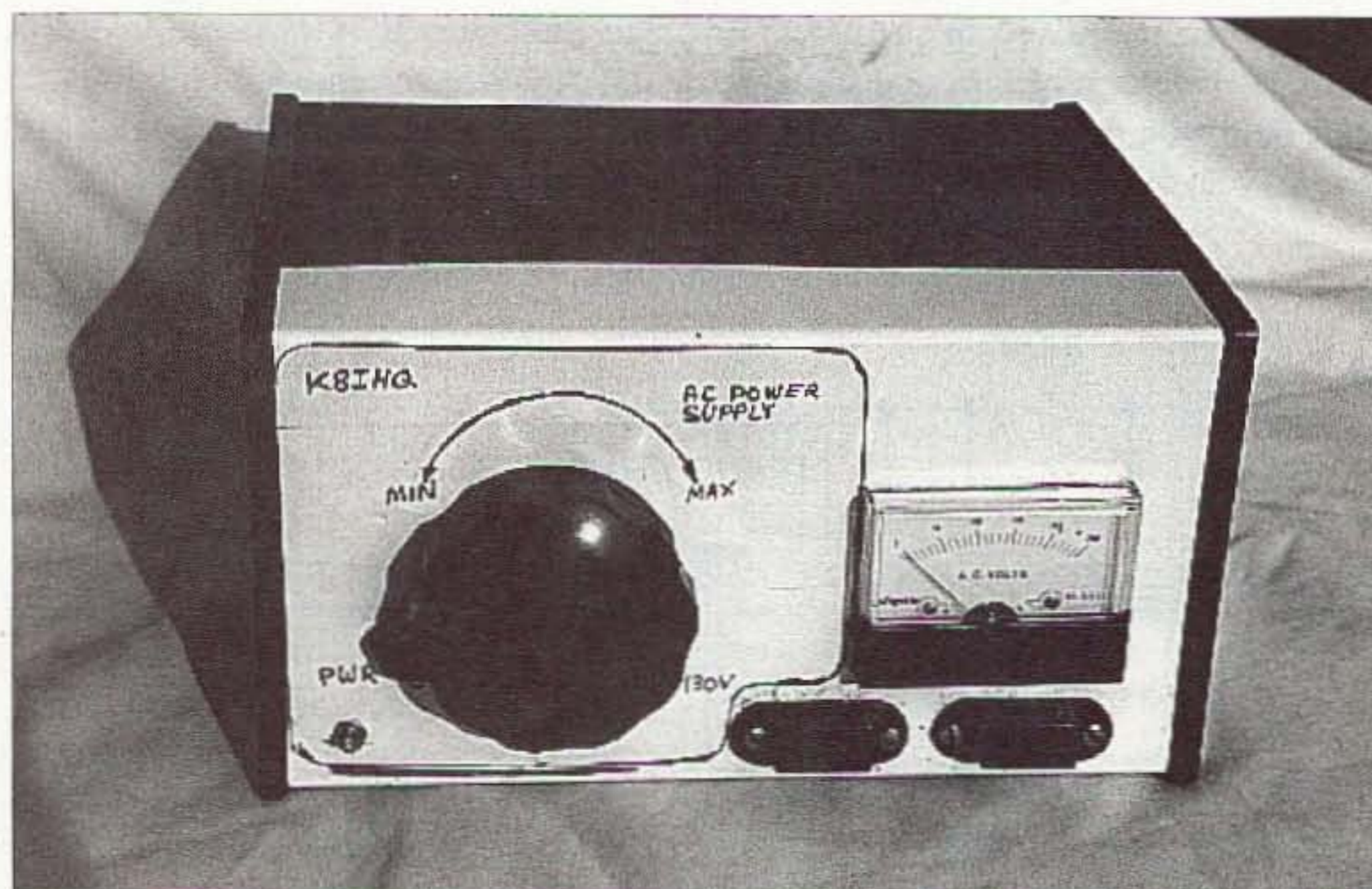


Photo A. In case, ready to go.



Well, the MW-8 I found had holes in the bottom, back, and also the front panel. The hole in the front got bigger to accommodate the AC voltmeter. The other front holes got covered by a piece of contact paper purchased at a local office supply house. Use a black felt marker to put the markings and scales on. The holes in the rear of the enclosure were enlarged to handle the two fuses, and one new one was made for the 0.5-inch strain relief for the line cord. Again, use the felt marker to identify the fuse sizes, etc. The marker can be had at your local post office for one dollar! It has both a broad and very fine point. What a deal for one buck!

Once the components are mounted, you will be ready for the wiring of the unit. Use insulated AWG #18 or larger. See Table 1 for parts info. The

Qty.	Part	Source	Cost
1	MW-8 enclosure	Ten-Tec	\$17.00
1	3A SB fuse #31-155	Hosfelt Electronics (HE)	.30
1	3A fuse #31-359	HE	.06
2	Fuseholders #43-206	HE	1.50
1	Strain relief	Local	.25
1	Line cord #60-372	HE	1.75
1	120 VAC 3A Variac auto xfmr	Hamfest or flea market	15.00
1	130 VAC MOV #V130LA20B	HE	.60
2	Panel-mount AC receptacles	Local	1.00
1	150 VAC panel meter (RS #22-412 = \$13)	Hamfest or flea market	1.00
4	0.1 µF 250 VAC box caps #15-828	HE	.25
1	Dual 8.2 mH toroid choke 250 VAC 5A 0.2 Ω #18-129 Pulse Engg #96180	HE	.35
1	SPDT 3 A toggle switch #51-268	HE	.75
1	Perfboard RS #276-1396	Radio Shack	3.50
OR			
1	PCB	FAR Circuits	4.00 + 1.50 s/h
4	Sets aluminum standoff hardware #6	Your choice	1.00
3	Solder lugs #6	Your choice	.15

Table 1. Parts list.

suppliers' info is listed below in the text. The use of clear 100% silicone caulk to mount the components onto a perforated board works well. Or, you can use the PCB available from FAR Circuits. (I originally used perfboard, but now there is a PCB available.)

Now that you have all the components and assemblies, you can wire the components together using the schematic. Follow the schematic in Fig. 2, and as each wire is installed use a yellow hi-lighter (Broad Point) to mark each wire on the schematic. I find that nearly no mistakes will happen when this procedure is used.

When everything is wired and checked, you can plug it in and flip the switch with the Variac at zero volts. No smoke generally indicates you have done a good job. A blown fuse indicates you did something wrong! If everything is OK, then plug a lamp into the utility plug and turn the Variac slowly to 120 VAC, watching the bulb's intensity increase as voltage increases. Ensure the AC voltmeter is also functioning correctly.


Now you have a soldering iron heat controller — among some other good things! Good luck!

#### Notes/Sources

FAR Circuits, 18N640 Field Ct., Dundee IL 60118-9263. PCB is \$4 + \$1.50 S/H.

Hosfelt Electronics, (1-888-264-6464), catalog.

Jameco Electronics, (1-800-831-4242), catalog.

Ten-Tec, (1-800-231-8842), catalog. 

#### Pay TV and Satellite Descrambling New ..... Volume 12 ..... New

Pay TV and Satellite Descrambling VOLUME 12 has latest cable and satellite fixes including new EK-1, bullet blockers, etc. \$18.95. Complete Pay TV And Satellite Descrambling Series CD-ROM, Vol. 1-12 \$59.95. Scrambling News Online includes piracy \$59.95/yr. Hacking Digital Satellite Systems Video IV \$29.95. Everything listed here only \$99.95. Free catalog.

Scrambling News  
915 N.W. 1st Ave., #2902  
Miami, FL 33136  
Voice/FAX 305-372-9427  
www.scramblingnews.com

#### From MILLIWATTS to KILOWATTS™



#### RF PARTS HAS IT!

Complete inventory for servicing Amateur, Marine, and Commercial Communications Equipment.

- Transmitting Tubes & Sockets
- RF Power Transistors
- VHF/UHF RF Power Modules
- Low Noise RF FET's
- Bird Electronics Wattmeters
- Doorknob Capacitors
- Chokes • Broadband Transformers

Se Habla Español • We Export

Visit our Web Site for latest Catalog pricing and Specials:  
<http://www.rfparts.com>

ORDERS ONLY  
1-800-RF-PARTS • 1-800-737-2787

ORDER LINE • TECH HELP • DELIVERY INFO.  
760-744-0700

FAX TOLL-FREE FAX  
760-744-1943 888-744-1943

E-MAIL: [rpf@rfparts.com](mailto:rpf@rfparts.com)



**RF PARTS**  
435 SOUTH PACIFIC STREET  
SAN MARCOS, CA 92069

#### Amplifiers, ATU Down Converters & Hard to Find Parts

##### LINEAR AMPLIFIERS

**HF Amplifiers**  
PC board and complete parts list for HF amplifiers described in the Motorola Application Notes and Engineering Bulletins:

AN779H (20W)	AN 758 (300W)
AN779L (20W)	AR313 (300W)
AN 762 (140W)	EB27A (300W)
EB63 (140W)	EB104 (600W)
AR305 (300W)	AR347 (1000W)

**2 Meter Amplifiers**  
(144-148 MHz)  
(Kit or Wired and Tested)

35W - Model 335A,	\$79.95/\$109.95
75W - Model 875A,	\$119.95/\$159.95

##### HARD TO FIND PARTS

- RF Power Transistors
- Broadband HF Transformers
- Chip Caps - Kemet/ATC
- Metalclad Mica Caps - Unelco/Semco
- ARCO/SPRAGUE Trimmer Capacitors

We can get you virtually any RF transistor! Call us for "strange" hard to find parts!  
**DIGITAL FREQUENCY READOUT**  
For older analog transceivers  
TK-1 (Wired and Tested) \$149.95

##### ATU Down Converters

(Kit or Wired and Tested)

Model ATV-3 (420-450)	(Ga AS - FET) \$49.95/\$69.95
Model ATV-4 (902-926)	(GaAS - FET) \$59.95/\$79.95

For detailed information and prices, or write for our free catalog!

Phone  
(937) 426-8600  
FAX  
(937) 429-3811

**CCI Communication Concepts Inc.**  
508 Millstone Drive • Beavercreek, Ohio 45434-5840  
e-mail: [cci.dayton@pobox.com](mailto:cci.dayton@pobox.com)  
[www.communication-concepts.com](http://www.communication-concepts.com)

**ADDITIONAL ITEMS**

- Heat Sink Material
- Model 99 Heat Sink (6.5" x 12" x 1.6"), \$24
- CHS-8 Copper Spreader (8" x 6" x 3/8"), \$24
- Low Pass Filters (up to 300W) for harmonics \$12.95
- Specify 10M, 15M, 20M, 40M, 80M or 160M
- HF Splitters and Combiners up to 2KW



# \$5 Infrared Remote Tester

*Build this and look like a hero.*

*This article describes a simple device to test all kinds of infrared transmitting devices. All parts are available at Radio Shack at a total cost of around \$5. It has no adjustments and the physical layout is not critical.*

Okay, you're a ham. By default, you're also the electronics expert of the family. On call "24/7" (hours a day/days a week) for all kinds of questions. For example, some family member tells you: "My TV remote doesn't work." What do you do? First, you check that the batteries are installed properly, then you check the batteries with your DMM/VOM to

make sure they're good. You point it at the TV, CD player, DVD player, etc., and hopefully it works. If it does, you're a hero for discovering that the batteries were put in backward after the old dead ones were replaced.

But what do you do if it still doesn't work? How can you tell if the problem is in the remote or the TV? I suppose you could go to a store and buy one of

those universal remotes. But what if you're checking an IR keyboard or mouse or other device with an IR transmitter that doesn't have a generic replacement available at the corner store?

This article describes an IR receiver that tells if the IR is transmitting by blinking an LED at the same rate as the transmitted signal. You can build this very simple project for about \$5 and have a portable checker that you can loan to friends, relatives, and neighbors. All parts are available at Radio Shack; if you have the proverbial "well stocked junk box," you may already have most parts on hand.

## Circuit operation

The schematic with typical waveforms is shown in Fig. 1. The incoming IR signal shines on the domed top of transistor Q1, causing it to conduct current, resulting in a voltage drop across R1. Op amp U1a is wired as a buffer to isolate the detector from the rest of the circuit. C1 couples the signal from this buffer to amplifier U1b. U1d with R6 and R7 provide a "stiff" virtual ground halfway between ground and the supply voltage. This virtual

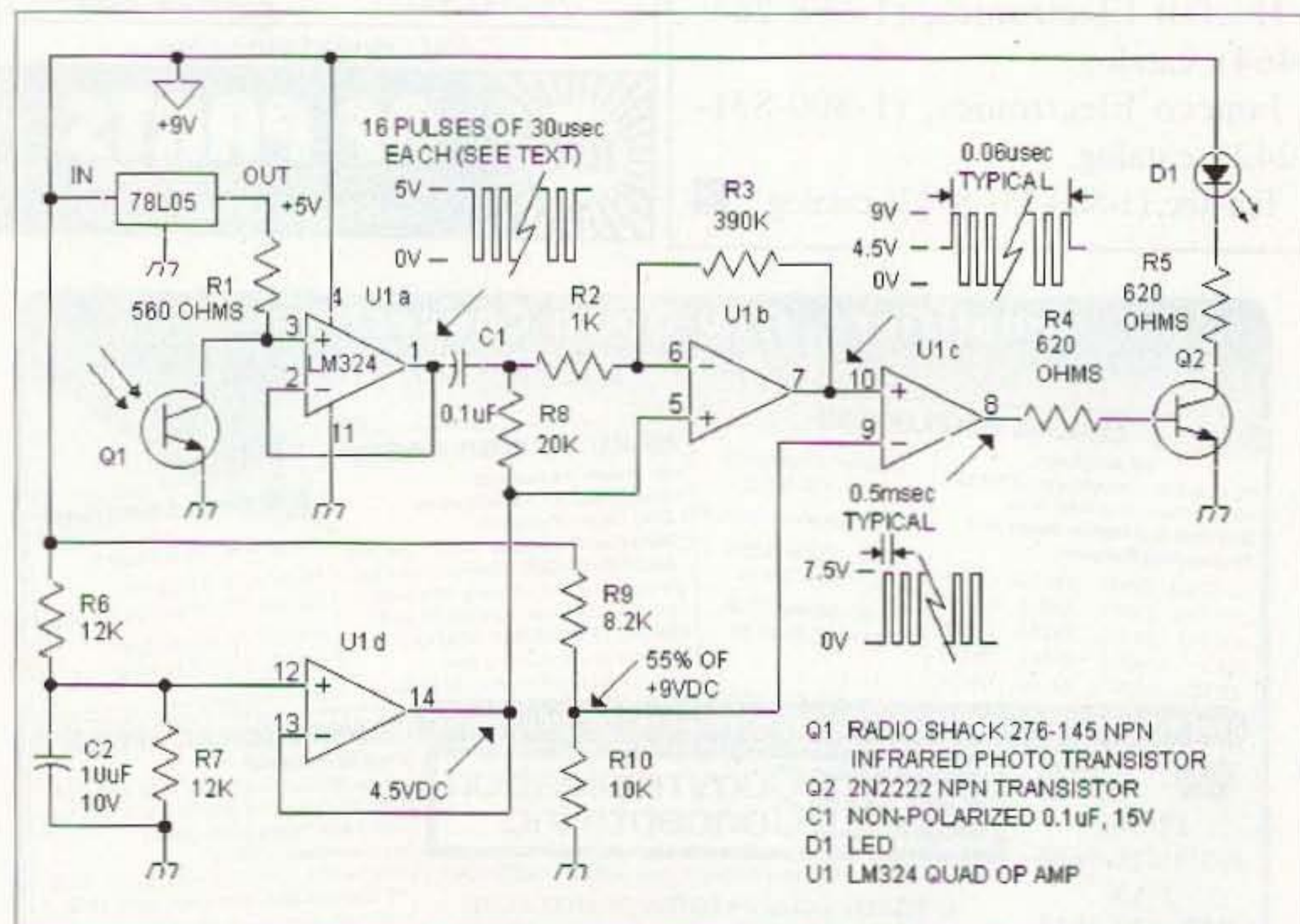
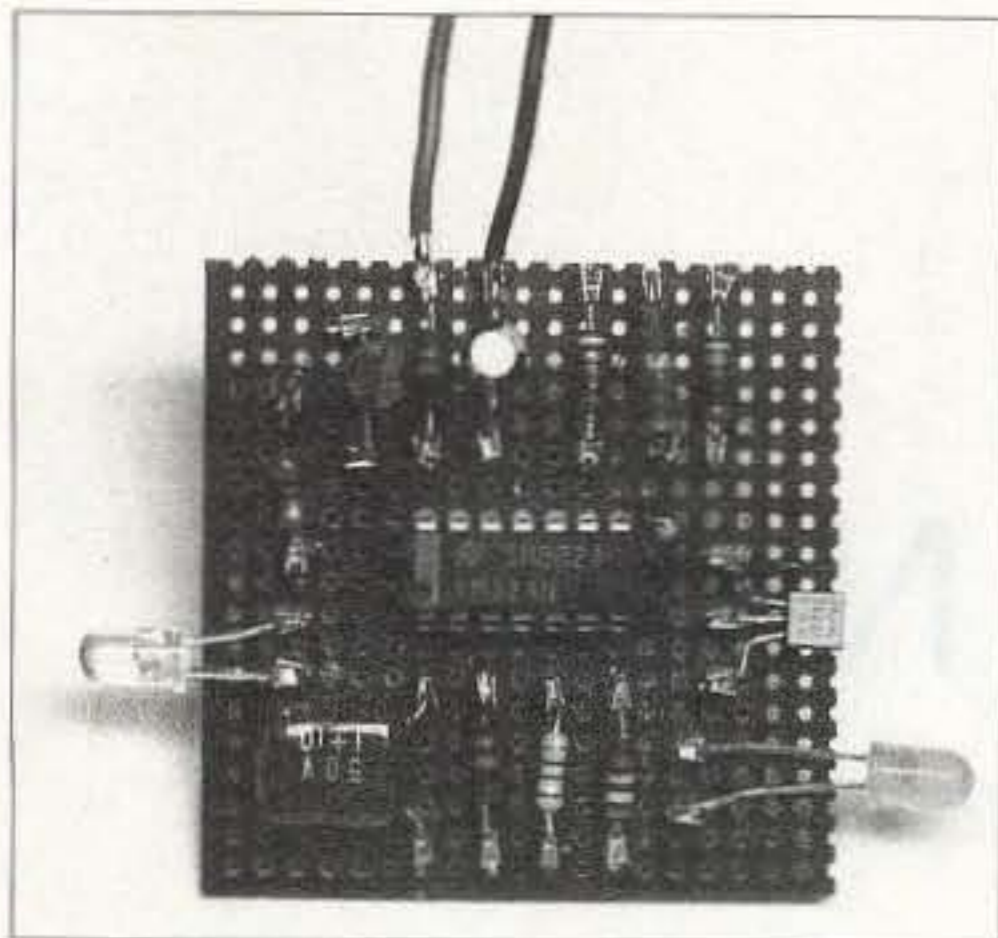


Fig. 1. Schematic with typical waveforms.





**Photo A.** Here's the board, right out in the open so you can get a good look.

ground is used to make the power supply act like it is a  $\pm 4.5$  volt power supply. The bottom of R8 is tied to virtual ground to keep the input to U1b from floating to V+ or V-. If the input did float either high or low, operation of the circuit would cease.

U1b with R2 & R3 amplify the signal by a factor of 390 ( $R3/R2$ ). The voltage at U1b pin 7 is halfway between V supply and ground, with the IR signal superimposed on top of it. By amplifying the signal by a factor of 390, it saturates the output of U1b. The squarewave output of U1b goes from 1.5 volts less than the supply voltage to true ground. U1d is used as a comparator. Pin 9 is held at 5% above virtual ground by resistors R9 and R10. Pin 8 goes to +7.5 volts when pin 10 is more positive than pin 9. Q2 is turned on through R4 only on the positive part of the squarewave signal from U1d. Q2 lights the LED.

I used an LM324 since it is capable of accepting and outputting a low voltage right down to 5 millivolts above -V supply (pin 11). This is needed since Q2's base must be less than 0.65 volts above true ground to shut off with no incoming signal.

The waveforms shown on the schematic represent just part of a complex waveform. Vary the timebase of an oscilloscope from 0.5 milliseconds to 20 microseconds to see all parts of the actual waveform. The amplitude at U1a pin 1 will vary with distance. I obtained 3 volts peak-to-peak at 3 inches. The maximum working range was 23 feet. The signal at the IR sensor at this distance is of course very low.

## Construction

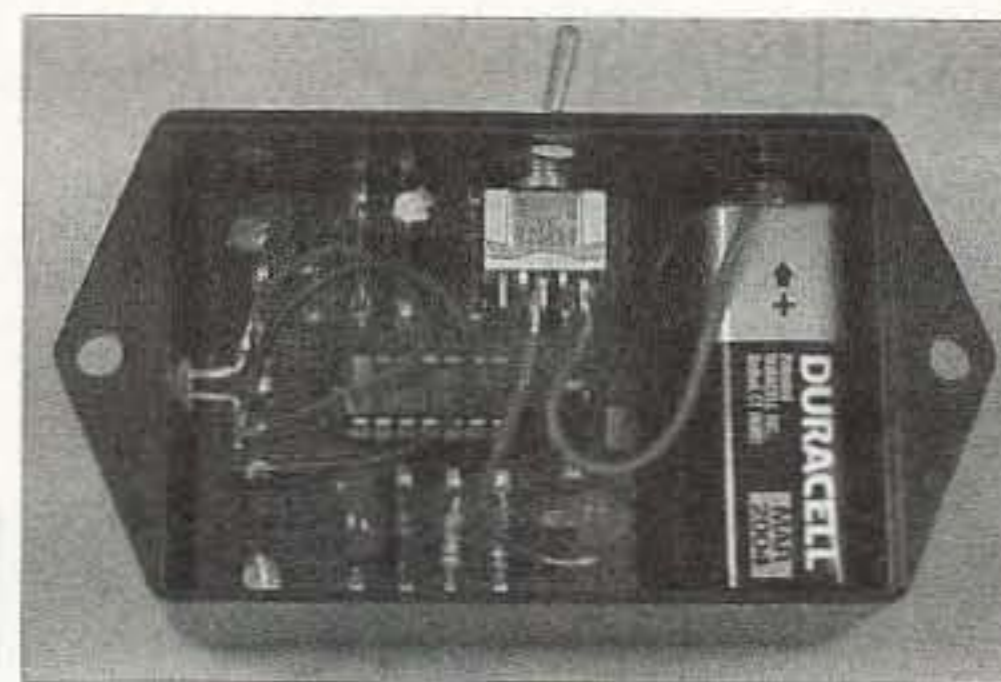
I constructed my unit using perf-board and push-in clips. I didn't choose to lay out or fabricate a PC board since I built only one unit. Before mounting the board in a small box the project looked like **Photo A**. The completed unit can be put in a small box (**Photo B**). I suggest locating the input transistor at the end of the box and the LED on top of the box.

You will have to perform testing in a dimly lit room (not total darkness) or shield the IR detector with an opaque tube to let light in only from "head-on." If sunlight or bright lights are shining on the detector, the LED will be on full-time and prevent you from testing a remote unit. You could also reduce the gain of U1b so the tester is not as sensitive, but I did not try this.

An interesting point is that you can see the 60 Hz sine wave from an incandescent light bulb by monitoring pin 1 of U1 with an oscilloscope. You will have to adjust the sensitivity of the oscilloscope to accommodate the signal level since it will vary with the distance to the light bulb.

## Summary

You can build this project in just a few hours. With it you can help neighbors, relatives, and fellow workers troubleshoot their IR transmitter devices. If you make it look homemade,



**Photo B.** The completed unit.

people will likely ask how you knew to build a tester like this. Use that opportunity to talk up electronics and ham radio as a hobby.

There are probably some changes you can make to produce a waveform at IC1b pin 7 that is a little more squared off (it is quite rounded off) and more accurately represents what is actually being sent from the IR transmitter. I didn't bother to research this any further since I just wanted to know if the IR remote was actually transmitting. If you have an oscilloscope, monitor pin 1 to see the differences between codes sent when pushing different buttons.

I had fun building and debugging this project. If you build it, please let me know how you like it and if you made any changes. I would like to hear from you. Don't be surprised if you get that "Gee, what an electronics genius you are!" look from someone you help. Happy soldering! 73

## Ham Mall

*The world's largest internet store dedicated to Ham Radio!*

**www.HamMall.com**

This is the internet store that has it all! Open 7 days per week - 24 hours per day. Browse through our catalog viewing pictures, descriptions, accessories, and our low prices. If you are looking for a hard to find item, Email us at [Bill@HamMall.com](mailto:Bill@HamMall.com), and we will try to locate it for you.

### Check out all we offer!

Call Wall QSL Manager Listing News, Announcements and Specials  
Ham-to-Ham Discussion Groups Ham Shack Photos

Visa/MasterCard accepted on line. Free shipping in continental US on all orders over \$100.

When in Seattle visit us at:

Radio Depot, Suite 176, 5963 Corson Ave., So. Seattle, WA 98108  
Phone (206) 763-2936 Fax (206) 763-4172



# QRP Drives Ham Nuts

*Buys "critical mass" of parts and then goes on bizarre building spree.*

*As with most of my hobbies, my interest in amateur radio has waxed and waned over the years. Until about a year ago, I was in an amateur radio downturn. I had even sold my HF rig, and was in possession of only my trusty collection of ancient Icom u2AT and u4AT handhelds, and a Sony shortwave radio.*

For some reason, I decided that QRP was going to be the spark this time around, and determined that when I got back on HF, it would be with a rig I built myself. I had an old copy of the 1986 edition of the *QRP Notebook* by W1FB, and re-read it cover to cover four or five times. My files bulged with QRP articles torn out of magazines, and I thought I had accumulated a good supply of parts over the years.

Full of anticipation, I pulled out WBØNQM's 11/1990 *73 Amateur Radio Today* article, "TTL Transceiver for 40 Meters," and headed for the workshop. A quick review of the parts list revealed a big shortfall. Our local electronics store and three nearby electronics surplus stores were almost no help. You could find 2N2222s, the occasional MFP102, and assorted resistors and capacitors, but for toroids, magnet wire, interstage transformers, or variable caps, it was going to require extensive planning ahead. No amount of searching revealed a single receiver or transmitter that could be built with in-house stock, or parts available locally.

I ended up having to rummage through all the available ARRL/W1FB

books and my article file, making lists of parts I was likely to need. I ordered a handful of every type of toroid mentioned, and rolls of magnet wire. The Radio Shack magnet wire assortment covers only half of the common sizes, and they don't stock toroids. (They do have an assortment of largely unmarked TV-type RF coils and chokes, but these are mostly not useful for QRP work. You wonder why they don't have a toroid assortment...)

Below is my Amidon shopping list, which has enabled me to tackle most of the projects I have found. Dan's and other outlets sell most of these items. Fry's Electronics stores even stock T50-2 and FT37-43 toroids, and some sizes of magnet wire. The list:

- 1 BN43-3312 balun
- 1 BN43-202 balun
- 1 BN43-7051 balun
- 8 T37-6 iron powder toroid
- 4 FT30-43 ferrite toroid
- 8 FT37-43 ferrite toroid
- 8 T50-6 iron powder toroid
- 6 FT50-61 ferrite toroid
- 6 FT50-43 ferrite toroid
- 6 FT37-61 ferrite toroid
- 2 FT37-63 ferrite toroid
- 6 T68-2 iron powder toroid

- 4 T37-2 iron powder toroid
- 8 T50-2 iron powder toroid
- 6 T68-6 iron powder toroid
- 1 pk DFB43-101 ferrite beads
- 1 pk DFB43-301 ferrite beads
- 1 spool each #20, #24, #26 magnet wire

This whole list was around \$95.

From Dan's, I ordered some 2N3866s, CA3046s, NE602s, and some MC1496s. He also has RCA 40673 parts, and 10.7 MHz IF cans, which appear in many projects. I also got a number of air variable capacitors and mica capacitors from him. From Mouser, I got more IF transformers, 4k/600 ohm transformers, some tuning caps, and RF chokes.

After literally ten orders from various web sites, I thought I had a critical mass of parts. Here are rigs I built, and the results I had:

**TTL Transceiver for 40 Meters** (Rick Lucas, WBØNQM, 73, 11/90, pp. 30-32). This one appealed to me — it looked simple, and I was sure I had most of the parts. I ended up having to place several orders to get the chokes and 1.0  $\mu$ H variable. The local surplus store had the TTL heat sinks, but that was it. The receiver never



worked properly due to local AM overload. I think the old Mylar variable cap I had in my parts bin was suspect. Note that FAR, who supplies circuit boards for many projects, will also provide reprints of the original magazine articles for a small charge.

**Poor Ham's QRP Rig** (*WIFB QRP Notebook*, 1986, pp. 30-31). After stern admonitions from WIFB on the necessity of having a good enough rig for a proper signal, this one had several stages and looked solid enough. I had trouble here in the output stage — and learned that an 820 pF ceramic cap that says 820 on it might be an 820, or it might be an 82. An 821 is a better bet. This one is reliable, and with all the stages has made a good test source, as it is not all that sensitive to changes in loads. And this one needs #24 magnet wire — not in the Radio Shack assortment. Using the Sony shortwave in SSB mode, I spent hours trying for a first contact with the transmitter connected to a dummy load. I swear I almost got someone to respond.

**Boots for the 1-Watter** (*WIFB QRP Notebook*, 1986, pp. 32-33). Learning the futility of calling CQ QRP, I tried this amp. The first effort, with junk box transistors, did not work. I learned about the need to have  $f_T$  several times higher than the target frequency. It was nice to not need a special RF transformer — but if you are ordering toroids from Amidon, what's another item on the list? This one finally worked for a minute, and then stopped. I think I have excessive wire lengths someplace.

**Cubic Incher (80m)** (*1986 ARRL Handbook*). Try finding a 1000 pF trimmer cap anywhere. Our local antique radio store (there is not one in every city, alas) had some mixed larger square trimmers in a bin. A \$14.95 capacitance meter add-on (used in solving the "is 820 really 820" issue above) revealed a 1000 pF model. This worked well with a spare TV colorburst crystal, and an NTE transistor from our local electronics store. I miswired the power just once (learning about protection diodes) and had to get a new transistor, this time an ECG. Now the transmitter was chirpy. This

one went on the shelf, until a Michael Jay Geier KB1UM article "Cassette Box Special" (73, 4/90, pp. 46-50), suggested that cheap color burst crystals were not a good idea for transmitters. I changed crystals — no chirp.

**Two-Stage Regenerative Receiver** (*WIFB Design Notebook*, p. 109). Despite admonitions that minimum-component receivers were frustrating, I built this one, and spent hours putting it in a metal box. It had weak output, never worked properly. I also learned I am a few miles from a powerful AM station that gets into everything. Adapting knobs to those large screwdriver-type trimmer caps is not fun.

**Small Wonder Labs/ SW+ (NNIG) Kit.** Having learned a thing or two about toroids, I tried this kit. The crystal filter, "grounded to reduce blow-by" was just the ticket for eliminating interference from my local AM station. The signals were nice and clear — and hearing stations on a rig you built yourself is every bit as good a feeling as advertised. I learned I make one wiring mistake for every ten connections wired or components installed. There is nothing wrong with the directions here. Moving to a transceiver and having frequency agility is luxurious. The price for this one as a board-only kit is very attractive.

**Small Wonder Labs/ White Mountain 80m SSB Kit.** After some time playing with the SW+ above, I

remembered one thing — I hate CW. This kit was complex, but well within my comfort level. It worked the first time, which was a plus. It receives really, really well, but attempts to reach my local SSB section net (with most stations running kilowatts) were futile. I bought a new HF rig about this time — "to tune the antenna," I said. I broke down and got the matching cabinet and frequency counter package — it looks nice, and it's fun to know where you are on the band.

**Ramsey Q80 15W Amplifier Kit.** Determined to reach the Minnesota Traffic Net, I bought this kit. I put it together in several rushed hours counting down to the traffic net. The first try, it behaved just like the "Boots" amp above — one transistor (actually MOSFET) got really hot, the other was cool. One of the output filter toroids required doubling up on the windings, which seemed suspect, so I called Tech Support at Ramsey. He said to check the transformer wiring, making sure the insulation was not scraped in the core, causing a short. He said the filter toroid was OK with two layers. I found I had not scraped enough coating off one of the transformer windings entering the board prior to soldering. On power up I was getting 100 watts out, and a poor tone, which the book said was due to a bad match. I was running to the dummy load via the tuner at some random setting. Oh, well. The

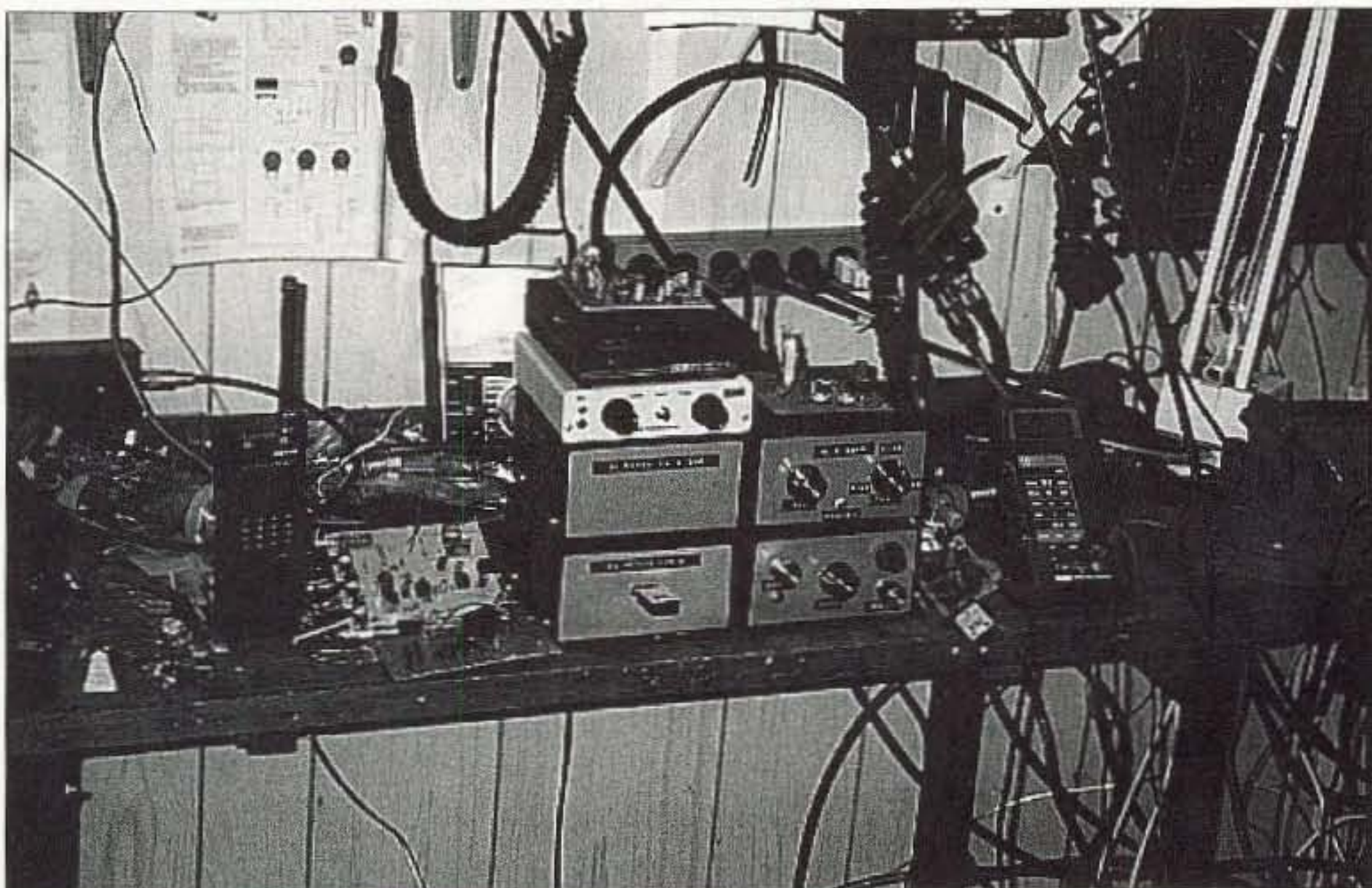


Photo A. Some of the rigs built by NY9D.



directions for this one are really good — they tell you the functions of many of the parts as you install them. I did finally reach my net with the White Mountain rig plus the amp.

**W1FB Five Watt Class C 5W Amp** (*W1FB QRP Notebook*, 1991, p. 129). While waiting to call Ramsey, I took a day off from work, this time for a non-push-pull amp, which I was determined to get working. This one called for 560 pF mica caps. Rather than guess if some nice micas marked 560 were really 560s, I had some giant, waxy color-coded jobs from a grab bag at Dan's. These had 560 written in marker. I drilled out the holes in the FAR Circuits PC board for the thick leads. (This is not good if your boards have plated holes.) In a surprise move, this amp worked the first time. Wow. I also found out that my Poor Ham's 40m transmitter had a grungy-sounding signal when amplified, so I tuned it up. With the help of my handy transistor substitution book, this amp was powered by the output transistor from one of six broken CBs I got for a dollar each. One rule I have learned: If you want radio parts in your junk box, you pretty much have to start by taking apart radios.

**W1FB Universal DC Receiver** (*W1FB QRP Notebook*, 1991, pp. 77–82, Fig. 3-27). Finally believing W1FB on the “too-simple” receiver issue, I ordered up the board for the Universal DC receiver from FAR. This would also be the ultimate test of my new junk box, which was mostly filled with stuff I had ordered. I also have been busily accumulating more electronic scrap. Attempts to pull the old Ham Radio trick of begging broken TVs from repair shops failed (somebody was buying these) but I was able to get six used VGA monitors from a local secondhand PC shop. These are a rich source of small signal transistors, trimpots, electrolytic caps, and ceramic caps. W1FB specifies NPO caps, which I was ignorant of before. The VGA monitors are a decent source of these, easily spotted (once you know what to look for) by their black stripes. I have not been able to get this receiver to work. The 4k/600 ohm

transformers for this one were back-ordered for a while. One big question — a value for C3 is not specified.

**Ramsey 80m Receiver.** While on the subject of things not available, I ordered a Ramsey 80 receiver from their Web site. I got a nice call the next day saying these were out of stock. I remembered that AES stocked them, and got one in a few days. This one went together in a flash, and worked the first time. The tuning is a bit touchy, so I am going to substitute a multiturn pot like the Small Wonder units have. Some local AM tended to get into this rig, which was greatly reduced with my antenna tuner front-ending it. I was pleased to see the use of pots and varactor diode-type tuning. I am learning to hate variable capacitors, due mostly to obsolescence and short supply issues. I did order a 30m version of this receiver from Ramsey, and a matching cabinet. I found a 10.140 MHz crystal in an old CB, and want to get on this band.

Looking ahead, the Norcal QRP site has a new 10m surface mount kit. They have a warning as well that we need to get to know about surface mount technology, as the through-hole devices are going away. I only have one concern here — I find I can install surface mount devices, but do have trouble removing them without ruining them.

I think that once you build a few projects, and get them working, you can tackle almost anything. The local Minnesota QRP Club had a contest for an 80m transceiver design. I was interested a few months ago, but not in a position to compete. After a few more months, and few more projects, who knows?

[P.S. We thank quite-sane (we hope) NY9D for putting up with this article title in the spirit in which it was intended, fun. — ed.]

#### Sources/References

Amateur Electronic Supply, 5710 W. Good Hope Road, Milwaukee WI 53223, 1-800-558-0411, [<http://www.aesham.com/index10.html>].

Amateur Radio Consignment Center, St. Paul MN, (651) 644-3102.

Amidon, 240 Briggs Avenue, Costa Mesa CA 92626, (714) 850-4660, [<http://www.bytemark.com/amidon/index.htm>].

*ARRL Handbook* and *QST Magazine*, [[www.arrl.org](http://www.arrl.org)].

*ARRL QRP Notebook*, Doug DeMaw, ARRL, First Edition, 1986 (out of print).

Dan's Small Parts and Kits, Box 3634, Missoula MT 59806-3634, (406) 258-2782, [<http://www.fix.net/dans.html#dan's03>].

Digi-Key, 701 Brooks Avenue, Thief River Falls MN 56701-0677, 1-800-344-4539, [<http://www.digkey.com>].

ECG Semiconductors, 1001 Snapps Ferry Road, Greeneville TN 37745 (products sold through distributors), [<http://www.ecgproducts.com/ECGCrossReference/index.html>].

FAR Circuits, 18N640 Field Court, Dundee, IL 60118, (847) 836-9148 voice/fax (boards and matching article reprints), [<http://169.207.3.68/~farcir/index.htm>].

Fry's Electronics — stores located mostly in the western US.

Minnesota QRP Club, [<http://www.qsl.net/mnqrp/>].

Mouser Electronics, 958 North Main, Mansfield TX 76063-4827, 1-800-346-6873, [<http://www.mouser.com>].

Norcal QRP Club, [<http://www.fix.net/~jparker/norcal.html>].

NTE Semiconductors, 44 Farrand Street, Bloomfield NJ 07003-2597, 1-800-631-1250 (products sold through distributors), [[www.nteinc.com](http://www.nteinc.com)].

*QRP Power*, Joel Kleinman and Zack Lau, ARRL, First Edition, 1996, ISBN 08725-95617.

Ramsey Electronics, 793 Canning Parkway, Victor NY 14564, (716) 924-4560, [<http://www.ramseyelectronics.com/cgi-bin/SoftCart.exe/scstore/Hframeset.htm?E+scstore>].

RF Parts, 435 South Pacific Street, San Marcos CA 92069, 1-800-737-2787, [<http://www.rfparts.com/>].

*73 Amateur Radio Today Magazine*, 70 Hancock Road, Peterborough, NH 03458-1107, (603) 924-0058.

Small Wonder Labs, Dave Benson

*Continued on page 58*



# Bookbind THIS! — Part 1

*Get organized, and save money, too.*

*What do you do with all of your technical publications such as 73 Amateur Radio Today? Do you stack the publications on a shelf, stuff them into a box, or throw them away? Are you aware of the valuable information that has been imparted on the pages of each issue placed into your hands?*

**H**ams, above most others, communicate technical information via schematic diagrams. Schematic diagrams carry the concept of a project design and techniques for achieving a useful piece of equipment. Unless the various issues are cataloged and stored where they can be found, the valuable information is essentially lost forever.

Not everyone can afford to have a huge library room available to them. I suffered from attempting to store the various publications on a shelf, and soon ran into a dilemma of disappearing storage space. To solve the problem at my house, I started binding the publications into annual volumes and then placing them in an organized fashion onto the same shelves. To save space with each annual volume, it was necessary to remove and save selected parts out of each issue before re-binding it into a volume. Each volume is marked with the magazine title and the publication year so that it will be easily identified.

Although the process steps for binding publications is simple and without surprises, it takes longer to describe the process than it actually takes to

implement all of the steps. As a result, the bookbinding process has been broken up into three parts. I've included a number of pictures and diagrams in an attempt to make the techniques clear without anyone having to guess. In addition, a listing of the process steps is provided in the sidebar. Although this procedure works well, please understand that the approach I've outlined here is only one of many ways to accomplish the task, so you are encouraged to experiment to find a technique that works for you. The important thing to remember is that valuable information must be saved.

Perhaps the biggest inhibitor in any "new" process is the tool inventory required to make the process work smoothly. The tools that I selected for my use were drawn from what I had on hand for doing woodworking projects. Perhaps the only two "critical" items are the wood rasp for trimming the stem and the padding compound used for gluing the pages of the new volume. The wood rasps that I use have very sharp teeth that cut bound paper easily without tearing. I've used other types of wood shaper tools with some success, but really prefer the rasp.

## Material and tools

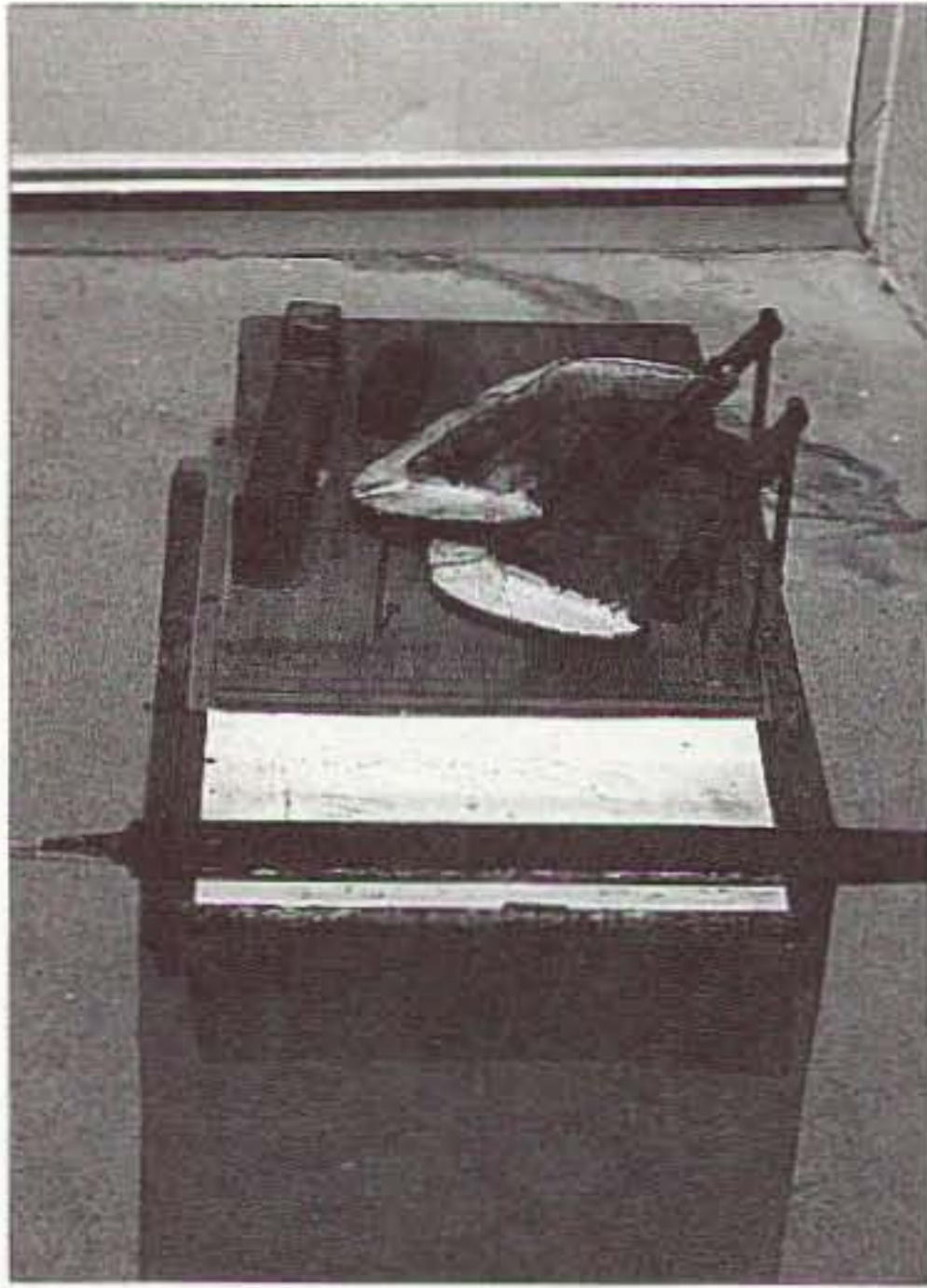
Materials used in the bookbinding process are basically three items: kite string, padding compound (pad cement), and manila folders. Except for the padding compound, the other two are very common. **Photo A** shows the tools and padding compound used in my process.

A nonwaxed kite string is used to



*Photo A. Needed tools and pad cement.*

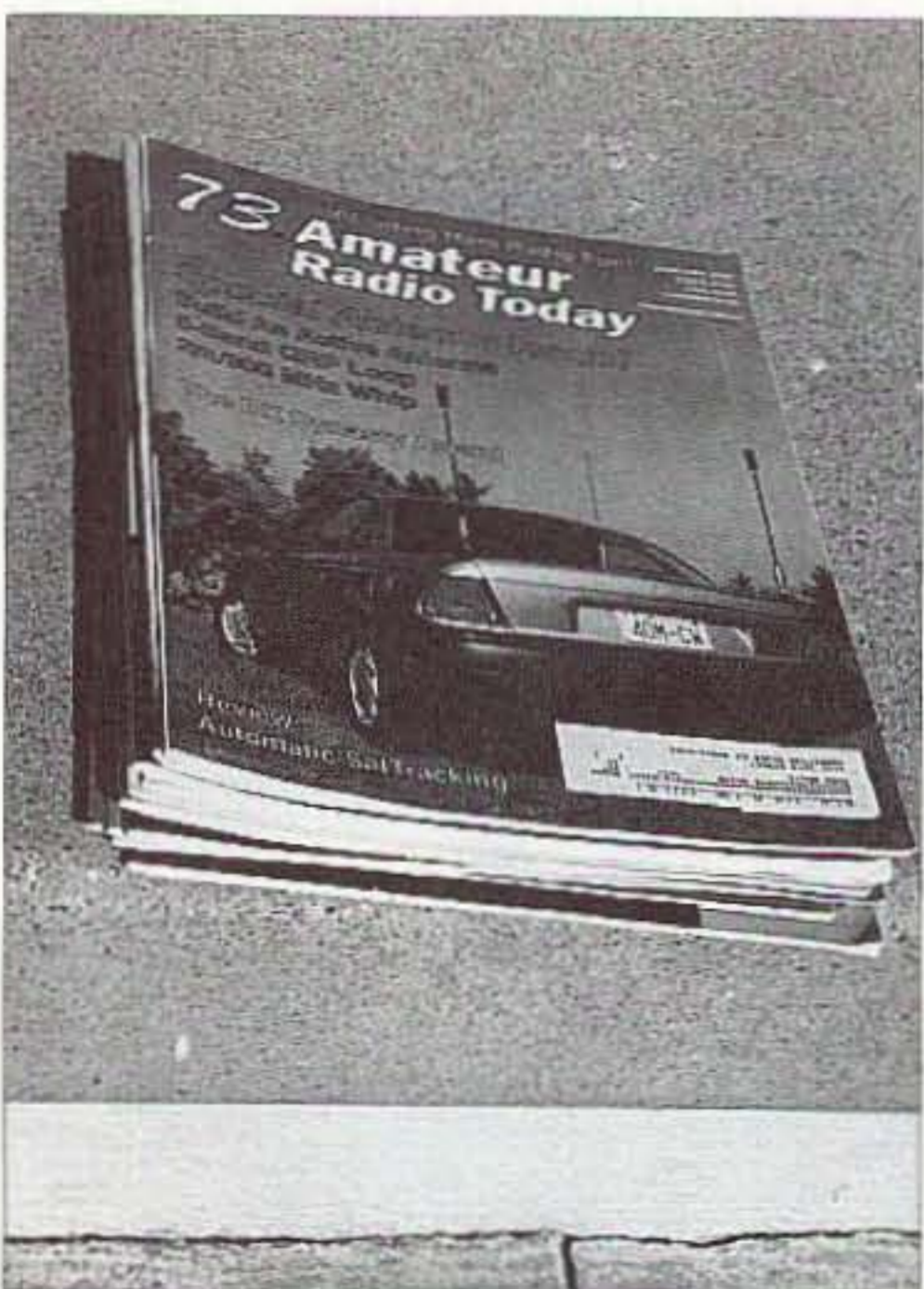




*Photo B. Clamping fixture, clamps, and weights.*

provide mechanical strength to support the glued stem. To "test" the string for suitability, lay a short piece in water. If water is absorbed into the string, then it is suitable for this process.

I've tried several types of glue to hold the "new" volume together, but prefer the use of padding compound, also known as pad cement. The compound dries as a clear, flexible, and tough binder that adheres to the paper pages. I've used "white glue" for gluing the book stem with success. But



*Photo C. Twelve issues stacked in month order — January on top and December on the bottom.*

the drawback showed up a few years later when the white glue became hard and would crack when the book was opened up fully. Otherwise, it certainly did the job. Padding compound/cement is available at most bookbinding operations and at suppliers of bookbinding materials. I've found that one quart of compound will last me several years.

After the "new" volume has been glued, a new cover is placed around it. The material that I've been using successfully for cover material is called Index Bristol. Most people recognize the material as a "manila file folder." The typical and preferred size is 8-1/2 x 11 inches with a "straight cut" (no notches or tabs). The advantage of the new cover is that it adds very little to the total volume, but dresses up the new volume and provides additional strength to the glued stem. Straight-cut file folders work well for the majority of volumes that do not exceed about one inch in thickness. If the new volume exceeds one inch, then a sheet of material larger than a file folder may be required. Large sheets of Index

Bristol in various sizes can be obtained through most stationery stores that provide customized ordering. The typical size sheet that I've found useful is approximately 26 x 32 inches. Each sheet can be cut down to cover three large/thick volumes.

Tools used in this suggested bookbinding process are assembled from "what's available" in the woodshop. The wood rasp is perhaps the most critical tool of all because it is "key" for trimming the binding stem of the volume. Wood rasps are available in most hardware stores.

Here is a listing of the tools and aids that I've found useful:

- Wood rasp
- Large "C"- or wood clamps
- Hacksaw, metal cutting blade
- 3/8"-wide acid brush, or equivalent
- Scissors
- Vacuum cleaner with hose and narrow pickup nozzle
- Sharpie™ black marking pen, fine tip
- Wooden pencil, #2
- Misc. weights
- Flat bar, wood or metal

### Bookbinding Steps

1. Collect and sort magazines into stacks of annual issues.
2. Stack issues from December (bottom) to January (top).
3. Tie stacks with string until ready to tear them apart.
4. Tear each issue down into individual pages.
5. Thin each issue for parts to save and those to discard.
6. Tie completed stack with string until ready to bind.
7. Adjust binding fixture for narrowest page.
8. Place one page at a time into the binding fixture.
9. Clamp the volume.
10. Rasp the stem to make all pages equal width.
11. Saw slots into the stem for string.
12. Cut notches into the stem to ensure capturing all pages with glue.
13. Vacuum to remove paper dust.
14. Tie string into the sawed slots.
15. Scrub glue into the string and paper.
16. Remove the volume from the clamps.
17. Select a cover for the volume.
18. Crease and fold the cover to fit the volume.
19. Apply glue to the volume stem.
20. Insert the volume into the cover.
21. Drop-impact the volume to seat the volume into the cover.
22. Place the volume in clamps while glue is drying.
23. Using scissors, trim the cover to fit the volume.
24. Mark the cover.
25. Crease and open the new cover.



• Wood for making clamping blocks/ fixture

A word about the flat bar is in order. The bar that I've been using is a large, flat mill file that I happened to find at a swap meet. Because of the length and stiffness, it has been an ideal bar for holding the top side of the volume during clamping. **Photo B** shows the clamping bar, clamping block, clamps, and miscellaneous weights. Alternate "bar" materials will also work. Wood, and aluminum or steel angle stock are suitable materials for a bar. If wood is selected, Douglas fir, oak, ash, walnut, etc., are the better choices and will work well if the thickness is greater than 1/2 inch. Stiffness is the key, to reduce the tendency of bowing while under clamping pressure.

### Beginning steps

The first step in the process is to collect all of the annual issues of a given publication and stack them face up, with the December issue on the bottom

and with January on the top. A length of kite string is loosely tied around the stack to keep it organized in preparation for the tear-down step. Step two involves separating the issue page by page until the annual volume has been completed. Again, a length of kite string is placed around the loose volume pages to keep them organized until the binding process has begun.

Part 2 of *Bookbind THIS!* will discuss the types of bindings that a ham is most likely to encounter with various publications, the steps involved with separating the pages, and "thinning" out the volume for saving shelf space.

Part 3 of the series will discuss the process for binding and gluing the volume, followed by the marking of the new cover for the new volume.

Take advantage of the opportunity to save all of the valuable electronic information that has been placed into your hands. Utilize the bookbinding process as a stepping-stone for recovering shelf

space and saving valuable knowledge in an organized manner.

*[Here's a simple book shelving riddle for a likely harmonic or maybe even your next club meeting. If you take a year of 73 (12 issues of 64 pages each) and put the issues on a shelf in normal left-to-right monthly order, how many pages will there be (excluding covers) between the first page of January (don't count that) and the last page of December (don't count that, either)? — J.B.]*

**Answer to Bookbind This! riddle:** Easy, huh?  $12 \times 64 = 768$ , less 2 (Jan. first page, Dec. last page) = 766. **WRONG** — Guess again!

The correct answer is 640. Remember, the first page of the January issue sits to the right of all other January pages on the shelf, just as the last page of December sits to the left of all other December pages on the shelf. So the January and December issues are effectively excluded from the count. Thus,  $10 \times 64 = 640$ . 73

# Maldol

A Tradition of Consistent Quality

# HAND CRAFTED ANTENNAS

From Professional Engineers



### MK-30H Motorized Mount

The ultimate in convenience.

12VDC Heavy Duty Motor with Remote Switch  
Attaches easily to trunk lids or the rear door of Vans/SUVs. 360° adjustable. Slip-clutch protects the motor gears from stripping. Max Antenna Height: 62 inches. Max Antenna Weight: 16oz. Accepts standard SO-239 cable assembly (FVS-50) for mounting PL-259 type antennas. (NMO antennas require SO-239 cable assembly and Comet AD-25M adapter)



### PRM-T Heavy Duty Lip Mount

Attaches to a trunk or rear door of Vans/SUVs. Holds antennas up to 85 inches securely. Completely adjustable, rubber gasket protects vehicle paint.

### FVS-50 Deluxe Coax Cable Assembly

Attach the FVS-50 to the PRM-T heavy duty adjustable mobile mount. 16 feet 9 inches total length with 18 inches of RG-188 type coax for easy entry into the vehicle without causing wind noise, water leaks or coax damage. PL-259 barrel is detachable for easy installation, weather cap included.

## HT ANTENNAS

"Cat Whisker" whip is lightweight and very durable. Made from the same material as unbreakable eyeglass frames.

### AS-30

2M/70cm HT "GAIN" Antenna  
Gain: 0/2.15 Length: 15 inches  
Conn: SMA

### AS-20

2M/70cm HT Antenna  
Length: 8.5 inches  
Conn: SMA

## MOBILE ANTENNAS



### EX-104B/EX-104BNMO

2M/70cm Dualband Antenna  
Gain: 0/2.15dBi Length: 15 inches  
Max Power: 50W Conn: PL-259 or NMO

### EX-107RB/EX-107RBNMO

2M/70cm Dualband Antenna  
Gain: 2.6/4.9dBi Length: 29 inches  
Max Power: 80W Conn: PL-259 or NMO  
Ground Independent

### SHG-140B/SHG-140BNMO

2M Mobile Antenna  
Gain: 4.1dBi Center Loaded 5/8 wave  
Length: 56 inches Max Power: 200W  
Conn: PL-259 or NMO  
Ground Independent

### SHG-1500B/SHG-1500BNMO

2M/70cm Mobile Antenna  
Gain: 4.5/7.5dBi Length: 59 inches  
Max Power: 200W Conn: PL-259 or NMO  
Ground Independent



1275 N. Grove Street • Anaheim • CA 92806  
(714) 630-4541 • (800) 962-2611  
Fax: (714) 630-7024 • [www.cometantenna.com](http://www.cometantenna.com)



# Guessless Beam Pointing

*This has been around for years, but for you newcomers ...*

*It would be hard not to notice the improving conditions on our HF bands. During the next few years, contacts around the world will be easy to make and signal strengths will be very high. Working DX will be possible with "barefoot" rigs and simple antennas such as dipoles and verticals.*

**A** beam antenna can do a much better job however. For example, a three element yagi beam can show about an 8 dB gain over a 1/2 wave dipole mounted at the same height, or a power ratio of about 6 to 1. In other words, a 100 W station with a 3 element beam will sound like a 600 W station using a dipole, and the beam will make just as great an

improvement in receiving. All gain antennas such as yagis, quads, and phased arrays provide significant improvements to both your transmitted signal and to your receiving capability.

Most dipoles are in a fixed position, and their directions of maximum radiation are not easily changed. A rotatable beam, though, can concentrate your radiated power in the direction

you desire — just point it toward the station of your choice.

When you are out hunting, you aim your gun at the squirrel, rabbit, bird, or whatever. How can you accurately point your beam at a DX station you can't see? There are computer programs available which can tell you the true bearing or direction from your QTH to major world locations — referenced to true north. Since about 1960, I have been using modified desk-size globes of the world to show me where to point my beams both quickly and cheaply. See **Photo A**. This particular globe is one I modified for my dad back in the mid-fifties, while I was home on leave from the Air Force. It's not very fancy looking, as I had no "press-on" lettering available then to give it a more professional look. It does give accurate bearing information to any place in the world from my present QTH in southern Illinois. The following instructions are valid for locations in the northern hemisphere. If your QTH is south of the equator, you must modify the procedures accordingly.

While a standard globe can usually be rotated around its North Pole/South



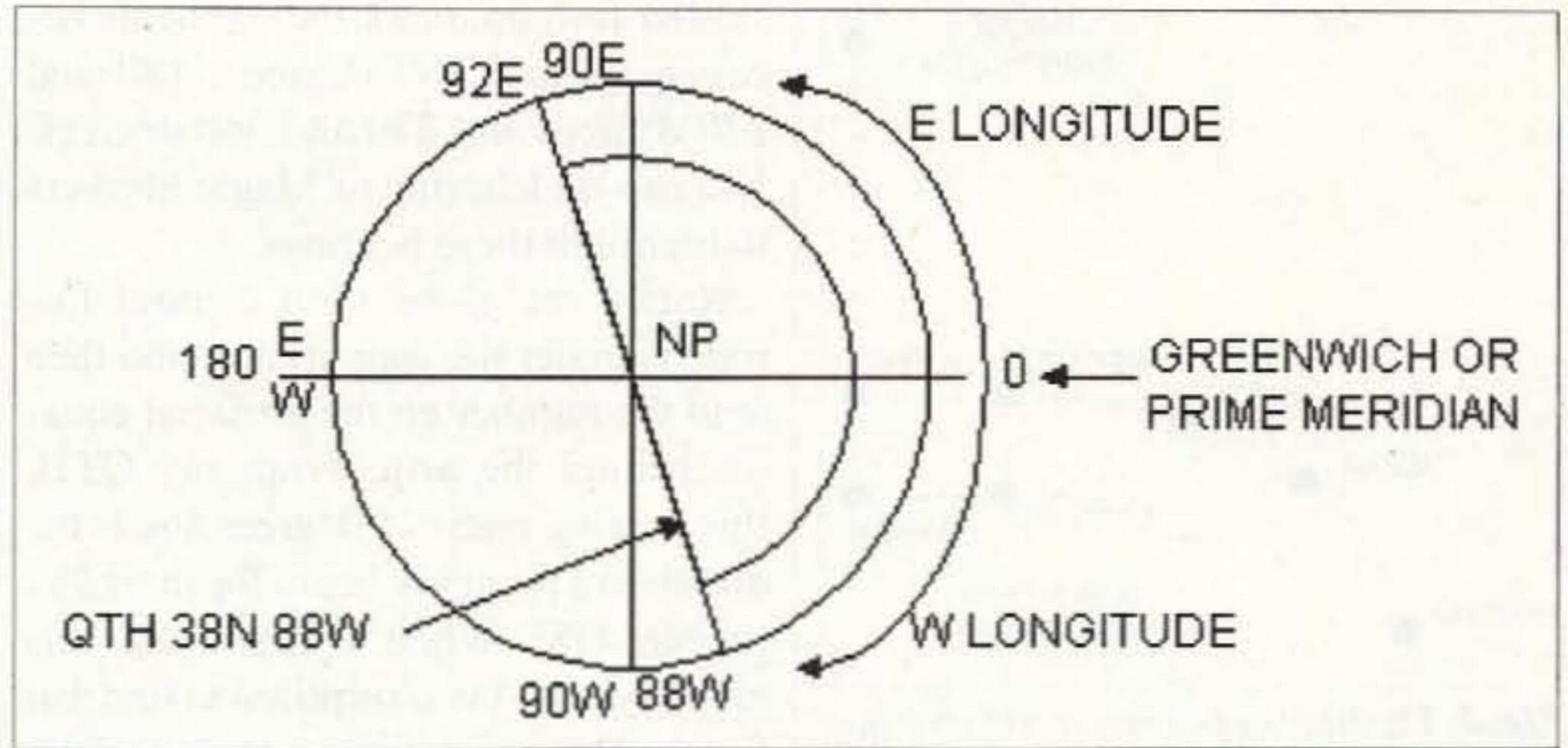
*Photo A. This globe gives accurate bearing information to any place in the world from my present QTH in southern Illinois.*



Pole axis, the modified globe has a new axis of rotation and is not usable at other QTHs more than a few miles away. The modification requires the axis of rotation to be changed to one that passes through the location of your QTH and through a point on the opposite side of the globe. Most of the cheaper desk-size globes have mounting systems that are flexible enough to allow the supporting pivots to be removed from their North Pole and South Pole bearings. Then, a pivot hole, the same size as the original North/South pivot holes, must be drilled at the location of your QTH and another one on the opposite side of the globe. The exact location of this second hole should be determined accurately to ensure smooth globe rotation as well as directional accuracy. The easiest way is to take advantage of the latitude and longitude markings on the globe. Latitude is simply measured from the Equator (latitude zero degrees) to the North Pole (latitude 90 degrees north) and, similarly, from the Equator to the South Pole (latitude 90 degrees south).

My QTH is located at about 38 degrees north latitude/88 degrees west longitude. The latitude of the opposite hole will be 38 degrees south latitude. The desired longitude of the opposite hole is not so readily apparent. **Fig. 1** represents the Earth as viewed from an imaginary point directly above the North Pole. Longitude is measured from the Greenwich, or Prime meridian, eastward and westward to a line of longitude exactly opposite the Prime meridian. East longitude then is measured from zero to 180 E and West longitude similarly measured from zero to 180W. (The 180W and 180E lines of longitude coincide and represent the International Date Line, although adjustments have been made locally to satisfy political desires.)

As shown, the 88 degree west line of longitude, from my QTH through the North Pole, turns into the 92 degree east line of longitude on the other side of the pole. Note that these lines are 180 degrees apart. So, for my QTH, the desired location of the opposite pivot hole will be 92 degrees east longitude/



**Fig. 1.** This represents the Earth as viewed from an imaginary point directly above the North Pole.

38 degrees South latitude. I marked this point and drilled the second pivot hole at that spot. Your new pivot hole positions should be calculated using the latitude and longitude of your QTH.

Now reassemble the globe to the mount using the new pivot points. Looks strange, doesn't it! The upper pivot point now is at your QTH rather than the North Pole. Most globes have a pivot support system in the form of a semicircle. This semicircle is usually calibrated in degrees of latitude north and south of the Equator (which is marked with a zero); the North Pole is at 90 degrees, as is the South Pole.

Hold a pencil or Magic Marker against this semicircular support at the zero (0) position, or midpoint, in such a way that the tip of the pen/marker just touches the globe proper. Now, rotate the globe through 360 degrees, leaving a trace completely around the globe. This is your new artificial equator. For a more professional look, use a pencil to make this line and then use PC artwork as an overlay to produce a smooth line. Next, rotate the globe until the empty pivot hole that

**HamCall™ CD-ROM**  
U.S. & International - Over 1.5 million listings

*We make a new HamCall every month! Clearly, the most comprehensive and current CD-ROM available.*

**Latest Features**

- Choose font and color of data display.
- Displays flag and map for each country.
- Shows CQ, ITU zone, and continent.
- History list shows each call sign entered.

View & search interests of 26,000 hams.

Search for club, military, RACES, vanity, silent keys, name, address, and more.

Over 1,566,000 U.S. and International listings, 104,000 e-mail addresses, 4,000 photos and QSL cards, 30,000 vanity calls, and 12,000 references to QSL managers.

Shows short & long path distance & bearing.

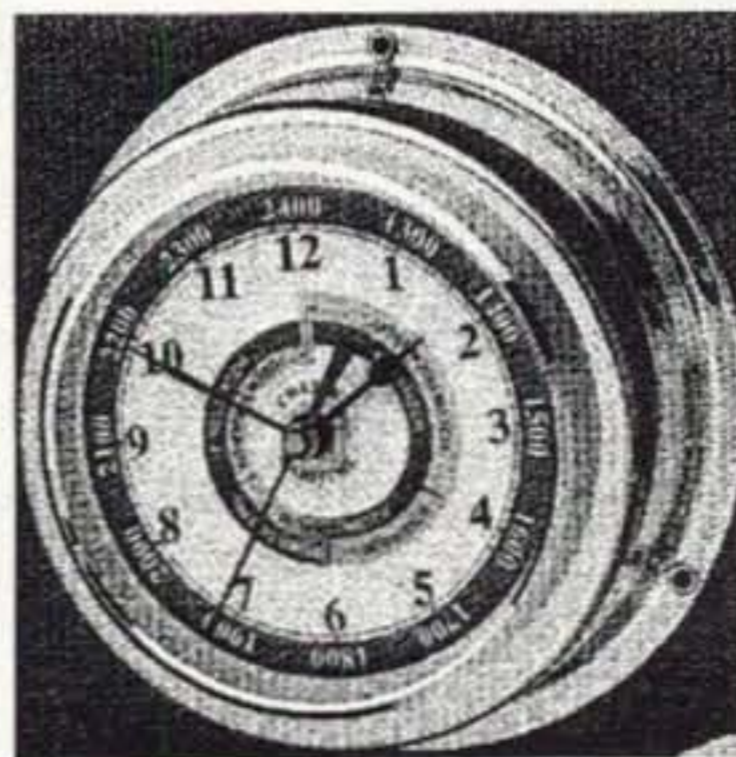
Precise latitude/longitude for over 90% of addresses.

HamCall is \$50.00, included is 6 months free access to our Internet Search Service - request when ordering.

*HamCall Mousepad, with morse code reference, 7.5" x 8", blue with yellow letters. \$5.00+\$3 shipping.*

\$5.00 shipping per order. Your satisfaction guaranteed!  
Free 800 technical support - we won't let you fail.

**BUCKMASTER**  
6196 Jefferson Highway • Mineral, VA 23117 USA  
e-mail: info@buck.com www.buck.com  
540:894-5777 • 800:282-5628 • 540:894-9141 (fax)



### Chelsea Clock

Clockmakers since 1897  
The choice of The Coast  
Guard Foundation.

Quartz Clock  
4" Dial

Beautifully hand-polished.  
Stamped brass case and bezel.  
Curved glass crystal.  
Wall or bulkhead mounting.  
Made so well they last from generation to generation!  
Order this month and save \$20!

**Your price \$75**

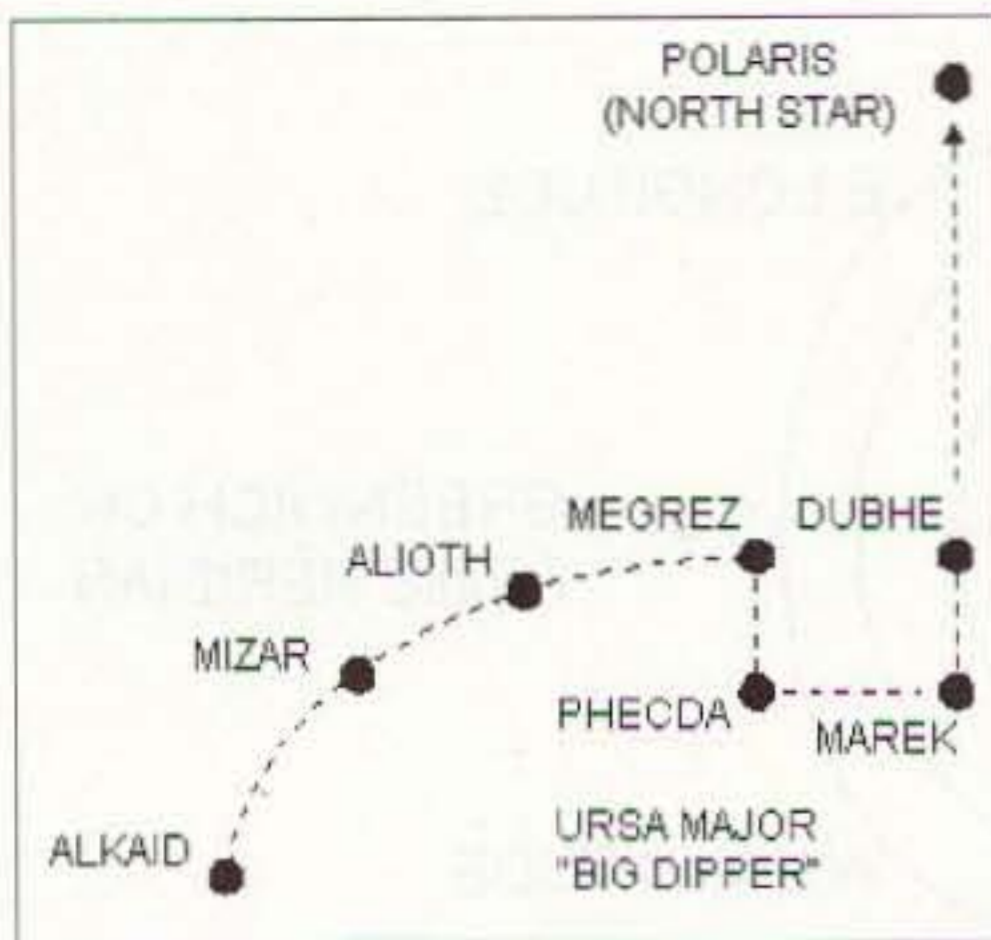
**Omega Sales**

**P.O. Box 376**

**Jaffrey NH 03452**

**1-800-467-7237**





**Fig. 2.** The Big Dipper and its relationship to Polaris.

had represented the North Pole just lies under the semicircular support arm. Mark this point on the artificial equator — this now represents the direction of north, zero degrees or 360 degrees.

Repeat this with the pivot hole that represented the South Pole. This mark will represent the direction of south, or 180 degrees. Now rotate the globe until the new artificial equator intersects the real Equator somewhere to the west of Africa. A mark here will indicate the true direction of 90 degrees, or east. Repeat for the intersection of the artificial equator and the real Equator somewhere west of Hawaii. This point will mark the direction of 270 degrees, or west.

The location of markings for the bearings between 0 and 90 degrees will have to be determined by measuring the distance between 0 and 90 degrees along the artificial equator and dividing it into 6 equal segments which can be used to mark the 15, 30, 45, 60 and 75 degree positions. In a

similar fashion, mark the segments between 90 and 180 degrees, 180 and 270 degrees and 270 and 360 degrees. Use rub-on lettering or Magic Markers to highlight these bearings.

Rotate the globe until Central Europe is under the support arm and then read the number on the artificial equator behind the arm. From my QTH, this bearing reads 45 degrees and is the direction I point my beam for most European DX. When I first used this globe system, I was surprised to find that South America was not to my south but more to the Southeast. This is an easy-to-use system to determine the true bearing to any place in the world. Just rotate the globe until the country of choice lies under the support arm (now the cursor), and read the bearing from the artificial equator line. The main problem remaining is to ensure that your beam and rotator can accurately position your antenna to the correct direction/bearing.

Once you know where the beam is to be pointed, you should make sure that your beam is mounted properly so that the rotor control meter displays the beam heading accurately. At zero, north or 360 on the meter, the beam should be pointing directly toward the north geographic pole. An easy way to locate true north is to use the star "Polaris," often called the North Star. Polaris is within one (1) degree of true north and is quite visible in the Northern Hemisphere. It can be located by using the stars in the Big Dipper (Ursa Major) as guides. The Big Dipper and its relationship to Polaris are shown in **Fig. 2.** (The Big Dipper will change positions during the year, but the pointer stars will always point to Polaris.)

Imagine a straight line from Marek through Dubhe and beyond. The first bright star that this imaginary line intercepts will be Polaris, the North Star. City lights may make Polaris hard to find. If so, a late night or early morning observation might be necessary. When you locate Polaris, stand at the base of your tower and find a suitable landmark directly between you and Polaris. This gives you a permanent reference toward true north, usable in the daylight when you will probably

be adjusting your beam. Adjust your beam mounting arrangement so that the beam points toward this landmark when the rotor control meter reads "Zero," "North," or "360." Your rotor control system will now be about as accurate as possible.

If you find it impossible to see Polaris from your QTH, a couple of alternative ways to determine true north are available. For one, many towns and cities have their streets laid out in a north-south and east-west pattern. If applicable, use a N-S street as a pointer to find true north. Your city engineer should have reliable information on the street layout in your town.

Also, a good magnetic compass can be used to find true north. Unfortunately, the north magnetic pole to which a compass needle points is not located at the north geographic pole. Local magnetic anomalies also effect magnetic compasses. The difference between true north and the direction to which a magnetic compass needle is pointing is called "magnetic variation" and this varies from location to location. Magnetic variation is shown on many maps as dashed lines, each marked in degrees and identified as east or west variation. These lines are known as isogonic lines or lines of equal magnetic variation. Interpolation must be used to find the variation at locations between adjacent lines. When variation is "east," magnetic north is east of true north. When variation is "west," magnetic north is west of true north. At my QTH, the variation is 4 degrees east, which means that a magnetic compass here will point 4 degrees to the east of true north. So I would have had to make a 4 degree adjustment to use a magnetic compass. Many sport and military compasses are available that have an adjustable bezel or sight assembly that permit offsetting the compass reading by the amount of local variation ( $\pm$ ).

Accurately determining the direction to the stations of your choice and then pointing your beam in that direction will maximize your chances for DX contacts, as well as permit more solid stateside QSOs. 73

### Subscriptions to 73 Magazine

Only \$24.97 — 1 year  
\$44.97 — 2 years  
\$65.00 — 3 years\*

\*best buy (54% off cover price!)

Call 800-274-7373



# CALENDAR EVENTS

Listings are free of charge as space permits. Please send us your Calendar Event two months in advance of the issue you want it to appear in. For example, if you want it to appear in the May issue, we should receive it by March 31. Provide a clear, concise summary of the essential details about your Calendar Event.

## MARCH 10

**KNOXVILLE, TN** On Saturday, March 10th, the Shriner/Hams of Kerbela Amateur Radio Service will sponsor their annual Hamfest at Kerbela Temple, 315 Mimosa Ave., Knoxville TN, 8 a.m.-4 p.m. Admission is \$5. Indoor vendor tables are \$8 each plus admission of \$5. Setup Friday from 4 p.m.-8 p.m., and Saturday 5 a.m.-8 a.m. Overnight security will be provided. Talk-in on 144.83 (T)/145.43(R); or 146.52 simplex. Smoking indoors is permitted in designated area only. Contact *Paul Baird K3PB, 1500 Coulter Shoals Circle, Lenoir City TN 37772. Tel. (865) 986-9562.*

**SCOTTSDALE, AZ** The Scottsdale ARC hamfest will be held starting at 6 a.m. at Scottsdale Community College, 101 North - Exit Chaparral Rd., 9000 E. Chaparral Rd, Scottsdale AZ. Parking \$2. Tables \$10. RV parking. VE exams. For more info, contact *Roger Cahoon KB7ZWI, 8501 E. Edward, Scottsdale AZ 85250. Tel. (480) 948-1824. Mobile (602) 725-7256; Fax (602) 943-7651. Send E-mail to [rgcahoon@msn.com].*

## MARCH 10, 17, 21, 29, APRIL 17

**ST LOUIS, MO** Three FREE all-day Severe Weather Observation training seminars are planned at various locations around St. Louis County. All are welcome, including those from outside the area. Free parking. Certification provided for R.A.C.E.S. and SKYWARN, all at no cost. At most locations, SKYWARN Level 1 Training is presented in the morning, and classes resume in the afternoon with the SKYWARN Level 2 Program. Training will be held as follows: Saturday all-day classes on March 10th, 17th and April 7th. Evening classes (Level 1 only), on March 21st and 29th. For locations call the *Severe Weather Info Line, (314) 615-7857*, for a taped message and additional information.

## MARCH 11

**AMHERST, MA** The Mount Tom Amateur Repeater Assn. will hold its 16th Annual Amateur Radio & Electronics Flea Market on Sunday, March 11th, at the Amherst Regional Middle School, 170 Chestnut St., Amherst MA. From Exit 4 on Mass Pike, take 91N to Exit 18, Rte. 9, take Rte. 9 North to Amherst Center. Left onto Pleasant St., right on Main

St. at third traffic light. High St. on left. Talk-in on 146.94(-) Mt. Tom rptr. Doors open at 7 a.m. for vendors, 9 a.m. for bargain hunters. Amateur and commercial license exam session at 10 a.m. Refreshments, 120 VAC, plenty of parking, help loading and unloading, handicapped accessible. Tables \$15 each. Tailgating \$5. General admission \$5 per person, under age 12 free. See the Web site at [[www.mtara.org](http://www.mtara.org)]. Contact *Cindy Loiero K1ISS at [n1fi@arrl.net, or (413) 568-1175* for table or exam reservations and additional info.

## MARCH 18

**JEFFERSON, WI** The Tri-County ARC will present "Hamfest 2001" Sunday, March 18th, at the Jefferson County Fairgrounds Activity Center, Hwy. 18 West, Jefferson WI, 8 a.m.-2 p.m. Vendors will be admitted at 7 a.m.; others at 8 a.m. only. Vendors only parking will be provided for unloading. Talk-in on the 145.49 rptr. Admission \$4. Table space, 8 ft., \$6 each. Reserve your space early. Contact *TCARC, 213 Fred-erick St., Fort Atkinson WI 53538. Tel. (920) 563-6381 eves.; FAX (920) 563-9551. E-mail [tricountyarc@globaldialog.com].*

**MAUMEE, OH** The 46th Annual Hamfest/Computer Fair of the Toledo Mobile Radio Assn. will be held 8 a.m.-2 p.m. at the Lucas County Rec. Center, 2901 Key St., in Maumee. For details, send an SASE to *Paul Hanslik N8XDB, P.O. Box 273, Toledo OH 43697-0273. Tel. (419) 385-5056; Web page [www.tmrahamradio.org].*

## MARCH 24

**ST. PAUL, MN** The Robbinsdale ARC, Inc. will host its 20th annual Midwinter Madness Hobby Electronics Show at the Gangelhoff Center which is located on the Concordia University campus in St. Paul. VE exams 8:30 a.m.-3 p.m. Super buys on computers, hardware, components, peripherals, and amateur radio equipment. Admission is \$7 at the door. Contact *RARC, P.O. Box 22613, Robbinsdale MN 55422; or call (763) 537-1722. Check the Web site at [<http://www.visi.com/~k0ltc>]. Send E-mail to [k0ltc@visi.com].*

## MARCH 25

**MADISON, OH** The Lake County ARA will hold

*Continued on page 58*

## TRANSMITTER LOCATION

New fixed site direction finders provide 2 degree accuracy, and include software for triangulation from a central control site. Mobile versions also available covering 50MHz to 1 GHz

### Doppler Systems Inc.

PO Box 2780 Carefree, AZ 85377  
Tel: (480) 488-9755 Fax: (480) 488-1295  
[www.dopsys.com](http://www.dopsys.com)

European Marketing Director Denis Egan  
PO Box 2, Seaton, Devon EX12 2YS England  
Tel & Fax: 44 1297 62 56 90





## Lessons From a Long Drive

*We are indeed a mobile society, as I experienced recently with a move from the southeast to the midwest to start my new career with the Nebraska Health System. Amid the preparations to prepare our house for sale and pack those things I would need to take with me in advance of the movers, I tried to look at the bright side. At least the drive from Florida to Omaha would give me some radio time.*

The three-day, 1,500-mile drive would give me ample opportunity to get in some operating time on both the HF bands and more than a few repeaters along the way. While I did get in some time, freezing rain and heavy snowstorms dictated that a significant amount of my time and attention be given to my driving rather than to the radio.

Nevertheless, I was able to make some contacts along the way and make a few observations. APRS was active, and I had programmed a series of repeater frequencies into the Kenwood TMD-700A. I intended to operate some HF during some of the longer stretches of the drive, especially where I did not expect much 2-meter activity.

Mobile HF operations are a bit different for a variety of reasons. We operate with limited power, a modest antenna, and limited band options. I have always been more successful at answering someone else's call than calling CQ myself. This means that I tune the band and listen in on what's happening. I had my resonators for 10 meters and 20 meters on the Comet CA-HV antenna and bounced between the two bands as time permitted. I was traveling during the week, so the stations I heard on the HF bands are probably quite a bit different than those I normally hear on evenings and weekends. I don't know if it was a bad day, the phase of the moon, or what, but I do have to admit that I was actually embarrassed by what I heard. In fact, I turned the rig off on several occasions because I had no desire to listen to what was going on.

On the other hand, I had delightful chats with several people on two-meter simplex. The people were polite, interesting and engaging. I couldn't help but think about all

the brouhaha that surrounded the elimination of the code requirement for the Technician class license and last year's license restructuring. As you may recall, many worried that these newcomers might ruin the hobby if we no longer had code as an entry requirement. While these fears proved groundless, I wonder if perhaps the opposite is true.

As I mentioned, both the courtesy and the quality of the subject matter were significantly higher on two meters than on HF. Many of these contacts mentioned that they were Technicians and we discussed a wide variety of topics and interests. Incidentally, some of the most intelligent conversations I had were with new hams who were teenagers. These conversations certainly made my trip far more enjoyable. We've all read articles stressing how important it is for the survival of the hobby to get younger hams involved. Getting younger people interested in the hobby may not only benefit the hobby and promote its growth, but may also lead to more interesting QSOs. It seems as though the younger folks are more open-minded, with a wider range of interests.

On the other hand, some of the HF operators I heard (who sounded old enough to know better) elicited no desire for me to pick up the microphone. In fact, it has forced me to offer the following unsolicited advice. I understand that those who read it seriously are probably good operators already and don't need it. Likewise, those at whom it is aimed will assume it is meant for someone else and either ignore it or get surly.

When I was much younger I was taught that in polite conversation one should avoid sex, politics, and religion. I tend to believe that this still holds true on the radio. Let's just say that many of the topics and much

of the language I heard on 20 meters, while certainly legal, tended to reflect poorly on those involved in the discussion. There's a time and place for everything, but I'm not sure 20 meters and a kilowatt meets these criteria. Maybe the reason we weren't getting as many new hams into the field is that they listened in on the bands and decided against it. There are plenty of interesting topics to address in a hobby that is global in its nature. I find it hard to believe that constant complaining about everything that's wrong with the world is necessary, and I'm sure such diatribes convince some potential hams to look elsewhere for a hobby.

I seem to recall reading when I first was studying to get my license that no one can claim ownership of a given frequency. Nevertheless, there appears to be a misunderstanding about this concept wherein certain operators feel (notice I don't claim that they "think") that certain frequencies are their private domain. I've never seen the appropriate regulation that gives certain operators special enforcement authority to ensure that anyone invading "their" frequency is dealt with swiftly and harshly.

Similarly, there are operators who might be well advised to go back to their study guide and bone up on propagation theory. Remember the ionosphere and its D, E, F1, and F2 layers? As I recall, it is quite common for propagation to be different between stations. In other words, your low power signal may be reaching me quite strongly while my high power signal is reflecting in such a manner as to miss you completely.

*Continued on page 59*



# HOMING IN

## Radio Direction Finding

Joe Moell P.E. K0OV  
P. O. Box 2508  
Fullerton CA 92837  
[Homingin@aol.com]  
[www.homingin.com]

## Your RDF Questions Answered

*The snow will soon be gone across most of North America, and hams in every state and province will be emerging from their shacks to go on hidden transmitter hunts, both on foot and in vehicles. Will you be among them?*

ARRL's Web site recently surveyed visitors about their participation in transmitter hunting, which is also called foxhunting and T-hunting. Over 2,400 Web-savvy hams replied, a respectable sample. About a quarter of them said that they did it occasionally or often. Is that true of the members of your local radio club?

On the other hand, 60 percent of survey responders had never tried Radio Direction Finding (RDF) contests of any kind. I wonder how that compares to other ham radio activities. The only clue at the ARRL's site was a survey of image modes, such as slow-scan and fast-scan ham TV. Almost 80 percent of responders said they had never tried them.

I have urged you to enjoy this exciting part of ham radio in the pages of this magazine for over 12 years. My Web site has promoted it for almost five years. The response has been gratifying. Lots of hams and nonhams want to know more. Not surprisingly, many of the inquiries are the same. This month, I'll let you in on the most frequently asked questions about RDF, and the answers.

### Getting Started Is Easy

Many newcomers overestimate the difficulty of putting on their first event. They ask: "My club wants to start transmitter hunting, but first we need a hidden transmitter. What is available?"

Before you can pick the proper tools for any job, you have to evaluate the job. Just as no screwdriver is perfect for every size screw, no hidden transmitter setup is ideal for all situations. Hiders use a wide variety of equipment. Power output and antenna type depend on the distance to the start point and the level of intended difficulty. Discuss

with your club whether you want to do short-range on-foot hunting, longer-range hunting on bicycles, or still-longer-range mobile hunts. Inquirers seldom tell me this in the first E-mail.

For your club's first mobile hunts, keep it simple. Have the hider stay with the transmitter and key it up at appropriate intervals. He or she can read into the mike from a book or from the club newsletter, or just make comments and urge the hunters on (**Photo A**). A starter hunt like this is a great way to end the weekly club or ARES net on your local repeater. With lots of folks listening then, you're more likely to get some of them to come out to find the T. Make sure to remind everyone to do their RDF on the repeater input frequency, not the output!

After a few hunts, you may want an unattended transmitting setup so that the hider doesn't have to stay with the rig. You could connect your two-meter hand-held or mobile transceiver to a tape recorder, playing an endless loop answering machine cassette with an appropriate message or sound effects, plus station ID. Some prefer to hide a dual-band hand-held and activate it on the subband from another transmitter.

Later on, after you gain some experience and have a better idea of your particular needs, consider a dedicated foxbox with tones and a cycling timer for hiding (**Photo B**). You'll need five units like this for on-foot hunts under international rules. I covered foxboxes in detail in "Homing In" for March 1998 and in my book on RDF. (*Transmitter Hunting — Radio Direction Finding Simplified* by Moell and Curlee is published by TAB/McGraw-Hill, ISBN number 007-1560068.)

Popular transmitter controllers for both mobile and on-foot foxhunts include PicCon by Byon Garrabrant N6BG and the

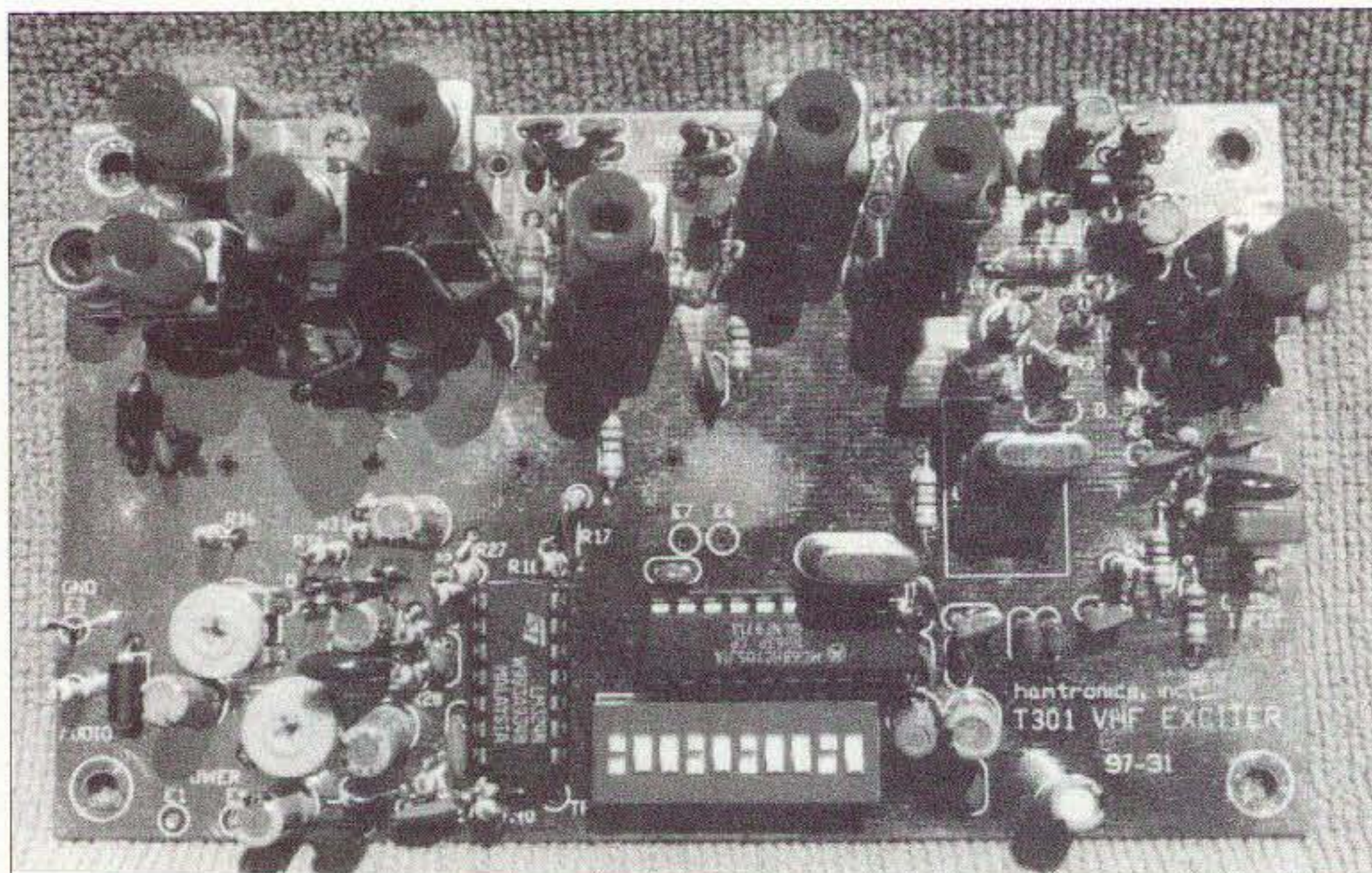
Montreal Fox Controller (MFC) by François Tremblay VE2JX and Jacques Brodeur VE2EMM. See "Resources" for more information. Advanced hunts with unattended transmitters are best on simplex frequencies, where they can't accidentally QRM repeater QSOs.

Miniature transmitters bring almost endless fun to advanced mobile hunts. In December's "Homing In," I told you about an informal contest in the San Francisco Bay area to see who could make the smallest fox transmitters. At that time, one ham had a



**Photo A.** A hidden transmitter setup doesn't have to be fancy. David Bunger NØQEC and Daniel Cowell KBØIEK of the Lincoln (Nebraska) Amateur Radio Club await the hunters as they read from my book into the mike. Note the transmitting beam antenna affixed to the sawhorse.

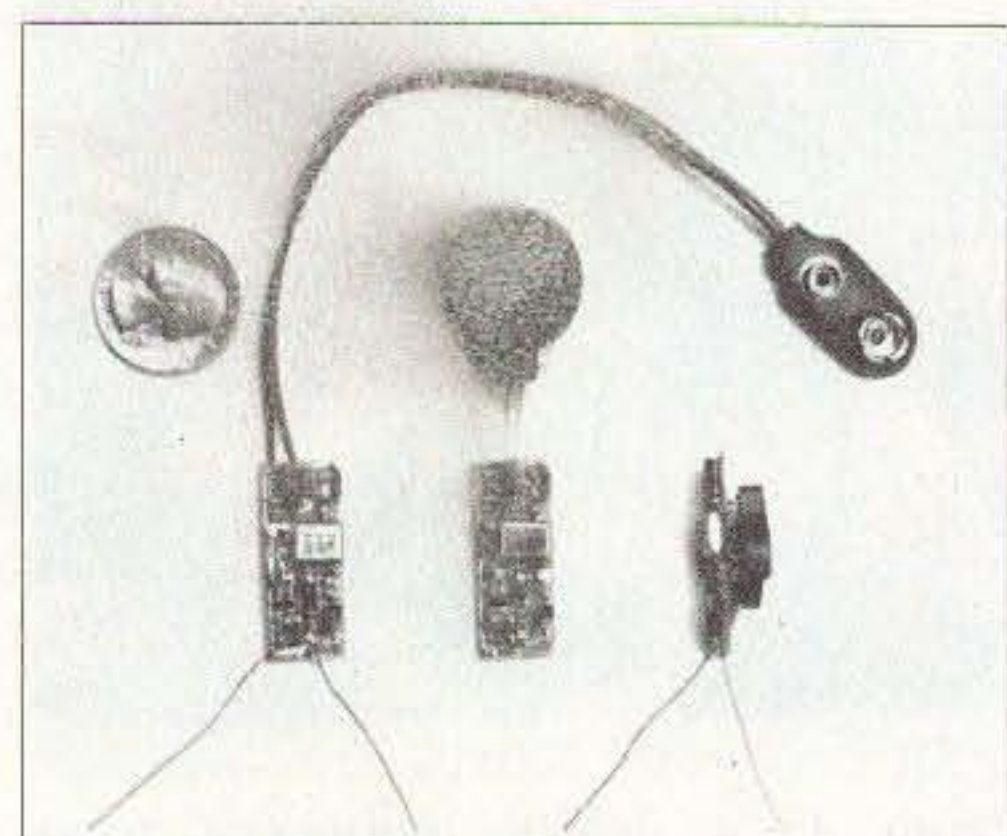




**Photo B.** VHF transmitter boards like this two-watt synthesized model (T301) from Hamtronics are ideal for medium-power foxboxes in surplus ammunition cans. They produce clean output when driving high-power amplifiers, if needed.

transmitter, battery, and controller that fit into a 35mm film canister. In a recent E-mail, Paul Shinn wrote, "That is now considered to be big. The latest creation is dubbed the Micro Montreal Fox (MMF). It is almost half the size and puts out 60 milliwatts!"

Paul continues: "The MMF is built into a waterproof metal enclosure and is only slightly larger than a 9-volt battery alone. We also have a one-watt version in the works that will be about the size of four 9-volt batteries put together. The size is mostly for the lithium ion battery pack. The guys here like transmitters that stay on continuously and the hunts run for 4 hours, so that limits our miniaturization. Now, if we could just build a nuclear reactor that's the size of a pea!"



**Photo C.** Whether for sport or for covert tracking, the biggest part of a tiny hidden transmitter is sometimes the battery. These transmitters, designed by Ken Bauer of Airtek, were featured in previous "Homing In" columns.

### Do-It-Yourself 007 Tricks

Question 2 is by far the most frequently asked, because it comes from both hams and nonhams: "I need a miniature transmitter to put on my prized possession to find it when it wanders away, or is stolen or abducted. What is available?" The "prized possessions" in these inquiries have included sports cars, TV sets, motorcycles, cats, coonhounds, and many other things, living or inert.

A stamp-size microtransmitter project was featured in "Homing In" for May and September 1993 (**Photo C**). This 25 milliwatt crystal-controlled rig was designed by Ken Bauer KB6TTS and can be tuned for either the 2-meter or 125-centimeter ham bands. Surface-mount construction isn't for everyone, so Ken's company, Airtek Engineering, also makes wired/tested transmitters. His primary market is hams who fly model gliders, to aid in their recovery.

I always remind inquirers that transmitters on ham frequencies may only be used by licensed amateur radio operators, and that plenty of T-hunting hams are ready and eager to track down nonham intruders on these frequencies. Station ID and control operator requirements of FCC Part 97 must also be followed (**Photo D**).

Even a QRP transmitter has to be spectrally pure, because it may end up near an airport or other sensitive location. The second harmonics of a two meter signal are on frequencies used by aircraft! Hiders in southern California like to put their T's on top of mile-high mountain peaks, where a few milliwatts can cover thousands of

square miles. There are some tiny transmitters being marketed to T-hunters that have not been reviewed by "Homing In" because my tests have shown them to be spectrally "dirty." Just as output filters are standard equipment in base and mobile ham transceivers, they should also be included in micro-T's, even if it means making them a bit larger.

There are several commercial suppliers of tiny transmitters and tracking receivers for the wildlife management market. They are also popular with owners of prized hounds. Magnum Telemetry, featured in "Homing In" for August 2000, is an example. Under FCC Part 15, these transmitters typically operate just below TV channel 7 or just above TV channel 13.

To save battery life, tracking transmitters are usually pulsed for a few milliseconds, about once a second. For RDF, most wildlife trackers use very sensitive receivers and beam or phased-array antennas. Special tracking receivers are expensive, but many users have had good results with ordinary hand-held scanning receivers. They should be multimode (including CW and SSB) models such as the Icom R-10, Trident TR2400, or Sony ICF-PRO80.

Most of the miniature "bug" transmitters that are advertised in experimenter magazines such as *Popular Electronics* and *Nuts and Volts* use the 88 to 108 MHz FM broadcast band. At first thought, it appears to be an advantage that they can be received on ordinary home and car radios. However, this means that effective range is limited by interference from powerful broadcast stations. Furthermore, modulation deviation in the FM broadcast band is 15 times greater than on two meters, and receiver bandwidth is correspondingly larger. This means that signal-to-noise ratio is degraded and that FM broadcast receivers are incompatible with narrowband Doppler RDF sets.

Attaching your own tiny transmitter and antenna means that the thief who takes your prize-winning feline can get it out of your detection range very quickly, or simply put your tabby in a car trunk to shield the signal. By contrast, commercial stolen vehicle recovery systems such as LoJack are effective because there are so many receivers in the service area that there is a good chance one will always be close by. In Los Angeles, over 400 squad cars are equipped, plus law enforcement helicopters and some fixed stations.

### Kid Trackers, Too?

Some inquirers carry this concept a step further, asking: "I want a pager-sized



tracking device to put on my toddler. This would work with a pocket-sized receiver and RDF set so I could locate the child in case he or she becomes lost or abducted."

I often suspect that these writers are thinking not only of their own kids, but of the money-making potential of this technique. In either case, the tracking of children is a much more serious and difficult matter than the tracking of sports cars. Here are just some of the many factors that must be considered:

- **Size** — For sufficient transmitter power and antenna size to permit tracking over a wide area, the child's transmitting device must be bigger and heavier than most people would desire.

- **RDF** — An effective tracker needs a "wide aperture" antenna for sensitivity and accuracy, so it cannot be pocket-sized. However, parents won't want to haul around a big tracker.

- **Battery Life** — The longer the battery must last, the bigger and heavier the transmitter on the child must be.

- **Antenna** — How do you put an effective antenna next to a child's body without detuning the antenna?

- **RF Radiation** — Is it safe to have a transmitting antenna next to a child's body?

- **Liability** — Will the maker be sued if parents do not quickly find their child with the device?

- **Security** — How do you keep criminals from tracking other people's lost children? What happens if a potential kidnapper uses RDF to locate the lost child before the parents do?

My advice is to leave kid-tracking to the professionals, and don't try it at home. If it were straightforward and easy, lots of companies would be doing it. The tracking devices would be as popular as Razor scooters. But as of this writing, I don't know of any. Sure, there are occasional news stories about such systems that will be available "real soon now." But somehow they never gain widespread acceptance.

Most proposed and publicized commercial child-tracking systems don't use true RDF. Instead, they opt for GPS or other time-of-arrival (multilateration) solutions. The mention of GPS makes hams think of using APRS for this application. The pros and cons of that approach are beyond the scope of this article, but keep in mind that a GPS receiver doesn't work well inside a car trunk, either.

A similar but equally often-asked question calls for a different approach. There are many variations, but this is typical: "Our construction company is losing small tools,

either by accident (such as falling into holes) or theft. Can a transmitter be inserted into items like wrenches, drills, or grinders, with a RDF unit capable of detecting them from outside a vehicle?"

RDF is typically done at considerable distance, from yards to miles and beyond. For that, transmitters require long-term power sources (such as batteries) and efficient antennas. Such an installation fits in a sports car or animal collar, but is too large to go into small items such as hand tools. In addition, the transmitted signal can be detected by anyone with a receiver tuned to the proper frequency, or even a frequency counter, so these systems are not covert.

RFID technology at the job site exit is probably more appropriate for this tool-detection application. RFID systems precisely track property and objects at relatively close range. For instance, chips (also called transponders) can be implanted in pets to provide positive proof of ownership if the pet strays into the pound or is stolen. A reader device, passed over the chip, detects it and reads out the chip's unique ID code. Similar RFID systems sound an alarm when non-paid-for merchandise passes through the doors of a store. RFID is done at greater distance in automatic toll collection systems. The FasTrack® transponders for new southern California toll freeways can even be used to quickly pay for a McDonald's burger at the off ramp!

The chips (also called tags or transponders) are usually passive, meaning that they don't require battery power. They cannot be detected with conventional receivers, but only by a reader or polling device designed to be used with them. For a quick introduction to transponder technology with some links, see the Radio Frequency Identification (RFID) Systems page at the Virginia Polytechnic Center for Wireless Communications Web site, listed in "Resources."

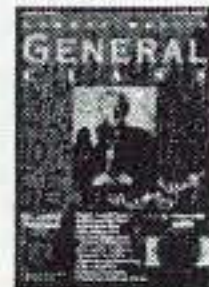
### Wrong-Way Beams

The last question for this month hasn't actually been asked many times, but it should: "Can I use my two-meter yagi or quad for RDF on other frequencies, such as the aircraft band for Emergency Locator Transmitters (ELTs), or the VHF marine band?"

No! The directional characteristics of parasitic antennas such as yagis or quads change significantly when frequency is varied by only a small amount. I thought every ham knew this until I put on one of the first 223 MHz hunts in southern California a decade ago. It wasn't in a truly difficult-to-find place, but one hunter couldn't seem to

## The Gordon West Study Guides

Examination Test  
Questions & Answers  
for General Class and Extra Class  
with explanations of the answers



General Class  
\$12.95  
Plus \$3.50 S&H



Extra Class  
\$14.95  
Plus \$3.50 S&H

### Omega Sales

P.O. Box 376

Jaffrey, NH 03452

800-467-7237



### AD SALES

call

**Evelyn Garrison**

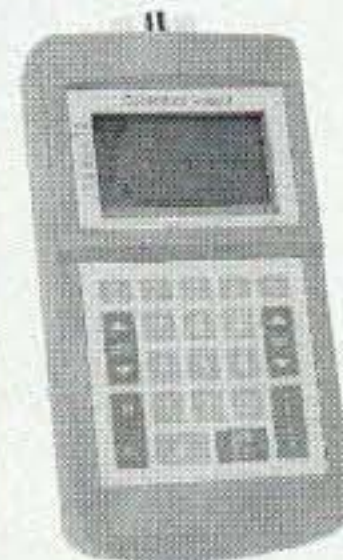
**1-425-557-9611**



**RF and Audio Equipment**

### CableMate®

Time Domain Reflectometer (TDR)



Specifically  
Designed  
for the RF  
Service Technician.

**Reduced Price!**  
now only **\$399.95**

Detect and Locate Faults (Real Time)  
in cables ranging from 16 to 2,000 feet.

**Come take a look**

at our updated website

**www.aea-wireless.com**



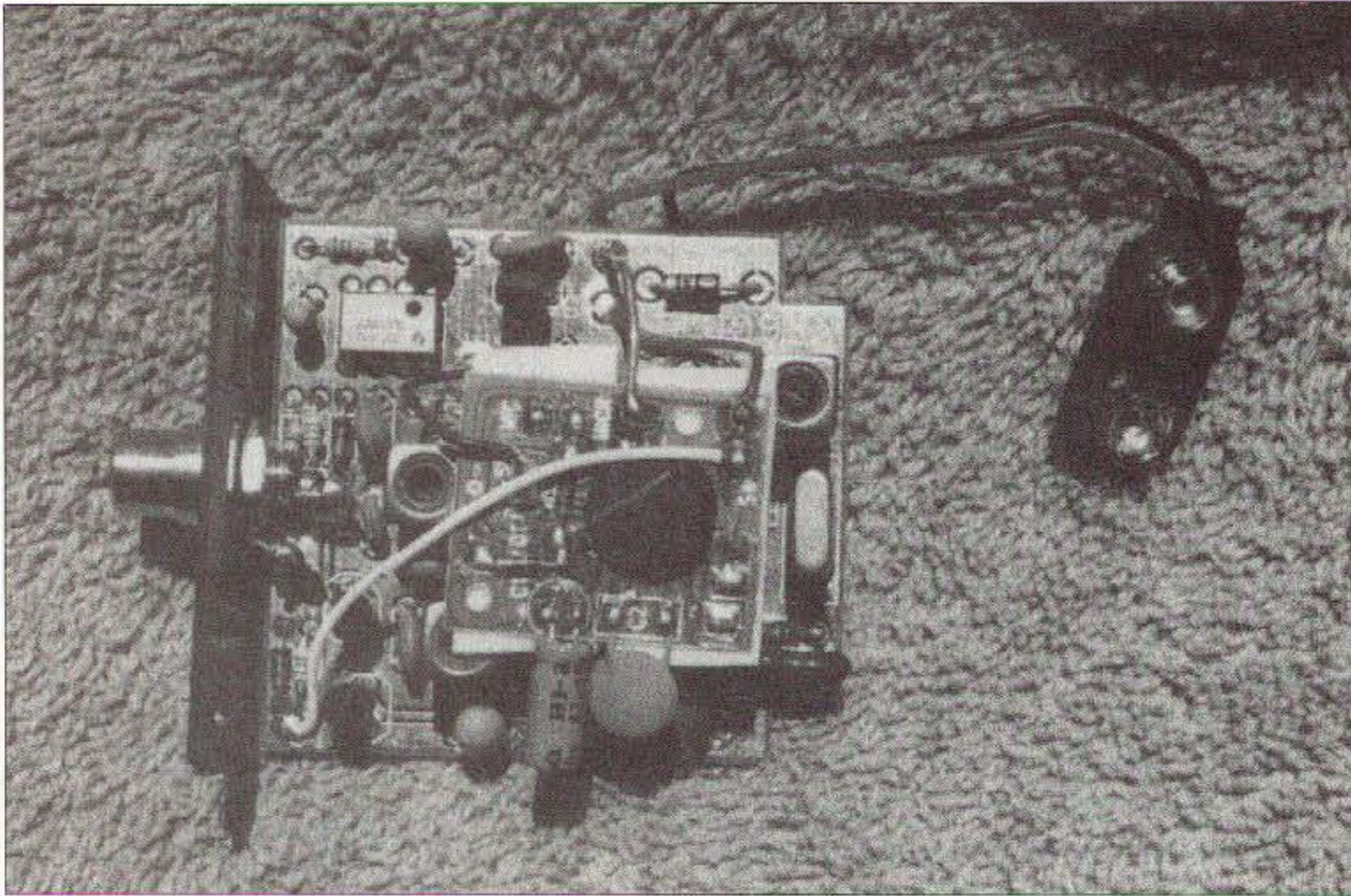
**RF and Audio Equipment**

1487 Poinsettia  
Suite #127  
Vista, CA 92083

P: (800) 258-7805  
P: (760) 798-9687  
F: (760) 798-9689

e-mail: aea@aea-wireless.com



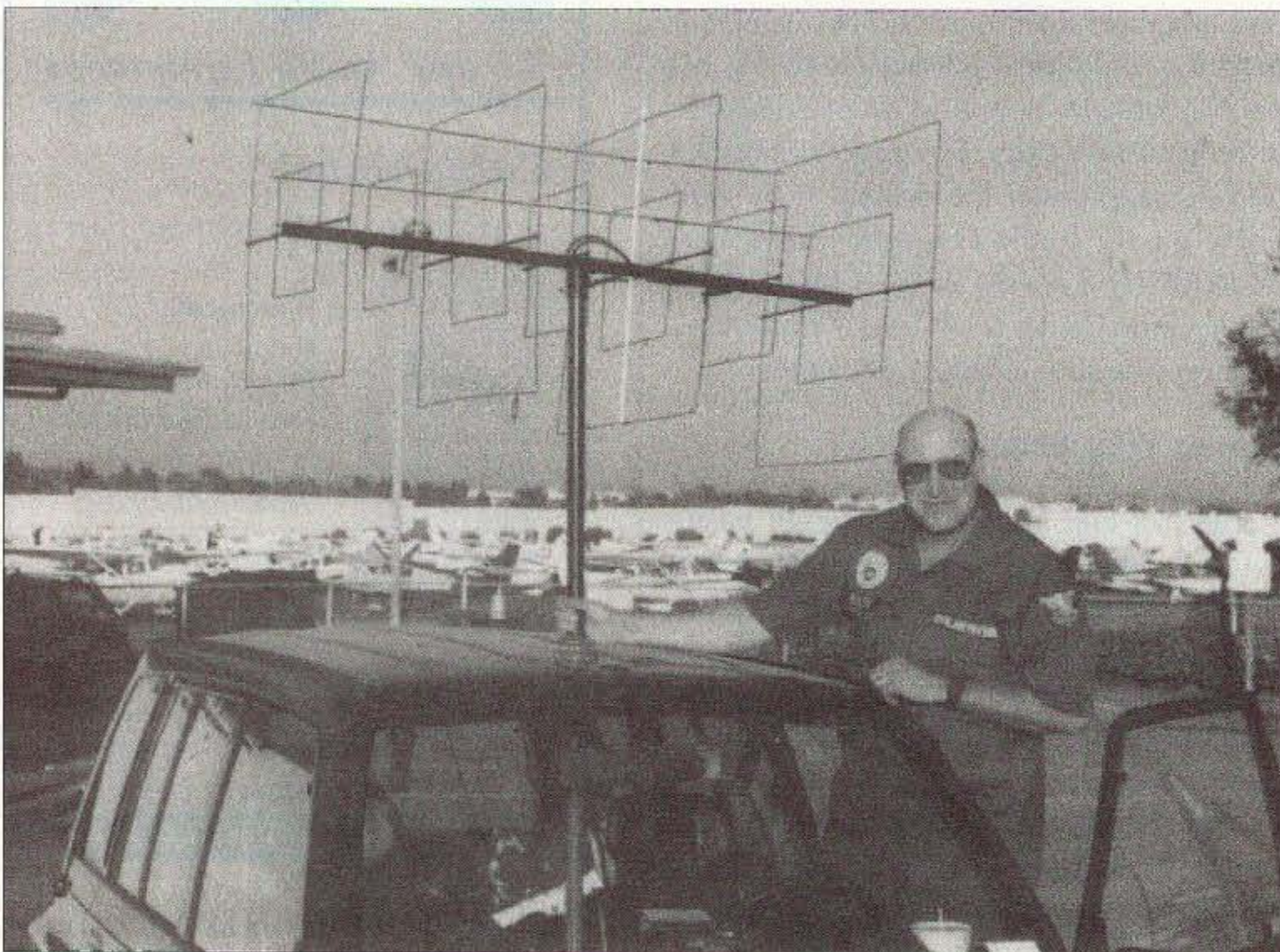


**Photo D.** You don't have to use surface-mount techniques to build a small two-meter transmitter. This cigarette-pack-size rig by Don Lewis KF6GQ was built around the Motorola MC2833 transmitter and 555 timer ICs, both in DIP packages. It puts out five milliwatts. The top board came from a voice-message greeting card, now used to generate audio modulation and station ID.

close in. Every time I talked to him, he was in a different spot that was equally far from my location.

Finally, I asked what equipment he was using for RDF. He replied, "My two-meter quad, of course!" I asked him to take a bearing on my signal and tell me what it was. Sure enough, it was off by almost 120 degrees!

Space for this month is almost gone, so I won't go into all the theory, but suffice it to say that a full-size VHF or UHF quad or yagi won't have full gain or directivity when used at more than plus or minus 3% of its design frequency. A shortened or loaded gain antenna (such as the Shrunken Quad in my book) is even more sensitive



**Photo E.** VHF/UHF yagi and quad antennas must be operated within a few percent of their design frequency for best RDF performance. Bob Miller N6ZHZ of the Civil Air Patrol built this special cut-to-frequency dual-band quad for tracking weak aircraft Emergency Locator Transmitter signals on 121.5 and 243.0 MHz.

to frequency, with a usable bandwidth of one-quarter percent or less.

An Internet foxhunting mailing list recently had a message about hams in the state of Washington who discovered that their two-meter beams worked backwards when tracking 121.5 MHz ELTs. That's no surprise when you consider that the reflector of a 146 MHz beam is about the same size as the director of a 121.5 MHz beam. Similarly, an illustration at the "Homing In" Web site shows how a two meter beam "points rearward" when tracking 172 MHz wildlife transmitters, and has almost 8 dB less gain, too.

Incorrect feedpoint matching is another problem of off-frequency beams that usually doesn't appear in antenna design software plots. It results in additional unwanted pattern lobes and nulls, caused by interaction of the feedline pickup and beam response. Since it's easy and inexpensive to make yagis and quads with optimum dimensions and matching for any VHF/UHF frequency, take the time to do the job right (**Photo E**).

### What's Your Question?

I enjoy corresponding with hams and clubs that are getting started in hidden transmitter hunting. But before you press the E-mail SEND button, check the "Homing In" Web site. The answer to your question might already be on the Frequently Asked Questions page, or somewhere else in the 30 subpages there.

Please don't get anxious if you don't get an immediate answer. If I can reply completely from information in my head or if I need more details from you, you'll probably hear back right away. But if I have to do any research at all, such as look up a Web site or magazine article reference to recommend to you, then your mail goes into the "to do" file and might take a while to emerge, especially if a business trip intervenes. Don't give up unless it's been at least a couple of weeks, then send me a reminder in case I lost your mail or it didn't get to me.

One of my greatest frustrations is to do the research to answer a specific question, then have the reply bounce back to me because the sender changed E-mail addresses or canceled his E-mail account. If you're not going to be at your return E-mail address for at least three weeks, kindly wait until you have a "permanent" address before sending your inquiry.

*Continued on page 59*

**Say you saw it in 73!**



# QRP

## Low Power Operation

Michael Bryce WB8VGE  
SunLight Energy Systems  
955 Manchester Ave. SW  
North Lawrence OH 44666  
[prosolar@sssnet.com]

## More HW-9

*Last time, we talked about the slipping VFO in the HW-9. I've received many letters and E-mails from readers telling me that those hints put several HW-9s back on the air. Let's hope this month we can get some more HW-9 QRP rigs operating.*

The HW-9 is a very good QRP transmitter. However, it suffers from several problems. This month I'll take a look at some of these ailments and how to overcome them.

### Low RF output

Besides the slipping VFO, the second most common problem with the HW-9 is low RF output on the higher frequencies. This problem is most notable on 10 meters and 12 meters. Sometimes, the 15-meter band becomes unstable, but has more than enough RF output.

To fix the instability problem, we need to look all the way back to the predriver. "From the factory," Heathkit used MPS6521 transistors (Heath p/n 417-172) for Q401 and Q402. These are the pre-drivers that drive transistor Q404. Q404 is a 2N3866 (Heath p/n 417-205) that is more than adequate in power gain and frequency. Now, if you have ever built a QRP transmitter utilizing a 2N3866, you can relate to this. That transistor has a wild side to it. If the circuit is not designed correctly, a 2N3866 will become an amplifier and an oscillator at the same time. Looking into the radio, you'll see there are ferrite beads on the base leads of Q401 and Q402. This indicates there are some instability problems.

The stability problem is not with the 2N3866 but rather the two predrivers, Q401 and Q402. In a nutshell: too much gain. The fix is to install something a bit tamer. For Q401, try a metal-cased 2N2222. Yup! And for Q402, a 2N3904 works. I've tried some 2N4401s, but was not impressed. I also tried MSPA20s and some 2SC1711s for Q401.

With 13.8 volts, my HW-9 produces about seven watts on 80 meters and about three and a half on 10 meters. I've heard some

people talking about getting upward of nine watts out on 80 meters. Remember, the idea here is clean power, not just power.

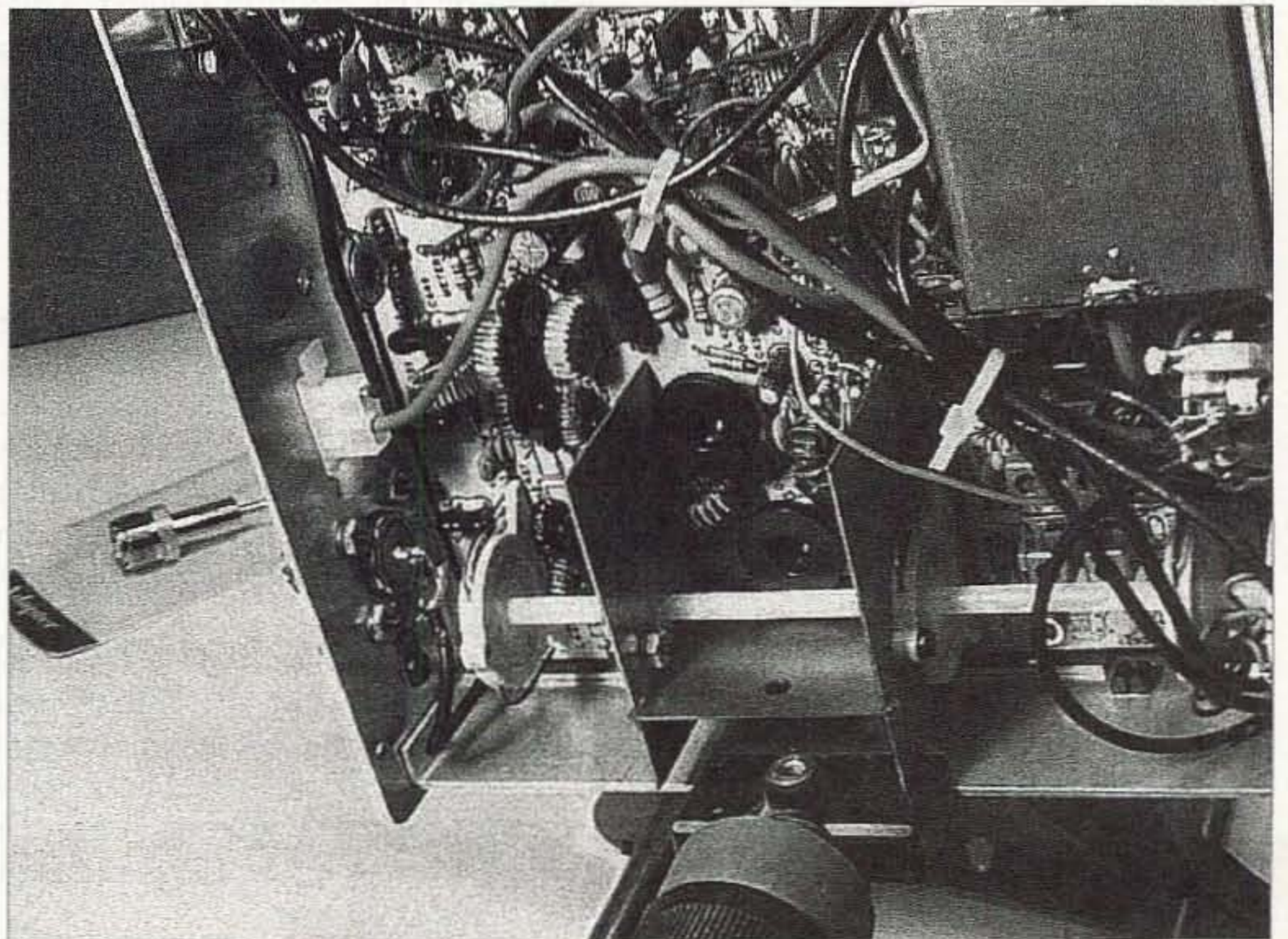
That amount of power is quite high for a QRP radio. If you're long-winded, better check the temperature of the heat sinks on the HW-9's finals. Also, it's not a bad idea to install a heat sink on the 2N3866 as well.

I've talked to quite a few QRP ops, and one of the questions they have about the HW-9 is lack of power on the higher frequencies. The dropoff in power is especially noticeable on 10 meters. If you have done the fixes above and still can't seem to get 3-5 watts out on 10 meters, use your

fingertip and gauge the temperature on the final transistor's heat sink. They both should be quite warm to the touch after a few minutes of key-down. If one takes the skin from your finger and the other one is stone cold, you had better order a replacement. The final transistors used in the HW-9 are MRF237s. You can get these from RF Parts, 435 South Pacific St., San Marcos CA 92069, 1-800-737-2787. E-mail: [rfp@rfparts.com].

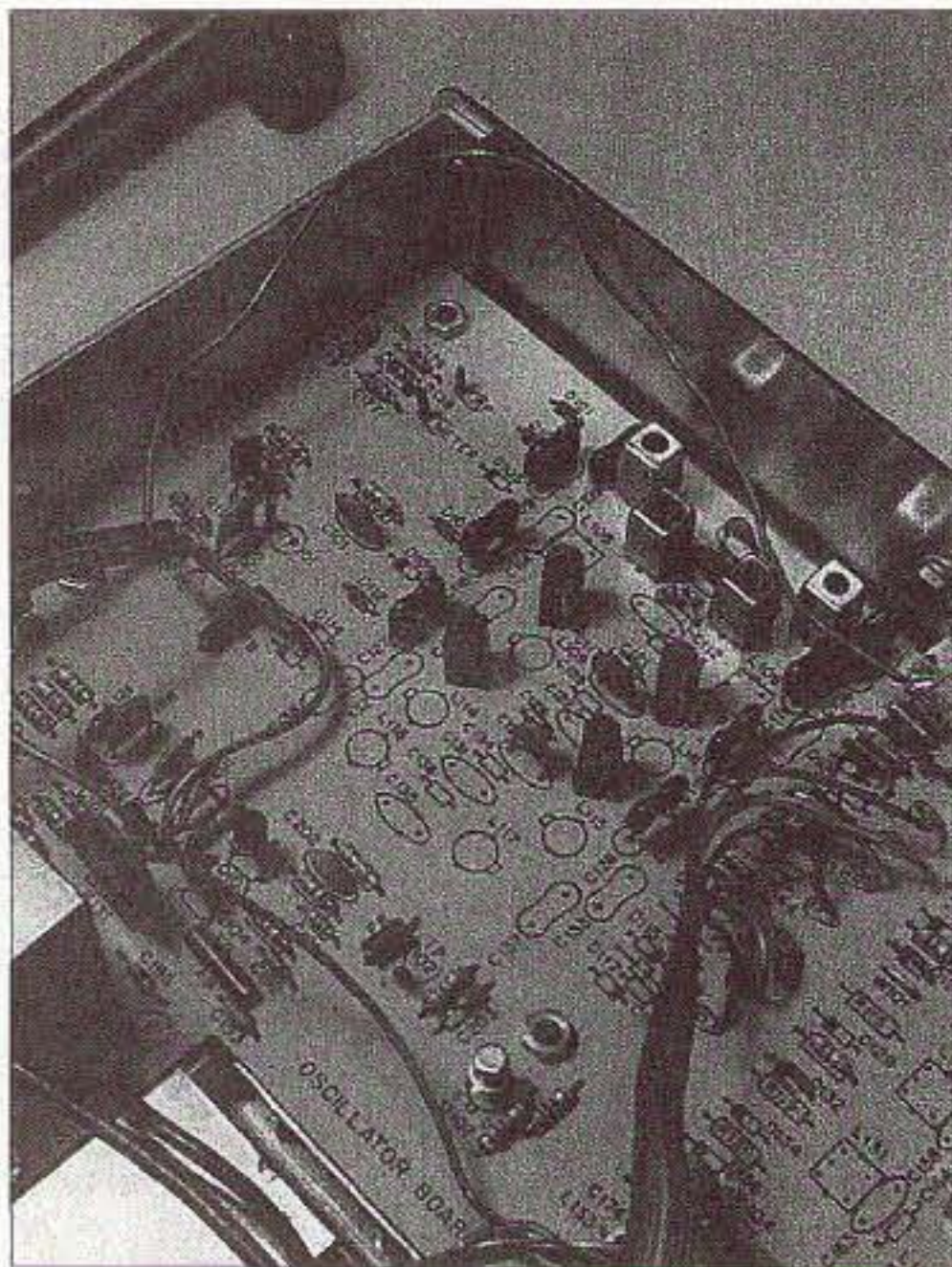
### Better voltage regulation

I did not sit in the design meetings when the HW-9 was being born. So, I don't know



**Photo A.** The bottom PC board for the HW-9. In the bottom center you'll see the two black heat sinks for the final transistors. On the left of the finals you'll see the two empty slots for the filters. These open locations would be filled with the correct inductors needed.





**Photo B.** The top PC board for the HW-9. Most of the mixer circuits are here. Also, note the large amount of unstuffed parts. Again, these were for the "band kit" giving the user the WARC bands.

why the engineers did not have the BFO and HFO oscillators run from the internal +9 regulated supply. Instead, the VFO and HFO oscillators are supplied by the unregulated voltage coming in from the outside world.

To improve the stability of the circuits that operate from the +9 volts, change U402 from a 78L08 to a 78L09 regulator, and replace D409 with a jumper wire. You'll see an overall improvement in operation. But the BFO and HFO are still running from an unregulated source. So, other than ripping up PC board traces, make sure you operate your HW-9 from a rather "stiff" power source.

### Fixing the keying problems

The HW-9 keys way too soft. In fact, speeds over 25 wpm are hard copy. Most QRP ops use a keyer with a weight control to help stiffen up the keying on the HW-9. A better way is to change out some parts.

The first place to start is by removing C578, a 47  $\mu$ F electrolytic, and replacing it with a 10 electrolytic capacitor. This shortens the trailing edge but affects the mute delay line. To fix this, change the value of resistor R444 from 180 ohms to 1500 ohms.

Try the HW-9 out again. If you find the LEADING edge of the CW waveform is too hard, change capacitor C435 from 2.2  $\mu$ F to 4.7  $\mu$ F.

### Some audio improvements

In my HW-8 Handbook, one modification to improve audio was as simple as

removing a capacitor and turning it around. You can do the same with the HW-9. Unsolder capacitor C336, a 2.2  $\mu$ F electrolytic, and install it backwards for polarity. It should be reversed from what is shown in the manual, schematic, and PCB silk-screening.

Some operators have had improved audio by subbing a TL084C quad FET op amp for the LM324 used at U304. Since this op amp is in a socket, it only takes a few seconds to swap out. I can't tell any difference in my HW-9. But others say the change was well worth the effort.

While you're messing with the active filter, you might want to check the values of these parts: resistors R354 and R359 and capacitors C339, C341, C344, and C345. They should all be as close to value as possible. And as in any audio filter, only the best-quality parts should be used. Leave the cheap stuff in the junk box. The better the quality, especially the capacitors, the better the filter will perform.

### Modifying the AGC loop

Some find the AGC a bit too fast for them. You can alter this AGC loop by changing the value of either C317, a 3.3  $\mu$ F electrolytic, or increasing the value of R312. You might want to play with the values of these two components. You can alter the AGC by lowering the value of C317 or increasing the value of R312.

The HW-9 is a great radio. It's easy to work on, and has plenty of features. Aside from the problems (and what radio does not have a bug or two) listed above, the HW-9 would be at home in any QRP operator's shack.

### Finding an HW-9

Although they were sold right up to the end, the Heathkit HW-9 still brings in lots of money on the used market. I don't know why, either. Depending on the options, such as power supply and WARC band kit, plan to pay from \$200 up to \$450 for one. An UNBUILT HW-9 on eBay went for almost \$2000!

Every now and then, I've seen the optional band kit listed on eBay. These seem to hover at about \$50 each. If you're handy with winding coils, you could hand-make the needed parts. You'll need to order the necessary crystals for the HFO oscillators for each band you want.

### QRP ARCI FDM: Don't miss this one!

This year, the Dayton Hamvention will

be celebrating the 50th event. And again, this year the QRP ARCI will be holding their "Five Days in May" QRP bash. The last several years, it's been a sold-out affair. So, here is the info you need to reserve your seat.

"The QRP Amateur Radio Club International (QRP-ARCI) proudly announces the sixth annual 'Four Days In May' QRP Conference commencing Thursday, May 17, 2001 — the first of four festive days of 2001 Dayton Hamvention activities. Mark your calendar for these four days, and register early for this not-to-be-missed QRP event of the new century. Amateur radio QRP presentations, workshops, and demonstrations will be the focus of the full-day Thursday QRP Symposium to be held at QRP ARCI headquarters — the Ramada Inn Dayton South.

"Here is a brief overview of the four days:  
"Thursday: QRP Symposium: 8:00 a.m.–4:30 p.m. Contribution: \$15.00. Topics include: SMT Construction — George Dobbs G3RJV, and Interference to Amateur Radio — Ed Hare W1RFL. And more — monitor the QRP-F, QRP-I, and QRP ARCI Web site [<http://www.qrparci.org/>] for details on other presentations.

"Thursday Evening: Author Social, 7:00 p.m.–11:00 p.m. No charge. A chance to meet and talk with the QRP Symposium speakers.

"Friday Evening: Vendor Social — starting at 8:30 p.m. No charge. Friday evening has been set aside for QRP vendors. Here is a chance to eyeball the latest equipment and talk with the vendors.

"Saturday Evening: QRP ARCI Awards Banquet — 7:00 p.m. to 9:00 p.m. \$25.00 per ticket. Advance tickets only, see Web site for details. Saturday evening starts with the annual QRP ARCI Awards Banquet honoring QRPers who have made major contribution to QRP and amateur radio. We will also announce the winners of the various 'build-it' contests. Fantastic door prizes, great speaker, tons of fun — be there.

"Later on Saturday Evening: Display of the building and design contest entries and winners, PLUS the Radio Show — FREE! Saturday evening provides time for QRPers to socialize with the QRPers from around the world. Show off your projects/collections at the Radio Show! All entries for the building and design contests will be on display. This year we have two general categories:

"1. Wide open category — bring your latest homebrew or kit project.

"2. The second contest is 'in the works.' Monitor the QRP-F, QRP-I, and QRP ARCI Web site [<http://www.qrparci.org/>] for details."

For more information, checkout the Web



site. It will be updated as more information is tied down. Hope to see you there.

### April QRP Contest

Here are the rules for the April QRP Contest.

1. When: April 14 1200Z through April 15 2400Z, 2001. Work a maximum of 24 hours of the 36-hour period. CW only. Work station once per band.

2. Categories: All-band, Single band, High bands, Low bands, Multi-Op, DX.

3. Exchange: RST; State, Province, or Country (S/P/C); ARCI number (nonmembers, send power).

4. QSO Points: Member = 5 pts. Nonmember, different continent = 4 pts. Nonmember, same continent = 2 pts.

5. Multipliers: S/P/C total for all bands. S/P/C's count once per band.

6. Power: >5W = x1. 1-5W = x7. 250mW-1W = x10. <250mW = x15.

7. Final score = QSO points x Total SPCs x Power multi.

8. Suggested Frequencies (kHz): General — 1810, 3560, 7040, 14060, 21060, 28060. Novice — 3710, 7110, 21110, 28110.

9. Team competition: 2 to 5 members per team, or unlimited number of operators as long as a maximum of 5 transmitters on the air at a time. Compete individually as well as on the team. Team captain must send list of members to Contest Manager before contest.

10. Send QRP ARCI contest entries within 30 days of contest date to: Randy Foltz K7TQ, ATTN: Spring QSO Party, 809 Leith St., Moscow ID 83843, or E-mail ASCII-text entries to [rfoltz@turbonet.com].

73



#### TRANS-MITTING TUBE

Eimac #3CX10000A7 power output tube used in radio transmitters, RF heating equipment, sputtering and diffusion equipment.

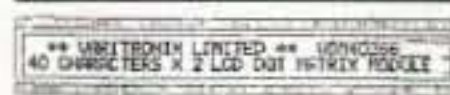
20A001 \$1495.00



#### Computer Beige DESK WART

Input: 115 VAC. Output: +5 VDC @ 3.0 A, +12 VDC @ 2.0 A, -12 VDC @ 0.35 A. With pinout docs.

98E015 \$7.95



#### 2x40 CHARACTER LCD DISPLAY

Has 14-pin interface with documentation to help you interface to your microcontroller projects.

94L005 \$14.95



#### NEW CATALOG!

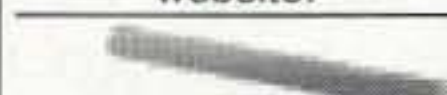
108 pages of bargains that you can download from our web site, or send US\$3.00 (\$4.50 foreign) for a printed copy.

#### TVRO PARTS BOARD

These are motherboards from block-conversion-type satellite TV receivers. The tuners and PROMs have been removed, but there are hundreds of useful RF and digital parts left, including the 70MHz IF strip.

94V005 \$7.95

Check the list of vacuum tubes on our website!



#### FERRITE ROD

1KHz-1MHz frequency range. Material 33. 5.875"L x 0.5"D. Docs included.

98P005 \$4.95



#### TV IF MODULE

Zenith part 9-1320 has AGC and video pots and audio, AFC and osc coils.

99V012 \$6.95



#### HELPING HANDS MAGNIFIER

Heavy cast iron base. 2X 2.2" magnifying glass. Locks at any angle.

93U002 \$5.95



#### NEC PASSIVE SPEAKERS

Excellent sound quality. Will handle up to 30 Watts. Woofer, midrange and tweeter in case.

20V004 \$8.95/pair

Minimum Order \$15.00. California Residents Add Sales Tax. Prices good 60 days from date of publication, and are subject to change without notice.



0004

## ALLTRONICS

Download Our Catalog:

<http://www.alltronics.com>

Open 9-6 M-F and 10-3 Sat.

Visa, M/C and AmEx accepted.

2300-D Zanker Road - San Jose, CA 95131-1114  
Voice (408-943-9773 - Fax (408) 943-9776

## ELMERS • VE's • INSTRUCTORS • CLUB GREETERS

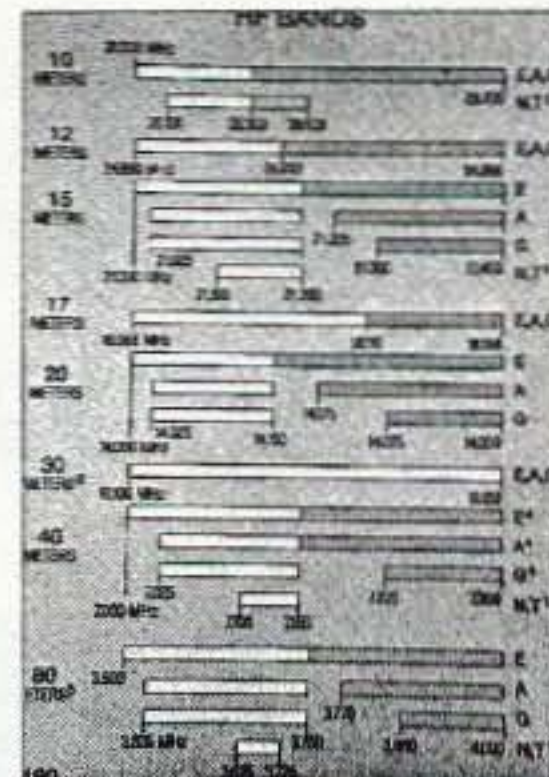
Become A

### HAM AMBASSADOR

The ham industry wants to support your efforts for ham radio growth with free instructor materials.



- Wall Maps • Log Books • Band Plan Charts
- Frequency Charts • Grid Square Guides
- Discounts on Licensing Materials
- Equipment Discount Program
- Gift Certificates



To request a detailed Ham Ambassador Introductory package, write to:

Gordon West c/o 73 Magazine 70 Hancock Rd.,  
Peterborough, NH 03458. E-mail design73@aol.com



## AO-40 Update

*Following the successful launch of Phase 3D, now AMSAT-OSCAR-40, on November 16, 2000, most of us listened for telemetry or just settled back to wait for transponder experiments. No one knew that a wild ride was just ahead!*

Early on Wednesday, December 13th, telemetry transmissions from AO-40 stopped while work on the main engine system was in progress. Within hours, E-mail activity on "AMSAT-bb" (go to [<http://www.amsat.org>] to subscribe) was incredible. What used to be a few hundred E-mails per week had now escalated to over 100 per day. If the telemetry had stopped at almost any other time, the event would probably have been given a nod, a simple reset command would have been sent to the satellite's IHU (Integrated Housekeeping Unit) computer, and system checkout, and other tests would have continued.

This was not the case. The loss of signal had occurred while valves in the propulsion system were being cycled. Due to the explosive nature of rocket fuel, and the pressures involved, this was not a good time to lose communications. Speculation, without sufficient data, swept through the AMSAT E-mail system.



**Photo A.** The Drake 2880 commercial microwave downconverter.

For both long-time and new satellite enthusiasts, it was a frightening and nervous moment. AO-40 is the largest and most valuable amateur radio satellite. It is not just a good thing and new toy for hamsat chasers; its long-term success or failure will have impact on amateur radio for years.

False reports about weak signals coming through on two meters or 70 cm were common. There was even an instance of someone sending signals through the AMSAT-OSCAR-10 transponder in an attempt to imitate AO-40 telemetry. Amazing.

In the meantime, the AO-40 ground control stations were carefully attempting to regain control. Karl Meinzer DJ4ZC coordinated these efforts, as the Phase 3D Project Manager Peter Guelzow DB2OS provided updates to AMSAT groups around the world as they became available.

Finally, on December 26th, Peter sent word that Ian Ashley ZL1AOX in New Zealand had successfully sent a reset command on the 1.2 GHz control frequency to enable the beacon transmitter on 2401.305 MHz. It worked. AO-40 was back on the air, but the big questions remained. What had happened, and how would it affect the mission?

### The event

During the 12 days of silence in late December, many theories were voiced, publicly and privately, about what had happened and why. Like news commentators with little or no information about a calamitous event, many words were posted with little validity. Ideas ranged from an onboard explosion, a serious computer reset, or even a collision with a micro meteorite. The only theory not presented was an attack from a Martian warship.

Until all of the telemetry from before and after the 12-day silent period has been studied, only conjecture can explain "the event." It is known that there was a problem during the first attempted orbital-correction motor firing. When the burn occurred, it lasted a few minutes too long. A sticking helium tank valve was being cycled by ground controllers after the longer-than-expected first burn was completed. Did the cycling of the valve cause something to fail onboard? Hopefully, the answer will be available by the time you read this. Check out news updates from AMSAT [<http://www.amsat.org>] and AMSAT-DL [<http://www.amsat-dl.org>] for possible updates.

### What's next?

When signals were once again streaming earthward from AO-40, and software uploads were working, it was time for a collective sigh of relief, but from a user standpoint several questions were evident.

It is apparent that the satellite's L-band (23 cm) receiver is working and that an S-band (13 cm) transmitter is operational. What if the VHF and UHF transmitters are out of commission?

The ground controllers will continue to analyze telemetry and test systems to find define any limitations caused by "the event." Early indications were that some temperature sensors were no longer working, and some current sensors were providing incorrect values. This would indicate something more than just a simple software glitch. If there are problems with some of the transmitters and receivers, we know that the 23 cm uplink and the 13 cm downlink work. It's a start.

Orbital corrections were not complete at the time of "the event." The current orbit is





Photo B. An alternative downconverter by Gardiner.

not the desired high-orbit elliptical one that the designers want. Instead it has an extremely tall apogee, or high point, of nearly 64,000 km, and a low perigee, or closest point to the earth, of about 370 km. What if it is too dangerous to try to fire the main motor again?

Orbital studies have shown that the current orbit, although not optimum, is stable. Even with the frighteningly low perigee, predictions show that the orbit will outlive the satellite's batteries and electronics by decades. If no further main motor firings are attempted, some adjustments may be possible with the ammonia arc-jet motor, if it is still operational.

### S-band reception

Until other onboard transmitters can be tested and brought on-line, it is necessary to listen for AO-40 on 2401.305 MHz SSB. The easiest way to do this is with a modified commercial TV downconverter originally designed for reception of AM TV between 2.1 and 2.5 GHz (MDS TV,

Multipoint Distribution Service TV), and subsequent conversion to low or high VHF TV channels.

The most common downconverter in use for S-band hamsat reception has been the Drake 2880. It was designed for an input range of 2.5 to 2.688 GHz, with output from 222 to 408 MHz. It is designed to be mounted at the antenna, operate from 13.7 to 24 VDC sent up the 75-ohm coax feed, and provide a noise factor of three dB. When it is used at nearly 100 MHz below its designed range, the internal gain and noise factor suffer. The output is also not within a ham band (two meters or 70 cm) when receiving 2401 MHz. Numerous experiments have been tested on the Drake to make it work better and provide more convenient operation for AO-40 reception. A good place to start if you are fortunate enough to have one of these units is on the Internet. Check out information from Jerry K5OE at [<http://members.aol.com/k5oe/drake.htm>]. Jerry provides first-hand experiences and a number of pertinent links to sites in England and Japan that provide everything necessary to get the Drake ready for use.

The Drake 2880 is not the only unit that can be used for AO-40 13 cm reception. Other successfully modified converters include Gardiner, Pacific Monolithics, Conifer, and others. Some good Internet sites to check for surplus converters and antennas include [<http://www.antennasystems.com/broadband.html#anchor932487>] and [<http://www.phillips-tech.com/main.asp?page=page4.asp>]. If all else fails, there are quality units built specifically for ham operation from SSB Electronics and Down East Microwave, to name two of the more common sources.

### Telemetry

Until the satellite is opened for analog or digital ham-to-ham contacts, telemetry is the only thing heard from AO-40. The typical format is at 400 baud PSK (phase shift keying). This type of telemetry has been

standard since the inception of the Phase 3 program over two decades ago. Hardware demodulators for this format are typically based on designs by James Miller G3RUH. However, with the proliferation of fast PCs, software alternatives have become common.

Using the line input on a typical PC sound card and appropriate software, the telemetry stream from AO-40 can be detected, demodulated, and displayed on a PC. With the addition of software for telemetry decoding, information on the satellite's status can be decoded and observed in real time. Go to the AMSAT Web site [<http://www.amsat.org>], find the link to "telemetry" on the opening page, and look for the P3T software from Stacey W4SM. You will also find links to sites that offer the sound-card demodulator and sources for code that work on non-PC systems. You'll enjoy the pursuit and the insight into AO-40's operations. 73

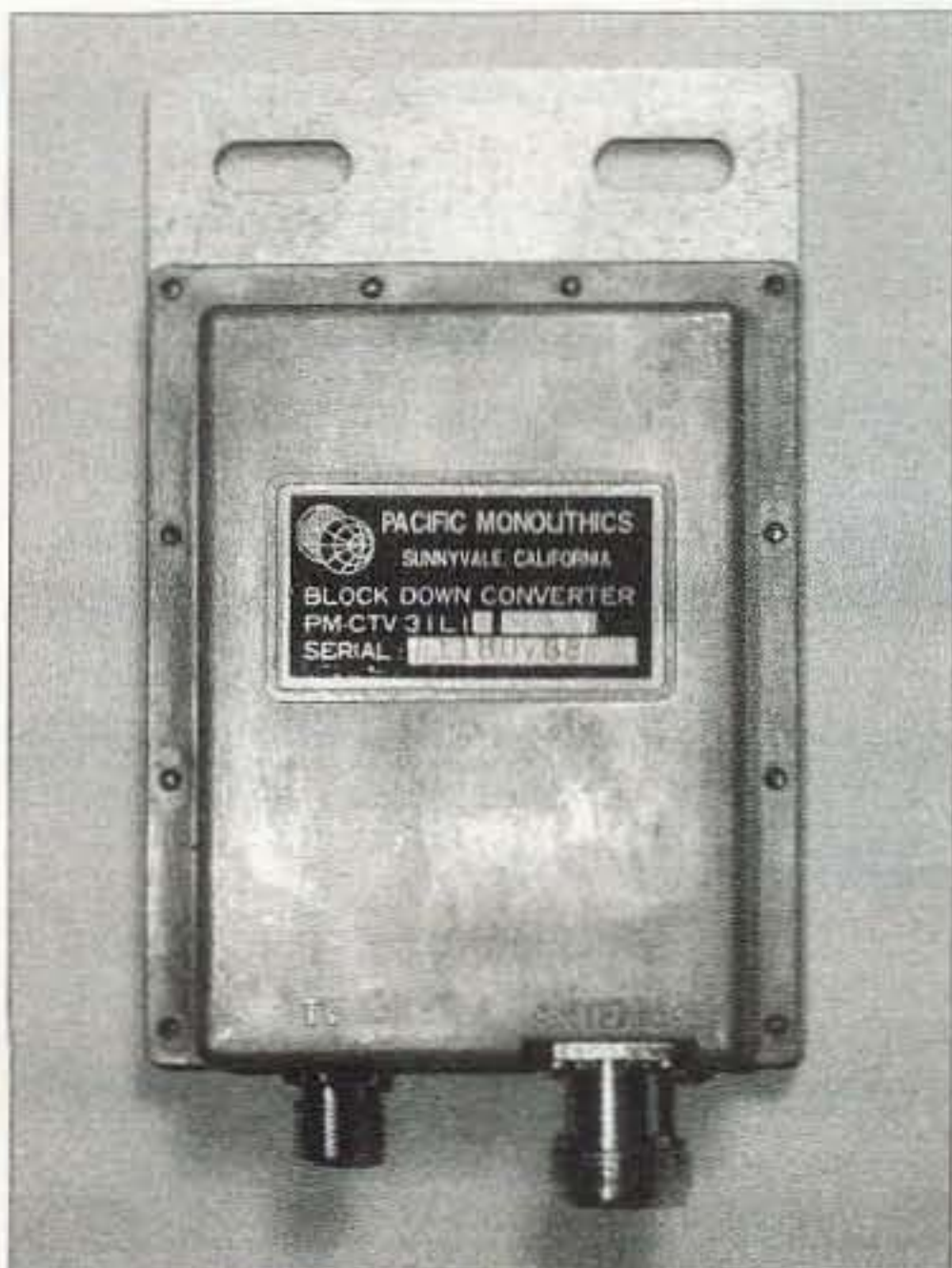


Photo C. Another alternative downconverter, from Pacific Monolithics.

### Subscriptions to 73 Magazine

Only \$24.97 — 1 year  
\$44.97 — 2 years  
\$65.00 — 3 years\*

\*best buy (54% off cover price!)

Call 800-274-7373

### The New Pools!

Examination Test  
Questions & Answers

The exact questions, multiple choices and answers for the Technician Class, General Class, and Extra Class operator's license.



Only  
\$9.95  
Plus \$3.50 S&H

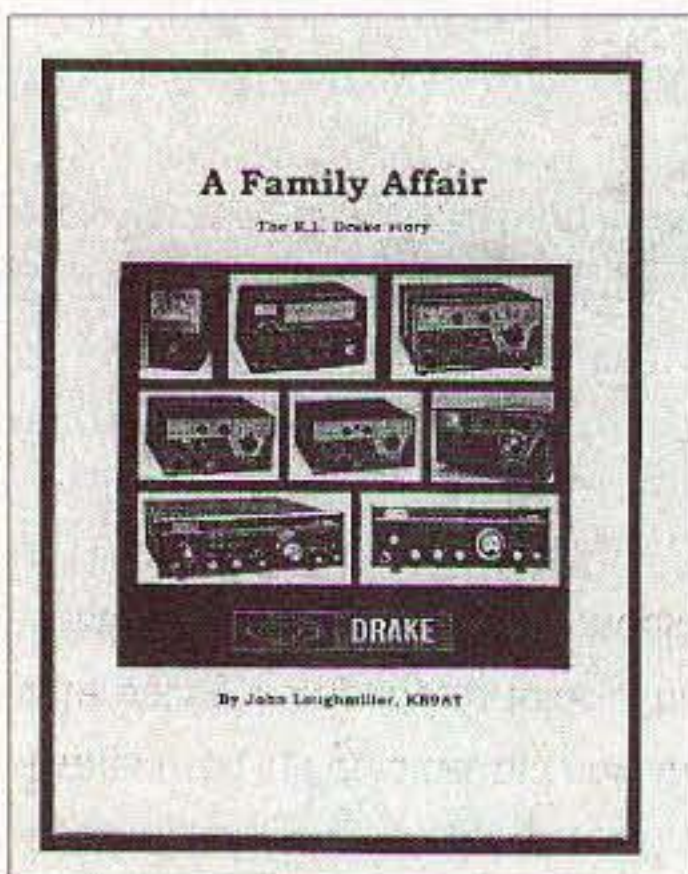
### Omega Sales

P.O. Box 376  
Jaffrey, NH 03452  
800-467-7237





# NEW PRODUCTS



## A FAMILY AFFAIR — THE R.L. DRAKE STORY

Here is the behind-the-scenes story of the famous R.L. Drake Company, focusing on the glory days when

Drake was king of amateur radio. Every ham and short-wave listener knew R.L. Drake from the outside, but now the inside story of this incredibly interesting company is told. This book also includes a huge section of useful circuits and modifications for many Drake radios. At 300 pages, it's an interesting read and a great technical reference. #1487, 8-1/2 x 11 inches, \$29.95.

For further information or to order, contact Universal Radio, Inc., 6830 Americana Pkwy., Reynoldsburg OH 43068; tel. (800)-431-3939; [www.universal-radio.com].

## ICOM'S IC-910H SATELLITE RADIO

The IC-910H VHF/UHF all-mode transceiver offers a full 100 W on VHF, eliminating the need for an external high power amplifier for satellite uplinks. For mode-J satellites, there's 75 W of output on UHF.

With dual high sensitivity DSP-compatible receivers, weak signal DX and satellite communications are second to none. Optional preamps for each band are available for installations requiring additional receive gain.

For further information, contact Icom America, Inc., 2380 116th Avenue N.E., Bellevue WA 98004, or your nearest Icom dealer.

## ANTENNAS: FROM THE GROUND UP

"Volume 1, Numbers 1 to 20" of this work by L.B. Cebik W4RNL is a practical-level antenna book for technicians, amateur radio operators, and students, providing direct and clear information on the theory of antennas "from the ground up." The reader gets a set of rational expectations based on as much clarity as a nonmathematical treatment of antennas can provide.

The book is based upon the kinds of questions the author receives from folks struggling to set up or improve an antenna within the limitations of modern yard sizes and budgets. Scattered among the chapters are a compendium of typical antenna patterns for common antennas on all of the HF bands. Setting reasonable expectations for antenna performance is the main goal of this book. #MFJ-3306.

For further information, please contact MFJ Enterprises, Inc., PO Box 494, Mississippi State MS 39762; tel. (800) 647-1800; fax (662) 323-6551; E-mail [mfj@mfjenterprises.com]; site [www.mfjenterprises.com].



## FREE ON-AIR CODE LEARNING INSTRUCTOR CASSETTES

Morse Code instructors may hold their code-learning classes over their local repeater or simplex frequencies with free code-learning cassettes from Gordon West WB6NOA. Each cassette is 90 minutes long and recorded monaurally for easy player-to-microphone pickup.

"All of the code-learning practice is narrated, and these audio cassettes are ideal for instructors to play over their

local repeater system," comments West, well-known for his innovative amateur radio teaching methods and materials.

"Instructors may also use these cassettes in the classroom, too, working in live code off the air as well as for additional code practice using computer programs or a set of paddles," adds West.

CW instructors may receive these cassettes at no charge by including a brief letter describing their upcoming on-air or in-class scheduled code course, as well as 10 first-class stamps for Priority Mail delivery.

"These free training cassettes are part of the Ham Ambassador program, and I encourage all instructors and repeater control operators to take advantage of this unique teaching opportunity," concluded West.

Send your request and class details to: Gordon West Radio School, 2414 College Drive, Costa Mesa CA 92626.

## GRUNDIG SATELLIT — ALL MODELS IN WORD AND PICTURE



In this book you'll find all the details for each model of the famous Grundig Satellit series. Tons of photos, fact, and specs for every member of this line, from 1964 to 2000. Over 120 photos show interiors, accessories, manuals, and even boxes. #2416, 126 pages, 5-3/4 x 8 inches, \$19.95.

For further information or to order, contact Universal Radio, 6830 Americana Pkwy., Reynoldsburg OH 43068; tel. (800) 431-3939; [www.universalradio.com].

## A GREAT gift idea for yourself, your ham friend(s), or your child's school library

is a subscription to 73 Magazine ... only \$24.97!  
Call 800-274-7373 or write to 70 Route 202 North,  
Peterborough NH 03458



# ADVERTISERS' INDEX

R.S.#	page	R.S.#	page	R.S.#	page	R.S.#	page
• AEA	41	• Communications Specialists, Inc.	21	86 MFJ Enterprises	7	• Radio Book Shop	42
• Alinco	CV2	• D & L Antenna Supply Co.	21	• Michigan Radio	49	• Radio Book Shop	47
• All Electronics Corp.	11	• Dayton Hamvention	15	160 Micro Computer Concepts	13	• Radio Book Shop	48
• Alltronics	45	13 Doppler Systems	37	193 Morse Tutor Gold	57	• Radio Book Shop	59
• Am-Com, Inc.	17	• E-Z Hang	21	• NCG	33	• Radio Book Shop	63
16 Astron Corporation	2	193 GGTE	57	• Omega Sales	35	34 Ramsey Electronics, Inc.	3
42 Bilal Company	13	• Ham Ambassador	45	• Omega Sales	41	• RF Parts	25
168 Buckmaster Publishing	14	• Ham Mall	27	• Omega Sales	47	254 Ross Distributing	51
56 Buckmaster Publishing	35	• Hamtronics, Inc.	9	• Radcomm Radio	57	• Scrambling News	25
99 Communication Concepts	25	42 Isotron	13	• Radio Book Shop	17	• Universal Radio, Inc.	13
10 Communications Electronics, Inc.	5	• Kenwood Communications Corp.	CV4	• Radio Book Shop	36	• W5YI Group	51
				• Radio Book Shop	41	• Yaesu	CV3

When you buy products from these advertisers, please tell them that you saw their ads in 73. Subscribe to 73 right now...call 800-274-7373 (9-5 Monday-Friday EST).



**Michigan Radio**  
SALES SERVICE

Local & Tech 1-810-771-4711, Service 1-810-771-4712, Fax Service 1-810-771-6546

**WE SHIP WORLDWIDE**

OPEN  
TUES, WED, THUR 10-6  
FRI 11-8  
SAT 10-3  
CLOSED SUN & MON



Terms do not include shipping. Price and availability subject to change without notice. Most orders shipped same day. COD's welcome (\$5.50 & shipping).

26014 Groesbeck, Warren, MI 48089  
**1-800-TRU-HAMM** (orders only)  
(800-878-4266)

Now on the World Wide Web

<http://michiganradio.com>

E-mail [mirad@mich.com](mailto:mirad@mich.com)



**KENWOOD**



**ICOM**



**YAESU**

Convert Excess Equipment to CASH • We buy good, clean, used equipment • Estate Sales



## DigiPanning

*Lots of updates are here for the taking. These computer-crafted radio modes seem to sprout new modes and updates for earlier programs like weeds in the spring lawn. I was going to say older programs instead of earlier. And that could have been politically correct in computer terms, but most of the soundcard software has been around less than two years.*

By the time I get this off to the magazine and you have it in your shack, even all I tell you about the new stuff will often have been replaced. It is fascinating how this is working. There is a virtual explosion of technology and we in the ham community are reaping the benefits.

This month's column will feature the latest, at this writing, of DigiPan, version 1.5. I had almost forgotten about what a great program this is. I had used it and downloaded a few of the updates through version 1.2 and was impressed with the intuitiveness of the program. It is still just as easy to install, set up and use as the earlier versions. What happened to the two "missing" versions seemed to have been a programming misfire, but the 1.5 really works.

It has two receive panes and they are large enough to hold 8 or 9 lines of text each, thus giving you time to read what is going on and see who is talking without fiddling with the scroll bars. Some of the programs with more than one receive pane get very limited in the amount of text they can hold. I shouldn't complain, though, because you can drag the divider between panes, even in DigiPan, and make one large receive pane if you wish.

### My definitions of easy

After I recalled it was time to check on the new version, I went to *The Chart*, copied and pasted the URL to my browser, and let the system put the file where I could find it. Then I recalled that the last version I had downloaded was a misfire, so I brought up the "Install/remove program" option in Windows95™ and removed the existing copy.

The second step was to double-click on the recently downloaded file, follow the few instructions necessary, and the new software

was installed. No fancy footwork or files to create by hand, just simply install it. I found the macros were in place from the prior installation, so there, again, was no extra effort needed.

The next step, after nosing around to see what was new, was to power up the rig and see what was going on. A few mouse clicks later and readable print was traveling across the monitor.

The fourth step in this success story was to answer a CQ from a UA0 just north of Japan. The path wasn't too great, but we copied each other well enough to call it a QSO. Just that easy — 1, 2, 3, 4, and we work a little DX on PSK31!

It was now time to go back and figure out a few things that didn't seem quite so obvious (unintuitive?). I still didn't have the foggiest idea how to actuate the second receive panel. I was only using half the available listening capabilities. Well, that was simple also.

When it is necessary to ask for help, DigiPan gives it big-time. It looks as though the help file spells out everything you will ever need to know about how to run the software. The file is extremely well written and I found several answers about as quickly as if the author were standing over my shoulder.

There is a pull-down menu that allows you to choose the two-channel capability, and I had found that but I needed a little more. The explanation was simple. You change the first or upper receive pane frequency by clicking the left mouse key in the waterfall on the desired signal. The lower pane is controlled with the right mouse key in the same manner. I probably would not have stumbled on that by myself, but it certainly was simple to find in the help file. (See Fig. 1.)

The second question I had was one I had learned about in a previous version and promptly forgot, and that was how to calibrate the spectrum line above the waterfall. I believe a search for "calibrate" turned up the answer to that one immediately, and a few more clicks and the line was reading as if it were meant for this place.

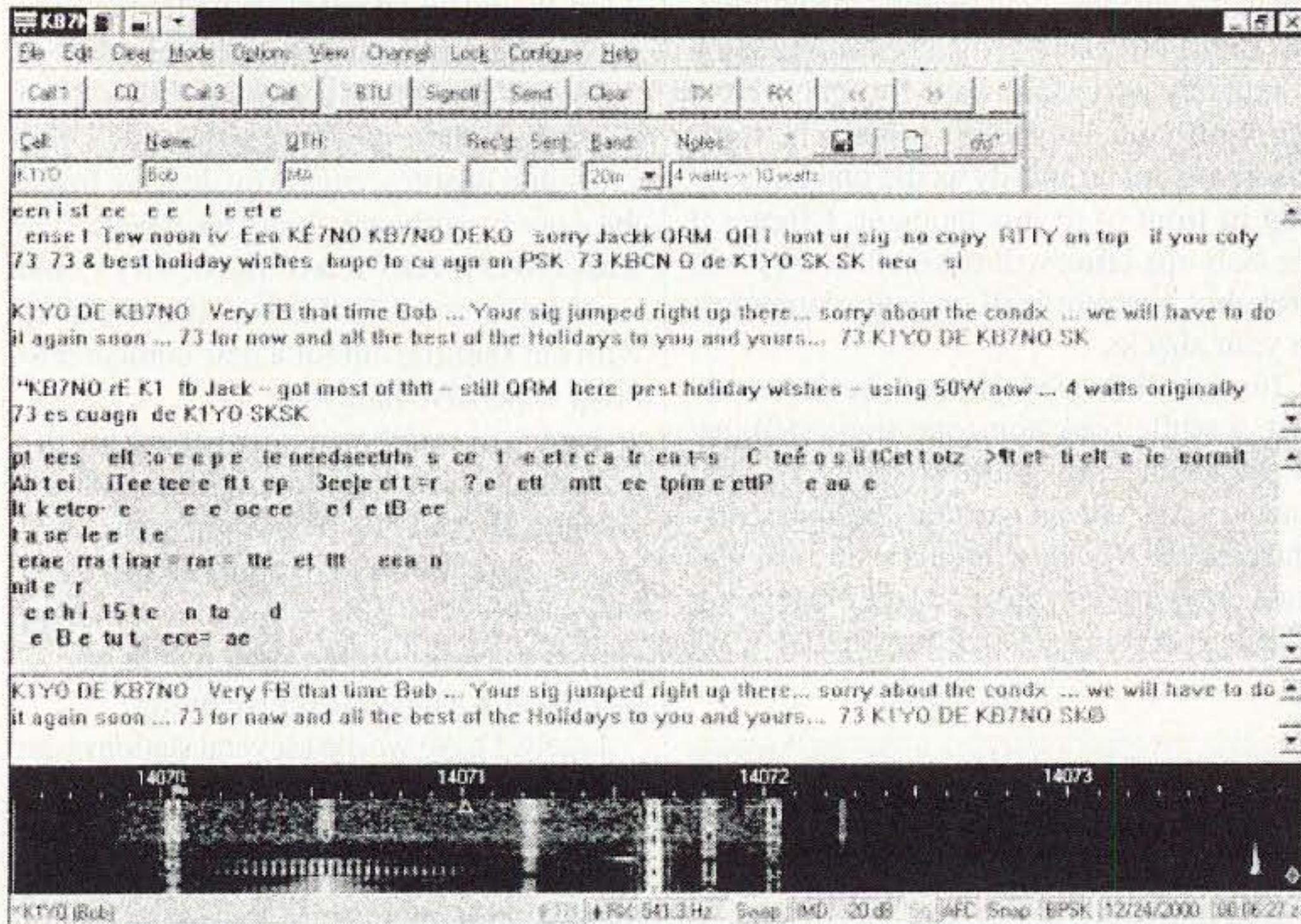
The program is just simply easy to use. I think that is why there are so many users. There is a minilog you can use and then export for your regular logging program. As a matter of fact, if you do not have a separate logging program and wish to do so, the minilog may answer all your needs, at least as far as working this mode goes.

One of the important features of using ham-generated software for this kind of mode is to have macros ready to do the typing (and save the thinking) for you. DigiPan has the capability of defining 24 macro buttons to do whatever you wish. Some are already defined for you, some are not defined. You will find they are easy to edit in the pop-up window when you right-click on any of the buttons. Instructions are contained within the window.

A few of the important macros are ready to use right-out-of-the-box. CQ is there, along with a button to answer a CQ, as well as buttons for turnovers and ending a QSO. I will edit these to suit, and, as I said, the editing is a cinch with the examples and needed reminders at hand as soon as you right-click on the button. Twelve macro buttons are shown across the top of the screen; then they are redefined as a second set of twelve when using the Control key.

If you haven't as yet gotten into soundcard modes, the DigiPan Help File has a section on that under "Equipment Setup." You can find how to route cables or make





**Fig 1. Screenshot — DigiPan 1.5.** This is new-and-improved software that so many hams have so willingly taken into their lives. This wasn't the best demo, but I wanted to show that a QRP station (at the other end) was making it. In the end, he was doing better than I with my big-gun 50 watts. His 4 watts started out real well. So I was concentrating so closely on this that the copy on the second pane which had been from the 14.071 marker got away. The little triangle at that frequency indicates where the lower (2nd) pane would be printing copy from. The upper pane frequency indicator has a little flag attached and is just to the right of 14.070. Left button snaps the pointer with the flag to the point in the waterfall where you spot a signal. Right mouse button does the same for the triangle indicator. The Help file is a wonder for clarity and information. Just about any reasonable question is answered so you can understand what you need to do. The macros, 24 of them, are easily edited and this is explained well. There is also sufficient information for transferring your mini-log info to your regular logging program if you desire. You will find just about everything you need short of a transceiver and an antenna to get you going in PSK31. Go for it!

up a PTT circuit (just like the one I use). It is thorough but not overkill. There is everything you need to get you going in PSK31.

Plus, if you don't wish to be bothered with the home-brew method of cabling and tweaking, the DigiPan Web site shows a reasonably priced interface that could save you a lot of steps. I haven't spoken with anyone using this setup as of this writing, but it is a good premise, an easy way to skip some tedium.

As many of you know, the author of this program, Nick, also writes MixW, a much more intense effort. MixW, in addition to doing a good job on PSK31, gets you into RTTY, packet, CW, and a few experimental modes, plus you can copy Pactor and Hellschreiber. There is a version 2 of MixW being awaited by those of us who see the fruits of Nick's efforts. I hope it works as well as this latest DigiPan. You can get a free demo of MixW by following the URL listed in **Table 1**.

WinWarbler fans will be pleased to know

Dave is still tweaking that program. I received an E-mail notice the other day that he had added a bit of clarity to the waterfall. I had heard a few complaints on the subject, so I downloaded the latest update, and it looks very good. The latest update when I started this paragraph was version 1.89. I just checked again and it is version 1.90. Where the technology goes by the time you read this, I cannot predict. It all moves very fast.

Better news yet, the Web site where you would normally download the WinWarbler software along with other of Dave's many creations contains instructions about getting and installing the updates. I did not realize this and was several updates behind. Of course, not knowing any better, it was working just fine. (Ignorance is bliss.)

I also received a message that the Zakanaka first version was ready for download. That is a fascinating project, but I ran into complications that thwarted the actual viewing. Some strange little glitch prevented

## GORDON WEST HAM TEST PREP TAPES BOOKS SOFTWARE VIDEOS

**Prepare for your ham test with "Gordo" WB6NOA as your personal instructor.**

- **THE NEW THEORY** on audio cassettes
  - No-Code Technician (4 tapes) .....\$19.95
  - General Class (4 tapes) ..... \$19.95
  - Amateur Extra Class (4 tapes) .....\$19.95
- **THE CODE** on audio cassettes
  - Learning CW (0-7wpm 6 tapes) .....\$29.95
  - Speed Builder (5-16wpm 6 tapes) .. \$29.95
  - Speed Builder (10-28wpm 6 tapes). \$29.95
- **NEW STUDY MANUALS** by "Gordo"
  - No-Code Technician (**Element 2**) .. \$11.95
  - General Class (**Element 3**) ..... \$12.95
  - Extra Class (**Element 4**) ..... \$14.95
- **PC SOFTWARE** with study manuals
  - No Code Technician (**Element 2**) ....\$34.95
  - Tech/Tech+/Gen. (+ Code, Windows)\$49.95
  - General Class (3+Code, Windows). \$34.95
  - Extra Class (4 + Code, Windows).. \$34.95
  - Ham Operator (Tech.-Extra + Code) \$59.95
  - Morse Software Only .....\$12.95
- **VIDEO** VHS with study manual
  - No-Code Tech Video Course..... \$31.95

Add \$5.00 shipping 1st item, .50 each additional  
Priority Mail 2-3 day service available  
VISA, Mastercard, Discover, & AMEX Accepted

**W5YI Group**  
P.O. Box 565101 • Dallas TX 75356  
**1-800-669-9594**  
[www.w5yi.org](http://www.w5yi.org)

208-852-0830  
<http://rossdist.com>

**Over 9010  
HAM Items  
in Stock!**

**KENWOOD**  
TM-G707A  
\$289.50

**RDC** Check Out Our Specials on our Web Page.  
ROSS DISTRIBUTING COMPANY All Prices Cash  
78 S. State Street, Preston, ID 83263 FOB Preston  
Hours Tue.-Fri. 9-12 2-6 • 9-2 Mondays, Closed Saturday & Sunday

me from getting a complete download of the file.

"So," thought I, "I will fix this." A friend had informed me he had overcome some download problems by replacing his copy of Netscape 4.7, the one I am using, with the new version 6. Then, for some reason on that day, I even had a problem downloading from Netscape.

The next day, the download from Netscape came off like a champ. The "path" must have improved, things are bound to look up. It was entertaining, to say the least, watching the new version of Netscape install itself as it was downloading. Quite a marvel in programming, I was thinking.

Then began the agony of watching this old 120 MHz computer crawl through the paces trying to sort out all the baggage in



the new Netscape package. That is the nicest way to relate my thoughts. But I persisted and attempted the Zakanaka download with the new "hot setup." Worked better, but not good enough. Never made it. A little window came up and said the download was complete when I knew it was about 25% short.

Oh well, what is left is to uninstall this fat new Netscape and watch for new opportunities to see the fabled Zakanaka in action. The lesson in all this is that there are many programs being written that will only run on very high end, one gigahertz machines. I am getting a little dismayed. I don't see any reasoning for this trend. But I am

not in the business of marketing the Internet, any of the browsers or the latest computers.

I merely try to find ways for you to have fun with your computers which, in some cases, are not as speedy as the one I am sitting in front of at this moment. I figure if the lash-ups I find will run on this, they will probably perform well on your computers in your shacks.

Just as a little aside, but on the same subject, a while back someone suggested one of the freebie virus scan programs. I downloaded it, installed it and that one apparently checked the system continuously. The reason I drew that conclusion was the computer was in a perpetual state of slowness. I guess

it too, would be a good program for the newest, fastest processor. Another uninstall.

What I am saying is there is still a lot of life left in these machines that are a few years into obsolescence. You do have to use the correct software. You can have a ball with PSK31, RTTY, MFSK16, SSTV, and most any new mode that is going to pop up with out shelling out for a new computer or other expensive hardware.

That is one of the factors that has always brought people to this hobby. I hear of loud-signal SSB and CW contest stations costing as much as a fancy house. And that is okay by me, everyone should have the choice to exercise that option. We can all coexist at whatever level we prefer.

Lately, I have worked several stations who were using 2 to 5 watts output on PSK31. One of them, I understood, was using one of the little QRP transceivers that costs less than \$200. Couple that with a low-buck laptop and, if the laptop is a bit ancient, use the G3PLX software for PSK31. You can get versions to run in DOS or Windows 3.1. Talk about using old tech.

A little power from a cigarette lighter socket alongside the road and you can have a small and very portable digital station that will work the same size world as the big-gun DX stations I was just mentioning. You may just not do it quite as quickly. It is a little like licking the ice cream cone rather than wolfing it down. The pleasure lasts longer and sometimes the taste is sweeter.

Another program I have let slip through the cracks is Throb. This is a creation of Lionel Sear G3PPT and is showing a lot of promise. It is reported, as was intended, to have superior throughput when the going gets rough.

I had downloaded an earlier version a few months ago and did not have much luck getting it comfortable in this system. At the time, there were too many unanswered questions.

Due to a bit of prodding, I downloaded the version 2.5, installed it, and carefully read the instructions. I wanted a success story to report. It worked. The only thing that did not cooperate was the PTT. And that, I am sure, can be easily explained. That I can work around.

I was finally able to hear the transmitted signal and even sent a series of CQs the other evening. I didn't really expect a reply, but it was fun to just see that here was this new mode working as expected. I had hams telling me for about a month that their copy worked. I am glad I went back and gave it another try.

Source for:	Web address (URL):
Mix W Soundcard program for PSK31, RTTY, new modes, MTTY, FSK31, more	<a href="http://tav.kiev.ua/~nick/my_ham_soft.htm">http://tav.kiev.ua/~nick/my_ham_soft.htm</a> <a href="http://users.nais.com/~jaffejm/mixwpage.htm">http://users.nais.com/~jaffejm/mixwpage.htm</a>
MMTTY New RTTY soundcard freeware plus links to other software	<a href="http://www.geocities.com/mmtty_rtty/">http://www.geocities.com/mmtty_rtty/</a>
TrueTTY — Sound card RTTY w/ PSK31	<a href="http://www.dxsoft.com/mitrty.htm">www.dxsoft.com/mitrty.htm</a>
Pasokon SSTV programs & hardware	<a href="http://www.ultranet.com/~sstv/lite.html">www.ultranet.com/~sstv/lite.html</a>
PSK31 — Free — and much PSK info	<a href="http://aintel.bi.ehu.es/psk31.html">http://aintel.bi.ehu.es/psk31.html</a>
Interface for digital - rigs to computers	<a href="http://www.westmountainradio.com/RIGblaster.htm">www.westmountainradio.com/RIGblaster.htm</a>
Interface info for DIY digital hams	<a href="http://www.qsl.net/wm2u/interface.html">www.qsl.net/wm2u/interface.html</a>
WinWarbler info and free download	<a href="http://www.qsl.net/winwarbler/">www.qsl.net/winwarbler/</a>
MFSK — related tech info — how it works	<a href="http://www.qsl.net/z11bpu/">www.qsl.net/z11bpu/</a>
Throb — New — lots of info	<a href="http://www.lsear.freemove.co.uk/">www.lsear.freemove.co.uk/</a> <a href="http://www.btinternet.com/~g3vfp/">www.btinternet.com/~g3vfp/</a>
Site with links to PSK31 and Logger 7, also Zakanaka	<a href="http://www.geocities.com/kc4elo/">www.geocities.com/kc4elo/</a>
PSKGNR — Front end for PSK31	<a href="http://www.al-williams.com/wd5gnr/pskgnr.htm">www.al-williams.com/wd5gnr/pskgnr.htm</a>
Digipan — PSK31 — easy to use — new version 1.5	<a href="http://members.home.com/hteller/digipan/">http://members.home.com/hteller/digipan/</a>
TAPR — Lots of info	<a href="http://www.tapr.org">www.tapr.org</a>
TNC to radio wiring help	<a href="http://freeweb.pdq.net/medcall/ztx/">http://freeweb.pdq.net/medcall/ztx/</a>
ChromaPIX and ChromaSound DSP software	<a href="http://www.siliconpixels.com">www.siliconpixels.com</a>
Timewave DSP & AEA (prev.) products	<a href="http://www.timewave.com">www.timewave.com</a>
Auto tuner and other kits	<a href="http://www.ldgelectronics.com">www.ldgelectronics.com</a>
XPWare — TNC software with sample DL	<a href="http://www.goodnet.com/~gjohnson/">www.goodnet.com/~gjohnson/</a>
RCKRtty Windows program with free DL	<a href="http://www.rckrty.de/">http://www.rckrty.de/</a>
HF serial modem plans & RTTY & Pactor	<a href="http://home.att.net/~k7szl/">http://home.att.net/~k7szl/</a>
SV2AGW free Win95 programs	<a href="http://www.raag.org/index1.htm">www.raag.org/index1.htm</a>
Source for BayPac BP-2M & APRS	<a href="http://www.tigertronics.com/">www.tigertronics.com/</a>
BayCom — German site	<a href="http://www.baycom.de/">www.baycom.de/</a>
BayCom 1.5 and Manual.zip in English	<a href="http://www.cs.wvu.edu/~acm/gopher/Software/baycom/">www.cs.wvu.edu/~acm/gopher/Software/baycom/</a>
Int'l Visual Communication Assn. — nonprofit org. dedicated to SSTV	<a href="http://www.mindspring.com/~sstv/">www.mindspring.com/~sstv/</a>
Creative Services Software	<a href="http://www.cssincorp.com">www.cssincorp.com</a>
Hellschreiber & MT63 & Stream & scope	<a href="http://www.freeweb.org/varie/ninopo/iz8bly/index.htm">www.freeweb.org/varie/ninopo/iz8bly/index.htm</a>

Table 1. The Infamous Chart — Almost everything ... updated monthly.

Continued on page 59



# The History of Ham Radio

## Part 4: The early 1920s.

*The early days of radio embraced an era filled with gusto ventures and exciting stories, true tales from yesteryear we proudly relate to you through this "History of Ham Radio" series. It is our sincere wish that you remember these stories and pass them on to future generations later in time — with a similar "pass it on down" stipulation. Through our joint efforts, amateur radio's legacy will live forever. This month, in Part IV, we go back to the days of spark gaps and ozone in the shack.*

During 1921, for sending their signals, amateurs were still thinking in terms of spark transmitters. The vacuum tube, as a simple three-element detector, was being advertised prominently and illustrated profusely in all the wireless literature. Not until the VT-1, 201, 202, and other tubes came along could much conversion from spark transmitters take place. It was well into the 1921–1922 period that this happened, with the realization that wavelengths below 200 meters were of considerably more advantage for DX and better tuning characteristics than those at 200 meters and above.

While in the Signal Corps Officers' Training Camp in College Park MD in 1918, I saw and operated the first three-tube transmitter. It was similar in appearance to the first three-tube DeForest set that was extensively advertised in radio periodicals in 1921. It came equipped with Western Electric VT-1 tubes.

Reprinted from *73 Amateur Radio*, July 1977, where this was originally reprinted from *QCC News*, a publication of the Chicago Area Chapter of the QCWA.

Construction articles appeared monthly in the 1920 and 1921 magazines. These were simple circuit diagrams showing applications. The Fessenden, the Marconi, the Telefunken, the Colpitts and many others were displayed. The radio amateur was doing a lot of experimenting in adapting this new device to all sorts of circuit layouts with the goal

of improving the reception and transmission of signals.

Amateurs and commercial interests devised all sorts of receiving circuit combinations under such names as the *neutrodyne*, the *amplidyne*, the *Roberts*, the *Cockaday*, etc. One must remember that radio broadcasting had its real beginning in earnest right after



Photo A. Peoria Radio Sales Co., 1923–1924.



World War I, and the general public became all agog over this new mysterious phenomenon entering their homes. Hearing strange voices and music out of nowhere ... through earphones ... without wires ... It was unbelievable!

From now on, the ham was no longer alone with his dots and dashes in his little cubicle, carrying on his own brand of mysterious private conversation.

Serious consideration was being given by the amateurs to the possibility of making improvements in signal reception by adding several stages of tube amplification to the detector. The single crystal detector and the old coherer

could now be permanently replaced and abandoned. Those weak and often inaudible signals could now be picked out with ease and at a greater distance. And so, with the discovery of the regenerative circuit by Major Armstrong, the vacuum tube *started to oscillate* and gave signals a thousand-fold boost in strength.

The vacuum tubes were not quite ready for transmission purposes. Their lack of ruggedness, their size, their cost, and their scarcity held back adaptation by the amateur fraternity of tubes for strong CW signal generators. After the war, and even into 1922,

amateurs who had served Uncle Sam were still operating their spark transmitters.

Many of us were familiar with either the Army Signal Corps or the Navy gear. They all looked and operated alike. In the beginning of wireless adaptation to the armed services, very little innovation could be expected for field combat purposes. The quenched gap transmitter stood out as a most reliable unit. To the ham this was proven equipment. True, it operated in many instances from a 500 cycle source of power, but it was regarded as a dependable unit to cover fairly long distances and was used by commercial companies in the field. It was semiportable when loaded on a horse, a mule, or a two-wheeled cart.

The returning amateur was trained in the use of such transmitting equipment and took a fancy to the unit. He was very familiar with its performance, knew how to operate it, and had practical knowledge of its capabilities and application. During his period of service he was always thinking in terms of adapting it to his own use if and when he got back home. The one and only drawback was the 500 cycle power input. Replacing the quenched gap in the circuit proved a minor drawback.

When we examine the spark gap circuit used in all stations as illustrated and described in the literature of the early 1920s, it can be said that it was really quite simple and direct, and not difficult to understand in operation and performance.

The "spark-gap ham" preferred to build his own condenser. He would use glass plates, mostly 8" x 10" in size, obtained from a photographer who was ready to discard them. (Exposures were made on glass plates "in them olden days.") These were covered, both sides, with tin or aluminum foil or other thin metal sheets. Tobacco pouches were often sources of foil. Enough plates were coated so that the assembled condenser gave a value of .01-.012  $\mu\text{F}$ . To make sure that the unit could withstand potential surges as high as 25,000 volts, four of these sections were connected in series-parallel,



## Radio Pictorial

Just Recently Major Armstrong Started the World With His Regenerative Receiver. Dr. Franklin Leroy Satterlee, Noted X-Ray Specialist, Now Makes Public His Discovery on a Non-Regenerative Set Making One Detector Bulb Do the Work of Two Stages of Radio Frequency. It is Claimed With This Set that a Greater Receiving Range is Made than Heretofore Accomplished. This is the Set that Strongly Interested Gen. Squire, Chief Signal Officer of the United States, Who Said he Would Give but 15 Minutes to Test this Receiver, and Actually Gave Three Hours.

The Photo on the Left Shows Dr. Satterlee Comparing the Large Radio Sets with the Small One-Bulb Set on the Extreme Right, His New Invention, Embodying the Same Principles as the Large Set.

Few Users of the Vacuum Tubes Realize Just How Much Work is Involved in the Manufacture of These Tubes, and How Radio Engineers are Constantly Experimenting and Doing Research Work with a View to Improving Them. The Photo Below Shows Mr. Zhu S. Man, Graduate of the Hong Kong University of China, Plotting the Characteristics of Vacuum Tubes at Columbia College, N. Y.

(c) E. & H.

Above is the Latest Innovation, a Portable Radio Outfit, Including Loop, Batteries and Loud Speaker. It Can Be Operated Anywhere—on the street, in a Motor Car, on a Boat or in Any Building.

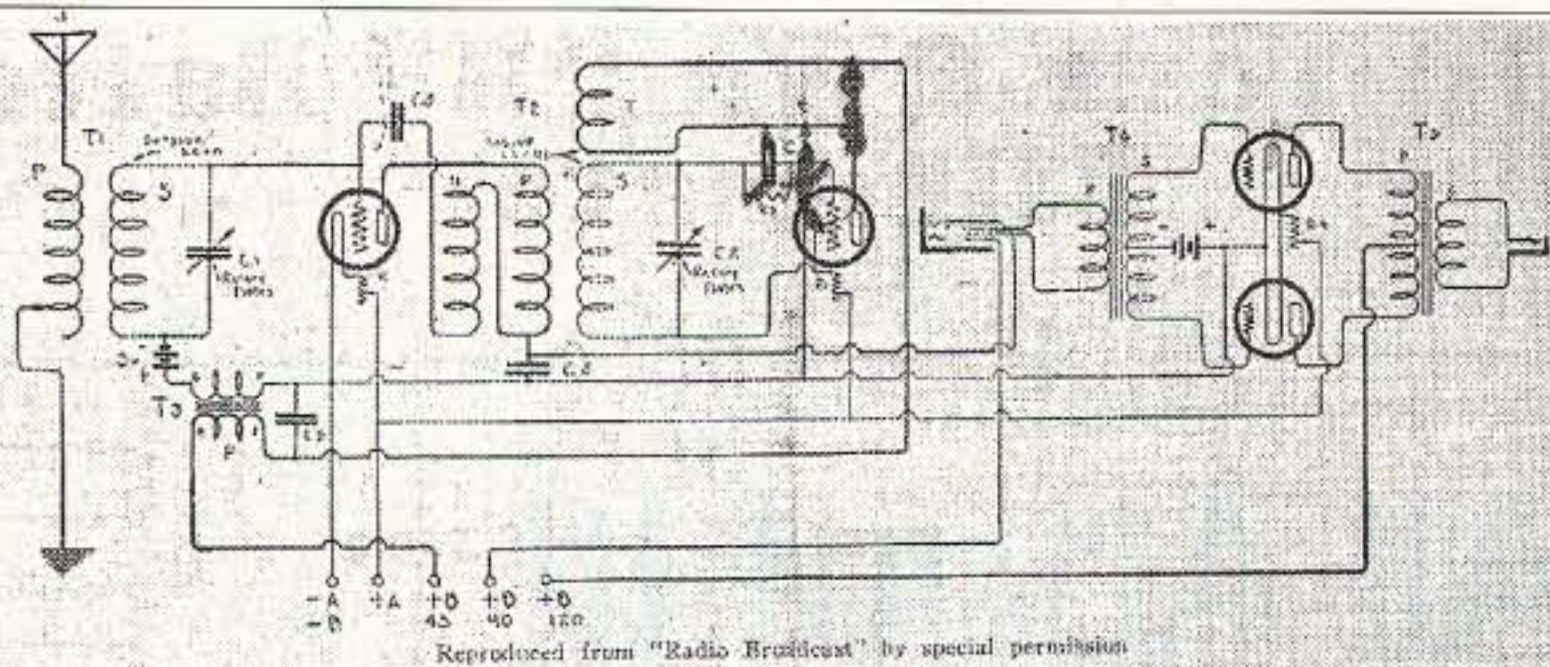
(c) Photo News.

While the Fordham University Station Was Designed Primarily for Relay Work Between the Various Colleges, It Has Proved so Successful that it Now Broadcasts Football Games Within a Radius of Many Miles. The Station Operates on 220 Meters and Uses Two to Four UV-200 Tubes.

(c) E. & H.

Photo B. Radio pictorial.





## ROBERTS SETS

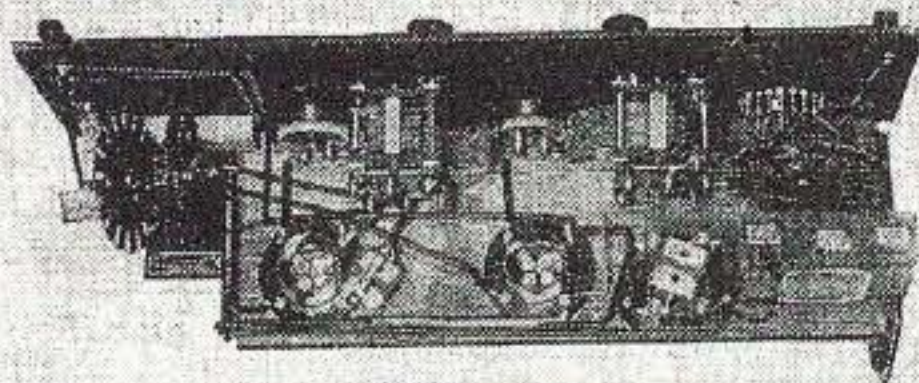
The famous Roberts Circuits have given a wonderful degree of satisfaction to thousands who have built them. Excellent selectivity, fine tone quality, and extraordinary volume. The two-tube set gives volume equal to the ordinary three-tube set, and the four-tube set, using push-pull amplification, gives volume equal to the ordinary five-tube outfit. If you haven't built a Roberts set, you've missed one of the best bets in radio to-day.

### Complete Parts 2-Tube Set

1 Set Nazeley Coils.....	\$ 8.00
2 Haynes-Griffin Extra Plate Vernier Condensers.....	10.00
2 Mica Condensers, .002 Mfd.....	.80
1 Mica Condenser, .0025 Mfd.....	.40
1 Amertran Audio Transformer.....	7.00
1 10 Ohm Rheostat with Knob.....	.75
1 UV 201A Socket.....	1.00
1 UV 199 Socket.....	.50
2 25 Ohm Resistance Strips.....	.50
1 Grid Condenser .00025 Mfd.....	.45
1 Grid Leak 2 Meg.....	.50
1 Switch Lever.....	.20
7 Contact Prints.....	.07
7 Binding Posts.....	.35
1 Hard Rubber Panel 7x21x3/16 (Undrilled).....	2.30
1 Wood Base.....	.75
Misc Spaghetti, Bus Bar, Screws, Nuts, Bolts.....	.75
<b>\$34.32</b>	

#### WELL WORTH HAVING

"Radio Broadcast's" booklet describing the famous Roberts Knockout Series of Receivers. Tells the whole story of these wonderfully efficient sets. Send for your copy now. Price, 50c.



### Complete Parts 4-Tube Set

1 Hard Rubber Panel 7x21x3/16, Drilled and Engraved.....	\$ 4.00
1 Base Board.....	.75
1 Set Nazeley Coils.....	8.00
2 Haynes-Griffin Extra Plate Vernier Condensers .0005 Mfd.....	10.00
1 Switch Arm.....	.20
7 Switch Points.....	.07
2 Switch Stops.....	.02
4 Sockets \$1.00 ea.....	4.00
1 Amertran Transformer.....	7.00
2 Push Pull Transformers (set) Como.....	12.50
3 Rheostats, \$.75 each.....	2.25
2 Jacks (Open and Double Cir.).....	1.40
7 Binding Posts.....	.35
1 Neutralizing Condenser.....	.50
1 Grid Leak (3 to 7 Megohms).....	.50
1 Grid Condenser .00025 Mfd.....	.45
2 Micadons .005 and .0025.....	1.00
2 C Batteries 4 1/2 Volts, @ \$.60.....	1.20
Misc. Bus Wire, Spaghetti, Screws, Bolts, Nuts, Lugs, Etc.....	1.00
1 Set Layout and Direction Sheet.....	1.00
<b>\$56.19</b>	

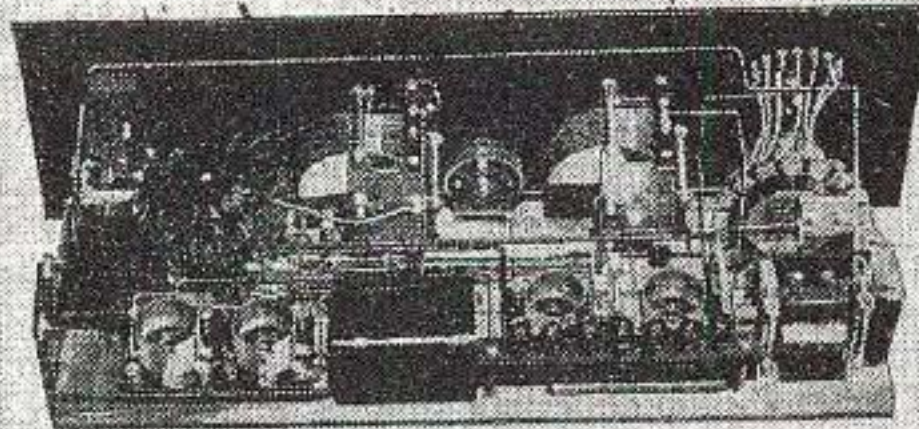


Photo C. Roberts sets.

making the capacitance still the correct value, approximately 0.01  $\mu$ F. The whole thing was immersed in oil. Not to do so caused corona discharges around the edges. Being well-soaked made them stand up much better under the high potentials. Even then, they punctured unexpectedly!

The high potential was quite dangerous around the place. It was important that the condenser box be surrounded by a protective wall and openly marked: DANGER — HIGH VOLTAGE — KEEP YOUR DISTANCE!

The discharge gap in the circuit is in series with the primary spiral inductance, usually made of flat-wound brass or copper ribbon. This was known as the oscillation transformer.

Every time the key in the low voltage primary circuit was closed, the charged condenser let loose for the shortest fraction of a second, in rapid fire, and discharged across the spark gap. On discharge, the energy surged around the helical coil, and, in turn, the secondary coil inductively coupled to the primary received a burst of electromagnetic energy. This in turn sent a damped wave signal out into the ether by way of the antenna configuration. A hot wire ammeter in series with the antenna to ground connection indicated the amount of current being emitted. A fuse block in the main power line provided protection against overloads.

Although the circuit looked quite simple, we amateurs had other problems

to contend with in meeting the 200 meter (or less) wavelength requirements. The condenser design value had to stay within the above stated  $\mu$ F limits. I will not attempt to delve into the mathematical equations to prove the point. Remember that we had a wrong concept of wavelength versus distance in those days.

Some amateurs were in a position to obtain 500 cycle power generators. Many signals could be heard on the air using such units. The signal coming from a 500 cycle source had a distinct tone quality. It was music to many an ear.

By way of interest, here is a statement which appeared in *Radio Amateur News* in 1920:

"Surely the US government is not imposing upon the American amateur when he limits the operating wavelength of your transmitter to 200 meters. Contrast this law to that of Canada, where the limit is placed at 50 meters. As a Canadian amateur recently remarked, with this short wave we may consider ourselves fortunate indeed to cover the extraordinary distance of one mile. As for democratic England, the would-be amateur is simply out of luck, for no license or permission is at present even obtainable under any condition. From the foregoing, we may therefore deduce the timely moral: *Keep your transmitter on the lawful side of 200 meters.*"

The amateurs up to now had really not discovered the potentially great advantage of the shorter wavelengths.

The rotary gap caused havoc on many occasions, since the studs had a tendency to become pitted after a short time of operation unless constructed of stuff that withstood the constant arcing in an open oxygen atmosphere. Of considerable help was an enclosed gap, sufficiently airtight to exclude oxygen to the extent possible.

Much experimenting with the number of studs on the rotor and the speed of the motor improved the efficiency of the system. An 1800 rpm synchronous motor and a wheel with twelve well-designed studs, made of material that could withstand pitting, usually

Continued on page 61



Dan Metzger K8JWR  
6960 Streamview Dr.  
Lambertville MI 48144-9758  
[dmetzger@monroe.lib.mi.us]

# Read All About It!

Part 5 of good stuff from The Hertzian Herald.

*This time: Lessons from industry; Yours truly, RMS; and Who said that?*

When I was a very young engineer I took a job with an elevator company and was assigned to design several pieces of test equipment for an electronic elevator controller. I was given a four-month timetable. The senior engineer to whom I reported, Gary, was the guy who had designed the controller, and he was a whiz. It soon became apparent that he knew way more than I did about electronic systems — so much so that I began to feel a little inferior. I would spend half an hour every morning picking Gary's brain about how his system worked, and then work the rest of the day trying to devise circuits to run his system through its paces to verify that it was doing what he designed it to do.

About midway through the project, Don, the vice president of engineering, invited me to have lunch with him. I was young, as I said, and foolish, and I brashly asked, "Don, why did you hire me? This test gear that I'm taking four

months to design — Gary could do that in two weeks."

Don smiled and said, "I know that — but Gary is my system designer and he's working on our next new product. I can't spare him for two weeks. If I could find another genius like Gary, I'd hire him — but I can't, so I have to hire guys like you. Gary can't do it all alone."

Since then, I've met some very impressive engineers who have worked on the space shots, the stealth bomber, and the latest microchips. I'd envy them for a while, but then I'd remember: "Gary can't do it all alone — they need me, too."

Once, at another company, my boss, Joe, came up just before quitting time and asked me to work up a calculation for the minimum beta required for the transistor in the "keyer" circuit of a display panel we were building. It seems that our shipment of transistors had gotten lost, and we would have to shut down production the next day unless some more could be found.

Well, the transistors had a guaranteed beta of 80, and we had been testing them all, so we had a bin full of rejects that fell below 80. If I could

verify by calculation that the value actually required in our system was, say, 50 or above, Joe could have the rejects retested and pick out those that were 60 or above and keep the production line going.

Next morning, while trying to wake up with my first cup of coffee, I started scribbling the calculations on a yellow pad. It came quite easily, and I had just gotten the number (46) when I heard Joe come up behind me. "Got that beta minimum?" he asked.

"Just got it," I said. "Let me recopy this in good form and we can have it out on an ECO (Engineering Change Order) in half an hour."

"No time for that," he said. "I'll just photocopy this and attach it to the ECO form." And with that he grabbed

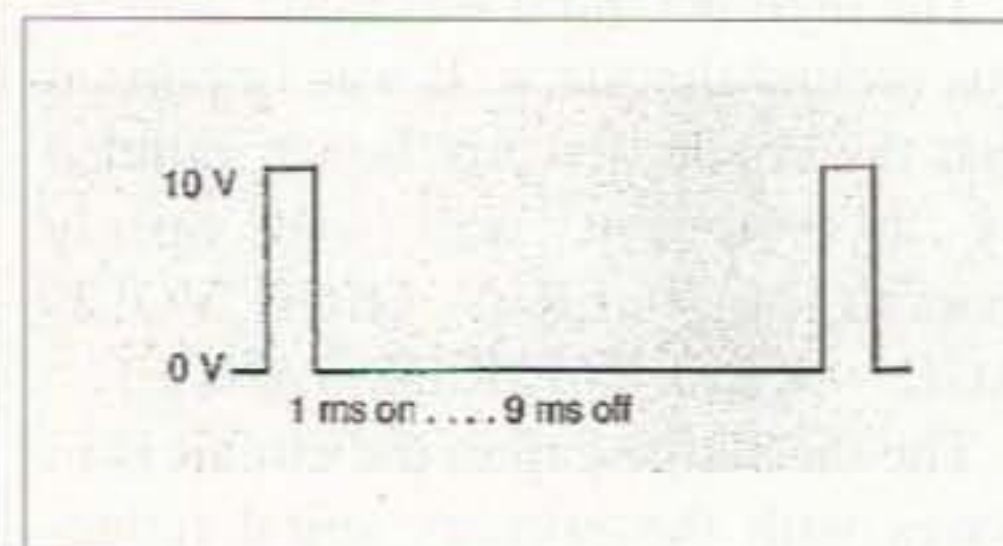


Fig. 1 An example using a 10 V DC pulse with a 10% duty cycle, applied to a 1-ohm resistor.

Reprinted with permission from *The Hertzian Herald*, newsletter of the Monroe County (MI) Radio Communications Association (MCRCA).



my coffee-stained scribble sheet and had it sent all over the plant with my name on it.

Since then, I don't make so much as a grocery list unless I do it neatly and in engineering form. And neither do I let my students get by with saying, "This is just my scribble sheet; I'll recopy it neatly later."

### Yours truly, RMS

This time, let's discuss the mysterious letters "RMS." RMS is a way of measuring AC voltages and currents so that when you do Ohm's Law ( $P = V^2/R$  or  $P = I^2R$ ) on a resistive circuit, you get the same results as with DC. Briefly, RMS means "equivalent to DC." The letters R-M-S stand for a mathematical technique in which you take the Root of the Mean of the Square. Fig. 1 shows an example using a 10 V DC pulse with a 10% duty cycle, applied to a 1-ohm resistor.

**Square:** During the 1 ms on time, power is  $V^2/R = 10^2/1 = 100$  W. During the off time, power is zero.

**Mean:** Average (mean) power is on-time power times the duty cycle:  $P_{avg} = 100 \text{ W} \times 10\% = 10 \text{ W}$ .

**Root:** The DC voltage that produces 10 W in a 1 ohm resistor is  $V = \sqrt{PR} = \sqrt{10 \times 1} = 3.16$  V. The pulse wave has an RMS value of 3.16 V. Note that RMS is not the same as average. The average voltage of the pulse wave, above, is 10 V x 10%, or 1.0 V.

To do the RMS technique on a sine wave, you have to slice the wave up into hundreds of time slots, square the voltage during each time slot to get hundreds of instantaneous powers, average all the powers over a full cycle, and take the square root to find the DC equivalent voltage. A computer can perform the hundreds of calculations necessary easily. The mathematics of calculus can actually slice the wave into an infinite number of time slots, square them all, average them, and get the square root — all in one operation.

The result, for a sine wave, is that a 1.414 V peak sine wave has an RMS value of 1.000 V. (Interestingly, 1.414 is the square root of 2.) Thus, for a sine wave,  $V_{rms} = V_{pk}/1.4114$  and  $V_{pk} = 1.414 V_{rms}$ .

RMS is the standard way of measuring AC, so the "120 V AC line" actually has a peak voltage of  $1.414 \times 120 = 170$  V.

The average value of a sine wave is, of course, zero; the negative half cycles cancel the positives. But the absolute average value (without regard to sign) of a 1.00 V RMS sine wave is 0.90 V. Ordinary AC meters (VOMs and inexpensive DVMs) respond to the absolute average value of the AC wave, and indicate 1.00/0.90 or 1.11 times that value. For a sine wave, this turns out to be the RMS value. For AC waves that are not sine-shaped, the reading is quite meaningless. For our 10 V, 10% pulse wave, the RMS value is 3.16 V and the average value is 1.00 V, but the reading would be 1.11 V.

TRMS meters are available (for a price) that will give the True RMS value of a non-sine wave, but read the specs closely. If the TRMS meter has a low-frequency cutoff, it will screen off any DC before taking the measurement. On such a meter, our pulse wave would read 3.00 V, not the correct value of 3.16 V.

Some final notes: (1) When you use RMS voltage or current to calculate the power in a resistor, you get average power. There is no such thing as RMS power. (2) You can use peak voltage to

calculate instantaneous peak power, if that's really what you want — but this is not standard, and not "equivalent to DC." Unscrupulous stereo-amp manufacturers used to advertise "peak power" until the FTC shut them down. A few even calculated something they called "peak-to-peak power" — a total fraud — and advertised that to hapless customers.

### Who said that? (Answers at end)

1. "Our inventions are but improved means to an unimproved end. We are

## WANT TO LEARN CODE?

**Morse Tutor Gold from G.G.T.E. is the answer for beginners and experts alike.**

\*Get the software the ARRL sells and uses to create practice and test tapes; and **Morse Tutor Gold** is approved for VE exams at all levels.

\*Since 1987, GGTE has guided nearly 20,000 hams and prospective hams around the world through proven structured lessons and a variety of character, word and conversation drills. Straight forward menus make the process simple and fun.

\*This program features easy and speedy self installation; random character drills with the characters you select; and you can create your own drills or import text files. You can type what you hear or copy by hand and see the results one line at a time. Pick the Farnsworth or the standard method; select the tone frequency most comfortable for you or select your code speed in tenths of a word per minute. For all DOS computers. You are always in command.

**Certified by**



**Morse Tutor Gold** uses your internal speaker or sound board. And, if you use a sound board **Morse Tutor Gold** supports volume control.

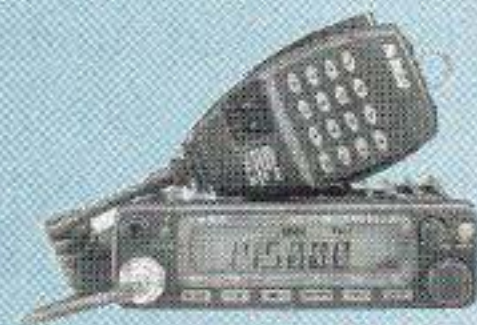
Sound Blaster and the Sound Blaster Compatibility Logo are trademarks of Creative Technology Ltd.



Available thru dealers, the ARRL, or send \$29.95 + \$4 S&H (CA residents add \$2.32 tax) to: GGTE, P.O. Box 3405, Dept. MS, Newport Beach, CA 92659 Specify 5 1/4 or 3 1/2 inch disk.

## USA's #1 Independent ALINCO Dealer!

4 years in a row



**DR-135TP**

2 Meter Mobile

Internal TNC for Packet & APRS®



**DR-605T**

2M/440 MHz Mobile/Base



**DX-70TH** Compact,  
100W, HF



**DR-610T**

2M/440MHz Mobile/Base



**DJ-196T**

2 Meter Handheld  
CTCSS en/decode  
and DCS

Call For Alinco  
Specials



**DJ-V5TH**

V/UHF, FM  
Handheld

**RADCOMM  
RADIO**

3300 82nd St. #E, Lubbock, TX 79423

1-800-588-2426

806-792-3669 FAX 806-785-3699

[www.rad-comm.com](http://www.rad-comm.com)





in great haste to construct a magnetic telegraph from Maine to Texas; but Maine and Texas, it may be, have nothing important to communicate. We are eager to tunnel under the Atlantic and bring the old world some weeks closer to the new; but perchance the first news that will leak through to ... America will be that the Princess Adelaide has the whooping cough."

2. "My dear, you fail to read the scale/ Correct to tenths of a division./ For gentler trade, those eyes were made/ And not for methods of precision."

3. "I, too, am an amateur."

4. "It ain't the things you don't know that get you into trouble. It's the things you know for sure — that ain't so."

Answers:

1. Henry David Thoreau wrote that in his essay "Walden" in about 1850. The first intercity telegraph line, from Washington DC to Baltimore, had been completed in 1844. The first successful "tunnel under the Atlantic" began operation in 1866. I often sigh and think of Thoreau's remark when a ham sends QRU TNX ES 73 on the second transmission. Nothing important to communicate.

2. James Clerk Maxwell, in England, penned those whimsical lines about female students in his physics classes — then called natural philosophy classes. By about 1864, Maxwell had devolved a set of 20 equations (later compacted to four) from which all of electrical and radio science can be derived. Yes, Ohm's Law, the capacitive-reactance formula, all the transmission-line and antenna formulas — all of them are implicit in the four equations of Maxwell. Among other things, Maxwell's equations predicted the existence of radio waves. Heinrich Hertz, in Germany, managed to generate these waves (wavelength about 6 meters) and send them across a room in 1888. Marconi, in Italy, read of Hertz's work, and the rest is well known to history. Aside from a stereotypically Victorian attitude on the "place" of women, Maxwell's lines show that a towering mathematical genius can have a touchingly human side.

3. Guglielmo Marconi said those disarming words to ARRL representative Paul Godley in 1921, when the latter

had come to Great Britain to attempt the first reception of amateur signals across the Atlantic. (He was successful.) I take nothing away from the real achievements of Marconi — they were many and impressive. But the public acclaim that was lavished on him was not accorded to others of equal accomplishment, because they were not "smooth operators." For example, Marconi's claim to have achieved trans-Atlantic communication in 1901 was universally accepted, even though he and his assistant were the only ones to hear the signals. And in 1912, he personally blocked news from the *Titanic's* rescue ship because he had made a lucrative deal with the *New York Times* for an exclusive story. But the public still lionized him.

4. While not original with him, this was the favorite quote of Major Edwin Howard Armstrong, inventor of regeneration (1912), the superheterodyne (1918), and FM radio (about 1935). The triode vacuum tube (1906) was "known" to be a little less sensitive and a lot more troublesome than the crystal detector until Armstrong showed what it could do in a feedback circuit. Heterodyning was known as a curiosity; "The Major" gave us the standard radio receiver circuit by heterodyning to a super-audible frequency. FM had been "proven" by mathematics to have "no advantages whatever," but Armstrong refused to believe it until he had tried it for himself. Commenting on his inventive style, Armstrong said, "Inventions are not made by theoretical musings, but by jackassing storage batteries around the laboratory." Perhaps the day for that kind of stubbornness is over, but a part of me hopes that it is not. 73

## Build Yourself an NVIS

*continued from page 18*

### References

*NVIS Communications*, by David Firdler and Edward Farmer. Available for \$14.00 from World Radio Books, P.O. Box 189490, Sacramento CA 95818. Excellent.

"NVIS Antennas," by Edward Farmer AA6ZM, *QST Magazine*, January 1995.

*US Field Manual 24-18*, "Single Channel Communications Techniques." Has a section on NVIS antennas.

### Net sources

NVIS Antenna Information (excellent Web site for NVIS systems): [www.tactical-link.com].

Construction of an NVIS Antenna, by Dr. Carl O. Jelinek: [www.qsl.net/vcars/carl/nvis.htm].

NVIS community at onelist.com: [www.onelist.com/community/nvis]. 73

## QRP Drives Ham Nuts

*continued from page 30*

NN1G, 80 East Robbins Avenue, Newington CT 06111, [http://www.smallwonderlabs.com/].

*Solid State Design for the Radio Amateur*, Wes Hayward and Doug DeMaw, ARRL, 3rd printing, 1995; ISBN 08725-90402.

*WIFB's Design Notebook*, ARRL, 1st Ed., 2nd printing, 1994. ISBN: 08725-93207.

*WIFB's QRP Notebook*, Doug DeMaw, ARRL, 2nd Edition, 1991, ISBN: 08725-90348. 73

## CALENDAR EVENTS

*continued from page 37*

its 23rd annual Hamfest/Computerfest on March 25th, 8 a.m.–2 p.m., at Madison High School on North Ridge Rd. New and used amateur radio, computer, and other types of electronic equipment will be featured. VE exams will be held for those interested in earning an amateur radio license. Admission \$5. 6 ft. tables \$8 each, 8 ft tables \$10 each. Call Roxanne at (440) 257-0024 to make table reservations.

**MONROEVILLE, PA** The Two Rivers ARC, Inc. of Greenock PA will hold their 29th annual Hamfest Computer Fair 8:30 a.m.–3 p.m. at the Palace Inn in Monroeville PA, (intersection of Routes 22 and 48, at turnpike). Vendor setup 6 a.m.–8:30 a.m. The registration deadline is March 9th. A confirmation will be sent upon receipt of payment. 6 ft tables including 1 chair, \$20 each, includes one vendor admission per table. 115/60 outlets are \$10 each. Additional vendor passes are \$5 each. Vendors using electrical outlets are responsible for providing multiple breakout strips or extension cords if needed. Food may NOT be sold by vendors.



Make checks payable to *Two Rivers Amateur Radio Club, Inc.* and mail to *Two Rivers Amateur Radio Club, Inc., Roxane Gaal, Hamfest Coordinator, 312 Lawrence Ave., N. Versailles PA 15137. Tel. (412) 823-6613; or E-mail [gaal@pgh.net].*

### MARCH 31

**WATERFORD, CT** The Radio Amateur Society of Norwich CT will hold their 31st Ham Radio Auction at the Waterford Senior Center on Rt. 85, starting at 10 a.m. Setup at 9 a.m. From Hartford, take Rt. 2 South to Rt. 11 to Rt. 85 South. From the Shoreline, take Rt. 95 to Rt. 85 North. Talk-in on 146.730(-). Bring your gear to sell (10% commission to RASON). Free admission, free parking. Contact *Mark KE1IU* at (860) 536-9633; or see the *RASON Web page* at [www.rason.org].

### APRIL 8

**STOUGHTON, WI** The Madison Area Repeater Assn. will host the "Madison Swapfest" on April 8th at Mandt Community Center, Stoughton Junior Fair Grounds, South Fourth St., Stoughton WI. Free parking. Doors open at 8 a.m. Talk-in on 147.15. Tickets \$4 in advance or \$5 at the door. Tables \$12-\$15 each. Contact *Madison Area Repeater Assn., P.O. Box 8890, Madison WI 53708-8890. Tel. (608) 245-8890. Web site [http://www.qsl.net/mara/].*

### SPECIAL EVENTS, ETC.

#### MARCH 17

**MACON, GA** The Macon ARC will operate W4BKM 1500-2200 UTC on Saturday, March 17th, at the 19th annual Cherry Blossom Festival in Macon. Phone 14.240, 21.335, and 28.390. For a certificate, send QSL and a 9 x 12 SASE to *Macon ARC, P.O. Box 4862, Macon GA 31208 USA.* 73

### ON THE GO

*continued from page 38*

When signals bounce, there are many factors that determine where they can be received and no guarantees that both signals will travel the same path.

I heard a Canadian station check if the frequency was in use. I heard no other station on the frequency and apparently neither did he. He then began to call CQ and the response was immediate and brutal. As soon as he unkeyed the microphone he received a broadside from a number of state-side stations informing him that he was too near an ongoing QSO. The Canadian ham replied stating that he could hear a station but that it was too weak to copy. That evidently

offended the stateside operators and they expressed their opinions quite freely. I decided to switch the rig off.

Notice that I have referred to these individuals as "operators" rather than hams. I feel that a ham sets and maintains certain standards and takes pride in his operating ability, his equipment, and himself. We used to have a name for these other operators. We used to call them lids. By whatever name, there seem to be a number of them out there.

But most hams are truly cut from a special bolt of cloth. I arrived in Omaha and set about concentrating on my new job, my temporary living arrangements and such, and haven't had much time to operate. When I have, though, I've had some great chats with the folks on the local repeaters who welcomed me, filled me in on the various repeaters, where they were, how they were linked and which ones would be best for use with an HT from my temporary QTH. I was invited to their weekly informal get-together.

What a difference! While I have focused on those whose operating practices were marginal, there are a lot of great folks on the band. To those, I say "thank you" for making a long trip more pleasant! 73

### HOMING IN

*continued from page 42*

#### Resources

Hamtronics, Inc.  
65-D Moul Road,  
Hilton NY 14468-9535  
(716) 392-9430  
[http://www.hamtronics.com]

PicCon Transmitter Controller  
Byon Garrabrant N6BG  
8128 Kokoma Dr.  
Las Vegas NV 89128  
[http://www.byonics.com/piccon/index.html]

Montreal Fox Controller  
Plans in "Homing In" for April 1998  
[http://members.aol.com/joek0ov/mfcupdate.html]

Airtek Engineering  
Ken Bauer KB6TTS  
2306 Turquoise Circle  
Chino Hills CA 91709  
(909) 393-9889  
[KenF1A@worldnet.att.net]

Magnum Telemetry  
312 W. Queen St.  
P.O. Box 1060  
Grifton NC 28530  
(252) 524-5391  
[http://www.magnumtelemetry.com]

RFID Systems Page  
[http://www.cwt.vt.edu/faq/rfid.htm] 73

### THE DIGITAL PORT

*continued from page 52*

I found several sites with the 2.5 download available. I have placed two of them in *The Chart*, and you will find there is a wealth of information and other software available at these URLs. Almost forgot to include one of the most important bits of info. One of the hangout frequencies for Throb is 28.080. After I learned that, I went there to monitor and found some MFSK16 activity. No Throb but that is promising. Most likely a digital watering hole worth checking into frequently.

We reported on the Stream software package in January and I just noticed that version 0.86 is available already. I checked the one in the computer, working very well indeed, and it is a lowly 0.83. I guess I just don't know how to keep up.

That's about it for this time around. Have fun. If you have questions or comments about this column, E-mail me [jheller@sierra.net]. I will gladly share what I know or find a resource for you. For now, 73, Jack KB7NO. 73

### WANTED

Fun, easy to build projects  
for publication in 73.

For more info, write to:

Joyce Sawtelle,  
73 *Amateur Radio Today*,  
70 Hancock Road  
Peterborough NH 03458.

### SAVE 47%!

on 12 months of 73

Only \$24.97

Call 800-274-7373



## In Like a Lion

*With Sunspot Cycle 23 peaking, it is very difficult to make accurate long-range solar predictions (this is being written at Christmastime), but I'm expecting intense activity for early March. DX conditions will probably not improve until the weekend of the 11th, so the first 10 days might be a good opportunity to finish those lingering winter projects, do the spring cleaning, and (gasp!) file the tax returns.*

Solar activity should subside from the 11th to the 14th and provide the first good DXing in quite awhile. The 15th through the 25th look to be rather poor, and so may provide another chance to get away from the ham shack. A few quiet days should occur around the equinox, and a few more good days near the end of the month may provide the best DXing since the year began.

On an optimistic note, springtime is historically good for 15 and 20 meters and should yield some rare contacts, especially in Asia and the Indian Ocean. Also, be ready for those elusive Arctic and Antarctic contacts since the gray-line will extend over the poles this month. Long paths work best at sunset and short paths work best at sunrise. Good luck!

### Band by Band Summary

#### 10 and 12 meters

Use these as daytime-only bands. Most openings will be to the east in the morning and to the south or west from noon onward. The strongest signals will typically come from stations located in Western Europe or Japan. Expect less utility from 10 and 12 meters as warmer weather arrives and the maximum usable frequencies (MUFs) decrease. Short-skip distances will be between 1,000 and 2,500 miles.

#### 15 and 17 meters

These are expected to be very good during the day and should even remain open into the evening at lower latitudes. Signals will peak toward the east in the morning, to the south around midday,

March 2001						
SUN	MON	TUE	WED	THU	FRI	SAT
				1 P	2 P	3 F-P
4 F-P	5 P	6 VP	7 P	8 P	9 F-P	10 F
11 F-G	12 F-G	13 G	14 G	15 F	16 P	17 P
18 P	19 F-P	20 F	21 F-G	22 F-G	23 P	24 P-F
25 F-P	26 F	27 F-G	28 G	29 G	30 F-P	31 F-P

EASTERN UNITED STATES TO:												
GMT:	00	02	04	06	08	10	12	14	16	18	20	22
Central America	(15) 20	(15) 20	20 (40)	(20-40)	x	x	x	(10)	(10)	(10-15)	10 (17)	12-20
South America	(17) 20	20 (40)	20 (40)	(20-40)	x	x	x	(10)	(10)	(10-15)	10-15	10 (20)
Western Europe	(20-40)	(30-40)	(30-40)	(40)	x	x	(15-20)	(10-20)	(10-17)	15-20	(15) 20	(20)
Southern Africa	(17) 20	(20-40)	(20)	(20)	x	x	x	x	(10)	10 (15)	12 (17)	(15-20)
Eastern Europe	x	(30-40)	(20-40)	(17-20)	(20)	x	x	(10-15)	(15)	(17-20)	(20)	(20)
Middle East	x	(20)	20	(20-40)	(40)	x	x	x	(10-15)	15	(17-20)	(20)
India/Pakistan	(17-20)	x	x	x	x	x	x	(15-17)	x	x	x	x
Far East/Japan	(17-20)	(20)	x	x	x	x	x	x	x	x	x	(15)
Southeast Asia	(17-20)	x	x	x	x	x	(17-20)	(10-15)	x	x	x	x
Australia	(15)	(17-20)	x	x	x	x	(20-40)	(20)	(10)	x	x	x
Alaska	(15) 20	(20)	(20-30)	(30-40)	(40)	x	x	x	(15-20)	(10-20)	(10) 17	15-20
Hawaii	(15) 20	20	(20-40)	(20-40)	(40)	x	x	x	(15-20)	(10-20)	(10-20)	15-20
Western USA	15-20	20 (40)	20 (40)	(20) 40	(30-40)	x	x	(10-20)	10 (20)	10 (20)	10 (20)	(15) 20
CENTRAL UNITED STATES TO:												
Central America	(15-20)	20 (40)	20-40	20-40	(20-40)	x	(10-20)	10-20	10-20	10 (20)	10 (20)	10-20
South America	(15) 20	17-30	20 (40)	20 (40)	x	x	x	(10-20)	10 (20)	10 (15)	(10-20)	12 (20)
Western Europe	(20)	(40)	(40)	x	x	x	x	(15)	(15-17)	(15-20)	(17-20)	(20)
Southern Africa	20	(20)	(20)	(20)	x	x	x	x	(10)	(10-15)	(10-17)	(15-20)
Eastern Europe	(20)	(20)	x	x	x	x	x	(15)	(15-17)	(17-20)	(20)	(20)
Middle East	x	x	x	x	x	x	x	x	(15)	(15)	(20)	(20)
India/Pakistan	(17-20)	(15-20)	x	x	x	x	x	(15-20)	x	x	x	x
Far East/Japan	(17-20)	(20)	x	x	x	x	x	x	x	x	x	(15)
Southeast Asia	(15-20)	x	x	x	x	x	x	(20)	(10-20)	x	x	x
Australia	(15-20)	(20)	x	x	x	x	x	(15-20)	(15-20)	15	15	15 (20)
Alaska	15-20	(15) 20	20	20 (30)	(30-40)	(40)	x	x	x	(10-20)	10-20	10 (20)
Hawaii	15-20	(15) 20	20 (40)	(30-40)	(40)	x	x	x	x	(10) 12	10-15	(10) 17
WESTERN UNITED STATES TO:												
Central America	10-20	15-20	15-30	(14) 40	20-40	(30-40)	x	(15-20)	10 (20)	10 (20)	10 (20)	10 (20)
South America	(10) 20	(15) 20	20 (40)	20 (40)	x	x	x	(10-20)	10 (20)	(10-15)	10 (15)	10 (20)
Western Europe	x	x	x	x	x	x	x	x	(15-17)	(15-17)	(17-20)	(17-20)
Southern Africa	(20)	(20)	(20)	(20)	(20)	x	x	x	x	(10-12)	(12) 17	(15-20)
Eastern Europe	x	x	x	(17-20)	(17-20)	x	x	(15)	(15)	(15-17)	(17-20)	(20)
Middle East	x	(20)	(20)	x	x	x	x	x	(15-17)	(20)	(20)	(20)
India/Pakistan	x	(17-20)	x	x	x	x	x	x	(15-17)	x	x	x
Far East/Japan	10-20	(20)	x	x	x	(40)	(40)	x	x	x	x	(10-20)
Southeast Asia	(10-15)	(10-15)	x	x	x	x	x	x	x	(15-20)	(15-20)	(10-15)
Australia	(10-15)	(15)	(17-20)	x	x	x	x	x	(15) 20	(15-20)	(15)	(10)
Alaska	(10) 20	(15) 20	20 (40)	(20) 40	(30-40)	(40)	(40)	(40)	x	(10-15)	10-15	10-20
Hawaii	(15) 20	20	(20-40)	(20) 40	(30-40)	(40)	x	x	x	(10-20)	(10) 20	15-20
Eastern USA	15-20	20 (40)	20 (40)	(20) 40	(30-40)	x	x	(10-20)	10 (20)	10 (20)	10 (20)	(15) 20

**Table 1.** Plain numerals indicate bands which should be workable on Fair to Good (F-G) and Good (G) days. Numbers in parentheses indicate bands usually workable on Good (G) days only. Dual numbers indicate that the intervening bands should also be usable. When one number appears in parentheses, that end of the range will probably be open on Good (G) days only.



and to the west in the late afternoon. Try the polar paths at local noon for brief openings into central and southern Asia. Short-skip can be expected to be about 1,000 miles.

### 20 meters

The best overall band, this will provide the most hours of HF operation. Expect openings to begin after sunrise and last well into the evening. Look for some exotic contacts between sunset and midnight as day breaks over Central Asia and the Indian Ocean. Short skip will average between 500 and 2,500 miles.

### 30 and 40 meters

Best from late evening to sunrise. Activity on these bands is certain to decline as warm weather arrives and atmospheric noise increases. Africa, the Middle East, and Asia should provide some opportunities for those hunting exotic contacts. Short skip will be less than 1,000 miles during the day and greater than 750 miles at night. 73

## The History of Ham Radio

*continued from page 55*

provided the right kind of pitch and whine to satisfy the critical ham in his quest to excel on the air.

By the characteristic frequency over the air, most ham stations were recognized without the usual QTH report. "I know the sound of his spark" was a common remark among hams.

After a station had its mechanical problems fairly well under control, the problem of decrement of the signal emitted received considerable attention. Specifications from the bureau in Washington decreed that the decrement could not, or should not, be higher than 0.2 when the energy was transferred to the antenna. Otherwise, the signal emitted would be unduly broad, with accompanying increased interference due to high damping.

What was this decrement all about? The subject was discussed at great lengths. It took front and center attention and was good for an argument anywhere, anytime. Decrement and how to meet its requirements waxed hot and furious from many podiums at conventions. Today you never hear the subject mentioned anymore.

Decrement, logarithmic decrement: Nobody knew very much about the subject, even though the Department of Commerce issued their well-known Bureau of Standards book entitled *Radio Instruments and Measurements #74*, on March 23, 1918. This gave technicians and engineers an in-depth documentation on the subject. Mr. B. West ex-8KEZ discussed spark dischargers at the St. Louis convention in 1920. In the course of his presentation, he was interrupted repeatedly by well-meaning listeners in the audience, as they confused the issue by introducing the "damping factor" and then wondering what was meant by *napierian*. The confusion usually brought down the house, and the heated discussion ended in a draw. Not even well-meaning intellectual cowhands from the western ranches knew what to make of these arguments and decided to leave well enough alone when they got back to their radio shacks.

So decrement, damping factor, impulse excitation, and increment — all these factors — were eventually solved by the usual "over-the-ether-waves-reporting" way — experimentally, with trial and error methods prevailing. It was understood that a low resistance (the lower the better) in the secondary discharge circuit gave a low decrement and allowed the energy to oscillate freely with consequent low heat loss. We seldom worried about impulse excitation anymore.

Our problems were put away for a while until the next convention came along. This was to be the First National American Radio Relay League super meeting at the Edgewater Beach Hotel in Chicago, to be reviewed in the next chapter.

We go back to our midnight operating hours when all is quiet and serene about the house. The ham does not want disturbances to interfere with his concentration on distant code from some far-off place. Besides, when the key is closed, the spark noise could disturb the neighbors, and any intruders into the privacy of the shack would be overcome by the ozone that often permeated the atmosphere. QRX 'til we meet later on, when fully recovered, in a fresh air environment.

*To be continued.* 73

## QRX

*continued from page 6*

as possible. The original "old-timers" and Elmers are gone, and consequently a part of ham radio slowly continues to fade.

To help stop this attrition of information, all radio communications enthusiasts are invited to join and contribute whatever information they have to this unique Internet reflector.

To subscribe to the Ham Radio History reflector, simply send a blank E-mail to [ham-radio-subscribe@egroups.com].

*Thanks to HRHR, via Newsline, Bill Pasternak WA6ITF, editor.*

## Cell Phones a Headache?

Children who use mobile phones risk suffering memory loss, sleeping disorders, and headaches. So says British physicist Dr. Gerard Hyland in research published in the medical journal *The Lancet*.

In his article, Dr. Hyland raises new fears over radiation caused by mobile phones. He says that those under 18 years old, who represent a quarter of Britain's 25 million mobile users, are also more vulnerable because their immune systems are less robust.

According to Dr. Hyland, radiation is known to affect brain rhythms and children are particularly vulnerable. Hyland says that if mobile phones were a type of food, they simply would not be licensed, because there is so much uncertainty surrounding their safety.

*Thanks to RF Safety News, via Newsline, Bill Pasternak WA6ITF, editor.*

## Death On-line

According to a spokesperson in the FCC Licensing and Technical Analysis Branch in Gettysburg, the FCC now can accept a printed copy of information appearing on the Internet as adequate proof of death "provided the printout contains certain, verifiable, information." The Licensing Bureau also will accept a list — with supporting documentation — of multiple requests for cancellation of amateur licenses.

According to information on the FCC's vanity Web site, [www.fcc.govwtb/amateur/vnityfaq.html], individuals can report the death of a licensee by submitting a signed request for license grant cancellation accompanied by a copy of an obituary or death certificate to the Licensing Branch.

The FCC says it's been able to match up the name, address, and birth date of the deceased included on some submittals it's received via the Ancestry.com site [http://www.ancestry.com] on the Internet. "The validity of these printouts as proof of death is equal to the same level of sufficiency as an obituary, in terms of reducing the risk of the inadvertent cancellation of a valid amateur call sign," the FCC spokesperson said.

*Thanks to Jennifer Hagy N1TDY, via Newsline, Bill Pasternak WA6ITF, editor.* 73



## NEVER SAY DIE

continued from page 8

No, this isn't ham radio stuff... but then, I've been asking you to get busy and write about any adventures the hobby has given you so I'd be able to use them in the magazine, and then publish them in a book to help clubs get youngsters interested in the hobby.

We need kids. We need 'em desperately. And what's happened to our school system is a big part of our problem in attracting kids.

### *Becoming What We Are* by Robert Anton Wilson

If you stroll through a large art museum, you will notice that Van Gogh does not paint the same world as Rembrandt, Picasso does not see things the way Goya did, Georgia O'Keeffe doesn't much resemble Rivera, Salvador Dali looks like nobody but himself, and, in general, no world-class artist became a "classic" by doing what somebody else had already done or even what everybody else in his/her own era did.

And in science, the names of Einstein, Dirac, the Curies, Bohr, Heisenberg, Schroedinger, John Bell, etc., live on because none of them took Newton as Holy Gospel: They all made unique and unpredictable innovations in basic theory.

And, in case you think this applies only to "arts and sciences," consider the most successful people in industry. Henry Ford did not get rich copying Fulton's steamboat; he made a car so cheap that anybody could afford one.

Howard Hughes produced movies that nobody else would have dared to attempt, and then went on to revolutionize the airline industry. Buckminster Fuller did not copy the cubical form of previous architects, but invented the geodesic dome; at last count, over 300,000 of his buildings existed, making him the most visibly successful architect in history. Steve Wozniak did not copy the computers of his day, but invented one that

even an "bloody eejit" (like me) could use (and even enjoy!). Etc.

We all need constant reiteration of these truisms because we live in a world where a multitude of very powerful forces have worked upon us, from birth through school to work, attempting to suppress our individuality, our creativity, and, above all, our curiosity — in short, to destroy everything that encourages us to think for ourselves.

Our parents wanted us to act like the other children in our neighborhood; they emphatically did not want a boy or girl who seemed "weird" or "different" or (Heaven forbid!) "too damned clever by far."

Then we enter grade school, a fate worse than Death and Hell combined. Whether we land in a public school or a private religious school, we learn two basic lessons: (1) there exists one correct answer for every question; and (2) education consists of memorizing the one correct answer and regurgitating it on an "examination."

The same tactics continue through high school and, except in a few sciences, even to the university.

All through this "education" we find ourselves bombarded by organized religion. Most religions in this part of the world also teach us "one correct answer," which we should accept with blind faith; worse, they attempt to terrorize us with threats of post-mortem roasting, toasting, and charbroiling if we ever dare to think at all, at all.

After 18 to 30+ years of all this, we enter the job market, and learn to become, or try to become, almost deaf, dumb, and blind. We must always tell our "superiors" what they want to hear, what suits their prejudices and/or their wishful fantasies. If we notice something they don't want to know about, we learn to keep our mouths shut. If we don't — "One more word, Bumstead, and I'll fire you!"

As my mahatmaguru J.R. "Bob" Dobbs says, "You know how dumb the average

guy is? Well, mathematically, by definition, half of them are even dumber than that."

"Bob" may have the average confused with the median, but otherwise he hit a bull's-eye. Half of the people you meet do indeed seem dumber than a box of rocks; but they did not start out that way. Parents, peers, schools, churches, advertisers, and jobs made them that way. Every baby at birth has a relentlessly curious and experimental temperament. It takes the first third of our lives to destroy that curiosity and experimentalism; but in most cases, we become placid parts of a docile herd.

This human herd all started out as potential geniuses, before the tacit conspiracy of social conformity blighted their brains. All of them can redeem that lost freedom, if they work at it hard enough.

I've worked at it for 50+ years now, and still find parts of me acting like a robot or a zombie on occasion. Learning "how to become what you are" (in Nietzsche's phrase) takes a lifetime, but it still seems the best game in town.

Wilson will be speaking at The Prophets Conference in New York City on May 18-20, 2001. For information check: [<http://www.greatmystery.org>]. Or call toll-free 1-888-777-5981.

The *Secret Guide to Wisdom* is my effort to help people regain the freedom our schools have taken away from them.

### Gun Control

Yes, kids shooting kids is terrible. Anyone shooting anyone sucks. In the case of kids, just as our doctors do their best to tackle the symptoms caused by poisons and bad nutrition with pills, shots, surgery, radiation, and so on, the media (and the unthinking public, unfortunately) want to try to keep guns out of the hands of people instead of eliminate what's been causing the problem.

There have been any number of attempts to control guns, but sadly, the gun nuts

are right: When you outlaw guns, only the outlaws have guns. In every case where a community has confiscated the public's guns, there has been a substantial resulting increase in crime.

If you were making your living as a burglar, would you rob houses in towns where you might be faced with an angry home owner with a shotgun, or would you head for a town where all of the guns had been confiscated?

Last year, at a cost of over \$500 million, Australia confiscated over 600,000 firearms and crushed them. And that included some beautiful collector's items. In the 12 months since then, homicides are up 3.2%, muggings up 8.4%, and armed robberies up 44%. In the state of Victoria alone, homicides using guns are up 300%.

Until the government confiscation of firearms, there had been a steady 25-year drop in homicides using guns.

### Our Universities

Defenders of the American school system claim that our universities are among the highest-rated in the world, and that Americans regularly win a high percentage of Nobel Prizes. Yes, Americans did win the most Nobel Prizes last year, but *none* of the winners were born here. They were all naturalized citizens.

Hmm, how come not one native American won a prize? For that matter, did you know that less than half of the Ph.D.s in engineering and math are received by Americans? The fact is that youngsters educated in American schools and colleges just can't compete with the foreign-educated students. As American public school test scores have plummeted, more and more foreign students have been displacing Americans in our top universities, and the worst declines have been in the most demanding subjects, such as science. We're training sociologists, when the world is demanding engineers, programmers, and scientists.

Continued on page 64



# Wise Up!

Here are some of my books which can change your life (if you'll let 'em). If the idea of being healthy, wealthy and wise interests you, start reading. Yes, you can be all that, but only when you know the secrets which I've spent a lifetime uncovering.

.....Wayne

**The Bioelectrifier Handbook:** This explains how to build or buy (\$155) a little electrical gadget that can help clean the blood of any virus, microbe, parasite, fungus or yeast. The process was discovered by scientists at the Albert Einstein College of Medicine, quickly patented, and hushed up. It's curing AIDS, hepatitis C, and a bunch of other serious illnesses. The circuit can be built for under \$20 from the instructions in the book. \$10 (#01)

**The Secret Guide to Wisdom:** This is a review of around a hundred books that will help you change your life. No, I don't sell these books. They're on a wide range of subjects and will help to make you a very interesting person. Wait'll you see some of the gems you've missed reading. \$5 (#02)

**The Secret Guide to Wealth:** Just as with health, you'll find that you have been brainwashed by "the system" into a pattern of life that will keep you from ever making much money and having the freedom to travel and do what you want. I explain how anyone can get a dream job with no college, no résumé, and even without any experience. I explain how you can get someone to happily pay you to learn what you need to know to start your own business. \$5 (#03)

**The Secret Guide to Health:** Yes, there really is a secret to regaining your health and adding 30 to 60 years of healthy living to your life. The answer is simple, but it means making some difficult lifestyle changes. Will you be skiing the slopes of Aspen with me when you're 90 or doddering around a nursing home? Or pushing up daisies? No, I'm not selling any health products. \$5 (#04)

**My WWII Submarine Adventures:** Yes, I spent from 1943-1945 on a submarine, right in the middle of the war with Japan. We almost got sunk several times, and twice I was in the right place at the right time to save the boat. What's it really like to be depth charged? And what's the daily life aboard a submarine like? How about the Amelia Earhart inside story? If you're near Mobile, please visit the Drum. \$5 (#10)

**Wayne's Caribbean Adventures:** My super budget travel stories - where I

visit the hams and scuba dive most of the islands of the Caribbean. You'll love the special Liat fare which let me visit 11 countries in 21 days, diving all but one of the islands, Guadeloupe, where the hams kept me too busy with parties. \$5 (#12)

**Cold Fusion Overview:** This is both a brief history of cold fusion, which I predict will be one of the largest industries in the world in the 21st century, plus a simple explanation of how and why it works. This new field is going to generate a whole new bunch of billionaires, just as the personal computer industry did. \$5 (#20)

**Cold Fusion Journal:** They laughed when I predicted the PC industry growth in 1975. PCs are now the third largest industry in the world. The cold fusion ground floor is still wide open, but then that might mean giving up watching ball games. Sample: \$10 (#22).

**Julian Schwinger:** A Nobel laureate's talk about cold fusion—confirming its validity. \$2 (#24)

**Improving State Government:** Here are 24 ways that state governments can cut expenses enormously, while providing far better service. I explain how any government bureau or department can be gotten to cut its expenses by at least 50% in three years and do it cooperatively and enthusiastically. I explain how, by applying a new technology, the state can make it possible to provide all needed services without having to levy *any* taxes at all! Read the book, run for your legislature, and let's get busy making this country work like its founders wanted it to. Don't leave this for "someone else" to do. \$5 (#30)

**Mankind's Extinction Predictions:** If any one of the experts who have written books predicting a soon-to-come catastrophe which will virtually wipe most of us out are right, we're in trouble. In this book I explain about the various disaster scenarios, like Nostradamus, who says the poles will soon shift (as they have several times in the past), wiping out 97% of mankind. Okay, so he's made a long string of past lucky guesses. The worst part of these predictions is the accuracy record of some of the experts. Will it be a pole shift, a new ice age, a massive solar flare, a comet or asteroid, a bioterrorist attack? I'm getting ready, how about you? \$5 (#31)

**Moondoggle:** After reading René's book, *NASA Mooned America*, I read everything I could find on our Moon landings. I watched the videos, looked carefully at the photos, read the astronaut's biographies, and talked with some of my readers who worked for NASA. This book cites 25 good reasons I believe the whole Apollo program had to have been faked. \$5 (#32)

**Classical Music Guide:** A list of 100 CDs which will provide you with an outstanding collection of the finest classical music ever written. This is

what you need to help you reduce stress. Classical music also raises youngster's IQs, helps plants grow faster, and will make you healthier. Just wait'll you hear some of Gotschalk's fabulous music! \$5 (#33)

**The Radar Coverup:** Is police radar dangerous? Ross Adey K6UI, a world authority, confirms the dangers of radio and magnetic fields. \$3 (#34)

**Three Gatto Talks:** A prize-winning teacher explains what's wrong with American schools and why our kids are not being educated. Why are Swedish youngsters, who start school at 7 years of age, leaving our kids in the dust? Our kids are intentionally being dumbed down by our school system—the least effective and most expensive in the world. \$5 (#35)

**Aspartame:** a.k.a. NutraSweet, the stuff in diet drinks, etc., can cause all kinds of serious health problems. Multiple sclerosis, for one. Read all about it, two pamphlets for a buck. (#38)

**One Hour CW:** Using this sneaky booklet even *you* can learn the Morse Code in one hour and pass that dumb 5wpm HF entry test. \$5 (#40)

**Code Tape (T5):** This tape will teach you the letters, numbers and punctuation you need to know if you are going on to learn the code at 13 or 20 wpm. \$5 (#41)

**Code Tape (T13):** Once you know the code for the letters (#41) you can go immediately to copying 13 wpm (using my system). This should only take a couple of days. \$5 (#42)

**Code Tape (T20):** Or, you can start right out at 20 wpm and master it in a weekend. \$5 (#43)

**Wayne Un-Dayton Talk:** This is a 90-minute tape of the talk I'd have given at the Dayton, if invited. \$5 (#50)

**Wayne Tampa Talk:** This is the talk I gave at the Tampa Global Sciences conference—where I cover amateur radio, cold fusion, health, books you should read, and so on. \$5 (#51)

**\$1 Million Sales Video:** The secret of how you can generate an extra million dollars in sales just by using PR. This will be one of the best investments you or your business will ever make. \$40 (#52)

**Reprints of My Editorials from 73.** Very few things in this world are as we've been taught, and as they appear. I blow the whistle on the scams around us, such as the health care, our school system, our money, the drug war, a college education, sugar, the food giants, our unhealthy food, fluorides, EMFs, NutraSweet, etc.

**1996 Editorials:** 120 pages, 100 choice editorials. \$10 (#72)

**1997 Editorials:** 148 fun-packed pages. 216 editorials. \$10 (#74)

**1998 Editorials:** 168 pages that'll give you lots of controversial things to talk about on the air. \$10 (#75)

**1999 Editorials:** 132 pages of ideas, book reviews, health, education, and anything else I think you ought to know about. \$10 (#76)

**2000 Editorials:** In the works.

**Silver Wire:** With two 3-in. pieces of heavy pure silver wire + three 9V batteries you can make a thousand dollars' worth of silver colloid. What do you do with it? It does what the antibiotics do, but germs can't adapt to it. Use it to get rid of germs on food, for skin fungus, warts, and even to drink. Read some books on the uses of silver colloid, it's like magic. \$15 (#80)

**Wayne's Bell Saver Kit.** The cable and instructions enabling you to inexpensively tape Art Bell W6OBB's nightly 5-hr radio talk show. \$5 (#83)

**NH Reform Party Keynote Speech.** It wow'd 'em when I laid out plans for NH in 2020, with much better, yet lower-cost schools, zero state taxes, far better health care, a more responsive state government, etc. \$1 (#85)

**Stuff I didn't write, but you need:**  
**NASA Mooned America:** René makes an air-tight case that NASA faked the Moon landings. This book will convince even you. \$25 (#90)

**Last Skeptic of Science:** This is René's book where he debunks a bunch of accepted scientific beliefs—such as the ice ages, the Earth being a magnet, the Moon causing the tides, and etc. \$25 (#91)

**Dark Moon:** 568 pages of carefully researched proof that the Apollo Moon landings were a hoax—a capping blow for René's skeptics. \$35 (#92)

## Radio Bookshop

Box 416, Hancock NH 03449

Name \_\_\_\_\_ Call \_\_\_\_\_

Address \_\_\_\_\_

City-State-Zip \_\_\_\_\_

Use the numbers in the brackets or copy page and mark the books you want. Add \$3 s/h per total order in US (\$5 priority mail), \$6Can, \$10 foreign.

Order total: US\$ \_\_\_\_\_ Phone (for CC orders) \_\_\_\_\_

MC/Visa for orders over \$10. # \_\_\_\_\_ Expire \_\_\_\_\_

www.waynegr.com • phone orders: 603-525-4747 • fax: 603-588-3205 • w2nsd@aol.com

Yes! Put me down for a year of 73 for only \$25 (a steal). Canada US\$32. Foreign US\$44 by sea.

I'd like to get more romance into my dreary life so send me your How-To-Dance Videos catalog.

I need some industrial strength stress reduction so send me your Adventures In Music CD catalog

Allow 4 weeks for delivery except foreign, though we try to get most orders shipped in a day or two.



# Barter 'n' Buy

Turn your old ham and computer gear into cash now. Sure, you can wait for a hamfest to try and dump it, but you know you'll get a far more realistic price if you have it out where 100,000 active ham potential buyers can see it, rather than the few hundred local hams who come by a flea market table. Check your attic, garage, cellar and closet shelves and get cash for your ham and computer gear before it's too old to sell. You know you're not going to use it again, so why leave it for your widow to throw out? That stuff isn't getting any younger!

The 73 Flea Market, Barter 'n' Buy, costs you peanuts (almost)—comes to 35 cents a word for individual (noncommercial!) ads and \$1.00 a word for commercial ads. Don't plan on telling a long story. Use abbreviations, cram it in. But be honest. There are plenty of hams who love to fix things, so if it doesn't work, say so.

Make your list, count the words, including your call, address and phone number. Include a check or your credit card number and expiration. If you're placing a commercial ad, include an additional phone number, separate from your ad.

This is a monthly magazine, not a daily newspaper, so figure a couple months before the action starts; then be prepared. If you get too many calls, you priced it low. If you don't get many calls, too high.

So get busy. Blow the dust off, check everything out, make sure it still works right and maybe you can help make a ham newcomer or retired old timer happy with that rig you're not using now. Or you might get busy on your computer and put together a list of small gear/parts to send to those interested?

**Send your ads and payment to: 73 Magazine, Barter 'n' Buy, 70 Hancock Rd., Peterborough NH 03458 and get set for the phone calls.** The deadline for the May 2001 classified ad section is March 10, 2001.

**President Clinton** probably doesn't have a copy of *Tormet's Electronics Bench Reference* but you should. Check it out at [[www.ohio.net/~rtormet/index.htm](http://www.ohio.net/~rtormet/index.htm)]  
—over 100 pages of circuits, tables, RF design information, sources, etc. BNB530

**TELEGRAPH COLLECTOR'S PRICE GUIDE:** 250 pictures/prices. \$12 postpaid. **ARTIFAX BOOKS**, Box 88, Maynard MA 01754. Telegraph Museum: [<http://wltp.com>]. BNB113

**Great New Reference Manual** with over 100 pgs of P/S, transistor, radio, op-amp, antenna designs, coil winding tables, etc. See details at [[www.ohio.net/~rtormet/index.htm](http://www.ohio.net/~rtormet/index.htm)] or send check or M.O. for \$19.95 + \$2.00 P&H to RMT Engineering, 6863 Buffham Rd., Seville OH 44273. BNB202

**RF TRANSISTORS TUBES** 2SC2879, 2SC1971, 2SC1972, MRF247, MRF455, MB8719, 2SC1307, 2SC2029, MRF454, 2SC3133, 4CX250B, 12DQ6, 6KG6A, etc. **WESTGATE**, 1-800-213-4563. BNB6000

**QSL CARDS.** Basic Styles; Black and White and Color Picture Cards; Custom Printed. Send 2 stamps for samples and literature. RAUM'S, 8617 Orchard Rd., Coopersburg PA 18036. Phone or FAX (215) 679-7238. BNB519

**Cash for Collins:** Buy any Collins Equipment. **Leo KJ6HI**. Tel./FAX (310) 670-6969. [[radioleo@earthlink.net](mailto:radioleo@earthlink.net)]. BNB425

**Browse** our web site and check out the "Monthly Special." TDL Technology, Inc. [www.zianet.com/tdl](http://www.zianet.com/tdl). BNB500

**MAHLON LOOMIS, INVENTOR OF RADIO**, by Thomas Appleby (copyright 1967). Second printing available from **JOHAN K.V. SVANHOLM N3RF**, SVANHOLM RESEARCH LABORATORIES, P.O. Box 81, Washington DC 20044. Please send \$25.00 donation with \$5.00 for S&H. BNB420

**Ham Radio Repair**, Quality workmanship. All Brands, Fast Service. **Affordable Electronics**, 7110 E. Thomas Rd., Scottsdale, AZ 85251. Call 480-970-0963, or E-mail [HAM\\_SERVICE@AOL.COM](mailto:HAM_SERVICE@AOL.COM). BNB427

**METHOD TO LEARN MORSE CODE FAST AND WITHOUT HANGUPS** **Johan N3RF**. Send \$1.00 & SASE. SVANHOLM RESEARCH LABORATORIES, P.O. Box 81, Washington DC 20044 USA. BNB421

**ASTRON** power supply, brand-new w/warranty, RS20M \$99, RS35M \$145, RS50M \$209, RS70M \$249. **Web:** [[www.aventrade.com](http://www.aventrade.com)]. Call for other models. (626) 286-0118. BNB411

**HEATHKIT COMPANY** is selling photocopies of most Heathkit manuals. Only authorized source for copyright manuals. **Phone:** (616) 925-5899, 8-4 ET. BNB964

**"MORSE CODE DECIPHERED"** Simple, elegant, inexpensive, comprehensive, logical, easy! E-mail [[judlind@earthlink.net](mailto:judlind@earthlink.net)]. BNB428

**Electricity, Magnetism, Gravity, The Big Bang.** New explanation of basic forces of nature in this 91-page book covering early scientific theories and exploring latest controversial conclusions on their relationship to a unified field theory. To order, send check or money order for \$16.95 to: American Science Innovations, PO Box 155, Clarington OH 43915. Web site for other products [[http://www.asi\\_2000.com](http://www.asi_2000.com)]. BNB100

**COLLOIDAL SILVER GENERATOR!** Why buy a "box of batteries" for hundreds of dollars? Current regulated, AC powered, fully assembled with #12 AWG silver electrodes, \$74.50. Same, but DC powered, \$54.50. Add \$2.50 shipping. **Thomas Miller**, 216 East 10th St., Ashland, OH 44805. Web address [www.bioelectrifier.com](http://www.bioelectrifier.com). BNB342

**COLD FUSION! - FUEL CELL! - ELECTRIC BICYCLE!** Each educational kit: (Basic - \$99.95, Deluxe - \$199.95, Information - \$9.95.) CATALOG - \$5.00. ELECTRIC AUTOMOBILE BOOK - \$19.95. **KAYLOR-KIT**, POB 1550ST, Boulder Creek CA 95006-1550. (831) 338-2300. BNB128

**ANTENNA SCIENCE:** Why do antennas radiate electromagnetic waves? Learn for yourself from this enlightening paper by **MAX RESEARCH**. Gain an understanding of the radiation mechanism of antennas! Written in a clear style for radio hobbyists, inquisitive amateurs and experimenters. \$4.95 ... ppd. Order from **MAX RESEARCH**, P.O.

Box 1306, East Northport, NY 11731.

BNB426

**ROHN TOWERS HUGE DISCOUNTS CHECK PRICES AT HILLRADIO.NET** BNB600

**K8CX HAM GALLERY** <http://hamgallery.com> BNB620

**TOWER for Sale.** 100-ft. **MILITARY AB-105c.** Heavy-duty galvanizing. Dismantled, includes guy wire, screw anchors, new bolts, excellent condition. **Jim W9GLR: 5165 Island View Circle South, Polk City, FL. 33868-8901.** [jimw9glr@juno.com](mailto:jimw9glr@juno.com) (863)-984-1317. BNB630

**Wanted:** Manual or copy for 14AVQ/WBS Hy-gain antenna. Bob, 35 Clarence St., Belleville, MI 48111. [K8HHP@Yahoo.Com](mailto:K8HHP@Yahoo.Com).

New miniature oscillator modules are now available ... all under \$20 ... plus our great reference book is still for sale. Write to **RMT Engineering**, 6863 Buffham Road, Seville, OH 44273 or see our Web site at [www.ohio.net/~rtormet/index.htm](http://www.ohio.net/~rtormet/index.htm).

## NEUER SAY DIE

*continued from page 62*

Today's leaders in science and technology are people who haven't been dumbed down by our American public schools and colleges.

When New Hampshire was awash in presidential hopefuls, all claiming they're going to improve American schools, it's interesting that not one of them offered *any* actual proposals for doing this. Of course, they don't dare; otherwise, they'd have the teachers' unions fighting them, while generously funding their competitors.

Is the situation hopeless? Hey, that's up to you! I've explained how you can help solve this misery, but I can't seem to get your attention.



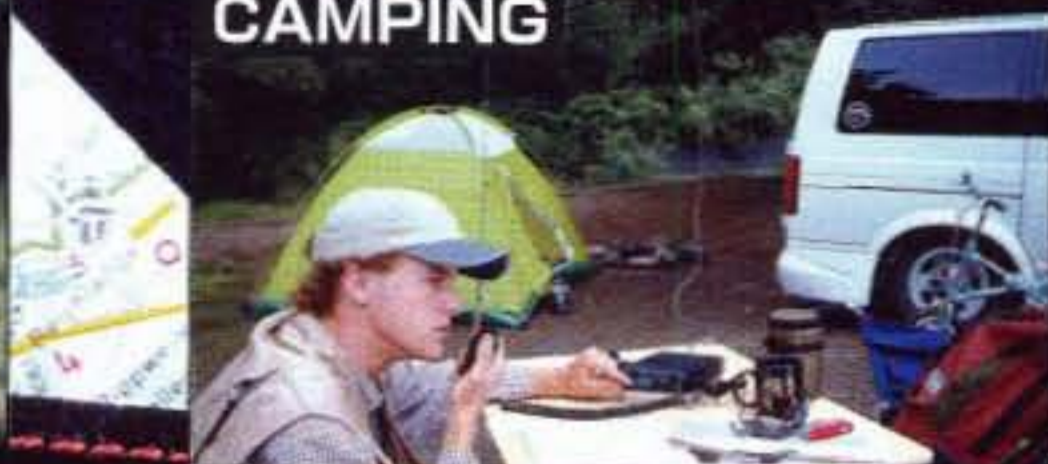
# The Ultimate Backpacker!

FIELD



## Ham Radio in the Great Outdoors: It's the Best with Yaesu's FT-817!

CAMPING



HOME



Actual Size

**Bring Ham Radio along on your next hiking, camping, or business trip with Yaesu's amazing new FT-817 Multimode HF/VHF/UHF Portable Transceiver!**

● **ULTRA COMPACT:** Measuring just 5.3" x 1.5" x 6.5" WHD (135 x 38 x 165 mm) and weighing about 2 1/2 pounds (1.17 kg, including the supplied antenna and alkaline cells), the FT-817 is small and light enough to take along wherever you're going.

● **WIDE FREQUENCY COVERAGE:** 160-10 meters on HF, plus the 50, 144, and 430 MHz Amateur bands. Plus FM Broadcast, AM Aircraft, and Public Safety receiver coverage.

● **MULTIMODE DESIGN:** Ready for action on SSB, CW, AM, FM, FM-Wide (Rx), 1200/9600 bps Packet, and Digital, including dedicated USB and LSB PSK-31 configurations.

● **5 WATTS POWER OUTPUT:** Using a new-technology all-band MOS FET power amplifier, the FT-817 provides 5 Watts of power output when using a 13.8 Volt DC source. When using Alkaline batteries or the optional FNB-72 Ni-Cd Battery Pack, power is automatically set to 2.5 Watts; via Menu, this can be changed to 0.5 Watt, 1 Watt, or up to 5 Watts.

● **WIDE CHOICE OF POWER SOURCES:** The FT-817 is equipped with an alkaline "AA" cell battery case, and a 13.8 volt DC cable is also supplied. Available as an option is the FNB-72 Ni-Cd Battery Pack (9.6 V, 1000 mAh), which can be recharged using a 13.8 Volt power supply while the radio is being operated.

● **TWO ANTENNA PORTS:** A "BNC" connector is provided on the front panel, and a type "M" connector on the rear panel, with Menu selection of which connector will be assigned for operation on HF, 50 MHz, 144 MHz, and 430 MHz.

● **OPTIONAL 10-POLE COLLINS® MECHANICAL FILTERS:** An optional filter slot is provided, accommodating either the YF-122S (2.3 kHz) SSB filter or the

YF-122C (500 Hz) CW filter. You get "base station" performance even from a mountain top.

● **INCREDIBLE MEMORY RESOURCES:** You get a total of 208 memories, including 200 "regular" memories which may be separated into ten groups of up to 20 channels each. And you can append an Alpha-Numeric "Tag" to each memory to aid in channel identification.

● **A CW OPERATOR'S DREAM MACHINE:** You get a built-in Electronic Keyer with adjustable weighting, adjustable CW Pitch, CW Normal/Reverse frequency tuning, and you can even use the microphone's UP and DOWN keys to send CW via the Keyer.

● **BUILT-IN CTCSS AND DCS:** The built-in CTCSS and DCS Encoder/Decoder systems provide you with the versatility you need for repeater access or selective calling.

● **DUAL-COLOR LIQUID CRYSTAL DISPLAY:** Select from Blue or Amber display illumination, which can also be switched off to conserve battery life. And while you're away, the Spectrum Scope will provide you with a visual record of activity  $\pm 5$  channels from your current operating frequency.

ALL MODE PORTABLE TRANSCEIVER

## FT-817

HF/50/144/430 MHz Multimode Transceiver

**YAESU**  
Choice of the World's top DX'ers™

For the latest news, hottest products:  
Visit us on the Internet! <http://www.yaesu.com>

©2000 Yaesu USA 17210 Edwards Road,  
Cerritos, CA 90703. (562) 404-2700

Specifications subject to change without notice. Specifications guaranteed only within Amateur bands. Some accessories and/or options are standard in certain areas. Frequency coverage may vary in your country. Check with your local Yaesu Dealer for specific details.

**See the exciting new FT-817 at your Yaesu Dealer's showroom today!**



# The DXer's Advantage... Packet Cluster Tune



**TS-B2000 PC or Mobile Unit**



**RC-2000 Compact Mobile Head**

Brochure  
& Operators  
Manual  
Available  
at our Website

## The All New TS-2000 Multi Band/Multi Mode Transceiver

The all new Kenwood **TS-2000** series transceiver offers today's demanding Amateur operator high performance operation without the compromising limitations found in other similar multi-band, multi-mode transceivers. The **TS-2000** offers three distinct operation platforms, the traditional transceiver with full function front panel, or the high-tech looking "silver box" version that allows mobile operation with the new RC-2000 compact control head, or the ARCP-2000 computer control program making the **TS-B2000** functional from your personal computer. The new **TS-2000** offers 100 watts on HF, 6 meters and 2 meters, 50 watts on 70cm, and when you add the optional UT-20 1.2 GHz module at 10 watts, you will have assembled the most advanced dual receiver multi-mode transceiver ever produced. You will be happy to know the **TS-2000** is transverter frequency display function ready to work the latest satellite frequencies available.

IF stage DSP in the main band and AF stage DSP in the sub-band provide unparalleled noise reduction performance. Because the **TS-2000** has a built-in TNC, DX Packet Cluster Tune is available on the sub-band and can automatically shift the desired HF or 6 Meter frequencies direct to the main band for instant contacts. A DXer's dream come true. You will also be sure to enjoy the built-in antenna tuner, 5+1 antenna ports, RS-232 terminal and the world's first HF fully backlit front control panel.

The **TS-2000** multi-band multi-mode transceiver, the highest performance Amateur Radio ever produced. **Available now.**

**KENWOOD**  
COMMUNICATIONS CORPORATION

AMATEUR RADIO PRODUCTS GROUP  
3975 Johns Creek Court, Suwanee, GA 30024  
P.O. Box 22745, Long Beach, CA 90801-5745, U.S.A.  
Customer Support: (310) 639-5300 Fax: (310) 537-8235  
01ARD-2057 #011401



ISO 9001  
JQA-1205

Communications Equipment Division  
Kenwood Corporation  
ISO9001 certification

**INTERNET**

Kenwood Website  
<http://www.kenwood.net>  
Kenwood Information  
<ftp://ftp.kenwood.net>