

Including Ham Radio Fun!

MARCH 1998

ISSUE #450

USA \$3.95

CANADA \$4.95

# 73<sup>®</sup> Amateur Radio Today

*International Edition*

**Antennas:**

**Stealth**

**Portable**

**20-40m Loop**

**MM Adventures**

**ATV Rocketry**

**Reviews:**

**Comm Spec's ID-8**

**MFJ-224 2m Analyzer**

**Test Equipment You Can Build**



0 74851 08725 1

# SYNTHESIZED VHF FM EXCITER & RECEIVER MODULES

## No more waiting for crystals!



Hamtronics is pleased to announce a new line of its vhf fm transmitters and receivers, popular for repeaters, voice and data links, control, telemetry, and other demanding applications.

T301 Exciter and R301 Receiver provide high quality nbfm and fsk operation on 144-148 MHz (and 148-174 MHz for export and gov't services). Features include:

- Dip switch frequency selection.
- Exceptional modulation for voice and ctcss.
- Very low noise synthesizer for repeater service.
- Direct fm for data up to 9600 baud.
- Commercial grade tcxo for tight frequency accuracy in wide range of environmental conditions: 2ppm -30 to +60°C.
- In stock for same day shipping.

### TA301 EXCITER

Rated for continuous duty, 2-3W output.

- Kit .....only \$109
- TCXO option ...\$40
- Wired/tested ...\$189 (includes TCXO)
- Inquire about models for higher frequencies.



### R301 RECEIVER

- Kit .....only \$139
- TCXO option ...\$40
- Wired/tested ...\$209 (includes TCXO)
- Our traditional crystal-controlled receivers and exciters are still available for all vhf and uhf bands.

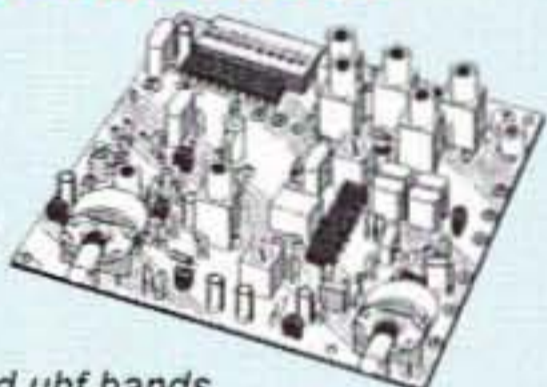

## CRYSTAL CONTROLLED VHF & UHF FM EXCITERS & RECEIVERS

**FM EXCITERS:** 2W output, continuous duty.

- TA51: for 6M, 2M, 220 MHz ..... kit \$99, w/t \$169.
- TA451: for 420-475 MHz. .... kit \$99, w/t \$169.
- TA901: for 902-928 MHz, (0.5W out) ..... w/t \$169.

**VHF & UHF POWER AMPLIFIERS.**

Output levels from 10W to 100W ..... Starting at \$99.

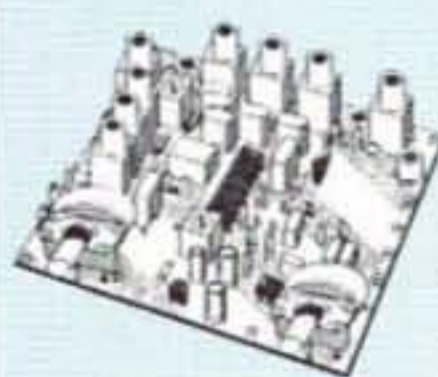

**FM RECEIVERS:**

- R100 VHF FM RCVR Very sensitive - 0.15µV. Superb selectivity - both crystal and ceramic IF filters, >100 dB down at ±12 kHz, best available anywhere, flutter-proof squelch.

For 46-54, 72-76, 140-175, or 216-225 MHz. .... kit \$129, w/t \$189.

- R144 RCVR. Like R100, for 2M, with helical resonator in front end. .... kit \$159, w/t \$219.
- R451 FM RCVR, for 420-475 MHz. Similar to R100 above. .... kit \$129, w/t \$189.
- R901 FM RCVR, 902-928MHz ..... \$159, w/t \$219.

## Get more features for your dollar with our REP-200 REPEATER

A microprocessor-controlled repeater with full autopatch and many versatile dtmf remote control features at less than you might pay for a bare bones repeater or controller alone!



Now - 2 meter machines in stock for next day shipment! Call for details.

- kit still only \$1095
  - factory assembled still only \$1295
- 50-54, 143-174, 213-233, 420-475 MHz. (902-928 MHz slightly higher.)  
 \* FCC type accepted for commercial service in 150 & 450 MHz bands.

**Digital Voice Recorder Option.** Allows message up to 20 sec. to be remotely recorded off the air. Play back at user request by DTMF command, or as a periodical voice id, or both. Great for making club announcements! ..... only \$100.

**REP-200C Economy Repeater.** Real-voice ID, no dtmf or autopatch. .... Kit only \$795, w&t \$1195.

**REP-200N Repeater.** Without controller so you can use your own. .... Kit only \$695, w&t \$995.

## You'll KICK Yourself If You Build a Repeater Without Checking Out Our Catalog First!

Hamtronics has the world's most complete line of modules for making repeaters. In addition to exciters, pa's, and receivers, we offer the following controllers.

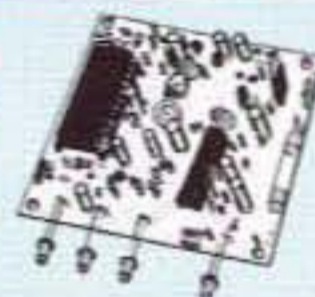

**COR-3.** Inexpensive, flexible COR module with timers, courtesy beep, audio mixer. .... only \$49/kit, \$79 w/t.

**CWID.** Traditional diode matrix ID'er. .... kit only \$59.

**CWID-2.** Eprom-controlled ID'er. .... only \$54/kit, \$79 w/t.

**DVR-1.** Record your own voice up to 20 sec. For voice id or playing club announcements. .... \$59/kit, \$99 w/t.

**COR-4.** Complete COR and CWID all on one board. ID in eprom. Low power CMOS. .... only \$99/kit, \$149 w/t.

**COR-6.** COR with real-voice id. Low power CMOS, non-volatile memory. .... kit only \$99, w/t only \$149.

**COR-5.** µP controller with autopatch, reverse ap, phone remote control, lots of DTMF control functions, all on one board, as used in REP-200 Repeater. .... \$379 w/t.

**AP-3.** Repeater autopatch, reverse autopatch, phone line remote control. Use with TD-2. .... kit \$89.

**TD-2.** Four-digit DTMF decoder/controller. Five latching on-off functions, toll call restrictor. .... kit \$79.

**TD-4.** DTMF controller as above except one on-off function and no toll call restrictor. Can also use for selective calling; mute speaker until someone pages you. .... kit \$49.

### SUBAUDIBLE TONE ENCODER/DECODER



Access all your favorite closed repeaters!

- Encodes all standard CTCSS tones with crystal accuracy and convenient DIP switch selection.
- Comprehensive manual also shows how you can set up a front panel switch to select tones for several repeaters.
- Decoder can be used to mute receive audio and is optimized for installation in repeaters to provide closed access. High pass filter gets rid of annoying buzz in receiver.
- TD-5 CTCSS Encoder/Decoder Kit ..... only \$39
- TD-5 CTCSS Encoder/Decoder Wired/tested ..... \$59

## LOW NOISE RECEIVER PREAMPS

**LNG-( ) GAAS FET PREAMP**

STILL ONLY \$59, wired/tested

- Make your friends sick with envy! Work stations they don't even know are there.
- Install one at the antenna and overcome coax losses.
- Available for 28-30, 46-56, 137-152, 152-172, 210-230, 400-470, and 800-960 MHz bands.



**LNW-( ) ECONOMY PREAMP**

ONLY \$29 kit, \$44 wired/tested

- Miniature MOSFET Preamp
- Solder terminals allow easy connection inside radios.
- Available for 25-35, 35-55, 55-90, 90-120, 120-150, 150-200, 200-270, and 400-500 MHz bands.

## TRANSMITTING & RECEIVING CONVERTERS

Go on a ham satellite adventure! Add another band for the next contest. Thrill in the excitement of building your own gear, and save a bundle.

No need to spend thousands on new transceivers for each band!



- Convert vhf and uhf signals to/from 10M.
- Even if you don't have a 10M rig, you can pick up very good used xmtrs & rcvrs for next to nothing.
- Receiving converters (shown above) available for various segments of 6M, 2M, 220, and 432 MHz.
- Rcvg Conv Kits from \$49, wired/tested units only \$99.

- Transmitting converters for 2M, 432 MHz.
- Kits only \$89 vhf or \$99 uhf.
- Power amplifiers up to 50W output.



## Finally - A Professional Quality Receiver to Monitor Weather Broadcasts!

Our RWX is a very sensitive and selective Hamtronics® grade receiver to monitor critical NOAA weather broadcasts.

Excellent 0.15µV sensitivity provides good reception even at distances of 70 miles or more with suitable antenna. No comparison with ordinary consumer radios!

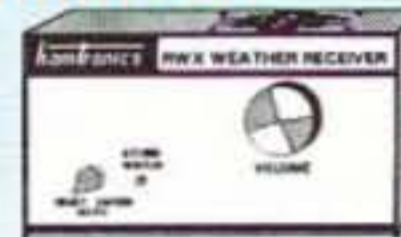

Automatic mode provides storm watch, alerting you by unmuting receiver and providing an output to trip remote equipment when an alert tone is broadcast.

Small enough for emergency or portable use, it can even be powered from a small 9-12V battery when needed. Crystal controlled for accuracy; all 7 channels provided (162.40 to 162.55).

You can buy just the receiver pcb module in kit form or buy the kit with an attractive metal cabinet, AC power adapter, and built-in speaker. It is also available factory wired and tested.

- RWX Rcvr kit, PCB only ..... \$79
- RWX Rcvr kit with cabinet, speaker, & AC adapter ..... \$99
- RWX Rcvr wired/tested in cabinet with speaker & adapter ..... \$139

We make many other products, too numerous to fit on one page. See prior month's ad for more. Hamtronics also makes Receivers for Weather Satellites & WWV and various data adapters & pwr amplifiers for radios.

Buy at low, factory-direct net prices and save!  
 For complete info, call or write for complete catalog.  
 Order by mail, fax, email, or phone (9-12, 1-5 eastern time).  
 Min. \$5 S&H charge for 1" lb. plus add'l weight & insurance.  
 Use Visa, MC, Discover, check, or UPS C.O.D.



View Catalog on our Web Site:  
[www.hamtronics.com](http://www.hamtronics.com)  
 email: [jv@hamtronics.com](mailto:jv@hamtronics.com)

Our 35<sup>th</sup> Year  
**hamtronics, inc.**  
 65-D Moul Rd; Hilton NY 14468-9535  
 Phone 716-392-9430 (fax -9420)

# Get on the Outernet!™

There's a Kantronics 9612 Plus about to enter service aboard Mir

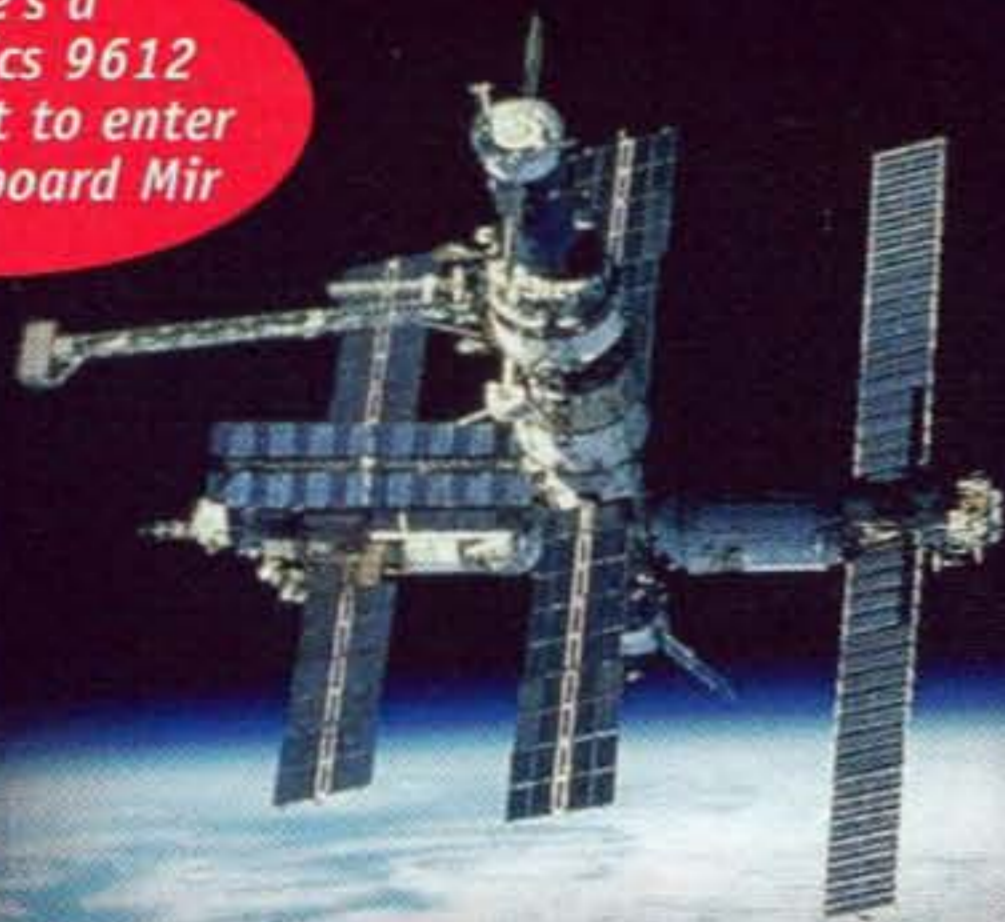

There's a world of digital communications fun and adventure that *only hams can enjoy* and Kantronics makes it possible for you to explore it. No matter if you call our products TNCs, wireless modems or digital controllers, the "Outernet™" offers a world of adventure, including satellite communications, APRS®, DX spotting, BBS operations, WEFAX, EMWIN, TCP/IP links, remote control and sensing, telemetry, HF e-mail with commercial service providers and more!

Commercial versions of Kantronics TNCs are being used in ever-increasing numbers!

Kantronics offers a number of ways to enjoy the growing field of digital communications. Choose the unit that suits your interests and budget. All Kantronics units come with a one-year limited warranty and can be upgraded when firmware updates become available.

## KPC-3 Plus



- 1200 bps - Now with more features!
- Packet, GPS/APRS, Host, KISS and WEFAX modes
- Personal Mailbox (PBBS) now supports multiple calls
- Copies NWS EMWIN with optional software
- Remote access, sensing and control with two A/D and two control lines
- KA-Node or option K-Net networking capability
- PBBS 100k, expandable with optional 512k RAM
- Uses external power or internal 9v battery
- NEWUSER mode and online help

8.2 Firmware now with Advanced GPS/APRS UI digipeating available for all 3 models!

## KPC-9612 Plus



- 1200 port AND second port of 4800 ~ 38,400 bps
- Most modes/capabilities of the KPC-3 Plus and POCSAG (paging)
- Unique design allows the addition of *another port, high or low speed\**
- KA-Node or K-Net option works with multiple ports
- Remote access, sensing and control capability
- Telemetry transmission capability
- NEWUSER mode and online help

## KAM Plus



- Same great KAM Plus performance in an attractive new package!
- Dual port VHF/HF (1200/≤300 bps) multimode TNC
- Packet, GPS/APRS, Host, KISS, WEFAX, CW, RTTY, AMTOR, PACTOR, G-TOR™, TOR, and Free Signal Detection for HF e-mail
- 100k personal mailbox standard, expandable with optional 512k RAM
- Remote access capability
- Real time, battery backed clock
- NEWUSER mode and online help
- New style case available for older Kam Plus units

# Kantronics

1202 E. 23rd St., Lawrence, KS 66046  
tel: 785-842-7745 • fax: 785-842-2031  
e-mail: [sales@kantronics.com](mailto:sales@kantronics.com)  
web: [www.kantronics.com](http://www.kantronics.com)

Specifications subject to change without notice or obligation. APRS® is a registered trademark of Bob Bruninga, WB4APR. All registered trademarks remain the property of their respective owners. \*Expansion modules anticipated for availability in early 1998.

## SWITCHING POWER SUPPLIES

	CONT.	ICS	WT.(LBS)
SS-10	7	10	3.2
SS-12	10	12	3.4
SS-18	15	18	3.6
SS-25	20	25	4.2
SS-30	25	30	5.0



SS-25M With volt & amp meters  
SS-30M With volt & amp meters

## ASTRON POWER SUPPLIES

• HEAVY DUTY • HIGH QUALITY • RUGGED • RELIABLE •

### SPECIAL FEATURES

- SOLID STATE ELECTRONICALLY REGULATED
- FOLD-BACK CURRENT LIMITING Protects Power Supply from excessive current & continuous shorted output
- CROWBAR OVER VOLTAGE PROTECTION on all Models except RS-3A, RS-4A, RS-5A, RS-4L, RS-5L
- MAINTAIN REGULATION & LOW RIPPLE at low line input Voltage
- HEAVY DUTY HEAT SINK • CHASSIS MOUNT FUSE
- THREE CONDUCTOR POWER CORD except for RS-3A
- ONE YEAR WARRANTY • MADE IN U.S.A.

### PERFORMANCE SPECIFICATIONS

- INPUT VOLTAGE: 105-125 VAC
- OUTPUT VOLTAGE: 13.8 VDC ± 0.05 volts (Internally Adjustable: 11-15 VDC)
- RIPPLE Less than 5mv peak to peak (full load & low line)
- All units available in 220 VAC input voltage (except for SL-11A)

### SL SERIES



### • LOW PROFILE POWER SUPPLY

MODEL	Colors		Continuous Duty (Amps)	ICS* (Amps)	Size (IN) H x W x D	Shipping Wt. (lbs.)
	Gray	Black				
SL-11A	•	•	7	11	2 5/8 x 7 5/8 x 9 3/4	12
SL-11R	•	•	7	11	2 5/8 x 7 x 9 3/4	12
SL-11S	•	•	7	11	2 5/8 x 7 5/8 x 9 3/4	12
SL-11R-RA		•	7	11	4 3/4 x 7 x 9 3/4	13

### RS-L SERIES



### • POWER SUPPLIES WITH BUILT IN CIGARETTE LIGHTER RECEPTACLE

MODEL	Continuous Duty (Amps)	ICS* (Amps)	Size (IN) H x W x D	Shipping Wt. (lbs.)
RS-4L	3	4	3 1/2 x 6 1/8 x 7 1/4	6
RS-5L	4	5	3 1/2 x 6 1/8 x 7 1/4	7

### RM SERIES

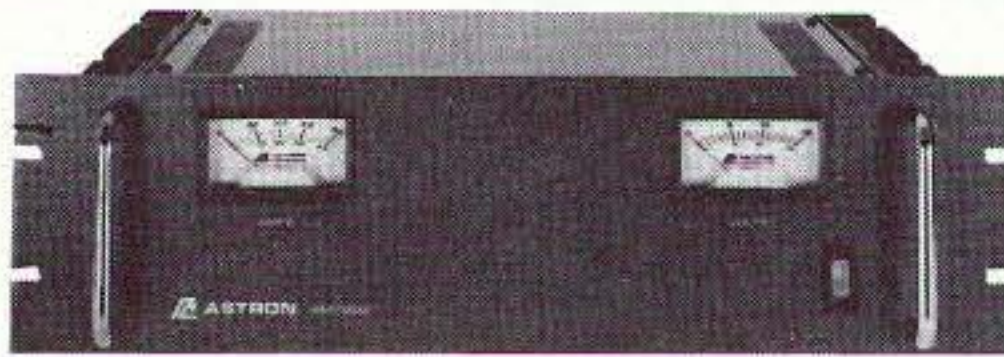

MODEL RM-35M

### • 19" RACK MOUNT POWER SUPPLIES

MODEL	Continuous Duty (Amps)	ICS* (Amps)	Size (IN) H x W x D	Shipping Wt. (lbs.)
RM-35A	25	35	5 1/4 x 19 x 12 1/2	38
RM-50A	37	50	5 1/4 x 19 x 12 1/2	50
RM-60A	50	55	7 x 19 x 12 1/2	60
• Separate Volt and Amp Meters				
RM-12M	9	12	5 1/4 x 19 x 8 1/4	16
RM-35M	25	35	5 1/4 x 19 x 12 1/2	38
RM-50M	37	50	5 1/4 x 19 x 12 1/2	50
RM-60M	50	55	7 x 19 x 12 1/2	60

### RS-A SERIES



MODEL RS-7A

MODEL	Colors		Continuous Duty (Amps)	ICS* (Amps)	Size (IN) H x W x D	Shipping Wt. (lbs.)
	Gray	Black				
RS-3A		•	2.5	3	3 x 4 3/4 x 5 3/4	4
RS-4A	•	•	3	4	3 3/4 x 6 1/2 x 9	5
RS-5A		•	4	5	3 1/2 x 6 1/8 x 7 1/4	7
RS-7A	•	•	5	7	3 3/4 x 6 1/2 x 9	9
RS-10A	•	•	7.5	10	4 x 7 1/2 x 10 3/4	11
RS-12A	•	•	9	12	4 1/2 x 8 x 9	13
RS-12B	•	•	9	12	4 x 7 1/2 x 10 3/4	13
RS-20A	•	•	16	20	5 x 9 x 10 1/2	18
RS-35A	•	•	25	35	5 x 11 x 11	27
RS-50A	•	•	37	50	6 x 13 3/4 x 11	46
RS-70A	•	•	57	70	6 x 13 3/4 x 12 1/2	48

### RS-M SERIES



MODEL RS-35M

MODEL	Continuous Duty (Amps)	ICS* (Amps)	Size (IN) H x W x D	Shipping Wt. (lbs.)
• Switchable volt and Amp meter RS-12M	9	12	4 1/2 x 8 x 9	13
• Separate volt and Amp meters RS-20M	16	20	5 x 9 x 10 1/2	18
RS-35M	25	35	5 x 11 x 11	27
RS-50M	37	50	6 x 13 3/4 x 11	46
RS-70M	57	70	6 x 13 3/4 x 12 1/2	48

### VS-M AND VRM-M SERIES



MODEL VS-35M

### • Separate Volt and Amp Meters • Output Voltage adjustable from 2-15 volts • Current limit adjustable from 1.5 amps to Full Load

MODEL	Continuous Duty (Amps)			ICS* (Amps) @13.8V	Size (IN) H x W x D	Shipping Wt. (lbs.)
	@13.8VDC	@10VDC	@5VDC			
VS-12M	9	5	2	12	4 1/2 x 8 x 9	13
VS-20M	16	9	4	20	5 x 9 x 10 1/2	20
VS-35M	25	15	7	35	5 x 11 x 11	29
VS-50M	37	22	10	50	6 x 13 3/4 x 11	46
VS-70M	67	34	16	70	6 x 13 3/4 x 12 1/2	48
• Variable rack mount power supplies						
VRM-35M	25	15	7	35	5 1/4 x 19 x 12 1/2	38
VRM-50M	37	22	10	50	5 1/4 x 19 x 12 1/2	50

### RS-S SERIES



MODEL RS-12S

### • Built in speaker

MODEL	Colors		Continuous Duty (Amps)	ICS* Amps	Size (IN) H x W x D	Shipping Wt. (lbs.)
	Gray	Black				
RS-7S	•	•	5	7	4 x 7 1/2 x 10 3/4	10
RS-10S	•	•	7.5	10	4 x 7 1/2 x 10 3/4	12
RS-12S	•	•	9	12	4 1/2 x 8 x 9	13
RS-20S	•	•	16	20	5 x 9 x 10 1/2	18
SL-11S	•	•	7	11	2 3/4 x 7 5/8 x 9 3/4	12

# THE TEAM

El Supremo & Founder  
Wayne Green W2NSD/1

Associate Publisher  
F. I. Marion

Associate Technical Editor  
Larry Antonuk WB9RRT

Nitty Gritty Stuff  
J. Clayton Burnett  
Priscilla Gauvin  
Joyce Sawtelle

## Contributing Culprits

Bill Brown WB8ELK  
Mike Bryce WB8VGE  
Joseph E. Carr K4IPV  
Michael Geier KB1UM  
Jim Gray W1XU/7  
Jack Heller KB7NO  
Chuck Houghton WB6IGP  
Dr. Marc Leavey WA3AJR  
Andy MacAllister W5ACM  
Dave Miller NZ9E  
Joe Moell KØOV  
Steve Nowak KE8YN/5  
Carole Perry WB2MGP

## Advertising Sales

Frances Hyvarinen  
Roger Smith  
603-924-0058  
800-274-7373  
Fax: 603-924-8613

## Circulation

Linda Coughlan

## Data Entry & Other Stuff

Christine Aubert  
Norman Marion

## Business Office

Editorial - Advertising - Circulation  
Feedback - Product Reviews  
73 Amateur Radio Today Magazine  
70 Route 202N  
Peterborough NH 03458-1107  
603-924-0058  
Fax: 603-924-8613

Reprints: \$3 per article  
Back issues: \$5 each

Printed in the USA

**Manuscripts:** Contributions for possible publication are most welcome. We'll do the best we can to return anything you request, but we assume no responsibility for loss or damage. Payment for submitted articles will be made after publication. Please submit both a disk and a hard copy of your article [IBM (ok) or Mac (preferred) formats], carefully checked drawings and schematics, and the clearest, best focused and lighted photos you can manage. "How to write for 73" guidelines are available on request. US citizens, please include your Social Security number with submitted manuscripts so we can submit it to you know who.

MARCH 1998  
ISSUE #450

# 73 Including Ham Radio Fun! Amateur Radio Today TABLE OF CONTENTS

## FEATURES

- 10 *Truckez-Vous Mon Boat? — N4UAU*  
*Ham friends to the rescue for Voyageur.*
- 17 *Wouldn't You Really Rather Drive a BUIC? — K8KWD*  
*Part 2: software for your interface circuit.*
- 23 *Getting High the Ham Way — KB9MRB*  
*Adventures in ATV rocketry.*
- 26 *High Impedance Analog Volt/Test Meter — W6WTU*  
*Here's a useful gadget to build while you wait for spring!*
- 30 *Amazin' Hall Tree Vertical — K5CW*  
*Grab your coat and take your hat ...*
- 39 *The ZenerMeter — KA4J*  
*A test set for zener and other diodes.*
- 43 *Cheap and Portable Loop — WV8R*  
*... for 20 through 40 meters.*
- 80 *Out of Sight, Out of Mind — WB4BNU*  
*Discretion is the better part of neighborhood amity. Part 1: strategy.*

## DEPARTMENTS

- WB6IGP 74 Above & Beyond
- 73 Ad Index
- KB1UM 55 Ask Kaboom
- 88 Barter 'n' Buy
- K4IPV 50 Carr's Corner
- NØUJR 87 Cartoon
- KB7NO 59 The Digital Port
- WB2MGP 77 Hams With Class
- NZ9E 52 Ham to Ham
- KØOV 61 Homing In
- 6 Letters
- W2NSD/1 4 Never Say Die
- 72, 79 New Products
- KE8YN/5 58 On the Go
- W1XU 87 Propagation
- WB8VGE 57 QRP
- 8 QRX
- 42, 44, 48, 78, 79, 83, 88 Radio Bookshop
- WA3AJR 71 RTTY Loop
- 34 Special Events
- 84 Updates

## REVIEWS

- 36 *Secrets of the 224 — NØBLX*  
*Inside MFJ's 2-Meter FM Analyzer.*
- 46 *Automatic Morse Station IDer from Comm Spec — K4CHE*  
*Perfect for fox hunting and repeaters.*

## HAM RADIO FUN SECTION

- W2UW 64 *Don't Leave Home Without It*  
*An ingenious tester for your wallet or purse.*
- NØBLX 67 *Bridge Over Troubled Watters*  
*Why buy what you can build?*

**On the cover:** Fern Lamoureux VE2FSP's *Robin Hood*, sporting a folding dipole for 20-15-10m, was captured in Kingston, Ontario, by N4UAU while on his St. Lawrence Seaway odyssey (page 10). We'll be happy to pay for your cover photo—no matter where it's from—so get busy and start shooting!

**Feedback:** Any circuit works better with feedback, so please take the time to report on how much you like, hate, or don't care one way or the other about the articles and columns in this issue. G = great!, O = okay, and U = ugh. The G's and O's will be continued. Enough U's and it's Silent Keysville. Hey, this is *your* communications medium, so don't just sit there scratching your...er...head. FYI: Feedback "number" is usually the page number on which the article or column starts.

**73 Amateur Radio Today** (ISSN 1052-2522) is published monthly by 73 Magazine, 70 N202, Peterborough NH 03458-1107. The entire contents ©1998 by 73 Magazine. No part of this publication may be reproduced without written permission of the publisher, which is not all that difficult to get. The subscription rate is: one year \$24.97, two years \$44.97; Canada: one year \$34.21, two years \$57.75, including postage and 7% GST. Foreign postage: \$19 surface, \$42 airmail additional per year, payable in US funds on a US bank. Second class postage is paid at Peterborough, NH, and at additional mailing offices. Canadian second class mail registration #178101. Canadian GST registration #125393314. Microfilm edition: University Microfilm, Ann Arbor MI 48106. POSTMASTER: Send address changes to *73 Amateur Radio Today*, 70 N202, Peterborough NH 03458-1107. *73 Amateur Radio Today* is owned by Shabromat Way Ltd. of Hancock NH.

**Contract:** By being so nose-y as to read this fine print, you have just entered into a binding agreement with *73 Amateur Radio Today*. You are hereby obligated to do something nice for a ham friend—buy him a subscription to *73*. What? All of your ham friends are already subscribers? Donate a subscription to your local school library!

# NEVER SAY DIE

Wayne Green W2NSD/1



## Exciting Times

It's difficult to write a New Year's piece in November, so you'll get this along in February or March and have to make do. As of 1/1/98, none of the doom-and-gloommeisters' catastrophe predictions had yet materialized, leaving me with little but a bunch of exciting things to think about for the new year. There's so much going on that I don't know what to write about next.

You already know, I hope, that cold fusion is getting warmer. When it started out with the Pons and Fleischmann announcement in 1989 that they'd been able to generate excess heat using palladium and a simple electrolyte, both physicists and chemists snorted that it was impossible. There was no theory to explain it, so P&F had to have made some sort of stupid mistake. Several labs tried to replicate the experiment and failed, quickly papering the media with press releases dumping on P&F. A few labs confirmed the excess heat, but kept quiet about it, not wanting to upset government funding of their other research.

Now, nine years later, the foremost experimenter in the field, Dr. Jim Patterson, has a string of patents for systems which have been regularly producing enormous quantities of excess heat. Professor John Bockris of Texas A&M was one of the first to suggest that the excess heat might be coming from the transmutation of elements. His fellow professors immediately formed a lynch mob and tried to get him fired for making such a crazy suggestion.

Well, it turns out that Bockris was right. Elemental transmutation has been solidly confirmed. And this is providing, for the first time, a way to get rid of those thousands of tons of radioactive waste that have been building up. The cold fusion cells convert radioactive elements to non-radioactive elements. That's going to make the development of cold fusion power sources all the more difficult for the oil, coal, gas, and power companies to stop, even with all the money their lobbyists are lavishing on Congress.

## Super Gardening

Another subject that has me all excited has to do with the different ways that have been discovered to speed plant growth. One of the books in my *Guide* (for which, apparently, no amount of pleading will get you to fork over a lousy five bucks) is a beaut by Chris Bird, *Secrets of the Soil*. Fabulous book.

One of the products described in the book was something called Sonic Bloom. At the time I read the book I sent a letter asking for more information. Nothing happened, so I almost forgot about it. But every now and then I'd hear Sonic Bloom mentioned, so I dug out my letter, looked up Dan Carlson on my phone ROM, and called him. Wow, was he interesting to talk with!

Dan sent me an information package and a video, which converted me from being interested to being really excited. This stuff is absolutely amazing!

What Dan discovered was that playing music to plants gets them to open up and draw in more nutrients, which helps them to grow faster and produce bigger, sweeter fruit and vegetables. He was getting three times the normal growth and huge fruit and vegetables—if you call 400-pound pumpkins huge.

His next step was to spray the plants with nutrients containing all the minerals long gone from our soil. The combination of the music and the spray is producing plants seven times as large as normal. He now has the world record for an indoor plant, a purple passion plant that's 1300 feet long! They normally grow to about 18 inches.

His video shows tomato plants with 500 tomatoes on a single vine, and interviews with a long string of exceedingly happy farmers who have been using Dan's system. It's producing bigger, sweeter fruit and faster growing plants, even under adverse growing conditions.

You can get a Sonic Bloom kit from Dan for \$50, complete with audio tapes, and start growing your own giant vegetables or whomping up a bodacious science fair project: Scientific Enterprises, 708-119th Lane NE, Blaine MN 55434.

## The Pyramid

At about the same time as I was being amazed by Sonic Bloom, I got a book from Acres USA called *The Pyramid* by Les Brown. It's a 20-year-old book, but it's a corker. Les built some small

pyramids and found that they helped seeds and plants grow faster, make sweeter fruit, and the fruit stayed fresh much longer after being picked. He went on to build a 30-foot pyramid out of wood with three floors of garden in it.

This whole business about pyramid power is weird. I've read about it mummifying animals and sharpening razors. Then there is the mystery of the pyramids in Egypt, which we could not replicate today, even with all of our technology. The more I read about the pyramids, the more amazing they are.

Can the alleged power of pyramids be used to help our plants grow and produce better fruit and vegetables? Les Brown's book says yes, and he has the photographs to prove it. The 80-page book is \$3 from Acres USA (#3045), (800) 355-5313.

If you're interested in the Great Pyramid, you'll enjoy a book packed with statistics about it. It's a scientific as well as a construction marvel. I found *The Great Pyramid Speaks* by Joseph Gill at Barnes & Noble for \$7. Another great book is Peter Tompkins' *Secrets of the Great Pyramid*. This is a large (416-page), profusely illustrated book. Dowsers has it for \$30, (800) 711-9497. Graham Hancock has also done a wonderful job in his *The Message of the Sphinx*, 350 pages, hardcover, \$27.50 from Dowsers.

## Radionics

While we're dealing with things unexplainable by science, but which anyone not too brainwashed to try can prove are real, we have what is called radionics. With this "power" it's possible to rid fields of pests and to improve plant growth. I've got a couple books on the subject, but I'll be getting more.

How is it possible to put a photograph of a field into a device and have it keep pests from bothering the crops in that field? Ridiculous, right? Well, so's dowsing, which has been working reliably for

thousands of years and still has no "scientific" explanation. Is it even remotely possible that there are still a few things we don't yet understand?

Look, we know that the accumulation of knowledge (and technology) has been speeding up. A hundred years ago scientists were just as certain as those today that they knew the fundamentals of everything. Ditto two hundred years ago.

If you know of any outstanding books on radionics, let me know.

### Feeding Roots

Jim Patterson, the cold fusion pioneer, has a bunch of patents in many fields, but one of interest to farmers is his micro-piping system for delivering water (and nutrients) directly to the roots of plants. A bundle of tiny plastic tubes can be stuck into the ground next to a plant's roots and, by osmosis, will siphon water as needed to the root system from a jar or even a pipe system. This is particularly efficient for arid areas where it's important to keep water evaporation to a minimum. This could help open vast desert areas to cultivation in the Middle East.

### Magnets

If you've read the Davis and Rawles book on magnetism, which I've recommended in my *Guide*, you know that plants growing over the south pole of magnets grow much faster than control plants. Those over north poles grow slower and tend to be deformed. The book is 132 pages and is \$15 from Acres USA (#703).

I've been after Don Lorimer, who has been lecturing on the power of magnets to heal animals and people, to do a book on the subject. Once you get to know more about magnets you're going to be taking your freshly distilled water and putting it in the morning sunlight on top of the south pole of a strong magnet before

you drink it—as I have been doing. Don has found that the south pole energy helps wounds heal incredibly fast, while north pole energy can slow down or stop cancer growth.

### Prayer

In *The Secret Life of Plants*, also by Chris Bird, I learned that plants and humans can communicate. Anyone who wants to can prove this to themselves by planting a couple seeds in plastic cups. Select one seed to talk to. Tell it frequently what a fast growing, beautiful plant it is going to make. Think about it every now and then lovingly. Ignore the other seed. You can even plant a third seed and tell it every now and then how ugly and awful it is. Tell it how much you dislike it. The results will make you a believer.

On the same level, whatever that is, this same force also works on children and animals. I suppose that, no matter how much I've been after you to read *Kinship of All Life* by Boone, you haven't bothered. Spend the \$11 and get it from Radio Bookstore (#5280), (800) 243-1438. The *Plants* book, same source, is \$16 (#5300).

### Gravel

John Hamaker and Don Weaver back up what Dr. Joel Wallach preaches in his *Dead Doctors Don't Lie* tape, plus in his books, *Let's Play Doctor* and *Rare Earths—Their Secrets to Health and Longevity*. The fact is that our bodies need a bunch of minerals that are no longer available to plants on our farms. Farmers have been substituting chemical fertilizer, which makes the plants grow, but doesn't provide us with the minerals our bodies have been designed to use over the millions of years they developed.

In the Hamaker-Weaver book, *The Survival of Society*, they call for the remineralization of our

farms. Weaver documents the fact that remineralized earth grows healthier, bigger plants, with larger and sweeter produce. Cows fed hay from mineralized fields give more milk and have more meat on their bones in a shorter time. The book is \$12 from Radio Bookstore (#6221).

### Light, Too!

Another book reviewed in my *Guide* is *Health and Light* by Ott. Ott was a photographer who wanted to take pictures of plants and flowers. To keep them undisturbed for good photos he tried growing them in a box with a glass top. He got lousy plants. He found that the plants required ultraviolet rays from the sun in order to grow strong and healthy. His work was carried on by Jacob Lieberman in *Light, Medicine of the Future*, where he shows that people also need those UVs if they are going to be healthy. Yes, it's in my *Guide*, and you can get it from Radio

Bookstore (#5430) for \$17. You'll be out in the sun without your glasses for at least 20 minutes a day after reading this well documented book. Yes, I know that too much UV is harmful, but our bodies developed using UVs and we need 'em—particularly in our eyes.

### Dirt

There are all kinds of soil, so it shouldn't be any real surprise that some sod is better than other for plants. So we want to learn how to provide an optimum soil for plant growth. There are a bunch of books on composting, which is a way to return your garbage to the soil. But mostly you want to read Bird's *Secrets of the Soil*, which Acres USA really should sell. Maybe it's out of print. Chris died a couple years ago, but I believe his wife is carrying on his work.

The bottom line, of course, is that the better the soil, the

*Continued on page 38*

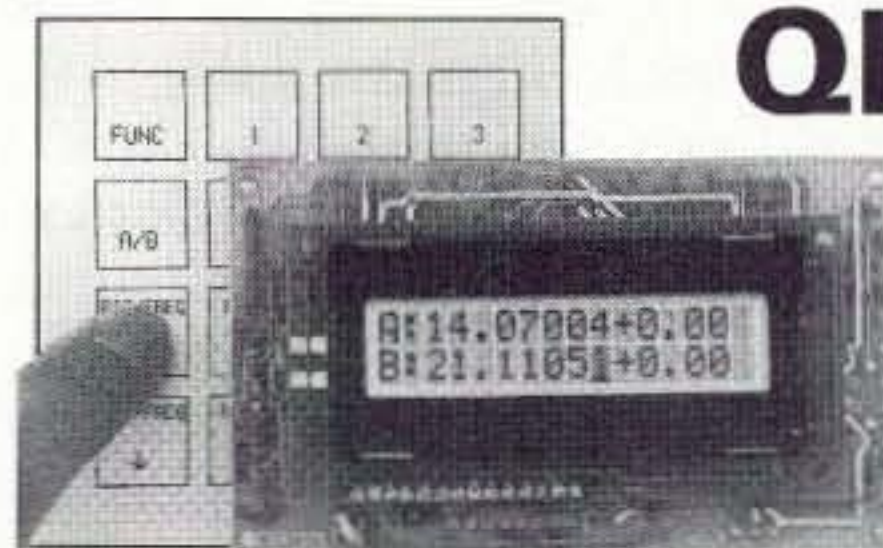

## QRP VFO!

High power key pad controlled direct digital synthesis VFO for low power enthusiasts

Get base station performance from your QRP rig with keypad controlled VFO featuring:

- ✓ Keypad entry of frequency
- ✓ 10 Hz to 25 MHz frequency range
- ✓ Digital VFO with 10 Hz resolution & display
- ✓ Variable rate incremental keypad or rotary tuning
- ✓ Dual VFOs (A&B) allows cross band selection
- ✓ 100 memories for VFO A&B
- ✓ Keypad selection of bands
- ✓ RIT (+/- 9.99kHz)
- ✓ Size: L-4" X H-2.5" X D-0.9"

*Special limited time introductory price: \$149 (U.S.)*

Order now and also receive the RS-232 option to control VFO operation via your PC. Orders: 1-800-923-3423.

Info: (Tel.) 905-470-2900 (Fax) 905-470-6742.

*Menu Plus*

Menu Plus Inc.  
1271 Denison St., Units 56-57  
Markham, Ontario, Canada L3R 4B5

**NEW!**

CIRCLE 335 ON READER SERVICE CARD

# LETTERS

## From the Ham Shack

**Jim Stanley W6GH.** You are correct in your position that we need to review and possibly modify amateur radio as it is today. Having been first licensed as an amateur more than 30 years ago, I am now observing a paradigm shift within the hobby, that previously I would not have expected. You are correct in your assumption that most young people are interested in computers and the Internet rather than radio. As my nine-year-old son stated, "Radio is boring ... there is no video." Or regarding packet operation, "Hey, this is really slow, can't we do this on the net?"

I personally did not own a VHF or UHF radio until a couple of years ago. Most of my hamming is confined to high power single point HF operation; lots of CW and usually never operating above 20 meters. I also spend much time on 160 meters operating my converted broadcast transmitter on AM. We even moved out of the city to get away from any restrictions on antennas so my patch of semi-rural real estate now looks like an antenna farm.

If we are to continue to enjoy this hobby and the associated spectrum made available to us, we must begin to develop technologies and modes that are applicable to current mediums such as the Internet and television. Both color video and high-speed data transmission are a must if we expect to interest young people. And let's face it, many of us were Novice amateurs when we were young. Amateur radio offered excitement and the potential for experimentation. For many individuals, such as myself, amateur radio provided the building blocks for a career in engineering and communications.

As an active VE with the ARRL VEC I am painfully

aware of the low interest in upgrading to General, Advanced or Extra Class licenses. Most examinations we give today are for codeless Technician licenses.

One of the problems I observe today with regard to interest in HF operation is the cost of equipment. A decent transceiver from Japan costs about as much as a Pentium™ computer loaded with all the goodies. Which one do you think a youngster would rather have? Years ago most of us got our HF start with a one-tube transmitter, such as a 6L6 special, and perhaps a simple regenerative receiver. Nowadays, it's difficult for most youngsters to obtain the parts for a station such as this, let alone to find a kind, helpful, older ham to Elmer them. Then there is the problem of space for an HF dipole, if they live in an urban environment. The list of issues is extensive.

As someone who has devoted much effort to the CW mode even with spark transmitters, I must say it is a bitter pill to swallow, to think we must dumb down our hobby by reducing the proficiency requirements for CW in favor of more participants in the hobby. However, maybe we need to seriously consider reducing the proficiency for CW to five or seven wpm for the General Class license. Perhaps the Novice Class license could be issued for a term of two (2) years or four (4) years, with only a simple technical test consisting of FCC Rules and simple visual recognition of code characters; with no speed requirement for receiving. This would allow Novices to operate within confined band segments and learn Morse code on the air, like many of us did, in some cases without licenses.

Perhaps offering a license targeted at color ATV operation and high-speed data transmission for

Internet connections would be attractive to many potential amateurs. Alas, if we older hams don't take action soon, there may be no amateur radio for our future generations to enjoy and learn from. I offer these ideas only as possible solutions to our dilemma and invite anyone to share their viewpoint on this subject.

*Seems like a "Catch-22" situation. We need to keep upgrading our technology in order to attract youngsters, yet it is the youngsters who have always been the pioneers in the hobby, so without youngsters we aren't likely to have much progress. I don't agree that setting up even more license classes is going to solve anything. I also don't think that the cost of equipment is a serious problem. My first receiver (a seven-tube, including the 80 rectifier) cost about \$60. But that was in 1938 dollars, and that would come to around \$1,200 in today's dollarettes. We're getting a lot of firepower for our bucks these days. Anyway, my proposal is to eliminate the stupid and divisive class system that the ARRL has promoted since antiquity and issue one amateur radio license. Period. Then we need to get busy and add video to our contacts. We need faster packet. Much, much faster. We need repeater-Internet connections. We need duplex operation. We need to get out of the 1950s and into the 1990s with our technology ... Wayne.*

**Steve Rudin W1WSN.** There are no REAL surplus parts stores around; no cheap supply of crystals at a neighborhood store; no diagrams and descriptions in an easy-to-read *Radio Amateur's Handbook* for kids to plow through and build a 6AG7 five-watter as I did, using Popsicle® sticks stuck in drilled wood as a coil form; no ready source of old receivers or military equipment for "peanuts." And the thing that frightens me the most is that as we old-timers move on, the younger crop of amateurs will have increasingly

fewer resources with which to build, play and learn.

This is my 45th year in amateur radio, without a break. I have been on CW, AM, SSB, RTTY, facsimile (beer-can drum home-brew units), packet, satellite, FM, etc. I've chased DX, rag-chewed, and contested. There was lots of motivation then ... old-timers who took you under their wing, surplus counters galore, even at Radio Shack™ (where I worked), ways to work the world on CW using a \$5 transmitter and a power supply from an old TV—and yes, things have really changed.

I often wax nostalgic, and thus have taken to restoring old ham gear of years gone by. I hope that we will have a forthcoming generation of similar hams, who can delve into micro-processor-controlled imported computerized communications gear as well.

I still home-brew a lot of gear, but it just doesn't feel the same! And shopping for parts is a lot harder! I guess I still love the good old days!

**Rev. Harry Arsenault KIPLR.** Your comments on smoking hit home. My parents smoked and they're both dead. Secondly, on bad doctors, I concur. I have a Pharm.D., and being trained as a pharmacist, I see my profession as that which covers their (doctors') buns. I mean, "Do you really want to prescribe this?" As I was pursuing my graduate degree and working in a retail store, I was fascinated by the stupidity that could have caused drug interactions.

**John Phillips K2QAI.** You mentioned your mother calling you from a long distance when you were experiencing a profound crisis that she could have known nothing about, just to check on your welfare. Well, I have an interesting story to share with you. My 16-year-old son and the daughter of my friend

*Continued on page 79*



# MFJ 300 Watt Roller Inductor Tuner

World's only 300 watt AirCore™ Roller Inductor Antenna Tuner gives you absolute minimum SWR... Covers 6 Meters thru 160 Meters... lighted Cross-Needle meter... tunes any antenna... 8 position antenna switch... dummy load... balun... 1 year No Matter What™ warranty

**Covers 6 Meters thru 160 Meters!**

MFJ-969

**\$189<sup>95</sup>**

**Call your dealer for your best price!**



NEW MFJ-969 gives you MFJ's superb AirCore™ Roller Inductor and full 6 Meter thru 160 Meter coverage!

You get everything you've ever wanted including... 300 Watts PEP SSB full featured antenna tuner, widest matching range, lighted Cross-Needle SWR/Wattmeter reads true peak forward power, QRM-Free PreTune™, 8 position antenna switch, built-in 50-Ohm dummy load and heavy duty 4:1 balun -- all in a tough, scratch-proof cabinet.

**AirCore™ Roller Inductor**

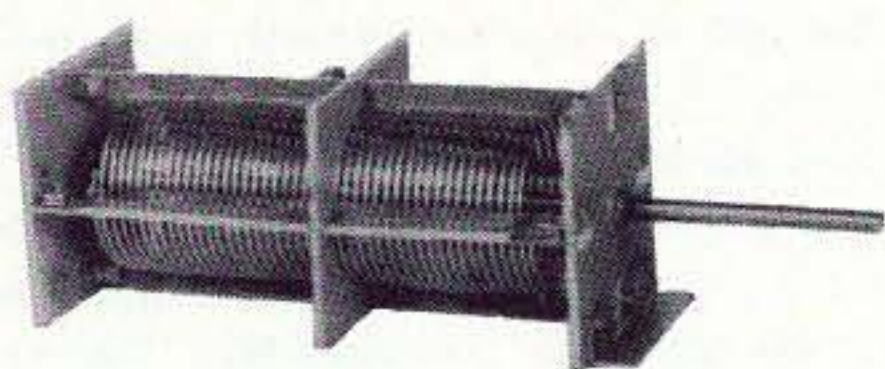

MFJ-969's AirCore™ Roller Inductor, three-digit turns counter and spinner knob gives you exact inductance control for absolute minimum SWR.

MFJ's exclusive AirCore™ Roller Inductor has an air core that can't burn up! You get ultra high-Q, the lowest loss, highest efficiency and highest power handling of any roller inductor in ham radio.

MFJ's exclusive Self-Resonance Killer™

## MFJ-989C world famous 3 KW Antenna Tuner



MFJ-989C **\$349<sup>95</sup>** More hams use MFJ-989s than any other 3 KW antenna tuner in the world!

The rugged MFJ-989C handles 3 KW PEP SSB and covers 1.8 to 30 MHz including all MARS and WARC bands.

Match dipoles, verticals, inverted vees, random wires, beams, mobile whips, shortwave -- nearly any antenna. Use coax or balanced lines.

MFJ's new AirCore™ Roller Inductor, three-digit turns counter and spinner knob gives you exact inductance control for absolute minimum SWR. It has an air core that can't burn up! An exclusive Self-Resonance Killer™ removes damaging self resonances.



keeps potentially damaging self-resonances away from your operating frequency.

Large self-cleaning wiping contact gives you excellent low-resistance connection without contact arcing or burning.

Solid 1/4 inch brass shaft has self-align bearings for smooth non-binding operation.

**Covers 6 Meters thru 160 Meters**

The MFJ-969 covers all frequencies from 6 Meters through 160 Meters, including the "magic band" -- the widest matching range of any full featured antenna tuner.

**Match any Antenna**

You can match dipoles, verticals, inverted vees, random wires, beams, mobile whips, shortwave receiving antennas -- nearly any antenna. You can use coax cable or balanced feedlines. Has heavy duty 4:1 balun.

**Lighted Cross-Needle Meter**

MFJ's lighted Cross-Needle Meter shows you SWR, forward and reflected power simultaneously. It reads true peak forward power and average power on 300 watt or 30 watt ranges.

Meter light has ON/OFF switch and requires 12 VDC or 110 VAC with optional MFJ-1312B, \$12.95.

**8 Position Antenna Switch**

MFJ's 8 position antenna switch lets you

select two coax fed antennas, random wire/balanced line or built-in dummy load for use through your MFJ-969 or direct to your rig.

**QRM-Free PreTune™**

MFJ's QRM-Free PreTune™ lets you pre-tune your MFJ-969 off-the-air into a built-in dummy load without causing QRM.

Pre-tuning into a dummy load makes tuning your actual antenna faster and easier.

**Full Size Dummy Load**

The MFJ-969 has a full size non-inductive 50 Ohm dummy load.

You'll find it handy for tuning, testing and repairing your rig, setting power level, adjusting your mic gain and more.

**Superior Cabinet**

Each MFJ-969 cabinet has a new tough scratch-proof vinyl cladding. You won't find a tougher, longer lasting finish anywhere. Measures 3 1/2 x 10 1/2 x 9 1/2 inches.

**No Matter What™ Warranty**

Every MFJ-969 is backed by MFJ's famous one year No Matter What™ unconditional warranty. That means we will repair or replace your MFJ-969 (at our option) no matter what for a full year.

**Call your dealer for your best price!**

## MFJ versatile 1.5 KW Tuner



MFJ-962D **\$249<sup>95</sup>** Use your barefoot rig now and have capacity to add a 1.5 KW PEP SSB amplifier later! Lighted Cross-Needle SWR/Wattmeter. 6 position antenna switch, Teflon® wound balun, ceramic feedthru insulators for balanced lines. 1.8-30 MHz. 10 3/4 x 4 1/2 x 14 7/8 in.

**Free MFJ Catalog**

Nearest dealer/Free Catalog... 800-647-1800

<http://www.mfjenterprises.com> FAX: (601) 323-6551  
•1 year unconditional warranty •30 day money back guarantee (less s/h) on orders from MFJ •Add s/h

**Our 25th Year!**

**MFJ** MFJ ENTERPRISES, INC.  
P.O. Box 494, Miss. State, MS 39762  
(601) 323-5869; 8-4:30 CST, Mon-Fri  
Technical Help: (601) 323-0549  
E-Mail: [mfj@mfjenterprises.com](mailto:mfj@mfjenterprises.com)  
Prices and specifications subject to change. ©1997 MFJ Enterprises, Inc.

**MFJ... the world's most trusted name in antenna tuners**

## A QSL for Chuck

Chuck:

Hi! How you doing? Hey! Thanks for the contact on the *Mir* repeater last Thursday! I have a great story to go with it.

I saw a short story on the Colorado AMSAT Net Web page. It said that Chuck KIØAG had worked *Mir* on a rubber duck! That gave me all kinds of hope to work the *Mir* repeater on my HT with my home-brew yagi.

When I returned home after reading the Colorado AMSAT Web page at the Salt Lake City Library, I started to program my FT-530 for the *Mir* space station repeater frequency. I went into VFO (A) and programmed the uplink frequency with the 141.3 PL tone. Then I went to VFO (B) and I programmed the downlink frequency. My plan was to toggle back and forth as I worked the Doppler shift with the arrow keys. Not a bad plan for a first attempt. This could work, if I didn't lose my place making the up- and downlink Doppler shifts.

I checked the latest Sat-Track prediction for the *Mir* space station. I found that the best pass for my location in Salt Lake City, Utah, was at 1241-1252 UTC, local time 5:41 a.m. through 5:52 a.m. at a maximum elevation of 45.4 degrees. This would be the best pass of the day. "I wake up at 5:30 a.m. every day anyway," I thought. "No problem for me to work this pass. I'll still have time for a donut!" Yeah, right.

Well, at 5:00 a.m. I woke up and was still very tired. Knowing that my alarm was still set for 5:30 I went back to bed. At about 5:37 the alarm clock finally woke me up. I got up and let the dogs out. It was now about 5:40 a.m. I was still not dressed when I let the dogs back in. That's when I saw the clock in my ham shack. It was 5:43 a.m. *Mir* was up—and I was not!

I grabbed my FT-530 and quickly put on a fresh battery. I slipped on my shoes without tying them. I headed out the front door of my house, then ran back into the house to get my truck keys. My five-element yagi was on the front seat of my pickup truck and if I were going to make this pass work, I needed it. I opened the door of the pickup. I quickly connected the coax cable to the HT and turned it on. That's when I heard, "KIØAG."

"It's Chuck!" I said to myself. My antenna was still flat on the seat of my truck! I quickly pointed the antenna straight up into the dark sky. I toggled to VFO (A) and I called, "KIØAG, KC7QFS, Hi Chuck from Paul." I toggled back to VFO (B) but I didn't hear anything. I waited for what seemed like one or two minutes (but it was really about 10 seconds), then I remembered to make a Doppler shift

on the downlink. I quickly made a Doppler shift, toggled back to VFO (A) and made another Doppler shift. Then I called Chuck one more time and toggled back to VFO (B). That's when I heard Chuck say "KC7QFS, KIØAG." It was about 5:48 a.m.

I walked out of the driveway into the street to get a better line of sight with the *Mir*. I looked up into the clear November sky. I could see the space station *Mir* moving across the blackness. Pushing the VFO and making other Doppler shifts was failing as *Mir* moved behind the mountains.

But I did it! I worked the *Mir* repeater with my friend Chuck at his home in Colorado! Plus, I did it with an HT on only two watts!

I was doing an end-zone dance in the street. It was then I realized I was still in my pajamas with a radio in one hand and a five-element yagi in the other—and a single thought in my head: Did I lock myself out of the house?

Yes, I once worked the *Mir* in my pajamas! How it got in my pajamas, I'll never know ... *with apologies to Groucho Marx.*—de Paul Michelsen KC7QFS.

## Ham RF Exposure Guidelines (Effective January 1, 1998)

The FCC has published OET Bulletin 65, Evaluating Compliance with FCC Guidelines for Human Exposure to Radiofrequency Electromagnetic Fields, Edition 97-01, August 1997. Supplement B, "Additional Information for Amateur Radio Stations," was available in November.

For the latest news and linkage to related Web sites, visit the ARRL RF-Safety Web page at [<http://www.arrl.org/news/rfsafety>]. To obtain the FCC documents refer to the FCC site at [<http://www.fcc.gov/oet/dockets/et93-62/>] and go from there.

As part of the implementation of these new guidelines, there is a new Form 610 series, dated Sept. 1997. There are three new forms in this series: Form 610 is for basic transactions, Form 610-A is for operating privileges for foreign nationals, and Form 610-B is for club stations. These new forms must now be used for all licensing transactions (as of January 1, 1998). The new forms all contain a statement to the effect that the applicant understands and complies with the new RF Safety Regulations. The new Form 610 series can be obtained on the FCC WWW site at [<http://www.fcc.gov>]; the ARRL Web page at [<http://www.arrl.org>]; by contacting the FCC Cen-

tral Phone Service at 1 (888) CALLFCC (225-7245); by writing the FCC at 1270 Fairfield Road, Gettysburg PA 17325-7245; or by contacting the ARRL.

There are several key dates to remember.

1. New licensees after January 1, 1998, must be in compliance with the new regulations at the time of first licensing. That is, the applicant will certify compliance by the act of signing off on the new 610.

2. All those licensed prior to January 1, 1998, will have to be in compliance with the new RF exposure regulations whenever a new Form 610 is filed for license renewal, upgrade, or other modifications.

3. All stations, new or old, must be in compliance with the new regulations no later than September 1, 2000. This date must be met whether a Form 610 has been filed previously or not.

From an article in December 1997's *MarcKey*, newsletter of Manteca (California) ARC.

## Lack of Interest?

While conducting a study of sexual behavior, a researcher interviews an amateur radio operator.

"Can you tell me when you last made love?" she asks.

"Nineteen fifty-nine," he answers.

Having heard something of the lack of interest in sex prevalent among amateur radio enthusiasts, the researcher is sympathetic. "That's an awfully long time!" she says.

"I suppose," says the ham, glancing at his watch, "but it's only twenty-one fifteen now."

From ARNS Bulletin, January 1998.

## The Doctor is Destinated: More Questions & Answers for the New Ham

**Q.** An antenna expert told me that the best antenna for my ham is a thing called a die pole. He explained how to make it even better by adding extra elements, but I can't figure out how to connect them.

**A.** Actually, if it has more than two elements it is no longer a dipole. Much less a die pole. The easiest thing to do would be to get your wife to hold a third element in close proximity to the center of the antenna formerly known as a dipole. She will most certainly resonate when you transmit, which is why this type of antenna is known as a naggi.

**Q.** In building a kit, how do you know which component is which and where it goes on the printed circuit card?

**A.** It's a lot easier than it looks. Just put components anyplace where they will fit. When you're finished you will have to send it back to

the manufacturer to get it fixed anyhow, so why waste a lot of time?

**Q.** I've just bought a new whip for my mobile ham. A friend told me it probably needs to be swarred in. How do I do that?

**A.** I bet your friend has a CB, right? We frown on CB talk here in the ham community. The correct terminology is VSWR, pronounced "V-S-W-R" for "vertical standing wave ratio," or "S-W-R" for short. This is the ratio of the standing waves (on the transmission line) to unity, or the input power. To measure them, try operating while you are standing vertically. If you hit the repeater better than when you are sitting, then you need to adjust your height. If you are hitting it about the same, then your VSWR is OK and your antenna is VIZ-WARRED in.

Each month the Doctor will answer the most interesting questions from readers. Questions may be edited for length and clarity, which is why many of them disappear altogether. Address your questions to the Doctor in care of this publication.

Author anonymous, TNX Low Down, official journal of the Colorado QRP Club [cq@aqc.com].

## Top 10 Reasons to Operate QRP

10. The power output will match your 10-foot whip.
9. You can't afford a big amplifier.
8. Your hearing aid battery will run your rig.
7. You joined Big Guns Anonymous.
6. Your whole rig will fit inside your microphone.
5. RF burns will heal quicker.
4. "That's not a lapel pin—that's my rig!"
3. You can still have fun during an emergency.
2. People can get "up close and personal" with their speakers.
1. You can operate from all 10 "most wanted" DX countries!

TNX Dennis W. Murphy KB6LZW.

## So You Think KDKA Was First?

Most people believe that the first commercial AM station was KDKA in Pittsburgh—when Frank Conrad 8XK started playing records on the air for his friends and neighbors back around 1920. KDKA may have been the first station to receive a commercial broadcast license, but there was a thriving commercial station in existence 10 or more years before the government began regulating radio.

This station was in San Jose, California. It began broadcasting in 1909, using a crude spark transmitter. When it received its formal call letters

it became 6XE, later KQW. Today it is KCBS, San Francisco.

Dr. Charles Herrold ran a radiotelegraph school in San Jose. In 1909 he began a regular schedule of voice and phonograph music to call attention to his school. His broadcasts, in those pre-vacuum tube days, were received by the same crystal sets used to receive spark gap Morse code.

By 1911, Dr. Herrold had developed a quenched spark generator consisting of a copper tube surrounding a precision-machined carbon rod. He immersed this spark gap in alcohol and he water-cooled the entire device. He applied modulation with a multiple-element, water-cooled carbon microphone in series with the high voltage supply.

Because of the alcohol bath and precision tolerances the arc carrier wave produced by this transmitter was considered to be exceptionally pure. One person described the signal as being inaudible unless modulation was applied.

Voltage for the transmitter was—at first—stolen, via a hooked stick, from a 600 VDC trolley line running outside a second floor window. Later, the trolley company installed permanent service to the station along with an electric meter. At one point, Herrold said, his transmitter consumed 9 kW from the electric supply.

Dr. Herrold kept up a regular schedule of music and news for over a decade. Besides broadcasting to the ham radio operators, he established a public listening hall several miles away in downtown San Jose. Since the loudspeaker had not yet been invented, people listened to his broadcasts on telephone handsets located throughout the hall.

Dr. Herrold's operation had all the trappings that distinguish a commercial broadcasting station. A local phonograph store supplied popular records for him to play on the air in return for mentioning the source of the records. Local musicians sang and played songs over the air. Dr. Herrold read news from the local paper. He sold cash advertising to department stores and food markets. He documented the size and location of his audience by inviting listeners to write in for a gift certificate that could be redeemed at a merchant near the listener. Over 4000 of these certificates were distributed. One of his sponsors, a candy company, promoted a specific type of candy on his programs. They claimed the sale of this item increased not only in San Jose, but in communities all up and down the Pacific coast.

These broadcasts developed enough of a reputation that when Dr. Lee deForest was unable to get his vacuum tube transmitter operating in time for the 1915 San Francisco Pan-Pacific Exposition, he used Dr. Herrold's transmissions—almost 50 miles distant—to demonstrate his new vacuum tube receiving apparatus. Throughout the run of the fair, Dr. Herrold's station was on the air at least eight hours a day.

Unfortunately, Dr. Herrold's apparatus would not function at wavelengths below 600 meters, so when the FRC established the present AM broadcast band in the 1920s, Dr. Herrold gave the KQW license to others who had sufficient

capital to purchase new Western Electric™ equipment. At first it was used by the First Baptist Church of San Jose to broadcast its Sunday services. Later, the station added farm and agricultural news to the schedule. In the 1940s, KQW was sold to the CBS radio network and in 1951 it became KCBS.

Author's Note: This information comes from a collection of Dr. Herrold's papers that I found at work, compiled and published by a journalism professor in San Jose. The reference is *KCBS—Broadcasting's First Station, Records and Documents Supporting the Claim by Charles D. Herrold that He Established the World's First Radio Station in San Jose, California, in 1909, which is now KCBS.*

This article, by Lou Schneider N6YMQ, appeared in the September 1995 *GEARS Newsletter*, and was reprinted in the *ARNS Bulletin*, April 1997.

## Spark Gap Cure Outlawed

Treating pain with a spark gap transmitter is illegal. So said federal officials who have halted sales of a device called The Stimulator.

The Stimulator was advertised on television as a pain reliever. The US Attorney's office contended that the apparatus is essentially a camp stove igniter that emits nothing more than an electrical spark.

But a spokesman for a firm that distributed The Stimulator claimed that it emits a charge to provide electromagnetic stimulation and that testimonials from customers say it does alleviate pain. The government did not buy the explanation or the testimonials. It declared that a spark gap will not cure any ills and ordered sales of the item halted immediately.

Via FCC Press Release; *Harmonics*, June 1997. 73

### WANT TO LEARN CODE?

**Morse Tutor Gold from G.G.T.E. is the answer for beginners and experts alike.**

\*Get the software the ARRL sells and uses to create practice and test tapes; and **Morse Tutor Gold** is approved for VE exams at all levels.

\*Since 1987, GGTE has guided nearly 20,000 hams and prospective hams around the world through proven structured lessons and a variety of character, word and conversation drills. Straight forward menus make the process simple and fun.

\*This program features easy and speedy self installation; random character drills with the characters you select; and you can create your own drills or import text files. You can type what you hear or copy by hand and see the results one line at a time. Pick the Farnsworth or the standard method; select the tone frequency most comfortable for you or select your code speed in tenths of a word per minute. For all DOS computers. You are always in command.

**Certified by**



**Morse Tutor Gold** uses your internal speaker or sound board. And, if you use a sound board **Morse Tutor Gold** supports volume control.

Sound Blaster and the Sound Blaster Compatibility Logo are trademarks of Creative Technology Ltd.



Available thru dealers, the ARRL, or send \$29.95 + \$4 S&H (CA residents add \$2.32 tax) to: GGTE, P.O. Box 3405, Dept. MS, Newport Beach, CA 92659 Specify 5 1/4 or 3 1/2 inch disk.

CIRCLE 193 ON READER SERVICE CARD

# Truckez-Vous Mon Boat?

*Ham friends to the rescue for Voyageur.*

Sam Ulbing N4UAU  
5200 NW 43rd St.  
Suite 102-177  
Gainesville FL 32606  
[n4uau@afn.org]

These days, I can't believe I ever went sailing without a ham radio on my boat—like I did for a few years when I was not a ham. Fortunately, in 1997, when I started a planned 2000-mile cruise down the St. Lawrence River via Halifax, Nova Scotia, to the Chesapeake Bay, I did have a ham rig. My trip turned out to be a disaster, but the support of my many ham friends kept it from being worse.

The trip started on June 9, 1997, but the background for it had developed even before I was a ham. My wife Lee KD4DZX and I had retired on our Cape Dory 40 in 1986 and headed south. The first couple of years, we sailed and made many friends, but we were always sad when we parted since we knew we would probably never see them again. In 1987, we tried to sail from the Bahamas to Bermuda, a five-day ocean passage, where we were to meet a friend who was flying in. The weather turned bad, though, and we had to change our landfall to the USA. All the time, we were fruitlessly trying to use VHF to get a message to the friend that we weren't going to arrive in Bermuda. Obviously, no one heard us 300 miles out to sea!

Then, in the winter of 1987-88 in the Bahamas, I met Bob KA3OCS, sailing the *Malulani*, who dramatically changed my boating life. Bob showed me how he was able to keep daily contact with friends back home on his ham radio. More important, he showed me that I could get vital information from a place called the Waterway Net—weather reports which were not available on VHF in the Bahamas, due to the remoteness of most of the islands, and the latest information on customs procedures.

[The Waterway Radio and Cruising Club meets at 0745 Eastern time on 7268. For more information, contact Club Secretary Peter Nevins N3BBB at 1693 Anne Court, Annapolis MD 21401-6512 (SASE is nice) or E-mail petenevins@aol.com. The CW net meets on 7128 at 0700 and is less formal.]

Twice I heard a ham relaying life-saving information to a Coast Guard helicopter. In one case, a person had been severely injured by an outboard motor—but with the help of hams he was quickly evacuated by helicopter. The other case was a ruptured appendix. Far from the nearest town, the person might have died if the Waterway

Net had not been there to organize help. I was convinced.

Although I had wanted to be a ham since the 8th grade, I had never got around to doing it. I realized it was time to get in gear. That summer I worked on my code. It was not easy, but I persevered and in July 1988 passed my Novice (KC4GJZ)—only to learn that if I wanted a reciprocal license to operate in the Bahamas, I had to have a General ticket. *Help!*

I knew the theory would not be a problem, but could I make 13 wpm by November, when we were due to leave? Out with the tapes, boring; better was W1AW—at least it had stories that were interesting. Memorizing has never been my strong point. I knew I had to do more. So I made the ultimate sacrifice: I got the key out and got on the air! I recall that first QSO—Lee says she thought I was going to die of a heart attack I was sweating so much and breathing so hard. I had written down what I had planned to say:

“GM, my name is Sam. My QTH is Naples FL. Your RST is nnn” ... a chance to ad-lib!

It worked great, except my first contact was with KA3OUL, from Mars,



# Wireless Video Headquarters



## The Cube



### World's Smallest TV Transmitter

Perfect video transmission from a transmitter you can hide under a quarter and only as thick as a stack of four pennies- that's a nickel in the picture! Transmits color or B&W up to 150' to any TV tuned to cable channel 59 with a solid 20 mW of power. Crystal controlled for no frequency drift with performance that equals law enforcement models that cost hundreds more! Deluxe model includes sound using a sensitive built-in mike that will hear a whisper 15 feet away! Units run on 9 volts and hook-up to most any CCD camera. Our cameras shown below have been tested to mate perfectly with The Cube and work great. Fully assembled.

- C-2000 Video Transmitter Cube.....\$89.95**
- C-3000 Video and Audio Transmitter Cube.....\$149.95**



### CCD Video Cameras

If you're looking for a good quality CCD board camera, stop right here! Our cameras use top quality Japanese Class 'A' CCD arrays, not the off-spec arrays that are found on many other cameras. You see, the Japanese suppliers grade the CCDs at manufacture and some manufacturers end up with the off-grade chips due to either cost constraints or lack of buying 'clout'. These cameras have nice clean fields and excellent light sensitivity, you'll really see the difference, and if you want to see in the dark, these are super IR (Infra-Red) sensitive! Available with Wide-angle (80°) or super slim Pin-hole style lens. Both run on 9 VDC and produce standard 1 volt p-p video. Add one of our transmitter units for wireless transmission to any TV set, or add our Interface board (below) for Audio sound pick-up and direct wire connection to any Video monitor or TV video/audio input jacks. Fully assembled.

- CCDWA-2 CCD Camera, wide-angle lens.....\$99.95**
- CCDPH-2 CCD Camera, slim fit pin-hole lens.....\$99.95**

### CCD Camera Interface Board

Here's a nifty little kit that eases hook-up of your CCD camera module to any video monitor, VCR or video input TV set. The board provides a voltage regulated and filtered source to power the camera (CCD Cameras require a stable source of power for best operation), sensitive electret condenser mike for great sound pick-up and RCA Phono jacks for both audio and video outputs. Runs on 11 - 20 VDC.

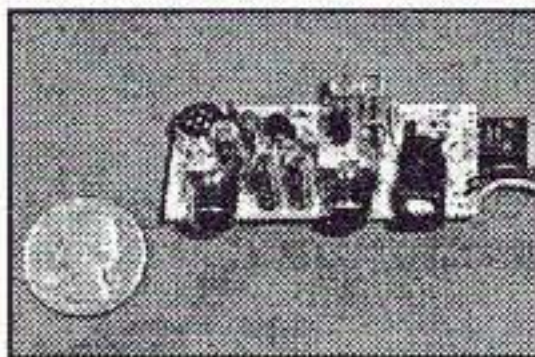

- IB-1 Interface Board Kit.....\$14.95**

### Budget TV Transmitter



Transmit audio and video to any TV set with this fully assembled transmitter. Although not tiny, it still offers some neat features. Takes standard 1 volt p-p video and audio and transmits on any UHF TV channel of your choice from 17 - 42. Has rugged metal case, includes AC adapter, whip antenna and even RCA phono plug patch cords! Can also run on 12 VDC.

- VS-2 Video and Audio Sender, Fully Assembled.....\$29.95**

### IR Illuminator for CCD Cameras

See in total darkness with one of our CCD video cameras and this IR illuminator! IR light can't be seen, illuminate the scene with IR and a CCD camera 'sees' just fine. The array of 24 extra high intensity LEDs are invisible to anybody - except for aliens and Casper! Runs on 12 VDC. Illuminates similar to that of a bright flashlight.



- IR-1 IR Illuminator Kit.....\$24.95**

### MicroEye CCD Camera & Transmitter Combo

We married together one of our quality CCD cameras, a sensitive electret microphone and a small TV transmitter to give you a super neat - and tiny - all in one, 'knows all, sees all, hears all' package! Small enough to fit into a cigarette pack and powerful enough to transmit up to 150' to any standard TV set. Tunable to operate on TV channels 4, 5, or 6 and runs on 9 to 20 VDC. The sensitive mike picks up normal voice within an average size room. Ideal for private detectives, investigators, hobbyists, babysitters, model rocketeers, RC airplanes and other uses limited only by your imagination. Camera module is fully wired and the transmitter unit is an easy to build kit that goes together in an evening. Includes all parts, handsome jet-black case and clear, concise instructions with ideas for use. And, don't forget, our CCD cameras are very sensitive to IR light - just add the IR-1 IR Illuminator kit for see-in-the-dark operation!



- ME-2000 MicroEye TV Transmitter Combo .....\$149.95**

### Wavecom Wireless Video and Audio Transmission System

Transmit extremely clean and sharp video and audio up to 300 feet. Wavecom transmits in the 2.4 GHz band using FM and circular polarization for state-of-the-art transmission. There is no fading, ghosting, humming, buzzing or picture rolling when using the Wavecom. System consists of two parts, a transmitter unit and a receiver unit. Switch selectable 4 channel operation allows use of multiple Wavecoms in the same geographic area. Connections are video and audio in and out using standard RCA phono jacks. Includes AC wall plug adapters, patch cords, coax cable jumper, TV antenna A/B switch and complete hook-up instructions. Fully assembled with one year warranty.



The Wavecom Sr. has all of the features above plus adds the capability of transmitting your TV/DSS/VCR remote control signals from the receiver unit back to the transmitter unit. This is great for controlling your DSS satellite receiver or VCR from any room in the house. We also offer the small internal transmitter module assembly for those who wish to make their own concealed video transmitter system. Module is about the size of a couple of matchboxes and includes microwave patch antenna.

- WC-1 Wavecom Jr. Wireless System.....\$189.95**
- WC-5 Wavecom Sr. with Remote Capability.....\$239.95**
- WC-TX Transmitter Module Assembly.....\$105.00**



## RAMSEY ELECTRONICS, INC.

793 Canning Parkway Victor, NY 14564

Call for our free catalogue or visit us on the web: [www.ramseyelectronics.com](http://www.ramseyelectronics.com)

**Toll-free Order Service: 1-800-446-2295**

Sorry, no technical info or order status at this number

**For Tech Info or Order Status, Call the Factory Direct**

**Phone (716) 924-4560**

**Fax (716) 924-4555**



**ORDERING INFO:** Satisfaction Guaranteed. Examine for 10 days, if not pleased, return in original form for refund. Add \$5.95 for shipping, handling and insurance. Orders under \$20, add \$3.00. NY residents add 7% sales tax. Sorry, no CODs. Foreign orders, add 20% for surface mail or use credit card and specify shipping method.



Pennsylvania, and naturally that entailed a joke about being in Pennsylvania and not on the planet. Whoa, there: No one said Novices had to copy jokes. Did he say the planet Mars? Thank goodness for QRN; I did a hasty "Sri no CPI, QRN, 73" and went for an Extra-Strength Tylenol™! But I hung in, finally passed the General test and began to enjoy the benefits of ham radio. Little did I realize the dividends that would accrue for my trip in 1997.

*From the log of Voyageur:*

*June 9, 1997, 0855: "Cleared Sodus Bay harbor, set sails, doing 5 knots."*

I planned to spend several days sailing from Sodus Bay NY to Kingston, Ontario, where I would pick up George W2TOH and Mimi N2RNC, and then head down the river. This would give me a few days to finish the jobs I had postponed when I suddenly had to fix a sick starter two days earlier. The boat was bristling with ham gear: two two-meter rigs, my HF rig, and two QRP rigs which I hoped to use when I got to the islands of the Gulf of St. Lawrence.

The sail across Lake Ontario was pleasant, a nice light breeze and clear skies. It was a good start because Lake Ontario can be very rough—more than one boat has sunk there. In June fog is common but that day it was not very



**Photo A.** W2TOH loading assorted antenna parts.

thick, so it was easy to spot the freighters crossing my path.

George, at his cottage in the Thousand Islands, and I maintained a regular sked on the Watertown (New York) repeater. I have found that on Lake Ontario, two meters is much more useful than marine VHF for a number of reasons. In general the average ham is a better, more polite operator, and the frequencies are often less crowded. On eastern Lake Ontario the most important reason is the existence of the Watertown repeater. While this repeater is located several miles inland, its antenna is 2000 feet high. This meant that with my 55-foot-high mast-head antenna I was able to reach it wherever I sailed on the east end of the lake. [My two-meter (and marine VHF) antenna is a home-brew ground plane vertical copied from the ARRL *Handbook*. I have used it for five years now, and find it works as well as the expensive commercial ones.]

Marine VHF communications with land stations, on the other hand, was limited. Only the Coast Guard has antennas high enough to pick up my signal in the middle of the lake, but of course they don't handle "idle chit-chat"—just life and death emergencies. Also, I could not file a float plan with them, but was encouraged to call them if my boat started to sink!

I wanted a better way to stay in touch with the world while I was out of sight of land, so I filed my float plan with George and checked in with him every two hours. I knew if I had a problem I could call on 147.255+ and even if George was not by the rig, there were lots of other hams listening who would relay a "MAYDAY" if it came to that.

The two-meter rig is a reassuring piece of gear on a boat. I found I was also using mine for planning purposes. My starter problem two days earlier looked like it might delay the schedule for picking up George and Mimi. Although I was not near a phone, I apprised George of this during our regular morning sked. He knew everything that was going on almost as soon as it happened.

Part of my routine on longer cruises is to give a position report at least

weekly to the Waterway Net on 40 meters. This net was started to serve boaters in the southeastern USA and Bahamas. Now, more and more of its thousand-plus members are going elsewhere but still want to keep in touch. One day, after I had checked in to let the net know I was about to start my trip to Nova Scotia, I got a call from Randy NØILI, on *Oui Si*. I hadn't seen Randy since the Bahamas in 1993. He said he was sailing along the East Coast and expected to be in Nova Scotia around mid-August. Would I be there then? How nice! Here I was going single-handed to a distant place, and already a rendezvous was set up with an old friend!

Ham radio was also the reason George and Mimi would be going along. George had been a work acquaintance in 1979, but had retired and I had not seen him for years. One day in the Bahamas, we met a boat and got to chatting with its non-ham owners. When they learned we were originally from Rochester NY, the inevitable question was asked: "Do you know ... ?" This time we did! I told them I had known George since before I was a ham, and would they please let him know my call? A week later, George called me on the net and we reestablished our friendship. When I moved the boat to Lake Ontario, we talked daily on two meters and became good friends.

The St. Lawrence River is about 600 miles long and drains the Great Lakes into the North Atlantic via the Gulf of St. Lawrence. Halifax, Nova Scotia, where I planned to meet Lee for vacation, is 400 miles farther. The river starts out only a few miles wide, but with a strong current and much commercial traffic.

Any ship wishing to go to a port on the Great Lakes must use this river. By the time it enters the Gulf, it's 60 miles wide. In the first 180 miles downriver to Montreal, there are seven locks designed for oceangoing ships. Small boats are allowed to use the locks, but few concessions are made to these littler vessels.

It is advisable to have three people on board: two to handle the lines and one to run the boat. George and Mimi

were to go as far as Quebec City, 150 miles downstream from Montreal where the river starts to widen. They would be line handlers, and George had the additional title of radio officer.

While my two-meter antenna worked well, my HF antenna left something to be desired. I had never chosen to cut my backstay to make it an antenna, because I felt it was not wise to tamper with a major piece of structural gear (although many do with no problem). But I knew many boats with vertical backstay antennas and weak signals, so I had settled on a coax-fed inverted vee hoisted partway up the mast. It was neat and worked well on 40 meters, but was useful only at anchor. Further, it was very weak on 80 meters even though it tuned up. Several of my friends wanted to follow me on this trip. I needed a better "underway" antenna that would work on several bands.

At George's suggestion, I tried a ladderline-fed dipole cut at about 40 feet. Why 40? Why not? It was a nice length. I have a tuner on board so I could match the antenna, and I had found calculations of antenna length did not mean much on the boat. The metal rigging changes everything. My old inverted vee had the lowest SWR when it was about 26—not 33—feet long. Using a ladderline feed greatly improved the 80-meter signal. The fact that the ladderline runs inside along the boat's hull to the stern did not appear to hurt the signal. I hoisted one leg of the dipole with a lead from the top of the mast and ran the other along the deck. This "lazy inverted vee" worked and became my ship's antenna.

George also worried about my ability to communicate if I lost my mast or if the antenna wire broke and, since I planned to do most of this trip alone, he wanted an antenna that was simple to put up. He loaded a flock of Hustlers and other parts aboard the boat (Photo A) and said he would concoct the "Foxhole Antenna" during the trip.

My planned trip required many charts. I owned 150 but needed four more. One reason for going to Kingston was to meet up with John VE3LGS, on *Tumblehome*, whom I had met via the Waterway Net a couple

of years earlier. John had a friend who had the charts I needed and would let me borrow them. Charts are a major investment for sailors, at \$15 each, and I was glad not to have to buy them, since I would pass through the area they covered in less than a day.

*June 13, 1500: "Anchored in Kingston harbor. Will clean boat, cash travelers' checks, review plans with Mike."*

Kingston is a lovely tourist town with lots of sights, restaurants, and entertainment. It is also home for Mike VE3MBV, on *Ben-Varrey*. I had first met him and his XYL, Ursula, in Marsh Harbour, Bahamas, when I needed to fix a rip in a sail. Ursula had a sail sewing machine on board and offered to do it. Now Mike was taking me to the store for groceries. Perhaps he had an ulterior motive, as he was scheduled to be my crew from Halifax to Maine later in the trip.

While waiting in Kingston, I noticed a boat with an unusual antenna system on the stern (Photo B) so I dinghied over and met Fern VE2FSP, on *Robin Hood* out of Montreal. He showed me his home-brew 20-, 15-, and 10-meter dipole, which he could fold up out of the way, or let the arms down to use. As soon as Fern learned I was going downriver, he brought me aboard so he could point out some good places to know about on the trip.



*Photo B. VE2FSP with Robin Hood and its folding dipole antenna.*

*June 15, 1000: "All provisioned, charts on board, fueled up. George and Mimi due to board at noon and we will head downriver."*

Sailing through the Thousand Islands is one of the wonders of the world. If you haven't done it I recommend it (there are many tour boats and places to rent boats). Operating /MM is fun and for US citizens a reciprocal is not needed—just be sure to add /VE3 to your call. It took full attention



*Photo C. Bluenose II—or floating antenna towers?*

to control the boat through some of the narrow spots with swirling currents and it made me wonder how the early explorers ever got up the river without motors. That night we "dropped the hook" in a quiet cove and used the Watertown repeater to let VE3LGS know our QTH and that all was okay. The next day we'd be out of range of it and depend on HF.

The next few days we motored or sailed down the river, past towns, some big and busy, but most small and sleepy. Always lots of current. My boat only does about six knots, but we found that a two-knot current helped us to make many miles each day. Along the way we passed the *Bluenose II*, a replica schooner from Lunenburg, Nova Scotia, that was on a special tour of Canada. I looked at its two 90-foot-high masts and couldn't help wondering how an antenna would work up there (Photo C).

We settled into a daily routine. In the morning I'd pass our position and status usually to the Waterway CW net and in better conditions also to the SSB net. I generally preferred CW because it is more fun and in last summer's conditions was more reliable. Ed AD4FJ, whom I've known for several years and have yet to meet, would E-mail my status to Lee. (Will she ever learn CW and upgrade her Codeless Tech, so we can talk directly? Not to put the pressure on or anything ...)

Much of the time, George was busy working on his "Foxhole Antenna." If I understood all his technical jargon, it was a like a dipole but made with two Hustlers. "After all, a Hustler is a resonant device like a wire but a lot shorter." The idea was to use one Hustler as a vertical antenna and the other as a horizontal counterpoise mounted with a bracket on the stern rail.

He would have preferred to mount both horizontally at the top of my mast, but the tradeoff of using the mast for sailing purposes instead of an antenna tower won out! George spent a lot of time tuning for the frequencies I needed, and he used my new "Voltage Booster" (as described in my July 1997 *QST* article) to power his test

gear so that he didn't have to run a 12-volt extension cord. George tried to make the antenna "idiotproof" by marking the exact lengths of the whips. He told me this was so that in an emergency I would not have to think, but I wondered if there was another message there about my antenna skills!

*June 18, 0630: "Near Trois-Rivières—Forward water tank empty but we will be in Quebec City tonight."*

We knew we were in Quebec province now because almost all the VHF traffic was in French. The current and wind were strong, causing big waves, and we were motoring into the wind. One of the classic places to "use caution and go through only in good weather" is the Rapids Richelieu. Here a rock bar lies across the river. A channel has been dredged out of the rock and all the current funnels through it.

---

***"Perhaps the best solution was just to ship the boat to Chesapeake and have it fixed there."***

---

*June 18, 1100: "Hard going in the waves. Good to have a faithful engine."*

At 1300, disaster strikes! The transmission breaks. One minute the boat was moving and the next we were drifting toward the shallows. Quickly George took the wheel, while I went forward to get some sails up so we could at least maneuver to avoid the shallows. I called the Canadian Coast Guard on VHF (fortunately their operators are bilingual) and they arranged for a tow into Quebec City. Repairs took a week and cost a lot of money, so I was feeling pretty low. But George and Mimi were determined to keep my spirits up, and they took me on a tour of old Quebec. On Friday, they had to leave and I was on my own.

Peter, a local sailor I had met, took me to a bank so I could get some money for grocery shopping. They needed to see my driver's license, and that's when disaster struck again: I had lost it! I remembered that the last time I used it was at the bank in Kingston so I called VE3MBV and asked him to check. The next day on 7268, I learned "no

license." Oh, boy, first the starter, then the transmission, now the driver's license. Surely this is the end of it. But ...

*June 24, 0800: "Underway again. Peter sailing with me to Gros Caucona."*

The weather was nice, but there was no wind so we motored all the way. It was midnight and pitch-black dark when we motored through the Traverse de Saint-Roch. It is in this very narrow part of the river that the current is its strongest, up to eight knots. That's faster than I can motor, so I was using my GPS and radar as well as eyeballs to make sure I did not stray out of the channel.

*June 25, 0400: "Arrive at Gros Caucona. Temperature 49 degrees."*

That afternoon as Peter climbed up to the dock to catch his ride home, he said, "Now that you're into the saltwater part of the river, you're going to find it is a lot colder and foggier." Oh, great!

*June 26, 0800: "18th day of the trip and all alone. Sunny and warmer with wind forecast NW 10 to 20. Should be good sailing. Had good SSB with George on 7220 and Mike on 7055 (I am /VE2 so 7055 SSB is okay). Also a nice CW with Kitty KD3UL; she will E-mail Lee. Expect to leave at 9 a.m. with a fair tide."*

For the next three weeks I would be sailing alone, in open waters with harbors far apart, on a part of the river that was cold and foggy. Ham radio would be my main method of contact with the outside world. I was nervous but excited as I motored out of the harbor and slowed the motor to 1200 rpm so I could hoist the sails.

Disaster strikes again! The motor takes off all on its own and revs up to 3000 rpm or more. I try to stop it (on a diesel you pull a lever to cut off the fuel). Nothing. White smoke is pouring out the exhaust as the engine happily revs up. Will it finally just explode? How do I stop it? After 10 years (maybe it was 10 seconds—I'm not sure), the engine finally slows down and I can stop it.

**OK, don't panic now ...**

The engine has stopped, so it won't explode, but I don't dare start it again. Fortunately, the breeze is from the



right direction and the current is with me. It's 50 miles to the next harbor, so at five knots plus two for the current I should get there in seven hours—if the wind holds. Except that the current will change in about seven hours. In any case, I will need to get a tow and I'd better start letting people know so they can change their plans.

This seems like a major problem; perhaps I'll need a new engine. I call the Coast Guard. It's the same voice I heard on my call the week before. I explain today's problem and say I am going to sail to Rimouski but will need a tow in and is there a mechanic there?

In the process of explaining, I mention that I will use my ham radio to pass other messages. The voice says, "What's your call?" Turns out he is Andre VE2ABK, and he will try to help. Half an hour later, Andre calls to say he has called the marina at Rimouski and has arranged everything. My next call was on the Waterway Net frequency. I knew the net was over, but there is usually someone listening. Sure enough, I got Claire KC4LBZ. She would call Lee to tell her the bad news.

Nothing to do now but sail and think: How lucky I was that both problems had occurred just *after* I had passed through dangerous waters. How scary it is to have a runaway engine and not be able to stop it. I began to realize how much support I was getting from my ham friends on this trip and how nice it was to be able to pick up the mike (or key) and talk to a friend when I was in need. It was dark by the time the towboat got me into Rimouski.

Being broken down in a remote town in Quebec is less than ideal if you do not speak French. I had to ask the marina to call a mechanic. One said he would be there by noon, but he never did show up. I learned he was sometimes not very dependable. The second-best mechanic was out fishing for "several days." The third-string mechanic, a ship's mechanic from a freighter, said he would look at it as soon as he could, but was busy with two other boats and really did not know much about my kind of motor—it was too small.



*Photo D. Voyageur awaiting the truck. Just visible are the ladderline to dipole on deck and the "Foxhole Antenna" on stern rail.*

After a long-distance call to a mechanic in the States, I learned that my problem was probably a bad injector pump. Now the difficulty was defined—but how to fix it? More long-distance calls and I learned that if I could somehow get my boat towed 60 miles back upriver and get the mast taken down, there was a marina that would call a mechanic to come from Quebec City, 100 miles away, to fix it.

It was beginning to look like a very expensive and time-consuming repair job. And there was still the language problem. I was beginning to feel overwhelmed. Perhaps the best solution

was to just ship the boat to the Chesapeake and get it fixed. That too would be expensive, but probably no more so than fixing it here—and if repairs took a month at Rimouski it would be too late to finish my trip anyway.

The following morning, I passed my plight to the CW net and also to VE3LGS, VE3MBV, and W2TOH on SSB. Suddenly things began to look up. VE3MBV suggested I truck the boat back to Kingston. It was cheaper, the mechanics speak English and, best of all, Mike had done a similar repair job on his boat and offered to help me. I thought if I did that, I might be able



*Photo E. VE2ABK with his daughter.*

## Pay TV and Satellite Descrambling 1998

Pay TV and Satellite Descrambling 1998 includes all satellite fixes \$15.95. Satellite Hacker Package \$39.95. Hacking Digital Satellite Systems Video \$39.95. One year Subscription to Scrambling News includes web \$29.95. Best Deal. Everything here only \$99.95. C.O.D. is OK. \$6.00. Free catalog.

### Scrambling News

1060 Niagara Falls Blvd., #110  
Tonawanda, NY 14150

716-283-6910. [www.scramblingnews.com](http://www.scramblingnews.com)

CIRCLE 36 ON READER SERVICE CARD

**208-852-0830**

<http://www.rossdist.com>

**SPECIAL!**  
Under  
**\$162.00**



**ICOM**  
**IC-T2A**  
2 Meter Handheld



Check Out Our Specials! We're On The Web.  
Over 9030 HAM Items in Stock. All Prices Cash FOB Preston  
ROSS DISTRIBUTING, 78 S. State Street, Preston, ID 83263  
Hours Tue.-Fri. 9-6 • 9-2 Mondays. Closed Saturday & Sunday

CIRCLE 254 ON READER SERVICE CARD

to salvage some of the summer sailing and of course I would learn a lot from working with Mike.

The next day Mike told me he had talked to a marina: There was a slip for me, we could do the engine work, and there was a mechanic who would counsel us. He had also called the diesel dealer to check parts availability. But how to find a trucker? "Truckez-vous mon boat?" wouldn't cut it in Rimouski. VE3LGS said he knew a company that was nearby—as well as the owner. A few phone calls and it was arranged. All this time, AD4FJ was sending E-mails to Lee.

June 30, 1100: "Boat hauled out onto land and the mast taken down. Truck due July 3."

Now I had a chance to try the "Foxhole Antennas" (Photo D). They worked, but not as well as the "lazy inverted vee" hoisted on deck. I used a broom at the stern, a six-foot pole I found in the trash at the bow, and a boat hook which extended to eight feet in the center. The 40-foot legs hung over the ends of the boat. I realized that if the boat were floating instead of on land, the ends of the dipole would be dragging in the water and the antenna most likely would not have worked at all.

Working on the boat that afternoon, I heard "Hello, *Voyageur!*" and looked out to see a guy in a tee shirt (Photo E). "Hi, I'm Andre VE2ABK, the Coast Guard operator who handled your calls. I thought I'd drive down and see how you are making out and if I can help." We chatted, I showed him my "shack" and we swapped QSL cards. I know every time I look at his card, I will have a lot of memories.

July 4, 0930: "Boat and I arrive in Kingston. Mike and Ursula here to greet us."

Mike had arranged for the mechanic to come to the boat that afternoon. It was all downhill now. Mike and I spent two days removing the injector pump, with him doing most of the dirty work. A week to get it repaired gave me time to do other things, like re-rig the boat and make new vacation arrangements for Lee. All this time, as you can imagine, the boat was a mess. Cooking was out of the question, but Mike and Ursula came to the rescue again, by having me over for dinner most nights. Two more days of dirty work and an hour of the mechanic's time got the engine running like new with no damage done by the runaway.

Lee changed her vacation to come to Kingston and, to celebrate, George and Mimi drove over to Kingston to join Mike and Ursula and us for lunch. (John was away sailing.) Mike finally got to sail, but only back to Sodus Bay instead of to Maine. Maybe next year?

Well, that was my trip. A small sailing story but one that showed me the benefits of being a ham. I'll never go to sea again without a ham radio!

## Barry Electronics Corp.

WE SHIP WORLDWIDE  
WORLD WIDE AMATEUR RADIO SINCE 1950  
Your one source for all Radio Equipment!

For the best buys in town call:  
**1-800-990-2929**

Los Precios Mas Bajos en Nueva York

WE SHIP WORLDWIDE!

Export orders expedited.  
Special export prices.

**KITTY SAYS: WE ARE OPEN 7 DAYS A WEEK**

\*Sat. 10-5 \*Sun. 12-3-6 \*M-F 9-6 Come to Barry's for the best buys in town.

**MOTOROLA** M120, GM300, GR300 repeaters, & SM50

Radios for Business, Governments,  
Consulates, Embassies. Stocked  
and Serviced. Overseas and  
Domestic Orders.

"YAESU HAM & VERTEX BUSINESS RADIOS" FT51-R, FT-8500, FT-10, FT-11, FT-2500, FT-3000, FRG-100B, FT-1000D, FT-50R, FT-5200, FT-840, FT-900AT, FT-920, VXR-5000 repeater 25 watts, VHF or UHF. Marine Mobile VXM-100.

**ICOM**

HAM, MARINE, BUSINESS  
AND AVIATION RADIOS

281-H, 2000-H, 2350-H, A-22,  
IC-77, IC-706, IC-707, IC-T2A  
& IC-756.  
NEW F30L/F40LT, V100



WHEREVER I GO, I TAKE MY RADIO.  
SPECIALIST IN RADIOS:  
•BUSINESS •MARINE  
•AVIATION •HAM RADIOS  
•SCANNERS

**KENWOOD**



Shortwave Receivers  
R-10, R-100, R-7000, R-8500,  
R-9000.

NEW — 220 MHz  
BUSINESS RADIOS  
WITH REPEATERS

Business Radios:  
Motorola, ICOM, Maxon, Yaesu,  
FT-200B/700B, etc. Uniden,  
Regency, Reim  
Marine ICOM: M10A, mlt, etc.  
Aviation ICOM: A22, A200

Electron Tubes  
3-500Z, 572B, 6JS6C,  
12BY7A, & 6146B

FT-50R Yaesu

Save money on batteries.  
Call for Special Prices.

Barry's supplies all  
MFJ products  
Call us direct.

SHORTWAVE RECEIVERS  
STOCKED

Wide selection of SW &  
Amateur Publications

Antenna Tuners:  
MFJ,  
ICOM, KENWOOD,  
YAESU, VERTEX

COMMERCIAL  
& HAM  
REPEATERS  
STOCKED.  
WRITE FOR  
QUOTES

KANTRONICS  
KAM PLUS Etc.

2 Meter, 440, 220MHz  
Band-Pass Filters from DCI

Amplifiers- Icom, Kenwood, Yaesu,  
RF concepts, Mirage, TE Systems,  
HF/VHF/UHF, AMERITRON, etc.

Telephone Autopatch

Fm & AM Broadcast  
Transmitters Stocked  
Satellite Phones

Garmin &  
Magellan  
Global Positioning  
Systems

BENCHER PADDLES,  
BALUNS, LOW PASS FILTERS  
IN STOCK

ASTRON POWER SUPPLIES  
Belden Wire & Cable, Int'l Wire

NEXTEL Radios-5 burrough  
coverage in NY.

Surveillance Devices  
Available

Shortwave Receivers  
Drake • Grundig • JRC • Sony  
Sangean • Panasonic • Yaesu  
ICOM • Lora • Kenwood

CB Radios Stocked

148GTL, Washington, Ranger 2950-70.  
Antennas: Wilson, Antron, etc.  
Power mikes w/beeps -  
ECHO - SilverEagle etc.

ALINCO DJ-180, DJ-G5TY, etc.  
Telephone Scramblers  
Hy-Gain Towers

ANTENNAS: A-S, AES, Cushcraft,  
Hy-Gain, Hustler, KLM, METZ,  
Urban, MODUBLOX, TONNA,  
Butternut, Multi-Band, Alpha Delta,  
ANLI, Antenna Specialist, Barker &  
Williamson, Comet, Diamond, GAP,  
Larsen, Etc.  
Watt-Meters Stocked.

Bird Wattmeters &  
Elements in Stock



BARRY ELECTRONICS CORP., 540 BROADWAY, NY, NY 10012 (Five blocks N. of Canal St., between Spring & Prince St.) FAX 212-925-7001 Phone 212-925-7000

New York City's LARGEST STOCKING TWO WAY RADIO DEALER  
COMPLETE REPAIR LAB ON PREMISES

"Aqui Se Habla Espanol"

BARRY INTERNATIONAL  
FAX 212-925-7001 Phone 212-925-7000  
For Orders Call 1-800-990-2929

Monday-Friday 9 AM to 6 PM  
Saturday 10-6 PM / Sunday 12-30-6

Subways: #6 Spring St. stop, N. or R. train to Prince St. stop  
F train to Houston St. stop.  
Bus: Broadway bus to Prince St. stop, Path train to 9th St./6th Ave.

COMMERCIAL RADIOS STOCKED:  
•MOTOROLA •ICOM  
•MAXON •STANDARD,  
•YAESU •RELM etc.  
We serve municipalities,  
businesses, Civil Defense,  
etc. Portables, mobiles,  
bases, repeaters...

SALES FINAL

Technical help offered upon purchase

FAX: 212-925-7001

CIRCLE 41 ON READER SERVICE CARD

# Wouldn't You Really Rather Drive a BUIC?

*Part 2: software for your interface circuit.*

L. VanProoyen K8KWD  
8330 Myers Lake NE  
Rockford MI 49341

While it is somewhat beyond the scope of this Basic Universal Interface Circuit article to cover the gambit of programming techniques required to produce a slick radio control program, I have included a few things that should be of help in understanding ICOM's CI-V and Kenwood control software requirements. And who knows? It may be just the incentive some of you need to continue experimenting and writing just such a program.

Part of my reason for "rolling my own" software is that inevitably I'll find I want to do something that a commercial package won't allow, and without source code ... well? Also, in keeping with my objectives in starting this project, I wanted to explore the control software requirements a bit to increase my understanding of how my radio(s) worked, and writing my own software is certainly the most cost-effective approach to that.

To do all this, the first step I needed to accomplish (after getting the interface working) was to acquire an ability to display data from the radio in some usable form. My ICOM manuals told me that

the data was in hexadecimal format, as are commands, etc., so I used the Windows™ terminal program to save the data to a file which I later viewed under DEBUG (DEBUG displays file data in a hex format). I wanted to see if the data looked at all like the radio manual's description, and it did—sort of.

Eventually, the terminal program and DEBUG routine proved tedious, so I came up with the QBASIC routines for ICOM radios shown below:

*Port initialization. Note: This usually has to be run once per session.*

```
OPEN "COM1:1200,N,8,1,CD0,
CDS0,OP0,RS,TB1024,RB1024"
FOR RANDOM AS #1
```

*Check for Receive buffer characters.*  
PRINT LOC(1), #1

*Write Receive buffer to a string for display.*

```
a$ = INPUT$(LOC(1)), #1
```

*Display input string in hex format.*  
For i = 1 to len(a\$):

```
PRINT HEX$(ASC(MID$(a$,i,1)
));:
PRINT " ";:next i
```

*Command string constants. Note: rad\$ (radio ID) is radio specific. Hex 48 is for the IC-706.*

```
hdr$=chr$(&hfe):rad$=chr$
(&h48):
cad$=chr$(&he0):=end$=
chr$(&hfd):
nul$=chr$(0):fqw$=chr$(5)
```

*Write a frequency (146.520) to radio (see below for data format and protocol).*

```
PRINT #1, hdr$;hdr$;rad$;
cad$;fqw$;nul$;chr$(&h52);
chr$(&h46);chr$(&h01);end$;
```

*Send commands to radio (see radio manual CI-V info for command codes; also below).*

```
PRINT #1, hdr$;hdr$;rad$;
cad$;chr$(&h{command});chr$
(&h{secondary code if needed
});end$;
```

To make things easier, I chose QBASIC because it's bundled with

```
'Sample QBasic Frequency Write and Display Program
'for ICOM Radios with CI-V Remote Jacks .. K8KWD.
'This program was tested on the IC-706 and IC-756
'(with CI-V address changed to 48h, Auto Baud selected
'and Transcieve ON) using a
'Compaq Aero Notebook Computer 8-10-97.
```

```
OPEN "com1:9600,n,8,1,cd0,cs0,ds0,op0,rs,tb1024,rb1024" FOR RANDOM AS #1
```

```
hdr$ = CHR$(&HFE): rad$ = CHR$(&H48): cad$ = CHR$(&HE0): end$ = CHR$(&HFD)
nul$ = CHR$(0): fqw$ = CHR$(5): fqr$ = CHR$(3)
w = 0: in$ = "": B$ = ""
```

```
SCREEN 1 'set up the big screen
```

```
'FOR i = 1 TO 4096: NEXT i 'add delay if necessary
PRINT #1, hdr$; hdr$; rad$; cad$; fqr$; end$; 'get initial freq data
'FOR i = 1 TO 4096: NEXT i 'more delay here if required
```

```
WHILE w = 0 'start the main loop
  IF LOC(1) > 10 THEN
    CLS
    LINE (75, 70)-(250, 100), , B 'draw box around freq display area
    ip$ = INPUT$(LOC(1), #1)
  END IF
```

```
IF LEN(ip$) > 10 THEN 'update frequency display
  freq$ = RIGHT$(ip$, 11) 'make sure enough data gets transfered
  LOCATE 12, 15
  PRINT HEX$(ASC(MID$(freq$, LEN(freq$) - 1, 1)));
  PRINT HEX$(ASC(MID$(freq$, LEN(freq$) - 2, 1))); ". ";
  PRINT HEX$(ASC(MID$(freq$, LEN(freq$) - 3, 1)));
  m$ = HEX$(ASC(MID$(freq$, LEN(freq$) - 4, 1)))
  PRINT LEFT$(m$, 1); ", "; RIGHT$(m$, 1); 'put a comma between khz & hz
  PRINT HEX$(ASC(MID$(freq$, LEN(freq$) - 5, 1)));
  PRINT " MHz";
  ip$ = ""
  LOCATE 2, 2: PRINT "ICOM Frequency Control Program - K8KWD"
  LOCATE 24, 1: PRINT " f-key to Enter Frequency ";
  LOCATE 25, 1: PRINT " Q-key to Exit ";
END IF
```

```
B$ = INKEY$ 'scan for keyboard inputs
IF B$ = "f" THEN 'we want to do a frequency write
  LOCATE 5, 10
  FOR i = 1 TO 33: PRINT " "; : NEXT i 'clear screen area
  LOCATE 5, 10
  LINE INPUT "Enter Freq MHz.kHz "; c$
  i5 = 0 'this was a pesky little problem with my math
  d = INSTR(c$, ".") 'figure out where decimal point is
  IF d >= 1 THEN 'add a little trap for garbage keyboard entry
    m$ = LEFT$(c$, d - 1): k$ = MID$(c$, d + 1) 'split MHz & kHz
    ma = FIX(VAL(m$)): ka = FIX(VAL(k$)) 'make them into numbers
    IF LEN(k$) = 1 THEN ka = ka * 100
    IF LEN(k$) = 2 THEN ka = ka * 10
    IF LEN(k$) = 4 THEN
      i5 = ka MOD 10: ka = ka \ 10
    END IF
    IF LEN(k$) = 5 THEN
      ka = ka \ 10: i5 = ka MOD 10: ka = ka \ 10
    END IF
    IF LEN(k$) = 6 THEN ka = ka \ 1000
    IF LEN(k$) > 6 THEN ka = 0
    db5 = ma \ 100: i1 = ma MOD 100: i2 = (i1 \ 10) * 16: i3 = i1 MOD 10
    db4 = i2 + i3: i1 = (ka \ 100) * 16: i2 = ka MOD 100: i3 = i2 \ 10
```

```

db3 = i1 + i3
db2 = ((i2 MOD 10) * 16) + i5
LOCATE 6, 20
FOR i = 1 TO 33: PRINT " "; : NEXT i 'clear screen
LOCATE 6, 20
PRINT #1, hdr$; hdr$; rad$; cad$; fqw$; nul$;
PRINT #1, CHR$(db2); CHR$(db3); CHR$(db4); CHR$(db5); end$;
FOR i = 1 TO 4096: NEXT i 'add a little recovery delay
END IF
PRINT #1, hdr$; hdr$; rad$; cad$; fqr$; end$; 'update freq display
END IF 'end of if freq write

IF B$ = "Q" THEN w = 1 'that is all folks
WEND

```

Sidebar 1. Sample ICOM CI-V control program listing, ICOMTST.BAS.

most recent versions of DOS, and therefore on many computers. While it is not generally installed with Windows 95, if you snoop around the "CAB" files on 95's distribution disk, you should be able to find it included. QBASIC worked fine for my experimenting (and my initial control program), so long as I remembered to start it from (the DOS prompt under) Windows. For some reason, trying to access ports directly from DOS causes my computer to go to lunch—some missing driver, I suspect.

### ICOM control software

I continued experimenting with the CI-V system by coding test lines as shown above and saving them to a file (so I could recall them later). By commenting out (') lines, editing others, skipping to QBASIC's "Immediate" screen to try other things, etc., I was able to find out a lot about the data formats, required protocols, etc.—things you need to know to write control software. Many of these types of details were not intuitively obvious to me from the information contained in my radio manuals.

Most of what I was able to figure out about the ICOM CI-V command structures and data formats is as follows:

#### General command format.

```

hdr$ hdr$ rad$ cad$ cb$
sc$ {data} end$

```

Where: **hdr\$** = FE (hex); **cad\$** = E0 (computer's address); **rad\$** = 48 (hex IC-706 address); **cd\$** = hex command byte; **sc\$** = hex secondary command; **end\$** = FD (hex terminator byte)

### CornerBeam?

SWR < 1.2:1 across the band  
Gain of a 15 ft Yagi  
No dimension over 7 ft  
40 dB Front-to Back Ratio  
60° Half-power Beamwidth  
Mounts directly to mast  
Vertical or Horizontal Polarization  
2meters \$145, 220 MHz \$145, 70 cm \$115, Dual 146/440 \$165  
Weighs only 10 lbs. Add \$11 Shipping & Handling. Info \$1.

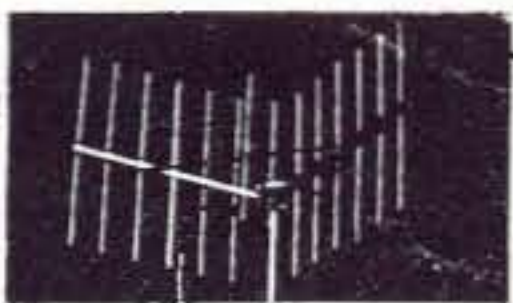

AntennasWest  
Box 50062 Provo UT 84605

Order HotLine  
801 373 8425

CIRCLE 380 ON READER SERVICE CARD

Pico-J rolls up and hides in his 4-ounce pocket-sized holder, waiting like the Genie in a bottle till you need full-quieting signal pouch.

Call him forth and his glistening black weather sealed lines reveal a sleek end-fed halfwave antenna ready to hang anywhere. Suspend in the apartment closet or patio doorway. Attach Pico-J to window glass or curtain rod. He needs no radials for broadband low-angle omni halfwave gain.

Carry Pico-J with you for emergencies. Hang in the motel when on the road. He improves range, boosts reception, saves batteries. Pico-J comes ready for work with 72" isolated coaxial feedline and gold pin BNC. Typical edge-to-edge SWR under 1.2:1. Hand-crafted in the U.S.A.



Info \$1  
Box 50062-D  
Provo, UT  
84605

Models  
2 Meters  
440MH  
Dual Band add \$6

Antennas West  
Order Hotline  
801-373-8425

19.95

CIRCLE 89 ON READER SERVICE CARD

## BATTERIES 15% OFF! NICD & NiMH!

### These Selected Items:

FNB-12	PB-34	EBP-36
FNB-12M	PB-34M	EBP-36M

Above batteries are warranted for 12 months

**CALL NOW!**  
**(800) 634-8132**

**PERIPHLEX**  
**REPLACEMENT BATTERIES**

Policies and prices subject to change without notice.  
Offer expires March 31, 1998

Advanced Battery Systems, Inc., 300 Centre Street, Holbrook, MA 02343  
(781) 767-5516 • Fax (781) 767-4599  
<http://home.navisoft.com/periphlex>

CIRCLE 68 ON READER SERVICE CARD

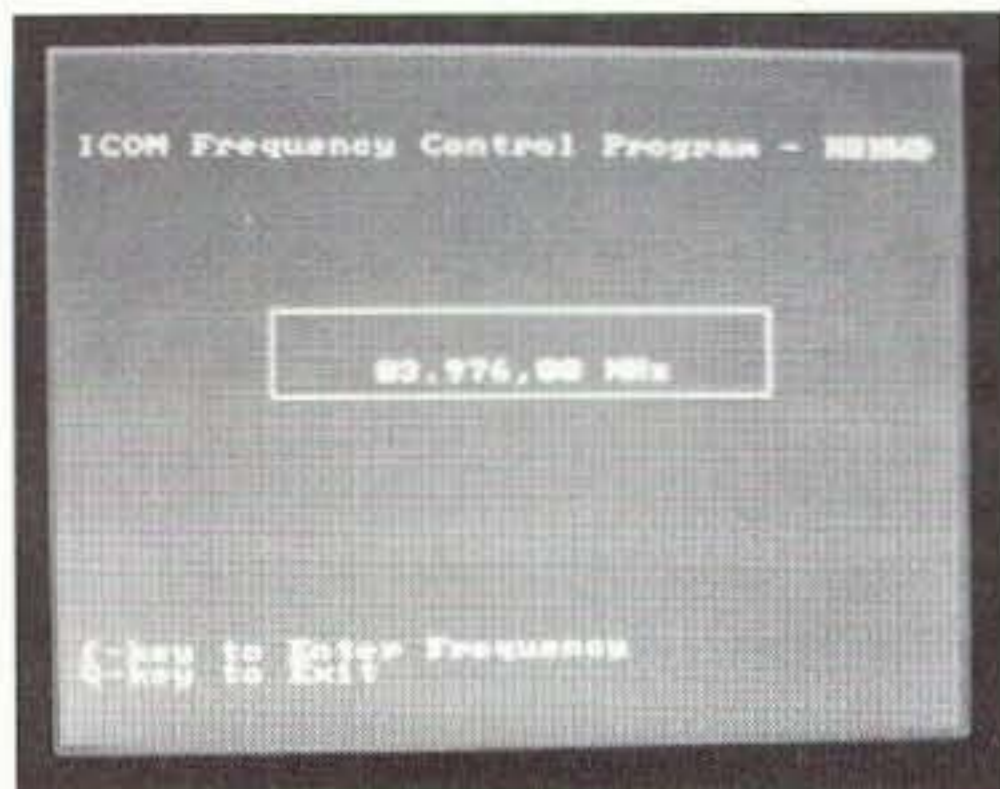

**Photo F.** Computer display showing frequency control and display for an ICOM IC-756 using the basic universal interface with the sample program "ICOMTST.BAS" (see Sidebar 1).

*Note:* See radio manual for specifics on command and secondary code values (cd\$ and sc\$) and your default radio address (rid\$).

*Frequency data format: five data bytes, ascending byte order, descending byte value order with 1/2-byte BCD digit coding.*

DB1 DB2 DB3 DB4 DB5

Where: DB1 = 10 Hz & 1 Hz BCD digits; DB2 = 1 kHz & 100 Hz BCD digits; DB3 = 100 kHz & 10 kHz BCD digits; DB4 = 10 MHz & 1 MHz BCD digits; DB5 = 1000 MHz & 100 MHz BCD digits

*Example:* To write 147.525 MHz, the command string would be FE FE 48 E0 05 00 50 52 47 01 FD.

*Example:* To write 3.795123 MHz, the command string would be FE FE 48 E0 05 23 51 79 03 00 FD.

*Note:* Spaces are shown between the hex value bytes for clarity only. The frequency write sequence is 11 bytes total length. Also, note that for frequency writes, the secondary command field is used for data.

*Radio output data format.*

hdr\$ hdr\$ cad\$ rad\$ nul\$ {data} end\$

Where: Values and formats are similar to those in transmit.

*Example:* The radio outputs frequency data whenever the VFO knob is operated. For my IC-706, setting the VFO to 146.520 results in the radio generating a final data block that looks like this:

FE FE 00 48 00 00 00 52 46 01 FD

*Note:* This data looks a lot like the command string for frequency write, except that the radio inserts zeros in the cad\$ and command fields to complete the eleven-byte data block.

*Miscellaneous commands—Set Mode.*

hdr\$ hdr\$ rad\$ cad\$ chr\$ (&h{mode cmd}) chr\$ (&h{sub cmd}) end\$

Where: {mode cmd} and {sub cmd} values are included in the radio's manual.

*Example:* To set CW mode, for example, the command block looks like:

FE FE 48 E0 06 03 FD

*Note:* The data stream received by the computer after sending this command looks something like this: FE FE E0 48 FB FD. The "FB" in the fifth byte position indicates the command was received OK. The radio returns "FA" in this location in case of error.

*Miscellaneous commands—Get Frequency.*

hdr\$ hdr\$ rad\$ cad\$ chr\$ (3) end\$

The radio replies with the following data:

FE FE E0 48 03 00 00 52 46 01 FD

when the current frequency happens to be 146.520 MHz.

*Note:* The "03" command is echoed back in the command byte field.

*Miscellaneous commands—Get Mode.*

hdr\$ hdr\$ rad\$ cad\$ chr\$ (4) end\$

The radio replies with the following data:

FE FE E0 48 04 05 01 FD

*Note:* Mode data is contained in the sixth byte field as "05" (which translates to FM mode). The mode codes follow those used to Set Mode, and are included in the radio manual. The fifth byte again echoes the Get Mode command. The seventh byte ("01") indicates normal filter selection. If a narrow filter were selected, this byte would be "02". Again, this information as well as more "Miscellaneous Commands" should be in the radio manual's "Remote Jack (CI-V) Information" section.

I understand there's a CI-V reference manual available through ICOM's parts department, and it might be a good investment for those contemplating development of a more comprehensive control program. As for me, I was able to meet my basic objective with a few additional formatting and decoding functions to deal with keyboard entry and screen display of frequency data.

## Kenwood control software

Kenwood radios are perhaps easier to write control software for because command and data formats are in ASCII text format. This means you can use a standard terminal program such as that bundled with Windows to send commands and display data, although a custom program to enter and display data in a more "user friendly" format is much nicer to use.

Obtaining a manual for Kenwood's IC-232C might be a good investment for those whose primary interest is in Kenwood radio applications. This manual includes quite a bit of command reference which would be useful in developing Kenwood radio control software. The TS-50 uses a subset of commands that many Kenwood radios use, and I have included those of which I am aware below:

*General command structure.*

All commands must be in uppercase letters and are terminated with a semicolon (;). Many commands perform dual functions, e.g., they can be used to both read and write data.

*ID;*

Returns radio identification number:  
ID004;  
for the TS-440, for example.  
ID013;  
for the TS-50, for example.

*IF;*

Returns current status in a 35-character string such as:

IF00001850000XXXXX-015000X0701000XXXX;

Where: "X" inserted here for typesetting purposes means blank space, would normally appear as gap or unoccupied. The first eleven characters

```

'Sample QBasic Frequency Write and Display Program
'for the Kenwood radios .. K8KWD.
'This program was tested with the TS-50 using an
'IBM ThinkPad Notebook Computer 6-18-97.

OPEN "com1:4800,n,8,2,cd0,cs0,ds0,op0,rs,tb1024,rb1024" FOR RANDOM AS #1

SCREEN 1 'set up for big screen display
        'this seems to work for most displays .. CGA to VGA

PRINT #1, "FA;"; 'get VFO A's freq for initial display

WHILE w = 0 'this is the main program loop
  IF LOC(1) > 10 THEN
    'draw box around frequency display area
    CLS
    LINE (75, 70)-(250, 100), , B
    ip$ = INPUT$(LOC(1), #1) 'read input data
  END IF

  IF LEN(ip$) > 13 THEN 'update frequency display
    freq$ = ip$ 'make sure enough data gets transferred
    i = LEN(freq$)
    LOCATE 12, 15
    PRINT MID$(freq$, 6, 2);
    PRINT ".";
    PRINT MID$(freq$, 8, 3); ","; MID$(freq$, 11, 3);
    PRINT " MHz";
    ip$ = "" 'zero the input string after getting data
    LOCATE 2, 2: PRINT "Kenwood Frequency Control Program - K8KWD"
    LOCATE 24, 1: PRINT " f-key to Enter Frequency ";
    LOCATE 25, 1: PRINT " Q-key to Exit ";
  END IF

  b$ = INKEY$ 'scan for keyboard inputs
        'this routine looks only for f or Q
        'note lower & upper case distinction
  IF b$ = "f" THEN 'do a frequency write
    'clear out the screen area for display
    LOCATE 5, 10: FOR i = 1 TO 33: PRINT " "; : NEXT i: LOCATE 5, 10
    LINE INPUT "Enter Freq MHz.kHz "; c$
    d = INSTR(c$, ".") 'figure out where decimal point is
    IF d >= 1 THEN 'add a trap for bad keyboard entry
      m$ = LEFT$(c$, d - 1): k$ = MID$(c$, d + 1)
      'split data into MHz & kHz components
      IF LEN(m$) = 1 THEN hdr$ = "FA0000" ELSE hdr$ = "FA000"
      IF LEN(k$) = 0 THEN t1$ = "FA000000;"
      IF LEN(k$) = 1 THEN t1$ = "00000;"
      IF LEN(k$) = 2 THEN t1$ = "0000;"
      IF LEN(k$) = 3 THEN t1$ = "000;"
      IF LEN(k$) = 4 THEN t1$ = "00;"
      IF LEN(k$) = 5 THEN t1$ = "0;"
      IF LEN(k$) = 6 THEN t1$ = ";"

      LOCATE 6, 20: FOR i = 1 TO 33: PRINT " "; : NEXT i: LOCATE 6, 20
      PRINT #1, hdr$; m$; k$; t1$;
      hdr$ = "": m$ = "": k$ = "": t1$ = ""
      FOR i = 1 TO 4096: NEXT i 'add some recovery time delay
    END IF
    PRINT #1, "FA;"; 'request VFO A frequency update
  END IF 'end of if frequency write

  IF b$ = "Q" THEN w = 1 'end the program
WEND

```

Sidebar 2. Direct frequency entry and display program for the TS-50, KNWDTST.BAS.

**CAPTURE IMAGES LIKE THIS DIRECTLY FROM SPACE ON YOUR PC!**



- Internal Systems and Portable, External (Parallel Port) Systems Available for IBM Compatibles.
- Capture Full Satellite Resolution (2-3 Miles with NOAA Satellites!) with Either System.
- Professional Software with "Point and Click" User Interface, Mouse Support, Satellite Tracking, Zoom, GIF and Binary Output, False Colorization, Printer Support, Grid-ding, IR Temperature Calibration, Animation, **Much More...**
- PLL Circuitry Automatically Provides **Ruler Straight** Images. No Complicated Timing Settings Required.
- Simple Antenna Used for NOAA and Meteor Satellites. **NO Dish Required.**
- SVGA to 1024x768x256.
- Receive High Resolution Images from NOAA, Meteor (Russia), GOES, and Meteor-sat Satellites, and HF Fax.
- Receivers, Antennas, Downconverters, and Feed-horns also Available Separately or in Complete Systems.
- Internal Demodulator with Software only \$289. Multi-FAX Programmable Satellite Receiver: Just \$249!
- Call, Write, or Fax for Complete Information. Download the above and dozens of other images (as well as software and current orbital elements) from our home page at <http://www.frontiernet.net/~multifax/>

**MultiFAX**® 30 Steele Road  
Victor, NY 14564

Voice: 716-425-8759(BBS after 5PM) Fax: 716-223-6198

*All Aluminum*

- |                    |                        |
|--------------------|------------------------|
| Chassis Kits       | Rack Shelves           |
| Cabinet Kits       | Rack Equipment         |
| Assembled Cabinets | Antenna Grounding Kits |
| Slope Box Kits     | Tower Mounted Box Kits |
| UHF & VHF Antenna  | Dipole Hangers         |
| Power Divider Kits | Other Enclosures       |

Small sheets Aluminum and Brass  
UHF / VHF Antenna Parts

*Byers Chassis Kits*

Charles Byers K3IWK  
5120 Harmony Grove Road • Dover, PA 17315  
Phone 717-292-4901  
Between 6PM and 9:30 PM EST. Eves.  
E-mail k3iwk@juno.com

CIRCLE 222 ON READER SERVICE CARD

represent frequency in the same format as "FA" above. Characters 12 through 16 are not used. Characters 18 through 21 represent RIT frequency in Hz, with the 17th giving the direction as plus (+) or minus (-). Characters 22 and 23 indicate RIT/XIT status respectively; zero = off, one = on. Character 24 is not used. Characters 25 and 26 indicate memory channel number. Character 27 indicates whether the radio is in receive or transmit; zero = receive, one = transmit. Character 28 indicates current mode (see mode command above). Character 29 indicates function similar to function command described above. Character 30 indicates whether scan is on or off; zero = off, one = on. Character 31 indicates if split mode is on or off; zero = off, one = on. Characters 32 through 35 are not defined.

**FA;**

Returns current VFO A frequency as:  
FA00014317000;  
for 14.317000 MHz, for example.  
The frequency data is in an eleven-digit format with the leftmost digit

representing the 10 GHz value, and the rightmost, the 1 Hz value.

**FA[data];**

Writes a frequency to VFO A. Note that there are 11 data digits that must be filled (using zeros as appropriate) for this command to work. It's possible with the TS-50 (and, I suspect, other Kenwoods) to write frequencies to the 1 Hz level.

**FB; and FB[data];**

Same as FA; and FA[data]; as described above, except that these commands read or write frequency data from/to VFO B.

**FN[Cmd Code];**

Function command, selects VFO A/ B or Memory. FN0; = VFO A. FN1; = VFO B. FN2; = Memory mode.

**MD[Cmd Code];**

Mode command, sets Communications mode. MD1; = LSB. MD2; = USB. MD3; = CW. MD4; = FM. MD5; = AM. MD6; = FSK.

**RX;**

Commands rig to receive (see TX; command).

**SP[Cmd Code];**

Sets Split mode on or off. SP0; = off. SP1; = on.

**TX;**

Switches radio to transmit. Once sent, the radio remains in transmit until the RX; command is sent (or power off).

**Program listings**

Finally, I have included a listing of my QBASIC program, "ICOMTST.BAS", as **Sidebar 1**. It shows how I keyboard-enter and display frequency data for my ICOM radios. **Photo F** shows the computer display presented by this program. Similarly, I've included a listing of "KNWDTST.BAS" as **Sidebar 2**. This shows a similar implementation for the Kenwood radios.

I will be happy to provide ASCII copies of these listings on IBM diskette to those who send me a blank disk and self-addressed, stamped diskette mailer. Have fun!

**ISOTRON**  
ANTENNAS FROM 100-10 METERS

NO TUNERS  
NO RADIALS  
NO COMPROMISE  
PRICES START AT \$49.95

SEVEN EXCELLENT REVIEWS  
JUST DON'T HAPPEN BY CHANCE  
CALL US FOR A FREE CATALOGUE

See review in 73, Oct. 1984; 73, Sept. 1985; 73, March 1986  
CQ, Dec. 1988; W.R., Mar. 1991; 73, Nov. 1994; 73, Apr. 1996

ASK ABOUT OUR NEW ISOTRON 160C!

**BILAL COMPANY**  
137 MANCHESTER DRIVE  
FLORISSANT, COLORADO 80816  
(719) 687-0650

CIRCLE 42 ON READER SERVICE CARD

*The NiCad Lady - N6WPA*

*Losing your source of power?*

Have your old case refitted with **NEW** cells and \$ave!

**Convert your pack to NiMH!**

Same size pack — HIGHER capacity!

- \*Handhelds \*LapTops \*Commercial Radios \*Camcorders
- \*Portable Scanners \*Test Equipment \*Power Tools
- \*Any Special Application

NEW replacement packs & Individual cells also available!

Call for a price list!



17052 Alameda Drive Perris, CA 92570  
(909) 789-0830 FAX (909) 789-4895

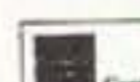

CIRCLE 141 ON READER SERVICE CARD



# Getting High the Ham Way

*Adventures in ATV rocketry.*

Andreas Forrer KB9MRB  
3700 N. Lake Shore Dr., #304  
Chicago IL 60613

**E**ncouraged by "Rocket Video" in the July 1997 issue of *73 Amateur Radio Today*, we decided to present our experiences with rocket video to a wider audience. Transmitting live video from a rocket in flight, however, is about the only thing our project(s) has in common with the one described by author Jeff Johnson KC5AWJ. We are not trying to break the sound barrier; as a matter of fact we try to stay below it, although we can't help breaking it once in a while. Going beyond the speed of sound creates a multitude of aerodynamic and structural problems for the rocket, which increases the complexity of a project like this (hey, it's called "rocket science" for a reason!).

We use live video downlink normally for two reasons: first, as pure entertainment for the audience; and second, as a way to do aerial photography. Since we use the live video downlink only as a way to achieve a different goal and not as the object of the project itself, we decided to keep it as simple as possible. We achieved this by putting off-the-shelf components together: From PC-Electronics we bought the TXA5-RC ATV transmitter

board, which is capable of 1.5 watts PEP, enough power to receive a picture from a rocket at altitudes beyond 50,000 feet AGL (another group of people actually flew a similar setup to even higher altitudes). Although this transmitter could be equipped with a sound board, we did not use that in our flights. Ground tests of that board

---

***"Experience shows that, in rocketry, the best solutions are the simplest ones."***

---

were not satisfying. Instead we flew once the XTL3000 transmitter from Xandi Electronics with a microphone. Although the reception was clear, the sound itself was rather disappointing. Of course, it depends on where in the rocket you position your microphone, but all we got out of it were some typical wind and engine thrust sounds—nothing really spectacular, and it didn't seem worth the effort of adding all this equipment to the payload.

The ATV transmitter was fed by eight 1.5 V AA batteries, which let it operate at its lower power limit. Since

our flights did not go beyond 20,000 feet and the transmission time at around 10 minutes was rather short, we were able to get away with this simple approach. We experimented with even less battery power (9 V alkaline and a series of camera batteries), but it seems that eight 1.5 V AAs is about the lower limit of operating power for this transmitter.

Another point of discussion is the ideal camera setup. According to PC-Electronics' information sheet (it comes with the transmitter), the ideal antenna is a horizontal omni with two dipoles at 90° fed to the same coax leading to the transmitter. The dipoles are sticking out of the rocket body tube to either side. The reason for the dipole is that a rocket normally rotates around its longitudinal axis, due to imperfections in the construction. So we tested this configuration on several flights. Actually, on the first one, we embedded the two dipoles within canard fins mounted about halfway up the rocket body. Although that made them less of an aerodynamic drag problem, these canard fins typically created lift. Unfortunately, it was enough lift to steer our rocket off course. Combined with a



**Photo A.** The experimental rocket is being prepared for launch. The author inserts the pyrotechnic igniter into the composite motor while two friends check the ATV test transmission. The CCD camera looks through a window below the silver ring underneath the nose cone.

motor, which was close to being under-powered for the size and weight of the overall vehicle and somewhat oversized fins at the end of the rocket, this caused the rocket not only to weathercock, but actually to turn almost 90° and fly horizontally—similar to a cruise missile. From this experience we learned that it might have been a better idea to hide the dipoles within the regular fins at the end of the



**Photo B.** The ATV elements removed from the payload section show, at the left, the power regulator and battery pack for the camera, and the camera itself. To the right are the battery pack for the transmitter (mounted lower within the rocket body) and the whip antenna. The transmitter is on the other side of the board and balances the weight, as the board is mounted vertically.

rocket, but that solution makes it difficult to mount the transmitter and camera, as the booster section normally has not enough space for these parts. Also, we did not want to make the antenna feedline any longer than absolutely necessary.

We decided to hide the dipoles in two Nylon™ tubes sticking out of the body frame. Although not ideal from an aerodynamic perspective, this would at least not cause any lift forces. Tested on several flights, this solution worked quite well, but we were still not perfectly happy because of the added drag. Also, we weren't sure how fast we could actually go with this configuration without breaking it in the airflow.

We decided to try a different approach and use a simple whip antenna, knowing that we might lose reception due to the rocket's rotation. We replaced the dipoles with a Diamond RH77CA whip, which we mounted vertically within the body tube. Obviously, this restricts the choices in the selection of the material for your body tube. Aluminum and carbon fiber would shield the antenna, so we decided to use phenolic tubing reinforced with several layers of Fiberglass™ (this also prevents the brittle phenolic tube from cracking). The flight results were very encouraging: almost no loss in picture quality. Although each rotation of the rocket can be detected by a brief buzz in the picture, we never really lost the signal. We might even go as far as to argue that this is an added benefit, since we were now able to determine the roll behavior of our vehicle. This was a welcome surprise, since even with the dipoles approach, we were still able to spot the occasional buzz in the picture, when the phases shifted. These results, however, were not completely unforeseen—as we learned from talking to another group of high power rocketry enthusiasts, who also use the Diamond antenna instead of dipoles.

Since the transmitter requires only a regular video signal as input, it's builder's choice regarding the camera. We flew a high resolution color camera with a built-in power regulator. This camera



**Photo C.** The rocket's two-colored booster passes by the camera window within the payload section.

from SUN computers was designed for video-conferencing via the Internet and was very compact. Again, we had to find a reliable, but small enough, power source for it. Although the camera uses a similar input voltage as the transmitter, we followed PC-Electronics' advice concerning separate power sources for transmitter and camera. We experimented with various configurations and concluded that the eight AA 1.5 V batteries would do just fine. The camera would run out of battery power after roughly 30 minutes, while the transmitter could live on for at least another 15 minutes.



**Photo D.** This shot of Bong Recreational Area in Wisconsin was taken during descent. Clearly visible are the pathway leading through the park and the ramp towards the runway in the lower right-hand corner. The white "cloud" is a reflection of the sunlight in the window.

We used the color camera on a demonstration flight in Sheboygan (Wisconsin) at a "Rockets for Schools" event. The live feed was projected onto big screens, on which the audience was able to watch the events. Seeing the rocket blast off into a blue sky, then the booster separate and eventually the waters of Lake Michigan approach for the splash-down was quite a crowd pleaser (a friend of ours made a videotape of this broadcast and sent more than 50 copies to interested parties). The payload compartment cracked on impact, and the transmitter, as well as the camera, got soaked, but they were operating again after the batteries were replaced!

On other occasions we also tested "pinhole" cameras. We used an IR-responsive CCD camera in combination with a power regulating kit. It can operate in bright light or darkness and produces black and white images of a lesser resolution. These pictures are, of course, not as spectacular as the ones from the color camera, but the system is smaller and less expensive. Once you fly rockets, you have to start to think about the risks involved for your expensive payload section.

Both cameras allow for either vertical or horizontal mounting since they are compact enough to fit within a regular four-inch diameter body tube. Once we used a mirror, rotated by 45°, and therefore allowing the camera to look outside during ascent. The mirror was dropped at apogee and the camera then continued to look straight down while descending under the parachutes. Although this worked, it adds to the complexity of the overall construction of the vehicle. Experience shows that, in rocketry, the best solutions are the simplest ones. There are still plenty of things you never *considered* that can and will go wrong. Murphy shows no mercy.

Since the batteries have a rather limited lifespan, it is essential to be able to turn the whole system on and off at any time. We used microphone jacks, which allow current to flow, when no plug is inserted. The jacks were mounted towards the outside of the body tube so that we were able to insert and remove the plugs at any time.

For aerodynamic reasons, jacks are also the better choice, when mounted on the outside.

The ground equipment consists of a TVC-4G GaAsFET 70 cm ATV downconverter from PC-Electronics, which converts the 426 MHz frequency to channel 4 on a regular TV set. A normal HF cable runs from the converter to your portable TV set, which ideally has a built-in video recorder. The EB-432 ("Eggbeater") antenna with the RK-70 cm radial reflector kit from M2 is perfectly capable of receiving the downlink. In comparison tests with multiple receiving stations of the same flights, we were able to discover that the best antenna strategy would be to follow the flight path with the antenna on the ground rather than just have it sit on a high pole (although the differences were rather minor). Critical for the ground equipment is a stable 12 V power source. For redundancy we normally set up two independent ground stations, one working off a car battery and one working off a power generator using 110 VAC. We made comparison tests with different ground antennas, including amplified ones, but the Eggbeater seems to be good enough to receive the signal from the powerful transmitter. None of the other receiving ground stations had significantly better reception.

However, we were able to spot a difference in the reception quality of the TV sets. It appears that older black and white TVs have better receivers built-in than today's color TVs. These differences were most notable during ground tests. Once the vehicle was airborne, however, these differences disappeared as the quality of the picture drastically improved. This was due to the antenna setup and the interference created by the transmitter. Although the results were certainly pleasing, they would not suffice to do any scientific aerial photography.

That is why we also add a SLR camera to the payload section, which we control remotely through a standard R/C system. The ATV system allows us, via the live feed, to pick the best moment to shoot the SLR picture.



*Photo E. Seconds before touchdown. The parking lot, the launch area and the visitors' house are visible on this shot looking straight west.*

Since a rocket is always in motion, including the descent time under the parachutes, it is difficult to get very sharp pictures. However, there are always moments during which the payload section does not swing or move and still shows some interesting objects on the ground. During these moments, nearly perfect shots can be achieved with the remote control following the ATV's eye. 73

**HamCall™ CD-ROM**  
U.S. & International - Over 1,454,000 listings

**HamCall™ has been rated one of the "top 100" CD-ROM's by PC Magazine!**

The HamCall CD-ROM allows you to look up over 1,454,000 callsigns from all over the world, including over 300 call areas. Over 118,000 new and updated international listings, including Australia!

The same CD works in DOS, Windows 3.x, Windows 95, and Mac. On a PC running Windows or DOS, you can look up hams by call, name, address, city, state, ZIP, call sign suffix, county, and now **soundex** last name searching. PC's can also view photographs, **edit** records (now including fax number), and calculate **beam heading** and **distance**. Macs can retrieve by call, last name, and ZIP.

- Displays precise latitude, longitude, and grid square for almost every U.S. and DX call.
- Calculates beam heading and distance from your station.
- Enhanced label printing for Windows. Select printer & font & print any size label. Label size, margins, columns, and rows are fully configurable. Also supports copy and paste.

Also on HamCall are over 143,245 cross references from old to new calls, over 3,400 photos, over 46,256 e-mail addresses, 15,000 vanity calls and much more.

HamCall price is still \$50.00 plus \$5.00 shipping U.S., \$8.00 international.

**BUCKMASTER**  
6196 Jefferson Highway  
Mineral, VA 23117  
e-mail: info@buck.com  
540:894-5777 • 800:282-5628 • 540:894-9141 (fax)

CIRCLE 56 ON READER SERVICE CARD

# High Impedance Analog Volt/Test Meter

*Here's a useful gadget to build while you wait for spring!*

Hugh Wells W6WTU  
1411 18th Street  
Manhattan Beach CA 90266-4025

With technology speeding toward digital, analog instruments have been left behind. Digital has improved our ability to obtain accurate measurements from electronic circuits, so how can you miss with digital accuracy? Perhaps you can't miss if a specific measurement value is of concern, but there are occasions when an analog display is

more indicative of a circuit response where a numerical digital indication can be confusing.

An S-meter indicating a received signal level is an example of a desired analog function that is not satisfied very well with a digital display. Tuning adjustments in transmitters and receivers create analog responses that need to be "observed" with an analog meter

function, not digital. Although a digital display indicates the response, following the rolling digits is a little tough. Now may be the time to restore the capability for monitoring and displaying an analog function or response.

If you've given up your analog meter, then the project described here is for you. **Fig. 1** shows the front panel layout using a square meter.

It is a simple instrument to build, and being a general-purpose meter, its characteristics have deliberately been changed from the typical analog voltmeter where a stepped range switch has been used. For this instrument, a potentiometer has been used to provide a variable control over the range and input sensitivity. The meter pointer may be set conveniently to any desired starting point and then moved, as necessary, when using the instrument for monitoring an analog function. Calibration of the range pot will vary with the pot selected for use. But in all cases, the markings are only approximate.

Should the instrument be used for measuring DC voltages, the full scale value can be set using a digital voltmeter. After setting the full scale value,

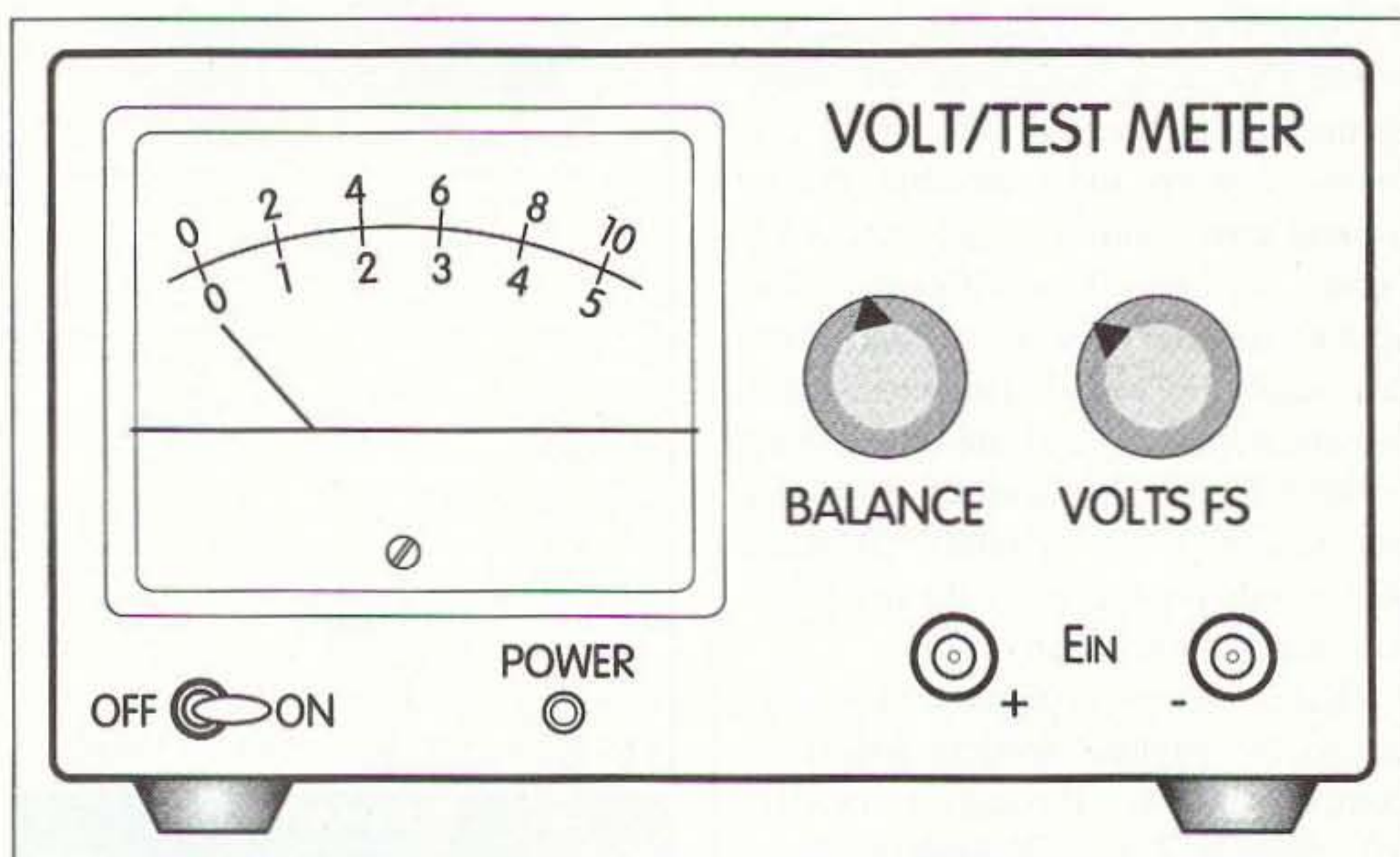

**Fig. 1.** Panel view of the Analog Volt/Test Meter. The small circle under the meter is the power LED.

WEB & Internet Access  
Compliments of EriNet

# DAYTON hamvention®

May 15, 16, 17, 1998 ■ Hara Arena, Dayton Ohio

SPONSORED BY THE DAYTON AMATEUR RADIO ASSOCIATION, INC.

### TICKET DEADLINES

- Advanced registration orders must be postmarked no later than May 1 (USA) or April 24 (Canada).
- Ticket requests that are received **AFTER** the deadline will be processed and **HELD** for pick-up at the Hara Arena box office beginning Wednesday, May 13 at 9:00 a.m.

### EXHIBIT SPACE

See our Web site for more information. ([www.hamvention.org](http://www.hamvention.org))

#### ■ Inside Exhibit Booths

For an application, please Fax (937) 376-4648 or E-mail to [exhibits@hamvention.org](mailto:exhibits@hamvention.org)

#### ■ Outdoor Flea Market Space

For an application, please Fax (937) 276-8902 or E-mail to [fleamkt@hamvention.org](mailto:fleamkt@hamvention.org)  
Flea market spaces are sold IN ADVANCE ONLY. No spaces sold at gate!

### UNOFFICIAL ACTIVITIES

To be listed in our program and on our Web site, please Fax (937) 274-8369 or E-mail to [info@hamvention.org](mailto:info@hamvention.org)

### SPECIAL SERVICES

Details are available on our Web site. ([www.hamvention.org](http://www.hamvention.org))

- A limited number of paid reserved ADA parking permits are available. Free ADA off-site parking is also available. Please send requests via Fax/Phone: (937) 669-1163 or E-mail to [lmccoy@glasscity.net](mailto:lmccoy@glasscity.net)
- License Exams reservations are recommended. Walk-ins accepted, if room is available.

### BUS SERVICE

Bus service will be provided between Hamvention, Air Force Museum, Salem Mall and Forest Park Mall parking areas. Check our Web site for more information. ([www.hamvention.org](http://www.hamvention.org))

### COMMUNICATIONS

WWW: <http://www.hamvention.org>

MAIL: Hamvention, Box 964, Dayton, Ohio 45401-0964

FAX: (937) 274-8369

E-Mail: [info@hamvention.org](mailto:info@hamvention.org)

PHONE: (937) 276-6930. Chairman Voice Mail box numbers are available on our Web site.



General Chairman: Dick Miller, N8CBU  
Asst. General Chairman: Jim Graver, KB8PSO

## ADVANCE REGISTRATION

### FOR CHECK OR CREDIT CARD ORDERS:

Make checks payable to: Dayton HAMVENTION  
Enclose the amount indicated in U.S. dollars. For credit card orders, please add \$1.25/ticket service charge. A \$25 service charge will be assessed on all returned checks.

Mail to: Dayton Hamvention Box 1446 • Dayton, OH • 45401-1446  
or FAX to (937) 278-4633

Please type or print your name and address clearly!

	Quantity		
Admission..... (valid all 3 days)	_____	@ \$15.00*	= \$ _____
Grand Banquet.....	_____	@ \$30.00**	= \$ _____
<b>Alternate Activities</b>			
Saturday Luncheon.....	_____	@ \$10.00	= \$ _____
Credit Card Service Charge.	_____	@ \$1.25/ticket	= \$ _____
		<b>Total \$</b>	<b>_____</b>

\* \$20.00 at door \*\*\$35.00 at door, if available



Call \_\_\_\_\_

Expiration Date: \_\_\_\_\_

Month Year

Name \_\_\_\_\_

Address \_\_\_\_\_

City \_\_\_\_\_

State \_\_\_\_\_

Zip \_\_\_\_\_

Daytime Phone ( ) \_\_\_\_\_

Evening Phone ( ) \_\_\_\_\_

PLEASE PRINT! THIS IS YOUR RETURN LABEL.

DAYTON  
hamvention®

the meter response will be linear and will track the scale markings reasonably well.

I wanted to develop a solid state VTVM-style instrument to obtain an analog response suitable for monitoring an analog circuit function, and possibly use the instrument as a DC voltmeter. The results?

- One megohm input impedance to minimize circuit loading
- Low frequency bandwidth
- Variable input sensitivity
- One volt full scale (FS) sensitivity
- Both left and center pointer zero set is available using the balance control
- The circuit will accommodate a meter movement from 50  $\mu$ A to 1 mA (by adjusting some values)
- Meter responds in a manner similar to a VTVM's
- The meter exhibits the accuracy/linearity of the basic meter movement when used as a DC voltmeter

### The circuit

An LM741 op amp provides the foundation of the Analog Volt/Test Meter, as shown in Fig. 2. The input impedance of the LM741 is relatively low, requiring an FET input stage to increase the impedance value. However, the transfer curves of a JFET are nonlinear, which creates a nonlinear calibration response when a linear response is needed. To correct the situation and create a linear response, it is necessary to raise the op-amp gain sufficiently to allow operation over a very narrow portion of the FET curves. The resulting circuit response appears to be at least as linear as the meter scale markings. Any remaining nonlinearity in the FET response is transparent to the user.

After experimenting with several gain values, the op-amp gain was set at 1.2, which appeared to provide a sufficiently linear response when using a

0.5 mA meter movement. The circuit will accommodate most any meter current value from 50  $\mu$ A to 1 mA, but it may be necessary to select a different gain value to accommodate a desired meter response when the meter current approaches or exceeds 1 mA. However, it is suggested that the gain remain at a value less than 2. Typically, the resistance value of R6 is the only value that needs to be changed in order to achieve a full scale meter movement for the selected meter. The value of R6 is selected by experimentation, using the following procedure:

- Connect the selected meter to the circuit.
- Set the input range pot to max sensitivity (full CW position).
- Apply 1.0 VDC to the input terminals.
- Adjust the value of R6; a 250 k pot may be used temporarily, until the meter pointer barely exceeds the full scale meter value.

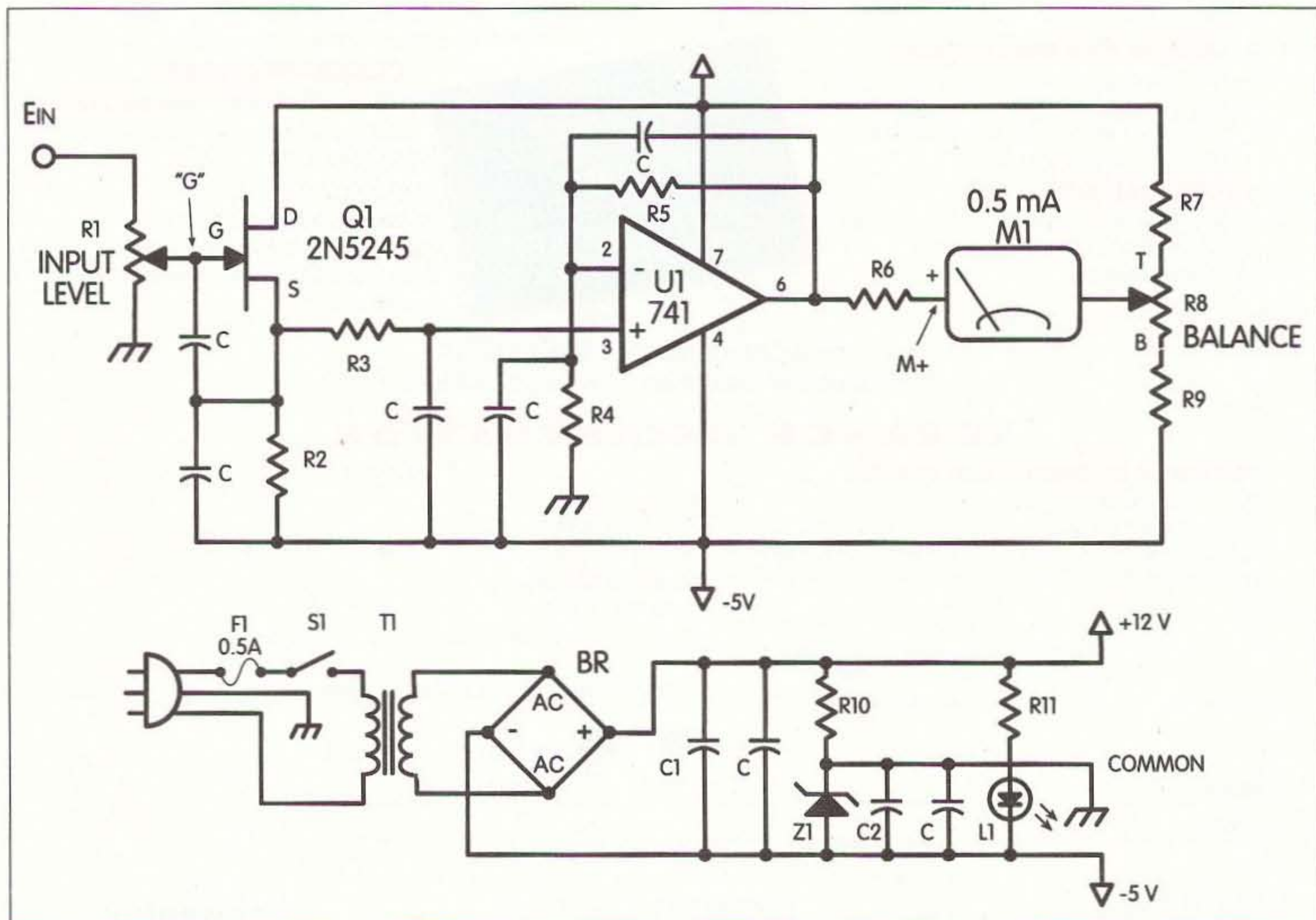

Fig. 2. Schematic diagram of the Analog Volt/Test Meter.

## Parts List

R1	1 M pot
R2*	1.2 k 1/4 W
R3	22 k 1/4 W
R4	100 k 1/4 W
R5	120 k 1/4 W
R6*, R7	2.2 k 1/4 W
R8	1 k pot
R9	1 k 1/4 W
R10	240 Ω 1/4 W
R11	1 k 1/4 W
"C"*	0.005 μF – 0.1 μF 15 V disc cap
C1	330 μF 25 V radial cap
C2	47 μF 6 V radial cap
BR	any 0.5 – 1 A bridge rectifier
F1	1/8 – 1/2 A minifuse
L1	LED power indicator
M1*	0.5 mA 2-1/2 inch square meter
S1	miniature power switch
T1	12.6 V @ 0.3 A power transformer (RS #273-1385A)
U1	LM741 op amp & 8-pin socket
Q1	2N5245 JFET or equivalent
Z1	4.7 – 5.2 V 1/4 – 1/2 W zener diode

Cabinet (RS #270-253A)  
Input terminals/jacks of choice  
Power line cord  
Standoff bushings for board mounting  
Printed wiring board or equivalent  
\* See text

Table 1. Parts list.

- Measure the pot's resistance value and select a fixed resistor value close to, or slightly less than, the pot's measured value.

- Tack the selected resistor into the R6 location and repeat this procedure.

Note: With the fixed resistor installed, the input range pot may be adjusted downward (CCW) slightly, to

position the pointer exactly at the full scale value when 1.0 VDC is applied to the input terminals.

Calibration markings for the range pot are performed by applying a known full scale voltage value to the test terminals and adjusting the range pot to obtain a full scale indication. After marking the full scale voltage value on the panel, the range pot is positioned to a full CCW position before the next and higher input voltage is applied.

### Construction notes

- The Analog Volt/Test Meter may be mounted in any suitable box or cabinet, as there are no critical parameters other than some RF susceptibility. Any wiring technique is suitable. The size of the meter movement dictates the actual cabinet size required. A two and a half-inch square meter was used in the prototype. As shown, the instrument was mounted in a Radio Shack™ #270-253A cabinet.

- Many bypass capacitors have been used throughout the circuit. These are marked simply as "C" in Fig. 2.

- Any disc ceramic capacitance value between 0.005 μF to 0.1 μF is suitable. The capacitors are used in an attempt to reduce the instrument's susceptibility to RF energy. The capacitors help, but unfortunately they do not correct all of the RF sensitivity problem. Therefore, some caution must be exercised when operating the instrument in the presence of a strong RF field.

- Though a 2N5245 JFET was used in the prototype, almost any JFET will work in the input circuit. It is suggested that a family variant of the 2N5245-48, an MPF102, or a 2N4416 be used as an alternate for the 2N5245. Regardless of the JFET selected for the project, the value of resistor R2 may require adjustment. The value of R2 is adjusted to obtain a near-zero voltage differential between the JFET terminal "S" and "COMMON" (JFET "G" is tied temporarily to "COMMON" for this test).

### Try it!

The Analog Volt/Test Meter fills the gap created by the advancement of digital measurement techniques, which have pushed analog instrumentation into the

background. There is still a need; build the Analog Volt/Test Meter and restore analog response measurements to your workbench. 73

# FREE!

## NEW CATALOG

CALL TOLL FREE: 1-800-JAN-XTAL

Quality Crystals  
and Oscillators for:

AMATEUR BANDS • CB • MARINE VHF  
SCANNERS • MICROPROCESSORS • PAGERS  
P.O. Box 60017 • Fort Myers, Florida 33906

VISA (941) 936-2397 MasterCard

# JAN Crystals

CIRCLE 242 ON READER SERVICE CARD

## Where's the Beam?

Unobtrusive DX Gain Antennas for 80 thru 10  
• Easily hidden • Install Fast • Fixed or Portable •



There's a 20 meter antenna with real DX Punch hidden in this picture. You can't see it, and your neighbors can't either. But it works DX barefoot anyway. How about a low profile 80-40-30 m-bander? Or a 2 element monobander for the attic? All easily fit the pocketbook—Priced \$29 to \$99. Work DX without telling the neighbors.

Infopack S1 AntennaWest  
Box 50062-R, Provo, UT 84605 (801) 373-8425

CIRCLE 332 ON READER SERVICE CARD

NEW for ham radio operators!

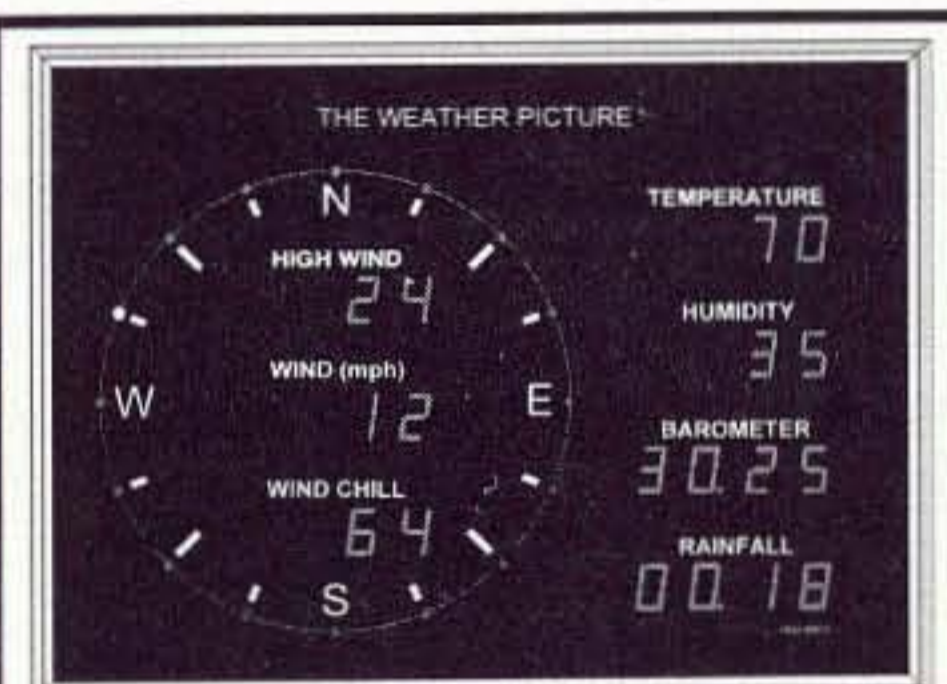

Size shown: 15 1/4" x 11 1/4"

## Put the weather on your wall

The Weather Picture™ is an eye-popping new wall unit that continuously displays all the vital weather data you have selected, without having to press a single button. Big red numerals are easy to read from across the room, day or night. Available in two sizes, in brushed aluminum or elegant solid teak frame. The separate control unit provides detailed data—more than enough to satisfy even the most dedicated weather buff.

Purchase the Weather Picture together with the incomparable ULTIMETER® Weather Station, starting at under \$400. Or add it to your existing ULTIMETER System for less than \$150. It's easy to add programmable display modules to The Weather Picture now or later as needed.

For complete details, call, fax, or write us. Or visit our Web Site to see and try our ULTIMETER Systems. "The best!" says *WeatherWatch* magazine.

1-800-USA-PEET

or 732-531-4615 FAX: 732-517-0669

www.peatbros.com

©PEET BROS COMPANY

1308-8037 Doris Ave., Ocean, NJ 07712

# Amazin' Hall Tree Vertical

*Grab your coat and take your hat ...*

Burt Syverson K5CW  
3401 Garner Lane  
Plano TX 75023

The antenna usually poses a real dilemma for the HF operator who wishes to take his radio with him when he travels by means other than automobile. There are a myriad of questions. What about luggage restrictions? Will there be any natural supports for a horizontal wire, and if there are, will it be necessary that you emulate a mountain goat or steeplejack to use them?

A vertical antenna seems like a good alternative. However, there is the possibility of receiving a bloody nose if a passer-by gets inadvertently entangled in your ground radials.

The vertical loop seemed like a good possibility to me. I built the one described in the May 1994 issue of *QST* (even though it would not fit in a suitcase and I had doubts about it). I tried it running QRP, with very poor reports on 20 CW (nothing better than 5/5/9). I felt that there must be something better.

A friend of mine, who owns Electronic & Parts Outlet in Richardson, Texas, asked me if I knew of any use for 38-inch, swivel-base, telescoping whip antennas, as he had a real "crowd-stopping" price on them. The wheels started to turn, and I came up with what I call the Hall Tree Vertical. This is because it gives you the urge to hang up your hat or coat when you look at it. It requires no radials, is self-supporting, operates 10 through 20 meters, is easily transportable (it weighs only approximately 11 pounds in its four-foot gun carrying case), is relatively inexpensive to build, and performs quite well for its size.

Electronically, it is a centerfed vertical half-wave antenna with inductive loading. A 1:1 50-ohm balun at the feedpoint reduces interaction between the feedline and the radiator as well as

has other benefits, e.g., the ferrite core is somewhat lossy in the VHF-UHF frequency region, and therefore reduces harmonics which could cause television

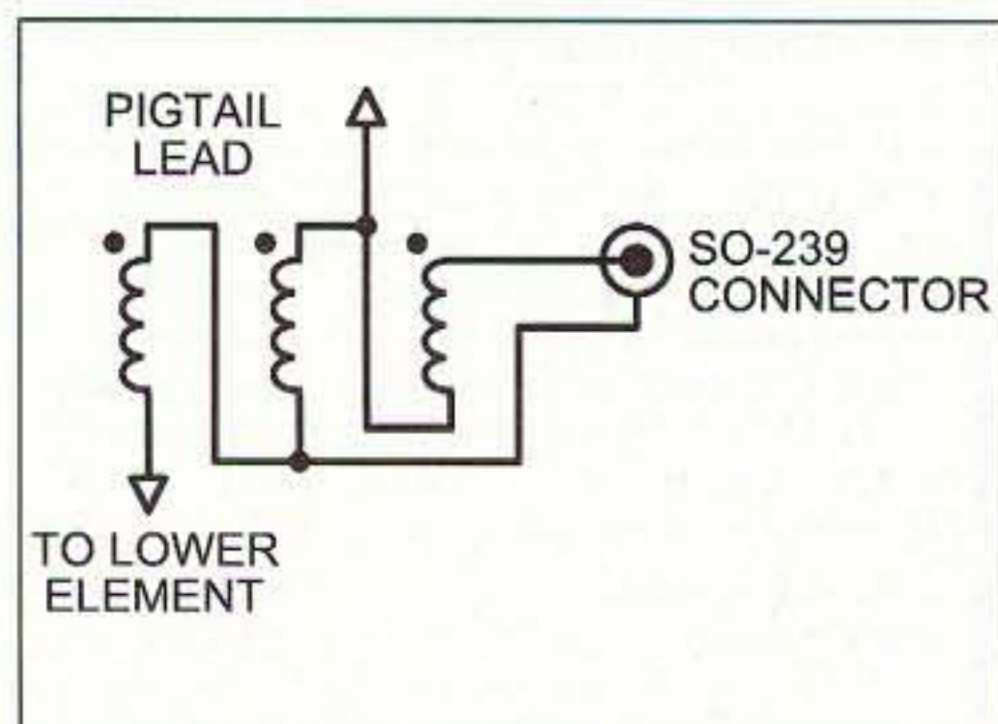

**Fig. 1.** 50- to 50-ohm balun (one required). Ten turns #18 Formvar™ trifilar wire wound on Amidon Associates™ ferrite toroid FT-140-67 form.

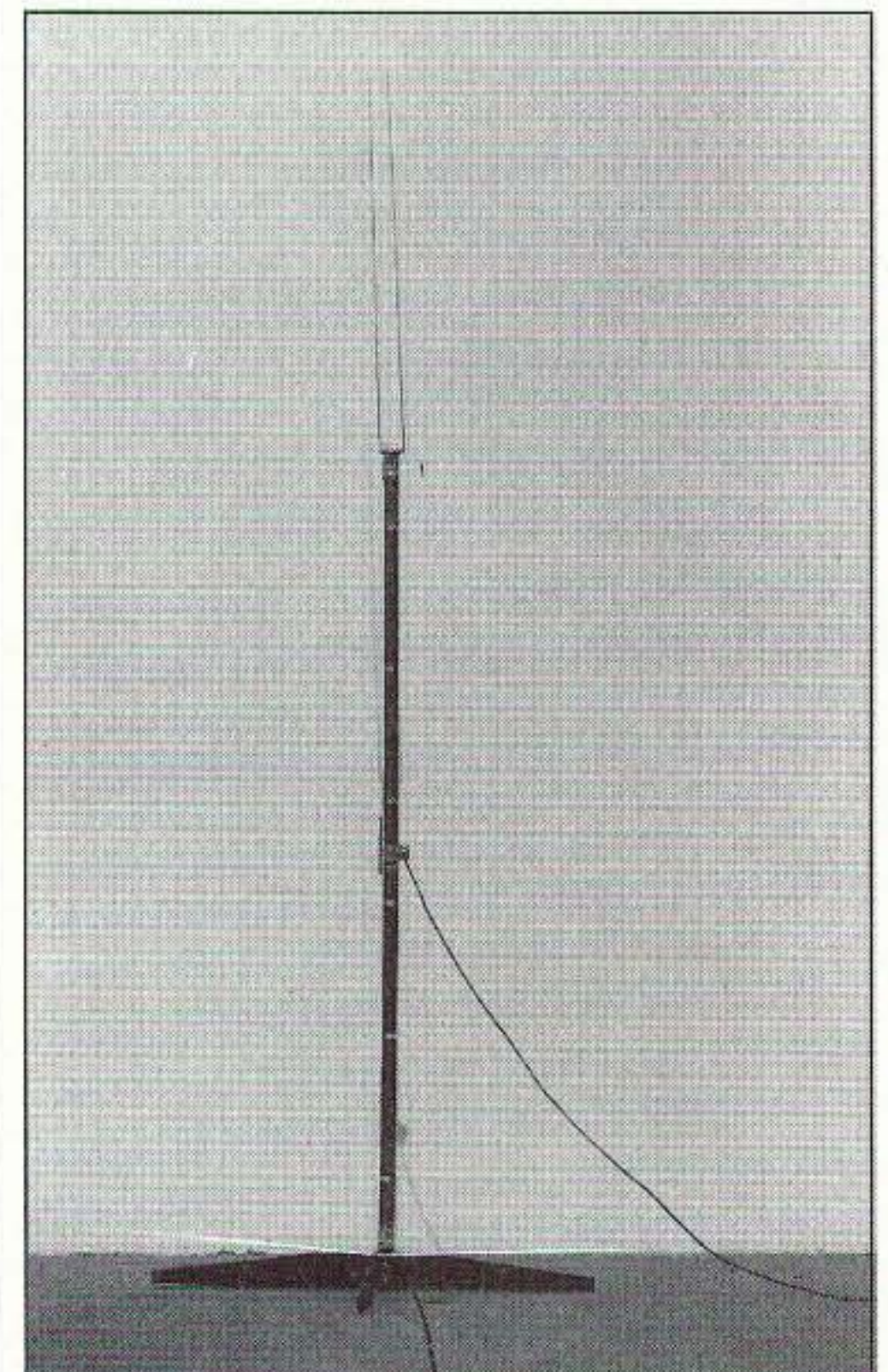

**Photo A.** Hall Tree Vertical in use—metal foot extensions (folded underneath) can't be seen. Note both top and bottom whips. Photos by Peg Syverson.



interference. Also, by reducing antenna currents in the feedline, it eliminates unwanted currents, making it easier to obtain a minimum SWR, which is done by adjusting the telescoping elements. Band selection is made by changing connections on the loading coils.

The antenna support is the familiar Christmas tree stand design. It is made from two 1- x 4- x 46-inch pieces of crisscrossed pine. Each corner has a 1/8- x 1/2- x 18-inch piece of steel, mounted with a single screw, that can be extended in windy conditions. The mast is made from 1- x 2-inch pine. The lower section is 46 inches long. The top section is 41 inches long. The two sections are hinged at the center.

The top section contains two telescoping 38-inch whip antennas, loading coil, and 37-inch piece of 3/4-inch copper tubing. The tubing is flattened and a binding post is mounted on the lower end. The lower section has the balun and SO-239 connector mounted at the top end with another 37-inch piece of copper tubing, loading coil, and two more whip antennas at the bottom. The lower section is held to the base by two 3-inch carriage bolts and wing nuts. Two screw eyes in each

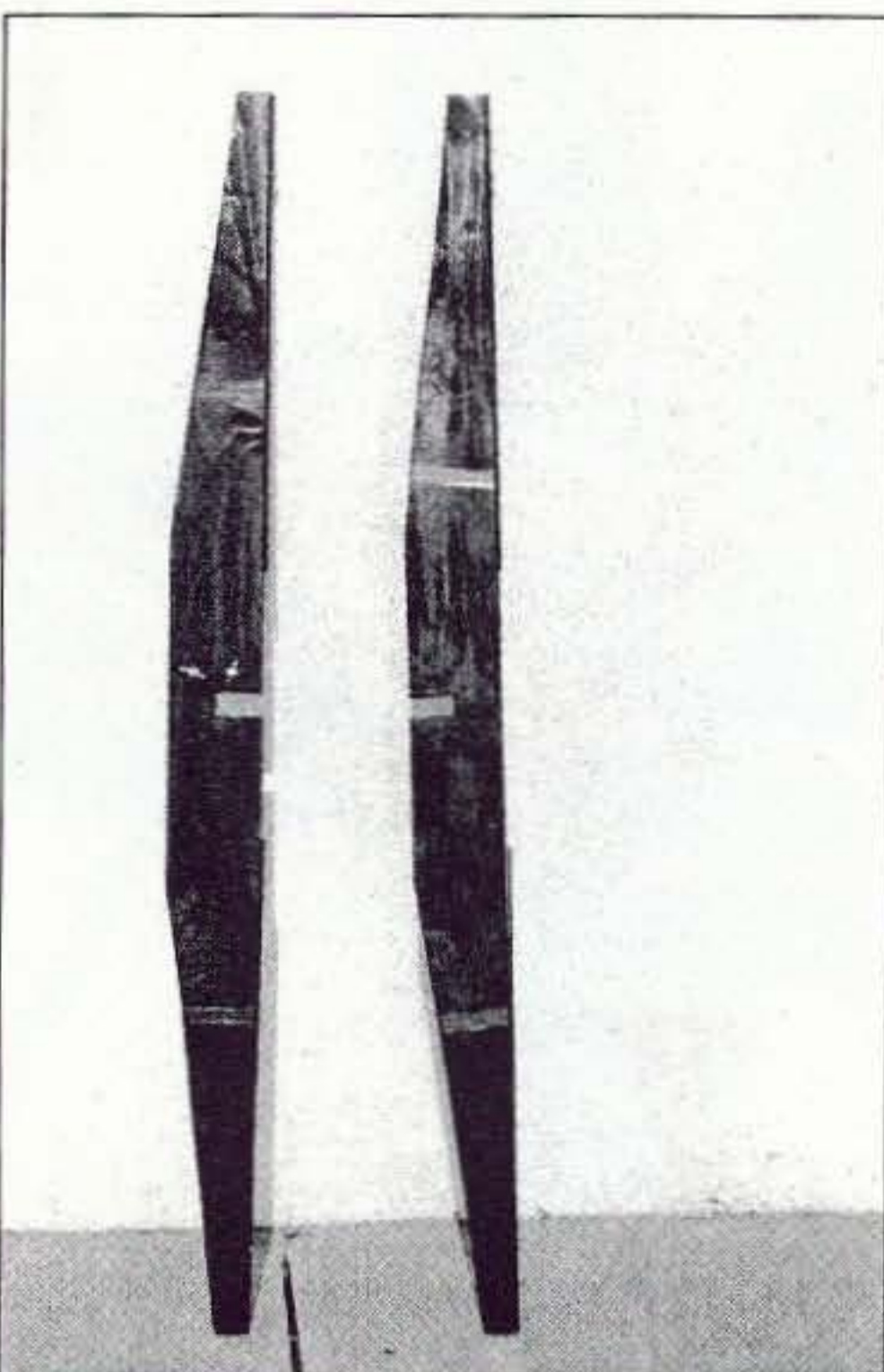

Photo B. Christmas tree stand base sections with metal extensions partially visible.

- DIP switch programmable
- CTCSS encoder
- All 32 EIA tones from 67.0 to 203.5 hz included
- May be ordered with custom tones

SS-32PA Encoder  
9" x 1.3" x 4"

- Fully enclosed CTCSS encoder
- All 32 EIA tones from 67.0 to 203.5 hz included
- Perfect for mobile / base applications

TE-32  
5.25" x 3.3" x 1.7"

**SS-32PA DIP Switch Programmable CTCSS Encoder \$28.95**

**TE-32 Multi-Tone CTCSS Encoder \$49.95**

TP-3200 Shared Repeater Tone Panel

- 51 CTCSS Tones
- 106 DCS Codes
- Supports 157 Repeater Subscribers
- On-Line Computer Help
- Repeater CW ID
- Air Time Loading & Analysis Graphs
- Signalling Formats: CTCSS, DCS & DTMF

TP-3200D Table Top Version \$269.95 each

TP-3200RM-A Single Rack Mount version \$279.95 each

\*TP-3200RM-B Triple Rack Mount version \$279.95 each

\*Holds up to three TP-3200s

ID-8 Automatic Morse Code Identifier  
1.85" x 1.12" x .35"

**NEW LOWER PRICE \$69.95**

**COMMUNICATIONS SPECIALISTS, INC.**  
426 WEST TAFT AVENUE • ORANGE, CA 92665-4296  
(714) 938-3021 • FAX (714) 974-3420  
Entire U.S.A. (800) 854-0547 • FAX (800) 850-0547  
<http://www.com-spec.com>

CIRCLE 10 ON READER SERVICE CARD

**CALL TOLL FREE**  
(800) 292-7711 orders only  
Se Habla Español

**YOUR ONE STOP SOURCE**  
FOR ALL YOUR TEST  
EQUIPMENT NEEDS

CALL OR WRITE FOR OUR  
NEW FREE 64 PAGE  
CATALOG!  
(800) 445-3201

**NEW XK-700 Digital / Analog Trainer**  
Elenco's newest advanced Digital / Analog Trainer is specially designed for school projects. It is built on a single PC board for maximum reliability. It includes 5 built-in power supplies, a function generator w/ continuously sine, triangular and square waveforms, 1,500 tie point breadboard area. Tools and meter shown optional. (Mounted in a professional tool case made of reinforced metal).

**XK-700**  
Assembled and Tested \$189.95

**XK-700-SEMI Kit**  
Assembled and Tested \$174.95

**XK-700K - Kit**  
\$159.95

Made in U.S.A.

**Elenco Scopes**  
Free Dust Cover & Probes

S-1325 25MHz	Delayed Sweep	\$325
S-1330 25MHz	Delayed Sweep	\$439
S-1340 40MHz		\$475
S-1345 40MHz	Delayed Sweep	\$509
S-1360 60MHz	Delayed Sweep	\$749
S-1390 100MHz	Delayed Sweep	\$895

**DIGITAL SCOPE SUPER SPECIALS**

DS-303 40MHz/20MHz Analog/Digital \$895

DS-603 60MHz/20MHz Analog/Digital \$995

**4 Functions in One**  
**MX-9300**  
\$459.95

**Features**

- One instrument w/ four test leads and measuring systems.
- 1.3GHz Frequency Counter
- 2MHz Sweep Function Generator
- Digital Multimeter
- Digital Triple Power Supply

• 0-30V @ 3A, 15V @ 1A, 5V @ 2A

**NEW Tektronix DMMs**

- 40,000 Count
- High Accuracy
- Tektronix Quality
- 3 Year Warranty

DMM 912	\$179
DMM 914	\$229
DMM 916	\$275

**20MHz Sweep/Function Generator with Frequency Counter Model 4040**

- 0.2Hz to 20MHz
- AM & FM Modulation
- Burst Operation
- External Frequency Counter to 30MHz
- Linear and Log Sweep

10MHz - Model 4017	\$309
5MHz - Model 4011	\$239

**\$399**

**Fluke Scopemeters**

123	NEW	\$950
920		\$1445
960		\$1895
97		\$1895
990		\$2095
105B	NEW	\$2495

**ALL FLUKE PRODUCTS ON SALE!!**

**Technician Tool Kit TK-1500**

26 tools plus a DMM contained in a large flexible tool case with a handle ideal for everyone on the go!

**\$49.95**

**Fluke Multimeters**

Model 260	\$63	Model 12	\$64
Model 700i	\$85	Model 83	\$235
Model 730i	\$115	Model 85	\$299
Model 750i	\$139	Model 87	\$299
Model 770i	\$154	Model 853E	\$475
Model 790i	\$175	Model 867BE	\$650

**DIGITAL LCR METER Model LCR-1810**

- Capacitance 0.1pF to 20µF
- Inductance 1µH to 20H
- Resistance .01Ω to 2000MΩ
- Temperature -20°C to 750°C
- DC Volts 0-20V
- Frequency up to 15MHz
- Diode/Audible Continuity Test
- Signal Output Function
- 3 1/2 Digit Display

**\$99.95**

**B&K High Current DC Power Supply**

- Variable 0-14VDC
- Thermal Function
- Current Limiting

Model 1680 12A	\$159
Model 1680 28A	\$239

**B&K 13.8V Fixed DC Power Supplies**

Model 1680 6A	\$39
Model 1680 15A	\$75

**Quad Power Supply Model XP-581**

Four Fully Regulated DC Power Supplies in One Unit

4 DC Voltages: 3 Fixed, 1 Variable

- +5V @ 3A
- +12V @ 1A
- -12V @ 1A
- 1 Variable 2.5 - 20V @ 2A

**\$89.95**

**Digital Multimeter Model M-1700**

**\$39.95**

11 functions including freq. to 20MHz, cap to 20µF. Meets UL-1244 safety specs.

**10% OFF ON ALL STANDARD AMATEUR RADIO PRODUCTS Including Accessories**

**Elenco LCR & DMM Model LCM-1950**

**\$69**

12 Functions  
Freq to 4MHz  
Inductance  
Capacitance

**Handheld Universal Counter F-2800**

**1MHz - 2.8GHz**

**Features:**

- 15 segment RF signal strength bargraph 1MHz - 2.8GHz.
- 15 segment RF signal strength bargraph.
- 5 hour NiCd battery operation.
- High speed 250MHz direct count for high resolution.

**NEW \$99**

**Kit Corner over 100 kits available**

**Model AR-2N6K**  
2 Meter / 6 Meter Amateur Radio Kit

**\$34.95**

**Model AM/FM-108K**  
Transistor Radio Kit

**\$29.95**

**35mm Camera Kit Model AK-540**  
Learn all about photography

**\$14.95**

No Soldering Required

**Radio Control Car Kit Model AK-870**

- 7 Functions
- Radio Control Included

**\$24.95**

No Soldering Required

**Repair System Soldering and Desoldering Station Model SL-916**

Top-of-the-line repair system will handle desoldering. Temperature controlled soldering from 300°F to 790°F (150°C to 420°C), desoldering temperature range 410°F to 900°F (210°C to 480°C). The system is based on principle of vacuum absorption of the solder from the PC board.

SL-925 - Desoldering System with Digital Display also available. \$325.00

**\$425.00**

**Guaranteed Lowest Prices**

UPS SHIPPING 48 STATES 5%  
OTHERS CALL FOR DETAILS  
IL Residents add 9.25% Sales Tax

**C&S SALES, INC.**  
150 W. CARPENTER AVENUE  
WHEELING, IL 60090  
(847) 541-0710 • FAX: (847) 541-9904  
[http://www.elenco.com/c\\_s\\_sales](http://www.elenco.com/c_s_sales)

**15 DAY MONEY BACK GUARANTEE**  
**FULL FACTORY WARRANTY**

PRICES SUBJECT TO CHANGE WITHOUT NOTICE

CIRCLE 184 ON READER SERVICE CARD

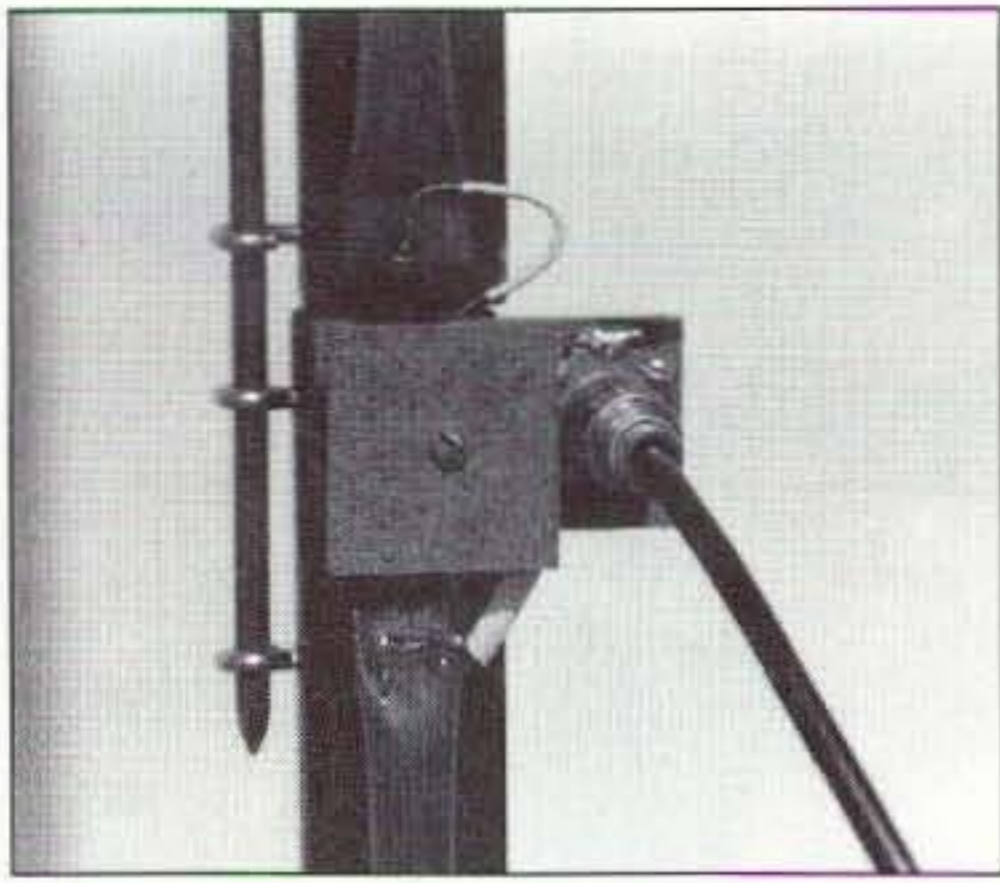

Photo C. Feedpoint in operation.

section on either side of the hinge and a 60-penny nail hold the two sections erect when in use.

The swivel base antennas present a mounting problem because they have metric threads. They are paired and tied together electrically, so there are several possibilities; the antennas I use are cheap, but they're made for mounting in a slotted hole with a metric-size mounting stud. Every constructor may not be equipped to do things the same way I did, depending on such various factors as mechanical experience, access to a machine shop, variety of stock in the local hardware store, etc. It may not be truly universal, but I would suggest that a 1/2-inch x 1/16th-



Photo D. Feedpoint folded for shipment.

### Parts List

Qty.	Description
4	70 Telescoping Antenna from EPO
1	8-foot length of 1x2 pine
1	8-foot length of 1x4 pine
10 ft.	3/4" copper tubing
4	1-1/2 foot x 3/4 inch x 1/8 inch steel strips
1	Ferrite toroid (FT-140-67)
2	Powdered iron toroid (T-106-6)
40 ft.	#18 copper magnet wire
1	2-inch hinge
1	SO-239 coax connector
1	Binding post
6	1/2-inch Nylon cable straps
4	3/8-inch Nylon cable straps
12	#6 3/4-inch RH wood screws
3	#6 2-inch RH wood screws
4	#8 1-inch RH wood screws
4	#4 - 40 x 3/8 RHMS
12	#6 - 32 x 3/4 RHMS
4	#4 lockwashers
24	#6 lockwashers
8	#8 flat washers
4	#4 - 40 nuts
24	#6 - 32 nuts
2	1/4 - 20 x 2-inch carriage bolt
2	1/4 x 20 wingnuts
1 ft.	1/4-inch copper tubing
4	Screw eyes
1	60d nail
	Misc. (Carrying case, paint, solder, partial sheet of 1/4-inch Masonite )

Table 1. Parts list.

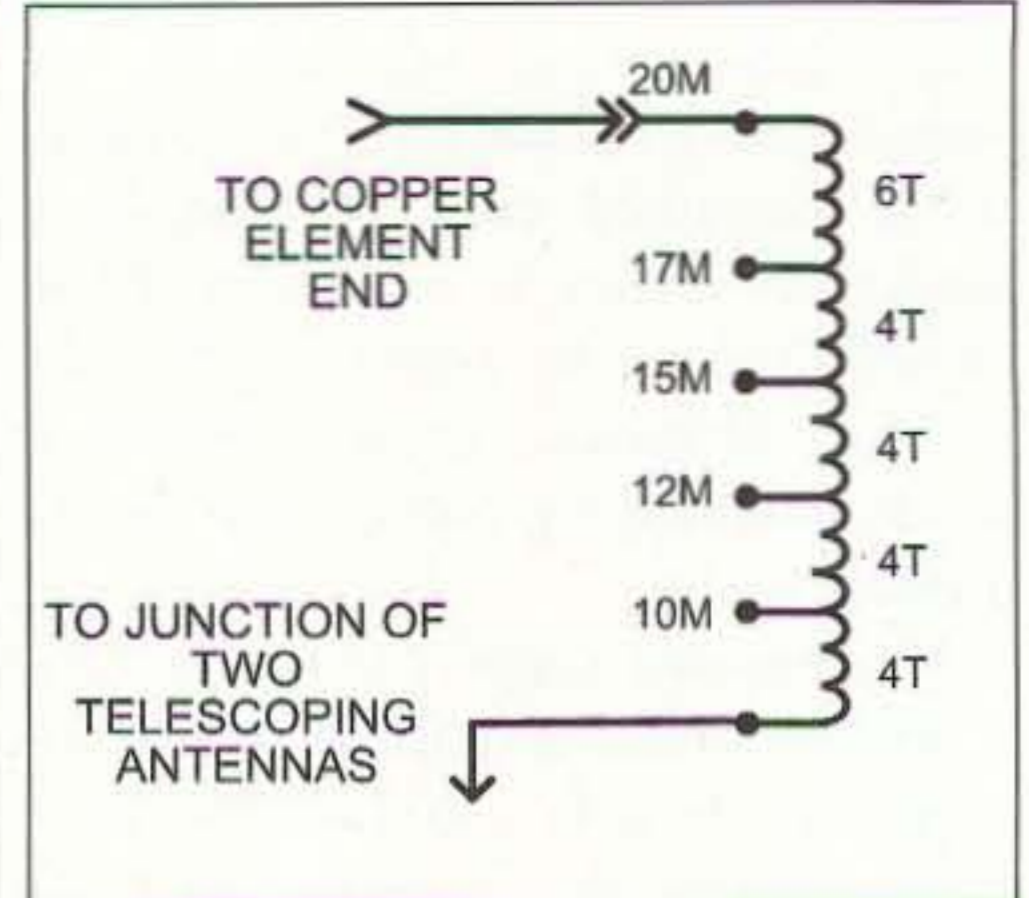

Fig. 2. Loading coils (two required). #18 Formvar wire wound on Amidon powdered iron toroid T-106-6.

inch piece of sheet metal could be bent into a "U" shape, with a base drilled with two #28 (or 1/8th-inch) holes for fastening it to the mast with #6 round-head wood screws. The sides of the "U" should be approximately 5/8-inch long and drilled to the clearance size of the antenna mounting studs. Solder lugs with a short connecting lead can be used on each stud for making electrical connection to the loading coils.

Powdered iron toroid cores are not customarily used in antennas. These cores have limited power handling

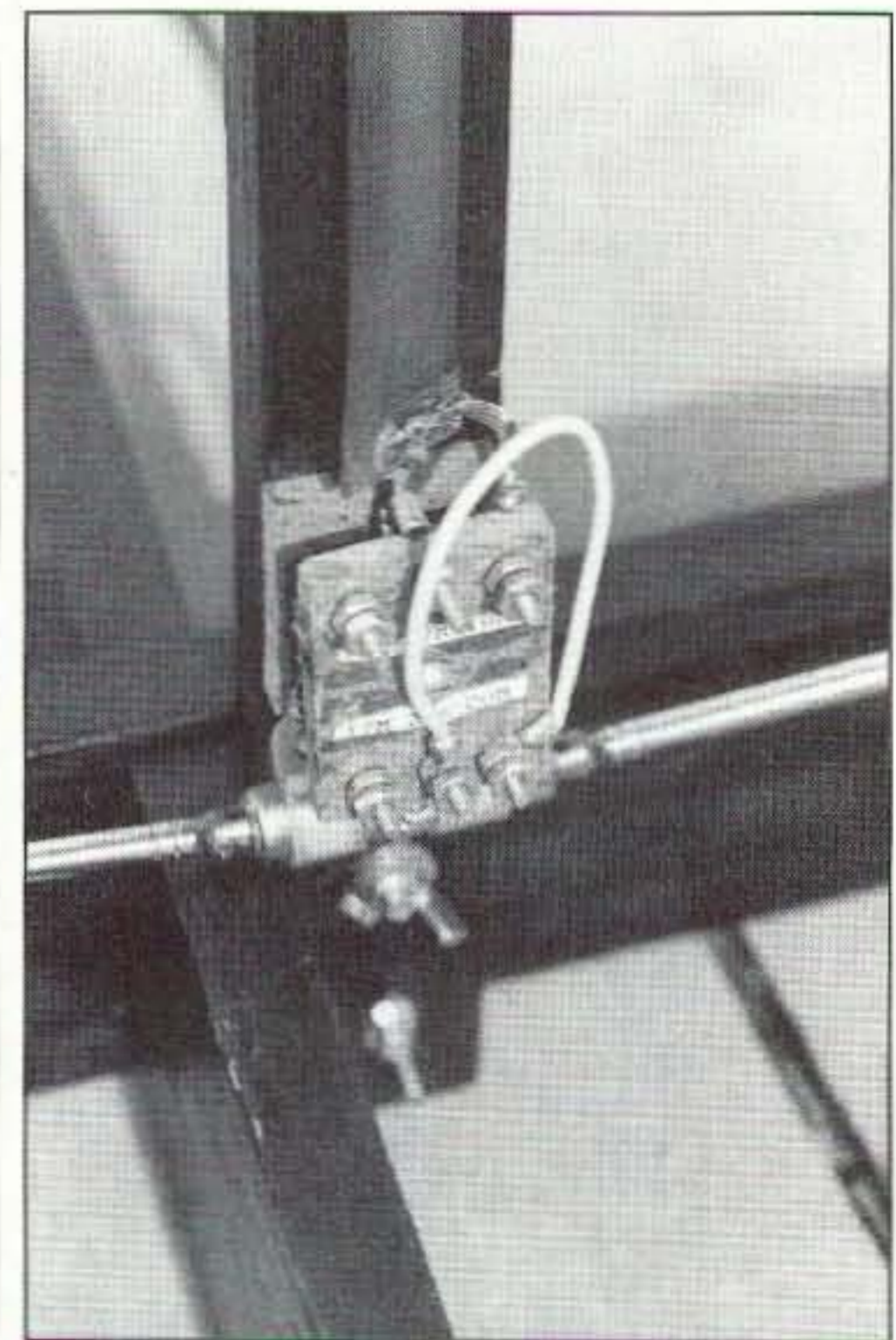

Photo E. Lower loading coil, showing #6-32 hardware with jumper for band changing. Lower elements horizontal when in operation.

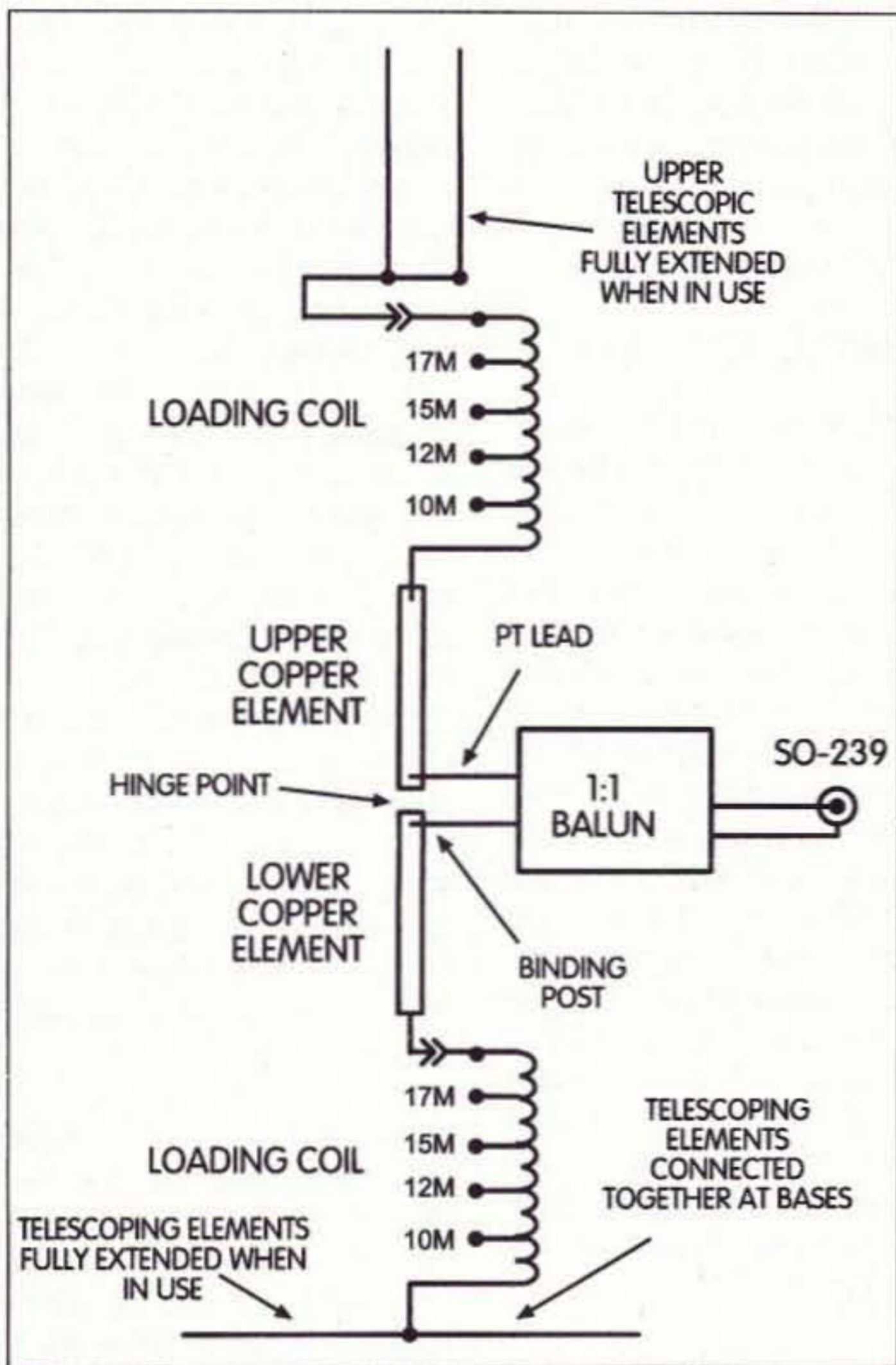

Fig. 3. Complete diagram.

capability. Because the ends of the windings are in close proximity to one another as well as to the core, there is danger of a high-voltage flashover as well as damage from overheating if the input power is raised too far. However,

shell of the SO-239—the feedline is temporarily disconnected) can be used to

Continued on page 79

this antenna was designed to be a QRP antenna; it was not intended to be used over the 100 W level. Discernible heating or arc-over has not been experienced. The powdered iron toroid cores' high "Q" contributes to the antenna's efficiency.

Replacement 38-inch, swivel base, telescoping whip antennas are a common item at hamfest and surplus stores. In operation, the upper telescoping elements are fully extended vertically to 38 inches (except on 10 meters where a better SWR is usually obtained at 31 inches). On all bands, the antenna is resonated by adjusting the lower elements horizontally, equal lengths together for minimum SWR. Coupling a dip meter through a two-turn loop (between the inner conductor and the

24 DIFFERENT PANELS PRE-PUNCHED FOR POPULAR CONNECTORS

MAKE TEST FIXTURES QUICKLY!  
PANELS ARE 0.040" RAW ALUMINUM

**Lab Box-It™**

MODEL	W x D x H in.	PRICE
LAB-1	1.5 x 2.0 x 0.75	3.75
LAB-2	1.5 x 4.0 x 0.75	4.50
LAB-3	1.5 x 6.0 x 0.75	5.25
LAB-4	2.0 x 2.0 x 1.0	4.00
LAB-5	2.0 x 4.0 x 1.0	4.75
LAB-6	2.0 x 6.0 x 1.0	5.50
LAB-7	2.0 x 2.0 x 1.5	4.10
LAB-8	2.0 x 4.0 x 1.5	5.00
LAB-9	2.0 x 6.0 x 1.5	6.00

FREE SURFACE SHIPPING ON PREPAID ORDERS (CONT. U.S., CANADA & MEXICO)

ORDER BY DECEMBER 31, 1997 AND SAVE 20% OFF YOUR TOTAL!

MUST MENTION #ST97 TO RECEIVE DISCOUNT \$30.00 MINIMUM ORDER AFTER DISCOUNT

VISA MasterCard

ORDERS 800-634-3457 FAX 800-551-2749  
OFFICE 702-565-3400 FAX 702-565-4828  
SESCOM, INC. 2100 WARD DR., HENDERSON, NV 89015  
SESCOM, INC. is not responsible for inadvertent typographical errors and prices and specifications are subject to change without notice.

CIRCLE 167 ON READER SERVICE CARD

**Next Day** **QSLs**  
Two-Color Rainbow Assortment

Baraboo, Wisconsin  
Sauk County  
**K9ZZ**

Call Today & We Ship

	Next Day	2nd Day	ASAP
100	\$29.95	\$24.95	\$19.95
200	\$39.95	\$34.95	\$29.95
400	\$49.95	\$44.95	\$39.95
500	\$54.95	\$49.95	\$44.95
1000	\$99.95	\$89.95	\$79.95

Info 51  
Antennas West  
(801) 373-8425

All orders ppd 2nd day air! priority mail.  
For overnight air delivery add \$10.  
Box 50062-S, Provo, UT 84605

CIRCLE 5 ON READER SERVICE CARD

From Micro Computer Concepts

**RC-1000 REPEATER CONTROLLER**

- Autopatch • Reverse Autopatch
- User Programmable CW ID, Control & User Codes & Timeouts

Manual with schematics • 90-Day Warranty  
Wired & Tested w/ manual .... **\$199.95**

VISA MasterCard

Micro Computer Concepts  
8849 Gum Tree Ave.  
New Port Richey, FL 34653  
**813-376-6575**

CIRCLE 160 ON READER SERVICE CARD

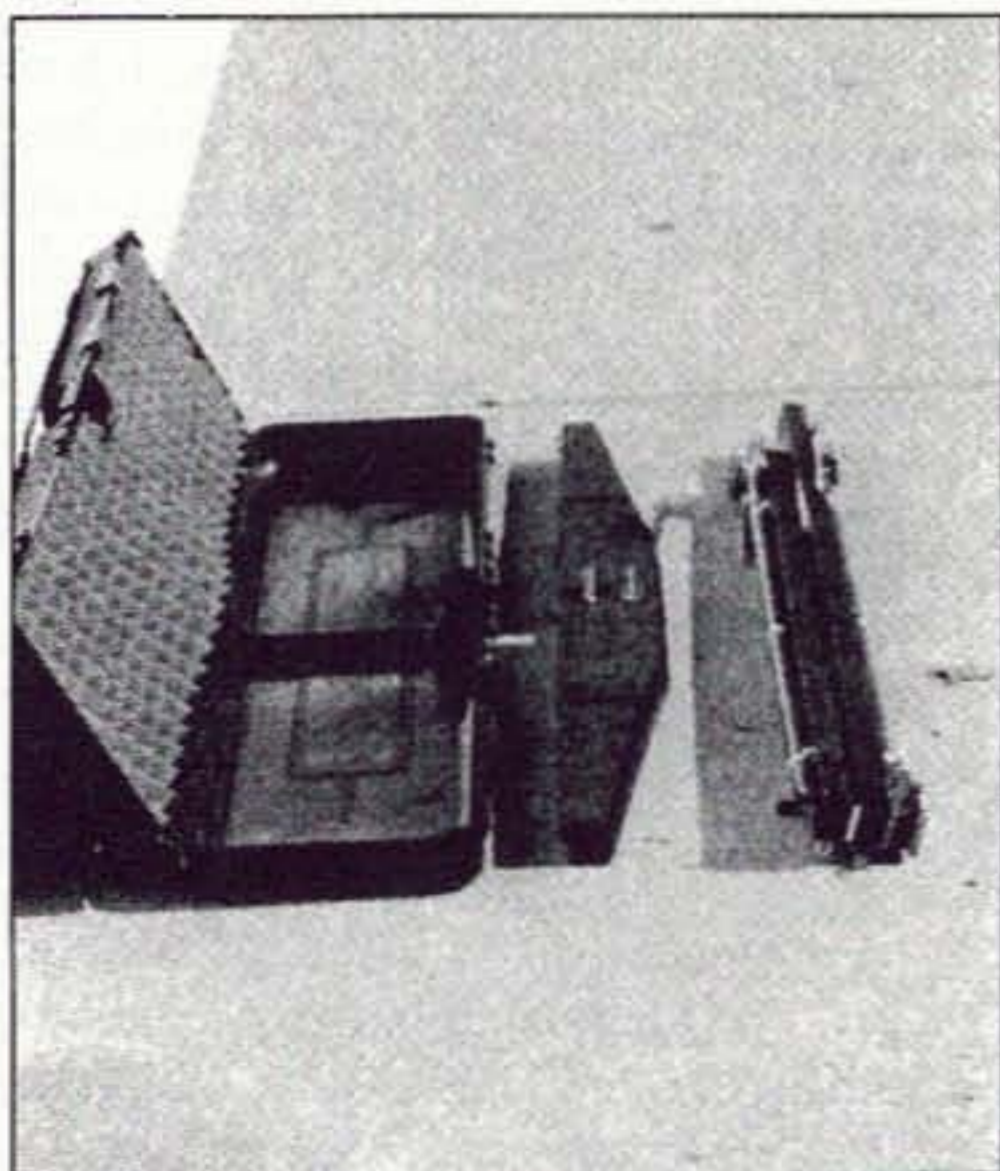

Photo F. Ready to pack and go. Leave your worries on the doorstep ...

THE ORIGINAL WD4BUM  
**HAM STICK™ ANTENNAS**  
for HF MOBILE OPERATION  
**\$19.95 each**

The only lightweight HF mobile antenna recommended by noted author Gordon West, WB6NOA

- Monobanders for 75 to 6 meters.
- Very rugged fiberglass & stainless steel.
- Telescopes for easy adjustment.
- 3/8 x 24 TPI base fits most mounts.
- Low profile & low wind load.
- Needs no springs or guys.
- Complete tuning & matching instructions included.
- Approximately 7 ft. tall.
- 600 watts.

Cat. #	Band	Cat. #	Band
9175	75 meters	9115	15 meters
9140	40 meters	9112	12 meters
9130	30 meters	9110	10 meters
9120	20 meters	9106	6 meters
9117	17 meters		

NEW ENHANCED  
**DISCONE SCANNER ANTENNA**  
Only **\$36.95**

- 800 To 900 MHz enhancement.
- Transmit on 146, 220, and 440 amateur bands.
- Rated to 150 Watts.
- Compact, will fit in 36" x 36" space.
- Receives all AM-FM & SSB frequencies.
- Gain improves with frequency increase.
- Mounts to any vertical mast 1" to 1 1/2".
- Aluminum mount & elements.
- 8 cone & 8 disk elements—same as other discones selling for nearly 3 times our price.
- Accepts standard PL-259 connector.
- For type "N" connector add \$5.00.

**MOBILE COLINEAR ANTENNAS**

THE ULTIMATE PERFORMER

- Honest 4.5dB gain.
- 1000 watts DC.
- 17-7 ph stainless steel top sec.
- Rugged fiberglass base station.
- Base fitting is std. 3/8 x 24 TPI.

Length  
9007 - 146 MHz 7' 2" • 9038 - 220 MHz 4' 9"  
9440 - 440 MHz 2' 5"

**\$19.95**

Base station version available **\$29.95**  
9007-B • 9038-B • 9440-B

**Tri-Magnetic Mount MODEL 375**  
Only **\$39.95**

Now with no-rust all stainless steel hardware

- Holds all Hamstick Antennas and many others.
- Over 400# of holding power.
- 12" X 14" foot print.
- 3/8 x 24 thread mounting.
- 15' RG 58 coax w/PL-259.
- No rust aluminum construction.

CIRCLE 275 ON READER SERVICE CARD

**Lakeview Company, Inc.**  
3620-9A Whitehall Rd., Anderson, SC 29626 • 864-226-6990  
FAX: 864-225-4565 • E-Mail: hamstick@hamstick.com • www.hamstick.com

VISA MasterCard ALL 100% MADE IN USA Add \$7 per order S/H

# SPECIAL EVENTS

Listings are free of charge as space permits. Please send us your Special Event two months in advance of the issue you want it to appear in. For example, if you want it to appear in the June issue, we should receive it by March 31. Provide a clear, concise summary of the essential details about your Special Event.

## MAR 1

**NEW WESTMINSTER, BC, CANADA** The Burnaby ARC's 11th Annual Fleamarket will be held at New Westminster Armouries, 6th Street and Queens Ave., New Westminster BC. Open to sellers at 9 a.m., open to buyers 10 a.m.–2 p.m. Talk-in on VE7RBY 145.35(-), or 442.85. Contact by telephone, between 7 p.m. and 9 p.m. PT, Harry VE7HNC, (604) 530-3962; Graham VE7ABC, (604) 530-1907; or packet VE7ABC @VE7KIT.

## MAR 7

**ABSECON, NJ** The Shore Points ARC will sponsor its 16th annual hamfest, "Springfest '98," at Holy Spirit High School on Route 9, 3/4 of a mile south of Route 30, starting at 8 a.m. Admission is \$5 (non-ham XYLs and children free). Indoor tables (limited AC available) are \$7 per 8-foot section in advance, \$10 at the door. Reservations will be accepted. Outdoor tailgating (weather permitting) is \$5 per painted parking space (first come, first served, no reservations accepted). Setup at 6:30 a.m. Free parking. For info write to SPARC, P.O. Box 142, Absecon NJ 08201; or call Eva KB2QXU at (609) 407-2923. Talk-in on 146.385/.985, PL 146.2 Hz.

**ROSEVILLE, MI** The L'Anse Creuse ARC will hold its 3rd annual Amateur Radio Open House at the Macomb Mall in Roseville MI, for the purpose of introducing ham radio to the public. As part of the demonstration, the club will operate station N8LC, 1500 UTC–2100 UTC, and will invite visitors to join them on the air. Voice operation will be in the General portion of the 40 and 20

meter bands. Listen for them on or near 7230 on 40 meters, and 14.330 on 20 meters. Anyone who contacts the station can receive a commemorative certificate. Send a QSL card and SASE to N8LC, c/o Diane Scalzi, 21621 Briarcliff, St. Clair Shores MI 48082-1299. Please include a 9-inch x 12-inch envelope with 64 cents postage if you want an unfolded certificate. Otherwise, send a business-size envelope with 32 cents postage.

## MAR 14

**KNOXVILLE, TN** The Shriners of the Kerbela Amateur Radio Service will sponsor the Kerbela Hamfest at the Kerbela Shrine Temple in Knoxville, 8 a.m.–4 p.m. Admission is \$5. Indoor vendor tables are \$8 each, plus admission of \$5. Setup Fri., 4 p.m.–8 p.m. and Sat., 5 a.m.–8 a.m. Overnight security provided. Talk-in on 144.83/145.43 or 146.52 simplex. Smoking indoors permitted in designated area only. For additional information contact Paul Baird K3PB, 1500 Coulter Shoals Circle, Lenoir City TN 37772. Tel. (423) 986-9562.

## MAR 14–15

**MIDLAND, TX** The Midland ARC will hold their annual St. Patrick's Day Hamfest 9 a.m.–5 p.m. Sat., March 14th, and 8 a.m.–2:30 p.m. Sun., March 15th, at the Midland County Exhibit Building. This is also the ARRL West Texas Division convention. Some of the many features include a huge inside flea market, dealers, large tailgate area, T-hunts, and more. VE exams will be given at 1 p.m. on Sat. Pre-registration is \$7. Registration at the door will be \$8. Tables \$12 each for the first four and \$17 each for each additional table over four. For more info,

contact Midland ARC, P.O. BOX 4401, Midland TX 79704; or Larry Nix N5TQU, by E-mail [oilman@lx.net]. You can see the Hamfest flyer and download a registration form at [http://www.lx.net/edge/midswap.html].

## MAR 14, 21, 28; APR 4

**CLAYTON, MO** The annual St. Louis County SKYWARN Severe Weather Observation Training Seminars will be held on the Saturdays listed above. For locations call the Severe Weather Info Line, (314) 889-2857. You will get a taped message and additional information. All are welcome, including those from outside the area; no advance registration required. Free parking. SKYWARN Level 1 training is presented in the morning, and classes resume in the afternoon with the SKYWARN Level 2 program. Certification is provided for RACES and SKYWARN, all at no cost. One need not be a ham operator to attend and participate in the program. Please call for additional information.

## MAR 15

**JEFFERSON, WI** The Tri-County ARC "Hamfest 1998" will be held at the Jefferson County Fairgrounds Activity Center, Hwy. 18 West, Jefferson WI, 8 a.m.–2 p.m. Admission is \$4. 6-ft. table space, \$5; 8-ft. space, \$6. Reserve space early. Send your SASE to TCARC, W9MQB, 711 East Street, Fort Atkinson WI 53538. Tel. (920) 563-6502. An equipment test table will be available. Vendors will be admitted at 7 a.m., others at 8 a.m. Vendors: Please unload at the northwest side door; parking will be provided for unloading. No early sales. Talk-in on 145.49 rptr.

**MAUMEE, OH** The Toledo Mobile Radio Assn. (TMRA) will hold their 43rd Annual Hamfest/Computer Fair, 8 a.m.–3 p.m., at the Lucas County Recreation Center, 2901 Key St., in Maumee. For details send SASE to TMRA/Paul Hanslik, P.O. Box 273, Toledo OH 43697-0273; or call Paul N8XDB at (419) 243-3836.

**STERLING, IL** The Sterling-Rock Falls ARS 38th Annual Hamfest will be held at the Sterling High School Field House, 1608 4th Ave.

There will be a large indoor flea market, radio, electronic items, computer and hobby gear. Free parking, including areas to accommodate campers and self-contained mobile homes. Dummy load available to test equipment. Tickets \$3 in advance, \$4 at the door. Tables \$5 without elec., \$6 with. First table is \$6, each additional is \$5. Bring your own power cord. Setup Sat. 6 p.m.–9 p.m., and on Sun. at 6 a.m. Doors open to the public at 7:30 a.m. Sun. For advance tickets and tables, write to Sterling-Rock Falls ARS, P.O. Box 521, Sterling IL 61081-0521; or call Lloyd Sherman KB9APW at (815) 336-2434. E-mail: [lsherman@essexl.com]. Make checks payable to Sterling-Rock Falls Amateur Radio Society. Talk-in on 146.25/.85 W9MEP rptr. Advance ticket orders must be received by Mar. 1st. Please send an SASE.

**YORK, PA** The York Springfest will be held 8 a.m.–3 p.m. at York County Vo-Tech School, 500 yards south of Exit 6, I-83. Tailgating, VE exams, and a Hamfest/Computer Show will be featured. Admission is \$5. The event is sponsored by the Keystone VHF Club. Contact Ted Rodes, 17 Sedgwick Dr., East Berlin PA 17316. Tel. (717) 259-8063. Web page: [http://members.aol.com/yorkfest].

## MAR 21–22

**BETHPAGE, NY** The Long Island Mobile ARC will present a weekend Ham Radio Course at Briarcliffe College, 1055 Stewart Ave., Bethpage NY, Sat., Mar. 21st–Sun., Mar. 22nd, 9 a.m.–6 p.m., for anyone interested in obtaining their entry level amateur radio license. There is no prerequisite for registering—just a desire to become a ham. No minimum age limit, but we recommend age 10 and above. The cost per person is \$35. This includes the workbook, lunch each day, and refreshments at breaks. It does not include the exam cost of \$6.25. There will be a number of instructors, including LIMARC Past President Norm Wesler K2YEW, current LIMARC President George Tranos N2GA, and current Vice President Rob Todaro N2JIX. For more info, please call the LIMARC 24-hour info line at (516) 520-9311; or

E-mail to [N2GA@aol.com]. Registration is limited, so please reserve now to secure your spot. Indicate age if less than 18. Please make checks payable to LIMARC for \$35 per person. Include name, address, phone, and E-mail address. Send to LIMARC Weekend Class, P.O. Box 392, Levittown NY 11756.

### MAR 22

**GRAYSLAKE, IL** The Libertyville and Mundelein ARS, assisted by the North Shore Radio Club, will hold "LAMARSFEST '98" at the Lake County IL Fairgrounds in Grayslake. This large, indoor, radio, computer, and electronic swapfest will be open 8 a.m.-2 p.m.; setup is at 6 a.m. Advance commercial setup by arrangement. Admission is \$5 at the door. Swapfest tables \$10 each. Wall tables \$15 each. Commercial tables \$25 each. Table reservations until March 14th. No additional charge for power. VE exams. No tailgating. For info and reservations, contact Dave Gudewicz KB9KDA, LAMARSFEST 98, 5 Brigantine Lane, Grayslake IL 60030. Tel. (847) 937-8227 until 9 p.m. Talk-In on 147.945/.345 NSRC rpt., and 146.52 simplex.

**MADISON, OH** The Lake County ARA will hold its 20th annual Hamfest 8 a.m.-2 p.m. at Madison High School on North Ridge Rd. in Madison. VE exams, DXCC and WAS checking, ham-related forums, and a test bench are some of the features of this event. Admission \$5 at the door. Table space for vendors is \$8 for a 6-foot table and \$10 for an 8-foot table. Reservations for tables can be made by calling Roxanne at (440) 256-0320.

**YONKERS, NY** The Yonkers Raceway will be the location for the Westchester Emergency Comm. Association's annual radio and electronics hamfest. This indoor and outdoor event will feature all types of new and used ham radio equipment, computers, CB, shortwave, scanners, and other varieties of electronic equipment and parts for sale. Major equipment dealers, VE exams, radio forums, a radio tech clinic, and tailgating will also be featured. Free unlimited parking. Handicap accessible. Admission is \$6, children under 14

free with adult admission. For more info please call the WECA info-line at (914) 741-6606, or visit the WECA Web site, [WWW.WECA.ORG]. Talk-in on the WECA rpt. on 147.060 MHz, +600 Hz, PL 114.8.

### APR 3-4

**ATLANTA, GA** The 2nd South-eastern VHF Society Conference will be held Fri. and Sat., April 3rd and 4th, in Atlanta GA. Antenna measurements will be done on Friday, starting with 144 MHz and working up in freq., amateur bands only, please. A maximum of two antennas per band per individual may be tested. Please supply a Female N connector or SO-239. Please pre-register. For more info, contact Antenna Measurements Chairman Dale Baldwin WB0QGH at [wb0qgh@mindspring.com]. Noise Figure Testing will be conducted on Saturday. For more info, contact the Noise Figure Measurement Co-Chairman Charles Osborne WD4MBK, at [cosborne@pipeline.com]; or Fred Runkle K4KAZ at [engineer@rightmove.com]. There will be a Friday evening flea market, a Saturday evening banquet, SVHFS auction, and family program. Register before March 14th and receive a discount! You are invited to visit the Web site at [www.akorn.net/~ae6e/svhfs].

### APR 4

**WATERFORD, CT** A Ham Radio Auction, sponsored by the Radio Amateur Society of Norwich, will be held at 10 a.m. at the Waterford Senior Center on Rt. 85. From Hartford, take Rt. 2 south to Rt. 11 to Rt. 85 South. From the shoreline, take Rt. 95 to Rt. 85 North. Talk-in on 146.730(-). Bring your gear to sell (10% commission to RASON). Free admission, free parking. Contact Tony AA1JN at (860) 859-0162; or see the RASON Web page at [www.ims.uconn.edu/~rason].

### APR 5

**MIDDLETON, WI** The Madison Area Repeater Assn., Inc., will hold its 26th annual Madison Swapfest at the John Q. Hammons Trade Center in Middleton. Take Hwy. 12 (the Beltline) west of Madison and exit westbound on Greenway Blvd. Commercial exhibitors and vendors with 6 or more flea market tables will be admitted beginning at 1 a.m.; other flea market sellers will be admitted at 6 a.m. Doors open to the general public at 8 a.m. New and used electronics gear, from computers to communications equipment, will be on sale. Lots of parts for the electronics hobbyist will also be on hand. Free parking. Hotel accommodations available at the adjoining

Marriott Hotel, as well as at several nearby hotels. Talk-in on the MARA rpt, W9HSY, on 147.75/.15. Admission is \$5 per person in advance, \$6 at the door. Children under 10 admitted free. 2.5-foot x 6-foot flea market tables are \$15 in advance, plus admission. Reserve early. Reservation deadline is March 28th. For tickets, tables, or spaces, write to MARA, P.O. Box 8890, Madison WI 53708-8890 USA. Tel. (608) 245-8890. Visit the swapfest Web site at [http://www.cs.wisc.edu/~jeremyc/mara/swapfest/].

### AUG 8

**HUNTINGTON, WV** The Tri-State Amateur Radio Assn. (TARA) will hold their Hamfest at the Huntington Memorial Fieldhouse at 2590 5th Ave. For more information call Bernie Mays at (304) 743-5459, or E-mail to [wb8zer@juno.com].

### SPECIAL EVENT STATIONS

#### MAR 21

**MACON, GA** The Macon ARC will operate W4BKM 1500-2300 UTC, at the 16th annual Cherry Blossom Festival in Macon GA. Phone, 7.235, 14.240, and 21.335; CW, 7.135, 14.035, and 21.135. For a certificate, send your QSL and a 9-inch x 12-inch SASE to Macon ARC, P.O. Box 4862, Macon GA 31208 USA. 73

# Michigan Radio

SALES SERVICE

**WE SHIP WORLDWIDE**

Local & Tech 1-810-771-4711, Service 1-810-771-4712, Fax Service 1-810-771-6546

23040 Schoenherr, Warren, MI 48089

**1-800-TRU-HAMM** (orders only)

E-mail at mirad@mich.com

TH-79A(D)

TMV7A

TM-261A

## KENWOOD

TS-50/60

TS-570

FT-8500

## YAESU

FT-50R

FT-2500M

FT-900AT

VX-1R

FT-51R

FT-1000

TM-742

TS-950SDX

FT-920

FT-1000MP

FT-8100R

**Convert Excess Equipment to CASH We buy good clean, used equipment Estate Sales**

# Secrets of the 224

*Inside MFJ's 2-Meter FM Analyzer™.*

Peter A. Bergman NØBLX  
3517 Estate Dr. SW  
Brainerd MN 56401

How would you like to be able to check and set the deviation on your two-meter transceiver, or evaluate an antenna: gain, beamwidth, bandwidth, front-to-back ratio, and sidelobe suppression? Or map out a repeater's field strength? Maybe you got a heck of a

deal on some coax and want to know what the loss really is. You're installing an antenna and you want to know which side of the tower is really the better spot. What is the real gain, in dB, of that new receive preamp? You're trying to find a hidden transmitter or jammer and the blinky lights on your rig just won't give you the sig-

The precision meter is three inches across and is calibrated to read received signal strength in dBm and deviation in kHz. It also has a discriminator scale and a battery condition scale.

On the bottom of the 224 there is an RCA jack for connecting the unit to an oscilloscope. A general-purpose scope will do fine since only audio signals are being observed. There is also a 1/8-inch phone jack which allows connection of a mono or stereo headset. The "Monitor" button turns on an internal audio amplifier to drive the headset to acceptable volume levels.

Once I had read the instruction manual and installed a fresh nine-volt alkaline battery (not included), I was ready to try the new MFJ-224. The 14-page manual includes a two-page "orientation" section, so that's where I started. After a few minutes of experimenting with the controls and listening to repeaters around the area it was time to put my new signal analyzer to work.

The first thing I did was to switch my two-meter rig to 146.52 with the output connected to a dummy load.

I fed the rig with a 1 kHz tone from an audio signal generator. If that hadn't been available I could have used the

*"It's not often that a new gadget makes a payoff so quickly, but the MFJ-224 did for me!"*

nal strength information you need. Maybe you want to scan the two-meter band quickly to track an interfering signal. How would you like to get a look at the quality of the signal out of your rig? Does this sound like it will take a shelf full of expensive test equipment? Not so!

Enter the new MFJ-224 2-Meter FM Analyzer™. The 224, designed by Rick Littlefield K1BQT, is, at heart, a tunable-oscillator two-meter receiver. What makes it so useful is the built-in meter and associated circuitry (Photo A).



Photo A. The MFJ-224 FM Analyzer.  
Photo by NØBLX.

sidetone from an HF rig or a code practice oscillator. Barring that, I could have used the test tone from a TNC.

Then, using the discriminator scale on the 224, I carefully tuned it to 146.52. Next, I switched to the deviation scale and keyed the transmitter while feeding the 1 kHz tone into the microphone. Oops! Overdeviation is a definite no-no, but my rig was a long way from over-anything. After increasing the deviation to a more reasonable level I found that I could hit repeaters that required the power amp before. It's not often that a new gadget makes a payoff so quickly, but the MFJ-224 did for me!

Next I connected the 224 to a quad beam I've been playing around with for a while. Although this five-element design is very popular and has been written up in a couple different ham magazines I thought more might be better. Sure enough, going to six elements seemed to help and adding a seventh seemed to help a bit more. I thought. I had been using over-the-air reports while trying to modify the design. The trouble with this is one fellow will give you a poor report when things are actually improving, and the next report, from someone else, will be pretty good. What you won't know at the time is that the first guy is a recording engineer who finds Brownian movement offensive. The second person entertains himself copying CW on 7.112 with an ARC 5 receiver. He can pull a full copy signal through a vault door so almost anything sounds good to him.

The 224 FM Analyzer confirmed my belief. More importantly, it made it possible to quantify the improvement each change made. The improved performance was not imaginary and I could determine when I had reached the point of diminishing returns.

Claims we hear about antenna gain are a lot like stories we hear about fishing and hunting. "Yhup, I got that 32-point buck at four hunnert yards, uphill, in the rain, with my trusty old thutty-thutty. Too bad I lost him durin' the earthquake on my way out of the woods." Or, "The Ozone Burner Juan 2000 rubber ducky will outperform ..."

## Okay, let's get real

Whether you have a factory-made antenna or are rolling your own from scratch the MFJ-224 makes it possible to know, in real numbers, how that design works.

First of all, you will want to establish a standard against which to measure your new antenna. Let's say you want to check out that O B Juan against the old rubber ducky you've been using on your handheld. The old ducky is your standard, but switching antennas back and forth while driving around town asking for signal reports probably won't tell you much. There are too many variables. And it's dangerous.

You'll want an open area as free of RF reflections as possible. The center of four or five square miles of salt marsh would be ideal but you will probably have to settle for something less, like a trip to the park.

Next you need a signal to receive. Monitoring the local repeater is okay but not ideal. You will want as steady a signal as possible. Get a friend with a base station to transmit a steady tone, not voice, for your tests.

Once you have a "standard" antenna, the test antenna, an open area and a steady signal you are ready to perform some tests. Install the "standard" antenna on the FM Analyzer, switch to Discriminator and turn the tuning knob until the steady test signal centers the needle on the lower scale. Now switch to Signal and note the received signal strength on the top scale. Without changing anything else install the test antenna and note the received signal strength. The difference between the readings is the gain or loss, in dBm, of the antenna being tested.

When testing the quad I mentioned earlier a similar procedure was followed. The difference was that I used a vertical dipole as a standard against a quad loop. Then I added and removed elements and played with spacing on the test antenna and plotted those results. Now I have an antenna test range right in my own front yard. Sometimes I wish I lived across the street so I could

Continued on page 38

# ALL ELECTRONICS

C O R P O R A T I O N

## RED Ultrabright LED

### PAINFULLY BRIGHT RED LED

2500 to 4000 mcd @ 20 ma. These T 1 3/4 (5 mm diameter) red LEDs are significantly brighter than conventional LEDs. At close range, they are painful to look at. They are great for attention getting displays that can be seen from a distance. Water clear in off-state.



CAT # LED-42

2 for \$1<sup>20</sup>

10 for \$5.00  
100 for \$45.00  
1000 for \$400.00

## Stepper Motor

Airpax # LB82246

Unipolar, two-phase, 6 lead stepper motor. 500 ohm coil. 7.5 degrees per step. 1.4" dia. X 0.7" body. Oval mounting flange has holes on 1.65" ctrs. 0.08" (2mm) dia. shaft is 0.4" long and is fitted with a 0.31" dia. gear with 18 teeth. 15" leads.

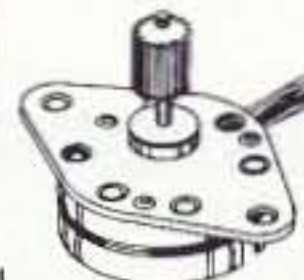

CAT # SMT-28

\$2<sup>00</sup> each

## Equipment Knob

Alcoknob # PKG90B1/4

0.86" dia. X 0.56" black molded phenolic knob with brushed aluminum face. Ribbed body with indicator line. Brass insert with two set screws. Fits 1/4" full round shaft.



CAT# KNB-74

2 for \$1<sup>50</sup>

25 for \$16.25  
100 for \$50.00

## "Hi-8" Video Cassette

SONY Hi-8 Top quality, metal particle 120 minute video cassettes. Used for a short time, then bulk-erased. Each cassette has its own plastic storage box.



CAT # VCU-8

\$3<sup>00</sup> each

10 for \$28.00  
100 for \$250.00

ORDER TOLL FREE

1-800-826-5432

CHARGE ORDERS to Visa, Mastercard, American Express or Discover

TERMS: NO MINIMUM ORDER. Shipping and handling for the 48 continental U.S.A. \$5.00 per order. All others including AK, HI, PR or Canada must pay full shipping. All orders delivered in CALIFORNIA must include local state sales tax. Quantities Limited, NO COD. Prices subject to change without notice.

CALL, WRITE  
FAX or E-MAIL  
for our FREE  
96 Page  
CATALOG  
Outside the U.S.A.  
send \$3.00 postage.

MAIL ORDERS TO:  
ALL ELECTRONICS  
CORPORATION  
P.O. Box 567  
Van Nuys, CA 91408  
FAX (818)781-2653

e-mail allcorp@allcorp.com  
internet - http://www.allcorp.com/



## Handheld Repeater Controller

Spectrum Electronic Products 10 introduces the world's first Control and programming, handheld repeater controller. No larger than most handheld radios, the HRC-10 converts a single or dual-band radio into a full featured simplex or duplex repeater system. Key features of the HRC-10 include voice IDer, DTMF hang and time-out timers, Digital Voice Operated Squelch (DVOS™), telemetry tones, and private voice mail slot. **\$299**

<http://www.spectrum-usa.com>  
800-566-2788 - fax 408-336-9461

CIRCLE 69 ON READER SERVICE CARD

## REPEATER HEADQUARTERS

Make "Commercial Quality" repeaters from GE and Motorola Mobiles

- 45 Watt VHF Micor from \$99
- 40 Watt UHF Master II from \$199

Conversion Information Available!

<http://www.versatel.com>

**VersaTel**  
COMMUNICATIONS

Orders: 800 456 5548  
Info: 307 266 1700  
FAX: 307 266 3010

CIRCLE 259 ON READER SERVICE CARD

## EVERY ISSUE OF 73 Amateur Radio Today on Microfiche!

The entire run of 73 from October 1960 through last year is available.

You can have access to the treasures of 73 without several hundred pounds of bulky back issues. Our 24x microfiche have 98 pages each and will fit in a card file on your desk.

We offer a battery operated hand held viewer for \$75, and a desk model for \$260. Libraries have these readers.

The collection of over 800 microfiche, is available as an entire set, (no partial sets) for \$325, plus \$5 shipping (USA). Annual updates available for \$10. Satisfaction guaranteed or money back!

### BUCKMASTER

6196 Jefferson Highway  
Mineral, Virginia 23117  
540:894-5777 • 800:282-5628  
e-mail: [info@buck.com](mailto:info@buck.com)  
Fax 540:894-9141

CIRCLE 168 ON READER SERVICE CARD

## Secrets of the 224

continued from page 37

watch all the fun stuff that happens over here ...

Suppose you are trying to pick the best spot for a Field Day antenna. The MFJ-224 can help you out there. Sometimes a few feet one way or the other can make a difference that is difficult to detect by ear alone.

If you add a small beam antenna to your 224 you can be into foxhunting in a hurry—or be able to track a jammer or problem kerchunker.

The MFJ-224 is an all-around handy unit. Besides the applications already mentioned, it can be used to map repeater field strength, measure preamp gain, analyze audio quality with a scope and tune low-power transmitter stages. Yes, it has enough coverage for MARS and CAP operators.

Although the FM Analyzer requires a light touch when tuning, the receiver has proven stable enough for all the applications I've tried, including monitoring. Operation is very easy to learn. The compact size (eight inches long by three and three-quarters inches wide by three and one-quarter inches deep, including projections) and light weight make the MFJ-224 very convenient on the bench or in the field.

Construction of the 224 is up to MFJ's usual high standard. Panel and meter markings are clear and easy to read. The case is held together with machine screws and threaded inserts, not sheet metal screws which loosen and quickly get lost. The vinyl-clad finish is both attractive and durable.

The instruction manual is 14 pages long, very comprehensive and easy to understand. It starts with the technical specifications, runs through a list of applications and operating instructions and ends with two pages of schematic and field service guide. If something does go wrong with your 224, MFJ is one of the few outfits that doesn't penalize you for trying to fix the unit yourself.

The MFJ 2-Meter FM Analyzer™ is a useful addition to the shack and, of course, it carries MFJ's one-year "No Matter What" unconditional guarantee.

For a free catalog and the name of your nearest dealer call MFJ at (800)

647-1800. The company can also be reached at MFJ Enterprises, Inc., Box 494, Mississippi State MS 39762. Telephone (601) 323-5869; FAX: (601) 323-6551; Tech Help: (601) 323-0549. **73**

## NEVER SAY DIE

continued from page 5

better plants you can grow. This ties in with the remineralization of Hamaker-Weaver.

### Water

If you don't think fluorides in your drinking water are going to affect your body, try growing plants with that stuff. Ditto chlorine. Beyond providing plants with lots of pure water, if you can lower the surface tension of the water it will be more easily absorbed by the plants, making for faster, more healthy growth. You can do this by exposing the water to the north pole of a magnet or by adding some of Pat Flanagan's Crystal Energy to it. Crystal Energy is too expensive for farming, but can be used on house plants and humans.

There are several manufacturers of magnets for water pipes aimed at keeping the minerals in the water from sticking to the pipe, gradually clogging it. I'd like to see some tests of these used on water for plant growth. I'll be surprised if they don't help.

### Hydroponics

Those huge gorgeous gift fruits they sell in the Japanese railroad station stores are grown hydroponically. If you've been to Epcot Center™ I hope you went through their special hydroponic garden exhibit. They grow most of the vegetables for the Epcot restaurants there.

Hydroponically grown fruit and vegetables are economical to grow and are superior in appearance, flavor, and nutritive value. They can be grown disease free, grown faster, and have better keeping qualities than most fruit and vegetables. Around 15 minutes a day spent gardening should feed a family using a 10- x 12-foot part of their backyard. You can read *Hydroponic Gardening* by Bridwell, which is \$12 from Acres USA (#6182) to get all the details. You grow everything without soil.

### Now Let's Suppose

What would happen if some enterprising person were to start combining these growth enhancers? Like using Sonic Bloom in a pyramid greenhouse, using

Continued on page 48



# The ZenerMeter

*A test set for zener and other diodes.*

Larry G. Ledford KA4J  
553-4th St. SE  
Cleveland TN 37311  
[KA4J@juno.com]

If you do any building of or repair work with electronic equipment, you soon acquire a VOM, scope, transistor tester, and cap meter. All are very useful, but they won't check out the one component found in most regulated power supplies and many other circuits: the zener diode. Granted, you can jury-rig a VOM, power supply, and enough clip leads to test the diodes, but if you are tired of a "lap work" work bench (where sparks and hot components fall into your lap), read on!

I was troubleshooting a Heath SB-220 amplifier with no bias. I suspected a zener that was connected to the same board on which the high voltage diodes were mounted. I didn't want to test the voltages with the high voltage present, so I built the ZenerMeter.

The ZenerMeter will let you identify the voltage a zener was designed for (up to about 30 volts). You can also test regular silicon, germanium, and light-emitting diodes (LEDs). Defective diodes can be detected, and the polarity of diodes shown. The zener capability of regular diodes and LEDs also can be identified.

The test set is a self-contained portable unit that is AC-powered and safe in use. It has a built-in voltmeter to

read zener voltages and a set of jacks to allow connection to a digital voltmeter for very precise voltage measurement. A set of colored LEDs is used to identify diode polarity.

Referring to **Fig. 1**, you can see that the circuit to test the zener function consists of a 24-volt transformer-powered half-wave rectifier that when filtered supplies about 30 volts DC. This is connected across a 10 k pot used as a simple adjustable voltage divider. This voltage is fed through a 1 k current-limiting resistor to the zener diode under test. The diode is connected to the unit by way of two binding posts, one of which is grounded. A voltmeter is connected across the diode also to monitor the voltage. A parallel set of jacks allows you to connect a DVM (digital voltmeter) for a more precise voltage reading. As the voltage is slowly raised, a point will be reached at which the voltage across the diode remains steady as more voltage is applied. This is the zener voltage of this diode.

For the test of polarity, also called the GO/NO GO test, the binding post above ground holding the diode under test is switched to two colored LEDs connected in parallel (but in opposite

directions) and coupled to the AC voltage at the center tap of the transformer through a 1 k current-limiting resistor. The AC voltage should be around 12 volts.

On each swing of the AC line, one of the LEDs will light if the diode under test will conduct in that direction. The voltmeter and the DVM jack are disconnected, as they are not needed in this test. Four different LED states identify either polarity of the diode, a shorted (or very leaky) condition, or an open diode.

I built my ZenerMeter into a old RCA VTVM case that I acquired for a buck at a hamfest. It's a good size, with plenty of room inside. The meter movement and the case were about all that I could use in the conversion but it saved money and a lot of hole cutting. Look around your junk box (room?) and see if you have some item you can convert. If not, the next hamfest will have something you can use. If you use an old VTVM case as I did, be sure the meter is okay. If the VTVM does not work as it should, that can be used as a lever to lower the price.

Start your construction by building the power supply. See what voltage you get across the 10 k pot. If you get

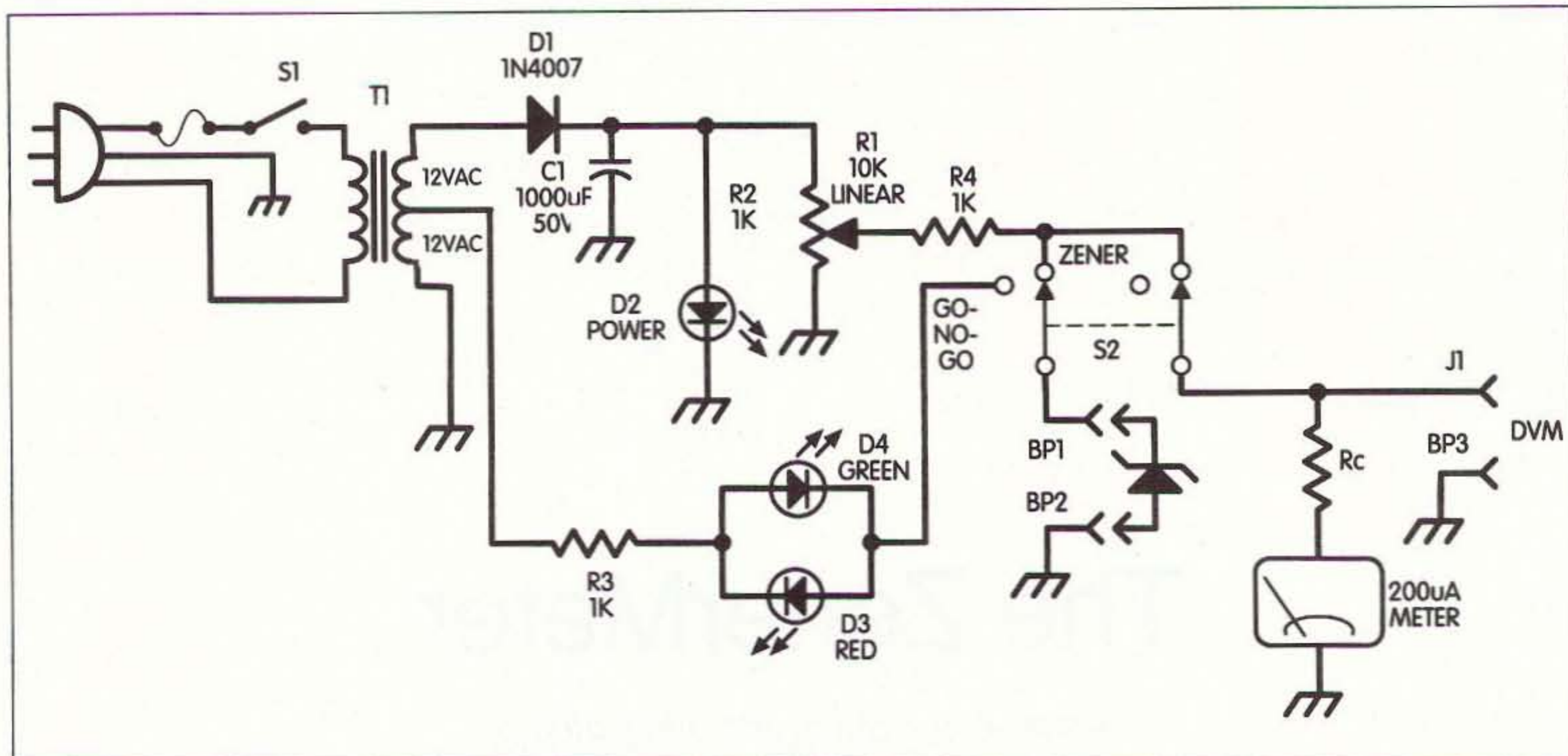

Fig. 1. Schematic.

25 to 35 volts, all is well. It's only important so you can determine what range your meter needs to read. You don't want to peg the meter if you turn the pot all the way up. Nor do you want all the reading bunched up on the low end of the range.

My unit had just under 30 volts, so I disassembled the meter and removed the metal faceplate. (Do this very carefully, making sure not to bend the pointer!) Using white correction fluid, I removed all the unneeded scales and modified the desired one (0-3 VDC) to

read 0 to 30 VDC by covering the decimal places in the numbers. When the fluid dries, you can use a permanent marker to letter "Zener Test Set" and any other information you want on the faceplate. Very carefully reassemble the meter and mount it in place.

A better-looking meter front could be made by photocopying the old meter face, whiting out unneeded scales, and using an inkjet printer to make appropriate ones. Then you could Xerox™ the finished work onto a page of Avery

label paper with adhesive backing. Just be sure that the added thickness of the paper doesn't cause the meter pointer to drag.

Mount all the other components except the two colored LEDs used in the GO/NO GO test. Temporarily tack these two LEDs (which are connected back-to-back) in place. Connect a known-to-be-good diode (1N400x—not a zener) with the cathode (banded end) to the grounded binding post and the other end to the above ground binding post. With power on, switch S2 to GO/NO GO. If the red LED lights, permanently solder the LEDs in place. If the green LED lights, reverse the LEDs in the circuit. Confirm that the red LED now lights and then permanently solder the two in place. These LEDs must be visible from the front panel. See Fig. 2 for the layout I used.

Finish wiring the unit by connecting the meter through an appropriate multiplying resistor. The meter I used had a 200 microamp movement. I tried a 150 k ohm resistor as a multiplier and the meter read low. A 1 megohm resistor was placed in parallel with the 150 k and a 25 k trimpot was placed in series. This combination gave me the ability to adjust above or below the actual voltage. To calibrate the connected unit, place the unit in "Zener Test".

#### GO/NO GO CHART

LED STATUS	TEST	CONNECTIONS		
		Zener	Diode	LED
Green	OK	Correct	Reversed	Reversed
Red	OK	Reversed	Correct	Correct
Both	Shorted or Leaky			
Neither	Open or High Voltage			
Your Name and Callsign				

Table 1. ZenerMeter GO/NO GO chart.

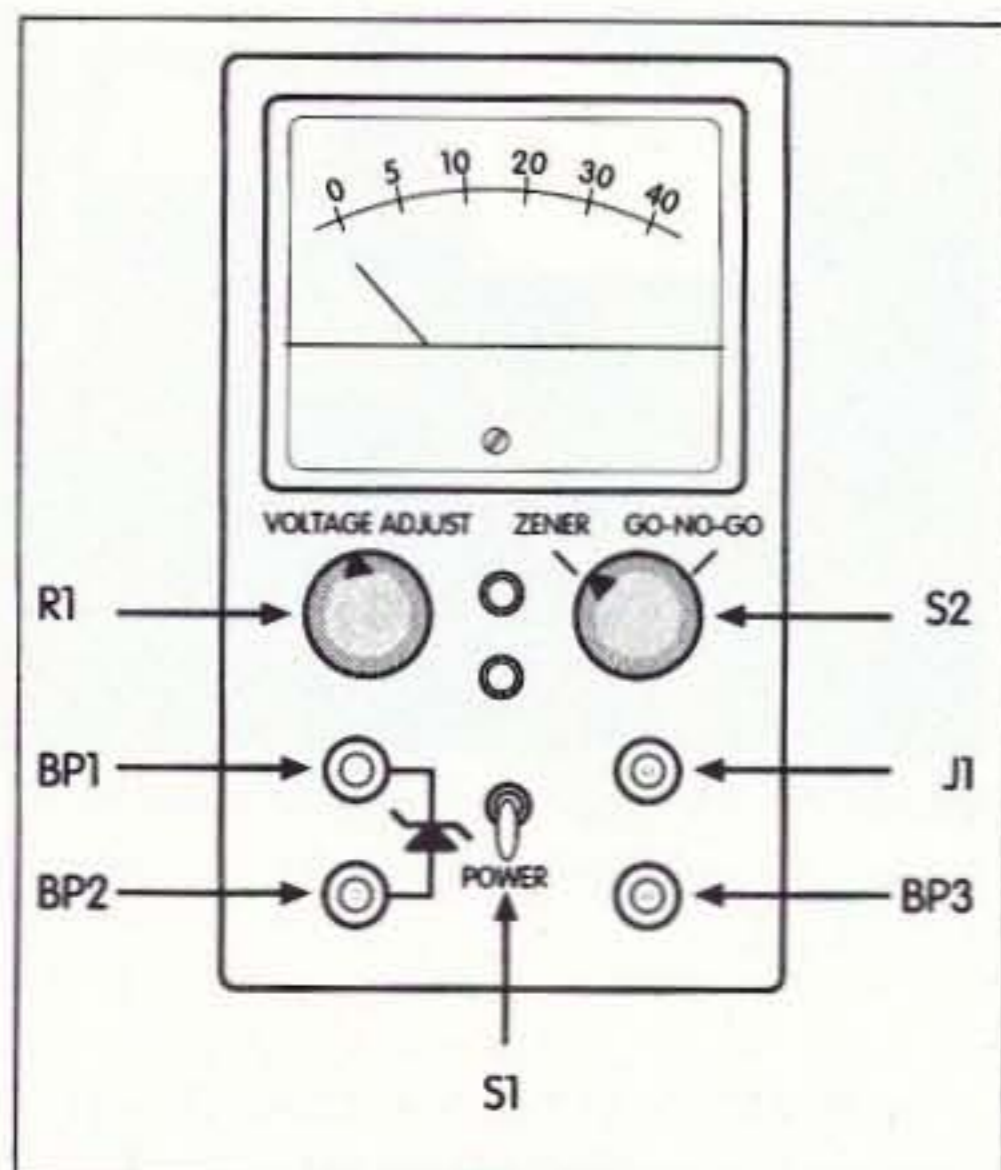

Fig. 2. Front-panel layout.

Connect a digital voltmeter of known accuracy to the DVM jack and turn the unit on. Turn the voltage up to near maximum and adjust the calibration pot until the meter reads the same as the DVM.

#### Parts substitution

Any diode with a PIV of 100 volts or more can be used for D1. The red and green LEDs used in the GO/NO GO test can be replaced with a tricolor LED with two leads, but not one with three leads (they cannot be connected back to back). C1 is not critical in value but must have a working voltage greater than the voltage coming from D1. T1 could have a bit smaller- or larger-voltage secondary. But too small

and you won't be able to test higher-voltage zeners; too large, and it may destroy a diode. Current capability only needs to be about 40-50 mA. M1 could be a regular voltmeter, but it would be cheaper to re-calibrate a used one.

Binding posts are used to connect the diode under test to the circuit, but to save time, I made two adapters from banana jacks and alligator clips. These plug into the binding posts, and diodes can be attached to the alligator clips. To test an in-circuit diode, one end should be disconnected and both ends connected via clip leads. Keep it safe: Apply no power to the circuit while the diode's under test!

The connections to the DVM are through a pin jack (for the positive lead) and a binding post (for the negative lead). This is to mate with my DVM, which has an alligator clip for the negative lead. I can easily plug in the positive probe and clip the ground lead to the binding posts.

#### Testing procedures

Now that we have built our new piece of test equipment, let's put it to the test! Select an unknown diode and connect it to the diode binding posts. The polarity is unimportant at this time. Turn switch S2 to "GO/NO GO". Turn S1 to "ON". One of four LED combinations may occur:

1. The green LED will light. This means that the zener is OK and connected

1. Turn power on.
2. Switch to "Go/No Go".
3. Connect diode.
4. Re-orient diode if LED shows it reversed.
5. Turn "Voltage Adjust" pot to extreme left.
6. Switch to "Zener".
7. Slowly bring voltage up until it no longer rises.
8. Connect digital voltmeter to measure voltage more accurately.

Table 2. ZenerMeter directions.

## See the FUN you've been missing!



Every day more and more hams are enhancing their enjoyment of ham radio by adding images to their conversations. Join the fun!

new Pasokon TV Lite ..... \$30 + \$3 shipping.  
Pasokon TV Classic ..... \$200 + \$5 shipping.

Absolute Value Systems  
115 Stedman St. #7  
Chelmsford, MA 01824-1823  
(508) 250 0611

<http://www.ultranet.com/~sstv>

CIRCLE 351 ON READER SERVICE CARD

### Desert Storm Solar

10 watt DesertStorm panel is size of open 73 magazine, weighs 11lb, and delivers 600mA for 12v charging or direct operation. Tough, Solid, with no glass to break. So rugged Uncle Sam used this for spotter communications and portable repeaters in Desert Storm. Ready to use. \$169. Add \$5 S&H. Info \$1.



AntennasWest  
Box 50062 Provo UT 84605

Order HotLine  
801 373 8425

CIRCLE 340 ON READER SERVICE CARD

### PC HF Facsimile 8.0



For Windows™ \$179.95

SSC is proud to announce PC HF Fax 8.0 for Windows. Now you can receive weather Fax, FEC, RTTY, Morse Code, Navtex, Amtor and Sitor while working with other software. The package comes with our new Windows FSK demodulator, software, manual and database. Just plug it in, connect your receiver, and you are copying the world! Call or write for our FREE Products Catalog.

Visa and MasterCard Welcome

#### Software Systems Consulting



615 S. Elcamino Real  
San Clemente, CA 92672  
Tel: 714/498-5784  
Fax: 714/498-0568  
<http://www.sscorp.com>

CIRCLE 250 ON READER SERVICE CARD



**Photo A.** The ZenerMeter tests a zener diode (6.10 volts), with a DVM hooked up alongside as a more accurate readout of the zener's voltage.

correctly (to run the zener voltage test). If you are testing a regular diode or LED and get a green indicator LED, this means that the test diode is good but connected backwards. An LED under test will light if it is good.

2. The red LED will light. This means the zener is OK but connected backwards. If it is a regular diode, it is good and correctly connected. Again, a good LED under test will light.

3. Both LEDs light. The diode under test is shorted or very leaky. Test it for voltage regulation. You may have to reverse the leads at the binding posts. Many of the components we get as

bargains are often "floor sweepings" that fail industrial testing but can still be used in many projects.

4. Neither LED lights. The diode is open, or has zener voltage higher than about 15 volts. Run the zener test anyway—you might get lucky!

### Zener test

1. Turn R1 to the extreme counterclockwise position.

2. Turn S2 to "Zener".

3. While watching the meter, slowly bring up the voltage by turning R1 clockwise.

4. At some point, the voltage will stop going up as you continue to raise it with R1.

5. This voltage, as measured by the meter, is the zener voltage. If you need to know the precise voltage, connect a DVM to the jacks. Do not continue to raise the voltage much beyond the point at which it stabilizes.

If the voltage never rises above zero, the diode is shorted. Reverse its polarity and retest it. If the voltage never shows a point where it stabilizes, then the diode is open or has a higher-than-30-volt zener point. Reverse polarity and retest—you have nothing to lose.

Non-zener diodes can also be used as a zener substitution or in series with others to create a very precise voltage reference. Silicon diodes "zener" at about 0.7 volts, germanium diodes at about 0.3 volts, and LEDs at about two volts.



**Photo B.** An LED in the zener test mode shows the voltage at which it "zeners" (1.713 volts).

Congratulations! You have just constructed a useful piece of test equipment to help you build and repair your gear. Make a copy of the schematic and paste it inside the unit. You may wish to copy the set of directions on the back to help you remember how to use it. Have fun!

73

**BIOELECTRIFIER™**  
EXPERIMENTAL MICRO-CURRENT SUPPLY  
Now FULLY ASSEMBLED with batteries and FINE SILVER (not stainless steel) electrodes  
**\$89.50 +\$2.50 S&H**  
*Beware of IMITATIONS!*  
ALSO...  
COLLOIDAL SILVER GENERATORS  
ZAPPERS, SILVER ELECTRODES, SEMI-KITS, etc.  
send SASE for information  
On the WEB: [www.infocom.com/~thomil/](http://www.infocom.com/~thomil/)  
To order, send CHECK or MONEY ORDER to:  
**THOMAS MILLER, WA8YKN**  
314 South 9th Street  
Richmond, IN 47374  
Voice/FAX (765) 962-3509 [thomil@infocom.com](mailto:thomil@infocom.com)

**160-10 G5RV QuicKits™**  
created by AntennasWest Box 50062-S, Provo, UT 84605  
Fast & Easy to Build  
• Fail-Safe visual instructions  
• No measuring or cutting  
• Everything included  
• Finish antenna in minutes  
**Quality Components**  
• Presoldered Silver Fittings  
• Kinkproof QuietFlex wire  
• Fully insulated, wax sealed, no-corrode, low noise design  
Tune All Bands Incl WARC  
Want Plans, Patterns, Data? Order TechNote #124-D \$6.95 ppd USA  
Order Hot-Line: Add \$5 P&H  
**1-800-926-7373**

• Double Size G5RV 204 ft. 160-10 Dipole	\$59.95
• Full Size G5RV 102 ft. 80-10 Dipole	\$39.95
• Half Size G5RV 51 ft. 40-10 Dipole	\$29.95
• Quarter Size G5RV 26 ft. 20-10 Dipole	\$24.95
• Ready-Made 102 ft G5RV	\$50.00
• Ready-Made 51 ft G5RV/2	\$40.00
• 200' Dacron 250F line	\$11.95

CIRCLE 116 ON READER SERVICE CARD

## Radio Bookshop

Phone 800-274-7373 or 603-924-0058, FAX 603-924-8613, or see order form on page 88 for ordering information.

### Rene's Books

**NASA Mooned America.** René makes an airtight case that NASA never landed anyone on the moon. Ridiculous, of course, so maybe you can be the first to find fault with René's 30 "gotchas." He sure convinced Wayne. \$28.

**The Last Skeptic of Science.** René blows holes in one cherished scientific dogma after another. Do you believe there have been ice ages? That the moon causes the tides? That the iron core of Earth causes its magnetic field? That the transmutation of elements is difficult? Another \$28 well spent.

### Parts List

BP1, BP2, BP3	Banana-plug-type binding posts
C1	1000 $\mu$ F 50 V electrolytic capacitor
D1	1N4007
D2, D3	Red LED
D4	Green LED
J1	Pin jack, chassis-mounted
M1	Voltmeter, 30-volt range or recalibrated surplus meter (see text)
R1	10 k $\Omega$ pot, linear
R2, R3, R4, R5	1 k 1/2 W resistor
S1	SPST switch
S2	DPDT switch
T1	Transformer, 110 V primary, 24 VCT secondary

Miscellaneous: Case, line cord, 2 alligator clips, 2 banana plugs

Table 3. Parts list.

# Cheap and Portable Loop

...for 20 through 40 meters.

Jay M. Jeffery WV8R  
26150 Village Lane, Apt. 209  
Beachwood OH 44122

This is the ultimate minimal-cost and minimal-construction loop antenna. It is portable and can be quickly disassembled and tossed in the trunk or on the rear seat of a car—yet it is large enough to give a good account of itself when you are operating QRP (although you would need a sturdier variable capacitor if you wished to exceed 10 or 15 watts). Finding components for it in the basement and building it took less than two hours.

## The circuit design

The circuit design is quite simple. There is a main loop in series with a trimmer capacitor (20–180 pF) and a feeder loop about one-fifth the size of the main loop. **Fig. 1** shows the circuit. Ocean State Electronics has such a capacitor (#TC-463). Their phone number is (800) 866-6626.

## Constructing the antenna

The main loop is made of solid insulated #12 house wire. #10 is worth a try, but I was using what I could find in the basement. This loop is 144 inches long. The feeder loop is made of the same wire and is 28 inches long. The

wire of the loops is mounted by means of pieces cut from a terminal block (Radio Shack #274-678). The three pieces needed are cut so that they each have two connector terminals and a hole that accepts a small wood screw. These sections are then fastened to the support mast.

The mast is a three-quarters-inch by one-half-inch hardwood trim strip four feet, four inches long. The base is made from one-inch-thick pine board built up in the center by means of a smaller piece of the same board. A rectangular hole cut in the center of the built-up base should be a tight fit for the mast. This way the parts can be easily pulled apart for transporting. See **Photos A and C**.

The capacitor is soldered to two short pieces of #12 bare wire so that it can be inserted in the terminal block mounted at the top of the mast. The heavy wire provides the rigidity needed when the capacitor is being tuned. See **Photo B**.

The second block is mounted at the bottom of the mast to hold the bottoms of both loops (**Photo C**).

The main loop is divided into two parts. About half an inch of insulation

is removed from the ends so that they can be inserted in and held by the blocks. The top block connects the loop halves in series with the capacitor. See **Photo B**.

The bottom block connects the two halves together. When the halves are

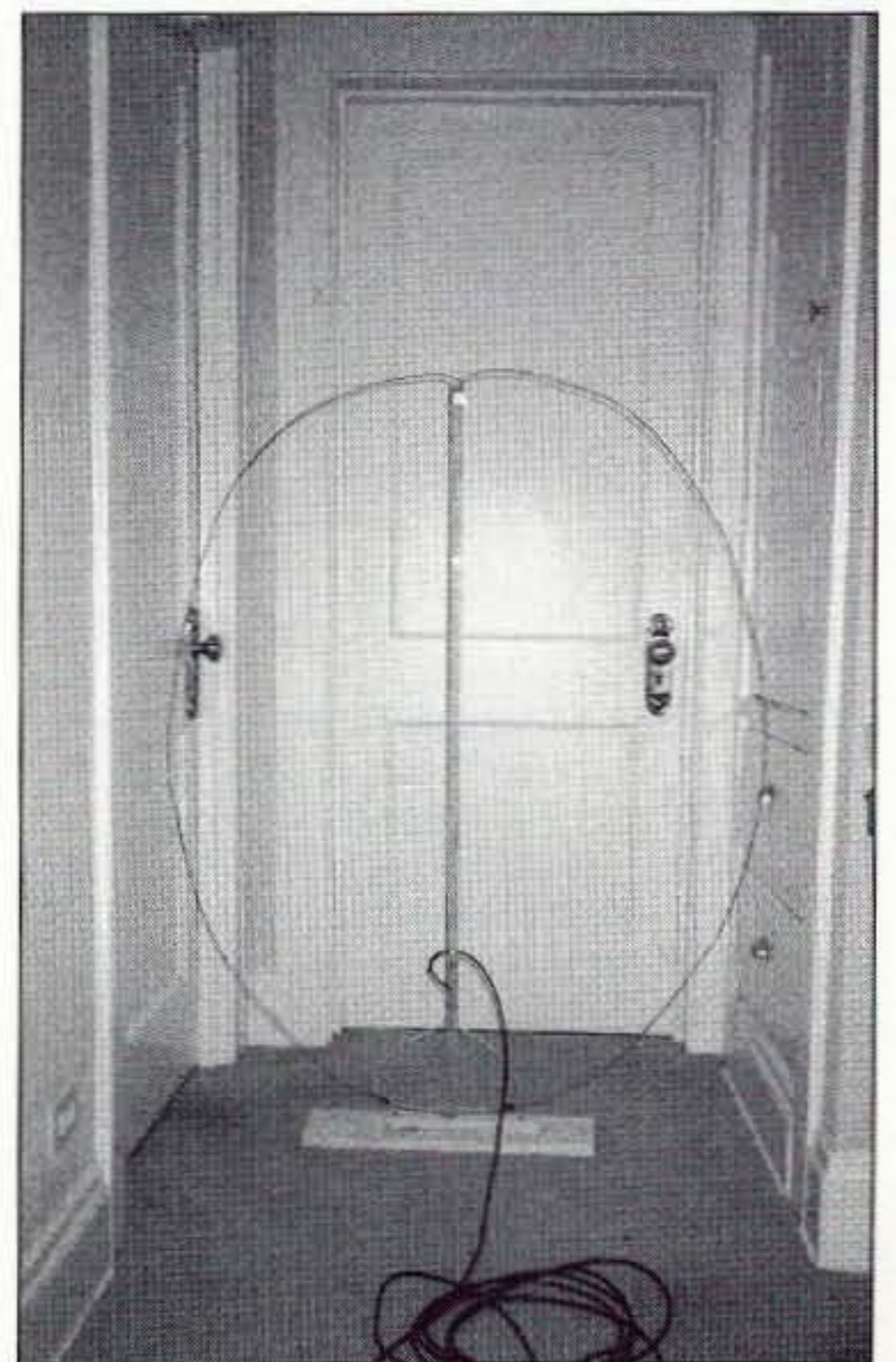

**Photo A.** General appearance of the portable loop.

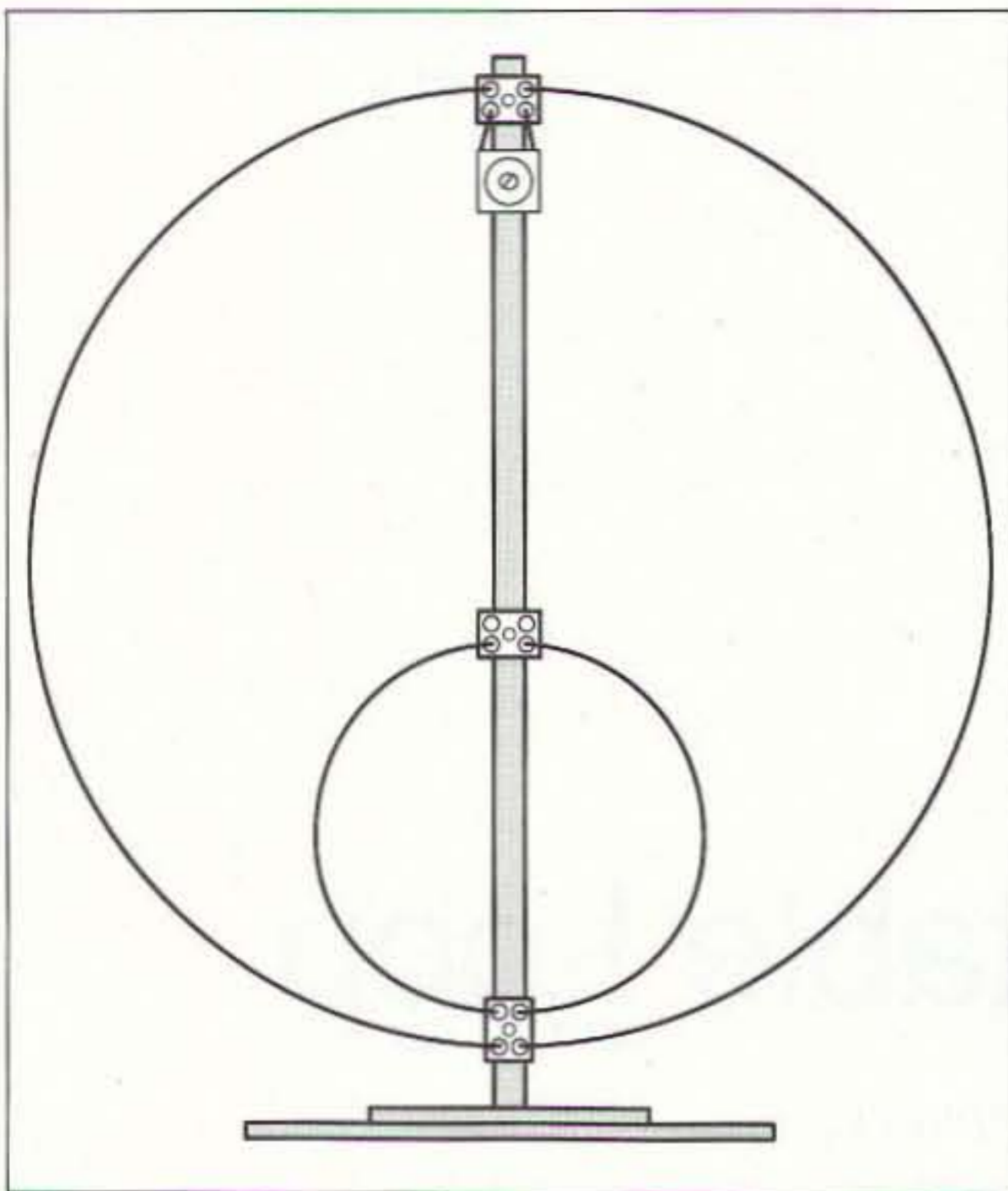

Fig. 1. The loop circuit.

attached, the wires are bent into an oval shape. The loop can keep its shape without a crossbar when used inside a building. Using it outside in the wind requires more rigidity and a clamp to hold it to something like a picnic table. If you toss it in the car for a trip, you may have to reshape it a little before use.

possible on either side of the block. I taped the loops together for close proximity and rigidity (Photo C).

#### Tuning and operating the loop antenna

The loop can be tuned to a specific frequency by connecting it to a receiver which is set for the frequency to be used. Using an alignment tool (such as the Antique Radio Supply #ST-8609 or just a thin dowel sharpened into a screwdriver), tune the trimmer capacitor until you hear background noise or a signal. Maximize the noise or signal. Final tuning can be done by transmitting at low power when the frequency is clear and adjusting the trimmer until a field strength meter is maximized. A quicker and cleaner way is to use an antenna analyzer to get the best SWR.

Placing an antenna tuner and an SWR meter in the line will help to protect your rig and give a greater range of frequencies without retuning the antenna itself. Avoid touching the antenna during transmissions. Touching any open metal on the antenna could cause injury even with low power.

The loop is designed to be used in the vertical position. This allows the loop to be used when placed near the ground or something that acts like a ground plane. This position has the

A third terminal block is positioned high enough above the bottom of the main loop to hold the top of the feeder loop. This loop is also divided into two halves for mounting. This terminal block also connects the coax to the feeder loop. The coax is secured to the mast by means of a piece of Plexiglas™ and a wood screw. The coax should come out from the mast as close to a right angle to the plane of the loop as possible. See Photo C.

The bottom of the feeder loop connects through the top connector of the bottom terminal block section. Bring this loop as close to the bottom of the main loop as possible

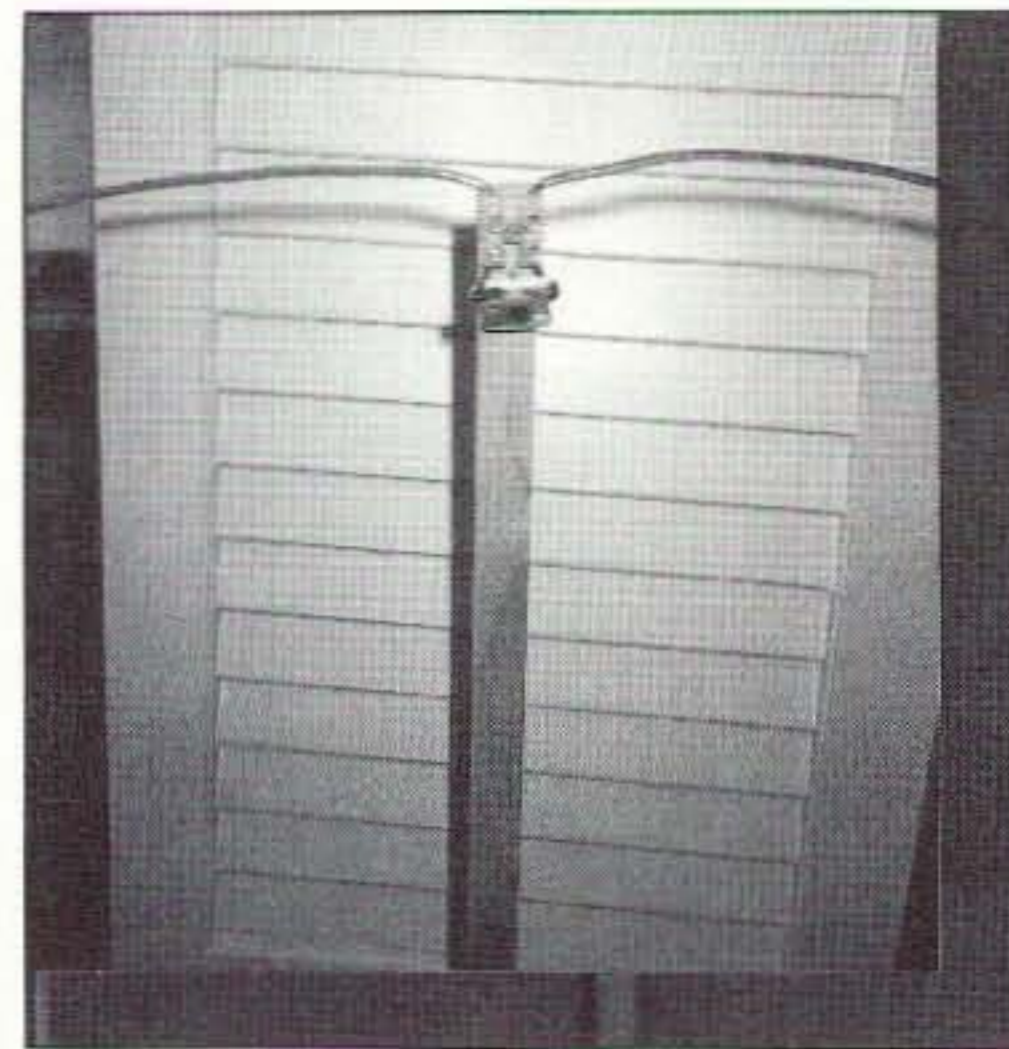

Photo B. Top connections of the portable loop.

added advantages of providing a null perpendicular to the center of the plane of the loop, as well as gain in the plane of the loop.

#### Important considerations

The antenna is designed for indoor use, but with a crossbar, a cover on the capacitor, and a clamp to hold it down to a picnic table or any nonmetallic flat surface it could very well be used outside. If you live in a building that contains a lot of metal in its construction (e.g., steel and concrete, aluminum siding, etc.), then you will need to get the antenna outside of the building. Also, it should not be placed near a mass of metal.

#### It works fine

If tuned properly, the antenna works quite well using a couple of watts. I've even made some local contacts with it using a NorCal 40-9er running 150 milliwatts. I got good reports, but then again, they were within 50 miles—with as much as five watts you could "work the world!" 73

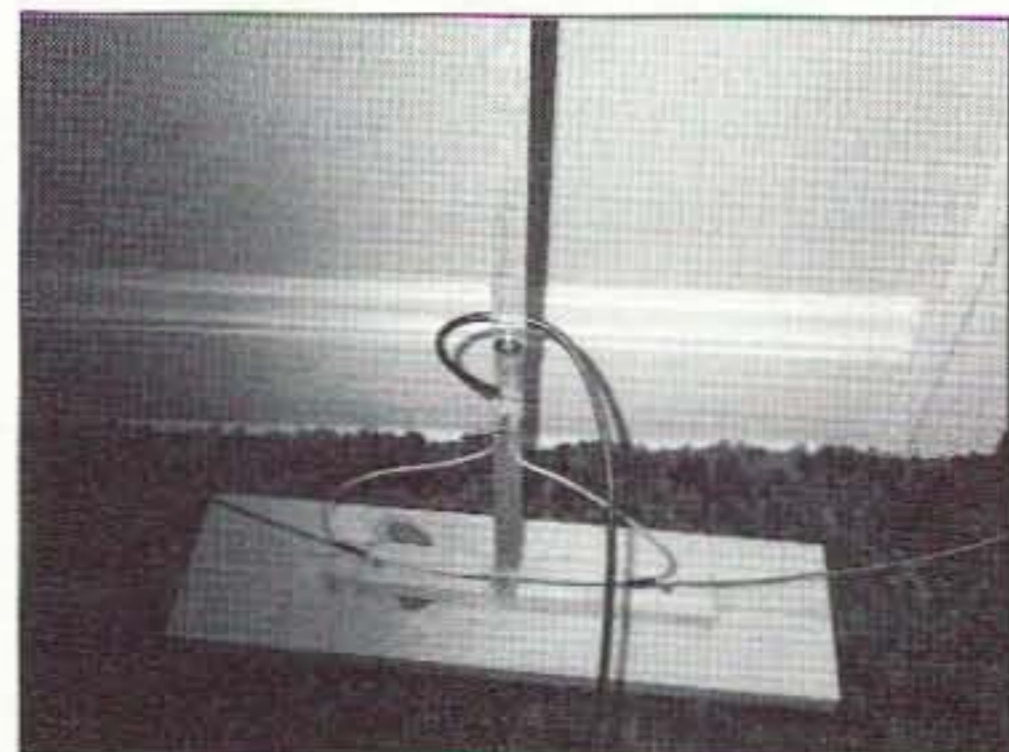

Photo C. Base and base connections of the portable loop.

## Radio Bookshop

Phone 800-274-7373 or 603-924-0058, FAX 603-924-8613, or see order form on page 88 for ordering information.

### Wayne's Five Buck Books:

**98 Books You're Crazy if You Don't Read.** Brief reviews of books that will help make you healthy, wealthy, and wise. If you are sick you did it to yourself through messing up your body. This is probably the single most important five bucks you'll ever spend.

**How to Make Money, A Beginner's Guide.** Commuting to work is stupid. You can't get fired, laid off, downsized or outsourced if you own your own business. This is an instruction book on how to get others to pay you to learn what you need to know to be independently wealthy, have a ball doing it, and have that ham shack you've dreamed of.

**Grist I.** Fifty of Wayne's recent non-ham oriented editorials. They're about almost anything and guaranteed to almost make you think. You'll sure have things to talk about on the air other than your antenna and the weather.

**Grist II.** Fifty more non-ham editorials. Even more fascinating stuff to think and talk about.

# Explore The World of Quorum Wefax

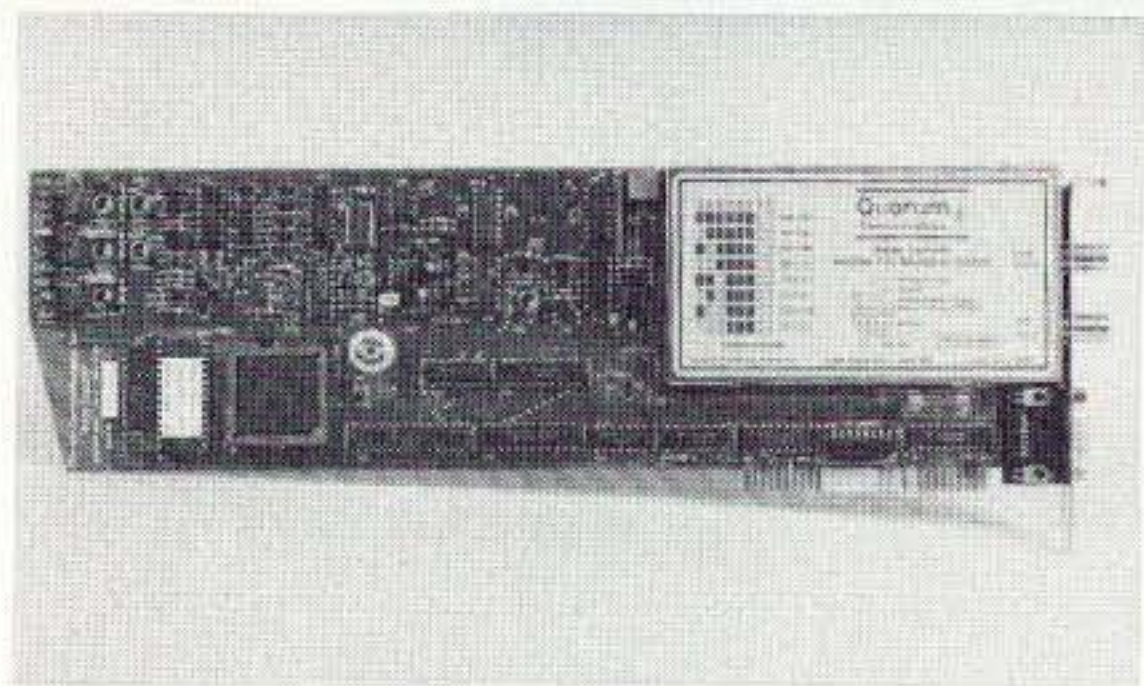
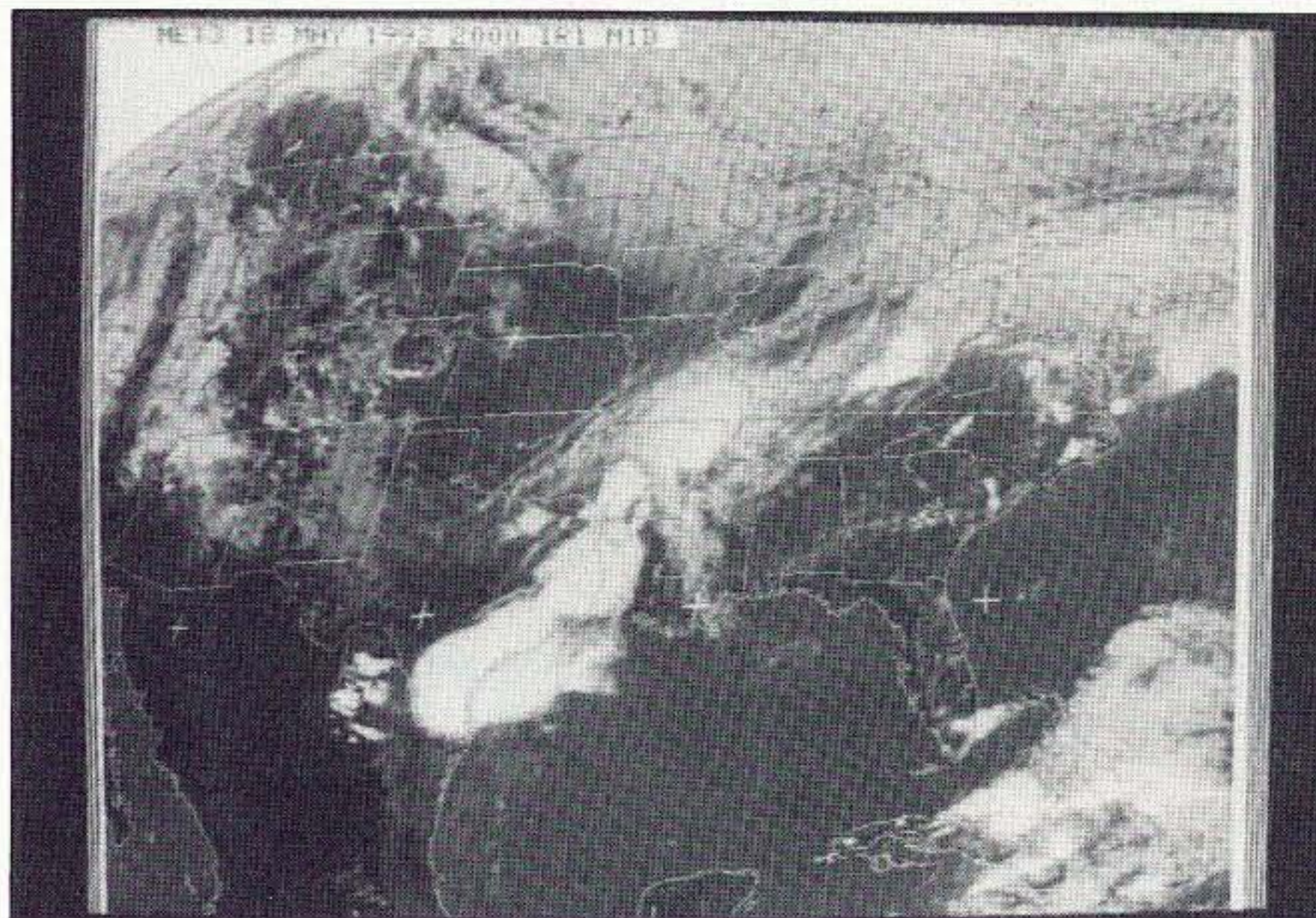

## Wefax Explorer

Integrated Wefax / APT Receiver and Scan Converter with Qfax software.

**\$695.00 complete**

shipping and taxes not included

## The Best Price / Performance. Period!

Construct a Wefax / APT reception system from individual component receivers, scan converters and image processing software and you'll spend more money for fewer features, poorer performance, no automation and a jungle of wires. With the Wefax Explorer, simply connect an antenna and a few mouse clicks later you're receiving the highest quality images possible. The Explorer is backed by a 1 year limited warranty and the extensive experience of the leading Wefax hardware manufacturer. Quorum equipment is used by virtually all wefax suppliers in worldwide amateur, commercial and military systems.



## QFAX Features

- **GOES / Meteosat Wefax Reception**
- **NOAA / Meteor APT Reception**
- **HF Nafax Reception**
- **Dual RF ports for geosync and polar reception under software control**
- **Integrated preamp and down converter power inserters**
- **50 user definable configurations**
- **Software controlled receiver with 2 UHF, 10 VHF memories and scan**
- **On board audio amplifier and speaker with software controlled volume, squelch and mute**
- **Automatic Unattended Animation works continuously**
- **8 bit data for up to 256 gray levels**
- **View at up to 1280 x 1024 256 color**
- **Use TIFF, GIF or PCX file formats and convert to BMP, JPEG, EPS and binary**
- **Contrast, Brightness, 3D effect, Sharpen, Smooth, Noise, Histograms and other image processing**

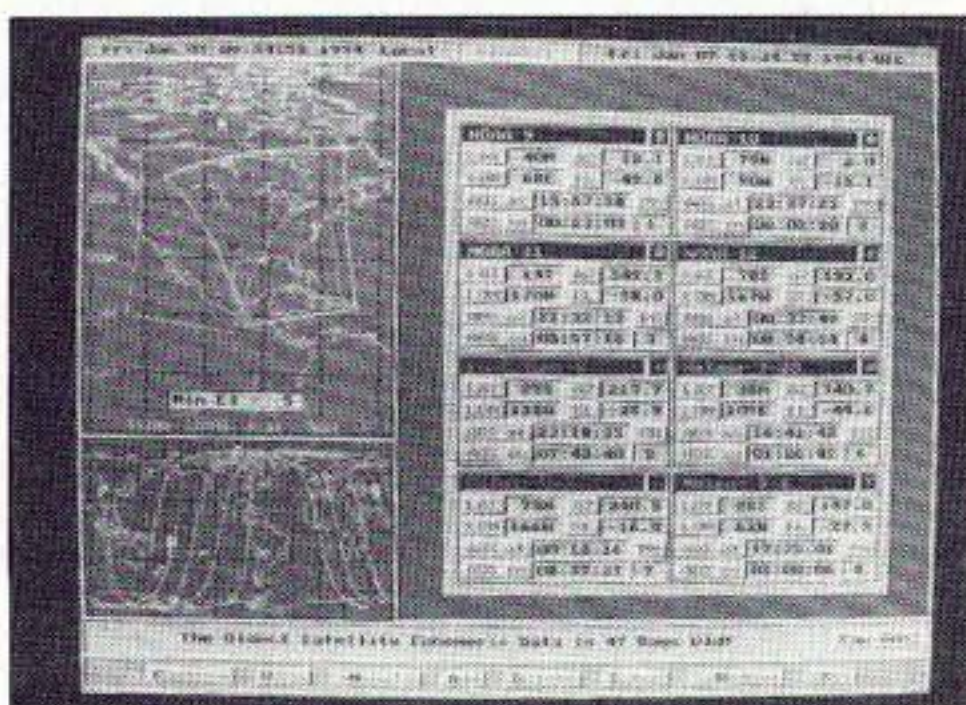

- **Integrated Satellite visibility prediction with automatic capture for up to 8 satellites simultaneously**
- **Automatic time and ephemeris stamping for navigation**
- **27 day programmable schedulers**
- **Automatic digital gain lock in ALL modes, PLL clocking**

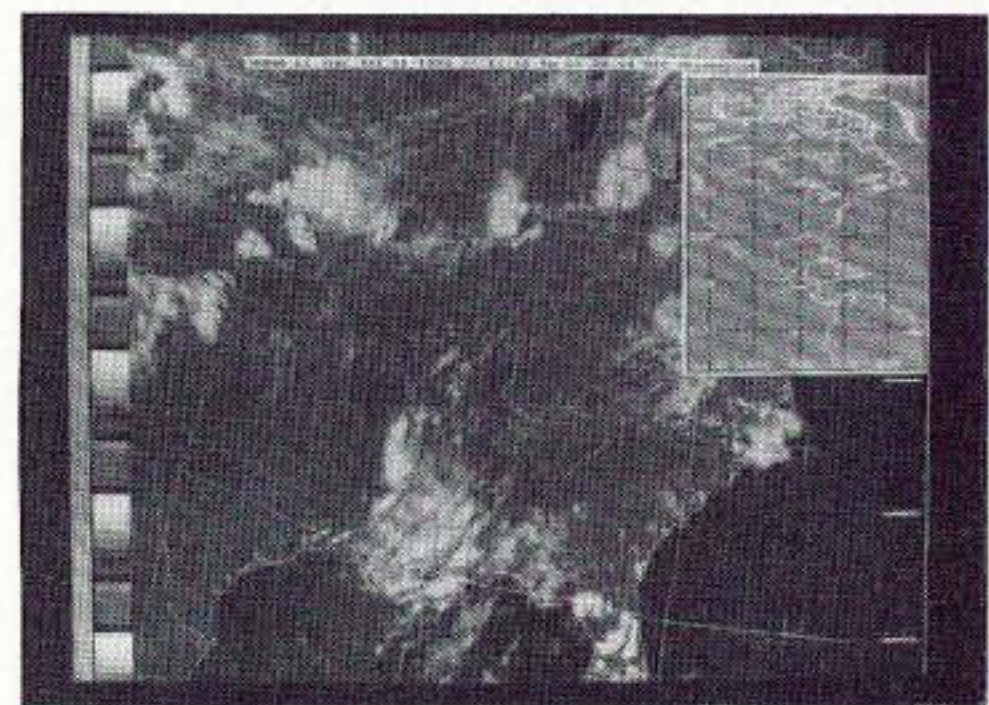

- **Ephemeris based NOAA APT navigation with geo-political and Lat-Lon overlays**
- **NOAA Tools show satellite path, Lat-Lon of cursor, distance and bearing to reference point**
- **Automatic Temperature Calibration**
- **Color Palettes and NOAA curves**

**Quorum Communications, Inc.** FAX(214) 915-0270  
8304 Esters Blvd. - Suite 850 - Irving, Texas 75063 (214) 915-0256 BBS (214) 915-0346

# Automatic Morse Station IDer from Comm Spec

*Perfect for fox hunting and repeaters.*

Breckinridge S. Smith K4CHE  
104 Brookfield Drive  
Dover DE 19901

When you read the ham magazines every ad seems to sport a board with a microprocessor installed. It's hard to evaluate all the products but when I saw the ad for this IDer board by Communications Specialists I immediately ordered one to test as a foxbox timer/IDer and to install on our local UHF repeater, which was being rebuilt. Good-bye, diode matrix—hello, microprocessors!

The ID-8 is made by Communications Specialists, Inc. (most technicians refer

to the company as "Comm Spec") and Comm Spec has been making specialized boards for over 30 years. Their PL boards are well known in the two-way industry and their technical help over the phone is great.

The package containing the ID-8 arrived, and my wife watched carefully as I unpacked two small pieces.

"What is that?" she asked.

"Nothing, honey. Just a microprocessor board."

"Oh, another gadget—don't you have enough?"

(Take a minute here to laugh.)

## Back to business

I found that the main board, with its MC68HC705C8CFN CMOS processor, and the plug-in keyboard (which mates with the main board for programming your specialized information, such as timing intervals, callsign identification, or messages) were in the box. All of your programmed information is permanently stored in an EEPROM and can be altered at will. Power can be removed from the board

and the information will remain intact. The board is small, measuring 1.85 by 1.12 inches. The keypad looks like a Touch-Tone™ pad, but actually is a 12-button keyboard that takes lines low, via the programming port (J2 on the board). The keypad plugs into the top of the board, piggyback style, and expands the area of the board by an inch and a half. Comm Spec cautions you on the first page of the instructions to provide room in your installation to allow plugging in the keyboard.

If you find that your installation area is cramped, you can always power up the board temporarily, program your info, and then remove the keyboard prior to the installation.

While I examined and tested the board, I realized that there wouldn't be any tedious sessions of soldering wires or connectors to the board; the wires are color-coded and are hard-wired to a connector for mating with the board. There is no microscopic soldering of jumpers, or removal of jumpers, to set up or program the board. This can only enhance reliability of your installation

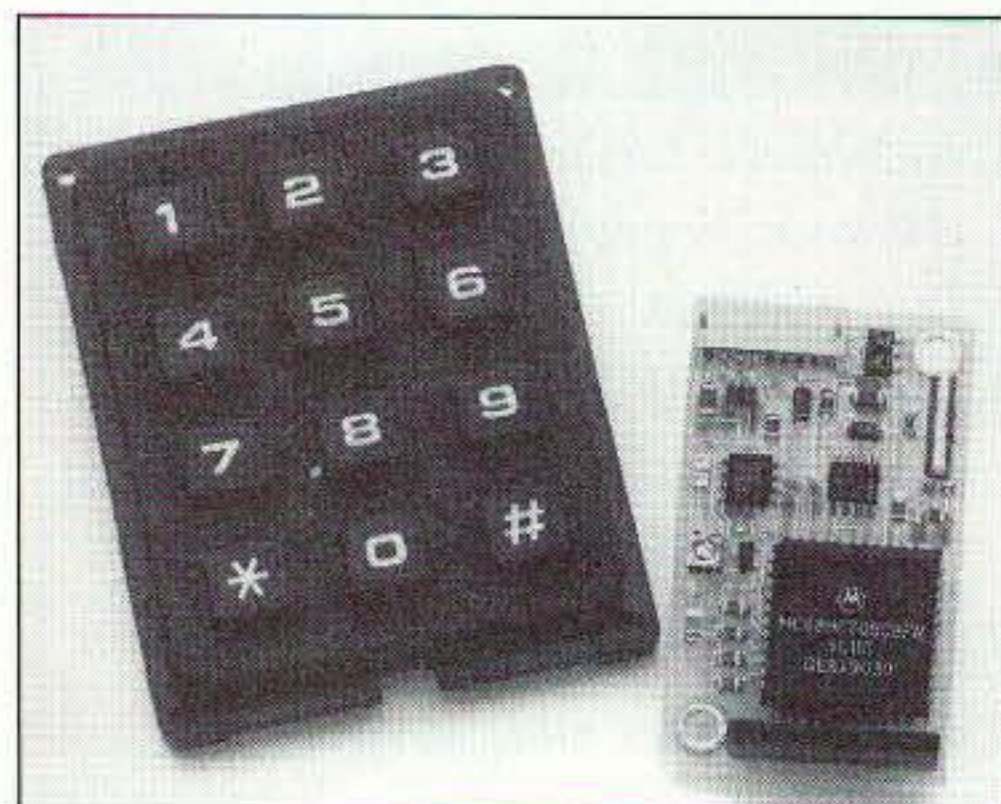

**Photo A.** Communications Specialists, Inc.'s Model ID-8 automatic Morse station identifier.



(and keep you out of surface-mount therapy). The board has its own voltage regulation, and can accept 6.0 to 20.0 VDC with a current drain of only 6 mA. During my testing I just used a nine-volt battery, and the battery seemed to last forever. You can immediately test the board to get a feel for the operation, as it is factory-programmed with a call and timing values—just hook up power and listen to the audio output.

### The whole pizza

I was initially concerned about the specific number of characters that I could store in the IDer slots, as I had plans for longer messages, but Comm Spec has provided the whole pizza—not just a slice. You can program a message of up to 216 Morse characters in a single slot or message. You can have up to eight separate IDers or messages, with 69 characters in the first message, and 21 in each of the other messages, or you can gang messages together. The messages are selected by three wires on the board that you ground to activate. Be sure to consult the message table on which wires to select your message; for example, to select message #2, you ground message wire #3, which is a little confusing. A really nice feature of the board is that you don't have to leave any unused message select lines "high" or "low" and there are no external resistors. You just simply leave a wire unconnected, if it is not used. If you just leave the "message select" wires alone and don't ground any of the lines, then message #1 is activated.

### Neat twist

When you use this board to key a foxbox you can have an exterior switch on the box, so that when the first hunter finds the box, he flips the switch and a different message, such as "The fox is found" will now be sent at the same interval. "The fox is found" message concept was first used on the East Coast by Dwayne WD8OYG, of LDG Electronics. It puts a different twist on the hunt.

The Morse code table in the ID-8's instructions is used for your programming. It uses two digits for each alpha-

numeric character and includes everything you could want, including fraction bar, space, period, and all the CW stuff such as AR, BK, BT, and SK. If you don't like code, throw some of them in anyway—just to confuse everyone. The CW audio tone frequency can be programmed from 100 to 3000 cycles and the speed is variable from 1 to 99 wpm; 70 wpm seems like a good speed for repeater IDers. If you want to have your foxbox key up with a steady carrier *without* sending a lot of CW, then just program in lots of "spaces" to provide the necessary transmit "on" time and then include a short ID. During the programming process, it's best to be able to monitor the audio output of the board, as the ID-8 will beep each time you enter a programming mode, and will generate another beep when you successfully complete a programming sequence. You can test-play your messages without disconnecting the keyboard; just leave it in place and type in one of the eight "play messages" commands. One of my favorite audio monitoring tools that I use in the shop is a Radio Shack™ amplifier (#277-1008C), which has its own nine-volt battery, audio amp, and speaker, all built into a small box.

As you punch the keys, if you screw up, the ID-8 sends out a triple beep to advise you of your lapse in mental dexterity. Comm Spec obviously has a ham on their staff, as the Morse code table is perfect and the programming is easy. If you get messed up during the programming and want to declare programming bankruptcy, then just key in the "reinitialize" code, and the board will return to its factory default values so you can start over.

### Good timing

The timing sequences for your message or ID can be programmed via the keyboard; you can send a message at a programmed interval when the trigger input wire is active. The ID-8 won't send the message until the interval has expired and the trigger line is active. If you have built repeaters, you know sometimes you spend a lot of time hunting all over your equipment for signals of the right polarity to activate

**VIDEO-TRANSMITTERS  
SMALLEST IN THE WORLD**

**AMAZING VIDEO-TRANSMITTERS!**

- 900 MHz Crystal controlled, range 300-600 feet, 10 mW, from 119 \$
- Size only 0.8" X 0.4" AM or FM modulation, IDEAL FOR SECURITY!
- High quality B&W or Color picture, PAL or NTSC SYSTEM.
- Long range units are available upon request, no audio!
- SMALLEST IN THE WORLD TRANSMITTER CH 59- 433 MHz- 99 \$
- RECEIVERS FOR 900 MHz for AM or FM, TUNABLE, from 149 \$
- PANEL ANTENNAS 19dB GAIN, 900 MHz, from 69 \$
- NEW!!! MMDS DOWNCONVERTERS 2.5-2.7GHz, with antenna- 199 \$
- VIDEO-TRANSMITTERS 2.4 GHz, size 0.8" X 0.6" FM modulation!
- MAKE YOUR OWN TV STATION:
- TV UHF TRANSMITTERS-EXCITERS, PLL, FOR EXPORT ONLY!
- LINEAR AMPLIFIERS UHF for TV EXCITERS, High Quality Units! Wideband 470- 900 MHz, 1- 10 W Output power, only 2 mW Input!
- HIGH GAIN TV ANTENNAS FOR TRANSMITTERS, FILTERS...

PLEASE SEND 2 \$ FOR A CATALOG. DISCOUNTS FOR QUANTITY. FREE SAMPLES! SOME RESTRICTIONS MAY APPLY!



**VOSTEK ELECTRONICS**  
P.O. BOX 60043,  
1052 PAPE AVE.  
M4K 3Z3, TORONTO, ONT.  
FAX/PHONE 416 423-7024  
E-MAIL: [vostek@globality.com](mailto:vostek@globality.com)

CIRCLE 182 ON READER SERVICE CARD

**TNT** Today's No-Tune  
Multiband Antenna

<p>No pruning. TNT is No-Tune on 80 cw, 40, 20, 17, 12, 10. TNT/2 is No-tune on 40, 20, 10. Work other bands w/ tuner. DX &amp; Gain rise w/ frequency.</p> <p>Ready to Use Includes isolation balun &amp; 99 ft RG8x</p> <p>The modern coax-fed version of the classic off-center fed window.</p> <p>Technote 126--\$6.95 ppd</p> <p><b>Antennas West</b> Box 50062S, Provo, UT 84605</p>	<p>No tuning. Kink-Proof Wx-Sealed Low Noise</p> <p>No knobs to twist. No traps or Resistors Insulated to 3000 V Rated 500 Watts</p>	<p><b>TNT</b> \$89.95 +\$8 Window 135 ft. long P&amp;H</p> <p><b>TNT/2</b> \$79.95 +\$7 Window 67 ft. long P&amp;H</p> <p>Order Hotline <b>800-926-7373</b></p>
--	--	---

CIRCLE 135 ON READER SERVICE CARD

## BIOELECTRIFIER

### PLANT GROWTH STIMULATOR

- COMPACT SIZE, 4.5" X 2.25" X 1"
- ADJUSTABLE OUTPUT UP TO 25 VOLTS
- STAINLESS STEEL ELECTRODES
- WIRED AND TESTED

FOR MORE INFORMATION

SEND SASE TO:

SEAGON COMPANY  
5541 OAKVILLE CENTER  
SUITE 215  
ST. LOUIS, MO 63129

CIRCLE 241 ON READER SERVICE CARD

your add-on boards. The neat thing about the ID-8 board is that during programming you can program the board to trigger on a "low" or a "high." There is also an inhibit line that can be programmed to inhibit transmission of the message on either a "low" or a "high" signal.

The timing sequence was interesting to play with. If your message is very long, for example a minute and 30 seconds, then the full message is played and the timing interval begins. The interval timer can be set from zero to 99 minutes and to the nearest one-minute increment. If you don't like even-minute timing, then put in a delay in the hold-off timer for the number of seconds desired. During your foxbox operations just keep the trigger input keyed and the foxbox will continuously transmit at the programmed interval.

The push-to-talk output of the board is an open-collector transistor with a specification keying rating of 80 volts and 300 mA. This should be more than adequate for keying needs. Comm Spec gives the usual caution about keying relays with this line, so be sure to install a protection diode across any relay coil that is keyed by the board.

I mentioned earlier that there has to be a ham on the staff at Comm Spec, as they've thought of everything. The output of the board can be programmed to be either audio or carrier wave mode. In audio mode the output is audio but in carrier wave mode the output is via the PTT Output and the Morse code keys this line, which can be used to key

your CW transmitter with the same PTT keying limits of 80 volts and 300 mA. During my testing, I also found that when the PTT output is used for CW keying, the tone is still available for modulation of the carrier. Thus, you can send true modulated CW for a unique sound. The CW output on the PTT line is perfect for beacons on VHF or if you want an interesting foxhunt, try keying the foxbox carrier on and off with the CW message. Put an important clue in the message—make those hunters get off their duffs and learn some code!

For your repeater installations there are a couple of features that can be programmed. A courtesy tone, which consists of a 50-millisecond beep, is generated at the input of a signal transmission; the courtesy beep can transmit as soon as the "trigger" input is released from an active condition and is inhibited automatically during Morse code transmission. Another good timing feature for repeaters is a "front porch delay" which will delay the sending of the message for up to 10 seconds, and can be programmed via 100 millisecond increments via the keypad. There is plenty of audio available on the board, up to four volts, and it's adjustable by a pot on the board. According to Comm Spec's note on the instruction sheet, the pot does not have any stops and can be rotated 360 degrees.

I really liked the board. Overall, I'd call it an excellent product from Comm Spec—a rugged little board that has bounced around my workbench for a month. I deliberately tried to abuse it, and it survived. It's not sensitive to RF and is easy to install. A lot of features are crammed into a small space; it has its own programming device and it's easy to change programming in the field. It's perfect for a basic repeater IDer, propagation beacon, or foxbox. The price is \$69.95. You can order it from Communications Specialists, Inc., by telephoning (800) 854-0547; FAXing (714) 974-3420; or by writing Communications Specialists, Inc., 426 West Taft Avenue, Orange CA 928665-4296. Be sure to check out the Web site at [<http://www.com-spec.com>].

## NEVER SAY DIE

Continued from page 38

magnetized (wetter) water, prayer, UVs, and so on. The mind tends to boggle (with apologies to my old car rallying friend Alan Turoff, who invented not the word, but the game Boggle™—I see, according to the TV program *King of the Hill*, that they're having Boggle tournaments these days). If nothing else, what a great science fair project it would make for kids to grow seeds using these systems for increasing growth, both alone and in combinations. With Sonic Bloom providing about seven times ordinary growth, by the time a few other approaches are used we could be seeing 10 and even 20 times standard growth!

Yes, I guess I'll have to start a newsletter or journal for the super-growth gardening fans. Should I call it *The Green Thumb*?

Not only can we start producing fruit and vegetables which will be infinitely healthier to eat, but these technologies should also go a long way towards feeding the world's hungry.

## Dowsing

Okay, what do you think about dowsing? Do you really believe that people can find water underground dependably? Like almost anything else, your answer will probably be determined by how knowledgeable or ignorant you are on the subject. It is easy to hold strong opinions on things of which you are ignorant.

Some months ago I reviewed *Vibrations* by Owen Lehto. This is the most practical how-to book I've found on dowsing. But Owen doesn't waste a lot of time trying to convince unbelievers. Christopher Bird, however, does in his monumental *The Divining Hand*. Once you've read this book I guarantee you will no longer be a skeptic. You won't even be on the fence. Bird goes over the history of divining, which goes back at least a thousand years. Then he covers the scientific research done in the field. And there's been plenty. He's done his usual massive amount of research.

For instance, a scientist set up an experiment by driving two iron posts in the ground several feet apart. He fed a small voltage to them to see if dowsers could detect it. He found that 80% of the people he tested could invariably detect a 20 mA current. A few could detect currents of 1 mA, and one chap was unfailingly able to detect 1  $\mu$ A of current. This chap was also able to direction-find any radio station while blindfolded. They gave him the frequency and his dowsing rod would point to it.

There are water well drilling companies who use dowsing to find wells and charge

## Radio Bookshop

Phone 800-274-7373 or 603-924-0058, FAX 603-924-8613, or see order form on page 88 for ordering information.

### Code Tapes

73T05 **Genesis 5 wpm code tape** This beginning tape takes you through the 26 letters, 10 numbers and necessary punctuation complete with practice every step of the way. \$7.00

73T06 **The Stickler 6 wpm code tape** This is the practice tape for those who survived the 5 wpm tape and it is also the tape for the Novice and Technician licenses. It is comprised of one solid hour of code. Characters are sent at 13 wpm and spaced at 5 wpm. \$7.00

73T13 **Back Breaker 13 wpm code tape** Code groups again at a brisk 13+ wpm so you'll be really at ease when you sit down in front of a steely-eyed volunteer examiner who starts sending you plain language code at only 13 per. \$7.00

73T20 **Courageous 20+ wpm code tape** Go for the Extra class license. \$5.95

73T25 **Mind Boggler 25+ wpm code tape**. \$7.00

nothing if they fail to provide water at a flow rate they guarantee. They've never failed.

Experienced dowsers can find water veins, tell you how far down they are and the flow in gallons per minute to expect. They can even do this working with a map. They can reliably find lost objects and people. They can dowse for metals, oil, coal and natural gas. With oil they can tell how far down the top of it is, the size of the deposit, and its depth.

Dowsers can diagnose illnesses and locate the site of the trouble. They've found that many, if not most cases of arthritis and cancer involve people sleeping over several veins of water. When their beds are moved to a place where there are no underground water veins they miraculously recover. Underground water veins can also make animals sick, and even trees!

Well, if something coming from the water is making people sick, then it should be possible to detect it scientifically, right? And they can, using a gamma ray detector! In some way the moving water projects a narrow beam upward which, over time, can generate many different illnesses. But you don't need a gamma ray detector when a simple pendulum will do the job.

An experienced radiesthesiast (medical dowser) can use a pendulum to find the cause of an illness and to find the best medicine to cure it. They can even do this from afar! And it works on animals as well as people.

By shielding a dowser's body they've been able to locate the areas of the body which do the detecting, with one being located in the head by the pineal gland and the other by the adrenal glands.

If you'd like to become an expert on the subject, get Chris's book. It's \$30 and is available from several sources. It's a big, glossy, well illustrated book. It's listed in the American Society of Dowsers book catalog, (800) 711-9497; Radio Bookstore, #5963, (800) 243-1438; Acres USA, #6194, (800) 355-5313.

It's easy to learn to dowse, and almost anyone can do it. But it takes experience to get to be good at it and to learn the right questions to ask. You can do it with bent rods, a pendulum, a piece of plastic (à la the Hieronymus machine), or even just with your hands.

I suppose I should have put this into the April issue as a way to deal with readers so grounded in science that they get upset when something unexplainable is claimed to work. Well, I'll put my science background up against just about anyone's, but it hasn't stopped me from reading and learning new (or old) and exciting things.

## Fair Enough?

If all those weird ways of stimulating plant growth for a science fair project aren't enough, I've got one more for you. This has to do with voodoo—no, it's what's called "paramagnetism." It seems that if you hang things by a string and put a magnet near them, those which are paramagnetic will be attracted a little bit. Stuff that's weakly repelled is called diamagnetic. Like wood and water. Most organic stuff is diamagnetic and the most paramagnetic are volcanic rock and ash. Like basalt, which is almost off the chart.

It's difficult to measure paramagnetism with a string and a magnet, so the "experts" in the field use a pendulum. Well, why not—once you get the hang of it, a pendulum will dowse for just about anything you ask it to.

But you don't have to buy into any of this to do the experiment and see for yourself. Some high school kids have won local and state science fair contests with this one.

Since basalt has the most power, if you can find or make a basalt rock about three inches in diameter and 12 inches long, you're in business. Granite will do. The idea is to emulate in miniature the round towers of Ireland. About 65 of these still remain, and the fields around them are in much demand by local farmers, who want to fatten their cows on the luxurious grass that grows there.

For the experiment use two plastic buckets or dishes filled with potting soil from the same bag. Plant radish seeds about half an inch deep around the pots, three or four seeds per hole. Water both pots the same and keep both in the sunlight, but in one place the stone in the middle. The shape of the rock isn't critical.

After eight days in a growing temperature of 70–80°F., pull the plants up and weigh the roots' "held in place" soil. You'll see that the plants to the east are the smallest and lightest. Those to the north and south will be middle-sized, and those to the west of the rock will be the largest and heaviest. The plants in the control pot should all be the same.

Now why should a rock in the pot have such a startling effect on plant growth?

The next step, naturally, is to start using this phenomenon to our advantage.

If you're interested in reading more about this you can read *Paramagnetism* by Phil Callahan (#6158 from Acres USA, \$15) and *Enlivened Rock Powders* by Harvey Lisle (#6103, Acres USA, \$15).

I've been interested in the using of rock powders to both stimulate plant growth and as a way of providing the minerals which are missing from our

commercially grown produce. In the Hamaker-Weaver book, *The Survival of Civilization* (Acres USA, #6221, \$12), Weaver mentions his eating a quarter to a half teaspoon of rock dust every day to supply the missing minerals. Talk about nitty-gritty! But it solved his chronic constipation problem.

There are a bunch of enlivened rock powders on the market that farmers feed to their livestock. It makes the animals more alert, have glossier coats and be generally much healthier, so they should help people too. Hmm, have you any rock powder recipes for me? Yum.

## Supersonic Lemons

By treating the roots of a lemon tree with supersonic sound, an experimenter has been growing two-pound lemons. He found that the tree's branches were producing four flowers instead of one, so he pinched off three of the flowers, allowing all of the growth to go into the fourth. The lemons grow so large that they have to be supported so they won't fall off the tree before they are ripe.

No, I don't have any details on the frequencies used, so get busy and start experimenting. That should make a great project using any fruit or vegetable bush or tree.

## Rocking

David Merrill, a Suffolk, Virginia, high school student, won top honors at the regional and state science fairs with his mice and music experiment. After establishing a baseline of 10 minutes for mice to navigate a maze, David started playing music 10 hours a day to two groups, keeping the third without music as a control. He then put the mice through the maze three times a week for three weeks. The control group was able to cut five minutes off their time. The classical music group cut eight and a half minutes off their time, and the rock music group took 20 minutes longer to navigate the maze.

David had to cut his experiment short because all the rock music group killed each other. None of the other groups did that. (Source: *Washington Times*.)

Which brings the question to my mind of how much of the kids killing kids we're seeing these days may be caused by them listening to rock music? Guns in schools, falling SATs, a lack of motivation and perseverance could all be connected to some extent to the hard rock craze and addiction.

So, how much classical music did you play to your children while they were in

*Continued on page 84*

# CARR'S CORNER

Joseph J. Carr K4IPV  
P.O. Box 1099  
Falls Church VA 22041-0099  
[carrjj@aol.com]

## The Internet: Where's it going?(And what does it mean to ham radio?)

A little historical perspective: The Battle of New Orleans (1814) was the only major land battle won by the United States during the War of 1812—but it was a hollow victory, because it took place two weeks after the war ended. The message announcing the end of the war did not arrive in time. Why? Because communication in 1814 was very, very slow. Messages went by horseback courier or sailing ship. General Andrew Jackson enjoyed no better communications between Washington and New Orleans than Julius Caesar had between Rome and Gaul. Indeed, Caesar may have had better communications because of the road system built by the Romans.

The modern telecommunications revolution began less than a generation after the Battle of New Orleans, when Samuel F.B. Morse (of code fame) invented the telegraph. By the Civil War much of the country was humming with telegraph wires, and communications time between distant cities was reduced to a few minutes. Stonewall Jackson had communications technology that Andrew Jackson could not even comprehend. It took another generation to invent the telephone, which allowed voice communications, still another to invent radio, and yet another to make widespread use of radio communications. Ham radio operators helped a lot in the development of early radio.

The accelerating rate of progress in communications is seen by certain historical events. The first transatlantic telegraph

cable was completed between 1855 and 1857, and could transmit no faster than about 50 or 60 words per minute. A transatlantic cable required a huge voltage at each end to be able to "tickle" a telegraph responder on the other end. I've read that 1,800 volts DC were used to overcome 2,000 miles of I-R losses in the copper wires!

It wasn't until 1955, a century later, that the first transatlantic telephone cable was laid. Transatlantic telephone service actually began in the 1930s using high-frequency shortwave radio channels. Capacity was limited, and waits of several days to get a free line were not uncommon. Ionospheric disturbances and magnetic storms, caused by solar activity, often eliminated the telephone channel for hours to days at a time.

Only nine years after the first transatlantic telephone cable went into service the first global communications satellite (AT&T's *Telstar I*) was launched. In the decades since *Telstar I* so many satellites (communications and otherwise) have been launched that colliding with "space junk" is a distinct hazard. A plan is approved to launch hundreds of new communications satellites in low Earth orbit in the next few years. Progress in telecommunications today proceeds at such a whirlwind pace that it is difficult to keep pace with advances.

Concurrent with, and because of, the telecommunications revolution, is the development of now commonly-available services such as cable TV and the Internet. Where Andrew Jackson and Julius Caesar had to wait weeks for messages to arrive, we today have instantaneous

messaging, graphics, video and audio available at our fingertips through the telephone companies, Internet service providers (ISPs) and cable TV companies.

The baseline capability expected by the public has increased dramatically in only the past two decades. Where most users were limited to a single channel analog voice system (telephone), we now have the ability to conduct on-line sessions with participants in all states and on all continents, simultaneously.

## The Internet

The Internet started out a couple decades ago or so as a means for scientists and engineers connected with the Defense Advanced Research Projects Agency (DARPA). The World Wide Web (WWW) was added much later, but buzzes with activity. The amount of information that you can obtain from the WWW is simply stupendous.

Some people don't want to use the WWW because, they say, pornographers and child-abusing perverts hang out there. They sure do, but so what? First, although you might occasionally click into a porn/pervert site, and you may occasionally get objectionable E-mail pointing to such sites, you won't normally encounter them unless you want to. It's kind of like "adult" bookstores. I find them objectionable, so I take note of their blacked-out windows and pass them by ... I don't go into stores I object to ... it's that simple. Nor do I go to WWW sites that look suspicious.

As to the child abusers and perverts on the WWW, it's almost impossible to get involved with one of those unless you want to. Although kids get suckered in, adults rarely do ... and neither will the kids if they are well trained and counseled. Besides, if you read the local paper in almost every town, there are perverts and abusers everywhere.

Don't let the scary stories get to you. If you have a computer

and a modem, then find an Internet service provider (ISP) that suits you and jump in. You can contact me at [carrjj@aol.com].

## Where it's going

We're witnessing a coalescence of the three telecommunications services used by the public: telephone, cable TV, and Internet. The telephone companies and cable TV companies are rapidly either becoming ISPs themselves, or partnering with existing ISPs to offer bundled service. Canada and the United Kingdom are ahead of the US in this respect. The UK users might be driven to flat-fee cable TV and Internet bundled services because they use metered telephones (a long WWW surfing session can cost big bucks).

The key to combining services is to provide a broadband connection. The telephone companies can't do that easily in some areas because of the "last mile" problem; i.e., they use twisted pair copper wires for the connection to your house. Don't count them out, however, because they have some really righteous technical capability. One study found, however, that telephone companies don't compete well with non-phone companies, and attributes it to their being monopolies for so long.

Cable TV companies already have 550-MHz to 800-MHz broadband service to homes. These can be used for high-speed Internet access if a cable modem is supplied. Although presently expensive, they are available in some areas.

The technical problem faced by the cable guys is that their present plants are one-way only. Converting to two-way plants, which is needed for Internet, is costly. It can be overcome, however, if the market is there in your area.

As telephone companies and cable TV providers begin to enter the Internet business, especially since they are able to provide broadband capability,

stresses and strains on the technical infrastructure of the net will increase. The Internet is already seriously constrained by its architecture, current bandwidth and growth rate. "The Internet is growing exponentially, but its instability is growing at an even more unnerving clip" said one commentator. If the net is unstable, then its utility to all users is compromised.

One problem is that a major source of the instability is the inability of routers to "... announce and withdraw traffic routes accurately and frugally ..." One source of the problem is that routers are overburdened with those routing updates, and those which see the greatest number of updates are the most likely to drop data packets. The effect of dropped packets on TCP/IP is "... a sign of congestion, prompting a dramatic slowdown in the flow of information across the network." Router instability also has encouraged widespread implementation of software aimed at route "dampening," a process that lets Internet service providers turn a deaf ear to routers that repeatedly issue updates. Users behind such overactive routers risk losing their connections.

Update levels across the core Internet are on the order of three to six million per day, while experts claim that tens or hundreds of thousands is more reasonable. One problem is that "... 99 percent of these update messages indicate that a route is unavailable, even if the router has yet to announce that the route was ever available." This fact indicates that the network is "looping," i.e., sending out the same message over and over throughout the day, with its own update message traffic being the major factor that makes the routes unavailable.

### Non-random network announcements

Network announcements, e.g., route availability, are expected to occur randomly throughout each minute of the day. Random

message generation tends to lessen the load on the system. However, it is noted that such messages are generated periodically, not randomly, on a cycle of about 30 seconds. This class of problem was traced to the Routing Information Protocol (RIP) several years ago when it caused the Internet to collapse.

Some authorities are claiming that problems in the Cisco Systems routers are the cause of the problem. There is a conscious design trade-off in Cisco routers between speed and memory that results in "... a small number of extraneous [route] withdrawals ..." But Craig Labovitz (Merit Network Researcher) states that the source of the 30-second synchronization problem is not known. He asserts that only one percent of the problems can be attributed to any one vendor product. Labovitz does not know what causes the 30-second phenomenon, but suggests it is "... a systemic, widespread, inherent problem that we might be able to fix in the Internet infrastructure." The problem is being worked on by routing vendors, ISPs as a consortium, and the Internet Engineering Task Force (IETF) through the National Science Foundation's Routing Arbiter Project.

[Note: Chaos researchers might be interested in examining this problem. Synchronization is a well-recognized phenomenon in chaotic systems. In addition, the work of Stuart Kaufmann at the Santa Fe Institute indicates that chaos is possible in any system that has more than three nodes and two connections per node, which qualification the Internet probably meets.]

### Weak link phenomenon

Internet traffic sends data packets by different available routes. Imperfections such as timing fluctuations ("jitter") and latency (pauses between request and delivery of packets) are a real problem for large applications such as graphics. Because the packets may pass through a number of routers and ISPs, the

weakest link in this chain between originator and receiver of the item sets the perceived quality of the entire network. As a result, varying capabilities between ISPs make it possible to seriously degrade overall quality. A large amount of upgrading might need to happen as the net expands.

### Bandwidth limitations

Multimedia, voice/telephone, video, net FAX, and a host of other applications being sent over the Internet are increasing the demands for bandwidth at a tremendous rate. High-bandwidth users are replacing multiple T1 lines (1.544 mbps) with T3 lines (44.763 mbps) or OC3 fiber optic (155.52 mbps) lines. A typical ISP uses four to six T1 lines, and many are rapidly moving to eight to 10 T1 lines. Part of the pressure moving the ISPs to T3 lines is the difficulty



in obtaining new T1 connections from the bandwidth providers.

One source claims that the Next Generation ISP will require scalable bandwidth from three to 155 mbps. Other sources note that the largest Network Access Point (MAE East) reached 240 mbps in 1996, and that MFS Data Services (NAP in San Jose, CA) expected to hit 500 to 600 mbps in 1997. MAE East reports that it "... will be cranking to the tune of 7.2 gbps by the time (2000) rolls around."

Telephone companies and cable TV companies stand to gain ground because of the higher bandwidth now being required by Internet customers. They already have the bandwidth infrastructure needed for new applications.

[Note: An implication of upgrading the Internet is that it may no longer be a "free" resource. It is expected that some sort of billing will be instituted

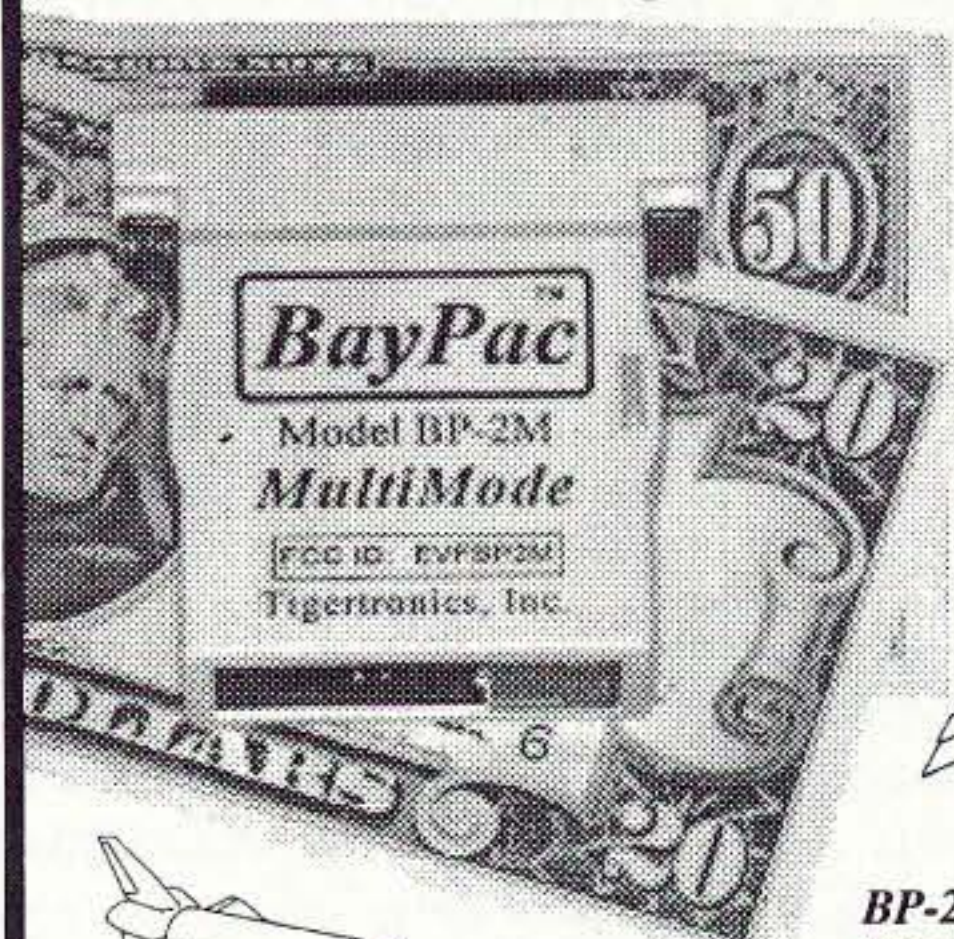
# MultiMode





## BayPac™



SITOR A/B  
ARQ/FEC  
BAUDOT  
PACKET  
NAVTEX  
FAX 480  
AMTOR  
WEFAX  
SYNOPSIS  
ASCII  
RTTY  
SSTV  
CW  
More...

BP-2 Packet Only \$49.95  
BP-2M MultiMode \$69.95  
+ \$5 Shipping & Handling

The best little packet modem just got better! Building on the tradition of the BP-1 Packet Modem, we are very proud to announce the BP-2 and BP-2M. The BP-2 is a new and improved version of our famous BP-1, while the BP-2M expands your horizons even further with MultiMode operation! So, whether you have been waiting to automate your CW, checkout AMTOR or just copy Weather Fax - Now is the time for you to jump in and join in all the fun!



**Call Today! 1-800-8BAYPAC**  
800-822-9722 (541) 474-6700 Fax 474-6703  
World Wide Web: <http://www.tigertronics.com>

Tigertronics, Inc. 400 Daily Ln. P.O. Box 5210 Grants Pass, OR 97527  
CIRCLE 269 ON READER SERVICE CARD

# HAM TO HAM

Your Input Welcome Here

Dave Miller NZ9E  
7462 Lawler Avenue  
Niles IL 60714-3108  
[dmiller14@juno.com]

Moderator's note: Roger and Ron Block of PolyPhaser Corporation have put together a well-written series of tips and suggestions on how we can effectively protect our ham radio stations from the effects of a lightning strike. Part 2 of that series was presented last month; part 3 follows.

## Lightning protection— what your mother never told you, Part 3!

We continue this ongoing series on lightning protection with some tips on ham radio tower installations. Be sure to read the two previous parts in this series in the January and February issues of 73 too, as they contain information essential to achieving a complete understanding of

the material. You can read the entire text immediately, by calling up the Special Bulletin "Protection to Keep You Communicating" at PolyPhaser's home page on the World Wide Web at: [<http://www.polyphaser.com/>]. Past "Ham To Ham" columns can be accessed at 73's "Ham To Ham" column home page (with special thanks to Mark Bohnhoff WB9UOM), on the World Wide Web, at: [<http://www.rrsta.com/hth>].

Now on to this month's topic. The first rule ... don't use a non-conductive structure for an antenna support! Conductive towers or metal poles should be used for mounting antennas high into the air. If the tower or pole has sliding contacts (telescoping, crank-up or push-up), the joints should be jumpered using short

sections of copper strap attached with appropriate clamps such as PolyPhaser's TK clamps (see Fig. 1). Normally, self-supported and guyed towers do not require jumpers across their joints. Joint compound should also be used so that rain water will not drip onto the galvanized surface of the support structure.

Guyed towers are better from a lightning protection perspective, if the guy anchors are grounded properly. Because the anchors are located away from the tower base, some of the strike energy will traverse the guy wires to ground, even though these guy wires may have relatively high inductance. This is OK, because the more the strike energy is divided, the less energy the equipment indoors may see, and that, after all, is our objective.

## Dissimilar metals

Copper should never touch galvanized metal without proper joint protection. Water shedding from copper contains ions that will wash away the galvanized (zinc) tower covering. Stainless steel can be used as a buffer

(transition) material (see Fig. 2); however, stainless steel is not a particularly good electrical conductor. If stainless steel is used as a buffer between copper and galvanized metals, the surface area of the contact should be large and the stainless steel itself should be thin. Joint compound (available from a number of sources, including PolyPhaser) should be used to augment the connection, so that water will not be allowed to form a "bridge" between the dissimilar metals.

## Magnetic energy

Lightning produces a very large magnetic field as would be expected with its typically 18,000 ampere pulse. This magnetic field will tend to inductively couple into all nearby conductive materials. There are two ways to minimize the amount of magnetic coupling:

1. Carefully shielding all sensitive equipment.
2. Placing some distance between the equipment and the likely strike location.

A galvanized steel sheet may also help (when used as a

in the future. The abortive foray of America Online™ into "unlimited" access may well be a portent for the future. "... Service providers cannot make adequate margins through flat-fee access and undifferentiated service."]

## So what does it mean to us?

Like many other technologies, the Internet is a two-edged sword. There are benefits and problems. The bennies include being able to research technical and operating topics, and to make connections with others doing the same. Checking into any forums or Web sites dealing with amateur radio shows a plethora of really neat stuff out there. Also, we can promote amateur radio on the Web, distribute training materials, and

generally use it for educational purposes. There is no reason why there can't be an on-line "Virtual Elmer" to mentor our newbies and future Novices.

On the down side, keep in mind why amateur radio exists: "to serve the public interest, convenience and necessity" (PICON principle). One of the ways we meet our PICON responsibilities is distributing message traffic. But who needs us when they can send E-mail? Also, in times of disaster amateur radio does brilliant work handling emergency traffic, especially of the "health and welfare" (H&W) variety. Although disaster authorities can rapidly fly in a satellite communications system (heck, they've got 'em small enough to fit into a suitcase), those systems and the authorities operating them are

usually too busy to handle a lot of H&W traffic. Yet, it's the H&W traffic that means so much to people whose loved ones are in the disaster area.

Now, however, it is all too easy to set up impromptu H&W networks on the Internet. And the originating stations in the disaster area can use cellular telephones and laptop computers to do the work.

It's not all downside, however. There is no reason why the ham operator doing the H&W traffic can't also be on the Internet. It is really little more than one more way of getting the H&W traffic to its final destination. What we need to do is figure out how to best merge amateur radio and Internet services in times of disaster.

On the technical side, there might be a few problems. Cable TV lines already sometimes

leak energy into the two-meter and six-meter ham bands. That can only be expected to increase unless the local utilities use fiber optic cables to distribute their services. There are also compression techniques now available that will permit high data rates in the HF spectrum, so we might see problems on the HF ham bands as well.

## Connections ...

I can be reached via snail mail at the address above; or via Internet E-mail at [carrj@aol.com]. My books can be bought through Amazon Books™ on the World Wide Web [<http://www.amazon.com>]. Be sure to type "Joseph J. Carr" (my full name) in the search panel if you don't want to get a lot of titles by other "J" or "Joseph" Carr authors. 73

magnetic shield) to attenuate the lightning's magnetic field pulse (usually by about 10 dB). This steel sheet should be at least 30 gauge (0.016 inch thick) and should be bonded to the system ground. The shield must also be broadside to the direction from which the pulse will emanate.

Distance can sometimes be effectively used to limit magnetic field coupling. The strength of any magnetic field diminishes at the rate of one over the distance squared. Since a moderately high tower is more likely to be struck than any other nearby structure, the placement of the tower with respect to your equipment room warrants significant consideration. Factors to consider include the magnetic energy that will likely radiate from the tower, and the benefit of distance in terms of the inductive loss provided by the length of the orthogonally-run coax; this added inductance of the coax line will help buffer any energy entering the equipment area. So this is one time when inductive loss is desirable. Do not, however, add loops to your coaxial line, since those loops may act as a transformer (depending upon their orientation), actually capturing more of the magnetic field energy and ultimately bringing it right into your ham shack!

Additionally, extra distance to the shack will provide more time for the tower ground system to absorb and dissipate the strike's energy, resulting in less energy heading toward your equipment. These factors indicate that a separation between the tower and the operating equipment of greater than 20 feet appears reasonable. For towers already located closer than this, it may be necessary to utilize some form of shielding (as mentioned previously) to minimize the magnetically induced energy.

### Antenna location

A ground-mounted vertical antenna is similar to a ground-mounted tower. Both should

have a substantial and low impedance connection to the station ground system. However, if the antenna or tower is mounted on a roof, the inductance inherent in the vertically-run conductors to the ground system can be significant. Voltages of several hundred thousand volts could be present. To reduce the inductance in these ground conductors, increase the surface area of the conductors (wider copper straps) as well as the number of conductors. For the roof-mounted antennas and towers, the multiple down-conductors can be spread over the roof and can then be brought down to ground in multiple locations. This will require the ground system to encircle the building (also called a perimeter ground) as shown in Fig. 3.

As an added benefit, this multiple down-conductor approach tends to reduce the mutual coupling between down-conductors and provides a low-impedance, unsaturated perimeter ground to absorb the conducted surge. The magnetic fields will be divided, and at least in theory, tend to cancel in the middle of the building (although in practice, the chances of these stray magnetic fields canceling on anything other than a perfect, geometrically-balanced and spaced down-conductor array, are slim to none).

*That's all from Roger and Ron Block for this month. Be sure to check back next month for more thrilling advent...er, advice on helping to keep your ham station safe from the devastating effects of a lightning strike.*

### Telco two-fer

**From Tom Siolek N3VUF:** "I recently acquired a Radio Shack™ HTX-212 two-meter transceiver, which I'm using as a base station to check into my local two-meter nets as well as for packet radio. I've found it to be a fine radio for both applications. Yet, since it doesn't have a separate data port for direct connection to a TNC, the

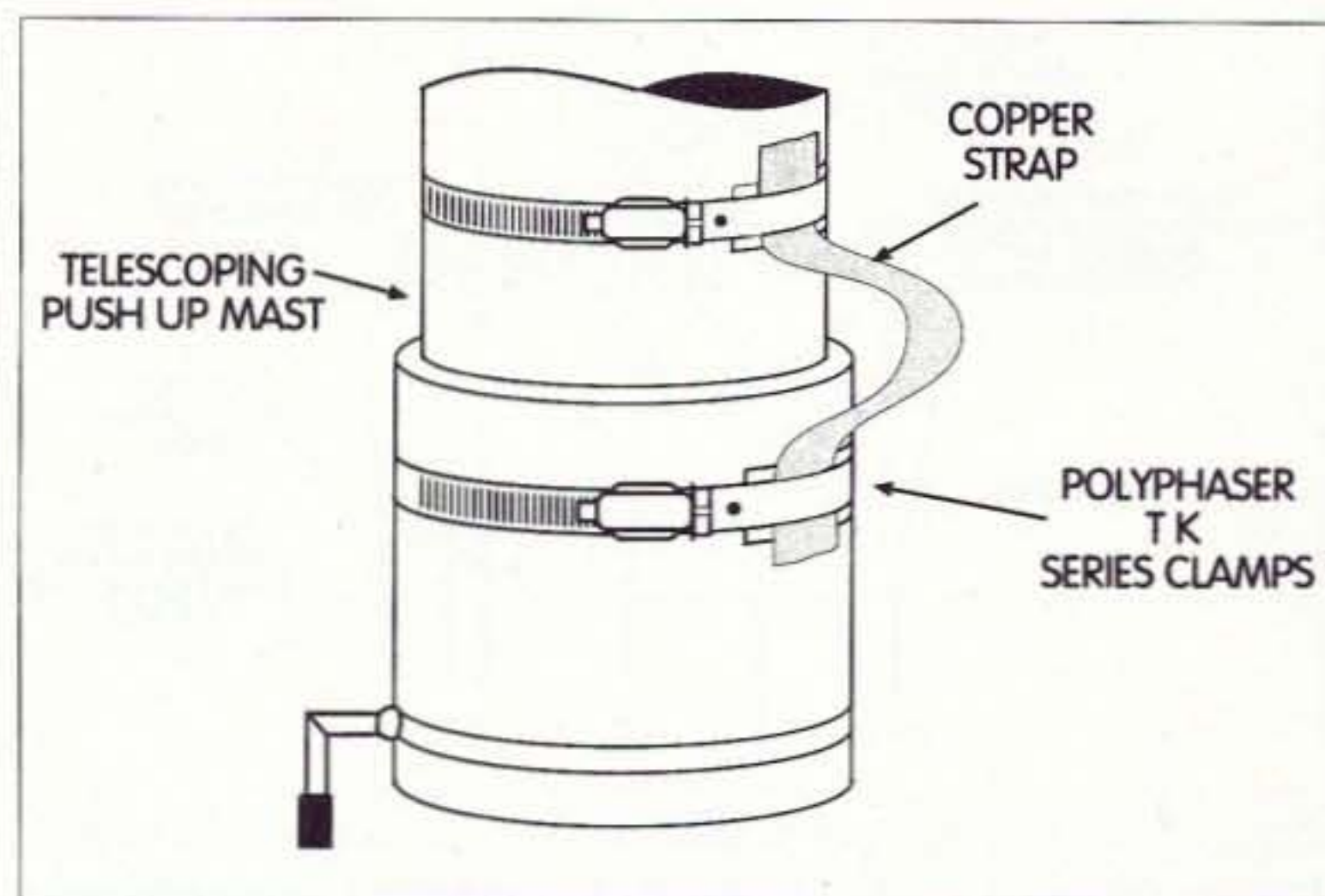
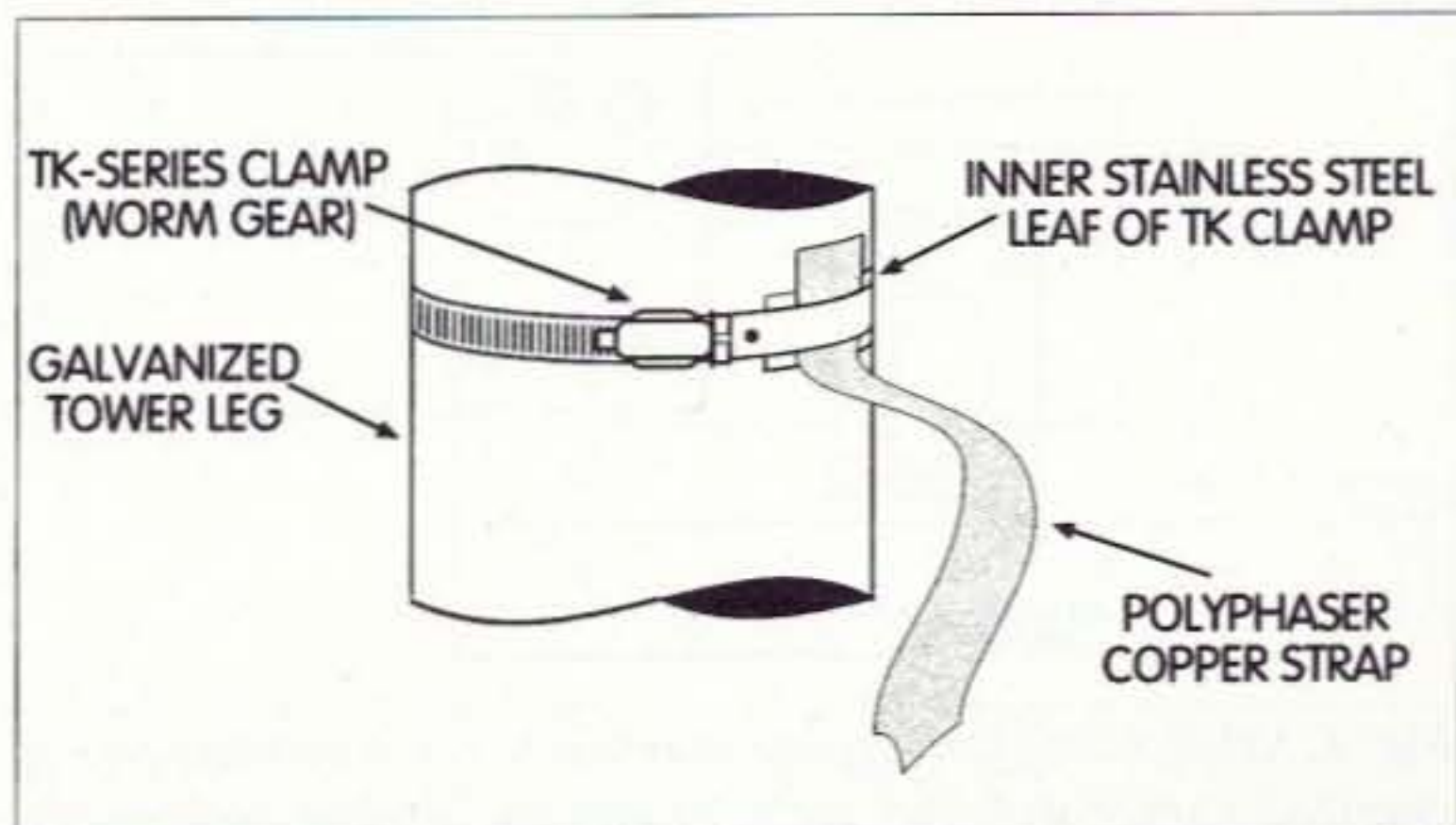

**Fig. 1.** The proper method of bonding two sections of a push-up or telescoping radio mast using PolyPhaser TK series clamps. It's important to remember that copper should never directly touch galvanized steel.

user must disconnect the microphone and replace it with a cable going to the station TNC for data work. Because the keypad and up/down scan buttons reside on the microphone, the user ends up losing the ability to change frequencies easily while running packet. For packet node hoppers, this can be an annoyance, since the only available frequency control is the detented main tuning knob, which has proven to be somewhat slow and cumbersome. The inefficiency is compounded if the computer monitor is located some distance away from the radio; it's not practical to run the microphone and its controls over to the remote position. There are commercially available in-line boxes that will

switch between a microphone and TNC cable, but the ones I've seen so far won't accommodate the type of connector used on the HTX-212, plus they come with a rather high cost for a fairly simple function. The microphone jack in this radio is an RJ-45 type, the same that's used in Ethernet computer networks. There are other two-meter transceivers having similar setups today, so users of any of these may well benefit from the following low-cost solution that I've come up with.

"To allow me to use the microphone controls while running packet, I simply plug in a standard modular eight-conductor duplex adapter ... directly into the HTX-212. This device will automatically split a single



**Fig. 2.** Closer view of the TK clamp mechanics.

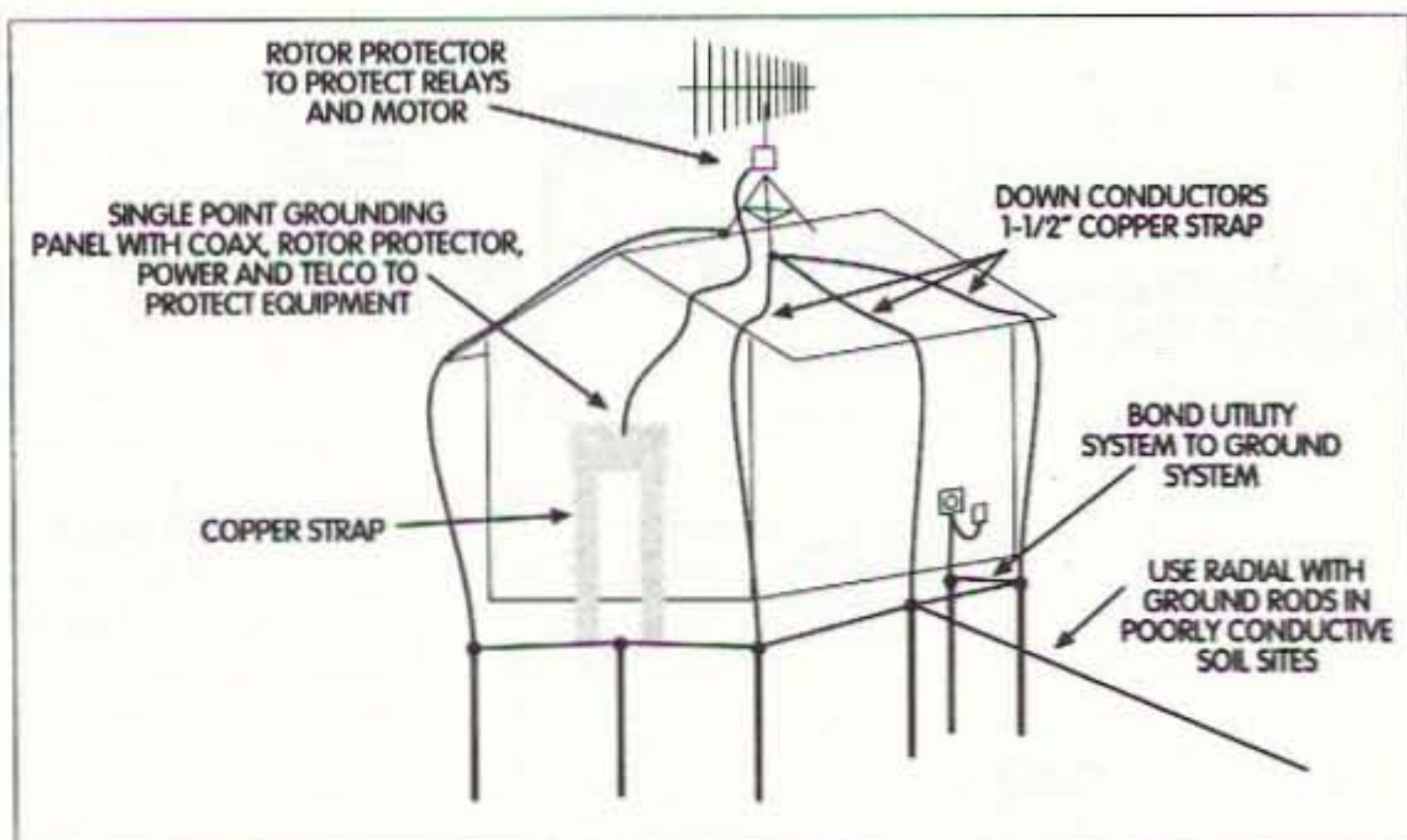
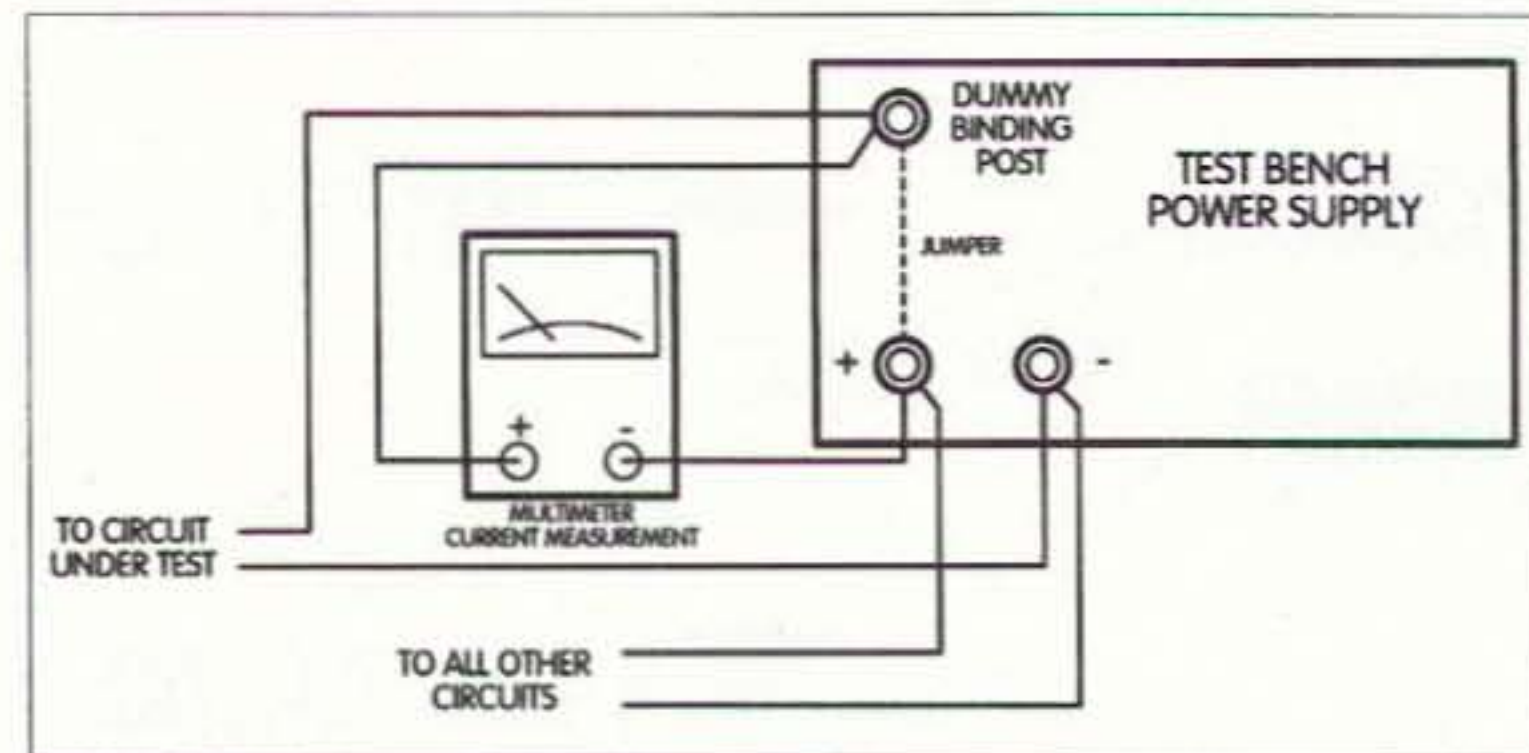

**Fig. 3.** A fairly typical roof-mounted antenna installation that should incorporate wide copper-strap down-conductors to a perimeter ground system. Note the tie-in with the existing utility ground connection.

modular RJ-45 jack into dual modular RJ-45 jacks ... just what I want. I then plug the microphone into one of the jacks, and the TNC into the other. This lets me operate packet, while not relinquishing the ability to directly input frequencies from the HTX-212's microphone-mounted keypad. The adapter I used is made by GC Electronics and carries their part number 30-9657. It cost me a mere \$3.32 at my local electronics supply house, a lot less expensive than any other alternative I've seen. You might also be able to find these eight-conductor splitters in computer stores that stock Ethernet 10BaseT network cabling supplies or via mail-order from some of 73's advertisers.

"One caveat ... the setup works great on packet, but I've noticed that I end up with some 60 Hz hum superimposed on my

voice signal when I operate on voice FM to transmit (with the TNC cable still plugged into the splitter). This appears to be due to inductive pickup from my station power supply, via the TNC's cable (since it clears up as soon as I disconnect the cable going to the TNC). It's not a huge problem for me, since I only use the RJ-45 splitter during digital operation, but I thought I'd mention it just in case you run into something similar. The inexpensive answer, of course, is to simply unplug the TNC's RJ-45 cable when you wish to operate on voice mode. Perhaps better isolation between the microphone and TNC circuitry might be the final answer, if you'd like to keep both items permanently connected, but that's the kernel of another, more involved project ... a home-brewed RJ-45-based switch box. For right now, the



**Fig. 4.** NØBLX's tip for keeping your test bench a bit more free of clip-lead clutter with the use of a dummy binding post on the bench power supply.

\$3.32 solution works well enough."

*Moderator's note:* The 60 Hz hum that Tom noticed on his two-meter FM voice signal might also be due to a ground loop condition among the TNC, the two-meter transceiver, the computer, etc., or it could even be traced to a bit of RF feedback showing up as a hum-like extraneous modulation. Either case would require some "setup-specific" troubleshooting, but as Tom states, the easiest answer may be to just unplug the unneeded TNC cable when operating any other mode.

### Clip-lead clutter reducer

**From Peter Bergman NØBLX:** "Often after building or repairing some electronic gadget, it's nice to know exactly how much current the item is drawing. Using the meter on the bench power supply itself (if your supply even has one) isn't always the full answer to the question. Power supply meters aren't usually all that accurate and you're generally stuck with just one 'overall' range, which may not be the right one for your needs. The meter on the power supply also records all of the current being supplied to all of the devices that may be connected to it at the time—again, perhaps not what you'd like to see specifically. The usual approach that most of us take at this point is to grab our collection of alligator-tipped test leads and start lashing our multimeter into the circuit. The result is clip-lead clutter, and often unintentional shorts or dangerously exposed wires scattered around our work area. The cure for this form of clip-lead clutter is amazingly simple. Take a look at Fig. 4 and you'll see what I mean.

"All you need to do to avoid the clutter is to install one of those handy five-way binding posts on your power supply's front panel—the type of binding post that allows you to hook

up several wires to it at the same time, safely. It's just a dummy binding post, so you don't have to connect it to anything internally in the supply! It's basically just a splicing point for one of your multimeter's test leads, and the lead that will feed voltage to the equipment or circuit under test. It's the simple and safe way to put your multimeter in series with the device whose current you'd like to check, and Fig. 4 shows the concept graphically. When you don't want the multimeter in series with the bench supply, just connect a short from the power supply's negative post to the dummy post and you're back to the old days!"

*Moderator's note:* I'll have to admit that this solution to clip-lead clutter never crossed my mind ... great suggestion, Peter!

### Family (of) ties

Back in the October 1996 "Ham To Ham" column, I described one possible method of making your own cable coil ties from standard hook-and-loop sew-on strip material, available at most fabric and variety stores. A reader recently sent me a sample of a find that he came across for prefabricated cable ties, using an even better material ... double-sided Velcro™.

**From Charlie Smith KE4OZN:** "I recently ran into a great product that I use almost every day and I know that other hams would do the same if they knew about it. They're one-piece cable ties using the Velcro loop & hook principle, but with an interesting twist. Grip Strips™, as they're called, are made from strips of double-sided Velcro, i.e., the top side is the 'fuzzy' or 'looped' side, the opposite side is the 'pinchy' or 'hooked' side. The material has this double-sided feature throughout its entire length. It can be wound around a cable coil or power tool cord, and then attached to itself, to hold the cord in a neat coil for storage or transport. Grip Strips, made by GB Electrical, Inc., 6101 N.



# Ask KABOOM

## Your Tech Answer Man

Michael J. Geier KB1UM  
c/o 73 Magazine  
70 Route 202 North  
Peterborough NH 03458

### New modes!

Many of us who write in the ham radio press make comments to the effect that there's lots of uncharted technological territory for hams to explore, and we should all get cracking! We try hard to get everybody all worked up, but we never seem to actually suggest any of these miraculous new modes. I've been thinking about that for a while now, and I've come up with a few I think might actually work and be very useful, and which can be played with by any reasonably technically competent ham. So I'm going to propose a couple of new ways to communicate. Who knows? Perhaps one of them will change the face of ham radio! Even if they don't, they're food for thought.

### Packet voice

Have you seen the new digital cellular and PCS phones? They get much better battery life than regular, analog phones, which are basically the same technology as our FM HTs. Why? Because they don't transmit continuously! Instead, they transmit their digital information in bursts, with the resulting duty cycle of transmission being far less than the 100% required for regular analog voice transmission. Of course, it's the transmitter that kills the batteries, so keeping its duty cycle down boosts battery life enormously. That's what makes those new ultra-small phones practical.

Does this transmission method sound familiar? Yup, it's

the same thing we've been doing with packet radio for years! The difference here is that they're sending voice data, not text. (Well, OK, some new phones offer text messages, too, but that's not the point here.)

Why can't we do the same thing over our repeaters? I propose an experiment like this: Make a digital controller for a two-meter, 220, or 440 MHz radio. Have the controller digitize the voice and then packetize it. Then, have it blast the data over a standard FM rig, using a normal voice or packet repeater for relay. The connections between the radio and the controller would be essentially the same as with any present packet setup. The big operating difference would be that the PTT button is connected to the VNC (voice node controller—cute, huh?) instead of directly to the radio. Otherwise, the whole thing would be transparent.

So, while you're talking, the controller would be cycling the transmitter on and off. In this type of use, it might be a good idea to disable the acknowledgment part of the system, to avoid

having the repeater tied up with all those "acks." If you're not solid into the repeater, you'll simply drop out, as with regular FM. Of course, if you want to get fancy, you could have the repeater send you acks, and then you'd *know* whether or not you were making it into the machine, even while you were speaking! An indicator on your rig would come on, letting you know when you weren't making it. How's that for cool?!

This system could employ the digital equivalent of CTCSS, too. In unconnected mode (to use the present packet radio terminology), everyone could hear your transmissions, and you could hear everybody else, too. That would be the normal mode of use, and would allow roundtables and such, just as we have now. If you wanted to get rid of others' transmissions, you'd just select "private" or "connected" mode, selecting from perhaps 10 codes, numbered one to 10. (You and the station with which you wanted to communicate would simply select the same code.) Everyone could still hear you (after all,

Baker Road, Milwaukee WI 53209, come in three lengths (eight, 11, and 15 inches long) and in three colors (red, green and black) for different sizes of coils and to quickly identify different cables. The 11-inch size (an all-around handy size), in red, is designated as 45-V11RD. They're available in the electrical supply departments of many hardware stores and larger home centers for about \$2.50 to \$3.00, depending upon their length, for a package of five. That's less than \$1 each, which I feel is well worth the expenditure, since they should last at least as long as the cable itself ... maybe longer! Grip Strips have a widened design at one end, which also has a cutout slot for self-storing the tie right on the cabling, but I prefer to utilize a small (four-inch) plastic cable

tie or two to make sure that the Grip Strip stays with a particular cable or power tool permanently. The strips can easily be cut to a smaller size, so you might want keep a stock of the longest ones as a norm. I think that once you've tried these little gems, you'll "stick" with them!"

Murphy's Corollary: Whatever it is that you want to do, you must always do something else first that you *don't* want to do.

The "Ham To Ham" column is here to provide a forum for your ideas, even if they may be, well, a little different. Different can often be very creative, and those are the ideas that I really enjoy receiving and including on these pages. Don't worry about your writing skills—just include as much detail as you can and I'll put it together in the style of the column. Let's hear from you!

As always, many thanks to those who've contributed to this month's column, including:

Roger Block, President  
PolyPhaser Corporation  
2225 Park Place, POB 9000  
Minden NV 89423-9000

Tom Siolek N3VUF  
32 Westwood Park Drive  
Havertown PA 19083  
[n3vuf@aol.com]

Peter A. Bergman NØBLX  
3517 Estate Drive SW  
Brainerd MN 56401

Charlie Smith KE4OZN  
12900 Meadow Creek Lane  
Apt. 204  
Pineville NC 28134

Note: The ideas and suggestions contributed to this column

by its readers have not necessarily been tested by the column's moderator nor by the staff of *73 Magazine*, and thus no guarantee of operational success is implied. Always use your own best judgment before modifying any electronic item from the original equipment manufacturer's specifications. No responsibility is implied by the moderator or *73 Magazine* for any equipment damage or malfunction resulting from information supplied in this column.

Please send any ideas that you would like to see included to the moderator at the address at top. We will make every attempt to respond to all legitimate ideas in a timely manner, but please send any specific questions, on any particular tip, to the originator of the idea, not to this column's moderator nor to *73 Magazine*. 73

privacy goes against the spirit, and the law, of ham radio), but you wouldn't hear them, just as with present-day CTCSS. And, if someone else wanted to join in or make a comment to you, all he or she would have to do is select the same code, which would be displayed on all receivers whenever either one of you was speaking.

And, unlike with analog CTCSS, multiple codes could be employed. Why do that? Well, one code could be for the repeater itself, for the purpose of avoiding mutual interference, as is done now. But, the digital system would allow you to add another code for selective calling.

Another very cool feature of this system is that multiple users could share the repeater without bothering each other, which is something unthinkable in the analog realm. All that's required is for each station's controller to avoid transmitting

when the channel is busy, resulting in automatic interleaving of signals. Of course, just as with regular packet, things will bog down dramatically when the channel is busy, and some collisions may occur (although these should be much rarer than with traditional packet, since everyone presumably can hear the repeater). The faster the data rate, though, the shorter each blip will be, making the channel available for more and more traffic.

Obviously, this isn't going to happen at 300 baud. To get usable voice transmission, a minimum of 9600 baud will be required, at least by today's digital compression standards. But we already have 9600-baud packet modems, so that shouldn't be a problem. And, more efficient data coding may lead to less data per second of speech, easing the bandwidth problems down the line.

Initial experiments can easily be done with current packet gear and normal voice repeaters, although some modifications may be required. In particular, the repeaters might need to have their long squelch tails chopped off, to avoid bogging the system down. And, of course, you'll have to build something to digitize the voice and compress the data before you feed it to your VNC, but modules to do that are commercially available in the computer telephony market right now. Remember, you don't need high-quality sound here, so the digitizing doesn't have to be complex or expensive. There are plenty of hobby-level A/D converters out there for next to nothing. As for the data compression, initial experimenters can use their home computers. OK, so it won't be very portable at first. Eventually, I foresee the digital controllers integrated right into our HTs and mobiles, just as they are with digital phones now. The rigs will look just as they do today, except perhaps for a new command or two on their menus, and their blinking transmit lamps!

I suspect that a mode something like this one is the future of VHF/UHF ham communications, and I predict that within 10 years we'll all be using it. In fact, I predict that packet radio, currently languishing under the onslaught of the Internet, will eventually be looked upon as the pioneering infrastructure which eventually led to this leap into modern voice communications. OK, it's nearly the new year as I write this, so I'm permitted to make some foolish predictions!

#### Walk 'n' look

Why limit such a powerful technique to voice? There are digital videophone devices out there right now that can send full-color images, at 15 frames per second or so, over analog phone lines, using 33.6 kbps and 56 kbps modems. Why not

put together a "walk 'n' look" system which can send a few frames per second of color video over the same radio channels I just described, along with the voice? We don't really need 15 fps, at least at first, so we could get by with slower modems. (Sending high data rates is harder over radio channels than over the phone lines anyway, due to noise and phase problems.) Using today's tiny CCD cameras and those lovely active-matrix color LCD panels found in the better pocket TV sets, you could have a powerful ATV system and carry it around in your pocket! And, unlike today's analog ATV, it wouldn't require tons of bandwidth or lots of power. I, for one, find the prospect of digital, pocket-sized ATV very exciting.

#### Shoot the bird

Once you have a packetized voice and/or video system in place, why limit yourself to terrestrial repeaters? A lowered-duty cycle technique like this is a natural for satellite relay. If it got popular, dedicated, miniature amateur birds would undoubtedly be launched. Hopefully, some would be geostationary and have sensitive enough receivers that no pointing or high-gain antennas would be required on the ground. Plus, with the interleaving inherent in the system, many people could share the birds at once. Whip out your HT or video HT and connect with somebody halfway around the world. Fun, huh?

#### Wanna try?

Anybody out there want to try some of this stuff? Alas, as a struggling musician, I simply can't put the time into it myself, much as I'd love to. If you do try it, send me a note detailing your progress, and I'll put it into a future column. Remember, we hams aren't finished innovating, not by a long shot!

Until next time, 73 de  
KB1UM. 73

## WE DON'T BUILD THE MOST, WE JUST BUILD THE BEST!

- Our LM-470D is now redesigned to hold 15 ft. of antennae at 70 mph!
- Tri-Ex builds the finest in crank-up, free-standing or guyed towers.
- All towers are complete with rigid concrete base mount.

CALL  
OR WRITE  
FOR A FREE  
CATALOGUE!



**Tri-Ex**<sup>®</sup>  
**TOWER CORPORATION**

7182 Rasmussen Ave. • Visalia, CA 93291

Where engineering and quality come first!

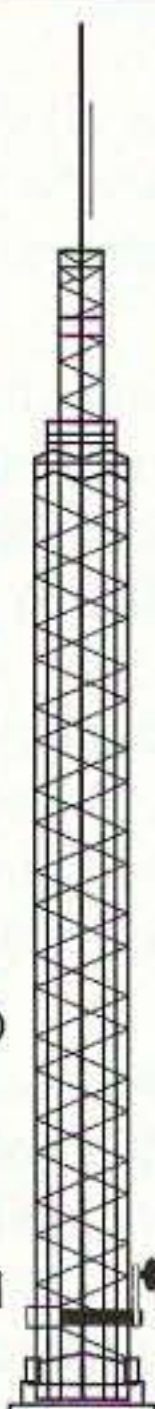

TO ORDER CALL  
800-328-2393

FAX  
209-651-5157

CIRCLE 22 ON READER SERVICE CARD

## Low Power Operation

Michael Bryce WB8VGE  
955 Manchester Ave. SW  
North Lawrence OH 44666  
[prosolar@sssnet.com]

Picking up where we left off last time ...

Let's hope that by now your HW-8 is working just like it should. But deep down inside, you feel there's something missing with the little rig. Well, the HW-8 is a great platform for adding your own modifications! In fact, I've seen some HW-8s with so many modifications, it's hard to believe the rig was once an HW-8! If you've ever seen Adrian Weiss WØRSP's HW-8 Super Contest Machine, you know what I'm talking about.

### HW-8 modifications

There are lots of tweaks and peaks you can do to enhance the operation of the HW-8. However, before we get the soldering iron hot, I've found some goodies any Heathkit owner will want to know about.

First, the green paint used in almost all of the Heathkits was really put on thin. Scratches in the paint were a fact of life if you ran Heathkit equipment. I've found a company that sells "Heathkit green" paint. It's from a company called R&R Designs, 202 Midvale, Marshall WI 53559. (800) 372-4287. E-mail at [rehummel@aol.com]. A 12-oz. spray can is \$14.95 + \$3 shipping. They also have touch-up bottles, and if you're *really* into Heathkits, you can buy the paint by the gallon! They have several colors, so be sure you ask for the one matching your HW-8.

I guess if you're that taken by the HW-8 and Heathkits in general, you should also be reading the *Heathkit Journal*. It's \$25 per year in the US and \$30 in Canada. It's by the same people who sell the paint, so the address

and phone are the same. However, the 800 number is for orders only. If you have questions, call Robert Hummel at (608) 255-0400.

Let me make this clear. I have not ordered, nor have I tried to use, any of the paint products above. Also, if you're not up to the task of repainting a cabinet, perhaps you should pass on the project. Personally, I'd practice on someone else's HW-8 first!

If you need a manual or schematic for your HW-8, the only authorized source is, of course, Heathkit. Give them a call at (616) 925-5899.

### And now the modifications

Before we begin, your HW-8 should be in working order. Don't do any of the modifications if the rig is sick—and do only *one* modification at a time. Completely check the HW-8 for proper operation after the mod is made before moving on to the next one. While the modifications presented here are simple, some of the complex modifications conflict with other modifications. And lastly, if you don't know what you're doing, then don't attempt *any* of these modifications!

### Meter lamp

This is a classic, and perhaps the easiest to do. Basically, you add a small grain-of-wheat lamp behind the meter. You can get these lamps from your local Radio Shack™ store. Check the many surplus electronics mail-order places for the best price and selection. Add power to the lamp, and the meter takes on a nice warm glow.

There are two ways to power the meter lamp. One is to pick up +12 volts from the rear of the power switch. This applies power to the meter lamp whenever power is applied to the HW-8. However, the HW-8 uses a multi-pole AMP connector for power. I've rigged up the connector to supply power only to the meter lamp when I'm using an external AC supply or my large battery bank. A second power cord was wired to bypass the meter lamp when operating in the field from a smaller battery. All you need is a spare connector and a few pins and sockets for the AMP connector. Again, Radio Shack carries these connectors. Plan how you want the pins and sockets installed into the nylon heads. If you screw up, they're damn near impossible to remove without the proper tools.

If the meter lamp is too bright for your liking, add a small current-limiting resistor in series. A solder lug strip is easily added. Use a solder lug strip having at least five lugs ... well, use it in the next mod. Remove the nut from the screw closest to the VFO knob holding the meter in place. Remove the single solder lug (it's the bent one holding the meter) from this nut as well. Solder a bare wire about three inches long to this lug. Replace the lug on the screw. This is our ground connection. Whatever you do, don't try to solder to this lug while it's still touching the back of the meter. Heat from the soldering iron will cause the back of the meter to melt. If that happens, you're in really deep dung! I know of no sources for replacement HW-8 meters. Use the solder lug strip to hold your current-limiting resistor and the grain-of-wheat lamp itself. The lamp's leads hold it in place. You can bend the leads to suit the amount of light the lamp places on the meter's back side. Replace the top of the rig, turn off all the lights in the room and fire the little guy up. Now, sit back and enjoy your handiwork! After a few minutes, don't you

wish that meter did something besides just sit there and glow? Well, that's the second modification—adding an audio-driven S-meter to the HW-8.

### An audio S-meter for the HW-8

This is a classic modification. I've seen several, but this one is simple and it works. Nothing fancy—it just makes the meter's needle move. The stronger the signal, the more the needle moves. The circuit does not provide any AGC to the receiver. During transmit, the S-meter's circuit is transparent to the HW-8 circuit used to drive the same meter to indicate transmit power. This circuit is simple and effective.

In a nutshell, here is how it works: A sample of audio is picked up from the high side of the HW-8's volume control. Diode D1 rectifies the audio and directs it to an RC circuit. This RC circuit consists of R1 and C1. C1 has more control than R1 and it's best to change the value of C1 rather than R1. A lower value at C1 will give a quicker response to a signal. Any value from 10 µF to 47 µF will work.

Resistor R2 isolates the S-meter circuit from the transmit circuit on the HW-8's PC board. Don't drop this value lower than 10 k. The value shown, 12 k, provides a nice action.

Diode D1 is a 1N914. However, if you want your meter a tad more sensitive to weaker signals, a 1N34 diode should be used. If you do, then you may have to experiment with the value of R2, increasing its value to prevent pinning the meter's needle with really strong signals.

If you did as I said, and installed a multi-solder lug terminal strip, use this strip and point-to-point wiring to assemble the S-meter. While there are no adjustments to be made, you may want to fine-tune R2 and C1 to achieve the desired operation.

## Mobile, Portable and Emergency Operation

Steve Nowak KE8YN/5  
1011 Peacock Ave. NE  
Palm Bay FL 32907-1371  
[pangen@compuserve.com]

### Mobile antennas

I tend to have a love-hate relationship with antennas. I love how a good antenna can make operating a dream, but I hate the gyrations sometimes necessary to install it successfully, especially given my interest in mobile and other non-permanent installations. While stacked monobanders at an altitude which approaches major airline routes provide optimum performance, they are in no way mobile. The more mobile an antenna, the less one expects it to perform. I decided, therefore, to look at antennas which can provide reasonable performance while also being easily installed for mobile operations.

My first choice was to pick an antenna for two-meter /440 MHz operations that would be easy to install, operate reasonably well, and, out of deference to the XYL, be relatively inconspicuous since

it would be attached to her car. Initially I attempted to use a magnetic mount on the trunk lid so that it could easily be stowed in the trunk when not in use. Unfortunately, many of today's cars have much less steel than one might expect, and the magnet found absolutely no attraction to the trunk lid. Plan B was for a glass-mount antenna, although my expectations for this option were quite low. I had tried glass-mount antennas in the past, but the emergence of metallic-based tinted (sometimes called passivated) glass prevents them from working well. I had hoped that, as cellular telephones became more developed, the technology for through-the-glass antennas had kept pace. Cellular antennas, after all, are almost universally glass-mounted, and appear on every type of vehicle imaginable.

After looking through a number of catalogs, I found

that Radio Shack™ sells one that covers both two meters and 440 MHz. This turned out to be a stock item, rather than one that needed to be ordered, so I purchased one from the local store and decided to see if it would work.

I started by attaching the antenna to the rear window glass with masking tape. This is not quite as easy as it sounds, since

which to clean the window, and the alcohol when mixed with generous amounts of elbow grease will ensure that the antenna will stay put. I carefully lined up the outside block so that the antenna was as vertical as possible. Once I was happy with its alignment, I removed the backing from the adhesive pad and attached it to the glass. This must be right the first

---

***"Installation was not difficult, although some of the directions were in Japanese."***

---

it took about six strips of tape to support the external mounting block and antenna plus a few more for the internal block. After getting everything lined up, I used my handie-talkie and UHF/VHF SWR meter to check the SWR at low power. I was getting 1.5:1 or better throughout both bands, so I decided to install the antenna permanently. To be successful, it is essential to make certain that the glass is clean before mounting the antenna. Most household glass cleaners contain silicone which will inhibit a good bond, so they are not the answer. The package contains an alcohol swab with

time, because the glue will not let you move the block once it is attached. It was now easy to line up the inside block, attach it, and then route the coax to the front of the car. Because of a curve to the rear window, it was necessary to place a very small bend in the antenna shaft, but I decided to wait a few days to give the glue time to cure before I started making mechanical adjustments which might disrupt the seal.

I located the tuning tool that came with the antenna, and prepared to adjust the antenna. I was pleasantly surprised to find that when I transmitted,

### Reverse polarity protection

I won't take too much time, but needless to say, the HW-8, like so many other rigs of its day, did not provide any protection if you connected it up backwards. Several months ago, I showed you some modifications to Ten-Tec's QRP rig. They work just as well here in the HW-8.

I prefer to use a three-amp diode to ground. If you reverse-connect the rig, the diode conducts and blows the power line fuse. I don't like cutting holes in an HW-8, so an in-line fuse holder works for me. Also, I don't care for the AGC type of fuses during portable use. In-

stead, I like the ATC type. These are the same types you'll find in all the new automobiles. Radio Shack sells an ATC in-line holder for a buck or two. They also carry the low-amperage ATC fuses as well.

If you have to remove the PC board from the rig, there are two more modifications you may want to do. Both center on the RF amplifier in the receiver's front end.

The first mod ensures the front-end amplifier, Q1, is turned off during transmit. This modification prevents damage to Q1 by routing +12 volts from the top of the T/R relay. When you key the HW-8, the end result is that Q13 conducts and sends +12 volts to the T/R relay's coil. By tapping this volt-

age and applying it to Q1, we can cause the amplifier to shut down. A small signal diode and a 22-ohm resistor are all that is needed for the modification. A sleeve of heatshrink tubing can house the two parts. Tack-solder them to the bottom of the PC board. You'll need to run a small jumper from the relay coil to the diode/resistor combination.

### Increased sensitivity for the HW-8

Although I found my HW-8 to hear just fine, many other hams have reported lackluster sensitivity. A simple fix is in order for improved sensitivity. Remove Q1 (the MPF 105) and replace it with a 2N4416 FET.

The 2N4416 has one extra pin that is unused in the HW-8. This extra pin is the ground connection for the case of the 2N4416. You can either leave it "floating" or drill a small hole in the PC board for it and ground the pin.

### W1FB-SK

If there is one drawback with writing a monthly column it is the lead time between publishing day and breaking news. Having said that, by now most of the QRP family has heard that Doug Demaw W1FB is a Silent Key. It's kind of hard not to mention QRP, or home-brewing QRP equipment, without mentioning his name. Doug will be missed.

# THE DIGITAL PORT

Jack Heller KB7NO  
712 Highland Street  
Carson City NV 89703  
[jheller@sierra.net]

## Freebies in ham radio: Here's a good one, but you will work for it!

This month, there are several areas to cover, but I will try to be coherent. It just seems that so many things depend on the order of other things to get done before you can start the new fun project.

Last month, I promised myself openly in this column that I would get the PCFlexnet software up and running. Well, I did. There were a few skirmishes with other associated elements in this digital kingdom, but I will begin by telling you how far I advanced along the trail toward a non-TNC, no-modem, simply-a-soundboard packet system.

The PCFlexnet group has a Web page at [<http://d10td.afthd.thdarmstadt.de/~flexnet/>]. There, you will catch the vision of a remarkable approach to digital communications. They have engineered at least ten software modules that can co-exist to facilitate communication via packet (and other modes to come) on a variety of platforms.

Most of us were introduced to packet radio on the premise that you buy a terminal node controller (TNC), cable it between the radio and computer, load a terminal program, learn about configuration, and put it on the air. This still works for most of us, and the Flexnet system supports and improves on that method.

The next innovation was a software-intensive packet system that worked with a simple serial modem (e.g., BayCom). The cost and size of hardware suddenly shrank. Flexnet modules support this also.

You will recall that in January this column featured my experience with SSTV. The first trial was with a serial modem using the JVFAX software, then with the W95SSTV, which worked superbly using the soundboard in my computer with no external hardware between the computer and the radio. Flexnet modules make this possible for packet.

## Runs under Windows 95™

Now here is a plus. Much of the software from Europe has worked well in DOS, and the warning has been that it will cause erratic problems if you attempt to run it under Windows™ (trust them—it does). Flexnet also makes this statement, and it is an inconvenience for most of us. But they have

fixed that nagging problem with a Windows 95 Add-On Package.

The scope of all this appears overwhelming at first. I am writing this with a dozen of their most pertinent printouts sitting before me, totaling over forty pages, and there is much more. I also have some instructions forwarded by Paulo CT1DTA, who is an avid proponent of the packet system he is running with Flexnet through a serial modem.

## Where to start?

Last month I downloaded several archives and decompressed them. After scanning through the documentation I had printed, I determined the necessary files I needed from these archives. Although loading the modules with a batch file was recommended, I started experimenting by loading them manually in the sequence the advised batch file would have done it.

It didn't work the first few times. I had all the files necessary, plus about as many more, but I had placed them in three separate directories. They all needed to be in one

the reflected power needle did not budge on my SWR meter. In actual operation, this antenna has consistently performed better than my expectations.

Naturally, for HF mobile operations, one can expect more challenges. Once again, I wanted a system that would be easy to install, although I was not as concerned about keeping it inconspicuous since this would be on my car. I did wish to avoid making any permanent changes to the car such as drilling holes in the visible parts of the body. I also wanted an antenna that would provide a low enough profile for me to drive through most parking garages without the need to remove the mast. I spoke with representatives from several companies to get their perspectives on antenna options. The prevailing opinion

was that a mount needed to be attached to the car's underbody, a trailer hitch or a permanent ball mount, to be workable. This did not fit with my expectations, so I continued searching. After a while I did find a trunk lid mount and antenna that I thought might meet my needs. Comet Antennas™ offers a choice of heavy-duty trunk lip mounts, as well as single- and multiband HF antennas. Several of the mounts allow the antenna position to be adjusted through a wide range so they can be used not only on trunks, but also hatchbacks or even rear van doors.

I decided to try the single band QE line with a 20-meter resonator. Since much of my HF operating time is while going from one appointment to the next, I tend to stay on 20 meters. This also allowed me to meet

my height restriction since the 49-inch antenna, when mounted on the car, results in a total clearance requirement of seven and a half feet, which will clear most parking garages with room to spare.

I suspect that in the future I will add resonators for 40, 15 and 10 meters. These can be switched using the quick disconnect feature of the antenna mount. This quick disconnect is also useful for minimizing theft or vandalism problems since the resonator can be released quickly and stored out of sight.

Installation was not difficult, although some of the directions were in Japanese. Most of the installation process is almost intuitive. One thing that you must remember is that the trunk lid must be RF bonded to the rest of the car body in order to act as a ground plane. I used a

short length of braid removed from RG-8 coax to connect the trunk lid and car body and it seems to work well.

Naturally, the proof is in the performance, and so far I am pleased. Although it is difficult to compete on a power basis with stations running a kilowatt into a beam, I've already had stations at the other end of a pileup respond to the "eight mobile" even though there were more powerful signals from which to choose.

Personally I prefer to rag-chew, so I don't chase as many contacts as others. On the other hand, I do expect to be able to maintain a contact for a 20- to 30-minute QSO without struggling to hear the other station, and so far this antenna is doing a fine job. If you have a chance, check out 20 meters during the day and we can compare notes. 73

directory. Fine, I put them all together. Still didn't cooperate, but it was to a point where the Windows 95 Add-On would load.

I have First Aid Windows 97™ installed. It came up and said there was a missing file. Upon clicking the "Fix it" button, it found the file and installed it in the right place. That still wasn't enough, but it was getting closer. The next time around, I got an automatic listing while in the DOS mode that two drivers were missing.

Strangely to me, I could locate those files with the Windows explorer utility, but it couldn't copy them. So I windowed out to DOS and it was a snap. Things began to look up. This wouldn't have happened if I had placed all the files in one directory, but I have a problem with mixing everything all at once. Too many things without a rigid hierarchy seem to muddle this mind and, occasionally, the computer.

Just one more time to shut the computer down, start it in DOS mode, load the modules in the order that works, start Windows and load the 95 Add-On. Got through all that with no errors and the promised PCFlexnet icon was in the task bar.

### Does it work?

The next test was going to be a little difficult to evaluate. As usual, there are missing pieces to the puzzle. I had loaded the serial modem driver, but my VHF serial modem is unable to transmit and the project to build a new one is only slowly taking shape.

With the serial modem plugged in and the radio tuned to a node that sends a beacon every 10 minutes, I waited for an indication. According to the LED on the radio, there was a signal, but no screen display. However, there seemed to be some action in the corner of the Winpack program that simulates LEDs.

Another 10 minutes went by and when the next beacon was sent, there was a definite flicker on one of these LEDs. I called that a sign of success. It has a

way to go, but I know if we got this far, we can conquer the next hurdles.

### It will take a little hardware, too

If you read some of the comments by Tom Sailer, who has a linked Web page [[www.ife.ee.ethz.ch/~sailer/pcfindex.html](http://www.ife.ee.ethz.ch/~sailer/pcfindex.html)] from the PCFlexnet page, you will realize how far into the future the project is looking. He makes some statements about the fact that modes such as packet, AMTOR, and PACTOR will work well through this medium except for a problem of operating the PTT.

For this, a few solutions have been developed. They are described in a document on his Web site with diagrams for simple circuits to make it happen. This is one of the areas I will have to work on, now that I am convinced the software works. Then I can see if the terminal software in the shack will really work as indicated. Just a few more steps and it looks like I'll be home free.

When all is together and running, I can summarize all the steps and get as close to step-by-step as I know how, so you can try it yourself. It will be fun. If you read into this what I do, this is the digital wave of the future. The problem at this time is that it hasn't been packaged for plug 'n' play. I have an engineer friend, who tells me that where he works, that phrase is pronounced "plug 'n' pray." It will be a while before that level of sophistication arrives. But as they say, this is a hobby and, therefore, how you and I have fun.

Now for some of the other computer-related happenings around the shack that may be good to store in the back of your memory. Some of these things really slowed progress for the past several weeks.

### Some complications

One of the disgruntling things to happen was my inability to log on to the local ham BBS

lately. You would think that would be a simple problem since the BBS antenna is just a few miles across the valley and I have such a variety of hardware and software.

Everything appeared in working order. My station could copy the output from the BBS perfectly on the screen. When my radio sent a connect request, it read perfectly across the BBS monitor. Then things fell down. They just couldn't do the handshake. The BBS would respond with the proper acknowledgment but my system would continue to send connect requests and seemingly ignore the packets being sent from the BBS.

With the sysop, Martin, on the landline, we used separate radios to monitor the sounds of the signals. His sounded strange to me and mine sounded strange to him. We went to voice mode with my radio and my signal would break up. I tried a different radio and it seemed to cure the breakup but was weak. I decided that was due to less power and possibly a mismatch along the feedline.

The next day I tried a few experiments. With each of two different antennas in place, the connection problem persisted. With an old IC-2AT plugged in, there was still no connection, but suddenly this little radio was registering much more power on the wattmeter than the 10-watt radio had been.

### Found it!

The test antennas were on a different piece of coax but were much lower—about six feet off the driveway. When I plugged in the regular coax and antenna to the IC-2AT to take advantage of the increased height and gain, the BBS came up and connected, first try.

Obviously, the problem was the radio, but it was working just enough to fool me and probably most casual observers. It is getting ancient, but is a good all-mode two-meter rig I feel is worth repairing. The real clue

was the wattmeter. It is an old Swan meter that requires calibration. Therefore, you can get any reading you set it for, so, on its own, it is not a standard. You only know there is a problem when you compare to another radio of (hopefully) known quality.

### Update for Winpack

In my quest for knowledge, I often check the Hamnet forum on CompuServe. It seems the folks at CompuServe feel pressure to get new, flashier effects by continuously changing their software. I do not like to use the CompuServe software because, though it works every time, it is very slow compared to my favorite program, Tapcis™.

Tapcis is light-years ahead in speed and utility. The problem is that every time CompuServe makes a change the aftermarket software folks have to match it in order to remain compatible. Again, it was time to tweak the software. When I finally got to Hamnet, I happened on an update for Winpack, version 6.3.

I installed that, though the author claims the changes are simply improved utilities and, if you are having trouble, the update won't fix a thing. Well, hello: The update made the program so stable, I will recommend it as excellent shareware for packet running under Windows.

They are claiming improved performance with the serial modems and capability to interface with PCFlexnet. The screen didn't change perceptibly to me, but I took a screen shot with it running during a session and with the pop-up Flexnet menu in place. The point is that I haven't found a program with a conflict while Flexnet is running. The packet session was running directly through the Comm port to the TNC (see Fig. 1).

Another challenge entered my life when my daughter gave me an old hand scanner which she had replaced a few years ago with a flatbed (the kids are always ahead of me in the yuppie devices department). Anyway, this worked, but the images

# HOMING IN

## Radio Direction Finding

Joe Moell P.E. K00V  
P. O. Box 2508  
Fullerton CA 92837  
[Homingin@aol.com]  
[http://members.aol.com/  
homingin/]

### Radio foxes don't howl

Is the weather warming up where you live? In just a few weeks, winter will be over and discussions at your local ham club will turn to ideas for outdoor activities. Who will be Field Day chairman this year? Shall we have a barbecue? How about a spring hamfest or picnic? What can be done that's different to attract newcomers and bring back the folks who have drifted away?

Everybody loves mysteries, so why not have a club picnic in the park this spring and include a bunch of hidden transmitters for everyone to find? Better yet, why not make on-foot direction finding (also called foxhunting, foxtailing, radio-orienting and ARDF) into a new club project?

Foxtailing seems like a well-kept secret here in the US, but in many parts of the world, it's an important sport. Some say it's bound to become an Olympic event eventually. Just like

orienting, formal foxtailing meets involve maps, compasses and stopwatch timing. There are records to be broken and medals to be won.

Formal rules for ARDF are set by committees of the International Amateur Radio Union (IARU). There's no space this month to go into all the rules and practices of the sport, but you can read all about it in past "Homing In" articles such as "FARS, Friendship, and Foxhunting" in the January 1998 issue of 73. You will also find lots of details about ARDF at the "Homing In" Web site listed above. This time, I'll focus on fox transmitters and how to make them quickly and inexpensively.

### Ammo source becomes RF source

Foxtailing in Europe and Asia is done on 80-meter CW and two-meter AM. Right now,

almost all ARDF activity here in IARU Region 2 (North and South America) is on two meters, using continuous FM carriers with tone-modulated CW (MCW) instead of AM. It is anticipated that the official Region 2 IARU foxhunting rules, when finalized, will favor FM over AM because of FM's widespread use and the preponderance of FM receiving gear here.

Typical IARU-style hunts have five foxes spread out in a woody park. A radio-orienting fox (foxbox) consists of a transmitter, battery, antenna, and controller. The controller generates Morse Code signals and station identification according to IARU standards: MOE for fox #1, MOI for fox #2, MOS for fox #3 and so forth. Foxes must transmit for 60 seconds each in perfect sequence, one after the other in numbered order. Controllers provide this

were coming out very narrow. I determined the images were close to scale if the scanner was moved at the incredibly slow speed of one inch per minute. Perhaps I can build a mechanical drive to accomplish such a speed.

### Tape backups—going out of vogue?

A small tragedy resulted from this encounter. By the time I jockeyed the I/O addresses, DMA, and IRQs around, my computer lost contact with the internal SCSI backup tape drive. The nature of this setup seems to be that I cannot find a way to change the settings back to work the way they used to, even with the board for the scanner removed. Just too many toys in a system that is reaching its limit.

This wasn't the end of the world. The capacity of the tape drive was becoming lackluster after several years of service, and I could justify an external drive. Then came an awakening. At the store, as well as in the catalogs, there is little evidence of tape drives anymore. Times have

changed. It looks as if the highly touted 100-megabyte removable disk drives have taken over.

That looks like a good way to go, but I prefer a drive capable of making an unattended pass where I am not shuffling disks. I came home with the only tape drive easily available, hoping my old software would suffice. The plug-in process for the hardware was very basic—the drive cables to a parallel port and daisy chains to the printer.

The included software was a kick. It turned out to be what must be the only major name brand left, Seagate™, which is what I had been using in a slightly different format. Very nice. With the CD in the drive, the setup process begins automatically and a message appears saying backups will be happening in five minutes.

I waited several minutes, watching little emblems rotate on the screen before realizing it needed one of those emblems to be clicked. Then the installation really began. I had sweated it a little as I read the

minuscule documentation that spoke of I/O addresses, DMAs, and IRQs. But that must have been for a DOS installation. The program figured all this out on its own and a backup was in progress in about 30 minutes.

I mention this because, even after the industry reduces every aspect of running a computer to plugging it in, we are still expected to fill in the blanks and push a few buttons ourselves. And, of course, I wanted to make a few excuses for why I haven't completed the Flexnet project or the VHF modem by now.

Also, as digitally-inclined hams, we should welcome the opportunity to get to the basic nuts and bolts of these modern forms of communication. The thought just occurred to me that I will suffer severe nausea if this hobby is ever brought to the level where it is run by a remote control "flipper." I cannot stand to be in the same room with a "flipper" and his TV, or, worse, with him when he grabs my remote. Now

you know one of my weaknesses.

If you have questions or comments about this column, E-mail me at [jheller@sierra.net] and/or CompuServe [72130,1352]. I will gladly share what I know or find a resource for you. On packet, when you get a chance, drop me a line [KB7NO @N7NPB.#NONEV.NV.U.S.A.NOAM]. For now, 73, Jack Heller KB7NO. **73**



**Fig. 1.** Screen shot of Winpack software operating with Flexnet running idle in the background. The PC Flexnet pop-up screen is available for special controls and is normally not visible. There appears to be no conflict with other programs when the Flexnet modules are loaded, even when Winpack is active on a Comm port.



**Photo A.** Ammunition-box foxes are rugged and easy to carry. They blend in well with surroundings.

timing, using crystal time bases to maintain synchronization.

At present, PicCon is the only domestic fox controller that meets IARU specifications. It produces timed turn-on/off plus MOE/MOI/MOS signaling in CW with callsign identification. Programming of its non-volatile memory is done with DTMF tones. A complete description and review of PicCon was in "Homing In" for March 1997. Special quantity pricing of PicCons in kit form is now being offered, to encourage clubs to build complete foxbox sets. Contact Byon Garrabrant N6BG at his new address (8128 Kokoma Drive, Las Vegas NV 89128) or check the PicCon Web site via link from the "Homing In" site.

IARU regulations permit foxes to run between 250 milliwatts and 1.5 watts. Powers of all foxes on a course should be within 3 dB of each other. You

don't need to follow these rules for your local hunts, but it's nevertheless important to be able to adjust power to suit the course. For hunts in small parks, running less than a half watt will preserve battery life, enabling longer practice sessions. When it's time to try ARDF in a really big park, over a watt may be necessary when a fox is a mile or more away from the start. You may even need to put the fox antenna up in a tree.

PicCon can control almost any VHF-FM transmitter, including handie-talkies. Kits for crystal-controlled or synthesized two-meter FM transmitter boards of about a watt are available from several sources. One is 73 advertiser Hamtronics Incorporated, 65-D Moul Road, Hilton NY 14468; (716) 392-9430.

The cost of five complete foxboxes built from HTs or kits can easily exceed \$1000. If your club has that kind of treasury,

great. If not, there are many ways to build them on a shoe-string budget. For my own project, the biggest cost savings came by using transmitter boards salvaged from surplus 1980s-vintage 151 MHz business-band mobile transceivers. The price was right (free!) and the boards from these Yaesu FTC-1525A and FTC-2025 sets are of quality equal to or better than most of today's transmitter kits.

Check local flea markets and business radio suppliers to see what you can find. Get good documentation from the source if at all possible, because manufacturers' prices for old service manuals are far too high. Fortunately, the circuits of sets using discrete semiconductors are relatively easy to trace, even without a schematic.

For inexpensive, sturdy, waterproof enclosures, it's hard to beat surplus military ammunition boxes (**Photo A**). The size I like (5-1/2 x 11 x 7 inches inside) is twice as big as necessary, but the large surface of the removable lid makes it easy to mount all parts except the battery (**Photo B**). Add provisions for a bicycle chain and lock if you're worried about theft.

Flea markets and military surplus outlets are good sources of ammo boxes. I have even seen them at the "Camo Store" in a mall, but prices were too high there. Don't pay more than about \$5 each. Look over the merchandise closely and pick boxes with good lid seals, to keep your transmitter parts dry and prevent corrosion.

### Build 'em tough

Over the years, I have learned the hard way that Murphy has a special fondness for foxboxes. There are lots of things that can go wrong when you put a hidden transmitter in a remote spot. You cross your fingers hoping that it will come on at the appointed time with full power and that your batteries will last for the duration. You certainly don't want to have to go out to

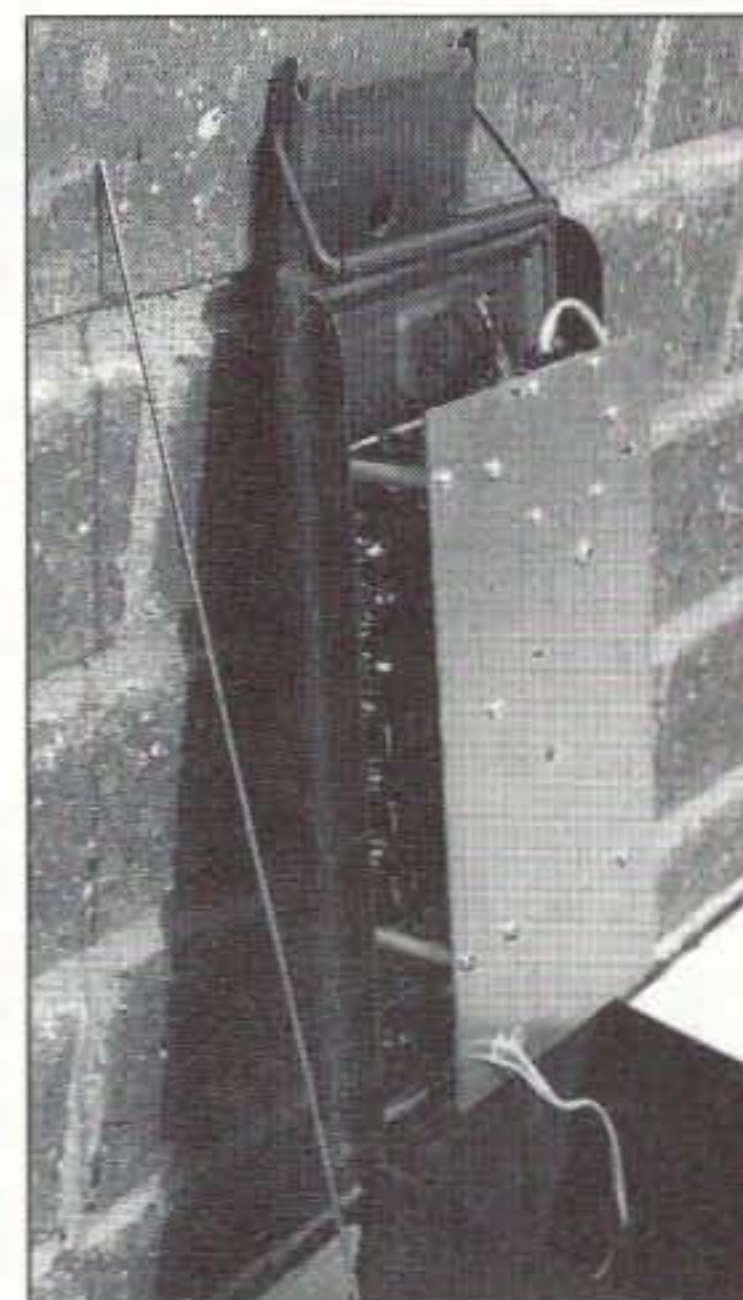

**Photo B.** A completed transmitter inside the lid of its ammo box. The crystal deck and PicCon controller are mounted under a copperclad board, which also provides physical protection for all circuits. The 1/8-inch jack is for DTMF audio input to program the PicCon.

service it during the hunt, thereby giving away its location.

PicCon includes a delayed startup feature that allows you to put out your foxes several hours before the hunt and have them automatically come on at start time. However, just a few milliseconds of power interruption in the interim will reset the timer. There's no way to tell if this has happened until it's too late, so take extra steps to prevent it. I eliminated all switches between battery and PicCon. Fuse holders can become intermittent, so I made my own battery fuses out of AWG 32 wire and soldered them into the circuit.

My surplus radios had separate 12-holder crystal boards for receiver and transmitter. I used the transmit crystal boards without the switches and their potential for intermittents (**Photo C**). This permits future frequency changes in the field by moving one wire. (You *do* carry a small soldering torch along, don't you?) The coordinated frequency for transmitter hunts in



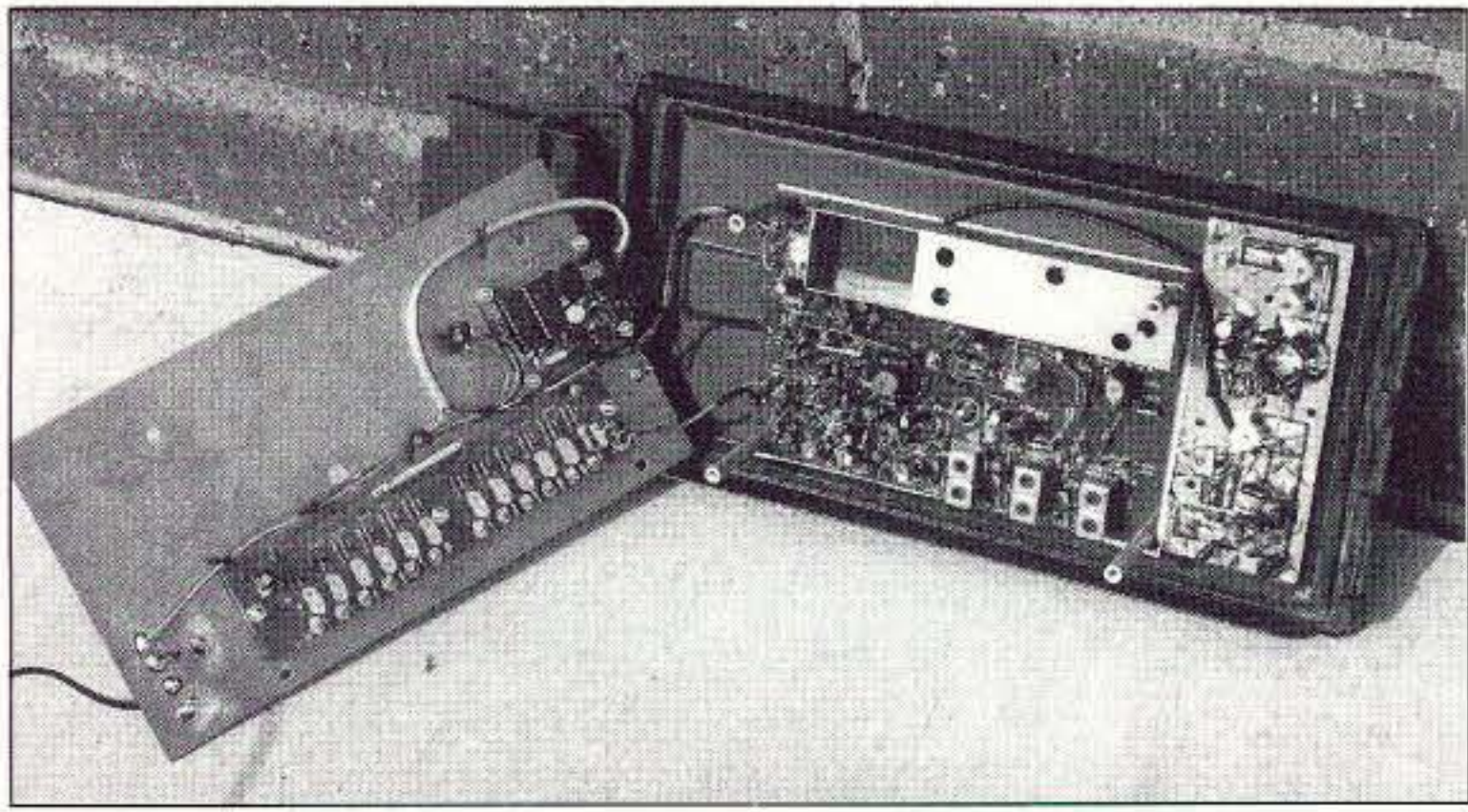

**Photo C.** View of the foxbox circuits with the crystal deck and PicCon exposed.

southern California is 146.565 MHz. This frequency is also popular among other cities in the US and Canada. I purchased five crystals for \$50 total, plus shipping, from Cal Crystal Lab, 1156 North Gilbert Street, Anaheim CA 92801; (714) 991-1580.

The Yaesu transmitter board output originally went to a separate heat-sinked 35-watt final stage. Power from the "bare-foot" board exceeds five watts, so there was no need to use the finals. An easy and effective way to adjust power on boards like this is to control the supply voltage to the RF stage just preceding the output stage. A variable resistor wired as a rheostat will do it, but there may be a large power change as the battery sags during the hunt. In a quick test with a resistor selected to run an FTC-2025 board at 1.5 W with a nearly charged

battery (12.85 volts), the power was only 0.75 W at near discharge (12.0 V). A better solution in my case was to use an LM317 IC to regulate the pre-output stage voltage over the range of three to nine volts, sufficient to adjust from 0.1 to 3 W out of the board. With this regulator, power remains nearly constant as the battery discharges.

Retuning from business band to two meters was a simple matter of installing the new crystal and adjusting each stage from oscillator to output for resonance. The output stage trimmers were set for best efficiency (maximum RF output consistent with minimum current draw). I then used a spectrum analyzer to verify signal stability and purity.

Fox transmitters must follow good amateur practice, which includes suppression of spurious emissions and harmonics. A filter in the output of commercial rigs accomplishes this, but there is no such filtering of the preceding stages. Sure enough, the spectrum analyzer showed that the modified FTC-2025 board output was stable, but second harmonic was only 16 dB down. So I removed the final stage from its enclosure in the transceiver and wired it into the ammo box, passing the transmitter output through just the low-pass filter components. Upon retest, power was the same but all harmonics were well below -40 dB, in accordance with FCC regulations.

**Photo D** shows the harmonic filter portion of the final board. You can easily make a filter like



**Photo D.** Low-pass filter section of the Yaesu final amplifier. The potentiometer and diode are part of a reflected power sensor circuit that is not used at present.

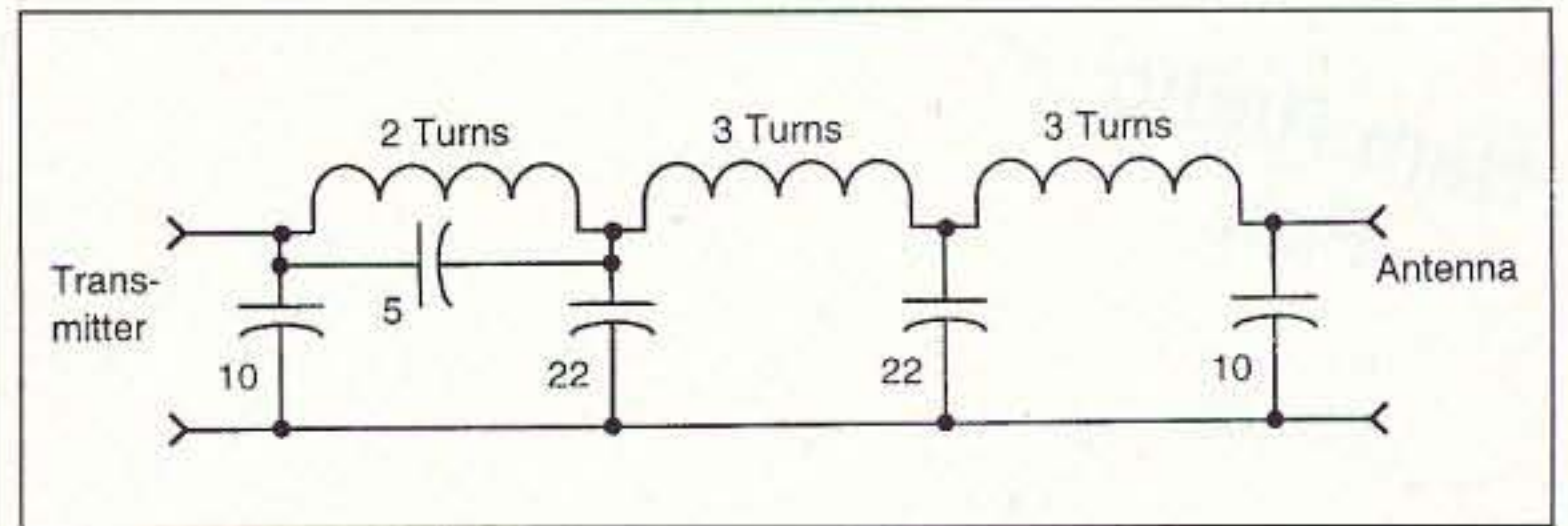

**Fig. 1.** Schematic of a simple low-pass filter for two meters. Capacitance values are in picofarads.

it from scratch on a 2- x 2-inch piece of copperclad board, using a Dremel™ tool to grind pads for the ungrounded component nodes. **Fig. 1** is the schematic. Wind the coils on a 15/64-inch drill bit using AWG #20 enamel-covered wire, then slide off the bit and install. An attenuation versus frequency curve for this filter is posted at the "Homing In" Web site.

Your transmitters will probably draw between one-half and one ampere from a 13-volt source, so you will need relays or hefty transistors to key them on and off. I found a small relay on each Yaesu board that is just right for keying. Its coil draws 40 mA, which is more than the PicCon keying circuit is designed for. Fortunately, the PicCon switching transistor can handle 40 mA, and more base drive for it is available from the PIC chip. Changing R4 on the PicCon from 10 k to 910 ohms accomplished this.

Select your batteries in accordance with current drain and anticipated hunt time. Let's say that the transmitter pulls 800 milliamperes at maximum power, including the relay coil. If there are to be five foxes in sequence, the duty of each fox is 20%, which is 160 mA on average. The PicCon draws 12 mA continuously, so the battery requirement for a three-hour practice session is  $3 \times (160 + 12) = 516$  mA-hours. Battery capacity diminishes with age, so it's best to add a safety factor of about 100% and choose a one ampere-hour or greater battery pack for this example.

Before shelling out cash for rechargeable batteries, check with the biomedical engineers at your local hospital. Regulations call for periodic replacement of backup batteries in some portable medical devices. You might be able to obtain some used but fully functional sealed lead-acid packs just for the asking.

A simple vertical antenna that's adequate for most small-park hunts is a 19-1/2-inch length of 3/32-inch bronze welding rod in a PL-259 plug. I salvaged SO-239 connectors from the Yaesu radios and mounted them near the center of the ammo box lids, for best ground plane performance of the whips. To clear the protruding terminal on the back of the SO-239 under the transmitter board, I drilled holes in an unused area of each board (**Photo E**).

After the solder fumes cleared and the drilling debris was swept up, I added my expenses and discovered that I had spent only \$65 per foxbox. The majority of the total cost was for the PicCon controllers. Not bad for a few evenings' work!

*Continued on page 71*

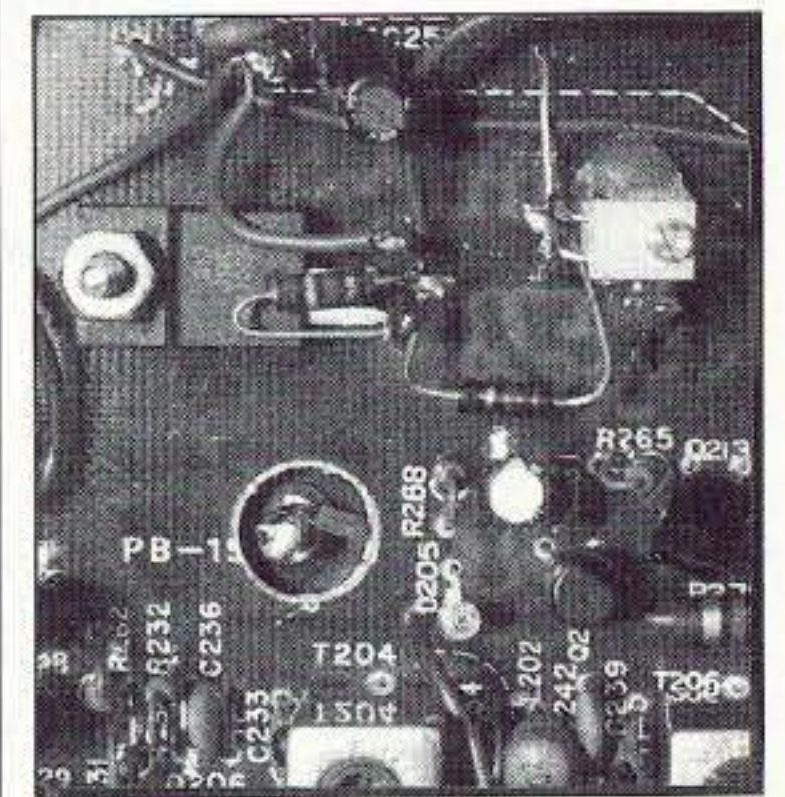

**Photo E.** The added LM317 IC and potentiometer provide power regulation and control. Below the IC is a hole for access to the SO-239 output connector.

# Don't Leave Home Without It

*An ingenious tester for your wallet or purse.*

Glenn E. Yingling W2UW

28 Lawrence Avenue

P.O. Box 62

Newark Valley NY 13811-0062

**P**icture yourself at a hamfest. You suddenly see the headphones of your dreams and then realize you have no way to test and verify that they are in operating condition. Or perhaps you're at a friend's house and want to test something so that you can be the hero of the moment. At some time you have probably wished that you had some sort of continuity tester with you so that you could check to see whether

something is working. I know that I have, many times, but because I had forgotten to bring one or did not foresee that I might be needing it, I was not able to perform any test on a circuit.

Well, no longer—not since I have my special “Never-Left-At-Home Tester” in my wallet at all times! With my credit card-sized tester, I can check most everything you can with a standard ohmmeter, including:

- Diodes
- Headphones
- Speakers
- Bulbs
- Resistors
- Tube filaments
- Switches
- Coils
- Motor windings
- Fuses
- Transistor junctions
- Wiring cables
- Chokes
- Meter movements
- Potentiometers

My tester is nothing more than a music module recycled from a greeting card and attached to a stiff backing about the size of a credit card. These modules come self-contained, with their own piezo speaker element, and operate from a 1.5 VDC watch battery. The attachment of the module to the backing can be made with an adhesive, or it can be soldered to a piece of printed circuit board material. My design uses a Radio Shack™ multipurpose printed circuit board as the backing, with the module soldered to it. I also add two flexible leads with probes to the plus (+) and minus (-) terminals of the music module. I then wrap tape over the whole thing and slip it into my wallet along with my credit cards. Although the tape covers the piezo element, it does not muffle the tone.

My Never-Left-At-Home Tester cost me only \$4.07! That's 89 cents for the music module (#G2744, Electronic

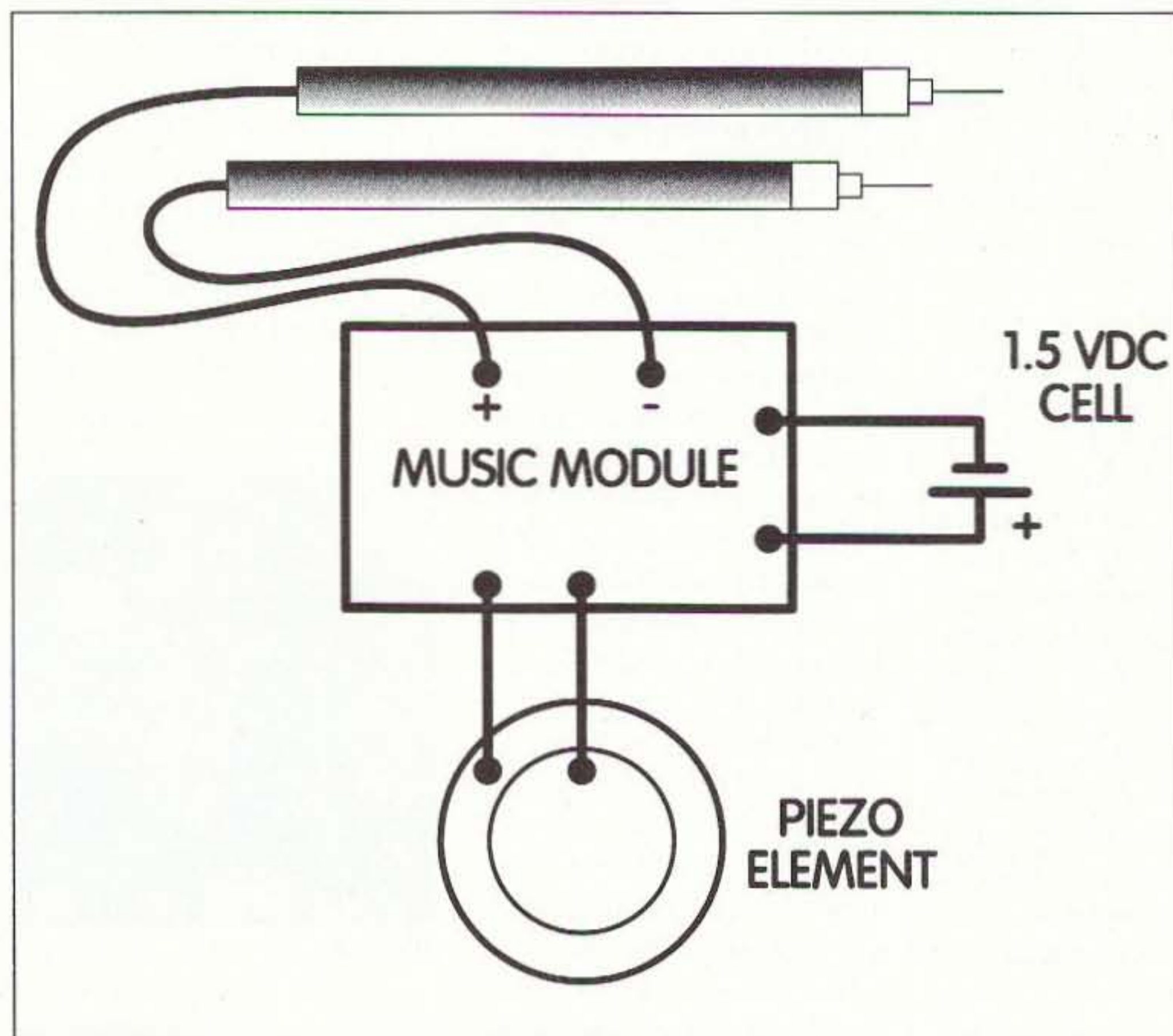

**Fig. 1.** Schematic diagram of the Never-Left-At-Home Tester. Note: Probes are drawn much larger than indicated in text.

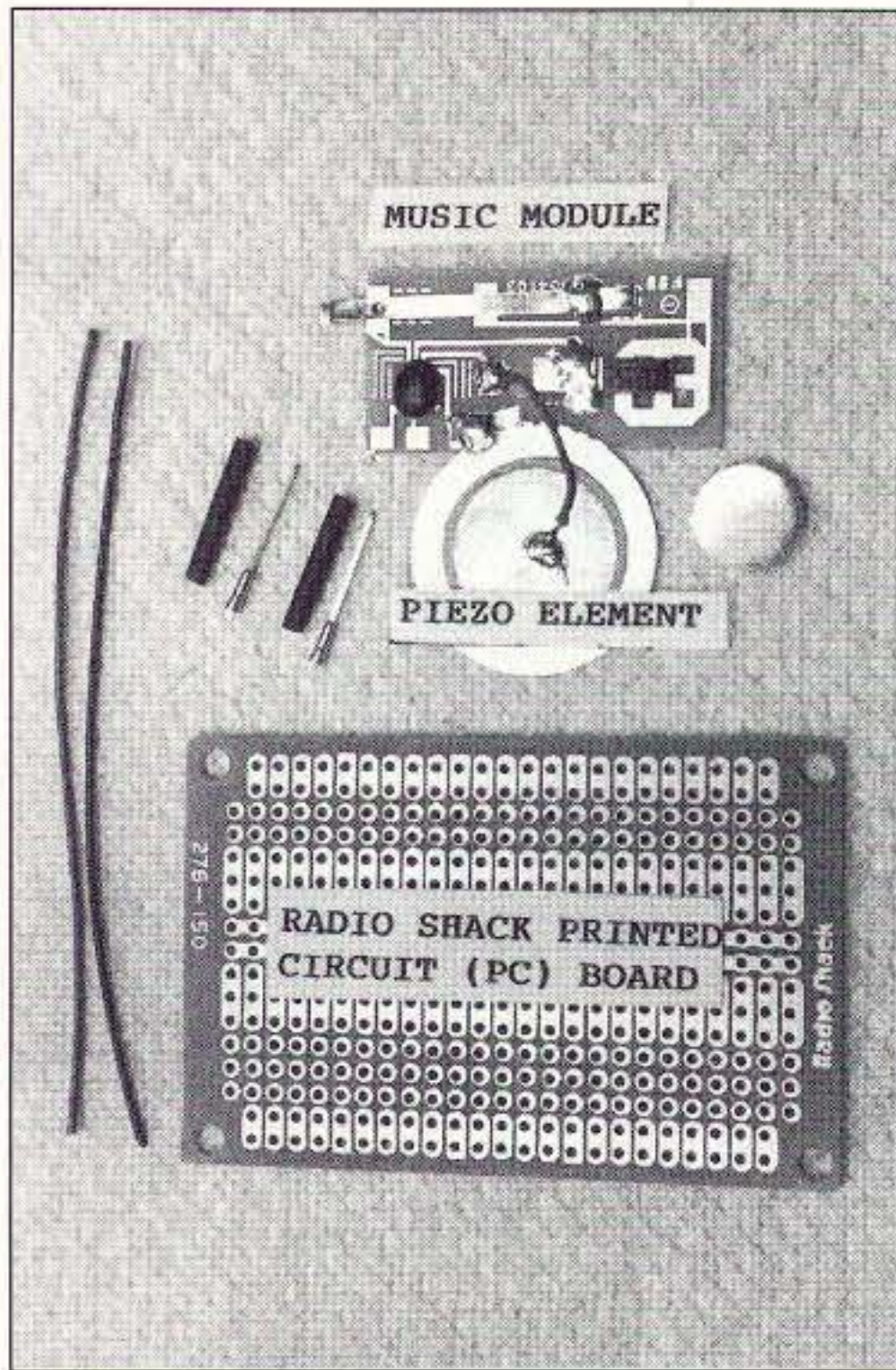

Photo A. Original parts kit.

Goldmine, P.O. Box 5408, Scottsdale AZ 85261); \$1.19 for the PC board (RS #276-150); \$1.99 for Battery 391 (RS #23-107); and nothing for the solder, wire, tape, and epoxy from my junk box. Of course, you may have to spend a few cents in postage or gasoline.

However, you can reduce this cost quite a bit if you have a friend who sends you a greeting card with the music module and battery included! But if you are short of such extravagant

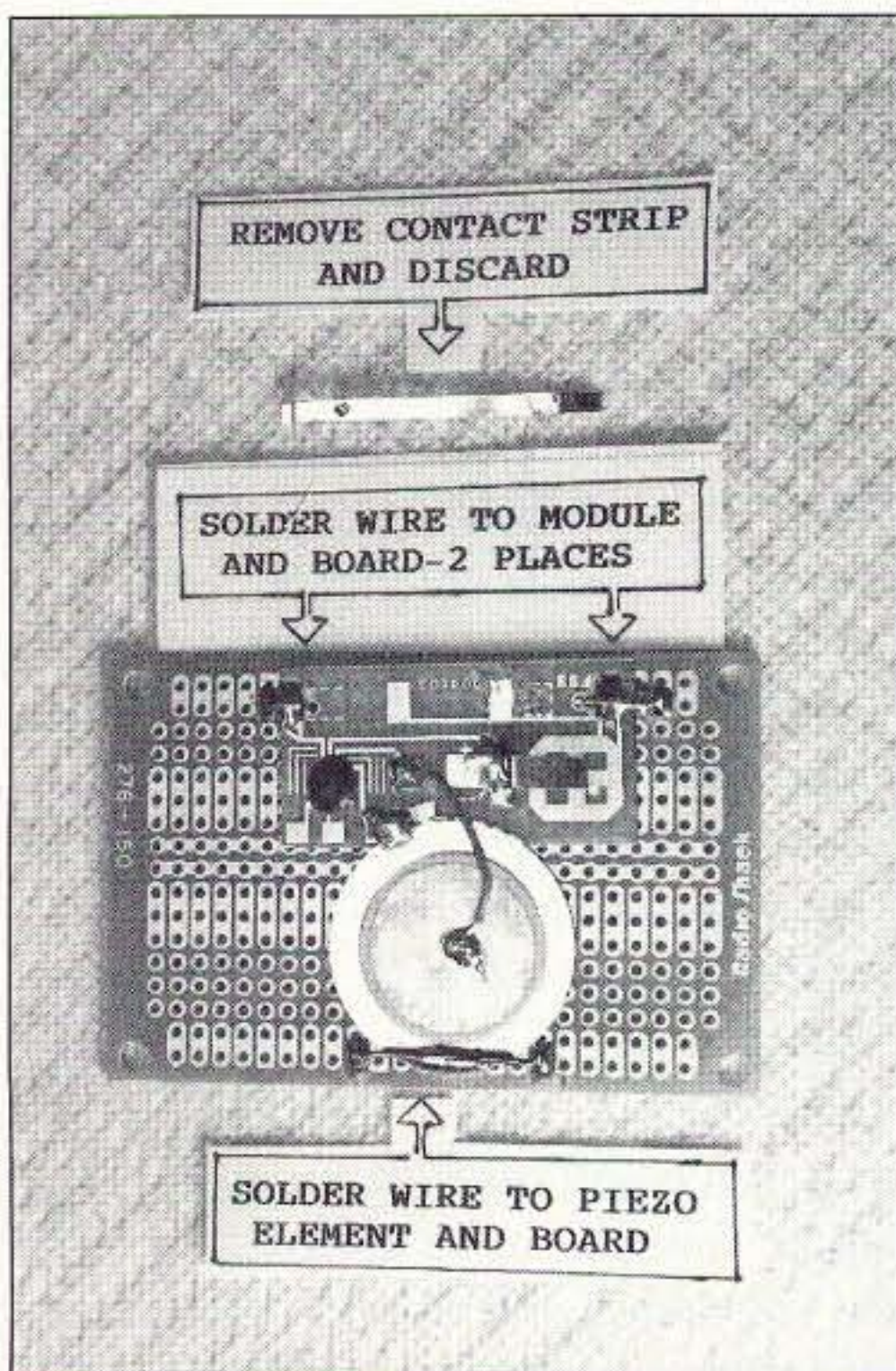

Photo B. Module mounted onto board.

friends, you can still purchase the battery for 25 cents by buying LR44 watch batteries from Electronic Goldmine at two for 50 cents (Electronic Goldmine #G8540). With a scrap piece of PC board for the backing, the total price now adds up to \$1.14 (89¢ plus 25¢)! HI! I prefer my approach, though, because the Radio Shack 391 watch battery is thinner (only 0.075 inches) and the RS PC board is easy to work with.

### How it works

The principle of operation of this continuity tester is that the two test probes complete the circuit between the 1.5 VDC battery and the music module (see Fig. 1). The module then responds with an electronic rendition of that old favorite tune "Let Me Call You Sweetheart," indicating that my circuit under test is in sweetheart shape!

If the item being tested has a somewhat high resistance, the "tune" will become quite distorted. For very high resistances, the tune may eventually stop, but a "buzz" or "tick" will continue to be heard which aids in estimating (through experience) what the impedance might be. I have found that some modules will produce a "tick" with resistances up to 10 megohms. In fact, one module that I tried would "tick" slowly if I completed the circuit through my left and right hands!

There is little danger of causing damage to any circuit being tested, because the battery voltage is only 1.5 VDC and the current through any low impedance will be no more than 1 mA.

### Putting it together

Photos A through D illustrate the way I assembled the tester. On the music module that I used, there is a flexible metal contact "strap" about an inch long that I unsoldered and discarded. Examine this "switch" to observe where the plus (+) and minus (-) contacts are made, as you will be soldering test probes onto those pads on the music module for its use as a tester.

Photo A identifies the original parts that are used in making the continuity tester.

Photo B shows the mounting of the module to the PC board with three

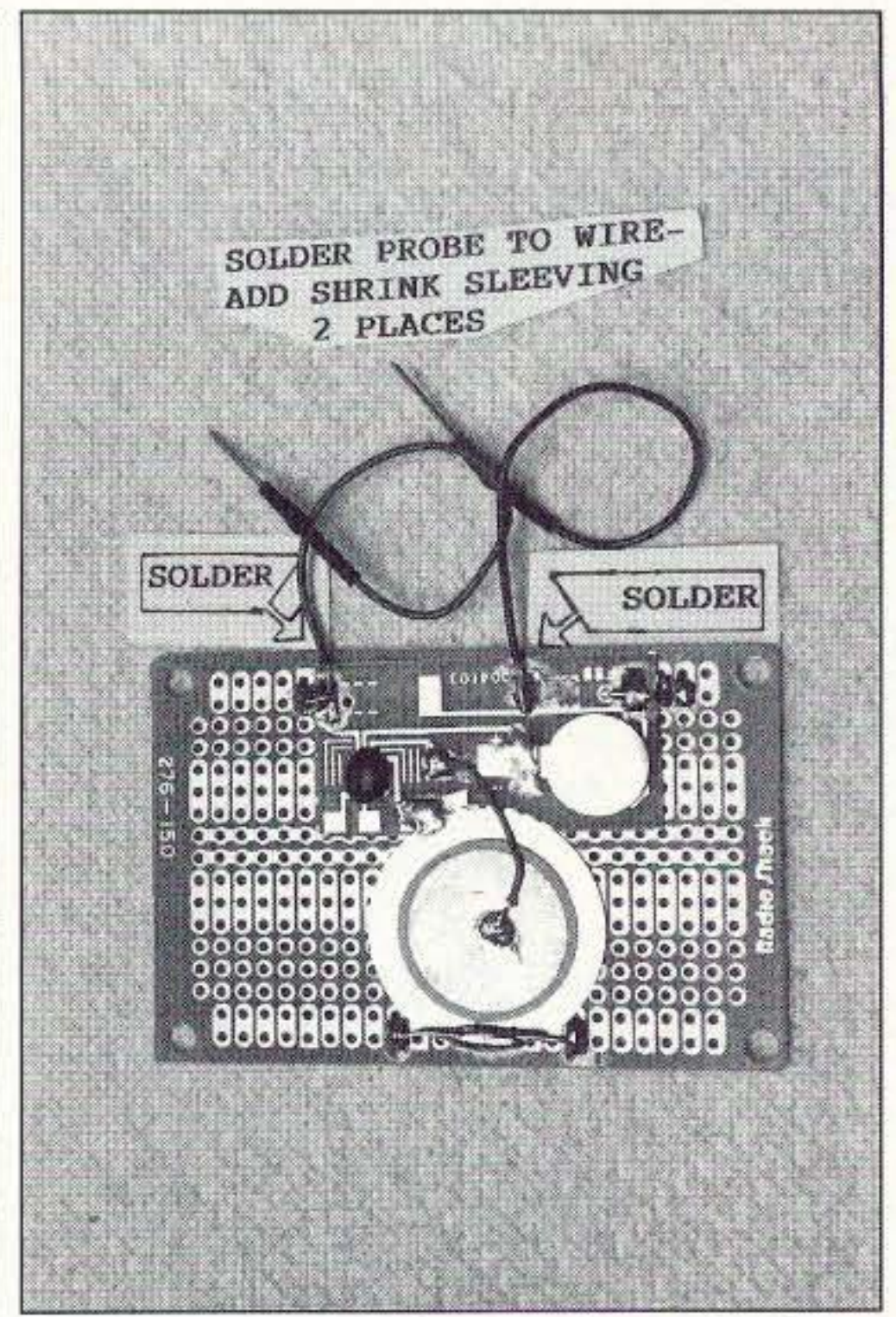

Photo C. Prepare and install test leads.

small wires at two corners of the module and at the piezo element. These wires are soldered to the module and the piezo element and then are pushed through the PC board and soldered to the "land" on the plated wiring side of the board. By the way, you may solder a part of the wire directly onto the piezo element with no effects on its operation.

Photo C shows my preparation and attachment of the two test probes. You

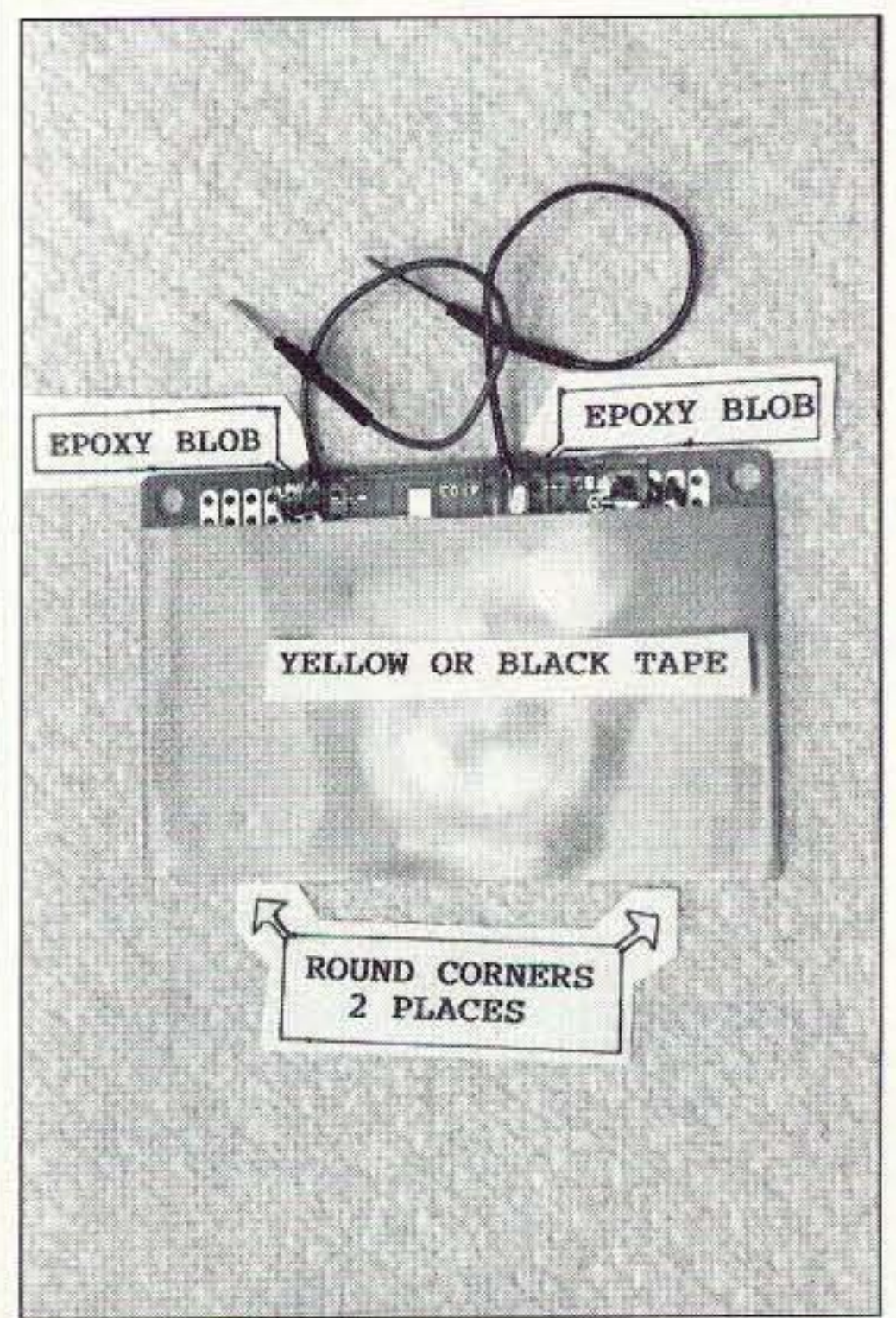

Photo D. Final adjustment.

Mr. NiCd

THE BEST BATTERIES  
IN AMERICA!

**MARCH '98 SPECIALS!**

Packs & Charger for YAESU FT-50R / 40R / 10R:

FNB-40xh Slim-NiMH	7.2v	650mAh	\$41.95
FNB-V47 (NiCd)	7.2v	1200mAh	\$39.95
FNB-47xh (NiMH)	7.2v	1800mAh	\$49.95
FNB-41 (5w NiCd)	9.6v	700mAh	\$39.95
FNB-41xh (5w NiMH)	9.6v	1000mAh	\$49.95
BC-601c Rapid/Trickle Charger			\$64.95

For YAESU FT-51R / 41R / 11R:

FNB-31 pack	4.8v	700mAh	\$33.95
FNB-38 pk. (5W)	9.6v	700mAh	\$44.95
BC-601b Rapid/Trickle Charger			\$64.95

For YAESU FT-530 / 416 / 816 / 76 / 26:

FNB-26 pack	7.2v	1200mAh	\$29.95
FNB-27s pk. (5w)	12.0v	800mAh	\$35.95
BC-601a Rapid/Trickle Charger			\$64.95

For YAESU FT-411 / 470 / 73 / 33 / 23:

FNB-10 pack	7.2v	600mAh	\$20.95
FNB-11 pk. (5w)	12.0v	600mAh	\$24.95
FBA-10 6-Cell AA case			\$14.95
BC-601a Rapid/Trickle Charger			\$64.95

Packs for ALINCO DJ-580 / 582 / 180 radios:

EBP-20ns pack	7.2v	1500mAh	\$29.95
EBP-22nh (5w)	12.0v	1000mAh	\$36.95
EDH-11 6-Cell AA case			\$14.95

For ICOM IC-Z1A / T22-42A / W32A / T7A:

BP-180xh (NiMH)	7.2v	1000mAh	\$44.95
BP-173 pk. (5w)	9.6v	700mAh	\$49.95
BC-601d Rapid/Trickle Charger			\$64.95

For ICOM IC-W21A / 2GXAT / V21AT: (Bk. or Gr.)

BP-131xh (NiMH)	7.2v	1500mAh	\$39.95
BP-132s (5w)	12.0v	850mAh	\$39.95
BC-601e Rapid/Trickle Charger			\$64.95

For ICOM IC-2SAT / W2A / 3SAT / 4SAT etc:

BP-83 pack	7.2v	600mAh	\$23.95
BP-84 pack	7.2v	1200mAh	\$34.95
BP-83xh pk. (NiMH)	7.2v	1500mAh	\$39.95
BP-90 6-Cell AA case			\$15.95

For ICOM IC-02AT etc & REALISTIC HTX-202:

BP-8h pk.	8.4v	1400mAh	\$32.95
BP-202s pk.	7.2v	1400mAh	\$29.95
IC-8 8-Cell AA NiCd/Alkaline Case			\$15.95
BC-350 Rapid Charger			\$59.95

For KENWOOD TH-79A / 42A / 22A:

PB-32xh (NiMH)	6.0v	1000mAh	\$29.95
PB-34xh (5w-NiMH)	9.6v	1000mAh	\$39.95
KSC-14 Dual Rapid/Trickle Charger			\$64.95

For KENWOOD TH-78 / 48 / 28 / 27:

PB-13T (w/chg. plug)	7.2v	600mAh	\$23.95
PB-13xh (NiMH)	7.2v	1500mAh	\$39.95
BC-15A Rapid/Trickle Charger			\$64.95

For KENWOOD TH-77, 75, 55, 46, 45, 26, 25:

PB-6 (w/chg plug!)	7.2v	600mAh	\$27.95
PB-8xh (5w-NiMH)	12.0v	1500mAh	\$49.95
KSC-14 Dual Rapid/Trickle Charger			\$64.95

For STANDARD C-628A / C558A / 528A / 228A:

CNB-153xh pack	7.2v	1500mAh	\$32.95
CNB-152 pk. (5w)	12.0v	800mAh	\$32.95

For STANDARD C-168A / C468A:

CNB-161 pack	7.2v	600mAh	\$26.95
--------------	------	--------	---------

Mr. NiCd also supplies batteries for your  
**LAPTOP COMPUTERS / CELLPHONES**  
**CAMCORDERS / NiCd & NiMH INSERTS**  
 We can rebuild your Computer pack! Call!  
 Mail, Phone, & Fax orders welcome! Pay with  
 MC / VISA / DISCOVER / AMEX

**CALL OR WRITE FOR OUR FREE CATALOG!**

Mr. NiCd - E.H. Yost & Company  
 2211-D Parview Rd., Middleton, WI 53562  
**Phone: (608) 831-3443**  
**Fax: (608) 831-1082**  
**E-mail: ehyst@midplains.net**

can use pins out of an old connector that you may find in your junk box. After you have soldered them to your wire leads, you can put shrink sleeving over the solder joints to keep them from breaking. I use very small insulated and stranded wire for the leads since they will be coiled up in the credit card holder of my wallet. I next locate the plus (+) and minus (-) pads on the module referred to previously and solder a prepared test lead to each of them. At this step, I also install the watch battery under the battery contact on the upper right side of the module. If you are installing a very thin battery, it may be necessary for you to bend the battery terminal so that it will contact the battery more tightly.

Photo D shows my completed wallet or purse continuity tester. I put a blob of epoxy on each of the test probe wires at their attachment point on the board to strengthen the solder joint there. Next, I round off the lower corners of the board a bit so that it will slip easily into my wallet. I then wrap the tester with tape. I use the tape wrapping (it can be black electrical tape) to protect the module, keep the battery in place, and (again) make it even easier to slip the tester in or out of the credit card holder of my wallet.

As I stated earlier, you may also attach the module to a scrap piece of PC board with glue or adhesive and forgo the printed card and the soldering of the module to it as shown in Photo B. If you choose to do this, don't forget to solder your test leads onto the music module pads as shown in Photo C.

I suggest that you use a red wire for the plus (+) lead and a black one for the minus (-). This will aid you in determining the type of transistor junction you are checking and the forward direction of any diodes that you check.

Also, you may use this tester as a code practice oscillator as illustrated in Photo E. The first note of the "Sweet-heart" tune is so long that you can even send code as slowly as 5 wpm if you desire. The photo shows a practice key comparable in cost to the rest of this project. HI!

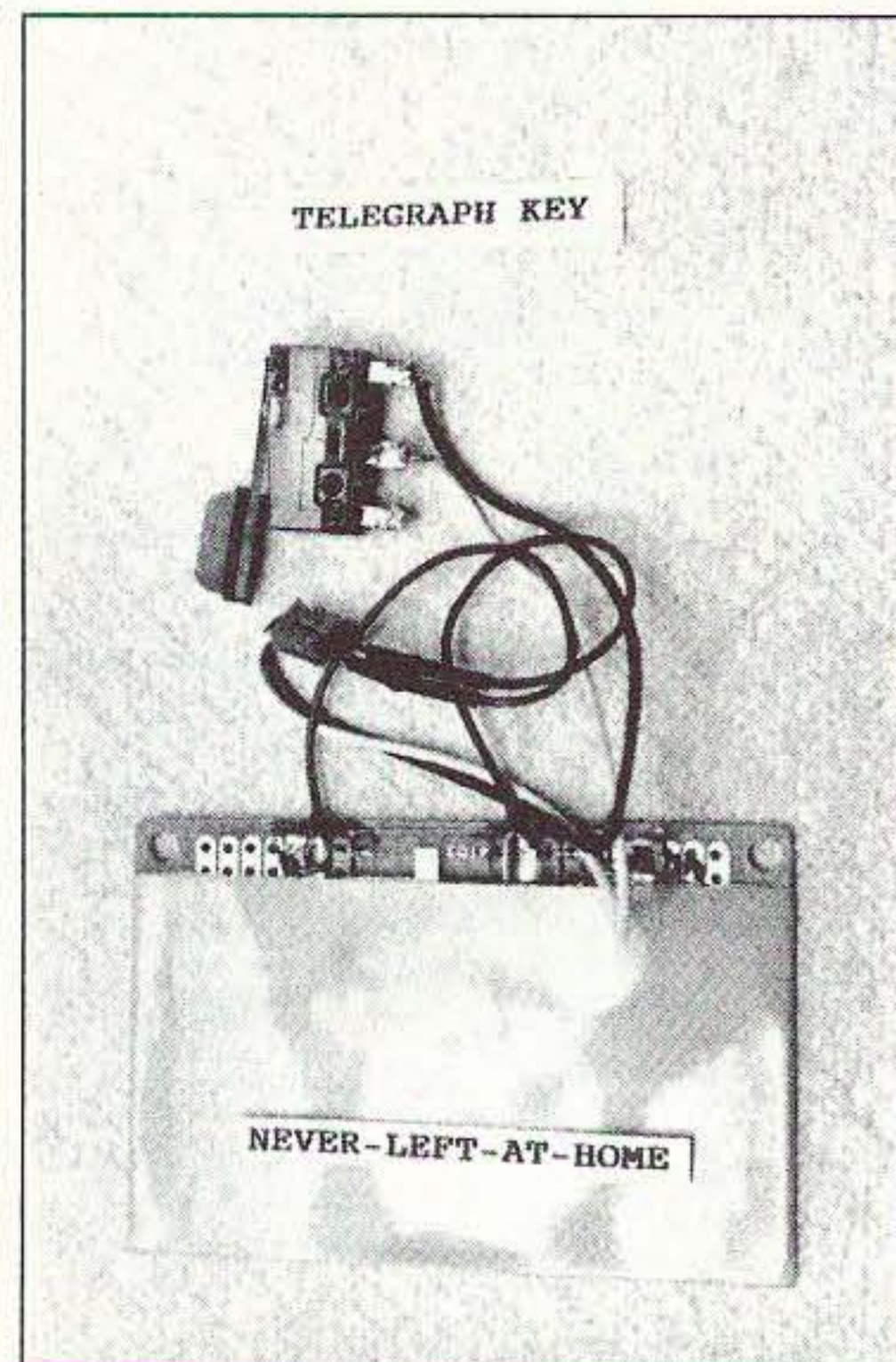

Photo E. Code practice Oscillator.

**Afterword**

We all recognize that it is becoming harder and harder to attract new and particularly younger persons to amateur radio. I attribute this to the fact that there are more and more things that now appear magical to the newcomer and amateur radio has become just one of many. The competition is cellular phones, pagers, TV, VCRs, computers, satellites, the Internet, and so forth. In many of our cases, when we got started in ham radio it seemed like *magic*. It still is to me (even at age 70, and a ham for 44 years!), but to today's youth it may be more ho-hum. Therefore, this project may be used to an advantage by radio clubs through helping to introduce Morse Code and showing the fun of making useful electronic devices with simple resources.

My friend, Kenneth Doolittle W2SMR (dating from the 1934 era of amateur radio), was very amused at my pocket tester when I showed it to him on the way to a hamfest; and he made the appropriate snide remarks on its usefulness. However, during the hamfest he came to me and asked if I could verify that the filament in an antique No. 199 tube was intact. HI! So, you can be assured that you will find good use for this tester if you choose to build one!

# Bridge Over Troubled Waters

*Why buy what you can build?*

Peter A. Bergman NØBLX  
3517 Estate Dr. SW  
Brainerd MN 56401

**T**est equipment? Build my own test equipment? From scratch? Sure, why not? No, I'm not suggesting you try putting together a four-channel, holographic projection oscilloscope with ten gigs of memory, but there are numerous pieces of test gear that are very handy and easy to build.

For example: If you start with a working flashlight, two lengths of test-lead wire, and a pair of alligator clips or test probes, you could make a continuity tester. And it would still work as a flashlight.

Or, a worn-out three-inch Phillips screwdriver, a 12-volt light bulb, a foot of insulated wire, and an alligator clip can be made into a dingus that is very handy for testing fuses and tracing wires in an automobile.

The RF impedance bridge I'm going to describe here is a bit more sophisticated technically than either of the examples I've given, but still is not all that hard to understand and build. See **Photo A**.

First of all, what can you do with an RF bridge? Depending on the design, one of these can do quite a lot. With this one you can tell if an antenna or other device presents a 50-ohm load to the transmitter at the design frequency.

Why did I decide to build an RF bridge when I already own a very nice, factory-made antenna analyzer? First of all, because of its simplicity, this unit covers a greater frequency range. It is cheap to build and is a very light, compact piece of equipment. Besides, building, especially scratch building, is a gas. I have assembled a lot of kits and really enjoy it, but scratch building is special. And, if someone leaves it on a stump at Field Day, I'll be irritated but I won't be financially destroyed.

This device is based on the Wheatstone bridge, which might not have been mentioned in your ham radio classes. The Wheatstone bridge was developed by S.H. Christy in 1833, but Sir Charles Wheatstone worked out so many applications for it that it now bears his name. Sir Charles was a very prolific nineteenth century scientist who deserves a lot more attention than he has gotten.

If you look at **Fig. 1**, you will see that the Wheatstone bridge consists of two parallel voltage dividers composed of R1/RV and R2/RX. According to Ohm's Law, if the bridge is constructed so that R1 equals R2, there will be zero volts' difference and no

current flow between points A and B when the value of RV equals the value of RX, the unknown.

The Wheatstone bridge is capable of measuring resistance to a high degree of accuracy. In the days when telegraph wires connected the country, a



**Photo A.** Front view of the RF bridge. For scale, KBØYXB is 52 inches tall. Photos by author.

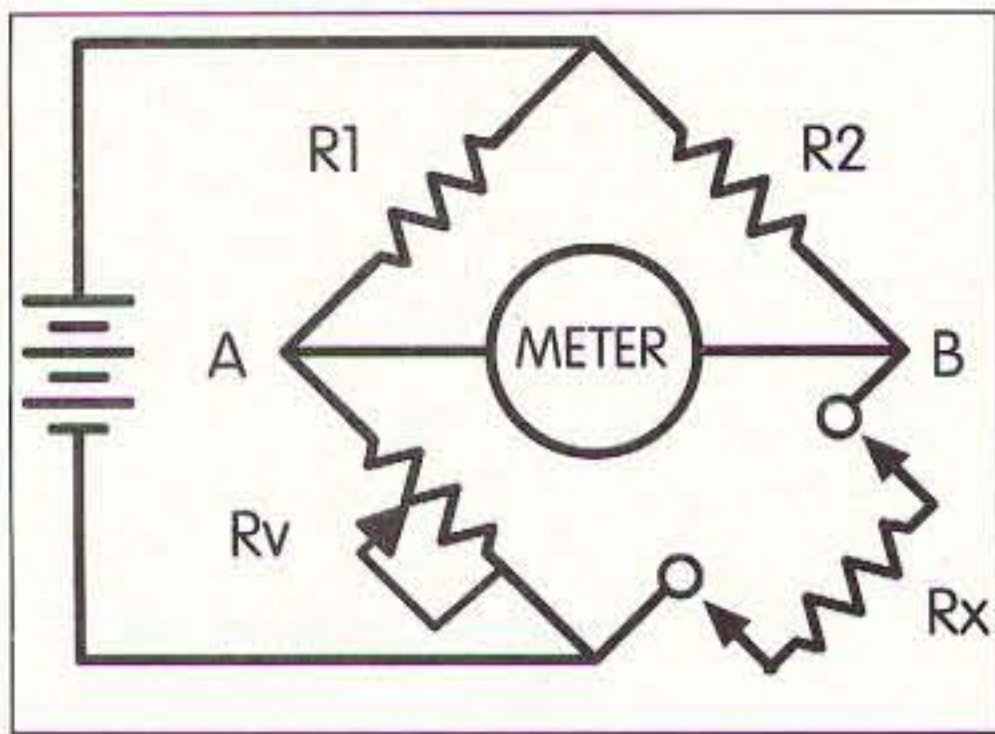

Fig. 1. Basic DC Wheatstone bridge.

break in the line between two stations could be located by measuring the resistance to ground of the broken wire. Since the resistance of a unit length of wire was known, it was easy to calculate which repair crew was closer to the break.

This was great for DC and "pure" resistance, but for radio frequency alternating current and the complex impedances present in antennas, the bridge must be a bit more complex. If we substitute reactance for resistance, ohm for

ohm, and AC for DC, the bridge can be brought into balance the same as it could with just resistance. There are many possible combinations and the example here is just one of them.

The design of the RF bridge discussed here is pretty freely based on information from the *Radio Handbook*. More information is available from a multitude of sources under headings including: RF impedance bridge, ratio-arm measurements, Wheatstone bridge, impedance measurements, standing wave ratio measurements, and others.

When a pair of unterminated parallel conductors is connected to a Wheatstone bridge or an ordinary ohmmeter, it will measure infinite resistance and there will be zero current flow. See Fig. 2a. Modified to include more complex impedances and fed with RF energy instead of DC, something different occurs when the bridge is connected to the same pair of conductors. At some frequency, the conductors

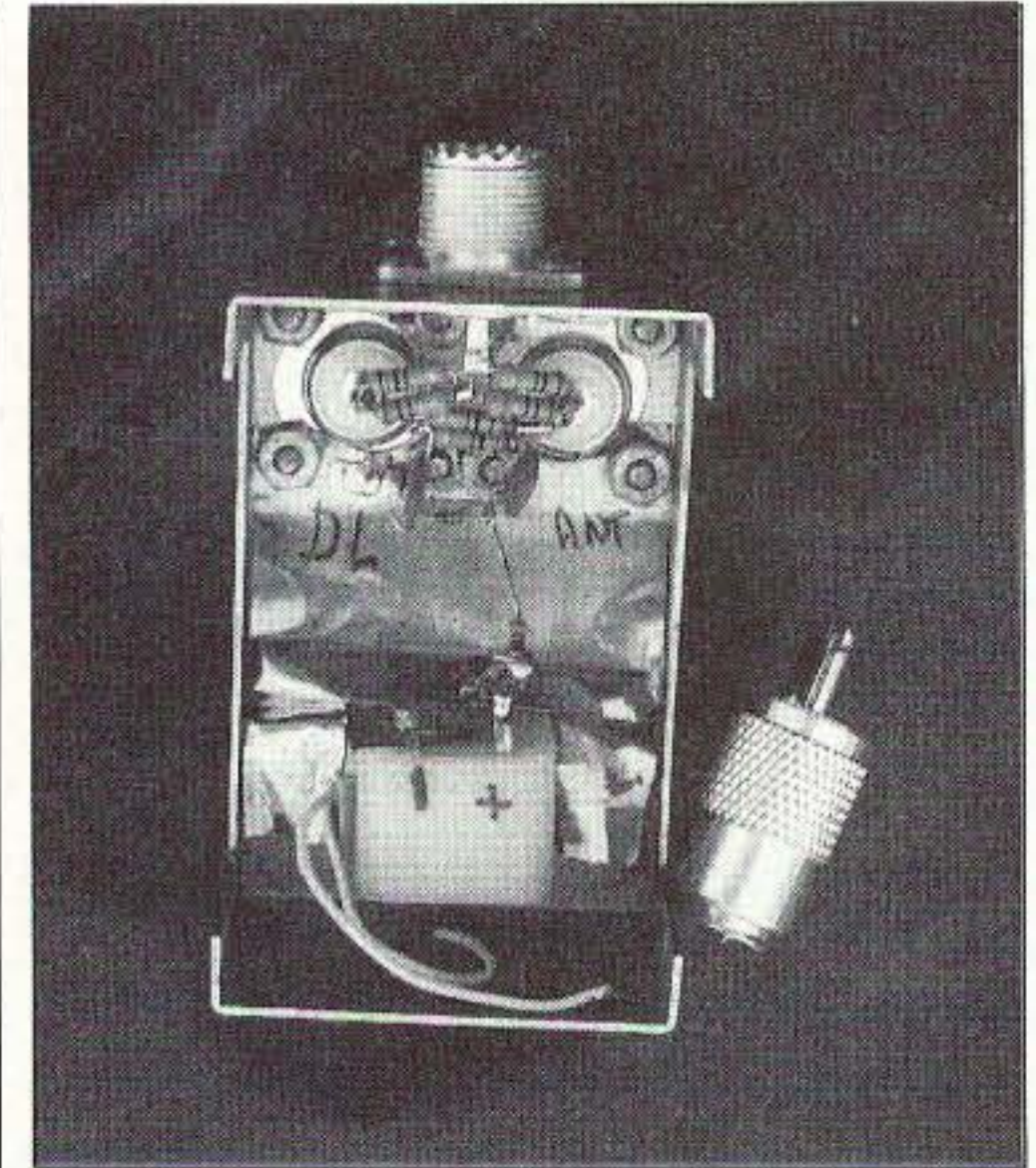

Photo B. Inside view of the RF bridge.

will be a quarter wave in length. See Fig. 2b. At that resonant point, there will be minimum resistance and maximum current will flow. This short circuit condition could be used to filter out or "trap" an unwanted frequency.

In Fig. 2c, the conductors have been separated so that each side is a bit over nineteen inches long and the DC bridge still sees an open circuit. With the AC (RF) bridge, things are a lot different. See Fig. 2d. Somewhere in the neighborhood of 146 MHz the spread-out conductors are going to have an impedance of about 50 ohms. The RF bridge will be in balance and the meter will display a minimum or null reading if Rv is also 50 ohms. By making the spread-out portion longer or shorter we can move that resonant point, where the 50-ohm impedance occurs, to the desired RF frequency.

The situation changes again when we test closed loops such as quads, or shunt-fed antennas like the J-pole. See Figs. 2e and 2f. The DC bridge will show a short circuit, but the RF bridge will indicate a null at the resonant frequency, telling us that the antenna has an impedance of about 50 ohms to match our rig. I've known cases where individuals built these types of antennas and then refused to use them because their ohmmeter showed the antenna to be a short circuit. If they had used an antenna analyzer like the MFJ-259 or even a simple RF bridge, like the one described here, they would have seen the truth and felt free to connect the antenna to their rig.

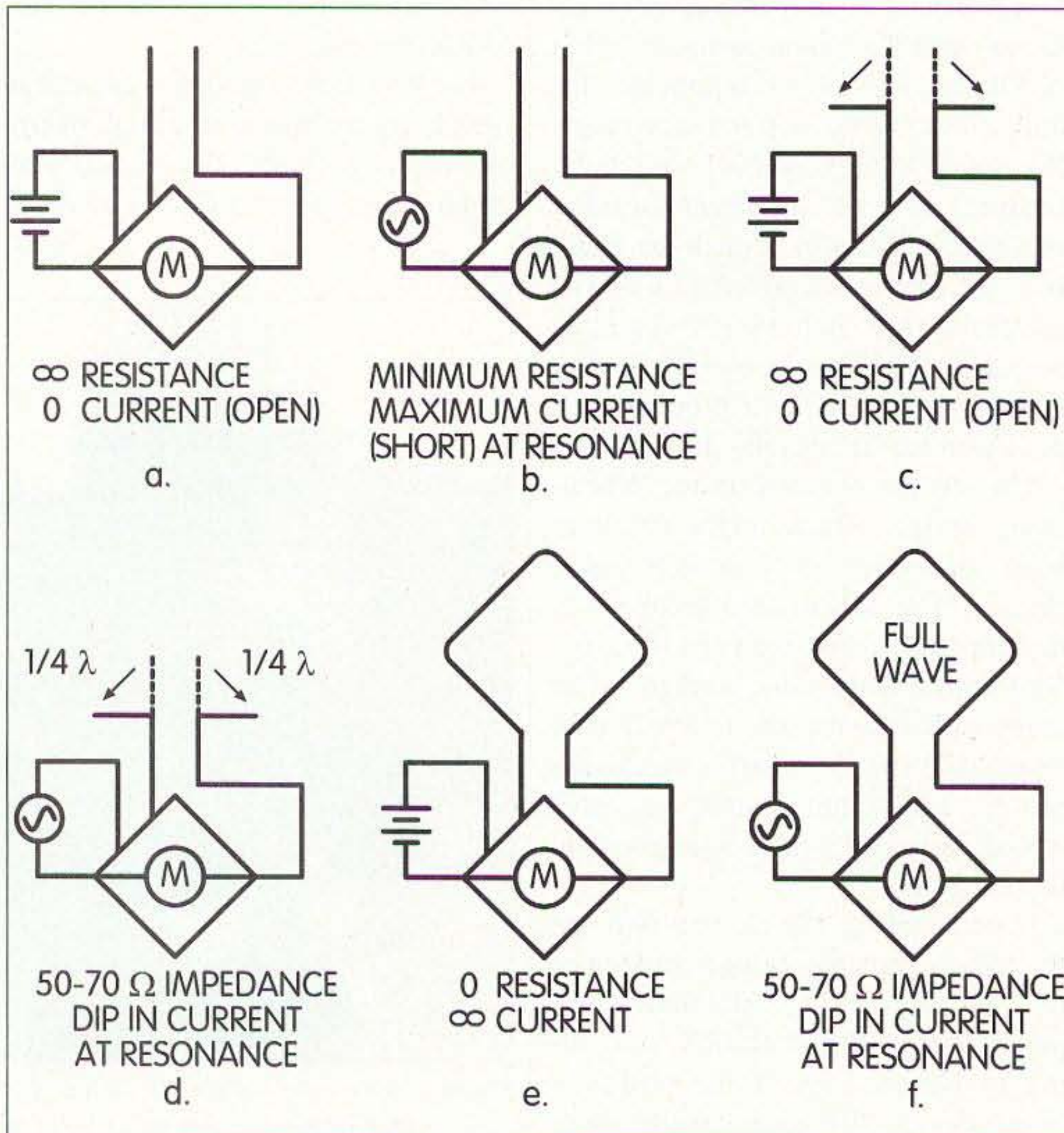

Fig. 2. Simple RF bridge.

Although most of the parts in this project came from my junk box, they are also available from Radio Shack™ and other sources. In my research I found everything at the Shack except a suitable meter. A reasonably sensitive meter of about 100 microamperes is required. I used the S-meter from a junk CB. A dead stereo might also be a good source. Either of these can be found at hamfests, garage sales, and dumpsters. Or, you could contact some of the numerous parts suppliers who advertise in this magazine.

You could dispense with the built-in meter entirely. Instead of the meter, install another female chassis mount connector. An RCA jack would probably do. Then make a shielded cable to reach your multi-meter, assuming it has a 100-microamp scale and an analog movement. That arrangement will not be as portable, but could save a few bucks.

I used SO-239 chassis connectors on this unit and a pair of PL-259s to make the reference loads because I had them and they match most of my gear.

The enclosure I used (**Photo B**) is commercially made, but there are some interesting possibilities on the spice and instant coffee rack. I've used metal Band-Aid™ boxes for small projects like this, but the challenge is similar to building a ship in a bottle. Notice that I lined the inside of the front panel with brass shim stock. Copper might have been better, but I used what I had and it did allow the very short leads I wanted. By bending the brass stock and bringing it almost to the back of the meter, I was able to fold the negative terminal over and solder it directly to ground. The same is true of the R4 and R6/C3 ground points. The only excess lead length is the 3/8 inch between D1/C2 and R5, which does not seem to cause any problems. The two white wires visible in the photo are for meter lighting and are not used in this application.

In Fig. 3, resistors R1, R2, and R3, and the two reference (dummy) loads should be matched in value as closely as possible. I was able to produce a matched set of five pairs by starting with 100-ohm 1/4-watt 5% resistors

which had actual values ranging from 98+ to 102+ ohms. This proved to be easier than finding five matched 50-ohm resistors. You might prefer using sets of four each, 200-ohm resistors, particularly for the reference loads. Arrange the resistors in ascending order and select one from each extreme to make each pair. It should come out very close. Keep the leads as short as possible to minimize stray inductance. Don't worry too much about the internal stray inductance of the resistors, as it will decrease when they are connected in parallel.

If, after all your care in selecting resistors, the bridge won't quite balance, you will want to install the small variable capacitors indicated by the dotted lines. These are simply small copper tabs soldered to the ground plane and adjusted by bending them near the input/output lines of the bridge.

If you can't find the .0022  $\mu$ F capacitors, try anything from .001 to about .0047  $\mu$ F. You should be able to find a pair that will work satisfactorily in the Radio Shack #272-801 assortment pack.

Sensitivity of the bridge decreases as the frequency increases, but this design should still be useful through the 70 cm band. RF input can be provided by a signal generator, QRP rig, or handheld. My unit indicates an open or short at the antenna connector with a full-scale deflection when driven by about two watts in the 80-meter band. In the 440 band, it requires about five or six watts for the same indication.

Since all I'm really looking for is a null reading, I've not tried making a new scale for the meter. I guess I'm not

## Amplifiers, ATV Down Converters & Hard to Find Parts

### LINEAR AMPLIFIERS

#### HF Amplifiers

PC board and complete parts list for HF amplifiers described in the Motorola Application Notes and Engineering Bulletins:

AN779H (20W)	2 Meter Amplifiers (144-148 MHz)
AN779L (20W)	(Kit or Wired and Tested)
AN 762 (140W)	35W - Model 335A, \$79.95/\$109.95
EB63 (140W)	75W - Model 875A, \$119.95/\$159.95
AR305 (300W)	
AN 758 (300W)	440-450 MHz Amplifiers
AR313 (300W)	(SSB-FM-ATV)
EB27A (300W)	100W - Model KEB 67, \$159.95
EB104 (600W)	
AR347 (1000W)	



### ATV Down Converters

(Kit or Wired and Tested)  
Model ATV-3 (420-450)  
(Ga AS - FET)  
\$49.95/\$69.95  
Model ATV-4 (902-926)  
(GaAS - FET)  
\$59.95/\$79.95

### HARD TO FIND PARTS

- RF Power Transistors
  - Broadband HF Transformers
  - Chip Caps - Kemet/ATC
  - Metalclad Mica Caps - Unelco/Semco
  - ARCO/SPRAGUE Trimmer Capacitors
- We can get you virtually any RF transistor! Call us for "strange" hard to find parts!

### DIGITAL FREQUENCY READOUT

For older analog transceivers  
TK-1 (Wired and Tested)\$149.95

For detailed information and prices, call or write for our free catalog!

### ADDITIONAL ITEMS

Heat Sink Material  
Model 99 Heat Sink (6.5" x 12" x 1.6"), \$24.00  
CHS-8 Copper Spreader (8" x 6" x 3/8"), \$24.00  
Low Pass Filters (up to 300W) for harmonics  
Specify 10M, 15M, 20M, 40M, 80M or 160M  
HF Splitters and Combiners up to 2KW

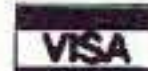

Add \$4.50 for shipping and handling

**CCI Communication Concepts Inc.**

508 Millstone Drive • Beavercreek, Ohio 45434-5840  
Phone: (937)426-8600 • Fax (937)429-3811  
E Mail: cci.dayton@pobox.com

CIRCLE 99 ON READER SERVICE CARD

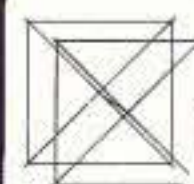

### CUBEX CO., INC.

40 YEARS OF QUALITY ANTENNAS  
SKYMASTER H.F. KITS FROM \$275.95  
PRE-TUNED H.F. QUADS FROM \$389.95  
Quad Antennas From 2 Through 40 Meters

2 METER 4 EL. PRE-TUNED \$49.95 + S&H  
6 METER 2 EL. PRE-TUNED \$69.95 + S&H  
BEST PRICES ON DOUBLE BRAIDED "DACRON" ANTENNA ROPE  
visit our new web site <http://www.cubex.com>

Write Or Call For Free Catalog  
7024 Southwest 21st Place, Unit D, Davie, FL 33317  
(954) 236-3663 FAX (954) 236-5576

CIRCLE 166 ON READER SERVICE CARD

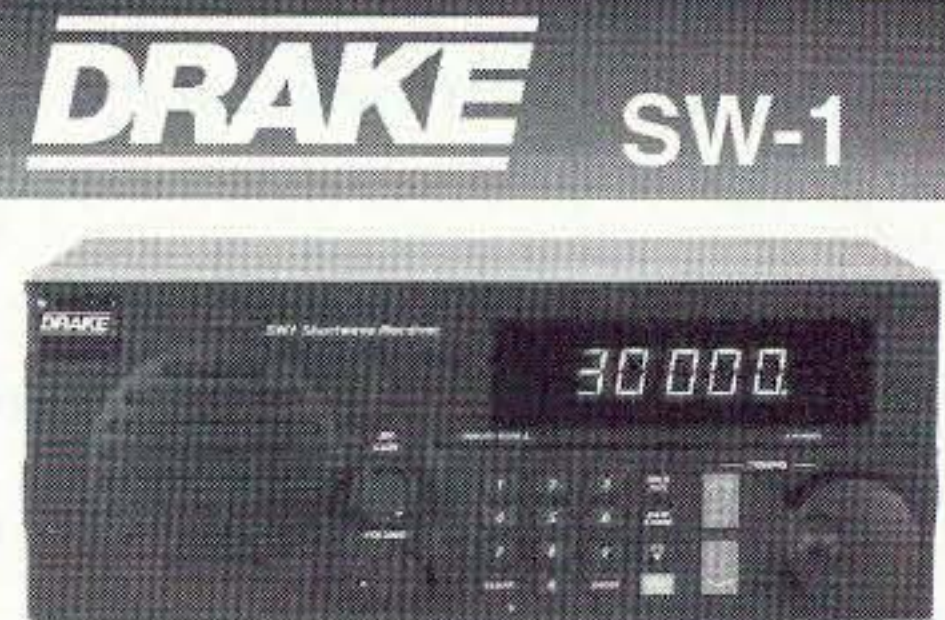

The Drake SW-1 sets the stage for worldwide shortwave listening with ease, simplicity and clarity. The SW-1 offers superb sensitivity, selectivity and full audio. Coverage from 100 through 30000 kHz provides solid coverage of longwave, medium wave and shortwave in the AM mode (no S.S.B.). This makes it an ideal broadcast receiver for the desk or bed-stand. Tuning is a snap via the keypad, manual tuning knob, Up-Down buttons or 32 programmable memories. The huge LED display provides accurate frequency readout to 1 kHz. Antenna input is via a 50 ohm terminal or SO-239 jack. A 1/8" mini jack is provided for use with earplug or headphones (not supplied). Includes AC wall adapter.  
Regular Price \$249.95 Sale \$199.00 (+\$7 UPS)

The advanced Drake SW-2 features S.S.B. reception, Synchronous Detection, 100 memories and optional remote. Only \$489.95 (+\$7 UPS)



### Universal Radio

6830 Americana Pkwy.  
Reynoldsburg, OH 43068

◆ Orders: 800 431-3939

◆ Info: 614 866-4267

◆ FAX: 614 866-2339

[www.universal-radio.com](http://www.universal-radio.com)

Quality Communications Equipment Since 1942

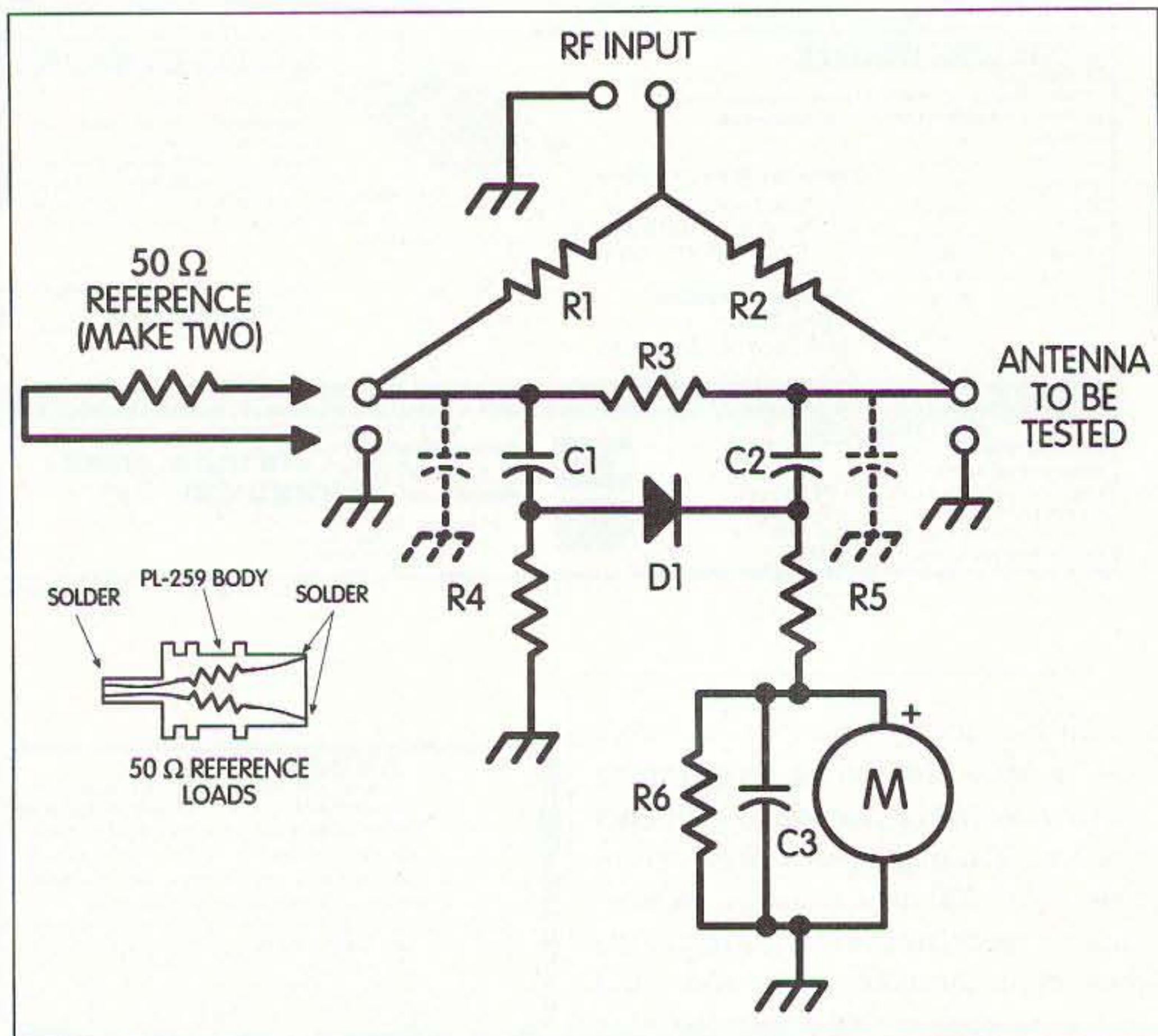

Fig. 3. RF impedance bridge.

very fussy about meter scales on home-brew gear. In fact, I have a home-brew reflectometer on the bench that is calibrated in roentgens. Since no change I might make to the scale would be an improvement in utility or appearance, I've left it alone. Besides, visitors find it amusing I think. Apparently I'm not too fussy about front-panel marking either.

The metalwork in this project could be done with just a hand drill, a couple of bits, and a small assortment of files. Assembly requires only a screwdriver and nutdriver or duckbill pliers. The electronic portion needs only side-cutter and needlenose pliers, a soldering pencil, and rosin core solder.

### Test and alignment

1. With both matched reference loads installed, apply a low level of RF to the input.

A. Indication on meter? Install "tab capacitors" and adjust for balanced null.

B. No indication on meter? Increase RF input ... slightly. Still no indication? Go to Step 2.

2. Remove reference load on antenna connector and apply low level RF signal to input.

A. Over 75% scale reading on meter? Go to Step 3.

B. Under 75% scale reading? Increase RF input and go back to Step 2A.

C. No indication on meter? Check RF input. Check solder joints. Check grounds. Check circuit against schematic. Check for open reference load. Check meter. Go back to Step 1.

3. Install reference load on antenna connector and apply same level of RF as in Step 2A.

A. Null? Go to Step 4.

B. Reading on meter? Refine adjustment of tab capacitors to minimize. Go back to Step 3A.

You may not be able to get an absolute zero reading, but it should be very close.

4. Connect an antenna you have been using to the antenna connector and see how it looks. If the antenna is a rubber ducky, be prepared to be appalled.

When performing antenna tests, please remember to keep power levels as low as practical and to identify all transmissions as required.

Do I consider this bridge a replacement for my MFJ-259 Antenna Analyzer? Definitely not! What we've done here is explore some of the theory involved in an instrument like the 259 and tried to show that useful/usable test equipment can be constructed from materials easily found by the home builder.

Have fun, and if you have any ideas about that holographic projection oscilloscope, please let us know. 73, Pete NØBLX.

### Suggested reading

*Radio Handbook*, William I. Orr W6SAI, Editors and Engineers, Indianapolis IN 46268.

*The Radio Amateur's Handbook*, ARRL, Newington CT 06111.

*The ARRL Antenna Book*, ARRL, Newington CT 06111. 73

### Parts List

R1, R2, R3	50 – 51 Ω 1/4 W resistors, matched within 1% (RS #271-1108)
Reference Loads (2)	50 – 51 Ω resistors, matched within 1%, mounted in male RF connectors
R4, R5	10 kΩ 1/4 W resistors
R6	100 kΩ 1/4 W resistors
C1, C2	.0022 ceramic disc capacitors (RS #272-801)
C3	.001 μF disc capacitor
D1	1N45 or equivalent Germanium diode
M	100 μA meter
J1, J2, J3	RF connectors to match Reference Loads
Enclosure	Bud #CU-2101B or RS #270-235 (or equivalent)

Table 1. Parts list.



## Amateur Radio Teletype

Marc I. Leavey, M.D., WA3AJR  
P. O. Box 473  
Stevenson MD 21153  
[ajr@ari.net]

Without a doubt, amateur radio operators have traditionally formed the backbone of communication of this country, and of the world. Whether or not this will continue in this computer age is another story. For sure, the tales some of our cohorts tell ring true in many a shack.

Such was the story told in a letter from W.R. Crockett W3OHF, whose attention was grabbed by our discussion of teleprinter lubrication and maintenance. He writes:

"I worked at the *Voice of America* here in Greenville for about 30 years as a technician, but one of my peripheral duties was Teletype™ maintenance and repair, since we operated a worldwide Teletype schedule with the other relay stations throughout the world—a very busy schedule.

"The organization sent me to Teletype repair school in Chicago sometime in the early seventies.

We were trained on the Model 28 ASR and associated units. We later used Model 35s. I have repaired Model 28s in my dreams at times. They were a nightmare of many hundreds of parts. We stocked a huge number of all parts used in the 28s.

"The subject of lubrication was a complicated one. The Teletype Corporation lubricant was very expensive, so we used a number of solutions that were later found to be harmful to humans if inhaled or [acquired] through skin contact. After many efforts, we settled on cleaning them in a large drum containing #2 fuel oil. It left a slight amount of lubricant film but dissolved the hardened grease deposits. Some cleaning solutions would remove grease and oil, but form a slight corrosion if not sprayed with some form of lubrication. We settled on a mixture of Varsol™ with a slight amount of WD-40™. That left a slight amount of oil

## Homing In

continued from page 63

### Leaders needed

As this month's "Homing In" goes to production, the North American ARDF Organizing Task Force is awaiting action from ARRL's Executive Committee on a proposal by the Friendship Amateur Radio Society to sponsor an official IARU Region 2 ARDF Championship in Portland, Oregon, during the summer of 1999. If ARRL approves it and creates the necessary ARDF leadership positions in the US, the next step will be establishing an IARU Re-

gion 2 ARDF Working Group, similar to those already in existence for the other two IARU regions.

"Homing In" will keep you informed of progress toward the western hemisphere's participation in this important world radio sport. Meanwhile, you can become an innovator and leader in a new American ham activity. Read up on the principles of ARDF, talk up the sport at your club meetings, train up the promising radio-athletes at your local practice sessions and write up your local fox-tailing news. Then send the write-ups to me so we can spread the word in future installments of this column. **73**

film on the metal which did not corrode after a short time.

"After the VOA changed from mechanical to electronic RTTY, those units became available for a song on the government surplus lists. Some were obtained by hams, but I don't know why. They require a lot of attention if used very much.

"I dropped the mechanical stuff for ham use and got into solid state with software for my hamming interests. I hope I have recovered some of my former sanity, which suffered severely while I was repairing the mechanical stuff."

I appreciate the perspective, and information on yet another lubrication scheme. As to why hams would snap up old mechanical teleprinters, I, for one, appreciate the sound and feel of an old printer, in a way that keyboards and monitors just can't satisfy. Of course, what good are teleprinters if there is nothing to

print? And while there are few things that can beat a good QSO, I commonly receive questions from RTTY fans looking for commercial stations to copy.

This year, you have to check out Klingenfuss Publications' *Super Frequency List* CD-ROM. A leading publisher of books and CDs for professional short-wave radio monitoring for 29 years, Klingenfuss Publications puts out a wide variety of materials of interest to the digital amateur.

As Joerg puts it, the CD-ROM contains 11,100 entries, with the latest schedules of all clandestine, domestic, and international broadcasting services on shortwave, compiled by top expert Michiel Schaay from the Netherlands; 11,800 special frequencies from the international best seller *1998 Guide to Utility Radio Stations*; plus 960 abbreviations and 15,400 formerly

Continued on page 74

## TRANSMITTER LOCATION

New fixed site direction finders provide 2 degree accuracy, and include software for triangulation from a central control site. Mobile versions also available covering 50MHz to 1 GHz

 **Doppler Systems Inc.**

PO Box 2780 Carefree, AZ 85377  
Tel: (602) 488-9755 Fax: (602) 488-1295  
www.dopsys.com

European Marketing Director Denis Egan  
PO Box 2, Seaton, Devon EX12 2YS England  
Tel & Fax: 44 1297 62 56 90



CIRCLE 13 ON READER SERVICE CARD

# NEW PRODUCTS

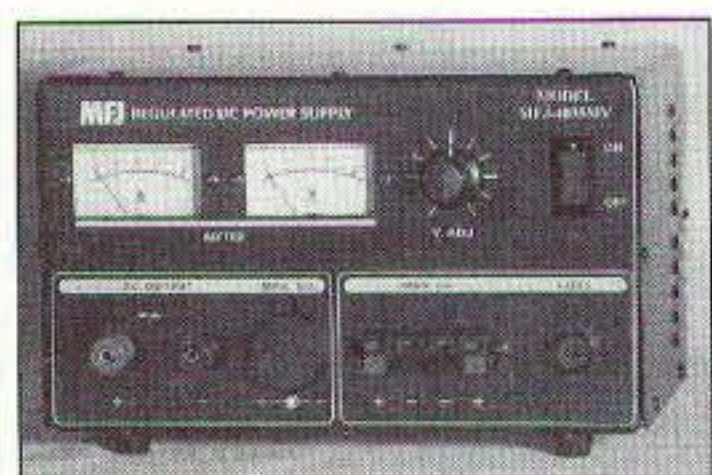

## MFJ-4035MV POWER SUPPLY

MFJ Enterprises, Inc., is pleased to announce the new MFJ-4035MV 35/30 amp adjustable regulated DC power supply. This new heavy-duty power supply features 35 amps surge and 30 amps continuous, and is adjustable and regulated. Voltage is front-panel adjustable from one to 14 VDC with detent set at 13.8 VDC. The power sup-

ply has lighted front panel meters and an ON/OFF switch.

Great features help protect your investment—like the built-in circuit protection that automatically shuts down the power supply when it's drawing too much current, a quiet internal fan that keeps components cool—plus lots more!

The MFJ-4035MV is priced at only \$149.95, and of course it carries MFJ's famous *No Matter What™* one-year limited warranty. For the name of your nearest dealer or to order, call (800) 647-1800; FAX (601) 323-6551; E-mail [mfj@mfjenterprises.com]; or visit the Web site at [http://www.mfjenterprises.com].

## VLF RADIO! THE SOUNDS OF LONGWAVE

Kevin Carey WB2QMY, "Below 500 kHz" Editor for *Monitoring Times*, narrates this 60-minute cassette tape. It lets you hear actual recordings of ships at sea, non-directional beacons, European broadcasters, experimental lowfers, military radioteletype stations, WWVB, 10–14 kHz Omega and natural radio. Some of these signals become more rare by the day, and are preserved here for their historical value. Included with the tape are reference notes, a longwave spectrum chart, and a listener logsheet. *VLF RADIO!* is designed to be an introduction for the newcomer or a reference tool for the seasoned DXer. Tapes will be shipped within 48 hours by First Class mail, for \$11.95 (US) each, postpaid, from Kevin Carey, P.O. Box 56, West Bloomfield NY 14585.



## USER-FRIENDLY RADIO FROM THE "NO COMPROMISE" GUYS

SGC, Inc., announces the SG-200 HF Transceiver, designed and built to meet the needs of the experienced and the not-so-experienced radio

operator. The simple controls and functionality make the SG-200 a pleasure to use in the shack, installed in a vehicle, or packing through rough country—the SG-200 is great wherever space is at a premium.

Features include a 1.8–29.7 MHz frequency range, 0–20 watts PEP transmitter power, 40 simplex or semi-duplex memories, and lots more, at a suggested retail price of \$595. Check it all out at SGC's Web site at [http://www.sgcworld.com], then contact your dealer or call (800) 259-7331 for the name of the dealer nearest you.

## WORLDWIDE RADIO IN A LITTLE BLACK BOOK ... ER, BOX

The IC-PCR1000, from ICOM America, Inc., is a "black box" that can transform your computer screen into a high-quality wideband receiver. It connects to computers externally, providing compatibility with many different PC models, even laptops, and offers both band scope functions and exceptional receiver/scanner performance.

It's about the size of a book, yet it puts worldwide reception at your fingertips. Go *beyond* the Internet—the IC-PCR1000 receives local radio and television broadcasts, as well as high frequency/shortwave broadcasts that carry data transmissions, news, music, and events from other countries—enjoy the BBC or an Australian rugby match! You can also scan fire, police, search & rescue, commercial, military, aircraft, and marine communications. With a good antenna, the PCR1000 covers the globe, enabling a computer with Windows® 3.1X or Windows® 95 to become an HF shortwave receiver; worldwide *mobile* reception is a reality, since the PCR1000 may be used in a vehicle by simply connecting to a laptop and using the power from a 12 V cigarette lighter.

Three receiver interface screens, including a communications receiver screen that displays a typical receiver front panel showing S-meter level, frequency readout, and a keypad are great features of the PCR1000, as is the unlimited number of memory channels. And all for a suggested retail price of \$599! For more information, and the name of your local dealer, visit ICOM's Web site at [http://www.icomamerica.com].

## FREE CATALOG FROM TECHAMERICA

Hobbyists, home-brewers, and electronics professionals can easily order individual electronic components, test equipment, and specialized tools from a catalog designed to serve the needs of small business and individual purchasers. There's no minimum order, shipping is cheap and fast, and credit card orders can be placed 24 hours a day, seven days a week. Get a copy of the latest TechAmerica catalog by calling (800) 877-0072 or visit the Web site at [www.techam.com].

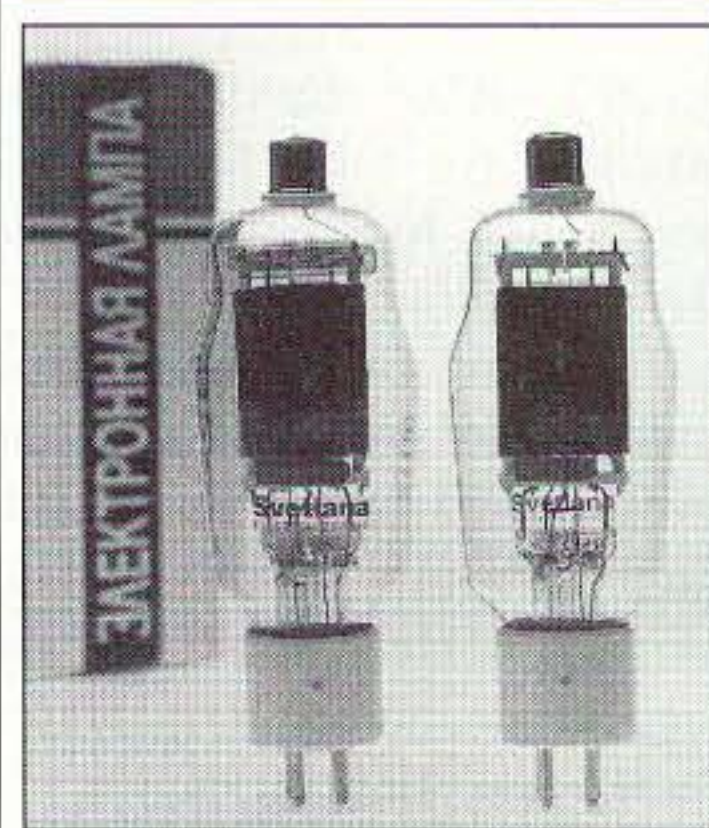

## SVETLANA'S 812A TRIODE

Svetlana Electron Devices, Inc., introduces a modern version of the 812A, which was developed in 1939 by RCA. The new medium- $\mu$  triode is a companion to (and is identical

to) Svetlana's popular high- $\mu$  811A. Both of these power triodes are intended for use in class AB, class B, and class C RF and audio amplifiers, and both feature a low-loss ceramic base and a bonded-ceramic plate cap thermal insulator for high-power RF transmitting tube capability. Svetlana provides an excellent ceramic socket for both types (the Svetlana SK4A), as well as a ceramic plate cap connector, the Svetlana PC1A.

See your dealer or contact Svetlana at: 3000 Alpine Road, Portola Valley CA USA 94028. Call (415) 233-0429 or FAX (415) 233-0439.

**Return Address**

\_\_\_\_\_  
\_\_\_\_\_  
\_\_\_\_\_  
\_\_\_\_\_



**73 Magazine**

**70 Route 202 N**

**Peterborough NH 03458**

**USA**

# YES! I want to grow with 73 Amateur Radio Today.

**Mail This  
Card Today!**

Send me 1 year (12 issues in all) of 73 for the low price  
of \$24.97! (I save over \$22.00 off the cover price.)  
For instant service dial toll free: 800-289-0388.



Newsstand rate \$47.40. Basic subscription rate \$24.97 (Canadian orders add \$7.00 per year plus \$1.40 GST; other foreign countries add \$19.00 per year for surface mail, \$42.00 per year for airmail. Please allow 4-6 weeks for delivery of first issue.

FAX: (603) 924-8613

B9803SS8

MARCH 1998

MAIL: 73 MAGAZINE  
70 ROUTE 202 NORTH  
PETERBOROUGH, NH 03458

## READER SERVICE CARD

1	2	3	4	5	6	7	8	9	10	201	202	203	204	205	206	207	208	209	210
11	12	13	14	15	16	17	18	19	20	211	212	213	214	215	216	217	218	219	220
21	22	23	24	25	26	27	28	29	30	221	222	223	224	225	226	227	228	229	230
31	32	33	34	35	36	37	38	39	40	231	232	233	234	235	236	237	238	239	240
41	42	43	44	45	46	47	48	49	50	241	242	243	244	245	246	247	248	249	250
51	52	53	54	55	56	57	58	59	60	251	252	253	254	255	256	257	258	259	260
61	62	63	64	65	66	67	68	69	70	261	262	263	264	265	266	267	268	269	270
71	72	73	74	75	76	77	78	79	80	271	272	273	274	275	276	277	278	279	280
81	82	83	84	85	86	87	88	89	90	281	282	283	284	285	286	287	288	289	290
91	92	93	94	95	96	97	98	99	100	291	292	293	294	295	296	297	298	299	300
101	102	103	104	105	106	107	108	109	110	301	302	303	304	305	306	307	308	309	310
111	112	113	114	115	116	117	118	119	120	311	312	313	314	315	316	317	318	319	320
121	122	123	124	125	126	127	128	129	130	321	322	323	324	325	326	327	328	329	330
131	132	133	134	135	136	137	138	139	140	331	332	333	334	335	336	337	338	339	340
141	142	143	144	145	146	147	148	149	150	341	342	343	344	345	346	347	348	349	350
151	152	153	154	155	156	157	158	159	160	351	352	353	354	355	356	357	358	359	360
161	162	163	164	165	166	167	168	169	170	361	362	363	364	365	366	367	368	369	370
171	172	173	174	175	176	177	178	179	180	371	372	373	374	375	376	377	378	379	380
181	182	183	184	185	186	187	188	189	190	381	382	383	384	385	386	387	388	389	390
191	192	193	194	195	196	197	198	199	200	391	392	393	394	395	396	397	398	399	400

Charge my  Payment Enclosed  
 AMEX  MC  VISA

Card # \_\_\_\_\_ Exp. Date \_\_\_\_\_

Signature \_\_\_\_\_

Name \_\_\_\_\_

Address \_\_\_\_\_

City \_\_\_\_\_ State \_\_\_\_\_ Zip \_\_\_\_\_

This card valid March 31, 1998

"You make the 73 supporting advertisers very happy  
when you're interested in them" ... Wayne

## FEEDBACK

**The Pitch:** 73 wants to know what you want to read. Help us by voting on this month's features and columns. (Line at upper right hand corner of page where article/column starts shows the Feedback #.)

**The Payoff:** Each month we'll draw a card at random. If yours is picked, you'll receive a one-year subscription (or extension) to 73.

Where did you get this copy of 73? \_\_\_\_\_

B9803BS8

999  newsstand

998  subscription

## FREE INFORMATION READER SERVICE CARD

**Reader Service:** To Receive more information on the products advertised in this issue of 73, circle the appropriate number(s). Please allow 6 weeks for processing of inquiry.

Article #																				
Great																				
OK																				
No Way																				

I'd like to see more \_\_\_\_\_

I'd like to see less \_\_\_\_\_

# ADVERTISERS' INDEX

R.S.#	page	R.S.#	page	R.S.#	page	R.S.#	page
351	Absolute Value Systems ... 41	222	Byers Chassis Kits ..... 22	86	MFJ Enterprises ..... 7	•	Radio Book Shop ..... 83
68	Advanced Battery Systems ..... 19	184	C & S Sales, Inc. .... 31	•	Michigan Radio ..... 35	•	Radio Book Shop ..... 88
•	All Electronics Corp. .... 37	99	Communication Concepts 69	160	Micro Computer Concepts 33	34	Ramsey Electronics ..... 11
380	Antennas West ..... 19	10	Communications Specialists 31	193	Morse Tutor Gold ..... 9	254	Ross Distributing ..... 16
89	Antennas West ..... 19	166	Cubex ..... 69	248	Motron Electronics ..... 73	36	Scrambling News ..... 16
332	Antennas West ..... 29	•	Dayton Hamvention ..... 27	248	Motron Electronics ..... 78	241	Seagon Company ..... 47
5	Antennas West ..... 33	13	Doppler Systems ..... 71	114	Mr. Nicd ..... 66	167	Sescom, Inc. .... 33
340	Antennas West ..... 41	114	E. H. Yost ..... 66	•	MultiFAX ..... 22	250	Software Systems Consulting ..... 41
116	Antennas West ..... 42	193	GGTE ..... 9	54	NCG ..... CV4	69	Spectrum Electronics ..... 38
135	Antennas West ..... 47	•	Greater Baltimore Hamboree and Computerfest ..... 74	•	PC Electronics ..... 77	141	The Nicad Lady ..... 22
57	Antennas West ..... 81	•	Hamtronics, Inc. .... CV2	68	Peet Bros. .... 29	•	Thomas Miller ..... 42
297	Antique Electronic Supply . 73	42	Isotron ..... 22	257	Periphex ..... 19	269	Tigertronics ..... 51
16	Astron Corporation ..... 2	242	Jan Crystals ..... 29	•	Quorum Communications . 45	22	Tri-Ex Tower Corporation ..... 56
41	Barry Electronics Corp ..... 16	158	Japan Radio Co. .... CV3	•	Radio Book Shop ..... 42	•	Universal Radio ..... 69
42	Bilal Company ..... 22	•	Kantronics ..... 1	•	Radio Book Shop ..... 44	259	Versatel Communications . 38
56	Buckmaster Publishing ..... 25	275	Lakeview Company, Inc. ... 33	•	Radio Book Shop ..... 48	182	Vostek Electronics ..... 47
168	Buckmaster Publishing ..... 38	335	Menu Plus Inc. .... 5	•	Radio Book Shop ..... 78		
				•	Radio Book Shop ..... 79		

When you buy products from these advertisers, please tell them that you saw their ads in 73.

Subscribe to 73 right now...call 800-274-7373 (9-5 Monday-Friday EST).

**Motron** 310 Garfield St Suite 4  
 PO Box 2748  
**ELECTRONICS** Eugene, Oregon 97402  
<http://www.motron.com>

New DTMF Decoder

**\$79.00**  
 plus shipping

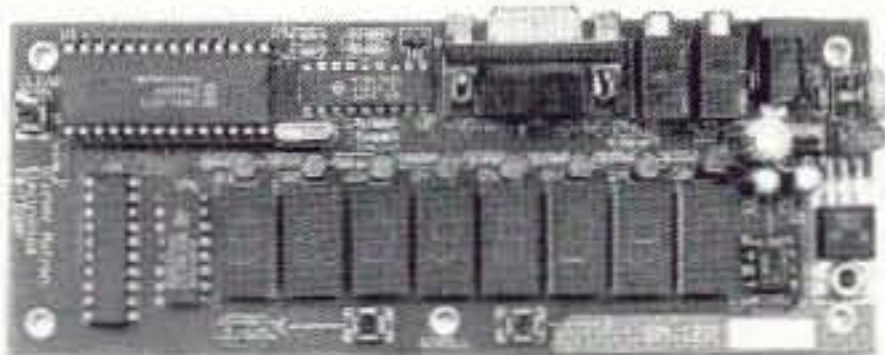

The **ToneLogger™**

DTMF Decoder Display Board with ASCII Serial Output decodes all 16 DTMF digits and features a large 8-digit LED display, an amplified audio output, jumper selectable Normal and High-speed decoding, and an ASCII serial output at 9600 baud. The 56 character memory is viewed, without loss of data, by scrolling either left or right. Although a computer is not required, the serial ASCII output allows for automatic logging of decoded number groups. Logging software for both DOS and Windows environments is included with each **ToneLogger™** purchase. The **NEW ToneLogger™** is 2-1/4" x 6" and requires 9 VDC at a minimum of 150 ma current.

**ToneLogger™** Assembled & Tested PCB **\$79.00**  
**CAB-3** Audio & Computer Cables **20.00**  
**PMK-1** Plastic Mounting Kit **15.00**  
**PS-9/2** 9 VDC @ 200 ma AC Adaptor **10.00**

Visa, MasterCard, American Express, and Discover/Novus accepted.  
 COD \$5 (Cash or Money Order only) S/H: \$8 USA; \$11 Canada; \$16 Foreign

**Orders: (800) 338-9058**

Info: (541) 687-2118 Fax: (541) 687-2492

CIRCLE 248 ON READER SERVICE CARD

**TUBES-PARTS-BOOKS-SUPPLIES**

(602) 820.5411 FAX (800) 706.6789

FIND EVERYTHING YOU NEED  
 WITHOUT A LOT OF DOUBLE TALK

*I wonder where can I find a 2A3 audio tube?*

*With 50,000 watts we can broadcast for bla bla bla bla bla*

Call or fax today for our new 60 page FREE catalog of vintage tubes, hard to find parts, books and supplies. We have everything you need to build new or repair classic audio equipment at prices you haven't seen in decades.

**ANTIQUE ELECTRONIC SUPPLY**

6221 SOUTH MAPLE AVENUE  
 TEMPE, AZ U.S.A. 85283

VISIT OUR WEBSITE AT [WWW.TUBESANDMORE.COM](http://WWW.TUBESANDMORE.COM)

CIRCLE 297 ON READER SERVICE CARD



Fig. 1. Klingenfuss's CD is the mother lode of frequencies.

## RTTY LOOP

continued from page 71

active frequencies—all on one compact disk for PCs with Windows™. Not only can you browse through all that data in milliseconds, but you can search in next to no time—even combined!—for specific frequencies, countries, stations, languages, callsigns, and times as well. It can't get faster than this!

The superb software has been completely revised again, and

now features DLL interfaces for Radio Manager (SHOC), RCON (Lowe), and Visual Radio (Liedtke). A powerful concurrent word search facility is included as well. The disk runs under standard Windows and Windows95™. Whether you are an international radio listener, a businessman or a tourist traveling worldwide, a professional monitoring service, or a circumnavigator sailing around the globe, this is the way—just a few keystrokes and you have it all!

Apart from the usual incremental search features, the most powerful tool is the concurrent word search facility (function key F9). Examples: In the broadcast database BC98, entering the words "bbc", "en", and "12:34" takes you, within less than a second, to 39 entries with all BBC frequencies worldwide broadcasting in English at 12:34 UTC.

The search word sequence is free: If you enter "23:45",

"as", and "en", this gives you 30 entries with all broadcasts in English to Asia at 23:45 UTC.

You can get a look at the contents of the disk, and more, at their Web site: [http://ourworld.compuserve.com/homepages/Klingenfuss/]. There, you can even find current hot frequencies and selected other information from the Klingenfuss archives. Believe me, if you are looking for commercial, military, or other non-amateur RTTY, this is the best way to locate something of interest.

The disk is available directly from them, for DEM60, worldwide surface postage included. You can contact Klingenfuss Publications at Hagenloher Str. 14, D-72070 Tuebingen, Germany. Or E-mail them at [klingenfuss@compuserve.com].

Just make sure to mention "RTTY Loop" when you call, okay?

Once again, we have looked at both sides of radio teletype. The classic mechanical grease monster, and the latest up-to-date computer technology for accessing radio teletype information.

And then, of course, we have the Web. Not the movie—I'm referring to the RTTY Loop home page. Check it out at [http://www2.ari.net/ajr/rtty/] for past articles, links of interest to all of us, and a listing of the RTTY Loop Software Collection, which is always growing. Let me hear from you, via E-mail at the above address or by snail-mail if you must! Next month, even more stuff you all have been asking about, right here in RTTY Loop! 73

Number 74 on your Feedback card

## ABOVE & BEYOND

VHF and Above Operation

C. L. Houghton WB6IGP  
San Diego Microwave Group  
6345 Badger Lake Ave.  
San Diego CA 92119  
[clhough@pacbell.net]

### Filters for the amateur microwave bands

This month, I would like to cover filters for our microwave bands by depicting some of the ones I have constructed and comparing them to commercially available amateur-band filters. That's right—I said "commercially manufactured amateur-band." The TTE Filter Corporation of Los Angeles has made available a filter for 1296 MHz that can be used with existing equipment or as part of home-brew transceivers.

Anything that can be utilized at microwave in the pursuit of an improvement in our transceiver's operation is of great importance. One point here that I readily endorse is the construction of home-brew or home-assembled

equipment. This filter is one of the key elements in the construction of a radio transverter. The other keys are the preamp, power amplifier, and mixers.

I get great joy out of amateur electronics, or more correctly amateur microwave operations, by constructing my own transceivers and utilizing material that can be found in surplus or be home-contrived. Building transceivers is a very rewarding experience, and I will always prefer it to purchasing an off-the-shelf device—especially since for microwave operation the latter are virtually nonexistent. Don't get me wrong: There are some very nice 1296 MHz transceivers out there, but this is where they end. I haven't seen a manufactured unit for

**DON'T MISS THIS ONE!**

**GREATER BALTIMORE  
HAMBOREE AND  
COMPUTERFEST**

HOST TO THE  
**ARRL MD STATE CONVENTION**  
**March 28 & 29, 1998**  
**Timonium Fair Grounds**  
**Timonium, Maryland**

Saturday 8 A.M. - 5 P.M. and Sunday 8 A.M. - 4 P.M.

**ONE OF THE LARGEST SHOWS  
IN THE ENTIRE COUNTRY**  
*Over 17,000 Attended Last Year!*

**ARRL Forums & Programs • Banquet**  
**10 Acres of Indoor and Outdoor Sales**  
**3 Buildings • 1,100 Indoor Spaces**  
**Indoor Fleamarket • Outdoor Tailgate**  
**Indoor Tailgate • FCC Exams**

**Discount 2 Day Admission By Advance Sale Only!**

For More Information: E-Mail - gbhc@concnetric.net, Internet Address -  
www.gbhc.org, Write To: G. B. H. & C., P.O. Box 95, Timonium, MD  
21094-0095, Voice and Fax Back 1-410-HAM-FEST or Outside Of MD  
1-800-HAM-FEST

**Sponsored by: The Baltimore Amateur Radio Club, Inc.**

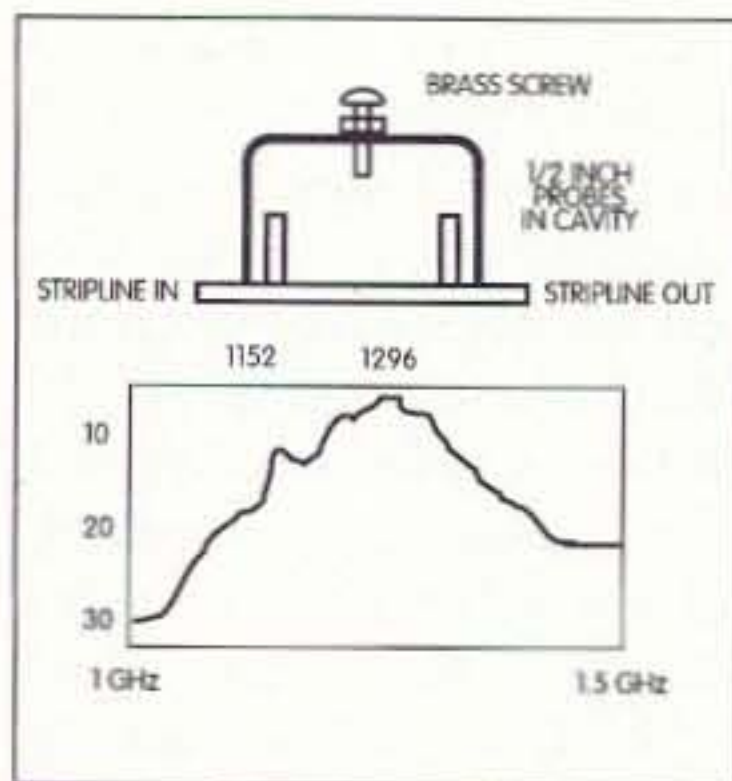

**Fig. 1.** Copper pipe cap filter for 1296 from standard plumbing fitting. Add a brass screw and two half-inch probes on either side of the center line, tied to PC board stripline traces.

any frequency above 1296 MHz, and that's the prime reason we have to construct our own units.

I have been tempted to go out and purchase off-the-shelf equipment for frequencies above 500 MHz, but have held back the impulse, preferring converters for lower frequency equipment instead. The reasons are many, but they can hinge on component cost and availability.

Part VHF and part microwave, 1296 MHz is a transition band. The material available for component scrounging is a little difficult to obtain without some looking. The oscillator seemed hard to get until we came up with a 1152 MHz synthesizer

from surplus material that our group makes available. Add the local oscillator mixer and filter and a suitable amplifier with switching, and you're on the air.

Amplifiers for high power can be obtained from Mitsubishi. With minimal drive, they will put out 10 watts of power. RF preamplifier circuits abound in many books and periodicals, or can be dead-bug constructed on a small piece of PC board and put in a small metal box for shielding. Sounds complicated, but when you think about it a transverter is nothing but a bunch of parts to convey your low-frequency transceiver to a higher frequency for operation. One nice part of that is that all the bells and whistles of your low-frequency transceiver translate to the same operation on the higher frequency. Getting expanded use of your existing transceiver and translation to a higher frequency—now *that's* a high-value service!

Okay—now let's assume we have taken care of the amps, mixers, and oscillators needed for the transverter. What, then, is missing? Well, it's the filters to limit the frequency of operation to a specific required band of operation. The filter should eliminate the local oscillator and the unwanted mixer product. It should have a very good (low) SWR and

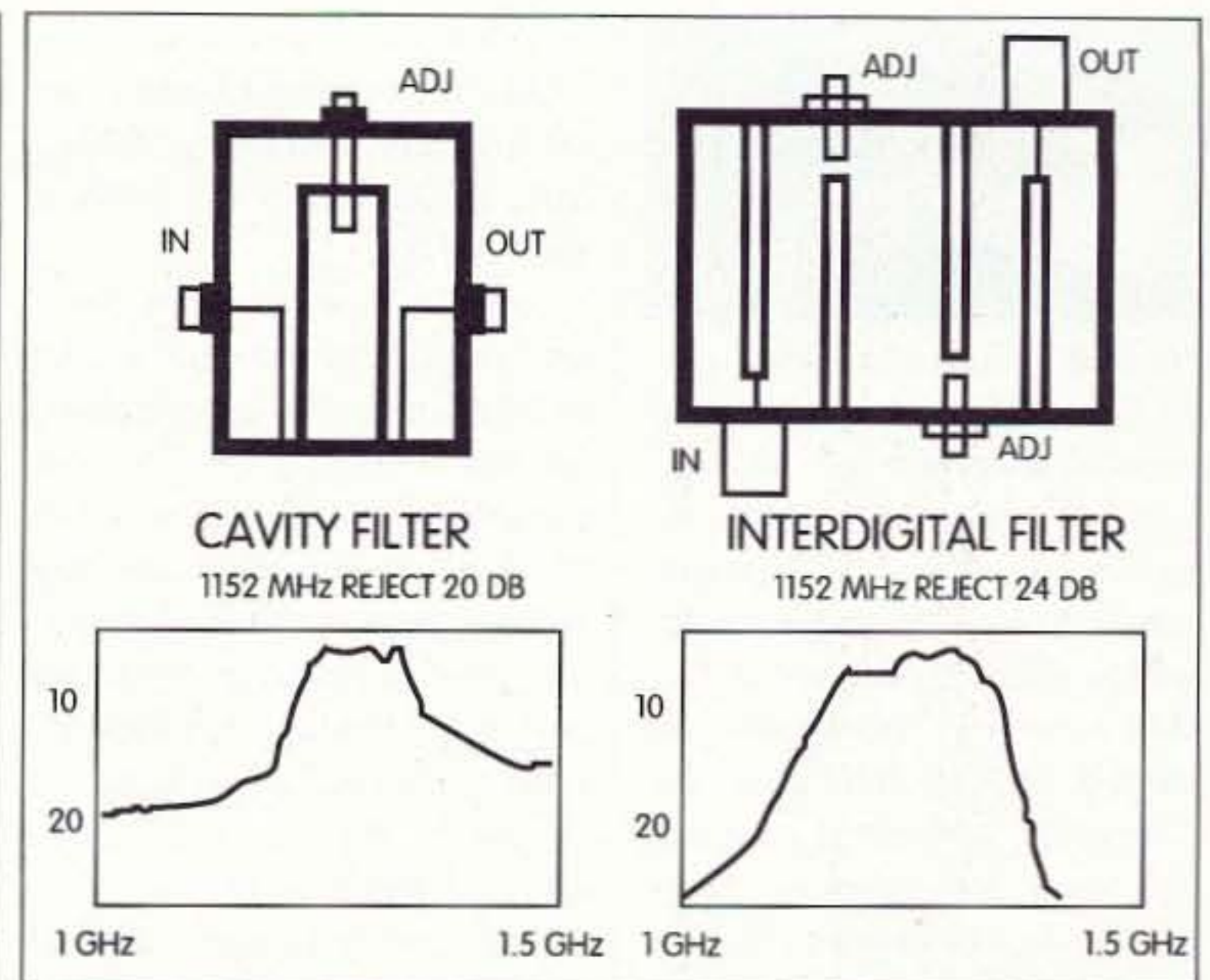

**Fig. 2.** Cavity filter and interdigital filter for 1296 MHz. The cavity filter and pipe cap filter are quite similar and tuned by one adjusting screw. The interdigital filter has multiple quarter-wavelength elements; each is tuned by an opposing screw.

low insertion loss, and minimum passband ripple. In other words, the passband should be flat.

Let's look into the nuts and bolts of just what a filter can do for us, particularly at the microwave frequencies of interest. Normally, microwave operation is considered to take place from 1000 to 10,000 MHz, but recent equipment has pushed that limit upward. It's not that no one operated above 10 GHz before, but rather that equipment was quite scarce for those frequencies. As a matter of fact, such equipment is quite hard to locate and material usually must be scrounged for almost any frequency above 1000 MHz. This dearth has rekindled a great spirit of homebrew and a desire for self-improved technical expertise—things you don't get from purchasing materials ready to use out of the box.

The shift to microwave for me came about because of my interest in experimentation construction, as well as very enjoyable operation in testing the fruits of my labor. Sure, I had some equipment that was purchased ready-to-go, but constructing a working transceiver and then improving it gave me greater satisfaction than just going out and buying one. Personal satisfaction was at stake here.

Getting to the point of this column, let's take a look at the plus and minus sides of filters and compare them to see what a good filter can do to improve performance. The main function of a filter is to prevent out-of-band mix products from being radiated.

By definition, a filter is supposed to pass wanted frequencies and give attenuation to unwanted ones. For 1296 MHz, the 1152 MHz local oscillator normally used means that a 144 MHz two-meter transceiver can serve as the IF stage receiver/transmitter and still retain all its two-meter features. Mixer

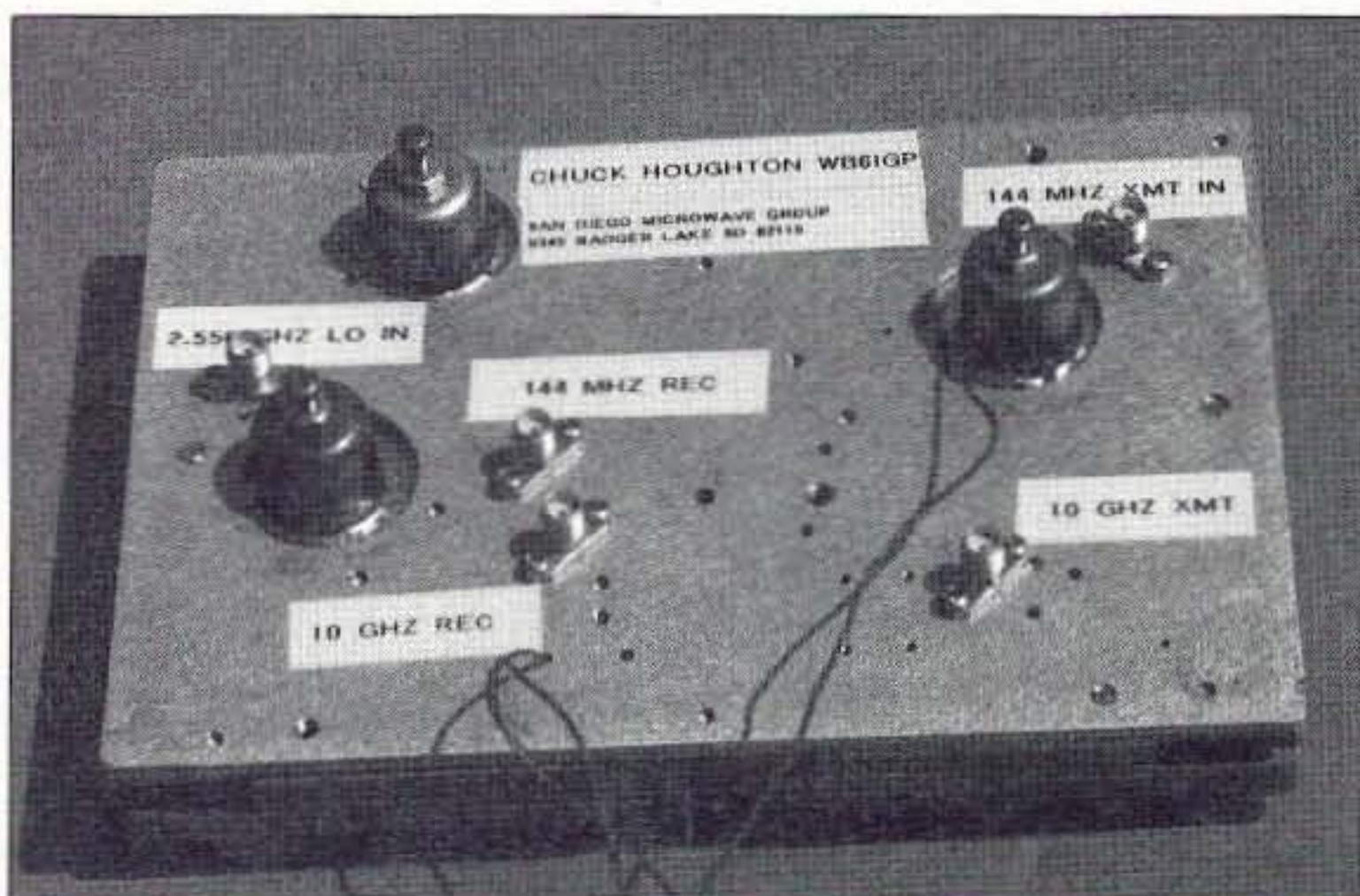

**Photo A.** Copper pipe cap filter constructed from common plumbing materials. Two internal probes and copper circuit board with 50-ohm striplines and two connectors complete the pipe cap filter. Adjustment is by a brass tuning screw on top of pipe cap in the center, penetrating into the cavity between the two probes from the stripline coupling.

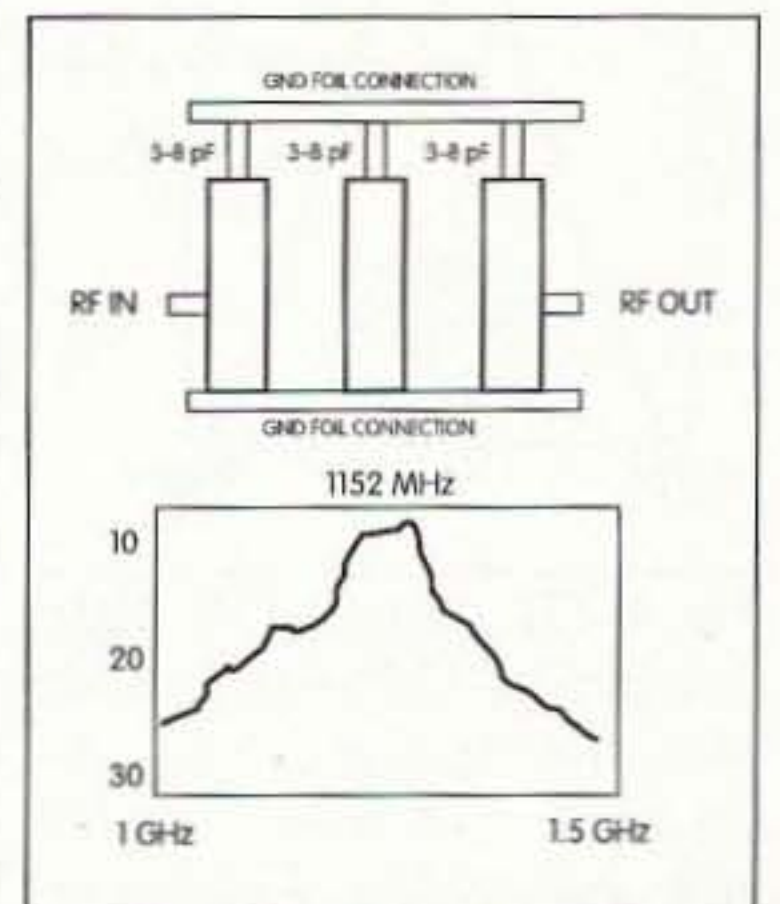

**Fig. 3.** PC board filter for 1296 MHz constructed from PC board traces and three small-value variable capacitors.



**Photo B.** Waveguide below cut-off filter. Constructed from a three-inch section of 10 GHz brass waveguide, two SMA connectors, and a 1 to 5 pF Johanson piston capacitor. The capacitor adjusts the filter to resonance and the SMA connectors' center pins are shorted to the bottom of the waveguide, forming a coupling link inside the waveguide. Very similar in construction to the pipe cap filter except coax connector probes are grounded on the bottom of the waveguide in this filter and capacitor used to resonate instead of copper or brass screw.

products produced from mixing 1152 MHz and 144 MHz include the desired product 1296 MHz and the very undesirable products of 1152 MHz and 1008 MHz.

Also, the filter must be capable of full-band operation. That is, it must provide minimal

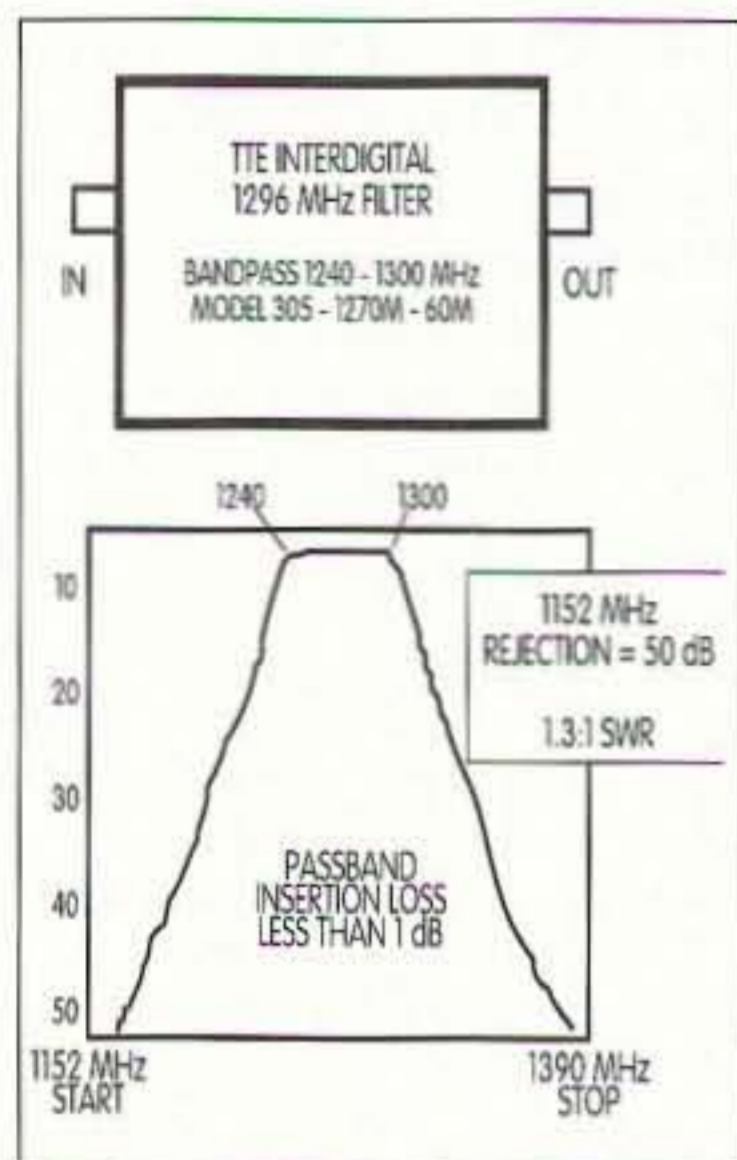

**Fig. 4.** TTE filter for 1296 MHz. Bandpass is 1240 MHz to 1300 MHz. Has 50 dB rejection of local oscillator frequency of 1152 MHz and still provides great rejection of signals outside of band edges, with less than 1 dB insertion loss. A great job in engineering such a useful filter!

attenuation to signals in the 1296 MHz amateur band from the low edge frequency of 1240 MHz to the top of the band at 1300 MHz.

Now let's get on with some test results and see what I have to offer on filters as examined on my workbench. The test equipment used was an HP-8620 sweep oscillator and my HP-432 power meter to manually plot frequency response curves of various filters tested. I had made connection from the output of the HP-432 power meter chart recorder output, which provided ample gain and chart drive to plot the differences in passband ripple to a few tenths of a dB. This allowed a basis for comparison among various filters tested.

Not having a custom factory filter for a specific amateur frequency before, I wanted to perform quite a few tests to characterize the filters in detail. In earlier tests, I was quite satisfied modifying existing filters or constructing them and adjusting them for best peaking at a given frequency point of use. As long as I had some rejection to my opposite mix product and the local oscillator frequency, I would use the filter as is. Of course, a better engineered filter could be accomplished, but that always seemed to be a target we could just not hit.

I just kind of ran with what I was able to get after several tries, sometimes even constructing several filters for the same frequency and selecting the one that presented the best results. The wobbly test results were due to my manufacturing construction differences. If your workbench or shop is like mine, metalwork is somewhat difficult to fabricate to exacting dimensions.

The construction of a perfect filter demands exacting pains and dimensional stability to obtain great results. The desired filter should have all of these properties. A flat passband, steep side skirts of high attenuation at other frequencies, and low insertion loss at the passband

frequency are some of the very desirable attributes.

The different types of filters I have used at 1296 MHz include a 3/4-inch pipe cap, a stripline-PC board filter, a waveguide below cutoff filter, and the TTE five-pole interdigital filter. All units were designed for use at 1296, with the exception of the PC board filter—which worked at 1152 MHz and compares well.

### The lab work

Initially each filter was tested for insertion loss, and then for how much rejection it had at 1152 MHz. This frequency is the common local oscillator frequency used in most transverters working with a two-meter IF (1152 plus 144 MHz equals 1296 MHz). Right off the bat, I could see some very great differences when comparing my filters with the stated performance data on the TTE filter. My home-brew filters' rejection to 1152 was evident, but their side skirts were not very steep and they seemed to roll off in the 20 dB to 30 dB attenuation range.

After making full frequency tests, it was very evident that my home-constructed filters were usable. But the tests also showed that quite a bit of improvement was needed to match the TTE 1296 MHz filter. In all categories the TTE filter showed vastly better performance, with lower insertion loss, flat bandpass over 1240 to 1300 MHz, 50 dB rejection to the local oscillator frequency, and quite steep filter band edges—all the attributes of a very high quality filter. See **Fig. 4** for the TTE filter evaluation. In **Figs. 1, 2, and 3**, I've included samples of the bandpass curves and drawings for the other associated filters I had constructed previously. As you can see, they roll off and are not nearly equal within the main bandpass area. Additionally, my rejections of the local oscillator at 1152 MHz were not nearly as great as the TTE filter's.

Overall, in comparison I would have to state that the TTE filter is by all means quite an excellent filter. I am sold on its performance. I have made some additional tests using my old HP-851 spectrum analyzer. I looked at the output of each filter in actual operation using my 1296 MHz transverter with its 1152 MHz LO and two-meter IF driver. The TTE filter showed a very marked improvement in operation with regard to conversion loss and rejection to out-of-frequency signals such as the LO and lower mix product of the LO minus the two-meter drive signal. Attenuation (rejection) to these signals was over 20 dB better with the TTE filter and should result in quite an improvement in operation.

With the TTE filter's increased out-of-band rejection, I exposed the transverter to a high-power interfering signal (another signal generator with +10 dB power output) on an out-of-band frequency (1320 MHz) and did not notice any effects to a weak signal being received at 1296 MHz. These out-of-band signals from local commercial transmitters plague both the converters and our IF rigs alike on hilltops. This filter was very effective in reducing problems caused by interfering near-frequency transmitters on the same hilltop on which we are operating our equipment.

When these tests started out, I knew that the filters I had constructed were not top-notch, but were reasonable considering the facilities I had available to construct them and the materials I had at hand.

The overall rating that I can give the TTE filter is top-notch. It has solved the problem of a bandpass filter and provided all the attributes that an "ideal filter" should have. I recommend this product to you for incorporation into your 1296 MHz transverter.

Remember, all the components needed to construct any frequency transverter are an amplifier, a mixer, and a filter



# HAMS WITH CLASS

Carole Perry WB2MGP  
Media Mentors Inc.  
P.O. Box 131646  
Staten Island NY 10313-0006

## Demos by kids

Every year as the end of the fall school term draws near, I look forward to seeing the culmination of months of work as the students demonstrate their projects in ham radio class. The school population at Intermediate School 72 in Staten Island NY is quite diverse. The 6th, 7th, and 8th graders bring in projects ranging from the extremely simple to the more complex. What's important is that all of the 400-plus children participate in demonstrating some kind of creative effort.

I'll describe the ones that were the most popular last year. Perhaps you can pass these ideas along to a teacher, or use them yourself when introducing a youngster to ham radio.

Two 7th graders brought a bicycle to school and spoke about "Testing a Dynamo." They had a large chart which explained that Michael Faraday first generated an electric current in 1831.

He moved a magnet in and out of a coil of wire and found that this made an electric current flow through the wire. This discovery led to the invention of the dynamo.

Nowadays we use dynamos to make much of our electricity, and a lot of our present way of life is based on Faraday's discovery. The boys propped up their bicycle so the class could observe their wonderful demonstration. They proceeded to explain that on some bicycles, the lights are powered by a simple dynamo. The movement of the wheels makes a magnet turn around inside a coil of wire. This makes electricity flow in the wire and the lights come on.

They turned the bicycle upside down and balanced it on the handlebars and the seat. They switched on the front light and turned the pedals slowly at first, then quickly. We then asked the class to observe what happens to the light when the dynamo is

to limit off-frequency operation from the conversion of a two-meter transceiver (IF system) to 1296 MHz. The filter is the main item to limit out-of-band products and reject the local oscillator.

Specs for the TTE filter are: Model 305-1270M-60M; pass-band, 1240 to 1300 MHz; pass-band insertion loss, 1 dB maximum; passband SWR, 1.25:1; impedance, 50 ohms; dimensions, 1.1" x 1.75" x 4.1"; SMA coax connectors; cost, \$200.

I hope you will take advantage of this TTE 1296 MHz filter and TTE's entry into providing an excellent product for the amateur microwave filter market. This

area was totally void of any entry prior to their designing this great filter. I wish them success and hope that enough interest in this filter creates a desire to provide additional filters to the market. That's TTE Incorporated, 11652 Olympic Blvd., Los Angeles CA 90064. Tel. (310) 478-8224; E-mail [sls@tte.com], Web site at [http://www.tte.com].

Well, that's it for this month. Next month I will try to get ready and describe a surplus synthesizer that can be used to generate the 1152 MHz—allowing you to form the basic start for a 1296 MHz transverter of your own.



Photo A. Greg (left) and Brian demonstrate a model car they built and "wired up."

turned faster. It's a good idea to have the class try to predict the outcome first.

The image of the bicycle on my desk in the classroom stays with the kids and helps them to remember more vividly the concepts we're demonstrating.

I've done the famous "flaming pickle" demo to get the kids'

attention many times. Last term, however, the most popular demonstration was the "getting electricity from a lemon" one. I printed up the directions for the project and had a group of the 6th graders demonstrate it for their class.

You make two slits in the skin of a lemon and push a copper

## AMATEUR TELEVISION

Web site: [www.hamtv.com](http://www.hamtv.com)

### GET THE ATV BUG

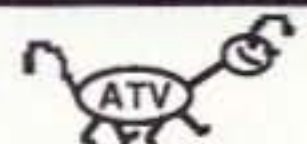

≥10 Watt pep

Transceiver  
Only \$499

Made in USA  
Full Color  
and sound



### TC70-10 420-450 MHz ATV Transciever

ATV is no more difficult to get on vs. any voice mode except you just plug in your camcorder to transmit, and your TV set to receive the picture and sound. That's it - you're seeing as well as talking to other hams live and in color just like broadcast TV. No other radios, computers or interface boxes required.

**DX** is 90 miles snow free line of sight using 14dBd ant.

**Show** the shack, home video tapes, zoom in and describe projects, show computer graphics or programs, repeat SSTV or even Space Shuttle Video and audio if you have a TVRO. Go portable or mobile, do public service events, RACES, AREC, CAP, transmit the local radio club meet.

**HAMS; Call, Write or Email for our 10 page ATV Catalogue** for more info - We have it all! Transmitters, Downconverters, Amplifiers, Repeater modules, and more. We also have wired and tested boards for the builder, R/C, Rocket and Balloon ATVers.

(626) 447-4565 M-Th 8am-5:30pm pst Visa, MC, UPS COD

**P.C. ELECTRONICS**

Email: [tomsmb@aol.com](mailto:tomsmb@aol.com)

24 Hr. FAX (626) 447-0489

2522 Paxson Lane Arcadia CA 91007



**Photo B.** Seventh graders present their doll houses with lighting and burglar alarms.

coin (penny) into one slit and a piece of aluminum into the other slit. Make sure the two metals are not touching each other inside the lemon. If you hold the coin and the aluminum gently against your tongue, you should be able to feel a tingle of electricity.

The current flows because a chemical reaction takes place between the metals and an acid in the lemon juice. The lemon juice acts in the same way as

Volta's salt water or the chemical paste in a battery.

I used this fun lemon demo to lead to a discussion about batteries. I assigned a group of four 7th graders to organize and present a "Make Your Own Battery" lesson. Their materials were: two pieces of 12-inch-long wire, cellophane tape, four copper coins, four pieces of aluminum, and a paper towel soaked in salty water.

Here are the directions:

1. Sandwich a piece of the salty paper towel between a penny and a piece of aluminum cut from an aluminum can.

2. Tape the bare end of one wire to the penny.

3. Now make three more sandwiches and stack them all together copper-side-up.

4. Finally, tape the bare end of the other wire to the piece of aluminum on the bottom of the voltaic pile.

5. Now take the free end of each wire and touch both ends lightly to your tongue. You should experience a gentle tingle of electricity.

It is very important to stress to the kids that they will feel only a tiny tingle and that they will not be harmed. Explain that in the voltaic pile, chemical reactions cause a tiny electric current. The current flows from one wire to your tongue and then into the other wire.

After doing a unit on circuits, several students built doll houses, wired up their own lighting, and installed their own circuitry for burglar alarms. The photos of the doll house are all of "alarmed" houses. There were several different techniques used. One is as follows, the equipment being a battery, aluminum foil, cellophane tape or glue, and a small buzzer.

1. Cut a piece of cardboard three inches by six inches and fold it in half.

2. Tape strips of foil around the cardboard.

3. Tape a wire to each piece of foil.

4. Join the wires into a circuit with the battery and the buzzer.

5. Set up the burglar alarm near a door so that anyone coming through the door will tread on the card and set off the buzzer.

Most of the children who did the burglar alarm project built it into a doll house instead of putting it by a real door. But it is a fun project either way.

When all the demonstrations were done, I had students from each class visit my other classes to share their work. I teach 13



**Photo C.** Seventh grader Lauren made an electrical quiz board with ham radio questions.

different classes a week. The students really gained a lot by listening to each other. Some of the other fun projects that were built were a ballroom with revolving lights from "Beauty and the Beast," a remote-control model car, a traffic light, a robot, several electrical quiz boards, and a variety of static electricity setups.

The important thing was that everyone had a good time and learned lots of good lessons from the whole experience. 73

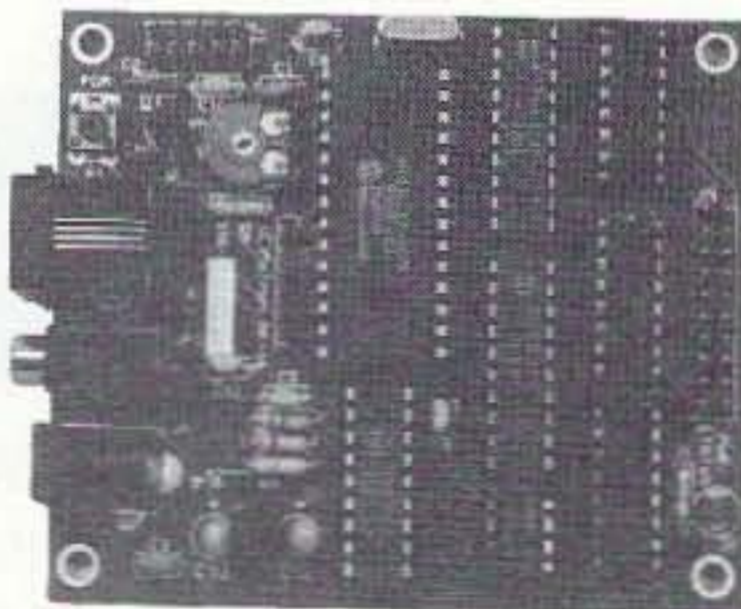

**Photo D.** These girls from the seventh grade show off their robot with blinking eyes.

**Motron** 310 Garfield St Suite 4  
**ELECTRONICS** PO Box 2748 Eugene, Oregon 97402 **Only \$99.00**  
<http://www.motron.com>

## Control your home from your radio!

The AUTO-Kall® AK-16 DTMF Controller Board features 16 relay driver outputs and DTMF to X-10 house control capability!



Using your radio keypad, you can control either the relay outputs, X-10 modules, or both! X-10 operation requires the PL-513 Power Line Interface (\$20). The AK-16 mates readily with our **RB-8/1** (\$99) or **RB-16/1** (\$149) relay boards. The 0-12 digit security code is user programable using your DTMF keypad. Additional features include reprogrammable CW ID and several modes of operation, including two with CW response tones. Printed circuit board, assembled and tested. VISA, MASTERCARD, AMERICAN EXPRESS, DISCOVER CARD COD ON CASH OR MONEY ORDER BASIS ONLY S/H: \$8 USA; \$11 CANADA; \$16 FOREIGN. COD: \$5

Price and Specifications are subject to change without notice  
*Se Habla Español. Pida por Don Moser.*

**Orders: (800) 338-9058**  
**Info: (541) 687-2118 Fax: (541) 687-2492**

CIRCLE 248 ON READER SERVICE CARD

**SAVE 47%!**

on 12 months of **73**.

**ONLY \$24.97**

Call 800-274-7373

# NEW PRODUCTS

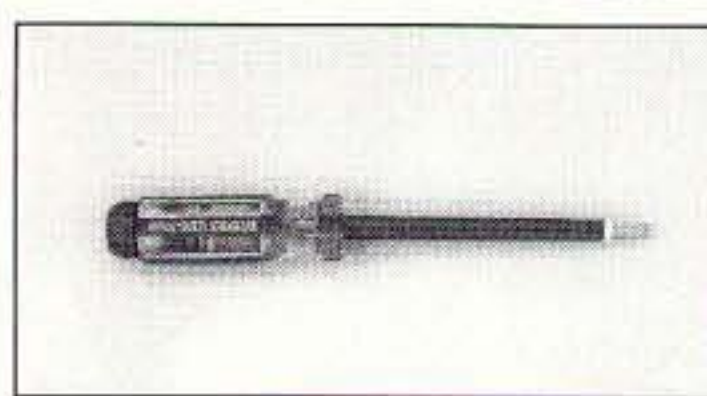

## VRROOM!

Jensen Tools' new HotRod™ safety screwdriver detects the presence of voltage and indicates it with a flashing red LED

in the handle. The double-insulated blade provides circuit protection in electrical work; it's voltage-protected for use up to 600 volts and comes with two AAA batteries and a five-year warranty. Find the HotRod in Jensen Tools' latest catalog—get a copy by calling (800) 426-1194 or (602) 968-6231; FAX (800) 366-9662 or (602) 438-1690; visit the Web site at [http://www.jensentools.com].

## #1 BEST-SELLING BOOK IN AMATEUR RADIO

Why? Simple—the *1998 ARRL Handbook* is more than 1,200 pages of explanations, information, and practical projects that will help you face the millennium with confidence. The new *Handbook* is the special 75th Edition, a real collector's item—but unlike most collectors' items, it's *useful*. Chances are, you'll turn to the 30-chapter *Handbook* more than to any other reference work—and right now it's specially priced at \$32 plus \$6 shipping & handling.

Call toll-free 1 (888) 277-5289; FAX (860) 594-0303; E-mail [pubsales@arrl.org]; or write to The American Radio Relay League, 225 Main Street, Newington CT 06111-1494.

## MORSE CODE: BREAKING THE BARRIER, BY DAVE FINLEY N1IRZ

This new book from MFJ Publishing is advertised as "The Fastest, Most Effective Path to Code Proficiency" and is for anyone who wants to enjoy using the code on the air—it shows how you can combine modern technology with German psychologist Ludwig Koch's revolutionary (back in 1936) training technique. Using a computer or microprocessor-based pocket code trainer (MFJ-418), you can use Koch's technique to build high-speed code proficiency quickly. According to Finley, Koch's method is very effective because you receive frequent positive reinforcement. You're assured that you are making progress, and thus are less likely to quit out of frustration. There's also a fascinating history of telegraphy.

Order your copy (stock #MFJ-3400) from MFJ Publishing for \$14.95 plus shipping by calling (800) 647-1800; FAX them at (601) 323-6551; or check out dealer and ordering information at the Web site: [http://www.mfjenterprises.com].

If you're a No-Code Tech, and you're having fun operating, tell us about it! Other No-Code Techs will enjoy reading about your adventures in ham radio—and we'll pay you for your articles. Yes, lots of nice clear photos, please. Send your stuff to Joyce Sawtelle in the Editorial Department, *73 Magazine*, 70 Route 202 N, Peterborough, NH 03458.

## LETTERS

continued from page 7

of long standing seem to really have developed a connection of some sort between them (not girlfriend/boyfriend, just friends). So, this young lady is currently off for a year in Japan as an exchange student and my son missed chatting with her, but figured he could survive the eight-month absence. Then he

got into a real bad teenage romance situation, making him very upset, depressed, etc. After a couple of days of this, he got up one morning and announced that he just had a dream where he was discussing the problem with his friend in Japan and he now felt much better about everything. OK, the imagination is a wondrous thing. But imagine how I felt when he showed me the E-mail

he got from Japan that afternoon asking if their "little chat" had helped him get back on track. Then, a couple of days later he had more difficulties with his girlfriend and he got another E-mail from Japan the next day telling him that he had to get himself together since she was in a different time zone and he was keeping her awake! While I can't explain it, I have little doubt of the truth of the story.

It seems like all the published letters say this but I'll add my comment that the main reason I purchase *73* is to read your editorials. They're great! Keep up the good work!

Thanks, John. Sherry and I are constantly reading each other's minds. This seems to be an ability that almost anyone can cultivate, once they get past the idea that it's impossible ...  
Wayne. 73

## Amazin' Hall Tree Antenna

continued from page 33

record the element lengths, to save time looking for minimum SWR later on.

I have been most pleased with the field strength tests I have performed as well as the operating results obtained on 20 meters. Field strength measurement indicates that the Hall Tree Vertical has a 4.6-dB advantage over my loop, which I have since given away.

From a public park in Killarney, Ireland, running battery-powered 10 watts, after several 100% QSOs, I received a 5/7/9 from Novgorod, Russia. I have duplicated the antenna twice and the results have been consistently good.

### Sources

Telescoping 38-inch swivel-base whips  
Electronic & Parts Outlet  
1750 Alma Suite 100  
Richardson TX 75081

Ferrite and powdered iron cores  
Amidon Associates  
P.O. Box 956  
Torrance CA 90508

4- x 9- x 48-inch single rifle carrying case  
Sporting goods stores  
or

Doskocil Mfg. Company  
P.O. Box 1246  
Arlington TX 76004-1246 73

# Out of Sight, Out of Mind

*Discretion is the better part of neighborhood amity. Part 1: strategy.*

Kevin Scott WB4BNU  
1939 McLennon Court  
Lawrenceville GA 30243

**L**ike many hams, I too dream of putting up a few tall towers, one with a few beams to cover my favorite HF bands, another to cover my favorite VHF/UHF bands. But why stop with two? It's only a dream and I am allowed to do that. Now, back to reality ...

My wife prefers to live in a subdivision neighborhood, not out in the country with several acres and an antenna farm. Darn! For now, most new subdivisions have rules prohibiting outdoor ham-style antennas (thank Washington for letting in DSS and local TV antennas; let's keep it up). This, of course, poses a real threat or challenge to the successful operation of my hobby. The choice is mine. I chose the challenge approach, as I want to beat the system with ham ingenuity to show that it can be done.

Unless you live on an unrestricted antenna farm, give up the idea of running 1.5 kW with an extended zepp up one-half wavelength on 160 meters. Maybe you won't have *the* strongest signal during that pileup but you can and will get through—if you have the patience and you put the effort into optimizing the antenna system that you already have. Look at the folks running

QRP. For most of you out there, you *can* do it if you plan ahead. I live in an area with restrictions, but there are many ways to make things work for *you!* It mostly takes planning plus a little PR and good luck.

I have seen many articles in several ham magazines over the years devoted to putting up disguised antennas. Some work well, others don't. In most instances they are compromises. I was able to use bits and pieces of each of

---

***“Introduce yourself to your new neighbors and let them get to know you before you tell them about your hobby.”***

---

these articles and come up with a few more ideas of my own to find a solution for me, one with as few compromises as possible. My hope is that you will do the same. One article will not be a cure-all for all people, but I hope to reach a few of you. If I do, then it was worth my time to write this.

This article will not apply to everyone out there with a desire to transmit on HF, but my goal is to spark some ideas of ways to put together an an-

tenna system that can work. Be creative. Apply what fits, expand on it; throw away the ideas that do not apply at all. First, I will elaborate on what I call my “Commandments” for antenna installations, then I will elaborate on some of the challenges I was able to overcome. Some of these may seem obvious to the old-timers, so be patient. My goal is to spawn ideas for the ham who needs it—regardless of the age of the license!

## The Commandments

I. If you have trees, use them! Most anything with some height to get your antenna in the clear will be a bonus.

II. Make friends with your neighbors and educate them about your wonderful hobby. This can be a tricky one depending on where you live and your neighbors' past experiences with other hams, if any. I cannot stress good PR enough. It goes a long way when you help your neighbor fix something with their house—maybe a leaky garden hose, or, especially, something electronic—like hooking up or programming a new VCR. In my case, I get to use their trees as antenna supports.

*Continued on page 82*

# Corner Beam?

**Big Forward Gain  
Wide Backward Rejection  
Exceptional Bandwidth  
Distortion Free Pattern**

Your antenna makes all the difference at VHF and UHF—It determines transmitting range. It sets the limit for weak signal reception. And it decides what interference you'll hear and create.

An omnidirectional antenna radiates uniformly in all direction, and it also hears noise and interference from every direction.

A directional antenna not only sends your signal where you want, it hears the signal it's pointed at, rejecting others. It also lets you operate with minimal power, cutting interference you inflict on other stations.

CornerBeam's clean sharp pattern without sidelobes or spikes reaches past the noise and interference to get the message through. Its wide rear rejection lets you null out strong nearby signals to reduce interference.

#### Look what CornerBeam does:

- 10 dB gain vs. dipole
- 40 dB Front-to-Back
- 60 degree Half-power Beamwidth
- SWR <1.1:1 across the band
- No dimension over 4 ft
- Mounts directly to mast or tower
- Vertical or horizontal polarization
- No need for offset or side mount



#### Corner Beats Yagi

A yagi with the same gain would have a 10-ft boom. Yagi bandwidth would be less than half. More important, CornerBeam produces no side lobes, no back lobes.

#### Improved Data Communication

Because CornerBeam's pattern has no unwanted side spikes, phase noise is reduced to a minimum. The result is reduced data error rate, faster packet circuits. When you want a distortion free signal, think CornerBeam, not yagi.

#### CornerBeam for Repeaters

If your repeater shares a frequency with another, the deep wide null toward the rear could keep your signal out of the neighboring repeater's receiver and turn a deaf ear to its signal. A pair of CornerBeams can be combined to provide special radiation footprints. A CornerBeam aimed at an area your repeater hears poorly could improve service where incoming signals from HTs are presently too weak. CornerBeam makes it possible to increase repeater density while reducing interference.

#### Bandwidth Pays Off

With its exceptional bandwidth, your CornerBeam can be put to work right out of the box without special tweaking. It can serve you now when you're working repeaters with an FM handheld, and later when you set out to work satellites or go after small signal DX at 144.2 MHz.

CornerBeam can still be your beam when you join MARS at 143/148 MHz or team up with the sheriff's communications interface team at 158 MHz.

#### Scanning Too?

CornerBeam's gain & bandwidth extend monitoring range from aircraft to to marine & public service frequencies. ■

#### On the Internet

[www.itsnet.com/~radventr](http://www.itsnet.com/~radventr)

#### Corner Beam Models

Band	Max Dim	WindLd	Price
2 meters	4 ft	<2 sqft	\$145
220 MHz	4 ft	<1 sqft	\$145
70 cm	3 ft	<1 sqft	\$115
Dual 146/435	4 ft	<3 sqft	\$165

#### Construction: Aircraft aluminum.

Booms are square. Elements are solid rod. Stainless hardware included for tower and mast mounting accepts up to 1.5" dia. mast and may be rotated for vertical or horizontal polarization. Connector is SO-239 for VHF, N female for UHF. Dual-Band antenna has separate driven elements, weighs only 10 pounds.

**Dimensions** given in table are for reflector elements & booms.

**Options:** Commercial Frequency \$45.

**Duplexer:** Add \$80 for VHF/UHF

Duplexer and cabling for single coax feed of Dualband 146/435 Corner.

**Shipping:** UPS ground to continental USA (\$11 S&H). Air Parcel Post to HI, AK, & Possessions (\$14 P&H). Canada (\$16 P&H).

Allow 2 weeks for delivery.

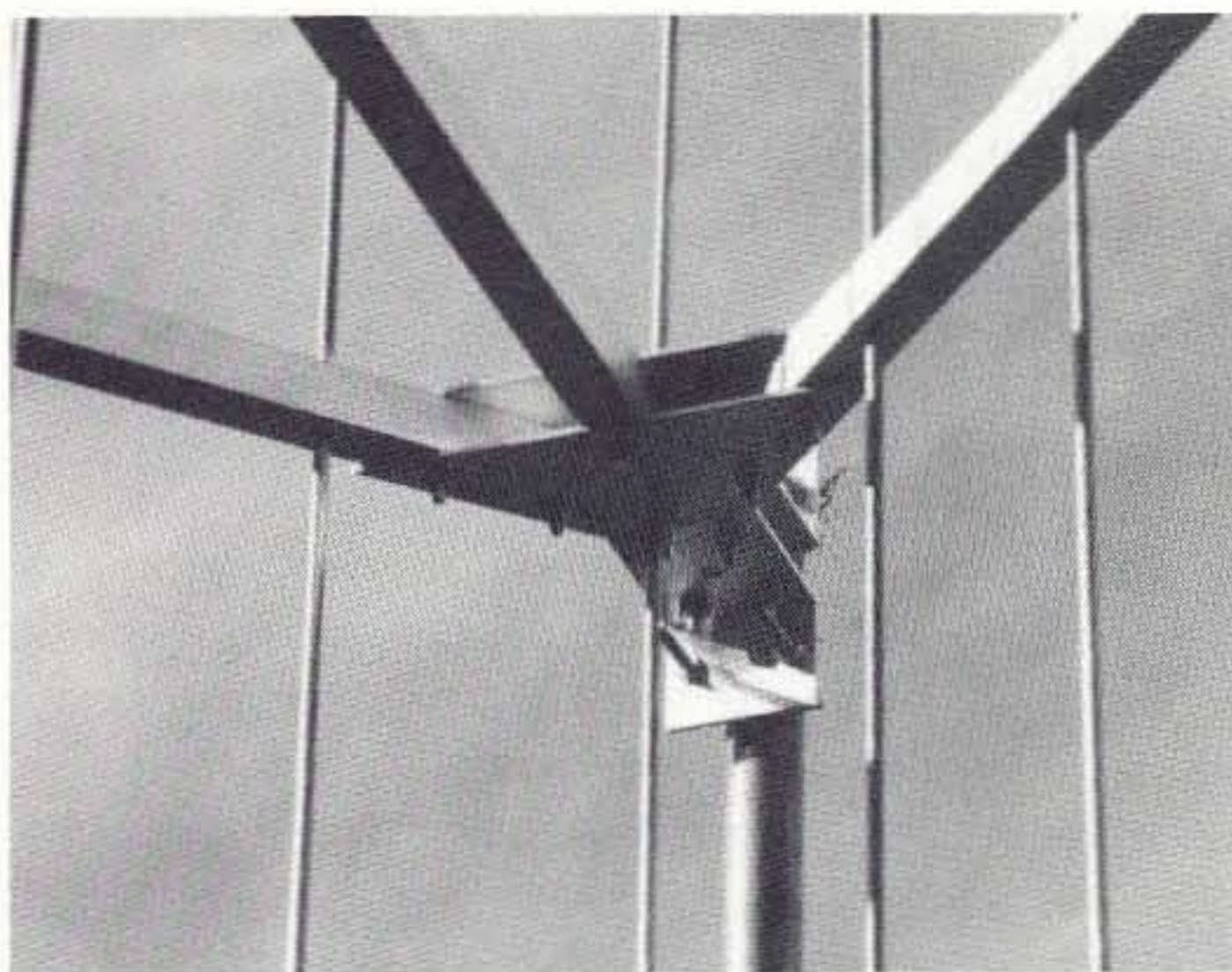

#### Measured CornerBeam Pattern

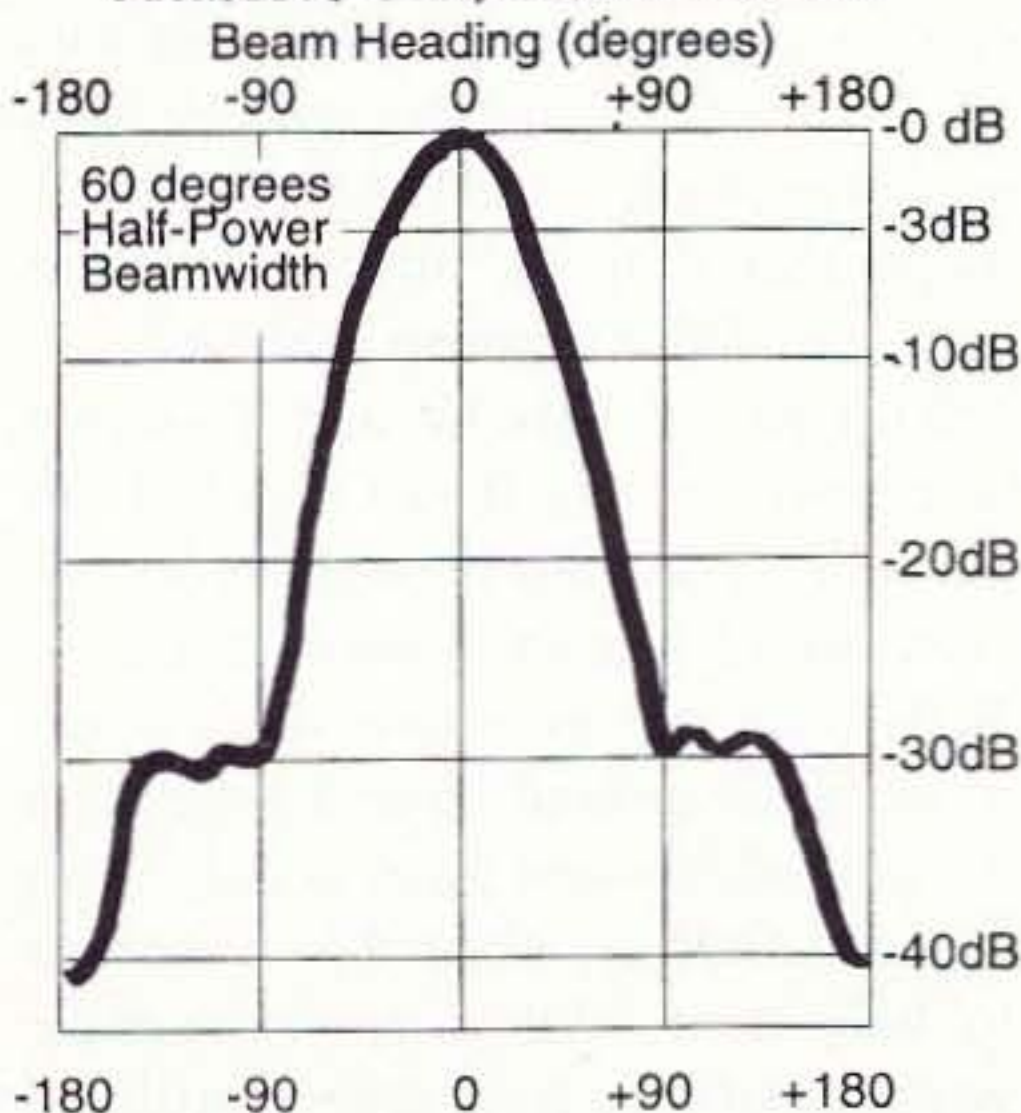

#### Yes, I want Performance in My Corner!

Send my CornerBeam:  2m,  220MHz,  70 cm,  Dual 146/435.

Options:  DualBand Duplexer,  Commercial/Marine. Frequency: \_\_\_\_\_

Name \_\_\_\_\_ Amt. Enclosed \_\_\_\_\_

Call \_\_\_\_\_ Phone \_\_\_\_\_

Street \_\_\_\_\_ Unit \_\_\_\_\_

City \_\_\_\_\_ State \_\_\_\_\_ Zip \_\_\_\_\_

**Antennas West**

Box 50062-S Provo UT 84605

InfoPak

\$1

Tech 801 373 8425 Fax 801 373 8426

Order Hotline

**800 926 7373**

CIRCLE 57 ON READER SERVICE CARD

III. Get your antenna in the clear as much as possible and away from the house as well, if you can. This can help alleviate RFI from bugging the XYL (TVI or touch-sensitive lamps turning on and off when you transmit).

IV. What they can't see, they can't complain about. I will go more into this one later.

V. Camouflage, camouflage, camouflage! More on this one later, too.

VI. Put more into your antenna and coax than power amplifiers (more planning, more effort, more money, but don't go overboard). The most important part of a good transmitting and receiving system will always be the antenna. Need I say more?

VII. Plan ahead. Good planning now can mean WAS or DXCC later.

VIII. If at first you don't succeed, keep trying!

*Commandment I: If you have trees, use them!*

Most areas of the country have trees, but many new subdivisions cut them all down to make way for "progress." Sometimes they replant new trees but these are young and short. If you do not have any trees in your yard or your neighbor's yard or are in an apartment, find another tall support. Look around—you may get lucky! For years, I have successfully used trees as antenna supports. One of my antennas is an insulated (to prevent DC shorts and corrosion) wire that runs to the top of a tree and back down again. It is with this antenna that I worked 35 new states towards my WAS during the 160-meter contest last February, most of these during the first night and most



**Photo A.** This modified remote tuner is the heart of the author's stealth system (plans in Part 2).

with a 5-9 signal! (I had to start my quest for WAS all over again as I moved quite a bit from my previous QTH.) I will go over this antenna in great detail in Part 2 of this article.

*Commandment II: Make friends with your neighbors.*

I can't go far enough with this subject. I have found that if properly approached, most people couldn't care less about your antennas—especially if they can't see them. The antenna size-to-disapproval rating seems to follow an exponential curve, so I won't be pushing for a triband beam anytime soon and I have done fairly well without it. Be sure to introduce yourself to your new neighbors as soon as you can and let them get to know *you* first before you tell them about your hobby. That way they will already know that you are a reasonable person and will not feel so threatened when you ask to use their tree as a wire antenna support. Some of my new neighbors got me a little nervous when I asked them about using one of their trees to be a support for my inverted L antenna and they wanted to see what I was talking about. Once I showed them the wire and what I was planning to do, they couldn't have cared less. A quick prayer beforehand might also have been a help.

*Commandment III: Get your antenna in the clear as much as possible.*

As has been written many times, the more an antenna is in the clear, the better it will radiate and the more uniform and predictable the radiation pattern will be. Unless you plan on having a tuner as part of your antenna design, keep your antenna away from objects that could cause it to detune during changing weather or other conditions. Nearby metal objects such as gutters should be avoided unless you are tuning it up as an antenna.

I prefer to keep my antennas away from my house for several reasons: It lowers the RF levels at the shack inside the house, reducing TVI, phone interference, touch-sensitive lamp tripping, and even starting the air conditioning system. It lowers the received

noise from sources located inside my house. I also prefer not to have an indoor antenna—my ductwork throughout the attic has a metalized jacket and the insulation sheathing of my house is covered with aluminum foil, which acts as an RF shield. If you have no other choices, some antennas in less-than-optimal locations are better than none.

*Commandment IV: What they can't see, they can't complain about.*

*Commandment V: Camouflage, camouflage, camouflage!*

These two go together. Be discreet. If you can keep your antenna out of plain sight by using the natural or manmade surroundings of your QTH, do it! As I mentioned earlier, one of my antennas runs up to the top branch of a tall tree in my backyard (mostly) along its trunk and then back down again. The keys to its ambiguity are: the wire gauge is fairly thin (20-gauge, multistranded and insulated; it was zip cord from Radio Shack™ that I split in half) and it was spray-painted with camouflage colors to match that of the tree supporting it. Recently while strolling through the paint section of my local Home Depot™ I found that Krylon® now makes several colors of camouflage paint. They have a flat sheen and come in brown, green, and beige colors. I did the same thing with the inverted L and it blends in very well with the trees.

A note concerning the inverted L: I used larger wire for the horizontal span and smaller wire for the vertical section. I also keep a reasonable amount of slack in the horizontal span section to improve its chances of survival when strong winds cause the trees to sway. When I used thinner wire, I found that it broke on two different occasions. What a pain to restring it!

Back to numbers IV and V—make sure your antenna is not visible from the street. Use your house to block the view; wooden privacy fences help, too. Both of my antennas have tuner boxes mounted at ground level. I have used the aforementioned paint to help them blend in and have planted some bushes to hide them. Other operators have written that they have draped artificial

vines on their antennas to blend them in with the surroundings. Of course, these do not have wire cores. But here's an idea: What if you used the wire core of an artificial vine as a disguised antenna? See? There are *many* ways to get an antenna up in the air without drawing attention.

*Commandment VI: Put more into your antenna and coax (money and time) than power amplifiers.*

What bands you plan to operate on and what power level you plan to use will determine the *minimum* requirements for your coaxial cable, tuner rating, etc. My longest run is about 100 feet and the bands I will operate from this antenna are 160–40 meters at 100 watts. I stuck with RG-8X because the added cost and size of RG-8 wasn't worth it for me at these low frequencies, and RG-58 was definitely out of the question. The RG-8X was also a nice size for pulling multiple runs through my conduit. If you will be running your coax outside in conduit, make sure that the jacket can sustain extended periods of time under water without breakdown.

Most quality coaxes will meet this requirement. However, if you plan on exposing the coax to direct sunlight, get one with a UV-rated jacket so you will get some life out of it. I used some that was not UV-rated and in six months the jacket had become hard and cracked, letting in moisture to corrode the copper jacket. If you plan to run higher frequencies, look at using a quality grade of RG-8 or RG-213. I will not go into VHF and higher frequencies here, as there are many other things to consider.

Your tuner, if you have one, should be able to properly handle the power output of your transmitter. Make sure that your inductor is as large a gauge as possible to reduce power losses, and that your capacitors have a sufficient voltage rating to handle the power output of your transmitter. If it will be outside, make sure you weatherproof it as well as you can. There are surplus Fiberglas™ boxes that work really well. They are UV-resistant and large enough to fit most tuner needs. The

more watertight your enclosure, the less often you will have to replace corroded wires and contacts. For those of you with antennas that require a ground system, I will go into that subject in the next section. A good antenna in a good location with a good match will go a long way. Just ask the QRP aficionados.

*Commandment VII: Plan ahead. Good planning now can mean WAS or DXCC later.*

If you have an opportunity to put in the required elements for a good antenna system way before you ever plan on completing it, do it. When I moved into my new house, the backyard was grass-seeded and was pretty sparse. My wife and I committed early on to putting down sod since we have dogs and a small child and didn't want to be cleaning dirt and clay off of the floor everyday. Before we put down the sod, I ran two-inch conduit with sprinkler valve boxes (available at home improvement or plumbing stores) in future antenna locations. I also spread out a ground system of eight to 10 pieces of 12-gauge insulated copper wire on top of the dirt. Each radial originated from an area most likely to host a vertical. This was all in place at least a year before I put in the antenna, but at least it was there. It would be a lot more difficult to put this in with the sod already in place.

### More on ground systems

For a vertical antenna or any type requiring a ground system, this is the heart of its efficiency. Practically speaking, the more of and the longer the radials, the better. Soil conductivity, proximity to the water table, and salt water if you are lucky, determine how well the ground system will work. A reasonable ground system consists of four to eight quarter-wavelength (for the lowest frequency of operation) radials equally spaced. There would be some improvement in ground efficiency from eight to 16 and a little more from 16 to 32, and so on, but more radials beyond this point will have a diminishing return. For most amateur standards, eight will do just

fine. If you do not have the real estate to do this, put out as many as you can as long as you can. You may bend the radials around the corner of your house or lot if necessary. Don't get discouraged if you can't put up an optimal system as you might see in books and articles; install what you can. It is better than no ground at all. Another alternative is to put a screen such as chicken wire or hardware cloth under the base of the antenna. Copper mesh is best if you can afford it or find it. Surface area is very important so keep that in mind. Larger wire is preferred over small wire and copper strips are preferred over wire and so on.

*Commandment VIII: If at first you don't succeed, keep trying!*

If your first antenna doesn't work well, talk to some other local hams who may have some ideas to improve your situation. There are a lot of commercial antennas out there that tailor to the needs of those with limited space or antenna restrictions. Check them out to see if their performance will meet your needs and your wallet will accommodate their costs. If you have to erect a portable antenna every time you want to operate, find ways to minimize the setup so it is not such a chore. Use a mobile antenna on your car; I don't know of any antenna restrictions on that.

My hope is that you will be able to use some of the ideas presented here to put up an antenna system that will be right for you. In Part 2 of this article I will review an inexpensive multiband antenna system that I put together and am currently using successfully. Remember: Life, liberty, and pursuit of QSOs! 73

## WANTED

Fun, easy to build projects for publication in 73.

For more info, write to:

Joyce Sawtelle,  
73 Amateur Radio Today,  
70 Route 202 North,  
Peterborough NH 03458.

# UPDATES

## WE DIDN'T HEAR ANY BEEPING ...

Unfortunately, the wiring for the two probes was transposed in the schematic diagrams for the "Beeper Short Circuit Detective" project in the December 1997 "Ham To Ham" column. Here's how the correct wiring should be:

Probe #1: One wire goes to the junction of R4 and R5, the other to IC2, pin 3.

Probe #2: One wire goes to common (shown as the ground symbol), the other to the negative end of C2.

The PCB offered by FAR Circuits is correct with regard to the above probe pads, but capacitor C2 is marked on the board incorrectly. The plus (+) sign on the board should actually be the

negative end of C2. This is relevant only to those readers who ordered the FAR Circuits PCB.

## SIDETRACKED SATTRACK

In the review of the SatTrack automatic satellite tracking system (page 32, 73, January 1998) somehow the final paragraph of text wandered off. Reader Ralph Katz KB8ZQY noticed that the address and contact information were missing—and he's absolutely correct: What good is a glowing review if you can't find the manufacturer? This should help:

C&S Engineering  
9229 Goldenrod Drive  
Fort Wayne IN 46835  
Telephone (219) 485-1458.

## NEVER SAY DIE

*Continued from page 49*

the womb and while they were young children? How many Strauss CDs have you in your collection? How about Joplin? And I mean Scott Joplin, not Janis. If you're not sure what to buy in classical music, spend the two bucks for my guide to a 100-CD classical music collection.

## From Inside Arabia

A letter from AB4Y, who is working in Saudi Arabia, got me to thinking about the repercussions of the development of cold fusion. Our small towns will be enhanced by the loss of all those corner gas stations, but what will happen to the OPEC countries? My correspondent says that when the demand for oil vanishes the Saudis will go back to the 6th century. The Saudis have no literature, no skills, no infrastructure, nothing that will allow their country to exist. Saudis have no work ethic, no conception of learning, no appreciation for the value of education—espe-

cially technical and engineering education—no concept of the non-Muslim world, no ambition, no drive, no concept of excellence. Without the oil the country would go back to people living in tents in the desert.

Their technical work is done by Pakistanis, Muslim Indians, and Filipinos. Grunt labor is done by Sri Lankans, Bangladeshis, and Yemenis. Chuck's company brought in 130 Sri Lankans to clean up the airport.

He says the toilets are filthy. They were designed with toilet paper holders, but they don't use paper. Instead, they have a hole in the floor with places for your feet as you squat and a hose to wash yourself off afterward. The Saudi version of the bidet. There's no soap or paper towels in the public toilets (hmm, that's like many of ours).

In Arabia, Israel is a non-country. Books and magazines have the word "Israel" blacked out. It's blacked out on wall maps. Also, any depiction of the female body is blacked out. The government

has hundreds of Bengalis to put India ink on any photo that might be objectionable. Even articles and drawings in the *Reader's Digest* are cut out or blacked out. All pictures of men and women kissing, and any references to alcohol, including beer, are blacked out.

All incoming packages are inspected, and using the Internet is forbidden. Satellite dish users must subscribe only to approved channels. Well, you get the idea.

The advent of a new energy source such as cold fusion will be catastrophic to most of the Arab oil countries, who have been living a life of ease on oil money.

## College

My father was just the right age when World War I came along, so he went to military school and then into the Army, where he opted for the Army Air Force. He always felt inferior about having missed college, so there never was any question during my school years about my going on to college. Which I dutifully did.

Fortunately, in a way, World War II came along and sucked me into the Navy after two years at Rensselaer Polytechnic Institute. Well, being a New Hampshire boy, I'd planned on going to Dartmouth, but my being a ham and up to here in building electronic equipment convinced my high school advisors that I really should go for electrical engineering. So I did. Big mistake.

The Navy electronic school was superb. I loved it! Then, four years later, after the War, I went back to RPI to finish up. Unfortunately, by then I'd started to wise up. Oh, I enjoyed being president of the Radio Club, singing in the Glee Club, being the sound man for The Players, and working the world from my super ham station in the basement of our fraternity house (Sigma Chi). We were riding high, with our president being elected the Grand Marshall of the school, and our winning both the interfraternity scholarship and sports cups. Plus

we lived in the old governor's mansion in the posh part of town. That was nice because I had lots of room to hang wire antennas.

But the college was lousy. Beautiful campus, bum curriculum, plus terrible teachers.

The professors were busy doing research and had little time for teaching, so we had to make do with graduate students as teachers. If you bother to read any of the education magazines or books, you know that this situation has gotten infinitely worse since my days in college.

Thirty years ago, professors averaged 12-15 hours a week teaching. Now it's six hours or less a week. That means it's taking two or three times as many professors to teach. So, if you have any question as to why college costs have been rising far faster than inflation, just remember that teacher salaries have been way ahead of inflation for years, and we need twice as many.

So what are all these professors researching? You don't want to know. Their aim is to earn tenure, and that means being published. So one professor is doing a study of wood rats to try and see why they are leaving Pennsylvania. 99.44% of the research papers are published and disappear into college libraries, never to be seen (or needed) again. But that's the system, and the only people who really suffer are the students, who have to help pay for all this foolishness. Well, actually, mostly it's their parents who are paying the bills.

As I've griped before, the usual college graduate has managed to forget around 95% of what was "learned" by cap and gown time. Fortunately, 99% of the stuff crammed into their heads for test passing has little relevance to their later business, family, or social lives, so it doesn't matter that it's forgotten.

Those research projects cost a lot more than the professor's time. There's often travel, laboratory equipment, and research assistants. Then there's the art of grant proposal writing, which is



a whole industry in itself. But then grants are a multi-billion-dollar industry, and one way or another we're footing the bill for this nonsense.

Well, gee, look at some of the amazing developments that have come from the system—like the transistor. Well, um, maybe. There's powerful evidence now that many of our more remarkable discoveries resulted from the infusion of alien technology recovered from crashed UFOs. Col. Corso was the man at the Pentagon who helped researchers develop transistors, ICs, lasers, night vision, and other breakthroughs. Read his book, *The Day After Roswell*, for the full story. It's been a best seller, and no one has yet come forward to challenge his story. Several people with excellent credentials have confirmed it.

If you've been reading much you've seen some of the silly research projects that have been funded. You know, like Professor Jane Dirks of Carlow College, who did a study of the ethnic backgrounds of people she met while walking her dog. Her paper was presented at a meeting of the American Anthropological Association. Darn, the wonderful things we've been missing!

### Ron Brown

I've been listening to the Art Bell radio talk show and you haven't—otherwise you'd know about the bullet hole that was found in Secretary Ron Brown's head when his body was brought back from the airplane "accident" in Croatia. Investigative reporter Chris Rudy had both an interesting story and the evidence to back it up.

You probably remember the reporting on the so-called accident, where the plane with Ron Brown and a group of American businessmen crashed, killing everyone aboard. The first reports were that bad weather was involved. Later, it was admitted that the weather was just fine. Then they said there was a problem with a missing or misplaced radio navigation signal which had led the plane astray. Unfortunately the man

who they claimed had moved the transmitter was found as an apparent suicide.

The doctor who examined Brown's body when it was brought back to the US reported a hole in the middle of his forehead. X-rays showed the fragments of a bullet inside the head. Rudy took photos of the body and the x-rays, which were posted on the Art Bell Web site ([www.artbell.com](http://www.artbell.com)). Later, another x-ray was made, with the x-ray out of focus enough so the bullet fragments didn't show. Now I know you're not going to believe this, but nothing whatever was mentioned of the bullet hole in the final medical report, and all of the x-rays have disappeared.

The "accident" put an end to a lot of embarrassing stuff that was expected to come from a pending official investigation of Ron Brown's affairs which was predicted to result in the indictment of several high government officials.

I realize that Bell's show is on in the wee hours, but he has interesting enough guests to make it worthwhile to record his show and listen to it at your convenience. Yes, he's on in your area—you just have to tune around the AM radio band some night and find which station brings it in best. He's on from 10 p.m. until 3 a.m. Pacific time five nights a week. I get him best on 1210 WPHT (Philly), 770 WABC (NYC), and 1100 WTAM (Cleveland). I use my VCR to tape the show.

### The Rat Race

If you are not a rat, why are you stuck in the rat race?

Okay, what do I mean by the rat race? Fair enough question. Let me try to quantify it. You're participating in the rat race if you:

1. Have been working for someone else for more than a year or two.
2. Went to a public school.
3. Went to college.
4. Aren't making enough money and don't have the freedom to travel when you want to.
5. Have a chronic illness.

6. Are addicted to alcohol, caffeine, or nicotine.

7. Are living in a major city.

Well, you get the picture, and the odds are that you are in the rat race, complete with the usual stresses. Hey, I worked for others for several years. I went to public school. I went to college, and I lived in New York City for 30 years, on and off, so I know the rat race personally. And the resulting stresses.

But, as soon as it was even remotely practical, I moved from New York to New Hampshire. And by the time I was 40 I'd visited over 50 countries. If it hadn't been for WWII, which took four very valuable years out of my life, I might have progressed earlier.

Of course, I didn't know any better than to go with the flow (floe?), so I sucked in, along with everyone else, on the group-think acceptance of the usual life track. There were no books or magazine articles suggesting that there might be some alternatives. In the 1960s millions of kids opted to drop out of the system. Their alternative, a version of socialism, failed, just as socialistic approaches have failed everywhere they've been tried.

Just because our public schools suck and are getting suckier; just because our colleges ditto; just because our medical industry is screwing the hell out of us; just because our politicians are ditto; just because our legal and prison system are ridiculously expensive and are failing to do their job; just because most of us are stuck working for a jerk, and with little in prospect in the long run—is no reason to stay mired in the depths of a rut when making some changes in your habits and thinking could let you thumb your nose at the crap everyone else has to live with.

### Free Will

I've been thinking again, which is never a good sign for readers who are monomaniacal about amateur radio. How much can you think about amateur radio, anyway? The

short, dry editorials in the other ham rags answer that question. Also, our betters at the League have decreed that we should not discuss politics or religion over the air—and by extension, this would hold for the ham magazines. Only the free-thinking or the rebellious dare challenge the ARRL dictates (made for our own good, of course). Fortunately these weirdos are in the minority.

That written, let's consider the concept of free will. How much free will do we have in life? Those of you who've done your homework and watched the movie *7-14-21-28-35* have graphically seen how firmly established are the patterns of a whole lifetime by the time a child is seven years old.

The documentary interviewed a bunch of kids when they were seven, then 14, 21, and so on. While it did demonstrate how little we change after childhood, it didn't go into the things that had formed their characters so solidly by the time they were seven. The influences of the parents and extended family, of treatment during the prenatal period, the birthing process, day care, and so on. These are the experiences upon which a lifetime of living are built and habit patterns formed which are virtually unbreakable.

If you smoke or are fat, you know how powerful habits can be. Alcoholics and other drug addicts know, too. And it's these same destructive habits which keep us from changing our eating, working and behavioral patterns. You know by now that changing your diet to one mostly of raw fruit and vegetables and stopping your input of poisons will help clear up most of your chronic illnesses and extend your life substantially. But that doesn't get you to pass up McDonald's™, Dunkin Donuts™ or KFC™. It doesn't stop your drinking coffee or eating Danish. Or fries with your Whopper™.

Which brings up the question—since these lifestyle patterns (habits) are learned early, they're the result of the early training of your parents and

teachers—so how much freedom of will do we actually have?

We tend to equate complexity with randomness. That's why chaos theory so surprised scientists. There turned out to be some sort of order to what we'd perceived as randomness. Hmm. Which brings up the question of whether there is any randomness at all? Is the future solidly written in the patterns of the past and present?

One of the big problems computer scientists faced was what seemed like a simple matter: designing a random number generator. It was needed for shuffling cards and rolling dice by game designers. It turned out to be a major problem. Computers, like Mr. Spock, are totally logical, so there is no randomness anywhere in their workings. The programmers "solved" this problem by designing pseudo-random generators.

By extension, if the complexity of the cause and effect of weather patterns could be coped with, we would see that there is *no* randomness involved. Yes, we'd have to be able to take into consideration the flight of a butterfly and how the movement of air caused by its wings will affect the weather a thousand miles away. That's complex beyond our brains or computers, but is there any randomness really involved?

Viewed from that perspective, the universe, our galaxy, our solar system, our planet, and your life are all the inevitable product of an enormously complex system. Complex? You bet! Random?

I'm reminded of the fatalistic beliefs of the Egyptians when my father visited Egypt in 1938, while setting up bases for the first trans-Atlantic airline, American Export Airlines. When driving through Muslim countries he had to beat on the door of his car to get pedestrians to move out of the way. Their belief that they would die when their time had come was so strong that they refused to get out of the way of cars. They were not going to die until their

time had come, and when it did, nothing could prevent it.

American Export Lines was America's leading steamship line and their major tourist route was around the Mediterranean Sea, so that's where they wanted their airline to go, too. My father spent a year organizing seaplane bases for the airline in places like Barcelona, Genoa, Beirut, and Alexandria. There were few international airports in those days, so flying boats were the only practical way to fly. Then came WWII, with the Navy taking over control. The airline ran all through the war under my dad's direction, going the southern route during the winter via Belem to Dakar and up to London. In the summer they flew via Gander, Newfoundland, to Iceland and London.

Just before the end of the war President Roosevelt, who was a good friend of Juan Trippe, the president of Pan-American, issued a Presidential Order saying that no steamship line could own an airline. This ended with Pan-American taking over American Export Airlines. How much in political "donations" did that order cost Pan-American?

Ooops, as usual I have digressed.

Knowing that being overweight is going to make you sick and shorten your life, do you have the free will to change your diet and to stop poisoning your body? Can you stop smoking, drinking beer and coffee? Will you invest \$180 in a Genesis™ still from Damark and stop poisoning your body with fluorides, chlorine and all the other toxic crap your water supply is providing? Like the Arabs, will you refuse to get out of the way of the onrushing truck (figuratively)? By the time you have emphysema, a heart attack or a stroke, the moving finger will have writ. But it's *your* finger that has done the writing, not Mother Nature or God. Or Satan. Unless you are a total prisoner of your habits (which includes procrastination) you can opt for Alzheimer's and being tied to a chair in a nursing home or for being out

there skiing the slopes of Aspen with me. I think you *do* have a choice.

### Gold Mine

If you know of any lawyers who might be interested in making some really big bucks, there's a golden opportunity for them just waiting. For once the lawyers in England are way ahead of our American counterparts. They, with the help of the government, have instituted class action suits against Colgate™ for the damage the fluorides in their toothpaste have done in permanently discoloring children's teeth. It's called dental fluorosis and is a discoloring and mottling of the teeth caused by fluorides in the drinking water and in fluoride-laced products, such as toothpaste.

In the first case Colgate settled out of court for nearly \$2,000 to a 10-year-old child.

In the US it is estimated that around 30% of the children in nonfluoridated water areas suffer from some degree of fluorosis and around 80% of the children are affected in areas where the water is fluoridated.

In addition to municipalities adding fluorides to their water and toothpaste companies adding fluorides, also liable would be dentists and pediatricians who daub fluorides on their patients' teeth or prescribe fluoride supplements. Bonanza!

Liable, also, would be newspapers and magazines endorsing the use of fluoride supplements or water fluoridation, media advertising fluoridated products, the manufacturers of the products, and their advertising agencies.

While there are some products which might not, by themselves, result in dental fluorosis (mottling), their products do contribute to the problem and could be named as co-defendants, providing some very deep pockets to pick for enterprising lawyers.

Dental fluorosis has been a well known result of fluoride exposure for many years, so the firms and groups providing these products have no excuse that "they didn't know"

about it. Thus, they have the responsibility to warn customers of possible injury from their products.

If you have been brainwashed by the media and the ADA on the benefits of fluoridated water it's time to do some homework and dirty up your mind with some data. If you'll read *Fluoride, The Aging Factor*, by Dr. Yiamouyiannis (#4162 from Acres USA, \$15), which I've recommended in my past editorials (please stop griping about my being repetitious—I'll stop when you stop ignoring what I'm telling you), you find that there are no known benefits to the drinkers of fluoridated water and plenty of dangers. The book is also reviewed in my \$5 *Guide to Books You're Crazy if You Don't Read*. The truth is that a high percentage of us in America are being slowly poisoned and it's shortening our lives. Fluorides increase the risk of heart disease, cancer, allergies, and even brain damage.

If fluoridation is so great, why have 12 Nobel Prize winners termed it worthless? And why have Austria, Egypt, France, Germany, Greece, Holland, India, Italy, Norway, Spain, Sweden and other countries either never accepted or else stopped fluoridation?

The worthlessness of fluorides in the water as far as preventing tooth decay in children goes has been proven in double-blind tests. What hasn't yet been documented is what it is doing in the way of birth defects, which can be subtle. Mothers who don't distill their water before drinking it are taking one heck of a gamble with the lives of their children.

These chemicals are big business and generate millions of dollars for the producers.

Oh, yes, have you looked at the fine print on any of the fluoride-laced toothpastes recently? Since April of 1997 they've all had to have a poison warning on them.

No, I'm not going to get into an argument over whether brain damage makes a person more likely to become a ham. You listen to 14,313 for a while and make up your own mind. 

# PROPAGATION

Hoo, boy! I'm not sure if I should tell you to put on your boots, snowshoes, or wind-breakers! The "conditions" between the 10th and 12th, and again between the 21st and 23rd, could be awesome from the standpoint of weather and other geophysical effects, as well as propagation. There may be greatly increased solar activity on or about the 11th and again around the 22nd which could shut down the HF bands, then bring them to life! Within a few days after a "blackout," the bands usually recover from excessive ionization. You may discover superb DX propagation for a week after the 26th, but probably not between the 12th and 15th.

On the days surrounding poor or very poor HF activity, VHFers should pay close attention to the bands and expect some unusually interesting DX, particularly on six and two meters.

Generally Poor, except for occasional transequatorial propagation with F2 openings on the best days—most likely South and Central America.

DX to Africa and Latin America on the Good days possible, with short-skip out to about 1,000 miles or so in the US.

Your best band for DX openings around the world from dawn to dark, and openings to the Southern Hemisphere after dark in evening hours. You can expect excellent short-skip during the daytime to 2,500 miles or so.

These bands ought to be open for DX from just before sunset to just after sunrise. Signals from the east should peak until midnight, and after midnight to other areas. Daylight short-skip of about 500 miles will be possible, and

MARCH 1998						
SUN	MON	TUE	WED	THU	FRI	SAT
1 G	2 G-F	3 F	4 F	5 F	6 F	7 F
8 F	9 F-P	10 P-VP	11 VP-P	12 P-F	13 F	14 F
15 F-G	16 G	17 G	18 G-F	19 F	20 F-P	21 P-VP
22 VP	23 P	24 P-F	25 F-G	26 G	27 G	28 G
29 G	30 G	31 G				

nighttime short-skip to 1,500 miles or more will be available.

Occasional DX to various areas of the world should be possible between sunset and sunrise when QRN levels permit on Good (G) days (see calendar). Short-skip during darkness to 1,500 miles or more.

This band ought to begin to come alive during the hours of darkness when QRN permits. Try the days marked G on the calendar for best results. DX toward the east until midnight, and to other areas afterwards until dawn. Short-skip to 1,500 miles will prevail when the band is quiet. 73, W1XU.

EASTERN UNITED STATES TO:												
GMT:	00	02	04	06	08	10	12	14	16	18	20	22
ALASKA							20	20				
ARGENTINA								15	15	15	15	15
AUSTRALIA						40	20	20			15	15
CANAL ZONE	20	40	40	40	40		20	15	15	15	15	20
ENGLAND	40	40	40				20	20	20	20		
HAWAII		20			40	40	20	20				15
INDIA							20	20				
JAPAN							20	20				
MEXICO		40	40	40	40		20	15	15	15	15	
PHILIPPINES							20	20				
PUERTO RICO		40	40	40			20	15	15	15	15	
RUSSIA (C.I.S.)							20	20				
SOUTH AFRICA									15	15	15	
WEST COAST			80	80	40	40	40	20	20	20		

CENTRAL UNITED STATES TO:												
ALASKA	20	20							15			
ARGENTINA										15	15	15
AUSTRALIA	15	20				40	20	20				15
CANAL ZONE	20	20	40	40	40	40			15	15	15	20
ENGLAND		40	40					20	20	20	20	
HAWAII	15	20	20	20	40	40	40					15
INDIA								20	20			
JAPAN								20	20			
MEXICO	20	20	40	40	40	40			15	15	15	20
PHILIPPINES								20	20			
PUERTO RICO	20	20	40	40	40	40			15	15	15	20
RUSSIA (C.I.S.)								20	20			
SOUTH AFRICA										15	15	20

WESTERN UNITED STATES TO:												
ALASKA	20	20	20		40	40	40	40				15
ARGENTINA	15	20		40	40	40					15	15
AUSTRALIA		15	20	20			40	40				
CANAL ZONE			20	20	20	20	20	20				15
ENGLAND									20	20		
HAWAII	15	20	20	40	40	40	40					15
INDIA		20	20									
JAPAN	20	20	20			40	40	40			20	20
MEXICO			20	20	20	20	20					15
PHILIPPINES	15							40		20		
PUERTO RICO			20	20	20	20	20	20				15
RUSSIA (C.I.S.)									20			
SOUTH AFRICA										15	15	
EAST COAST	80	80	40	40	40	40	40	20	20	20		

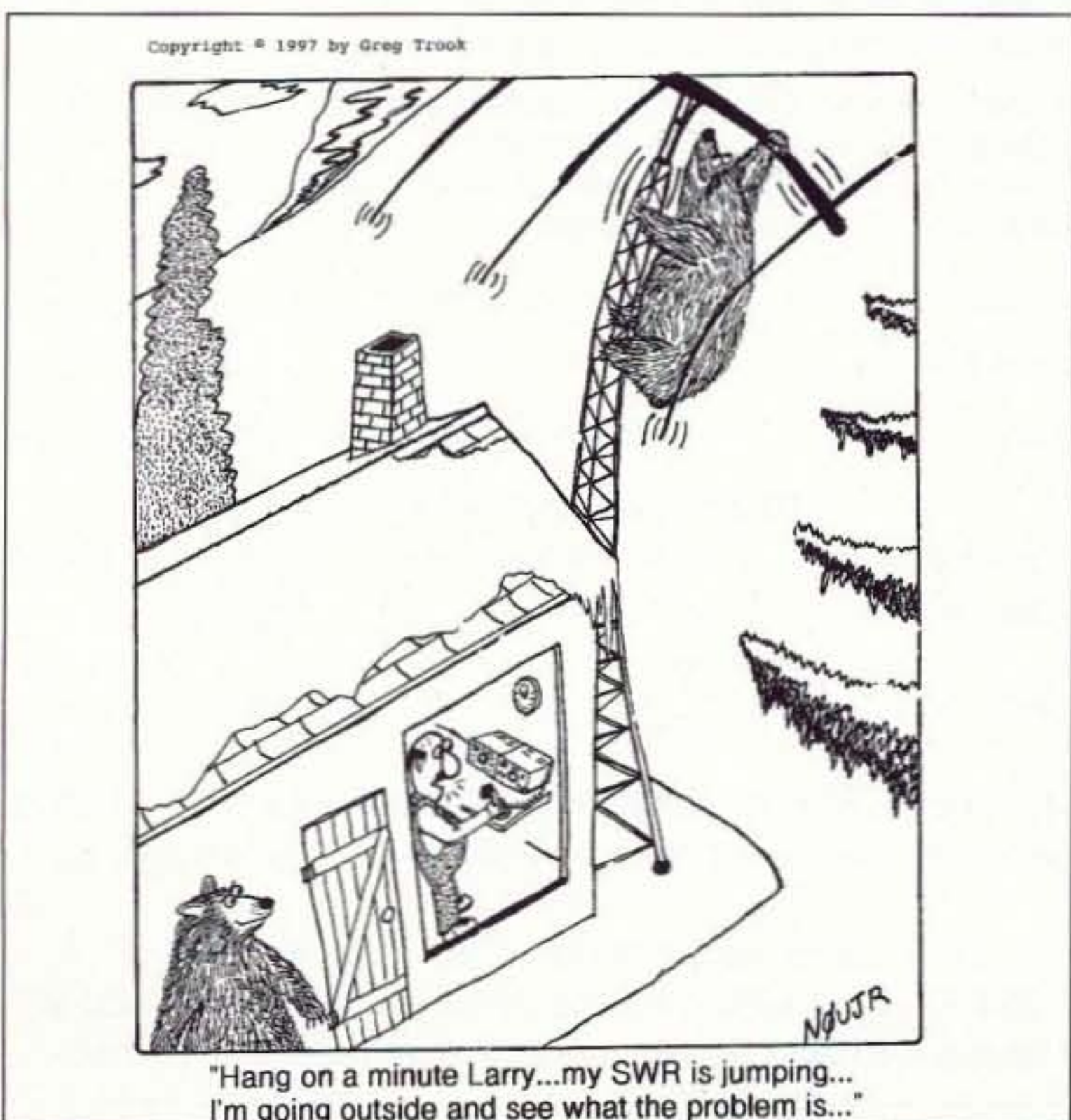

# Barter 'n' Buy

Turn your old ham and computer gear into cash now. Sure, you can wait for a hamfest to try and dump it, but you know you'll get a far more realistic price if you have it out where 100,000 active ham potential buyers can see it, rather than the few hundred local hams who come by a flea market table. Check your attic, garage, cellar and closet shelves and get cash for your ham and computer gear before it's too old to sell. You know you're not going to use it again, so why leave it for your widow to throw out? That stuff isn't getting any younger!

The 73 Flea Market, Barter 'n' Buy, costs you peanuts (almost)—comes to 35 cents a word for individual (noncommercial!) ads and \$1.00 a word for commercial ads. Don't plan on telling a long story. Use abbreviations, cram it in. But be honest. There are plenty of hams who love to fix things, so if it doesn't work, say so.

Make your list, count the words, including your call, address and phone number. Include a check or your credit card number and expiration. If you're placing a commercial ad, include an additional phone number, separate from your ad.

This is a monthly magazine, not a daily newspaper, so figure a couple months before the action starts; then be prepared. If you get too many calls, you priced it low. If you don't get many calls, too high.

So get busy. Blow the dust off, check everything out, make sure it still works right and maybe you can help make a ham newcomer or re-tired old timer happy with that rig you're not using now. Or you might get busy on your computer and put together a list of small gear/parts to send to those interested?

**Send your ads and payment to: 73 Magazine, Barter 'n' Buy, 70 Rt. 202N, Peterborough NH 03458 and get set for the phone calls.** The deadline for the June 1998 classified ad section is April 10th, 1998.

**METHOD TO LEARN MORSE CODE FAST AND WITHOUT HANGUPS** Johan N3RF. Send \$1.00 & SASE. SVANHOLM RESEARCH LABORATORIES, P.O. Box 81, Washington DC 20044 USA. BNB421

**FREE DISK CATALOG** of Ham Radio and other IBM Shareware programs and CD-ROMs. Specify disk size. **MOM 'N' POP'S SOFTWARE**, P.O. Box 15003-HM, Springhill FL 34609-0111. (352) 688-9108. [momnpop@gate.net]. BNB710

**HIGH END SUBWOOFER AMPS, ALUMINUM CONES, OTHER AUDIO STUFF.** Burnett Associates. (603) 924-2383. Fax (603) 924-3392. [FDTF77B@prodigy.com]. BNB999

**RF TRANSISTORS TUBES** 2SC2879, 2SC1971, 2SC1972, MRF247, MRF455, MB8719, 2SC1307, 2SC2029, MRF454, 2SC3133, 4CX250B, 12DQ6, 6KG6A, etc. **WESTGATE** 1-800-213-4563. BNB6000

**TIRED OF IRONING?** PCB service. No \$ setup, free scanning available. **FIRST PROTO**, 4201 University Drive, #102, Durham NC 27707. (919) 403-8243. BNB5005

**SHORTCUT PROJECT CONSTRUCTION TIMES.** Quickest Protoboards available, handle analog, digital, microcontroller circuitry. Unique design eliminates 90% manual wiring. **Oricom Technologies**, (303) 444-9776, [www.sni.net/~oricom]. BNB111

**MAHLON LOOMIS, INVENTOR OF RADIO**, by Thomas Appleby (copyright 1967). Second printing available from **JOHAN K.V. SVANHOLM N3RF**, SVANHOLM RESEARCH LABORATORIES, P.O. Box 81, Washington DC 20044. Please send \$25.00 donation with \$5.00 for S&H

BNB420

**Audio Equipment Wanted:** 1930s-1960s. Tube-type amplifiers, large or small speakers, mixers, microphones, tubes, parts, etc. Especially Western Electric, Jensen, Marantz, MacIntosh, JBL, etc. 1-800-251-5454 BNB202

**COLLOIDAL SILVER GENERATOR!** Why buy a "box of batteries" for hundreds of dollars? Current regulated, AC powered, fully assembled with #12 AWG silver electrodes, \$74.50. Same, but DC powered, \$54.50. Add \$2.50 shipping. **Thomas Miller**, 314 South 9th Street, Richmond IN 47374. BNB342

**ASTRON** power supply, brand-new w/warranty, RS20M \$99, RS35M \$145, RS50M \$209, RS70M \$249, AVT. Call for other models. (626) 286-0118. BNB411

**HAM GOODIES!** Free Shack Attack Catalog. (801) 878-2760, [kb7vrd@aol.com], [http://www.vcnet.com/sa]. BNB45

**BIOELECTRIFIER™** 5 Hz micro current supply for plant and animal research. Semi-Kit \$38.00. Assembled complete with batteries and silver electrodes \$89.50. Add \$2.50 postage. **Thomas Miller**, 314 South 9th Street, Richmond IN 47374. BNB343

**HEATH COMPANY** is selling photocopies of most Heathkit manuals. Only authorized source for copyright manuals. **Phone:** (616) 925-5899, 8-4 ET. BNB964

**CLASSIC RADIOS.** RadioFinder Web list revised weekly: [www.radiofinder.com] Tel/FAX 1-(313) 454-1890, [finder@radio.com]. BNB700

**WANTED:** RF Installation Technician—Future Vision, Inc. is seeking individuals to install wireless data communication systems throughout the US and Canada. Candidates should have experience installing antennas, transmission lines, grounding systems, and tower climbing. Microwave & spread spectrum experience is a plus! This position includes extensive travel. Please forward résumé and salary requirements to Jim Hong KA8ZGP at [jim@futurevision.net] or by mail: **Future Vision, Inc.**, 1709 N. West Ave., Suite 117, Jackson MI 49202. Future Vision, Inc. is an equal opportunity employer. [www.futurevision.net]. BNB836

## Radio Bookshop ORDER FORM

You may order by mail, telephone, or fax. All payments are to be in US funds. Allow 4 weeks for delivery. (Prices subject to change without notice if suppliers increase prices or new editions cost us more.)

ITEM	TITLE	QTY	PRICE	TOTAL

**Shipping:** All orders add \$5.00 handling \*plus there is an additional at cost shipping charge added to all foreign orders. We ship UPS where possible, please give us street address. **S&H\* TOTAL \$**

Make checks payable to "Radio Bookshop."  
Foreign Orders: Choose one  surface shipping  air shipping (Surface delivery may take 2-3 months.)  
\*Note: The actual foreign shipping costs will be additional to the regular shipping and handling fees.

Name \_\_\_\_\_ Phone \_\_\_\_\_

Address \_\_\_\_\_

City \_\_\_\_\_ State \_\_\_\_\_ Zip \_\_\_\_\_ Country \_\_\_\_\_

\$10 minimum for credit card orders

Total Paid \$  Check/Money Order  AMEX  MC  VISA

Card # \_\_\_\_\_ Expires \_\_\_\_\_

Signature \_\_\_\_\_ Date \_\_\_\_\_

Telephone: 603-924-0058, 800-274-7373, FAX 603-924-8613

Mail: Radio Bookshop, Dept. 398, 70 Route 202 N, Peterborough NH 03458

YES, Send me 12 issues of 73 at the low rate of \$24.97 (save 47% over the cover price). Canada add \$7 plus \$1.40 GST; Foreign add \$19 surface; \$42 airmail.

## Radio Bookshop

Phone 800-274-7373 or 603-924-0058, FAX 603-924-8613, or see order form on this page for ordering information.

### Wayne's Five Buck Books & Stuff:

**Boilerplate.** 45 of Wayne's ham oriented editorials. Great material for club newsletter editors who are always short of interesting items for filler.

**Submarine Adventures.** Wayne's WWII adventures on the USS Drum SS-228, now on display in Mobile, Alabama.

**Wayne's Caribbean Adventures.** Scuba diving and hamming all through the Caribbean. 11 islands in 21 days on one trip? You bet, and you can't beat the price either.

**Wayne & Sherry's Travel Diaries.** Cheapskate traveling to Russia, Europe, and so on. Now, how did Wayne and Sherry fly first class to Munich, drive to Vienna, Krakow, Prague, and back to Munich, staying at excellent hotels and eating up a storm, all for under \$1,000?

**Cold Fusion Journal - Issue #20.** Read the latest scoop on cold fusion in this whopping 92-page sample issue. Cold fusion dead? No way!

**One-Hour CW Course.** How anyone can pass the 5 wpm code test with less than one hour of study. This also explains the simplest system for learning the code at 13- and 20-per ever discovered. Or, do it the old fashioned (ARRL) hard way and suffer. Your choice.

Other, Slightly More Expensive Stuff:

**Pure Silver Wire** for making those miracle silver colloids. Two 3" lengths of #10 99.999 pure silver wire \$15. Should last for years.

**Bioelectrifier Handbook.** Background, circuits, uses, etc. \$10.



# JST-245

## 160-10 Meters PLUS 6 Meter Transceiver



**Fifteen reasons why your next HF transceiver should be a JST-245...**

- 1** All-Mode Operation (SSB,CW,AM,AFSK,FM) on all HF amateur bands and 6 meters. JST-145, same as JST-245 but without 6 meters and built-in antenna tuner.  
★ JST-145 COMING SOON ★
- 2** MOSFET POWER AMPLIFIER • Final PA utilizes RF MOSFETs to achieve low distortion and high durability. Rated output is 10 to 150 watts on all bands including 6 meters.
- 3** AUTOMATIC ANTENNA TUNER • Auto tuner included as standard equipment. Tuner settings are automatically stored in memory for fast QSY.
- 4** MULTIPLE ANTENNA SELECTION • Three antenna connections are user selectable from front panel. Antenna selection can be stored in memory.
- 5** GENERAL COVERAGE RECEIVER • 100 kHz-30 MHz, plus 48-54 MHz receiver. Electronically tuned front-end filtering, quad-FET mixer and quadruple conversion system (triple conversion for FM) results in excellent dynamic range (>100dB) and 3rd order ICP of +20dBm.
- 6** IF BANDWIDTH FLEXIBILITY • Standard 2.4 kHz filter can be narrowed continuously to 800 Hz with variable Bandwidth Control (BWC). Narrow SSB and CW filters for 2nd and 3rd IF optional.
- 7** QRM SUPPRESSION • Other interference rejection features include Passband Shift (PBS), dual noise blanker, 3-step RF attenuation, IF notch filter, selectable AGC and all-mode squelch.
- 8** NOTCH TRACKING • Once tuned, the IF notch filter will track the offending heterodyne ( $\pm 10$  KHz) if the VFO frequency is changed.
- 9** DDS PHASE LOCK LOOP SYSTEM • A single-crystal Direct Digital Synthesis system is utilized for very low phase noise.
- 10** CW FEATURES • Full break-in operation, variable CW pitch, built in electronic keyer up to 60 wpm.
- 11** DUAL VFOs • Two separate VFOs for split-frequency operation. Memory registers store most recent VFO frequency, mode, bandwidth and other important parameters for each band.
- 12** 200 MEMORIES • Memory capacity of 200 channels, each of which store frequency, mode, AGC and bandwidth.
- 13** COMPUTER INTERFACE • Built-in RS-232C interface for advanced computer applications.
- 14** ERGONOMIC LAYOUT • Front panel features easy to read color LCD display and thoughtful placement of controls for ease of operation.
- 15** HEAVY-DUTY POWER SUPPLY • Built-in switching power supply with "silent" cooling system designed for continuous transmission at maximum output.



*Japan Radio Co., Ltd.*

430 Park Ave., 2nd Floor New York, NY 10022 Phone: (212) 355-1180 Fax: (212) 319-5227

CIRCLE 159 ON READER SERVICE CARD

**Featuring the COMET  
Exclusive SLC System:**

- Linear Coil for Maximum Gain
- Soldered Element Joints
- ABS Radome Joints: Weather Proof/Invisible to RF for the Finest Radiation Pattern

**COMET** has an extensive line of Mono-Band/Dual-Band/Tri-Band Antennas for Base Station and Repeater use.

**GP-3** • Dual-band 146/446MHz Base Repeater Antenna  
Gain & Wave: 146MHz 4.5dBi 6/8 wave • 446MHz 7.2dBi 5/8 wave x 3 •  
Max Pwr: 200W • Length: 5'11" • Weight: 2lbs. 9ozs. •  
Conn: Gold-plated SO-239 • Construction: Single-piece fiberglass

**GP-6** • Dual-band 146/446MHz Base Repeater Antenna  
Gain & Wave: 146MHz 6.5dBi 5/8 wave x 2 • 446MHz 9.0dBi 5/8 wave x 5 •  
Max Pwr: 200W • Length: 10'2" • Weight: 3lbs. 8ozs. • Conn: Gold-plated SO-239 •  
Construction: Fiberglass, 2 Sections

**GP-9/GP-9N** • Dual-band 146/446MHz Base Repeater Antenna • BEST SELLER!  
Gain & Wave: 146MHz 8.5dBi 5/8 wave x 3 • 446MHz 11.9dBi 5/8 wave x 8 •  
Max Pwr: 200W • Length: 17'8" • Weight: 5lbs. 11ozs. • Conn: GP-9 Gold-plated  
SO-239 • GP-9N Gold-plated N-type female • Construction: Fiberglass, 3 Sections

**CA-62DB** • Mono-band 6 Meter Vertical  
Gain & Wave: 52MHz 6.5dBi 5/8 wave x 2 • Max Pwr: 500W • Length: 21'8" •  
Weight: 5lbs. 11 ozs. • Conn: SO-239 • 2MHz band-width after tuning (6M) •  
Construction: Thick-wall aluminum, 5 sections

**CX-333** • Tri-band 146/220/446MHz Base Repeater Antenna  
Gain & Wave: 146MHz 6.5dBi 5/8 wave x 2 • 220MHz 7.8dBi 5/8 wave x 3 •  
446MHz 9.0dBi 5/8 wave x 5 • Max Pwr: 120W • Length: 10'2" • Weight: 3lbs. 1oz. •  
Conn: Gold-plated SO-239 • Construction: Fiberglass, 2 Sections

**GP-15** • Tri-band 52/146/446MHz Base Repeater Antenna  
Gain & Wave: 52MHz 3.0dBi 5/8 wave • 146MHz 6.2dBi 5/8 wave x 2 • 446MHz 8.6dBi  
5/8 wave x 4 • Max Pwr: 300W • Length: 7'11" • Weight: 3lbs. 1oz. • Conn: Gold-plated  
SO-239 • 2MHz band-width after tuning (6M) • Construction: Single-piece fiberglass

# COMET

For a complete catalog of **COMET** Antenna products call or visit your local dealer. Or, contact **NCG Company** at 800/962-2611. Use **COMET** products, and enjoy amateur radio to it's fullest!

1275 N. Grove Street • Anaheim • California 92806  
(714) 630-4541 • (800) 962-2611 • Fax: (714) 630-7024

CIRCLE 54 ON READER SERVICE CARD