

Including Ham Radio Fun!

DECEMBER 1997

ISSUE #447

USA \$3.95

CANADA \$4.95

*International Edition*

# 73<sup>®</sup> Amateur Radio Today

El Cheapo GPS Mag-Mount  
Compact 80m Antenna  
Kit Building Basics  
Mobile HF Loop



Review:  
Hamtronics TD-5





# SYNTHESIZED VHF FM EXCITER & RECEIVER MODULES

## No more waiting for crystals!



Hamtronics is pleased to announce a new line of its vhf fm transmitters and receivers, popular for repeaters, voice and data links, control, telemetry, and other demanding applications.

T301 Exciter and R301 Receiver provide high quality nbfm and fsk operation on 144-148 MHz (and 148-174 MHz for export and gov't services). Features include:

- Dip switch frequency selection.
- Exceptional modulation for voice and ctcss.
- Very low noise synthesizer for repeater service.
- Direct fm for data up to 9600 baud.
- Commercial grade tcxo for tight frequency accuracy in wide range of environmental conditions: 2ppm -30 to +60°C.
- In stock for same day shipping.

### TA301 EXCITER

Rated for continuous duty, 2-3W output.

- Kit .....only \$109
- TCXO option ...\$40
- Wired/tested ...\$189 (includes TCXO)
- Inquire about models for higher frequencies.



### R301 RECEIVER

- Kit .....only \$139
- TCXO option ...\$40
- Wired/tested ...\$209 (includes TCXO)
- Our traditional crystal-controlled receivers and exciters are still available for all vhf and uhf bands.

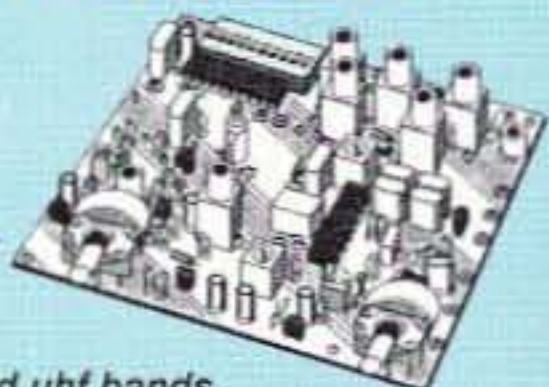

## CRYSTAL CONTROLLED VHF & UHF FM EXCITERS & RECEIVERS

**FM EXCITERS:** 2W output, continuous duty.

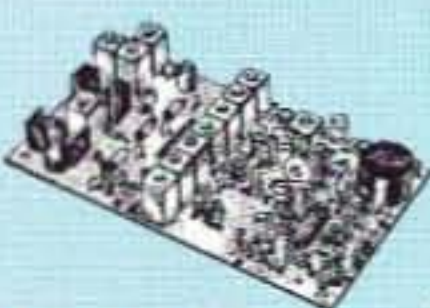

- TA51: for 6M, 2M, 220 MHz ..... kit \$99, w/t \$169.
- TA451: for 420-475 MHz. .... kit \$99, w/t \$169.
- TA901: for 902-928 MHz, (0.5W out) ..... w/t \$169.

**VHF & UHF POWER AMPLIFIERS.**

Output levels from 10W to 100W ..... Starting at \$99.

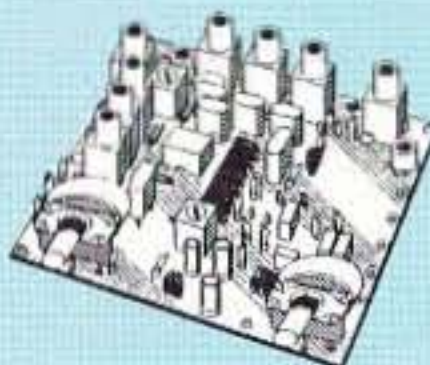

**FM RECEIVERS:**

- R100 VHF FM RCVR Very sensitive - 0.15µV. Superb selectivity - both crystal and ceramic IF filters, >100 dB down at ±12 kHz, best available anywhere, flutter-proof squelch.

For 46-54, 72-76, 140-175, or 216-225 MHz. .... kit \$129, w/t \$189.

- R144 RCVR. Like R100, for 2M, with helical resonator in front end. .... kit \$159, w/t \$219.
- R451 FM RCVR, for 420-475 MHz. Similar to R100 above. .... kit \$129, w/t \$189.
- R901 FM RCVR, 902-928MHz ..... \$159, w/t \$219.

## Get more features for your dollar with our REP-200 REPEATER

A microprocessor-controlled repeater with full autopatch and many versatile dtmf remote control features at less than you might pay for a bare bones repeater or controller alone!



Now - 2 meter machines in stock for next day shipment! Call for details.

- kit still only \$1095
  - factory assembled still only \$1295
- 50-54, 143-174, 213-233, 420-475 MHz. (902-928 MHz slightly higher.)  
 \* FCC type accepted for commercial service in 150 & 450 MHz bands.

**Digital Voice Recorder Option.** Allows message up to 20 sec. to be remotely recorded off the air. Play back at user request by DTMF command, or as a periodical voice id, or both. Great for making club announcements! ..... only \$100.

**REP-200C Economy Repeater.** Real-voice ID, no dtmf or autopatch. .... Kit only \$795, w&t \$1195.

**REP-200N Repeater.** Without controller so you can use your own. .... Kit only \$695, w&t \$995.

## You'll KICK Yourself If You Build a Repeater

Without Checking Out Our Catalog First!

Hamtronics has the world's most complete line of modules for making repeaters. In addition to exciters, pa's, and receivers, we offer the following controllers.

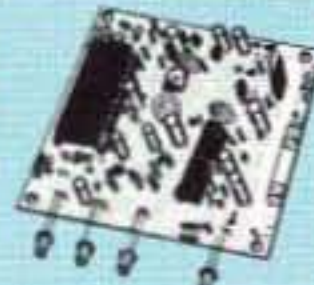

**COR-3.** Inexpensive, flexible COR module with timers, courtesy beep, audio mixer. .... only \$49/kit, \$79 w/t.

**CWID.** Traditional diode matrix ID'er. .... kit only \$59.

**CWID-2.** Eprom-controlled ID'er. .... only \$54/kit, \$79 w/t.

**DVR-1.** Record your own voice up to 20 sec. For voice id or playing club announcements. .... \$59/kit, \$99 w/t.

**COR-4.** Complete COR and CWID all on one board. ID in eeprom. Low power CMOS. .... only \$99/kit, \$149 w/t.

**COR-6.** COR with real-voice id. Low power CMOS, non-volatile memory. .... kit only \$99, w/t only \$149.

**COR-5.** µP controller with autopatch, reverse ap, phone remote control, lots of DTMF control functions, all on one board, as used in REP-200 Repeater. .... \$379 w/t.

**AP-3.** Repeater autopatch, reverse autopatch, phone line remote control. Use with TD-2. .... kit \$89.

**TD-2.** Four-digit DTMF decoder/controller. Five latching on-off functions, toll call restrictor. .... kit \$79.

**TD-4.** DTMF controller as above except one on-off function and no toll call restrictor. Can also use for selective calling; mute speaker until someone pages you. .... kit \$49.

### SUBAUDIBLE TONE ENCODER/DECODER

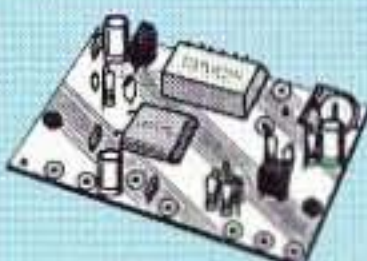

Access all your favorite closed repeaters!

- Encodes all standard CTCSS tones with crystal accuracy and convenient DIP switch selection.
- Comprehensive manual also shows how you can set up a front panel switch to select tones for several repeaters.
- Decoder can be used to mute receive audio and is optimized for installation in repeaters to provide closed access. High pass filter gets rid of annoying buzz in receiver.
- TD-5 CTCSS Encoder/Decoder Kit ..... only \$39
- TD-5 CTCSS Encoder/Decoder Wired/tested ..... \$59

## LOW NOISE RECEIVER PREAMPS

**LNG-( ) GAAS FET PREAMP**

STILL ONLY \$59, wired/tested

- Make your friends sick with envy! Work stations they don't even know are there.
- Install one at the antenna and overcome coax losses.
- Available for 28-30, 46-56, 137-152, 152-172, 210-230, 400-470, and 800-960 MHz bands.

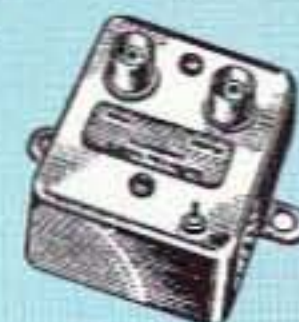

**LNW-( ) ECONOMY PREAMP**

ONLY \$29 kit, \$44 wired/tested

- Miniature MOSFET Preamp
- Solder terminals allow easy connection inside radios.
- Available for 25-35, 35-55, 55-90, 90-120, 120-150, 150-200, 200-270, and 400-500 MHz bands.

## TRANSMITTING & RECEIVING CONVERTERS

Go on a ham satellite adventure! Add another band for the next contest. Thrill in the excitement of building your own gear, and save a bundle.

No need to spend thousands on new transceivers for each band!



- Convert vhf and uhf signals to/from 10M.
- Even if you don't have a 10M rig, you can pick up very good used xmtrs & rcvrs for next to nothing.
- Receiving converters (shown above) available for various segments of 6M, 2M, 220, and 432 MHz.
- Rcvg Conv Kits from \$49, wired/tested units only \$99.

- Transmitting converters for 2M, 432 MHz.
- Kits only \$89 vhf or \$99 uhf.
- Power amplifiers up to 50W output.

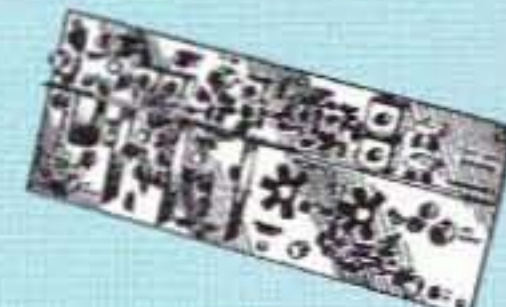

## Finally - A Professional Quality Receiver to Monitor Weather Broadcasts!

Our RWX is a very sensitive and selective Hamtronics® grade receiver to monitor critical NOAA weather broadcasts.

Excellent 0.15µV sensitivity provides good reception even at distances of 70 miles or more with suitable antenna. No comparison with ordinary consumer radios!



Automatic mode provides storm watch, alerting you by unmuting receiver and providing an output to trip remote equipment when an alert tone is broadcast.

Small enough for emergency or portable use, it can even be powered from a small 9-12V battery when needed. Crystal controlled for accuracy; all 7 channels provided (162.40 to 162.55).

You can buy just the receiver pcb module in kit form or buy the kit with an attractive metal cabinet, AC power adapter, and built-in speaker. It is also available factory wired and tested.

- RWX Rcvr kit, PCB only ..... \$79
- RWX Rcvr kit with cabinet, speaker, & AC adapter ..... \$99
- RWX Rcvr wired/tested in cabinet with speaker & adapter ..... \$139

We make many other products, too numerous to fit on one page. See prior month's ad for more. Hamtronics also makes Receivers for Weather Satellites & WWV and various data adapters & pwr amplifiers for radios.

Buy at low, factory-direct net prices and save!  
 For complete info, call or write for complete catalog.  
 Order by mail, fax, email, or phone (9-12, 1-5 eastern time).  
 Min. \$5 S&H charge for 1" lb. plus add'l weight & insurance.  
 Use Visa, MC, Discover, check, or UPS C.O.D.



View Catalog on our Web Site:  
[www.hamtronics.com](http://www.hamtronics.com)  
 email: [jv@hamtronics.com](mailto:jv@hamtronics.com)

Our 35<sup>th</sup> Year  
**hamtronics, inc.**  
 65-D Moul Rd; Hilton NY 14468-9535  
 Phone 716-392-9430 (fax -9420)



Are you **missing**  
out on some  
**fun?**



Use **more** of  
your **privileges**—  
Go **Digital!**

*Are you only using a small portion of your ham radio license? Here's just some of the fun you may be missing!*

- APRS® Position Reporting and mapping
- Easy Satellite Communications
- Displaying and printing WEFAX weather maps
- Paging via Amateur Radio
- DX spotting and getting those rare contacts
- Packet bulletins, traffic, e-mail and news
- Telemetry-remote sensing and control  
(KPC-3 Plus and KPC-9612 Plus)

Kantronics offers a number of ways to enjoy the growing field of digital communications. Choose the unit that suits your interests and your budget. All Kantronics units come with a one-year limited warranty and can be upgraded when firmware updates become available.

**NEW!** KPC-3 Plus

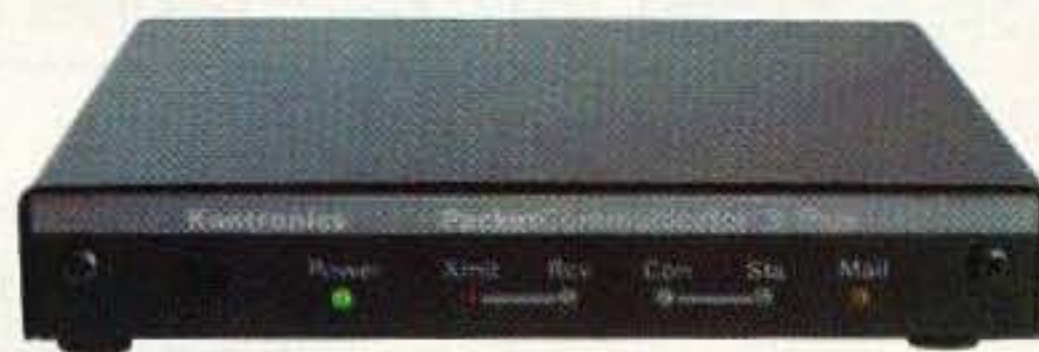

- 1200 bps - Now with more features!
- Packet, GPS/APRS, Host, KISS and WEFAX modes
- Personal Mailbox (PBBS) now supports multiple calls
- Copies NWS EMWIN with optional software
- Remote access, sensing and control with two A/D and two control lines
- KA-Node or option K-Net networking capability
- PBBS 100k, expandable with optional 512k RAM
- Uses external power or internal 9v battery
- NEWUSER mode and online help

**NEW!** KPC-9612 Plus



- 1200 port AND second port of 4800 ~ 38,400 bps
- Most modes/capabilities of the KPC-3 Plus and POCSAG (paging)
- Unique design allows the addition of *another port, high or low speed\**
- KA-Node or K-Net option works with multiple ports
- Remote access, sensing and control capability
- Telemetry transmission capability
- NEWUSER mode and online help

**NEW LOOK!** KAM Plus



- Same great KAM Plus performance in an attractive new package!
- Dual port VHF/HF (1200/≤300 bps) multimode TNC
- Packet, GPS/APRS, Host, KISS, WEFAX, CW, RTTY, AMTOR, PACTOR and G-TOR™
- 100k personal mailbox standard, expandable with optional 512k RAM
- Remote access capability
- Real time, battery backed clock
- NEWUSER mode and online help

**Kantronics**

1202 E. 23rd St., Lawrence, KS 66046  
tel: 785-842-7745 • fax: 785-842-2031  
e-mail: [sales@kantronics.com](mailto:sales@kantronics.com)  
web: [www.kantronics.com](http://www.kantronics.com)

Specifications subject to change without notice or obligation. APRS® is a registered trademark of Bob Bruninga, WB4APR. All registered trademarks remain the property of their respective owners. \*Expansion modules anticipated for availability in late 1997.



## SWITCHING POWER SUPPLIES

	CONT.	ICS	WT.(LBS)
SS-10	7	10	3.2
SS-12	10	12	3.4
SS-18	15	18	3.6
SS-25	20	25	4.2
SS-30	25	30	5.0



SS-25M With volt & amp meters  
SS-30M With volt & amp meters

## ASTRON POWER SUPPLIES

• HEAVY DUTY • HIGH QUALITY • RUGGED • RELIABLE •

### SPECIAL FEATURES

- SOLID STATE ELECTRONICALLY REGULATED
- FOLD-BACK CURRENT LIMITING Protects Power Supply from excessive current & continuous shorted output
- CROWBAR OVER VOLTAGE PROTECTION on all Models except RS-3A, RS-4A, RS-5A, RS-4L, RS-5L
- MAINTAIN REGULATION & LOW RIPPLE at low line input Voltage
- HEAVY DUTY HEAT SINK • CHASSIS MOUNT FUSE
- THREE CONDUCTOR POWER CORD except for RS-3A
- ONE YEAR WARRANTY • MADE IN U.S.A.

### PERFORMANCE SPECIFICATIONS

- INPUT VOLTAGE: 105-125 VAC
- OUTPUT VOLTAGE: 13.8 VDC ± 0.05 volts (Internally Adjustable: 11-15 VDC)
- RIPPLE Less than 5mv peak to peak (full load & low line)
- All units available in 220 VAC input voltage (except for SL-11A)

### SL SERIES



### • LOW PROFILE POWER SUPPLY

MODEL	Colors		Continuous Duty (Amps)	ICS* (Amps)	Size (IN) H x W x D	Shipping Wt. (lbs.)
	Gray	Black				
SL-11A	•	•	7	11	2 5/8 x 7 5/8 x 9 3/4	12
SL-11R	•	•	7	11	2 5/8 x 7 x 9 3/4	12
SL-11S	•	•	7	11	2 5/8 x 7 5/8 x 9 3/4	12
SL-11R-RA		•	7	11	4 3/4 x 7 x 9 3/4	13

### RS-L SERIES



### • POWER SUPPLIES WITH BUILT IN CIGARETTE LIGHTER RECEPTACLE

MODEL	Continuous Duty (Amps)	ICS* (Amps)	Size (IN) H x W x D	Shipping Wt. (lbs.)
RS-4L	3	4	3 1/2 x 6 1/8 x 7 1/4	6
RS-5L	4	5	3 1/2 x 6 1/8 x 7 1/4	7

### RM SERIES



MODEL RM-35M

### • 19" RACK MOUNT POWER SUPPLIES

MODEL	Continuous Duty (Amps)	ICS* (Amps)	Size (IN) H x W x D	Shipping Wt. (lbs.)
RM-35A	25	35	5 1/4 x 19 x 12 1/2	38
RM-50A	37	50	5 1/4 x 19 x 12 1/2	50
RM-60A	50	55	7 x 19 x 12 1/2	60
• Separate Volt and Amp Meters				
RM-12M	9	12	5 1/4 x 19 x 8 1/4	16
RM-35M	25	35	5 1/4 x 19 x 12 1/2	38
RM-50M	37	50	5 1/4 x 19 x 12 1/2	50
RM-60M	50	55	7 x 19 x 12 1/2	60

### RS-A SERIES



MODEL RS-7A

MODEL	Colors		Continuous Duty (Amps)	ICS* (Amps)	Size (IN) H x W x D	Shipping Wt. (lbs.)
	Gray	Black				
RS-3A		•	2.5	3	3 x 4 3/4 x 5 3/4	4
RS-4A	•	•	3	4	3 3/4 x 6 1/2 x 9	5
RS-5A		•	4	5	3 1/2 x 6 1/8 x 7 1/4	7
RS-7A	•	•	5	7	3 3/4 x 6 1/2 x 9	9
RS-10A	•	•	7.5	10	4 x 7 1/2 x 10 3/4	11
RS-12A	•	•	9	12	4 1/2 x 8 x 9	13
RS-12B		•	9	12	4 x 7 1/2 x 10 3/4	13
RS-20A	•	•	16	20	5 x 9 x 10 1/2	18
RS-35A	•	•	25	35	5 x 11 x 11	27
RS-50A	•	•	37	50	6 x 13 3/4 x 11	46
RS-70A	•	•	57	70	6 x 13 3/4 x 12 1/2	48

### RS-M SERIES



MODEL RS-35M

MODEL	Continuous Duty (Amps)	ICS* (Amps)	Size (IN) H x W x D	Shipping Wt. (lbs.)
• Switchable volt and Amp meter				
RS-12M	9	12	4 1/2 x 8 x 9	13
• Separate volt and Amp meters				
RS-20M	16	20	5 x 9 x 10 1/2	18
RS-35M	25	35	5 x 11 x 11	27
RS-50M	37	50	6 x 13 3/4 x 11	46
RS-70M	57	70	6 x 13 3/4 x 12 1/2	48

### VS-M AND VRM-M SERIES

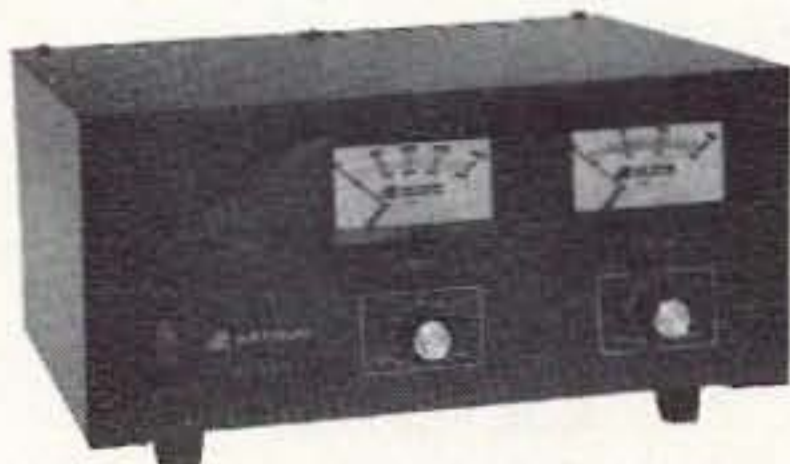

MODEL VS-35M

### • Separate Volt and Amp Meters • Output Voltage adjustable from 2-15 volts • Current limit adjustable from 1.5 amps to Full Load

MODEL	Continuous Duty (Amps)			ICS* (Amps) @13.8V	Size (IN) H x W x D	Shipping Wt. (lbs.)
	@13.8VDC	@10VDC	@5VDC			
VS-12M	9	5	2	12	4 1/2 x 8 x 9	13
VS-20M	16	9	4	20	5 x 9 x 10 1/2	20
VS-35M	25	15	7	35	5 x 11 x 11	29
VS-50M	37	22	10	50	6 x 13 3/4 x 11	46
VS-70M	67	34	16	70	6 x 13 3/4 x 12 1/2	48
• Variable rack mount power supplies						
VRM-35M	25	15	7	35	5 1/4 x 19 x 12 1/2	38
VRM-50M	37	22	10	50	5 1/4 x 19 x 12 1/2	50

### RS-S SERIES



MODEL RS-12S

### • Built in speaker

MODEL	Colors		Continuous Duty (Amps)	ICS* Amps	Size (IN) H x W x D	Shipping Wt. (lbs.)
	Gray	Black				
RS-7S	•	•	5	7	4 x 7 1/2 x 10 3/4	10
RS-10S	•	•	7.5	10	4 x 7 1/2 x 10 3/4	12
RS-12S	•	•	9	12	4 1/2 x 8 x 9	13
RS-20S	•	•	16	20	5 x 9 x 10 1/2	18
SL-11S	•	•	7	11	2 3/4 x 7 5/8 x 9 3/4	12



# THE TEAM

El Supremo & Founder  
Wayne Green W2NSD/1

Associate Publisher  
F. I. Marion

Associate Technical Editor  
Larry Antonuk WB9RRT

Nitty Gritty Stuff  
J. Clayton Burnett  
Priscilla Gauvin  
Joyce Sawtelle

## Contributing Culprits

Bill Brown WB8ELK  
Mike Bryce WB8VGE  
Joseph E. Carr K4IPV  
Michael Geier KB1UM  
Jim Gray W1XU/7  
Jack Heller KB7NO  
Chuck Houghton WB6IGP  
Dr. Marc Leavey WA3AJR  
Andy MacAllister W5ACM  
Dave Miller NZ9E  
Joe Moell K0OV  
Steve Nowak KE8YN/5  
Carole Perry WB2MGP

## Advertising Sales

Frances Hyvarinen  
Roger Smith  
603-924-0058  
800-274-7373  
Fax: 603-924-8613

## Circulation

Linda Coughlan

## Data Entry & Other Stuff

Christine Aubert  
Norman Marion

## Business Office

Editorial - Advertising - Circulation  
Feedback - Product Reviews  
73 Amateur Radio Today Magazine  
70 Route 202N  
Peterborough NH 03458-1107  
603-924-0058  
Fax: 603-924-8613

Reprints: \$3 per article  
Back issues: \$5 each

Printed in the USA by  
Quad Graphics

**Manuscripts:** Contributions for possible publication are most welcome. We'll do the best we can to return anything you request, but we assume no responsibility for loss or damage. Payment for submitted articles will be made upon publication. Please submit both a disk and a hard copy of your article [IBM (ok) or Mac (preferred) formats], carefully checked drawings and schematics, and the clearest, best focused and lighted photos you can manage. "How to write for 73" guidelines are available on request. US citizens must include their Social Security number with submitted manuscripts so we can submit it to you know who.

DECEMBER 1997  
ISSUE #447

# 73 Amateur Radio Today

Including Ham Radio Fun!

## TABLE OF CONTENTS

## FEATURES

- 10 **Distributed Capacity Folded Loop** — W6NBC  
*This ceiling-mount antenna will really go to your head!*
- 18 **How to Silverplate RF Tank Circuits** — WB2CQM  
*A simple and inexpensive process to reduce losses.*
- 24 **Build Your First Kit!** — N0BLX  
*Just follow one ham's simple advice.*
- 27 **Limited Space Antenna** — HL9BK / K2KSY  
*Short of real estate? This might help!*
- 29 **How to Build A Great Ham Club** — W2NSD/1  
*Good advice from the PR master.*
- 31 **Electronic Construction from A to Z, Part 2** — AA0XI / VK5FN  
*Everything you wanted to know about building stuff but were afraid to ask.*
- 48 **Affordable Antenna Project for APRS** — N7ZEV  
*Build an external antenna for your GPS receiver.*

## DEPARTMENTS

WB6IGP	50	Above & Beyond
	73	Ad Index
KB1UM	52	Ask Kaboom
WB8ELK	77	ATV
	88	Barter 'n' Buy
K4IPV	74	Carr's Corner
KB7NO	58	The Digital Port
WB2MGP	76	Hams With Class
W5ACM	60	Hamsats
NZ9E	82	Ham to Ham
K0OV	54	Homing In
W2NSD/1	4	Never Say Die
	72	New Products
KE8YN/5	56	On the Go
W1XU	87	Propagation
WB8VGE	80	QRP
	6	QRX
	23, 44, 57,	
	62, 76, 88	Radio Bookshop
WA3AJR	62	RTTY Loop
	46	Special Events

## REVIEW

- 42 **Hamtronics' TD-5 Subaudible Tone Encoder/Decoder Kit** — WB9RRT  
*Guaranteed success.*

## HAM RADIO FUN SECTION

- AA0OF 64 **We Joined the North Pole Network!**  
*Radio ho ho!*
- WF6P 67 **Let Your Fingers Do the Talking**  
*... or, wire you smiling?*
- WF6P 69 **Amateur Radio Maritime Mobile Nets**  
*Staying in touch—and staying safe—on the briny.*

**On the cover:** Peppy new SX-20 Sidebander amateur HF SSB/CW transceiver features Direct Digital Synthesis, dual VFOs, built-in iambic keyer, selectable tuning speeds, and much more. Available assembled or as kit from Ramsey Electronics. 73 HQ's Christmas tree features lovely elfette Melanie Carey, daughter of Circulation Manager Linda Coughlan. Assembled form only, (sorry) not available. Happy Holidays!

**Feedback:** Any circuit works better with feedback, so please take the time to report on how much you like, hate, or don't care one way or the other about the articles and columns in this issue. G = great!, O = okay, and U = ugh. The G's and O's will be continued. Enough U's and it's Silent Keysville. Hey, this is *your* communications medium, so don't just sit there scratching your...er...head. FYI: Feedback "number" is usually the page number on which the article or column starts.

**73 Amateur Radio Today** (ISSN 1052-2522) is published monthly by 73 Magazine, 70 N202, Peterborough NH 03458-1107. The entire contents ©1997 by 73 Magazine. No part of this publication may be reproduced without written permission of the publisher, which is not all that difficult to get. The subscription rate is: one year \$24.97, two years \$44.97; Canada: one year \$34.21, two years \$57.75, including postage and 7% GST. Foreign postage: \$19 surface, \$42 airmail additional per year, payable in US funds on a US bank. Second class postage is paid at Peterborough, NH, and at additional mailing offices. Canadian second class mail registration #178101. Canadian GST registration #125393314. Microfilm edition: University Microfilm, Ann Arbor MI 48106. POSTMASTER: Send address changes to 73 Amateur Radio Today, 70 N202, Peterborough NH 03458-1107. 73 Amateur Radio Today is owned by Shabromat Way Ltd. of Hancock NH.

**Contract:** By being so nosy as to read this fine print, you have just entered into a binding agreement with 73 Amateur Radio Today. You are hereby obligated to do something nice for a ham friend—buy him a subscription to 73. What? All of your ham friends are already subscribers? Donate a subscription to your local school library!



# NEVER SAY DIE

Wayne Green W2NSD/1



## The Magnet Motor

For doubters, here's a photo of me (**Photo A**) on the Takahashi magnet-powered motor scooter on my last visit to London. Yes, it uses a small battery to start the motor, but from then on the magnet motor not only powers the scooter, but also recharges the battery. And it goes like a demon.

I admit that I don't know much about magnets. But even so, I just don't understand how it is possible to take energy out of magnets without demagnetizing them. I keep asking myself the question: Where's the energy coming from?

We know now that cold fusion gets its excess energy from the transmutation of elements, which is not really fusion, unless it's occurring on a microscopic (or smaller) level. So what's going on with magnetic motors? I've watched one over-unity theory after another evaporate when closely

investigated. I've yet to see any substantiation for the zero-point energy concept. I have yet to meet anyone who's seen an N-machine generating power.

Yet the Takahashi scooter really scoots! And Dr. Takahashi has excellent credentials. He developed the Sony Trinitron™ and Walkman™, and has a string of remarkable patents. I've seen the scooter. I've driven it. But I just don't understand how it can run, and run, and run.

## Big Brother

A clipping from Jim Kocsis WA9PYH waves a flag for any entrepreneurial experimenters out there. Any left?

It seems that GEICO, the auto insurance company, lent almost a million bucks to Laser Technology Inc. (LTI), an outfit making laser speed detectors for the police. The idea was to develop a new feature for the guns which

would record a car's speed and capture a video image of it. They're working now on a character recognition (OCR) system which would make it so the police could set up the system anywhere and have it automatically mail out speeding tickets. This would be an incredible revenue generator.

This has nothing to do with safety and everything to do with generating money, both for the towns and for insurance companies, since their premiums automatically go up when you get a speeding ticket—which explains GEICO's investment.

Your job, oh great inventor, is to come up with a product that will blind the video camera—perhaps high intensity IR LEDs?

A few years ago I gave you a golden opportunity to get into the business of jamming police radar when I published an article on a gadget that would do this, and do it legally. But you just sat there and did nothing, as usual, letting someone else put the product on the market and make a killing. Tsk.

## Skip This

Yes, I've been thinking again, so you really ought to skip down to my next item and not bother your head with this stuff.

Anyway, one of the guests on a recent Art Bell show was Johnny Holland, who's been involved with the parapsychology lab at Princeton University (PEAR). I've mentioned their work before, but this is the first time I've heard a first-hand report from anyone.

Holland mentioned that they discovered that if their test subjects were given the answers to the questions they were asked after the test was over that this seriously affected the test results. That's right, there was precognition involved.

Well, so much for not learning from history. Back in the 1940s I worked as chief engineer and announcer at WEEB in North Carolina and one of the other announcers was William Cox, who was helping Dr. J. B. Rhine with his parapsychology experiments. So naturally I helped with many of the experiments. Along about 1949 Rhine discovered the precognition problem, which meant that he had to throw out all of his research data and start over again, making sure that his test subjects were never given the correct answers.

So the guys at Princeton, having not done their homework by reading Rhine's books and other reports, had to painstakingly reinvent the wheel.

Yes, the PEAR group has conclusively demonstrated the weird powers of the mind, including psychokinesis, where the mind is able to influence matter. They have a computer program on their Web site which will allow anyone to prove to themselves that they, too, can influence matter with their minds. Try [jh@pearinc.com] and see how much you can influence white noise to make a picture.

One of the things I've editorialized in the past has been the question of where our memories are stored. We know that some people who've lost over half of their brains in accidents still have their memories. And other people, who've lost the other half of their brains, still have their complete memories. And then we look at the quantity of storage needed to keep a lifetime of memories of everything we see, hear, feel or experience, and we run out of storage space in anything we can imagine.

I propose that our memories are stored outside of our



**Photo A.** The Takahashi magnet-powered motor scooter goes like a demon!



physical bodies. This would also help explain the reports from thousands of people who've had near-death experiences and tell us that when we go to the other "side" we still have all of our memories. This is why these people, when they come back, start getting busy educating themselves. They tell us that we're here to learn things, not to take as free a ride as we can, watching ball games and drinking beer through life.

When you die one of the first things that happens is a full life review, complete with your feeling how what you've done and said has felt to others.

Several of the books in my guide to "books you're crazy if you don't read" have to do with life and death. There's *The Secret Life of Plants*, which explains how plants and people communicate. Then there's Boone's *Kinship of All Life*, which explains how you can communicate with any living thing, right on down to a fly. As I've mentioned, I've never had to swat another fly since reading that book. Sir Crookall's *The Supreme Adventure* shows the similarity of the dying process as reported by near-death experiencers and from the departed, reporting back through psychics on the next "plane."

Then there's the amazing book by Mae Sewall, *Neither Dead Nor Sleeping*, which chronicled her communications with her dead husband and pianist Artur Rubinstein.

When I was a practicing psychologist I found there was no problem under a light hypnosis to get my patients to recall any moment of their lives in full sound and color. And that included memories of sounds and feelings during the nine months before birth. Further, it was no more difficult to regress them to past lives, complete with minute details. No, they were not famous people, just peasants and farmers. The few cases where I took the trouble to check the facts recovered from these sessions showed them to be accurate.

Sewall explained that on

the "other side" they are busy writing, inventing, and so on, and then passing this stuff on to us. Which could explain why most of the famous composers have said that their music has come to them in a dream state, all ready to be written down. We hear the same story from writers and other creative people. Perhaps creativity is mostly an ability to relax one's mind and open a channel for such communications with those who would help us.

Sewall explained how her husband and Rubinstein were able to influence events in our world, getting her speaking tours whenever they needed for her to have money to help with one of their projects. Putting this together with precognition raises questions about our so-called free will. How free are we?

I realize that we are, essentially, prisoners of our past and that our so-called decisions are probably completely governed by our experiences. But then there's the serendipity factor which can change everything for us. And, as Scott Adams explained in his latest book, *The Dilbert Future*, we have the weird power to have some control over serendipity.

Well, I've rattled on at length, as usual, so perhaps it's time to stop trying to get you to actually think.

### **The Ice Caps Are Melting! The Ice Caps Are Melting!**

Yes, the end of the world is near, with the carbon dioxide buildup, the growing ozone hole, and the ice caps melting. We're doomed, doomed!

Well, maybe. But as far as the ice caps melting goes, reader Roger Cerney from Colusa, California sent me some photos taken in 1989 by a friend of his who went to Antarctica to install antennas (**Photo B**). The 120-foot towers installed in 1960 were by then almost buried under the snow, with only 15 feet left showing. The tip of a crane was still showing, but it's buried now until the next thaw.

If you miss having something to worry about, you

might consider that the south polar ice cap is way off center, so as the snow builds up it'll tend to wobble the earth more and more, eventually turning it around suddenly so the poles end up in the tropics, and the tropics at the poles.

There's abundant evidence that this has happened before, so you might want to at least worry a little. There's isn't a lot you can do beyond that. Well, you could learn to swim real good so you'll be ready for the five-mile-high waves that are predicted to wash over most of America.

### **Biocommunications**

Maybe we don't need radio and the ionosphere, or satellites, to achieve instant communications anywhere in the world. Or a ham ticket, for that matter. The communications medium is there, it's just that as far as I know, no one has done much about investigating its potential.

Some months ago—maybe a couple of years by now—I reviewed a book by Robert Stone called *The Secret Life of Your Cells*. As I explained, I found *The Secret Life of Plants* so interesting that I called Cleve Backster, the chap who'd done the original research on plant-human communications. I figured he must have made some progress in the 20 years since the plants book. I was right. He put me in touch with Brian O'Leary, who'd been working with

him on human cells and their ability to communicate with each other. And Brian put me onto the Stone book.

Plants, in some way, are able to communicate with each other, and with humans. Well, we know that when we speak to them and tell them what wonderful plants they are, they grow faster and taller. You doubt it? Then just try it with a couple beans in pots. Tell one how great it is going to be and how much you're going to like it. Tell the other how ugly it is going to be and how you are going to hate it. You'll be amazed at the difference.

Backster and O'Leary found that when they took some cells from a person's mouth, put them in a petri dish to grow, and then put a meter on them, that the meter worked in tandem with another meter connected to the person whose cells were used. Even thousands of miles away!

What we don't know is the speed at which this communication takes place, which I suspect is instantaneous. Yes, faster than light. We also don't know what bandwidth we can develop using this approach. If we modulate a human (or perhaps even an animal or plant) cell with light, can we then demodulate another cell from the same living source?

This cellular communications explains the experience of a woman who had an organ transplant from a young man

*Continued on page 39*



**Photo B.** Almost 40 years later, only a tenth of the crane is visible above the snow.



# QRX . . .

## Extra Special 9-Year-Old

Rebecca Rich KBØVVT of Raytown, Missouri, has attracted quite a lot of attention recently—and deservedly so.

For starters, few who see her suspect that the cute little youngster with the flowing red tresses is a licensed amateur. And when they do get past that surprise, how about this: She's an Extra! And if that's not enough, how many Extras do you know who reached that pinnacle at *age 8*?

But it's all true, thanks to hard work, love of ham radio, and no doubt more than a little help from mom Barbara KGØUT and dad David KGØUS.

In fact, word of Rebecca's precocity is spreading. While on vacation with her parents in Maui during November 1996, unfortunately Rebecca had her Yaesu FT-51R stolen. This was not only a monetary loss, but a sentimental one as well—she had been given the HT as a reward for getting her General. Her father got the word out about the theft, but that was about all that could be done.

Or so everyone thought. Enter Yaesu, in the person of Mikio Maruya, Executive Vice President:

"We are sorry to hear of the misfortune that befell your family while vacationing on Maui ...

"We understand the FT-51R was a gift to Rebecca for earning her General Class license and that this radio was also her first ... We can appreciate that this radio must have been of great significance and sentimental value to her ...



Photo A. Rebecca Rich KBØVVT became an Extra when only eight.

"Nothing can ever truly replace Rebecca's original radio, but with your approval we would like to help lessen her loss by presenting her with a new complimentary FT-51R ...

"The future of ham radio is today's youth ... We hope that Rebecca will continue to enjoy her ham radio hobby for many years to come ..."

To Rebecca's delight, an FT-51R and ADMS-1c software package soon arrived.

And we hear that KBØVVT's fame continued to grow at last October's 50th Anniversary Convention of the QCWA in Kansas City. There, she was introduced by Bill Pasternak WA6ITF during his Future of Amateur Radio seminar and used as an example of what can happen when we help and encourage young people to get involved in amateur radio. Amen, Bill, and many congratulations to KBØVVT ...

## 20/20 Foresight

"I think there is a world market for maybe five computers."—Thomas Watson, chairman of IBM, in 1943.

Borrowed from *UTARC Newsletter*, April 1997, by way of June 1997's *Maple Valley Hamlink*, official newsletter of MVARC, Maple Valley WA.

## A Condensed History of Capacitors

The capacitor, or condenser, in its original form, was known as the Leyden Jar. It was discovered in late 1745 and early 1746 by several people. Remember, at this time only static electricity could be generated, as Volta would not invent his pile for another 45 years and it would be 85 years before Faraday discovered how to generate electricity with magnetism.

Von Kleist, Dean of the Cathedral at Kamin in Pomerania (now parts of Poland and Germany), wrote on November 4, 1745, about a small vial in which he had placed an electrified nail. He noticed that he could only obtain a shock from it when he held the vial in his hand. He concluded that the human body must have something to do with it.

In January 1746, a man named Cuneus, assistant to professor Peter Van Musschenbrock, at Leyden, Holland, received the next shock. Musschenbrock theorized that the reason electrified bodies lose their charge was because of the air around them, so he tried to charge water contained in a glass jar. The idea was that the glass would insulate the water from the air. Cuneus was holding the jar in his hand when it was discon-

nected from the static electricity machine—he received a large enough shock that he dropped the jar. When the experiment was repeated, it took Cuneus two days to recover, after which he stated that he would not repeat it again for all of France [a rather peculiar threat—ed.].

Later in 1746, a Dr. Bevis in Britain improved the design by coating the outside with tinfoil and suspending a metal chain from the cover to the water. His next step was to eliminate the water, replacing it with metal shot. And to prove that the form of the jar had nothing to do with the principles involved, he took a flat sheet of glass and coated each side with tinfoil to within an inch of the edge. It worked just as well as a jar with the same area.

Dr. Watson, a London apothecary and physician, showed that the force of the shock was increased when the glass was thinner, and established the law that the force of the charge was proportional to the area of the coated surface and to the thinness of the glass. The Leyden Jar became a scientific novelty, and large numbers of electricians traveled around Europe shocking people.

The abbot of Nollet entertained ladies of the French court by killing birds with the discharge. To amuse the king, the abbot sent a discharge through 180 guardsmen in order to watch them all jump simultaneously. Later he did the same thing to a circle of monks 5,400 feet in diameter.

When the novelty wore off, serious study began. In 1748, Dr. Watson formed a two-mile circuit of wire and announced that the amount of time necessary for electricity to pass through it was "altogether inappreciable."

In 1746, Benjamin Franklin had announced his theory that lightning and electricity were identical. He was ignored and ridiculed. In 1750, he suggested using pointed iron rods as conductors to draw lightning from the clouds. In 1752, he performed his famous kite experiment with a Leyden Jar, and eventually was made a Fellow by the Royal Society because of his work. He proved Bevis correct: Energy was actually stored in the glass. It was left to Faraday many years later to define and measure the dielectric constant.

Volta later gave the name condenser to the device, as electricity was considered to be a fluid that could be condensed. When Marconi signaled from Poldhu to Glace Bay, he used a battery of classically designed Leyden Jars that were later replaced by condensers. The name was changed to capacitor sometime after 1938—perhaps around 1948. [Anybody know?—ed.]

From an article by Jim Boyer KB9IH, in *Squelch Tale*, official newsletter of the Chicago FM Club, Inc., October 1997.

## Greek to You

Greece's *Radio Telecommunications Magazine* has announced two new Hellenic Awards. Publisher Nick Cassimis SVØCY/KD2IR tells us that the CW and SSB awards can be obtained





# Wireless Video Headquarters



## The Cube



### World's Smallest TV Transmitter

Perfect video transmission from a transmitter you can hide under a quarter and only as thick as a stack of four pennies- that's a nickel in the picture! Transmits color or B&W up to 150' to any TV tuned to cable channel 59 with a solid 20 mW of power. Crystal controlled for no frequency drift with performance that equals law enforcement models that cost hundreds more! Deluxe model includes sound using a sensitive built-in mike that will hear a whisper 15 feet away! Units run on 9 volts and hook-up to most any CCD camera. Our cameras shown below have been tested to mate perfectly with The Cube and work great. Fully assembled.

**C-2000 Video Transmitter Cube.....\$89.95**

**C-3000 Video and Audio Transmitter Cube.....\$149.95**

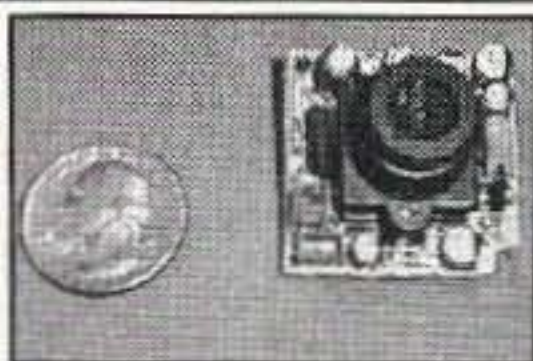

### CCD Video Cameras

If you're looking for a good quality CCD board camera, stop right here! Our cameras use top quality Japanese Class 'A' CCD arrays, not the off-spec arrays that are found on many other cameras. You see, the Japanese suppliers grade the CCDs at manufacture and some manufacturers end up with the off-grade chips due to either cost constraints or lack of buying 'clout'. These cameras have nice clean fields and excellent light sensitivity, you'll really see the difference, and if you want to see in the dark, these are super IR (Infra-Red) sensitive! Available with Wide-angle (80°) or super slim Pin-hole style lens. Both run on 9 VDC and produce standard 1 volt p-p video. Add one of our transmitter units for wireless transmission to any TV set, or add our Interface board (below) for Audio sound pick-up and direct wire connection to any Video monitor or TV video/audio input jacks. Fully assembled.

ers grade the CCDs at manufacture and some manufacturers end up with the off-grade chips due to either cost constraints or lack of buying 'clout'. These cameras have nice clean fields and excellent light sensitivity, you'll really see the difference, and if you want to see in the dark, these are super IR (Infra-Red) sensitive! Available with Wide-angle (80°) or super slim Pin-hole style lens. Both run on 9 VDC and produce standard 1 volt p-p video. Add one of our transmitter units for wireless transmission to any TV set, or add our Interface board (below) for Audio sound pick-up and direct wire connection to any Video monitor or TV video/audio input jacks. Fully assembled.

**CCDWA-2 CCD Camera, wide-angle lens.....\$99.95**

**CCDPH-2 CCD Camera, slim fit pin-hole lens.....\$99.95**

### CCD Camera Interface Board

Here's a nifty little kit that eases hook-up of your CCD camera module to any video monitor, VCR or video input TV set. The board provides a voltage regulated and filtered source to power the camera (CCD Cameras require a stable source of power for best operation), sensitive electret condenser mike for great sound pick-up and RCA Phono jacks for both audio and video outputs. Runs on 11 - 20 VDC.

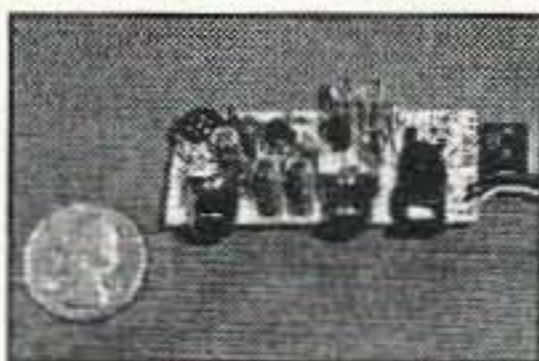

**IB-1 Interface Board Kit.....\$14.95**



### Budget TV Transmitter

Transmit audio and video to any TV set with this fully assembled transmitter. Although not tiny, it still offers some neat features. Takes standard 1 volt p-p video and audio and transmits on any UHF TV channel of your choice from 17 - 42. Has rugged metal case, includes AC adapter, whip antenna and even RCA phono plug patch cords! Can also run on 12 VDC.

**VS-2 Video and Audio Sender, Fully Assembled.....\$29.95**

### IR Illuminator for CCD Cameras

See in total darkness with one of our CCD video cameras and this IR illuminator! IR light can't be seen, illuminate the scene with IR and a CCD camera 'sees' just fine. The array of 24 extra high intensity LEDs are invisible to anybody - except for aliens and Casper! Runs on 12 VDC. Illuminates similar to that of a bright flashlight.



**IR-1 IR Illuminator Kit.....\$24.95**

### MicroEye CCD Camera & Transmitter Combo

We married together one of our quality CCD cameras, a sensitive electret microphone and a small TV transmitter to give you a super neat - and tiny - all in one, 'knows all, sees all, hears all' package! Small enough to fit into a cigarette pack and powerful enough to transmit up to 150' to any standard TV set. Tunable to operate on TV channels 4, 5, or 6 and runs on 9 to 20 VDC. The sensitive mike picks up normal voice within an average size room. Ideal for private detectives, investigators, hobbyists, babysitters, model rocketeers, RC airplanes and other uses limited only by your imagination. Camera module is fully wired and the transmitter unit is an easy to build kit that goes together in an evening. Includes all parts, handsome jet-black case and clear, concise instructions with ideas for use. And, don't forget, our CCD cameras are very sensitive to IR light - just add the IR-1 IR Illuminator kit for see-in-the-dark operation!



**ME-2000 MicroEye TV Transmitter Combo .....\$149.95**

### Wavecom Wireless Video and Audio Transmission System

Transmit extremely clean and sharp video and audio up to 300 feet. Wavecom transmits in the 2.4 GHz band using FM and circular polarization for state-of-the-art transmission. There is no fading, ghosting, humming, buzzing or picture rolling when using the Wavecom. System consists of two parts, a transmitter unit and a receiver unit. Switch selectable 4 channel operation allows use of multiple Wavecoms in the same geographic area. Connections are video and audio in and out using standard RCA phono jacks. Includes AC wall plug adapters, patch cords, coax cable jumper, TV antenna A/B switch and complete hook-up instructions. Fully assembled with one year warranty.



The Wavecom Sr. has all of the features above plus adds the capability of transmitting your TV/DSS/VCR remote control signals from the receiver unit back to the transmitter unit. This is great for controlling your DSS satellite receiver or VCR from any room in the house. We also offer the small internal transmitter module assembly for those who wish to make their own concealed video transmitter system. Module is about the size of a couple of matchboxes and includes microwave patch antenna.

**WC-1 Wavecom Jr. Wireless System.....\$189.95**  
**WC-5 Wavecom Sr. with Remote Capability.....\$239.95**  
**WC-TX Transmitter Module Assembly.....\$105.00**



## RAMSEY ELECTRONICS, INC.

793 Canning Parkway Victor, NY 14564

Call for our free catalogue or visit us on the web: [www.ramseyelectronics.com](http://www.ramseyelectronics.com)

**Toll-free Order Service: 1-800-446-2295**

Sorry, no technical info or order status at this number

**For Tech Info or Order Status, Call the Factory Direct**

**Phone (716) 924-4560**

**Fax (716) 924-4555**

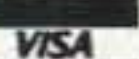

**ORDERING INFO:** Satisfaction Guaranteed. Examine for 10 days, if not pleased, return in original form for refund. Add \$5.95 for shipping, handling and insurance. Orders under \$20, add \$3.00. NY residents add 7% sales tax. Sorry, no CODs. Foreign orders, add 20% for surface mail or use credit card and specify shipping method.

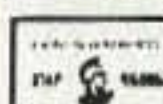
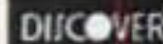



by having two (2) confirmed contacts with each of the SV1 through SV9 regions (18 contacts per award). To apply, send QSL copies and \$10.00 (US) per award to *Radio Telecommunications Magazine*, Hellenic Award '97, 165 Egeou Street, 17124 Nea Smirni, Athens, Greece. For further info, use E-mail [radiotel@hol.gr] or FAX (011) 30-1-975-3304, or visit their Web site at [http://www.radiomagazine.com].

## A DXer's Night B4 Christmas

By Ward Silver  
[hwardsil@wolfenet.com]

'Twas the night before Christmas  
And all 'cross the bands,  
No DX was stirring  
From Brazil to Japan.

My antennas were pointed  
With painstaking care,  
In hopes that a new one  
Soon would be there.

The family was nestled  
All snug in their beds,  
While visions of TVI  
Danced in their heads.

In my slippers and sweater,  
Chores finally past,  
I'd just settled in  
For DXing at last.

When out of the speaker  
There arose such a ruckus,  
That I grabbed for my 'phones  
To see who the DX was.

Down to the low end  
I tuned in a flash,  
And switched in a filter  
To get rid of some hash.

With the shack in the light  
Of the amplifier's glow,  
I tuned up and down  
Hoping DX would show.

When what to my wondering  
Ears did appear?  
But a rapid-fire pileup  
With DX in the clear!

As DXers clamor,  
Calling low and then high,  
When after a rare one  
Raise a great hue and cry.

More rapid than popcorn  
The callsigns they came,  
And he heard them, and logged them,  
And called them by name.

"OH and PY and Hotel Charlie  
Eight,  
JA and ZS and a Washington State!"

"All forty zones  
and six continents, too.  
I can copy you all!  
It's a marvelous zoo!"

I could tell he was rare  
From that fluttery sound.  
And I heard him quite clearly  
As he turned it around.

"GM GE ES BEST DX TOO  
QSL VIA BURO ES BCNU"

His fist, how it sparkled,  
His callsign, sent well,  
Made his signal to ring  
Like the sound of a bell!

He worked through the callers  
Like a championship.  
And even tailenders;  
Worked 'em lickety-split.

I wasted no time and  
Went straight to my work,  
Calling up three  
Where the big signals lurk.

My call came right back  
Like he knew I was there.  
The code crackled over  
The cold winter air.

And then it was over,  
It was down in the log.  
I filled out my card  
And sipped some eggnog.

But I heard him exclaim  
Before calling anew,  
"Merry Christmas to all,  
Listening up one to two!"

73, Ward NØAX

## Top Ten Reasons for Working Phone

10. You can work your neighbors at the same time, via their TV sets and telephones.
9. I can never think of anything to say on CW.
8. The Q codes sound really cool when you say them out loud.
7. My kids think I sound like Donald Duck on SSB.
6. Umm ... I can't find my key.
5. On phone I can usually tell if the operator is of the opposite sex.
4. I can use either Upper Side, or Lower Side, or both!
3. On phone, if somebody has trouble copying me I can just turn up the mike gain and shout.
2. A phone signal occupies like a jillion times as much bandwidth as a CW one, so more people will hear me.
- And the Number One Reason for Working Phone:
1. I love the sound of my own voice, so let everybody hear it!

From *Low Down*, official journal of the Colorado QRP Club (cq@aqol.com); originally in *Key Note*, FISTS CW Club, Hadley MI.

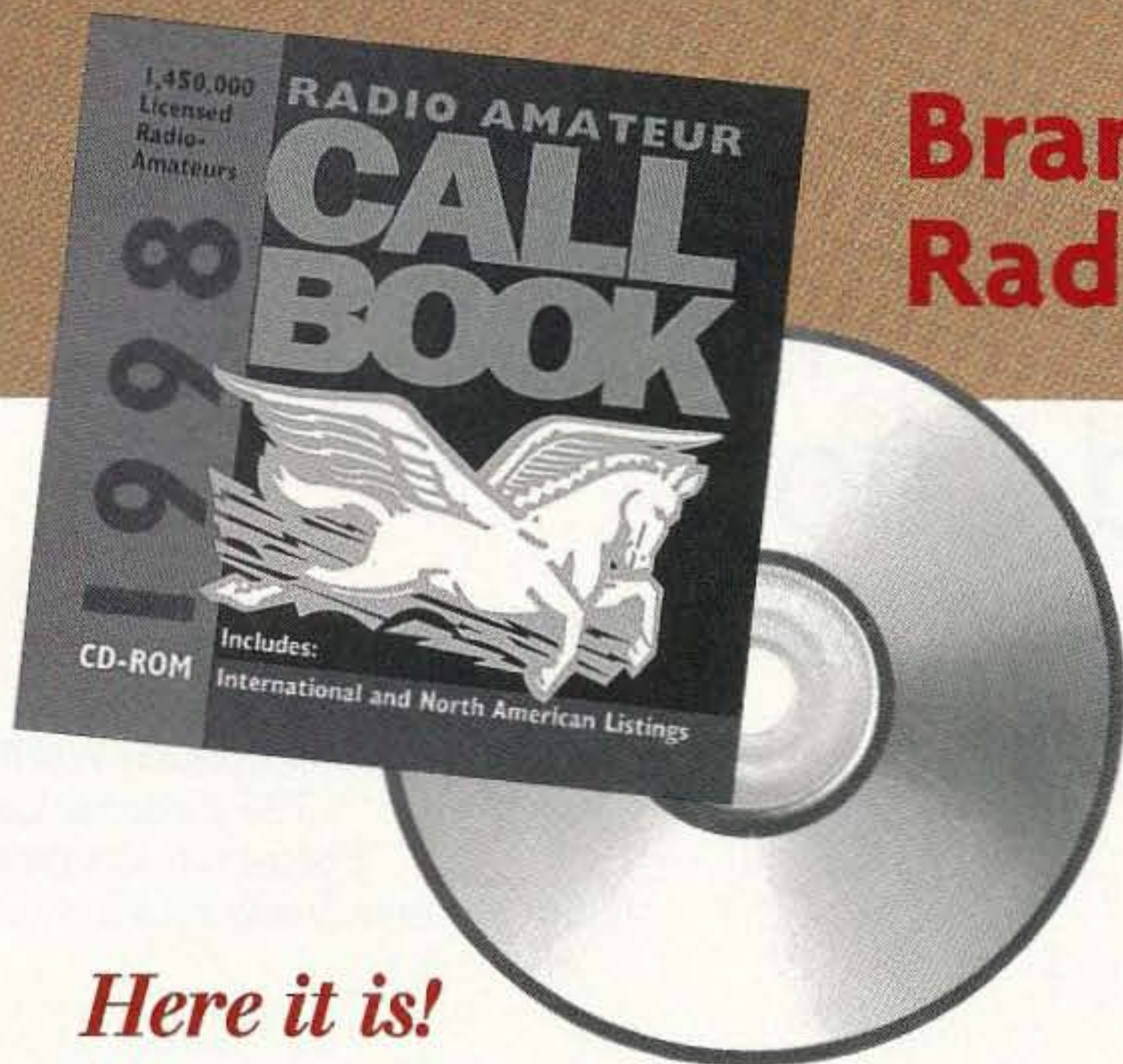

Photo B. This beautiful Greek certificate could be yours.



# RADIO AMATEUR

# CALLBOOK 1998



## Brand NEW Amateur Radio Prefix Maps!

*Here it is!  
The most  
accurate and extensive  
CD-ROM available!*

### FEATURES

- QSL Managers—We currently list over 54,000 entries.
- Browse feature
- Windows/DOS platform for US & international data retrieval
- Windows icon driven by mouse & DOS via menu
- Data display by callsign, last name, city, license class issue & expiration dates
- Search US stations by callsign, last name, county & zip code
- Search international data by callsign or text search by name, street, city, province or region after selection of country
- Print labels from Windows/DOS platforms. Windows application can do multiple label printing tasks.
- Listings of clubs, then and nows, military & silent keys
- US data includes time zones, latitude, longitude listings & area codes
- Morse code sound output to PC speaker

**Radio Amateur Callbook**  
1695 Oak Street • Lakewood, NJ 08701

### OUR NEW CD OFFERS UNMATCHED COVERAGE OF THE WORLD...

Brand new Colorful Maps of most of the World including small islands. Click on a button to view. "Only on the Radio Amateur Call Book CD-Rom."

The CD-ROM contains more than 1,450,000 listings worldwide covering more than 250 countries, islands and dependencies. The Radio Amateur Callbook/CD-ROM contains both North American and International listings!

Listings can be found quickly by name, location and call letters— even when the information is incomplete!

Extended Wordsearch allows users to specify search criteria. Search by name, city, zip code, all in one search!

The most accurate & extensive CD-ROM available.

The introduction of many new fields— Special Comment, Previous Call, Previous Class, Vanity Call Sign Indicator, E-Mail Address & Fax #.

### ORDER TOLL FREE

1-888-905-2966 (USA Only)  
1-732-905-2961 • Fax 1-732-363-0338  
E-mail: 103424.2142@compuserve.com

or fill out the coupon below. VISA/MC/AMEX accepted.

### ORDERING COUPON

Please send me:

QTY.	ITEM	NUMBER	PRICE
_____	Callbook CD-ROM	RACD05	\$ 49.95
Available November, 1997			

#### If ordering by credit card:

Card Type \_\_\_\_\_ Exp. Date \_\_\_\_\_

Card # \_\_\_\_\_ Signature \_\_\_\_\_

Address \_\_\_\_\_

Email address \_\_\_\_\_

**If ordering by check or money order:** I have enclosed a check/money order for \$ \_\_\_\_\_. (Please add sales tax in CA, DC, IL, MA, NJ, NY, OH, PA, TN, VA and Canada, and \$5.00 per order for postage and handling in US; \$7 for all shipments outside US.) Please include shipping instructions. Prepayment is required.



# Distributed Capacity Folded Loop

*This ceiling-mount mobile antenna will really go to your head!*

John Portune W6NBC  
724 Celestial Lane  
Foster City CA 94404  
[John\_Portune@mail.sel.sony.com]

If you own a Fiberglass™ pickup shell, motorhome, or boat, this compact 40-meter mobile loop will compare favorably with a mobile whip antenna. What's better, it's invisible from the outside of the vehicle.

Over the years, the ham community has ignored small transmitting loops for the HF bands. Today, however, we live in a shrinking world. Everything is smaller: our rigs, our cars, even our QTHs.

I was curious. Would a loop work well there? Could it compete with a conventional HF whip antenna?

To answer this question, we need to get back to basics, to understand the fundamental strengths and weaknesses of both types of antenna.

## Key principles

Compact transmitting loops and mobile HF whips are usually considered small antennas. Their total size is less than roughly 1/4-wavelength. How well each performs depends heavily on three key issues: (1) radiation resistance; (2) coupling field size (my term); and (3) antenna height.

In a full-sized antenna like a dipole, radiation resistance is comparatively high—about 73 ohms. In a compact loop or a mobile whip, the radiation resistance is much lower. Here are the formulas for the radiation resistance for a small loop and a short vertical whip (without loading coil or capacitive hat):

### Loop

$$R_r = 19500 \times (D/WL)^4$$

where

$R_r$  = Radiation resistance in ohms

$D$  = Diameter of loop in meters

$WL$  = Wavelength in meters

### Whip

$$R_r = 392 \times (L/WL)^2$$

where

$R_r$  = Radiation resistance in ohms

$L$  = Length of whip in meters

$WL$  = Wavelength in meters

To illustrate, **Table 1** translates the loop formula into real numbers. Notice how rapidly radiation resistance decreases with size. Why is this important?

In the theoretical world, it isn't. An antenna with low radiation resistance, like a loop or a mobile whip, can radiate just as well as an antenna with high radiation resistance, like a dipole. The only difference will be the voltage and current in each antenna.

In the real world, however, antennas also have conductor resistance. The metal in an antenna is not perfect. All

Loop Diameter (Feet)	$R_r$ (Ω)	$C_r$ (Ω)	Efficiency (%)
10	0.49	0.089	85
9	0.32	0.080	80
8	0.20	0.071	74
7	0.12	0.062	67
6	0.064	0.053	55
5	0.031	0.044	41
4.5	0.020	0.040	33
4	0.013	0.035	27
3	0.004	0.027	12
2	0.0008	0.018	4
1	0.0000	0.00089	0.05

**Table 1.** Radiation resistance ( $R_r$ ), conductor resistance ( $C_r$ ), and efficiency of loops made of 3/4-inch (0.9-in. OD) copper pipe at 7 MHz.



# MFJ TUNERS

## MFJ-949E Deluxe 300 Watt Tuner

More hams use MFJ-949's than any other tuner in the world!

More hams use MFJ-949s than any other tuner in the world!

**Why?** The world's leading antenna tuner has proven reliability and can match any real antenna!

### Tunes any Antenna

The 949E tunes out SWR on dipoles, verticals, inverted Vs, beams, random wires, mobile whips, SWL.

Use coax, random wire, or balanced lines with heavy duty 4:1 balun.

### Full 1.8-30 MHz Operation

1000 volt tuning capacitors, extra heavy duty inductor switch, Teflon® insulators and proper L/C ratio gives you arc-free operation 1.8 to 30 MHz. Handles 300 Watts PEP SSB.

### Lighted Cross-Needle Meter

MFJ's lighted Cross-Needle Meter shows you SWR, forward and reflected power simultaneously. Read peak/average on 300/30 Watt ranges.



**\$149<sup>95</sup>** MFJ-949E

### Super Antenna Switch

8 position super antenna switch selects two coax fed antennas, random wire/balanced line or built-in dummy load for use through your MFJ-949E or direct to your transceiver.

### QRM-Free PreTune™

MFJ's QRM-Free Pre-Tune™ lets you pre-tune your MFJ-949E

off-the-air into its built-in dummy load.

### Full Size Dummy Load

A full size -- 3/4 inch diameter by 5 inches -- non-inductive 50 ohm dummy load easily handles 300 watts of abusive tune-up power.

### Custom Inductor Switch

The inductor switch is custom designed to withstand extremely high RF voltages and currents.

### Superior Cabinet

Each MFJ-949E cabinet is

chemically treated and has a new tough scratch-proof vinyl cladding. You won't find a tougher, longer lasting finish anywhere.

Detailed logging scales and legends are permanently silk screened on a real aluminum front panel and back panel.

### Superior Construction

Every MFJ-949E uses Teflon® insulating washers, wing-nut for ground post, fire-retardant epoxy glass PC board, heavy .063 inch thick aluminum chassis, heavy gauge wire, custom cabinet.

### No Matter What™ Warranty

Every MFJ-949E is backed by MFJ's famous No Matter What™ unconditional warranty. We'll repair or replace your MFJ-949E (at our option) no matter what for a full year.

**In Stock at all Ham Dealers!**

## More hams use MFJ tuners than all other tuners in the world! Why settle for an imitation when you can have the real thing?

### MFJ's World famous 3 kW Tuner



MFJ-989C **\$349<sup>95</sup>** More hams use MFJ-989s than any other 3KW tuner in the world!

The rugged MFJ-989C handles 3KW PEP SSB and covers 1.8 to 30 MHz including all MARS and WARC bands.

MFJ's new AirCore™ Roller Inductor, three-digit turns counter and spinner knob gives you exact inductance control for absolute minimum SWR.

You can match dipoles, verticals, inverted vees, random wires, beams, mobile whips, shortwave -- nearly any antenna. Use coax or balanced lines.

You get everything you've ever wanted in a high power, full featured antenna tuner -- widest matching range, lighted Cross-Needle SWR/Wattmeter, antenna switch, built-in dummy load, balun, convenient flip stand -- all in a sleek, compact cabinet.

### MFJ's versatile 1.5 KW Tuner



MFJ-962D Use your barefoot rig now and have the capacity to add a 1.5 KW PEP amplifier later! Lighted Cross-Needle SWR/Wattmeter. 6 position antenna switch, Teflon® wound balun, ceramic feedthru insulators for balanced lines. 1.8-30 MHz. 10<sup>3</sup>/<sub>4</sub>x4<sup>1</sup>/<sub>2</sub>x14<sup>7</sup>/<sub>8</sub> in.

### MFJ's portable/QRP Tuner

Tunes coax, balanced lines, random wire 1.8-30 MHz. Cross-Needle Meter. SWR, 30/300 or 6 watt QRP ranges. 6x6<sup>1</sup>/<sub>2</sub>x2<sup>1</sup>/<sub>2</sub> in. **\$89<sup>95</sup>**

### MFJ's super value Tuner



MFJ-941E The new MFJ-941E gives you a 300 watt PEP tuner with lighted Cross-Needle Meter. Covers 1.8-30 MHz. **\$109<sup>95</sup>**

Antenna switch selects 2 coax lines (direct or thru tuner), random wire, balanced line or external dummy load. 4:1 balun. 1000 volt capacitors.

**Call your dealer for your best price!**  
Nearest dealer/Free catalog... 800-647-1800

### 2 Knob Differential-T™ Tuner



MFJ-986 The MFJ-986 Differential-T™ 2 knob tuner uses a differential capacitor to make tuning foolproof and easier than ever. It ends constant re-tuning with broadband coverage and gives you minimum SWR at only one best setting. 3 KW PEP. 1.8-30 MHz. **\$299<sup>95</sup>**

Roller inductor makes tuning smooth and easy. Turns counter lets you quickly re-tune to frequency.

Lighted Cross-Needle Meter reads SWR/forward/reflected/peak/average power in 2 ranges. Current balun reduces feedline radiation and forces equal currents into unbalanced antennas.

### MFJ's mobile Tuner



MFJ-945E **\$99<sup>95</sup>** Don't leave home without this mobile tuner! Let the MFJ-945E extend your antenna bandwidth so you don't have to stop, go outside and adjust your mobile whip. Now includes 6 Meters.

Small 8x2x6 inches uses little room. Lighted Cross-Needle SWR/Wattmeter with lamp switch. 1.8-30 MHz. 300 watts PEP. Mobile mount, MFJ-20, \$4.95.

### MFJ's 6 Meter Tuners

The MFJ-906 has lighted cross-needle SWR/Wattmeter, bypass switch. Handles 100W FM, 200W SSB. For coax fed antennas. MFJ-903, same as MFJ-906, less SWR/Wattmeter, bypass switch. **\$49<sup>95</sup>** MFJ-906 **\$79<sup>95</sup>**

### MFJ's smallest Versa Tuner

The MFJ-901B is our smallest -- 5x2x6 inches -- (and most afford-able) 200 watt PEP tuner -- when both your space and your budget is limited. Great for matching solid state rigs to linear amps. **\$69<sup>95</sup>**

### MFJ's random wire Tuner

Operate all bands anywhere with any transceiver with the MFJ-16010. It lets you turn a random wire into a transmitting antenna. 1.8-30 MHz. 200 watts PEP. Ultra small 2x3x4 inches. **\$39<sup>95</sup>**

### MFJ's VHF or UHF Tuners

MFJ-921 or MFJ-924 **\$69<sup>95</sup>** MFJ-921 covers 2 Meters/220 MHz. MFJ-924 covers 440 MHz. SWR/Wattmeter. 8x2<sup>1</sup>/<sub>2</sub>x3 in. Simple 2-knob tuning for mobile or base.

### MFJ's artificial RF Ground

Creates artificial RF ground. Eliminates or reduces RF hot spots, RF feedback, TVI/RFI, weak signals caused by poor RF grounding. Also electrically places a far away RF ground directly at your rig by tuning out reactance of connecting wire. **\$79<sup>95</sup>**

Tech Help: (601) 323-0549 FAX: (601) 323-6551

<http://www.mfjenterprises.com>

**MFJ** MFJ ENTERPRISES, INC.  
P. O. Box 494, Miss. State, MS 39762  
(601) 323-5869; 8-4:30 CST, Mon-Fri.  
E-Mail: mfj@mfjenterprises.com  
Prices and specifications subject to change. © 1997 MFJ Enterprises, Inc.

**MFJ... the most trusted name in antenna tuners**



metals exhibit resistance. The problem is that it's in series with the radiation resistance. Transmitter power gets divided between the two. The part that goes to conductor resistance is wasted as heat. The portion that gets to the radiation resistance is the useful part. It becomes radio waves.

The real culprit is skin effect, the well-known tendency of RF current to flow only on the surface of a conductor. Here is that formula:

$$R = 0.00096 \times \sqrt{F/D}$$

where

R = Conductor resistance in ohms/ft

F = Frequency in MHz

D = Conductor diameter in inches

Again, I'll give this equation some real numbers. For example, let's take a large conductor, 3/4-inch (0.9-inch OD) copper water pipe. At 7 MHz, conductor resistance is 0.0028 ohms per foot. That's not much, you say. Take a look at the third and fourth columns of **Table 1**. Even with a conductor this large, for loops smaller than five feet the conductor resistance is actually greater than the radiation resistance. Instead of being a minor problem, skin effect eats us alive in compact loops.

## Two additional concerns

What's more, even the type of metal we use to build a loop is important.

Silver	0.94
Copper	1.0
Gold	1.4
Aluminum	1.6
Chromium	1.8
Zinc	3.4
Brass	3.7 - 4.9
Tin	6.7
Steel	7.6 - 12.7
Lead	12.8

**Table 2.** Relative resistivity of common metals, compared to copper.

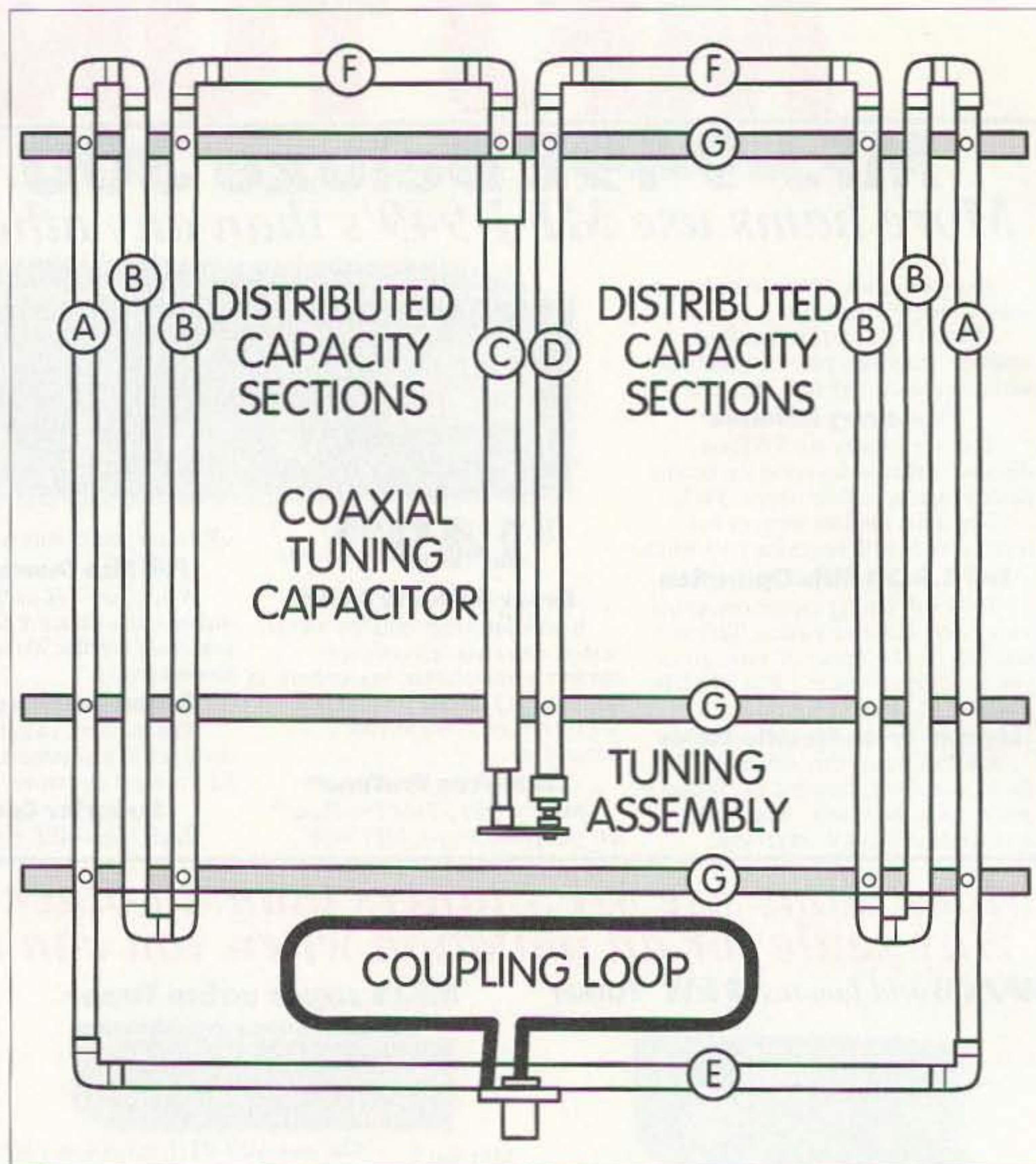

**Fig. 1.** The distributed capacity folded loop.

I've listed the relative resistivities of some common metals in **Table 2**. I've included silver and gold for curiosity more than practicality. Gold is interesting, however. You might think that it would be the best conductor. Surprisingly, both silver and copper are better. We use gold on connectors not because of superior conductivity, but because it resists corrosion.

Copper is really the only choice for a loop. Even aluminum, which is suitable for larger antennas, has 60% more resistance. We can't afford this when we are fighting skin effect in a loop. Other metals are worse.

Perhaps you are thinking about silverplating. It's a good idea at much higher frequencies, but at 7 MHz the skin depth is too thick. Plating does not become practical until we are operating at UHF frequencies.

Also, the shape of the conductor is

important. Round is best. A flat strap, for example, suffers much more from skin effect than a round conductor. Not only does the RF current move outward, it also moves to the edges.

For most small loops, 3/4-inch household copper water pipe is the most reasonable choice. It has moderately low conductor resistance and it's inexpensive.

## A mobile whip

Whips don't suffer as badly from conductor resistance loss. In the equations above, you'll notice that the radiation resistance of a loop decreases in proportion to the fourth power of diameter. For a whip, it's only the second power of length. The radiation resistance and the efficiency of a typical 40-meter mobile whip are much higher than for a comparable loop. Does that make a whip better than a loop for mobile? Not necessarily.



In theory, a 1/4-wavelength mobile whip antenna is not a complete antenna. It is physically only half a dipole. It's often called a monopole. The missing half of the antenna exists, but it's a mirror image of the real half of the dipole in the ground plane under the monopole. Without it, the monopole would not function. The coupling field from the real half of the antenna becomes RF currents in the ground plane to complete the electrical circuit of the antenna.

If the ground plane under the antenna is a perfect conductor, the monopole will radiate just as well as if the other side of the dipole were actually present. In the typical mobile situation, however, the ground plane is terrible.

At HF frequencies, the vehicle's body is much too small to be the entire ground plane. The coupling field even for a short whip is many meters in diameter at 7 MHz. Contrast this with VHF, where the coupling field is only roughly a meter in diameter. Here the car body can provide the complete ground plane.

Soil makes up most of the ground plane at HF. Compared to a metal car body, soil is a poor conductor. It varies with location, but soil resistance is always at least 10 ohms, even in the best case.

Like conductor resistance, the soil resistance is in series with the radiation resistance, and the power again gets divided. At HF, most of the transmitter's power only heats up worms.

### A mobile loop

In contrast, a mobile loop does not suffer in the same way. First, it isn't half an antenna like a mobile whip. The coupling field can make a complete circuit in space. Part of it does not have to become currents in the soil. The other half of the antenna is physically present.

The second reason is the size of the coupling field of a loop compared with a whip. Because the ends are folded back in a loop, the coupling field is mostly confined to the center of the loop. This makes it much smaller than the coupling field of a whip. Without

going into the math, my loop's coupling field is roughly the same as a tiny 12-inch dipole's. The loop's energy becomes a radio wave long before it ever reaches the soil.

Does this mean that a loop is better for mobile operation? Again, not necessarily. There is more to the story. Here's where we get to antenna height.

Like any antenna, a loop works best in free space, far away from surrounding objects. Anything that you place near an antenna induces losses and lowers its efficiency.

Because of its very small coupling field, the electric and magnetic fields of a loop are more intense than for a whip. In free space this would not be a problem. Due to its shape, however, we normally have to mount a loop close to the metal body of the car.

For the whip, the metal body is an asset—it improves the ground plane. But for the loop, it is a disadvantage. Near the metal body of the car, losses induced by the loop's intense magnetic field are unfortunately quite high.

It is just easier to get a whip higher in the air than a loop. Notice the photo of my truck. The whip on average is several feet higher than the loop, so it is less of a "grounded" antenna.

What can we conclude, then? Is one antenna the clear winner for mobile



*Photo A. Truck with 40-meter Hustler mobile whip. Loop not visible, inside.*

operation? Frankly, no. A whip is easier to get higher in the air, and it suffers less from conductor resistance loss. However, it suffers badly from soil resistance loss. Also, it's ugly.

A loop does not suffer from soil resistance loss and is aesthetically much more attractive, at least from the outside of the vehicle. It, however, suffers badly from magnetic loss in the car's body. Therefore, both antennas are very highly compromised by the

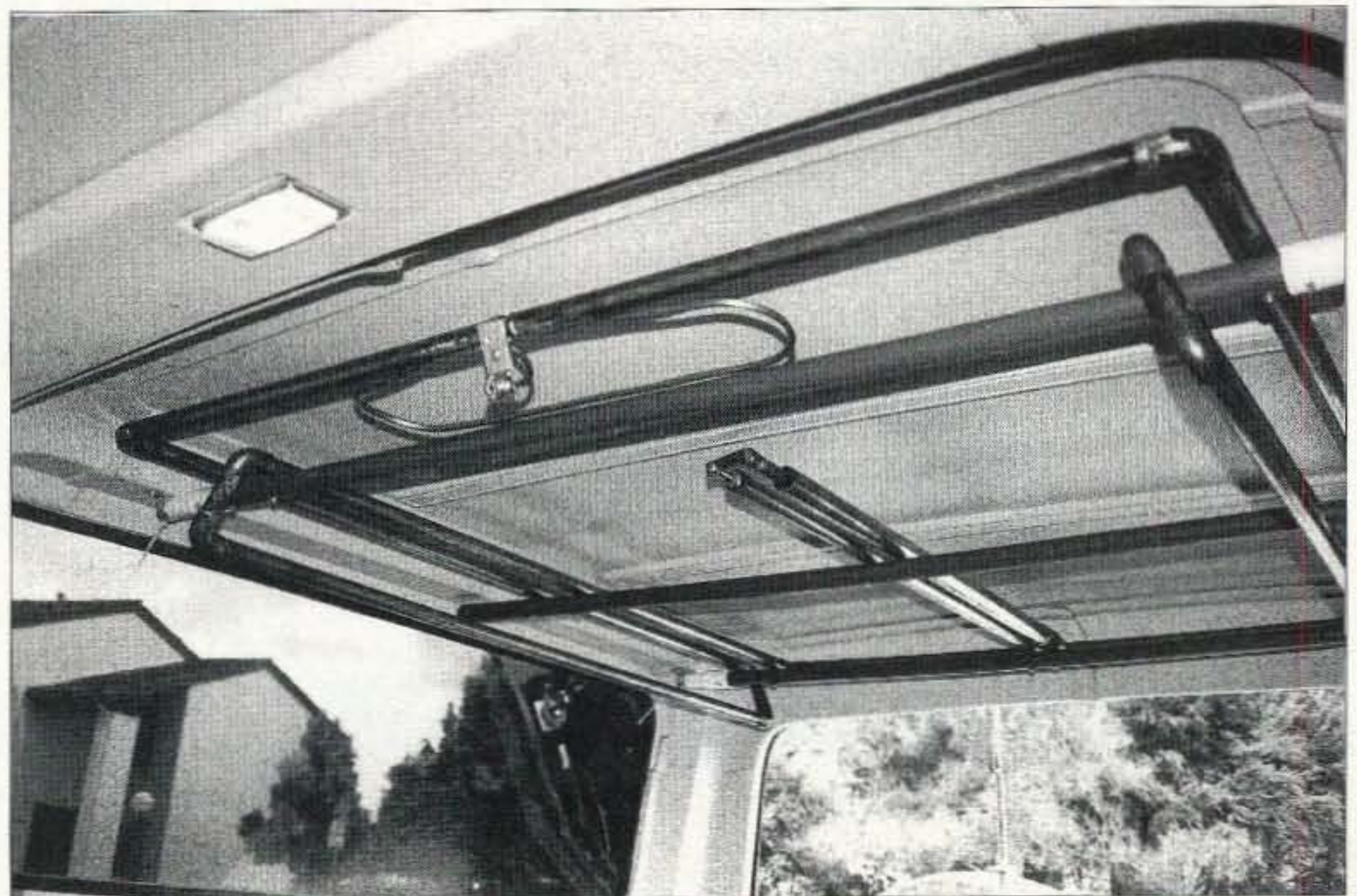

*Photo B. Interior of truck from the driver's position with loop mounted on underside of Fiberglass shell. Mount loop with connector forward.*



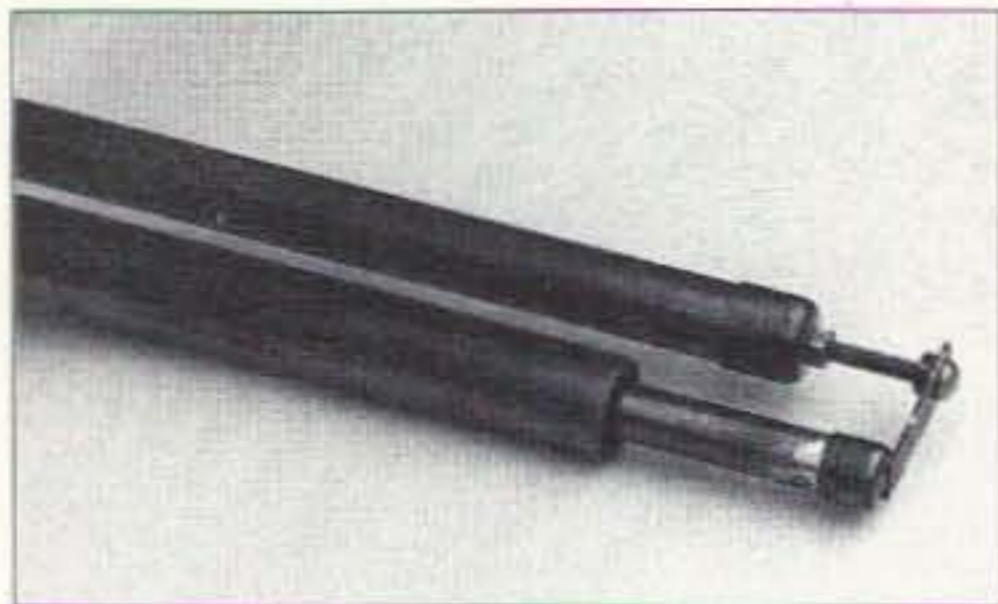

Photo C. Close-up of the tuning assembly of the coaxial capacitor.

mobile environment. Neither is significantly better than the other.

Later in this article, I will share with you my personal comparisons of the two antennas, based on operational experience. Like most antenna articles, the proof of the pudding comes from using the antennas on the air. I will say here, though, that my experience with the loop has been quite good.

### Designing the mobile loop

Now that we are armed with all this theory, let's design the loop. The first consideration in the mobile environment always is space. Realizing that big is better, I made the loop as big as I could. It had to fit on the underside of the Fiberglass shell of my truck. It's a rectangular loop 47 by 51 inches, but I made it a little smaller than necessary so that it would fit on a smaller truck (my pickup is a full-sized model).

Loops, incidentally, do not have to be round. Shape isn't important. Only the total area of the loop matters. That's what couples to space, not the shape. For

calculating purposes, my 47- by 51-inch rectangular loop is roughly equivalent to the round 4.5-foot loop shown in the figures.

You will notice from Fig. 1 that the loop is more than just a simple loop. There is a good reason for this, and I will get to that shortly. First, however, we need a little more theory.

### The tuning capacitor

A small loop antenna is essentially a parallel tuned circuit, an inductor in parallel with a capacitor. By making the inductor physically large enough to have usable radiation resistance, the circuit will act as an antenna. Making the inductor into a single-turn loop accomplishes this nicely. Then, by adding capacity across the ends of the loop, usually in the form of a tuning capacitor, we bring the circuit to resonance.

The capacitor, however, is the difficult part of this design. Remember, voltage and current in any small antenna are high. My loop has a radiation resistance of roughly 0.02 ohms. A dipole, at 73 ohms, is almost 4000 times higher. The voltage and current multiply by this ratio. In a small loop they can reach tens of thousands of volts, and many dozens of amps. It takes a very substantial tuning capacitor to withstand this.

So I set out to do something about the tuning capacitor. Could I eliminate or minimize it? The answer to both of these is yes. By taking advantage of another characteristic of all antennas, I

eliminated the conventional tuning capacitor entirely. In theory, all coils also possess a small amount of capacitance. We call it *distributed capacity*.

If we could make the loop large enough, the distributed capacity would bring the loop to resonance all by itself. Loops are naturally self-resonant, without a capacitor, at a circumference of roughly 1/4-wavelength. On 40 meters, this would be a loop roughly 10 feet in diameter.

A 47- by 51-inch loop is too small to be self-resonant at 7 MHz. I measured mine with an FET dip oscillator. It resonated at 21–22 MHz without a capacitor. If I had wanted to use it on 15 meters, that would have been fine. I mostly work 40 meters mobile, however.

So I added more conductor. To maintain the required 47- by 51-inch size, I folded the extra length back. Notice Fig. 1. This is an old trick to increase distributed capacity that I read in a 50-year-old antenna textbook. The self-resonant frequency now dropped to between 13–14 MHz. Again, if I had wanted to work 20 meters, I would have been close.

Then by extending the ends of the loop downward, to form a linear capacitor, as shown in Fig. 1, I lowered the resonant frequency a couple more MHz. I was getting close. A small air-variable would have taken me the rest of the way, had I wanted. My objective, however, was to completely get rid of the conventional tuning capacitor.

You'll see my final solution in Fig. 1. It's a coaxial capacitor also made of copper pipe. It's inexpensive and you can make it yourself. You won't have to locate a large, expensive tuning variable. This capacitor will handle a 100-watt mobile transceiver. I haven't tested its maximum power handling capacity. If you want to run more power, all you have to do is use larger pipes for the capacitor.

### Tuning the loop

As you can also see, I made the center conductor of the coaxial capacitor adjustable like the slide of a trombone. With this arrangement I can tune the loop to any segment of the 40-meter band. Yes, the loop is a fixed-frequency

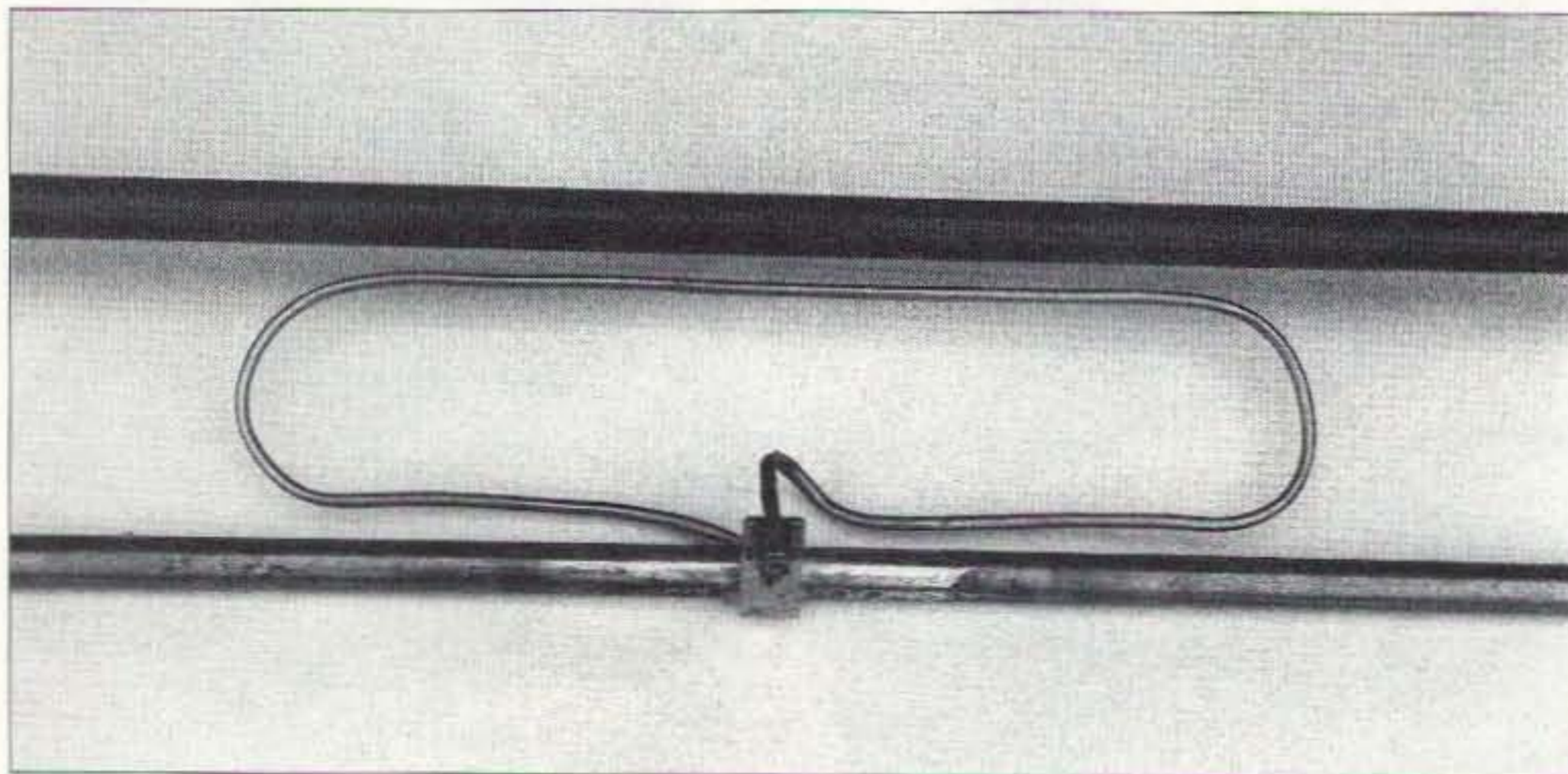

Photo D. Close-up of feed loop, made of soft quarter-inch copper tubing. Solder one end directly to main loop near connector. Solder other end to the center pin of the feed connector.



device, but so is my mobile whip. I have to change the length of the whip for a different band segment. Where's the sin in doing the same for a loop? In my particular vehicle, the tuning adjustment is right behind the driver's seat.

Also, like any small antenna, the loop is extremely sharp in tuning, but so is my whip. Any small antenna that isn't sharp isn't efficient. A small antenna that is broad has high losses. It's a law of physics. Incidentally, from bandwidth alone I know that the two antennas are very similar in total efficiency.

With the loop or the whip, you must operate within roughly a 25 kHz window to stay below 3 to 1 SWR. Otherwise, you will need to move the adjusting assembly. For convenience, you could parallel the coaxial capacitor with a small wide-spaced variable. 20 picofarads would be adequate.

### Automatic antenna tuners

While I'm talking about bringing the loop to resonance, let me say something here about automatic antenna tuners. While it is theoretically possible to feed

a loop with an automatic antenna tuner, it's not a good idea. You'll have the same problem if you use a tuner with a loaded whip. The tuner is able to provide a matched load for your rig. It won't, however, necessarily maintain the efficiency of the antenna. Worse yet, you may damage your tuner.

For a loop or small loaded whip to work properly, high circulating currents must flow. Remember, it has low radiation resistance. Once we tune out the reactance, high currents will flow in the low radiation resistance. We don't, however, want these high currents in the tuner. If you use a tuner to cancel the reactance as you move frequency, some of the high current will begin to flow in the tuner and in the transmission line. Neither may be able to stand it. It is best to bring a loop or mobile whip to resonance by reactance located in the antenna, not in a tuner. That's why the commercial loops have heavy-duty motor-driven tuning capacitors in them. In my particular case, I tune the loop by distributed capacity and the coaxial tuning capacitor. Both are part of the loop.

### Feeding the loop

To couple the loop to your transceiver, you will need a feed network. Most conventional feed techniques work well. I tried a gamma match, a shunt match, a capacitive match, and a loop match. All of these worked, once I got them tamed. The easiest method proved to be loop coupling, however. You can see the details in Fig. 1.

To my surprise, the shape size, location, and wire size of the coupling loop are not critical. For durability, I made it out of 1/4-inch soft copper tubing. Make it roughly one-quarter of the diameter of the main loop. Mine is a rounded rectangular loop roughly four inches by 18 inches.

The most convenient place to locate it appears to be at the midpoint of the main loop. Here the impedance is very low. Solder the grounded end of the coupling loop directly to the main loop, as shown. Mount the feed connector on a small copper strap also soldered to the main loop.

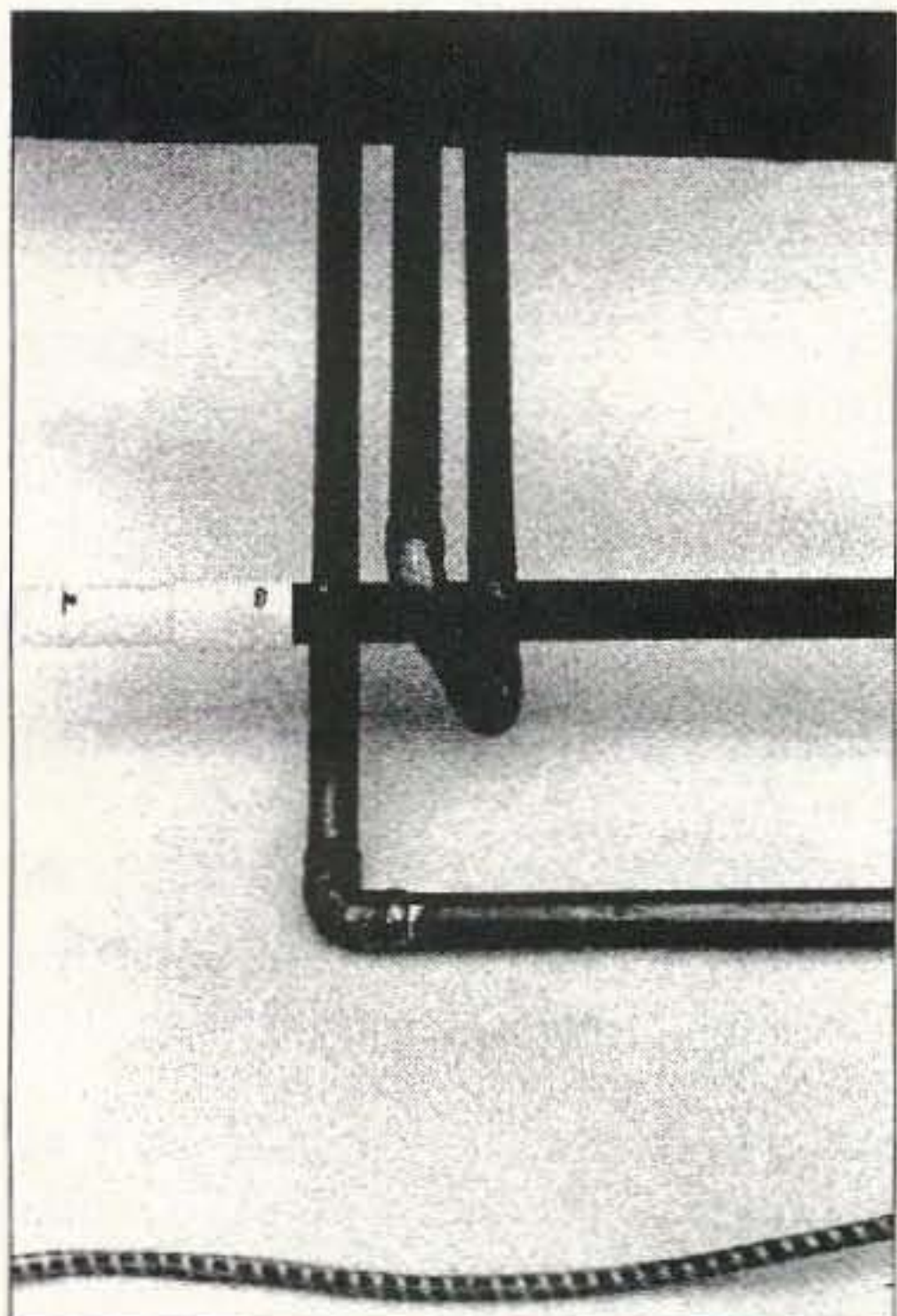

*Photo E. Close-up of the end of triple pipe sections at the sides of the loop, showing how to orient pipes and elbows. These sections increase the distributed capacity of the loop and lower its self-resonant frequency.*

Mr. NiCd

**THE BEST BATTERIES  
IN AMERICA!**

**HOLIDAY '97 SPECIALS!**

*NEW for YAESU FT-50R / 40R / 10R:*

FNB-V47 pk.	7.2v	1200mAh	\$39.95
FNB-41 pk. (5w)	9.6v	700mAh	\$39.95
BC-601c	Rapid/Trickle Charger		\$64.95

*For YAESU FT-51R / 41R / 11R:*

FNB-31 pk.	4.8v	700mAh	\$33.95
FNB-38 pk. (5W)	9.6v	700mAh	\$44.95
BC-601b	Rapid/Trickle Charger		\$64.95

*For YAESU FT-530 / 416 / 816 / 76 / 26:*

FNB-26 pk.	7.2v	1200mAh	\$29.95
FNB-27s pk. (5w)	12.0v	800mAh	\$35.95
FNB-27xh (NiMH)	12.0v	1000mAh	\$48.95
BC-601a	Rapid/Trickle Charger		\$64.95

*For YAESU FT-411 / 470 / 73 / 33 / 23:*

FNB-10 pk.	7.2v	600mAh	\$20.95
FNB-11 pk. (5w)	12.0v	600mAh	\$24.95
FNB-11xh (NiMH)	12.0v	1350mAh	\$49.95
FBA-10	6-Cell AA case		\$14.95
BC-601a	Rapid/Trickle Charger		\$64.95

*Packs for ALINCO DJ-580 / 582 / 180 radios:*

EBP-20ns pk.	7.2v	1500mAh	\$29.95
EBP-22nh (5w)	12.0v	1000mAh	\$36.95
EDH-11	6-Cell AA case		\$14.95

*For ICOM IC-Z1A / T22-42A / W32A / T7A:*

BP-180 pk.	7.2v	700mAh	\$39.95
BP-173 pk. (5w)	9.6v	700mAh	\$49.95
BC-601d	Rapid/Trickle Charger		\$64.95

*For ICOM IC-W21A / 2GXAT / V21AT:*

BP-131xh (NiMH)	7.2v	1350mAh	\$39.95
BP-132s (5w)	12.0v	850mAh	\$39.95
BC-601e	Rapid/Trickle Charger		\$64.95

*For ICOM IC-2SAT / W2A / 3SAT / 4SAT etc:*

BP-83 pk.	7.2v	600mAh	\$23.95
BP-84 pk.	7.2v	1200mAh	\$34.95
BP-83xh (NiMH)	7.2v	1350mAh	\$39.95
BP-90	6-Cell AA case		\$15.95
BC-79A	Rapid/Trickle Charger		\$64.95

*For ICOM IC-02AT etc & REALISTIC HTX-202:*

BP-8h pk.	8.4v	1400mAh	\$32.95
BP-8xh (NiMH)	8.4v	2250mAh	\$52.95
BP-202s pk.	7.2v	1400mAh	\$29.95
IC-8	8-Cell AA NiCd/Alkaline Case		\$15.95
K-1011/BC-35	Rapid Charger		\$59.95

*For KENWOOD TH-79A / 42A / 22A:*

PB-32 pk.	6.0v	700mAh	\$22.95
PB-34 pk. (5w)	9.6v	700mAh	\$34.95
KSC-14	Dual Rapid/Trickle Charger		\$64.95

*For KENWOOD TH-78 / 48 / 28 / 27:*

PB-13 pk.	7.2v	700mAh	\$25.95
PB-18xh (NiMH)	7.2v	2250mAh	\$49.95
BC-15A	Rapid/Trickle Charger		\$64.95

*For KENWOOD TH-77, 75, 55, 46, 45, 26, 25:*

PB-6 (w/chg plug!)	7.2v	600mAh	\$27.95
PB-8sh pk. (5w)	12.0v	1000mAh	\$39.95
KSC-14	Dual Rapid/Trickle Charger		\$64.95

*For STANDARD C-628A / C558A / 528A / 228A:*

CNB-153 pk.	7.2v	1200mAh	\$29.95
CNB-152 pk. (5w)	12.0v	800mAh	\$32.95
CSA-181	Rapid/Trickle Charger		\$64.95

Mr. NiCd also supplies batteries for your  
**LAPTOP COMPUTERS / CELLPHONES  
 CAMCORDERS / NiCd & NiMH INSERTS**  
 We can rebuild your Computer pack! Call!  
 Mail, Phone, & Fax orders welcome! Pay with  
 MC / VISA / DISCOVER / AMEX

**CALL OR WRITE FOR OUR FREE CATALOG!**

**Mr. NiCd - E.H. Yost & Company**  
 2211-D Parview Rd., Middleton, WI 53562  
**Phone: (608) 831-3443**  
**Fax: (608) 831-1082**  
**E-mail: ehyst@midplains.net**



Key	Qty.	Item
A	2	49-inch lengths, 3/4" copper pipe
B	4	45-inch lengths, 3/4" copper pipe
C	1	35-inch length, 1" copper pipe
D	1	36-inch length, 3/4" copper pipe
E	1	43-inch length, 3/4" copper pipe
F	2	18.5-inch lengths, 3/4" copper pipe
G	3	47-inch lengths (min.), 3/4" schedule 80 PVC pipe
	4	3-inch lengths, 3/4" copper pipe
	1	18-inch length, 1/2" copper pipe
	14	Elbows, 3/4" copper
	1	Reducer, 1" to 3/4" copper
	1	End cap, 3/4" copper
	1	End cap, 1/2" copper
	1	Strap, 1/2" x 2-1/2" x 1/16" flat copper
	1	Screw, 1/4-20 RH brass
	3	Nuts, 1/4-20 brass
	15	Screws, 10-24 x 2-1/2" RH brass
	15	Nuts, 10-24 brass
	5	Feet of tubing, 1/4" copper
	1	SO-239 connector, chassis mounting
		Teflon™ for insulators (see text)

Table 3. Parts list for folded loop.

### Constructing the loop

Cut all the copper pipe pieces to size according to the parts list. Make the center conductor of the coaxial tuning capacitor roughly a foot longer than specified. You'll need this for final tune-up. Then assemble the entire loop unsoldered, flat on the floor. Before soldering the pieces together, you will need to get a good picture of how everything fits.

Pay particular attention to the three parallel pieces at the sides of the loop. Note that the middle pipe does not lie in the plane of the loop, like the other two. When viewed from the top, the three side pipes form an equilateral triangle. Make certain to space the two that lie in the plane of the loop by three inches. Connect the elbows at the ends of the side sections with the three-inch pieces of pipe specified in the parts list.

Also, be careful to space the two pipe pieces in the center of the loop half an inch apart. This spacing is important in order to obtain adequate capacitance at the ends of the loop.

Then solder the entire loop together. Clean all connections thoroughly with steel wool and apply a coating of solder flux. This is important. I used liquid rosin flux, but the acid paste type is fine also. Use a propane torch. The biggest soldering iron will not be adequate. Any type of solder is fine. I used electrical-type.

Be careful not to allow too much solder to collect on exterior surfaces. Surface solder will reduce conductivity. Use a file to clean surfaces down to bare copper again. Afterwards, clean off the flux with solvent. It isn't necessary to polish the loop. Moderate surface corrosion will have little effect on performance. I spray-painted the loop to match the interior color of my truck.

Next, install the three pieces of schedule-80 PVC pipe. Their function is to keep the loop rigid. Drill holes through the loop and the PVC pipe for the screws. Do not, however, drill a hole through the coaxial capacitor. I used the PVC pipes to mount the loop in my vehicle. You may make them longer than specified for easier installation.

Now solder together the tuning assembly of the coaxial capacitor. Remember to solder a brass 1/4-20 nut inside the three-quarter-inch end cap that fits on the end of the loop. Use a stainless steel bolt and nut to hold the brass nut in place during soldering.

Then fabricate the insulators that separate the inner and the outer conductors of the coaxial capacitor. If you have access to machining facilities, turn them from Teflon™ or polystyrene.

A word of caution. Not all plastics are suitable. The electric field inside the capacitor is intense. Many plastics, PVC for example, exhibit too much dielectric loss. I constructed my insulators by wrapping heavy half-inch Teflon™ tape around the center conductor and securing the outer end with electrical tape. In any case, make the insulators as small as possible. Most of the capacitor's dielectric should be air.

### Initial tune-up

For initial tune-up, a dip oscillator is most convenient. When you built the loop, you left the center of the coaxial tuning capacitor longer than required. With mine this way, the loop resonated at roughly 6.5 MHz. Then, with a tubing cutter, I shortened the center conductor in small increments until I brought it onto the 40-meter band. I performed the initial tune-up by hanging the loop on short ropes from the ceiling of my garage. You may want to leave the center conductor just slightly too long, to allow for final adjustment on the vehicle. The resonant frequency did not change much when I installed it in my truck, however.

Once you get the loop in band, an SWR bridge is sufficient to indicate the resonant frequency of the loop. The SWR bridge is a permanent part of my mobile installation. It dips sharply as I quickly tune across the band while applying very low power.

You will adjust the coupling loop in much the same way. First, tune the main loop to resonance. Then bend the coupling loop until the SWR is best. I was able to obtain an almost perfect match. The procedure is remarkably simple to



**Please fill out this multi-purpose card when you want to place a Subscription to 73, renew your Subscription to 73, order FREE Reader Service information, and/or tell us what you think of this issue by filling out the Feedback part of the card.**

**Our entire staff thanks you...your card will be entered in our monthly drawing when you include Feedback information about this issue.**



**Please fill out this multi-purpose card when you want to place a Subscription to 73, renew your Subscription to 73, order FREE Reader Service information, and/or tell us what you think of this issue by filling out the Feedback part of the card.**

**Our entire staff thanks you...your card will be entered in our monthly drawing when you include Feedback information about this issue.**



perform. Once you find the correct shape and position, you will never again have to adjust the coupling loop.

How well does the loop work? Very well, thank you. As I promised earlier, let me give you some comparisons between the loop and my mobile HF whip.

The whip is the popular Hustler™ mobile antenna with the large high-efficiency kilowatt resonator. It's mounted at the top center of the tailgate, on the spare tire rack. This is a good location because of the Fiberglass back on my truck. All of the whip is above the metal body. I installed a shunt-feed network at the base of the whip to be sure that the whip was properly matched to 50 ohms.

At the operating position, I installed a two-way coax antenna switch and two identical feed cables to make the comparison. In all cases I operated both antennas on the same frequency, very near the resonant frequency. Power was the same for all tests, roughly 100 watts RMS.

What did I find? To be honest with you, there isn't very much difference. Most of the difference is caused by the height of the loop compared with the whip. Being lower, the loop puts more of its energy straight up. Therefore, I noticed the biggest difference in ground wave contacts. Here the loop is usually an S-point weaker on both receive and transmit. For short skywave contacts, the loop is at times the same as the whip. On receive, the loop is less sensitive to noise. In terms of making an effective contact, this offsets the slightly weaker signal.

My conclusion is that the loop is a good mobile antenna. A large mobile whip may be a little better. The more compact types that are popular today would be the same. The loop obviously won't work on every vehicle, but for the ham with a Fiberglass truck shell, motor home or boat, the loop is certainly worth considering. It might be your best answer on a vehicle totally without a metal body. I want to try it on a large Fiberglass boat, for example.

I mounted my loop so that I could easily remove it from the truck. On camping trips it is an outstanding performer if I hoist it up into a tree. Give it a try—you won't be disappointed. **73**

## DIRECTION FINDERS

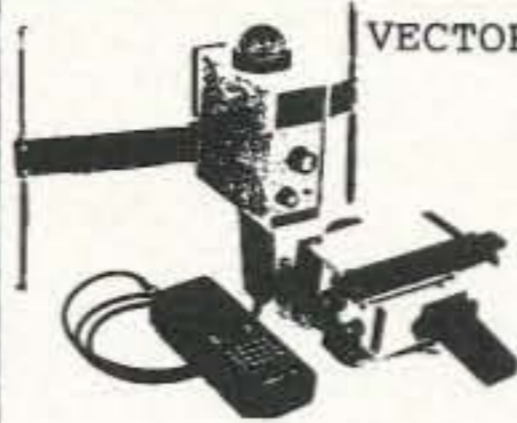

### VECTOR-FINDER

HAND-HELD  
PHASE SENSE  
ANTENNAS FOR  
VHF DIRECTION  
FINDING. USES  
ANY FM RCVR.  
ARMS FOLD FOR  
STORAGE.

TYPE VF-142 144-220 MHZ \$139.95  
TYPE VF-142Q LEFT-RIGHT LEDS &  
AUDIO, 144-220 MHZ \$239.95  
TYPE VF-142QM SAME AS Q MODEL  
EXCEPT FREQ. 144-500 MHZ \$289.95  
TYPE VF-121Q 115-130 MHZ  
PLUS 121.5 MHZ ELT FREQ \$379.95  
CALL ABOUT HF DF, ADD \$4.50 S/H  
ATTENUATORS CA ADD TAX



### RADIO ENGINEERS

7969 ENGINEER RD, #102  
SAN DIEGO, CA 92111  
619-565-1319 FAX 619-571-5909

CIRCLE 58 ON READER SERVICE CARD

## Pay TV and Satellite Descrambling 1998

Pay TV and Satellite Descrambling 1998 includes all satellite fixes \$15.95. Satellite Hacker Package \$39.95. Hacking Digital Satellite Systems Video \$39.95. One year Subscription to Scrambling News includes web \$29.95. Best Deal. Everything here only \$99.95. C.O.D. is OK. \$6.00. Free catalog.

### Scrambling News

1060 Niagara Falls Blvd., #110  
Tonawanda, NY 14150

716-283-6910. www.scramblingnews.com

CIRCLE 36 ON READER SERVICE CARD

## HamCall™ CD-ROM

U.S. & International - Over 1,406,000 listings



Over 106,000 new and updated  
International Listings, and all the latest  
U.S. listings, including vanity calls!

The HamCall CD-ROM allows you to look up over 1,406,000 callsigns from all over the world, including over 270 call areas.

The same CD works in DOS, Windows 3.x, Windows 95, and Macintosh. On a PC running Windows or DOS, you can look up hams by call, name, address, city, state, ZIP, call sign suffix, county, and now SOUNDEX last name searching. PC's can also view photographs, EDIT records, and calculate BEAM HEADING and DISTANCE. Macs can retrieve by call, last name, and ZIP.

•Displays latitude/longitude for almost every U.S. and DX call based on city or town for greater precision.

•Calculates beam heading and distance from your home QTH automatically. Distance is measured in miles and kilometers.

•Prints standard 1-up labels for QSL cards, and can now print all information for each ham. Also supports copy and paste.

Also on HamCall are over 140,000 cross references from old to new calls, over 3,300 photographs, over 33,000 e-mail addresses, and much more.

Price is \$50.00 plus \$5.00 shipping U.S., \$8.00 international.

### BUCKMASTER

6196 Jefferson Highway  
Mineral, VA 23117

e-mail: info@buck.com

540-894-5777 • 800-282-5628 • 540-894-9141 (fax)

CIRCLE 56 ON READER SERVICE CARD

## REPEATER HEADQUARTERS

Make "Commercial Quality" repeaters from GE and Motorola Mobiles

• 45 Watt VHF Micor from \$99

• 40 Watt UHF Master II from \$199

Conversion Information Available!

<http://www.versatel.com>

**VersaTel**  
COMMUNICATIONS

Orders: 800 456 5548

Info: 307 266 1700

FAX: 307 266 3010

CIRCLE 259 ON READER SERVICE CARD



## World's best ham weather station\*

The ULTIMETER® 2000 tracks more than 100 values to help you alert others to dangerous weather extremes and protect your own equipment.

Instant access to: • current values • today's highs and lows • long term highs and lows • time/date for all highs/lows • rain totals† for today, yesterday, and long term • alarms, and much more. Easy to install.

Features superbly accurate: • barometric pressure • 3-hr. pressure change • indoor/outdoor humidity† • dew point† • wind speed/direction • indoor and outdoor temperature • wind chill temperature • rainfall†.

Only \$379 plus shipping (†Optional sensors add'l.) Other ULTIMETER models starting at \$179.

\*Even *WeatherWatch* magazine (May, '96) concludes "the best we have seen."

## NEW! The Weather Picture®

An eye-popping add-on to your ULTIMETER

This new wall unit with its elegant teak or brushed aluminum frame displays all the vital weather data you pre-select, without having to press a single button. Big red numerals are easy to read from across the room, day or night. Interfaces with your ULTIMETER Weather Station, lets you customize data display. In two sizes. Introductory savings in effect thru 1/31/98.



Size shown: 15 1/4" x 11 1/4"

732-531-4615 1-800-USA PEET FAX 732-517-0669

PEET BROS. COMPANY, 1308-7127 Doris Ave., Ocean, NJ 07712

Our 22nd Year

© 1997 Peet Bros. Co.

Visit our Home Page to see and try our Weather Stations: [www.peetbros.com](http://www.peetbros.com)



# How to Silverplate RF Tank Circuits

*A simple and inexpensive process to reduce losses.*

Ronald Lumachi WB2CQM  
73 Bay 26th Street  
Brooklyn NY 11214-3905  
[WB2CQM@juno.com]

In order to attain super-signal, top-gun status in the DX pileups, the big boys all utilize a number of well-known, high-performance, big-signal, high-ticket-priced pieces of equipment in order to maintain their razor's-edge status. Multi-element Big Bertha arrays on wide-spaced booms, state-of-the-art legal-limit Peter Dahl Hypersil-transformer-equipped amplifiers, and minuscule-loss transmission cable are routinely installed from the outset to maintain a signal that is a cut above the crowd. It doesn't end there! Antenna components are continually manipulated in order to attain that elusive 1:1 SWR, and controls are tweaked to gain every ounce of power from paired high-current monster ceramic tubes.

From the "What's left to do?" scenario, a question naturally arises. If everyone in that exclusive club is equal in signal intensity and operating expertise from the starting gate, what's left to do legally to go that one increment higher?

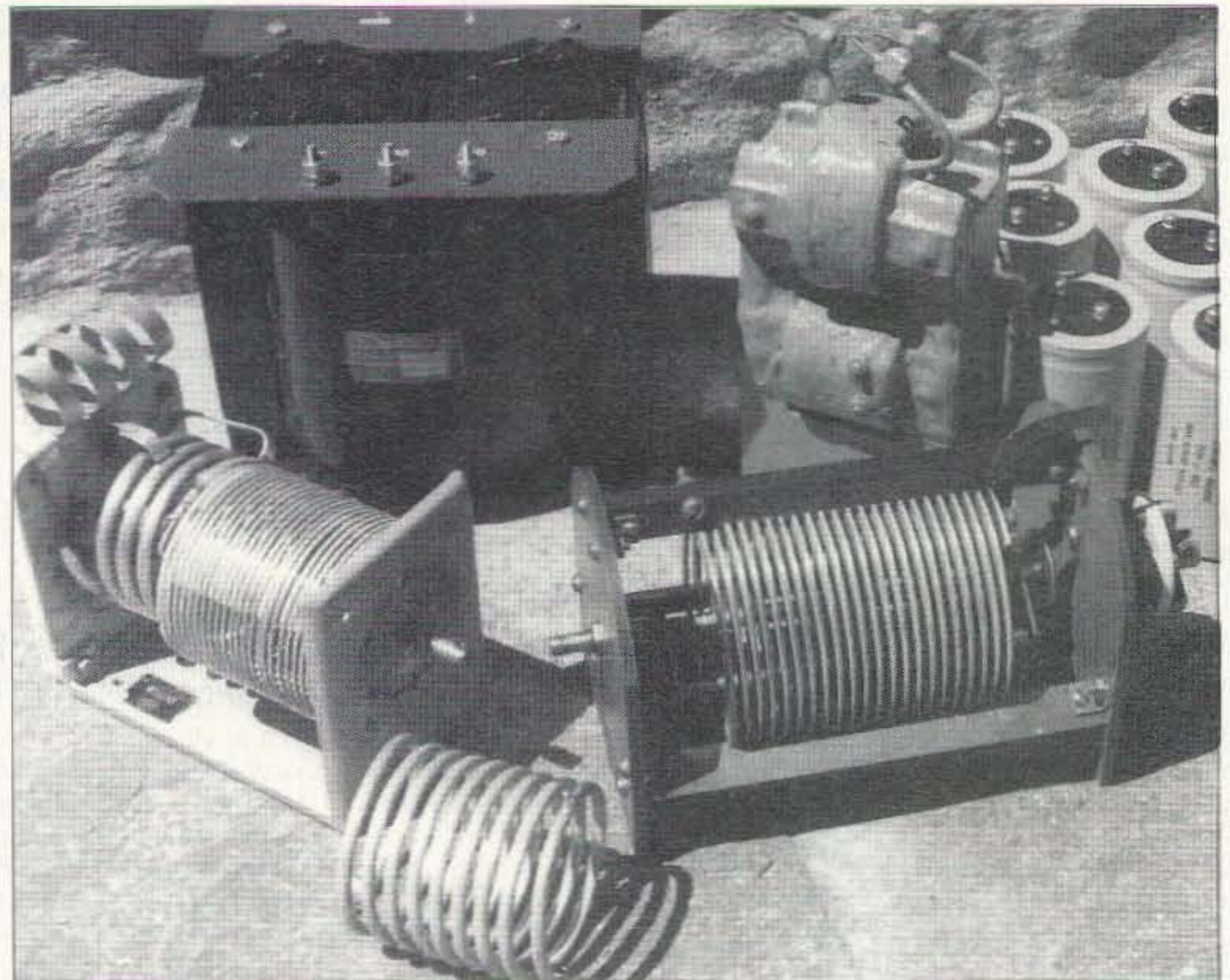

**Photo A.** Essential high-power amplifier components. View of an indispensable Peter Dahl high-current plate and filament transformer for top-gun linear amplifiers. Viewing CCW: a bank of 2000  $\mu\text{F}$  @ 450 VDC/500 VDC capacitors; the 10-160m roller inductor; a modified vintage B&W 850 A 10-160m tank circuit/integral switch combination; and a 10-40m coil. All have been silverplated and are ready for assembly.





**Photo B.** Silverplating kit (foreground) containing the jars of silverplating gel, copperplating gel for steel (see text), wire, clips, and plating brush. Note the metal "flap" on the top side of the brush that presses the bristles to the work being plated and completes the circuit. In the background is an array of chemical and abrasive cleaning materials, a wire-and-fabric abrasive wheel, emery cloth strips, and the optional Dremel tool for polishing those difficult-to-reach places.

In the quest to break away from the pack, and to stand out above the cacophony of pileup signals, the motivated radio amateur might consider focusing on the amplifier tank circuit to reduce inherent RF losses that may often appear at substantial levels of magnitude at higher radio frequencies. The material to accomplish this task is inexpensive, requires no special skill levels or equipment, and—more important—does not require any equipment disassembly. If it sounds like a win-win situation, read on!

### Tank circuit conductor losses

Radio amateurs are well aware that a DC current flowing through a conductor distributes itself uniformly throughout the cross-sectional area of the conductor. As a consequence, the ohmic resistance of the wire is directly proportional to the specific resistance of the conductor (data available from *ARRL Handbook* wire tables) and to its overall length; and inversely proportional to the cross-sectional area.

Simply stated, the heavier the gauge of the wire (using the shortest cabling length possible), the greater the current that can be carried through it with minimal losses. On the other hand, RF current does not behave in this highly predictable manner, and the consequences of subtle power losses, as it moves through a conductor, may have escaped the scrutiny of some radio amateur amplifier builders.

Consequently, in the quest to squeeze out more watts from linear amplifiers, RF characteristics remain a hot topic of discussion. The peculiarities of RF's behavior in linear output networks surface as a vital subject to study and master, and the application of this knowledge for circuit improvement is essential to achieve the ultimate high tech in amplifier design.

### What is skin effect?

RF current, because of its distinctive behavior as it passes through a conductor, meets additional levels of resistance because of a phenomenon

called *skin effect*. This is a result of alternating current inducing voltages in the center of the conductor that repel the flow of electrons outward towards the conductor's surface. This gathering density of electrons moving on the surface, rather than flowing throughout the inductor, in effect reduces the cross-sectional area through which the current flows. As a consequence, the resistance of the conductor is raised, resulting in increases in heat loss.

Skin effect becomes a more critical factor as frequency is increased. As an interesting note, here's the rationale for making RF tank circuits from copper tubing rather than a solid conductor. There is no need for the more

### Relative Resistivity of Metals

Metal	Resistivity Compared to Copper
Brass	3.7 – 4.9
Cadmium	4.4
Chromium	1.8
Copper (annealed)	1.0
Copper (hard drawn)	1.03
Gold	1.4
Iron	5.68
Lead	12.8
Nickel	5.1
Silver	0.94
Steel	7.6 – 12.7
Tin	6.7
Zinc	3.4

**Table 1.** Relative resistivity of metals, compared to copper.



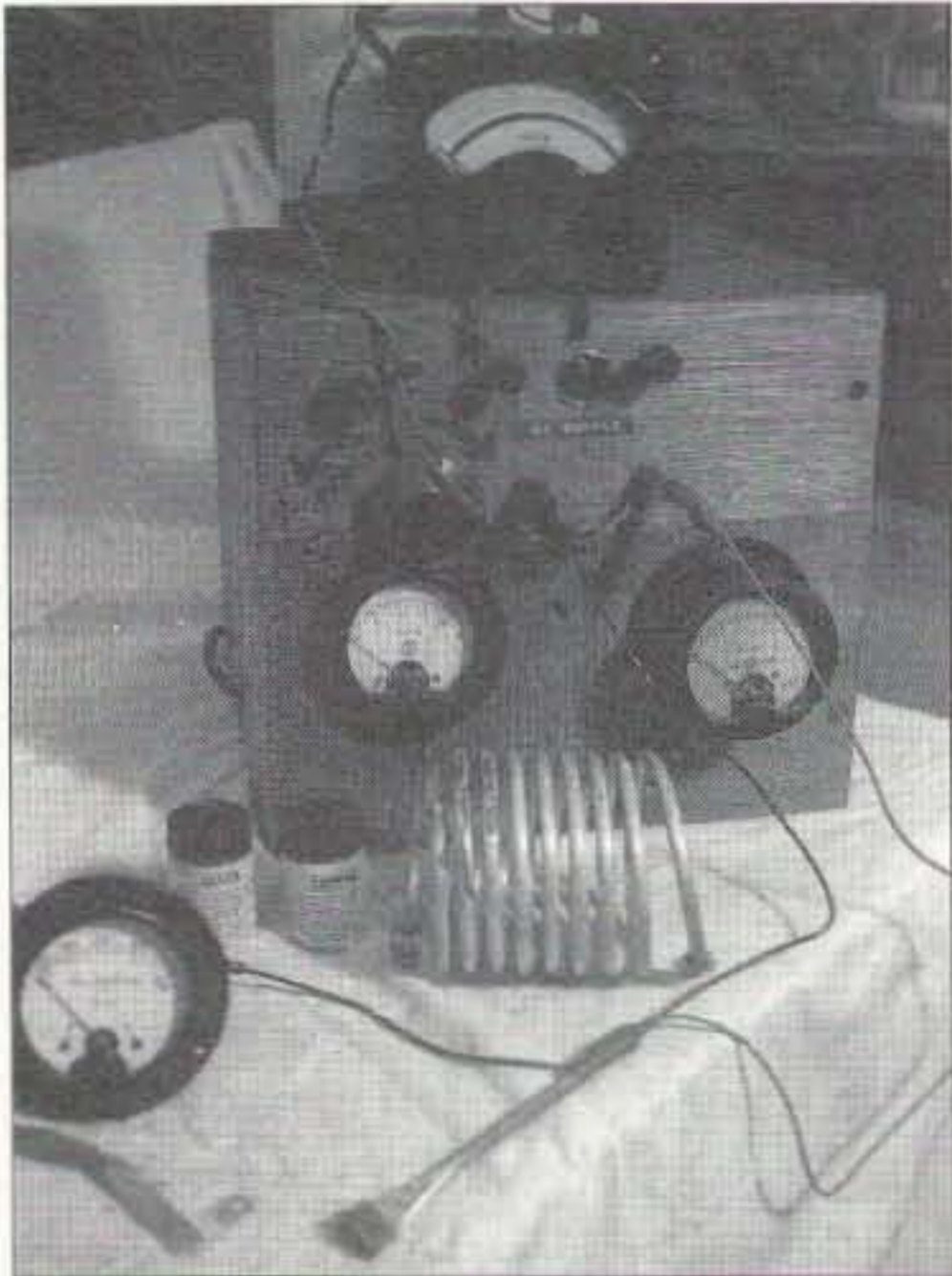

**Photo C.** Meet "Double Ugly," my circa-1962 variable home-brew supply (like the battery commercial, just keeps going and going). It provided all the required plating current. Hookup wire included with the kit was replaced with longer alligator clip leads to allow for greater movement. The meters at the top and to the left were temporarily added to the circuit. They provided an expanded scale for a more precise monitoring of the voltage and current. The positive lead is clipped directly to the plating brush. The negative lead passes through the 500 mA meter and is then connected directly to the work being plated. If a bench-type supply is not available, the manufacturer suggests using 2 or 3 #6 dry cells in series for 3 to 4-1/2 VDC (see text).

expensive and heavy solid rod simply because it does not conduct RF throughout its cross-sectional mass. As a matter of fact, the RF does not travel to any substantial depth below the surface or skin of the conductor.

With that in mind, take a look at the 10-20 meter portion of your linear amplifier tank circuit to verify the builder's awareness of this concept. If the tubing is not evident in at least this portion of the output network, it's time for a major circuit change. If you find a tank circuit containing virgin copper tubing and heavy 8-10 gauge wire (which will most probably be the case), then be sure you finish reading this article.

### The case for silverplating

The *ARRL Handbook* chapter dealing with Electrical Laws and Circuits

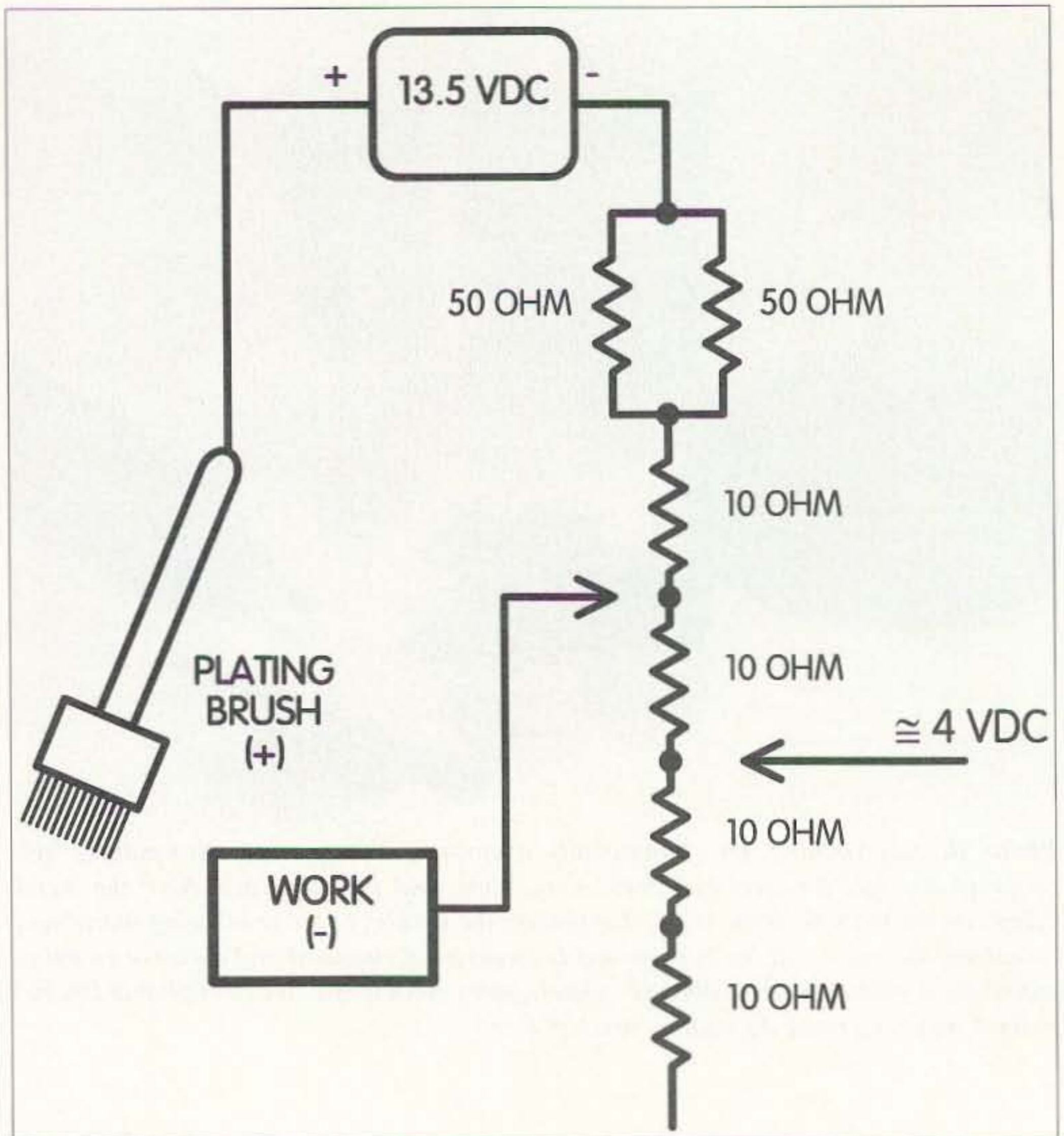

**Fig. 1.** Voltage divider.

contains a chart listing the relative resistivity of common metals (including gold), and indicates that only silver has a lower resistance to current flow than copper. (See **Table 1.**) The reference value of "1" applied to annealed copper is lower in silver by 6%. Combine this factor with the unique properties of high-frequency RF flowing on the surface of a conductor and it becomes abundantly evident that the silverplating (over copper) of RF tank

tubing or wire is a good investment in time and effort. It may breathe some new life into the old rig (as a result of the diminished ohmic losses) and just may net enough extra power, in the competitive DX world of pileups, to gain for you the exalted top-gun status on the DXCC Honor Roll.

### Where to begin?

Any attempt to adapt commercial techniques of silverplating for in-home

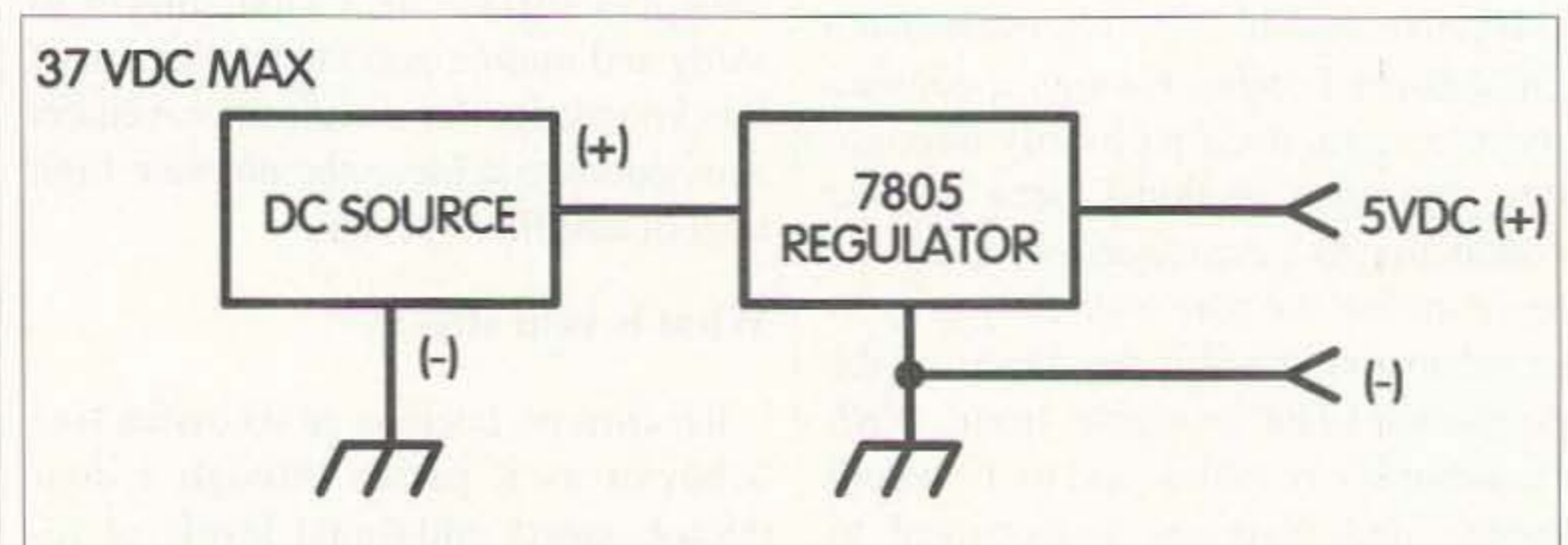

**Fig. 2.** Fixed voltage regulator.



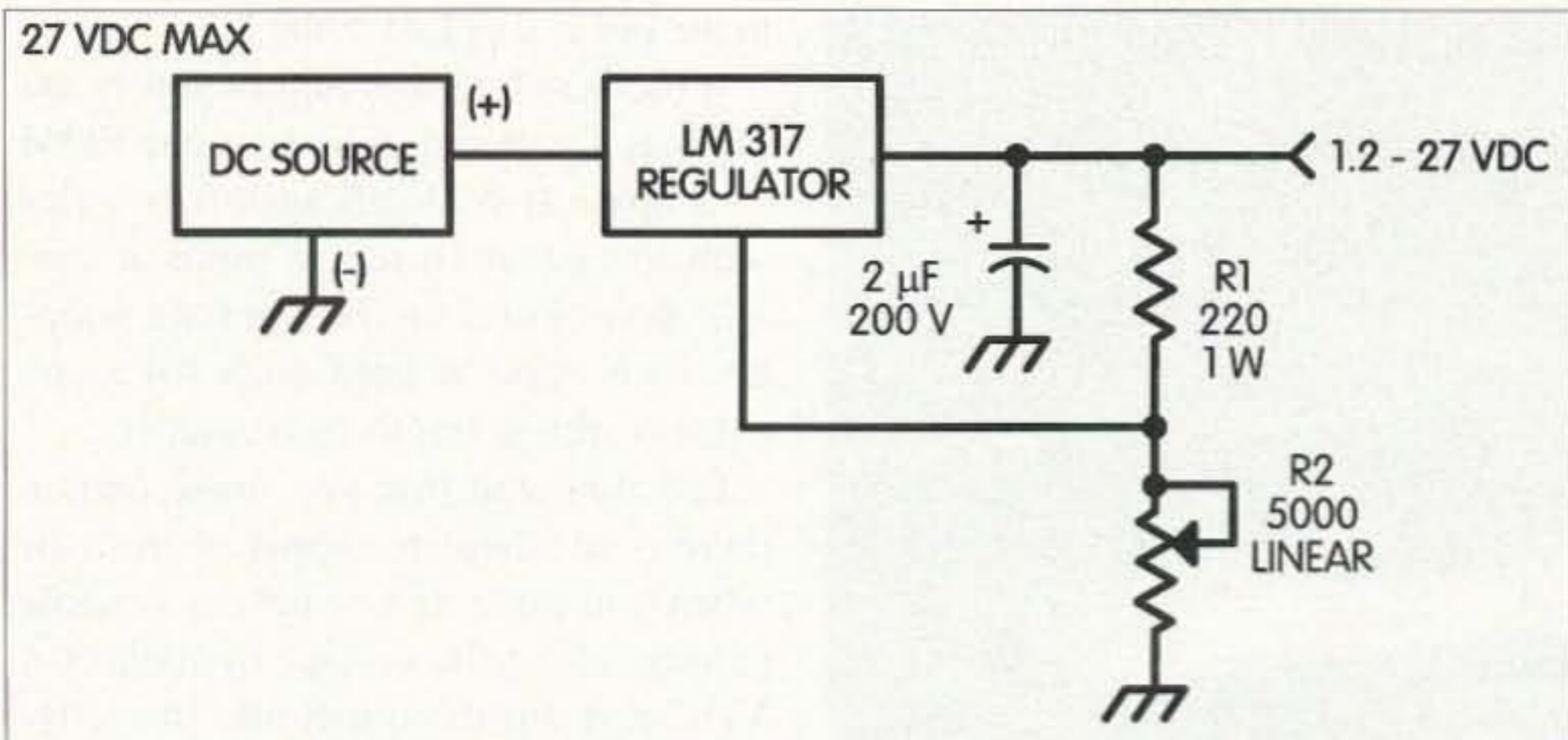

Fig. 3. Variable voltage supply.

use is out of the question primarily because of the complexity of the equipment and the toxicity of the chemical baths. An alternative solution is to purchase a plating kit supplied by a Dallas, Texas, firm that is both inexpensive and uncomplicated to use. All the material, including the chemicals, wire, and clips, is provided as part of the package. All that is needed is a power source rated at 3 to 4-1/2 VDC. The manufacturer recommends two #6 dry cells connected in series (3 VDC) for general plating work. In certain instances, you can simply wire up an additional battery to the string (4-1/2 VDC) for speedier plating on larger areas.

In my case, I used my circa-1962 "Double Ugly" bench variable supply (see Photo C). With its output adjusted for about 4 VDC, the process ran flawlessly. Current draw was about 200 mA. The dry cells are OK, but they are expensive and really have no practical value after completing the plating process.

The best deal is to use a bench-type (Astron or equivalent) 13.5 VDC supply, or to connect up to your automobile battery. Use the voltage divider circuit depicted in Fig. 1 to get the power level you need. Another alternative is to use a fixed voltage regulator (5 VDC) and power from a variety of DC sources (Fig. 2). There's always a power cube around from one of the video games, or check the battery pack on your HT or power screwdriver as a potential and renewable (rechargeable) power source. You may also consider a variable voltage regulator (Fig. 3) along with any one of the power sources suggested. This inexpensive

setup will conservatively provide voltages from 1.2-27 VDC at 1.5 A, and it can have a practical value for a variety of other projects down the line.

#### What's the trick in silverplating?

Heed the manufacturer's admonition that "plating can only be as good as the surface on which (it's) applied." In the plating of any metal, preparation is easily 95% of the task.

Begin the process by gathering up some brass/copper chemical cleaner, 400-grit emery paper, steel wool, and a supply of stiff-bristled toothbrushes. All of these can be located at the local home center at minimal cost. In addition, you'll need a supply of soft rags (old T-shirts are perfect), a handful of cotton swabs, and possibly a Dremel™ tool fitted with a couple of polishing discs to help get into the tight spots.

Our purpose is not to polish to a mirrored finish. All that is required to prepare for a clean plating surface, with good bonding characteristics, is to thoroughly remove all the copper oxidation. If the surfaces are flat, use the steel wool or 400-grit emery paper. For large areas, use a wire wheel. In tight spots, the chemical cleaner and toothbrush or swab are indispensable.

Make certain there is adequate ventilation in the work area. The best idea is to use the chemical cleaner outdoors, especially if you anticipate it may take some time to complete the cleaning.

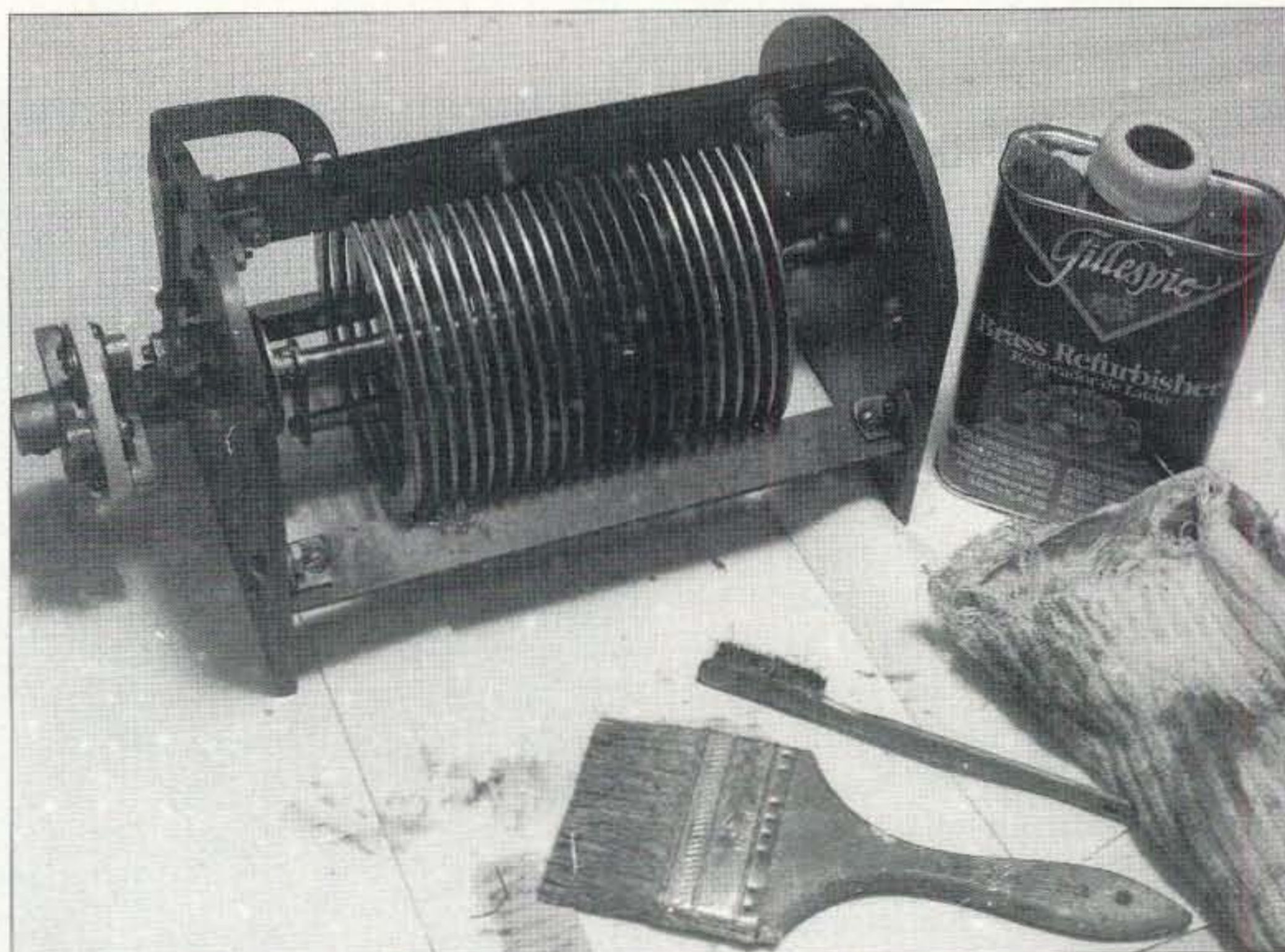
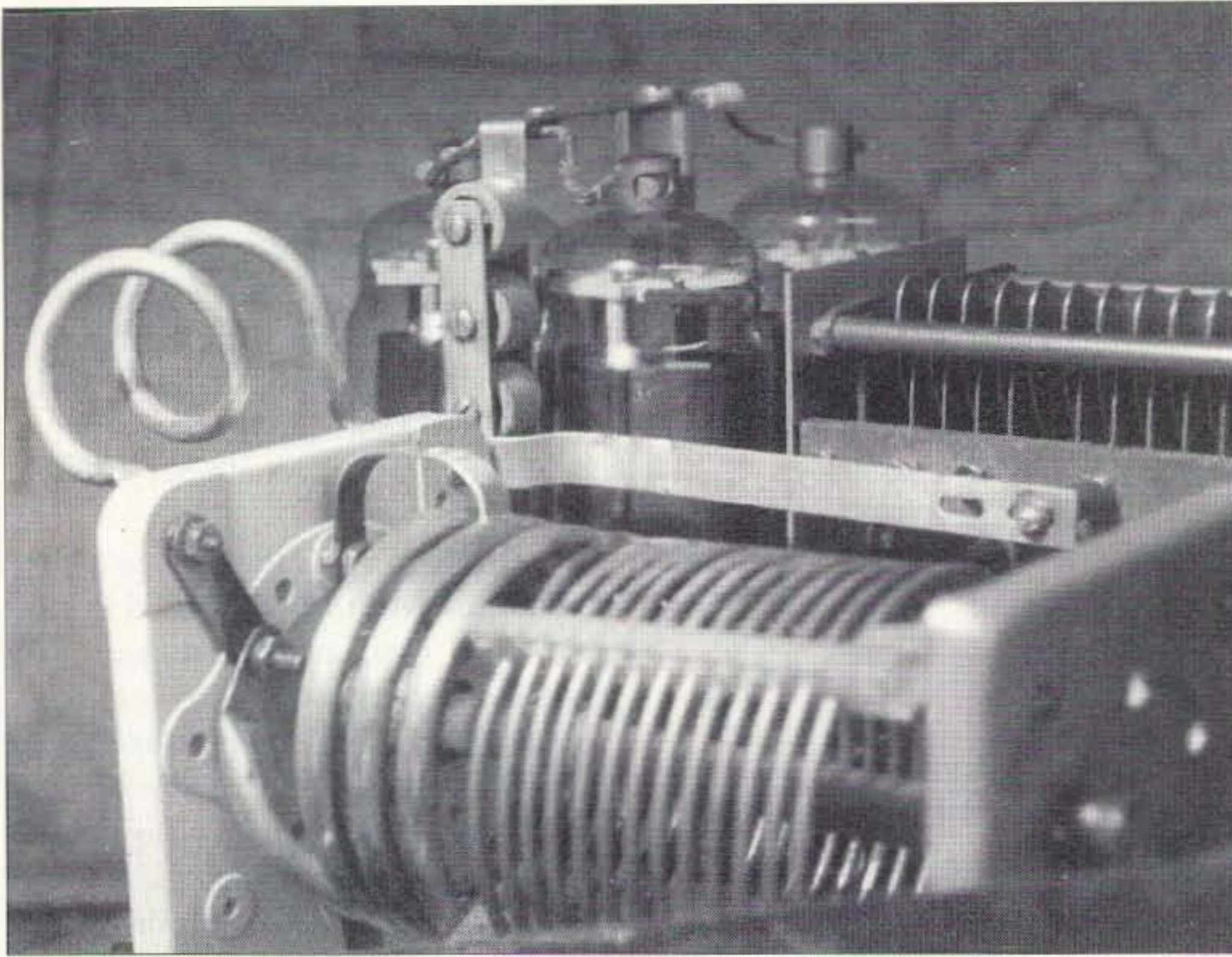

Photo D. Because of the difficulty of getting into hard-to-reach areas, a chemical cleaner was used to remove years of oxidation from the super-heavy-duty roller inductor. Note that the six center coil bands have not been cleaned to illustrate the contrast. The chemical was liberally brushed onto the metal. The process is similar to chemical paint stripping. A toothbrush assisted in getting to those hard-to-reach spots. A soft rag (lower right) was essential for removing any residue. The work area must be well ventilated. Working outdoors is highly recommended.





**Photo E.** View of a modified "three-hole" 813 linear amp. All the coils, flat copper stock, and flexible coax shielding to the tubes and the air-variable plate-tune capacitor have been silverplated.

Preparing the rotary inductor (see **Photo D**) for plating was indeed tedious and time-consuming. The work seemed endless and the cleaning progressed slowly, simply because many of the surfaces were difficult to reach. I took the operation outdoors and placed it on newspapers to protect the table from the chemical cleaner. However, the final product was worth the effort and will prove to be one of the vital links in the assembly of a state-of-the-art linear amplifier.

#### The final step

When you think you've done a yeoman's job on the preparation aspect of the task, go over it again to doubly ensure a clean, residue-free surface. Silver will not bond to an ill-prepared base! You will find that it's extremely difficult to overcome the urge to get going with the plating, but that aspect of the process will come soon enough.

The plating may even seem anticlimactic, since the actual silver application is quite simple and straightforward. It's often completed in a very short time—especially if the component parts are small with little

surface area. Use the wire and alligator clips supplied to connect the batteries' minus (-) terminal to one end of the surface to be plated and plus (+) terminal

to the brush supplied in the kit.

If the bench power supply you're using is not metered, wire up your VOM or a spare 0–500 mA meter in series with the negative leg to monitor current draw. I preferred using long jumpers with clips at both ends for some extra working length convenience.

I recommend that you make certain there is an adequate supply of fresh air when you plate. If you have a variable supply, adjust the voltage to about 3–4 VDC and dip the brush into the jelly-like compound, making certain that both the bristles and the underside of the anode are continually well-covered with plating material. If your meter indicates an increase in current flow after some plating, it's time to pick up some additional gel from the jar.

It might be a good idea to test your setup and perfect a rhythm utilizing a piece of scrap copper. Use short circular motions with the anode, firmly pressing the bristles to the work. Usually 20–30 seconds over an area will be sufficient to deposit a layer of silver. At regular intervals, renew the supply of plating material by dipping into the chemical container. For

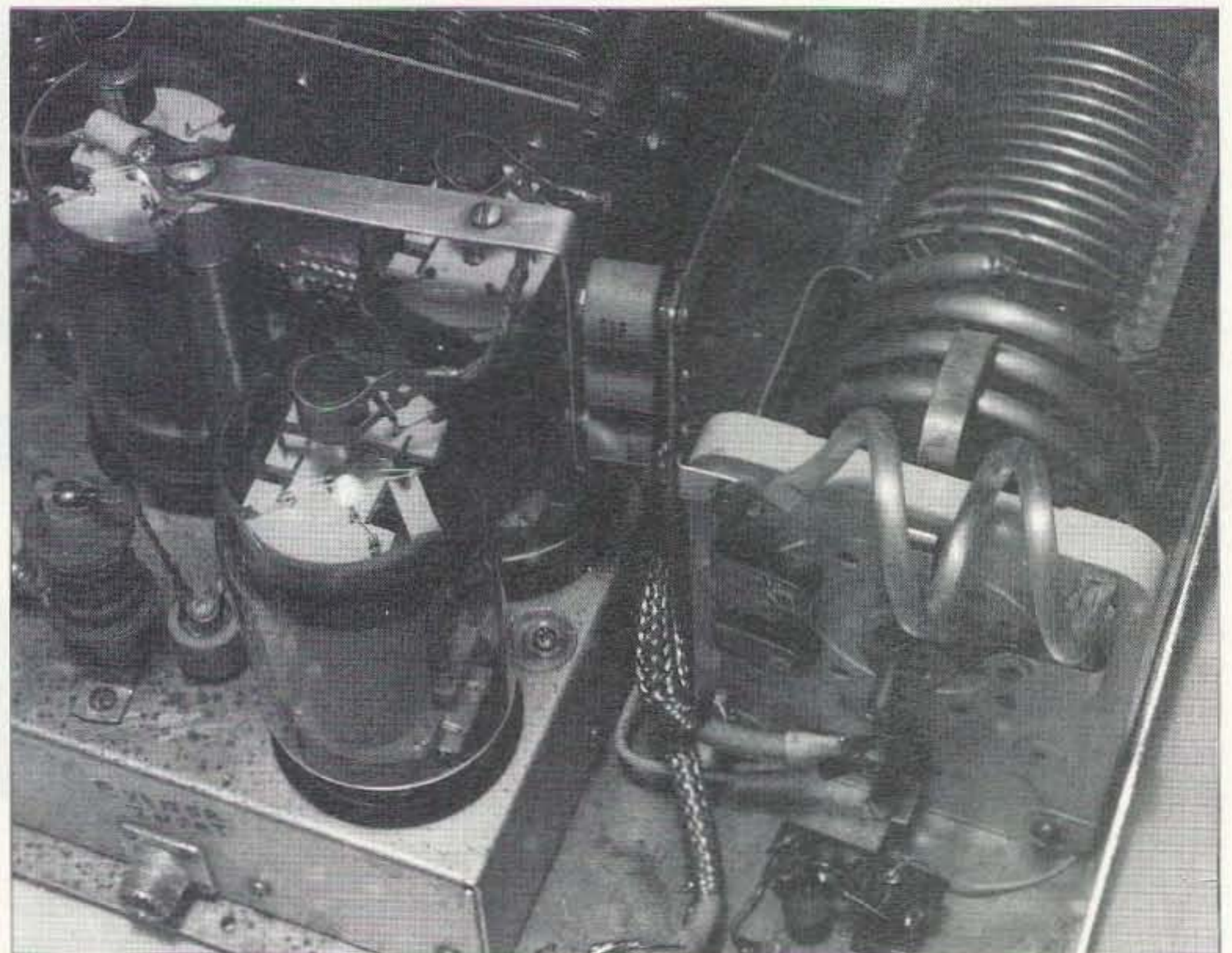

**Photo F.** This view of the 813 amplifier shows several silverplated components. The 850-A tank circuit and the 10 meter coil have both been plated. The flat stock connecting the vertical HV plate choke to the three "doorknob" capacitors, and the stock connecting the other side of the capacitors to the tank circuit have been silvered as well.





**Photo G.** The heavy copper strapping from the 4-1000 A plate cap, the plate parasitic choke, door knob supports, and the 8U coax shielding, which directs RF to the tank circuit and plate-tune vacuum variable, have all been dressed in a new coat of silver.

heavier plating, slow down the circular motion process to allow more time for the metal to transfer. You may even try experimenting with slightly increased voltages (6-8 VDC) to improve the metal transfer.

When you're done, rinse the surfaces with water or use a soft cloth to wipe the work clean. If there are areas that did not accept the silver because you missed a spot during preparation, don't be alarmed. Lightly polish the spot with the emery paper or steel wool and replating over those sections. Wipe the work area clean.

Use a little household silver polish to brighten up the silver finish and step back to take a good look at your project. You'll marvel at how well the system works and how much compound remains for other plating tasks. Incidentally, the supplier provides a bottle of copper undercoat in the kit if it's necessary to silverplate over steel (nuts, bolts, washers, etc.). When you're through, clean all the implements with water and dry thoroughly.

### What else can I plate?

The manufacturer, in addition to providing a silverplating kit, also offers a package of materials to plate both gold and nickel. If you've experienced oxidized contacts with plugs and sockets, you may consider their 24-karat goldplating kit for use in this problem area. Gold is a bit more expensive than silver, but a jar of material should last a long time. Whatever you do, avoid the temptation to plate your tank circuits in gold. The metal resistivity chart should dissuade you from that idea, since ohmic losses for gold are greater than those for copper. It will most certainly look great, but that's about as far as it goes!

### A final comment

Keep in mind that everything you do to finesse your electronic circuits results in an increase in radiated power. Perhaps someone may say the theoretical power increase due to the slightly lower ohmic resistance of silver is not worth the time and effort for this undertaking. In response, remember that the boys in the DX pack are very much neck-and-neck in their quest for that new and elusive country and whatever you can do to squeeze out even a couple of watts of power may be all that is necessary to make the difference in the pileup. Give it a try. You'll find it an interesting project. Success to you in both your plating and DXing endeavors ...

A silverplating kit, \$16.50 ppd., goldplating kit, \$39.00 ppd., and a combination gold/silver kit, \$48.50 ppd., are available from:

Texas Platers Supply  
2453 W. Five Mile Pkwy.  
Dallas TX 75223  
(214) 330-7168

For custom transformers/amplifier components, send for a brochure from:  
Peter W. Dahl Co. Inc.  
5869 Waycross Ave.  
El Paso TX 79924  
(915) 751-2300

# ALL ELECTRONICS CORPORATION

## 3 Volt Lithium Coin Cell with PC Leads

Panasonic # BR2330-1GU  
3 volt, 255 mAh coin cell. 0.9" diameter x 0.12" thick. 0.7" between positive and negative pc leads.



VERY SPECIAL PRICE  
LARGE QUANTITY AVAILABLE

**75¢** each

CAT #LBAT-16

20 for \$12.00  
100 for \$45.00  
1000 for \$300.00

## ELECTRET MIKE

Panasonic # WM 54BT-D  
Electret condenser microphone cartridge. Low impedance, omnidirectional mike. 20 - 12,000 HZ. 0.38" dia. x 0.175" high.



CAT #MIKE-36

**60¢** each

10 for \$5.50  
100 for \$45.00

## Ultrabright LED



PAINFULLY BRIGHT RED LED

2500 to 4000 mcd @ 20 ma. T 1 3/4 (5 mm diameter) red LED. Significantly brighter than conventional LEDs. Water clear in off-state.

CAT # LED-42 **2 for \$1.20**

10 for \$ 5.00 • 100 for \$45.00  
1000 for \$ 400.00

## 2 1/2" 8 Ohm Speaker

Panasonic # EAS65P76A3  
8 ohm 0.4 watt speaker with soft-edge paper cone for good frequency response. 0.93" overall depth. 2.25" wire leads with 2 contact (0.1" spacing) socket connector.



Large quantity available.

CAT # SK-255

**\$1.00** each

10 for \$8.50  
100 for \$70.00

ORDER TOLL FREE

**1-800-826-5432**

CHARGE ORDERS to Visa, Mastercard, American Express or Discover

TERMS: NO MINIMUM ORDER. Shipping and handling for the 48 continental U.S.A. \$5.00 per order. All others including AK, HI, PR or Canada must pay full shipping. All orders delivered in CALIFORNIA must include local state sales tax. Quantities Limited. NO COD. Prices subject to change without notice.

CALL, WRITE  
FAX or E-MAIL  
for our FREE  
96 Page  
CATALOG  
Outside the U.S.A.  
send \$3.00 postage.

MAIL ORDERS TO:  
ALL ELECTRONICS  
CORPORATION  
P.O. Box 567  
Van Nuys, CA 91408  
FAX (818)781-2653

e-mail allcorp@allcorp.com  
internet - http://www.allcorp.com/

### Wanted!

Stories about all the fun you've been having with Amateur Radio, for possible publication. Write to Joyce Sawtelle at 70 Route 202 North, Peterborough, NH 03458.



# Build Your First Kit!

*Just follow one ham's simple advice ...*

Peter A. Bergman NØBLX  
517 Estate Dr. SW  
Brainerd MN 56401

I have often heard old-timers say that kits aren't available anymore, and I've heard newcomers say they'd like to build a particle wave modulator or something of equal complexity. To the first I say, "Excuse me!?" There are a number of great kits available. To the newcomers, I say, "Great!"—but let's start with something a little simpler, like Ten-Tec's T-Kit 1001 Broadband RF Preamp.

I have had pleasant experiences with T-Kits in the past, so when I wanted a broadband RF preamplifier I decided to order their No. 1001. I was looking for something simple to assemble and easy to use for demonstration purposes. I also wanted to see if I could squeeze a couple more TV channels out of the rabbit ears. The 1001 is an excellent example of a kit for the beginner. It's something you can put together, get working, and use before you start on the kit you bought with the car payment money.

In previous articles I have recounted the joys of kit building as one of the many facets of the amateur radio hobby. I recall hearing it claimed, once upon a time, that kit building provided nothing but solder-

ing practice. It probably was not entirely true then and certainly is not true of the modern breed of kits. Ten-Tec has been producing quality ham gear for a long time and now its T-Kit division is providing products for those who want more hands-on experience.

Before saying any more about the 1001 kit, let's review a little basic elec-

tronics. In electronics classes, the "water analogy" is often used. Resistors are compared to flow restrictors, while capacitors and inductors are compared to storage tanks and filters. A similar analogy can be made for amplifying devices, either tube or solid state.

If you think of an amplifier as a valve, then the handle can be compared to the

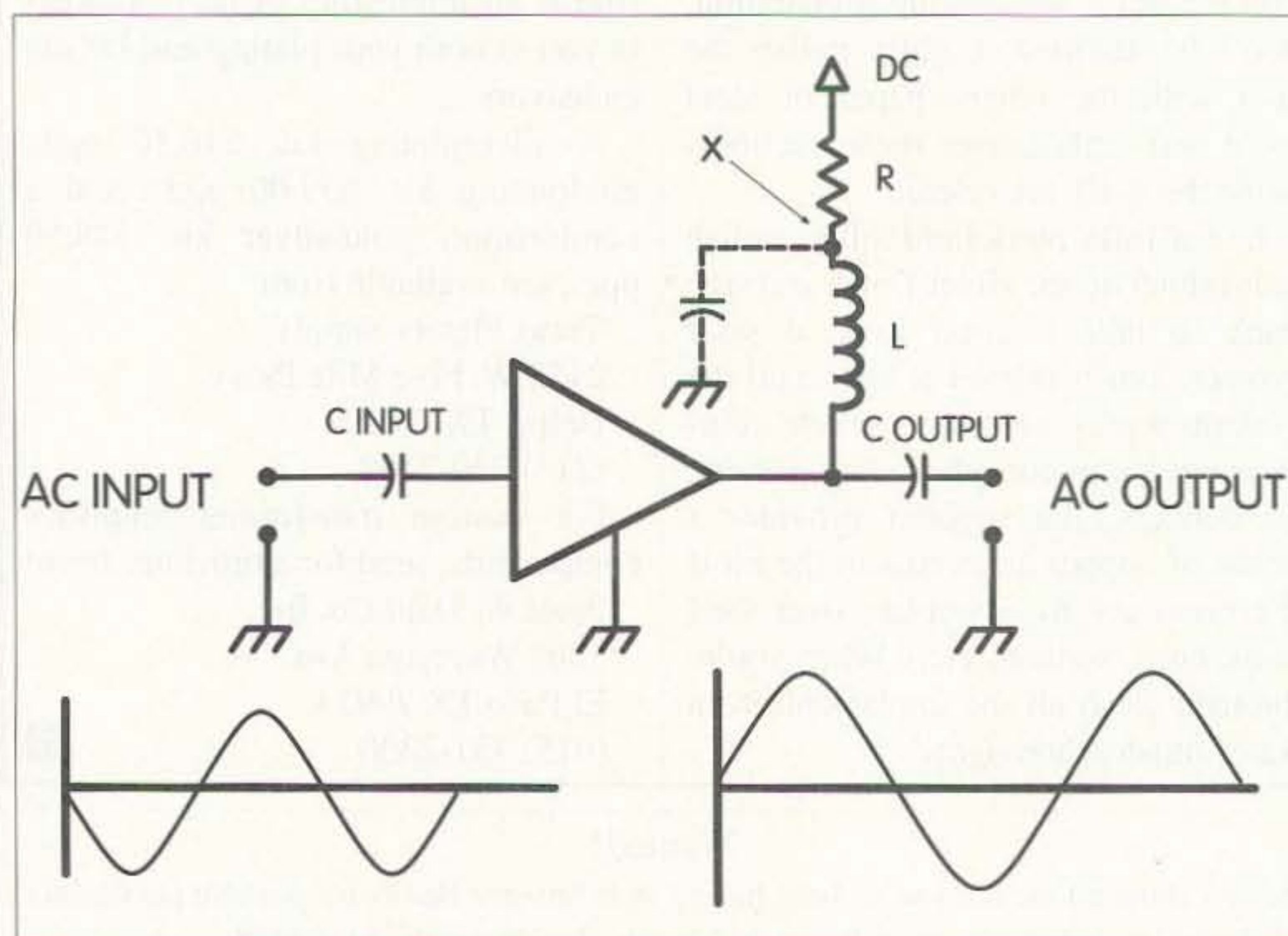

Fig. 1. Schematic of a simple amplifier circuit.



input signal and the fluid to the supply voltage. A relatively small input at the handle can control the flow of a large amount of fluid from the supply to the output.

The triangle in the center of Fig. 1 is the standard symbol for an amplifier. It doesn't matter if it's a bipolar transistor, MOSFET, tube, or whatever. In a diagram this simple it is easy to follow "conventional" practice and show input from the left, output to the right, and operating voltage in at the top.

Capacitors pass AC and block DC, so we want one on the input line. It will allow our AC signal from the previous stage or device to pass through to the amplifying device. It will also keep any DC at the input from getting through—in either direction. At the output we want the same thing to happen so we install another capacitor there. These are called blocking or coupling capacitors, depending on how you look at it.

We want our amplified signal to go to the next stage or device, where it can do some work for us. We do not want it to go to the power supply, where it could cause problems. Inductors pass DC and block AC—just the opposite of capacitors—so we'll install an inductor in the operating voltage line. If we were still concerned about the signal getting into the power line and from there into successive stages, we could install another capacitor between point "X" and ground.

The resistor in the DC line gives us a bit of control over the amount of voltage applied to the amplifier. We could install a variable resistor there which would give us a gain control, if we needed it. This bias resistor also helps provide current and temperature stability.

Notice that as the input goes positive, the output goes negative. In many applications that's OK, but if we need to have the output in phase with the input we can add another amplifier stage. This will re-invert the signal so it matches the original. We could even build a gainless stage so the signal inversion would occur while retaining the original amplitude.

# PETER DAHL CO.

## Heavy Duty Components FOR THE SERIOUS HAM

Hipersil Plate & Filament Transformers,  
High Voltage Rectifiers,  
DC Filter Chokes & Capacitors,  
Vacuum Variables, Roller Inductors,  
RF Plate & Filament Chokes.

Write or FAX for an extensive catalog

5869 Waycross Avenue  
El Paso, Texas 79924  
http://www.pwdahl.com

TEL:(915)751-2300  
FAX:(915)751-0768  
E MAIL: pwdco@teagle1.com



CIRCLE 287 ON READER SERVICE CARD

## The NiCad Lady - N6WPA

Losing your source of power?

Have your old case refitted with NEW cells and \$ave!

Convert your pack to NiMH!

Same size pack — HIGHER capacity!

\*Handhelds \*LapTops \*Commercial Radios \*Camcorders  
\*Portable Scanners \*Test Equipment \*Power Tools  
\*Any Special Application

NEW replacement packs & Individual cells also available!

Call for a price list!

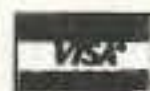

17052 Alameda Drive Perris, CA 92570

(909) 789-0830

FAX (909) 789-4895



CIRCLE 141 ON READER SERVICE CARD

### BackPack Solar?

10 watt DesertStorm panel is size of open 73 magazine, weighs 1lb, and delivers 600mA for 12v charging or direct operation. Tough, Solid, with no glass to break. So rugged Uncle Sam used this for spotter communications and portable repeaters in Desert Storm. Ready to use. \$169. Add \$5 S&H. Info \$1.



AntennasWest  
Box 50062 Provo UT 84605

Order HotLine  
801 373 8425

CIRCLE 340 ON READER SERVICE CARD

### CornerBeam?

SWR < 1.2:1 across the band  
Gain of a 15 ft Yagi  
No dimension over 7 ft  
40 dB Front-to Back Ratio  
60° Half-power Beamwidth  
Mounts directly to mast  
Vertical or Horizontal Polarization  
2meters \$145, 220 MHz \$145, 70 cm \$115, Dual 146/440 \$165  
Weights only 10 lbs. Add \$11 Shipping & Handling. Info \$1.



AntennasWest  
Box 50062 Provo UT 84605

Order HotLine  
801 373 8425

CIRCLE 380 ON READER SERVICE CARD

### WEATHER FAX

Satellite & HF FAX for IBM / Clones



Processes  
GOES, WEFAX,  
NOAA, VIS & IR, METEOR,  
APT, 240 LPM, 120 LPM & HF WEFAX. Connects to  
Computer Line Printer Port. The software was created by  
Dr. Ralph E. Taggart, WB8DQT. For details see chapter 5,  
Fifth Edition of the *Weather Satellite Handbook*.  
JV FAX 7.0 Compatible.

Complete Kit ..... \$159.95  
Assembled & Tested ..... \$189.95

### ViewPort

Color SSTV for IBM/Clones



Now  
compatible  
with & supplied with a copy of:  
KA2PYJ's VPVGA PA3GPY's MSCAN DK8JV's JVFX  
WB8DQT's FAX480 OZ2LW's HiScan  
Displays up to 16.7 million colors with TrueColor compatible video.

Complete Kit ..... \$149.95  
Assembled & Tested ..... \$179.95

CA res. add 7.75 % sales tax. S&H: \$6.50 (insured). Foreign orders add 20%.  
For information call or write:



A&A Engineering 2521 W. La Palma #K • Anaheim, CA 92801



(714) 952-2114 • FAX: (714) 952-3280



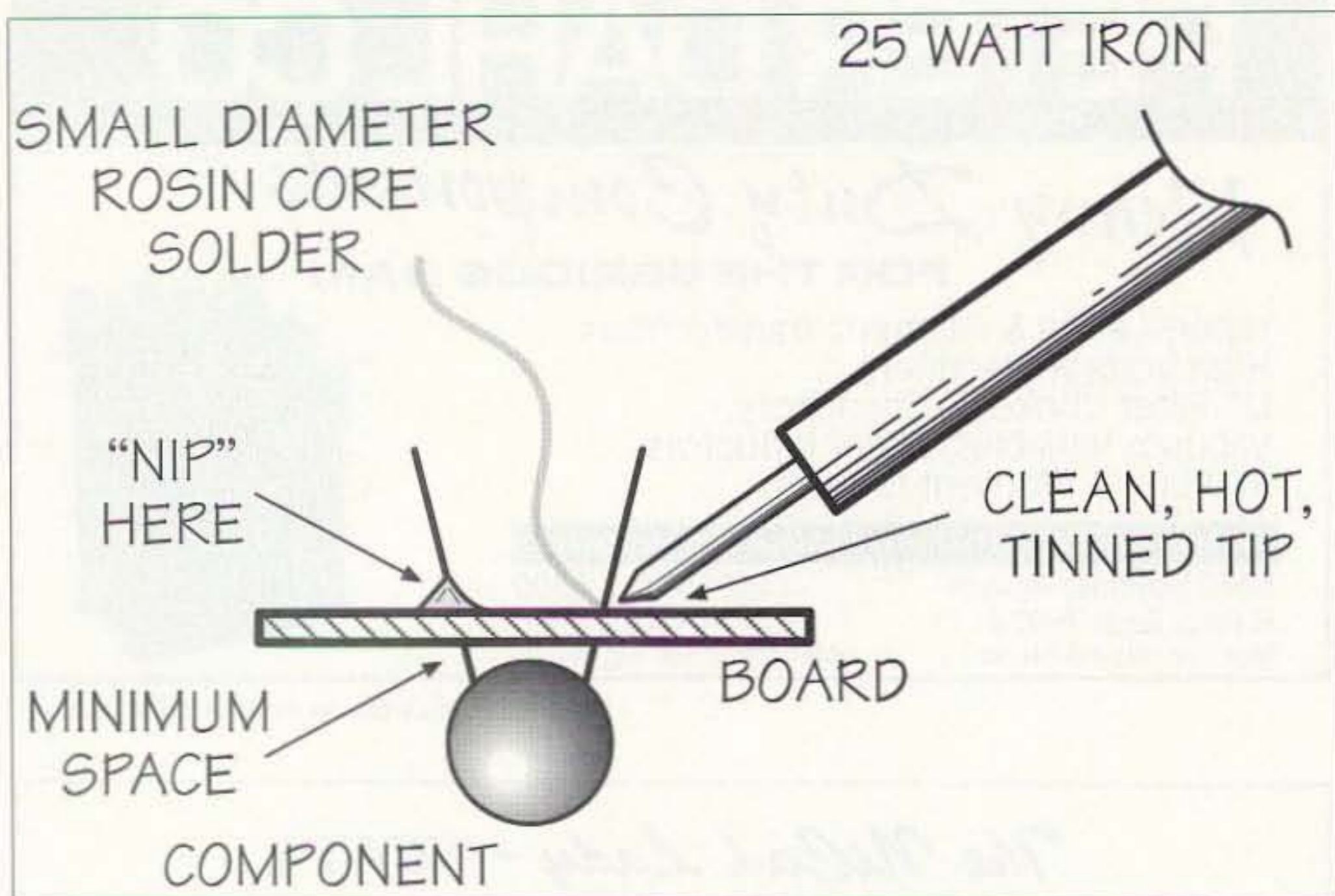

Fig. 2. Note that the joint must be smooth, shiny, and slightly concave.

Although inverted, the output has the same waveshape as the input. Or, rather, it is supposed to. In any high-gain device like the T-Kit 1001 very little drive signal is required. If a good strong signal is already present, adding amplification can also add distortion by overdriving the preamplifier or the following stage.

Now that we've dealt with some basic theory, let's take a look at soldering technique. See Fig. 2. This is the area that probably contributes the most to kit failure. It is not hard to learn how

to do it right, but it does take a bit of practice. That is why I recommend starting with a simple kit like the 1001.

First off, the board and all the components must be free of grease and corrosion. Second, you want to use appropriate tools and materials. Buying a kit pretty much takes care of the first item, so all you have to do is keep your hands clean and free of grease. Also, remember that solder contains lead, which is toxic, so eating or smoking while you are soldering is *not* recommended. You were wanting to cut back anyway, right?

Since you don't need a large assortment of tools to get started in kit building, buy the best you can afford. For this project you will need a small pair of diagonal cutters, a pair of needlenose pliers, an adjustable wire stripper, and a 15- to 35-watt soldering pencil. If the pencil you get has a replaceable tip, make sure you never screw it in much more than finger tight. Then make sure you loosen the tip at the end of your building session. That way it won't be seized into the heating element when it needs to be replaced. Some folks even recommend coating the threads with powdered graphite to help conduct heat and avoid seizing.



Photo A. Ten-Tec's T-Kit 1001.

When doing electronics work, never use anything but rosin-core solder. No one is going to have any sympathy for you if you use something else. For board assembly use small-diameter solder. I've known people who use smaller stuff but .030-inch works for me. If you use larger diameter solder you're going to find it hard to keep from getting too much on the joint. The possibility of creating solder bridges increases rapidly.

These bridges—shorts—create random power and signal paths that the designer never intended. The other soldering problem is the cold solder joint. Any joint that is not bright, smooth, and shiny is suspect, but can usually be corrected by reheating. The problem with cold solder joints comes from the fact that they may work *now*, but will not stand the test of time. Sooner or later, they lose conductivity and become open.

That's enough of the basics to get us started, so let's take a look at the 1001 preamp. This preamp is based on the Hewlett Packard MSA-0104 "Modamp." It has a 3 dB bandwidth of DC to 0.8 gigahertz, with a typical gain of 17 dB at 0.5 gigahertz. The kit is small enough that it can be built into many existing receivers. Its rated current draw is only 40 milliamps so power could be "borrowed" from the parent device easily.

The instruction manual meets T-Kit's usual high standard. Besides telling you what the device is and how to assemble it, there is enough theory and application information to help you go "beyond the device."

The T-Kit 1001 can be used as an IF or RF gain block in an original receiver design or added to an existing receiver. Assembly of the 1001 is so simple that it will give you an opportunity to spend time experimenting with applications. Because of its tremendous bandwidth, the 1001 can be used to increase the sensitivity of a very wide variety of receivers: public service scanners, SWL receivers, VHF/UHF monitors, TVs, you name it.

If you want to get your feet wet in kit building, this is a good place to start. 73 and have a ball!



# Limited Space Antenna

*Short of real estate? This might help!*

Francis Y. Kelson HL9BK/K2KSY  
PSC 450, Box 0826  
APO AP 96206-0826

**W**ith the coming of the summer doldrums, and band conditions being what they are, I found the need to expand my area of operations to another, primarily 80 meters. At the same time, I didn't want to lose the capability that I already had on 20 meters. It is a very good band from this part of the world, but with more activity for us during the daylight hours than the evening.

After dusk 80 meters showed an excellent potential for sporadic DX as compared to 40 meters, which is congested, to say the least, making my QRP operations virtually impossible.

What to do? The size of my roof only permits me the basic real estate necessary for a 20-meter dipole antenna—the noise element being a major factor, a vertical was out. So, with that in mind, I finally resolved my problem with the use of loading coils, in the same manner that is used with verticals.

Cramped for space? This little gem will surprise you. It's a dipole that is resonant at 3.5 MHz and 14 MHz, with the capability of being used on all bands from 3.5 MHz through 50 MHz with the aid of an ATU.

L2 and L3, the 3.5 MHz stubs, may be placed in almost any position.

You should note that **Fig. 1** shows a typical installation convenient at the time. Other configurations are certainly possible.

The T-bars were used for a now-vacant clothesline, and gave a tilt benefit

through which the direction of fire is accomplished. An added bonus is that extending the length of L2 to 18 feet, 8-1/2 inches, and joining it with the end tip of L3 provides a loop that is flat on 14 MHz. A radical approach to loop configurations—an asymmetrical triangle?

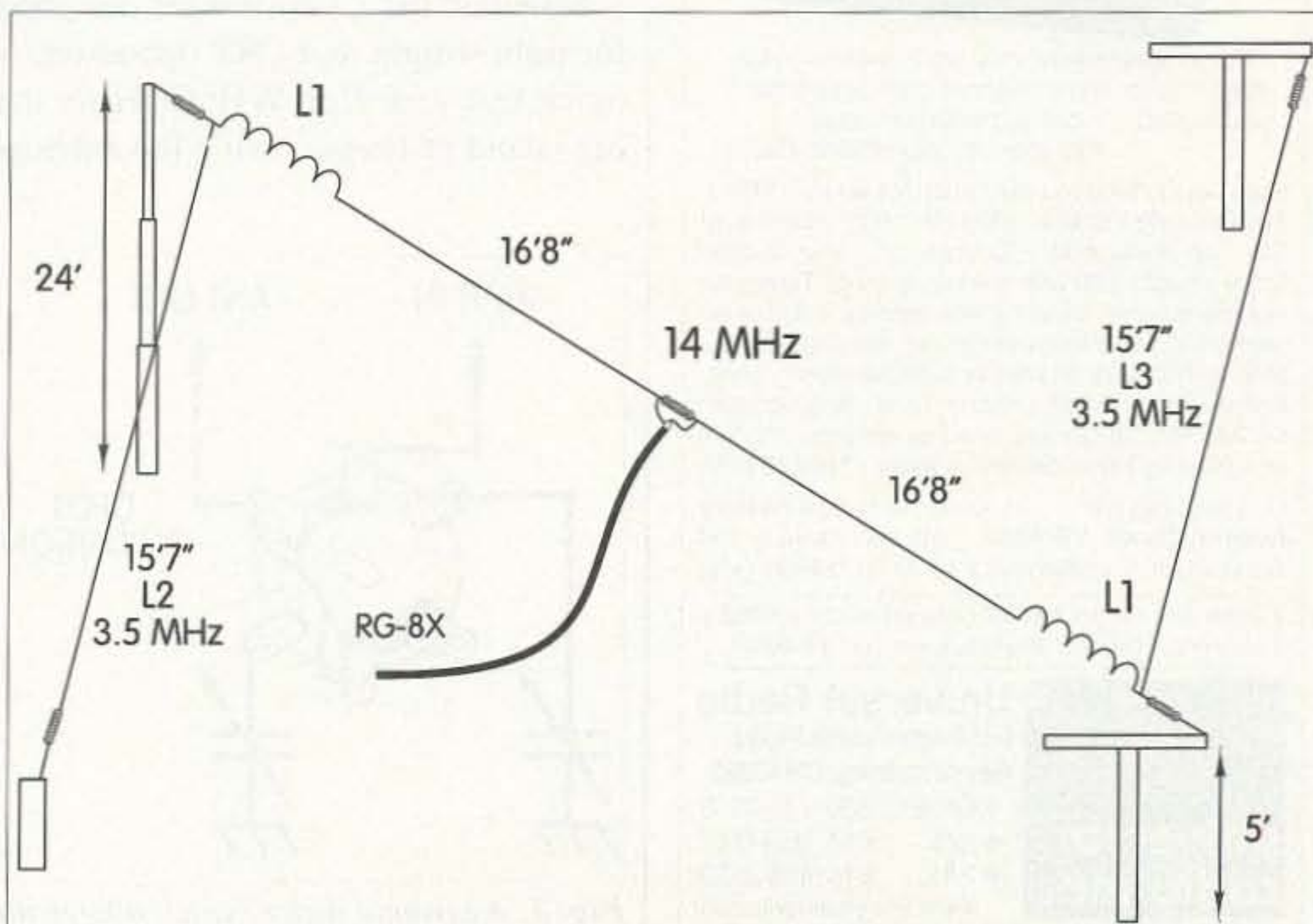

**Fig. 1.** One possible orientation of the limited space antenna.



From  
Micro  
Computer  
Concepts

## RC-1000 REPEATER CONTROLLER

- Autopatch • Reverse Autopatch
- User Programmable CW ID,  
Control & User Codes & Timeouts

Manual with schematics • 90-Day Warranty  
Wired & Tested w/ manual .... **\$199.95**



Micro Computer Concepts  
8849 Gum Tree Ave.  
New Port Richey, FL 34653  
**813-376-6575**

CIRCLE 160 ON READER SERVICE CARD

**ISOTRON**  
ANTENNAS FROM 160-10 METERS

NO TUNERS  
NO RADIALS  
NO COMPROMISE  
PRICES START AT \$49.95

SEVEN EXCELLENT REVIEWS  
JUST DON'T HAPPEN BY CHANCE  
CALL US FOR A FREE CATALOGUE

See review in 73, Oct. 1984; 73, Sept. 1985; 73, March 1986  
CQ, Dec. 1988; W.R., Mar. 1991; 73, Nov. 1994; 73, Apr. 1996

ASK ABOUT OUR NEW ISOTRON 160C!

**BILAL COMPANY**  
137 MANCHESTER DRIVE  
FLORISSANT, COLORADO 80816  
(719) 687-0650

CIRCLE 42 ON READER SERVICE CARD

## GRUNDIG YB-400



"The compact model most preferred by our panelists for listening to major worldband stations... audio quality is tops within its size class."

Passport to Worldband Radio

Here's everything you want at a price you can afford. The Grundig YB-400 covers LW, MW, FM and all of SW. An illuminated LCD reads to 1 kHz on SW. Enjoy smooth SSB with fine tuning knob. Tune your favorite stations instantly with keypad entry or 40 memories. Other features include: dual digital clock-timer with snooze and dial lock. Switches for: Wide-Narrow, Local-DX and Hi-Low Tone. Supplied with six AA cells, carry case, wind-up antenna, manual and Grundig Wave Guide. #0040 \$169.95 (+\$6)

Universal has a limited number of like-new **Factory Reconditioned YB-400s**. All accessories and same one year limited warranty. #1704 \$149.95 (+\$6)

Order now and get a **FREE radio stand** and a **FREE copy of DX Tips For Beginners** with your YB-400!



**Universal Radio**  
6830 Americana Pkwy.  
Reynoldsburg, OH 43068  
♦ Orders: 800 431-3939  
♦ Info: 614 866-4267  
♦ FAX: 614 866-2339  
www.universal-radio.com  
Quality Communications Equipment Since 1942

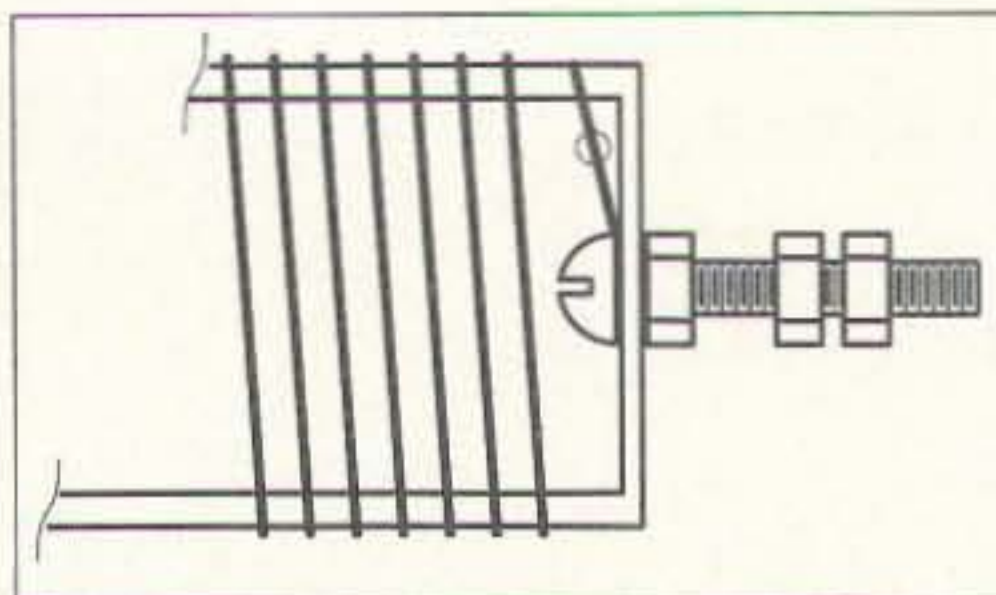

Fig. 2. A small machine screw-and-nut assembly provides coil strain relief.

This antenna will also tune with the aid of an ATU from 3.5 MHz through 50 MHz. L2 could be attached with a quick disconnect. When not needed, the wire simply is balled up at the 15 feet, 7 inches mark and tied off. Nope! You don't need to cut the wire to maintain a resonant condition. Just ball it up tightly, and tie it off as a dipole.

### Coil construction

The construction of both coils is straightforward. They were wound on plastic pill bottles that have a diameter of 11/16 inch. The coils are close-wound for a length of two inches, or 85 turns.

Referring to Fig. 2, you will note that screws were placed at each end. This was done to reduce any strain on the coils' windings. You can use any type of nonconductive form as long as the diameter requirements are met. A good coat of shellac is recommended as protection against the elements.

Note that the L1 coils were designed for light weight and QRP operation. A quick test with Ken WH6CQH on the big island of Hawaii using the antenna

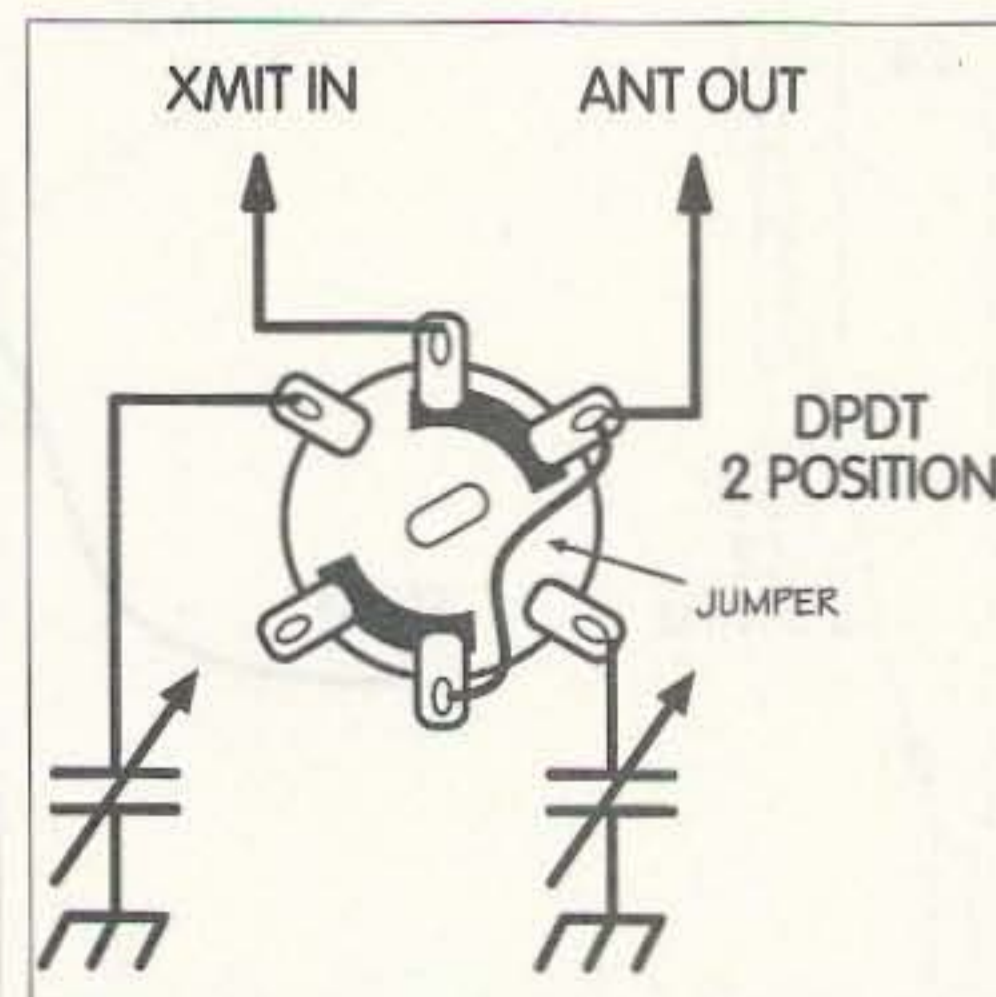

Fig. 3. A ceramic wafer switch allows the ATU to be easily bypassed.

in the dipole configuration revealed that the coils can sustain a power level of 50 watts. By the way, Ken was involved with a pileup from Europe, NA, and SA, and he gave me a "five by three" off the side of his beam, indicating that the wire is radiating. A further test in the loop configuration with Mario IK2IQP in Trieste, Italy, provided me with a five-nine and we held it for 25 minutes. 7J4ACS, Far East NCS, gave me a five-nine from the back of his beam, and the coils didn't even get warm. So it's back to four watts QRP, hi, with plenty of overkill.

### Tips

My ATU is a Ten-Tec 291. It has an excellent range and has been modified so that it can be switched out of the line. This is ideal for antenna experimentation, and for checking line resonance. As noted in Fig. 3, a good-quality ceramic wafer switch is recommended. A recent test with some commercial ATUs revealed that if, say, 20 watts were introduced, and an ideal SWR, and power out indication were observed, you may find that only about 200 milliwatts is actually leaving the ATU. They make excellent dummy loads.

I also use an MFJ SWR analyzer both for checking line resonance and for ATU adjustments to prevent interference. I have a simple home-brew switching unit to kick in the analyzer, but many good quality commercial units are available. You have to ensure that the loss is not more than 0.2 dB and that isolation is at least 60 dB to prevent damage to the analyzer.

As an afterthought, I was wondering what would happen if the RG-8 coax was replaced with 300-ohm line. If you try this, would you please drop me a line? Keep 'em resonant, folks. 73

- |  |
|--|
| 30 feet #24 enamel wire                  |
| 2 plastic pill bottles, 1-1/16" diameter |
| 85 feet speaker wire                     |
| RG-8/X mini coax, any length             |

Table 1. Parts list.



# How To Build A Great Ham Club

*Good advice from the PR master.*

Wayne Green W2NSD/1  
 c/o 73 Amateur Radio Today  
 70 Route 202 North  
 Peterborough NH 03458

**W**hen ham club meeting night comes along, do you have a problem with priorities? Should you go to the club meeting or to the dentist? Or perhaps a visit to your mother-in-law? Tough decision. The answer is to get the heck down to the club meeting and get the club off its collective ass. You can make the club so much fun the members will be fighting to have weekly meetings instead of monthly. Now stop sitting there wringing your hands, hoping someone else will do it.

Yes, I do a lot of things. You know why? Well, every time I look around and say to myself, gee, someone really should do something about so and so ... I realize that, heck, *I'm* someone. So I go ahead and do it. It's amazing how much you can get done when you decide to do it. Isn't it time you started making some decisions which will add to *your* life?

## Show biz

Okay, let's apply that concept to getting your ham club going like gangbusters. I said to stop wringing your hands—let's get to work on this. The

first thing you have to understand about ham clubs ... about any clubs ... is that you're in show business. It's basic—if the members don't have fun they aren't going to come back. Think about it.

What's fun to do at radio club meetings? One fun thing is to get to talk with your fellow hams. Have you built that part into your club meeting? Give 'em some refreshments about halfway through the meeting and maybe twenty minutes to chew the rag. Coffee and assorted doughnuts are good fare ... or fresh cider and doughnuts. Have you someone in the club who can make a homemade coffeecake?

A meeting can be made fun if you can find a good speaker. Is there a ham manufacturer or dealer within reasonable commuting distance of your club? Ask him or her to come in to show and tell the members about his product.

A hint on the care and feeding of speakers ... take care of them and feed them. Get maybe three or four members of the club to have dinner with the speaker before the meeting. Pay for dinner, you tightwads. If

you're driving your speaker to the meeting from the restaurant, you might have a two-meter rig in the car with the members talking up the meeting over the repeater. This will give the impression that you have a live group.

Once you're at the meeting place be sure that many of the members come up to the speaker and introduce themselves—perhaps with some compliments on his product. Get off to a good positive start. I hate to think of how many club meetings I've been to where the members all were busy talking with each other and ignored me completely. If you want your speaker to be interesting he has to be the star for the evening. Get him on early. Take the time to give him a good introduction. Give him any help he needs to demonstrate his product.

Start the meeting on time. How do you get the slow arrivers to stop straggling in late? Hold the door prize drawing first instead of last. A couple times missing the drawing and you'll find 'em remarkably punctual.



If you really must have a business meeting, keep it to under ten minutes. You should do this anyway, for nothing kills a club like extended business meetings. No good can come of it. Let the executive committee handle the business and give the club a fast report.

If you've a shortage of ham industry people in your area you should look around for ham fanatics to show and tell. Check out your members for any known DXers, packeteers, SSTVers, RTTYers, moonbouncers, meteor scatterers, microwavers, OSCARers, certifiers, contesters, builders, traffic handlers, and so on. Lift up the local rocks and see what wiggles.

I've seen some great DXpedition slides, and heard interesting talks on just about every ham fetish. They're out there if you'll beat the bushes. And don't dump the problem on the program chairman ... get the whole club to scrounge.

Can you get some Novices and Techs to come to the meeting half an hour early for a short technical talk and perhaps ten minutes of code practice? This is a good way to help newcomers get licensed—and club members move up the ladder more easily. The club has to be fun ... but it should also be supportive of the members. The club is where you provide the peer pressure to get 'em to get a higher class ticket. It's where you get more and more members to try new aspects of the hobby.

### Keep 'em short

Now, after the speaker and the Q&A ... and then after the feeding frenzy ... it's time for some reports. Short reports. This is the time for the TVI committee to report on its activities ... the licensing committee on new and upgraded licenses ... the school radio club Elmering committee ... the self-policing committee on recent complaints ... the program committee on upcoming entertainment ... news of club activities such as an auction, flea market, picnic, mountain-topping party, Field Day effort, and so on. How about organizing groups to

drive in a caravan to major hamfests and conventions?

At least one club member must be a desktop publishing whiz by now. Quickly, elect her/him editor of the club newsletter. Help him set up the reports he's going to need and the deadlines for the reports. You want to build interest in ham activities so get in reports on packet action, DXing scores, contest scores, antenna erecting parties, OSCAR contacts, and so on.

Does anyone in your club have a video camera? Great! Get him/her to do a video of the club activities. Get her to visit members and make a video of their stations. If the club has some fox hunts you can make a fun video of the hunters. If you don't have fox hunts, why not? A short video will brighten up a meeting. If you don't have someone in your club with a camcorder and another member who's into desktop publishing, you're badly in need of some new blood.

### Growth mode

How can you get new members? Easy ... the club newsletter is a good sales tool. Get someone with a computer to make a list of every ham in the *Callbook* in your zip code areas and start sending them the newsletter for perhaps four issues with an invitation to come to the next meeting. You might even tell them what fun they will have when they come. Remember, as I said, you're in show business now. Once you get them to their first meeting, be sure you have a committee to spot them and make a fuss over them. Introduce them during the meeting. Make them special and they'll be back.

You can't afford to send free newsletters to a zillion inactive hams, so rotate the free copies as you can afford. It wouldn't hurt to have club members take lists of the potential members and give them a call with a personal invitation to come to a meeting.

At meetings you can ask members to make a list of every ham they hear in the area who should be invited. This will help you pick up many which aren't listed in the

*Callbook* yet. It'll give you a first-class mailing list, too. These folks are active hams, so they'll probably be an easier sell than someone who hasn't turned on a rig in ten years. Make sure club members talk up the club on the air and invite everyone they talk with on the air to the next meeting.

Be sure to put a small poster in any local ham dealer store. You'll want to have posters in the local high schools, too. Your newspapers will list your meetings, complete with a short story on your speaker. Cut out a copy for the speaker and give it to him. It'll help his ego.

Does your neighborhood have any bulletin boards? Get your posters up there, too. How do you make posters? Somebody with a computer will be happy to oblige.

Have you thought about organizing some club outings? You might get a group together to visit a TV station ... an observatory ... an electronics plant ... an FAA station ... a research lab. You'll probably find at least one member with an "in" for such a visit.

### Now get going

Okay, I've primed the pump ... now I expect you to fill the pail. If you have any ideas on how to get clubs perking, send them in so I can pass your ideas along ... and give your club some credit.

Oops, I almost forgot. If I'm speaking at a club I ask for no smoking ... and generally get a round of applause for it. Why not ask your nicotine addicts to indulge in their drug habit outside? Nicotine is a poisonous oily substance gotten from tobacco leaves ... named after Nicot, a French diplomat who introduced the drug to France.

I've run into a few clubs who encourage the use of alcohol, passing around cans of cold beer—another drug with millions of addicts. Let's keep drugs out of club meetings ... alcohol, nicotine, pot, and cocaine. Phooey ... none of these drugs is going to improve your meetings.

*Adapted from 73 Amateur Radio, July 1986.*



# Electronic Construction from A to Z, Part 2

*Everything you wanted to know about building stuff—but were afraid to ask.*

Marshall G. Emm N1FN/VK5FN  
2460 S. Moline Way  
Aurora CO 80014  
[n1fn@mtechnologies.com]

Last month we talked about tools and basic construction techniques; now it's time to use what we have learned. We're going to build an AC voltage monitor, which uses colored LEDs to display a range of voltages. Electronically, it's pretty simple—a plug-pack transformer supplies DC voltage (which varies with the AC line voltage it's plugged into) to a pair of quad op amps. The op amps are configured for voltage comparison, and turn an LED on if the voltage is equal to or greater than a specified voltage. Seven LEDs are set for levels of 100, 105, 111, 118, 123, 128 and 132 volts AC, with a bar-graph effect: All LEDs below the measured voltage will be lit, and they are color-coded (two red, two yellow, and three green) so you can tell at a glance if the main voltage is within normal limits. For future reference, there is a similar kit available to monitor DC voltage on a 5, 8 or 12 V supply. You could put both units in one box for a complete station power monitor.

Everything you need to build the VM-110 is in this article: the schematic, parts list, parts overlay, and circuit board artwork (reprinted with permission),

or you can buy a complete kit from Milestone Technologies or Electronic Rainbow.

Why this particular kit? It's useful, you probably don't have one already, it's reasonably inexpensive, and it is of moderate difficulty. You'll be working with polarized components and integrated circuits, and along the way you'll have to overcome some challenges. A Rainbow Kit also conforms to my Rule #1 for kit selection: Never buy a kit from someone who won't fix it if you can't get it to work! You will usually have to pay a repair fee, but at least you know you won't be throwing your money away. And such a service is an indication that the kit seller has done everything possible to make the kit buildable.

While it might look like it at first glance, this is not a "project article" as such. Its purpose is to help you learn to build any project, not just this particular kit. Along the way we'll talk about things that aren't even related to this kit, and that's why it will take so much print space—when the actual instructions you would get with this kit are printed on a single side of a letter-sized page! Besides, the topic is really

huge. We're talking mechanical skills, manual skills, a considerable amount of knowledge, and, of course, experience. Experience is something you can only get for yourself, but you have to start somewhere. The intention here is to keep it as simple as possible, but give you a base to build on.

## Step One: Read the instructions

All of them! Even if it's a 30-page booklet, you really need to read through it to get an idea of how to proceed with construction, whether you will need to make any "option" decisions, whether the order of construction is mandatory, etc. And often you will find explanations for little mysteries, like extra parts or unusual parts that you might encounter in Step Two.

There are tremendous variations in the standards of documentation for kits. Sometimes you will be told in excruciating detail exactly what to do, and sometimes the instructions will be very general. Here are a couple of actual examples from kits I've built recently, word for word:

*Excruciating Detail:* "... 52a. Locate resistor R1 (1 k, Brown-Black-Red). Bend the leads and insert on the



component side of the board in the space marked 'R1' which is near the transformer you installed in step 48. Solder and trim leads."

*The "No Instruction" Instruction:* "Insert and solder all of the board-mounted components."

### On with the show

#### Rainbow's Assembly Instructions for the VM-110

Place all the parts on the Fiberglas™ side of the board and solder on the metal side.

1. Insert and solder all resistors.
2. Insert and solder D8, D9, D10, U1, and U2 (watch polarity).
3. Insert and solder R16 trimpot.
4. Insert and solder the LEDs and jump (watch polarity of LEDs).
5. Connect the wall transformer to your completed PC board. The solid wire is the "- input" and the wire with the white line is the "+ input."

Very carefully check all of your work before you apply power to your kit. To properly calibrate your kit, you must be able to monitor and adjust the incoming AC. Set your voltage to 118 VAC and connect your wall transformer. Adjust R16 until the #1, #2, #3, and #4 LEDs are "on." Check operation by varying the input voltage, and checking the voltage against the voltages given at the beginning of the article.

By adjusting R16 you can set the center LED to light from 111 to 123 VAC. You can also select a different color sequence for the LEDs, to better suit your situation.

The instructions for the VM-110 kit are about 80% of the way toward the "no instructions" end of the spectrum. That's good, because extremes are generally bad. In the excruciating detail approach it is assumed that you will follow the instructions step by step, and it's very difficult to change the order of construction even if you have good reasons for doing so. And such instructions are hard to maintain when the kit manufacturer makes a minor change—a lot of instructions have to be changed and they often miss one or two.

Sometimes you will have to make decisions as you build the kit, so it's a good idea to work your way through the choices before you start. Sometimes there are actual options, as, for example, a transceiver kit where you can select either fixed or variable IF filter bandwidth. The VM-1 DC voltage monitor lets you choose which base voltage to measure (5, 8, or 12 V) and what the steps should be for each LED (.25, .5, or 1 V steps). These options often have parts implications, so that's another reason for reading the manual before counting the parts.

There can also be "user modifications," or cases where you might want to do something different from the literal instructions. That's one of the great things about kit building—it's your kit and you can do anything you want with it! An example of this might be where a board-mounted pot is supplied and you would rather wire up an external pot on a control panel. Again, it helps to have these things in mind before you start building.

#### Step Two: Taking inventory

If you are gathering the components yourself this is not an issue, but if you have bought a kit it is important to find out right away if you got everything you paid for. Locate the parts list (Table 1) and inventory the supplied components. Check the values carefully, and check them off on the parts list as you go. In my experience wrong or missing parts are something of a rarity but it does happen, and reputable kit suppliers will fix the problem fast. In fact, if you start by checking the parts you will often be able to obtain a replacement before you actually need the part, especially with larger projects.

Usually there are only two problem areas in checking component values: resistors and caps. Resistors because there are often a lot of them and the value is indicated by colored bands, caps because there are often lots of them, too, with multiple standards for labeling, and frequently you will need a magnifying glass to read the lettering. A complete rundown on component identification would take more

space than the editor will let me have, so I'll refer you to the *ARRL Handbook*. You should learn the resistor color code, so I've provided it for you in Table 2.

Don't hesitate to use the process of elimination when you must. If you can't absolutely identify the nature or value of a component, go on and do the rest of them and see what's left. Often it helps to look at the quantity of a component, too. For example, you might be working on a kit (not the VM-110) that has .01 and .001  $\mu\text{F}$  capacitors which you can't tell apart, but since there are supposed to be two of the former and 15 of the latter you should be able to figure it out.

Sometimes you will find extra parts, and parts which are not listed on the parts list—case in point, the VM-110 I built while developing this article had an extra set (seven) of 1 k resistors. I've done kitting myself, and with inexpensive components like resistors it is occasionally easier to throw in extras "to make sure" than to re-count everything. Also in my VM-110 kit the plug-pack transformer was not listed on the parts list, nor were sockets for the integrated circuit chips.

You can test, or measure the value, of many components as you go. Until you have a lot of experience working with resistors, use your multimeter to confirm the value that you have deduced from the color code. Your multimeter will also tell you whether a diode is good (and confirm that it is, in fact, a diode), and some of the more elaborate multimeters will measure capacitance and inductance and even test transistors. Actual testing of components is generally a waste of time with commercial kits, but don't overlook it as a means of identifying parts.

As a more or less last resort (it's tedious work) you can cross-check the parts against the circuit diagram. And if all else fails, don't hesitate to get in touch with the kit supplier. Most of them are happy to clarify things for you and—even happier to find out where there are problems in the documentation.

#### About printed circuit boards ...

Printed circuit boards (PCBs or just "boards") come in a wide variety of types, colors, and materials. Every board



Parts List		
Part	Description	Color ID
R2, R4, R6, R8, R10, R12, R18	1 k resistor	Brn/Blk/Red
R3, R5, R7, R9, R11, R13, R14	330 Ω resistor	Org/Org/Brn
R16	1 k Ω trimpot	
R17	4.3 k resistor	Yel/Org/Red
R1	8.2 k resistor	Gry/Red/Red
R15	680 Ω resistor	Blu/Gry/Brn
D1, D7	Red LED	
D2, D6	Yellow LED	
D3, D4, D5	Green LED	
D8, D9	1N914 or 1N148	
D10	5.1 V Zener 1N4733	
U1, U2	LM324 IC	
PC Board	080-00240A	

Table 1. Parts list.

has two sides, and usually the components go on one side (the "component" side) and the solder connections are made on the other (the "solder," "foil," or "track" side). Sometimes, though, you might need to attach a component to the solder side of the board, or make solder connections on the component side.

And sometimes connections are needed on both sides of the board; this is called a double-sided board (actually there can be layered boards, too, with circuitry on one or more layers within the board). With double-sided boards, there is usually a requirement for connections between the two sides. Sometimes you will need to install "vias" or "feed-through" wires, which are soldered on both sides of the board. In other cases, the board comes with "plated-through" holes, meaning a metal grommet has been inserted in the component holes, which makes the connection between the two sides.

The "tracks" or circuit connections on the solder side of the board can be of pure copper or an increasingly wide variety of alloys. Pure copper boards occasionally carry enough oxidation that you should clean them before you start working with them. You can clean them with hot water and detergent, and scrub *lightly* with a scouring pad, but in my experience it's seldom necessary with commercial kits.

There are two "premium treatments" that can make boards easier to work

with. A board can be "solder-masked," which means the tracks and areas between the solder pads have been covered up with a material that solder won't stick to (making solder bridges a lot easier to avoid). And the component side of the board can be silk-screen printed with an outline of the parts and identifiers for each part, making it hard to get a component into the wrong holes. Unfortunately not all boards have these features (the VM-110 being an example of a single-sided board without solder-masking or silk-screening).

### Moving right along

But first, as Norm Abrams of *This Old House* would say, "a word about shop safety." We're not working with power tools here, but you do need to be careful with a couple of things. When you clip a lead from a circuit board, the clipped end is likely to go flying and could easily hit you in the eye. Wear safety glasses, if you have them. Ordinary glasses are probably of some value, and you can also put a fingertip on the lead before you clip it to keep it from flying. I've had a lot of things hit my glasses, so I know there really is some risk here. Soldering? Well, you're working with molten metal. What can I say? Be careful! And don't expose yourself to the fumes any more than you have to. Don't panic—normal hobbyist exposure to solder fumes should be harmless, but on the other hand don't take any unnecessary chances.

At this point, we should have the parts all inventoried, have our tools in place, and generally be ready to start working on the circuit board.

### Populating the board

I've always loved that expression: "populating" a circuit board. It conjures up images of real creativity and procreation, or something. When my children were small they thought I was building little "cities," and they loved to build their own cities with junk box components and a piece of Styrofoam. In any case, that's the term we use when we're talking about soldering components onto a circuit board.

Order of instruction can be important, so you can treat the following guidelines as rules of thumb which are

## HF SSB RECEIVER

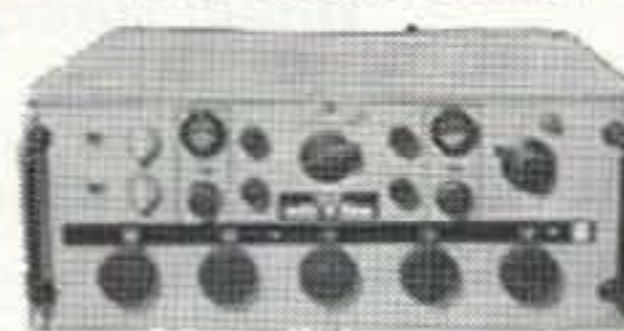

**R-1051B RECEIVER,** covers 2-29.9999 Mhz AM - CW - LSB-USB-LSB using six

decade band tuning + vernier; 500 Khz IF. Meters and controls for LSB & USB Levels; also BFO, 600 ohm audio & 50 ohm input impedance. Solid-state except for 3 tubes. Requires 115 VAC 50-400 Hz; 7x17.4x18.9, 85 lbs sh.

**USED-CHECKED** ..... \$650 \$350

**MANUAL** for R-1051B, partial repro ..... \$45

**SHOCKMOUNT**, new ..... \$22

**R-1051G**, later IC-version of above,

**CHECKED** ..... \$795 \$625

Prices F.O.B. Lima, O. • VISA, MASTERCARD Accepted.  
Allow for Shipping • Write for latest Catalog  
Address Dept. 73 • Phone 419/227-6573 • Fax 419/227-1313

### FAIR RADIO SALES

1016 E. EUREKA • Box 1105 • LIMA, OHIO • 45802

CIRCLE 75 ON READER SERVICE CARD

### CUBEX CO., INC.

40 YEARS OF QUALITY ANTENNAS

SKYMASTER H.F. KITS FROM \$275.95

PRE-TUNED H.F. QUADS FROM \$389.95

Quad Antennas From 2 Through 40 Meters

2 METER 4 EL. PRE-TUNED \$49.95 + S&H

6 METER 2 EL. PRE-TUNED \$69.95 + S&H

BEST PRICES ON DOUBLE BRAIDED "DACRON" ANTENNA ROPE

visit our new web site <http://www.cubex.com>

Write Or Call For Free Catalog

7024 Southwest 21st Place, Unit D, Davie, FL 33317

(954) 236-3663 FAX (954) 236-5576

CIRCLE 166 ON READER SERVICE CARD

## PC HF Facsimile 8.0



For Windows™ \$179.95

SSC is proud to announce PC HF Fax 8.0 for Windows. Now you can receive weather Fax, FEC, RTTY, Morse Code, Navtex, Amtor and Sitor while working with other software. The package comes with our new Windows FSK demodulator, software, manual and database. Just plug it in, connect your receiver, and you are copying the world! Call or write for our FREE Products Catalog.

Visa and MasterCard Welcome

### Software Systems Consulting



615 S. El Camino Real  
San Clemente, CA 92672

Tel: 714/4908-5784

Fax: 714/498-0568

<http://www.sscorp.com>

CIRCLE 250 ON READER SERVICE CARD



Basic Resistor Color Code			
Mnemonic Tip	Color	Value	Multiplier
Big	Black	0	1
Boys	Brown	1	10
Race	Red	2	100
Our	Orange	3	1,000
Young	Yellow	4	10,000
Girls	Green	5	100,000
But	Blue	6	1,000,000
Violet	Violet	7	10,000,000
Generally	Grey	8	100,000,000
Wins	White	9	1,000,000,000
	Silver		10% tolerance
	Gold		5% tolerance

#### Notes

1. Most resistors you encounter in kits will have four color bands: two significant digits, a multiplier, and a tolerance band. No tolerance band indicates 20% tolerance, but these are rare now. An easy way to calculate these values is to write down the first two digits, then add the number of zeros represented by the third (multiplier) band.
2. Resistors also carry power ratings, and if your kit contains resistors of more than one rating you will have to guess at those based on the physical size. Most that you encounter will be 1/4-watt, and size is relative to power rating, so for example a 1/2-watt resistor will be larger than a 1/4-watt one.
3. Silver and gold can be multiplier bands if they appear as the third band. In that case multiply the first two digits by .01 for silver and .1 for gold. For example, Red/Red/Gold/Gold would be a 2.2  $\Omega$  resistor, and Red/Red/Silver/Gold would be a 0.22  $\Omega$  resistor, both having 5% tolerance.
4. Precision resistors can have five bands, with three significant color digits, and a wider space between the multiplier and tolerance bands.

Table 2. Basic resistor color codes.

applicable to just about any kit. A good case to watch for is where there are progress checks as different parts of the circuit are completed, in which case you will have to do everything in the order described in the instructions (except maybe the IC sockets!).

#### Sockets first

Start with sockets for the integrated circuits, *regardless of what the instructions say*. I have yet to encounter a situation where this is a bad move, whereas I have often run into trouble

trying to hold the darned things flat amid a forest of previously-installed components. The solder pads for ICs are also very close together, and it's a lot easier to solder them if the board is otherwise empty! Double-check the orientation of the socket (there should be a notch at one end corresponding to the notch on the chip itself). Insert it into the component side of the board, then flip the board over so that it lies flat on top of the socket and hold it while you solder pins on diagonally opposite corners. Then solder the rest of the pins, going back and forth from

side to side. Soldering adjacent pins puts an awful lot of heat into a small area of the socket (or chip) and alternating sides allows for a bit of cooling. Remember to check the soldering as described last month before you go on to anything else. Most kits which use integrated circuits will include sockets for them. If not, run down to Radio Shack™ and buy sockets! They make working with ICs a whole lot easier and safer. Very rarely the circuit may be so sensitive that the additional "lead length" for a socket will cause problems, but usually the instructions will tell you that. Do *not* install the chips into the sockets until (a) you are instructed to do so or (b) as the very last step before applying power to the completed project.

#### Little flat things

Next, install the small components that lie flat, such as resistors and diodes. The reason for doing these next is that after you have installed taller components, it can be difficult to get the lower ones into position. You can do all of the resistors at this point, even vertically-mounted ones, or you can leave the vertical ones for later. For the flat-mounted components, hold the component in one hand and use your long-nose pliers to bend the leads at a 90° angle, close to the body of the component. Don't hold the head of the pliers right up against the body, though, because you can damage the component that way. You will be bending the component into a "U" shape which should slip right into the holes on the circuit board. If it doesn't fit, straighten the leads and do it again; don't try to adjust it by forcing it into position. Once the body of the component is flush with the surface of the board, bend the leads outward at about 45° on the solder side. Install three or four components, then solder them.

When you install components vertically (e.g., resistors and RF chokes), one lead goes straight down through the board and the other is bent down 180° alongside the body of the resistor, so one end of the body is snug against the board. The parts overlay diagram will usually have a circle around one



of the holes, and that's the one that the body goes against. The component is not polarized, so it doesn't matter which way it goes in, right? Wrong! Often you will need to use the exposed (bent) lead as a test point, and if you put the component in backwards you will have problems later because the needed side of the resistor is not accessible from the top of the board! The VM-110 parts overlay diagram illustrates vertical component mounting quite nicely (see R17 and D10).

### Everything else

Do the rest of the components in no particular order, or in the order listed in the instructions, or in whatever order you prefer. Three common approaches are (1) to work your way across the board from corner to corner, or (2) to work your way upwards in component size, or (3) do all the components of a given type. Each approach has its fans, and you'll eventually decide which works best for you.

Leave any off-board controls or wires until last, unless instructed otherwise for reasons of progressive testing.

### It doesn't fit!

Sometimes you will find that a lead or wire is too thick to go through the hole in the board, or the spacing of the holes is slightly off. This happens because the kit suppliers work with batches of kits, and exactly the same component might not be available. You can narrow the lead diameter *slightly* by scraping it with your hobby knife, or you can widen the hole with a small drill, or even by pushing a small screwdriver through it. If you widen the hole, be careful that you don't damage the solder pad, though. If the holes are improperly spaced, you may be able to fix the problem by soldering the component onto the tracks on the other side of the board (be extra careful about orientation, though).

Remember to check off the parts on the parts list or overlay diagram as you go. This will help to make sure that every component is installed. When you are done, another handy trick is to hold the board up to a light and look for

empty holes. Usually there won't be any. Sometimes, though, the circuit has changed, or the same board is used with other circuits, or the designer had extra holes drilled for some other reason, so empty holes don't always mean there are missing parts.

### Take a break

Your eyes are tired, your hands are getting shaky, you're getting a headache ... It's a huge temptation to do "just one more resistor" or "finish up the caps," or go ahead and "fire it up," but when you're tired you're far more likely to make mistakes. Don't try to finish the project in one session if more time is needed. You'll probably complete the VM-110 in under an hour, but for larger projects I find a 10- or 15-minute break every hour is very helpful. Traditionally, I finish building kits late at night, and I have learned over the years that it is best to ignore the temptation to test them immediately. They almost always work better the next day!

### The VM-110 board in particular

You can probably build the VM-110 in accordance with the generic construction steps described above, but let's look at some specifics.

You've probably noticed that the instructions are pretty rudimentary. For example, step 4 tells you to "Insert and solder the LEDs and jump (watch polarity of LEDs)." How high are you supposed to jump?

Well, they mean you should install the "jumper" between two holes on the right side of U2. It's any little scrap of bare wire, such as the trimmed lead from a resistor. Do it when you do the resistors, or you will find it pretty awkward.

Several of the components (resistors and diodes) were supplied on "ammo strips," or held together with paper tape on the ends. Generally, you cut them free of the paper strip with your flush cutting pliers, and generally you never pull them loose (or you could damage the component). But there are always exceptions, and in my VM-110 kit the 1 k resistors had unusually short leads. If you cut them from the tape,

you will find that there isn't enough lead left on R6 to mount it vertically. For just this one resistor, scrape the tape off the ends of the leads rather than cut it free. This is the kind of problem that is almost impossible to anticipate, so treat this warning as a freebie. Since I cut the resistor before discovering the problem, I had to find a solution, which turned out to be a spare 1 k resistor from the junk box. It's also possible to solder a new piece of wire onto the original one if you're careful.

### Installing the light-emitting diodes (LEDs)

We need to think a bit about the LEDs before installing them. First, we need to select an order, since we have three green ones, two reds, and two yellows. The order suggested in the parts list is fine for me [(reds on each end, then yellows, and three greens in the middle (D3-5)], but feel free to do it differently if you want.

You should be able to detect the flat side of the LED (just a tiny flattening on one side of the plastic ridge at the base of the body), but you can always check with a battery. Touch the leads to the terminals of the battery (1.5 or 9 V) briefly, and if the LED lights, the positive lead is the one in contact with the positive terminal. If it doesn't light, turn it around. (Make sure you use a current-limiting resistor with the higher voltages.)

The other thing we need to think about is what we are going to do with the board when it is finished. Ordinarily you might install the LEDs flush against the component side of the circuit board, but if you do it that way how will you mount it in a box? The ICs, vertically-mounted components, and trimpot (R16) all stand higher than a flush-mounted LED, so it will be difficult to mount the board in an enclosure in such a way that we can actually see the LEDs. Mount the LEDs above the board, with the base of each LED

LED 1	LED 2	LED 3	LED 4	LED 5	LED 6	LED 7
100	105	111	118	123	128	132

Table 3. Voltage readings.



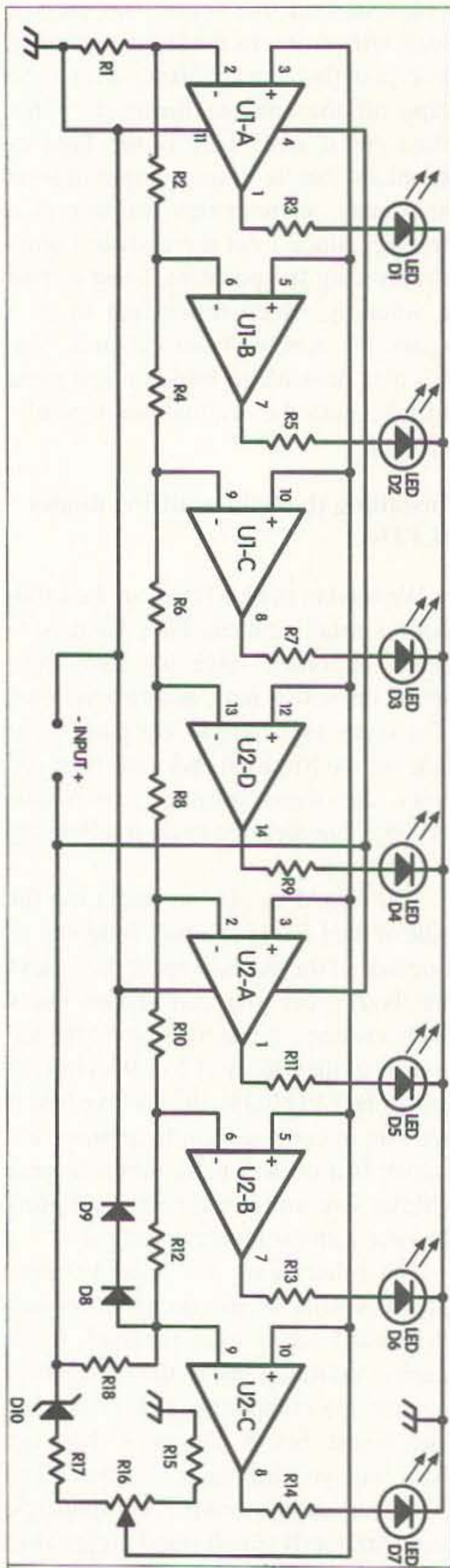

Fig. 1. VM-110 schematic.

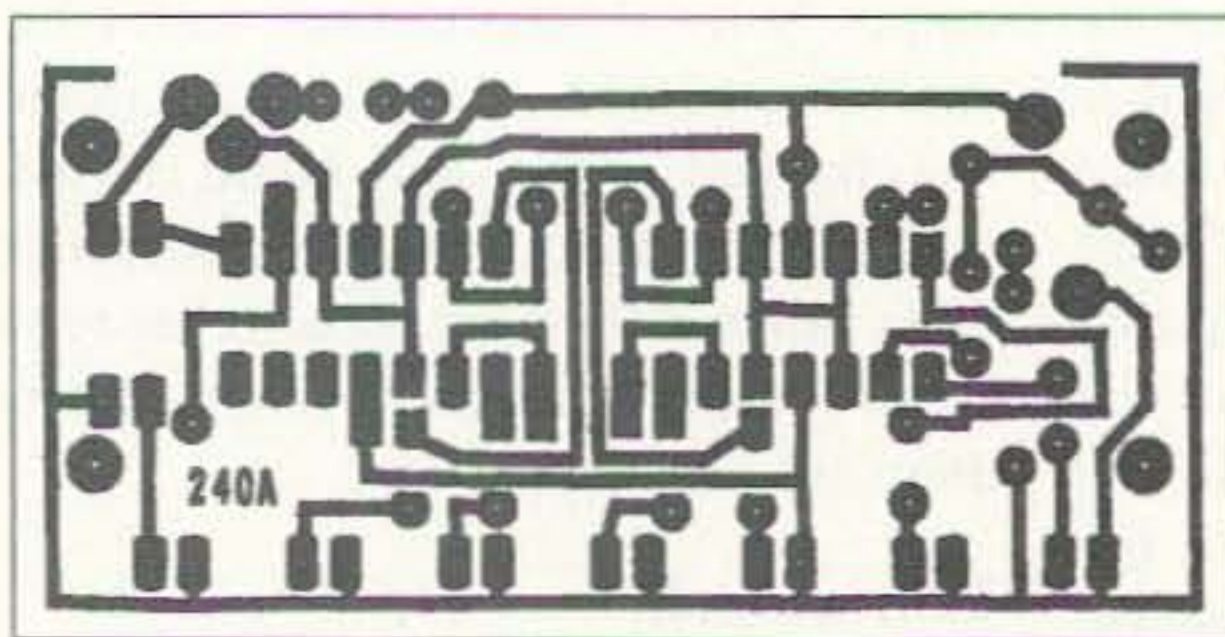

Fig. 2. VM-110 PCB.

about half an inch above the surface of the board. Visually check that the base of the LED is higher off the board than the other components. The leads could be bent 90°, but we are going to mount the board by inserting the LEDs into holes and gluing. Install the two end ones first (D1 and D7), measuring carefully; then you can just line up the interior ones (D2-6) visually.

### Installing the integrated circuits

Integrated circuits are sometimes tricky to install, and as a rule the more pins they have the trickier they are. Some (particularly CMOS devices) are extremely sensitive to static electricity, so you should make sure you have provided a static discharge path to ground before handling them. It may seem like a good idea, but never use a clip lead from your watchband to a convenient ground. If you do that you are *really* grounded and if you should happen to come into contact with a live wire, the results can be pretty drastic. A much

better bet is a commercial electrostatic discharge strap (disposable ones are inexpensive and can in fact be used many times). A commercial ESD strap has a resistance built into it, so while static will drain away to ground through it, a large current will not. It's also a good idea to ground the circuit board before inserting the chips. Connect a clip lead between the ground track (usually around the outer perimeter of the board) and a convenient electrical ground.

Make sure the ICs' pins are straight. Sometimes one or more will be bent out of line, and they are likely to fold under or outward as you try to insert the chip if you don't straighten them. Usually you will see that all of the pins are bent out at a slight angle from the vertical. In a commercial environment they are inserted with a special tool or by machine. To do them by hand you must bring the pins to vertical first. Grasp the chip firmly with your thumb on one end and middle finger on the other end, and press the pins at an angle against a flat surface such as the top of your workbench. Turn the chip around and do the same on the other side.

When you insert the chip, watch closely to see that all pins are going into slots, and not bent under or outward. If a pin bends under it can be extremely

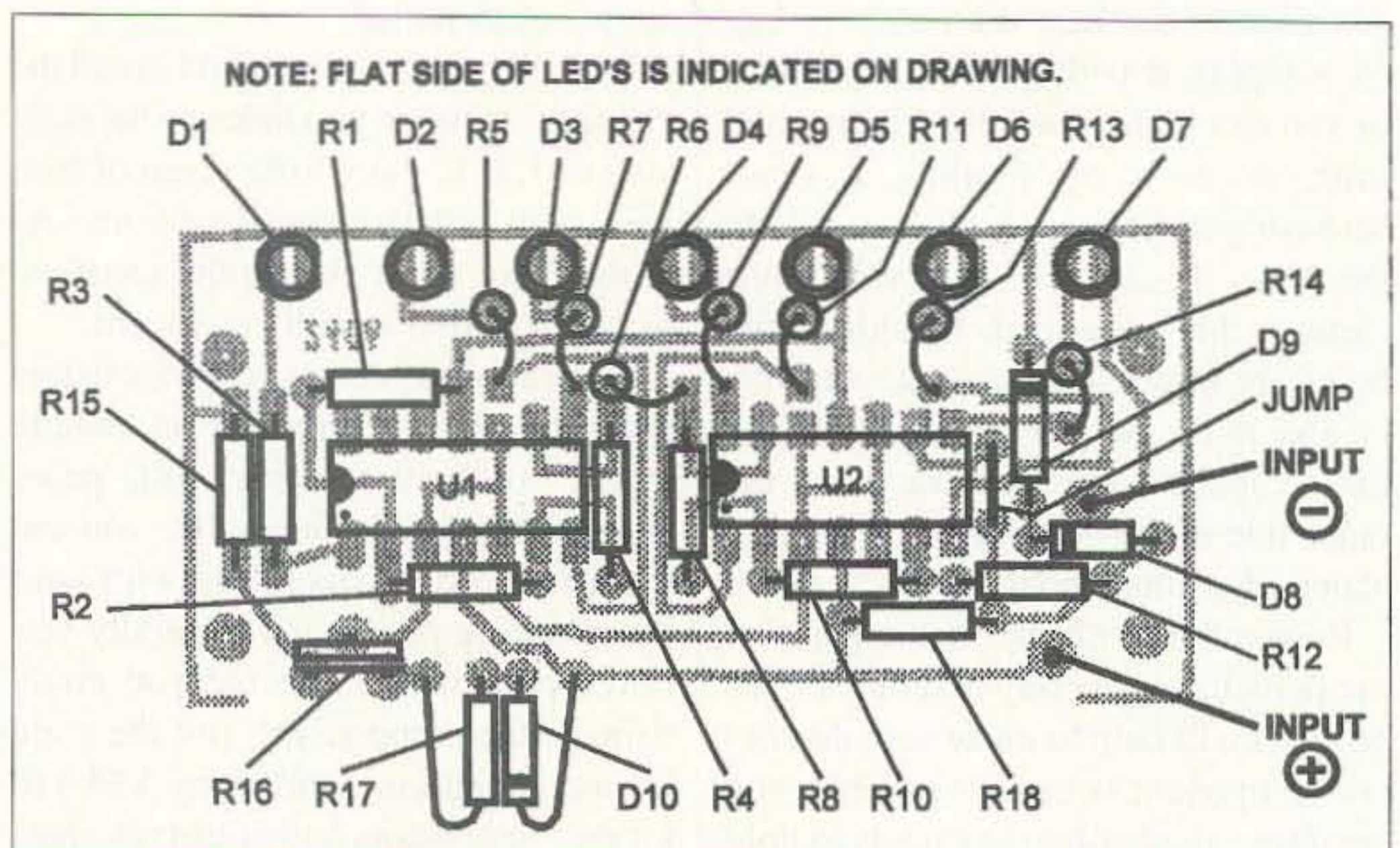

Fig. 3. Component overlay.

### Walking-Stick Beam?

Hold it in your hand—it's a walking stick made of all aluminum with rubber ends. But inside are all the elements of a 4 element Yagi that goes together in 2 minutes. Ready for the T-Hunt. Ready to get your signal out of a hole into the repeater. No little bits to drop and get lost. Everything fits clean and tight and tough. 2meters \$79, 70 cm \$49. Weighs only 1 lb. Add \$6 Shipping & Handling. Info \$1.

AntennasWest

Order HotLine  
801 373 8425

CIRCLE 324 ON READER SERVICE CARD



difficult to find later when the device doesn't work! Press the chip firmly into the socket.

### Cleaning up

You're nearly through building, now, so it's a good time to tidy up. Clean away any trimmed leads lying around your desktop (they can easily get into places they shouldn't and short things out!). Some builders will suggest that you clean the excess solder flux off the board, but I usually don't bother. The flux removal process is mechanically rough on the board, and seems to cause more problems than it solves. Sometimes, though, I will go back and clean a board where I suspect, but cannot find, a solder problem. I don't like doing it because it is messy and dangerous (unless I use a commercial flux remover which is messy, dangerous, and expensive). I use acetone (readily available in grocery stores as fingernail polish remover) in a *well ventilated area* and a paint brush for most ordinary fluxes. There are water-soluble fluxes available, but if you use those, please be sure the board is *thoroughly dry* before it comes into contact with any electricity!

Probably the best alternative is to use solder containing a "low-residue" flux. It's a little more expensive, but worth it.

### The smoke test

The smoke test is a time-honored tradition in ham radio and electronics construction. It's the point at which you apply power to a device for the first time, and see if anything catches fire or emits smoke. And we're ready for the smoke test on our VM-110 now, right? Wrong! There are still two things to do. First, take one more close look at the board, the component orientations, and the soldering. Second, use your multimeter across the power connections on the circuit board to make sure there is no short. On the power input of most circuits you should find either an infinite or at least a very high resistance. If you measure no resistance (or if your multimeter has an audible continuity tester and

## Amplifiers, ATV Down Converters & Hard to Find Parts

### LINEAR AMPLIFIERS

#### HF Amplifiers

PC board and complete parts list for HF amplifiers described in the Motorola Application Notes and Engineering Bulletins:

AN779H (20W)	2 Meter Amplifiers (144-148 MHz)
AN779L (20W)	(Kit or Wired and Tested)
AN 762 (140W)	35W - Model 335A, \$79.95/\$109.95
EB63 (140W)	75W - Model 875A, \$119.95/\$159.95
AR305 (300W)	
AN 758 (300W)	440-450 MHz Amplifiers
AR313 (300W)	(SSB-FM-ATV)
EB27A (300W)	100W - Model KEB 67, \$159.95
EB104 (600W)	
AR347 (1000W)	



**ATV Down Converters**  
(Kit or Wired and Tested)  
Model ATV-3 (420-450)  
(GaAS - FET)  
\$49.95/\$69.95  
Model ATV-4 (902-926)  
(GaAS - FET)  
\$59.95/\$79.95

### HARD TO FIND PARTS

- RF Power Transistors
  - Broadband HF Transformers
  - Chip Caps - Kemet/ATC
  - Metalclad Mica Caps - Unelco/Semco
  - ARCO/SPRAGUE Trimmer Capacitors
- We can get you virtually any RF transistor!  
Call us for "strange" hard to find parts!

**DIGITAL FREQUENCY READOUT**  
For older analog transceivers  
TK-1 (Wired and Tested) \$149.95

For detailed information and prices, call or write for our free catalog!

#### ADDITIONAL ITEMS

**Heat Sink Material**  
Model 99 Heat Sink (6.5" x 12" x 1.6"), \$24.00  
CHS-8 Copper Spreader (8" x 6" x 3/8"), \$24.00  
**Low Pass Filters (up to 300W) for harmonics**  
Specify 10M, 15M, 20M, 40M, 80M or 160M  
**HF Splitters and Combiners up to 2KW**

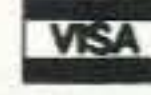

Add \$4.50 for shipping and handling

**CCI Communication Concepts Inc.**

508 Millstone Drive • Beavercreek, Ohio 45434-5840  
Phone: (937)426-8600 • Fax: (937)429-3811  
E Mail: cci.dayton@pobox.com

CIRCLE 99 ON READER SERVICE CARD

## "Charge Nearly Any NiCd and NiMH with One Charger!"



**\$40<sup>00</sup>**  
**SPECIAL**

#### NiCd

EBP-24S	7.2	1200ma NiCd
FNB-4SL	12	800ma NiCd
PB25S/26S	8.4	1200ma NiCd
PB-7S	7.2	1200ma NiCd

Above NiCd battery packs are warranted for 12 months from date of purchase.

#### NiMH

BP-84M	7.2	1300ma NiMH
FNB-25M	7.2	900ma NiMH
FNB-41M	9.6	900ma NiMH
PB-13SM	7.2	1300ma NiMH

Above NiMH battery packs are warranted for 6 months from date of purchase.

## PERIPHEx

### REPLACEMENT BATTERIES

Policies and prices subject to change without notice.  
Offer expires December 31, 1997

- For: Communications, Laptop, Camcorders & Many Other Applications
- Charges 4.8V, 6.0V, 7.2V, 8.4V, 9.6V, 10.8V, 12.0 Volt Packs
- Chemistries:  
Nickel Cadmium (Ni-Cd)  
Nickel Metal Hydride (NiMH)
- Discharges (Conditions)
- Rapid Charges (with Polarity Protection)
- Can be used in your Vehicle (Except for 10.8V & 12.0V Packs)



Advanced Battery Systems, Inc., 300 Centre Street, Holbrook, MA 02343  
(800) 634-8132 • (617) 767-5516 • Fax: (617) 767-4599  
<http://home.navisoft.com/periphex>

CIRCLE 68 ON READER SERVICE CARD



you hear the tone), look for a short. If there is a low resistance, look at the circuit diagram and trace the current path from the power supply. Sometimes a low resistance will still allow the tone to sound on an audible continuity tester, so if you hear the tone you might just want to measure the resistance and see if it is zero (a short) or a few ohms (possibly OK).

When you are ready to connect power for the first time, you should be ready to disconnect it very quickly, or apply it only for a moment. With the VM-110 I'd suggest that you connect 12 V from your station power supply using clip leads. But if you don't have a 12 V supply, you can use the plug pack transformer and plug it into the wall outlet as a way of switching it on and off. Note that the instructions say that the "solid wire is the '- input.'" By this they mean the solid-colored wire (without the white stripe); they don't mean solid wire as opposed to stranded wire!

Connect the ground (negative) lead first and then just *momentarily* touch the positive lead to its connection on the board, or if your power supply has a switch, connect both leads and turn the switch on momentarily. If you blow a fuse, you know you have a short circuit somewhere on the board. If you have a "protected" power supply, it would shut itself down (sometimes you can see this on the supply's voltmeter) without blowing a fuse. If a short circuit is evident, review the soldering and component orientations (especially diodes near the positive power input connection).

If you haven't blown a fuse, you can connect the positive lead and check for

smoke. Look and listen! Sometimes you will hear a crackling sound before you see or otherwise detect a problem. Look for actual smoke, for a resistor turning brown. If everything looks OK, you can make the power connection permanent and continue to set up and operate your device.

I've said "look and listen," but in fact you should use all your senses with the possible exception of taste. Sometimes you might see or hear a problem, and sometimes you might touch a resistor or transistor to see if it is hot. But don't overlook your nose, in a manner of speaking. Even if everything else seems OK, you might notice what we sometimes call a "brown smell." New electronic equipment does have a characteristic smell, but a brown smell is unmistakable. A light brown smell indicates that disaster is imminent. A dark brown smell indicates that the disaster has already happened.

If you know how much current the circuit *should* draw, and have a multimeter or ammeter which can handle that range, you should connect the meter into the positive power supply line before conducting the smoke test. Connect the positive lead of the meter to the positive side of the power supply, and the other "common" or "negative" lead to the positive input connection on the circuit board, so current will flow from the supply through the meter and into the board. If you can measure current, you can often see a problem (e.g. excessive current drain) before components are damaged. Similarly, low current drain (that is, below the specifications or your expectations) might indicate a problem in the circuit.

Finally, with power applied to the VM-110 circuit, adjust the variable resistor (R16) back and forth and you should see all of the LEDs progressively light up and go out as you adjust R16. Congratulations! Your VM-110 is *built!*

### Calibration

At this point, you have a working VM-110 and all that's left is to calibrate it. The instructions say that to "properly calibrate your kit you must be able to monitor and adjust the incoming AC."

The ability to adjust the incoming AC is probably beyond most of us, but fortunately it is enough to be able to monitor it. You *do* have a multimeter, right? Set it on the AC voltage range and carefully measure (and note) the voltage at the outlet you will plug the transformer into.

### Safety first!

Unlike most of the electricity that you will be working with when building kits, AC mains current is DANGEROUS. Make sure you are holding the test leads well back from the metal tips!

The "normal" AC supply voltage is capable of changing fairly dramatically depending on the total electrical load in your house and the quality of the supply from the power company, so it is a good idea to watch the meter for a minute or two and make sure that it is reasonably stable. If it isn't, check for electrical equipment being turned on and off in your house, and if necessary put the whole thing aside until late at night when a stable supply is virtually guaranteed.

Now connect the VM-110 (plug in the transformer) and adjust R16 so that the appropriate LEDs are lit, in the order mentioned in the first paragraph of this article and Table 3. For example, if you measured 120 volts, adjust R16 until LEDs one through three are lit. Continue until LED 4 is lit and then tweak it just the tiniest fraction farther (but not enough to light LED 5). That's it—we're done!

Next time we'll look at putting the finished VM-110 into an enclosure. We'll be using a plastic box, Radio Shack's 270-2712, or any other little box you might happen to have lying around. But now it's time to pat yourself on the back, grab a vessel of your favorite beverage, kick back and admire the pretty lights.

The Rainbow Kit VM-110, \$10.95 (+\$5 s/h) is available from Milestone Technologies Inc., 3140 Peoria St., Unit K-156, Aurora CO 80014, or call (800) 238-8205 for credit card orders. It is also available from Electronic Rainbow Inc., 6227 Coffman Road, Indianapolis IN 46268, or call (317) 291-7262.

**208-852-0830**  
<http://www.rossdist.com>

**SPECIAL!**  
\$370<sup>00</sup>

**KENWOOD**  
**TH-G71A**  
Dual-Band Handheld

**RDC** Check Out Our Specials! We're On The Web.  
Over 9050 HAM Items in Stock. All Prices Cash FOB Preston  
ROSS DISTRIBUTING, 78 S. State Street, Preston, ID 83263  
Hours Tue.-Fri. 9-6 • 9-2 Mondays. Closed Saturday & Sunday

CIRCLE 254 ON READER SERVICE CARD



**NEVER SAY DIE**  
Continued from page 5

and was able to feel his feelings and even "remember" his name—after he was dead. His cells either had great memories, or they were connected in some way to wherever his memories were stored.

With some research we might be able to take a few cells from a murdered person and find out from them who did the dirty deed. That sure will call for some big changes in law enforcement and trial law.

If we find that we can pass data via biocommunications systems we may some day have tiny communications systems which fit in a wristwatch. It just takes a couple of cells in a medium to keep them alive and a suitable detector/modulator. We might have to soak our wrist communicators in a nutrient solution every night.

Yes, this is far out, but not one bit of it calls for a technology that hasn't been demonstrated to have the potential.

Heck, I've been editorializing for over 30 years now about the potential market for snap-on roller skates so we could zip around cities faster and easier. But you've ignored me. Now I see that Rossignol, the ski company, has announced just such a product, which they're calling "Traffic." They're walking shoes that in-line roller skates snap into for instant skating.

And I even ran an article on how to build a legal radar jamming unit which not one reader picked up on. Not one! Now, 10 years later, it's a multi-million dollar market.

But then I've been preaching health for years and when I look around at hamfests and club meetings I see great big fat constipated guts and guys smoking. Talk about stupid!

So who's going to do the R&D so we can have a better, cheaper, faster communications system? Biocommunications?

The next step with that is researching communications through time, with the dead, and maybe with our ET visitors. Too far out for you? That just means that you haven't been doing your homework. After all, people who experience near-death come back and tell us about meeting dead friends and relatives, all with their memories intact. And we get the same reports via contacts through psychics with the departed.

**QRM Reduction**

A letter from Bob Chamberlain KE6KGO, the editor of the Inland Empire ARC newsletter in Fontana, California, likes the idea of hams demonstrating their code

Continued on page 40

**WANT TO LEARN CODE?**

**Morse Tutor Gold from G.G.T.E. is the answer for beginners and experts alike.**  
\*Get the software the ARRL sells and uses to create practice and test tapes; and Morse Tutor Gold is approved for VE exams at all levels.

\*Since 1987, GGTE has guided nearly 20,000 hams and prospective hams around the world through proven structured lessons and a variety of character, word and conversation drills. Straight forward menus make the process simple and fun.

\*This program features easy and speedy self installation, random character drills with the characters you select, and you can create your own drills or import text files. You can type what you hear or copy by hand and see the results one line at a time. Pick the Farnsworth or the standard method; select the tone frequency most comfortable for you or select your code speed in tenths of a word per minute. For all DOS computers. You are always in command.

**Certified by**  **Morse Tutor Gold** uses your internal speaker or sound board. And, if you use a sound board **Morse Tutor Gold** supports volume control. Sound Blaster and the Sound Blaster Compatibility Logo are trademarks of Creative Technology Ltd.

Available thru dealers, the ARRL, or send \$29.95 + \$4 S&H (CA residents add \$2.32 tax) to: GGTE, P.O. Box 3405, Dept. MS, Newport Beach, CA 92659 Specify 5 1/4 or 3 1/2 inch disk.

CIRCLE 193 ON READER SERVICE CARD

**Pico-J** rolls up and hides in his 4-ounce pocket-sized holder, waiting like the Genie in a bottle till you need full-quieting signal pouch. Call him forth and his glistening black weather sealed lines reveal a sleek end-fed halfwave antenna ready to hang anywhere. Suspend in the apartment closet or patio doorway. Attach Pico-J to window glass or curtain rod. He needs no radials for broadband low-angle omni halfwave gain. Carry Pico-J with you for emergencies. Hang in the motel when on the road. He improves range, boosts reception, saves batteries. Pico-J comes ready for work with 72" isolated coaxial feedline and gold pin BNC. Typical edge-to-edge SWR under 1.2:1. Hand-crafted in the U.S.A.

**Models**  
2 Meters 440MH  
Dual Band add \$6

**Antennas West**  
Order Hotline  
801-373-8425

Info S1  
Box 50062-D  
Provo, UT 84605

**19.95**

CIRCLE 89 ON READER SERVICE CARD

**KABULU**  **WB8ELK/m**

**VIDEO I.D. BOARD**



- Custom Graphics with your Call Sign
- 4 Screens (2 Hi-res/2 color bar)
- 12 VDC Operation
- Instant Video ID
- Video Relay for switching in Live Camera Video
- Built-in Automatic Sequencer-Timer (steps through all four screens)

**VDG-1 with pre-programmed calls: \$99**

Call or write for catalog of available graphics

**ELKTRONICS**  
12536 T.R. 77 • Findlay, OH 45840  
(419) 422-8206

**ELKTRONICS**  
12536 T.R. 77  
Findlay, OH 45840  
(419) 422-8206

**KABULU**  **WB8ELK**

**KABULU**  **WB8ELK**



**KABULU**  **WB8ELK**

CIRCLE 8 ON READER SERVICE CARD

**Measure Up With Coaxial Dynamics**  
**Model 81000A RF Directional Wattmeter**

Model 81000A is a thoroughly engineered, portable, insertion type wattmeter designed to measure both FWD/RFL C. W. power in Coaxial transmission lines. 81000A is comprised of a built-in line section, direct reading 3-scale meter protected by a shock-proof housing. Quick-match connectors, plus a complete selection of plug-in elements, gives the FRONT RUNNER reliability, durability, flexibility and adaptability with a two year warranty.

Contact us for your nearest authorized Coaxial Dynamics representative or distributor in our world-wide sales network.

**COAXIAL DYNAMICS, INC.**

15210 Industrial Parkway  
Cleveland, Ohio 44135  
216-267-2233  
1-800-COAXIAL  
FAX: 216-267-3142

*Service and Dependability... A Part of Every Product*

E-Mail [coaxial@apk.net](mailto:coaxial@apk.net) <http://www.coaxial.com>

CIRCLE 186 ON READER SERVICE CARD



## New Simplex Autopatch Use it like a cellular phone

Only \$144 !!

An Affordable  
Autopatch  
packed with  
Incredible  
features!!!!



### Requirements

- 1) Telephone line
- 2) 12v Power Supply
- 3) 2 dual band transceivers
- 4) Mic. connector that fits your transceiver

Full/Half Autopatch Only \$109.00

### Automatic CW identifier

(The Autopatch will automatically send call sign in CW when activated / deactivated)

### Programmable time out function

(If you accidentally get out of range, the autopatch will time out and hang up the phone line.)

### User selectable password

(Select personal password up to 9 digits to activate your autopatch)

### Reverse patch

(If you choose so, it will page you when your phone rings)

### Adjustable Volume

### Easy Installation

Compact size 1"x3-3/8"x5/8"

## Pocket Morse Code Trainer

Learn code faster and easier

Better than code tapes

Take it anywhere to practice

Light weight and compact

Ideal for beginners to advance

- \*Selectable code rates 3-33 wpm
- \*User friendly menu

\*Plays Standard and Farnsworth

\*Plays continuous fresh random code

\* Size 2 3/8x4.5X1

\*Selectable random character playing

\*Runs 30 hours on a 9 volt battery

\*Continuous newly \*One year warranty generated QSO (like the general exam)



### Ultimate Plus Only \$69.99

With LCD Display (Allow

### Deluxe Plus Only \$44.99

Is like the Ultimate except has no LCD

### Standard Plus Only \$29.99

Is like the Deluxe except has no internal speaker or random codes

### Six Modes of Operation

- 1) Continuous Fresh Random Code
- 2) Test for Copying Random Code
- 3) Plays Continuous New QSO or Basically a Conversation Between Two People
- 4) Selectable Random Code
- 5) Interactive Code Training
- 6) Playing Random Words

## DTMF CONTROLLER AND DECODER

Get 2 Features For The Price of 1 !

### DTMF Decoder

- \* Decodes and Stores 80 digits
- \* High speed Decoder (Up to 25 tone/sec)
- \* Runs on a 9V battery or 7.2 to 15V
- \* Digital display



### DTMF Controller \$79.99

- \* Manual override reset
- \* Wrong Number Reset
- \* 5 output (4 of which are transistor output and 1 is mechanical relay)

Computer Aided Technology, Inc.  
4525 Production Drive, Dallas, Texas 75235  
Phone: 214-350-0888

Visa/MC Accepted, Plus S/H, Tax if Applicable

## NEVER SAY DIE

Continued from page 39

skills once a year. "After all," he says, "you have to renew your driver's license every once in a while and have to take a proficiency test for that."

Maybe in California, but I've never had to take a test for my driver's license. When I got my first license they asked the guy who drove me there if I could drive. He said yes and that was that. I've never been retested, and that was over 50 years ago.

Now, regarding code and the ham license. Many years ago I jokingly suggested that all hams be required to be retested when their license was renewed. I'm still getting hate mail for that one. Well, I remember what happened when the League petitioned the FCC to require Generals to upgrade to Advanced in order to continue on the HF phone bands. As I've mentioned a hundred times, that brought about the greatest catastrophe in the history of the hobby. Fortunately the FCC only took away half of the phone bands.

The best way to get rid of around 90% of the General, Advanced and Extra Class licensees would be to require a code proficiency test for license renewal. "I'm not going to learn that damned code all over again!"

My original reasoning stemmed from the League's statement that the ability to use code is extremely important for emergency purposes. That was when they were doing everything they could to stop the no-code movement. They got hundreds of ARRL clubs to file comments to this effect with the FCC. If that statement was true, I suggested, then the continuing ability to use Morse should be tested.

If you agree that the code is an important skill and should be required for a ham license, then perhaps it's time we petitioned the FCC to make VEs institute such tests for renewals. Further, we don't want any of that 1920s kind of hand key crap, hams should be able to at least demonstrate their proficiency with speed keys. And, again, if the code is critically important, then hams should be constantly improving their skills and should demonstrate their ability to copy the code faster with each renewal.

However, another important aspect of the hobby is a familiarity with building techniques. Perhaps if the first renewal required the assembly from a box of parts of a spark transmitter? That would certainly be in keeping with the code skill requirement. On the second renewal we could build a small tube receiver. On the third a transistor unit. On the fourth an IC rig. And that'll take everyone up to about 65 years of age where, unless their

eating habits have changed substantially from today, most will be dead.

All in favor say "aye."

## Runny Noses

The following piece arrived via E-mail. It's something I've wanted to write about, but Dr. Millikin has saved me the trouble:

I'd like to call your attention to an article in the magazine *Discovery*, for February, 1997. Written by Kevin Krajick, a New York freelance writer, it highlights how little we know about airborne microbes and how they spread. For instance, in one study, the chicken pox virus was found in the air from a hospital patient's room and down the hall on the day after the patient had been discharged. For a layman, Mr. Krajick does a creditable job on hospitals and biological warfare, but there's another very important area that didn't receive much attention.

For example, the current American lifestyle has created a veritable paradise for respiratory pathogens in our public facilities. Now, we all breathe the same air, winter and summer. Our shopping malls, supermarkets, department stores, and discount houses all have central heating in the winter and air conditioning in the summer. The same applies to our theaters, courthouses, and office buildings, as well as to our public transportation, including airplanes, trains, buses, and even taxis.

Of particular note are our day care centers and our schoolhouses, because when a young child encounters a pathogenic microbe, it is usually the child's first exposure to it, meaning that no immunity has yet developed to it. Those "first infection patients" tend to shed the offending microbe into the environment in huge numbers, which facilitates its spread to their siblings, classmates, parents, and the entire community.

And finally come our hospitals, where we concentrate the germiest people in town. In all the above places, a breath of fresh air is now a rarity.

Admittedly, respiratory viruses haven't killed people in wholesale lots since the 1918-19 flu epidemic, but they certainly do take their toll on the very young, the very old, the immunosuppressed, and those with other diseases, such as heart trouble or diabetes. As for the impact of respiratory infections on the remaining "healthy" population, we have only to look at the number of work days lost every winter. Even so, that still doesn't account for the resulting human suffering, and the billions of dollars we spend every year trying to relieve it.

Indoor plumbing, safe water supplies, pasteurization, and food inspection have made a huge dent in orally transmitted



pathogens. Isn't it time we tried to make a similar dent on the respiratory front? Does anyone have any idea how vulnerable we might be if a really virulent emerging microbe became adapted to respiratory transmission? The plague bacillus can do it. Suppose a Hanta or an Ebola virus, or even the AIDS virus somehow became adapted to our nasal or bronchial system. Would we be in trouble?

Is anything being done about the situation? Apparently not much. What have you heard about filtering viruses from the air in a shopping mall? Or about disinfecting the droplets deposited on its floors, counters, doorknobs, telephones, toilet handles, or faucet taps?

Have you ever thought about the shopping carts in your supermarket, especially the ones with seats for infants, with their runny little noses and busy little hands? I checked on that some years ago with a major supermarket chain, and found that they sprayed their carts once a week with a steam hose. Is that adequate? All you have to do after using a cart is to rub your nose or eyes with either hand.

In short, very little seems to be known about the spread of our respiratory pathogens via our public facilities. Are shopping malls and supermarkets potentially hazardous to our health or not? Is it worth a pilot project to find out?

## OK Conspiracy

One of our readers, Roy Lavender, of Long Beach, California, mentioned that he was curious about some of the details of the Oklahoma City bombing, which used 4800 pounds of ammonium nitrate in a rental truck.

Roy points out that when he was a kid he used to blow stumps on his family's farm using ammonium nitrate. He said that he had to stay away from the hole for several minutes until the brownish fumes from some nitrogen compound dissipated. One whiff and he'd have a pounding headache.

He noticed the same precaution when he used cratering charges in the Combat Engineers in World War II. They were told during training that a single lung full of that compound would kill.

There was no mention of headaches or falling over dead after the explosion in Oklahoma City by any of the people in the agencies that were first on the scene.

As I recall, several building demolition experts have claimed that the pattern of destruction could not have been caused solely by a truck exploding outside the building.

On the other hand, what kind of an idiot would ever even suggest that our government might be lying to us?

Oh yes, Roy also brought up the fact that the continuously running seismograph at the U of OK at Norman registered two surface waves made by the explosions, ten seconds apart. If the truck made one wave, what could have made the second?

## Jobs

With the lowering of shipping costs, the movement of capital anywhere in the world in seconds, the lowering cost of communications and the proliferation of computers, jobs are going to tend to move to the areas of the world which have the lowest labor costs. And that sure isn't America. There will be increasing efforts to stem this movement via legislation, but that's as doomed to failure as attempting to stop the tides with sandcastle walls.

One more strike against America in this global business village is our continued lowering of educational standards. Well, we're already dead last of the developed countries in our quality of education, again proving that the socialist approach to doing things, no matter the lofty liberal ideals driving them, are going to fail, just as socialist schemes have failed in every country where they've been tried.

But even knowledge isn't going to make a lot of difference for most "jobs." We are, more and more, automating the routine work and hiring the cheapest labor in the world to do the unautomated work.

No, I don't have a good solution to the problems this presents, at least as far as

*Continued on page 45*

<b>Next Day</b> Baraboo, Wisconsin Sauk County <b>K9ZZ</b> Info \$1 <b>Antennas West</b> (801) 373-8425	<b>Call Today &amp;</b>			
	<b>We Ship</b>	<b>Next Day</b>	<b>2nd Day</b>	<b>ASAP</b>
100	\$29.95	\$24.95	\$19.95	
200	\$39.95	\$34.95	\$29.95	
400	\$49.95	\$44.95	\$39.95	
500	\$54.95	\$49.95	\$44.95	
1000	\$99.95	\$89.95	\$79.95	

All orders p/d 2nd day air/ priority mail.  
For overnight air delivery add \$10.  
Box 50062-S, Provo, UT 84605

CIRCLE 5 ON READER SERVICE CARD

**BROADCAST TRANSMITTER**

The FMS2 studio quality transmitter is FULLY crystal controlled and programmable to any FM broadcast frequency.

**Unit features:** ALC, 2:1 compressor, audio buffer / amplifier, pre-emphasis, roll off filter, stereo generator, digital PLL tuning, 75 MHz-125MHz bandwidth, 500mW power output and a special introductory price of only \$295.00 US.

Schematics for unit \$27 CATALOG 416-243-3225  
FAX ROLL INFO 416-243-1067 TEK LINE 416-243-2260



CIRCLE 245 ON READER SERVICE CARD

**Complete Relay System - Handle Talkie ready**

icom, Motorola, Yaesu ready



**Simplex Repeater System**  
DVR 501A

Burghardt's Amateur center 1-800-927-4261  
Burghardt Amateur Sales 182 North Maple Watertown S.D.  
Zip 57201-0073 Fax 1-605-886-3444

You Can Turn Your HT into a Simplex Repeater! 1000 uses! Well, at least hundreds. Digipeatering, automatic announcements, great emergency repeater, fox hunting, etc., and it's only \$189. Give yourself one for Xmas. It's Santa Approved. Now in stock at Burghardt Amateur Sales: 1-800-927-4261. Call us, plug it in, start having fun. See June '93 73 p.48.

CIRCLE 224 ON READER SERVICE CARD

**Silent Solar Power**



The \$299.95 Bullet-Tested QRV Solar Power Supply keeps your repeater on the air 'round the clock or powers your 100w HF station 60 hrs a month. Control circuit speeds charge, protects get cells & sealed batteries. Fully assembled, QRV, portable. Easily expanded.

Add \$10 S&H Info \$1  
**Antennas West**  
(801)373-8425 Box 50062 Provo UT 84605

CIRCLE 336 ON READER SERVICE CARD

<p><b>THE ORIGINAL WD4BUM HAM STICK™ ANTENNAS</b> for HF MOBILE OPERATION <b>\$19.95 each</b></p> <p>The only lightweight HF mobile antenna recommended by noted author Gordon West, WB6NOA</p> <ul style="list-style-type: none"> <li>• Monobanders for 75 to 6 meters.</li> <li>• Very rugged fiberglass &amp; stainless steel.</li> <li>• Telescopes for easy adjustment.</li> <li>• 3/8 x 24 TPI base fits most mounts.</li> <li>• Low profile &amp; low wind load.</li> <li>• Needs no springs or guys.</li> <li>• Complete tuning &amp; matching instructions included.</li> <li>• Approximately 7 ft. tall.</li> <li>• 600 watts.</li> </ul> <table border="1"> <tr> <td>Cat. #</td> <td>Band</td> <td>Cat. #</td> <td>Band</td> </tr> <tr> <td>9175</td> <td>75 meters</td> <td>9115</td> <td>15 meters</td> </tr> <tr> <td>9140</td> <td>40 meters</td> <td>9112</td> <td>12 meters</td> </tr> <tr> <td>9130</td> <td>30 meters</td> <td>9110</td> <td>10 meters</td> </tr> <tr> <td>9120</td> <td>20 meters</td> <td>9106</td> <td>6 meters</td> </tr> <tr> <td>9117</td> <td>17 meters</td> <td></td> <td></td> </tr> </table>	Cat. #	Band	Cat. #	Band	9175	75 meters	9115	15 meters	9140	40 meters	9112	12 meters	9130	30 meters	9110	10 meters	9120	20 meters	9106	6 meters	9117	17 meters			<p><b>NEW ENHANCED DISCONE SCANNER ANTENNA</b> <b>Only \$36.95</b></p>  <ul style="list-style-type: none"> <li>• 800 To 900 MHz enhancement.</li> <li>• Transmit on 146, 220, and 440 amateur bands.</li> <li>• Rated to 150 Watts.</li> <li>• Compact, will fit in 36" x 36" space.</li> <li>• Receives all AM-FM &amp; SSB frequencies.</li> <li>• Gain improves with frequency increase.</li> <li>• Mounts to any vertical mast 1" to 1 1/2"</li> <li>• Aluminum mount &amp; elements.</li> <li>• 8 cone &amp; 8 disk elements—same as other discones selling for nearly 3 times our price.</li> <li>• Accepts standard PL-259 connector.</li> <li>• For type "N" connector add \$5.00.</li> </ul>	<p><b>MOBILE COLINEAR ANTENNAS</b> THE ULTIMATE PERFORMER</p> <ul style="list-style-type: none"> <li>• Honest 4.5dB gain.</li> <li>• 1000 watts DC.</li> <li>• 17-7 ph stainless steel top sec.</li> <li>• Rugged fiberglass base station.</li> <li>• Base fitting is std. 3/8 x 24 TPI.</li> </ul> <p>Length 9007 - 146 MHz 7'2" • 9038 - 220 MHz 4'9" 9440 - 440 MHz 2'5"</p> <p><b>\$19.95</b></p> <p>Base station version available <b>\$29.95</b> 9007-B • 9038-B • 9440-B</p>
Cat. #	Band	Cat. #	Band																							
9175	75 meters	9115	15 meters																							
9140	40 meters	9112	12 meters																							
9130	30 meters	9110	10 meters																							
9120	20 meters	9106	6 meters																							
9117	17 meters																									
<p><b>Tri-Magnetic Mount MODEL 375</b> <b>Only \$39.95</b></p>  <p>Now with no-rust all stainless steel hardware</p> <ul style="list-style-type: none"> <li>• Holds all Hamstick Antennas and many others.</li> <li>• Over 400# of holding power.</li> <li>• 12" X 14" foot print.</li> <li>• 3/8 x 24 thread mounting.</li> <li>• 15' RG 58 coax w/PL-259.</li> <li>• No rust aluminum construction.</li> </ul>																										
<p><b>Lakeview Company, Inc.</b> 3620-9A Whitehall Rd., Anderson, SC 29626 • 864-226-6990 FAX: 864-225-4565 • E-Mail: hamstick@hamstick.com • www.hamstick.com</p> <p>ALL 100% MADE IN USA Add \$7 per order S/H</p>																										

CIRCLE 275 ON READER SERVICE CARD



# Hamtronics' TD-5 Subaudible Tone Encoder/Decoder Kit

*Guaranteed success.*

Larry Antonuk WB9RRT  
P.O. Box 452  
Marlborough NH 03455

Our local repeater had been converted to CTCSS (PL) operation several years ago, and most of the members of the club had long since switched over to synthesized programmable rigs. Still, every once in a while someone would show up with an old crystal rig or some commercial radio that needed an add-on CTCSS encoder. We had explored lots of options, and found that the boards from Hamtronics provided a good mix of high quality and reasonable cost. These were available in kit form as well, so we could save a few bucks by doing the soldering ourselves. We had used several different versions over the last few years, and were very pleased with the results.

It was no surprise, then, when the latest club member walked into a meeting with a newly-acquired rock-bound rig and a small package from Hamtronics. The surprise came when he opened up the package. It seemed that the current Hamtronics CTCSS encoder had been upgraded to the new TD-5 configuration. Suddenly things weren't quite as straightforward as they'd been with some of the previous kits.

The first thing that tipped us off was the fact that it seemed like half the parts were gone. We checked the kit against the parts list and of course everything was there—it just seemed like 22 parts weren't quite enough to get something like this to work. The reason for this apparent shortage was the fact that the TD-5 is based on a special-design IC, which is a complete tone generator/decoder system on a surface-mount chip. This chip digitally synthesizes the tones, so they are selected by flipping binary switches—no more 10-turn pots to adjust.

Once we had all the parts laid out, another small problem became obvious—our previous projects had all been “through-hole” PC boards. This was our first brush with surface-mount devices (SMDs). At first this seemed like a roadblock, but after a quick announcement it turned out that quite a few of the club members were used to working with SMDs.

There were basically two camps on this topic. The first camp believed that you needed special soldering equipment to mount SMD ICs. One guy had access to a station at work that used a

stream of hot air to melt the solder on the PC board where it contacted the IC—on all 24 pins at once. The second camp had done some home-brew SMD work before, and claimed that all you needed was a very sharp soldering pencil, a bright light, and a good eye. This argument progressed back and forth for quite a while, and in the end the sharp-soldering-pencil group won. A couple of the guys wound up taking the board and parts home that night, and did the touchy soldering work.

When we examined the completed board at our Saturday morning breakfast it looked great—just like a commercially manufactured soldering job. The technique they used was the same as that described right in the Hamtronics instruction sheet—positioning the chip, tacking down opposite corners, then carefully soldering each pin. Not only did these guys do a good job, they maintain that this is the *only* way to do this process.

Once you decide that you need special equipment to do a job like this—equipment out of reach of most hams—you cut yourself off from a great many current kit choices, and probably



a majority of those being developed in the future. By tackling SMD jobs yourself, you gain experience a little at a time, and soon you have the confidence to tackle any SMD job you might come across.

In any event, you definitely need to observe static preventative procedures when you work with this type of IC. This includes a grounded soldering iron and a wrist strap connected to an appropriate ground. (As we passed the board around the breakfast table on Saturday morning we kept it in the pink static-dissipating bag provided by Hamtronics—just in case.)

Our next task was, of course, to mount the board in the radio, so a few of us went right to work after breakfast. The TD-5 can be configured as an encoder, a decoder, or both. It won't do both at once, however; if you have a need for simultaneous encode and decode—like if you're building a repeater that uses PL on the output as well as the input—you will need two TD-5s.

We were going to use the board just in the encoder mode, but we had a small problem. Our ham with the rockbound rig was a commuter, and he had the radio set up on two different repeater frequencies. Of course, one was across the state line, and used a different PL tone.

The TD-5 can encode any of the 47 PL tones from 67.0 to 254.1 Hz. The proper tone is selected via a six-position dip switch on the board. But how do you change tones in normal operation? We couldn't re-mount the dip switch on the front of the radio. Even if we could, it wouldn't be too safe to try to switch in those different combinations on the interstate. We were kicking several possible solutions back and forth, and then one of us came up with the answer: Read the manual.

OK, so we didn't actually have to read the manual, we just had to look at the pictures. Hamtronics includes a diagram (and a thorough explanation, of course) of how to accomplish just what we were trying to do. The answer is fairly simple. The dip switch works by pulling down lines on the encoder/decoder IC. Any of the switch positions that are ON pull the corresponding lines to ground. All six of these lines

are read by the IC, and it produces a tone depending on the code that corresponds to the current combination of grounded lines. It's a fairly simple matter to just leave all the switch positions open, and run wires from the dip switch to a two-position toggle switch.

For instance, suppose you needed the tones 167.9 and 123.0. These two tones need switch combinations of 101010 and 010101, respectively. (Grounded lines = 0.) Just connect the wires from positions 2, 4, and 6 to one side of an SPDT switch. Connect positions 1, 3, and 5 to the other side of the switch, and connect the common side to ground. Now when you flip the toggle switch you will select either 167.9 or 123.0 Hz. It should be obvious that this will work fine, as long as the two tones you need don't share any common switch positions. If they do, you will note that the two sets of 0s basically combine, since all the pins are effectively shorted together. Luckily there's a fix for this problem—blocking diodes. By connecting each pin on the board to the toggle switch via a diode (1N914 or 1N4148) you create a situation where the pins are isolated from each other by a back-to-back diode combination. This is known as a diode matrix, and can be extended out for any number of tone choices. You just need a multi-position switch, and plenty of diodes. The manual gives detailed instructions on how to set up a diode matrix for the tone frequencies you need.

Once the tone switching was figured out our next step was to find a spot to inject the tone. This is sometimes a challenge, especially in older rigs. The key is to find a location downstream from the voice processing circuits (that could filter out the tone you are trying to inject) but far enough upstream so that the tone board has enough output voltage to properly modulate the transmitter *and* doesn't load down the voice audio. In our case the solution was easy. The rig we were working with had originally had an option for a PL board, so we tried an empty pin labeled CTCSS INPUT. (Hey, it was a long shot, but it worked.)

*Continued on page 44*

## CODEMASTER V

0-20WPM in 90 Days  
*Guaranteed!*

Codemaster V is the *only* computer-based Morse code training system that *guarantees* RESULTS! Whether you're a beginner or want to break the 30wpm barrier, it will take you as far as you want to go, and it's fun!

*Only*  
 **\$29.95**

Codemaster V has a wide variety of training and practice routines, trial exams, interactive arcade game, and *much more*. CM5 can use multiple Morse alphabets including foreign characters, and it's endorsed for military training! For any IBM compatible PC. S/H \$5.00 (in US). Credit card orders toll free!

Milestone Technologies, Inc.  
3140 S Peoria Unit K-156 Aurora, CO 80014  
(303)752-3382 sales@mtechnologies.com  
www.mtechnologies.com/mthome

**800-238-8205**

CIRCLE 136 on READER SERVICE CARD

**FREE!**

## NEW CATALOG

CALL TOLL FREE: 1-800-JAN-XTAL

Quality Crystals  
and Oscillators for:

AMATEUR BANDS • CB • MARINE VHF  
SCANNERS • MICROPROCESSORS • PAGERS

P.O. Box 60017 • Fort Myers, Florida 33906

VISA (941) 936-2397 MasterCard

**JAN** Crystals

CIRCLE 242 ON READER SERVICE CARD

## BIOLOGICAL HAMMING®

Bio-Hams® – study the chemistry of human aging.

Is electro-magnetically softened water of any health benefit compared to tap water? Or, is calcite in solution more apt than aragonite to form stones or hardened arteries?

Smokers – is it how you light up (butane, matches, etc.) that affects your health? Join this long-term study.

Create new experiments.

Contact Edward Vandegrift at  
1 (800) THEORY 5 or  
11759 San Vicente Blvd.  
Los Angeles, CA 90049

CIRCLE 355 ON READER SERVICE CARD



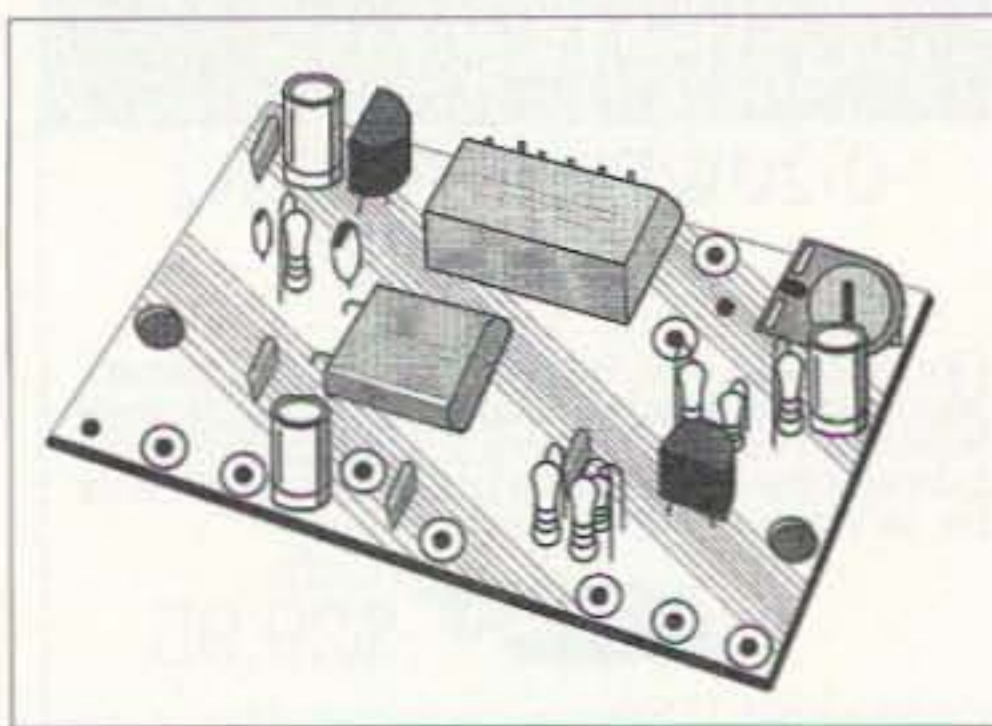

Photo A. Hamtronics' TD-5.

We used the onboard potentiometer to adjust the tone level, using our tried-and-true empirical split-the-difference approach. First, we found the spot where the tone level was just barely too low to key up the repeater, and marked this point on the potentiometer. Then, we

turned up the tone level until it got to the point where you could hear the PL tone as an annoying buzz in the speaker, and marked this point. We then set the pot to a point midway between the two marks. (OK, this isn't highly scientific, but it works well until we have time to swing by and visit our buddy with the radio shop. At that point we normally set our deviation to 300 Hz.)

That completed our simple tone encoder application, but there were a couple other items of interest that may be worth mentioning. Both of these have to do with tone filtering, and the concepts of "talk-on" and "talk-off."

Some deep voices (usually males) have audio components that are in the subaudible CTCSS tone range. Talk-on occurs when voice components appear at the repeater input that are the same frequency as the desired CTCSS tone. This can cause the repeater to key up intermittently and then drop out, if the repeater hears a transmission that does not have the correct PL tone, but does have some voice components in the PL tone range.

Talk-off, on the other hand, occurs when the correct tone is being transmitted, but the voice components happen to be of the same frequency but exactly out of phase with the PL tone. This cancels out the PL tone, causing the repeater to drop out for a second or two in the middle of each sentence. In either case the solution is to filter the voice audio before it is transmitted, removing all the tones that fall below 300 Hz. Then the only frequencies in the CTCSS range that can modulate the exciter will be coming from the tone encoder itself—not from any part of the voice audio. The TD-5 contains a built-in high-pass filter that makes it simple to filter these tones out of your microphone audio. Just loop the audio through two pins on the board, and your audio is automatically filtered. Likewise, the TD-5 contains a similar filter for the RX audio. This allows you to pass your RX audio through the chip to remove any remnants of PL tone on the received signal, removing that low-level buzz. This same filter can also be used to mute the RX audio,

if you choose to break the audio path rather than use the transistor output to switch off the receiver. (Muting the RX audio is more likely to be used in commercial rather than amateur applications, but this might come in handy in some special ham applications.)

A final point concerns the PC board itself. We had been used to seeing some pretty high-class boards from Hamtronics over the years, and the TD-5 was no exception. One point that did catch the eye of one of the club members was the use of "thermal" connections for the ground hookups. Since these connections hook directly to the large ground plane they are often very difficult to solder—the ground plane draws the heat from your soldering iron away as fast as you can pour it on. You often wind up heating up everything on the board except what you're trying to solder.

Thermal connections have a central ring that is separate from the ground plane, but connected with four thin traces. These traces make good electrical connections but don't transfer heat very well. They solder right up with no problems. Some of the club members argued that this was just good engineering practice, and that they would expect no less. Others thought that this was another sign that Hamtronics really understood their customers. Being hams themselves, they realized that not everyone has industrial-quality soldering tools, and this was a way to make it easier for the average hobbyist. Whatever the reason, it's just another point to add to the long list of things that make Hamtronics kits easy to build.

Whether it's the quality parts and boards, the explicit instructions, the troubleshooting tips, the modification suggestions, or the "thermal" connections, it all adds up to a product that almost guarantees kit-building success. Our group has found this to be the case over the years, and the new TD-5 CTCSS encoder/decoder is no exception.

Information on the TD-5 CTCSS encoder/decoder is available from Hamtronics, Inc., 65 Moul Road, Hilton NY 14468-9535. Telephone (716) 392-9430, FAX (716) 392-9420. 73

## Radio Bookshop

Phone 800-274-7373 or 603-924-0058, FAX 603-924-8613, or see order form on page 88 for ordering information.

### Tapes for Beginners

**73T05 Genesis 5 wpm code tape** This beginning tape takes you through the 26 letters, 10 numbers and necessary punctuation complete with practice every step of the way. \$7.00

**73T06 The Stickler 6 wpm code tape** This is the practice tape for those who survived the 5 wpm tape and it is also the tape for the Novice and Technician licenses. It is comprised of one solid hour of code. Characters are sent at 13 wpm and spaced at 5 wpm \$7.00

**73T13 Back Breaker 13 wpm code tape** Code groups again at a brisk 13+ wpm so you'll be really at ease when you sit down in front of a steely-eyed volunteer examiner who starts sending you plain language code at only 13 per. \$7.00

**73T20 Courageous 20+ wpm code tape** Go for the Extra class license. \$5.95

**73T25 Mind Boggler 25+ wpm code tape.** \$7.00

## WANTED

Fun, easy to build projects for publication in 73.

For more info, write to:

Joyce Sawtelle,  
73 Amateur Radio Today,  
70 Route 202 North,  
Peterborough NH 03458.



**NEVER SAY DIE**  
Continued from page 41

working for a large corporation is concerned. They're going to continue to need fewer unskilled workers, automate the skilled jobs as much as possible, and downsize their administrative staffs via computers and better communications. Even sales staffs will be cut as more of the sales effort can be moved to the Web and direct sales gradually edge out retailers and distributors—as we're seeing in the computer distribution business.

As a known Mac addict I get a steady stream of catalogs from MacMall, MacWarehouse, MacConnection, MacZone, Express Direct, CDW, and Power Computing. Who needs a computer store where I'd have to help pay for their location, the sales staff, extra shipping, support staff of bookkeepers, maintenance, shipping people, and so on?

So what's the answer for the average wage slaves? Are they going to have to make do with ever-lowering incomes?

Of course my proposal is to aim toward starting your own business. Keep in mind the truism that you're never going to make much money or have much real security working for someone else. Well, except maybe for the government, where job performance and skills are often irrelevant. But we already have more people working for the government than we have in manufacturing, so that isn't an infinite source of limited, but easy, money.

Neither is opening a mom-and-pop retail store, and then wondering what happened when a Wal-Mart™ moves into the neighborhood. No, the bridge to beating the game lies in owning your own business, selling a product in a fairly narrow niche. Look for a business where you can generate just a few million dollars in sales a year. If you get much larger the megacorporations will come to see you. I've been there and done that. When my magazine publishing revenues grew by 50% per year for seven years I got up to \$17 million in sales and the big boys gave me a choice of selling out or being crushed. I sold out. Some of my publishing competitors said go to hell, and they did. They were all soon out of business and have disappeared.

Most of the manufacturing companies are going to need management and marketing staffs in America, so we can hold on to as many of those jobs as possible by providing a skilled and well-educated work force. But that means totally changing our whole educational system, from the way we birth babies in hospitals to preschool, K-8, high school, and college. The whole system is a dreadful mess and

Continued on page 47

**BIOELECTRIFIER™**

EXPERIMENTAL MICRO-CURRENT SUPPLY

Now FULLY ASSEMBLED with batteries and FINE SILVER (not stainless steel) electrodes

\$89.50 +\$2.50 S&H

Beware of IMITATIONS!

ALSO...

COLLOIDAL SILVER GENERATORS

ZAPPERS, SILVER ELECTRODES, SEMI-KITS, etc.

send SASE for information

On the WEB: [www.infocom.com/~thomil/](http://www.infocom.com/~thomil/)

To order, send CHECK or MONEY ORDER to:

THOMAS MILLER, WA8YKN

314 South 9th Street

Richmond, IN 47374

Voice/FAX (765) 962-3509 [thomil@infocom.com](mailto:thomil@infocom.com)

See the FUN you've been missing!



Slow Scan TV

Every day more and more hams are enhancing their enjoyment of ham radio by adding images to their conversations. Join the fun!

new Pasokon TV Lite ..... \$30 + \$3 shipping.  
Pasokon TV Classic ..... \$200 + \$5 shipping.

Absolute Value Systems  
115 Stedman St. #7  
Chelmsford, MA 01824-1823  
(508) 250 0611

<http://www.ultranet.com/~sstv>

CIRCLE 351 ON READER SERVICE CARD

**Barry Electronics Corp.**  
WORLD WIDE AMATEUR RADIO SINCE 1950  
Your one source for all Radio Equipment!

For the best buys in town call:  
**1-800-990-2929**  
Los Precios Mas Bajos en Nueva York  
WE SHIP WORLDWIDE!  
Export orders expedited.  
Special export prices.



WHEREVER I GO, I TAKE MY RADIO.  
SPECIALIST IN RADIOS:  
• BUSINESS • MARINE  
• AVIATION • HAM RADIOS  
• SCANNERS

KITTY SAYS: WE ARE OPEN 7 DAYS A WEEK  
\*Sat. 10-5 \*Sun. 12:30-6 \*M-F 9-6 Come to Barry's for the best buys in town.

**MOTOROLA** MI20, GM300, GR300 repeaters, & SM50

Radios for Business, Governments, Consulates, Embassies. Stocked and Serviced. Overseas and Domestic Orders.

"YAESU HAM & VERTEX BUSINESS RADIOS" FT51-R, FT-8500, FT-10, FT-11, FT-2500, FT-3000, FRG-100B, FT-1000D, FT-50R, FT-5200, FT-840, FT-900AT, FT-920, VXR-5000 repeater 25 watts, VHF or UHF. Marine Mobile VX-M-100.

**ICOM**  
HAM, MARINE, BUSINESS AND AVIATION RADIOS  
281-H, 2000-H, 2350-H, A-22, IC-77, IC-706, IC-707, IC-T2A & IC-756.  
NEW F30L/VF40LT, V100

**KENWOOD**



Shortwave Receivers R-10, R-100, R-7000, R-8500, R-9000

NEW — 220 MHz BUSINESS RADIOS WITH REPEATERS

Business Radios: Motorola, ICOM, Maxon, Yaesu, FTH 2008/700B, etc. Uniden, Regency, Reim Marine ICOM: M19A, mil, etc. Aviation ICOM: A22, A200

"TS-505," TS-570D, TS-890S, AA41A, TM-V7A, TM-942A, TR-751A, Th-235A, Kenwood Service Repair, TS140S, TS990S, TS-790A, TS950SD, TH-79A(D), TH-2548A, TM-741A, TM-733A, TM-641A, TM-742A.

MARINE RADIOS ICOM M7, M11, M56, M710, M810, AVIATION PORTABLE ICOM A22, MOTOROLA, TRITON, MARINE

Cellular Phones  
Shortwave Radios  
Scanners  
Best Prices

**MOTOROLA RADIOS EXPORT & DOMESTIC CALL FOR PRICES**



Electron Tubes 3-500z, 572B, 6JS6C, 12BY7A, & 6146B

FT-50R Yaesu

Save money on batteries. Call for Special Prices.

Surveillance Devices Available

SHORTWAVE RECEIVERS STOCKED

Shortwave Receivers Drake • Grundig • JRC • Sony Sangean • Panasonic • Yaesu ICOM • Lowe • Kenwood

Computer Interfaces Stocked: MFJ-1270B, MFJ-1274, MFJ-1224, Kam Plus, KPC-3, MFJ 1278T, PK-900, DRSI PRODUCTS DSP 2232

Antenna Tuners: MFJ, ICOM, KENWOOD, YAESU, VERTEX

COMMERCIAL & HAM REPEATERS STOCKED. WRITE FOR QUOTES



2 Meter, 440, 220MHz Band-Pass Filters from DCI

CB Radios Stocked 148GTL, Washington, Ranger 2950-70, Antennas: Wilson, Antron, etc. Power mikes w/beeps - ECHO - SilverEagle etc.

Bird Wattmeters & Elements in Stock

MOTOROLA AUTHORIZED DEALER KACHINA COMMUNICATIONS DEALER AUTHORIZED DEALER **SONY** Shortwave Radios Stocked

Amplifiers- Icom, Kenwood, Yaesu, RF concepts, Mirage, TE Systems, HF/VHF/UHF, AMERITRON, etc.

Telephone Scramblers

Hy-Gain Towers

Overseas Telephone Systems for Rural Areas

Telephone Autopatch

ANTENNAS: A-S, AES, Cushcraft, Hy-Gain, Hustler, KLM, METZ, Urban, MODUBLOX, TONNA, Butternut, Multi-Band, Alpha Delta, ANLI, Antenna Specialist, Barker & Williamson, Comet, Diamond, GAP, Larsen, Etc. Watt-Meters Stocked.



BENCHER PADDLES BALUNS. LOW PASS FILTERS IN STOCK

Fm & AM Broadcast Transmitters Stocked

Garmin & Magellan Global Positioning Systems

ASTRON POWER SUPPLIES Belden Wire & Cable, Int'l Wire

NEXTEL Radios-5 burrough coverage in NY.

BARRY ELECTRONICS CORP., 540 BROADWAY, NY, NY 10012 (Five blocks N. of Canal St., between Spring & Prince St.) FAX 212-925-7001 Phone 212-925-7000

New York City's LARGEST STOCKING TWO WAY RADIO DEALER COMPLETE REPAIR LAB ON PREMISES

"Aqui Se Habla Espanol"  
BARRY INTERNATIONAL  
FAX 212-925-7001 Phone 212-925-7000  
For Orders Call 1-800-990-2929

Monday-Friday 9 AM to 6 PM  
Saturday 10-6 PM / Sunday 12:30-6  
Subways: #6 Spring St. stop, N. or R. train to Prince St. stop  
F train to Houston St. stop.  
Bus: Broadway bus to Prince St. stop, Path train to 9th St./6th Ave.

COMMERCIAL RADIOS STOCKED:  
•MOTOROLA •ICOM  
•MAXON •STANDARD  
•YAESU •RELM etc.  
We serve municipalities, businesses, Civil Defense, etc. Portables, mobiles, bases, repeaters...

e-mail: [barry\\_electronics@compuserve.com](mailto:barry_electronics@compuserve.com)  
We stock: Ailco, Ameco, Amertron, Antenna Specialist, ARRL, Astatic, Astron, Belden, Bencher, Bird, Butternut, CES, Cushcraft, Codan, Daiwa, Eimac, Henry Heil, Hustler, Hy-Gain, Icom, KLM, Nextel, Kantronics, Kenwood, Larsen, Maxon, MFJ, Mirage, Motorola, Nye, Palomar, RF Products, Shure, Standard, TUBES & Tube Cartons, Uniden, Yaesu, Vibroplex, Duplexers, Repeater, Scanners, Radio

WE NOW STOCK COMMERCIAL COMMUNICATIONS SYSTEMS DEALER INQUIRIES INVITED PHONE IN ORDER & BE REIMBURSED COMMERCIAL RADIOS STOCKED & SERVICE ON PREMISES. EXPORT orders shipped immediately. CALL

SALES FINAL Technical help offered upon purchase FAX: 212-925-7001

CIRCLE 41 ON READER SERVICE CARD



# SPECIAL EVENTS

Listings are free of charge as space permits.

Please send us your Special Event two months in advance of the issue you want it to appear in. For example, if you want it to appear in the March issue, we should receive it by December 30.

Provide a clear, concise summary of the essential details about your Special Event.

## NOV 29

**EVANSVILLE, IN** The 5th annual EARS Evansville Winter Hamfest will be held at the Vanderburgh County Fairgrounds, 8 a.m.–2 p.m. Central Time. Free parking, indoor flea market, commercial dealers. For table reservations or info, call Neil WB9VPG at (812) 479-5741; or write EARS, 1506 S. Parker Dr., Evansville IN 47714. E-mail [EARSHAM@aol.com] or visit the Web site at [http://members.aol.com/earsham/]. Setup begins at 6 a.m. Central Time on Sat. Wall spaces (2' x 8' table), \$10 each; flea market tables (2' x 8'), \$7 each. Admission, \$5. Talk-in on EARS wide area repeater network 145.150 Evansville/146.925 Vincennes. Alternate EARS repeater 145.110(-). Use 107.2 CTCSS on all frequencies listed. Be sure to visit your friends from "The Ham Station," a major vendor and contributor for the Evansville Winter Hamfest.

## DEC 6

**JACKSONVILLE, IL** The Central Illinois Winter Superfest, sponsored by the Illinois Valley ARC and Jacksonville ARS, will be held 8 a.m.–2 p.m. at Turner Junior High School, 664 S. Lincoln Ave. (one block north of Wal-Mart). Features include VE exams at 10 a.m. [pre-reg. required; contact Tim Childers KB9FBI, 773 E. College, Jacksonville IL 62650. Tel. (217) 245-2061]. Indoor flea market, radio and computer vendors, crafts, free parking, and refreshments. Admission: \$3 each, 2 for \$5; children under 16 free. Tables, with vendor pass, \$10 each. Vendor setup starts at 6 a.m. For further information, contact Jacksonville ARS, c/o Kaye Green KB9KHQ, 27 Ivywood Dr., Jacksonville IL 62650. Tel. (217) 245-6778.

## DEC 7

**HAZEL PARK, MI** The Hazel Park ARC will hold their 32nd annual Swap and Shop, 8 a.m.–2 p.m., at Hazel Park High School, 23400 Hughes St., Hazel Park MI. General adm. \$5, in advance or at the door. Tables \$14 each. Reservations must be received with check, no reservations by phone. Plenty of free parking. Talk-in on 146.64(-) (DART). Swap info, tables, and ticket reservations to HPARC, Box 368, Hazel Park MI 48030.

## JAN 17

**HAMMOND, LA** The Southeast Louisiana ARC, Inc., will hold the SELARC Hamfest at Southeastern Louisiana University, University Center, upper level. There will be adequate display space under climate-controlled conditions, with multiple meeting rooms and excellent parking. Inclined ramps to the exhibition level will ensure easy loading and unloading. Priority will be given to past vendors who register before Dec. 1st. Commercial vendor tables are \$15 for the first, and \$10 for each additional table (limited to 6); all tables \$20 after Dec. 1st. Swap tables are \$8 in advance, \$10 after Dec. 1st. No admission fee. This event will not allow flea market or craft items unless they are amateur radio or computer-related. Advertising space will be available on flyers and programs until Dec. 20th. Contact SELARC, Inc. (Hamfest 98), P.O. Box 1324, Hammond LA 70404-1324.

**ST. JOSEPH, MO** The 8th annual Northwest Missouri Winter Hamfest will be held on Jan 17th, 1998, 9 a.m.–4 p.m., at the Ramada Inn in St. Joseph MO, with special room

rates for Hamfest participants. The event is being co-sponsored by the Missouri Valley ARC, Green-Hills ARC and Ray-Clay ARC. The motel is located at I-29 and Frederick Ave. (exit 47 on I-29). Talk-in on 146.85 and 444.925. VE exams, major exhibitors and flea market all indoors. Free parking. Advance tickets \$2 ea. or 3/\$5; at the door \$3 ea. or 2/\$5. Pre-reg. requests received after Jan. 8th will be held at the door. Swap tables \$9 ea., first 2 tables. Commercial exhibitors welcome. Write for details to Northwest Missouri Winter Hamfest, c/o Gaylen Pearson WB0W, 1210 Midyett Road, St. Joseph MO 64506.

## JAN 18

**YONKERS, NY** The Metro 70 CM Network will hold an Electronic Flea Market, 9 a.m.–3 p.m., at Lincoln High School, Kneeland Ave., Yonkers NY. Free parking, indoor flea market. No tailgating. VE exams. New and used equipment for CB operators, amateur radio operators, commercial two-way radios, computers, stereo buffs, televisions, telephones, electronic parts and kits, and much more, will be on sale. Admission is \$6 for adults; children under 12, accompanied by an adult, are admitted free. For information, or to register as a vendor, call Otto Supliski WB2SLQ at (914) 969-1053. Talk-in on 449.425 MHz pl 156.7; 223.760 MHz pl 67.0; 146.910 MHz; and 443.350 MHz pl 156.7. Mail paid reservations to Metro 70 CM Network, 53 Hayward St., Yonkers NY 10704.

## JAN 24

**GALLATIN, TN** The Tennessee Valley Amateur Radio Network will hold its 8th annual Hamfest and Computer Show at the Gallatin Civic Center. Setup Fri. 5–9 p.m., Sat. 5–8 a.m. Open Sat., 8 a.m.–2 p.m. Tables \$10. Adm. \$5, XYLs and under 16 free. Talk-in on 147.90/.30 T 114.8. Food available. Free parking, handicapped accessible. VE exams by pre-registration only. Send 610, copy of license or certificate of successful completion, and an SASE to Ronnie Gilley, 512 Hillside Dr., Gallatin TN 37066. For hamfest info, contact Bill Ferrell N4SSB, 1253 Woodvale Dr., Gallatin TN 37066; or phone (615) 451-5992 and leave a message.

## JAN 25

**VILLA PARK, IL** The Wheaton Community Radio Amateurs will hold their 31st annual midwinter Hamfest on Super Bowl Sunday, Jan. 25th, 1998. It will be held at the Odeum Exposition Center, 8 a.m.–2 p.m. Tickets are \$6 in advance (with four prize stubs), or \$8 at the door (with one prize stub). Advance tickets may be purchased by sending a business-size SASE to WCRA, P.O. Box QSL, Wheaton IL 60189. Free off-site parking and bus service is included in the ticket price. All flea market tables by reservation; please call (630) 545-9950. For commercial area info, call (630) 545-9950; or fax (630) 629-7098. Talk-in on 145.390(-). VE exams will be held on-site.

## SPECIAL EVENT STATIONS

### DEC 6

**IOWA CITY, IA** The Iowa City ARC and the University of Iowa ARC, will operate station W0IO on Dec. 6, 1400Z–2300Z, to celebrate the 150th anniversary of the founding of the University of Iowa. The station will operate within 20 kHz of 7.250, 14.250, 21.300 and 28.400 MHz. For a certificate, send QSL and a 9" x 12" SASE to Jon Poulton W0CK, 729 Alpine Drive, Iowa City IA 52245 USA.

### DEC 6–7

**MESA, AZ** The East Valley Amateur Radio Group will operate WA7USA from 1500Z–2400Z to commemorate the battleship USS Arizona. Frequencies will be 14.240 MHz and 21.340 MHz. Stations contacted may request a certificate by sending a QSL card and a 9" x 12" SASE to EVARG, 3264 E. Carol Ave., Mesa AZ 85204-3245 USA.

### DEC 12–13

**BETHLEHEM, IN** The Clark County ARC will operate W9WWI, 1500Z Dec. 12th–2200Z Dec. 13th., in celebration of the Christmas season. Operation will be on General 75, 40 and 20 meters. QSL with an SASE for a certificate, to CCARC, 1805 E. 8th St., Jeffersonville IN 47130 USA.



DEC 13

**KENOSHA, WI** The Lakeshore Repeater Association, in cooperation with Carthage College, will operate a special event station in the Todd Wehr Center at Carthage College. The station will operate 1500 UTC-2100 UTC on 7.125, 28.335, 50.15, and 146.520 MHz, using the callsign N9LTA. Operation will be to commemorate Carthage College's Sesquicentennial. Additional information will be available during the event.

DEC 13-14

**BETHLEHEM/NAZARETH, PA** The Christmas City and Delaware-Lehigh ARCs will operate station

WX3MAS, 1400Z-0200Z on Dec. 13th and 14th, as the annual Christmas City event. Frequencies: SSB-3965, 7265, 14265 and 28365 kHz; CW-45 kHz from the band edge on 80/40/30m. For a certificate, send QSO info and SASE to DLARC-WX3MAS, RR4 Greystone Bldg., Nazareth PA 18064-9211 USA.

DEC 31

**FULLERTON, CA** The Fullerton Radio Club (CA) will operate a First Night special event station in the booth area of Fullerton's non-alcoholic celebration of New Year's Eve. The club station, W6ULI, will be operated on phone 00:30 UTC-07:30 UTC. Frequencies to be used will be

close to 7.25, 14.33, 21.33, and 28.40 MHz. For an 8-1/2" x 10" certificate, send an SASE to FRC, P.O. Box 545, Fullerton CA 92836.

JAN 10-11

**1998 HUNTING LIONS IN THE AIR CONTEST** The 26th annual Hunting Lions in the Air Contest will take place 0900 UTC Sat., Jan. 10th-2100 UTC Sun., Jan. 11th, with the objective of creating and fostering a spirit of international understanding and cooperation among amateurs and Lions, through worldwide communication. The contest is to commemorate the birthday of the founder of Lionism, Melvin Jones, born at Ft. Thomas AZ, USA, on

Jan. 13, 1879. Operators interested in additional info regarding this contest should write to Contest Committee, Lions Club Flen, Box 106, 642 23 Flen, Sweden. E-mail [goran.blumentahl@swipnet.se].

JAN 28

**SAN DIEGO, CA** The Challenger Middle School ARC, KI6YG, will operate a special event station to commemorate the 12th anniversary of the space shuttle Challenger tragedy, 1500 UTC-2400 UTC, on or near 14.250, 21.350, 28.350, and 146.52 simplex. QSL to Challenger Middle School ARC, 10810 Parkdale Ave., San Diego CA 92126 USA.

## NEVER SAY DIE

Continued from page 45

we're either going to change it, despite the fierce opposition of the educational unions, or we're going to suffer.

Or we can continue as we have, ignoring the problem and sedating ourselves with fast food, beer, and amusements, and let our kids worry about the mess they've inherited through our neglect.

Have you read any of the books about the Sudbury Valley School yet? About the mess our colleges are in? Or are you out there parading mindlessly with a poster expressing your anger over your job being moved to Mexico or Malaysia?

Hey, let's hope that some chap doesn't get the bright idea to start educating the millions of people in Africa! The problem with knowledge is that it can be taught to anyone. I've already mentioned that more and more of the Silicon Valley software meetings are being held in Chinese.

### Birth Defects

While watching the news, I saw pictures of crews spraying to kill mosquitoes around Orlando's Magic Kingdom™. That took me back to when I worked at WSPB in Sarasota as an engineer-announcer. I had the morning shift, so it was my job to get there early in the morning to put the station on the air. But at any

time of the day, getting from my car to the station meant a 10-yard dash through the mosquitoes and then beating a bunch off after getting into the building. And this despite daily aerial spraying of the whole area.

So what's all this got to do with birth defects? Well, I was reading recently that the incidence of birth defects has been increasing, with the curve sloping sharply upward. And that, in turn, got me to thinking that a birth defect has to be pretty severe before it's visible to the eye. 99.9% of birth defects are not visible. They're things like a lowering of IQ, potential later mental problems, autism, attention deficits, hyperactivity, emotional instability, and so on.

But below that are 99% of the invisible defects—which will tend to be passed along to their children.

So what causes birth defects? Just what you'd expect. Anything which can alter the mother's or father's genetic material. Scientists have agreed that nicotine, caffeine, and alcohol before conception often do cause birth defects. As do cocaine and other drugs. And it's fair to indict other poisons we breathe, eat, drink or inject into our bodies. And that includes the stuff food processors use to retard spoilage or color our foods, hormones fed or injected into animals to improve meat

or milk production, and so on. Plus poisons sprayed on fruits and vegetables to keep away insects.

Having a child today is one heck of a crapshoot. And keeping yourself away from all these poisons is nearly impossible. They're in the air, our water, our food, and immunization shots, and they're very difficult to avoid.

Worse, through the overuse of antibiotics in people and animals, diseases are mutating so they are resistant to all but the newest antibiotics. I'm hoping that silver colloids will be an answer to this, but the inability of the pharmaceutical companies to patent it and charge us a fortune for it probably means that they, aided by the AMA, FDA, and on through the medical alphabet, will fight to the last ditch to prevent it from even being tested.

But colloidal silver does seem to be a way to kill off the bad bugs, and one the bugs can't adapt to.

Even if some doctors do bona fide research on the effectiveness of silver, I guarantee that their results will not get published—because the medical journals are all funded by the pharmaceutical giants.

There isn't much you can do about this directly, but you can do your best to keep your poison input to a minimum. And women can take extra

precautions before and during pregnancy.

### Takes All Kinds

Well, hams made the papers! There was a story in the *Elkhart Journal and Courier* about a local repeater being jammed by beach balls. It seems that the repeater group somehow managed to irritate a creative ham enough so he has been building little transmitters, putting them into beach balls and leaving them on the Elkhart River shore.

The repeater group is frustrated because the FCC doesn't seem interested and the State Police say no state laws have been broken.

### Paparazzi

Yes, they're sure a nuisance to the famous, and they contributed to Princess Di's death. But before dumping a big bunch of blame on these scavengers, let's look at the whole food chain that makes them possible.

The reason these guys go to such lengths to take pictures of the famous is that the tabloids will pay huge amounts of money for the pictures. That makes it worth all the effort and time it takes to get the pictures.

The tabloids pay big money for the pictures because they sell more papers, making the

Continued on page 85



# Affordable Antenna Project for APRS

*Build an external antenna for your GPS receiver.*

Frank Kostelac N7ZEV  
4233 W. Warm Springs Rd.  
Las Vegas NV 89118

If you're into APRS (Automatic Packet Reporting System), you've no doubt discovered the need and expense of a remote antenna on your hand-held GPS unit. We discovered that a 1.5 GHz helix wound on a piece of PVC makes an excellent magnetic-mount GPS antenna.

The challenge is to turn a plastic egg (from the lingerie drawer) and a two-inch-long piece of 3/4-inch PVC (the type used to put in sprinkler systems) into a serviceable antenna for the state-of-the-art Global Positioning System operating in the 1.5 GHz portion of the spectrum. **Photo A** shows what it can look like using an egglike pantyhose container. However, my

wife informs me these are no longer available, so we have made some very colorful units from smaller plastic containers that were sold to put Easter candy in. By the way, just about any plastic container with a flat lid and an RF-transparent bowl can be used.

A chrome egg is another possible variation on the housing.

Once the chrome is scrubbed off with a scouring pad (a standard kitchen scrubber will work fine), the next challenge is to configure a mounting. A snap-off jelly jar lid (we used Welch's™) and three Radio Shack™ magnets can be glued together using a tube of clear silicone. The result is quite presentable and affordable.

Use one-eighth-inch-wide, adhesive-backed copper foil (printed circuit board repair foil). Two pieces (each about five and a half inches long) are attached to the form to make a helix arrangement. Mark the PVC at 90-degree intervals on both the top and bottom, and then attach the copper foil so as to get a twist between top and bottom. The tape used was printer circuit repair foil, but I have been using half-inch-wide tape that I was able to cut one-eighth-inch strips from. The tape is not critical, but the ability to solder it to the ground plane and to the coax is.

Next, solder the ground plane by soldering the four points of copper-to-copper contact at the bottom of the form.

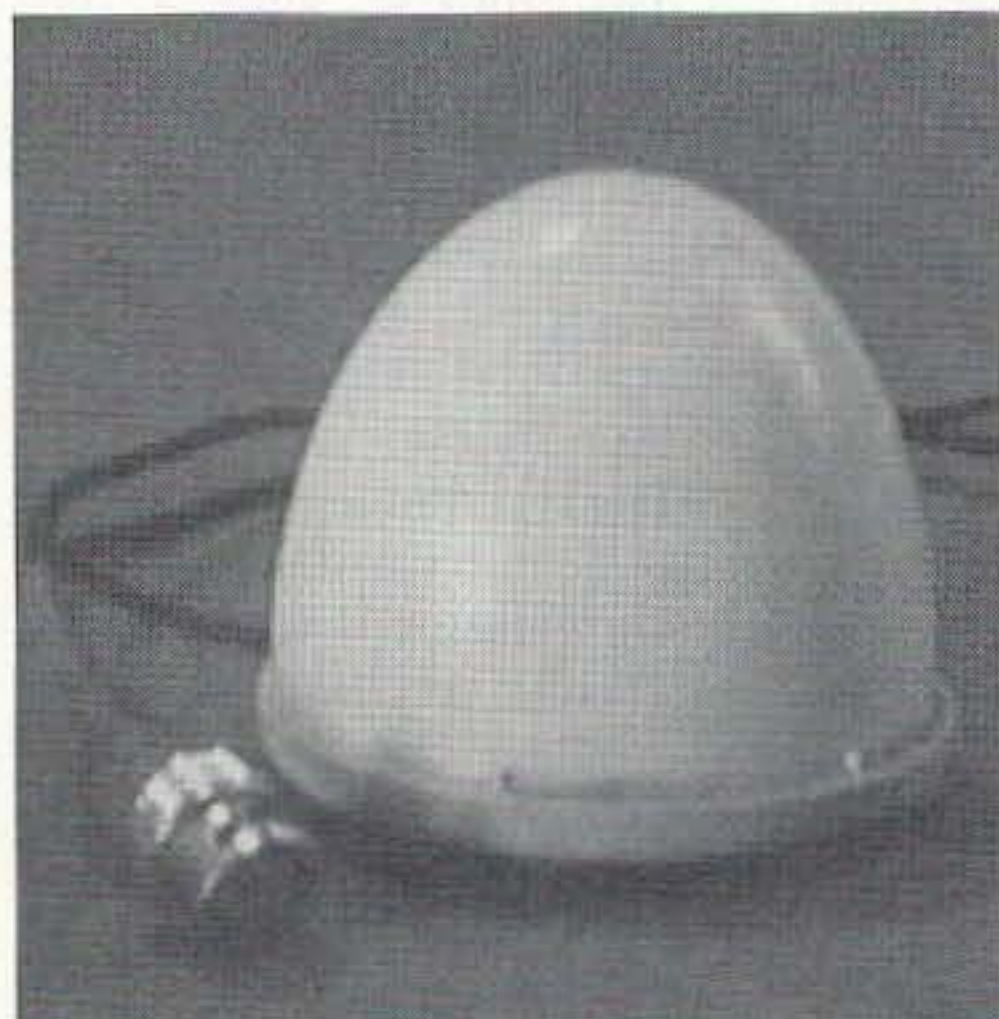

**Photo A.** The chrome is removed, and the egg, a jelly jar lid, and three magnets are glued together with clear silicone.

## Affordable APRS Antenna Project

- 1 4 cm x 4 cm piece of copper foil (for the ground plane)
- 12 inches of printed circuit repair foil (1/8-inch wide)
- 1 section 3/4-inch PVC (2 inches long)
- 1 egg-shaped radome (or any plastic container that is RF-transparent and large enough inside to accommodate the 2-inch-tall helix)
- 1 length of RG-174 coax (the shorter, the better at these frequencies)
- 3 quarter-sized round magnets (Radio Shack- Part# 64-1888 or 64-1879)
- 1 lid that matches the radome diameter (plastic or metal)
- 1 connector, appropriate to your GPS

**Table 1.** Parts list.



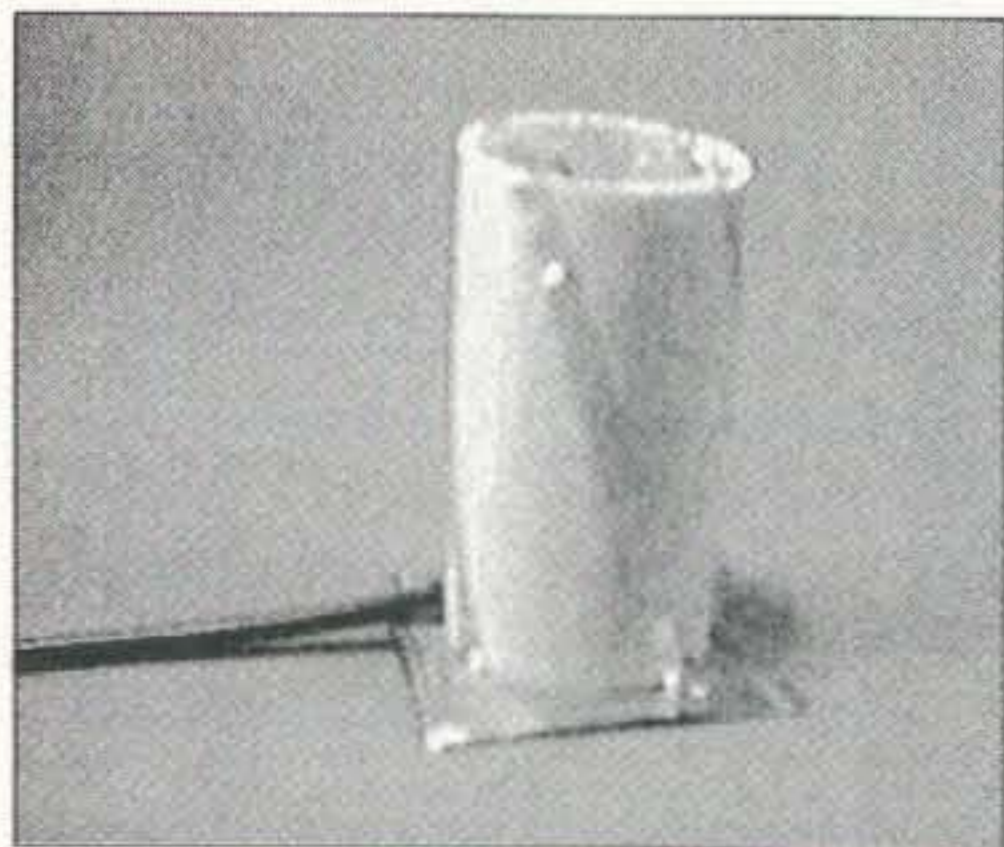
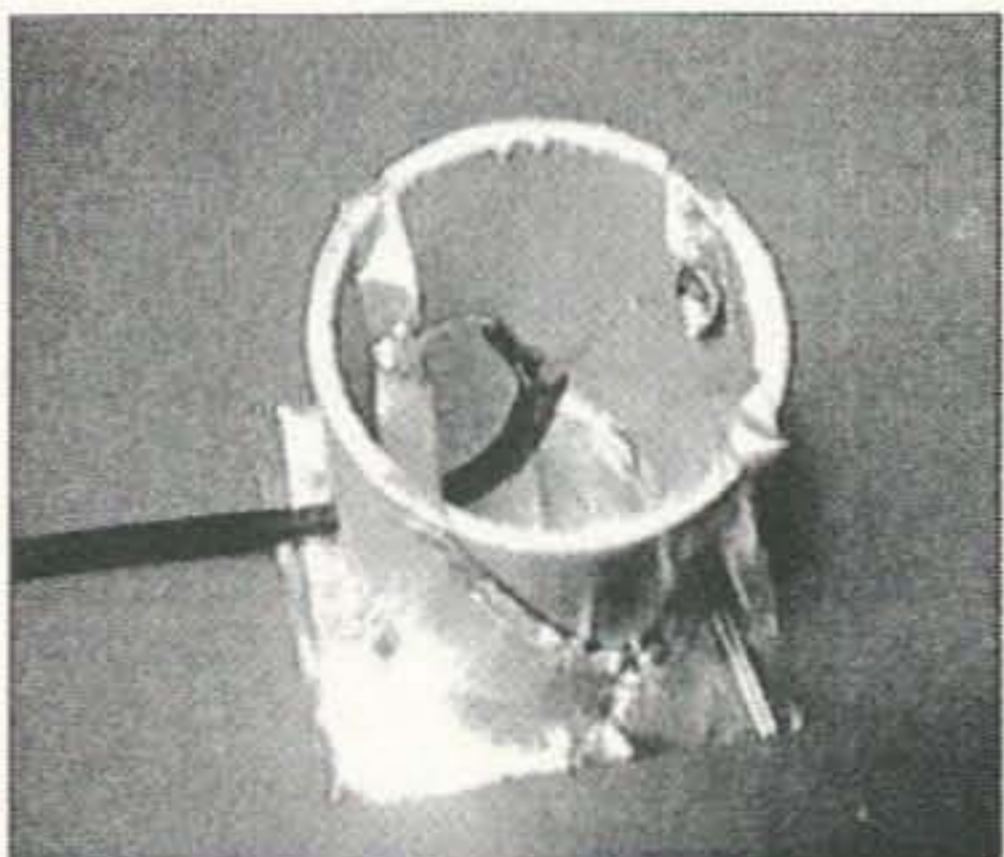

**Photo B.** With the helix formed on the PVC, the ground plane is attached. A hole in the PVC is left for the RG-174.

The ground plane itself is copper foil cut to 4 cm by 4 cm square. Then, drill a hole into the form near the bottom to allow the RG-174 to enter the form.

The center conductor and shield are each soldered to one of the foils running across the top of the PVC form. The completed antenna is then siliconed to the lid and the "radome" is siliconed over the antenna with a notch cut for the needed coax clearance. If you use Easter eggs or some other container this can get a little more complex, but it's still manageable.

A kit of materials is available for \$25.00 plus shipping from the author. Write to Frank Kostelac, 4233 W. Warm Springs Rd., Las Vegas NV 89118. Only money orders will be accepted, and the kit will be shipped COD. Please allow about 6 weeks for delivery, as the parts will be gathered once a response is determined. The connector is not included. And the radome will be the author's choice.



**Photo C.** The center conductor and shield are soldered to separate helix foils running across top of PVC, before entire PVC assembly is siliconed to jar lid and sealed.

## ELECTROMAGNETIC MEASURING TOOL

New TriField® Broadband Meter combines a broadband field strength meter with an AC magnetic & electric field meter in a single package. RF field strength setting (vertical, 10-1000 V/m @ 100 KHz -2.5 GHz) is ideal for making near-field transmitter measurements, finding RFI on a line, testing leaky microwave ovens or finding hidden surveillance "bugs". AC magnetic setting (0.2 -100 milligauss @ 60 Hz, range 50 Hz -100 KHz, full 3-axis magnitude) tests for magnetic interference (a sometimes nasty but difficult-to-pin-down problem with sensitive equipment), tells you which of several lines is carrying AC or pulsed current, finds underground power lines, tells you if a power supply or transformer is "on", without contact. AC electric field setting (0.5 -100 KV/m @ 60 Hz, range 50 Hz -100 KHz) tells you which line is "hot" vs. "neutral", finds AC wiring in walls, and determines whether equipment is properly grounded.

Includes standard 9-Volt battery, 1 year warranty. Price \$170 includes delivery in US, Canada. Also available: low cost digital DC magnetic & electrostatic field meters, air ion counters. Call for free catalog. All meters made in USA by AlphaLab, Inc. / 1280 South 300 West / SALT LAKE CITY UT 84101. Tel. 800-769-3754 or 801-487-9492. Major credit cards accepted.



## Weather Satellite Imagery



### PCMCIA Convertible Capture Board

- Low power - PCMCIA type II
- Use on your Laptop and Desktop
- HF Marine, NOAA polar satellites, GOES satellites
- Perfect for boat, vehicle, plane, or home

### Full Function Software

- DOS and Windows
- Sea surface temperatures
- Coastline and Lat/Lon grids
- GOES animation
- Decodes WEFAX headers

The Best in PC based Weather Satellite Imagery



**OFS WeatherFAX, Phone/Fac: (919) 847-4545**  
6404 Lakerest Court, Raleigh, NC 27612 E-Mail: jdahl@worldnet.att.net

## POWER POCKET

12V/2.0 Amp Hours of dependable power, in a convenient soft case. Simply insert the cigarette adapter plug normally used in your car's lighter to instead plug into the POWER POCKET. The POWER POCKET provides hours of extended talk time, up to 6 times longer than standard battery packs!

- Emergencies - Special Events - Search & Rescue - Hiking - Cycling - Hamfests - Field Day - Etc.

Without power, your HT is useless! Don't be caught without a POWER POCKET when you need it most.

- Compact slim design that is light weight, only 30 ozs., with a belt loop and shoulder strap included.
- 110V Wall Charger included. Charge rate: 6-8 hours from complete discharge.
- Sealed lead acid case, can be recharged to 100% without memory effect of NiCads.

The POWER POCKET is available from most major Amateur Radio Dealers, or contact:

**NCG COMPANY**  
1275 N. Grove Street  
Anaheim, CA 92805  
(800) 962-2611  
(714) 630-4541  
Fax (714) 630-7024



CIRCLE 54 ON READER SERVICE CARD



# ABOVE & BEYOND

## VHF and Above Operation

C. L. Houghton WB6IGP  
San Diego Microwave Group  
6345 Badger Lake Ave.  
San Diego CA 92119  
E-mail: [clhough@pacbell.net]

### Stocking the amateur junk box

How do you stock an amateur junk box with component parts—or, more importantly, where do you go to get the stuff to stock a junk box *with*? We are all collectors, but some of us have difficulty in locating materials cheaply.

How do you determine what parts should be on the “critical” list to start building your junk box? How complicated a system should you use in trying to sort the components you have collected? What method of storage should you use to store spare parts?

These are some of the questions that I run into time and again with new amateurs. There’s no one best answer, but I guess the foremost thing to cover is the main motive that thrusts us into the arena where a junk box is deemed necessary.

Amateur radio operators or just plain electronics hobbyists all have one thing in common—we want to construct our electronic projects, and more than anything else, we want them to be economical.

In this drive for economical projects, one thing is paramount: A junk box makes it possible to experiment or build projects from a home stock of component parts.

First, let’s define “junk box.” Contrary to what your non-amateur spouse may say, there is no “junk” in a junk box—it’s all precious stuff! Now, “stuff” is all the material we haul home and expect to rebuild or convert from obscurity into a full inspirational home-brew whatever. Translating that into standard text (spousal translation) traditionally means taking a pig’s ear and turning it into a silk purse.

Well, as far as I’m concerned, they never took rosin into the

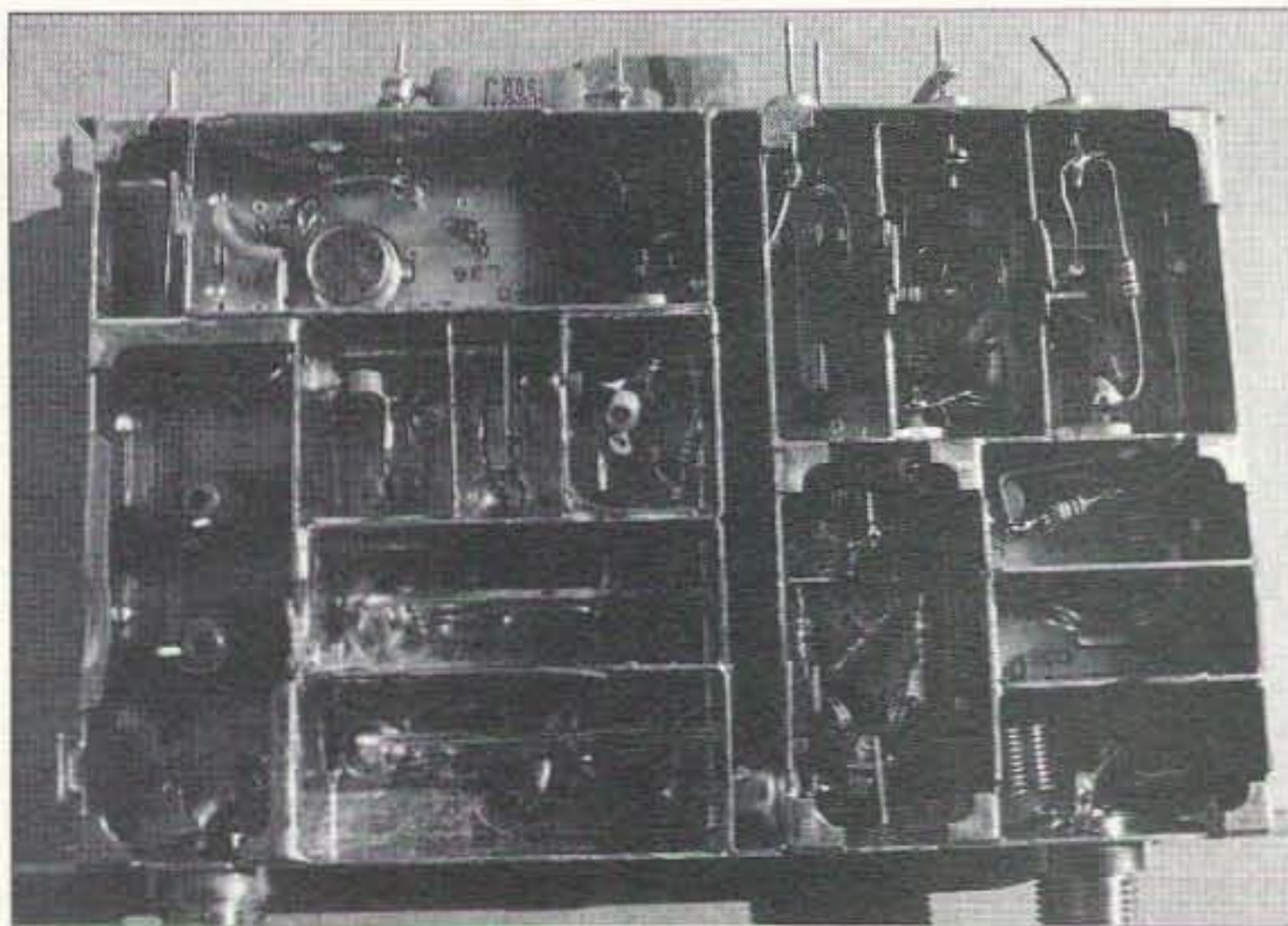

**Photo B.** Lots of parts in a cable TV tuner, a great home for many RF components. Besides a VCO (voltage controlled oscillator) and a DBM (double balanced mixer) there are several varactor diodes.

equation. From all evaluations this is the substance that I am hooked on. Many boxes of stuff were constructed with rosin going up in smoke as burnt offerings. I have constructed quite a few ugly boxes, and in the process of constructing them, I have made many mistakes—but have also learned a lot.

I volunteered my services as small parts bank manager in the Navy MARS program while assistant to the director of the 11th Naval District. I served in the capacity of small parts bank manager to the District (five western states). Now, that was a sorting job in itself but it taught me many things.

The most important thing is that whatever you haul home to add to a junk box, don’t let it turn to clutter or get lost. If you don’t use it or find a new home for it within, say, a year, get rid of it. The idea here is that you do not have vast storage space. What you do *not* want to get rid of is a selection of commonly-used parts like a good basic resistor and capacitor assortment.

Add to this basic beginning diodes and transistors, not just trying to collect every 2N part number, but useful things that you might need. For sure, you’ll need rectifier diodes in low and high voltage applications and basic low-power signal NPN and PNP transistors. If you’re going to build preamps, try to

find FET or JFET devices to add to this junk box.

Now the big question: Where do you locate parts? Well, I have taken advantage of swap meets and surplus sales to collect components for use. PC boards with exotic parts can be obtained at many swap meets at inexpensive prices. The cost is low, as parts have to be unsoldered to remove them, making reclaiming components a time-consuming venture.

There is hope, however—but you have to have eagle eyes to pick the better boards from the *real* junk boards. Computer PC boards and TV boards don’t have much in the way of premium parts for amateur projects. Look for boards that were used in synthesizers and RF applications like cable TV converters. See **Photo A**. Look (eagle-eyed) for component parts that are soldered without their leads being bent to hold them on the PC board. Leads that are not bent when inserted on a board are easier to remove.

Pick up catalogs and other literature, and become familiar with the color codes and markings of component parts. This will allow you to better recognize what you are looking at on a raw PC board. Sometimes it will not be obvious what the board was used for; don’t waste time trying to figure it out. Of course, if you happen to have

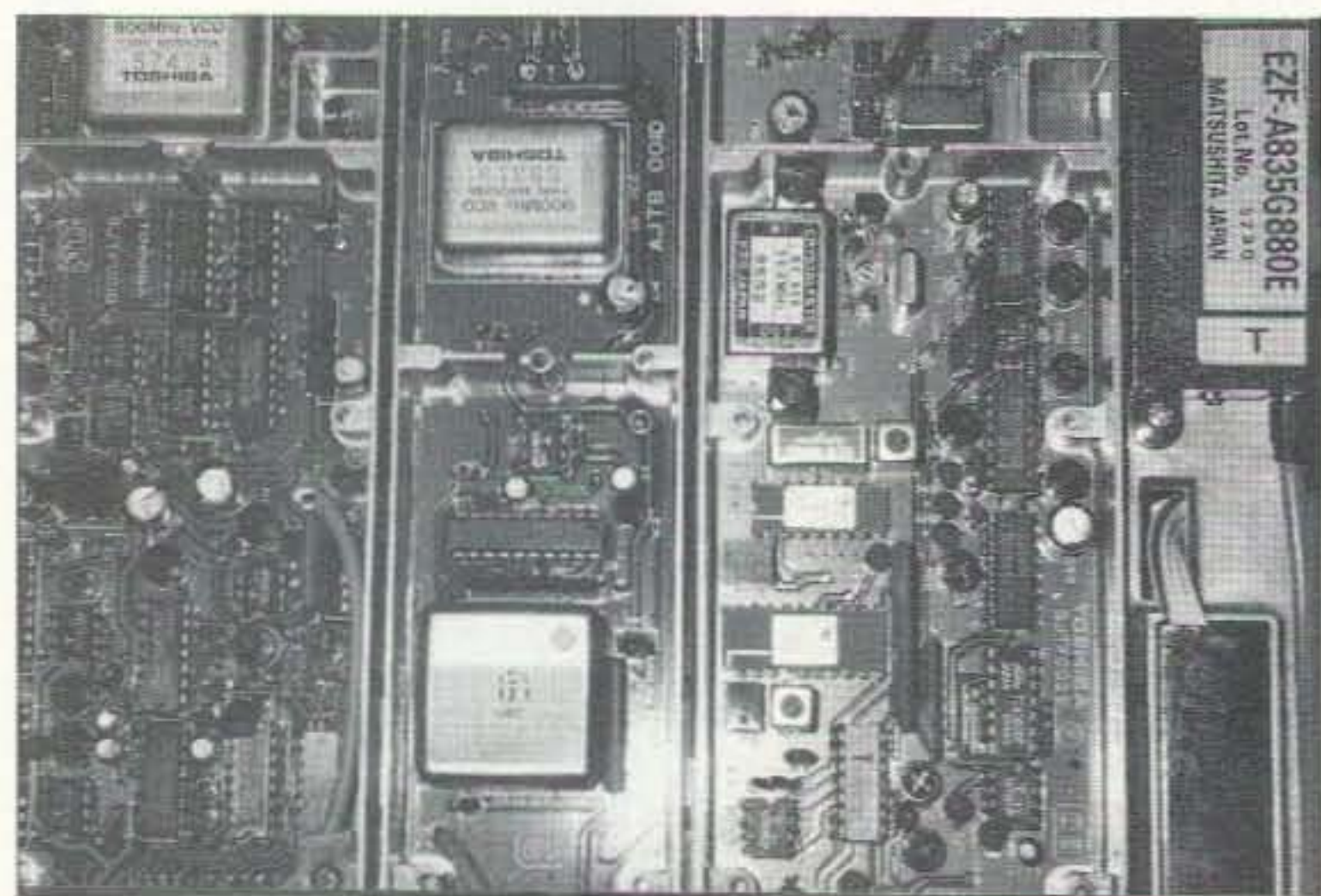

**Photo A.** Parts are where you find them. This photo shows some of the PC boards for an 800 MHz older large-style cell phone. At only \$2, it provided a crystal reference oscillator, two VCOs, a great 900 MHz RF preamp and several good chip ICs for future use.



several of a particular type of PC board, then investigate what can be done to convert it (or a portion of it) to a helpful amateur application.

When you have a small pile of PC boards that make better candidates for parts removal, remove, individually, the parts you want to save that would be damaged by high heat. Plastic-wrapped electrolytics and some plastic-insulated coil forms need to be removed with a soldering iron, something that will be soon be evident if you want to save the part.

Why? Well, because we will re-flow solder over the entire board at one time—with a big re-flow soldering machine which we will construct to unsolder the entire PC board at one time. Sound unbelievable? It's true. What you will use for desoldering the PC board is an inexpensive charcoal BBQ. Be careful using this technique, and follow safety procedures.

I use a full-face shop mask and cap, long-sleeved shirt, heavy shop apron with gloves, and a long pair of pliers or tongs to put the board in a BBQ. Use similar tools when lifting the board back out of the BBQ and don't skimp on safety protection. Wear safety glasses, or even better, use a shop shield that protects your whole face. You are dealing with hot melted solder and you need the protective clothing and protective gear. *Do not attempt this without protective gear!*

I use an inexpensive small round BBQ grill for charcoal cooking. Make a round metal "grill" or use the one provided and redress its diameter. You want the grill lowered in the BBQ itself to give some protection from air drafts directly on the PC board. This promotes fast and even heating of the PC board. And you want this grill about an inch above the charcoal and an inch or two below the top surface.

When the BBQ charcoal is ready (fully burning coals), you're ready for a session of desoldering. Don't forget the

protective gear. Prepare a cardboard box with a lining of newsprint. This is your parts depository and the newspaper serves as a target on the side of the box. The object is to heat the board till the parts are unsoldered without burning the board. This takes about a minute or two and then, carefully, in protective clothing, remove the board with the long pliers or tongs, hold the board vertically and tap it, shaking the parts towards the box and newsprint. If all is well the parts will come off (unless the leads are bent).

The parts fly off the unsoldered board onto the newspaper and slide down to the bottom of the box. Give the parts a little time to cool, then transfer them to a storage box. Separate the solder droplets and parts later. If the parts are not removed from the box bottom they will be covered with solder droplets when you do the next board.

Things to watch out for are overheating the board and burning the epoxy. Use the safety precautions outlined. Perform the operation when you have a controlled environment, such as no pets or children, and can work safely.

Whatever method you use to obtain parts, be it the desolder method or purchasing parts at a swap meet, store them in a see-through plastic box to make finding them easier. I have used the large parts cabinets before, but they work better for more aggressive builders who need a generic assortment of IC and transistors readily at hand. The cabinets are nice, but unless you are ready to start a developmental electronics shop, a small shop see-through bin is better and easier to store in an apartment or limited storage space. An alternative is to use small coin-type envelopes to put parts in (Photo C).

Sort items that will be used heavily, like resistors, by the last color band. In this way, with black as the last band, all resistors in value from zero to 100 ohms will be in this sort bin. Continue for other colors:

brown, red, orange, yellow, green, blue, violet, gray, white. In an average sort, the lower six colors representing zero to  $10^5$  as a multiplier will be heavily used, so prepare good-sized boxes or bags for a large quantity of them.

When you have your parts removed, the sorting begins. I usually pick the largest components out first and separate them into generic categories such as large resistors and transistors. Pick up some see-through small plastic boxes to sort parts that are smaller. A simple multiple bin can be a plastic egg holder. Sort resistors by the last color code band, which is the multiplier. In this way, I only have ten compartments to sort resistors in. Bin one is 0 to 100 ohms or color code "black" with bins two through seven for colors brown, red, orange, yellow, green, and blue. Bins eight, nine, and ten are for extra space and would be such very high values you might not normally see many of them.

The same works for the capacitor bin. Sort them to basic value, such as coupling in the low ranges of pF—say, 10 to 100 pF and 100 to 1000 pF or .001  $\mu$ F. Keep going with capacitors in the .01 and .1  $\mu$ F ranges. Next come the electrolytics and high-value  $\mu$ F capacitors. Use

the same sorting techniques as with the resistors. If you have large components that do not lend themselves to the snap parts box use a shoe box and some envelopes. Write the component part name on the tops of the envelopes and store them upright to make locating easier.

How you arrange your junk box must be structured on what your interests are. If you are into QRP projects you will slant the remaining space to low-power RF transistors and crystals in the amateur band, and variable capacitors to tune circuits to resonance. Don't forget the variable pots (potentiometers). I store them separated by low values under 1k, under 10k, 100k, and 1 meg. LEDs, knobs, nuts and bolts, and all other kinds of bits and pieces fill out the boxes.

What advice, out of all of this, have I taken to heart? Well, "keep the peace in the family" is the most important thing. Don't haul home the entire 35-inch TV to strip parts from—too much junk to get rid of. Shop smart and be parts savvy. Keep track of how much chaff you will have to get rid of compared with how many good component parts you can recover.

*Continued on page 52*

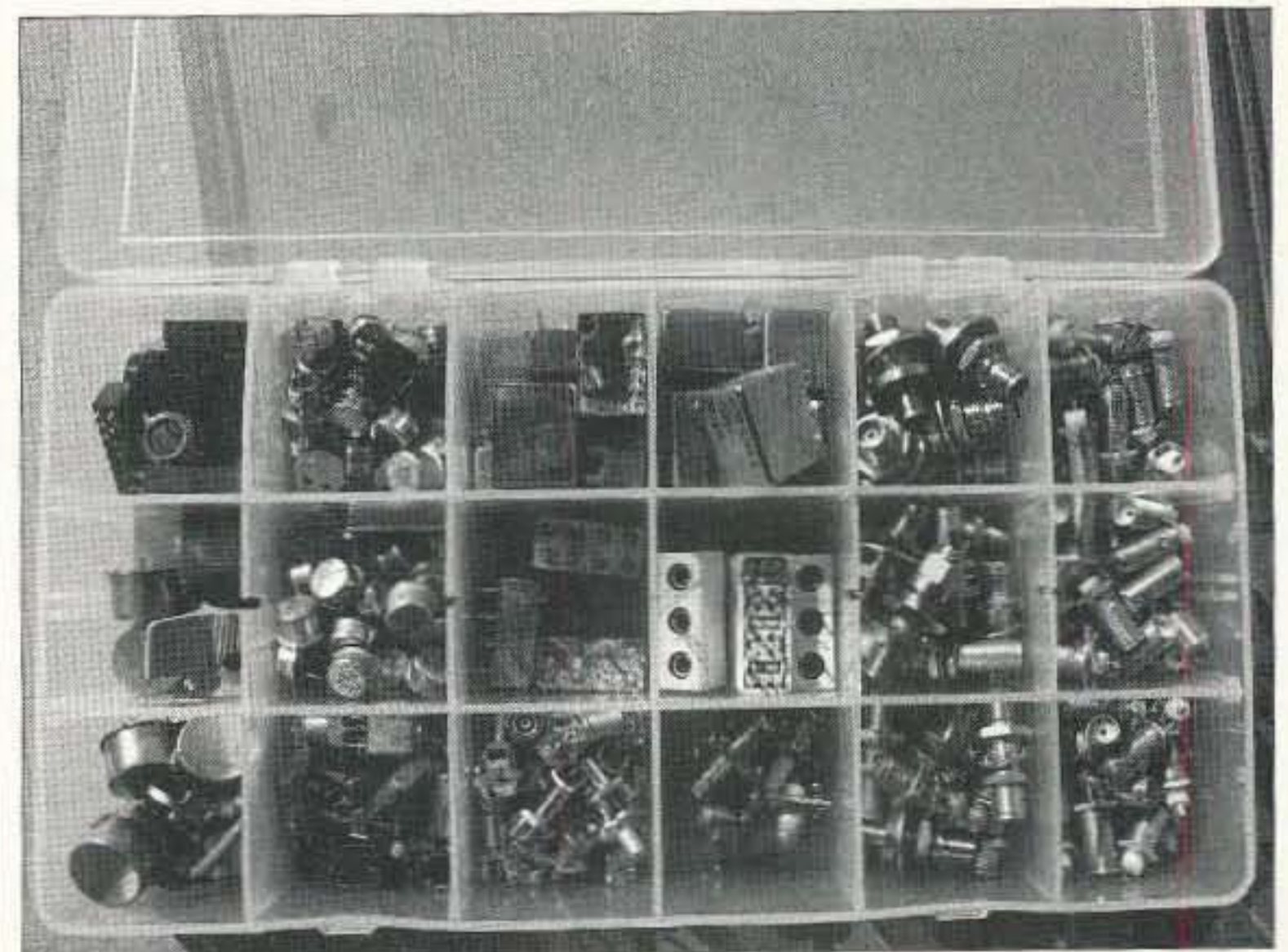

*Photo C. Plastic parts box used for see-through storage. Don't put them in a cardboard box as small parts get lost fast and are not worth keeping unless you can locate them when you need them.*



# Ask KABOOM

## Your Tech Answer Man

Michael J. Geier KB1UM  
c/o 73 Magazine  
70 Route 202 North  
Peterborough NH 03458

### More transmitters

Last time, we were exploring RF signal generation. Let's continue:

As I mentioned, class C amplifiers, which act as nonlinear switches, are considerably more efficient than linear amplifiers, so we use them as often as we can. Some modes, though, can't use such amplifiers—most notably, SSB. SSB is a lot like AM, so why can't we use a class C amp? After all, we saw how class C could make fine AM,

even though the final signal required linearity. Essentially, the final amp is used as the modulator. But simply modulating audio onto a carrier creates double-sideband AM, like it or not.

That's the "natural" form of amplitude modulation. To get SSB, extra steps are required.

We use SSB for several reasons: It uses half the band space per station, it eliminates heterodyne interference, and it takes way less power to get the same readability at the receiver. The

biggest reason we like it, though, is that SSB puts all the power into the information we want to send, without wasting any on a needless carrier or a duplicate sideband.

Getting a radio signal to do such tricks requires some processing. Essentially, you make a double-sideband signal first. You could do that with an AM modulator, but there's no point in doing it that way, since you'll be throwing away the carrier anyway. Besides, some of that carrier might leak through the filter. So a balanced modulator, which outputs two sidebands but no carrier, is used instead. Balanced modulators are surprisingly easy to make; you can do the job with four diodes!

Once you have your double-sideband signal, you then strip off the undesired sideband with a frequency-selective filter. That can be made from a few crystals or a ceramic filter. What's left is one sideband completely dedicated to your modulation. Then, you amplify it and out it goes! (In a real radio, the SSB signal is often mixed with another oscillator first, to put it on the frequency you've chosen.)

Since the SSB signal contains varying amplitudes which represent important aspects of your modulation, you can't send it to a class C amplifier that's going to clip the waveform or otherwise distort it. Such distortion would result in splatter and very ugly audio, not to mention out-of-band harmonics and garbage that just might earn you a free ticket—from the FCC. So, all amplifiers following the generation of an SSB signal have to be as linear as possible.

Still, what would prevent us from using the final amp as the modulator, just as we did with AM? That way, we could indeed use a class C amplifier. Well, it would work, but it would be incredibly wasteful. Essentially, we'd be making lots of RF power and then throwing it away! To throw away power, of course, means to turn it into heat. There are easier ways of

heating a room. Just for fun, though, let's look at how it might be done:

To create final-amp SSB generation, we would first make an oscillator and feed it to the amp, just as if we were going to do CW or AM. We would then modulate the amp's DC power supply, as with AM. The result would be regular AM, which we'd then turn into SSB via a filter which would remove the carrier and the opposite sideband. Considering that we'd be throwing away about two thirds of everything we made, that had better be a pretty big filter, though—capable of taking some power and dissipating some heat! The result would, indeed, be perfectly acceptable SSB. To get it, though, our power supply and amplifier would have to be as big and power-hungry as if we were sending regular AM. The only thing gained would be the reduction in spectrum use.

And now you know why nobody does it that way! By doing it at low signal levels and then linearly amplifying the result, much greater efficiency is obtained, even though the amplifier itself is less efficient. After all, with low-level modulation, we're only throwing away some fraction of a milliwatt, and we don't need nearly as big a power supply for the amplifier, either, because it isn't handling a carrier and only needs peak current during modulation peaks.

Multimode rigs which can do both AM and SSB generally create the AM at a low signal level and amplify it linearly, as if they were creating SSB. Heck, the linear amp is already there, and switching from SSB to AM requires little more than unbalancing the modulator (so the carrier can pass) and removing the sideband filter.

### Other TX modes

We use many modes besides voice. How do they fit into the scheme of things as far as transmitters are concerned? SSTV is actually a form of FM, even

### ABOVE & BEYOND

*continued from page 51*

How have I sorted parts in my shack? I have a small photo darkroom in my garage that doubles as my Fibber McGee's Closet. I have constructed shelves that go to the top of the eight-foot darkroom ceiling. I use small cardboard boxes with envelopes, sorting out a selection of resistors in the chip, 1/8-watt, 1/2-watt, and precision types. Capacitors are similarly stored with small chip-types and variables in the bin-type multi-compartment see-through boxes I mentioned before.

The work bench is similarly equipped, with more junk storage space, topped off with a small section of half-inch pipe on top, which holds wire spools of different colors of wire for hookup use. Nothing fancy—just practical. Large materials, like coaxial cable and such, are in the cable locker outside, in a small tool shed where the spiders reside.

It takes time to organize the materials and you have to keep at it. It makes no sense to store material unless you can locate

it later. If you have to dig in an endless series of boxes to find that choice part, you might as well not store it. Mark boxes on several sides as to what their contents are. Keep like items together. This makes it easier to locate later when you have almost forgotten where it is or where you put it. It's with the other similar wombats and the box is marked.

I have enclosed several photos of my shack and its storage facilities. You do not have to go to such extremes, but if you are a parts junkie like me you will put something together that absorbs space like a race horse. Whatever you put together, keep these three rules in mind:

1. Don't haul home very large items.
2. Don't accept everything unless you have a very large trash dumpster.
3. Store parts with others of the same type, for easy location when you need them.

The time spent collecting and storing parts is meant to aid you in the construction of a favorite project or a PC board—not create a storage monster. 



though it's carried on an SSB channel, at least on the HF bands. The information for the brightness and color of each dot in the picture is modulated onto an audio tone by wiggling its frequency around. The audio tone, essentially, is the FM carrier. That tone is then modulated onto a radio frequency carrier using SSB. The result on the air is FM.

Why? When you send a pure, sine-wave tone into an SSB transmitter, the output is a pure carrier whose frequency is offset by the frequency of the tone. So, as the SSTV's audio tone moves around in frequency, so does the transmitter's RF signal. But how can an SSB transmitter have a carrier in the first place? As far as the transmitter is concerned, it is sending modulation, not its *own* carrier. It just looks like a carrier to everyone else! Digital data can be sent in many ways. Most often, though, it's sent much like SSTV, except that the audio tone has only one of two states: up and down. So, instead of calling it FM, we call it "frequency shift keying."

### It's still FM

This quite naturally leads to the question of whether SSTV and data, such as RTTY, packet, or AMTOR, could be sent using a nice efficient class C amplifier. The answer is yes! We don't usually do it that way because we want to use our existing SSB rigs, which are intended primarily for voice operation. There's no reason, though, why a dedicated rig couldn't be built using class C. Such a rig wouldn't be useful for voice, but it would work great for SSTV and digital modes. I've long fantasized about making a QRP RTTY rig and using it with a palmtop computer, such as my Apple Newton, in the middle of nowhere. Oh, if I only had the time ...

### Transmitter oddities

Way back at the beginning of this transmitter mini-series, I mentioned the issue of Q, or

"quality factor." Essentially, Q indicates how efficient and resonant a tuned circuit actually is, and is expressed as inductance divided by resistance. In other words, the more inductance and less resistance a tuned circuit has, the higher its Q.

A tuned circuit acts something like an auto-transformer, in that it converts current to voltage. How? The incoming AC current is stored in the inductor's magnetic field, which then collapses as the incoming power reverses direction. The collapsing field cuts through the inductor's turns, making it generate a voltage. It's quite possible to wind up with voltages considerably higher than what you started with! Of course, you haven't created power from nothing, since the output current is reduced by the same ratio as the voltage increase.

Can you have too much Q? Yes, you sure can! With the buildup in voltage comes the prospect of doing some circuit damage. For instance, if you start with 12 volts of DC, and your transistors are rated at 18 volts, you should be OK, right? Sorry. If the tuned circuit converts that to 24 volts of RF, you'll fry that transistor. Similarly, capacitors and other components must be able to withstand the peak voltage created by the tuned circuit. Also, excessive Q can make enough voltage to interact with other components in an unstable manner, causing ringing or even unwanted oscillations not on the intended frequency.

Unfortunately, you don't always know what that voltage will be. Especially in the "tank" of a transmitter, the voltage you wind up with has a lot to do with the SWR of your antenna. If it's too high, the antenna won't accept the RF power, and the voltage across the tuned circuit will rise as the reflected power comes back. That's why you see zener diodes across the outputs of some solid-state RF final amplifier stages—the diodes break over and shunt the excess

voltage to ground, protecting the transistor. At least, that's how it's supposed to work.

### Letter time

Dear Kaboom,

I have an early HF rig that keeps blowing its finals! These things aren't cheap, and I'm tired of replacing them. What gives?

Signed,  
Zap 'n' Poof

Dear Zap,

Early designs were much more subject to this sort of thing than the stuff we have today. Partly, it's because the early transistors just weren't very sturdy when used for RF—their junctions broke down easily under excessive peak voltage. See if there's a more modern cross for the parts you've been

using. Plus, some designs were marginal, pushing the transistors to their limits. (Designers were used to tubes, which could more easily take it, and old habits die hard.)

Also, it could be that you have a bad filter cap on the DC line which is allowing RF feedback and spikes to occur. Remember, it's the voltage across the three elements of the transistor that determines whether it lives or dies, not the voltage to ground. If there is feedback or spikes, they can add to the output voltage and exceed the breakdown voltage of the transistor's junctions. Check the bypass caps near the transistors themselves. Finally, make sure the power has someplace to go. If your SWR is high, or some bad part is blocking the power between the transistors and the antenna, that'll do it, too.

Until next time, 73 de  
KB1UM. 73

**Motron** 310 Garfield St Suite 4  
PO Box 2748  
**ELECTRONICS** Eugene, Oregon 97402  
<http://www.motron.com>

New DTMF Decoder

**\$79.00**  
plus shipping

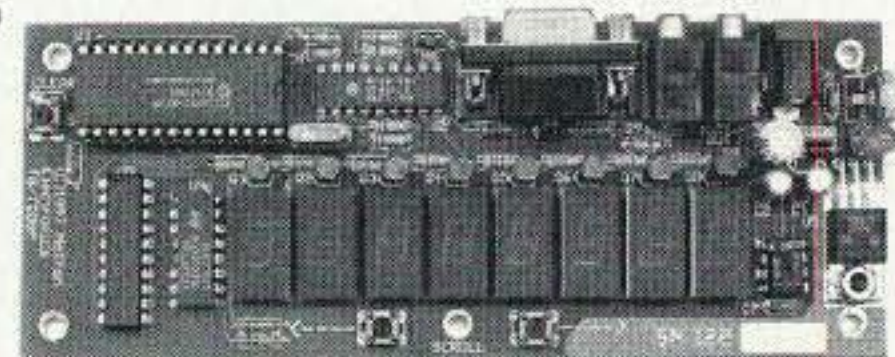

The **ToneLogger™**

DTMF Decoder Display Board with ASCII Serial Output decodes all 16 DTMF digits and features a large 8-digit LED display, an amplified audio output, jumper selectable Normal and High-speed decoding, and an ASCII serial output at 9600 baud. The 56 character memory is viewed, without loss of data, by scrolling either left or right. Although a computer is not required, the serial ASCII output allows for automatic logging of decoded number groups. Logging software for both DOS and Windows environments is included with each **ToneLogger™** purchase. The **NEW ToneLogger™** is 2-1/4" x 6" and requires 9 VDC at a minimum of 150 ma current.

<b>ToneLogger™</b> Assembled & Tested PCB	<b>\$79.00</b>
<b>CAB-3</b> Audio & Computer Cables	<b>20.00</b>
<b>PMK-1</b> Plastic Mounting Kit	<b>15.00</b>
<b>PS-9/2</b> 9 VDC @ 200 ma AC Adaptor	<b>10.00</b>

Visa, MasterCard, American Express, and Discover/Novus accepted.  
COD \$5 (Cash or Money Order only) S/H: \$8 USA; \$11 Canada; \$16 Foreign

**Orders: (800) 338-9058**

Info: (541) 687-2118 Fax: (541) 687-2492

CIRCLE 248 ON READER SERVICE CARD



# HOMING IN

## Radio Direction Finding

Joe Moell P.E. K0OV  
P. O. Box 2508  
Fullerton CA 92837  
[Homingin@aol.com]  
[http://members.aol.com/  
homingin/]

### New sporting goods for foxhunting

Looking for a great way to get young people interested in ham radio and electronics? Take them out to hunt hidden transmitters! What better way is there to hook them than the adventure, mystery and challenge of locating the source of signals with radio direction finding (RDF) equipment?

In dozens of nations around the world, amateur RDF (called foxhunting, radio-orienting and ARDF) is a popular sport for youth. Events in these countries are similar to orienteering competitions. About half a dozen low-powered transmitters

(foxes) are concealed throughout a large park or forest. They transmit one at a time, in numbered sequence, on the same frequency. Contestants see how many they can locate in a prescribed time period, usually about two hours.

Radio-orienting has been most popular in eastern Europe, China, Japan and former Soviet Union countries. It's now catching on in North America. Of course, you don't have to have formal championships just so the kids in your school, club or Scout group can enjoy the fun. All you have to do is scatter some little two-meter transmitters in a park, give 'em some gear and turn 'em loose!

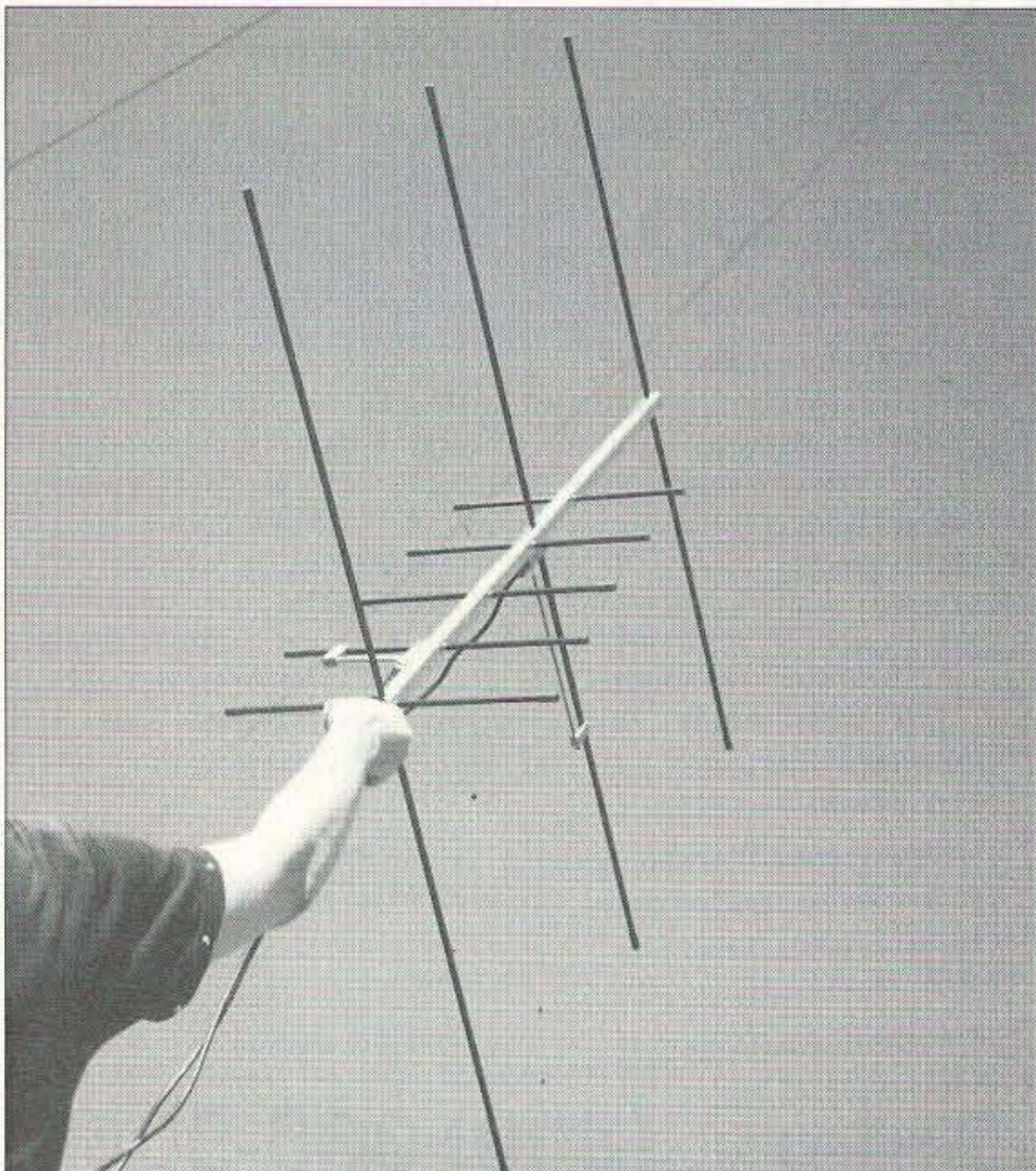

**Photo A.** Besides RDF on 146 and 440 MHz, you can use a dual-band Arrow yagi in a portable satellite station for OSCAR modes B and J, as shown here.

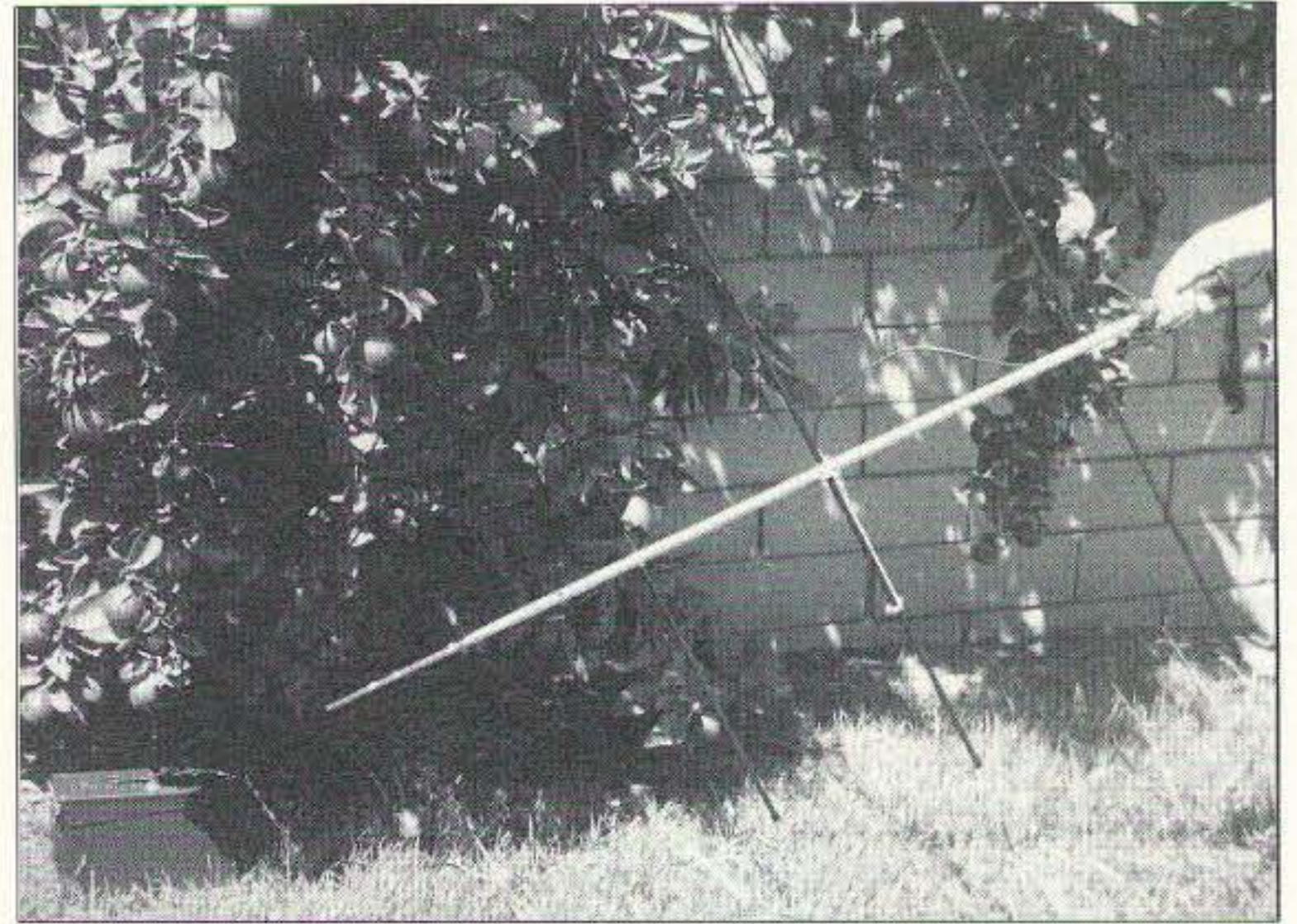

**Photo B.** The SAR2 155 MHz yagi and SAR's two-meter version look almost the same. They provide both improved communication range and RDF capability.

### What gear?

In general, the better your equipment, the more fun you'll have. Ordinary handie-talkies and scanners will get you started on two meters. Simple techniques such as body shielding provide useful bearings under most circumstances. A directional gain antenna makes bearings more accurate and helps detect and track very low-power foxes. Yagis of two to four elements are a popular choice.

Grade school kids won't think it's fun to hold a heavy object as they walk in the woods, so a yagi should be as light as possible. Arrow Antenna™ yagis have elements made from aluminum arrow shafts. Such elements are quite strong, but are about half the weight of an equivalent piece of ordinary tubular aluminum (**Photo A**).

The latest Arrow product is the Model 146/437-10. It has three two-meter elements and seven 70 cm elements on the same boom, with separate gamma matches and feedline terminations. You can track a two-meter signal on its fundamental, then quickly switch to the third harmonic as you close in, when the fundamental overpowers your receiver. The price of this 19-ounce dual-band yagi is \$73. Single-band models are also available, starting at \$49 for

three elements on two meters, weighing 15 ounces. For more information, contact Allen Lowe NØIMW at Arrow Antenna, 1803 S. Greeley Highway #B, Cheyenne WY 82007; tel. (307) 638-2369.

A new entry into the lightweight antenna market is Super Antenna Resources (SAR), run by Paul Andreasen K1JAN and Carl Calos KE6CCV (**Photo B**). Their primary product is the SAR2, a 155 MHz three-element yagi built on a 54-inch tapered aluminum boom that doubles as a walking and tracking stick. It weighs 15 ounces and costs about \$70. The gamma match assembly is pre-tuned for easy assembly in the field.

Cabco Industries, manufacturer of SAR antennas, welcomes custom orders for beams from 84 to 940 MHz. You can get a yagi without the long boom tip for T-hunting, or with a square boom for fixed-station mast mounting. For more information, write to SAR, P.O. Box 2610, Lompoc CA 93438; or call Cabco at (805) 736-0662 and ask for Carl.

For use by kids and adults in woodland foxhunts, a yagi's boom should be no longer than necessary. The photos show yagis being held by the supplied hand grips on the boom ends, but it will be easier for children to use them if you attach a mast



of PVC pipe to the balance point on the boom. With it, they can carry and rotate the antenna like a flagpole in a parade.

Caution: Eye protection should always be worn when running or walking with a VHF beam antenna.

A signal strength indicator (S-meter) is an important feature to have on the receiver you use for on-foot foxhunting. You'll also want to have a way to reduce signal strength as you approach the fox, to prevent receiver overload and help you take close-in bearings. Offset-type RF attenuators work best for on-foot two-meter RDF. More information on them is in recent editions of *The ARRL Handbook* and "Homing In" for July 1994.

### All in one

Championship foxhunters know that a receiver/antenna combination with good directivity, a wide range RF gain control and an accurate strength indicator makes them more efficient and proficient. It's also much easier for beginners to track signals using such a one-piece integrated device.

In every country where ARDF has high participation, special RDF receiver/antenna sets, kit or factory-built, are readily available. Some of them, such as the Altai-144 from Russia, lack the selectivity to perform well in crowded US band conditions. Mizuho in Japan makes an excellent ARDF set, but its price approximates that of a dual-band handie-talkie. Foreign built/tested ARDF sets are not sold widely in the USA because of the small perceived market and the cost of mandatory FCC Part 15 receiver certification.

New "single chip" circuits make it possible to produce small VHF receivers with excellent sensitivity and selectivity at modest cost. So far, no US manufacturer has put a set with special ARDF features, such as audio S-meter and wide-range attenuator, into its product line, but a good one is available "Down Under." It's made and

sold in kit form by Ron Graham Electronics (RGE). Ron VK4BRG welcomes stateside orders.

**Photo C** shows the complete receiver (Model RX-1) and antenna (Model ANT1/144) combination. The 11-ounce antenna features the classic HB9CV design with two driven elements spaced ten inches apart and fed out of phase so that the directional pattern is cardioid (heart-shaped). In other words, it has one forward gain lobe and one null in the back. Ron's design is optimized for best pattern (front-to-back ratio) at the expense of some gain reduction. The compact spacing of a two-meter HB9CV antenna makes it a popular choice among ARDF champions around the world.

For crashing through the brush, many foxhunters prefer antenna elements of curved steel tape that give way to foliage and snap back into place. Long elements of tape do not retain shape well, so the RGE beam has elements that are half rod, half tape. This is a good compromise. The flexible ends are covered with tough sleeving. They screw onto and off the rods for easy disassembly and transport.

The RX-1 is designed around the Motorola MC3362 dual-conversion receiver IC. A dual-gate MOSFET in the front end makes this a "hot" receiver; mine achieved 0.1 microvolt sensitivity. An LM386 audio driver provides plenty of sound in the headphones. The wide range (more than 100 dB) RF gain circuit controls Gate 2 of the MOSFET and stages within the MC3362. It can knock down a 350,000 microvolt signal enough to get a good bearing.

Instead of a panel S-meter, which is relatively fragile and difficult to watch while navigating through the woods, the RX-1 has a tone-pitch S-meter mode. As signal strength increases, the tone goes from a low growl to a high whine, then to supersonic frequencies. Australians call this the "whoopee" mode because of the whooping tones the user hears while sweeping the beam across an incoming signal.

The receiver kit includes all parts including the double-sided circuit board and a 4-3/8- by 2-3/8- by 1-3/16-inch aluminum box with all holes pre-drilled and tapped (**Photo D**). Labeling of the controls is done simply with two printed overlays, each with a clear plastic cover. It's not as elegant as dry transfer lettering or engraving, but the marks are very easy to read. If you seal the edges of the clear covers, you won't have to worry about rain or wear erasing the lettering.

Although not step-by-step for each part, the kit's instructions are readily understandable. A VHF receiver like this is probably not a good first project for someone new to electronics, but if you have a couple of successful kits under your belt or if you have an experienced Elmer to help you, there should be no problem building and testing this set.

If you have or can borrow a stable VHF signal generator and VHF frequency counter, tune-up is simple. With just a little back-and-forth tweaking of the capacitors and inductors (**Photo E**), I achieved full sensitivity and good selectivity. The audio S-meter is so sensitive that signals of 0.15 microvolt cause the growl pitch to increase. The front-to-back ratio of the antenna represents several octaves of pitch change.

### Off to the hunt!

Using the RGE set to get bearings is simple and intuitive. Set the RF gain to maximum and

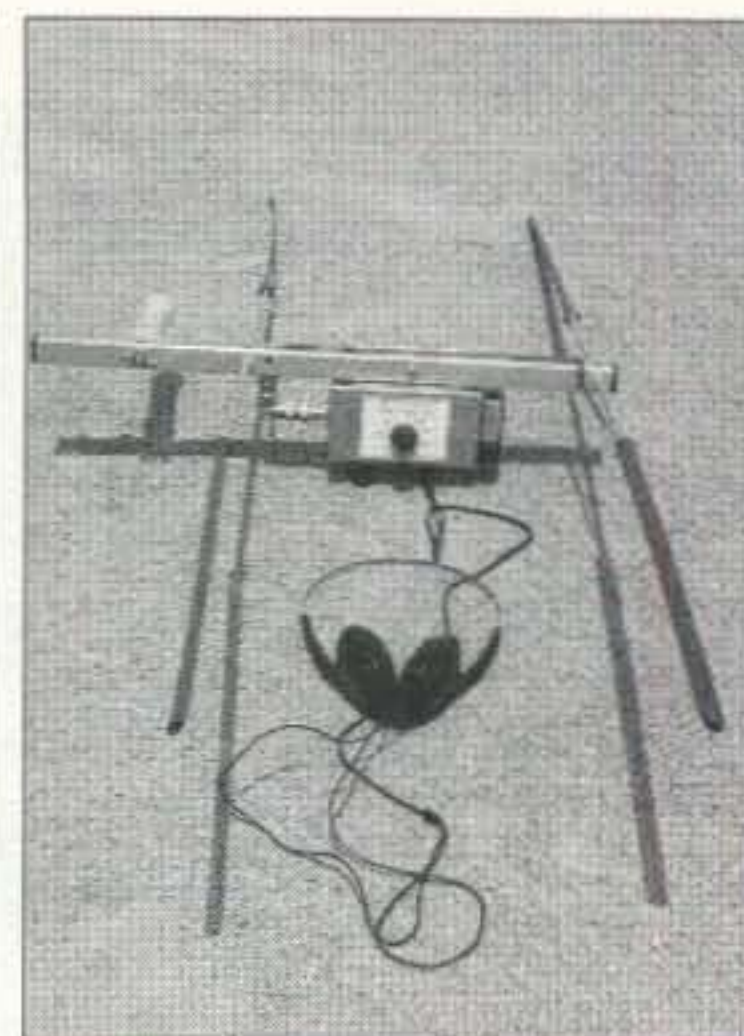

**Photo C.** The Ron Graham Electronics two-meter receiver/antenna set is designed for championship competitors. The optional wooden handle may be useful to some, but I have since removed it and just hold it by the end of its short boom.

tune in the fox signal while listening on the phones. Switch to the "whoopee" mode, reduce the RF gain control for a low audio tone and readjust the tuning control for highest pitch to center the signal. Now take bearings by turning the antenna in azimuth and listening for the highest tone, adjusting the RF gain control as necessary if the tone gets too high or too low.

Be sure to check with the antenna in both horizontal and vertical orientations and use whichever polarization provides the greatest signal (highest tone). Then walk toward the signal source (the direction of highest tone), reducing

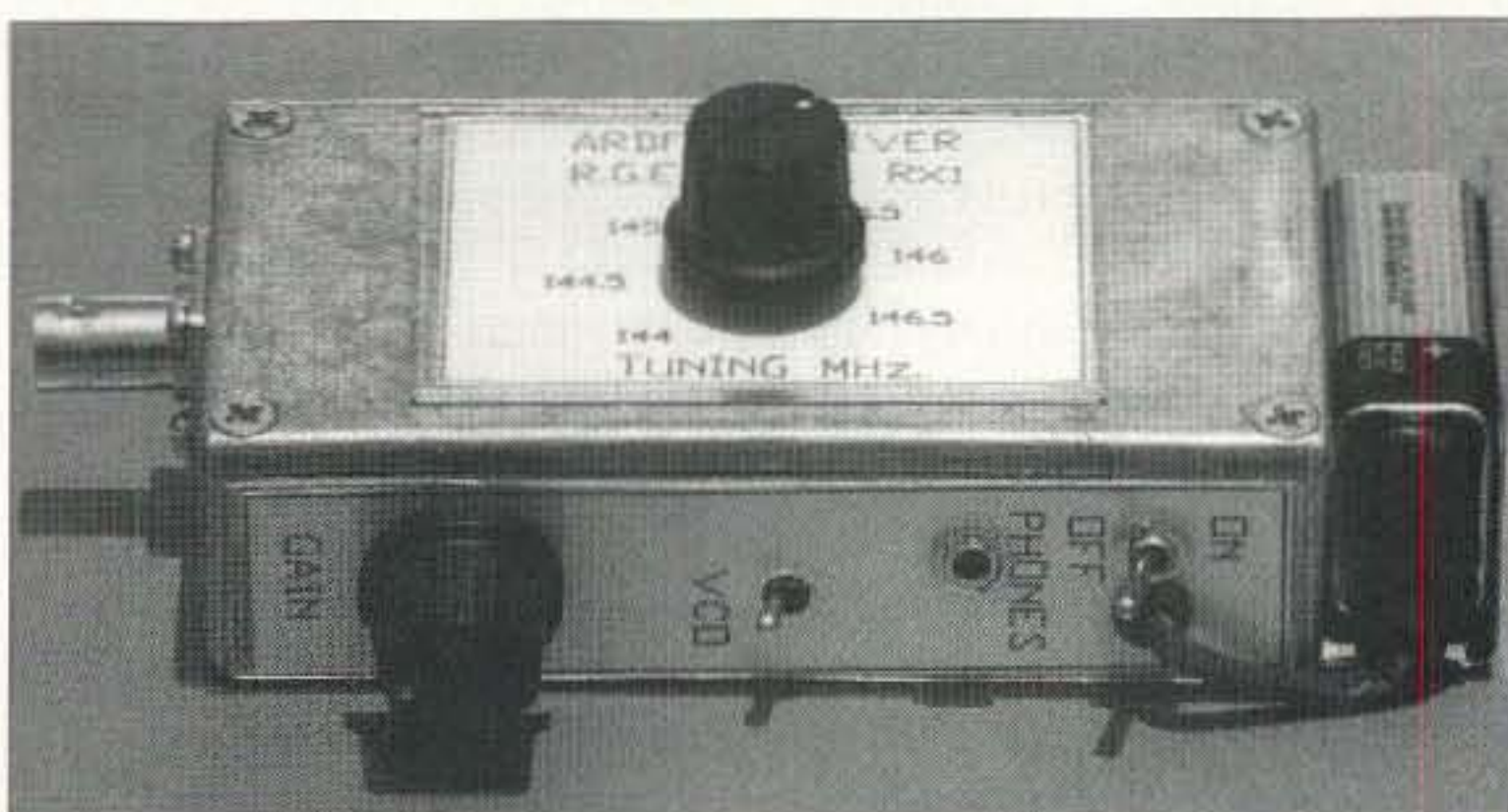

**Photo D.** The RX-1 is about the size of a cigarette pack and weighs twelve ounces. It includes a full-range attenuator and audible strength indicator (VCO mode).



# ON THE GO

## Mobile, Portable and Emergency Operation

Steve Nowak KE8YN/5  
1153 Malabar Road NE  
Palm Bay FL 32907

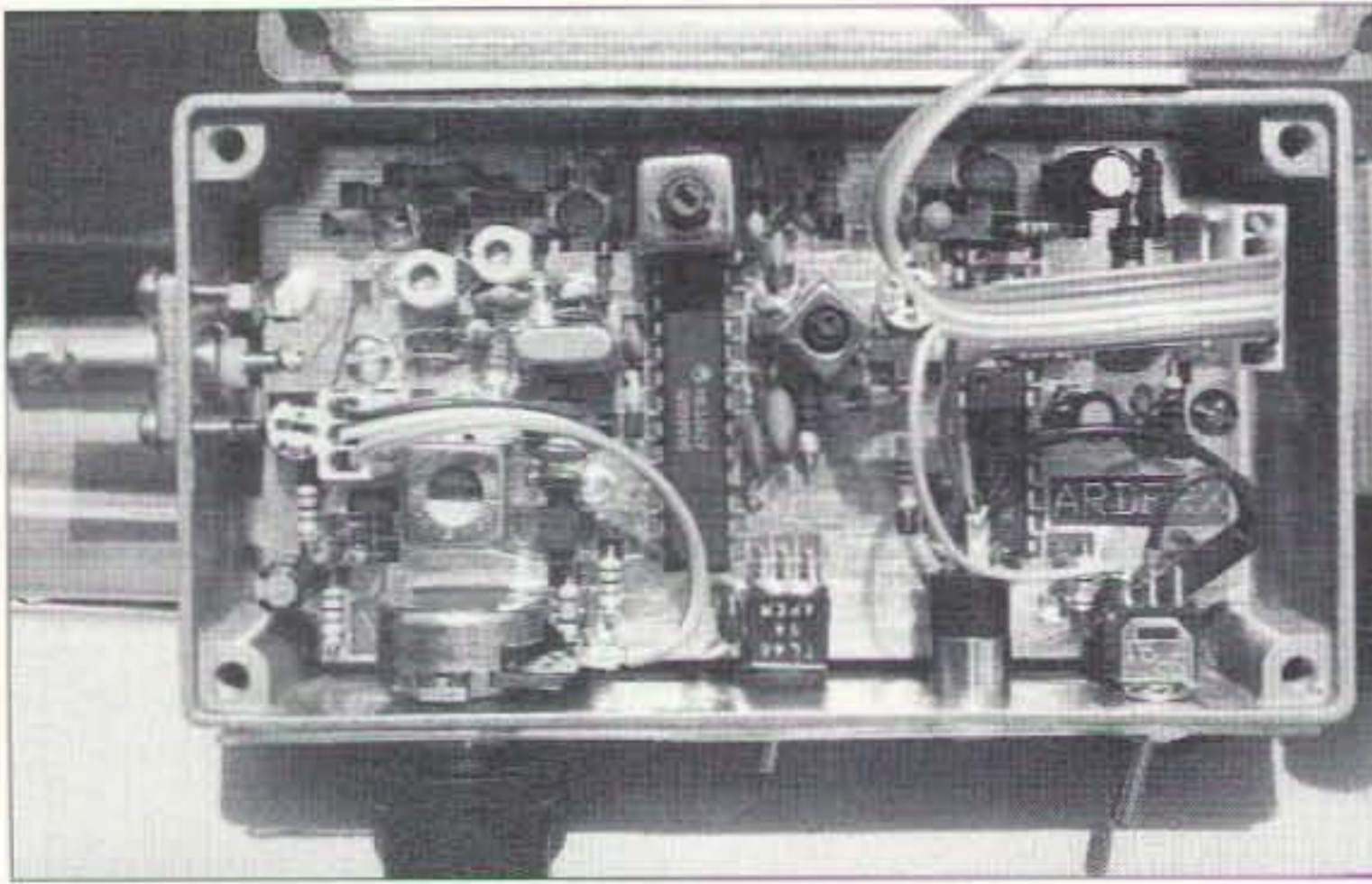

**Photo E.** Interior view of the RX-1 receiver. The MC3362 IC is voltage-tuned. A linear potentiometer on the cover is the frequency control.

the RF gain control when the pitch gets too high as you approach the fox. After a bit of experience, you'll be able to roughly judge distance to the fox based on the setting of the RF gain control.

With supplied components, the RX-1 covers only about 60% of the two-meter band. The dial marks are 144.0 to 146.5, but you can change the range by re-tuning the inductor in the first local oscillator stage of the MC3362. It is possible to change fixed resistor values in the tuning circuit to increase coverage to the full 4 MHz, but the single-turn frequency adjust potentiometer is already a bit touchy and this would make it even more so. Some Australian users have replaced this potentiometer with a ten-turn "knob pot" to give more bandspread and make it easier to find the hunt frequency.

Voltage to the local oscillator is well regulated, so tuning remains rock-solid as battery voltage falls from 9 V to 6.5 V. At 32 milliamperes typical current drain, battery life should be about 14 hours. Sensitivity falls off slightly as battery voltage droops to 7.5 V, then it diminishes more rapidly. It's down 15 dB at 7 V and 30 dB near end of life at 6.5 V. The battery mounts externally in its own cradle, where it's very easy to replace, even in the middle of a foxhunt.

Resting (no signal) pitch of the audio S-meter also drops

lower as the battery drains. You can use this characteristic as a good indicator of battery status. Q of the tuned circuits in the preamp stage is such that sensitivity falls off about 6 dB at the band edges when peaked at band center. This is not a problem under most foxhunt conditions.

In many countries, two-meter fox transmitters use amplitude modulation. For this reason and to simplify the audio S-meter function, the RX-1 has an AM detector stage. You can tune slightly off frequency to "slope detect" FM signals. This is good enough to identify a hidden transmitter signal from others on the band, but you won't want to use this set to monitor your local repeater.

European/Asian foxhunters use headphones so that their "whoopie" indications aren't heard by other competitors. The RX-1 is intended for headphone listening, too. They aren't supplied, but inexpensive Walkman™ types work fine. The LM386 output has enough power to drive a small speaker, but there's no room for it in the box, waterproofing would be a problem, and battery life would suffer. So stick with the phones.

Besides radio-orienteeing, a one-piece RDF set like the RX-1 is ideal for "sniffing out the bunny" at the end of your club's mobile hidden transmitter hunts. I have used it on several recent southern California T-hunts with

### Little or no warning

At times, it seems that science is getting better at predicting the type of situations where we might be called upon to serve. The ability to predict hurricanes has seemed to improve over the last few years, but then scientists discover the El Niño, La Niña phenomenon, and new questions are suddenly raised. Earthquake predictions, on the other hand, have generally been less than optimal. Nevertheless, we can be lulled into a false sense of security that we will get adequate warning of an impending disaster.

How does this affect us in our efforts to provide emergency communications? While amateur radio is primarily a hobby, it is one of those that can place significant demands on us. Let's compare this with other hobbies. A running enthusiast who wishes to run in a marathon (or even a 10 kilometer race) practices, trains, and prepares for the race for weeks or months before the day the race is to be run. He or she may prepare a training schedule which not only addresses physical training requirements but also a dietary plan, and

culminates on the day of the big race. The idea of a race being called with only a few hours' notice would be absurd. On the other hand, much of the time we are called upon to assist in emergency communications, it is with little or no warning.

Disaster or emergency communications support can be as physically, emotionally, and psychologically demanding as an athletic contest. It is not unusual to be called upon to work long hours for several days providing communications under austere conditions. How can we train for our potential communications marathon? Here are a few suggestions:

1. Try to use those skills you would need to use in an emergency.
2. Try to simulate some of the actual conditions you would encounter.
3. Try to promote the art and science of amateur radio.

Many of us are fairly comfortable chatting on the local repeater, or rag-chewing on the low bands. Hams describe their equipment, where they are, what they're doing. Conversations are

good results. In one case, the hidden antenna was mounted to be polarized at 45 degrees, between horizontal and vertical. This was immediately evident as I began the on-foot portion of the hunt, and I got nearly perfect bearings by canting the RGE antenna to match the 45 degree polarization.

Once constructed and tuned up by a competent builder, the RGE receiver/antenna combination is a sensitive, effective and easy-to-use RDF tool for two meters. Total cost of the receiver

kit, antenna and shipping is about 150 US dollars. For more information, write to Ron Graham, Box 323, Sarina, 4737, Queensland, Australia. Ron has a Web site; you can get there by link from the "Homing In" site.

Dale Hunt WB6BYU took his RX-1 to Japan in September for an international foxhunt sponsored by the Friendship Amateur Radio Society. Read about Dale's experiences and about plans for a multi-nation foxhunt on US soil in next month's "Homing In." 73



casual and spontaneous. This makes for interesting conversation and is appropriate most of the time. However, during emergency communications we need to modify operating procedure to be concise and accurate. A great way to practice this is during network operation. When the ARES, RACES, or repeater net is running, try to practice this style of communication. Perhaps net control would divide the net into two segments, the first requiring emergency-style communications, the latter being more social. The informal portion might be the time to include announcements or the swap and shop segment.

Use public service events for practice. When providing communications for a road race or a parade, agree to use the emergency style during the actual event. Before the event actually begins, and after it ends, drop back to a more casual style.

Another skill that may need to be worked on is to actually copy, in writing, the activity heard on the air. During a local net, preferably one where you do not recognize everyone's name and callsign as soon as they start speaking, try logging callsigns, names, locations, and the time they checked in. When you feel comfortable with that, offer to fill in as net control on occasion. As hard as it is to believe, most net control operators sometimes work late, have equipment problems, and even take the occasional vacation.

What about the conditions you might face in a real disaster? Don't count on the local repeaters being operational. How effective will the net be without the repeater? Neil Sedotal KC5BLQ, the Emergency Coordinator for the Baton Rouge area, periodically calls the emergency net on the usual repeater, then instructs all stations to go to battery power on a simplex frequency. This can be a real eye-opener as to how well a particular area would be covered under disaster conditions. While we get a taste of this during

Field Day, it is one thing to operate a bank of stations from one location powered by a generator, and quite another to operate on VHF from a number of locations.

Even operating using a battery-operated handie-talkie may not be realistic if you're loading it into a beam at 125 feet. It is better to use the type of antenna you would be using if working from a high school gymnasium being used as a shelter.

Finally, don't forget that amateur radio is fulfilling a commitment to the community. When operating at a road race or a parade, try to get the sponsors to include recognition of the fact that communications is being provided by amateur radio. Many times the average citizen is unaware of the fact that hams are providing support. Friendly rivalry among local clubs may cause us to emphasize that a particular group is responsible, which may be meaningless to those outside the hobby. When successful companies advertise, they aim the message at the customer, not their competitors. This is an excellent time to show others what an important asset we are. Have a banner made up that says in large letters, "Communications Support by Your Amateur Radio Neighbors." The club name can still be included, but shouldn't detract from the main message.

If we could plan effectively for bad weather, flooding, earthquakes, or other emergencies, they would not be disasters. They are disasters because they give little or no warning. As the Boy Scouts say, "Be Prepared!"

#### Temporarily off line

On a personal note, I've been cut off a bit from comments for the last month or so because I have been in the process of moving from Louisiana to Florida. This has restricted my ability to get mail, and the phone system where I've been living temporarily is not friendly to the modem on my computer. By the time

you read this, I'll be settled in my new home (and hopefully getting my antenna farm transplanted). If you've tried to contact me without success, I apologize. I look forward to your letters, packet messages,

radiograms, and E-mail messages. This is your column as much as it is mine. Please continue to share your ideas, experiences, and suggestions. Like any other ham, I do best with two-way communications. 

## Radio Bookshop

Phone 800-274-7373 or 603-924-0058, FAX 603-924-8613, or see order form on page 88 for ordering information.

### Wayne's Five Buck Books & Stuff:

**Boilerplate.** 45 of Wayne's ham oriented editorials. Great material for club newsletter editors who are always short of interesting items for filler.

**Submarine Adventures.** Wayne's WWII adventures on the USS Drum SS-228, now on display in Mobile, Alabama.

**Wayne's Caribbean Adventures.** Scuba diving and hamming all through the Caribbean. 11 islands in 21 days on one trip? You bet, and you can't beat the price either.

**Wayne & Sherry's Travel Diaries.** Cheapskate traveling to Russia, Europe, and so on. Now, how did Wayne and Sherry fly first class to Munich, drive to Vienna, Krakow, Prague, and back to Munich, staying at excellent hotels and eating up a storm, all for under \$1,000?

**Cold Fusion Journal - Issue #20.** Read the latest scoop on cold fusion in this whopping 92-page sample issue. Cold fusion dead? No way!

**One-Hour CW Course.** How anyone can pass the 5 wpm code test with less than one hour of study. This also explains the simplest system for learning the code at 13- and 20-per ever discovered. Or, do it the old fashioned (ARRL) hard way and suffer. Your choice.

Other, Slightly More Expensive Stuff:

**Pure Silver Wire** for making those miracle silver colloids. Two 3" lengths of #10 99.999 pure silver wire \$15. Should last for years.

**Bioelectrifier Handbook.** Background, circuits, uses, etc. \$10.

## MultiMode



# BayPac™

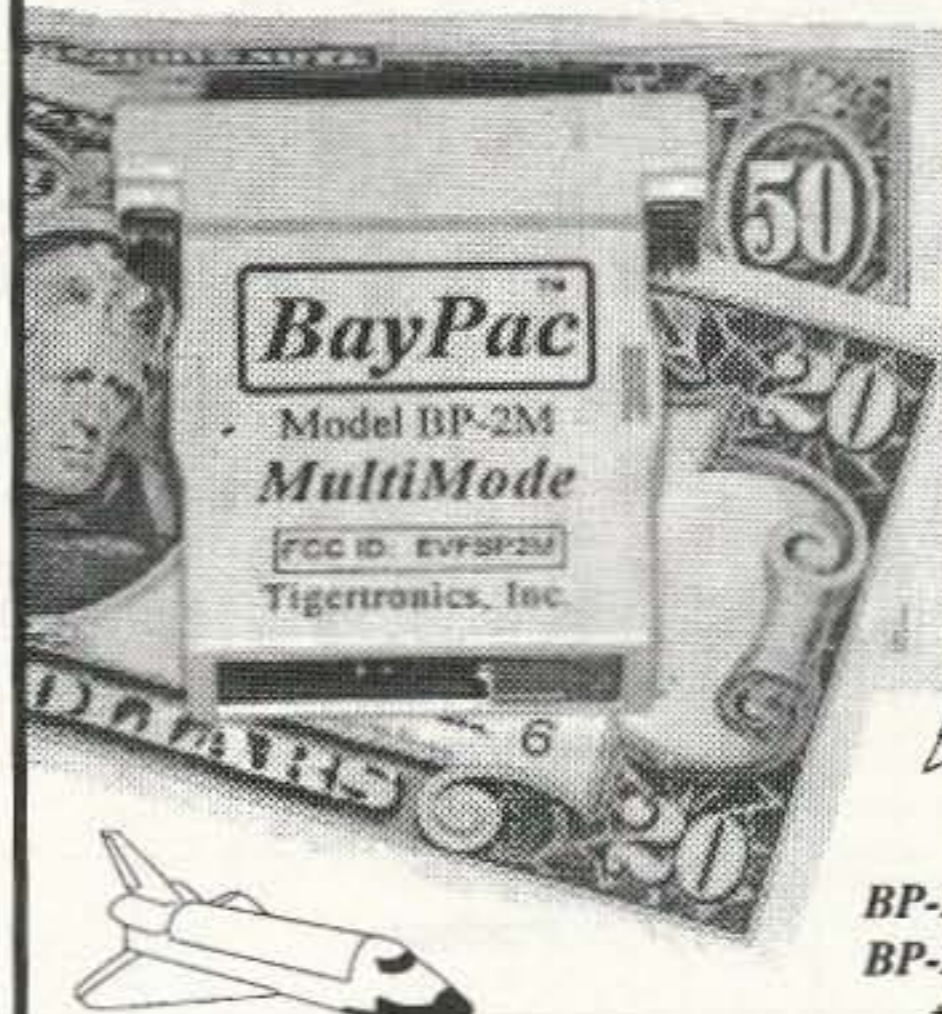

SITOR A/B  
ARQ/FEC  
BAUDOT  
PACKET  
NAVTEX  
FAX 480  
AMTOR  
WEFAX  
SYNOPSIS  
ASCII  
RTTY  
SSTV  
CW  
More...

BP-2 Packet Only \$49.95  
BP-2M MultiMode \$69.95  
+ \$5 Shipping & Handling

The best little packet modem just got better! Building on the tradition of the BP-1 Packet Modem, we are very proud to announce the BP-2 and BP-2M. The BP-2 is a new and improved version of our famous BP-1, while the BP-2M expands your horizons even further with MultiMode operation! So, whether you have been waiting to automate your CW, checkout AMTOR or just copy Weather Fax - Now is the time for you to jump in and join in all the fun!

**Tigertronics**  
INCORPORATED

Call Today! 1-800-8BAYPAC

800-822-9722 (541) 474-6700 Fax 474-6703

World Wide Web: <http://www.tigertronics.com>



Tigertronics, Inc. 400 Daily Ln. P.O. Box 5210 Grants Pass, OR 97527

CIRCLE 269 ON READER SERVICE CARD



# THE DIGITAL PORT

Jack Heller KB7NO  
712 Highland Street  
Carson City NV 89703  
[jheller@sierra.net]

## Keep that mail coming

You readers give me some truly great ideas through your correspondence. It comes in all flavors, E-mail and snail variety, and there are suggestions and solutions as well as questions. One of the most popular subjects has concerned my occasional omission of key facts such as Internet addresses. For several months, you folks were asking about the address at which to find XPWare (line 1 in **Table 1**). By now that has probably fallen off the wish list of most readers, but I hope this chart will be of at least some help by providing that and some other addresses of possible interest.

Dan KA3ZOF sent some ideas about solving serial port problems with diagnostic software. He gave me names of software packages. I ran a few searches on the Internet and found them located on a Web site loaded with useful files. The page address is listed on line 2 in the chart. I found three files referred to in Dan's message and downloaded them.

The largest file, MODEMD60.ZIP, required unzipping with a copy of PKUNZIP from PKWare. I found it to be a very well-written, powerful utility that displays the ports and their addresses and IRQs, and has

extensive documentation. More than just a listing of what the system is doing, it contains helpful suggestions about configuration, too.

The other two files were also compressed files. The difference was that they were compressed with a different system evidenced by the ARJ extender. There were many files listed with this compression scheme for which I did not have the decompression program.

Following a bit of logic, I hunted around the site and found a reference to a Main Index page. And there I found the real meat of the site. There are listings of numerous useful utilities to meet the needs of computer users of all types. And, yes, I did find the file, ARJ250.EXE, to compress/decompress using the ARJ archive system. It works in a straightforward way—that is, if you consider the use of PKWare as the norm. The commands are similar anyway.

## Don't try this at home

So that was a good adventure. However, one of the files I downloaded got me in a little trouble. The file MDMLITE.ARJ is a little utility to place a set of pseudo LCD lights on the screen to show when your modem is connected or transferring data. Sounds like fun. I made a quick attempt to watch it work with the copy of BayCom in this desktop computer.

In the process, I hooked up the serial cable to the BP-2M, turned on the W2A, and made a connection to the local PBBS. According to the authors of BayCom software, this won't work while I'm in a DOS window with Windows™ running, so I had never tried it. But it looked OK and here I was, happy as a clam, as I left to eat dinner while the automatic tape backup ran at that time of evening.

On my return the backup was concluded, but there was something not quite right. The cursor would not respond to the mouse. After going through a lot of extra calisthenics to close open files and shut down the computer, I was sure all would be well. "Well" is defined many ways, I guess. The mouse functioned after a reboot, but the tab key was executing a peculiar code. After another cold boot the system settled down. I learn very slowly.

By now, most of you realize that the BayPac™ BP-2M has occupied more of my time than I would like to admit. As of this writing, I have not gotten the multimode operation (e.g., AMTOR, RTTY, etc.) to function. The HamComm software package comes with some great diagnostics, and I think I have isolated the problem, but I am awaiting an E-mail reply from the author, W. F. Schroeder DL5YEC. (E-mail is quick, but the ham at the other end must translate my message, determine what I really asked, and then reply in English.)

Along the way, Don KA6LWC sent a note concerning the connec-

tion pinout I had published a few months back for the 9-pin-to-25-pin serial adapter cable. This one set me to thinking that perhaps the BP-2M multimode problem was a connector fault. He explained that the case of the 9-pin end should connect to the #1 pin on the 25-pin connector. I checked and, sure enough, it wasn't wired that way. Pin #1 is meant to be used for a chassis ground.

I was ready to rewire, but first I slipped the housing off the BP-2M and discovered there was no internal connection for that pin. Saved some time. The reason for the look-see was prompted by a more detailed sheet I located on serial cable and adapter combinations.

## Quality ham freeware for Windows 95®

Speaking of the Internet and available software for hams, I found a reference in a TAPR newsgroup to a site with freeware that works with the BP-2M under Windows 95 to do packet. The site is listed on line 3 in the chart. I hope you will be as impressed as I was. I admit I was skeptical at first, because whatever is free usually has a catch to it.

But George is serious about his programming. It isn't a difficult installation, but there is a slight communications barrier. However, if you apply a little patience and persevere to sort out the directions, it pays off (they are in English, but Greek-to-English is difficult at best). The program is excellent, although George does make modest statements about the need for further development.

Along with the modesty, there is a certain frankness about those who would install his software. George flatly states that if you do not know how to make your own shortcuts, his programs are not for you. I have to admit that sounds a little narrow, but just to show him, I never made the start-up shortcuts and the program still plays great. I have so far just brought the program to life from the "Run" window.

Line #	Source	Product	Address
1	XPWare	Multimode TNC Software	www.goodnet.com/~gjohnson/
2	Internet Web page	Utility software collection	www.dc.ee/Files/comm/
3	SV2AGW	Win 95 ham freeware	www.forthnet.gr/sv2agw
4	TAPR	Digital hardware and software	www.tapr.org
5	HamComm	Multimode modem software	www.accessone.com/~tmayhan/schem.htm

**Table 1.** Chart of addresses. These are the Internet addresses referred to in the article. Line 2 refers to a Web page for which I could not find a precise name listed on the home page, but the content is good.



If you go after this software, there are three files you must download. You will need the AGW Packet Engine, the heart of the system. However, this program will not function unless you download the system file, unzip it and install BWC32.DLL in your Windows/system directory.

The Packet Engine requires configuring, which is accomplished by right-clicking its button on the task bar and selecting properties. Remember, this is Windows 95 lingo. I don't think this program is available for Windows 3.1. You find the instructions on the Web page—no README files—so you may have to go back to check the info a few times.

Once you have these two in place, the AGW Terminal program, the third file you must download, can be unzipped and is ready to be executed. The configuration is very simplistic. You have already accomplished it in the Packet Engine. As a matter of fact, I looked for a specific configuration file and found no such name. You are ready to go except for clicking the File menu, choosing properties, and entering your call.

### Putting the SV2AWG freeware to work

The screen shot (see Fig. 1), is noteworthy. The pull-down menus are simple. The Help file is empty. George claims the program is so intuitive, you just don't need instructions. That is practically true. I pulled down the Actions menu and found the connect command and was on my way.

The first connect was displayed on the screen in a barely readable font size. I then realized the default point size was 6. Increasing to 12 relieved the eye strain. The fonts displayed on the screen can be chosen from a long list. You will notice two fonts in the picture. I changed fonts in the middle of a message download—just to see.

I hunted around on the node I was using in Reno, found a small functional ham BBS, W7UNR, at the local university, and connected to it to watch the

system work. George claims you can have a hundred ports open at once. I like to keep life simpler than that, but that is an impressive number.

This program is not specifically written for the BayCom-style modem. The original version is meant for use with a regular terminal node controller (TNC). The BayCom capability was just recently written into the original program. George also has available on his Web site a logging program, a BBS program, and a DX Cluster program. I say they are worth looking into.

### Kits for TNC?

Some have asked if there are any kits to build a terminal node controller (TNC). The only kits I am aware of at this time are from the Tucson Amateur Packet Repeater group (TAPR) (see line 4 in chart) and another from the BayCom people in Europe. Neither of these is a TNC, but a modem that is software driven. There is one hinted about in some messages from the UK which I think is similar again.

TAPR at one time marketed a kit to assemble your own TNC, but that has been discontinued. They operate as a nonprofit organization, and the requests for support overwhelmed them. It became one more of those modern technology developments that is more practical to purchase than to build.

The modems, however, are popular and the plans are readily available. On the Internet (see line 5 in the chart) you can find HamComm's recommended schematic complete with parts list.

I purchased mine assembled, in the interest of time. The real challenge is software—there are many packages available. Last month, I listed the software I had found—and there is still more to come.

Nearly all software being developed is shareware, so you can try it for fit before you buy. Shareware is often not well polished and the support is limited, but if it is out there, it has worked for someone. If you spend a little time and experiment you

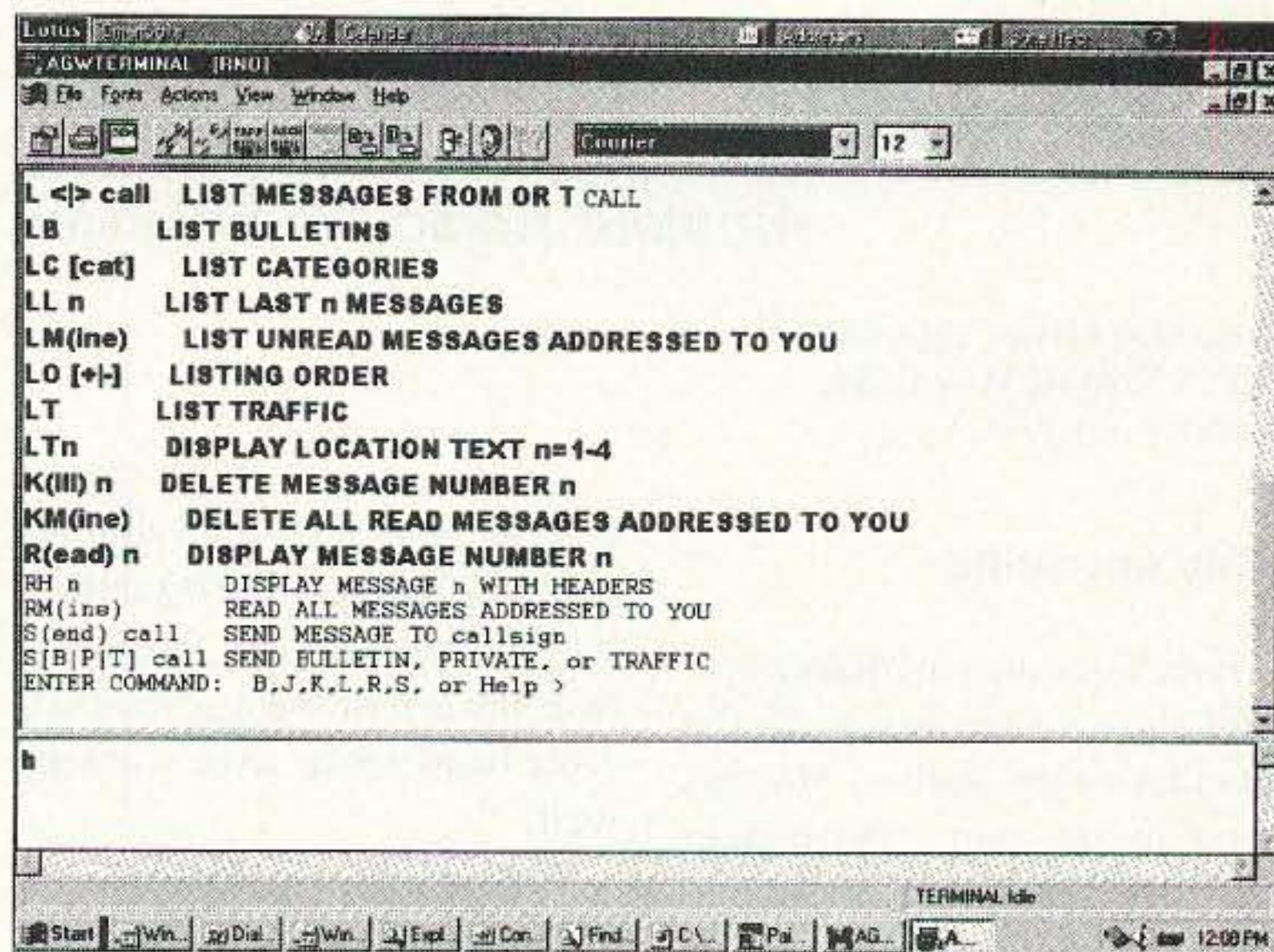

Fig. 1. SV2AGW freeware Win95 terminal program in action. Note different fonts.

will usually find what you are looking for. Plus, if it is almost right, you can contact the author and he may just add what you want and keep it in there for future releases.

If you have questions or comments about this column, please

E-mail me at the address above and/or CompuServe [72130,1352]. I will gladly share what I know or find a resource for you. On packet, when you get a chance, drop me a line at [KB7NO@N7NPB.# NONEV. NV.USA.NOAM]. For now, 73, Jack KB7NO. 73

## WE DON'T BUILD THE MOST, WE JUST BUILD THE BEST!

- Our LM-470D is now redesigned to hold 15 ft. of antennae at 70 mph!
- Tri-Ex builds the finest in crank-up, free-standing or guyed towers.
- All towers are complete with rigid concrete base mount.

**CALL  
OR WRITE  
FOR A FREE  
CATALOGUE!**



**Tri-Ex<sup>®</sup>**  
**TOWER CORPORATION**

7182 Rasmussen Ave. • Visalia, CA 93291

Where engineering and quality come first!

TO ORDER CALL  
800-328-2393

FAX  
209-651-5157

CIRCLE 22 ON READER SERVICE CARD



# HAMSATS

## Amateur Radio Via Satellites

Andy MacAllister W5ACM  
14714 Knights Way Drive  
Houston TX 77083

### Mirly operating

Ever since an American astronaut took up residence on the Russian space station, *Mir* has been in the news. Astronaut Norm Thagard went to *Mir* in March of 1995, and there has been an American on board ever since. Less than six months ago *Mir* was a party to a collision in space with a resupply ship. Since then there have been guidance computer problems, power shortages and life-support system difficulties. Questions were raised about sending any more astronauts to the station. At the last minute before the launch of *Atlantis* in September, NASA decided to continue the program and sent Dave Wolf (KC5VPF) to *Mir* to replace Mike Foale (KB5UAC).

There were problems with *Mir* prior to American participation, but the difficulties were not as prominent in the news in the US. On the positive side, all the experience gained with *Mir* will aid in planning and operation of any future multi-national space station.

While the radio, TV and newspapers reported difficulties and hardships on *Mir*, amateur radio voice and packet activity from the space station seemed unaffected. Primary operating frequencies have been changed and experiments on 70 cm FM have been conducted without interruption. As long as there are astronauts or cosmonauts on *Mir*, there will be some form of ham activity.

### Listening for *Mir*

Two-meter voice and packet operation are the dominant ham activities on *Mir*. The primary frequency is 145.985 MHz. Other frequencies have been

used in the past (145.55 simplex and 145.200-up/145.800-down), but the new simplex frequency near the top of the amateur satellite band seems to be working well.

The easiest way to listen for *Mir* is to set a two-meter radio or scanner on 145.985 MHz FM. Variables like Doppler shift, antenna orientation, distance and other factors will make a solid copy difficult on a simple system with a whip antenna, but most passes will be detected in time to switch antennas or orient the receiver and do some fine tuning for best reception.

The best option is to track the space station with beam antennas while continuously correcting for frequency shift, but good results can be had simply by leaving a squelched receiver

with an omnidirectional antenna on all the time. It is even possible to make contacts with *Mir* using a simple system and calling for *Mir* when reception is best. The voice callsign for *Mir* is RØMIR, although Dave Wolf may use his own call. The packet callsign for the onboard Personal Messaging System (PMS) is RØMIR-1. The packet system is on all the time. Voice contacts are only possible when a crew member is available, and the crew is only up when Moscow is awake. Thus voice contacts usually occur in the early morning or evening (Moscow time).

### Improved procedures

For serious *Mir* operation it is best to use a tracking program and current *Mir* Keplerian element sets. AMSAT (The Radio Amateur Satellite Corporation) sells tracking software for PCs and other computers. There are also programs available for free or as shareware that can be just as effective for *Mir*. A good place to start for software and

orbital element sets is the AMSAT site on the Internet. The Universal Resource Locator (URL) is [http://www.amsat.org/]. Even if your antenna is only a simple outside ground plane, knowing when to listen and how much Doppler shift to expect is very helpful. Other Internet sites to check for *Mir* information include: [http://www.grove.net/~hearsat/], [http://shuttle-mir.nasa.gov/] and [http://www.maximov.com/mir/mir2.html].

On two meters the Doppler shift is usually no more than 3.5 kHz on an overhead pass. At the beginning of the pass the signal will come in high. When the space station is at its closest approach there will be no apparent shift, and when *Mir* is moving away from your location the signal will be low in frequency. For most radios that tune in five-kilohertz increments, three receive/transmit memorized frequency pairs can be programmed. Memory one should have a receive frequency of 145.990 MHz and a transmit

```
>>> 00:05 Connected to RØMIR-1
Logged on to RØMIR's Personal Message System
CMD (B/H/J/K/KM/L/M/R/S/SR/V/?)>
```

Msg #	Stat	Date	Time	To	From	@BBS	Subject
239	P	09/23/97	07:56	RØMIR	W5ACM		Hello from Houston!
238	P	09/22/97	18:31	NASA5	N6CO		World News 9/22
237	PR	09/22/97	18:30	ALL	N6CO		2 Line <i>Mir</i> Keps 9/22
236	P	09/22/97	18:29	NASA5	N6CO		Misc
235	P	09/22/97	13:49	RØMIR	WF1F		Mike
234	P	09/22/97	13:10	RØMIR	VK2JYE		C RØMIR-1
233	P	9/22/97	12:08	ZL1AKJ	RØMIR		QSO
215	PR	9/20/97	10:32	ZL3TDA	RØMIR		Welcome back
214	PR	9/20/97	10:21	VE3VRW	RØMIR		Thanks
213	P	9/20/97	10:20	VE7IMM	RØMIR		Fly safe

```
8725 Bytes free
Next message Number 240
CMD (B/H/J/K/KM/L/M/R/S/SR/V/?)>
- Logged off
>>> 00:11 Disconnected from RØMIR-1
```

Table 1. Logging on to the *Mir* PMS.



frequency of 145.980, memory two can be set for 145.985 MHz simplex, and memory three should have the receive set to 145.980 MHz and transmit on 145.990 MHz. Tune the receiver for best reception during the pass. The appropriate transmit frequency will already be set.

### Working the PMS

The Personal Messaging System on *Mir* is very similar to other radio bulletin board systems (RBBS). The only difference is that this one covers almost the whole Earth twice a day and is a moving target. It uses standard packet radio at 1200 bps AFSK on FM. The commands are simple. Their letter representations are shown at every command-line prompt from the system. Familiarity with packet operation is essential since tracking, Doppler, timing and competition with other unheard stations are all happening simultaneously. A typical *Mir* pass will only last 10 to 12 minutes, so there's not much time for mistakes. **Table 1** shows some typical text as received from *Mir*. In this example the connection to *Mir* was established by connecting to RØMIR-1 using a small FM transceiver with amplifier and beam and a Tigertronics Bay Pac BP-2M. An old 286 laptop was used to run the Baycom software. After the connection had been established, the "L" command was sent to show the last 10 messages in the system. The "B" command is used to log off. To send a message to the crew it is appropriate to use the "S" command followed by RØMIR. You will be asked for "Subject?" and "Message:" When done, simply send a "/" EX" or CONTROLZ to save the exchange. Memory is very limited in the PMS, so it is not a good idea to send long messages. You should also not send messages to stations other than those on *Mir*. The PMS is for the *Mir* crew and not to be used as a store-and-forward system for ground-based users. There are

other digital satellites that perform that function. The "H" command provides a list of the command letters and their meanings. You can expect to have a message waiting for you in a day or so in response to any that you post to the *Mir* crew. **Table 2** shows an example of a log-on that announces new mail.

### Other packet operations

The packet system on *Mir* is not only a bulletin board in the sky. It is also possible to work RØMIR direct. This would be a connected two-way, keyboard-to-keyboard packet QSO. Before the PMS, this was the standard packet contact. Another use of the system is to use the digipeat function, or just to send transmissions using the UNPROTO mode. Direct connections using *Mir* are not recommended, but UNPROTO operation is accepted since it does not use excessive resources for retries. To set the UNPROTO mode in your Terminal Node Controller (TNC) type the command "UCQVRØMIR". Switch to the CONVERSE mode and see what happens. It is possible

to pass on messages to other stations within the 1000-mile wide footprint of *Mir* as it passes overhead.

### Getting a *Mir* QSL

Years ago it was difficult to get a QSL card for a *Mir* voice or packet contact. The card had to go to the Soviet Union for processing. Sometimes the wait was long. Other times the wait never ended. Today it is not a problem. The US QSL manager for *Mir* is Dr. Dave Larsen N6CO. Dave is the system operator (SYSOP) for the *Mir* PMS and he is the head of MIREX operations in the US. MIREX stands for the *Mir* International Amateur Radio Experiment. It was formed to handle prescheduled *Mir* school contacts. Dave's address is P.O. Box 1501, Pine Grove CA 95665. Dave's Internet address is doc@volcano.net, and the packet address is N6CO@N0ARY#NOCAL.CA.US.A.NOAM. When requesting a *Mir* QSL don't forget to include all pertinent information on your QSL card and to provide a self-addressed, stamped envelope (SASE) for the return card.

### Special *Mir* Achievement Award

Earlier this year Dave announced a new award for those who had completed both voice and packet contacts with *Mir*. It is a personalized color certificate (8 x 10) with a photo of *Mir* prominently displayed in the center. My certificate is shown as **Photo A**. The certificate shows the callsign RØMIR regardless of the callsign(s) worked. My contacts were for a voice QSO with U2MIR in 1988 and a packet contact with U2MIR in 1991. To get the certificate send Dave a \$10 donation along with copies of your *Mir* packet and voice QSL cards. Return postage is covered by the donation. Use Dave's *Mir* QSL address shown above for certificate requests.

### Future *Mir* operations

In September, *Mir* moved to 70 cm for a three-week test. In recent years the interference on two meters (even in the satellite band) has been excessive. A new operating frequency was chosen on 437.650 MHz to find out if a

```
>>> 23:09 Connected To RØMIR-1
Logged on to RØMIR's Personal Message System

You have mail waiting.

Msg#  Stat  Date      Time    To        From      @BBS  Subject
246   P      09/23/97  13:38   W5ACM     RØMIR     QSO

CMD (B/H/J/K/KM/L/M/R/S/SR/V/?)>
Posted      : 09/23/97      13:38
To          : W5ACM
From        : RØMIR
@BBS       :
BID         :
Subject     : QSO

>>> 23:15 Disconnected from RØMIR-1
```

**Table 2.** "Mail waiting" message from the *Mir* PMS.



# RTTY LOOP

## Amateur Radio Teletype

Marc I. Leavey, M.D., WA3AJR  
P. O. Box 473  
Stevenson MD 21153  
[ajr@ari.net]

### A LIT-tle chilly

It's December, and getting cold here in the mid-Atlantic states. And, I'm afraid, it's a LIT-tle bit chilly here in the shack—chilly because I made a little mistake, which I hereby correct.

In the October column, I responded to a question from Ted Bear W6RHB regarding the V20 CPU chip in his computer. In that column, I said:

"The old V20 chip, like its cousin the Z80, is poorly supported at this time."

Well, that's just wrong, wrong, wrong! Here's thanks to the E-mail kick I received from fellow columnist Michael Geier KB1UM, of "Ask Kaboom." Michael reminded me that:

"Actually, most DOS software, even including WordPerfect 5.1, will run quite happily on it. I have an old mini-notebook with a V20 or V30 (basically the same thing) in it, and it can run all kinds of things surprisingly fast."

In fact, the V20 was a second-sourced, updated 8088 chip, the same chip that was in the original PC. Michael also points out that:

"The CW software put out by MFJ (and written by Intellisoft) runs fine on it, and it's not a BASIC program. The CW copying capabilities of that program, though, seem pretty weak, no matter what kind of processor you use. I'm sure there are other DOS programs to read CW. In fact, those public domain disks sold at hamfests have plenty of them. They should all run fine on the V20."

The many simple programs in the RTTY Loop Software Collection should run as well. So, I stand corrected. Thanks, Michael.

### Gift time

Some time back, I began featuring in the December column items or sources of gifts for the RTTY-active ham. This month, I have rediscovered an old friend.

Fred Schmidt N4TT has been running Typetronics in Ft. Lauderdale, Florida, since the mid-1960s. I remember Typetronics when I was getting started about that time in ham radio, and especially when I was entering into the world of digital communication.

Here is your source for all things, and I do mean all things, related to Teletype™ machines. Parts including gears, keytops, covers, type bars, and even cranks are all available. Not satisfied with parts, Fred also stocks manuals for just about every machine, and consumables such as ribbons, paper tape, and paper. All of these, by the way, encompass not only machines of the Teletype Corporation, but Kleinschmidt and Mite teleprinters as well.

And besides all of these goodies, the stock at Typetronics also includes a number of terminal units, tubes, tools, and other accessories. In short, Typetronics is a one-stop shop for all of your teleprinting needs. Contact them at P.O. Box 8873, Ft. Lauderdale FL 33310; telephone (954) 583-1340. Be sure to tell them you read about it in RTTY Loop, okay?!

While we're on the subject of vintage machines, here's a place to see them, up close and personal. The North American Data Communications Museum bills itself as featuring Telephony Technology from Telegraph to Digital Transmission. Located at 3841 Reche Road, Fallbrook CA 92028-3810, it has on display 15

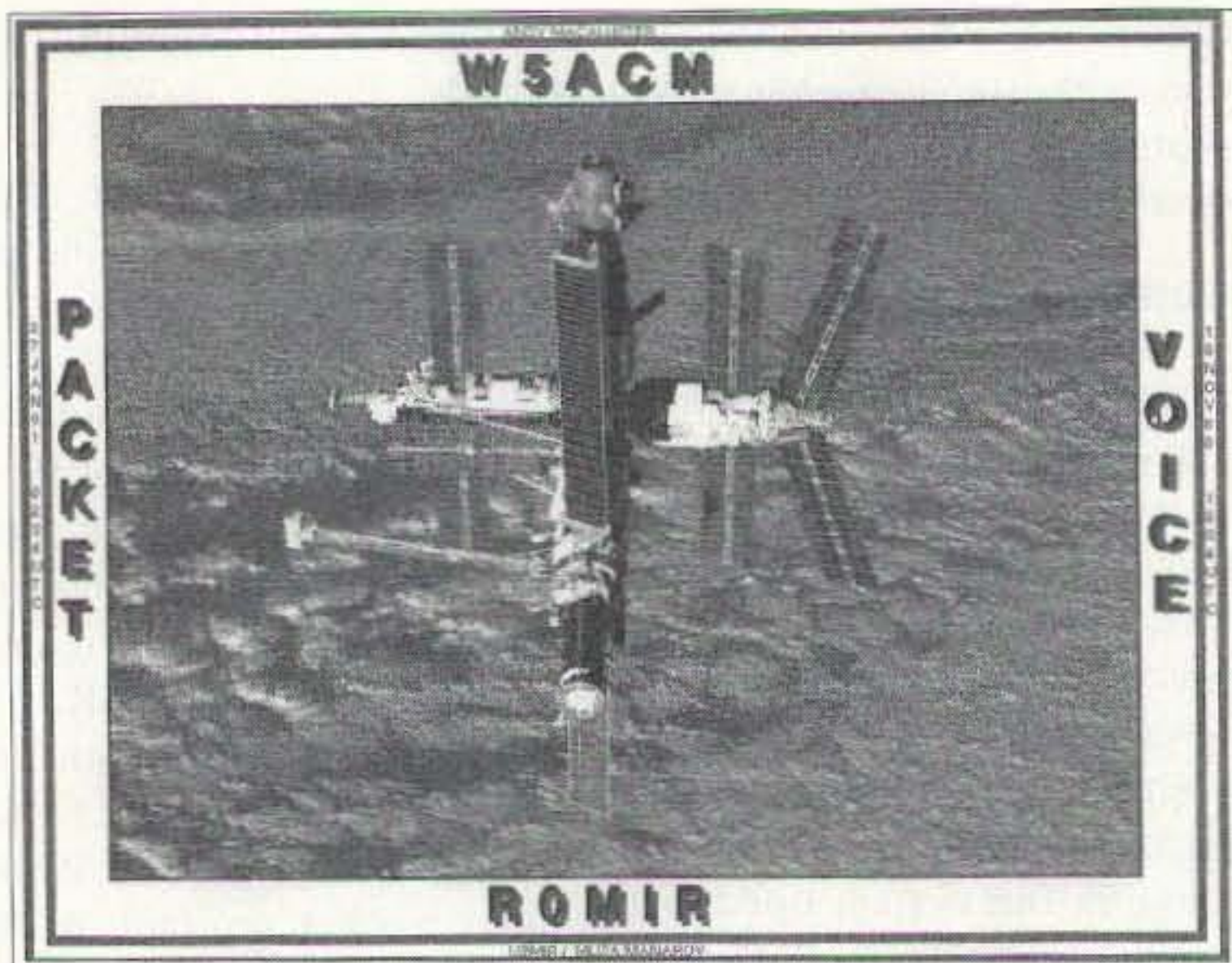

Photo A. The Special Mir Achievement Award for confirmed packet and voice contacts with Mir.

higher frequency band would be better. The results were mixed, but it was a beginning in the effort to escape the congestion on two meters.

Over 100 stations around the world made the transition to 70 cm. Voice contacts were logged and a lot of packet activity with the PMS took place. The radio on *Mir* is a dual-band Kenwood. It worked reasonably well during the experiment with the external dual-band whip. For terrestrial stations with beam antennas, signals were good. Doppler was the biggest problem. At 70 cm the shift can be as high as 20 kHz from beginning to end of an overhead pass. For all serious users this required effort for good voice communications and serious work for effective packet connections. While operations on

two meters are easier for ground-based stations, there is no interference on 70 cm for the *Mir* crew. Other ground-based two-meter activity and *Mir* VHF operations on 143.625 MHz are problems on *Mir*. More experiments on 70 cm may be scheduled in the future to find some relief.

### Straight Key Night

You're invited to join in the 26th annual Straight Key Night on OSCAR (Orbiting Satellite Carrying Amateur Radio), sponsored by AMSAT-NA for satellite enthusiasts worldwide. There are no rigorous rules and no need to send in any logs. Just call "CQ SKN" in the CW pass-band segment of any OSCAR from 0000 to 2359 UTC on January 1, 1998, or answer a "CQ SKN" call from another station. OSCAR Zero (moonbounce) contacts count also. Of course, all SKN operating must be done with a straight hand key.

Those participating are encouraged to nominate someone they worked for recognition as having the "best fist." To send in a "best fist" nomination, address it via E-mail to [w2rs@amsat.org], via packet radio to [W2RS@WA2SNA] or [W2RS@GB7HSN]. Those nominated will be featured in a bulletin sent to various ham publications and to the AMSAT News Service.

73

## Radio Bookshop

Phone 800-274-7373 or 603-924-0058, FAX 603-924-8613, or see order form on page 88 for ordering information.

### René's Books

**NASA Mooned America.** René makes an airtight case that NASA never landed anyone on the moon. Ridiculous, of course, so maybe you can be the first to find fault with René's 30 "gotchas." He sure convinced Wayne. \$28.

**The Last Skeptic of Science.** René blows holes in one cherished scientific dogma after another. Do you believe there have been ice ages? That the moon causes the tides? Another \$28 well spent.



### 35 ASR Teletype (1968)



35 ASR Teletype (c1967)

100 words per minute, 8 level ASCII coding, 110 Baud, 4 row automatic send and receive, 101C Dataset, Bell System dial TeletypeWriter eXchange (TWX) service. 4 row teletypewriters were deployed with their own switched network, called Wide Area Data Service (WADS) which was

separate from the national DDD network.

**Photo A.** You'll find this Model 35 ASR image—and many more like it—on the Web site of the North American Data Communications Museum.

different Teletypes; terminals; a DDS hub and end office; over 110 different test sets from telegraph to DS-1, and more, with Dataphones, Datasets, parts and datacomm accessories; not to mention over 100 volumes of literature and documentation. Take a look at their Web site at [<http://www.hem.com/nadcomm>]. Pictured is a look at the Model 35 ASR from their Web site's virtual tour of the museum. Check it out if you're in the area, or pop in over the Web.

Along with old machines and old paper, I received a question for a program that will output in Baudot, for use with a teletypewriter. I believe the old program RTTY 12G will do this. This program is about ten years old, and the documentation even mentions the IBM PCjr! Written by Glenn E. Welman KF4NB of Lexington KY, this is a small DOS-based program which, for that matter, may well run on that V20 mentioned above! I will add it to the RTTY Loop Software Collection, as well as feature it on the RTTY Loop home page for downloading.

There have been quite a few products promoted for lubricating old teletypewriters, since many of the "original" products are no

longer available. One such product which has been brought to my attention is "One Lube," available in the automotive department of most large variety stores. This lubricant is not likely to attract rodents and such, and seems to fill most requirements of teletypewriter lubrication. I would be interested in hearing from readers with other experiences in the realm of teletypewriter lubrication and maintenance.

#### Lore

As long as we are delving into ancient history, here's a piece of Teletype folklore that has recently surfaced on the Internet. The question was raised as to why teletypewriters printed in all upper case. As the story goes:

Decades ago, back in the days when it was the sole supplier of long-distance hardcopy transmittal devices, the Teletype Corporation was faced with a major design choice. To shorten code lengths and cut complexity in the printing mechanism, it had been decided that teletypes would use a monospace font, either ALL UPPER or all lower. The Question Of The Day was, therefore, which one to choose. A study was conducted on readability under various conditions of bad

ribbon, worn print hammers, etc. Lowercase won; it is less dense and has more distinctive letter forms, and is thus much easier to read both under ideal conditions and when the letters are mangled or partly obscured. The results were filtered up through management. The chairman of Teletype killed the proposal because it failed one incredibly important criterion:

"It would be impossible to spell the name of the Deity correctly."

In this way (or so, at least, hacker folklore has it) superstition triumphed over utility. Teletypes were the major input devices on most early computers, and terminal manufacturers looking for corners to cut naturally followed suit until well into the 1970s. Thus, that one bad call stuck us with Great Runes for thirty years.

I don't know. It's a nice story, but I really don't buy it. After all, all those 5 x 7 display tubes and early dot-matrix printers used all

caps. Let me know what you all think about this apocryphal story.

I mentioned the RTTY Loop Software collection, a growing group of programs of interest to the RTTY amateur. Receive a copy of the listing of programs available, and instructions on how to get the programs themselves, by sending a self-addressed, stamped envelope to the above address, or by requesting one by E-mail from my E-mail address above, or by logging on to the RTTY Loop home page, at [<http://www2.ari.net/ajr/rtty>]. Be careful of the case of those letters, by the way—they are all lower case. Trying to retrieve the page by typing RTTY instead of rtty will not work, thanks to the case-sensitive Unix system used on this and many other Web servers.

More next month—maybe even something from the present! Then again, who ever said RTTY was at the forefront of this crazy hobby of ours? 73

**Motron**

310 Garfield St Suite 4  
PO Box 2748

**ELECTRONICS**

Eugene, Oregon 97402

Only  
**\$99.00**

<http://www.motron.com>

## Control your home from your radio!

The **AUTO-Kall® AK-16 DTMF Controller Board** features 16 relay driver outputs and DTMF to X-10 house control capability!

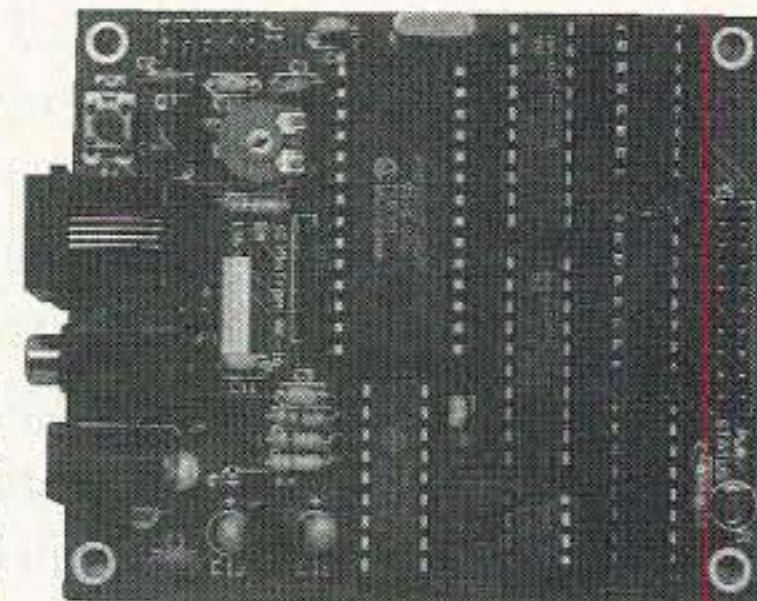

Using your radio keypad, you can control either the relay outputs, X-10 modules, or both! X-10 operation requires the PL-513 Power Line Interface (\$20). The AK-16 mates readily with our **RB-8/1** (\$99) or **RB-16/1** (\$149) relay boards. The 0-12 digit security code is user programable using your DTMF keypad. Additional features include reprogrammable CW ID and several modes of operation, including two with CW response tones. Printed circuit board, assembled and tested.

VISA, MASTERCARD, AMERICAN EXPRESS, DISCOVER CARD  
COD ON CASH OR MONEY ORDER BASIS ONLY  
S/H: \$8 USA; \$11 CANADA; \$16 FOREIGN. COD: \$5

Price and Specifications are subject to change without notice  
*Se Habla Español. Pida por Don Moser.*

**Orders: (800) 338-9058**

**Info: (541) 687-2118 Fax: (541) 687-2492**

CIRCLE 248 ON READER SERVICE CARD



# We Joined the North Pole Network!

*Radio ho ho!*

Michelle "Missy" D. Hollenbeck AAØOF  
Andover Schools Amateur Radio Club  
Andover Middle School  
1628 N. Andover Road  
Andover KS 67002

The Andover Schools Amateur Radio Club was looking for a holiday project that promoted amateur radio. Our club had limited funds, students were busy with holiday shopping and homework, and Christmas Day was quickly approaching. Lo and behold, the December 1996 issue of *73 Amateur Radio Today* arrived just in the "Nick" of time. After reading the article written by April Moell WA6OPS and Joe Moell KØOV, our decision was finalized. Andover Schools Amateur Radio Club (ASARC) would join the North Pole Network!

The students and I talked about how amateur radio operators in California had provided opportunities for sick children to talk to Santa Claus. Knowing that transportation for nondriving middle school students was a logistical concern, the students agreed that the best place for a "Talk to Santa" special event station would be at the local Andover IGA™ store.

A week before the scheduled event, I telephoned the manager of the IGA store.

"Glen, this is Missy from Andover Middle School. My amateur radio club would like to set up some amateur radio club equipment at the front of your store so that children can talk to Santa."

Glen was delighted with the idea. He told us that we could have the area directly in front of the ice freezers. He also told us to make signs to promote the event. Additionally, the IGA would place a table and chairs at the front of the store for our use. My basic fear was put to rest—there was an electrical plug nearby.

---

***Everyone wanted to talk to Santa, and more importantly, to Mrs. Santa, too!***

---

My students were impressed with the Moells' idea of handing out commemorative buttons. But with limited funds and no button-maker, we were in a quandary about what to do. Luckily for us, the mom of one of my former students (Sarah Galloway KBØMDP) worked at the Wichita USD 259 Edu-

cational Support Center. The Center had a button-maker and charged only 20 cents for each completed button.

With the special event station quickly approaching, our club made a visit to the Educational Support Center. Sure enough, the Center had all the needed supplies and several button-makers. But it was important to the students that our buttons had a good message, looked nice, and promoted amateur radio.

We decided on the slogan, "Using Amateur Radio, (child's name) talked to Santa." The child's name portion was intentionally left blank so that the children could choose their own special buttons and handwrite their own names.

After completing a sheet of six button designs, copies on festive red and green paper were made. Although we thought that the cutting-out process would be tedious, the Center had a special circular cutting tool that quickly and accurately cut out the designs. Even though the buttons looked nice, something definitely was missing. Thankfully, the Center had adorable tiny Christmas stickers.



The addition of assorted sticker designs truly made the buttons one of a kind.

The button assembly went quickly—that is, after we learned how to assemble the buttons correctly. First came the back part of the button, then the top part, and finally, the colored paper design and plastic overlay on top. With two quick pumps of the button-maker's handle, the buttons were complete. After we got the assembly part down pat, over 70 buttons were completed in less than an hour.

Then came the creative part! The club members were not satisfied with just handing out "I Talked to Santa" buttons. They also wanted personalized buttons that had other Christmas-related amateur radio themes. Laughter and giggles followed after numerous button designs were implemented. Some new button messages included "Santa Helper," "Rudolph uses GPS," "Santa uses GPS," and "Santa Only Talks on Amateur Radio."

Heeding the advice of the Moells, club members were concerned about handing out candy canes. (In fact, one of our members is diabetic. He shared with the club how hard it was to be a kid who can't eat candy.) Fortunately, we found some sugar-free candy canes along with regular ones.

When the special event was only two days away, a problem emerged. Our Amateur Radio Santa would not be able to help us with our special event station. I called for other amateur radio operators to help, but many were hesitant. After all, Christmas was only a few days away and everyone had so much to do.

Also, I was concerned about which frequency to use. Should I use simplex and not tie up the local repeater? Or should I use the local repeater so many people could hear the special event communications? My Elmer, Ray Metcalf WØQNX, said, "Use the repeater! That's what it's for!" So without any further hesitation, the use of the El Dorado Repeater (WØRGB) was planned.

But what about Santa? At the last moment I called upon Carol Musick KBØONM, a second-grade teacher in our district, to help us out. Carol said that she'd be glad to be our Mrs. Santa.



*Photo A. Special event station at the Andover IGA. Carol Musick KBØONM is making a radio check before the event starts. Notice the charcoal briquettes in the background!*

Then the students came up with a wonderful idea. How about if they were Mrs. Santa's elves?

Surely not, I thought. My middle school students pretending to be elves? What about being cool and all those adolescent rituals that they go through?

When it came time to set up the special event station, the students met my red Jeep Cherokee and me in the IGA parking lot. (Knowing that Mrs. Santa would be sitting in the Jeep with a two-meter handheld, it was important to park in an inconspicuous part of the parking lot.) Quickly we unloaded a two-meter radio, magmount antenna, power supply, world map, Christmas lights and tablecloth, candy canes, and of course, the buttons.

As we approached the IGA store, we were met with a huge display of charcoal briquettes occupying our planned location. The students exclaimed, "Why in the world are they trying to sell barbecue stuff during December?" After some quick footwork by the management, a table was brought to us and squeezed in between the massive stacks of briquettes. Unfortunately, the briquettes also covered up the electrical outlet. Next, the management provided a tattered extension cord to

supply us electrical power. (We quickly had a safety lesson about tattered extension cords.)

Time was of the essence. In just 10 short minutes, our special event station was scheduled to go on the air. "Mrs. Santa" arrived, garbed in a festive outfit. "Carol," I gently reminded her, "the kids won't see you." But Carol didn't seem to mind. She grabbed three of the student elves and off to the Jeep they ran. I turned around to look at the remaining students and they were decked out in Santa hats and Rudolph ears (and I thought middle school students always were concerned about being cool).

Quickly the students and I hooked up all the radio equipment. Alas, there was no apparent ground plane for the magmount antenna. But as my students gazed at the massive stacks of out-of-season charcoal briquettes, we realized that they were kept in a metal frame. After a quick inspection, we determined that the top of the stack had a metal plate. Splat! went the magmount antenna, as it stuck to the mountain of briquettes.

"This is a special event station ... calling CQ CQ CQ ... looking for Mrs. Santa ... this is AAØOF from Andover, Kansas ..."



24 DIFFERENT PANELS  
PRE-PUNCHED FOR  
POPULAR CONNECTORS

MAKE TEST  
FIXTURES QUICKLY!  
PANELS ARE 0.040" RAW ALUMINUM

**Lab Box-It™**

MODEL	W x D x H IN.	PRICE
LAB-1	1.5 x 2.0 x 0.75	3.75
LAB-2	1.5 x 4.0 x 0.75	4.50
LAB-3	1.5 x 6.0 x 0.75	5.25
LAB-4	2.0 x 2.0 x 1.0	4.00
LAB-5	2.0 x 4.0 x 1.0	4.75
LAB-6	2.0 x 6.0 x 1.0	5.50
LAB-7	2.0 x 2.0 x 1.5	4.10
LAB-8	2.0 x 4.0 x 1.5	5.00
LAB-9	2.0 x 6.0 x 1.5	6.00

FREE  
SURFACE  
SHIPPING ON  
PREPAID ORDERS (CONT. US, CANADA & MEXICO)

FREE  
CONSTRUCTOR'S  
CATALOG

ORDER BY DECEMBER 31, 1997 AND SAVE 20% OFF YOUR TOTAL!  
MUST MENTION #ST97 TO RECEIVE DISCOUNT  
\$30.00 MINIMUM ORDER AFTER DISCOUNT

VISA MasterCard

ORDERS 800-634-3457 ■ FAX 800-551-2749  
OFFICE 702-565-3400 ■ FAX 702-565-4828  
SESCOM, INC. 2100 WARD DR., HENDERSON, NV 89015  
SESCOM, INC. is not responsible for inadvertent typographical errors  
and prices and specifications are subject to change without notice.

CIRCLE 167 ON READER SERVICE CARD

## Field Day G5RV QuicKits™

created by Antennae West Box 50062-S, Provo, UT 84605

<ul style="list-style-type: none"> <li>Fast &amp; Easy To Build</li> <li>Fail-Safe visual instructions</li> <li>No measuring or cutting</li> <li>Everything Included</li> <li>Finish antennas in minutes</li> <li>Quality Components</li> <li>Presoldered Silver Fittings</li> <li>Kinkproof QuietFlex wire</li> <li>Fully insulated, wx sealed, no-corrode, low noise design</li> <li>Tune All Bands Incl WARC</li> </ul>	<ul style="list-style-type: none"> <li>• Double Size GSRV \$59.95 204 ft. 160-10 Dipole</li> <li>• Full Size GSRV \$39.95 102 ft 80-10 Dipole</li> <li>• Half Size GSRV \$29.95 51 ft. 40-10 dipole</li> <li>• Quarter Size GSRV \$25.95 26 ft 20-10 Dipole</li> <li>• ReadyMade 102 ft GSRV \$50.00</li> <li>• ReadyMade 51 ft. GSRV/2 \$40.00</li> <li>• 200' Dacron 250# line \$11.95</li> </ul>
--	---

West Plans, Patterns, Data? Order TechNote #124-D \$6.95 ppd USA  
Order Hot-Line: Add 65 P&H 1-801-373-8425

CIRCLE 296 ON READER SERVICE CARD

## BIOELECTRIFIER

PLANT GROWTH STIMULATOR

- COMPACT SIZE, 4.5" X 2.25" X 1"
- ADJUSTABLE OUTPUT UP TO 25 VOLTS
- STAINLESS STEEL ELECTRODES
- WIRED AND TESTED

FOR MORE INFORMATION

SEND SASE TO:

SEAGON COMPANY  
5541 OAKVILLE CENTER  
SUITE 215  
ST. LOUIS, MO 63129

CIRCLE 241 ON READER SERVICE CARD



Photo B. ASARC in their school ham shack. Seated (in middle with mike) is new Tech Plus Joseph Haynes KBØZCA. The students were busy being student elves with the second graders in Carol Musick KBØONM's class. Photo by AAØOF.

"This is Mrs. Santa, KBØONM ... I hear you loud and clear ..."

The conversations that followed were truly a wonderful display of positive amateur radio public relations. At first we thought that only children would want to talk to Santa, but we were wrong. Everyone wanted to talk to Santa, and more importantly, to Mrs. Santa, too!

Carol KBØONM was a remarkable Mrs. Santa. Some of the conversations went like this:

"Yes, this is Mrs. Santa. Oh, just wait a moment, I must wash my hands. I've been busy baking cookies. Oh, there we go ... now what was your wish for Christmas?"

"Oh, Santa and I always use amateur radio for our communications. We are so proud to be amateur radio operators.

"Yes, the elves are busy building toys for all the children. Would you like to talk to Elf Mickaela? She's our expert truck builder."

Then, out of the blue, came a deep "Ho! Ho! Ho!" Excitement filled the air. But who was Santa? Did one of the local amateur radio operators decide to join in on the fun?

After several conversations with Santa, we finally realized that the deep voice was also Carol's. At this point, multi-talented Carol had become both Mrs. Santa and Santa himself! Likewise, the elves had become reindeer caretakers, Nintendo™ 64 builders, and Tickle Me Elmo™ creators. There was even an elf who specialized in making money!

It's amazing how quickly time passes when you're having fun. Fun in this case was watching the faces of children, parents, and store clerks talk to Mrs. Santa, Santa, and the hard-working elves. The buttons, quite a novelty item, were a wonderful way to celebrate the special event station.

To thank Carol KBØONM for all her hard work, the following week the student elves and I set up a mini-special event station at our school ham shack. Carol's second grade students were then able to talk with "Santa's elves" via amateur radio.

ASARC is already discussing plans for next year's "Talk to Santa" special event station. We already know that we'll need more buttons and candy canes. Who knows? Maybe we'll request those massive stacks of barbecue briquettes!



# Let Your Fingers Do the Talking

*... or, wire you smiling?*

Arthur R. Lee WF6P  
106 Western Court  
Santa Cruz CA 95060

**W**hen you suddenly find that your microphone won't work or your key isn't functioning, it's time to take matters into your own hands.

You have often heard that in an emergency, we amateur radio operators can send code by flashlight, or by radio by touching two wires together. Of course we can do it—it's simple. But how many of us have tried? With today's modern high-quality electronics, we often ask ourselves how such an emergency could ever present itself. After all, our rigs are nearly foolproof and who ever heard of our microphones failing? We know it is far easier, and quicker, to go "voice" whenever the need arises for emergency communications.

As an instructor of Novice classes, I often tell my students to make up their own telegraph keys out of hacksaw blades, bent metal forks, or any imaginable contact material. One of my more innovative and enthusiastic students constructed hers out of her father's discarded flexible metal measuring tape. It worked fine!

As always, true emergencies never happen when we are prepared. They pop up at the most inopportune times and at

all hours of the night or day. Emergencies happen all the time, some big, some small. Here's one that happened to me.

My daughter-in-law Cybele KC6LKT, a Technician-class, was home in Sacramento with her rig when our schedule for CW practice on 40 meters came up. I had just arrived on vacation in San Diego and rushed to set up the rig my daughter had stored in the spare bedroom. Anticipating that the battery would be dead in the electronic keyer after a year's storage, I had purchased a nine-volt replacement battery. I also considered that the included battery might have just enough life in it for one last QSO before replacement.

Happy with the thoughts of talking to Cybele, I hooked up the rig and gave it a test. Everything was perfect. Even the keyer and paddle performed flawlessly, although the keyer audio sounded a bit weak when I sent a string of off-the-air CQs and callsigns.

On schedule, Cybele began carefully tapping out, "WF6P, WF6P, de KC6LKT." Fine, and she was right on frequency.

I came back with my callsign and we were in business.

She came back with a cheery, "Gud morn Dad, how u tdy?" I made

my reply and the keyer started wildly misbehaving in the strange manner that they do when the batteries go flat. There was just enough juice for me to send an AS (wait) or two, then my callsign. Cybele came back with her "OK, OK," and kept the frequency open.

I popped the cover off the automatic keyer, hoping to snap in the nine-volt battery and resume our QSO. I mentally congratulated myself for my foresight while contemplating what nice things I might say in our QSO. I was dumbfounded when my eyes focused on the two AA batteries that formed the power supply. Help! A frantic search was made throughout the house for some spare AAs. No luck.

Cybele began calling me again, wondering where I had ventured off to. Not to worry, I thought: My trusty old straight key lay nearby. I attempted to push the standard jack into the miniature jack receptacle on the back of the rig. What the heck? Quickly unscrewing the jack cover, I found the connections soldered to the terminals.

Cybele kept calling.

By now I was feeling helpless and frustrated. The ham keyer lead from the rig terminated in an RCA plug for





## Handheld Repeater Controller

Spectrum Electronic Products 10 include voice I Der, DTMF introduces the world's first Control and programming, handheld repeater controller. hang and time-out timers, No larger than most hand- Digital Voice Operated held radios, the HRC-10 con- Squelch (DVOS™), telemetry verts a single or dual-band tones, and private voice mail radio into a full featured sim- slot. **\$299**  
<http://www.spectrum-usa.com>  
 800-566-2788 - fax 408-336-9461

CIRCLE 69 ON READER SERVICE CARD

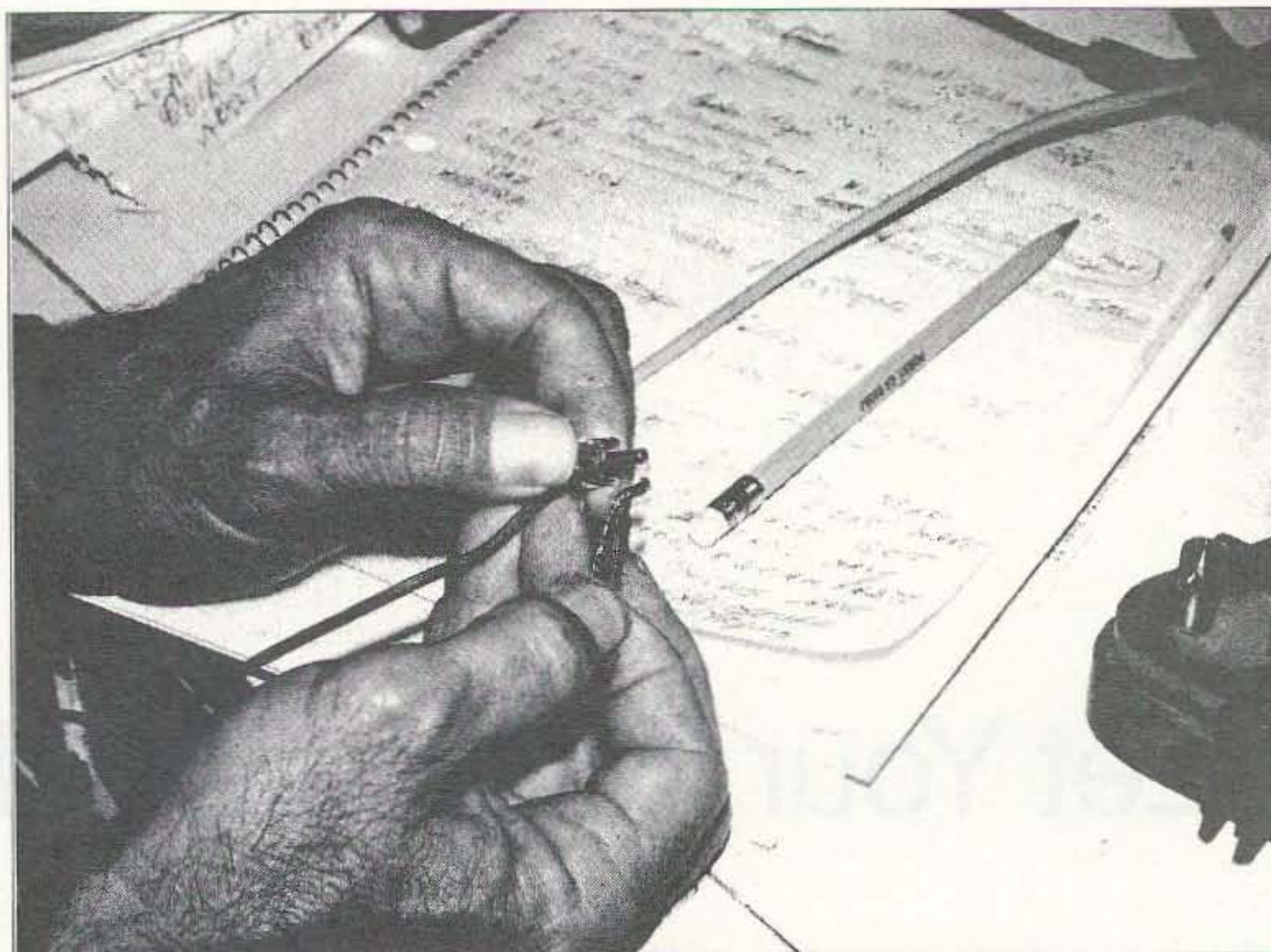

*Photo A. When batteries failed, a quick solution to the problem was necessary in order to continue with the QSO. One end of a jumper was wrapped to the ground side of the RCA jack and the other end used to touch the center connector. Morse code can be successfully sent at speeds up to 10 wpm by completing the wire contact. This "hasty key" can be made in only a few seconds if nothing else is available.*

## VOL.7 ULTIMATE MODIFICATION BIBLE ENORMOUS AMOUNTS OF INFORMATION

OVER 1000 MIKE WIRING CODES FOR CB AND HAM RADIOS.  
 OVER 500 CB POWER/MODULATION BOOST INSTRUCTIONS.  
 OVER 200 MODIFICATIONS FOR CB P.I.'s.  
 OVER 300 MODIFICATIONS FOR HAM RADIOS.  
 OVER 50 COMPLETE SYNTHESIZED CRYSTAL CHARTS WITH INSTRUCTION  
 OVER 20 PRECALCULATED MODIFICATION CRYSTAL CHARTS.  
 OVER 50 SCANNER MODIFICATIONS AND TEN METER RADIO MODIFICATIONS.  
 LINEAR SCHEMATICS AND ANTENNAS/COAX & GAIN/LOSS CHART  
 NEW: 30 CB SUPER MODULATION BOOST DESIGNS.  
 30 MODIFICATION OF NEWEST RADIOS. NO COD'S  
 AND WATTMETER MODIFICATIONS **\$29.95**  
 KDC SOUND ORDERS ONLY: 1-800-256-9895 MONEY ORDER/  
 P.O. BOX 8622, GRANGERLAND, TX 77302 MC/DISC/VISA/CK.  
 CIRCLE 151 ON READER SERVICE CARD

## EVERY ISSUE OF 73 Amateur Radio Today on Microfiche!

The entire run of *73* from October 1960 through last year is available.

You can have access to the treasures of *73* without several hundred pounds of bulky back issues. Our 24x microfiche have 98 pages each and will fit in a card file on your desk.

We offer a battery operated hand held viewer for \$75, and a desk model for \$260. Libraries have these readers.

The collection of over 800 microfiche, is available as an entire set, (no partial sets) for \$325, plus \$5 shipping (USA). Annual updates available for \$10. Satisfaction guaranteed or money back!

### BUCKMASTER

6196 Jefferson Highway  
 Mineral, Virginia 23117  
 540:894-5777 • 800:282-5628  
 e-mail: [info@buck.com](mailto:info@buck.com)  
 Fax 540:894-9141

CIRCLE 168 ON READER SERVICE CARD

the keyer. Aha! A solution presented itself. Taking a spare length of hookup wire, I wrapped one end around the ground side of the RCA plug. Then, with the lead plugged into the miniature jack at the back of the rig, I touched the wire to the center connector of the RCA plug. As could be expected, I heard a nice "dit!" on frequency.

Without pausing, I answered Cybele, simply offering a short comment to the effect that I was using a "wire touching" method to send code, and that the paddle and keyer were not being used.

How well did it work? Well for the next 55 minutes we carried on with our

CW QSO at about her speed of eight words per minute. There were no problems with my sending or hers. It sounded fine, except that my fingers did get a bit tired from holding the wire tightly to the ground side of the RCA plug.

Cybele did pay me a somewhat dubious comment later, when we got together in person. "Dad, your sending was fine, it was just like normal!" Hmm ... I wasn't sure about how to take that but I know she means well.

How's she doing on her code progress? Well, she's passed the General written exam and can copy about 10 wpm. Some things take practice and patience. 73

## Where's the Beam?

Unobtrusive DX Gain Antennas for 80 thru 10  
 • Easily hidden • Install Fast • Fixed or Portable •



There's a 20 meter antenna with real DX Punch hidden in this picture. You can't see it, and your neighbors can't either. But it works DX barefoot anyway. How about a low profile 80/40/30 tri-band? Or a 2 element monobander for the attic? All easily fit the pocketbook--Priced \$29 to \$99.

Work DX without telling the neighbors

Infopack \$1 AntennasWest  
 Box 50062-R, Provo, UT 84605 (801) 373-8425

CIRCLE 332 ON READER SERVICE CARD

## Desert Storm Solar

10 watt DesertStorm panel is size of open *73* magazine, weighs 11lb, and delivers 600mA for 12v charging or direct operation. Tough, Solid, with no glass to break. So rugged Uncle Sam used this for spotter communications and portable repeaters in Desert Storm. Ready to use. \$169. Add \$5 S&H. Info \$1.



AntennasWest Order HotLine  
 Box 50062 Provo UT 84605 801 373 8425

CIRCLE 340 ON READER SERVICE CARD



# Amateur Radio Maritime Mobile Nets

*Staying in touch—and staying safe—on the briny.*

Arthur R. Lee WF6P  
106 Western Court  
Santa Cruz CA 95060

**W**hen blue water passes under your keel and the compass points to new horizons, the amateur maritime mobile nets provide a friendly and reliable network of faithful and skilled radio operators who are standing by to help out in time of routine or emergency needs.

Without a doubt, one of the most important and interesting things you can do when offshore cruising is to link up with fellow sailors and land-based radio operators on the ham maritime mobile nets. This vital link can provide countless hours of entertainment, specialized marine weather observations, useful cruising information, and perhaps most important of all, a lifeline in case of emergency. In addition, it can provide a valuable and unique morale-building service: telephone patches to loved ones ashore.

## **Where do you start?**

If you are serious about cruising, give some thought and priority to outfitting your boat with ham equipment. To operate ham radios you will need a ham license, preferably a General class one. The General class license is relatively easy to obtain, although

some study of FCC regulations and low-level technical material is required. Also, you will have to learn (or relearn) to use Morse code. The General class amateur radio license is designed for use by the average person and the written test material is relatively easy to master without any prior knowledge of electronics. The code can be learned after a few weeks of effort but to get code speed up to the required 13 words per minute usually takes about a month or two longer. Test information, plus code practice tapes and study guides, complete with questions and answers, are available from the American Radio Relay League (ARRL), 225 Main Street, Newington CT 06111. Begin with *Now You're Talking*, for the Novice and Technician class licenses. The cost is approximately \$20.00. Study guides for the General class license sell for about \$10. Most Radio Shack™ stores carry these materials. And don't forget the famous series of code-training tapes offered by 73's Radio Bookshop.

## **What are the maritime mobile nets?**

Loosely defined, the nets are a conglomeration of ham radio operators

who have a strong personal interest in radio, boating and sailors who go down to the sea in ships. Almost all are sailors themselves or have been sailors in the past; many are ex-military, naval, or commercial operators who know what it is like to be out on the big ocean and who place a high value on radio communications. In general, those hams who inhabit the nets are highly skilled, responsible operators who spend many hours per day helping one another and other boaters with communications.

## **What purpose do the nets serve?**

All of the maritime mobile nets are there to serve boaters and provide a regular agreed-upon calling frequency where operators can join with each other to pass emergency or routine personal *non-business* message traffic.

## **Where do we find the nets?**

There are approximately 100 nets with some names indicative of the areas they serve. Some nets have extensive ranges, others are very local in nature. A sampling of net names are: Great Lakes Emergency Net, Pitcairn Net, UK Maritime Net, Florida Coast



## Some Terms Used on the Ham Radio Nets

Net Control	The person in charge of running the net for the day.
Relay Station	Someone who helps relay messages to net control from stations not heard by net control.
Checking In	To contact net control, usually give the suffix of a callsign only, until recognized by net control.
"Recheck"	A term to signify that you were unable to find the station you were looking for and now wish to return to the net.
"Re-entry"	A term used to signify that a previously checked-in station has gone off frequency, completed its traffic, and is returning to the net.
"Contact"	You have heard a station you wish to talk to. Net control will come back with "The contact, go ahead with your callsign."
"Info"	You either have or wish to receive more information on a subject under discussion by net control.
"Relay"	Usually given by net control, asking for anyone who heard the calling station to relay the information to net control.
"Check Out"	Notification to the net that you are leaving the frequency (if you have requested communication with another station).
"Break, Break"	You have emergency traffic and wish immediate access to net control.

Table 1. Glossary.

Net, Swedish Maritime Net and the South African Maritime Net. Twenty-one nets are listed in the ARRL Net Directory. Additionally, two highly active nets which are not listed but serve Pacific waters are the Baja California Net on 7.238.5 MHz (1600 UTC) and the Mañana Net on 14.342 MHz (1900 UTC). While most of the nets are geographically specialized, there is much overlap and boat information is readily exchanged.

### How do you check in with the nets?

Monitoring the nets does not require a license and should begin as soon as equipment is available. The quickest way to learn about the nets is to monitor them for a few daily sessions. This is an easy way to pick up the jargon and get the feel of the simple standard operating procedures. Then, with your General class license in hand, you will be ready to check in with the ham maritime mobile nets. There is no one right way to do it, but it speeds things

along to follow what everyone else is doing. Net control operators are a friendly bunch whose sole purpose in being on the air is to help you. Their reward is the warm feeling which comes from successfully passing message traffic and the "thank you" which follows.

### Tell me about some of the individual nets

Let's examine four Pacific Ocean nets. The Baja California Net, 7.238.5, 1600 UTC, is a very informal net with coverage of southern California waters, the coasts of Mexico, and the Sea of Cortez. The net manager is Ralph Eschborn N6ADJ, of San Diego, California, who coordinates the activities of his net controllers and relay stations, and maintains the day-to-day continuity of the net. On this net, daily weather reports are given for southern California and Mexican waters.

The Mañana Net, 14.342, 1900 UTC, provides greater communications range

than the Baja Net by extending to waters up and down the coast of North America and out into the Pacific. Net manager is Kermit Goettsche KB5HA, in Albuquerque, New Mexico.

The Pacific Maritime Mobile Net, 21.402 MHz, 2200 UTC, operates on a Pacific Ocean-wide basis, covering all waters from the North American Pacific coast to Asia, including parts of the Indian Ocean.

The most highly structured net is the Pacific Maritime Net on 14.314, 0530 UTC. This is a formal "roll call" net and boats transiting the oceans can request to be placed on a nightly muster sheet. Once they are placed on roll call, they are assigned a number and *must* check in when their number is called. The purpose of this net is to track boats across the pond for a safe passage. The Coast Guard is notified if boats fail to report on schedule. Boats on the roll call are required to provide initial information as to boat descrip-



tion, crew, communications capability, and destination. Daily reports include position, course, speed, wind speed and direction, and sea state.

### What can we expect of the nets?

Checking in with the nets can be considered somewhat like having a mailbox in the air. Here, you can make and meet friends and talk to loved ones ashore over phone patches. For chats after making contact, it is customary (and necessary) to move to an unused frequency to keep the nets clear for additional check-ins. Most boaters who are hams consider their ham contacts as high points of the day, especially when out of their home ports for long periods.

Hams ashore keep track of all boats who do check in and most nets have an operator who maintains either a written or computerized record of boat positions. Most of the net managers, net controllers and relay stations know each other, both on and off the air, meeting in person when they can or exchanging letters. It is common to hear the same shore operators check in on several of the nets, which affords a great deal of continuity. Information is passed from one net to another and most operators know each other by voice pattern, name and callsign. Because of this familiarity, it's easy to pass messages to boats, even when the ham radio operator or equipment is not on board. Hams try very hard to get the messages through and sometimes perform near-miracles. Many messages, both routine and emergency, have been passed to boats with hams aboard, then delivered to non-ham boats by marine VHF or personal contact. Some ham boaters have had to swim over to the next boat to deliver a message. One, in particular, rowed ashore and searched hotels and trailer parks in La Paz (Mexico) before locating the recipient of a message.

Ham radio should be considered an integral part of any cruising boat's communications and navigation package. The time, money and effort spent in obtaining the license and equipment will be repaid many times over in enjoyment and usefulness.

- DIP switch programmable
- CTCSS encoder
- All 32 EIA tones from 67.0 to 203.5 hz included
- May be ordered with custom tones



SS-32PA Encoder  
9" x 1.3" x .4"

**SS-32PA DIP Switch Programmable CTCSS Encoder \$28.95**

- Fully enclosed CTCSS encoder
- All 32 EIA tones from 67.0 to 203.5 hz included
- Perfect for mobile / base applications



TE-32  
5.25" x 3.3" x 1.7"

**TE-32 Multi-Tone CTCSS Encoder \$49.95**



TP-3200 Shared Repeater Tone Panel

- 51 CTCSS Tones
- 106 DCS Codes
- Supports 157 Repeater Subscribers
- On-Line Computer Help
- Repeater CW ID
- Air Time Loading & Analysis Graphs
- Signalling Formats: CTCSS DCS & DTMF

TP-3200D Table Top Version \$269.95 each

TP-3200RM-A Single Rack Mount version \$279.95 each

TP-3200RM-B Triple Rack Mount version \$279.95 each

\*Holds up to three TP-3200s



ID-8 Automatic Morse Code Identifier  
1.85" x 1.12" x .35"

**NEW LOWER PRICE \$69.95**

ID-8 Automatic Morse Station Identifier ~~\$89.95~~

**COMMUNICATIONS SPECIALISTS, INC.**

426 WEST TAFT AVENUE • ORANGE, CA 92665-4296  
(714) 998-3021 • FAX (714) 974-3420  
Entire U.S.A. (800) 854-0547 • FAX (800) 850-0547  
<http://www.com-spec.com>

CIRCLE 10 ON READER SERVICE CARD

**CALL TOLL FREE**  
(800) 292-7711 orders only  
Se Habla Español

**YOUR ONE STOP SOURCE FOR ALL YOUR TEST EQUIPMENT NEEDS**

**CALL OR WRITE FOR OUR NEW FREE 64 PAGE CATALOG!**  
(800) 445-3201

**NEW XK-700 Digital / Analog Trainer**

Elenco's newest advanced designed Digital / Analog Trainer is specially designed for school projects. It is built on a single PC board for maximum reliability. It includes 5 built-in power supplies, a function generator with continuously sine, triangular and square wave forms, 1500 Hz point-to-point area. Tools and meter shown optional (Mounted in a professional tool case made of reinforced metal)

**XK-700 Assembled and Tested \$189.95**

**XK-700 - SEMI KIT w/ Fully Assembled PC Board \$174.95**

**XK-700K - Kit \$159.95**

Made in the USA

**Elenco Scopes**  
Free Dust Cover and Probes



\$1325 25MHz	\$325
\$1330 25MHz Delayed Sweep	\$439
\$1340 40MHz	\$475
\$1345 40MHz Delayed Sweep	\$569
\$1360 60MHz Delayed Sweep	\$749
\$1390 100MHz Delayed Sweep	\$995
DS 303 40MHz/20Ma/s Analog/Digital	\$995
DS603 60MHz/20Ma/s Analog/Digital	\$1295

**Four Functions in One**  
MX - 9300 **\$459.95**

Features:

- One instrument with four test and measuring systems:
- 1.3GHz Frequency Counter
- 2MHz Sweep Function
- Generator
- Digital Multimeter
- Digital Triple Power Supply
- 0-30V @ 3A, 15V @ 1A, 5V @ 2A



**NEW Tektronix DMMs**

- 40,000 count
- High Accuracy
- Tektronix quality
- 3yr warranty

DMM 912 \$189  
DMM 914 \$235  
DMM 916 \$275



**20MHz Sweep/Function Generator with Freq Counter**  
B&K 4040

- 0.2Hz to 20MHz
- AM & FM modulation
- Burst Operation
- External Frequency counter to 30MHz
- Linear and Log sweep

10MHz B&K 4017 \$309  
5MHz B&K 4011 \$239

**\$399**



**Fluke Scopemeters**

123 NEW \$350  
92B \$1445  
92B \$1695  
99B \$2095  
105B NEW \$2495

**ALL FLUKE PRODUCTS ON SALE**



**Technician Tool Kit**  
TK - 1500

36 tools plus a DMM contained in a large flexible tool case with a handle ideal for every use on the job.

**\$49.95**



**Fluke Multimeters**

Model 10	\$63	Model 12	\$84
Model 701i	\$75	Model 83	\$235
Model 731i	\$97	Model 85	\$269
Model 751i	\$129	Model 87	\$289
Model 771i	\$154	Model 863E	\$475
Model 791i	\$175	Model 867BE	\$650

**B&K Precision Multimeters**

Model 389	\$109	Model 388A	\$99
Model 390	\$127	Model 2707	\$75
Model 391	\$143	Model 2860A	\$79
Model 5360	\$195	Model 5370	\$219
Model 5380	\$265	Model 5390	\$295

**DIGITAL LCR METER**  
Model LCR-1810

- Capacitance: 1pF to 20µF
- Inductance: 1µH to 20H
- Resistance: 1Ω to 200MΩ
- Temperature: -20°C to 75°C
- DC Volts 0 - 30V
- Frequency up to 15MHz
- Diode/Audible Continuity Test
- Signal Output Function
- 3 1/2 Digit Display

**\$99.95**



**B & K High Current DC Power Supply**

- Variable 3-14 VDC
- Thermal Protection
- Current Limiting

Model 1406 12A \$159  
Model 1408 25A \$239

**B & K 12.8V Fixed DC Power Supplies**

Model 1600 8A \$39  
Model 1602 15A \$75



**Quad Power Supply**  
Model XP-4

4 Fully Regulated DC Power Supplies in One Unit  
4 DC outputs: 3 fixed - 0V @ 1A, 5V @ 250mA, -12V @ 500mA  
1 Variable 0-12V @ 600mA

**\$29.95**



**Digital Multimeter**  
Model M-1700

**\$39.95**

11 functions including freq to 20MHz, cap to 20µF. Meets UL-1244 safety specs.



**10% OFF ON ALL STANDARD AMATEUR RADIO PRODUCTS**  
Including Accessories

**NEW Handheld Universal Counter**

F2850 10Hz - 2.8GHz  
Dual Input  
**\$149.00**

F2800 1MHz - 2.8GHz  
**\$99.00**

Features:

- Full range 10Hz - 2.8GHz (F-2850)
- 16 segment RF signal strength bargraph 1MHz - 2.8GHz (F-2800)
- Dual 50K/1MΩ inputs. (F-2850 only)
- 16 segment RF signal strength bargraph
- 10 digital LCD display with backlight. (F-2850 only)
- 6 hour NiCd battery operation.
- High speed 250MHz direct count for high resolution.
- Multifunctions: Frequency, Period and Auto Trigger & Hold. (F-2850).

**Specifications**  
Input Sensitivity (Typical)

Amplifier	1MΩ (F-2850 only)	50Ω
Impedance	1MΩ (F-2850 only)	50Ω, 50Ω/2:1
Range	10Hz - 50MHz (F-2850 only)	1MHz - 2.8GHz
Sensitivity	<10mV @ 10Hz - 10MHz (F-2850 only)	<1.5mV @ 100MHz
	<20mV @ 10MHz - 50MHz (F-2850 only)	<5mV @ 250MHz
		<5mV @ 10Hz
		<100mV @ 2.4GHz
Maximum Input	100Vrms (F-2850 only)	150Vrms



**Kit Corner** over 100 kits available

**Model AR-2N6K**  
2 meter / 6 meter Amateur Radio Kit

**\$34.95**



**Model AM/FM-108K**  
Transistor Radio Kit

AM/FM Transistor Radio Kit

**\$29.95**



**35mm Camera Kit**  
Learn all about photography

AK-540

**\$14.95**

No Soldering Required



**REMOTE CONTROL CAR KIT**  
MODEL AK870

7 functions  
Remote control included

**\$24.95**

No Soldering Required



**Guaranteed Lowest Prices**

UPS SHIPPING - 48 STATES 5%  
OTHERS CALL FOR DETAILS  
IL Residents add 8.25% Sales Tax

**C&S SALES, INC.**

150 W. CARPENTER AVENUE  
WHEELING, IL 60090  
FAX: (847) 541-9904 (847) 541-0710  
[http://www.elenco.com/cs\\_sales/](http://www.elenco.com/cs_sales/)

**15 DAY MONEY BACK GUARANTEE**  
**FULL FACTORY WARRANTY**

PRICES SUBJECT TO CHANGE WITHOUT NOTICE

CIRCLE 184 ON READER SERVICE CARD



## NEW PRODUCTS

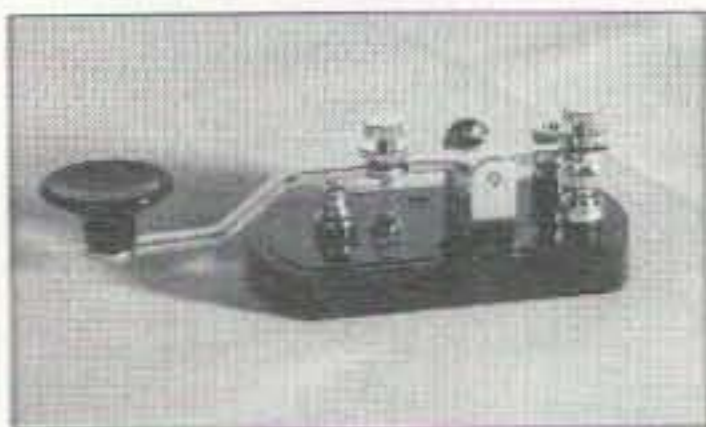

### Celebrate Straight Key Night Right!

MFJ proudly introduces its new telegraph key, MFJ-550. It's perfect for code practice, CW sending, and, of course, Straight Key Night. It looks like a handsome black-and-chrome antique, and for just \$7.95, you can hook the MFJ-550 to your transmitter and go on the air, ready to work QSOs.

The MFJ-550 comes from MFJ's Deluxe Code Practice Oscillator, MFJ-557. Thousands

of hams have learned to send code on the MFJ-557, at home and in classrooms. The MFJ-557 lets you practice sending at work, at home, in your car—practically anywhere—and a volume control allows adjustment from barely audible to blaring. You can practice without disturbing anybody else.

Both the MFJ-550 Telegraph Key and the MFJ-557 Deluxe Code Practice Oscillator are covered by MFJ's *No Matter What*™ one-year limited warranty. To order, or for the name of your nearest dealer, call (800) 647-1800; write to MFJ, P.O. Box 494 Mississippi State MS 39762; or FAX (601) 323-6551. See their Web site at [<http://www.mfjenterprises.com>].

### Keep It Under Your ... Pod?



Doppler Systems' new 6100 Series mobile DF systems, here fitted neatly into the low-visibility roof pod, uses their "AutoTrack" software program in your laptop computer. You record lines of bearing on a digital map, and a GPS receiver gives you your vehicle location and heading, which are displayed/stored on the map.

Repeat the steps as you drive, until you've closed in on your quarry.

The system is based on the DDF6100 display/processor, which uses advanced digital

signal processing to estimate the bearing angle. In addition, the DDF6100 provides the data multiplexing required to interface the GPS receiver, NBFM receiver and optional compass with the laptop computer through a single serial RS232 port.

For more information, prices, and a copy of the "AutoTrack" demo disk, call Doppler Systems at (602) 488-9755 or FAX them at (602) 488-1295 in the US; Doppler's European Marketing Director can be reached by telephone or FAX at +44 1297 625690; or check out the Web site at [<http://www.dopsys.com>].

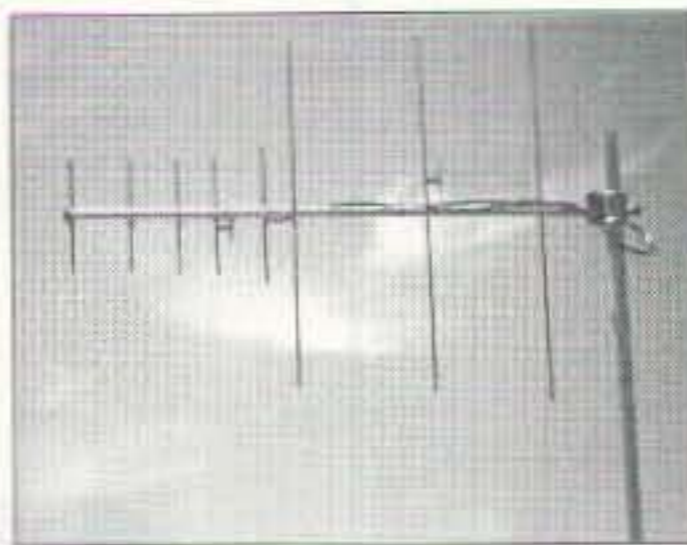

### Dual-Band Yagi from Comet

Comet has developed the CYA-240, a dual-band yagi—a new, unique design for 2m and 70cm that places the five UHF elements in front of the three VHF elements. Keeping them separate provides a superb radiation pattern.

The CYA-240 is perfect for packet, emergencies, or just to direct more output power to your contact station while reducing receive interference. It's rugged, but can be whipped together quickly for portable use, and is designed for vertical or horizontal polarization. Maximum power is 300 watts SSB, and 150 watts FM, and the Comet CYA-240's suggested price is \$109.95. That should inspire you to see your dealer or contact NCG Company at (800) 962-2611. At the very least, check out their Web page: [[www.cometantenna.com](http://www.cometantenna.com)].

### Thrills from the ARRL

The League has released a new book by Jeff Briggs K1ZM: *DXing on the Edge—The Thrill of 160 Meters*. The author, a well-known DXer and contester, has 270 countries confirmed on 160 meters, making him one of the leaders in DXing and an expert on this most challenging of the amateur bands.

The book contains a lot of "Topband" history from the beginning of operations there in the early '30s until today. Though the tales of famous 160-meter operators are entertaining, you'll also find useful information, tips and insights in it—including an audio CD with some exotic QSOs from prominent DX stations. The retail price is \$29.95, in softcover. Look for it wherever you buy ARRL publications, or order it from ARRL, 225 Main St., Newington CT 06111-1494. Phone (888) 277-5289 or FAX (860) 594-0303.

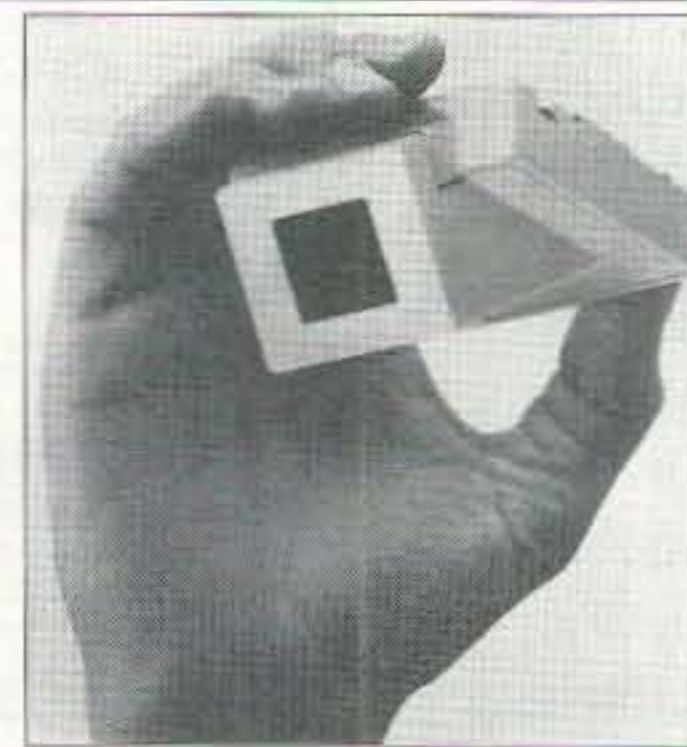

### Hide and Watch

The GBC CW-350 is barely bigger than a pack of cigarettes—it fits in the palm of your hand and weighs less than two ounces—but it provides

maximum performance with over 425 lines of resolution and .02 lux sensitivity. It's made to be mounted easily on ceilings or walls, and it blends easily into any decor. The CW-350 comes standard with a built-in electronic shutter and 4mm wide-angle lens. Other lenses are available, as well as optional audio capability. For more information, contact CCTV Corp., 280 Huyler Street, South Hackensack NJ 07606. Call (800) 221-2240, (201) 489-9595, or FAX (201) 489-0111.



**Return Address**

---

---

---

---



**73 Magazine**

**70 Route 202 N**

**Peterborough NH 03458**

**USA**



# YES! I want to grow with 73 Amateur Radio Today.

Mail This  
Card Today!

Send me 1 year (12 issues in all) of 73 for the low price  
of \$24.97! (I save over \$22.00 off the cover price.)  
For instant service dial toll free: 800-289-0388.



Newsstand rate \$47.40. Basic subscription rate \$24.97 (Canadian orders add \$7.00 per year plus \$1.40 GST; other foreign countries add \$19.00 per year for surface mail, \$42.00 per year for airmail. Please allow 4-6 weeks for delivery of first issue.)

FAX: (603) 924-8513  
MAIL: 73 MAGAZINE  
70 ROUTE 202 NORTH  
PETERBOROUGH, NH 03458  
B9712BS8

DECEMBER 1997

## READER SERVICE CARD

1	2	3	4	5	6	7	8	9	10	201	202	203	204	205	206	207	208	209	210
11	12	13	14	15	16	17	18	19	20	211	212	213	214	215	216	217	218	219	220
21	22	23	24	25	26	27	28	29	30	221	222	223	224	225	226	227	228	229	230
31	32	33	34	35	36	37	38	39	40	231	232	233	234	235	236	237	238	239	240
41	42	43	44	45	46	47	48	49	50	241	242	243	244	245	246	247	248	249	250
51	52	53	54	55	56	57	58	59	60	251	252	253	254	255	256	257	258	259	260
61	62	63	64	65	66	67	68	69	70	261	262	263	264	265	266	267	268	269	270
71	72	73	74	75	76	77	78	79	80	271	272	273	274	275	276	277	278	279	280
81	82	83	84	85	86	87	88	89	90	281	282	283	284	285	286	287	288	289	290
91	92	93	94	95	96	97	98	99	100	291	292	293	294	295	296	297	298	299	300
101	102	103	104	105	106	107	108	109	110	301	302	303	304	305	306	307	308	309	310
111	112	113	114	115	116	117	118	119	120	311	312	313	314	315	316	317	318	319	320
121	122	123	124	125	126	127	128	129	130	321	322	323	324	325	326	327	328	329	330
131	132	133	134	135	136	137	138	139	140	331	332	333	334	335	336	337	338	339	340
141	142	143	144	145	146	147	148	149	150	341	342	343	344	345	346	347	348	349	350
151	152	153	154	155	156	157	158	159	160	351	352	353	354	355	356	357	358	359	360
161	162	163	164	165	166	167	168	169	170	361	362	363	364	365	366	367	368	369	370
171	172	173	174	175	176	177	178	179	180	371	372	373	374	375	376	377	378	379	380
181	182	183	184	185	186	187	188	189	190	381	382	383	384	385	386	387	388	389	390
191	192	193	194	195	196	197	198	199	200	391	392	393	394	395	396	397	398	399	400

Payment Enclosed  
Charge my  AMEX  MC  VISA

Card # \_\_\_\_\_ Exp. Date \_\_\_\_\_

Signature \_\_\_\_\_

Name \_\_\_\_\_

Address \_\_\_\_\_

City \_\_\_\_\_ State \_\_\_\_\_ Zip \_\_\_\_\_

This card valid December 31, 1997

You make the 73 supporting advertisers very happy  
when you're interested in them ... Wayne

## FEEDBACK

**The Pitch:** 73 wants to know what you want to read. Help us by voting on this month's features and columns. (Line at upper right hand corner of page where article/column starts shows the Feedback #.)

**The Payoff:** Each month we'll draw a card at random. If yours is picked, you'll receive a one-year subscription (or extension) to 73.

Where did you get this copy of 73? \_\_\_\_\_

B9712SS8

999  newsstand

998  subscription

## FREE INFORMATION READER SERVICE CARD

Reader Service: To Receive more information on the products advertised in this issue of 73, circle the appropriate number(s). Please allow 6 weeks for processing of inquiry.

Article #																				
Great																				
OK																				
No Way																				

I'd like to see more \_\_\_\_\_

I'd like to see less \_\_\_\_\_



# ADVERTISERS' INDEX

R.S.#	page	R.S.#	page	R.S.#	page	R.S.#	page
• A & A Engineering	25	184 C & S Sales, Inc.	71	275 Lakeview	41	• Radio Book Shop	88
351 Absolute Value Systems	45	186 Coaxial Dynamics	39	86 MFJ Enterprises	11	• Radio Amateur Callbook	9
68 Advanced Battery Systems	37	99 Communication Concepts	37	160 Micro Computer Concepts	28	58 Radio Engineers	17
• All Electronics Corp.	23	10 Communications Specialists, Inc	71	136 Milestone Technologies	43	34 Ramsey Electronics	7
• Alphalab	49	276 Computer Aided Technology	40	193 Morse Tutor Gold	39	254 Ross Distributing	38
340 Antennas West	25	268 Computer Automation Technology	83	248 Motron Electronics	53	36 Scrambling News	17
380 Antennas West	25	166 Cubex	33	248 Motron Electronics	63	241 Seagon Company	66
324 Antennas West	36	114 E. H. Yost	15	114 Mr. Nicd	15	167 Sescom, Inc.	66
89 Antennas West	39	8 Elktronics	39	54 NCG	49	250 Software Systems Consulting	33
5 Antennas West	41	75 Fair Radio Sales	33	• OFS WeatherFax	49	69 Spectrum Electronics	68
296 Antennas West	66	193 GGTE	39	226 Pacific Sierra Research	81	141 The Nicad Lady	25
332 Antennas West	68	• Hamtronics, Inc.	CV2	• PC Electronics	77	• Thomas Miller	45
340 Antennas West	68	42 Isotron	28	• PC Electronics	79	269 Tigertronics	57
297 Antique Electronic Supply	75	242 Jan Crystals	43	• Peet Bros.	17	22 Tri-Ex Tower Corporation	59
16 Astron Corporation	2	158 Japan Radio Co.	CV4	68 Periphex	37	• Universal Radio	28
41 Barry Electronics Corp	45	• Kachina Communications, Inc	CV3	287 Peter Dahl Co.	25	259 Versatel Communications	17
42 Bilal Company	28	• Kantronics	1	• Radio Book Shop	34	191 W & W Associates	73
355 Biological Hamming	43	151 KDC Sound	68	• Radio Book Shop	54	245 Wavemach Communications	41
56 Buckmaster Publishing	17			• Radio Book Shop	61		
168 Buckmaster Publishing	68			• Radio Book Shop	62		
224 Burghardt Amateur Radio	41			• Radio Book Shop	79		

When you buy products from these advertisers, please tell them that you saw their ads in 73.

Subscribe to 73 right now...call 800-274-7373 (9-5 Monday-Friday EST).

## BATTERIES

BUY DIRECT FROM US, THE MANUFACTURER

Seasons Greetings

12% OFF

ON NiCd AND NiMH REPLACEMENT BATTERY PACKS  
MASTERCHARGERS POWERPAC +  
FOR THE MONTH OF DECEMBER

Monthly Discounts Applicable to End-Users Only.  
Look for January's Special of the Month



NYS residents add 8.5% sales tax. Add \$4.00 for postage and shipping.

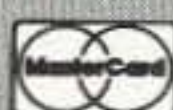
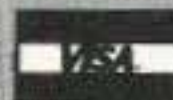

Prices and specifications subject to change without notice

**W & W Associates**

800 South Broadway, Hicksville, NY 11801

WORLD WIDE DISTRIBUTORSHIP AVAILABLE. PLEASE INQUIRE:

E-Mail: [w-wassoc@ix.netcom.com](mailto:w-wassoc@ix.netcom.com) Web Site: <http://www.wwassociates.com>

In U.S. & Canada Call Toll Free (800) 221-0732 • In NYS (516) 942-0011 • FAX (516) 942-1944

MADE IN THE U.S.A.  
SEND FOR FREE CATALOG AND PRICE LIST



# CARR'S CORNER

Joseph J. Carr K4IPV  
P.O. Box 1099  
Falls Church VA 22041-0099  
[carrj@aol.com]

## Digging DX out of the noise

This month we will take a look at several different things. From time to time I like to clean out the mailbox, report on a few products, or just randomly walk through radio technology. This month we'll do just that.

I received several E-mail and postal mail requests for information on reducing noise and other signals on the ham bands in order to dig out the weaker signals (presumably weak DX signals).

### Good selectivity

One of the ways that modern receivers help limit the effect of interfering signals is to provide good IF selectivity. I own a Drake R-8A receiver, and it came with switch-selectable filters of 500 Hz, 1.8 kHz, 2.3 kHz, 4 kHz and 6 kHz. I generally use one of the broader settings to home in on the signal, and then switch to a narrower bandwidth in order to copy the desired signal. This effectively blocks adjacent channel interference, but not co-channel interference.

Modern receivers also come with a couple neat features called passband offset and notch filter. The passband offset control allows you to move the IF passband small distances in center frequency in order to drop interfering signals down the slope of the IF passband curve, while keeping the desired signal closer to the center. **Fig. 1** shows the use of passband offset. In **Fig. 1A** both the undesired QRM/QRN signal and the desired signal are in the passband. Both will be heard, and copying the desired signal will be difficult. By moving the IF passband a short distance (**Fig. 1B**), the offending signal is dropped off the edge of the passband curve, while the desired signal is still in the passband.

The use of a notch filter is shown in **Fig. 2**. Again, the desired and undesired signals are in the passband together in **Fig. 2A**. By positioning the notch over the dirty, smelly bad guy signal, however, we can attenuate it considerably. This will increase the SNR considerably.

### Want to null strong signals?

Radio reception is essentially a matter of signal-to-noise ratio

(SNR). The "signal" is anything you want to hear, while the noise is anything you don't want to hear. And the definition of which is which changes with your goals. If you are into radio astronomy, for example, the galactic hash coming in from outer space is "signal" while the single-sideband (SSB) transmission from an exotic DX location is "noise." On the other hand, when you are trying to dig out that weak exotic DX it is the signal, and all other electromagnetic signals within the passband are noise. This includes other ham signals, lightning crashes, galactic noise, frying sounds from poor electrical connections and the whir of electric drills. For good radio reception, you need to either boost the desired signal, suppress the undesired signal, or both. Whatever it takes to get a favorable SNR. Some authorities claim that a 3 dB SNR will yield readable results, while 10 dB SNR is needed for "reasonably comfortable listening."

Over the years a number of devices have been used to eliminate the noise signal. For impulse noise (spark plugs, lightning, etc.) the old-fashioned Lamb noise limiter, diode noise clampers and noise blanker circuits have been tried. All of these circuits are more or less successful, but it's always seemed to me that the "... or less" part predominated with the noise I experienced. Besides, noise killer circuits won't do anything to rid our

receivers of co-channel and adjacent channel signals (especially the loud ones).

Experienced operators agree that one of the best ways to cancel noise is to use an antenna that has a pattern with at least one null. The dipole, for example, exhibits two nulls, one off of each end. Small loop antennas, on the other hand, have a pair of nulls that are perpendicular to the plane of the loop. A small loop antenna is one that has a total wire length of less than about 0.18. Typically, from one to 10 turns on a 24-inch frame and a suitable resonating capacitor will make a loop antenna for the high frequency ham bands (obviously, more turns are needed on the lower bands).

Several designs for small receiving loop antennas can be found in my book, *Joe Carr's Receiving Antenna Handbook* (Universal Radio, 6830 Americana Parkway, Reynoldsburg OH 43068-4113, or from Book Masters at 1-800-247-6553, or Amazon Books on the Internet at [http://www.amazon.com]).

**Fig. 3** shows the pattern of the small loop antenna. Note that the maxima (i.e., direction of maximum reception) occurs off the ends of the antenna, while the minima (nulls) are perpendicular to the plane of the loop. The nulls can be up to about -60 dB compared to the minima in practical antennas, although some of the theory books claim

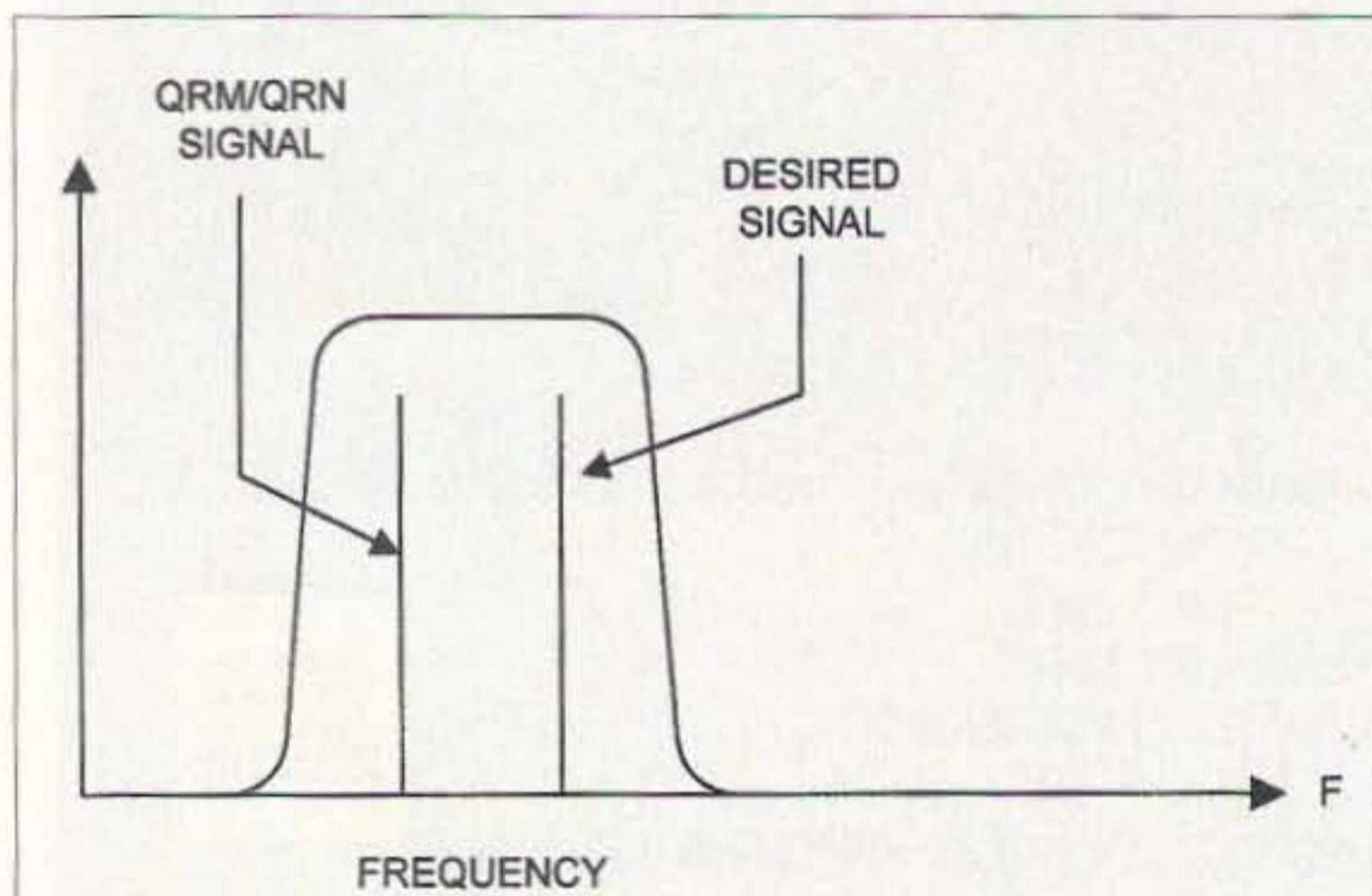

**Fig. 1A.** Both the undesired QRM/QRN signal and the desired signal are in the passband.

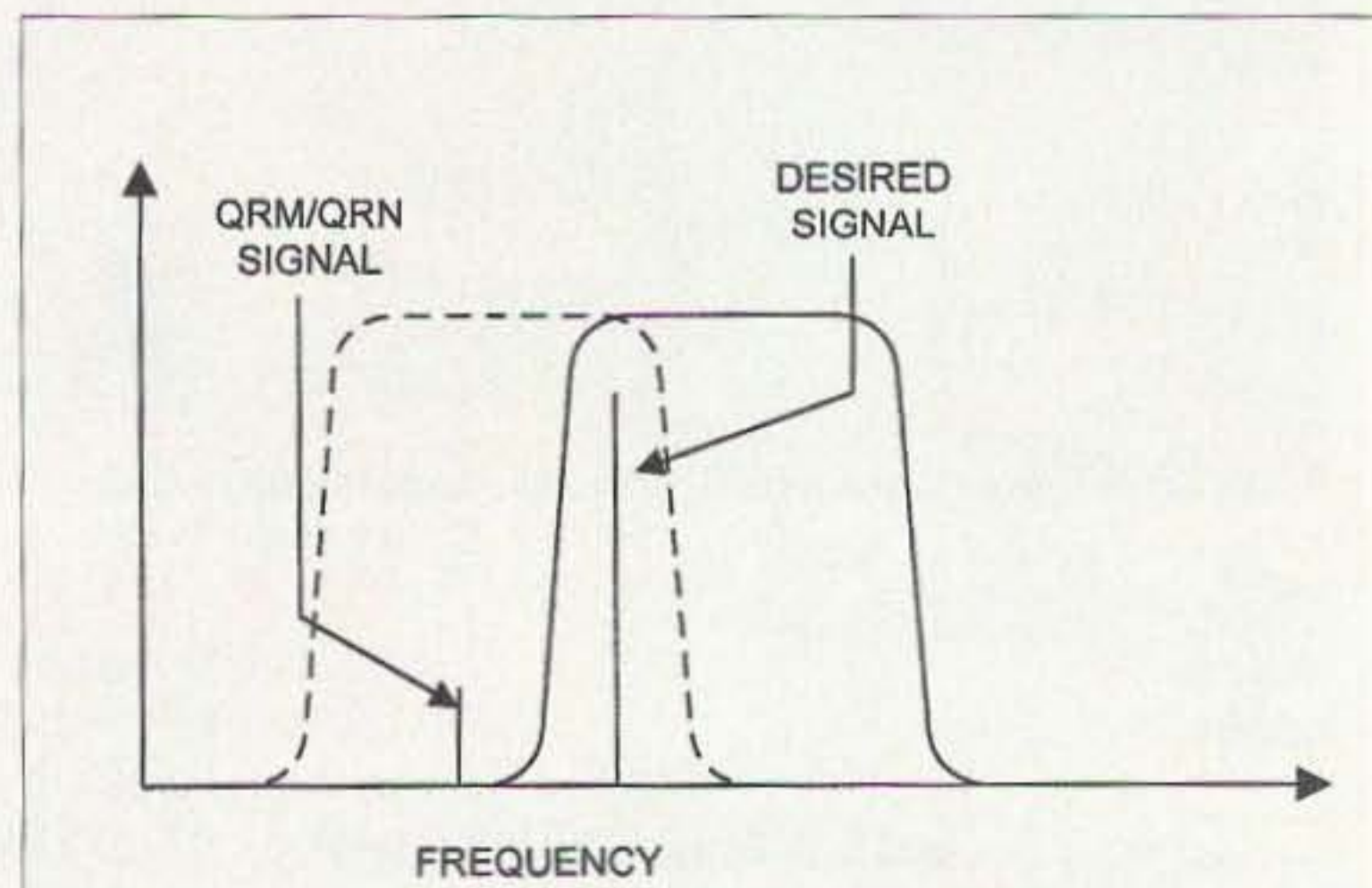

**Fig. 1B.** Moving the IF passband slightly leaves the desired signal and eliminates the undesired signal.



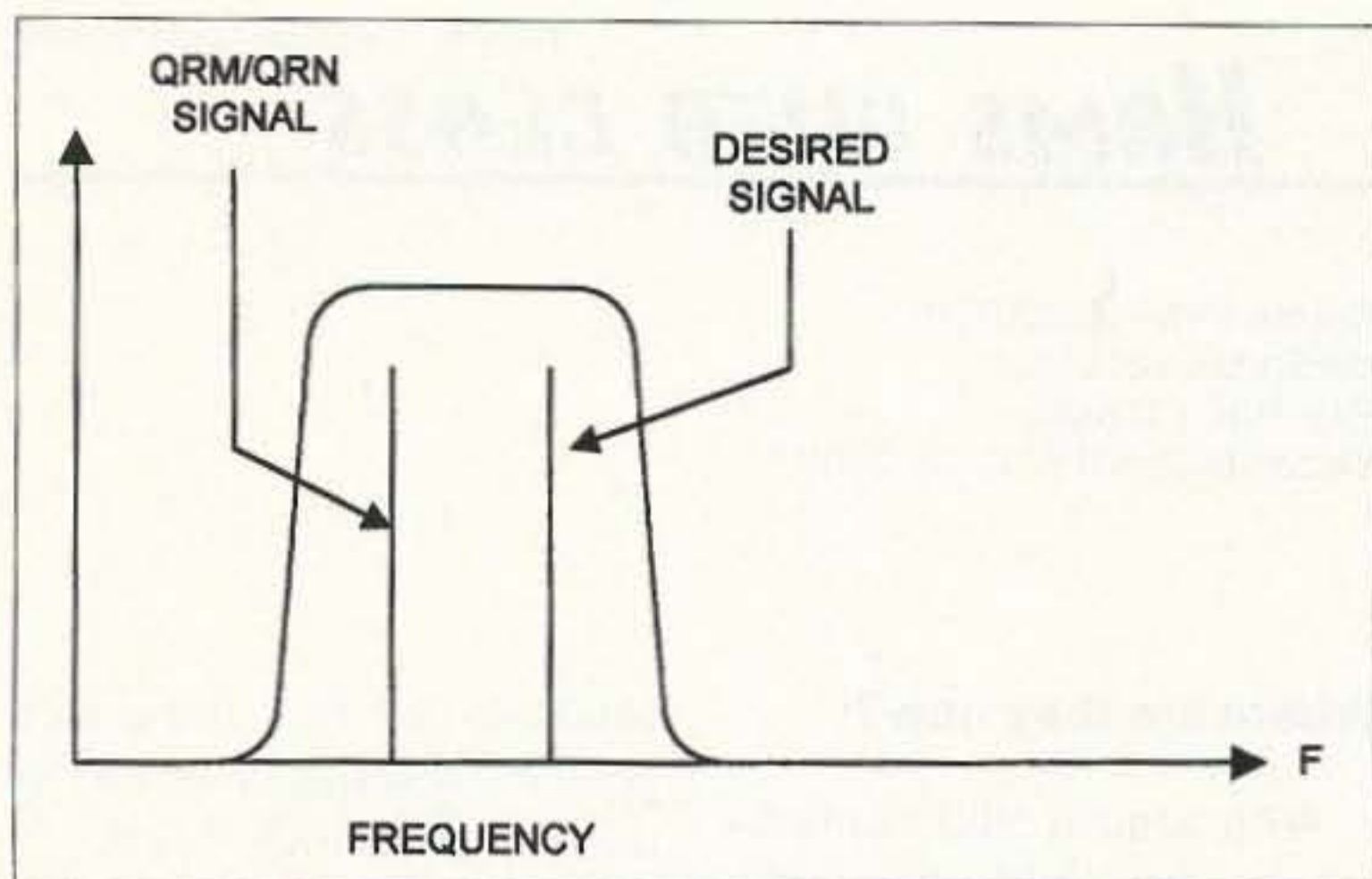

Fig. 2A. Using a notch filter.

up to -80 dB nulls. Even a sloppy loop with a -30 dB or -40 dB null will substantially reduce interfering signals.

The idea is to position the loop so that nulls are aimed at the QRM or QRN source. Even if the maxima are not positioned exactly on the desired signal, if the sensitivity ratio between the desired and undesired signal is favorable then all is well.

Of course, if you have a large yagi or cubical quad beam antenna, then don't worry too much about small

loops for receiving only ... the pattern of the beam will handle the task for you.

### An active phased null antenna

MFJ Enterprises, Inc. [P.O. Box 494, Mississippi State MS 39762; 1-601-323-5869 (voice), 1-601-323-6551 (FAX), and 1-800-647-1800 (orders only)], offers a neat device that turns your station antenna into a directional receiving phased array antenna with a null up to -60 dB (see Photo A).

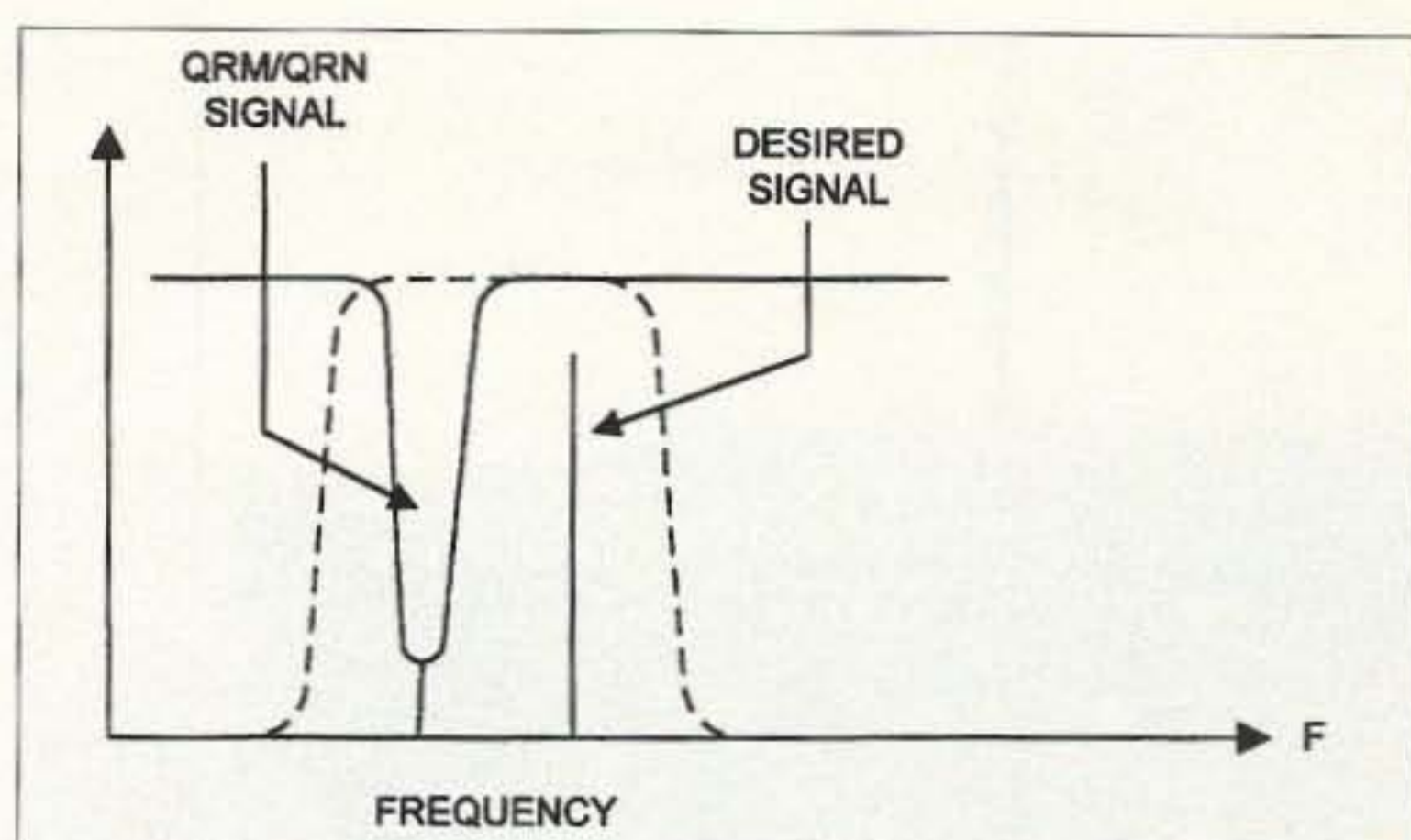

Fig. 2B. Attenuating the signal by repositioning the notch increases SNR considerably.

The device, model MFJ-1026, works on all modes, and at frequencies from VLF to VHF. This little active antenna and phasing control permits you to electronically "rotate" the antenna in order to place the null over a strong interfering signal. All you need to do is place the device in the transmission line between your antenna and either

a receiver or transceiver. Adjust the amplitude and phase control until the offending noise signal drops in strength. The instrument sells for \$119.95.

### Crystal sets, anyone?

Recently I had two different readers contact me about crystal sets. I must admit to a fondness

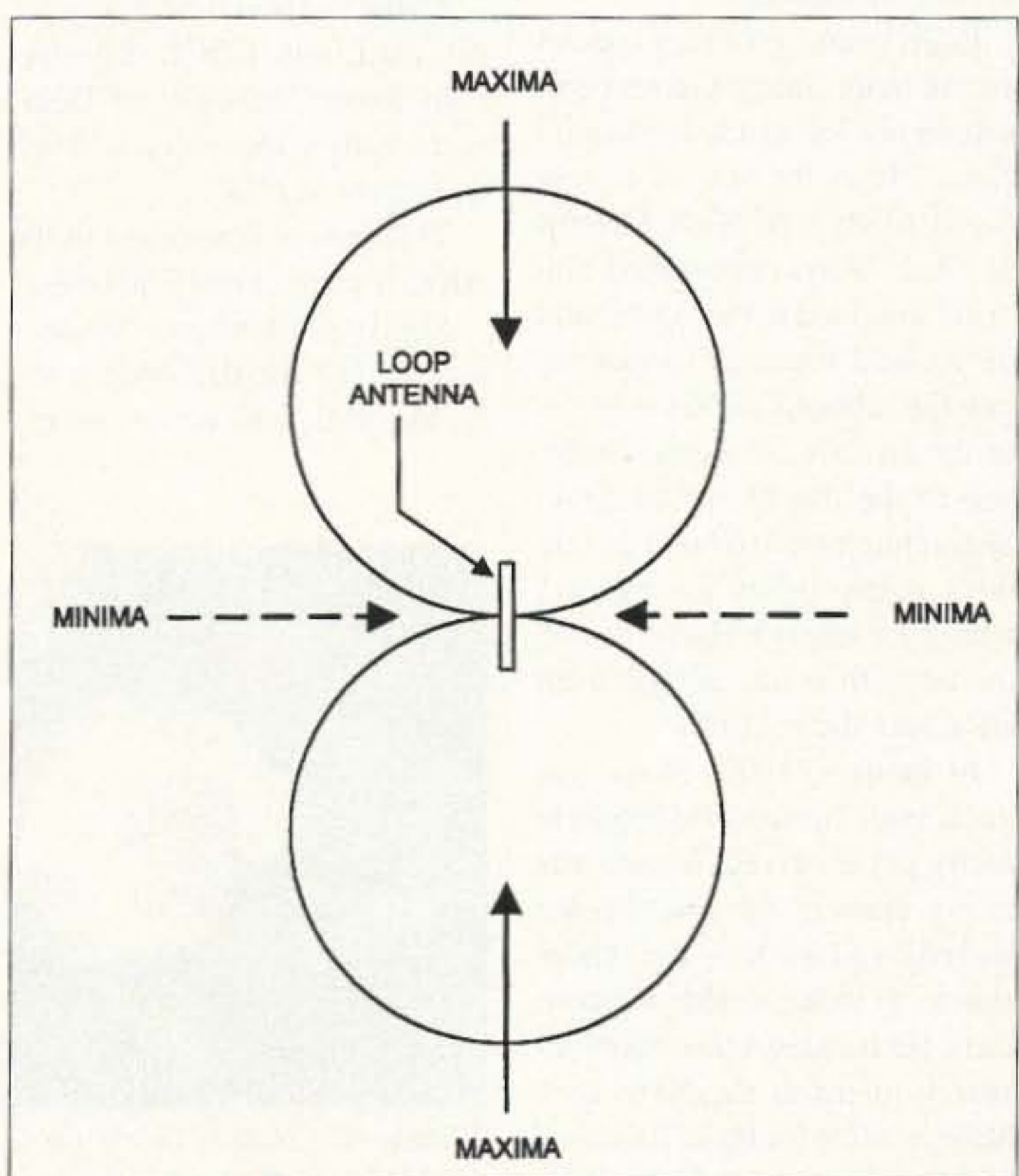

Fig. 3. Pattern of the small loop antenna.

TUBES-PARTS-BOOKS-SUPPLIES

(602) 820.5411 FAX (800) 706.6789

FIND EVERYTHING YOU NEED WITHOUT A LOT OF DOUBLE TALK

Call or fax today for our new 60 page FREE catalog of vintage tubes, hard to find parts, books and supplies. We have everything you need to build new or repair classic audio equipment at prices you haven't seen in decades.

With 50,000 watts we can broadcast for bla bla bla bla bla

I wonder where can I find a 2A3 audio tube?

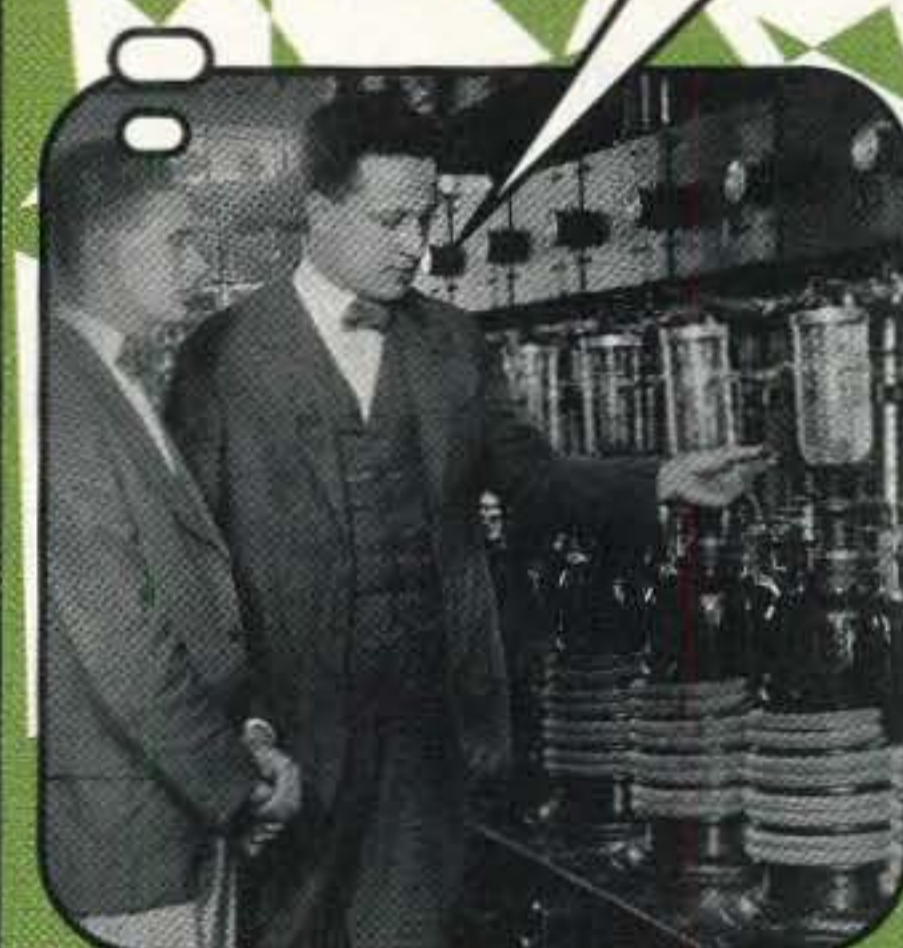

ANTIQUE ELECTRONIC SUPPLY

6221 SOUTH MAPLE AVENUE  
TEMPE, AZ U.S.A. 85283  
VISIT OUR WEBSITE AT [WWW.TUBESANDMORE.COM](http://WWW.TUBESANDMORE.COM)



## HAMS WITH CLASS

Carole Perry WB2MGP  
Media Mentors Inc.  
P.O. Box 131646  
Staten Island NY 10313-0006

### Where are they now?

With almost 900 students coming through the ham radio program every term, it's an impossible task to keep track of them all. Fortunately, many of the children come back to Intermediate School 72 in Staten Island (New York) to visit the ham shack again. Those 6th, 7th, and 8th graders who get licensed tend to stay in touch with me. We plan skeds, and the kids in my classes love to speak with my former students.

It always makes me feel good, of course, when the young hams spread the word in their new schools and set up radio stations and clubs in various high schools and colleges. I've been so proud to have been invited to SAREX contacts and special events run by former students.

Eight years ago a very special young man, Shaun Gartenberg, was in my 7th grade ham radio class. He is the son of a dear friend, Marty WA2YYX. Shaun's dad had always encouraged him to get involved in the hobby, and he looked forward to getting into the school's radio program, to the friends he would make, and to the fun he would have. Shaun happened to be in a class with many other youngsters who were eager to have fun on the air with young people from all across the country.

In January, 1990, Shaun got his Novice license and began to really get involved. Shaun was in my class in 8th grade again and enjoyed working the school station to make worldwide contacts. He became a laboratory research intern at the New York State Institute for Basic Research and Developmental Disabilities in Staten Island. He worked

hands-on for two and a half years in a research laboratory in the field of neurochemistry.

In 1996 Shaun became a member of the Cornell Bioengineering Society where he interacted with guest lecturers who were at the top of their field as scientists, educators, and doctors. He was also a teaching assistant for a computer science course during his sophomore year of college at Cornell University.

In January, 1996, Shaun joined the Cornell Amateur Radio Club. He participated in meetings once a week to help plan upcoming events for the club. He often works the club station and presently holds a General class license. He enjoys working CW on 40 and 80 meters and can often be heard on the NorthEast Connect on 145.250 MHz.

Shaun is a two-time winner of the Ed Ludin K2UK Scholarship from Chaverim of Delaware Valley. He won it in 1995 and again in 1997.

This year he is a winner of the ARRL General Fund Scholarship.

Shelly Gartenberg, Shaun's mother, is KB2DBF, and his sister Meredith, who was also in my



Photo A. The MFJ-1026.

for crystal sets because my first construction project in the mid-1950s was a crystal set with a "real" galena crystal. Galena is a lead-based natural mineral that has semiconductor properties (it's kind of like a naturally occurring semiconductor diode). In junior high school shop I built a crystal set based on the 1N34 diode. Unfortunately, I, lifelong smart-aleck, got into trouble with the teacher because I mouthed off when he didn't understand the idea of using a primary antenna winding of several turns over the main tuning coil to boost the signal.

Unfortunately again, I haven't had the time to pursue a dream of building the "ultimate" crystal set. This was a project that the late K4NFU (Johnnie H. Thorne) and I were going to launch one day. I would be interested in seeing any really super crystal set designs that you have. The best of them will be published in future editions of this column. Also, there is a Xtal Set Society (check the World Wide Web).

### Back to school

I think I owe an apology to my computer programming students at a local community college for the amount of homework I assign. My "day job" employer sent me to 14 weeks of graduate school where I will earn 15 credit hours towards a Master's Degree in Information Systems Technology (the next 15 hours are on me!). The first week I nearly drowned in the "fire hose" we received from the professors.

It's been a lot of years since I was in a formal school, so this was a shock to my system. But maybe I won't apologize after all. If an "old duck" like me can hack it, I guess some 20-year-olds can. Besides, it's fun to give out so much work (snicker, snicker, he says, while twirling his evil mustache!).

### Connections ...

I can be reached via snail-mail at P.O. Box 1099, Falls Church VA 22041, or via Internet E-mail at [carrjj@aol.com]. 

### Extra Special Subscription Offer

A 5 Year 73 Magazine subscription for only \$100!  
(That's just \$20 a year and only the beginning, folks.)

73 will also send a special nine month (school year) gift subscription in your name to the school library of your choice!

That's 69 issues for only \$100 (about \$1.45 each).

Such a deal! (Limited time offer. US only.) Order now.

800 274 7373 or mail to 70 R 202 N, Dept 100/69, Peterborough NH 03458



Photo A. Shaun Gartenberg KB2JNW, role model for students everywhere.



## Ham Television

Bill Brown WB8ELK  
139 Angela Dr. Apt. B  
Madison AL 35758

After months of preparation, an expedition from the Huntsville, Alabama, L5 Society (HAL5) set out on a 700-mile trek to Hampstead, North Carolina, to launch Project HALO (High Altitude Lift-Off). The HALO project's aim was to be the first private group to launch a rocket (carrying a live ATV system) into space from a balloon platform floating at 100,000 feet (a system known as the "rockoon").

### The rockoon

The rocket itself was a unique and safe-to-handle design called a hybrid that used a fuel of nitrous oxide (laughing gas) and common asphalt. We joked that we were driving on rocket fuel as we drove down the Interstate. Several ham radio payloads were designed into the rockoon system. The command and control uplink package was built by Clay Sawyer, Ed Myszka KE4ROC, Gene Young K4ZQM and his wife Gladys. Essentially, two separate two-meter HTs on different frequencies were used to allow us to remotely uplink the rocket firing command via TouchTones™ once the balloon had carried the rocket up to 100,000 feet. This system had additional relays to allow for

activation of safety cutdowns if the rocket had failed to ignite.

I designed a color TV downlink on 434 MHz that was attached to the side of the launch platform gondola to give us a great view of the rocket launch as it headed up into space. This package consisted of a one-watt PC Electronics™ KPA5-RC, a color CCD camera and an Olde Antenna Labs™ Little Wheel omni-horizontal antenna.

Ed Myszka KE4ROC and Clay Sawyer built the ATV and telemetry downlink that was carried in the nose cone of the rocket itself. Altitude information was encoded into an APRS-compatible packet format using a MIM module, a Trimble GPS board and a TEK FM transmitter on 446.00 MHz. Drogue and main chute deploy timers were also part of this package. The 1280 MHz FM ATV transmitter and amplifier (set to three watts) was designed and built by Richard Goode W8RVH and Hank Cantrell W4HTB. The rocket's camera was a miniature B/W model housed in a very rugged aluminum enclosure (model MVP5 from Micro Video Products™).

### Beyond the edge of space

The HALO team gathered at the launch site in Hampstead in

radio class, is KB2ZLS. Needless to say, the whole family is very proud of Shaun. He is an accomplished young man who is a credit to his family, to his community and to the hobby of amateur radio.

From time to time, I'll be featuring stories of other former students who have gone on to make their marks in the world thanks

to the influence of amateur radio and the contacts they have made.

If any instructors or teachers who are readers of the "Hams With Class" column have followed the careers or lifestyles of former ham radio students, please write to me so we can share the successes of these talented young hams, and use them as role models for our students. 73



*Photo A. The HALO team prepares to launch the rockoon system from a field near Hampstead, North Carolina. Photo by Ronnie LaJoie.*

the wee hours of Sunday morning, May 11th. It was a very cold frosty morning with absolutely no wind. Perfect conditions for a balloon flight! The rocket crew tested out the payload and command electronics; then Al Wright and Steve Mustaikis

started fueling the rocket with nitrous oxide. The balloon crew unfurled the delicate plastic envelope on the protective ground tarp, attached the Kjome™ launcher (to secure the balloon in place) and started the inflation process.

*Continued on page 78*

## AMATEUR TELEVISION

Web site: [www.hamtv.com](http://www.hamtv.com)

### GET THE ATV BUG

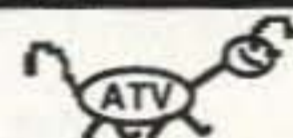

≥10 Watt pep  
Transceiver  
Only \$499  
Made in USA  
Full Color  
and sound

### TC70-10 420-450 MHz ATV Transciever

ATV is no more difficult to get on vs. any voice mode except you just plug in your camcorder to transmit, and your TV set to receive the picture and sound. That's it - you're seeing as well as talking to other hams live and in color just like broadcast TV. No other radios, computers or interface boxes required. DX is 90 miles snow free line of sight using 14dBd ant.

Show the shack, home video tapes, zoom in and describe projects, show computer graphics or programs, repeat SSTV or even Space Shuttle Video and audio if you have a TVRO. Go portable or mobile, do public service events, RACES, AREC, CAP, transmit the local radio club meet.

HAMS; Call, Write or Email for our 10 page ATV Catalogue for more info - We have it all! Transmitters, Downconverters, Amplifiers, Repeater modules, and more. We also have wired and tested boards for the builder, R/C, Rocket and Balloon ATVers.

(626) 447-4565 M-Th 8am-5:30pm pst Visa, MC, UPS COD

**P.C. ELECTRONICS**

Email: [tomsmb@aol.com](mailto:tomsmb@aol.com)

2522 Paxson Lane Arcadia CA 91007

24 Hr. FAX (626) 447-0489



## RTU continued

As the sun poked up above the horizon, and with just 30 minutes to go before our FAA launch window closed, Ben Frink KD4BFG (who attempted several rockoon flights of his own several years ago from Southeastern Community College—see the “ATV” column, 73, p. 52, May 1991) discovered two nearly empty tanks of helium as he was inflating the balloon. Concerned that we would not have enough helium in the balloon to lift the rocket payload, launch director Greg Allison phoned businesses in Hampstead and nearby Topsail Beach to obtain more helium (not an easy task in the wee hours of Saturday morning).

It turned out the local Food Lion™ store had two tanks they used for party balloons,

and they eventually sold them to us, after having said “No” at least three times (persistence and pleading pays off). This saved the day and allowed us to achieve final flight lift. The rocket crew lifted the payload and stretched the lines tight, the fill tube on the balloon was tied off and the call to the FAA went out for imminent liftoff. As Dr. Larry Scarborough, Peter Ewing, Ron Creel and I held the balloon launcher in place (see **Photo A**), Tim Pickens (our rocket lead) hit the balloon release mechanism with a hammer at 6:59:57 a.m. EDT. The balloon sailed off smoothly into the still morning sky carrying the rocket up on its way to the stratosphere, just five minutes before our deadline!

Spectacular color video of the balloon and the side of the rocket launch tube could be seen



**Photo B.** (l to r): Clay Sawyer and Tim Pickens finish assembly of the 7-foot, 4-inch-tall rocket. The ATV payload is just below the nose cone section. Photo by Bill WB8ELK.

### HALO SL-1 Rocket Description

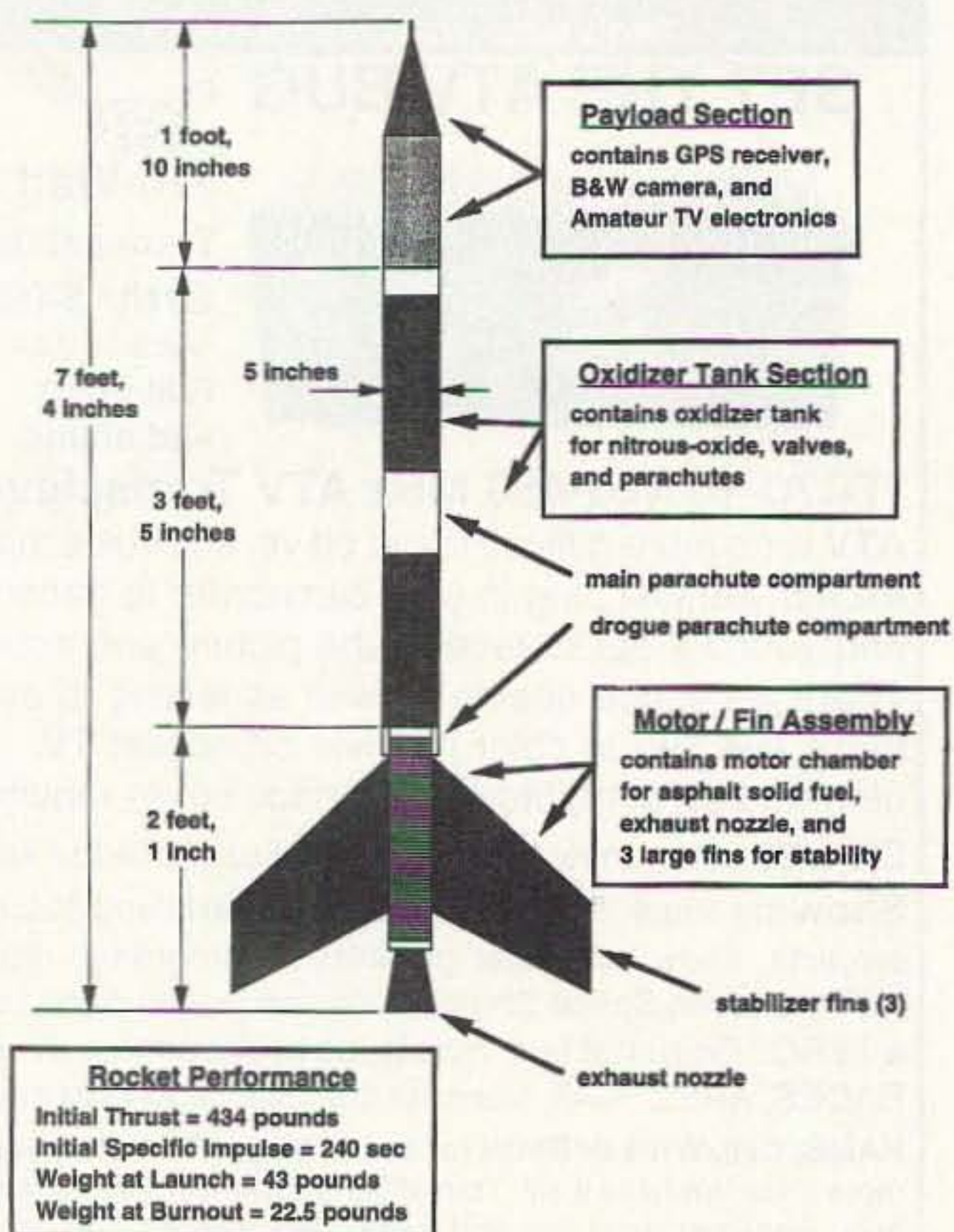

**Fig. 1.** The HALO rocket carried a payload with onboard ATV camera on 1280 MHz and a packet telemetry system. Drawing by Ronnie LaJoie.

in the command tent. The rocket video was viewable on another monitor, but little could be seen due to the protective plastic wrap around the gondola.

The GPS telemetry, downlinked via packet radio in APRS format, started to get weak after the rockoon exceeded 23,000 feet. The signal faded completely into the noise and we were unable to record any more usable position and altitude reports from that point onward. It appeared that the final transistor of the packet transmitter had burned out.

### A real blast

At 8:21 a.m., we had calculated the estimated altitude of the rockoon, based on the ascent

rate, to be around 60,000 feet. I said, “Since we are now above 49,000 feet, the barometric rocket safety switches are now armed and the rocket can be fired at any time.” Of course, we were hoping to reach at least 100,000 feet before firing off the rocket. Just 30 seconds later, I happened to be watching the video downlink, looking up at the balloon envelope, and thought that the balloon looked pretty full. Just then, one of the seams tore wide open, dumped out all of its helium and the balloon just folded up into a long streamer of plastic! As the rocket and gondola dropped rapidly, “Fire that rocket NOW!” I shouted to Ed Myszka KE4ROC. We had just over a minute to issue the “fire” command before



## Sketch of Project HALO Space Launch 1 Mission

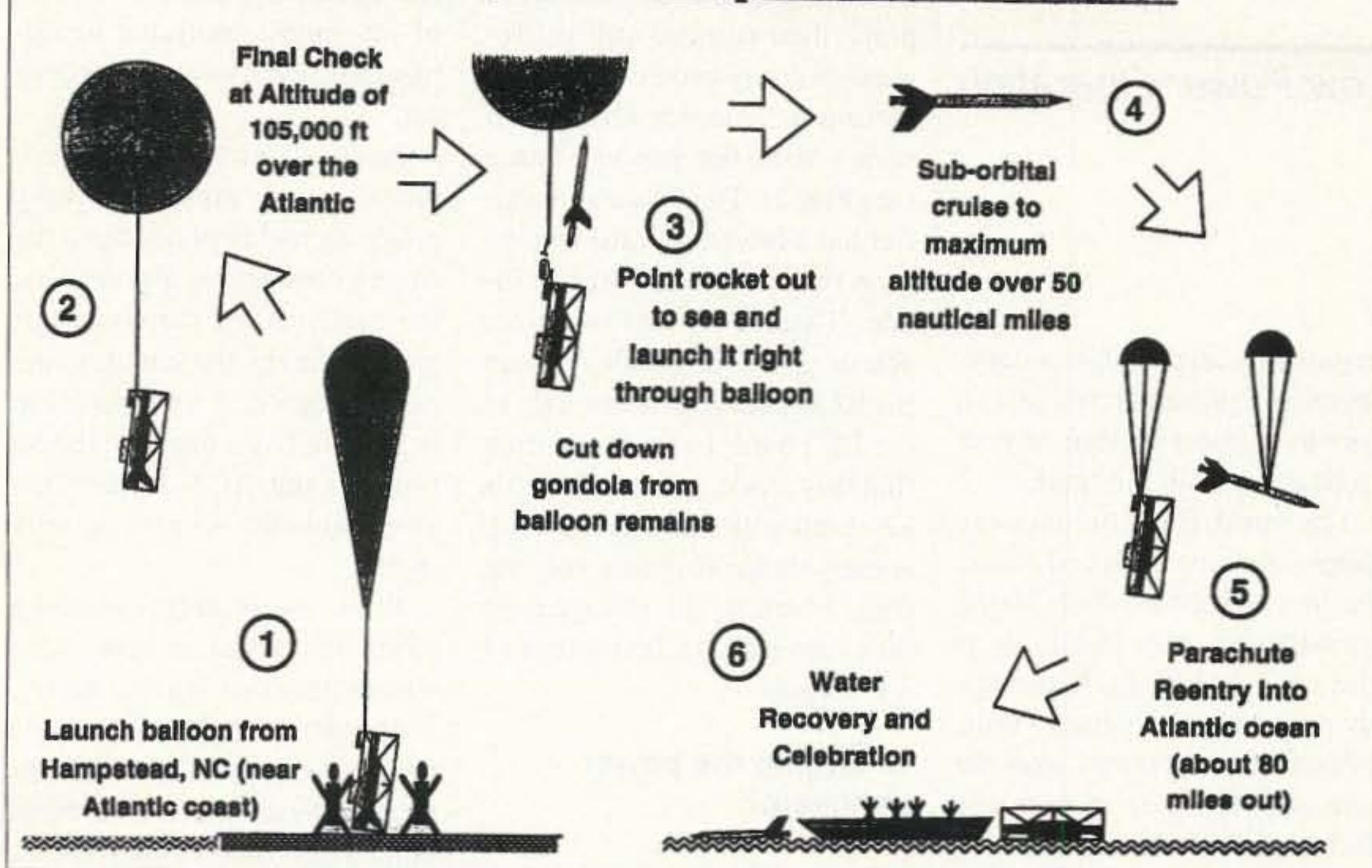

Fig. 2. Mission profile of the balloon flight and high altitude rocket ignition.

the safety switch disarmed the rocket at 49,000 feet.

Ed keyed down the two-meter transmitter and anxiously entered the firing code via TouchTones. Nothing happened ... he tried another time ... nothing ... and then a third (we had only seconds left before the safeties cut in). All of a sudden there was a bright flash and a cloud of smoke and the rocket leaped out of the gondola and off towards space. Bits of plastic tape and the plastic covering shredded off and fluttered past the camera view as the gondola continued its rapid descent. Miraculously, the camera had survived the rocket exhaust blast and continued to work flawlessly until the gondola splashed into the Atlantic Ocean.

We were treated to flashes of video from the rocket for about a minute, showing tantalizing views of the curve of the Earth. Since the rocket was spinning around rapidly, the ATV signal fluttered in and out and made it difficult to lock onto a good picture. After that, the video signal ceased and the rocket parachuted down into the Atlantic. We estimate our peak altitude to be between 30 to 36 nautical

miles. Both the gondola and the rocket splashed down about 120 miles east of the launch site and 50 miles from the nearest land. Since the GPS signals were unavailable, we were unable to direct Bob Brandhof W3QNS who was DFing the payloads from the chase boat to an accurate splashdown location. The rocket and gondola were very small straws in an extremely large haystack and, as a result, the chase boat did not recover the payloads.

Although we did not achieve space (defined as 50 nautical miles in altitude), we did set several records: The first successful amateur launch of a rockoon (rocket launched from a balloon), the highest launch of a hybrid rocket (hybrid referring to the nitrous oxide/asphalt fuel combination), and the highest-flying hybrid rocket to date.

We hope to fly again in the next few months from the Gulf of Mexico with a larger rocket and balloon to achieve our goal of reaching space. You can follow our launch status and progress by checking out my Web page at: [http://fly.hiwaay.net/~bbrown/] or going directly to the HAL5

HALO page at: [http://advicom.net/~hal5/HALO].

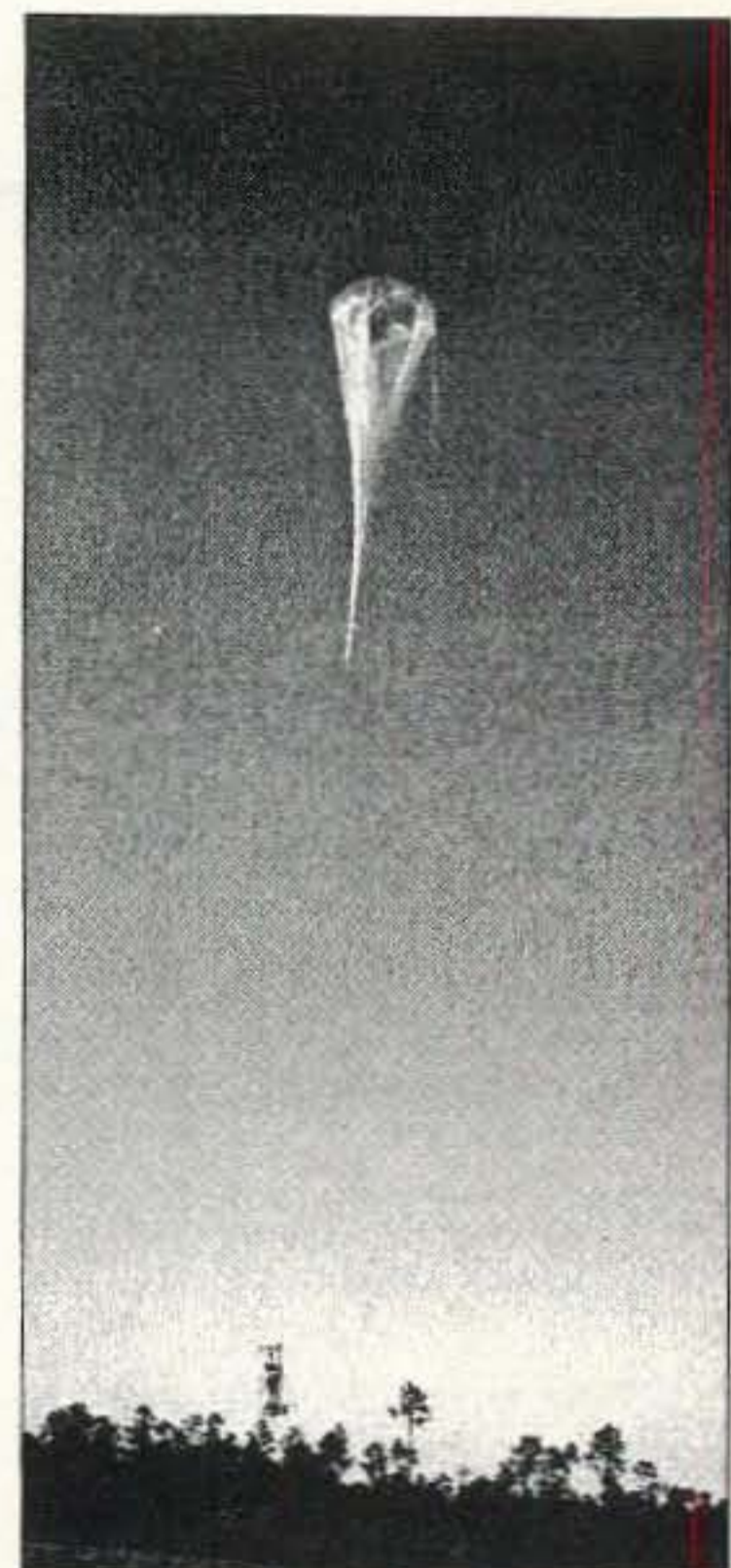

Photo C. The balloon lifts off, carrying the rocket on its way for a stratospheric launch. Photo by Ronnie LaJoie.

## AMATEUR TELEVISION

web site: [www.hamtv.com](http://www.hamtv.com)



Wired & tested boards start at \$49 for the builder.

**TVC-4G** only \$89  
Made in USA

## SEE THE SPACE SHUTTLE VIDEO AND GET THE ATV BUG

Many ATV repeaters and individuals are retransmitting Space Shuttle Video & Audio from their TVRO's tuned to GE-2 (85W) Tsp 9 vertical or weather radar during significant storms, as well as home camcorder video from other hams. If it's being done in your area on 420 - check page 577 in the 97-98 ARRL Repeater Directory or call us, ATV repeaters are springing up all over - all you need is one of the TVC-4G ATV 420-450 MHz downconverters, add any TV set to ch 2, 3 or 4 and a 70 CM antenna (you can use your 435 Oscar antenna). You don't need computers or other radios, it's that easy. We also have ATV downconverters, antennas, transmitters and amplifiers for the 400, 900 and 1200 MHz bands. In fact we are your one stop for all your ATV needs and info. We ship most items within 24 hours after you call.

Hams, call for our complete 10 page ATV catalogue.

1-626-447-4565 M-Th 8am-5:30pm pst Visa, MC, UPS COD  
P.C. ELECTRONICS Email: [tomsmb@aol.com](mailto:tomsmb@aol.com)  
2522 Paxson Ln, Arcadia CA 91007 24 Hr. FAX 1-626-447-0489



## Low Power Operation

Michael Bryce WB8VGE  
955 Manchester Ave. SW  
North Lawrence OH 44666  
[prosolar@sssnet.com]

I've just put the final touches on Ten-Tec's new 40-meter QRP transceiver. This is a dandy little rig that I'm sure will find its way into a lot of shacks. However, there are some items that need some attention.

### Ten-Tec QRP modifications

Before we begin, I must mention that if you perform the following modifications to the rig, it will no longer be under warranty from Ten-Tec. Also, before you start adding or changing things around, the basic rig should be operating normally. Most of the modifications are simple to do. However, you will be required to remove the PC board from the chassis and remove components from the circuit board. Make sure you have the necessary tools for working on a double-sided PC board with plated-through holes.

### Reverse polarity protection modification

This modification should be

required on all portable battery-operated equipment. It's just so easy to connect a piece of gear up backwards in the field.

The modification is very simple. A diode is placed across the power jack so that during normal operation, the diode is bias-off (see Fig. 1). If you apply power to the rig backwards, the diode conducts and takes the fuse out. There is in fact one drawback with this design. You must have a fuse in series with the supply line. No fuse means a lot of smoke!

I used a 1N5400 series diode. The 1N5400 has a 50-volt rating, while the 1N5401 is 100 volts. Either one will work, and they are available from Radio Shack™. They are both rated at three amps, which will easily hold until your two-amp fuse blows.

This is the modification I used. It always works and you don't have to worry about damage if you connect the rig up backwards. You *do* have to have a handful of fuses on hand, though!

If you don't care for the idea of carting around a lot of spare parts, then you can still get reverse polarity protection by inserting a Schottky rectifier in series with the power source (see Fig. 2). The Schottky rectifier has a lower forward voltage drop than a standard silicon diode. There's enough room for you to easily add this diode from the RCA phono jacks directly to the PC board. I should mention that this diode, even though it's a Schottky diode, will still drop some voltage. Running your rig from a battery, the voltage drop will cause a significant loss of RF output.

### Changing the power connector

I never did like the use of an RCA phono jack to supply power to a rig. It's not so much the connector on the rig, it's the plug attached to the wire that holds the juice that worries me. With the pin exposed, it's so easy for the plug to touch a grounded object and whoa! You've got a meltdown on your hands—another good reason God made fuses!

To keep the back apron of the rig from looking like Swiss cheese, I decided to use the original RCA jack. This time, I inserted a married pair of #16-gauge wires, terminated into a

Molex™ connector, through the RCA jack. I've standardized all of my mobile/portable equipment to use the same power plug set.

About six inches of wire produces a nice "pigtail" for easy plugging and unplugging of the Molex connectors. By the way, the male end of the connector goes to the rig, the female to the power source. A terminal strip is mounted by using an existing hole on the RCA jacks. This strip holds the reverse polarity diode.

While we're at it, I placed a 4700 µF capacitor across the supply lines coming into the rig. This capacitor helps to decouple the power supply. It also helps keep transmit chirps to a minimum while using a dying battery.

### Tuning upgrade

Like many of the club rigs we've seen in the past year, the Ten-Tec model uses a pot to adjust the frequency of the rig. You can smooth down the tuning rate of the rig by using a 10-turn pot. They're awfully expensive if they're new, but on the surplus market, they're not too bad. Hosfelt Electronics has a 10 k, 10-turn wirewound potentiometer for \$10.

This modification is easy enough. Just remove the original unit and replace with the 10-turn

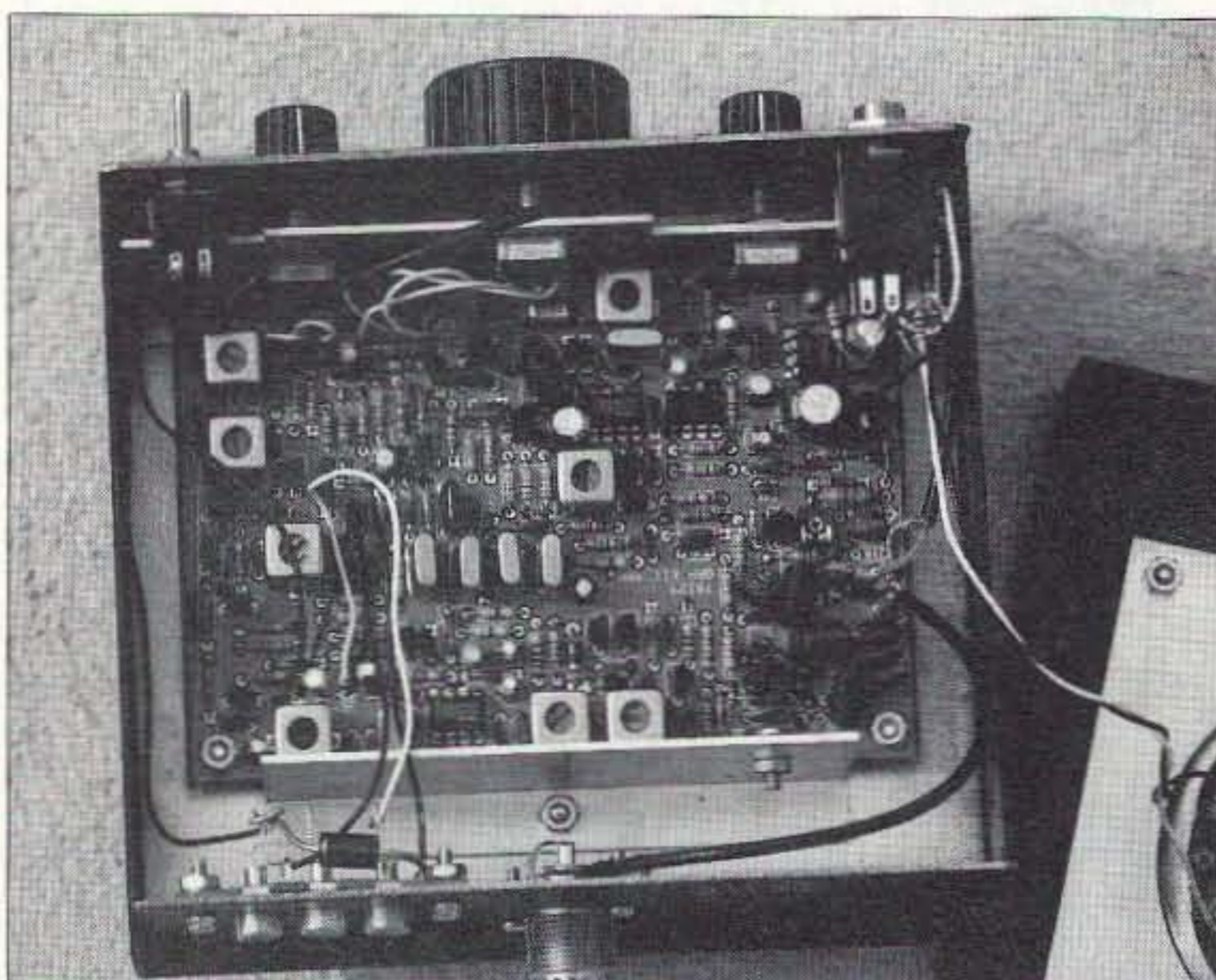

Photo A. Inside the Ten-Tec QRP transceiver.

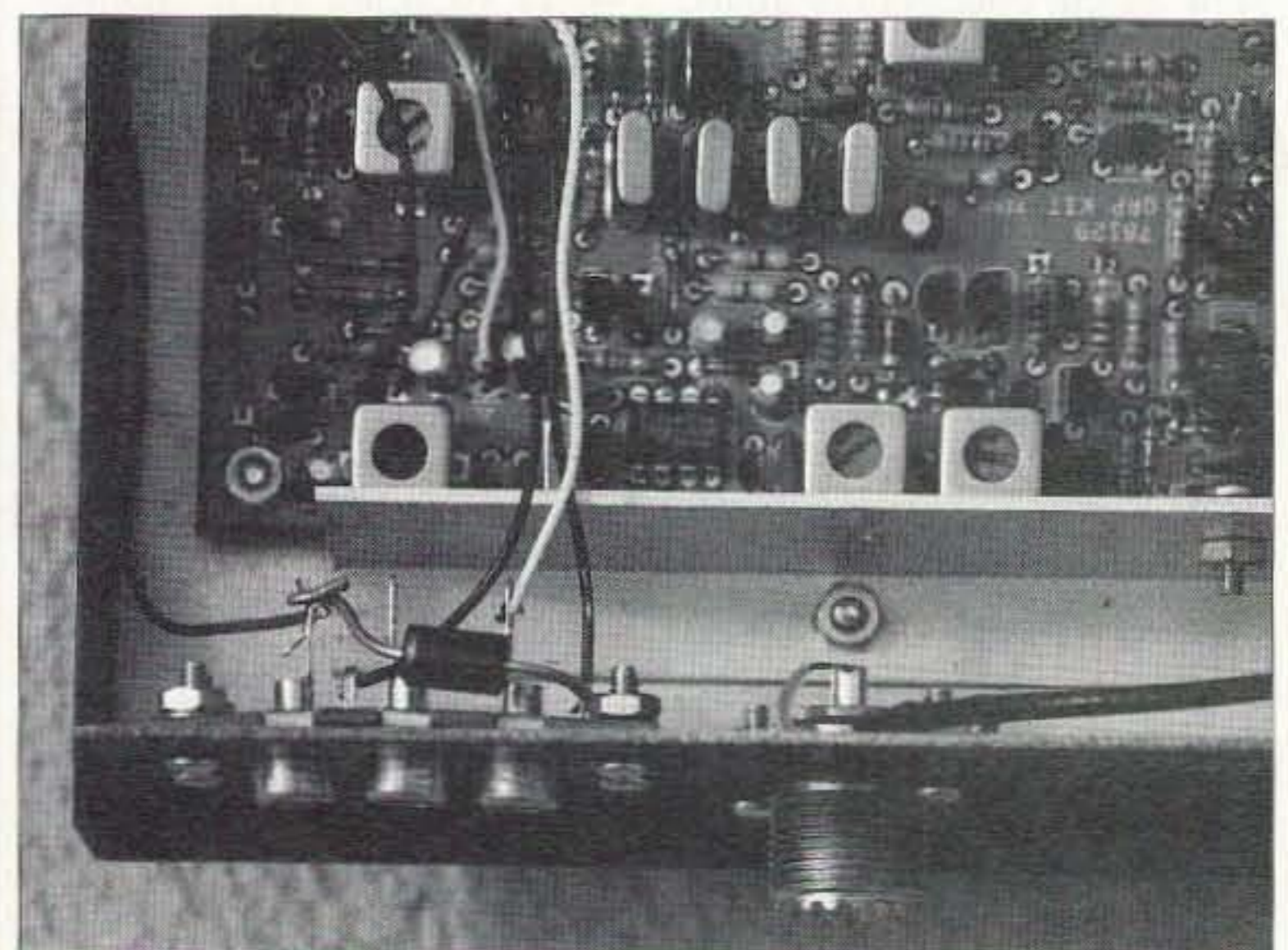

Photo B. The reverse polarity diode is placed across the power input jack. In this photo, the capacitor the author refers to has not yet been installed.



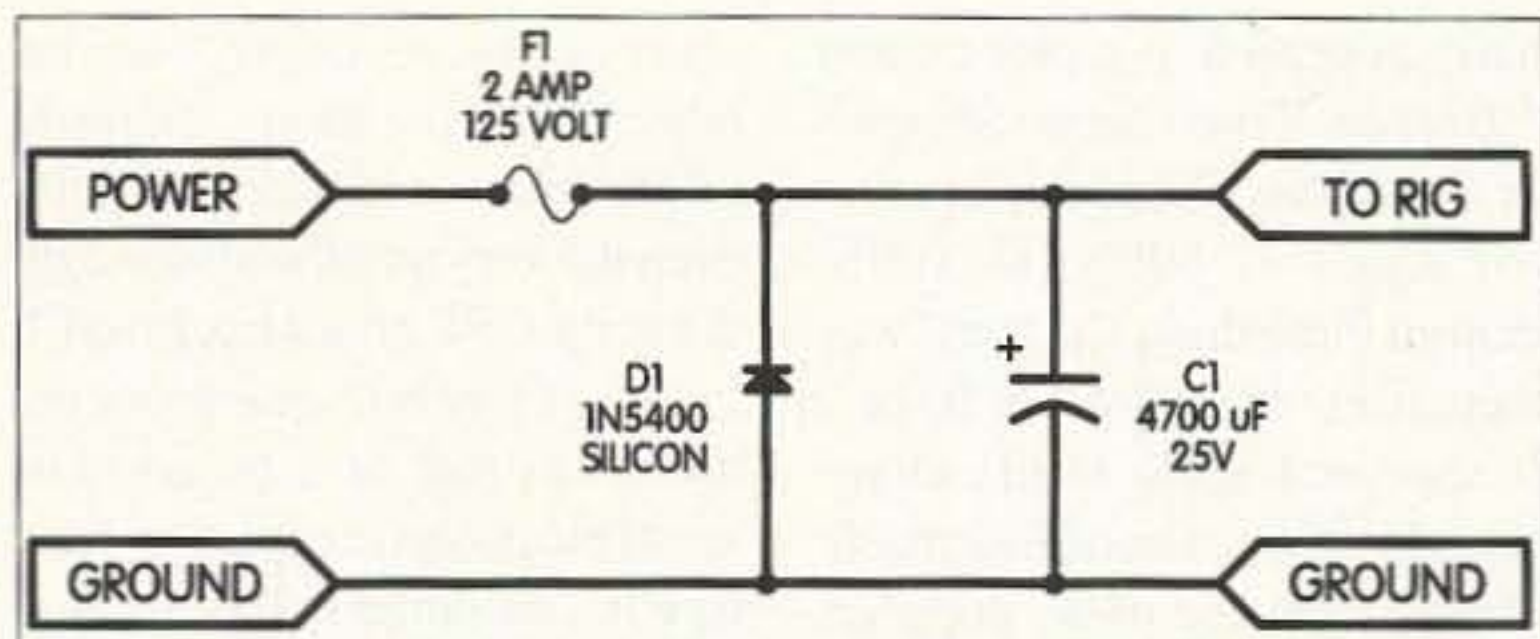

Fig. 1. Using a silicon diode for simple reverse voltage protection.

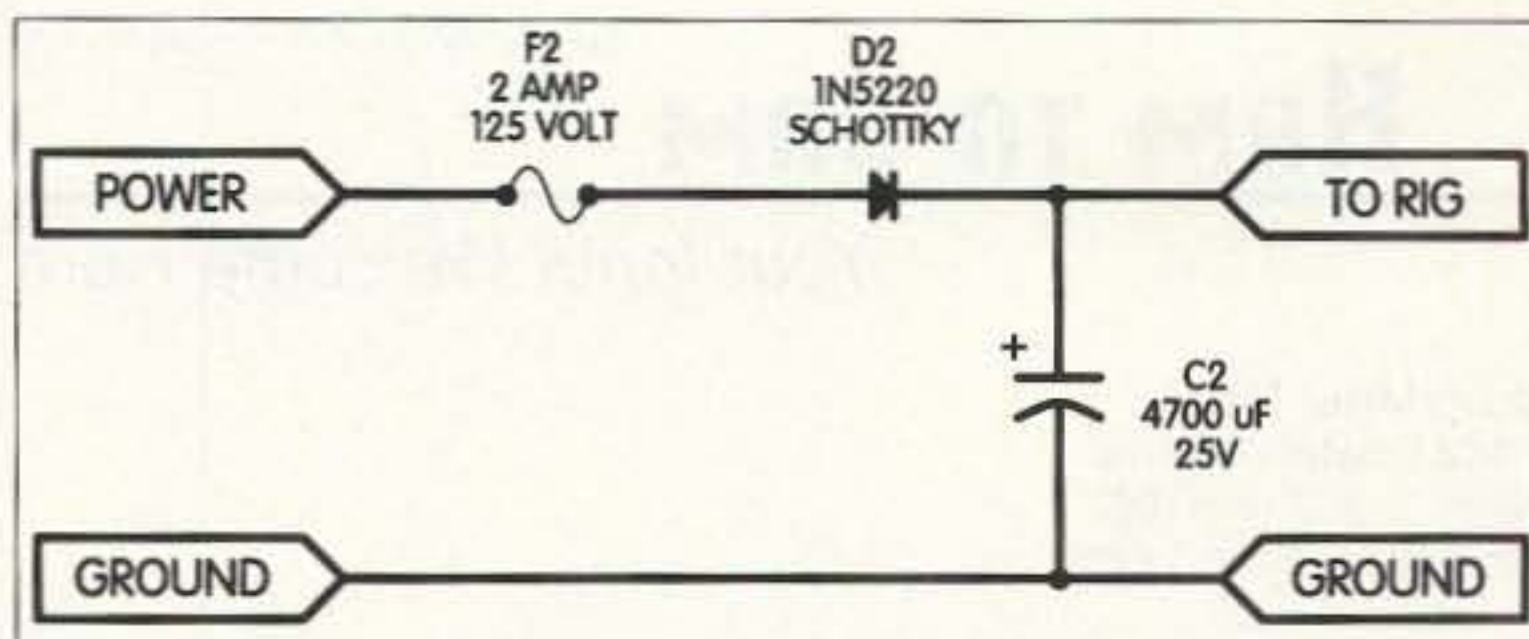

Fig. 2. Using a Schottky diode in series.

pot. Now, there is one drawback to this modification: You have no idea where you are on the band! I can live with this, since I usually just scan for stations calling "CQ" anyway.

### AGC modification

While the Ten-Tec rig has a very nice AGC, it may be either too slow or too fast for your operating style. To change the time constants, I replaced the AGC capacitor with a slightly smaller value. While it would certainly be possible to do, you could add a switch and select between a slow AGC and a fast AGC. However, I'm not sure such a modification would be worthwhile.

### Power-on LED

This modification is pure bells and whistles! I found I was always leaving the rig on, but with the volume turned down. A few dead gel cells later, I decided to add a small T-1 super-bright green LED. Although this LED placed an additional 20-mA load on the battery, I no longer forgot to turn off the rig. The LED was placed in the top right corner of the rig. A 1 k resistor will be required in series with this LED to limit current. Tap off of the power switch on the PC board to supply the juice for the LED. A small glob of Super Glue™ or similar gel holds the LED in place. Use the jelly or gelled adhesive, not the liquid—it won't run down the back of the front panel.

### Parts list

Here is a list of the part numbers I used to modify my Ten-Tec

QRP rig. All the parts came from Hosfelt Electronics (call for one of their catalogs at 1-800-264-6464).

Either diode is listed by its part number, such as 1N5400, or 1N5220 for the Schottky diode. The LED part number is 25-302. 10-turn pot, 10 k, is 38-172. Hosfelt also stocks the Molex connectors. Their part numbers are as follows: plug, #03-06-2011; receptacle, #03-06-1011. You will also need the proper pins and sockets for these housings. The female crimp number is 02-06-1103. The male crimp number is 02-06-2103. While you're at it, get the extraction tool. It's worth its weight in gold if you put a pin in the wrong hole in the housing. Also, get the proper crimper to do the job. For the .062 sockets and pins, the Hosfelt Electronics catalog number is W-HT-1921. You really can't do a proper job without these crimpers.

So far, those are all the modifications I've done on my Ten-Tec QRP transceiver. I do plan on installing an S&S Engineering digital display for frequency readout. There's plenty of room on the back apron to hold a variety of add-on circuits. Perhaps a memory keyer or a Rainbow antenna tuner would be nice.

If you have any modifications for this rig, by all means send them to me. I'll print up everything that's out there.

### Heathkit modifications

Also, if you have any new modifications for the Heathkit QRP rigs, the HW-7, HW-8, and HW-9, please let me know. I'm

looking for just about anything for the HW-7. A while back, a reader sent me a letter asking for mods for this classic QRP rig. Seems demand has outstripped the supply, as he paid \$125 for an HW-7!

The Heathkit HW-99 is a long-lost rig based on the HW-9, but with a power amplifier added. I'm looking for one of these rigs myself. So, if you've got one lying around, drop me a note. E-mail seems to work better for me since I've changed to a different ISP.

### A new year

1998 is just around the corner. I'm working on some QRP test equipment. I'm not sure what it will end up as, but the project should be interesting. Also, come next year we'll do some more building and repairing of our low power rigs. And as always, if you have circuits, ideas, or anything else dealing with low power, by all means send it my way.

Hope you all have happy holidays and a grand New Year! 73

Holiday Special!

**\$99**

until 12/19/97

**HFX™**

Here's what people are saying about the best propagation software available:

This is a cool product! — *Ham Radio Online*

HFX will become a powerful force in the field of HF-propagation prediction and analysis. — *QST*

HFX figures among the most complete and best developed prediction software tools. — *Megahertz*

Very intuitive and visual . . . easy to understand! — *CQ (Japan)*

It's uncanny how accurate (HFX) is! — *N9VHW*

Check out our web site for more information. Take the guided tour or download a demo copy and try it out yourself!

<http://www.psrv.com/hfx/>



For more information or to order, call or write us at:

**HFX-73**  
Pacific-Sierra Research Corporation  
2901 28th Street, Suite 300  
Santa Monica, CA 90405-2938, USA

1-800-820-4PSR  
FAX: 310-314-2323  
Outside the U.S. & Canada:  
310-314-2300  
E-mail: [hfx%mgate@psrv.com](mailto:hfx%mgate@psrv.com)

Visa and MasterCard accepted  
\$129.00 postpaid worldwide

CIRCLE 226 ON READER SERVICE CARD



# HAM TO HAM

Your Input Welcome Here

Dave Miller NZ9E  
7462 Lawler Avenue  
Niles IL 60714-3108  
[dmiller14@juno.com]

This month's column will deviate somewhat from the norm. Ordinarily I try to blend a balance of ideas, so that there exists a greater chance of there being something for everyone. This month's idea is so universal, however, that I'll be devoting the entire column to it.

Anyone who's done any amount of electronic troubleshooting will have run into a few instances where it's nearly impossible to find the defect, except by disconnecting just about everything connected across the circuit in question.

That can happen when there is a dead short somewhere. No matter where you might measure, using a normal continuity tester (usually an ohmmeter), the short is registered. If a visual inspection proves ineffective, the only thing left to do is to begin disconnecting parts (or circuit branches, ugh) until the short disappears. It's generally a long and frustrating exercise. Not any more!

Thanks to Jim Wood of Santa Cruz, California, you can now track down a short in "short" order! Jim Wood's circuit origi-

nally appeared as a piece titled "'Beeper' Finds Circuit Shorts," in *Electronic Design Magazine* for April 3, 1995 (© 1995, Penton Publishing Co.), and was thereafter voted "Best of Issue." It appeared again in the October 24, 1996, issue of *Electronic Design* because of its popularity. It is reappearing here with permission from both *Electronic Design Magazine* and from the author, Jim Wood.

Jim's circuit utilizes a pair of ordinary op amps in a clever circuit that will produce a 1,000 Hz tone when the circuit's test probes are connected together (simulating a short circuit), but will quickly be lowered all the way down to a low growl or ticking sound when even a very small resistance is placed between the tips of the probes. This means that as one of the probes is moved along a printed circuit board trace that's shorted

(moving toward the probe on the other side of the short), the pitch of the tone will change with even the very small resistance of the copper PC board trace itself! In fact, if you hold one probe on the wire lead of a brand-new small electrolytic capacitor (before it's mounted in the circuit), you can actually differentiate between that position and a movement of the second probe along that lead of as little as one-quarter inch or so ... just that minuscule amount of resistance is detectable.

It's easy to see why you can walk right up to a dead short using this technique, or at least get within a fraction of an inch of it. As you pass the short, the tone will begin changing again, telling you that you've gone too far. Sound like the kind of test instrument you could use?

## But wait! There's more!

Using Jim's circuit in reverse will also allow you to evaluate how much resistance might be present in test leads, connector pins, ground lugs, etc., that should be close to a dead short. Anything that is supposed to show nearly zero resistance can be judged (on a relative basis) as to whether it really is making good contact. You can then clean or adjust the contacts of whatever you're measuring to see what improvement is possible. In addition to the examples just mentioned, you might want to judge how much relative contact resistance exists in a selector switch, toggle switch, relay, mechanical contactor, or other component that's supposed to have no appreciable resistive component in it. Jim's circuit is the answer.

Here's perhaps the best part ... duplicating the "Beeper" short detective is inexpensive, because all of the component parts used are readily available at any good-sized hamfest, or from the component parts dealers who advertise here in *73 Magazine* each month. Furthermore, the entire circuit is at either an audio or a DC level, so parts

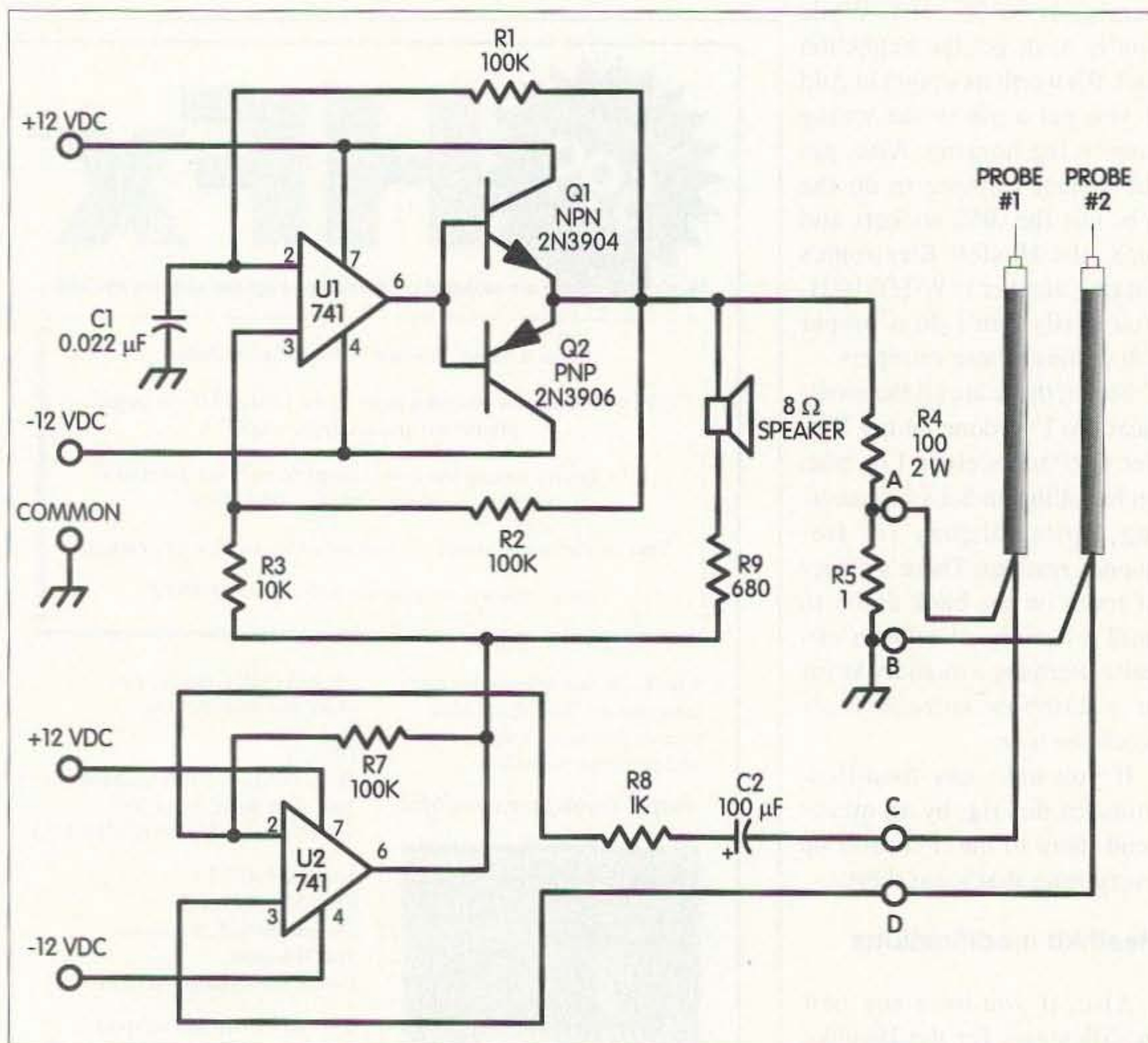

Fig. 1. The "Beeper" Short Detective circuit by Jim Wood, as originally presented in *Electronic Design Magazine* for April 3, 1995, and reprinted here with permission.



placement and wiring technique is also non-critical, as long as some reasonable care is exercised (as one would apply to any circuit where a degree of gain could potentially cause circuit instability). But it's not at all difficult to build a stable, usable unit when the parts specified are utilized. So I'd suggest that you build it "as shown" (in Fig. 1) first, and only then feel free to modify it if you think that you can improve upon the design for your own particular needs.

Most of the problems associated with duplicating any circuit seen in a magazine or book can be traced to not thoroughly checking over the final circuit for errors, using parts or values different from those the author suggests, or making modifications to the circuit *before* building it exactly as shown in the text. It's an error we all make from time to time. One modification that you can make that shouldn't pose a problem, however, is substituting a single LM1458 IC for the two separate LM741s. The LM1458 is simply dual LM741s in a single eight-pin DIP package that will save you a bit of board space. The pinout for this IC is shown in Fig. 4 if you decide to take that route.

I've built Jim's "Beeper" short detective, first exactly as suggested, then modified a tiny bit, and it works like a champ!

Take a look at the original design that Jim suggested (Fig. 1). The "Beeper" short detective is a classic free-running multivibrator, built around a pair of the commonly available 741 op amps, but with a few important additions. Transistors Q1 and Q2 deliver a plus and minus 10-volt square wave to resistor R4 and are capable of supplying 100 mA when the probe tips are shorted together. Resistor R5 assures that the open circuit voltage never exceeds 0.1 volt when the probes are open-circuited. The gain of U2 is equal to the R4/R5 divider loss, making the two op-amp outputs identical. The tone drops to a

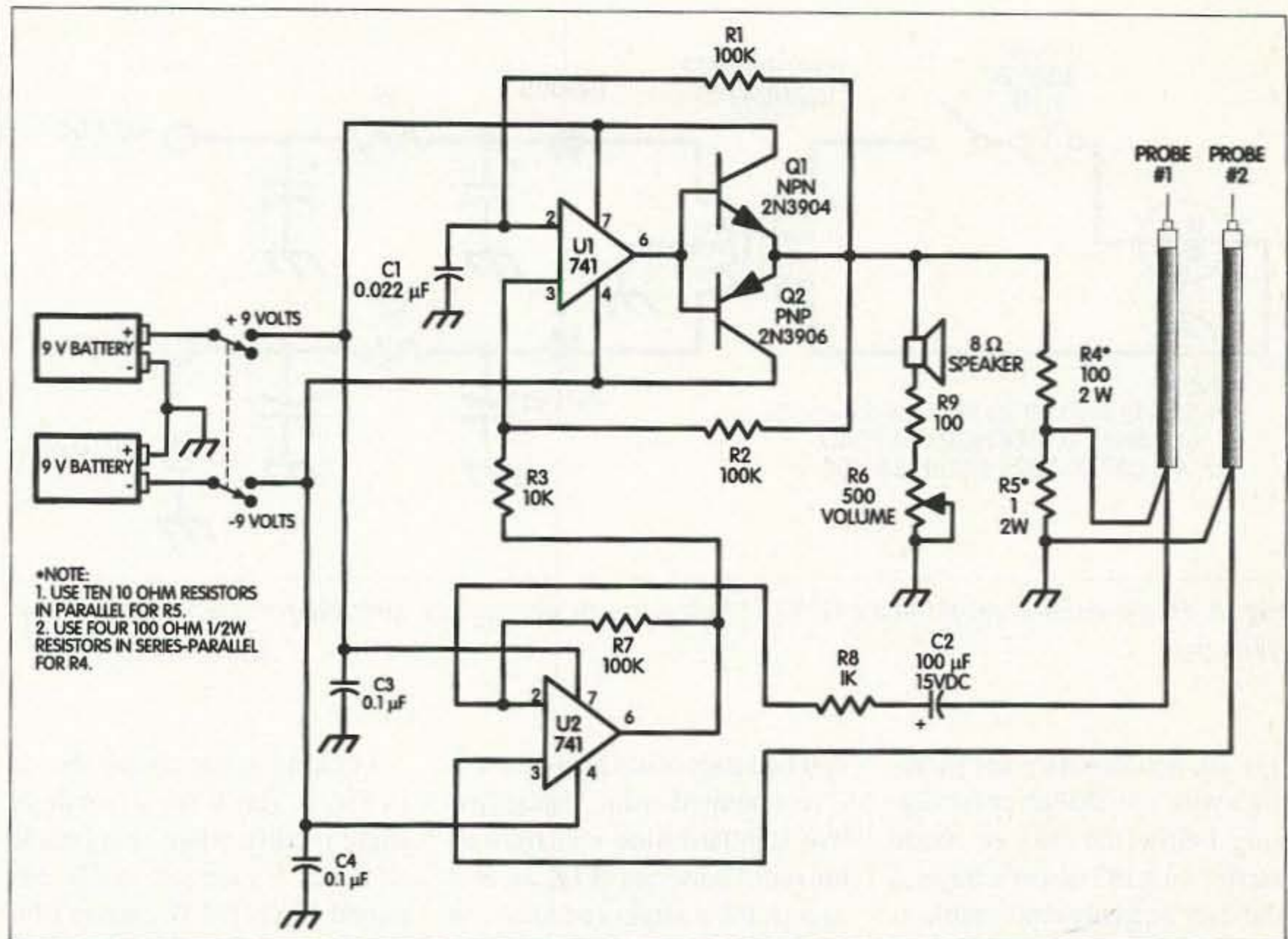

Fig. 2. NZ9E's modification.

low growl or ticking sound, effectively silencing the speaker when the probes are in the open (or high resistance) state. When the probe tips are a perfect short, however, U2's inputs are effectively shorted and the speaker will produce a 1 kHz tone. Anything between these two extremes, even a very tiny resistance, will produce a different-sounding tone, telling you immediately if you're headed in the right (or wrong) direction.

There is one precaution that must be observed. Notice that the schematic of Fig. 1 shows two wires going to each probe ... it's important that you follow this recommendation. U2's differential input must have its own separate path to the probe tips in order to eliminate test-lead resistance from the measurement. Miniature "zip-cord"-style speaker wire makes a good two-conductor test lead fulfilling this requirement. Along this same line of reasoning, the test probe tips themselves must make very low-resistance contact with the short circuit being traced; a pair of H.H. Smith™ 317 probe-tips are ideal ... their

## CAT-1000 Repeater Controller

### Attention Repeater Owners!

The CAT-1000 is packed with features normally reserved for controllers costing a thousand dollars or more.

#### Features Include:

- \* TI Voice Synthesizer
- \* DTMF Regenerator
- \* Forty Voice Messages
- \* DTMF Key-Pad Test
- \* Digital Voice Clock
- \* DTMF Audio Muting
- \* Grandfather Clock
- \* Full Feature Autopatch
- \* Forty DTMF Paging Memories
- \* Two CW Identifiers
- \* Sixty-Four Control Functions
- \* Doug Hall RBI-1 Interface
- \* Forty Link Preset Frequencies
- \* DTMF Command Generator
- \* Link Serial Tuning
- \* TS440 HF Remote Base
- \* Ten Emergency Speed Dials
- \* Reverse Autopatch
- \* Autopatch Cover Tone
- \* Link Auto Disconnect
- \* Eight User Function Switches
- \* Forty Macro Strings
- \* Phone Number Read Back
- \* Eight Memory Saves
- \* Caller ID Suppression
- \* DTMF Repeater Access
- \* Sixty Position Scheduler
- \* Ten Programmable Courtesy Tones
- \* Three-Hundred User Speed Dials
- \* FT767GX HF Remote Base
- \* Phone Number Lock-Out
- \* RS232 Interface
- \* Eight Hardware Inputs
- \* DVR Controller Ready
- \* Programmable Prefix Codes
- \* TTL Computer Interface
- \* Nineteen Programmable Timers
- \* Two-Tone Paging
- \* 300 baud on Board Modem

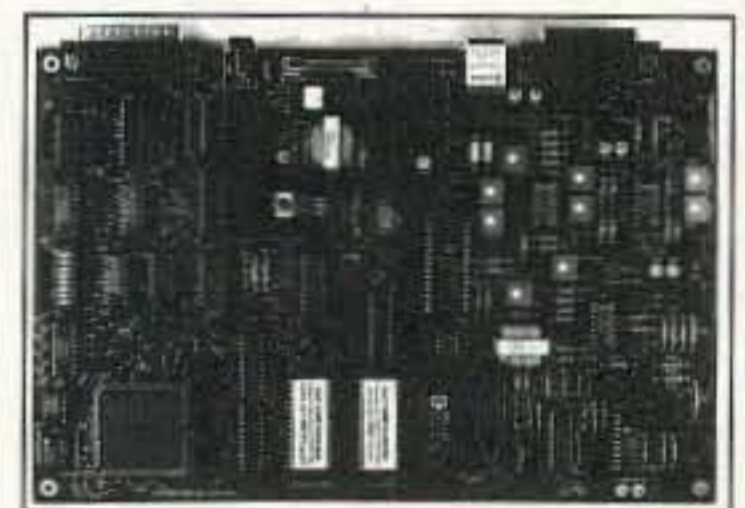

CAT-1000 Controller Board \$679.00. Wired and Tested.

Write or Call for a brochure describing the CAT-1000 Controller including schematic, voice word list, and control functions. Other Controllers with autopatch and TI voice synthesizer are available starting at \$299.00.

#### Computer Automation Technology Inc.

4631 N.W. 31st Avenue, Suite 142, Fort Lauderdale, Florida 33309

Phone: (954) 978-6171 - Fax: (561) 488-2894

Internet: <http://www.catauto.com>

CIRCLE 268 ON READER SERVICE CARD



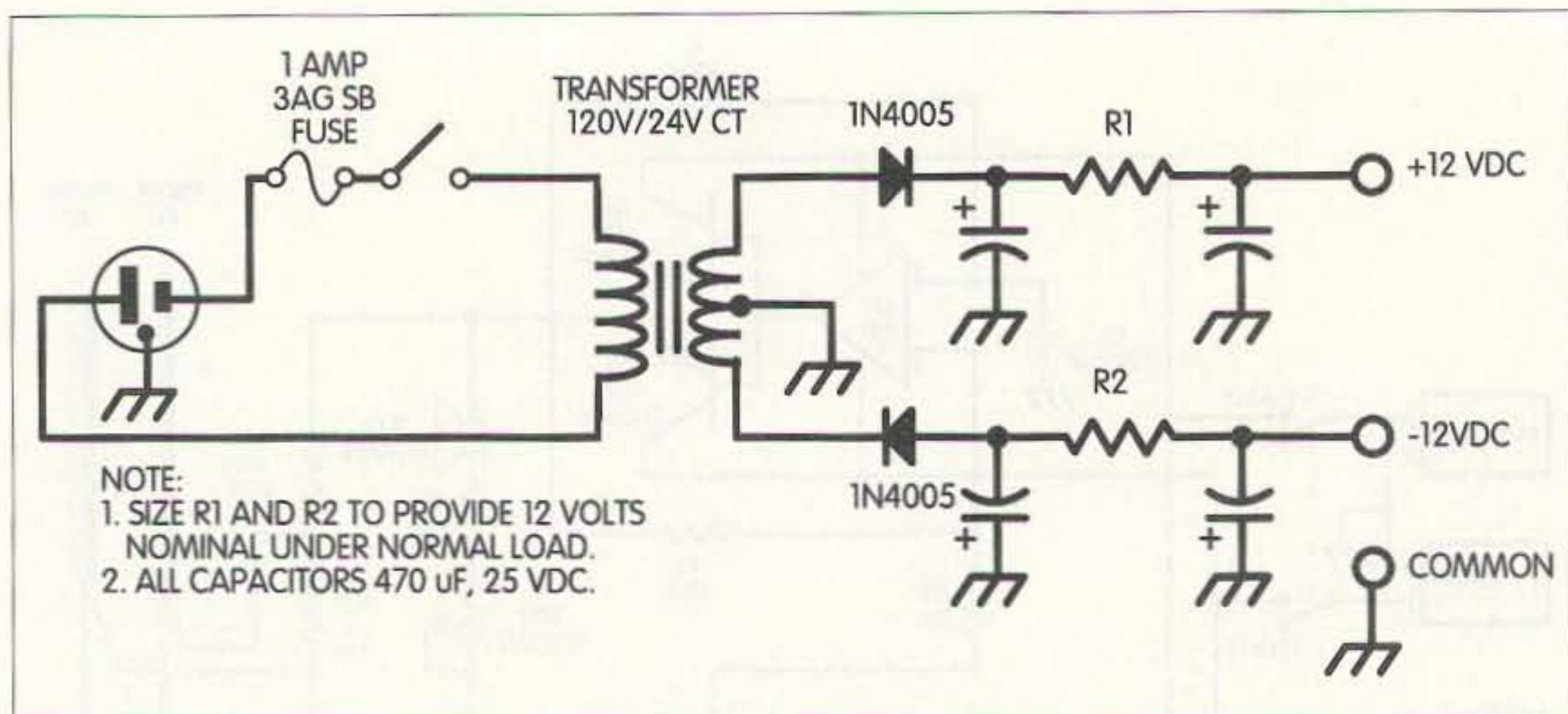

Fig. 3. Home-made dual-polarity 12 VDC half-wave power supply, suitable for use with the tester (see text).

tips are needle-sharp for piercing a wire's insulation or for digging below the flux or oxide barrier on a PC board's trace ... and they're easily replaceable as well. You can experiment with different probe tip ideas if you like—just make sure that you end up with ones having the very least contact-resistance possible.

The LM741s must also have a true plus and minus DC power source, with the common of the two supplies connected to the circuit common (illustrated as the ground symbol in Fig. 1). Don't let that stop you, however, because the power source requirement isn't all that difficult to meet. If you have a dual-polarity bench supply, you can simply use that. Two small 12-

volt batteries could also be used. I've operated mine using just two standard nine-volt transistor radio batteries (Fig. 2), and except for a slight reduction in speaker volume, it works just fine. You might also want to build a simple dual-polarity supply dedicated to the "Beeper" like the one shown in Fig. 3. The circuitry draws less than 100 milliamperes from each supply (or battery), so the supply can be of a reasonably low current design. Even two low current wall-cube power supplies could be used—just make sure that the proper polarity is supplied to the LM741 IC's supply pins, and that the other two leads from the cubes are tied together and to the circuit common (the ground symbol).

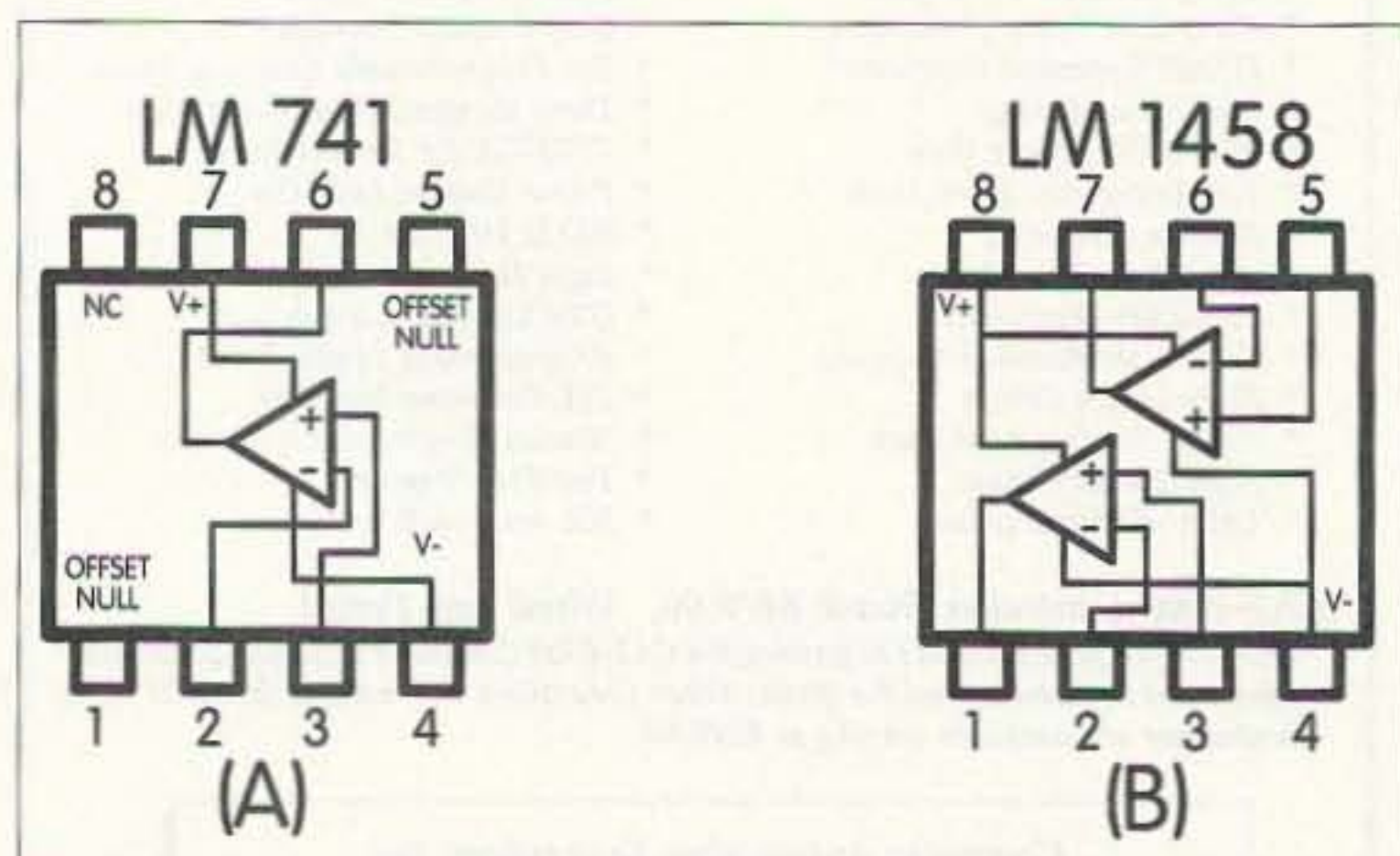

Fig. 4. Differences in pin numbering between LM741 and LM1458 (dual 741). Note that the schematics shown in Fig. 1 and Fig. 2 are labeled with pin numbers for the 741 and will need to be relabeled if the LM1458 is substituted.

Looking at the circuit shown in Fig. 2, you'll see a couple of small modifications that I made to mine. I used ten easily obtained 10  $\Omega$ , 1/4 W carbon film resistors in parallel for the 1  $\Omega$  resistor designated as R5 in the schematic. I also used a series/parallel configuration (of four 100  $\Omega$ , 1/2 W resistors) for the 100  $\Omega$ , 2 W resistor shown in the schematic as resistor R4. Placing all of the resistors right on the board, and wiring them as in Fig. 2, takes up very little additional room. I also changed R9 to 100  $\Omega$  and added a 500  $\Omega$  volume control (R6) to the speaker circuit. This affords some control over the ultimate volume level of the unit's output. I found that returning the speaker circuit directly to the common point increased the obtainable volume level a bit, especially if you're planning on using nine-volt batteries in place of the recommended plus and minus 12 volts as in Jim's original design. Again, however, it's probably best to build the circuit up originally by following the schematic of Fig. 1 exactly, then you can begin to experiment from there. I used a socket for the 741 ICs for ease in changing the op amps if needed, and I employed a very small "flat" speaker (snapped up at a recent hamfest) for the sound output device. I built my own short detective into a Radio Shack™ 270-283A experimenter's box

and perf circuit board combo. I like this combo for small projects since it incorporates both the project box and perforated circuit board (with foil pads) in one easy-to-use package. There may well be other areas in which some improvements can be made to better fulfill certain user needs for the short detective, and I'd be interested in seeing any that readers might suggest.

Fred Reimers KF9GX at FAR Circuits will supply prepared circuit boards (etched and drilled) for the "Beeper" Short Detective. All boards are made of G-10, FR-4 material, 1 oz. copper, solder-coated, and drilled. Anyone interested in building the project can order the board from:

FAR Circuits  
18 N 640 Field Court  
Dundee IL 60118  
[http://www.cl.ais.net/farcir/]

The circuit boards are \$4.25 each, plus \$1.50 shipping and handling *per order*. Orders are accepted only by surface mail or FAX. No orders will be accepted via e-mail. All orders must be prepaid by check, money order, VISA or Mastercard [credit card orders will include a \$3.00 service charge and may be FAXed to (847) 836-9148]. To order, please indicate the "ship to" address (orders will be shipped first class mail), home phone number, quantity of boards ordered, publication name (magazine in which the article appeared), issue date, and any other information that might be helpful in identifying the circuit board.

So that's it for this month. A very special thanks to the originator of the circuit featured:

Jim Wood  
c/o Inovonics, Inc.  
1305 Fair Avenue  
Santa Cruz CA 95060

#### New game in town

I recently received a catalog from TechAmerica™ (a subsidiary of the Tandy Corporation™), 546 pages of electronic components



## NEVER SAY DIE

Continued from page 47

money they pay for the pictures a good sound financial investment.

And that brings us down to the public (which may well include you), which shells out to buy the tabloids. This is the same curiosity that slows traffic as it goes past an accident. It's called gawking. And it's the same interest that increasingly dominates our TV news coverage. It even has a lot to do with the popularity of talk shows and *Geraldo!* interviews with weirdos. If you waste your time watching or reading this kind of crap, then you, in a way, helped contribute to Di's demise.

If, as is becoming increasingly believed by those studying death, we take our lifetime of memories with us when we pass on to whatever the next plane is, then many people are going to have a lifetime of irrelevant gawking in their memory storage, while I'll have the contents of several thousand books and conversations with experts in many scientific fields to work with "over there." As ye sow, so shall ye reap, it says in the Bible. So what are you sowing? Repent!

No, I have not yet succumbed to millennial fever, so I view with interest and amusement the many prophecies for an imminent end of the world—or, at the least, a major catastrophe which will "wipe out 90% of the world's population." So there's still

time to clean up your act and start inputting stuff that will not only help you during this incarnation, but might give you an edge in the long term. When you consider the general level of laziness, it's pathetically easy to get to be an expert in almost any new field that you find interesting.

### Kids

This photo of Patrick Curran KB2TNY (Photo C) reminded me of the first time I heard about amateur radio. I was 12 when my grandfather took me to visit a friend of his at a hotel in Bethlehem, New Hampshire. Bethlehem was a summer vacation town with 30 hotels (some huge!) and over 100 rooming houses. The son of the pastry cook (Mamie Stevenson) had a ham station in a little building out in back of the hotel. Harry W1CUN was sitting there talking to someone on 160 meters, the tubes in his final glowing cherry red. Wow! That got me to listening to 20 meters using my other grandfather's all-wave radio and collecting QSL cards from hams all around the world. How could I, even in my wildest dreams, imagine that 12 years later I'd have my own ham station in that same building, with me talking to the world?

That was right after World War II, when I got discharged from the Navy and had the summer of 1946 off before going back to college in the fall. Since our farm had no

electricity and Harry had moved to Vermont, I got to use his old shack for the summer. I put up antennas all over the place, complete with a vee beam for 75 meters.

Pat was eight years old when this photo was taken and he was busy racking up grid squares on two-meter SSB. Which brings up the matter of your kids (and probably grandkids). Are you sneakily infecting their dirty little minds with the ham radio virus? Hey, anything to keep them from getting being run over on the information highway. Or have they got their own Web site already?

If you've already done your dirty deed, please sit your kid down at the rig for a photo. Help convince me that amateur radio has not degenerated totally into a hobby for middle-class elderly white men—just a way for them to mark time through those few "golden" years between retirement and their eventual incarceration in nursing homes.

### L-Fields

Luck, a.k.a. serendipity, had me reading about a book by Dr. Harold Burr in the *World Research News* newsletter which seems right down your alley. That is, of course, if you have any pioneering blood left in your veins. The book, *Blueprint for Immortality*, was published, I believe, about 50 years ago.

Burr was messing around with a very sensitive voltme-

ter and found that all living things have electrodynamic fields which can be measured and mapped with a millivoltmeter. He called these "fields of life," or L-fields.

He found that he was able to detect when just about any part of the body wasn't working right, such as discovering cancers way before any clinical signs were detectable, just by the changes in voltage. This also turned out to be an extremely accurate way for women to determine the moment of ovulation.

The crummy article didn't say where Burr measured the voltages, just that the system worked on plants, animals and humans. I'll see if I can get a copy of the book, or at least more information about this. Maybe you can find a copy for me? In the meanwhile, let's see some articles on building millivoltmeters, and maybe some data on what you find using 'em. If you have any doctor friends, this could be an interesting and potentially valuable research project.

I'll be surprised if there isn't some connection between acupuncture points and significant voltage measurements.

Then, once we have some maps of the body's voltage fields, I wonder if there could be a reciprocal situation, where the application of a voltage might stop a developing illness? Hmm, you might want to check with an oscilloscope, just to make sure we're dealing with DC voltages.

If you stop to think about

and test equipment. Get your own copy by calling (800) 877-0072 or FAXing (800) 813-0087. It's well worth having in your catalog library, and if you're in Fort Worth or Denver, you can check out the Tech America walk-in stores!

The very best of Season's Greetings to everyone. Sue (KA9UCK) and I hope that your stocking is filled with all of the toys that a ham could want! Well, almost all—there's always next year! We'll return with the

column more in its normal format next time, but between now and then, try putting together Jim Wood's "Beeper" and give it a try ... I think you'll like it.

Please be sure to send me any ideas that you would like to see included in this column. We will make every attempt to respond to all legitimate ideas in a timely manner, but please send any specific questions, on any particular tip, to the originator of the idea, not to this column's moderator nor to 73 Magazine. 73



Photo C. Patrick Curran KB2TNY, age 8, working some grid squares on 2m.



this, the Bioelectrifier™ and the pulse unit, we're getting more and more into medical electronics. Well, that area is far less explored than potential consumer electronic products such as digital video disks. The communications and consumer electronics fields have pretty much left us amateurs behind, but that doesn't mean we can't find areas to research which are being ignored by both industry and government for economic or political reasons.

You might want to check the books by Robert Becker on electricity and the body. They're in my book guide and I've reviewed 'em in my past editorials. And while you're at it, you really ought to check on Rawle's and Davis's work with magnets and the body. And Ott's and Lieberman's with light and sickness. All these areas of investigation are pathetically under-researched. Why? Because modern medical research is almost totally devoted to finding patentable drugs to alleviate symptoms. That's where the big money is, not in either curing people of illnesses or helping them stay healthy. And money runs the medical business, just as it does everything else.

Good luck on finding a doctor interested in working with you on L-fields, the Bioelectrifier, or the pulse unit. Let me know how you make out.

### Doctors

When you get sick or break something, you go to the doctor. So do I. That's what my folks taught me and what I learned from school, the radio, movies, newspapers, and magazines. But as I've been reading, I've been getting a different perspective on the role doctors should play.

Now that I understand that virtually all of our illnesses are the result of what we've been doing to our bodies—lifestyle diseases—I can also understand why doctors are not taught much about health

and nutrition in medical school. Can you even imagine someone going to a doctor and explaining that they are in excellent health, they just want to know what they should do to stay that way? You can bet that none of the medical insurance plans are going to pay for that office visit. You can also be pretty sure that your doctor isn't going to have a good answer.

If you've been to college you know that about 95% of what you "learned" is now long lost. It went into your short-term memory so you could pass your tests. Well, it's no different for doctors in medical school. Like us, they learn better by doing, and that's during their internship, where they learn to diagnose symptoms and fix broken bones.

Doctors get almost all of their information about drugs from the drug sales reps, along with paid vacations, which include a seminar on the company's latest drug. They also bribe doctors with frequent flyer miles and "research grants" to use their drugs. This starts early, with the medical student being given a stethoscope or black bag, and then later business cards and prescription pads. What the drug companies downplay are the side effects of their often toxic drugs.

Let me quote the president of the AMA: "Medical education has traditionally focused on the principles of acute episodic health-care delivery, overlooking the concepts and applications of nutrition and preventive medicine."

As I've probably mentioned too often, the more research I've done on this, the more convinced I am that virtually every illness we get is lifestyle generated. That's something to think about when you, someone in your family, or a friend, has a heart attack, stroke, cancer, or any of the chronic illnesses such as arthritis and diabetes. Oh yes, Parkinson's and Alzheimer's too. Our hospital beds and nursing homes are filled with people who have mistreated their bodies.

But can I, just using reason and endless scientific studies as a tool, get you to give up beer and pretzels? Hamburgers and fries? Frosted fruit loops for breakfast? Toaster tarts? Doughnuts and coffee? Potato and taco chips? Deep-fried onion rings? Yummmm. Hey, I like most of that crap too. On my birthday weekend Sherry, Sage (daughter) and I went to the county fair and had a fantastic time eating the most delicious onion rings in the world, a great Italian sausage sandwich (cut into three), Pennsylvania Dutch funnel cake, and other such death-defying foods. Well, we took it easy this year. In the past we also ate a bunch of fudge, barbecued chicken, ears of corn, do-it-yourself sundaes, and French fries.

But most of the time these enlightened days I eat three apples, a couple bananas, a couple ears of fresh corn (in season), a salad, a bunch of raw vegetables, and a curried chicken thigh. And I love it.

### Roswell

If you are still buying the government's line that UFOs are bunk, then you sure haven't bothered to read very much. One of the best books I've found so far about the aliens (ETs, Visitors) is the recently released *The Day After Roswell*, by Col. Philip Corso (Ret.). Corso was right in the middle of things and has about as good credentials as you could ask for. He headed up the Foreign Technology desk in Army Research and Development at the Pentagon, worked for four years on the National Security Council, and so on.

In his book Corso describes the aliens recovered from the crashed ship at Roswell, as well as many of the artifacts he used to help industry R&D groups develop advanced technologies.

The ship, by the way, had no facilities for eating or waste disposal, so it was more like a scout ship and obviously had to operate from a base or mother ship.

The rash of recent TV shows with interviews of

people who were there at Roswell 50 years ago, plus interviews with the children of those who were there, have all had the same consistent story. Something big and important crashed there and the Army went to a lot of trouble to try and cover it up, including scaring the wits out of the locals with threats as to what would happen to them and their families if they ever told what they'd seen.

Yes, aliens are here and have been here for well over 50 years. Yes, their technology is way the heck ahead of ours. Their ship had no controls or instruments, being operated by mind control via headbands worn by the ETs.

Obviously, if they meant us harm, they could have quickly wiped out our resistance.

With that in mind, the reports of contactees make a lot of sense, whether *The Skeptical Inquirer* likes it or not. In this case *The National Enquirer* is more in line with reality than *Skep*. Hmm, I wonder how long it's going to take for *Skep* to acknowledge the reality of cold fusion. They've been ridiculing it for years now. And that helped me lose all respect for the magazine.

The Corso book is ISBN 0-671-00461-1, runs 341 pages, and costs \$24.

The next time you hear an Army or Air Force spokesman talking about the wreckage at Roswell being a weather balloon and the ETs merely dummies (which were not used in tests until six years after Roswell, by the way), you'll be laughing along with me. Oh yes, *Time* dutifully followed the Pentagon line in a recent cover article. So much for truth in our media and from our government.

Corso explained how he helped several new technologies develop—such as fiber optics, night vision, integrated circuits, and lasers—by cautiously feeding the alien technology to our scientists.

Why did Corso wait this long to spill the beans? He explains that he'd promised his general that he'd keep quiet while the general was still



# PROPAGATION

Jim Gray W1XU  
210 E Chateau Circle  
Payson AZ 85541  
[jimpeg@netzone.com]

Oh, how the DX rolls in when the solar flux improves! As I write (mid-September), solar flux has jumped from the sluggish 70s of the past two years to a sprightly 108, representing a 50% increase, and the DX bands have reacted accordingly. This is a good sign and may represent the hoped-for effective beginning of Sunspot Cycle 23.

The calendar shows the worst days for propagation this month (P-VP): 1st-3rd, 11th-13th, and 31st. The best days (G) should be the 19th, 20th, and the 27th. Average days (F) are likely to be the 5th-9th, 15th, 22nd-25th, and the 29th. The remaining days should show conditions trending. Don't let those Fair and trending days dampen your enthusiasm, though, because much good DX has been worked under such conditions. Rejoice! Things seem to be looking up.

## 10-12 meters

Generally Poor, except for occasional transequatorial propagation with F2 openings on the best days—most likely South and Central America.

alive. Now, with the general gone, Corso has put the whole story in a book—and it's on the best seller list!

## A Roaming ROM

If you drive around the country a lot you'll want to look into the new ARRL Repeater ROM. This \$44 ROM has maps of the US and Canada and it will lay out a travel route for you showing the repeaters you can access along the way. The ARRL Repeater Directory is handier in the car, but if you are planning

## 15-17 meters

DX to Africa and Latin America on the Good days possible, with short-skip out to about 1,000 miles or so in the US.

## 20 meters

Your best band for DX openings around the world from dawn to dark, and openings to the Southern Hemisphere after dark in evening hours. You can expect excellent short-skip during the daytime to 2,500 miles or so.

## 30-40 meters

These bands ought to be open for DX from just before sunset to just after sunrise. Signals from the east should peak until midnight, and after midnight to other areas. Daylight short-skip of about 500 miles will be possible, and nighttime short-skip to 1,500 miles or more will be available.

## 80 meters

Occasional DX to various areas of the world should be possible between sunset and sunrise when QRN levels permit on

a long trip the ROM will lay out the details for you so you can kerchunk repeaters as you go. I hope you have better luck than I do in finding anyone alive to talk with. When I get into a town with ten repeaters I figure I'm lucky to find even one where anyone is listening. With over 600,000 licensed amateurs, and over half pretty much isolated up on two meters, how come I can't find any life on all those two-meter repeaters?

The ROM only works with PCs, so we Mac people can go fly a kite. Yes, I have a #@! PC, but I hate the damned thing. 73

## DECEMBER 1997

SUN	MON	TUE	WED	THU	FRI	SAT
	1 P	2 VP	3 P	4 P-F	5 F	6 F
7 F	8 F	9 F	10 F-P	11 P	12 VP	13 P
14 P-F	15 F	16 F-G	17 G-F	18 F-G	19 G	20 G
21 G-F	22 F	23 F	24 F	25 F	26 F-G	27 G
28 G-F	29 F	30 F-P	31 P			

Good (G) days (see calendar), and also short-skip during hours of darkness to 1,500 miles or more.

## 160 meters

Following the usual summertime slump, this band ought to begin to come alive again during the hours of darkness when QRN permits.

Try the days marked (G) on

the calendar for best results. DX toward the east until midnight, and to other areas afterwards, until dawn. Short-skip to 1,500 miles will prevail when the band is quiet.

Please remember to let me know how these forecasts are working for you. Your feedback is much appreciated. Season's greetings to our friends everywhere! W1XU.

### EASTERN UNITED STATES TO:

GMT:	00	02	04	06	08	10	12	14	16	18	20	22
ALASKA							20	20				
ARGENTINA								15	15	15	15	15
AUSTRALIA						40	20	20			15	15
CANAL ZONE	20	40	40	40	40		20	15	15	15	15	20
ENGLAND	40	40	40				20	20	20	20		
HAWAII		20			40	40	20	20				15
INDIA							20	20				
JAPAN							20	20				
MEXICO		40	40	40	40		20	15	15	15	15	
PHILIPPINES							20	20				
PUERTO RICO		40	40	40			20	15	15	15	15	
RUSSIA (C.I.S.)							20	20				
SOUTH AFRICA									15	15	15	
WEST COAST			80	80	40	40	40	20	20	20		

### CENTRAL UNITED STATES TO:

ALASKA	20	20						15				
ARGENTINA										15	15	15
AUSTRALIA	15	20				40	20	20				15
CANAL ZONE	20	20	40	40	40	40			15	15	15	20
ENGLAND		40	40					20	20	20	20	
HAWAII	15	20	20	20	40	40	40					15
INDIA								20	20			
JAPAN								20	20			
MEXICO	20	20	40	40	40	40			15	15	15	20
PHILIPPINES								20	20			
PUERTO RICO	20	20	40	40	40	40			15	15	15	20
RUSSIA (C.I.S.)								20	20			
SOUTH AFRICA										15	15	20

### WESTERN UNITED STATES TO:

ALASKA	20	20	20		40	40	40	40				15
ARGENTINA	15	20			40	40	40					15
AUSTRALIA		15	20	20			40	40				
CANAL ZONE			20	20	20	20	20	20				15
ENGLAND									20	20		
HAWAII	15	20	20	40	40	40	40					15
INDIA		20	20									
JAPAN	20	20	20			40	40	40				20
MEXICO			20	20	20	20	20					15
PHILIPPINES	15						40		20			
PUERTO RICO			20	20	20	20	20	20				15
RUSSIA (C.I.S.)									20			
SOUTH AFRICA										15	15	
EAST COAST		80	80	40	40	40	40	20	20	20		



# Barter 'n' Buy

Turn your old ham and computer gear into cash now. Sure, you can wait for a hamfest to try and dump it, but you know you'll get a far more realistic price if you have it out where 100,000 active ham potential buyers can see it, rather than the few hundred local hams who come by a flea market table. Check your attic, garage, cellar and closet shelves and get cash for your ham and computer gear before it's too old to sell. You know you're not going to use it again, so why leave it for your widow to throw out? That stuff isn't getting any younger!

The 73 Flea Market, Barter 'n' Buy, costs you peanuts (almost)—comes to 35 cents a word for individual (noncommercial!) ads and \$1.00 a word for commercial ads. Don't plan on telling a long story. Use abbreviations, cram it in. But be honest. There are plenty of hams who love to fix things, so if it doesn't work, say so.

Make your list, count the words, including your call, address and phone number. Include a check or your credit card number and expiration. If you're placing a commercial ad, include an additional phone number, separate from your ad.

This is a monthly magazine, not a daily newspaper, so figure a couple months before the action starts; then be prepared. If you get too many calls, you priced it low. If you don't get many calls, too high.

So get busy. Blow the dust off, check everything out, make sure it still works right and maybe you can help make a ham newcomer or retired old timer happy with that rig you're not using now. Or you might get busy on your computer and put together a list of small gear/parts to send to those interested?

Send your ads and payment to: 73 Magazine, Barter 'n' Buy, 70 Rt. 202N, Peterborough NH 03458 and get set for the phone calls. The deadline for the March 1998 classified ad section is January 12th, 1998.

**HAM GOODIES!** Free Shack Attack Catalog. (801) 878-2760, [kb7vrd@aol.com], [http://www.vcnet.com/sa]. BNB45

**Audio Equipment Wanted:** 1930s-1960s. Tube-type amplifiers, large or small speakers, mixers, microphones, tubes, parts, etc. Especially Western Electric, Jensen, Marantz, MacIntosh, JBL, etc. 1-800-251-5454 BNB202

**FM MICRO/LOW POWER BROADCASTING 88-108MHz.** PLL Transmitters/RF Amplifiers/Antennas. Mono/Stereo, 50 mW to 100 W. Free catalog/info; call (250) 642-2859, or E-mail: [kscott@pinc.com]. R. Scott Communications Ltd. We ship worldwide from Canada! BNB102

**RF TRANSISTORS TUBES** 2SC2879, 2SC1971, 2SC1972, MRF247, MRF455, MB8719, 2SC1307, 2SC2029, MRF454, 2SC3133, 4CX250B, 12DQ6, 6KG6A, etc. WESTGATE 1-800-213-4563. BNB6000

**METHOD TO LEARN MORSE CODE FAST AND WITHOUT HANGUPS** Johan N3RF. Send \$1.00 & SASE. SVANHOLM RESEARCH LABORATORIES, P.O. Box 81, Washington DC 20044 USA. BNB421

**RIGS FOR SALE:** YAESU FT101EE with FTV650B \$400.00. YAESU FT890 excellent condition \$1000.00. KENWOOD TS140S excellent condition \$800.00. CW Filters in all rigs. RUSS N7BKW, (801) 972-5873. BNB706



GOOD AFTERNOON - I'M FROM THE FCC AND YOU'RE FROM SOMEWHERE UP S... CREEK!

**BIOELECTRIFIER™** 5 Hz micro current supply for plant and animal research. Semi-Kit \$38.00. Assembled complete with batteries and silver electrodes \$89.50. Add \$2.50 postage. Thomas Miller, 314 South 9th Street, Richmond IN 47374. BNB343

**The Communicator's Handbook:** A reference guide for the professional engineer or radio DXer with a list of FREE catalogs and much, much, more!! To order send \$9.98 U.S. check/m.o., Canada \$13.50 int'l postal m.o. to: S. Crawford, P.O. Box 83, Riverdale NY 10463. Fast FREE shipping. BNB749

**COLLOIDAL SILVER GENERATOR!** Why buy a "box of batteries" for hundreds of dollars? Current regulated, AC powered, fully assembled with #12 AWG silver electrodes, \$74.50. Same, but DC powered, \$54.50. Add \$2.50 shipping. Thomas Miller, 314 South 9th Street, Richmond IN 47374. BNB342

**SUPERFAST MORSE CODE SUPEREASY.** Subliminal cassette. \$12. **LEARN MORSE CODE IN 1 HOUR.** Amazing supereasy technique. \$12. Both \$20. Moneyback guarantee. Free catalog: SASE. Bahr-T6, 150 Greenfield, Bloomington IL 60108. BNB425

**HEATHKITS WANTED:** Premium prices paid for unassembled Heathkits. Rob W3DX, (804) 971-6812 evenings or [Robcap@aol.com]. BNB206

**MAHLON LOOMIS, INVENTOR OF RADIO,** by Thomas Appleby (copyright 1967). Second printing available from JOHAN K.V. SVANHOLM N3RF, SVANHOLM RESEARCH LABORATORIES, P.O. Box 81, Washington DC 20044. Please send \$25.00 donation with \$5.00 for S&H. BNB420

**BREAK THE CODE BARRIER:** A self-hypnosis tape that allows you to learn or increase code speed easily and quickly. To order send \$14.95 + \$3.00 S&H to Dr. Hal Goodman, P.O. Box 184, Eastport ME 04631. For more info send SASE or [http://www.nemaine.com/w3uwh/morse.htm]. BNB2031

**HEATH COMPANY** is selling photocopies of most Heathkit manuals. Only authorized source for copyright manuals. Phone: (616) 925-5899, 8-4 ET. BNB964

**CLASSIC RADIOS.** RadioFinder Web list revised weekly: [www.radiofinder.com] Tel/FAX 1-(313) 454-1890, [finder@radio.com]. BNB700

**ASTRON** power supply, brand-new w/ warranty, RS20M \$99, RS35M \$145, RS50M \$209, RS70M \$249, AVT. Call for other models. (626) 286-0118 BNB411

**TIRED OF IRONING?** PCB service. No \$ setup, free scanning available. **FIRST PROTO**, 4201 University Drive, #102, Durham NC 27707. (919) 403-8243. BNB5005

## Radio Bookshop ORDER FORM

You may order by mail, telephone, or fax. All payments are to be in US funds. Allow 4 weeks for delivery. (Prices subject to change without notice if suppliers increase prices or new editions cost us more.)

ITEM	TITLE	QTY	PRICE	TOTAL

**Shipping:** All orders add \$5.00 handling \*plus there is an additional at cost shipping charge added to all foreign orders. We ship UPS where possible, please give us street address. **S&H\* TOTAL \$**

Make checks payable to "Radio Bookshop."

Foreign Orders: Choose one  surface shipping  air shipping (Surface delivery may take 2-3 months.)

\*Note: The actual foreign shipping costs will be additional to the regular shipping and handling fees.

Name \_\_\_\_\_ Phone \_\_\_\_\_  
 Address \_\_\_\_\_  
 City \_\_\_\_\_ State \_\_\_\_\_ Zip \_\_\_\_\_ Country \_\_\_\_\_  
 \$10 minimum for credit card orders  
 Total Paid \$ \_\_\_\_\_  Check/Money Order  AMEX  MC  VISA  
 Card # \_\_\_\_\_ Expires \_\_\_\_\_  
 Signature \_\_\_\_\_ Date \_\_\_\_\_

Telephone: 603-924-0058, 800-274-7373, FAX 603-924-8613  
 Mail: Radio Bookshop, Dept.1297, 70 Route 202 N, Peterborough NH 03458

YES, Send me 12 issues of 73 at the low rate of \$24.97 (save 47% over the cover price). Canada add \$7 plus \$1.40 GST; Foreign add \$19 surface; \$42 airmail.



# The New Approach to HF Radio!

## The Kachina 505DSP Computer Controlled Transceiver

### Features:

- Works with any Computer Running Windows 3.1, 95 or NT
- Covers all Amateur HF Bands plus General Coverage Receiver
- IF Stage 16/24 Bit Digital Signal Processing (DSP)
- II DSP Bandpass Filter Widths from 100 Hz to 3.5 kHz (6 kHz in AM Mode)
- Band Activity Display with "Point and Click" Frequency Tuning
- On-screen Antenna "Smith" Chart, Logging Software and Help Menus
- Automatic Frequency Calibration from WWV or Other External Standard
- "Snapshot" Keys for Instant Recall of Frequencies and Settings
- Optional Internal Antenna Tuner

PC not included

**The Kachina 505DSP Computer Controlled HF Transceiver** After twenty years of building commercial transceivers in Arizona, Kachina has decided the time is right for a new approach to amateur radio. The Kachina 505DSP is nothing short of a revolution in HF transceivers.

**Why Use Knobs if You Have Windows?** The old-fashioned front panel has become too cluttered to be useful. Too many knobs, too many buttons. Kachina's 505DSP transceiver connects to your computer's serial port and is completely controlled under Windows™. With optional cables, the radio may be remotely located up to 75 feet away from your computer. Imagine combining a state-of-

the-art DSP transceiver with the processing power and graphics capabilities of your PC and you'll soon wonder why all radios aren't designed this way. Why settle for a tiny LCD display when your computer monitor can simultaneously show band activity, antenna impedance, heat sink temperature, SWR, forward and/or reflected power and a host of other information?

**16/24 Bit DSP/DDS Performance** In addition to 100% computer control, the Kachina 505DSP offers exceptional 16/24 bit DSP/DDS performance. IF stage DSP, "brick-wall" digital filtering, adaptive notch filters and digital noise reduction, combined with low in-band IMD and high signal-to-noise ratio, produce an

excellent sounding receiver. Sophisticated DSP technology achieves performance levels unimaginable in the analog world. The transmitter also benefits from precise 16/24 bit processing. Excellent carrier and opposite-sideband suppression is obtained using superior phasing-method algorithms. The RF compressor will add *lots* of punch to your transmitted signal without adding lots of bandwidth, and the TX equalizer will allow you to tailor your transmitted audio for more highs or lows.

**Seeing is Believing** American-made and designed, and able to stand on its own against the world's best, the 505DSP is bound to set the standard for all that follow. But don't take our word for it. Visit our website at <http://www.kachina-az.com> for detailed specifications, to download a demo version of our control software, or to see a current list of Kachina dealers displaying demonstration models in their showrooms.

**KACHINA**   
**COMMUNICATIONS, INC.**

P.O. Box 1949, Cottonwood, Arizona 86326, U.S.A.  
Fax: (520) 634-8053, Tel: (520) 634-7828  
E-Mail: [sales@kachina-az.com](mailto:sales@kachina-az.com)

Windows is a trademark of Microsoft Corp.  
Specifications and features subject to change without notice.





# JST-245

160-10 Meters PLUS 6 Meter Transceiver



*Fifteen reasons why your next HF transceiver should be a JST-245...*

- 1** All-Mode Operation (SSB,CW,AM,AFSK,FM) on all HF amateur bands and 6 meters. JST-145, same as JST-245 but without 6 meters and built-in antenna tuner.  
★ JST-145 COMING SOON ★
- 2** MOSFET POWER AMPLIFIER • Final PA utilizes RF MOSFETs to achieve low distortion and high durability. Rated output is 10 to 150 watts on all bands including 6 meters.
- 3** AUTOMATIC ANTENNA TUNER • Auto tuner included as standard equipment. Tuner settings are automatically stored in memory for fast QSY.
- 4** MULTIPLE ANTENNA SELECTION • Three antenna connections are user selectable from front panel. Antenna selection can be stored in memory.
- 5** GENERAL COVERAGE RECEIVER • 100 kHz-30 MHz, plus 48-54 MHz receiver. Electronically tuned front-end filtering, quad-FET mixer and quadruple conversion system (triple conversion for FM) results in excellent dynamic range (>100dB) and 3rd order ICP of +20dBm.
- 6** IF BANDWIDTH FLEXIBILITY • Standard 2.4 kHz filter can be narrowed continuously to 800 Hz with variable Bandwidth Control (BWC). Narrow SSB and CW filters for 2nd and 3rd IF optional.
- 7** QRM SUPPRESSION • Other interference rejection features include Passband Shift (PBS), dual noise blanker, 3-step RF attenuation, IF notch filter, selectable AGC and all-mode squelch.
- 8** NOTCH TRACKING • Once tuned, the IF notch filter will track the offending heterodyne ( $\pm 10$  KHz) if the VFO frequency is changed.
- 9** DDS PHASE LOCK LOOP SYSTEM • A single-crystal Direct Digital Synthesis system is utilized for very low phase noise.
- 10** CW FEATURES • Full break-in operation, variable CW pitch. built in electronic keyer up to 60 wpm.
- 11** DUAL VFOs • Two separate VFOs for split-frequency operation. Memory registers store most recent VFO frequency, mode, bandwidth and other important parameters for each band.
- 12** 200 MEMORIES • Memory capacity of 200 channels, each of which store frequency, mode, AGC and bandwidth.
- 13** COMPUTER INTERFACE • Built-in RS-232C interface for advanced computer applications.
- 14** ERGONOMIC LAYOUT • Front panel features easy to read color LCD display and thoughtful placement of controls for ease of operation.
- 15** HEAVY-DUTY POWER SUPPLY • Built-in switching power supply with "silent" cooling system designed for continuous transmission at maximum output.



*Japan Radio Co., Ltd.*

430 Park Ave., 2nd Floor New York, NY 10022 Phone: (212) 355-1180 Fax: (212) 319-5227

CIRCLE 159 ON READER SERVICE CARD