

# 73<sup>®</sup>

Including Ham Radio Fun!

SEPTEMBER 1996

ISSUE #432

USA \$3.95

CANADA \$4.95

# Amateur Radio Today

*International Edition*

Reviews:

MFJ-259 Analyzer

TD-3 Tone Decoder

Internet Software

## ARRL Lays An Egg

### See Page 4...

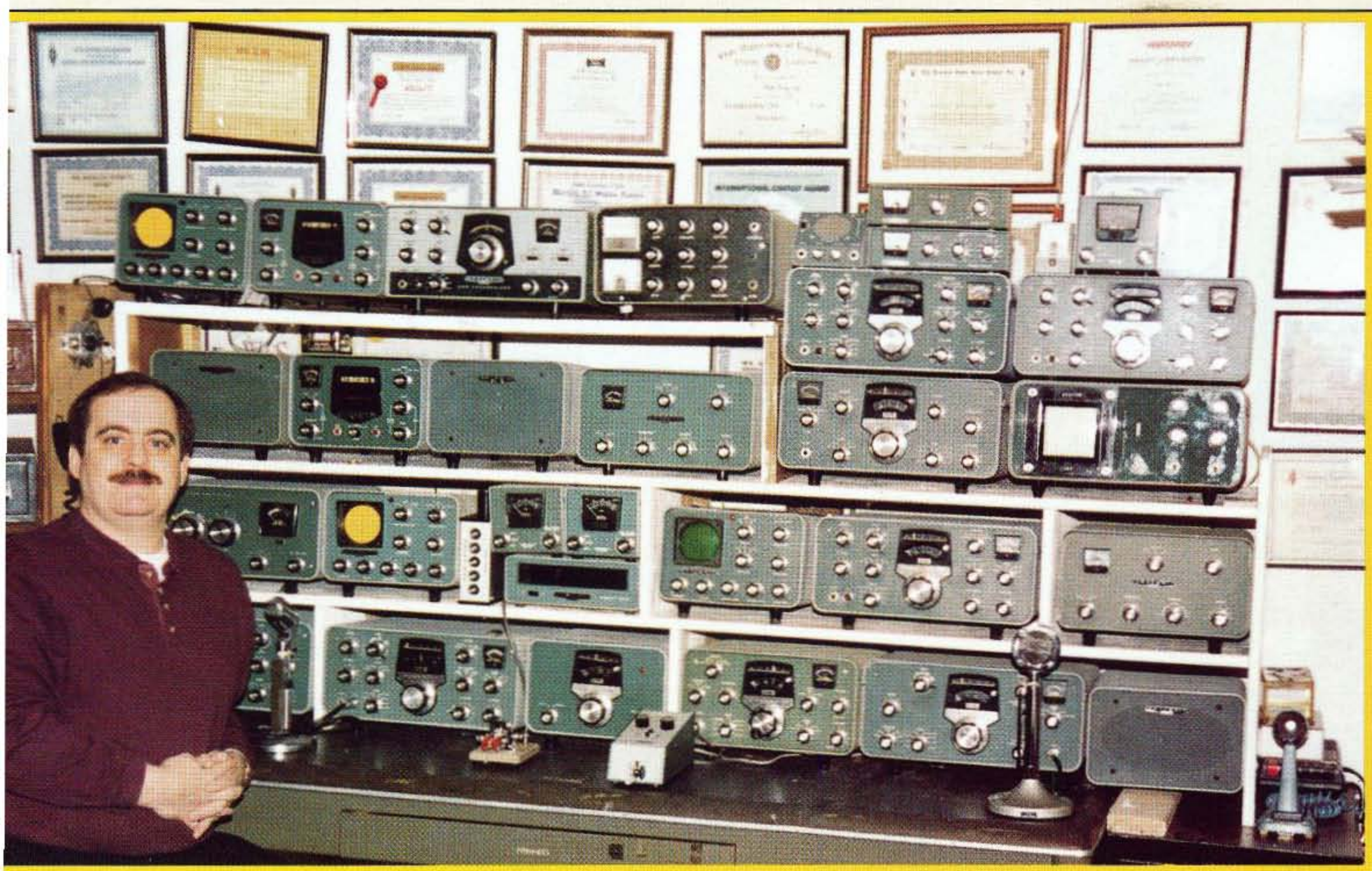

*Shane Brady WB2WPM and Heathkit radios*

**More Stealth Antennas**

**"Free Energy" Guide**

**Twin-T: Experimenter Ecstasy**

**Fractalize Your Antenna**





# JST-245

## 160-10 Meters PLUS 6 Meter Transceiver



*Fifteen reasons why your next HF transceiver should be a JST-245...*

- 1** All-Mode Operation (SSB,CW,AM,AFSK,FM) on all HF amateur bands and 6 meters. JST-145, same as JST-245 but without 6 meters and built-in antenna tuner.  
★ JST-145 COMING SOON ★
- 2** MOSFET POWER AMPLIFIER • Final PA utilizes RF MOSFETs to achieve low distortion and high durability. Rated output is 10 to 150 watts on all bands including 6 meters.
- 3** AUTOMATIC ANTENNA TUNER • Auto tuner included as standard equipment. Tuner settings are automatically stored in memory for fast QSY.
- 4** MULTIPLE ANTENNA SELECTION • Three antenna connections are user selectable from front panel. Antenna selection can be stored in memory.
- 5** GENERAL COVERAGE RECEIVER • 100 kHz-30 MHz, plus 48-54 MHz receiver. Electronically tuned front-end filtering, quad-FET mixer and quadruple conversion system (triple conversion for FM) results in excellent dynamic range (>100dB) and 3rd order ICP of +20dBm.
- 6** IF BANDWIDTH FLEXIBILITY • Standard 2.4 kHz filter can be narrowed continuously to 800 Hz with variable Bandwidth Control (BWC). Narrow SSB and CW filters for 2nd and 3rd IF optional.
- 7** QRM SUPPRESSION • Other interference rejection features include Passband Shift (PBS), dual noise blanker, 3-step RF attenuation, IF notch filter, selectable AGC and all-mode squelch.
- 8** NOTCH TRACKING • Once tuned, the IF notch filter will track the offending heterodyne ( $\pm 10$  KHz) if the VFO frequency is changed.
- 9** DDS PHASE LOCK LOOP SYSTEM • A single-crystal Direct Digital Synthesis system is utilized for very low phase noise.
- 10** CW FEATURES • Full break-in operation, variable CW pitch. built in electronic keyer up to 60 wpm.
- 11** DUAL VFOs • Two separate VFOs for split-frequency operation. Memory registers store most recent VFO frequency, mode, bandwidth and other important parameters for each band.
- 12** 200 MEMORIES • Memory capacity of 200 channels, each of which store frequency, mode, AGC and bandwidth.
- 13** COMPUTER INTERFACE • Built-in RS-232C interface for advanced computer applications.
- 14** ERGONOMIC LAYOUT • Front panel features easy to read color LCD display and thoughtful placement of controls for ease of operation.
- 15** HEAVY-DUTY POWER SUPPLY • Built-in switching power supply with "silent" cooling system designed for continuous transmission at maximum output.



*Japan Radio Co., Ltd.*

430 Park Ave., 2nd Floor New York, NY 10022 Phone: (212) 355-1180 Fax: (212) 319-5227

CIRCLE 159 ON READER SERVICE CARD

# Corner Beam?

**Big Forward Gain  
Wide Backward Rejection  
Exceptional Bandwidth  
Distortion Free Pattern**

Your antenna makes all the difference at VHF and UHF—It determines transmitting range. It sets the limit for weak signal reception. And it decides what interference you'll hear and create.

An omnidirectional antenna radiates uniformly in all direction, and it also hears noise and interference from every direction.

A directional antenna not only sends your signal where you want, it hears the signal it's pointed at, rejecting others. It also lets you operate with minimal power, cutting interference you inflict on other stations.

CornerBeam's clean sharp pattern without sidelobes or spikes reaches past the noise and interference to get the message through. Its wide rear rejection lets you null out strong nearby signals to reduce interference.

#### Look what CornerBeam does:

- 10 dB gain vs. dipole
- 40 dB Front-to-Back
- 60 degree Half-power Beamwidth
- SWR <1.1:1 across the band
- No dimension over 4 ft
- Mounts directly to mast or tower
- Vertical or horizontal polarization
- No need for offset or side mount

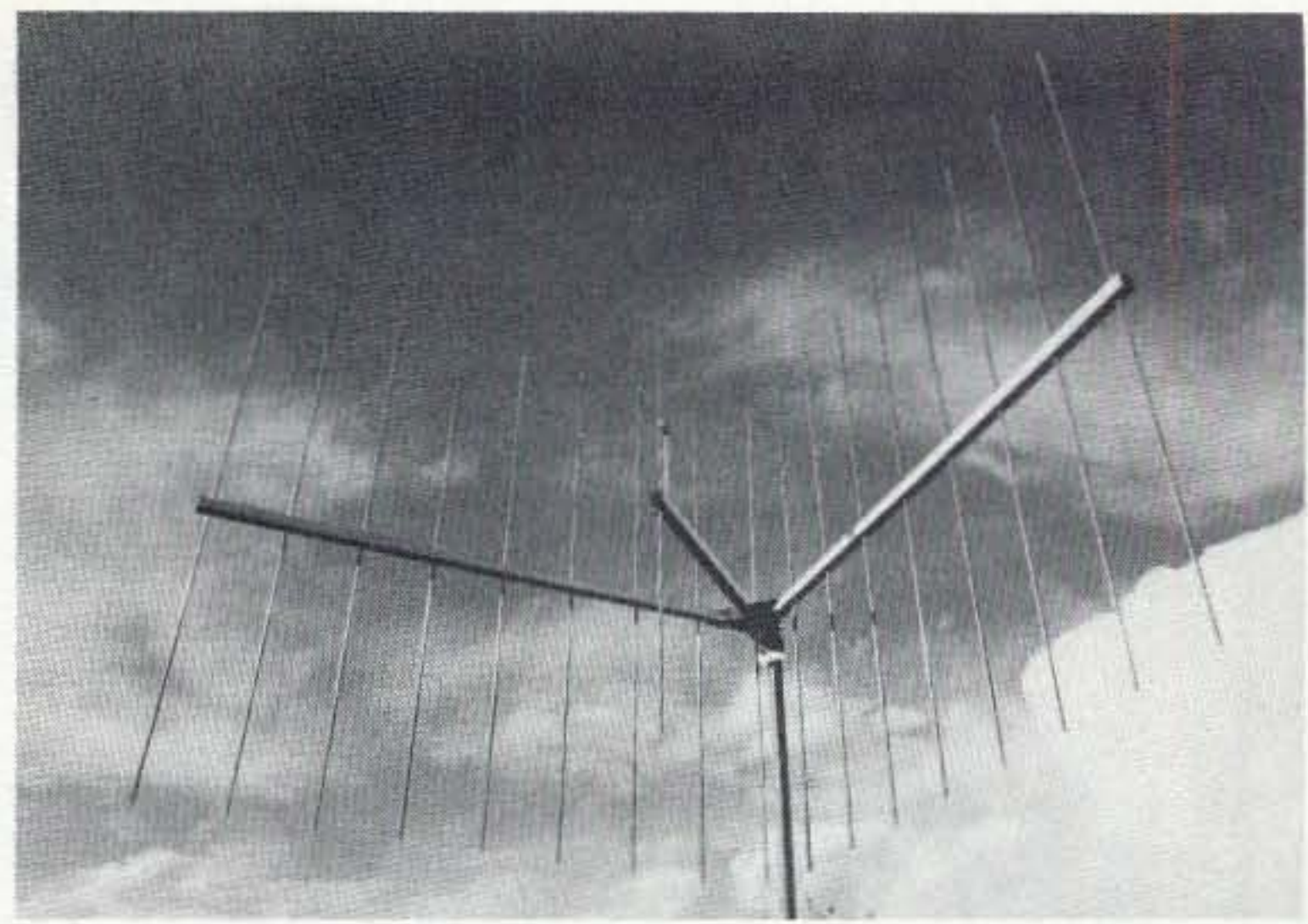

#### Corner Beats Yagi

A yagi with the same gain would have a 10-ft boom. Yagi bandwidth would be less than half. More important, CornerBeam produces no side lobes, no back lobes.

#### Improved Data Communication

Because CornerBeam's pattern has no unwanted side spikes, phase noise is reduced to a minimum. The result is reduced data error rate, faster packet circuits. When you want a distortion free signal, think CornerBeam, not yagi.

#### CornerBeam for Repeaters

If your repeater shares a frequency with another, the deep wide null toward the rear could keep your signal out of the neighboring repeater's receiver and turn a deaf ear to its signal. A pair of CornerBeams can be combined to provide special radiation footprints. A CornerBeam aimed at an area your repeater hears poorly could improve service where incoming signals from HTs are presently too weak. CornerBeam makes it possible to increase repeater density while reducing interference.

#### Bandwidth Pays Off

With its exceptional bandwidth, your CornerBeam can be put to work right out of the box without special tweaking. It can serve you now when you're working repeaters with an FM handheld, and later when you set out to work satellites or go after small signal DX at 144.2 MHz.

CornerBeam can still be your beam when you join MARS at 143/148 MHz or team up with the sheriff's communications interface team at 158 MHz.

#### Scanning Too?

CornerBeam's gain & bandwidth extend monitoring range from aircraft to to marine & public service frequencies. ■

**On the Internet**  
[www.itsnet.com/~radventr](http://www.itsnet.com/~radventr)

#### Corner Beam Models

Band	Max Dim	WindLd	Price
2 meters	4 ft	<2 sqft	\$145
220 MHz	4 ft	<1 sqft	\$145
70 cm	3 ft	<1 sqft	\$115
Dual 146/435	4 ft	<3 sqft	\$165

#### Construction: Aircraft aluminum.

Booms are square. Elements are solid rod. Stainless hardware included for tower and mast mounting accepts up to 1.5" dia. mast and may be rotated for vertical or horizontal polarization. Connector is SO-239 for VHF, N female for UHF. Dual-Band antenna has separate driven elements, weighs only 10 pounds.

#### Dimensions given in table are for reflector elements & booms.

#### Options: Commercial Frequency \$45.

**Duplexer:** Add \$80 for VHF/UHF Duplexer and cabling for single coax feed of Dualband 146/435 Corner.

**Shipping:** UPS ground to continental USA (\$11 S&H). Air Parcel Post to HI, AK, & Possessions (\$14 P&H). Canada (\$16 P&H).

Allow 2 weeks for delivery.

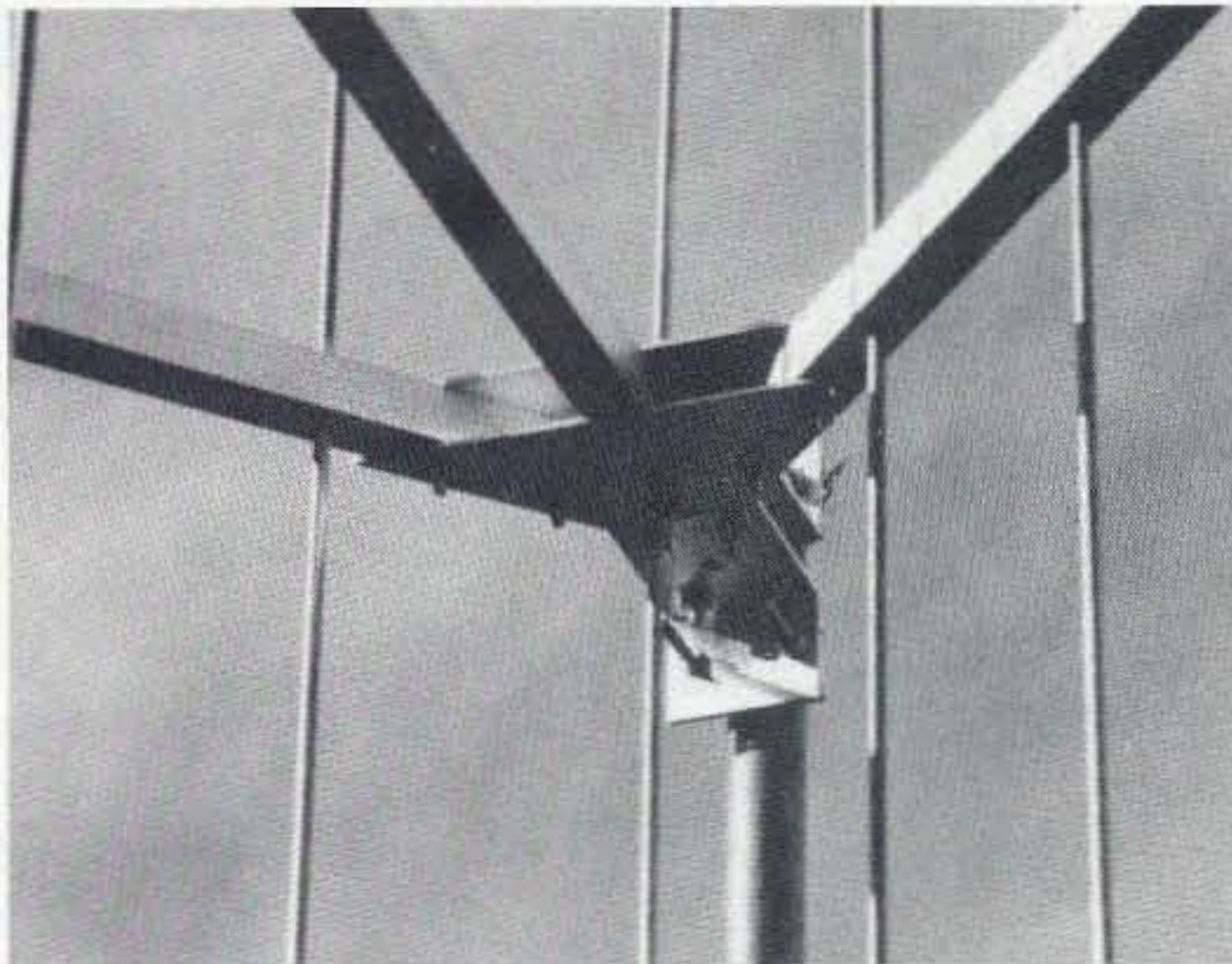

#### Measured CornerBeam Pattern

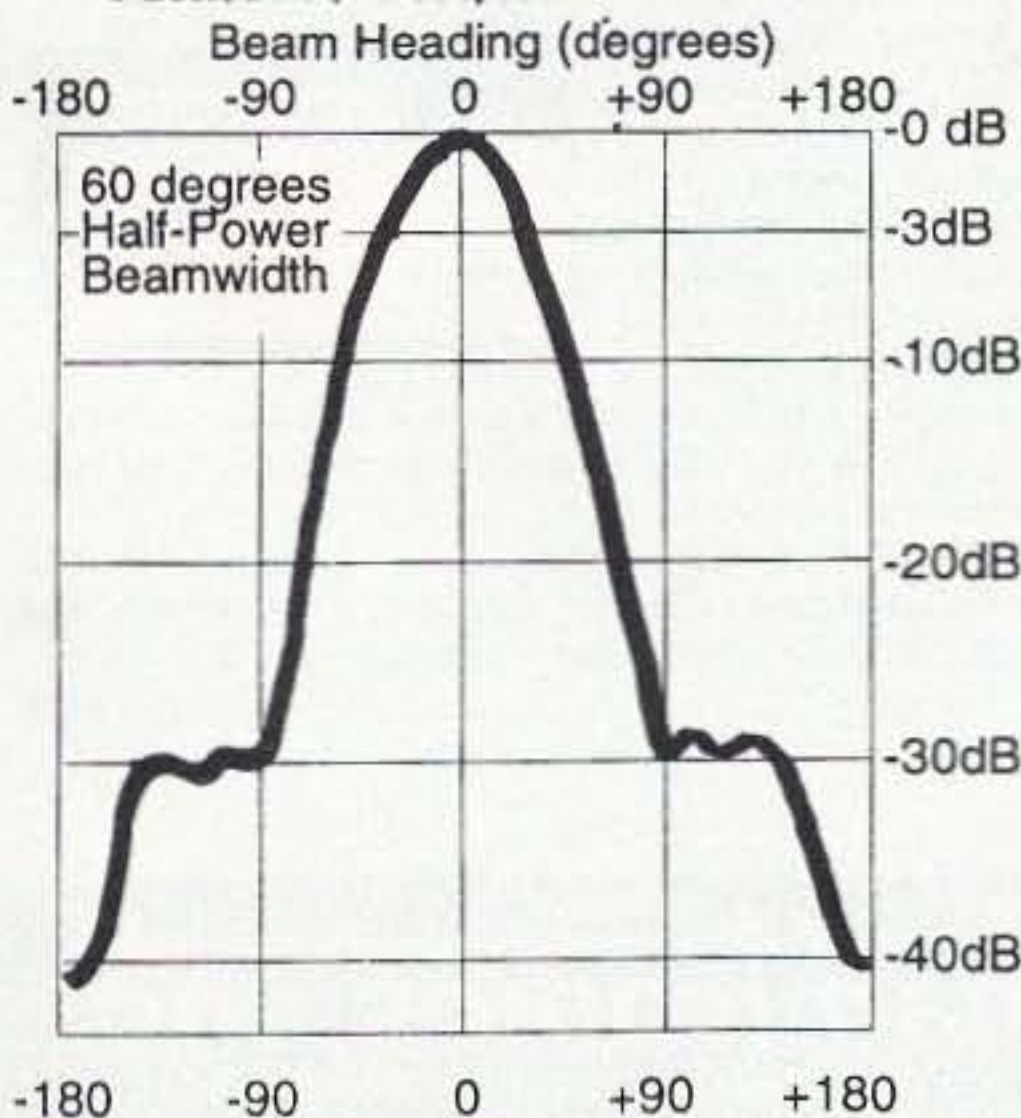

### Yes, I want Performance in My Corner!

Send my CornerBeam:  2m,  220MHz,  70 cm,  Dual 146/435.

Options:  DualBand Duplexer,  Commercial/Marine. Frequency: \_\_\_\_\_

Name \_\_\_\_\_ Amt. Enclosed \_\_\_\_\_

Call \_\_\_\_\_ Phone \_\_\_\_\_

Street \_\_\_\_\_ Unit \_\_\_\_\_

City \_\_\_\_\_ State \_\_\_\_\_ Zip \_\_\_\_\_

**Antennas West**  
Box 50062-S Provo UT 84605

InfoPak \$1

Tech 801 373 8425 Fax 801 373 8426

Order Hotline

**800 926 7373**

CIRCLE 57 ON READER SERVICE CARD

## You'll KICK Yourself If You Build a Repeater

Without Checking Out Our Catalog First!

Hamtronics has the world's most complete line of repeater controllers, cw and voice id boards, dtmf controllers, autopatches, ctcss boards, exciter, pa, and receiver modules. Here's a sample...

**CWID.** Traditional diode matrix, permits field changes; use with COR-3. .... kit only \$59



**CWID-2.** Miniature cwid board, eeprom-controlled, easy to build. .... only \$54/kit, \$79 w/t.

**DVR-1.** Add real speech to your repeater. Records your own voice up to 20 seconds. Use for voice id or to play club announcements. .... \$59/kit, \$99 w/t

**COR-3.** Inexpensive, flexible COR module with timers, courtesy beep, audio mixer. .... kit only \$49

**COR-4.** Complete COR and CWID all on one board. Low power CMOS logic, timers, courtesy beep, 2nd rcvr input, id in eeprom. .... only \$99/kit, \$149 w/t

**COR-5.** Microprocessor controller with all the bells & whistles! Full autopatch, reverse ap, phone remote control, lots of dtmf control functions, all on one board, as used in REP-200 Repeater. .... \$379 w/t

**COR-6.** COR timers, courtesy beep, voice id. Like COR & DVR-1 on one board! Record your own voice up to 20 seconds. Low power CMOS, non-volatile memory. .... kit only \$99, w/t only \$149.

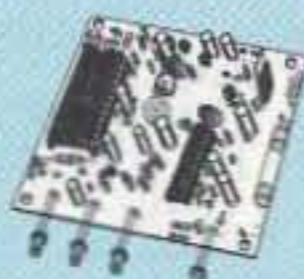

**AP-3.** Repeater autopatch, reverse autopatch, phone line remote control. Use with TD-2. .... kit \$89

**TD-2.** Four-digit DTMF decoder/controller. Five latching on-off functions, toll call restrictor. .... kit \$79



**TD-4.** DTMF controller as above except one on-off function and no toll call restrictor. Can also use for selective calling; mute speaker until someone pages you. .... kit \$49.

**TD-3.** CTCSS Decoder/Encoder. Prevents repeater access unless tone is present. Can also be used with mobile to access repeaters. .... kit only \$29.

## HIGH QUALITY VHF & UHF FM TRANSMITTER AND RECEIVER MODULES

**FM EXCITERS:** 2W output, continuous duty.

**TA51:** 6M, 2M, 220MHz. .... kit \$99, w/t \$169.

**TA451:** 420-475 MHz. .... kit \$99, w/t \$169.

**TA901:** 902-928 MHz, (0.5W out) ..... w/t \$169.

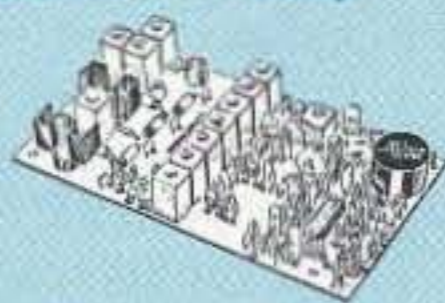

**VHF & UHF AMPLIFIERS.**

Output levels from 10W to 100W Starting at \$99.

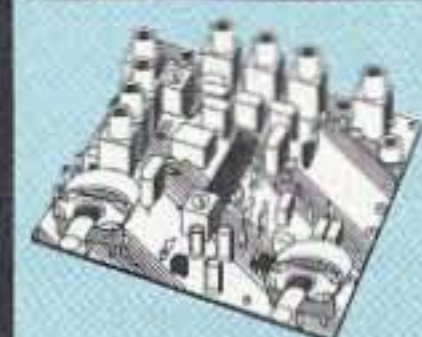

**FM RECEIVERS:**

• **R100 VHF FM RECEIVERS**  
Very sensitive - 0.15uV, superb selectivity - both crystal and ceramic IF filters for >100 dB at ±12kHz (best available anywhere), flutter-proof squelch.

For 46-54, 72-76, 140-175, or 216-225 MHz. .... kit \$129, w/t \$189.

• **R144/R220 RCVRs.** Like R100, with 2M or 220 MHz helical resonator in front end. .... kit \$159, w/t \$219.

• **R451 FM RCVR,** for 420-475 MHz. Similar to above. .... kit \$129, w/t \$189.

• **R901 FM RCVR,** 902-928MHz. .... \$159, w/t \$219.

## TRANSMITTING AND RECEIVING CONVERTERS

Go on a ham satellite adventure! Add another band for the next contest. Thrill in the excitement of building your own gear, and save a bundle.

No need to spend thousands on new transceivers for each band!



- Convert vhf and uhf signals to/from 10M.
- Even if you don't have a 10M rig, you can pick up very good used xmtrs & rcvrs for next to nothing.
- Receiving converters (shown above) available for various segments of 6M, 2M, 220, and 432 MHz.
- Kits from \$49, wired/tested units only \$99.



- Xmitting converters (at left) for 2M, 432 MHz.
- Kits only \$89 vhf or \$99 uhf.
- Power amplifiers up to 50W output.

## LOW NOISE RECEIVER PREAMPS

**LNG-( ) G<sub>A</sub>A<sub>s</sub> FET PREAMPS**

STILL ONLY \$59!

- Make your friends sick with envy! Work stations they don't even know are there.
- Install one at the antenna and overcome coax losses.



• Available for 28-30, 46-56, 137-152, 152-172, 210-230, 400-470, and 800-960 MHz bands.

**LNW-( ) ECONOMY PREAMPS**

ONLY \$29 kit, \$44 wired/tested

- Miniature MOS FET Preamp
- Solder terminals allow easy connection inside radios.
- Available for 25-35, 35-55, 55-90, 90-120, 120-150, 150-200, 200-270, and 400-500 MHz bands.

## WEATHER FAX RECEIVER



Join the fun. Get striking images directly from the weather satellites!

A very sensitive wideband fm receiver optimized for reception of NOAA APT and Russian Meteor weather fax images on the 137 MHz band. Covers all five satellite channels. Scanner circuit and recorder control allow you to automatically search for and tape signals as satellites pass overhead, even while away from home.

- R139 Receiver Kit less case ..... \$159
- R139 Receiver Kit with case and 12Vdc pwr adapter ..... \$189
- R139 Receiver Wired in case with 12Vdc adapter ..... \$239
- Internal PC Demodulator Board and Imaging Software ..... \$289
- Turnstile Antenna ..... \$119
- Weather Satellite Handbook ..... \$20

## Get more features for your dollar with our REP-200 REPEATER

A microprocessor-controlled repeater with full autopatch and many versatile dtmf control features at less than you might pay for a bare-bones repeater or controller alone!

Kit still only \$1095

w&t still only \$1295

50-54, 143-174, 213-233, 420-475 MHz  
(902-928 MHz slightly higher.)

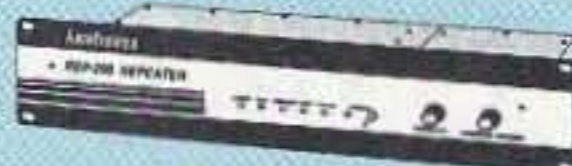

Digital Voice Recorder Option ..... only \$100.  
Great for voice ID or making club announcements.

REP-200C Economy Repeater. Voice ID, no dtmf or autopatch. .... Kit only \$795, w&t \$1195.

REP-200N Repeater. No controller so you can use your own. .... Kit only \$695, w&t \$995.

## SUBAUDIBLE TONE ENCODER/DECODER



Access all your favorite closed repeaters with TD-5 CTCSS Encoder/Decoder

Encodes all standard sub-audible tones with crystal accuracy and convenient DIP switch selection. Comprehensive manual also shows how you can set up a front panel switch to select between tones for several repeaters. Receiver decoder can be used to mute receive audio and is optimized for installation in repeaters to provide closed access. High pass filter gets rid of annoying buzz in receiver.

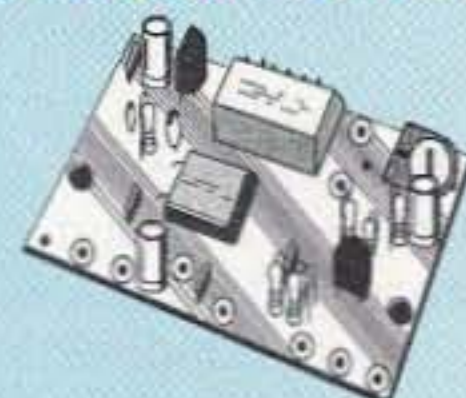

- TD-5 CTCSS Encoder/Decoder Kit ..... only \$39
- TD-5 CTCSS Encoder/Decoder Wired/tested ..... \$59

## Finally - A Professional- Quality Receiver to Monitor Weather Broadcasts!



Our new RWX is a very sensitive and selective Hamtronics grade receiver to monitor critical weather and emergency broadcasts from NOAA/NWS or Environment Canada.

Excellent 0.15µV sensitivity provides good reception even at distances of 70 miles or more with suitable antenna. No comparison with ordinary consumer radios or scanners! Automatic mode provides storm watch, alerting you by unmuting receiver and providing an output to trip remote equipment when an alert tone is broadcast.



Essential for airports, police and fire departments, CAP, broadcast stations, state and local emergency managers, amateur repeaters - anyone needing a professional quality receiver. Because of its reasonable price, it is also handy for bikers, hikers, boaters, hunters, farmers - any one who needs up-to-date weather info and emergency warnings, even from distant stations.

Small enough for emergency or portable use, it can be powered from a small 9-12V battery when needed. Crystal controlled for accuracy; all 7 channels provided (162.40 to 162.55).

You can buy just the receiver pcb module in kit form or buy the kit with an attractive metal cabinet, AC power supply, and built-in speaker. It is also available factory wired and tested.

- RWX Rcvr kit, PCB only ..... \$79
- RWX Rcvr kit with cabt, spkr, & 12Vdc adapter ..... \$99
- RWX Rcvr wired/tested in cabt with spkr & adptr ..... \$139

## WWW RECEIVER



Get time & frequency checks

without buying multi-band hf rcvr. Hear Geo Alerts for conditions affecting radio propagation. Very sensitive and selective crystal controlled superhet, dedicated to listening to WWW on 10.000 MHz. Performance rivals the most expensive receivers.



- RWWV Rcvr kit, PCB only ..... \$59
- RWWV Rcvr kit with cabt, spkr, & 12Vdc adapter ... \$89
- RWWV Rcvr wired/tested in cabt with spkr & adapter ..... \$129

- Buy at low, factory-direct net prices and save!
- For complete info, call or write for free catalog.
- Order by mail, fax, or phone (9-12 AM, 1-5 PM eastern time).
- Min. \$5 S&H charge for first pound plus add'l weight & insurance.
- Use VISA, Mastercard, Discover, check, or UPS C.O.D.

(See last month's ad for more products.)

Our 34th Year!  
**hamtronics, inc.**

65-D Moul Rd; Hilton NY 14468-9535  
Phone 716-392-9430 (fax 9420)

# THE TEAM

El Supremo & Founder  
Wayne Green W2NSD/1

Associate Publisher  
F. I. Marion

Associate Technical Editor  
Larry Antonuk WB9RRT

Nitty Gritty Stuff  
Priscilla Gauvin  
Joyce Sawtelle  
David Underwood

### Contributing Culprits

Bill Brown WB8ELK  
Mike Bryce WB8VGE  
Joseph E. Carr K4IPV  
Michael Geier KB1UM  
Jim Gray W1XU/7  
Chuck Houghton WB6IGP  
Dr. Marc Leavey WA3AJR  
Andy MacAllister WA5ZIB  
Dave Miller NZ9E  
Joe Moell K0OV  
Carole Perry WB2MGP  
Jeffrey Sloman N1EWO

### Advertising Sales

Frances Hyvarinen  
Roger Smith  
603-924-0058  
800-274-7373  
Fax: 603-924-8613

### Circulation

Linda Coughlan  
Helen Senechal

### Data Entry & Other Stuff

Christine Aubert  
Norman Marion

### Business Office

Editorial - Advertising - Circulation  
Feedback - Product Reviews  
73 Amateur Radio Today Magazine  
70 Route 202N  
Peterborough NH 03458-1107  
603-924-0058  
Fax: 603-924-8613

Reprints: \$3 per article  
Back issues: \$5 each

Printed in the USA by  
Quad Graphics

**Manuscripts:** Contributions for possible publication are most welcome. We'll do the best we can to return anything you request, but we assume no responsibility for loss or damage. Payment for submitted articles will be made upon publication. Please submit both a disk and a hard copy of your article (IBM (ok) or Mac (preferred) formats), carefully checked drawings and schematics, and the clearest, best focused and lighted photos you can manage. "How to write for 73" guidelines are available on request. US citizens must include their Social Security number with submitted manuscripts so we can submit it to you know who.

SEPTEMBER 1996  
ISSUE #432

# 73 Amateur Radio Today

## TABLE OF CONTENTS

### FEATURES

- 10 **The Amateur's Guide to "Free Energy" Devices - WA8YKN**  
*A history and hints for further experimentation.*
- 20 **Adventures on the Red Sea - KA9SOF**  
*DXing in style in an unforgettable setting.*
- 24 **The Wonderful Twin-T - AD4UA**  
*It's a code oscillator, a transistor, or even a piano!*
- 26 **A Kite/Balloon-Supported Zepp for 160 Meters - W1GV**  
*Make your antenna fly high!*
- 29 **My Indoor Antenna Farm - W6YBT**  
*Yes, you really can work DX with a stealth antenna..*
- 30 **Off 2, 4 Good - W0WUZ**  
*Cheap and easy fixes for TVI.*
- 34 **FRACVERT: Small Fractal Footprint Vertical - N1IR**  
*Fractal counterpoise or top hat too!*
- 36 **Have We Been Had? - WA8HSU**  
*Again?*
- 42 **An Antenna Plotting Oscillator - G2BZQ**  
*Here's a handy one-chip piece of equipment you can build.*
- 46 **Saving Ourselves From Ourselves - KN4HL**  
*It's called getting involved.*
- 69 **BC Band Antenna Switchover Relay - NZ9E**  
*A better way for Icom HF radios.*

### REVIEWS

- 23 **Your Next Buy: An MFJ-259 - K5LAD**  
*Wait 'til you see what this antenna analyzer can do for you!*
- 32 **TD-3 Subaudible Tone Decoder Module - WB9RRT**  
*Hamtronics' kit saves one club's treasury—and provides a group project!*
- 40 **Communicating on the Internet - K7UGQ**  
*With Quarterdeck—license-free!*

### DEPARTMENTS

- WB6IGP 72 Above & Beyond
- 73 Ad Index
- KB1UM 82 Ask Kaboom
- WB8ELK 76 ATV
- 44 Barter 'n' Buy
- K4IPV 54 Carr's Corner
- WA5ZIB 50 Hamsats
- NZ9E 56 Ham to Ham
- K0OV 61 Homing In
- 6 Letters
- W2NSD/1 4 Never Say Die
- 84 New Products
- W1XU 87 Propagation
- WB8VGE 52 QRP
- 8 QRX
- 44, 85, 86, 87, 88 Radio Book Shop
- WA3AJR 70 RTTY Loop
- 78 Special Events
- 45 Updates

### HAM RADIO FUN SECTION

- K2OAW 64 Communications Simplified Part 9  
*Why TV, radio, and other FM-carried communications really work.*
- W8DMR 68 From Kilowatts to Femtowatts?  
*Wrestling with those dog biscuits.*
- WB2WPM 80 Heathkit Mania  
*And all bought at bargain prices!*

**On the cover:** Shane Brady WB2WPM with his Heathkit collection. See page 80. (Photo by WB2JFP.)

**Feedback:** Any circuit works better with feedback, so please take the time to report on how much you like, hate, or don't care one way or the other about the articles and columns in this issue. G = great!, O = okay, and U = ugh. The G's and O's will be continued. Enough U's and it's Silent Keysville. Hey, this is *your* communications medium, so don't just sit there scratching your...er...head. FYI: Feedback "number" is usually the page number on which the article or column starts.

**73 Amateur Radio Today** (ISSN 1052-2522) is published monthly by 73 Magazine, 70 N202, Peterborough NH 03458-1107. The entire contents ©1996 by 73 Magazine. No part of this publication may be reproduced without written permission of the publisher, which is not all that difficult to get. The subscription rate is: one year \$24.97, two years \$44.97; Canada: one year \$34.21, two years \$57.75, including postage and 7% GST. Foreign postage: \$19 surface, \$42 airmail additional per year, payable in US funds on a US bank. Second class postage is paid at Peterborough, NH, and at additional mailing offices. Canadian second class mail registration #178101. Canadian GST registration #125393314. Microfilm edition: University Microfilm, Ann Arbor MI 48106. POSTMASTER: Send address changes to 73 Amateur Radio Today, 70 N202, Peterborough NH 03458-1107. 73 Amateur Radio Today is owned by Shabromat Way Ltd. of Hancock NH.

**Contract:** By being so nosy as to read this fine print, you have just entered into a binding agreement with 73 Amateur Radio Today. You are hereby obligated to do something nice for a ham friend—buy him a subscription to 73. What? All of your ham friends are already subscribers? Donate a subscription to your local school library!

## NEUER SAY DIE

Wayne Green W2NSD/1

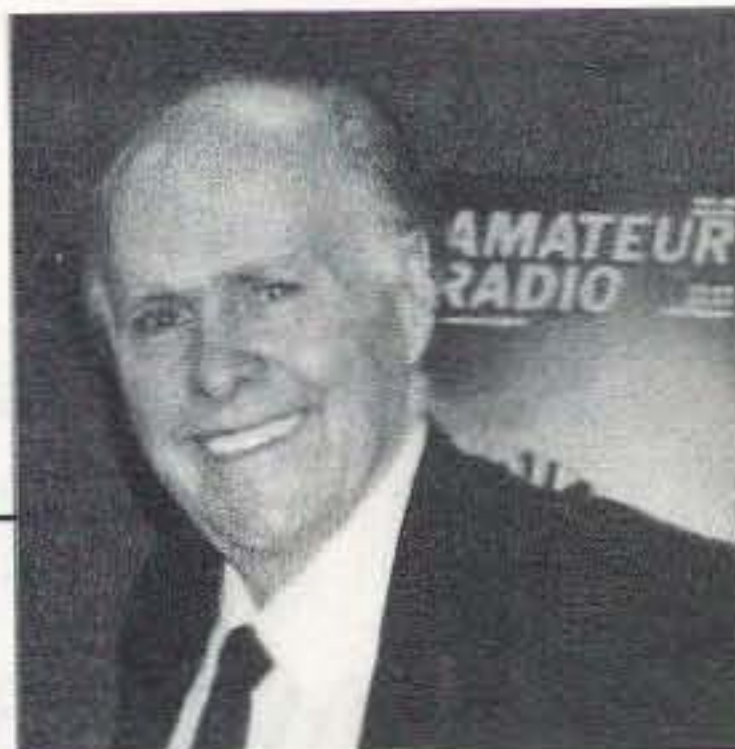

### Debacle?

I'm sure you're not going to believe that the ARRL plan to bury the Industry Working Group 2A (IWG-2A) of the 1997 World Administrative Radio Conference (WARC) in letters and E-mail from ARRL members has boomeranged, making what was a serious situation infinitely worse.

The League might have taken a hint when their initial pressures and threats were rebuffed by the IWG. But no, if a little pressure and threats don't work, let's escalate the attack. The predictable result is a very angry working group, one which is going to be even less willing to sit down and reasonably discuss the situation.

This all has to do with the potential loss of the 144 and 420 MHz bands to commercial development, as you probably know.

There is just an almost-minuscule possibility that the IW Group may suspect that the League is playing with a very weak hand. Other than rallying the blindly loyal members to send letters and E-mail, the League has few weapons for this battle they've chosen to pursue. Negotiation might have been a better tack.

The sharks in Congress have tasted blood and are eager to push for the sale of as much of the spectrum as possible. And guess which group has one of the biggest spectrum allotments? Make a second guess as to which group has the least lobbying power? Want to try for a third? Guess which group is providing the least in the way of benefits to the public in return for their use of billions of dollars of spectrum?

I see a gaping hole in human reasoning which is working to our disadvantage. Few of us seem to have any sense of the

future. Most of us are so totally wrapped up in the present and past that the future, as far as we're concerned, is totally in God's hands, not ours. So we're using up the world's resources of metals, oil, coal, natural gas, and so on, and who really cares about the mess we're leaving our grandchildren? We're eating fast-food crud, drinking poisoned water, breathing air that is killing trees, and thus substantially shortening our lives. And we hams are using about 3% of our allocated radio spectrum to have fun, and little more.

Sure, rag-chewing is fun. And DX pileups are a challenge for the combative. A handful of hams are adventurous, having fun with packet, the ham satellites, SSTV, DXpeditioning, and stuff like that. Maybe 2%. The rest are along for the ride, at least until the music stops. Tomorrow? Har-de-har.

I'm still looking at every ham club newsletter that comes in, hoping to find some mention that the club is holding tech sessions to help the youngsters understand radio and electronics. I'm not finding anything.

So, go right ahead with the ARRL plan and dump on the IW Group, making them even angrier and more likely to show us who's boss. The head of the group was contacted recently on the phone. His response was unprintable. The fate of our two major Tech bands is in the group's hands, so we're busy poking him and the other the group members with a pointed stick.

The loss of 2m and 70cm could, I suspect, just about wipe out the ham industry. Again. It was 30 years ago that the ARRL wiped out the whole ham industry with a really stupid attempt to generate some controversy in order to sell more magazines. The result of this unbelievable

miscalculation was that 85% of the ham radio stores went out of business within a year, and over 90% of the manufacturers blew away. Where will our hobby be if we wipe out the dealers and manufacturers again? And there's nothing like 100,000 Techs trying to sell their ham gear for anything they can get, to kill the industry. The Generals did that 30 years ago when threatened by the ARRL with the loss of their HF voice bands, and the American ham industry has never recovered.

The CB industry never recovered from their expansion to 40 channels. CB was growing like crazy, supported by movies and hit songs, and endless PR. Then, in a matter of weeks, it was dead, and most of the manufacturers were blown away.

### Sneaky Plan?

A West Coast Chicken Little correspondent has suggested that the hornet's-nest reaction of the IW Group is exactly what the League planned. He points out that the ARRL opposed both the Novice and Tech licenses, and has never considered either to be real hams. Real amateur radio is the HF bands, with ARRL traffic handling nets and CW DXing. By getting rid of the 144 and 450 bands, the hobby would be purified and get back to more like the way it used to be. Remember, he points out, the League has never done anything much to help promote repeaters. That was all done by 73.

That's an interesting concept, but I've never seen any signs of the League directors thinking two steps ahead, so I doubt the sky is starting to fall now.

### Tampa, November 23rd

Are you going to be with me as I try to cram about 10 hours of

information into a two-hour time slot? Please write and let me know what you'd like me to cover, because, left to my own devices, I'll deal with amateur radio; its past, present, and future. Then, if there's any interest, I'll explain the secret for making money and the shortcuts for doing it. I've lectured on this at several universities (like Yale, RPI, BU, Case Western, etc.).

Or you may be interested in the incredible developments in cold fusion and the opportunities that presents.

Maybe I'll explain some of the amazing things I've found out about how to keep your family healthy so they can knock our stupid Social Security tax system for a loop by living to over 100 in good health.

Education, tuitionless colleges, downsizing the government—there are lots of interesting things I can cover, if you want.

Or perhaps you'd prefer I stick 100% to amateur radio, explaining some of the ways hams win ARRL contests and awards by cheating. How about DXpeditions which weren't in the countries they said they were? I can name and give details on a bunch of those.

In the 1970s there were all kinds of opportunities to get in on the cellular telephone explosion. Then came microcomputers. Ken Olsen, the president of Digital Equipment, said in 1977, "There is no reason for any individuals to have a computer in their home." Two years earlier I was predicting in my editorials that the personal computer would one day be one of the largest industries in the world. The chairmen of Data General, Radio Shack, Wang, and Centronics all told me I was wrong. So did the chairman of TI. But my crystal ball hasn't failed yet. So what do I see as coming down the pike in communications developments? Just ask at Tampa.

Maybe you'd like to hear about my plan for getting hams into our state legislatures so we'll have some political clout. I think any ham club that really wants to can get a member elected. We don't want to be like the unhappy workers who find themselves suddenly out of work when their jobs are moved to Mexico. Unless we take the bull by the horns and run with it we're likely to find our ham bands have moved to Afghanistan.

*Continued on page 9*

# ORDER NOW 1-800 4 HOBBY KITS

## AIRCRAFT RECEIVER



Hear exciting air-craft communications—pick up planes up to 100 miles away! Receives 110-136

MHz AM air band, smooth varactor tuning superhet with AGC, ceramic filter, adjustable squelch, excellent sensitivity and lots of speaker volume. Runs on 9V battery. Great for air shows or just hanging around the airport! New 30-page manual details pilot talk, too. Add case set for "pro" look.

AR-1 kit.....\$29.95 Matching case set, CAR...\$14.95

## FM RECEIVERS & TRANSMITTER

Keep an ear on the local repeater, police, weather or just tune around. These sensitive superhet receivers are fun to build and use. Tunes any 5 MHz portion of the band and have smooth varactor tuning with AFC, dual conversion, ceramic filtering, squelch and plenty of speaker volume. Complete manual details how the rigs work and applications. 2M FM transmitter has 5W RF out, crystal control (146.52 included), pro-specs and data/mike inputs. Add our case sets for a nice finish.

FM Receiver kit Specify band: FR-146 (2M), FR-6 (6M), FR-10 (10M), FR-220 (220MHz).....\$34.95  
CFR Matching case set.....\$14.95  
FT-146 Two Meter FM transmitter kit.....\$99.95

## MICRO-MIKE

World's smallest FM wireless mike. Smaller than a sugar cube - including battery and mike. Two sets of SMT parts supplied in case you are clumsy! Terrific audio pick-up (pin drop at 5 ft) and transmit range of 300 ft. We include the battery (watch style), electret mike and even a tuning tool! Be a James Bond and learn SMT too!



FM-5 Micro mike kit.....\$19.95

## FM WIRELESS MIKES

Pick the unit that's right for you. All units transmit a stable signal in the 88-108 MHz FM band up to 300' except for High power FM-4 and PB-1 Phone bug that go up to 1/2 mile.

FM-1 Basic unit.....\$5.95  
FM-2, as above  
but with added mike pre amp.....\$7.95  
FM-4, long range with  
very sensitive audio pickup.....\$14.95  
PB-1, Phone bug needs no battery,  
hooks to phone line.....\$14.95  
MC-1, Micro size sensitive mike cartridge  
for FM-1,2,4.....\$2.95

## SURROUND-SOUND/REVERB

Add concert hall realism to your stereo, TV or even 2-way radio! Easily synthesize a stereo effect from mono sources or richly enliven regular music. Add a big-voice reverb to your radio voice that others will envy! Our reverb/surround sound kit uses a Bucket Brigade IC Device for reliable solid-state performance. Adjustable reverb, delay and mix controls to customize your sound. Easily connected to radios, stereos, CB's and TV's. Plenty of audio to drive a small speaker for stand-alone operation too. Experience the fun and realism that surround sound provides - without spending hundreds! Add our case set for a neat, pro look.

RV-1 Surround Sound/Reverb kit.....\$59.95 CRV Matching case set.....\$14.95  
RV-1WT Assembled RV-1 and case.....\$89.95

## TOUCH-TONE REMOTE CONTROL

Control virtually anything by Touch-Tone remote control. The URC-1 has 16 switched outputs, 4 adjustable voltage outputs (20 mV steps 0 to 5 VDC), two 10K digital pots (for volume, squelch, etc.) and 3 timers adjustable from 10 ms to 40 hours! Two level password control allows secure control and multi-level access. Six digit LED display shows currently entered codes and a crystal controlled touch-tone decoder provides reliable operation. There's nothing else like this unit, be in complete control of remote radios, thermostats, hi-fi's, homes or even factories with the URC-1. Add our matching case set for a handsome finish.

URC-1 Remote control kit.....\$129.95 CURC Matching case set.....\$14.95  
URC-1WT Fully assembled URC-1 and case.....\$189.95

## FM SUBCARRIER DECODER

Tap into the world of commercial-free music and data that is carried over many standard FM broadcast radio stations. Decoder hooks to the demodulator of FM radio and tunes the 50-100 KHz SCA subcarrier band. Many radios have a demod output, but if your radio doesn't, it's easy to locate, or use our FR-1 FM receiver kit which is a complete FM radio with a demod jack built-in. These "hidden" subcarriers carry lots of neat programming - from stock quotes to news to music, from rock to easy listening - all commercial free. Hear what you've been missing with the SCA-1.

SCA-1 Decoder kit.....\$27.95 CSCA Matching case set.....\$14.95  
FR-1 FM receiver kit.....\$24.95 CFR Matching case for FR-1.....\$14.95

## L-C METER

Measure inductors from 10 uH-10mH and capacitors from 2 pF-2uF with high accuracy by connecting the LC-1 to any digital multimeter. Two pushbutton ranges for high resolution readings and we even give you calibration components to assure proper accuracy of your kit! Active filters and switching supplies require critical values, no one should be without an accurate LC meter. For a pro look, add our matching case set.

LC-1 LC meter kit.....\$34.95 CLC case set.....\$14.95

## MOTOR CONTROLLER

Control the speed and direction of any motor. Use our SMD-1 for those nice steppers you see surplus, and our MSC-1 for DC motors. The stepper driver features variable speed, half step rotation, direction and power down mode, can drive most any stepper motor. Our DC driver features pulse width modulation control allowing full motor torque even at low speeds and can drive motors up to 50 VDC @ 10 Amps! Add our case set for a professional assembly.

SMD-1 Stepper kit.....\$24.95 MSC-1 DC motor kit.....\$24.95  
CSMD SMD-1 case.....\$14.95 CMSC MSC-1 case.....\$14.95

## SYNTHESIZED AUDIO GENERATOR

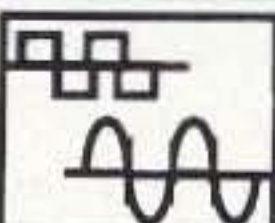

DDS (Direct Digital Synthesis) technology brings you a terrific audio generator at a fantastic price! Generates from 0.01 Hz to 50 KHz with five digit LED display of frequency. Sine and square wave output adjustable 0-5

volt p-p. Frequency selected by direct keyboard entry and with handy continuous tune tuning knob. Crystal controlled accuracy of 10 ppm and two memories for rapid frequency changes. Retire that jury-rigged old generator and treat yourself to the pleasure of using a new state-of-the-art SG-550!

SG-550 Kit...\$199.95 SG-550WT assembled.....\$269.95

## SHORTWAVE RECEIVER

Fantastic receiver that captures the world with just a 12" antenna! Can receive any 2 MHz portion from 4-11 MHz. True superhet, has smooth varactor tuning, AGC, RF gain control, plenty of speaker volume and runs on a 9V battery. Fascinating Scout, school or club project, provides hours of fun for even the most serious DXer. For the car, consider our shortwave converter. Two switchable bands (in 3-22 MHz range), each 1 MHz wide—tunable on your car radio dial. Add some interest to your drive home!



Shortwave receiver kit, SR1.....\$29.95  
Shortwave converter kit, SC1.....\$27.95  
Matching case set for SR1, CSR.....\$14.95  
Matching case set for SC1, CSC.....\$14.95

## AM TRANSMITTER

High quality, true AM broadcast band transmitter is designed exactly like the big commercial rigs. Power of 100 mW, legal range of up to 1/4 mile. Accepts line level inputs from tape and CD players and mike mixers, tunable 550-1750 KHz. Complete manual explains circuitry, help with FCC regs and even antenna ideas. Be your own Rush Limbaugh or Rick Dees with the AM-1! Add our case set for a true station look.

AM-1 Transmitter kit.....\$29.95  
CAM Matching case set.....\$14.95

## SCANNER CONVERTER

Tune in on the 800-950 MHz action using your existing scanner. Frequencies are converted with crystal referenced stability to the 400-550 MHz range. Instructions are even included on building high performance 900 MHz antennas. Well designed circuit features extensive filtering and convenient on-off/bypass switch. Easy one hour assembly or available fully assembled. Add our matching case set for a professional look.



SCN-1 Scanner converter kit.....\$49.95  
SCN Matching case set.....\$14.95  
SCN-1WT Assembled SCN-1 and case.....\$89.95

## STEREO FM TRANSMITTER

Run your own Stereo FM radio station! Transmits a stable signal in the 88-108 MHz FM broadcast band up to 1 mile. Detailed manual provides helpful info on FCC regs, antenna ideas and range to expect. Latest design features adjustable line level inputs, pre-emphasis and crystal controlled subcarrier. Connects to any CD or tape player, mike mixer or radio. Includes free tuning tool too! For a pro look add our matching case set with on-board whip antenna



FM-10A Stereo transmitter kit.....\$34.95  
CFM Case, whip ant set.....\$14.95

## DR. NI-CAD CONDITIONER/FAST CHARGER

Quit spending big bucks for replacement battery packs, rejuvenate and condition your batteries for peak capacity. Advanced circuitry has optimized discharge before charge to eliminate memory effect and to condition batteries that have been poorly cared for in the past. Quick charge rapidly brings battery to full charge in less than an hour—just 15 minutes for some types! And "top-off" charge mode squeezes every last bit of energy into each cell for the absolute most capacity. Switch-mode regulator controls constant current charge while being monitored by a negative delta-V system that cuts off the fast charge at the exact point of full charge—batteries are charged, not cooked! Charges NiCads or NiMH packs from 2 to 10 cells (easily expanded) and current capacities up to 10 Amp-hours. Runs on 12 to 15 VDC. Quit cooking your batteries, buying new packs, waiting hours for recharge, get a Dr. Ni-Cad today! Available in money saving kit form or wired and tested with case at a special price. Kit builders: add our matching case set for a snazzy finish.

DN-1 Dr. Ni-Cad conditioner/fast charger kit.....\$49.95  
CDN Matching case set.....\$14.95  
DN-1WT Fully assembled Dr. Ni-Cad with case.....\$89.95

## SPEED RADAR

New low-cost microwave Doppler radar kit "clocks" cars, planes, boats, horses, bikes or any large moving object. Operates at 2.6 GHz with up to 1/4 mile range. LED digital readout displays speed in miles per hour, kilometers per hour or feet per second! Earphone output allows for listening to actual Doppler shift. Uses two 1-lb coffee cans for antenna (not included) and runs on 12 VDC. Easy to build—all microwave circuitry is PC stripline. ABS plastic case with speedy graphics for a professional look. A very useful and full-of-fun kit.



SG-7 Complete kit.....\$99.95

## STEREO PEAK HOLD BARGRAPH

Finally a dual LED bar graph with a peak hold display! Bar graph displays are neat and eye catching but their speed is their downfall - they just can't capture the peaks. Our kit is like two units in one, a fast display to show the signal and a long persistence display to capture peaks, similar units go for hundreds of bucks! We offer 3 models: Linear for general use, Semi-Log for audio VU meters, and Log for power displays. Dual - for stereo! - 10 segment multi-colored LED display for snazzy, eye grabbing display and easily set ranges for virtually any signals, from voltmeters to audio VU meters to audio power amps to SWR meters. Complete instructions for easy hook-up to most any device. Add our matching case set for a sharp looking unit.

PH-14 Dual Linear bargraph kit.....\$39.95 PH-15 Dual Log bargraph kit.....\$39.95  
PH-16 Dual Semi-Log bargraph kit.....\$39.95 CPH Matching case set.....\$14.95

## SPEECH SCRAMBLER

Descramble most scramble systems heard on your scanner radio or set up your own scrambled communication system over the phone or radio. Latest 3rd generation IC is used for fantastic audio quality - equivalent to over 30 op-amps and mixers! Crystal controlled for crystal clear sound with a built-in 2 watt audio amp for direct radio hook-up. For scramble systems, each user has a unit for full duplex operation. Communicate in privacy with the SS-70. Add our case set for a fine professional finish.

SS-70 Scrambler/descramblerkit.....\$39.95  
CSSD matching case set.....\$14.95  
SS-70WT Assembled  
SS-70 and case set.....\$79.95

## CRYSTAL RADIO

Relive the radio past with a crystal set like your grandfather built. Uses genuine Galena crystal and catwhisker. Several different types of radios are built, including standard AM broadcast, shortwave and even WW II foxhole style. To compare modern semiconductor detectors, we include a diode for comparison. No soldering required and we even give antenna ideas. Radio for free, get it now before Clinton taxes it!

CS-1 Crystal set kit.....\$19.95

## TOUCH-TONE DECODER

Grab Touch-Tone numbers right off the air, phone or tape. A simple hook-up to any radio speaker or phone line is all that is required to instantly decipher touch-tone phone numbers or codes. A 256 digit memory stores decoded numbers and keeps its memory even in the event of power loss. An 8 digit LED display allows you to scroll through the memory bank to examine numbers. To make it easy to pick out number groups or codes, a "dash" is inserted between sets of digits that were decoded more than 2 seconds apart. A "central-office" quality crystal controlled decoder is used allowing rapid and reliable detection of numbers at up to 20 digits per second! For a professionally finished look, add our matching case set. Start cracking those secret codes tomorrow with the Tone Grabber!

TG-1 Tone Grabber kit.....\$99.95 CTG Matching case set.....\$14.95  
TG-1WT Fully assembled TG-1 and case.....\$149.95

## DIGITAL VOICE RECORDER

Chatterbox digital voice storage unit will record your message of up to 20 seconds. Time is split up into four 5 second blocks which can be played separately or cascaded for longer messages. An LED display shows message location and current mode for easy operation. Nifty built-in interfaces allow simple connection to transmitters for automatic keying when the PTT is initially closed or after it is released. You can even loop your rig's mike through the Chatterbox. For contest or fun use, the CB-1 can drive an external speaker. Includes a built-in electret mike. For that finishing touch, add our matching case set.

CB-1 Voice recorder kit.....\$59.95 CCB Matching case set.....\$14.95

ORDERS CALL 1-800-4 HOBBY KITS (446-2295) ORDERS ONLY  
TECH/ORDER/INFO (716)924-4560 FAX (716)924-4555



TERMS: Satisfaction guaranteed. Examine for 10 days. If not pleased return in original form for refund. Add \$4.95 for shipping, handling and insurance. For foreign orders add 20% for surface mail. COD (U.S. only) add \$5.00. Orders under \$20 add \$3.00 NY residents add 7% sales tax. 90-day parts warranty on kit parts. 1-year parts & labor warranty on wired units.

RAMSEY ELECTRONICS, INC 793 CANNING PARKWAY VICTOR NY 14564

CIRCLE 34 ON READER SERVICE CARD

# LETTERS

**Marc Yuen N6APJ.** I want to let you know that your "Never Say Die" column is the best part of the magazine. I've especially appreciated your comments on health and diet. I'm also a subscriber to *Cold Fusion* and am very interested in that field. Please continue with similar content in future issues. You might even recycle some 10-year-old ones.

I suffered a detached retina in my left eye in 1994 and a year later in my right eye. Now I'm up to eight surgeries between the two eyes. Recently, I found *The Healing Power of Herbs* by Michael Murray, ND, ISBN 1-5595-8700-8. I took the recommended herb and my sight has improved to better than 20/70 from 20/200.

I'm interested in seeing construction articles about things like adapting a TV tuner module for a spectrum analyzer, radio astronomy, environmental monitoring such as seismology and weather data collection via packet radio, and such. Lately I've been too busy to pursue hobby activities, but my work is rewarding (the hardware I'm building is going to Saturn).

*Well, I'm glad somebody likes my columns... Wayne.*

**Terry Schieler NØDFH.** My friend Larry Junstrum KN4UB should be on your "famous ham" list. He's the bass player for the popular rock group ".38 Special" and a strong spokesman for amateur radio. His phonetics are "Known Nationally 4 Ultimate Bass."

**Rudy Ault Jr. N2JZK.** Per your list of famous hams, you forgot to include W2NSD/1—Wayne Green: educator, entrepreneur, pioneer, and man of letters. Most of the folks you listed haven't done half as much as you have. Keep up the good work.

*Rudy, I'm not famous, just persistent. But amateur radio sure has provided me with a life of adventure... Wayne.*

**Antonio Anzevino WB2KDE.** I just wanted to make a few

## From the Ham Shack

comments about your editorial and get that list of the books you recommend. You know, at first I thought you were an old windbag, so I didn't bother to read your column. One evening I didn't have anything to read, so I reluctantly picked it up. The first book you mentioned was *The Cancer Cure That Worked*. I found this was a great book and, since then, have bought several other books you've suggested. All have been great.

I'm not the type to be idle, so I build things. Lotsa things. For instance, I have a good idea for a gadget which is really needed. I started off by contacting American manufacturers for parts in order to build a prototype. My patent attorney said to "go for it." Sad to say, I think I know one of the reasons the American economy is going down the tubes. Now I'll try and contact Asian manufacturers for the needed parts. That's more jobs that won't be available in this country.

I'm very much interested in your *Making Money*, though I really don't need to make a million since I'm comfortably retired. It's just that your column has pushed me a bit further than I normally would have gone.

I'd also like you to know that I now read your column as soon as the magazine arrives. I no longer think of you as a windbag, but as a down-to-earth guy who uses his "noodle." Thanks for pushing me into a more constructive attitude.

*Glad you're enjoying, Antonio. Yep, we've not only lost our consumer electronics industry to Japan, but we no longer make the parts either. Worse, we no longer make the machines to make the parts. Heck, we no longer make most of the tools to make the machines to make the parts... Wayne.*

**Dan Sealy AA7OA.** That Andy Griffith listed in the June issue isn't the actor, he's 20 years too young. You might want to list Paul Tibbets K4ZVZ, who was the pilot of the *Enola Gay* when it dropped the bomb on Hiroshima. And Jacob Beser

W3NOD, who was the electronics specialist on that trip. Then there's Emory Gordy Jr., the OM of Patti Loveless, the singer.

*I didn't see how Griffith could possibly have had time for hamming, so that makes sense... Wayne.*

**George Platt N1UUN.** I would like to take a moment to comment on the code requirement for General, Advanced, and Extra Class licenses. In view of the recent actions by the FCC to rescind the requirement for Morse code equipment on oceangoing commercial vessels and of the fact that the Coast Guard is no longer standing radio watch for CW communications, I think it is time for the ARRL to recognize that CW has passed its time as an essential method of communication. I will agree that CW on the HF bands will get through when QRM and QRN make other forms of communication unreadable. I will also agree that CW is an art form and a tradition of our hobby. But to set the code requirement up as a road block to the high frequency band is no longer acceptable. Fundamentally, it just amounts to "hazing."

I have no problem with making the tests more technically demanding, nor do I have any quarrel with reserving certain portions of the HF bands for CW communications, as we do now for packet and repeater modes in the VHF and UHF portions of the spectrum. My dissatisfaction derives from the exclusion of qualified technicians from the HF bands simply because they refuse to learn a language that is slow and becoming increasingly obsolete.

It must be recognized at some point that the code requirement is preventing otherwise qualified and interested amateurs from advancing in our hobby. Indeed, as time for recreation becomes more difficult to find, can we afford to demand that it be spent learning a language few people are listening to?

*Troublemaker... Wayne*

**Jim Carson WK2K.** I am writing about an article on page 90 of the June issue of *QST*, which has

me deeply concerned regarding the survival of the hobby into the 21st century, as well as a secondary issue about a long-standing problem of 40m band allocations.

First, let me introduce myself briefly. I was first licensed as WV2OYY in 1960. I upgraded to General, and through the activities of an Elmer, WA2KQG, became very active in CW and phone traffic nets. It was a wonderful experience as a high school student to deliver messages from such places as the Great Lakes Naval Training Center in Michigan. After a brief lapse, I resumed the hobby in 1970 as an Extra with a home-brew SSB HF station. I am an active VE and have taught several licensing classes. One of the classes was a Tech-to-General upgrade done on 2m. My son is N2PNA. While I don't have the time or resources to pursue the hobby as much as I would like to now, I occasionally use my vintage HQ170 and Viking II. (Yes, I can still do 20 wpm.) The future of the hobby is very important to me.

I think the ARRL has done some fine work; for example, the new bands at 10, 18, and 24 MHz. I am concerned that as a group we as hams may miss an important paradigm shift and go the way of the dinosaurs, if we miss our last chance to adapt.

It is my observation that the Morse code is decreasing in relevance to the future of the hobby. It further seems unbalanced because so much emphasis in license testing is placed on this one operating mode. If this much weight was placed on another less-used mode, say, satellite communications, video, or packet, I can imagine the protest that would result. Voice transmission is the mode of choice of the majority of hams, especially if you include the bands above 30 MHz. This could change if voice evolves as a spread-spectrum or a digital mode. It is important that we adapt to the rapid changes in technology; this is not to deny the right of other hams to enjoy the "antique" modes of AM or CW if they are interested in building simple equipment. Further, considering "rights," I do not think

*Continued on page 83*



# 5 BOOKS FOR ONLY \$4.95

WHEN YOU JOIN THE **Electronics Book Club**<sup>®</sup>

VALUES TO \$130.75

The leading source of information for electronics hobbyists for over 30 years!

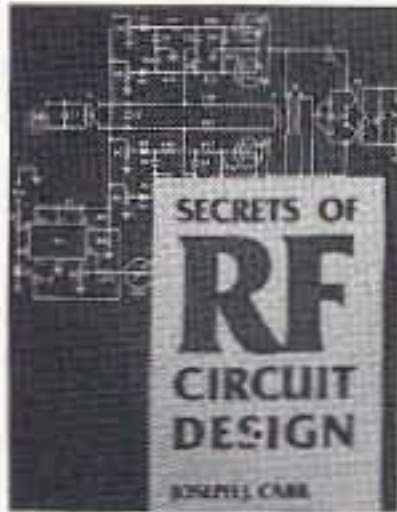

0100926-XX \$24.95  
Counts as 2

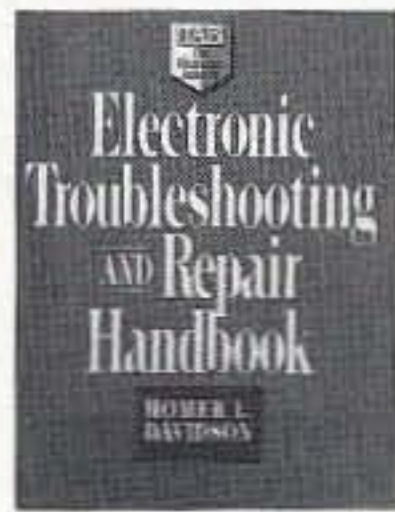

015676X-XX \$69.00  
Counts as 2/Hardcover



0304068 \$15.95

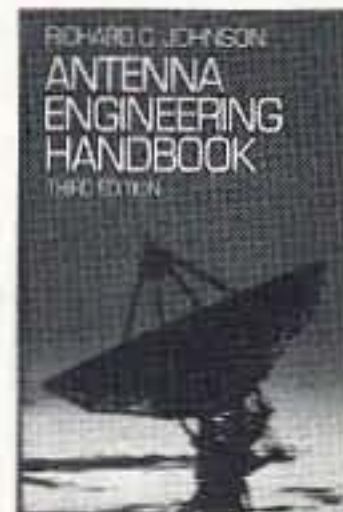

032381X-XXX \$119.50  
Counts as 3



0052387 \$28.95  
Hardcover



5869500 \$19.95



5870789 \$11.95



0365946-XX \$21.95  
Counts as 2

0111049-XX \$49.95  
Counts as 2/Hardcover

0047014 \$19.95



0156417 \$19.95

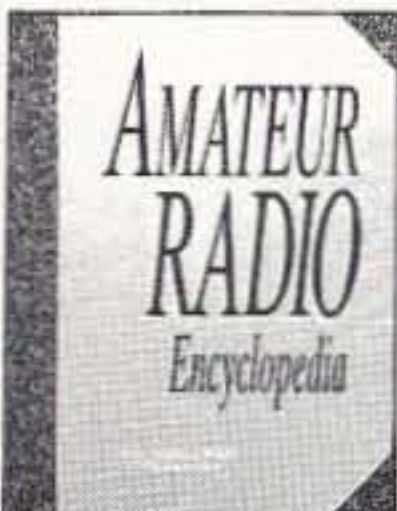

0235619-XXX \$50.00  
Counts as 3/Hardcover

0765340 \$16.95

5870770 \$11.95

0339635 \$24.95  
Hardcover



0350787-XX \$44.95  
Count as 2/Hardcover

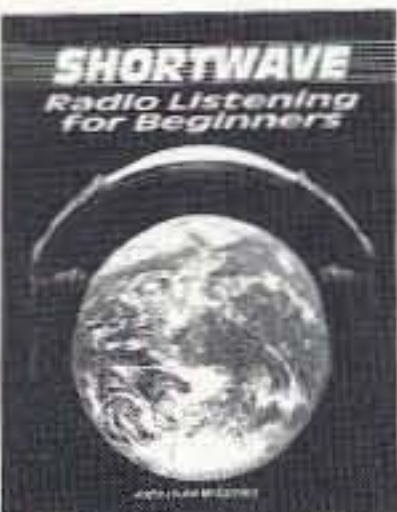

0449902 \$19.95  
Hardcover



0707618 \$19.95



076509X \$17.95

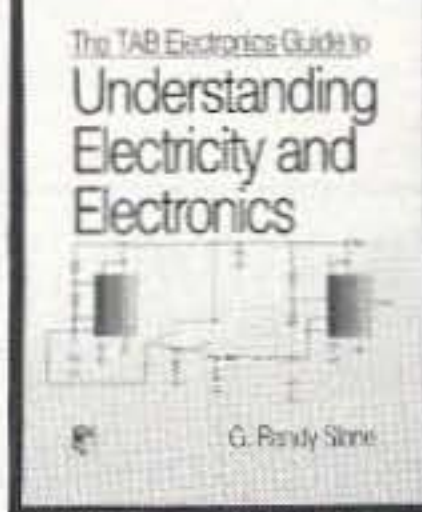

0582157 \$26.95  
Hardcover

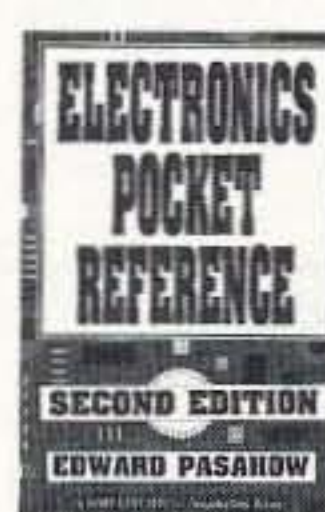

0487375 \$24.95

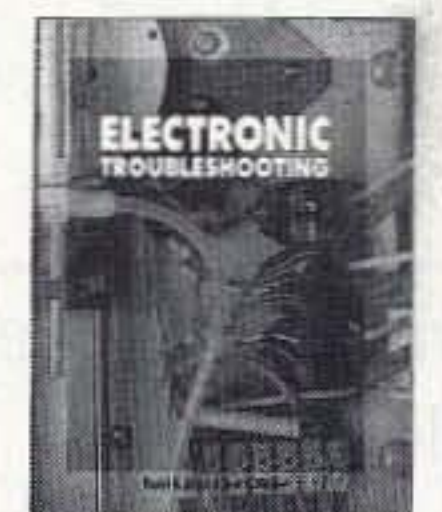

0650780 \$24.95

If coupon is missing, write to: Electronics Book Club, A Division of The McGraw-Hill Companies, P.O. Box 549, Blacklick, OH 43004-9918

## As a member of the ELECTRONICS BOOK CLUB...

you'll enjoy receiving Club bulletins every 3-4 weeks containing exciting offers on the latest books in the field at savings of up to 50% off the regular publishers' prices. If you want the Main selection, do nothing and it will be shipped automatically. If you want another book, or no book at all, simply return the reply form to us by the date specified. You'll have at least 10 days to decide. If you ever receive a book you don't want due to late delivery of the bulletin, you can return it at our expense. Your only obligation is to purchase 3 more books during the next 12 months, after which you may cancel your membership at any time. And you'll be eligible for FREE BOOKS through our Bonus Book Program.

PHONE: 1-614-759-3666  
(8:30 a.m. to 5:00 p.m. EST Monday-Friday)

FAX: 1-614-759-3749  
(24 hours a day, 7 days a week)

## Electronics Book Club

A Division of The McGraw-Hill Companies, P.O. Box 549, Blacklick, OH 43004-9918

YES! Please send me the books listed below, billing me just \$4.95 plus shipping/handling & tax. Enroll me as a member of the **Electronics Book Club** according to the terms outlined in this ad. If not satisfied, I may return the books within 10 days without obligation and have my membership cancelled.

--	--	--	--	--

If you select a book that counts as 2 choices, write the book number in one box and XX in the next.  
If you select a book that counts as 3 choices, write the book number in one box and XXX in the next two boxes.

Name \_\_\_\_\_

Address / Apt. # \_\_\_\_\_

City/State \_\_\_\_\_

Zip \_\_\_\_\_ Phone \_\_\_\_\_

Valid for new members only, subject to acceptance by EBC. Canada must remit in U.S. funds drawn on U.S. banks. Applicants outside the U.S. and Canada will receive special ordering instructions. A shipping/handling charge & sales tax will be added to all orders. STAR996

# QRX . . .

## Pitcairn Island Honors Hams

The Pitcairn Island Postal Administration has announced the issuance of amateur radio stamps in honor of the role played by amateur radio operators toward the betterment of the island. Pitcairn Island, with a total of 55 people—12 of whom are licensed hams—has its own post office and postal stamp issues. The British government designs and prints the stamps, and a substantial part of the tiny (1 mile by 2 miles) island's income is derived from the sale of these stamp issues to collectors worldwide.

Pitcairn's first licensed radio amateur was Andrew Young VR6AY. Andrew's first exposure to amateur radio began back in 1922 with a Marconi crystal receiver and a simple spark transmitter that was often used to communicate with passing ships. Over the years, Pitcairn's only communications station grew as technology improved and as ham radio friends from the outside world contributed the much-needed equipment. The operators on Pitcairn have utilized amateur radio for emergency medical advice, as well as for memorable QSOs with friends around the globe, over those intervening years.

A release date of September 4, 1996, has been set for the amateur radio series, with 20 cent and \$2.50 stamps, and a two-part \$1.50 stamp with a price of \$3.00. First Day Covers with all four stamps and the Adamstown, Pitcairn, day-of-issue cancellation are \$6.20. For further information or to order the special amateur radio stamp issue, contact:

The Office of the Government of Pitcairn  
(Postal Administration)  
British Consulate-General  
Private Bag 92014  
Auckland, New Zealand

TNX Dave Miller NZ9E.

## Milton Chaffee W1EFW Silent Key

Milton Chaffee W1EFW, who has been a valued member of the amateur radio community throughout most of his 83 years, became a Silent Key this past March. He dedicated his life not only to the betterment of amateur radio, but also to the prosperity of his country and community. He started his service in the Civil Air Patrol in 1942 raising to the rank of Tech Sergeant in four years. He later lent his administrative talents to councils such as his local housing authority, Chamber of Commerce, the ARRL (where he was director for seven years and Section Traffic Manager for Connecticut), and the QCWA. In addition, he held the position of ARNS treasurer for some time.

Mr. Chaffee was a man whose involvement in the world of amateur radio will serve as an example and an inspiration to hams everywhere. He will be missed by all those who knew him.

Thanks to ARNS Bulletin June 1996 for this information.

8 73 Amateur Radio Today • September 1996

## No "Hams with Class" in September 73

This month "Hams With Class" will not appear in 73 *Amateur Radio Today*. Carole Perry WB2MGP, the column's author, was not available due to a death in her family. All of us here at 73 send our warmest regards and deepest sympathy to Carole and her loved ones.

## Was It Something We SETI?

Did you catch the blockbuster movie "Independence Day" yet? When the evil aliens are poised to annihilate the planet, who mobilizes for worldwide defense? Hams, of course, and with Morse code, yet. And, for those 18 people out there who still haven't seen the movie, yes, we won!

## Ham Radio: Not Yet an Olympic Event

The chairman of the Olympic Broadcast Frequency Coordination Committee has announced that hand-held ham radios and scanners will be prohibited at Olympic events because of the possibility of their interfering with wireless microphones and/or live news broadcasts.

Cellular phones, though, will be allowed (as requested by the FCC) and exceptions to the ham rig ban could be made if "appropriate officials request them."

From *Newsline*; Newsline #977.

## What Some Guys Will Do for a Free Beer—or K2UDP Likes His Toast Plain ... No Jam, Please

The place: Tampa.

The time: sometime between 12:00 a.m. and 11:55 p.m., May 8, 1996.

The crime: foul-mouthery over the airways and interference with emergency communications.

The motive for risking apprehension: a bottle of beer.

Two jammers for the Tampa area were taken into custody this May (one for drunk driving and one for questioning regarding interference with emergency transmissions) after operator Jim K2UDP, with the help of fellow club members, talked to them on his repeater and invited them to meet him in a bar for a beer.

After tempting the jammers by offering to sell them a stolen rig, Jim "went out to his car" and called the police, who were already looking for the jammers.

During conversations that Jim had with the jammer called Kevin, Kevin confided to Jim that he thought that amateur radio was dangerous and that "My mother didn't raise stupid kids."

At this time, the radio confiscated from the jammers is being handed over to the FCC for RF comparison with the transmissions recorded by bay area repeaters.

TNX *Newsline*; Newsline #978.

## FCC License Figures

According to FCC figures, the numbers of new hams and of hams who have changed their class of licenses is up compared to the last half of 1995.

New hams for the months of January, March, and April have each totaled more than 3,000, and upgrades have topped 1,200. In February, new hams numbered 2,109, and there were 980 upgrades. During the last half of 1995, which included the Federal government furlough through the last half of December, the number of new hams averaged 2,137 per month, while upgrades averaged 811 per month. ©1996 *Amateur Radio Newsline*, from *PARKing Ticket*, newsletter of Plano Amateur Radio Klub.

## Locust Grove

In 1847, Samuel F. B. Morse wrote to his brother, describing the property he'd just purchased in Poughkeepsie, New York, as unequalled in beauty and constantly changing charm. Locust Grove, Morse's estate, was to be his country home until his death in 1872. In 1901 the property was bought by the Young family, and in 1975 Annette Inglis Young endowed a trust in perpetuity to maintain Locust Grove as an historic site and wildlife sanctuary.

Today, Locust Grove is a designated National Historic Landmark, and is open to the public May 1 to November 1, Wednesday through Monday, 10 am to 4 pm. The 150-acre estate lies along a bluff above the Hudson river, with view of the Fishkill Mountains to the south and the Catskills to the north, and includes historic gardens and buildings, acres of woods and scenic walking trails to the river.

The house contains a collection of 18th and 19th century furnishings belonging to the Young family, but the main point of interest for Morse enthusiasts is the Morse collection, comprising Morse memorabilia, a model of Morse's first telegraph, and a collection of early telegraph equipment.

Morse had a telegraph line wired into his office from the main route close by, and the sound of code can still be heard at his country home. Each year, Locust Grove holds a Telegraph Weekend, during which members of the Morse Telegraph Club use authentic equipment and American Morse for a transcontinental celebration of Morse's invention; while the Poughkeepsie Amateur Radio Club operates a Special Event radio station to demonstrate International code. For more information about the Samuel F. B. Morse Historic House and Grounds, and the many events scheduled there, radio-related or not, contact Locust Grove, 370 South Road, P.O. Box 1649, Poughkeepsie NY 12601-5234; telephone (914) 454-4500.

From *Morsum Magnificat*, June 1996.

## See why the RLC-CLUB knocks the competition's socks off!

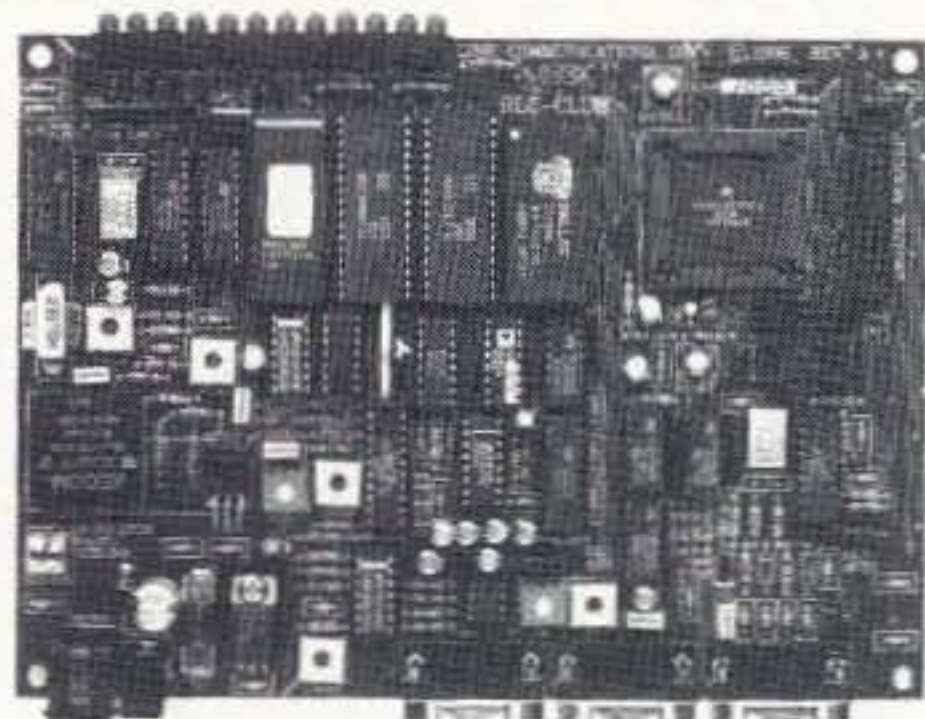

**\$500.00** RLC-CLUB

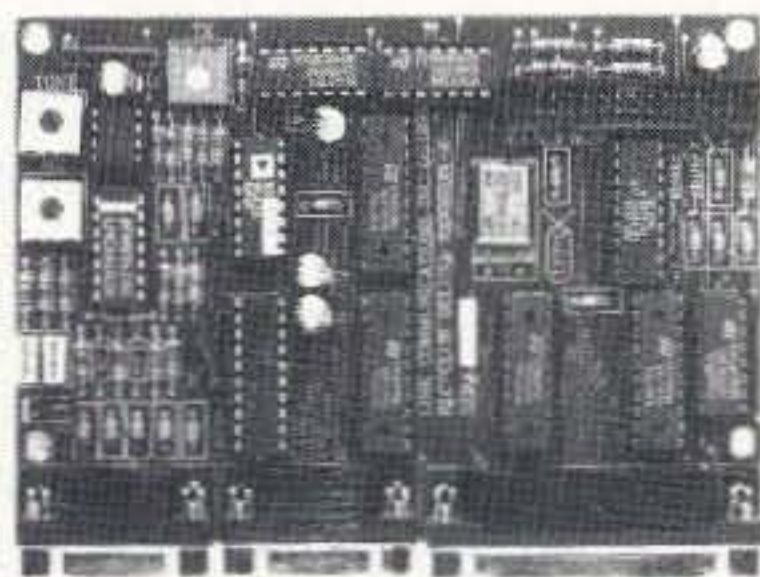

**\$175.00** DELUXE MODULE

Remote base support for Icom CI-V, Kenwood serial and Yaesu CAT HF/VHF radios. Other remote bases supported include the RLC-ICM IC-900 band module controller and the Doug Hall RBI-1 interface.

Only the RLC-CLUB controller system gives you Windows™ programming software that allows timers, messages, users and most functions to be set-up with the ease of a computer; very powerful autopatch features, and multiple repeater control at such a low price! And with the addition of the RLC-Deluxe module an additional radio port, increased output controls and support for our large voice mail based Digital Voice Recorder is provided.

### RLC-CLUB Controller

#### Dual Port Repeater and Remote Base Controller

- Individual full duplex repeater, link or remote base port with second additional radio port expansion using the Deluxe option module.
- Built in Autopatch with 500 number autodialer, 500 call sign slots, 500 user autopatch code and 500 number long distance dialing table.
- 100 time-of-day scheduler slots with grandfather clock function.
- TI voice synthesizer with 685 word male, female and special effects library
- Internal 16 second Digital Voice Recorder allows custom voice message.
- 2 analog temperature inputs, signal strength input and door alarm input standard.
- 8 output function control lines using the Deluxe option module.
- Built-in front panel 12-LED display. Shows COR, PL, PTT and DTMF valid.
- 19" Rack Mount Enclosure available for \$50.00.
- FCC part 68 patch with fuse and surge protection, FCC part 15 class A typed.
- Free Windows™ programming software included with easy on-line help menus.



**Link Communications, Inc.**

115 2nd Ave. NE • P.O. Box 1071 • Sidney, MT 59270-1071

World Wide Web Access: <http://www.link-comm.com/linkcomm> • Voice: (406) 482-7515 • Fax: (406) 482-7547 • Sales: 1-800-610-4085

## NEVER SAY DIE

Continued from page 4

Or maybe you're interested in what's going on with cold fusion and how this amazing phenomenon has forced physicists to rethink the structure of the atom. Or maybe not. Okay then, how about a recipe for some fabulous-tasting, healthy veggie dip? You'll love my "hurry-curry"—a delicious curried chicken dinner in 15 minutes.

When you write, please put "Tampa" on the left side of the envelope so I won't get it mixed with the stack of orders for my booklets which have resulted from my radio interviews. We've had to get an industrial-strength copier just to keep up with the booklet demand. It's a combination mimeograph machine and photo copier.

I'm really looking forward to the ARRL Convention at Tampa in November (23rd-24th). I particularly want to thank ARRL Director Frank Butler for his enthusiastic support, despite word from HQ that my speaking at the convention would "be inappropriate."

### Dayton Bombed?

Like most (all?) other hamfests, the HamVention attendance dropped this year. And this despite the increasing emphasis on computers, which seem like they are edging out the ham exhibitors. Well, that's where the money is these days. Maybe you've noticed that some of our major ham manufacturers have cut way down on their advertising. I've noticed. But then, I'm oddly sensitive to that sort of stuff.

Can Dayton be revived? Or is it likely to go the way of NCC, CES, and other formerly mammoth shows? No, I doubt it's the new date, or any of the other excuses the HamVention Committee is using to avoid serious introspection. Our hobby has changed. It's changed a lot! With over half our hams these days essentially confined to 2m and now justifiably fearful of losing their band, the interest in special aspects of the hobby which brought many to Dayton in the past has dropped. We're seeing a

drop in interest in SSTV, RTTY, moonbounce, ham satellites, and so on. It was the yearly gathering of such special interest groups which helped keep the HamVention growing for so many years.

Now, with our ranks aging, withering, and shrinking, the youthful enthusiasm which was behind the Dayton trek has dimmed. I saw few youngsters there last year. When I first started going to Dayton in 1955 the hotel was overrun with young hams. These days I have to dodge electric wheelchairs and not trip over walkers.

A side note: I've been surprised when I've talked to many of these doddering wrecks to find that they are years younger than I. Heck, I haven't done nearly as much as I could to take care of my body, but obviously I've done a lot better than most. But, you know, when I bring this up in my editorial, I get hostile letters from the crotchety old men who most need to start rebuilding their almost-destroyed bodies. Figures.

Anyway, back to Dayton. Maybe it's time to start trying some creative ideas to help bring the HamVention out of the 1930s, where it's frozen, and into the '90s. I've proposed several ideas in the past, but they've all fallen on blind eyes.

One problem for many hamfests is that they are almost all organized by hams with little experience in show business. Or even business, for that matter. They don't know how to deal with the marketing challenge. They don't know how or where to advertise, get PR (despite the availability of my admittedly superb video on the subject), attract exhibitors, and so on. None of these skills are intuitive, but it's a pity that our hobby has to bear the brunt of hamfest officials learning what they should already have known at the hobby's expense. Hamfests could be used to help recruit young newcomers. They aren't.

Hamfests are show business. They need stars. They need controversy. They need hoopla.

Continued on page 39

# The Amateur's Guide to "Free Energy" Devices

*A history, and hints for further experimentation.*

Thomas M. Miller WA8YKN  
314 South 9th Street  
Richmond IN 47374

Any scientist will tell you that "free energy" is impossible. The law of conservation of energy forbids any device that produces more energy than it consumes. To make matters worse, the laws of thermodynamics insist that every device has loss, so no machine can produce *as much* energy as it consumes. Some is always radiated away as heat. It's impossible to break even!

*"When an elderly and respected scientist says that something is possible, he is almost certainly right. When he says*

*that something is impossible, he is very probably wrong."*

*Arthur C. Clarke's First Law*

look, however, they might be surprised to find that we are not dealing with pro-peller-heads and con men. In fact, some

---

*"Imagine that we live in a world where it rains soup, and we all have forks."*

---

Over the years, a number of inventors have come forward with devices which seem to produce more energy than is required to drive them. Most scientists refuse to even examine these devices, and are quick to label the inventors as either lunatics or frauds. Were they to

of the inventors are physicists, professors, and experienced engineers, well respected (or at least *formerly* respected) in their field. But how can we believe even professionals of this caliber when their inventions violate the most sacred laws of physics?

The truth is that these "sacred laws" only apply to a closed system. There is nothing to prevent a device from extracting energy from another source, even an *unknown* source. None of the inventors claim that their devices create energy. They just tap some energy potential in the environment.

If we can believe some disturbing rumors, some free energy researchers have experienced more than criticism and ridicule. Engineer Robert Adams claims that his patent application was denied and his invention classified under a "Military Use" clause. Not only was his device suppressed for over 20 years, but he was harassed and his life threatened! While this may be hard to believe, there are *trillions* of dollars at stake, and all the political and social power that such incredible wealth represents—certainly a motive for those interested in maintaining the status quo.

Even though many experimenters are understandably secretive about their inventions, a number of so-called free

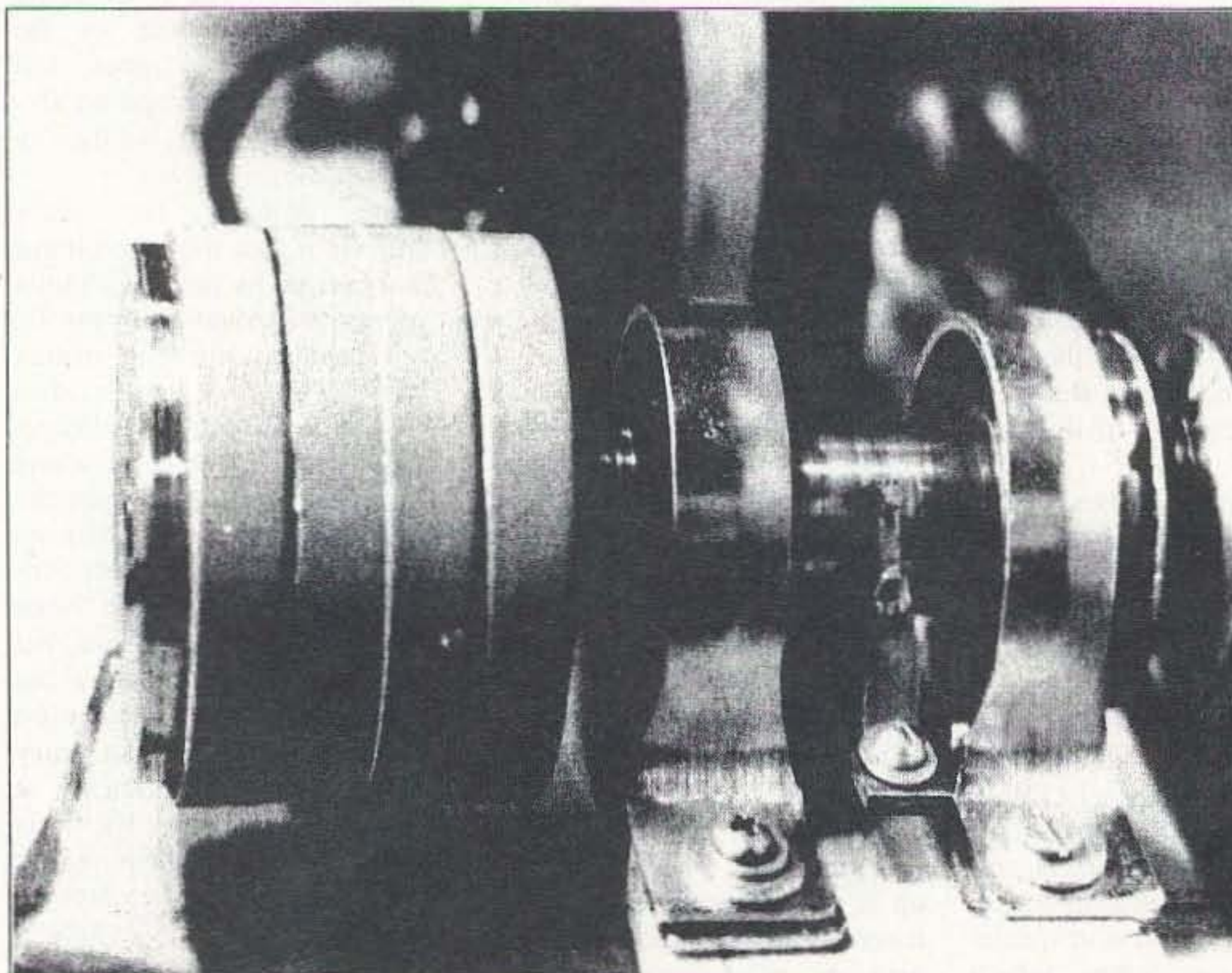

*Fig. 1. Extracting free energy from ocean waves. Nature is in constant motion, providing many sources of energy free for the taking.*

# MFJ Keyers

More hams use MFJ keyers than all others in the world! Choose the one that's right for you. Write or call toll-free 800-647-1800 for more info.

MFJ-422C  
\$134<sup>95</sup>

**MFJ Keyer/Bencher Paddle Combo** is the world's most popular keyer because it's the best of all CW worlds -- a compact MFJ Keyer that fits right on the Bencher iambic paddle! Iambic keying, speed, weight, tone, volume controls. Automatic or semi-automatic bug modes. RF proof. MFJ-422CX, \$79.95, keyer only.



**Deluxe Keyer, MFJ-407C, \$69.95**, gives you easy access front panel speed, weight, volume, tone controls, all keyer modes, dot-dash memories, jam-proof spacing, sidetone, speaker.

**Econo Keyer, MFJ-401C, \$49.95**, for dual iambic or single lever paddles. Sidetone, speaker, volume, speed, internal weight and tone controls.

## Memory Keyers

**Menu Driven -- so easy-to-use you don't need an instruction manual!**

MFJ-490  
\$164<sup>95</sup>

**MenuDriven Memory Keyer™** in a compact package mounted on a Bencher iambic paddle. Store 192 characters in 4 message memories. Morse trainer, sidetone, automatic serial numbering plus all the features of MFJ-492 except remote control jack and extra memory. MFJ-490X, \$109.95, keyer only, no paddle.



MFJ-492  
\$99<sup>95</sup>

**MenuDriven Memory Keyer™** stores 192 characters in 4 battery backed-up message memories. Expands to 8000 characters, 8 memories with MFJ-80, \$14.95. Automatic, semi-automatic bug or handkey modes, reverse dot/dash paddles, select iambic A or B or non-iambic modes. Morse trainer, automatic serial numbering, sidetone, volume and speed panel controls, remote control jack, plus more. MFJ-492 Remote Control, MFJ-78, \$19.95.



**Super MenuDriven Memory Keyer™ MFJ-493, \$139.95**, is the world's most sophisticated memory keyer. Stores 32,000 characters! Plug in AT keyboard and it turns into full featured CW keyboard. Serial port lets your computer control your keyer, compose, edit, display, save messages and record your transmissions. FCC Exam Simulator, QSO Simulator, Word Recognition Trainer, remote control jack, plus all the features of MFJ-492. MFJ-493 Remote Control, MFJ-79, \$19.95.

## CW Keyboard

MFJ-451  
\$99<sup>95</sup>

Stand alone CW Keyboard includes AT type keyboard, 200 character type-ahead buffer, two 100 character nonvolatile message memories, more. MFJ-451X, \$79.95, keyboard interface only.



## MFJ Iambic Paddles

MFJ-564  
\$49<sup>95</sup>

**MFJ Deluxe Iambic Paddle** features full range of adjustments in tension and contact spacing, self-adjusting nylon and steel needle bearings, contact points that almost never need cleaning, precision machined frame and non-skid feet on heavy chrome base. For all keyers.



# MFJ SSB Transceiver

MFJ-9420  
\$229<sup>95</sup>



Take this tiny MFJ 20 Meter SSB Travel Radio™ with you and enjoy DXing and ragchewing wherever you go.

It's the smallest rig of its kind! A complete station -- MFJ-9420, microphone, power supply and antenna -- fits easily in your brief-case!

12 powerful watts give you enough power to work the world -- even with a makeshift antenna -- but needs only a lightweight power supply.

Potent RF speech processing focus all your power into a clear highly-intelligible signal that even DX will notice.

You get high performance superhet receiver, razor sharp crystal filter, sensitivity down to noise, smooth vernier drive VFO, one watt of audio, speaker, real S-Meter, rugged transmitter, 14.150-14.350 MHz coverage and low current drain. Tiny 2 1/2 x 6 1/2 x 6 inches.

Plug-in this MFJ-415 module, \$39.95, and operate CW. 14.000-14.100 MHz. Has semi break-in, sidetone, key jack, CW/SSB switch.

**Special offer:** matching microphone and MFJ-9420 SSB Travel Radio™, MFJ-9420X, \$239.95. Microphone only: MFJ-290, \$29.95.

## MFJ CW Transceivers

MFJ-9020  
(20 Meters)  
\$189<sup>95</sup>



Put some fun back into ham radio and work QRP-DXCC with 5 watts!

You'll be amazed at how easy it is to work the world. Countries you've worked in the past become fair game once again.

These MFJ CW rigs are real radios with all the high-performance features you expect from expensive multi-band transceivers. You get a hot superhet receiver, sharp CW crystal filter, smooth VFO, RIT, AGC, built-in speaker, sidetone, adjustable full/semi QSK.

Models for 40, 30, 20, 17 and 15 Meters CW band, \$189.95 each. Please specify band.

Plug-in options: MFJ-412, \$39.95, Curtis keyer; MFJ-726, \$29.95, narrow audio filter.

## Portable Accessories

MFJ-971  
\$89<sup>95</sup>



**Antenna Tuner, MFJ-971, \$89.95.** Tunes coax, balanced lines, random wire, 1.8-30 MHz, Cross-Needle SWR/Wattmeter with two ranges.

**Battery/AC Power Pack, MFJ-4114, \$69.95.** Uses Ni-cad, regular or alkaline D cells or 110 VAC. Charges Ni-cads. No batteries.

**AC Power Supply, MFJ-4110, \$39.95.** Travel light and leave the heavy hardware at home. 110 VAC power supply delivers 13.8 VDC, 2 amps from rugged wall adapter and regulator module.

**Antenna, \$34.95.** Lightweight easy-to-carry single band folded dipoles for MFJ rigs and others. Specify 40, 30, 20, 17, 15 Meters.

## Free MFJ Catalog

Write or call toll-free . . . 800-647-1800

## Code Practice Oscillator

Deluxe MFJ Code Practice Oscillator has adjustable Morse key and oscillator-speaker unit mounted on a heavy steel base so it stays put. Tone, volume controls. Earphone jack. MFJ-557  
\$24<sup>95</sup>



For 110 VAC Keyer operation use MFJ-1312B, \$12.95, for MFJ-422C/401C/407C/490/492; MFJ-1315, \$14.95, for MFJ-493; MFJ-1305, \$12.95, for MFJ-557.

# Mobile Handbook

A super hands-on book with hundreds of useful ideas to make mobiling great!



MFJ-33 See how easy it is to have a ham shack in your car with this idea filled Mobile Handbook! For the beginning mobiler, Dave Ingram K4TWJ shows you how to set up a super mobile

installation! For the experienced, K4TWJ includes hundreds of useful ideas for mobiling on HF, VHF, 10 meters and FM, QRP and legal limit mobiling, mobile antennas and mobile CW.

K4TWJ shows you how to DX on the road, make antennas, reduce ignition noise and RFI.

## More ham radio books

**The Packet Radio Operators Handbook** by Buck Rogers K4ABT. How to build and use packet stations, Nodes, Rose switches, 9600 baud stations, trunks, backbones, networks, BBSs, interfaces. MFJ-3036, \$12.95.

**Packet Radio is Made Easy** by Buck Rogers K4ABT. Makes packet easy! How to set up, digipeating, mailbox, more. MFJ-32, \$9.95.

**Easy-Up Antennas** by W3FQJ. Gives you inexpensive, easy to build antennas for virtually every SWL or ham need. MFJ-38, \$16.95.

**Troubleshooting Antennas and Feedlines** by W1TF. How to troubleshoot and get your antenna system performing. MFJ-3301, \$12.95.

**73 Dipole and Long-Wire Antennas\***. 8 chapters, 7 appendices. MFJ-3302, \$12.95.

**73 Vertical, Beams and Triangle Antennas\***. All built and tested by W3FQJ. MFJ-3303, \$12.95.

**Oscar Satellite Revue** by K4TWJ. How to set up a satellite station. Quick Start guide, tracking data and equipment review included. MFJ-31, \$7.95.

**The Shortwave Listener's Guide for Apartment/Condo Dwellers** by W3FQJ. Key to indoor SWLing and DXing. MFJ-36, \$9.95.

**QuickStudy™ License Guides.** When you take written exam, correct answers jump out at you using MFJ's new QuickStudy™ concept. Each license class, \$7.95 each. No Code Tech, \$14.95.

**Golden Classics of Yesteryear** by K4TWJ. Remember your first rig with this fun filled golden age book. MFJ-30, \$9.95.

**The Fox Hunt Adventure** by Dave Casler KE0OG. Enjoy mystery and adventure as you follow a young group using ham radio to crack open a ring of drug dealers. MFJ-3101, \$7.95.

**The Wonderful World of Ham Radio: An Introduction for Young People** by Richard Skolnik KB4LCS. MFJ-35, \$7.95

**Ham Radio Communications Circuit Files** by W3FQJ. 61 bipolar transistor, FET and linear integrated circuits. MFJ-37, \$9.95.

**Solid State QRP Projects\***. 52 QRP projects in 8 chapters. MFJ-3502, \$12.95.

**FET Principles, Experiments and Projects\***. Practical FET circuit design. MFJ-3504, \$16.95.

\* Reprints of older classics by Ed Noll, W3FQJ

**Authors: Let us see your manuscripts**

**Nearest Dealer/Order/Catalog: 800-647-1800**

**Technical Help: 800-647-TECH (8324)**

• 1 year unconditional guarantee • 30 day money back guarantee (less s/h) on orders from MFJ • Free catalog

**MFJ ENTERPRISES, INC.**  
Box 494, Miss. State, MS 39762  
(601) 323-5869; 8-4:30 CST, Mon-Fri  
FAX: (601) 323-6551; add s/h

**MFJ . . . making quality affordable**

Prices and specifications subject to change © 1995 MFJ Enterprises, Inc.

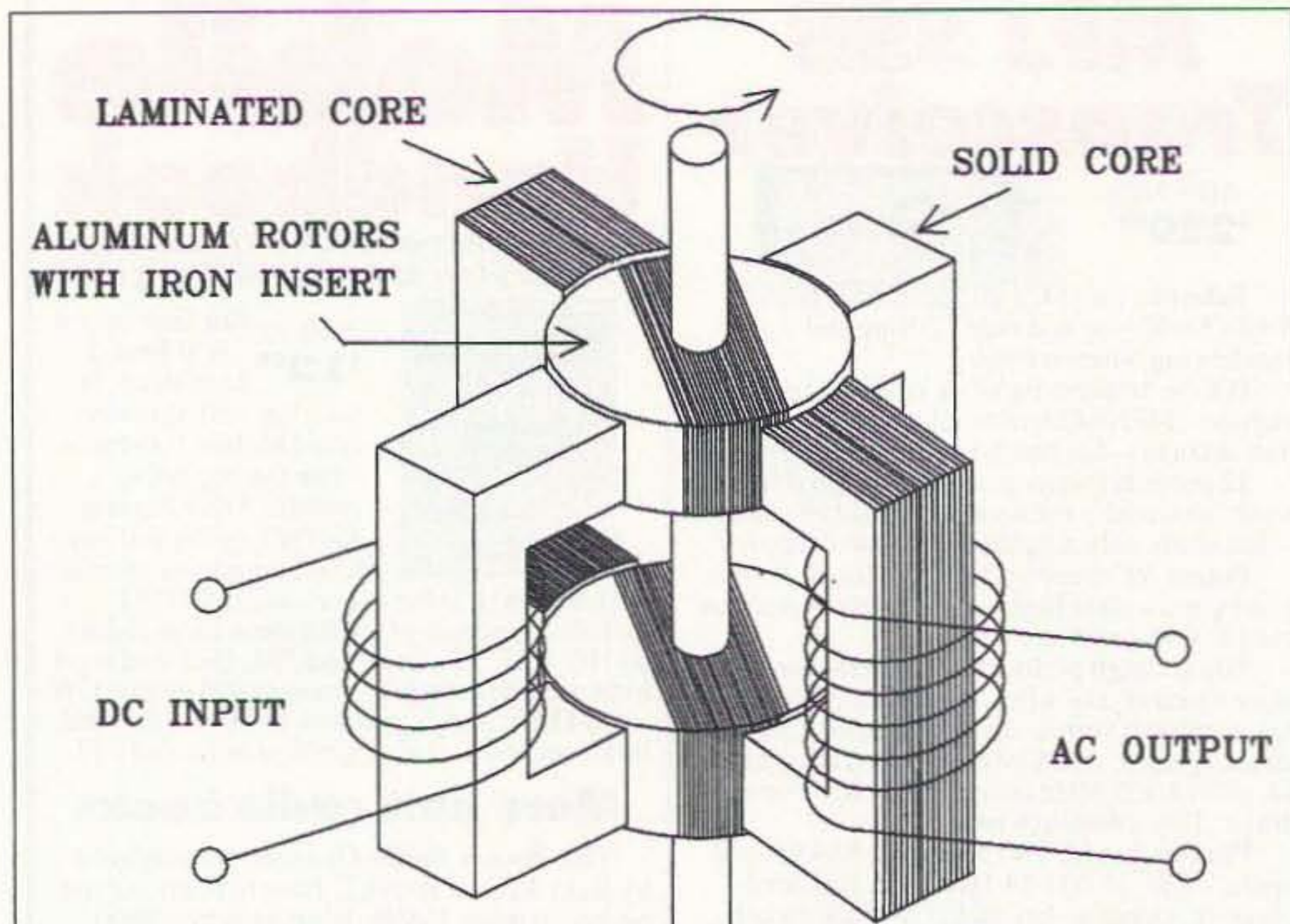

Fig. 2. The variable reluctance alternator, invented by Paul Brown, uses flux switching to convert DC to AC.

energy devices involve well-known, even patented, principles. Many of these are fairly simple, and a talented amateur with some basic electrical and mechanical skills can easily build and experiment with them. Amateur radio operators, being an intelligent and curious bunch, are in a perfect position to study these devices, and to validate or refute the free energy claims.

### The universe ... a free lunch?

We cannot "create" energy. The universe *is* energy. What we perceive as solid matter is nothing more than the interaction of energy fields. Not only can there never be an "energy shortage," but there is *nothing else but energy*. All we have to do is tap it and put it to use. Unfortunately, we don't. We allow others to extract this energy and sell it to us. We meekly accept their contention that energy is very expensive to produce, and we even allow ourselves to become totally dependent upon them for our survival. The government is always planning new ways to tax energy, although when the president says that he'll tax our BTUs, you may have to rearrange the letters to discover his true intent.

Imagine that we live in a world where it rains soup, and we all have forks. A few enterprising people learn to collect this soup, refine it, and process it into bite-sized chunks. They then sell it and become very wealthy and powerful.

There are always rumors of something called a "spoon," but those who know the most about soup (the soup collectors) assure us that no such thing can exist. There is, after all, no free lunch!

The truth is that the universe *is* a free lunch. Nature is in constant motion, conveniently arranged in perpetual cycles. From the twice-daily rise and fall of the tides to the constant motion of every molecule of matter, all can provide energy free for the taking.

---

***"Even Tesla, the man who harnessed Niagara Falls, could not understand the operation of the unipolar generator."***

---

All natural cycles have a "positive" and a "negative" portion, oscillating around a null, or zero point. For example, ocean waves exhibit crests and troughs, each time passing like a sine wave through the null point. Averaging all the waves produces zero—sea level—yet the momentary fluctuations above and below this point represent usable energy.

Fig. 1 shows a method of extracting energy from ocean waves, converting it into electricity. Such a system could just as easily operate a reciprocating pump, or do other useful work. This is a true free energy system which produces far more energy than it consumes ... free energy, not created, but extracted from the environment.

Some inventors of free energy devices claim to be able to tap the zero-point energy fluctuations in a different sort of ocean—the limitless sea of energy that underlies the universe itself.

### "Zero-point" energy and the quantum field

*"The only way of finding the limits of the possible is by going beyond them to the impossible."*

*Clarke's Second Law*

A few hundred years ago, scientists accepted the existence of the "ether," an invisible medium through which waves of electromagnetic and gravitational energy moved. The ether coupled cause and effect across distances and explained wave propagation, as they observed it. Scientists expended a great deal of time and effort trying to prove the existence of ether by attempting to measure the movement of the Earth through it, but none were successful. Eventually, they decided that there was no ether, and that space was just that ... nothing at all. Electromagnetic waves moved through the void because, well ... they just did, that's all!

Today, scientists believe that the void is actually a set of energy fields which interact to form a sea of randomly fluctuating energy. Whenever this energy reaches a certain intensity, a particle of

matter appears. Actually, two particles appear, one of matter and the other antimatter, since the law of conservation of energy requires that the books always balance. Usually, these particles only exist for the briefest moment before combining to release the energy that went into making them, and the cycle continues. It is interesting to note that, however intense the energy field of any single point at any given instant, the *overall energy cancels*. Everything, averaged together, equals nothing. Yet, just as with ocean waves, the local fluctuations of field intensity represent real, usable energy ... enough energy to create a universe.

Is it possible that these free energy devices actually tap into the ultimate source? Perhaps. Apparent violations of

## ASTRON POWER SUPPLIES

• HEAVY DUTY • HIGH QUALITY • RUGGED • RELIABLE •

### SPECIAL FEATURES

- SOLID STATE ELECTRONICALLY REGULATED
- FOLD-BACK CURRENT LIMITING Protects Power Supply from excessive current & continuous shorted output
- CROWBAR OVER VOLTAGE PROTECTION on all Models except RS-3A, RS-4A, RS-5A, RS-4L, RS-5L
- MAINTAIN REGULATION & LOW RIPPLE at low line input Voltage
- HEAVY DUTY HEAT SINK • CHASSIS MOUNT FUSE
- THREE CONDUCTOR POWER CORD except for RS-3A
- ONE YEAR WARRANTY • MADE IN U.S.A.

### PERFORMANCE SPECIFICATIONS

- INPUT VOLTAGE: 105-125 VAC
- OUTPUT VOLTAGE: 13.8 VDC ± 0.05 volts (Internally Adjustable: 11-15 VDC)
- RIPPLE Less than 5mv peak to peak (full load & low line)
- All units available in 220 VAC input voltage (except for SL-11A)

### NEW SWITCHING POWER SUPPLIES

	CONT.	ICS	WT.(LBS)
SS-25	20	25	4.2
SS-30	25	30	5.0

### SL SERIES



### • LOW PROFILE POWER SUPPLY

MODEL	Colors		Continuous Duty (Amps)	ICS* (Amps)	Size (IN) H x W x D	Shipping Wt. (lbs.)
	Gray	Black				
SL-11A	•	•	7	11	2 5/8 x 7 1/2 x 9 3/4	12
SL-11R	•	•	7	11	2 5/8 x 7 x 9 3/4	12
SL-11S	•	•	7	11	2 5/8 x 7 1/2 x 9 3/4	12
SL-11R-RA		•	7	11	4 3/4 x 7 x 9 3/4	13

### RS-L SERIES



### • POWER SUPPLIES WITH BUILT IN CIGARETTE LIGHTER RECEPTACLE

MODEL	Continuous Duty (Amps)	ICS* (Amps)	Size (IN) H x W x D	Shipping Wt. (lbs.)
RS-4L	3	4	3 1/2 x 6 1/2 x 7 1/4	6
RS-5L	4	5	3 1/2 x 6 1/2 x 7 1/4	7

### RM SERIES



MODEL RM-35M

### • 19" RACK MOUNT POWER SUPPLIES

MODEL	Continuous Duty (Amps)	ICS* (Amps)	Size (IN) H x W x D	Shipping Wt. (lbs.)
RM-35A	25	35	5 1/4 x 19 x 12 1/2	38
RM-50A	37	50	5 1/4 x 19 x 12 1/2	50
RM-60A	50	55	7 x 19 x 12 1/2	60
• Separate Volt and Amp Meters				
RM-12M	9	12	5 1/4 x 19 x 8 1/4	16
RM-35M	25	35	5 1/4 x 19 x 12 1/2	38
RM-50M	37	50	5 1/4 x 19 x 12 1/2	50
RM-60M	50	55	7 x 19 x 12 1/2	60

### RS-A SERIES



MODEL RS-7A

MODEL	Colors		Continuous Duty (Amps)	ICS* (Amps)	Size (IN) H x W x D	Shipping Wt. (lbs.)
	Gray	Black				
RS-3A		•	2.5	3	3 x 4 3/4 x 5 3/4	4
RS-4A	•	•	3	4	3 3/4 x 6 1/2 x 9	5
RS-5A		•	4	5	3 1/2 x 6 1/2 x 7 1/4	7
RS-7A	•	•	5	7	3 3/4 x 6 1/2 x 9	9
RS-10A	•	•	7.5	10	4 x 7 1/2 x 10 3/4	11
RS-12A	•	•	9	12	4 1/2 x 8 x 9	13
RS-12B		•	9	12	4 x 7 1/2 x 10 3/4	13
RS-20A	•	•	16	20	5 x 9 x 10 1/2	18
RS-35A	•	•	25	35	5 x 11 x 11	27
RS-50A	•	•	37	50	6 x 13 3/4 x 11	46
RS-70A	•	•	57	70	6 x 13 3/4 x 12 1/2	48

### RS-M SERIES



MODEL RS-35M

MODEL	Continuous Duty (Amps)	ICS* (Amps)	Size (IN) H x W x D	Shipping Wt. (lbs.)
• Switchable volt and Amp meter				
RS-12M	9	12	4 1/2 x 8 x 9	13
• Separate volt and Amp meters				
RS-20M	16	20	5 x 9 x 10 1/2	18
RS-35M	25	35	5 x 11 x 11	27
RS-50M	37	50	6 x 13 3/4 x 11	46
RS-70M	57	70	6 x 13 3/4 x 12 1/2	48

### VS-M AND VRM-M SERIES



MODEL VS-35M

### • Separate Volt and Amp Meters • Output Voltage adjustable from 2-15 volts • Current limit adjustable from 1.5 amps to Full Load

MODEL	Continuous Duty (Amps)			ICS* (Amps)	Size (IN) H x W x D	Shipping Wt. (lbs.)
	@13.8VDC	@10VDC	@5VDC			
VS-12M	9	5	2	12	4 1/2 x 8 x 9	13
VS-20M	16	9	4	20	5 x 9 x 10 1/2	20
VS-35M	25	15	7	35	5 x 11 x 11	29
VS-50M	37	22	10	50	6 x 13 3/4 x 11	46
VS-70M	67	34	16	70	6 x 13 3/4 x 12 1/2	48
• Variable rack mount power supplies						
VRM-35M	25	15	7	35	5 1/4 x 19 x 12 1/2	38
VRM-50M	37	22	10	50	5 1/4 x 19 x 12 1/2	50

### RS-S SERIES



MODEL RS-12S

### • Built in speaker

MODEL	Colors		Continuous Duty (Amps)	ICS* Amps	Size (IN) H x W x D	Shipping Wt. (lbs.)
	Gray	Black				
RS-7S	•	•	5	7	4 x 7 1/2 x 10 3/4	10
RS-10S	•	•	7.5	10	4 x 7 1/2 x 10 3/4	12
RS-12S	•	•	9	12	4 1/2 x 8 x 9	13
RS-20S	•	•	16	20	5 x 9 x 10 1/2	18
SL-11S	•	•	7	11	2 3/4 x 7 1/2 x 9 3/4	12

accepted physical laws often lead to opportunities to expand our knowledge of the universe. Just as "relativity" replaced Newton's laws of motion, Maxwell's theories are slowly being superseded by a new electrodynamics based in quantum mechanics. So, until someone invents the science of "Relativistic Thermoquantum Electromagnetic Dynamics," we will have to do what Faraday and Tesla did—build our own hardware, experiment, observe, and make it up as we go along.

### Lenzian loopholes?

*"Any sufficiently advanced technology is indistinguishable from magic."*

*Clarke's Third Law*

All conventional electric generators require power to drive them, and this driving power is always considerably greater than the total output of the generator. In other words, there is a net loss of energy. Some of this energy is lost through friction in the bearings and drive coupling, and in atmospheric drag against the spinning armature. Some waste heat is produced by current flowing through the windings and brushes, which may have several ohms of resistance. Iron cores also have resistance, and eddy currents will therefore contribute to radiated heat. Even so, the sum of all these losses represents a negligible amount of waste energy compared to the output of a

normal generator. Were these thermodynamic losses all we had to contend with, electrical generation would be essentially free.

Sadly, there is another factor to consider. When we rotate the armature of a generator we cause current to flow in the windings. This current, as it flows, must create a magnetic field. The problem is an electrical principle called "Lenz's law." This law states that the magnetic field created by the flow of current will

---

***"New technology has the disturbing habit of making the impossible suddenly commonplace."***

---

always oppose the field that created the current flow. In other words, if we drive a generator clockwise, the generated current will create a magnetic field which will try to drive the generator counterclockwise. The harder we push, the harder it will resist.

You can feel this effect by spinning the shaft of a large DC motor. Normally, the armature should turn easily, with only the friction of the bearings and the brushes to resist the rotation. However, if you short the motor leads together, the motor shaft will suddenly become very difficult to turn—perhaps even impossible to rotate by hand, if the motor is large. This braking effect is Lenz's law in action. It would also seem to have a braking effect on our search for free energy, for if Lenz's law is always true, then an "over-unity" generator is impossible.

Fortunately, there do seem to be some loopholes in Lenz's law. While it is true that any current must create a magnetic field, and Lenz's law does predict the polarity of that field, there are a few nonconventional types of generators which do not seem to reflect this force back to the driver.

One such device is the Adams Pulsed DC motor, invented by Robert Adams, former chairman of the Institute of

Electrical and Electronics Engineers, Inc. This motor uses a series of short, precisely timed pulses to energize each field magnet in succession. The field pulls a permanently magnetized armature nearly into position, then the field current is switched off. The collapsing field creates an opposite magnetic field which pushes the armature, which is by now past "dead center." As the counter field collapses, it is met by the next armature pole and another DC pulse, which starts the cycle over again. Mr. Adams has not only bypassed Lenz's law, but has in fact harnessed it!

Amateur radio operators should be able to recognize that this motor is operating in a state of resonance, and the same "fly-wheel" effect that we commonly see in a tuned circuit is at work here, increasing the efficiency. In radio terminology, this device is operating in class "C," as opposed to a normal motor which operates in class "A." Mr. Adams claims efficiency of over 300% in some models.

Another interesting device is Paul Brown's variable reluctance alternator, shown in Fig. 2. Resembling two transformer cores crossed at right angles, both magnetic circuits are opened and closed in turn by a rotating iron segment. The magnetic path for the counter field is open a good deal of the time, so efficiency is high. Some models, in fact, have shown efficiencies over 125%. Since it converts DC to AC while also acting as a step-up transformer, it should be ideal for generating 120 volts AC from 12 volts DC.

The Jameson and Kromrey motors seem to utilize a combination of the pulsed DC and flux switching techniques. It is interesting that the Takahashi scooter, which Wayne Green

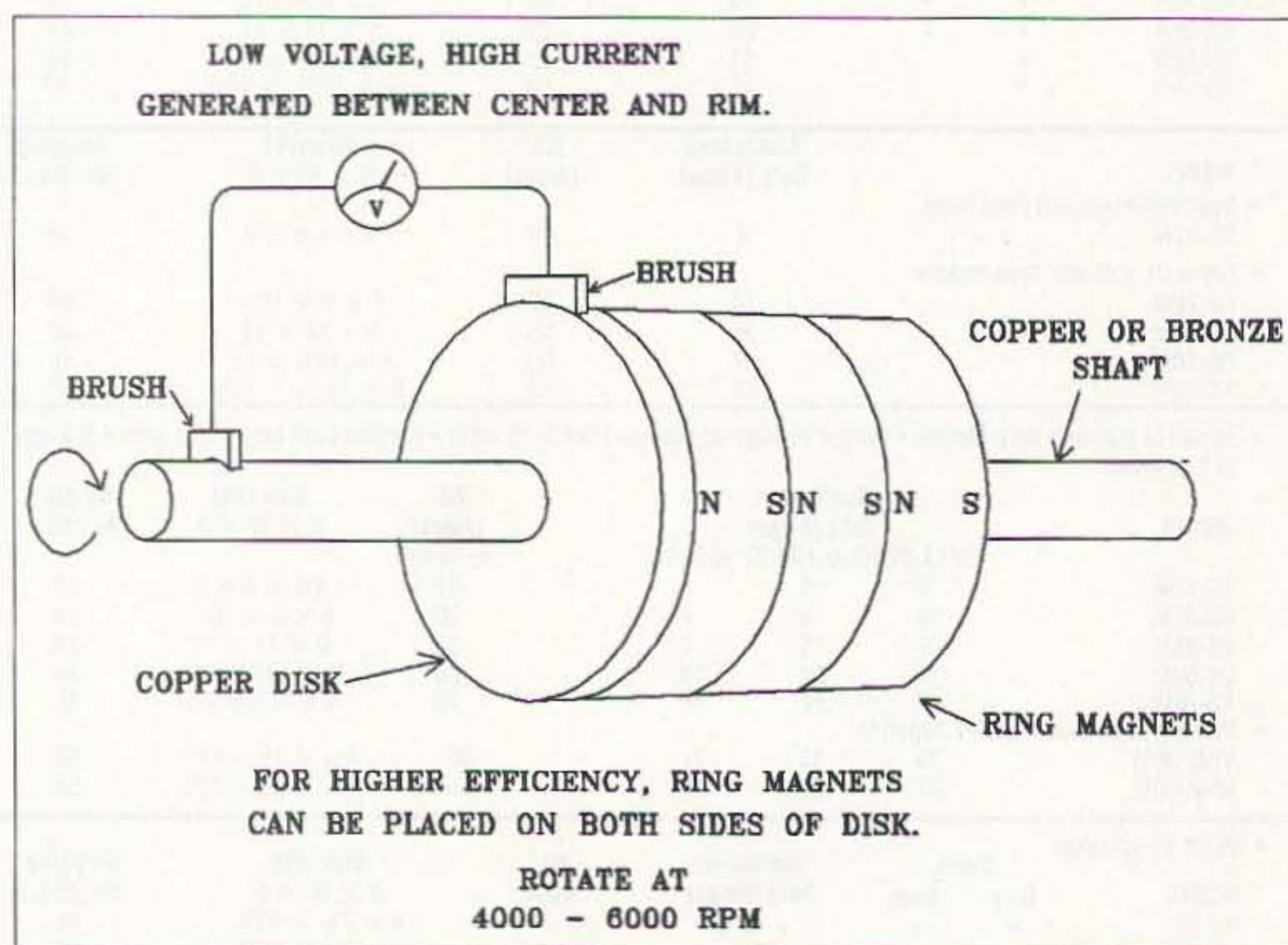

Fig. 3. Michael Faraday's unipolar generator (the "N" machine). Faraday discovered that rotating a disk in an axial magnetic field generates voltage between the center and the rim.



described in his February 1996 "NSD" editorial, is powered by an electric motor very similar to the one invented by Raymond Kromrey in 1968. The Kromrey motor (U.S. Patent #3,374,376) uses electromagnets in the armature, while the new design by Teruo Kawai (U.S. Patent #5,436,518) uses the Takahashi super magnets for greater efficiency. The Kawai patent states that "No force opposing movement of a rotor or movable element is generated." In other words, it bypasses Lenz's law.

Fig. 3 shows another free energy device which, due to the claims made by physicist Bruce DePalma, has become the focus of discussion and controversy: the "N" machine. This generator is nothing new, since it was discovered 165 years ago. It is unique, however, since in all that time no one has yet been able to explain how it works! It is also very simple to construct—the perfect starting point for the free energy experimenter.

#### Faraday's "N" machine

In 1831, Michael Faraday discovered that a conducting disk rotated in an axial magnetic field produces a voltage between the center and the rim. This was surprising, since in every other method

of generating electricity the magnetic field changes across a conductor, but in this case the disk is spinning in a totally homogeneous field. No change of either polarity or intensity occurs anywhere on the disk, and yet the voltage appears.

easily on the slippery surface. Now rotate the bottom magnet. The top one will just sit there. It will not even try to rotate with the bottom magnet. You will feel absolutely no magnetic drag to oppose the rotation of the bottom magnet,

***"Resisting change is like trying to put toothpaste back in the tube."***

Faraday experimented with this phenomenon, and discovered another puzzle: Rotating the disk and magnet together produced the same result as rotating the disk in front of a stationary magnet. Rotating the magnet alone, however, produced no voltage in a stationary disk. From this experiment, Faraday concluded that when a magnet is rotated on its polar axis, the magnetic field does not rotate with it! He ultimately decided that a magnetic field was a property of space, somehow invoked by the magnet.

You can prove this odd fact to yourself with two small disk or ring magnets and the "peel-off" paper backing from a stick-on label. Place a magnet on each side of the paper so that they are stuck together. Now move the bottom magnet around—the top one will follow, sliding

either—that's very important! It means that Faraday's unipolar generator exploits a "Lenzian Loophole." Even though Lenz's law requires that the counter field oppose the magnetic field that we used to generate the current, the fact that these fields are coaxial means that they cannot work against each other.

This phenomenon was observed by physicist Bruce DePalma in his experiments with the unipolar generator he calls the "N" machine. Spinning at 6,000 RPM, this device produced 1.05 volts at an astounding 7,200 amps, yet the power needed to drive the generator increased by only 268 watts.

Unfortunately, the unipolar generator is not yet the answer to our free energy dreams. While it does seem to bypass Lenz's law, in every other respect it is very inefficient. The electromagnet in DePalma's "N" machine consumed over 3 kW, while spinning the armature against the drag of 30 square inches of brushes required another 5 kW. The low voltage and extremely high current output from a disk rotating at high speed makes extracting the power nearly impossible, since normal carbon brushes create far too much friction, and have an internal voltage drop nearly equal to the output of the generator! A few researchers have had success with liquid brushes using mercury or even molten solder, but this is obviously dangerous and impractical.

A much better configuration was patented by Nikola Tesla in 1889 (U.S. Patent No. 406,968). Tesla's unipolar generator, shown in Fig. 4, consists of two disks rotating side by side, each operating in its own magnetic field. The disks are constructed with wide flanges and coupled together with a metallic belt. Reversing the magnetic field of one disk allows the two to operate in series, with the current extracted from the end of each shaft. In his experiments with this generator, Tesla noticed that when generating current, the counter

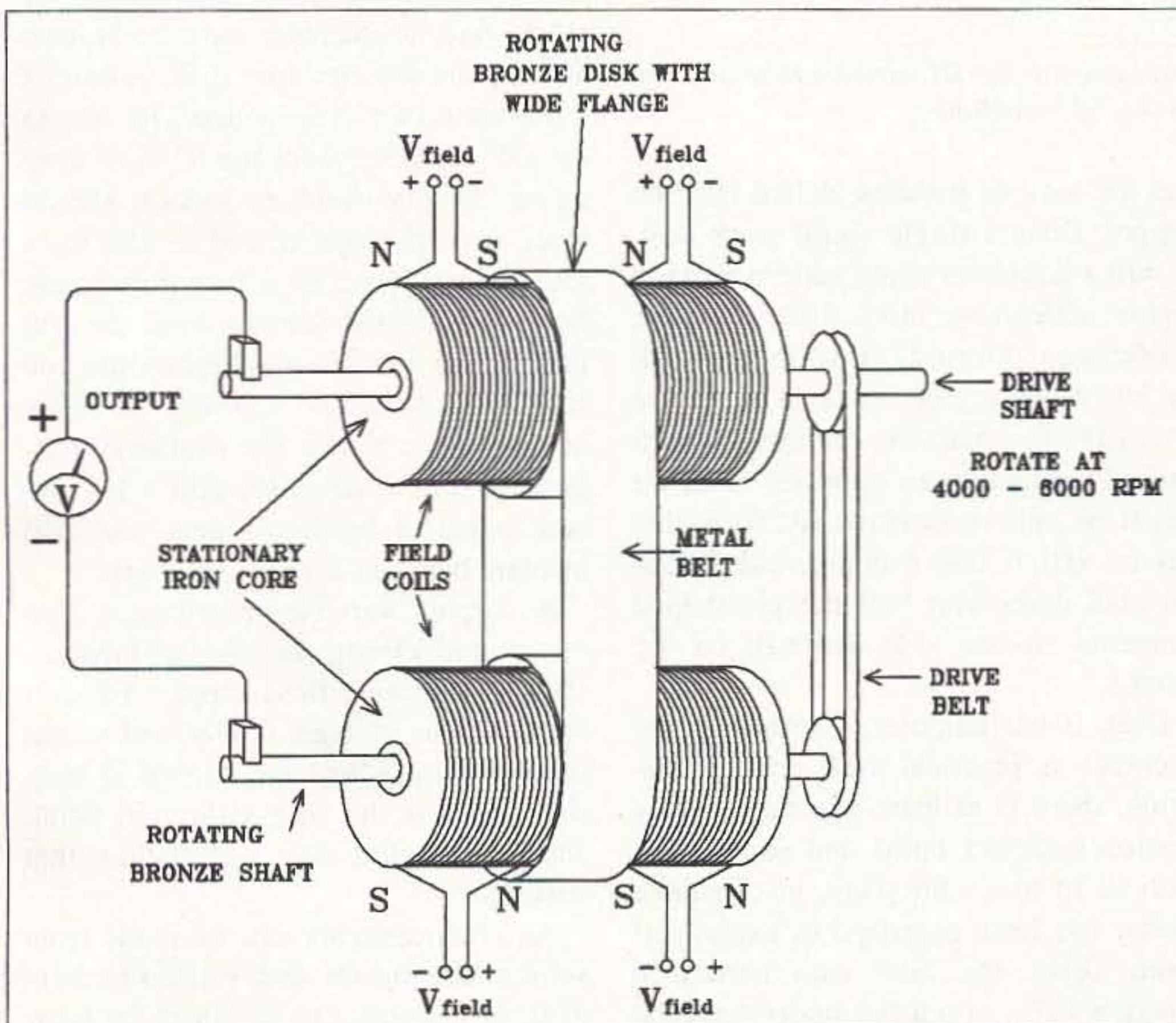

Fig. 4. Nikola Tesla's unipolar generator. Tesla made many improvements on the unipolar generator, although even he did not fully understand it.

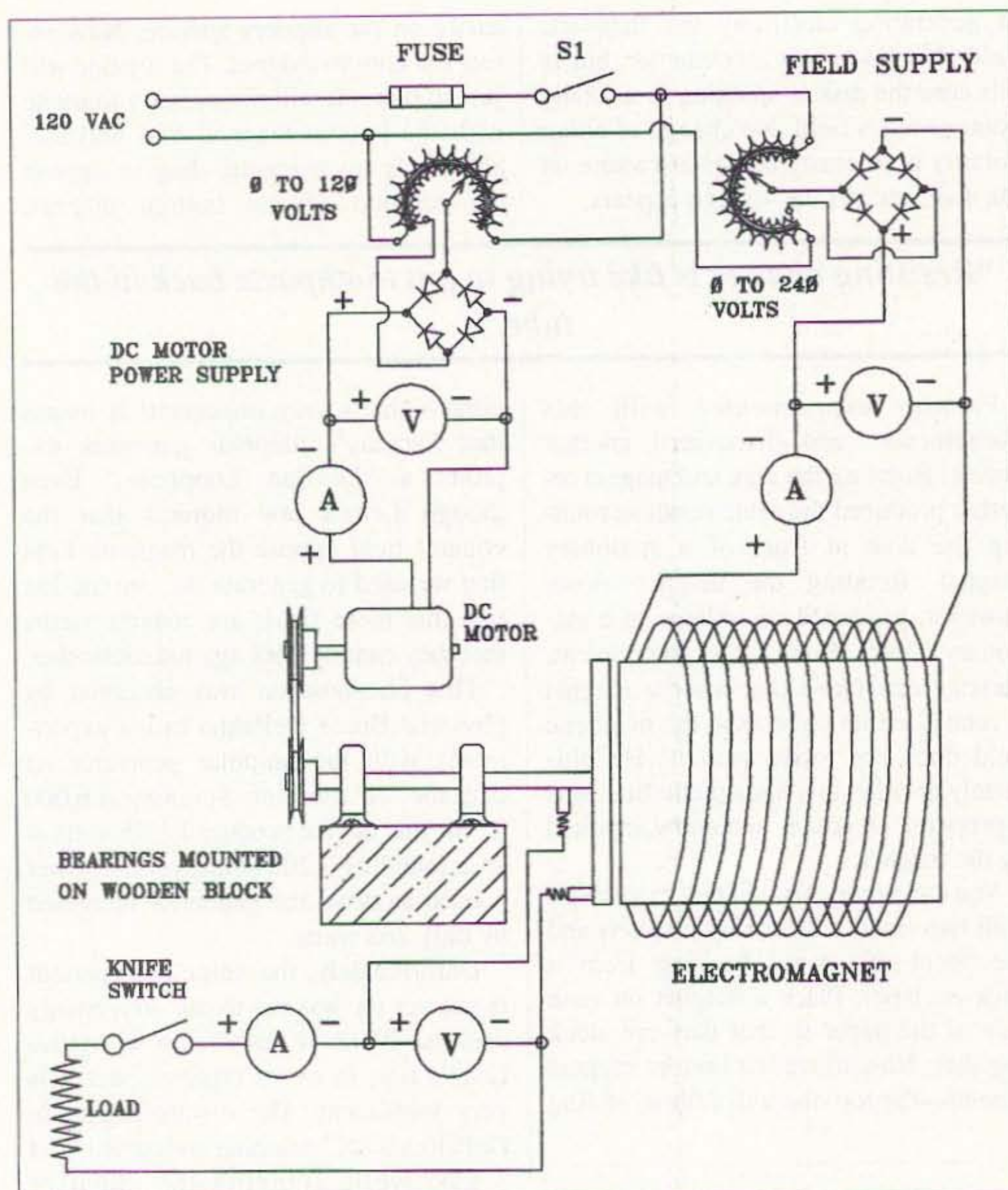

Fig. 5. "N" machine test circuit. Adjustable voltages for the DC drive motor and the electromagnet make it easier to experiment with the "N" machine.

field produced would actually *increase* the strength of the field electromagnets, to the point of eventual saturation! He proposed that, properly configured, this device could become totally self-exciting, similar to the "current accumulator" proposed by Sir William Thompson in 1865. Tesla also felt that if the solid disks were replaced with spirally-wound armatures, higher voltages could be generated—an exciting thought, since higher voltage would offset the brush losses and make the generator much more practical.

This is an area that can easily be tackled by amateurs. Experimenting with the voltage generated by different disk configurations does not require high current output, so surplus permanent magnets will work fine. Carbon brushes robbed from an old DC motor will suffice to contact the hub and rim. Disks can be cut from printed circuit board material

and the various patterns etched into the copper. Does a single spiral work best, or will a double or triple pattern provide higher efficiency, much like a bifilar, trifilar-wound toroid? How about a disk cut into radial segments, like a pie? If we also split the magnet, immersing each half of the disk in an opposite field, we might be able to produce AC from this device. (Hint: Use a double-sided copper-clad disk, with half the pie-shaped elements on one side and half on the other.)

Even if the unipolar generator never becomes a practical free energy machine, there is at least one reason why amateurs should build and experiment with it: In over 160 years, no adequate theory has been proposed to explain it! Even Tesla, the man who harnessed Niagara Falls, could not understand the operation of the unipolar generator. He stated that "... the operation will be clear

to us only when we shall have recognized the very nature of the forces concerned, and fathomed the mystery of the invisible connecting mechanism."

Recently, researcher Thomas Valone devised a mathematical model which explains the unipolar generator using zero-point energy fluctuations and the Special Theory of Relativity. If this turns out to be correct, for the first time amateur scientists can study a relativistic phenomenon.

Building a small unipolar generator is not really difficult, although having some mechanical skill is a plus. Steel bar stock, pulleys, belts, and pillow-block bearings are available at any hardware or farm supply store. You may even find a large solid aluminum pulley that will make a suitable disk. If you have access to a lathe, you can easily turn a disk out of brass, copper, or aluminum. The disk should be slightly smaller than the diameter of the magnets. Surplus "ring" magnets are available in the 3" to 4" diameter range, so this is a good inexpensive starting point. The output voltage is proportional to the diameter and speed of the disk, and also to the intensity of the magnetic field, so large, strong magnets are the key.

If you choose to make an electromagnet, the core can be ordinary steel bar stock, but the diameter must be at least as large as the armature disk. A coil of 2,000 turns of #22 enameled wire wound on a 4" diameter steel bar 5" to 6" long makes a good field magnet. It should draw several amps at 100 to 150 volts DC and will produce a strong magnetic field. It's a good idea to wind the coil bifilar, two wires in parallel, so that you can connect the two windings in series or parallel to match the available voltage. Be sure to cover the core with several layers of insulating tape, and also insulate between each layer of wire.

A surplus variable transformer, two meters and a bridge rectifier will make a simple adjustable field supply. You can increase the voltage slowly and watch for the point where the current sharply rises. This is the core saturation point, and you should stay well below that voltage.

An electromagnet can be made from solid stock and the disk rotated in front of it, or the core can be bored for bearings and the rotating shaft run through it. In either case, the electromagnet should

## Further Information:

*The Cosmic Code*  
by Heinz R. Pagels  
Published by Simon and Schuster  
Paperback edition by Bantam  
Books  
ISBN 0-553-24625-9

*Perfect Symmetry*  
by Heinz R. Pagels  
Simon and Schuster  
Paperback edition by Bantam  
Books  
ISBN 0-553-24000-5

*The Free Energy Device Handbook*  
by David Hatcher Childress  
Adventures Unlimited Press  
ISBN 0-932813-24-0

*How to Build a Flying Saucer: and  
Other Proposals in Speculative  
Engineering*  
by T. B. Pawlicki  
Published by Prentice-Hall, Inc.  
ISBN 0-13-402461-3

*The Anti-Gravity Handbook*  
by David Hatcher Childress  
Adventures Unlimited Press  
ISBN 0-932813-20-8

*Universal Laws Never Before Re-  
vealed: Keely's Secrets*  
by Dale Pond  
The Message Company  
ISBN 1-57282-003-9

*Tesla: Man Out of Time*  
by Margaret Cheney  
Dell Publishing  
ISBN 0-440-39077-X

*The Inventions, Researches and  
Writings of Nikola Tesla*  
by Thomas Commerford Martin  
Barnes and Noble  
ISBN 0-88029-812-X

*The Complete Patents of Nikola  
Tesla*  
by Jim Glenn  
Barnes & Noble Books  
ISBN 1-56619-266-8

CALL TOLL FREE  
(800) 292-7711  
Se Habla Español

**C&S SALES**  
EXCELLENCE IN SERVICE

WRITE FOR A  
FREE 60 PAGE  
CATALOG!

AFFORDABLE, HIGH QUALITY ELENCO OSCILLOSCOPES  
2 YEAR WARRANTY



**STANDARD SERIES**  
S-1325 25MHz \$335  
S-1340 40MHz \$489

**Features:**  
• TV Sync • High Luminance 6" CRT  
• 1mV Sensitivity • Complete Schematic  
• X - Y Operation • Plus much, much more!!

2 FREE probes included with each scope!!

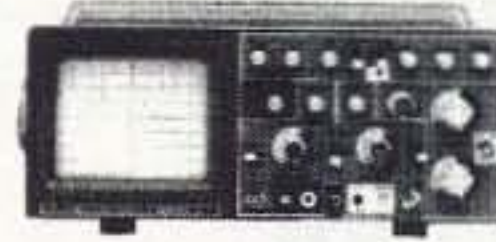

**DELUXE SERIES**  
S-1330 25MHz \$439  
S-1345 40MHz \$569  
S-1360 60MHz \$759

**Features:**  
• Delayed Sweep • Dual time base  
• Automatic Beam Finder • Illuminated internal  
• Z Axis Modulation • gradicule  
• Built-in Component Test  
• Plus all of the features of the "affordable" series!!

**MX-9300**  
Four Functions in One Instrument

**Features:**  
• One instrument with four test and measuring systems:  
• 1.3GHz Frequency Counter  
• 2MHz Sweep Function Generator  
• Digital Multimeter  
• Digital Triple Power Supply  
• 0-30V @ 3A, 15V @ 1A, 5V @ 2A



**\$479.95**

**B&K 2MHz Function Generator Model 4010**



**\$195.95**

• 0.2Hz to 2MHz  
• Sine, Square, Triangle, Pulse and ramp output  
• Variable duty cycle  
• Variable DC offset

**Model XP-581**  
4 Fully Regulated Power Supplies in One Unit

4 DC voltages: 3 fixed - +5V @ 3A, +12V @ 1A, -12V @ 1A • 1 Variable - 2.5 - 20V @ 2A

Ideal for laboratories, service shops and hobbyists.

**\$85**



**Fluke Multimeters**

**70 Series**  
Model 7011 ..... \$69.95  
Model 7311 ..... \$97.50  
Model 7511 ..... \$135.00  
Model 7711 ..... \$154.95  
Model 7911 ..... \$175.00  
**80 Series**  
Model 83 ..... \$235.00  
Model 85 ..... \$269.00  
Model 87 ..... \$289.00



**M-1700**  
Digital Multimeter  
11 functions including freq to 20MHz, cap to 20µF. Meets UL-1244 safety specs.  
**\$39.95**

**Model M-6100**

Features Computer Interface and Software



• Frequency to 4MHz  
• Capacitance to 40nF  
• Large 3 3/4 LCD Display  
• Temperature to 1999F  
• TTL logic  
• Data/Peak Hold  
• Audible continuity  
• Auto power off  
• Unit indicator  
• Diode test  
• w/ RS232 Cable

**\$125.00**

**B&K Model 1688**

High Current (25 amp) Power Supply  
Variable 3-14VDC



**\$249.95**

**1.3GHz Universal Counter Model F-1300**

• Period  
• Frequency & 8 other functions



**\$225**

**XK-550 Digital / Analog Trainer**

Elenco's advanced designed Digital / Analog Trainer is specially designed for school projects. It is built on a single PC board for maximum reliability. It includes 5 built-in power supplies, a function generator with continuously sine, triangular and square wave forms. 1560 tie point breadboard area.

**XK-550**  
Assembled and Tested

**\$169.95**

**XK-550K - Kit**  
**\$139.95**

Tools and meter shown optional



**Kit Corner** over 100 kits available

**Model AR-2N6K**  
2 meter / 6 meter  
Amateur Radio Kit  
**\$34.95**



**Model AM/FM-108K**  
AM/FM Transistor Radio Kit  
**\$29.95**



**M-2665K**  
Digital Multimeter Kit  
**\$54.95**

Full 34 Ranges w/ cap & trans tests

**TT-400K** Telephone Analyzer Kit  
**\$19.95**



**WE WILL NOT BE UNDERSOLD**

**C&S SALES, INC.**

UPS SHIPPING: 48 STATES 5%  
OTHERS CALL (\$5 min. / \$15 max.)  
IL RES. 8% TAX

150 W. CARPENTER AVENUE  
WHEELING, IL 60090  
FAX: (847) 541-9904 (847) 541-0710

**15 DAY MONEY BACK GUARANTEE**  
**FULL FACTORY WARRANTY**  
PRICES SUBJECT TO CHANGE WITHOUT NOTICE

CIRCLE 184 ON READER SERVICE CARD

**Mr. NiCd** YOUR SOURCE FOR **BATTERIES!**

• AMATEUR RADIO BATTERY PACKS  
• REPLACEMENT RECHARGEABLE INSERTS  
• LAPTOP COMPUTER BATTERIES  
• CAMCORDER BATTERY PACKS  
• CELLULAR PHONE BATTERY PACKS  
• SEALED LEAD-ACID BATTERIES  
• O.E.M. & CUSTOM ASSEMBLY PACKS  
• AUTHORIZED SANYO NiCd DISTRIBUTOR

Call or write for our free catalog!

**Mr. NiCd - E.H. Yost & Co.**  
2211-D Parview Rd., Middleton, WI 53562  
Phone (608) 831-3443 / Fax (608) 831-1082  
DEALER INQUIRIES INVITED

CIRCLE 114 ON READER SERVICE CARD

From Micro Computer Concepts **RC-1000 REPEATER CONTROLLER**

• Autopatch • Reverse Autopatch  
• User Programmable CW ID, Control & User Codes & Timeouts

Manual with schematics • 90-Day Warranty  
Wired & Tested w/ manual .... **\$239.95**



Micro Computer Concepts  
8849 Gum Tree Ave.  
New Port Richey, FL 34653

**813-376-6575**

CIRCLE 160 ON READER SERVICE CARD

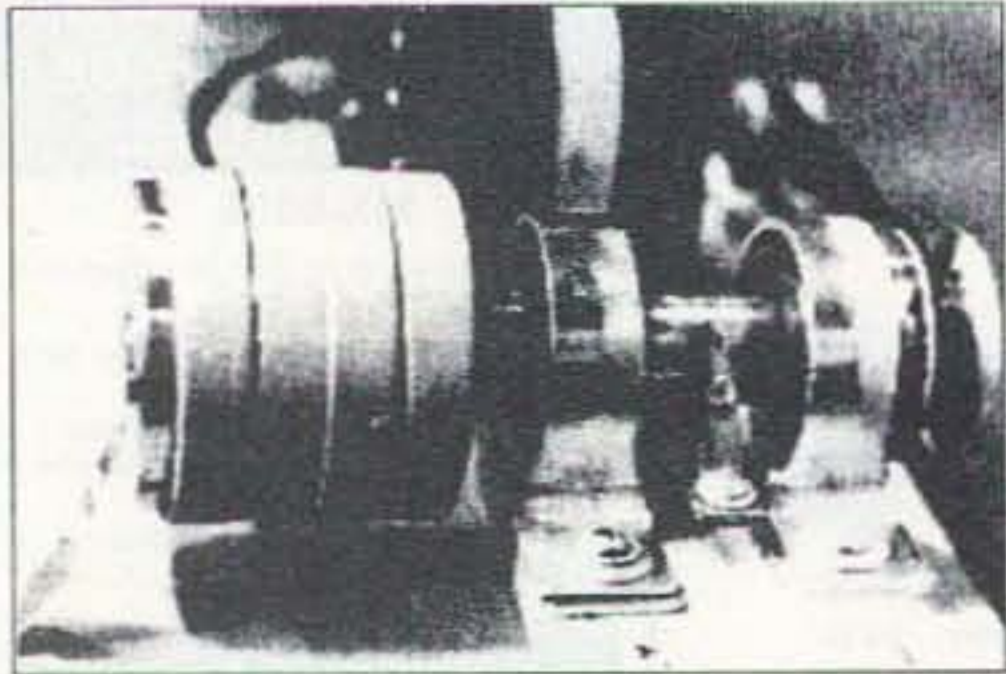

**Photo A.** This example of the Faraday unipolar generator uses surplus "ring" magnets and a copper disk, all rotating together on a solid copper shaft.

be stationary. At high RPMs a large diameter rotating electromagnet would probably explode due to centrifugal force.

Safety is always a big concern when rotating anything at very high RPMs since the centrifugal force at the rim is enormous. Be sure to mount a guard around the device to catch anything that might come loose, and remember to stay in front of the device, out of the plane of the armature. *Never* stand beside a high-speed rotating disk, guarded or not, and always wear eye protection!

A standard AC induction motor can be used to spin the unipolar generator at a fixed speed, but AC motors have a drawback: It is very difficult to measure the input power without some way to measure slip and power factor. The use of a DC motor will greatly simplify power calculations. A variable transformer and bridge rectifier, similar to the field supply, can be used to vary the motor speed

while making it easy to monitor the input voltage and current. Fig. 5 shows a typical test setup.

*"He who controls magnetism controls the universe!"*

*Dick Tracy*

Although many will argue that these free energy devices will never be practical, new technology has the disturbing habit of making the impossible suddenly commonplace. Breakthroughs in magnets and superconductors will certainly have a huge effect on power generation. But will that mean low-cost electricity from your local utility? Don't bet on it.

We need to remember that "practical" is a relative term. To some, practical means waiting fifty million years for dead dinosaurs to turn to hydrocarbon goo, then spending billions of dollars to pump it

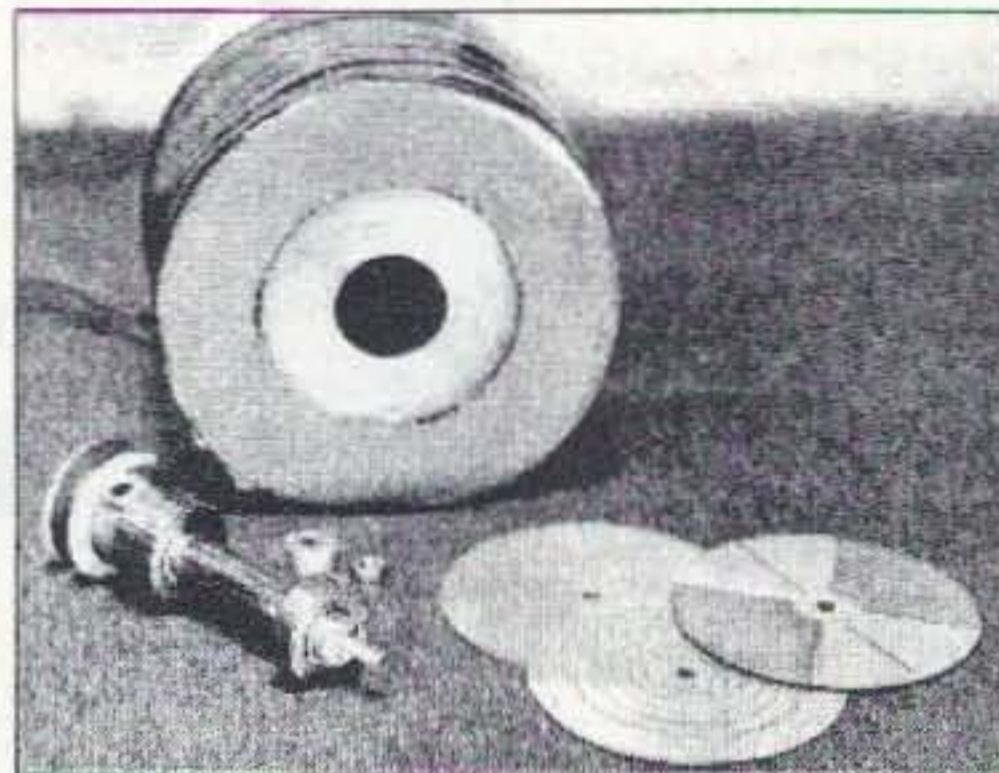

**Photo B.** Building the "N" machine. The shaft rotates on ball bearings that fit inside the electromagnet core. A solid aluminum disk and several experimental etched copper-clad disks are shown.

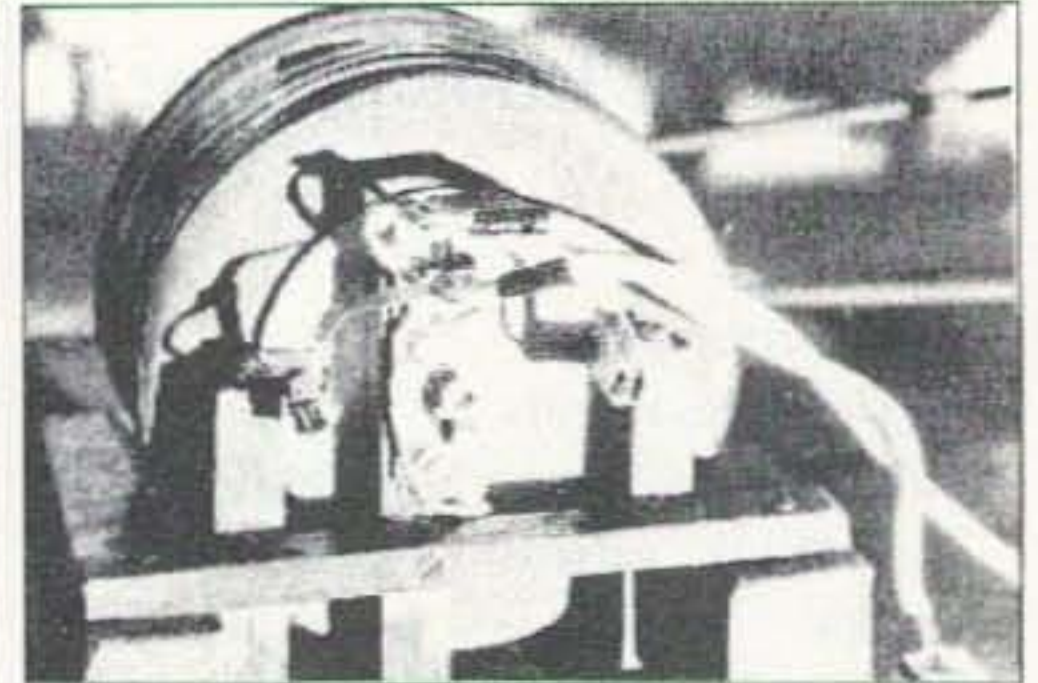

**Photo C.** Rotating at 8,000 RPM, the "N" machine generated two-tenths of a volt. When the output was shorted, the voltage dropped to near zero due to brush resistance. The jumper, a short piece of braid from RG-8U coax, quickly became too hot to hold.

out and refine it, finally burning it at something like 20% efficiency—poisoning the planet at every step of the process! This is obviously the most impractical system ever devised, but we are locked into it, thanks to the immense wealth and power of those who control it.

When an experimenter can build a simple device that defies explanation, it is just possible that the universe is trying to teach us something! Anomalies like this usually lead to a deeper understanding of the forces of nature, and could even launch an entirely new technology. Change can be resisted, but not for long ... that soon becomes akin to putting toothpaste back in the tube. Those who can anticipate and adapt to change will prosper. Those who cannot will eventually find themselves as extinct as the dinosaurs they now pump from the ground. 73

**School's starting...nice time to give a gift subscription to your child or grandchild's school library. While you're at it, why not arrange to share some of your ham experiences with the class. Call 800-274-7373.**

## THE RAIBEAM EATS YAGIS FOR LUNCH

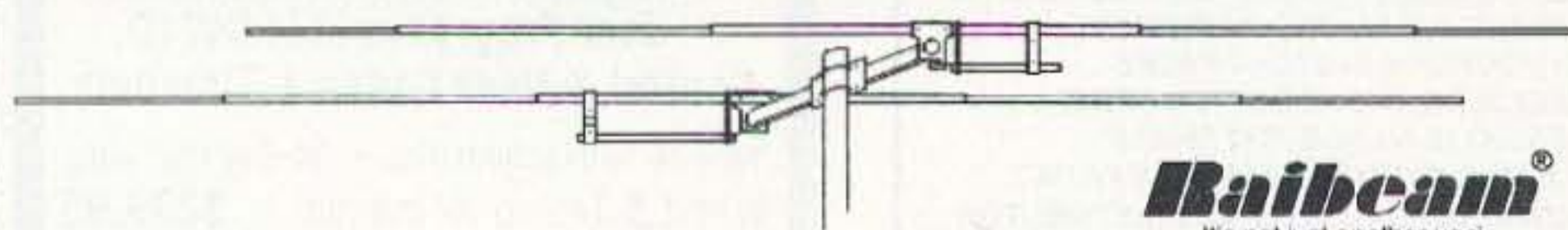

High performance 2, 3 and 4 element mono-band beams for 6m thru 20m featuring WA7RAI's critically coupled, bi-periodic<sup>PAT. PEND.</sup> dual drive system

Get the DX edge with higher gain - lower radiation angles - high F/B ratio - lower noise, plus a 100% performance guarantee. • High quality aluminum & stainless steel hardware • Built to survive • 2 KW PEP

### RAIBEAM USERS SAY IT ALL

"... I'm impressed that the 2 element Raibeam averaged less than 1 S-unit down from my 30' boom, 4 element (20m) quad on DX. It receives as quiet as the quad and the F/B ratio is excellent." ...K5UA

"...placed in the top 3 worldwide on 10m in the 1995 WPX with 400 watts and a Raibeam at 45 ft." ...ZL1AXB

"...compared to the Raibeam my KT-34 seems like a dummy load..." ...ZL1SB

"...only 2 elements and it beat my Log-periodic on DX by 3 to 4 S-units... unbelievable!" ...W5CKP

"...it's the best antenna I've ever used in 50 years of Ham Radio... and the F/B ratio is fantastic" ...WT4K/KH6

"...I was very surprised by the outstanding performance of my 2 element Raibeam..." ...W6TVW



**Raibeam Antennas Int'l**  
5638 West Alice Ave., Glendale, AZ 85302

Sales & information:  
**(602)931-9135**

9 am-5 pm MST  
Monday - Friday

E-mail:  
RAIbeam@aol.com

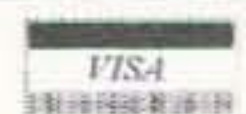

## Quantum Theory for Amateurs

Few things are more difficult to visualize than invisible waves propagating through an intangible energy field. It is still harder to imagine that the interaction of these invisible waves makes up virtually everything in our material universe. But, since this principle will be the basis for future technology, it's well worth our time to explore it.

If we apply a source of vibrations to a point on the side of a large pan of water, we will see the energy carried away as a series of waves moving across the surface. These waves will travel until they strike the other side of the pan, then they will reflect and radiate in a new direction. Before long, the entire surface of the water will be covered with waves of the same frequency, but moving in all directions.

Whenever these waves cross one another they combine, increasing in amplitude if the waves are in phase and decreasing if they are out of phase. Since the frequency and speed of each wave is equal, the interaction between them can form a stable interference pattern. A particular point on the surface of the water will be higher or lower than the surrounding surface, and will remain that way even though the waves that contribute to it continue to move across the water. All hams are familiar with this phenomenon, since it happens when RF energy is reflected back down a feedline to interact with the energy traveling to the antenna. It's called a *standing wave*.

Just as waves move across the surface of water, waves of energy travel through the quantum field, radiating and interacting to form standing waves. The difference is that there is not one, but *four* separate fields. Energy waves from three fields combine to form *three-dimensional* standing waves. The wave pattern from each of the three fields reinforces the other two and forms a stable particle of matter, just as a triangle is the most stable geometric shape. The fourth, or gauge field, is required to keep the pattern stable as it is rotated through any axis. This ability to rotate without changing the pattern is called "symmetry," and is very important to quantum theory.

Since the particle is a standing wave, it stays in one spot while the traveling waves that contribute to it pass through. Some theorists have suggested that this causes the particle to curl in on itself, creating a vortex. This vortex action, called "spin," is responsible for magnetism, and possibly other basic forces of nature as well. Wayne Green has suggested that this spin causes a gyroscopic force that we perceive as inertia, a theory which makes sense. Inertia is not radiated by waves, and does not seem to involve the exchange of a particle, therefore it must be related to spin. There simply isn't anything else.

### Multiplexed realities?

If we accept that everything in our material universe is composed of three-dimensional standing waves, then we have to accept that there is a fundamental frequency, and everything in our reality has to be composed of waves of that frequency or its harmonics. Energy of a non-harmonic frequency could also combine to create standing waves, but they would not appear to us as matter. In fact, they might not appear to us at all—a standing wave from that perspective would appear to us as a traveling wave. There could well be an infinite set of material realities occupying the same space at the same time, but out of sync with one another, each operating on a different fundamental frequency.

Now, if there are other realities overlapping our own, and if intelligent life also exists there, then they most certainly have evolved scientists, engineers, and of course, amateur radio operators. Your homework assignment is to figure out a way to *communicate with them!*

## Slow Scan TV

doesn't have to be expensive anymore!



Every day more hams are enhancing their communication by using images. Join the fun and see what you've been missing.

Quality Color SSTV is easy and affordable with *Pasokon TV*. \$239.95

Requires IBM PC-compatible, 386 or better CPU, 1 Megabyte of memory, color VGA display, MS-DOS. Shipping: \$5 to U.S.A. and Canada, \$15 for others. Write or call for complete details.

Absolute Value Systems  
115 Stedman St. # 7  
Chelmsford, MA 01824-1823  
(508) 256 6907  
e-mail: johnl@world.std.com

CIRCLE 351 ON READER SERVICE CARD

## DIRECTION FINDERS

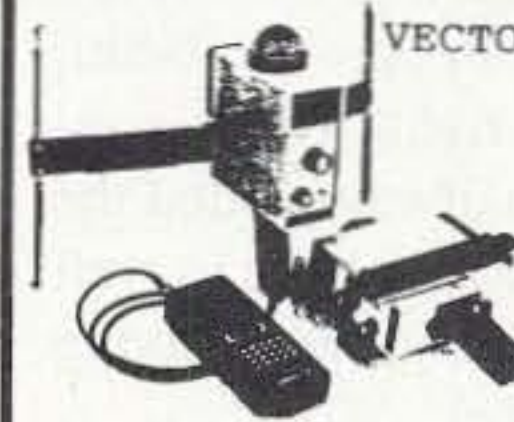

VECTOR-FINDER

HAND-HELD  
PHASE SENSE  
ANTENNAS FOR  
VHF DIRECTION  
FINDING. USES  
ANY FM RCVR.  
ARMS FOLD FOR  
STORAGE.

TYPE VF-142 144-220 MHZ \$139.95  
TYPE VF-142Q LEFT-RIGHT LEDS &  
AUDIO, 144-220 MHZ \$239.95  
TYPE VF-142QM SAME AS Q MODEL  
EXCEPT FREQ. 144-500 MHZ \$289.95  
TYPE VF-121Q SAME AS VF-142Q  
PLUS 121.5 MHZ ELT FREQ \$379.95  
CALL ABOUT HF DF, ADD \$4.50 S/H  
ATTENUATORS CA ADD TAX



RADIO ENGINEERS

7969 ENGINEER RD, #102  
SAN DIEGO, CA 92111

619-565-1319 FAX 619-571-5909

CIRCLE 58 ON READER SERVICE CARD

## UHF VIDEO TRANSMITTER

Miniature 200 Mw  
p.e.p. Video Transmitter  
Built tough. Housed in  
a black anodized  
milled aluminum case  
with stainless steel SMA  
antenna connectors  
& screws.



Available either at  
434 mhz or 423.25 mhz  
Using SAW Resonator technology

\$279 plus s/h \$5  
Check, Money Order, Visa or Mastercard  
CA Res. add 8.25% tax

### TECHNICAL

Modulation Type: AM  
Voltage: 12 vdc - 100 ma  
RF Output: 200 mw PEP  
Frequencies: 434 Mhz, 423.25 Mhz  
Specify when ordering  
Dimensions: 17/8" L x 1-3/8" W x 5/8" H  
47mm L x 34.5 mm W x 15 mm H

A.I.G., INC.  
P.O. Box 642057  
Los Angeles, CA  
90064-2057

TEL: 310 821-6770  
FAX: 310 821-6690

# Adventures on the Red Sea

*DXing in style, in an unforgettable setting.*

Carol Barsky KA9SOF  
4439 Hillcrest Oaks  
Owensboro KY 42303

**R**enting a modern houseboat equipped with amateur and marine mobile equipment offers DX excitement, a variety of experiences, and new friendships.

Beautiful beaches, crystal blue water, sunny days, and starry nights—sounds like a dream vacation in Hawaii, Tahiti, or a Caribbean island, right? There is another location about halfway around the world that offers all of the above as well as a terrific DX opportunity while living in comfort—Eilat, Israel.

Eilat, a sparkling gem of a city on the Red Sea, is situated in a unique location. To the east and west, one can see Jordan, Egypt, and Saudi Arabia, their reddish-brown mountain ranges providing stark contrast to the glittering Red Sea, which stretches to the south. It is truly a paradise for those who love to be near the

water as well as to explore the vast expanse of desert that rims the city. Coral reefs attract many beautiful fish and strange sea creatures, enticing snorkelers and scuba divers. Timna Park (about 20 miles north of Eilat) provides an opportunity to hike among fascinating rock formations and archeological discoveries. Also, with proper visas, you can cross the Egyptian and Jordanian borders for further adventures.

## Deluxe DX accommodations

For hams, the best way to enjoy the beauty of Eilat and the Red Sea is to rent a houseboat from Meir Globerman 4X4JP. His houseboats provide luxury accommodations at a reasonable price. Each air-conditioned boat sleeps four guests; there is one bedroom that sleeps

two, and the living room contains a folding double-bed sofa for two additional guests. The kitchen is fitted with a sink, refrigerator, and stove, and the dining area seats four. A color TV and radio/cassette stereo system provides entertainment when taking a break from the ham bands (if you can tear yourself away)! The bathroom contains a toilet, sink, and shower with hot water. Two small covered decks and a sun deck allow skin cancer enhancement or conversation in the fresh air. The centerpiece for hams is the marine mobile ham station mounted at the boat's helm. The radio and vertical antenna provide excellent HF coverage for hours of pileups! My husband Rich WA1GZY and I enjoyed this houseboat/ham radio vacation while visiting in Eilat last year.

After boarding the boat one hot May afternoon, we pulled out of the marina. The boat's engine provided a comfortable, steady cruising speed for the catamaran-style hull and we watched Eilat become a modern skyline in the distance. Off to the east, we could see Aqaba, Jordan—Eilat's neighbor—and the beautiful mountains to the east and west that reach south to the horizon. We eventually found a spot to anchor the boat and turned on the radio. Since Israel is seven hours ahead of US amateurs on the East Coast, and since good band conditions prevailed, 20 meters provided a lot of fun. European and Middle Eastern amateurs also enjoyed QSOs with us, and one evening Rich worked stations until 3 a.m.! One of his most memorable moments was attempting to talk to a Lebanese ham. He tried to establish a contact through a DX net, but the Lebanese ham stated that a QSO was not permitted—"not even for a moment." We then remembered that our status as



Photo A. A chat with the King. From left: Meir 4X4JP and His Majesty King Hussein of Jordan JY1. (Photo courtesy of 4X4JP.)



Photo B. Carol KA9SOF and Rich Barsky WA1GZY near the Israeli/Egyptian border.

an Israeli station changed the expected response.

Night life can be fun ashore too. The marina is near the Laguna Hotel, and a strip of interesting shops and restaurants line the marina. Tourists flock to the area

Globerman have the pleasure of talking to the King, but the next day, while on the Red Sea in one of his houseboats, Globerman once again met the King on the air and confirmed that he was marine mobile near the Israeli-Jordanian border

*"The centerpiece for hams is the marine mobile ham station mounted at the boat's helm."*

in the evening for food, friendship, and musical entertainment, and many of the other fine hotels are within easy walking distance. One evening we sat by the pool of a five-star hotel after dinner just to talk and enjoy the night sky, and we stayed until the lights were turned off at 1 a.m. All of these experiences, however, make Eilat's houseboat vacations unique and memorable—and one of the best opportunities for exciting amateur radio contacts!

#### A continuing saga

A few months after our return to the US, Globerman called to tell us about being informed by a friend that His Majesty King Hussein of Jordan (JY1) would be making a schedule with several hams, and Globerman was invited to join in the QSO. Not only did

between Eilat and Aqaba. Since the King was in Aqaba, Globerman received an invitation for coffee and a short visit at the Aqaba palace. Globerman jumped at the opportunity. After overcoming the red tape such an unexpected visit generates, his boat was escorted by Jordanian and Israeli maritime police, and he arrived safely to enjoy a pleasant chat with the King—certainly the highlight of Globerman's amateur radio career! Globerman's experience was even featured on Israeli television and radio and in newspapers.

The Eilat/houseboat vacation and friendship with Globerman continued to affect our lives. Soon after Globerman's visit with King Hussein, Rich was listening to 20 meters when he heard a Jordanian call sign. It wasn't the King, but Rich found that he was talking to the

## ALL ELECTRONICS CORPORATION

### SPECIAL! REDUCED PRICE 12 POSITION BARRIER STRIP



20 amp, single row, pc mount barrier strip with screw-clamp terminals. Just slip wire under clamp and tighten it down. 12 terminals on 0.375" centers. Black thermoplastic strip is 4.56" X 0.61". Barriers between screws are 0.63" high. Large quantities available.

CAT #TER-124

65¢ each

100 for \$50.00  
1000 for \$300.00

### SPECIAL PRICING! 12 VDC MINI-FAN

Sunon # KD1206PTS1  
12Vdc, 2.2 W fan.  
60mm X 60mm X 25mm.  
Black plastic housing.  
Five blade impeller.  
18" pigtail leads.  
While Supply Lasts!

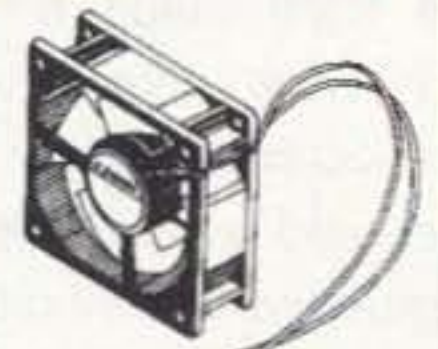

\$4.00 each

CAT# CF-35

10 for \$35.00

### SET OF 12, SPDT NUMBERED LIGHTED SWITCHES

Twelve push-on/push-off switches (only 6 pictured). Each switch has a 0.6" square yellow lens with a 0.25" high black numeral 1 through 12. They are lighted by a 28 volt, #85 wedge base incandescent lamp which can be easily replaced if a different voltage is desired.

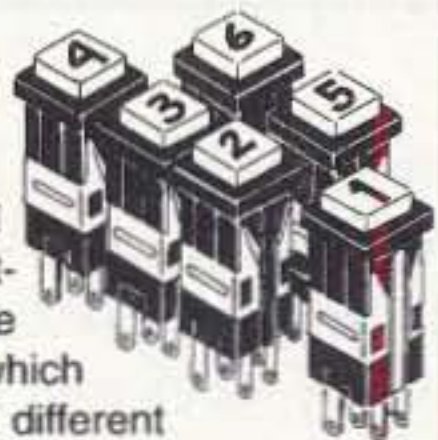

CAT #PBL-12

\$15.00 per set of 12

ORDER TOLL FREE

1-800-826-5432

CHARGE ORDERS to Visa, Mastercard, American Express or Discover

TERMS: NO MINIMUM ORDER. Shipping and handling for the 48 continental U.S.A. \$5.00 per order. All others including AK, HI, PR or Canada must pay full shipping. All orders delivered in CALIFORNIA must include local state sales tax. Quantities Limited. NO COD. Prices subject to change without notice.

CALL, WRITE  
FAX or E-MAIL  
for our FREE  
64 Page  
CATALOG  
Outside the U.S.A.  
send \$2.00 postage.

MAIL ORDERS TO:  
ALL ELECTRONICS  
CORPORATION  
P.O. Box 567  
Van Nuys, CA 91408  
FAX (818)781-2653

E-Mail allcorp@allcorp.com  
WWW http://www.allcorp.com/



Photo C. One of 4X4JP's houseboats. (Photo courtesy of 4X4JP.)

King's pilot, JY3AK, who was flying to Washington, DC. The microphone was eventually turned over to His Majesty, and Rich made his first contact with JY1. Rich, like Globerman, basked in the accomplishment of a much-sought-after and always-treasured contact. He mentioned our vacation in the Eilat and Aqaba area, along with our acquaintance

#### An Israeli vacation

We recommend a group tour for the other parts of Israel—especially if this is your first trip to the region. Tour guides are helpful, knowledgeable, and safety-conscious, and they provide a wonderful blend of history, religion, culture, and politics while keeping groups happy and

***"A houseboat vacation in Eilat is a wonderful opportunity to relax and enjoy amateur radio in a different part of the world."***

with Globerman and knowledge of Globerman's visit in Aqaba. The King said he hoped we could visit Jordan and possibly meet with him. (Unfortunately, I was outside walking our dog during this QSO and heard about it later! No, I didn't shoot the dog.)

Rich and I treasured the houseboat vacation in Eilat as a wonderful opportunity to relax and enjoy amateur radio in a different part of the world.



Photo D. Interior view of one of the houseboats. (Photo courtesy of 4X4JP.)

comfortable in air-conditioned tour buses. They provide hotel accommodations in various price ranges, and breakfast is often included.

We joined a group of approximately 30 people at the beginning of our trip, saving the houseboat DXpedition for the last few days of our vacation. We enjoyed many beautiful and moving sites such as the Western Wall, Dome of the Rock, and Mount of Olives in Jerusalem, Bethlehem, Masada and the Dead Sea, Sea of Galilee, Nazareth, and many archeological sites where Roman ruins are being uncovered and reconstructed. We spent one evening at a barbed-wire-protected kibbutz in the Golan Heights, and the next morning we took a tour to learn about the residents' unique lifestyle. We stayed overnight in the beautiful port city of Haifa and enjoyed the shopping, beaches, and museums of Tel Aviv and the night life in Old Jaffa. The country offers modern shops,

supermarkets, and malls, but the prices are higher than for comparable items in the US.

We're looking forward to a second trip to Israel and Jordan, and I know that one thing we will do again is venture out on the Red Sea in a blue-and-white houseboat with a small Israeli flag snapping from its HF vertical flagpole!

(At the time of this writing, houseboat rentals are \$150.00 per day Sunday through Thursday. Friday and Saturday are \$200.00 per day, or \$1050.00 for a full week. Gas is not included. For further information, contact Globerman at P.O. Box 666, Eilat, Israel; telephone 972-7-374285; fax 972-7-373531. Operating permits are included with the accommodations.)

[Wayne's note: I don't know about the problems of taking the houseboat into Jordanian waters, but getting a ham license in Jordan is easy. I'm JY8AA. Maybe someone can overcome the bureaucrats in Egypt and Saudi Arabia and make it simple to get licenses for all four nearby countries. But at any rate, don't miss a visit in Aqaba, king or no king in residence, and then a visit to not-too-distant Petra, the lost city carved out of stone ... Wayne.]

73

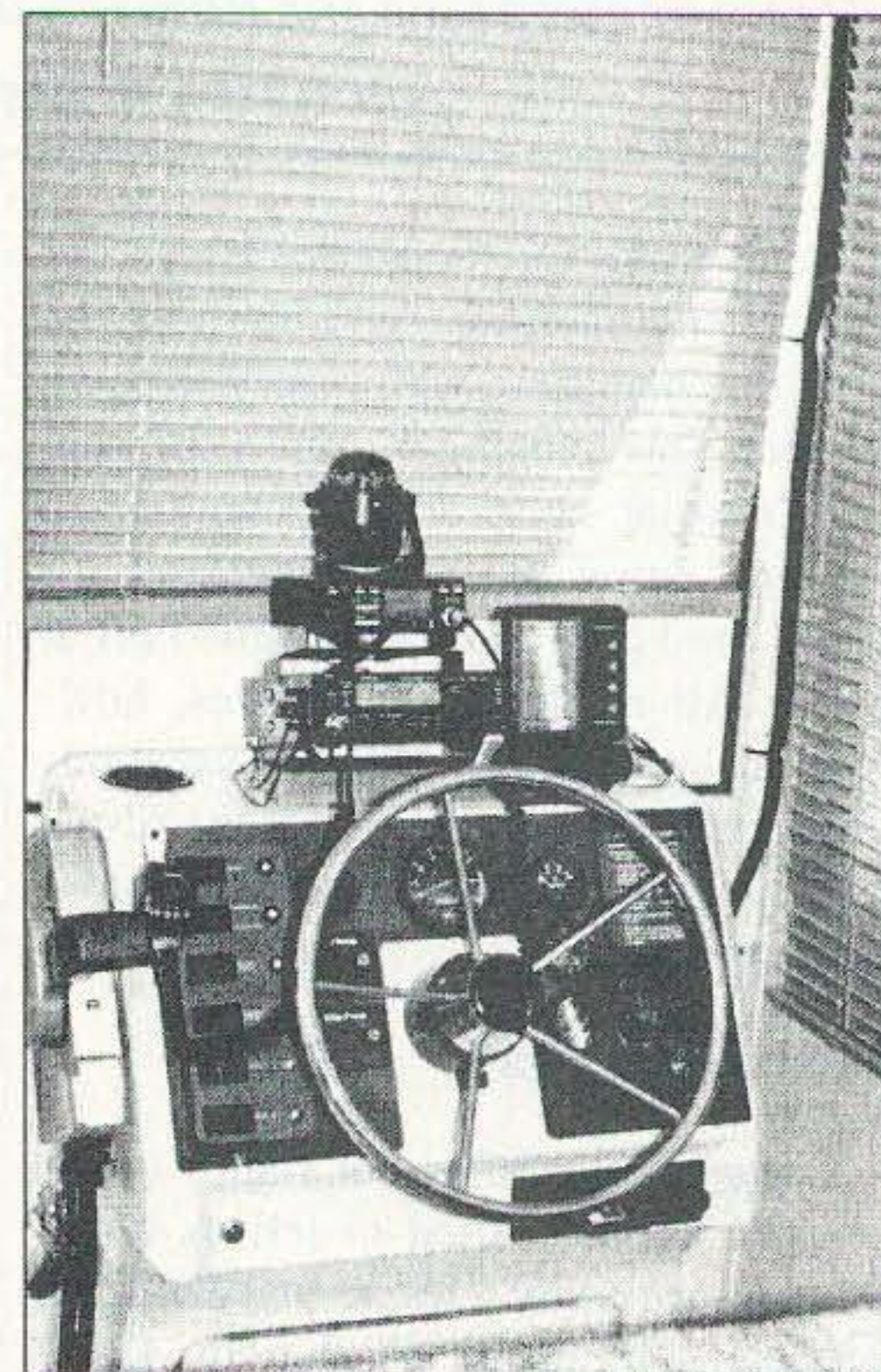

Photo E. At the helm is a Kenwood TS-50S HF band transceiver. (Photo courtesy of 4X4JP.)



# Your Next Buy: The MFJ-259

*Wait 'til you see what this antenna analyzer can do for you!*



Jim Pickett K5LAD  
9828 N. 151st East Ave.  
Owasso OK 74055-4852

We've always been told to tune a transmitter into a dummy load, and that's a wonderful idea, but what happens when we also use an antenna matchbox or tuner? That allows us to connect our transceiver to an antenna which is not a 50 ohm load, often not even close to it. The tuner can be tuned "in the neighborhood" by peaking the noise level while listening to the receiver. The transmitter, however, must

you tune up using your station transmitter. The detector circuitry of the analyzer is sensitive enough to detect the milliwatt signal of the oscillator while the station SWR bridge expects to see from 1 to 100 watts to make it read correctly. This low power oscillator assures you'll have a non-interfering signal while you are matching your antenna.

Does it work? Absolutely! **Fig. 1** shows how I hooked up my station. The antenna switch is simply a two-position antenna switch. Several companies, including MFJ, Daiwa, and B&W, make these coaxial switches.

**"MFJ has just what you need—their MFJ-259 antenna analyzer."**

still be placed on the air to fine-tune for the lowest SWR. While this latter operation is performed, the rig is connected to a working antenna and your signal will probably be making someone somewhere cuss you out. What you need is a way to adjust your antenna tuner to a perfect 50 ohm match while keeping your signal from radiating.

MFJ has just what you need—their MFJ-259 antenna analyzer, and it covers the range from 1.8 to 170 MHz, providing a readout of both your SWR and the RF resistance, using two separate panel meters. The 259 is small enough to be used portable and can be run on internal AA batteries or from a power cube in the wall. The unit has a built-in 10-digit LCD frequency counter which provides a readout of your frequency. It has a tunable oscillator which provides a substitute signal for the transmitter. Yes, the internal oscillator, when used as an SWR analyzer, will put out a signal which can be heard by a nearby station, but it is magnitudes less than when

Actually, I replaced the switch with an old coaxial relay so I can change from Tune to Operate with the flip of a small toggle switch. You may have to shop some flea markets to find a coax relay.

To tune my rig I flip the switch (S1), turn on the antenna analyzer, and set the oscillator to the frequency I want the antenna tuned to. I tune the antenna tuner to the minimum SWR on the analyzer meter and ignore the SWR meter in the tuner, since the signal from the analyzer is so very low that these meters do not even move. I also have a manual antenna switch (S2) which switches my transceiver output to a Heath Cantenna oil-filled 50 ohm dummy load. When the transmitter is matched to 50 ohms (thanks to the dummy load) and the antenna coupler input is matched to 50 ohms (thanks to the MFJ antenna analyzer), all I need to do is set the switches so the transmitter output connects to the tuner and I know I am sending maximum output to my antenna. I haven't placed my 100 watts on the air to get tuned up yet.

By the way, just to check and see if tuning the transceiver/SWR bridge/antenna coupler combination can be improved by tuning the conventional way, I tried it. I found I was tuned up perfectly.

The MFJ Antenna Analyzer is one of most useful ham tools I've ever owned. I've used it on all my antennas, including my mobile station. With my 259 I have found resonant points where I never expected to find them. For instance, I found that the Hustler antenna, with almost any resonator, also resonates at 6 meters with the resonator becoming a trap and resonating only the vertical shaft. That's pretty handy for some of those new HF mobiles which include 6 meters.

In addition, the oscillator in the 259 is very useful as a signal generator. You say the band sounds dead? When I wonder if my receiver has stopped working on a band, the 259 provides a quick answer. The frequency counter in the 259 is also often helpful.

Remember, the unit covers up to 170 MHz, so you can check all those 2 meter antennas. It is great to have an instrument to use in setting element lengths and matching networks for antennas you're building or have picked up at a hamfest. 73

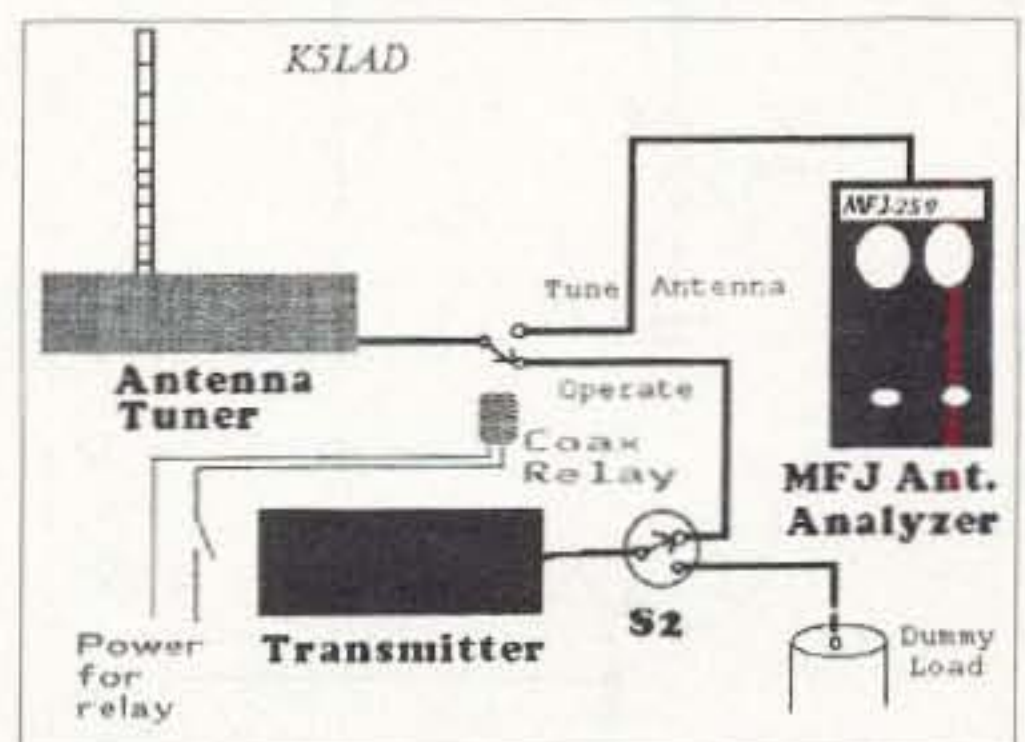

**Fig. 1.** Note that you can't feed the rig into the analyzer, frying it.

# The Wonderful Twin-T

*It's a code oscillator, a transistor tester, or even a piano. Start building!*

Herbert Foster AD4UA  
3020 Pennsylvania Street  
Melbourne FL 32904

This little treasure has so many uses that you'll be building a bunch of 'em. It's an audio oscillator that uses no inductors of any kind. The only reactive parts are three capacitors. Add a few resistors, one of which is adjustable, and almost any transistor you have in your junk box, and you have the Twin-T circuit. It's super reliable, simple to build, and the few parts are cheap. It lends itself to just about any style of construction. It puts out a nice clean sine wave and is stable as the Rock of Gibraltar. For stability, it's almost as good as a crystal-controlled circuit, and a heck of a lot cheaper. Experimenters can have a grand old

time with the Twin-T. So why hasn't it been more widely written up and talked about? I've often wondered.

It's a form of phase shift oscillator. Any oscillator is nothing much except an amplifier with its tail in its mouth. If you feed back some of the output to the input, in enough amplitude to make up for any circuit losses, and in phase with the input, it will oscillate.

Shack™ sells a multi-turn pot that adjusts with a screwdriver and gives a very wide range. Buy a RS Catalog No. 271-343. It's a 10k pot with a screw adjustment that takes 15 turns to get from one extreme to the other. Any transistor that I've tried in this circuit has worked. You just need to see to the correct polarity of the power supply. In

---

***"Any transistor I've tried has worked in this circuit."***

---

There's another phase-shifting circuit I've played around with that also uses a few capacitors and resistors, but the attenuation in the network is so high that the amplifier needs plenty of gain in order to get the needed amount of feedback. The Twin-T, with less loss in the circuit, does this with ease. With any given set of values in the parts of the two T circuits, at some frequency the phase from output to input will be shifted by exactly 180° and at this frequency, oscillation will take place.

The output can be taken through a capacitor of any reasonable size, .01 to .05  $\mu\text{F}$  being the usual. You can connect an earphone here and get a good signal, and you can also feed this point into an amplifier circuit.

For the resistive leg of the T, use two resistors of the same size. You can start with about 39k, and a .01  $\mu\text{F}$  capacitor in the T branch of that leg. For the capacitive leg, use a couple of .01  $\mu\text{F}$  capacitors, but make the resistor in the T branch adjustable. Radio

experiments I've run, 6 to 9 volts will do the job.

Although I'm showing the circuit values I've used, be sure to play around with your own values and see what you can do. You might even invent something! If you've been looking for a simple circuit with which to try your hand at making a PC board, you can't go wrong with this one.

## Uses for the Twin-T

After you have your Twin-T running, and have marveled at its simplicity, it's time to consider the many uses to which the Twin-T can be put. Perhaps the first one that comes to mind is a code practice oscillator. You can build one into a very small container and fit a straight key into the hot lead of the battery. Add an earphone, and you're home free. If you'd rather have a speaker going, go back to Radio Shack and buy an Amplified Speaker System, Catalog No. 32-2031A. It runs off of four C cells or a 9-volt wall transformer.

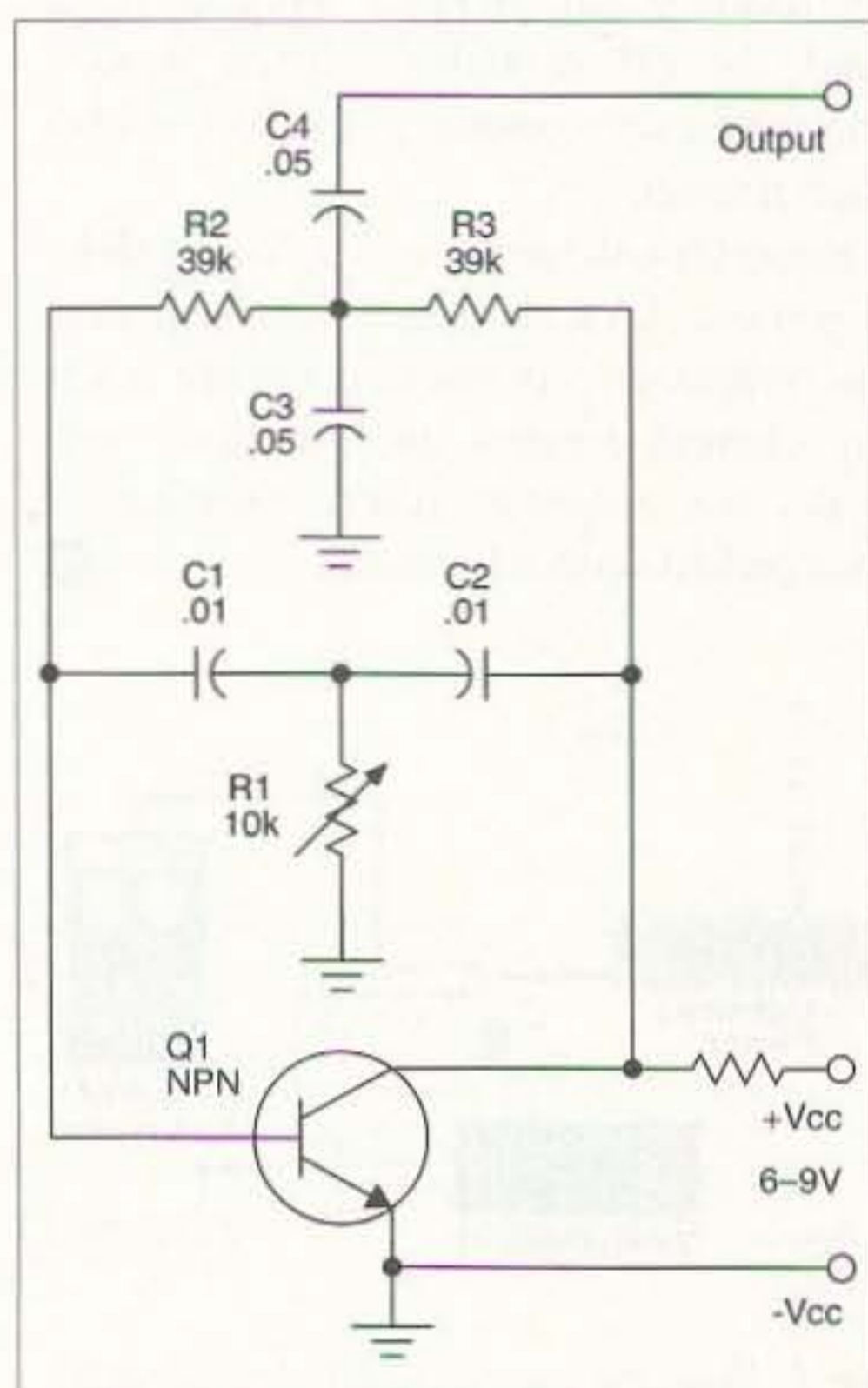

Fig. 1. Basic circuit for the Twin-T.

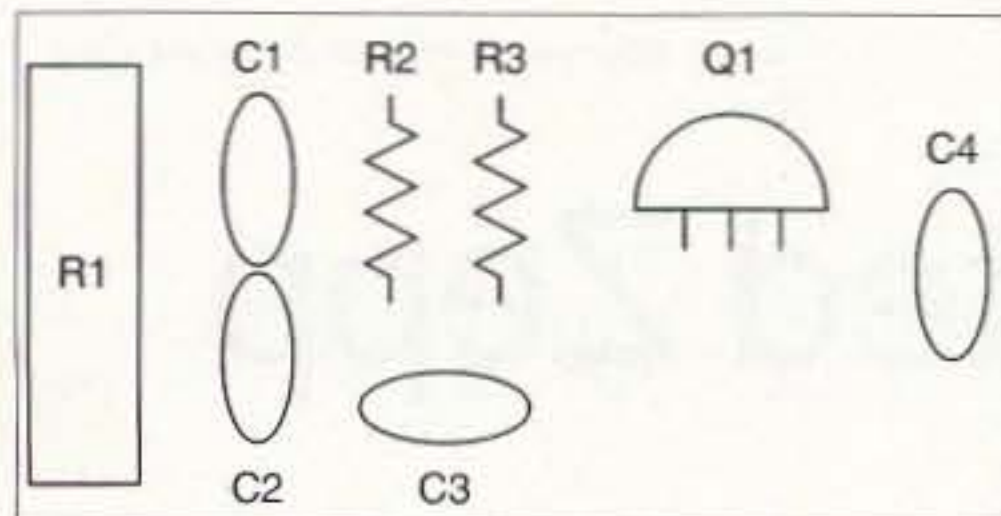

Fig. 2. Suggested parts placement on a 1" x 3" perf board. Use hook-up wire to connect the points. Place R1 so that the screw is accessible.

If you build your Twin-T on a small piece of perf board or as a printed circuit, you'll find that a small piece about 1" x 3" will take the entire circuit. This board can now be installed into the Speaker System mentioned above by simply placing it inside the enclosure. You'll find buckets of room where the small board can be placed. There's no real need to fasten it down. It will easily stand on the wires leading to the battery. Trace the positive lead from the battery holder to the ON-OFF switch, which is located on the amplifier board. Carefully tack-solder a wire to the load side of the switch, and run it through a straight key to the positive voltage input on your Twin-T board. Run a wire from the negative battery holder to the negative input on your board, or just connect that point to the amplifier's ground point; that's all it takes. If you now turn the system on, hold the key down, and advance the volume control, you should hear the Twin-T putting out a nice clean signal. You can then adjust the multi-turn pot until the frequency is satisfactory. If you are unable to reach the pitch you want, try different sizes of resistors in the T branch containing the two resistors. Just remember to use two resistors of the same size.

For another use of what you've just made, remove the straight key and replace it with a momentary contact push-button switch. Install this in the top of the amplifier case. It's a good idea to include a pilot light. Use an LED in any color you like for this. You now have a very good oscillator for use in zero beating a CW station. Set the pitch to equal the offset frequency of your transmitter. I have such a gadget right beside my transceiver and use it any time I'm up in a

CW mode. I've also made copies of this and presented them to friends. They invariably like it. You will too, if you try one.

If you build this version of the Twin-T, be sure to add a pilot light in the top of the amplifier case. Without one, it's easy to forget that the zero-beater is on, and walk away to do something else while your batteries run down. The push-button switch, of course, goes in series with the battery lead to the Twin-T board. This version takes an NPN transistor.

The Twin-T will start every time, all the time, with never a miss or hang-up. This makes it ideal for a musical instrument. With such an inexpensive circuit, you can easily make a discrete circuit for each note. About two and a half octaves will make a keyboard that any kid will have a ball with. If you are also into woodworking, you won't have much trouble fabricating a piano-like keyboard. A fast trip to your local library and an inquiry into electronic musical instruments will give you the frequencies needed for your project. Or just visit any well-stocked music store and buy a circular pitch pipe. You can easily adjust the various notes in one octave by checking the aural beat note between your oscillator and the pitch pipe.

A few words about an aural beat note and how to use it might be in order here. With the oscillator working, and connected to a speaker, blow into your pitch pipe. You should hear both notes. If they are reasonably close in frequency you'll hear a rapid flutter superimposed on them. As you adjust the screw on the multi-turn pot, the frequency of the Twin-T will change, and the flutter will become faster or slower, depending on the direction of the adjustment. If your adjustment is in the correct direction, the flutter will become slower. As you get closer to the correct setting, the flutter will start to sound more like WOW-wow-WOW-wow, as the two notes join in phase to produce a maximum, or oppose each other for a minimum. If you can make the WOW-wow slow down to about once per second, you're within a hertz of the right note. Keep trying, and you'll find that you can

make the wow stop almost entirely. You can beat up and down your keyboard, using the harmonics, to set other octaves.

This will sound odd, but don't try to get precisely on the frequency. If you try for high order precision and achieve it, your instrument will sound lifeless. A true pipe organ, which is the standard against which any instrument is judged, varies slightly in pitch as the pipes and tone modifiers change with humidity and temperature. Electronic organ manufacturers have gone to some amazing lengths in attempts to duplicate this slight dissonance.

Getting back to uses in the ham radio field, consider two of these Twin-T oscillators used as the required tones in checking an SSB transmitter. The big caution here is that the two tones should not be harmonically related. This subject receives a lot of attention in the *ARRL Handbook*.

Because of the reliability factor of the Twin-T, consider using it as a transistor checker. Use three short leads extending from the proper points in the circuit, terminating in small alligator clips. Each lead should be of a different color, no longer than about six inches, and marked for connection to the collector, base, and emitter of a transistor you'd like to test. You'll also need a double-pole double-throw switch to reverse the battery polarity so as to accommodate either an NPN or a PNP transistor. This can not only check the item for operation, but also determine which type it is. If a given transistor oscillates, it's good. Such a tester can even check many transistors in-circuit, as long as the circuit components are not of such a value as to swamp all oscillations. I have such a device in my tool box and consider it to be of great value. If my tester says a transistor is bad, I take it out of the circuit and test it again, before I give it the heave-ho into the trash barrel. But if the tester says it's good, I look elsewhere for the trouble.

You can let your imagination run wild here in playing with this wonderful circuit. Nothing will explode, and you aren't going to disrupt the environment. Furthermore, you don't have to own the keys to Fort Knox to finance your project. Have fun!

# A Kite/Balloon-Supported Zepp for 160 Meters

*Make your antenna fly high!*

Stan Gibilisco W1GV  
2301 Collins Ave. #A 632  
Miami Beach FL 33139

**H**ere's a way to really put out a big signal on 160 meters! Hook your antenna to a balloon for some really spectacular results. I've made a number of changes to improve the efficiency of this antenna since my article "Balloon-Supported Antennas for HF" in the September 1988 issue of *73 Amateur Radio Today*.

## Efficiency without radials

Many people say that a good ground system is necessary for antennas to perform efficiently. This is not true with certain types of antennas. An end-fed antenna does require a low-resistance ground if its input (feed) impedance is low. However, when an end-fed wire antenna measures any integral multiple of a half wavelength, the input impedance is extremely high and a low-resistance ground is not nearly as important. Since a low-loss ground generally requires many radials, an antenna is much simpler, cheaper, and easier to install if its feed-point impedance is very high.

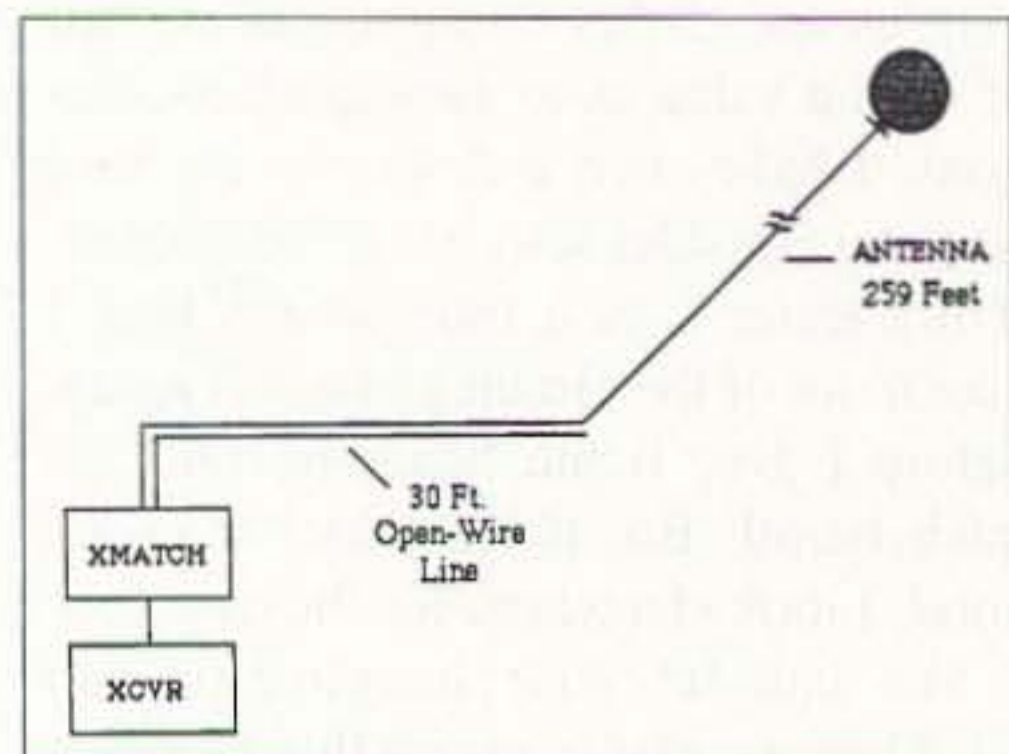

*Fig. 1. Basic scheme for the balloon-supported half-wave zepp. The feedline may actually be any length; it was used primarily to get a good match with a transmatch that could not handle the half-wave antenna alone.*

I chose a length of 259 feet (78.9 meters) for my end-fed wire antenna. This represents a half wavelength at 1.810 MHz. For a 160 meter contest, I planned to operate mostly between 1.800 and 1.820 MHz with the FT-101EE. Above 1.820 MHz, power must be reduced with this transceiver to keep spurious emissions under control, and 85 watts output is little enough power on this band.

I laid down two radials and employed a water-pipe (cold) ground at the station to provide a fair ground system. Using an antenna with a feed-point impedance on the order of several thousand ohms, the ground loss would be low even if the ground resistance were as much as 100 ohms—and that is a pessimistic estimate for the ground system I used.

## Zepp-feed advantages

Unfortunately, my transmatch could not match the extreme impedance of the half-wavelength, end-fed wire antenna to 50 ohms for the FT-101EE. It seems the unit did not have enough inductance to accomplish this, but the transmatch did provide a 1:1 SWR if the antenna were zepp-fed with 30 feet of open-wire transmission line (**Fig. 1**). This may seem strange—that, by introducing reactance into the feed-point impedance, a match could be easier to get than with zero reactance—but apparently the transmatch could tune out reactance enough to allow the somewhat lowered resistive component to be matched to 50 ohms. It worked, and that was all that mattered to me.

With zepp feed, the bandwidth is very narrow and the tuning of the transmatch extremely sharp. I was careful to ensure

that the antenna was exactly 259 feet (78.9 meters) long. I measured it with a tape measure bought just for that occasion! If the operating frequency is much different from the exact resonant frequency of the antenna, the feedline will become unbalanced and will radiate. This occurs a little bit even at resonance, but is not significant over the range of 1.800-1.820 MHz.

Zepp feed has several advantages. It can be used not only with a half-wave radiator, but also with a radiator that measures any integral multiple of a half wavelength. Also, it allows you to locate the antenna feed point away from the station. However, the SWR on the parallel-wire feeder is quite high so it is important to use a low-loss open line. Television "twinlead" is generally not good enough.

## Balloons for calm or light winds

The main difference between my earlier station and the current station is the position of the antenna. In 1987 it was about 25 feet (8 meters) above the ground; now it consists of a sloping radiator with the near end at ground level and the far end about 180 feet (55 meters) above ground. The wind results in a slope of about 45 degrees with the supports described here.

The balloons I used were either 40 inches (1 meter) or 54 inches (about 1.4 meters) in diameter at maximum inflation. I got them, along with the helium gas, from a local welding supply store. I used rubber stoppers to seal the balloons after inflation. A small screw eye in the stopper provided for the connection of the antenna, using a kite swivel (**Fig. 2**).

The antenna wire is Baygard 6 electric fence wire, which is lightweight and quite strong. The conductors are aluminum so the wire has excellent conductivity and low loss. I backed up this wire with nylon twine in case the wire came loose. You don't want to have the balloon fly away with all or part of the conducting line dangling from it!

For increased stability in light-to-moderate winds, glue a disk to the stopper (Figs. 3 and 4). This tends to deflect air downward. I have used disks of about three feet (one meter) in circumference with success to prevent the balloon from "heeling over" and becoming nearly useless in winds of 10-20 miles per hour.

Another stabilizing method is to use a kite in conjunction with the balloon. A dime-store variety eddy bow kite works well for this purpose. The kite is flown with the balloon behind it (Fig. 5). It is important to attach the kite securely to the balloon. You may need a heavier bridle on the kite than if it were flown alone. Also, the kite and antenna must be light enough for the balloon to lift them when the wind dies down.

### The antenna spool and safety precautions

The antenna wire and tether cord may be wound on an electric cord spool, available in most hardware stores. This spool allows rapid retrieval of the antenna and easy extension. It also provides a way of anchoring the antenna. I use a belt with extra holes punched in it to fasten the spool to a tree or other anchoring post (Fig. 6). A small insulator is attached at the end of the antenna to reduce end effects. The feedline is connected with a clip lead, as shown. It is important to fasten the whole assembly securely at all splice points.

There are several safety considerations that must be observed when an antenna of this type is used:

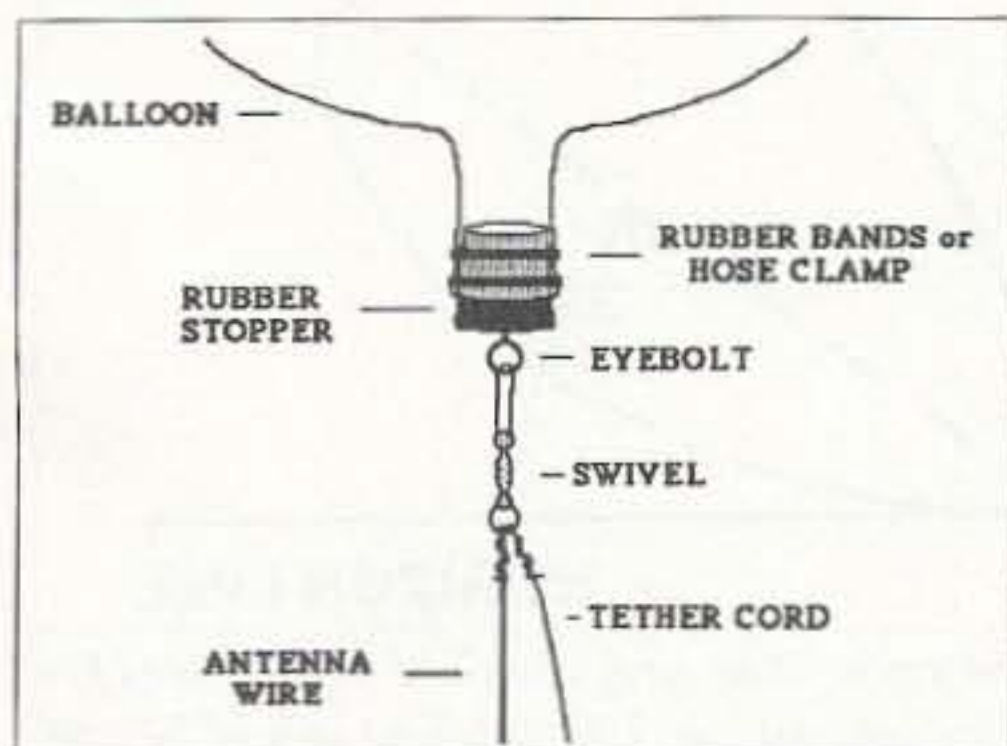

Fig. 2. Base attachment for connecting the balloon to the antenna wire and tether cord.

- The antenna must be shorter than the straight-line distance to the nearest above-ground utility line. The reason for this is obvious if you value your life!

- An atmospheric charge may develop on the wire, even in clear weather, so be careful because you can get a severe shock from the antenna wire when it is fully extended and not connected to the transmatch. A grounded wire may be used to discharge any potential before touching the wire.

- This type of antenna should never be flown during severe weather conditions or near thundershowers.

- It is best not to fly this type of antenna where it may come down on a roadway or other congested area.

- Federal Aviation Administration regulations require that a kite or balloon not present a danger to people, property or other aircraft. Further, balloons greater than 6 feet (about 1.9 meters) in diameter, or kites that weigh more than 5 pounds (2.27 kilograms), require special FAA permission before being used. (These large devices are not normally needed for amateur antennas.)

### Larger kites for moderate winds

In winds gusting to more than about 20 miles per hour, balloons do not behave well, so it's better to use a kite. A good choice for this purpose is the winged box kite, or delta-Conyne. These kites are available by mail from Into the Wind, 1408 Pearl Street, Boulder, CO 80302. Other types of kites that work well are the plain delta and the airfoil or Parafoil design.

Some larger kites, especially the delta-Conyne and airfoil, will pull hard, with up to 150 pounds of tension. A strong tether line is a necessity for these kites. Also, larger kites will have sufficient pull to require more sophisticated reel-in devices than the simple cord spool. Generally, a parafoil should be eight square feet or less, and a delta-Conyne should have a wingspan of eight feet or less. This is all that is required for a half-wave or even a full-wave 160 meter antenna.

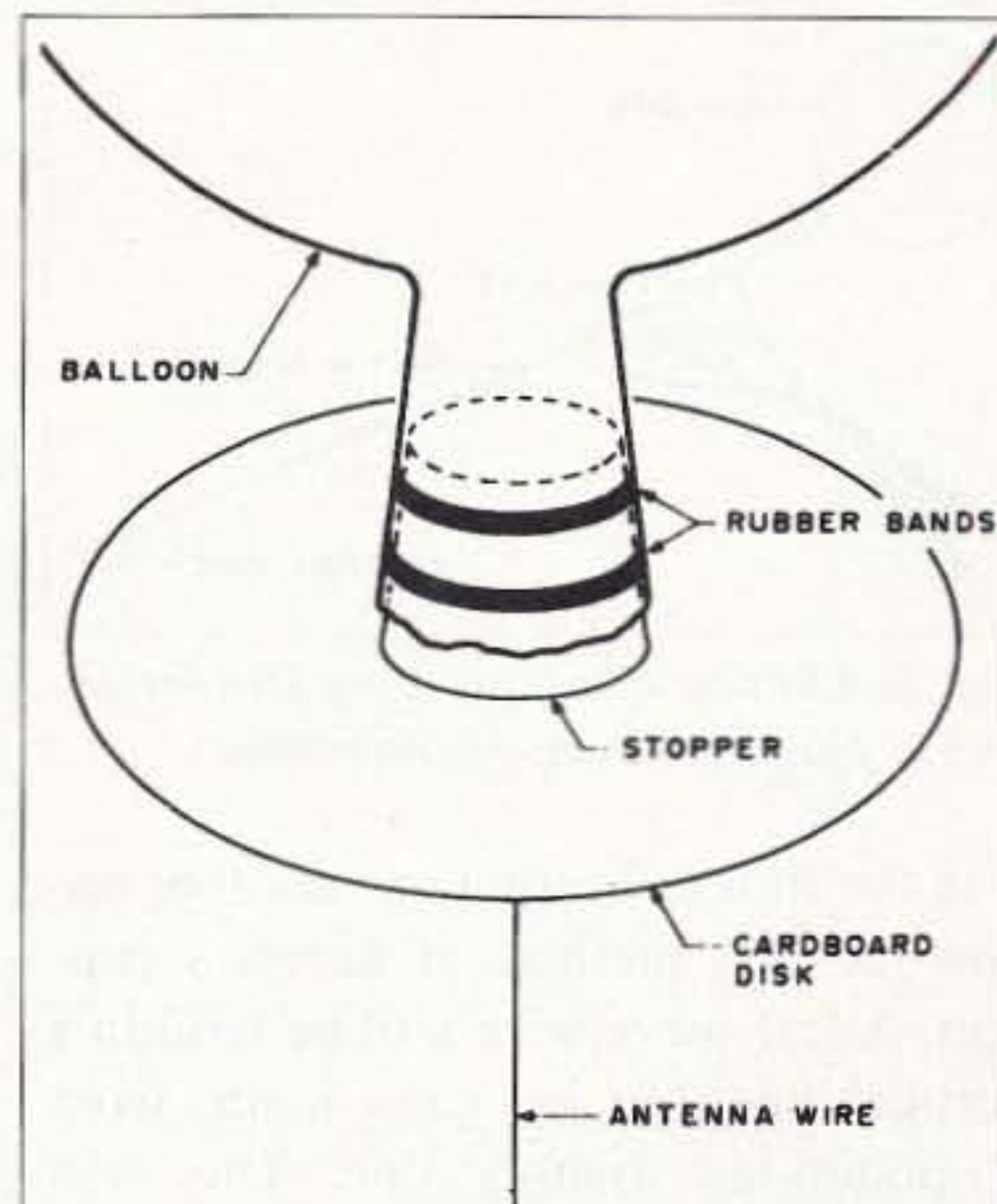

Fig. 3. Addition of a stabilizing disk for better balloon behavior in light-to-moderate winds.

### For the future

The antenna at WIGV during a 160 meter contest in 1988 was what I call a "balloon sloper." On the first night of the contest, December 3, the wind was from the southwest. Therefore, the optimum direction for the sloper was toward the southwest, and the worst direction was northeast. On the second night the wind was from the north-northwest, shifting to west. The optimum direction for propagation was therefore north-northwest, and shifted to west later on.

For a domestic contest, such as a 160 meter contest, moderate-to-high angles of radiation are actually more desirable than low angles. From the Minnesota location, a north wind is less desirable than a south wind if a balloon or kite is used to support the antenna.

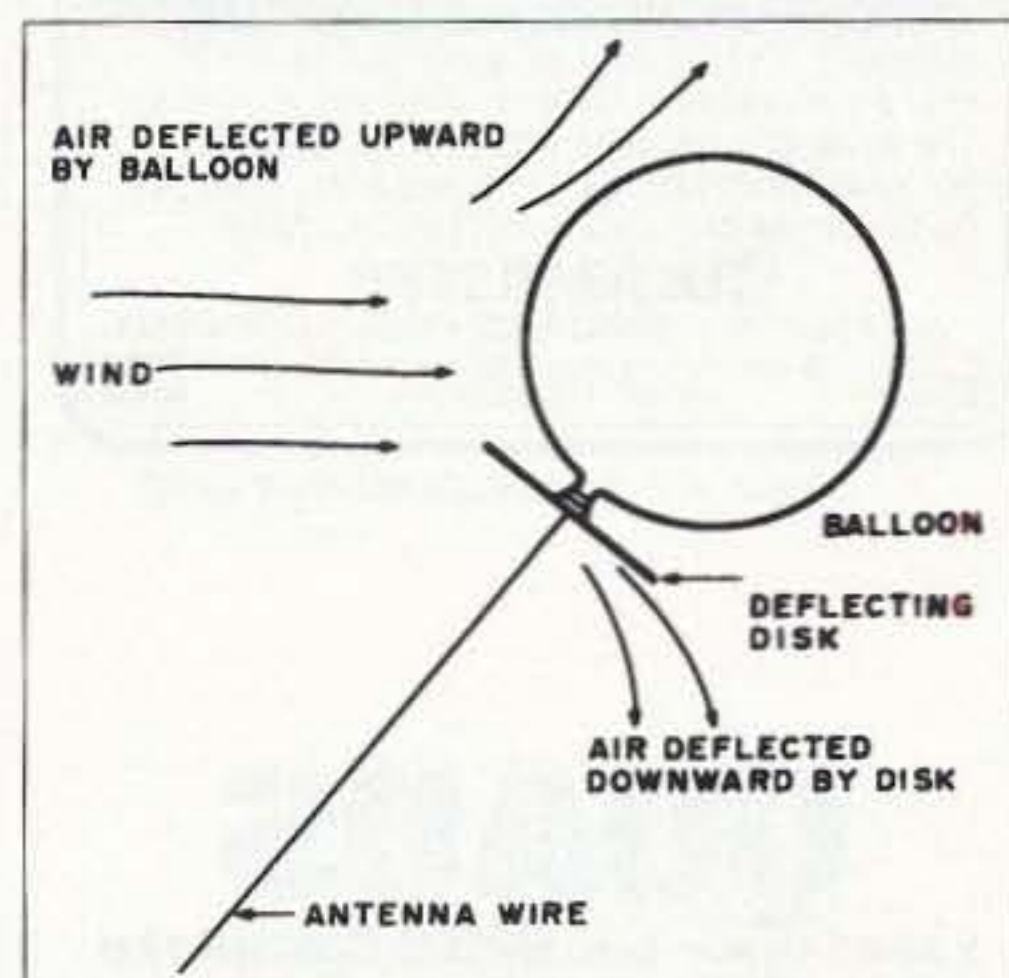

Fig. 4. The cardboard disk serves to stabilize the balloon in winds. The upward force from the disk balances the downward vector caused by air flowing around the balloon itself.

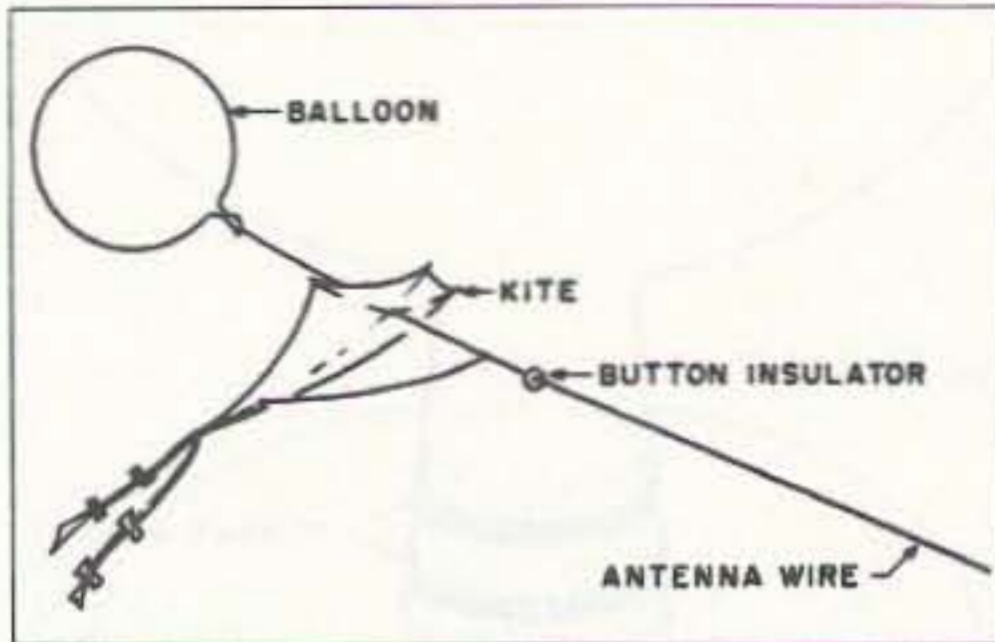

Fig. 5. Addition of a stabilizing kite for improved operation in moderate winds.

In the future, I might use another option for this method of antenna support. A full-wave wire will be held in a vertical position by guys made from 20-pound-test fishing line. This will result in a maximum radiation angle of about 36 degrees with respect to the horizon. The same feed system will be used. The antenna is shown in Fig. 7A, and the radiation pattern in Fig. 7B.

Other possibilities include flying a second wire near the driven wire to get a parasitic array. The second wire could be lengthened or shortened to render it a director or reflector. This scheme would require that the wind be out of the north or south, ideally, so that the maximum radiation would be toward the east or west.

Of course, Mother Nature has something to say. High winds, thunderstorms, ice storms, snow, or heavy rain make it difficult or impossible to fly this type of antenna. 73

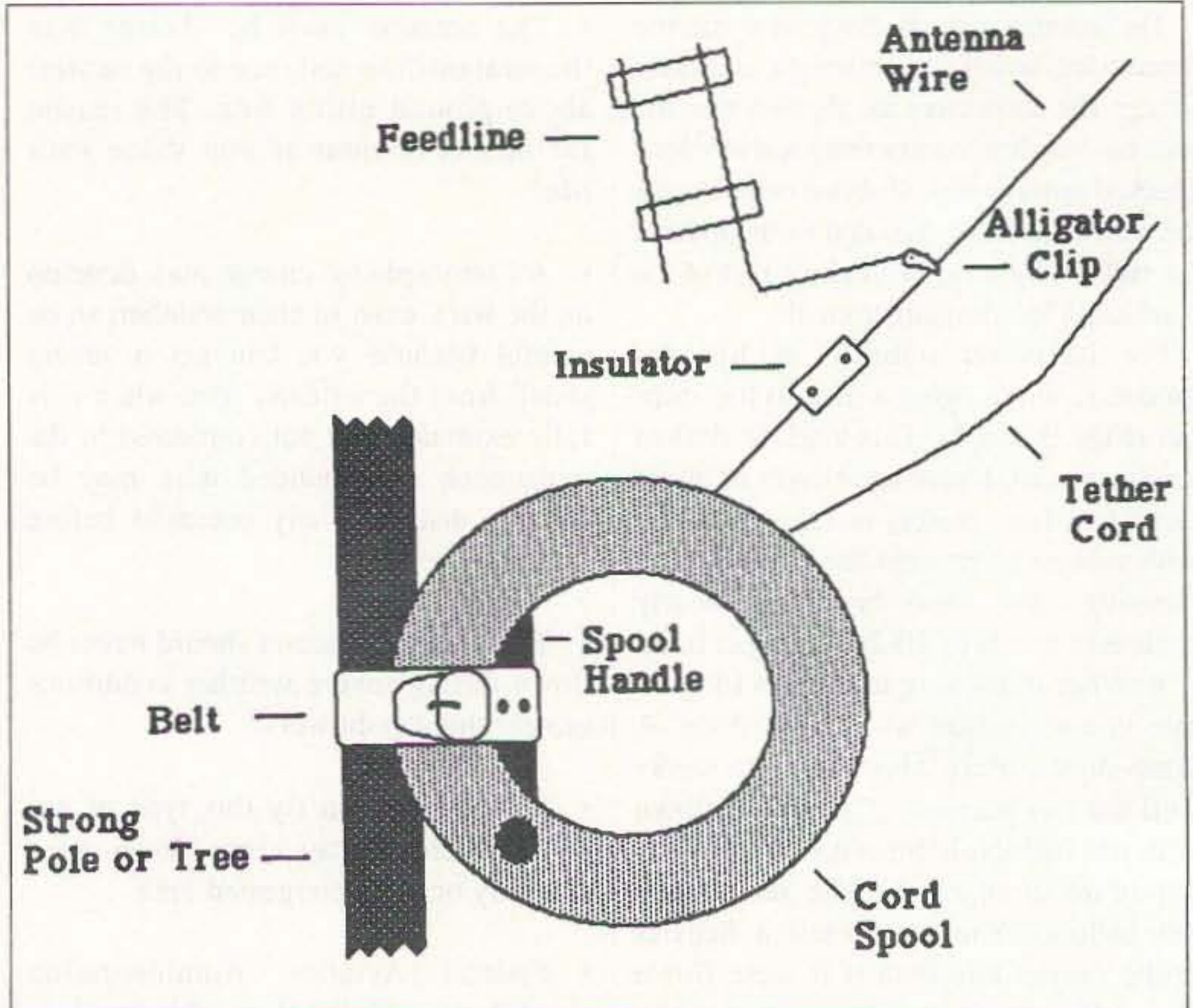

Fig. 6. The cord spool is anchored to a pole or tree using a belt with extra holes to allow it to be strapped tightly. An insulator reduces the end capacitance of the antenna. The feedline is connected with an alligator clip.

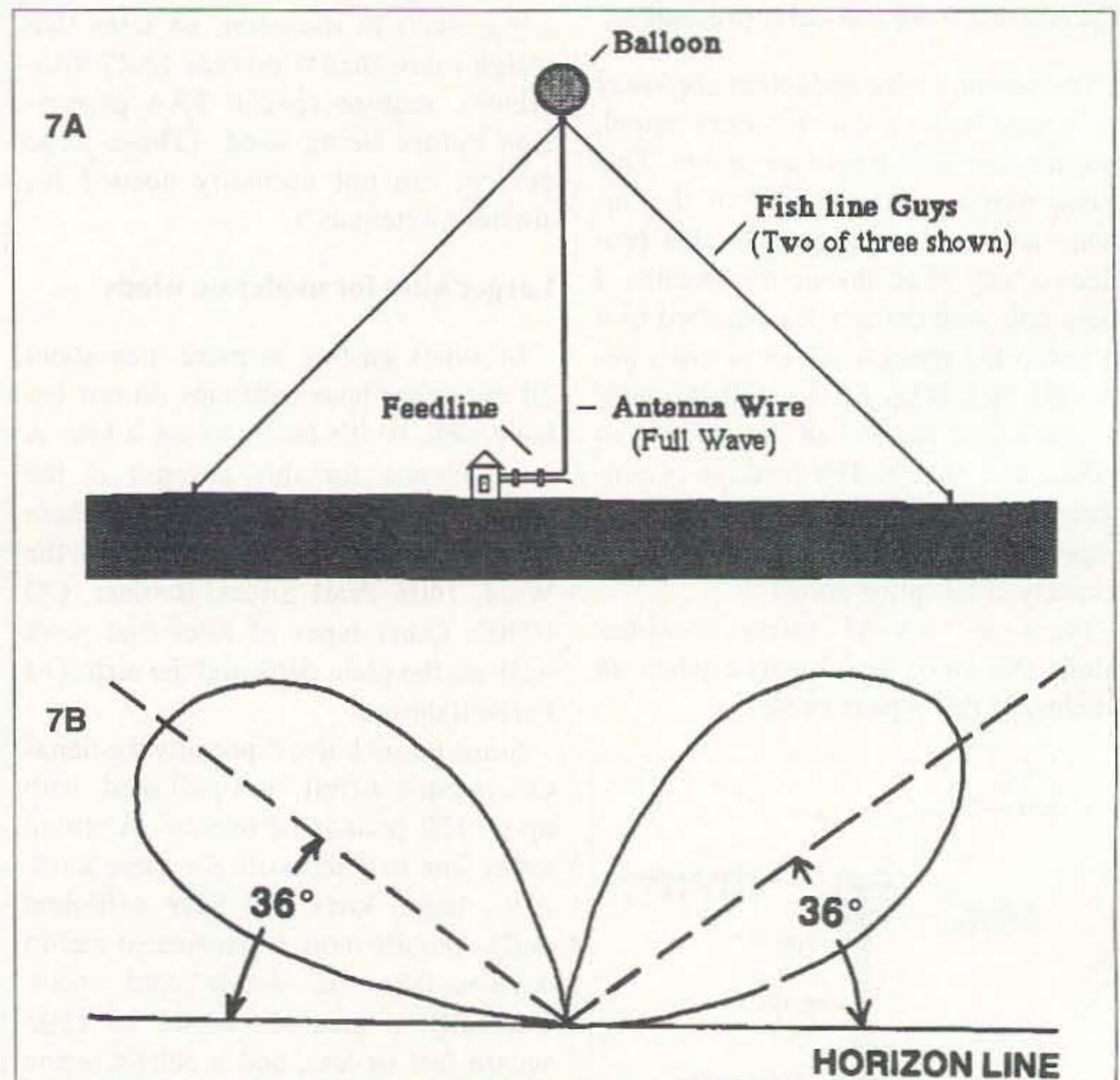

Fig. 7. A) The scheme for a vertical full-wave antenna. The height would be 530 feet for 1.810 MHz. B) The expected vertical-plane radiation pattern. The antenna would be omnidirectional in the horizontal plane and would theoretically provide excellent stateside performance from a central location such as Minnesota.

**"ONLINE" U.S. & INTERNATIONAL CALL DIRECTORY**  
 Hamcall's "Online Service" gives you access to over a million hams via your computer & modem. The latest data, updated every month! *Only* \$29.95 per year. Unlimited use--24 hours a day--you pay for the phone call. Call today 800:282-5628!

**BUCKMASTER**  
 540:894-5777 • 800282-5628 • FAX 540:894-9141  
 6196 Jefferson Highway • Mineral, Virginia 23117  
 Internet: info@buck.com

CIRCLE 7 ON READER SERVICE CARD

**QUADS**  
 5 Band 2 Element Quad **\$289 Complete**  
 Many other models available  
 Call for brochure today.  
 UPS Shippable

**Lightning Bolt Antennas**  
 RD #2, RT 19, Volant PA 16156  
 412-530-7396 FAX 412-530-6796

# My Indoor Antenna Farm

*Yes, you really can work DX with a stealth antenna.*

Robert W. Vreeland W6YBT  
45 Maywood Dr.  
San Francisco CA 94127

Radio operators of the French Resistance often used indoor antennas with satisfactory results. A typical Type B Mark II suitcase radio had a 6L6G final with an output of about 20 watts. The recommended antenna installation zigzagged wire across the ceiling to form a top capacitance. Another zigzag on the floor served as a ground counterpoise. The vertical portion that did most of the radiation was only about eight feet long.

Indoor antennas have several advantages. First, they are out of sight (my years on the TVI Committee taught me that the ham with the highest tower got

the most complaints.) Second, the antennas are protected from the weather, so they can be built without elaborate waterproofing or windload requirements. And third, no dangerous roof or tower climbing is required.

wide range. However, I didn't want to bring the open wire line down to the operating position. I then considered a half-wave voltage-fed loop. As in the case of a half-wave dipole, the ends of the loop would be very high voltage

---

***"Tar paper, shingles, and a half inch of plywood are all that stand between my 20 meter dipole and Japan."***

---

I prefer to have a separate antenna and tuner for each band. The antennas can then be pretuned and simply switched for band changing. My QTH is an English Tudor style house on the western slope of a hill. It has a peaked roof with a 17 in 12 slope. Only tar paper, shingles, and a half inch of plywood stand between my 20 meter dipole and Japan. The front of the house is 35 feet wide, just right for a 20 meter dipole (**Fig. 1**). In order to reduce transmission line loss, I have placed my 10 meter dipole in the back attic, right above the operating position. The dipole I use for 40 and 15 meters runs from the front of the house to the rear, then makes a 90-degree bend into the attic, where the walls are filled with insulation backed with aluminum foil. The foil-backed insulation is also laid over the ceiling, thereby insulating the attic from the living area. Of course, the unbonded aluminum foil is not a good electrical shield, so it has minimal effect on the antenna system.

What about 75 meters? A 120-foot dipole just wouldn't fit. A quarter-wave dipole fed by a quarter-wave resonant open wire line was a possibility. This was an attractive choice because the line would actually be part of the antenna, thereby permitting tuning over a fairly

points. This called for the use of a quarter-wave open wire feedline. You will recall that a quarter-wave line with a short or a very low resistance at one end will have a very high impedance at the other end. In order to avoid bringing the open wire line into the shack, I used 70 ohm transmitting type twin lead for the last 11 feet. This twin lead is no longer manufactured but you could use RG-8/U instead, if you are not too fussy about maintaining a perfectly balanced line. Actually, I added 15 feet of RG-8/U between the antenna switch where the 70 ohm line terminates and my Yaesu FC-757AT antenna tuner. The VSWR at the tuner output is 3.5 at 3775, 1.7 at 3880, and 3.1 at 4000 kHz.

Number 14 insulated house wires, spaced at four and a quarter inches, were used for the open wire line. It is 45.5 feet long. The spacers were cut from one-inch PVC water pipe. The loop itself is a single run of number 14 house wire extending with numerous bends all the way from the front of the house to the back attic and back. Its total length is 146 feet. This length was determined by the reliable cut-and-try method. Due to the presence of metal gutters and chicken wire lath, all of the antennas

*Continued on page 31*

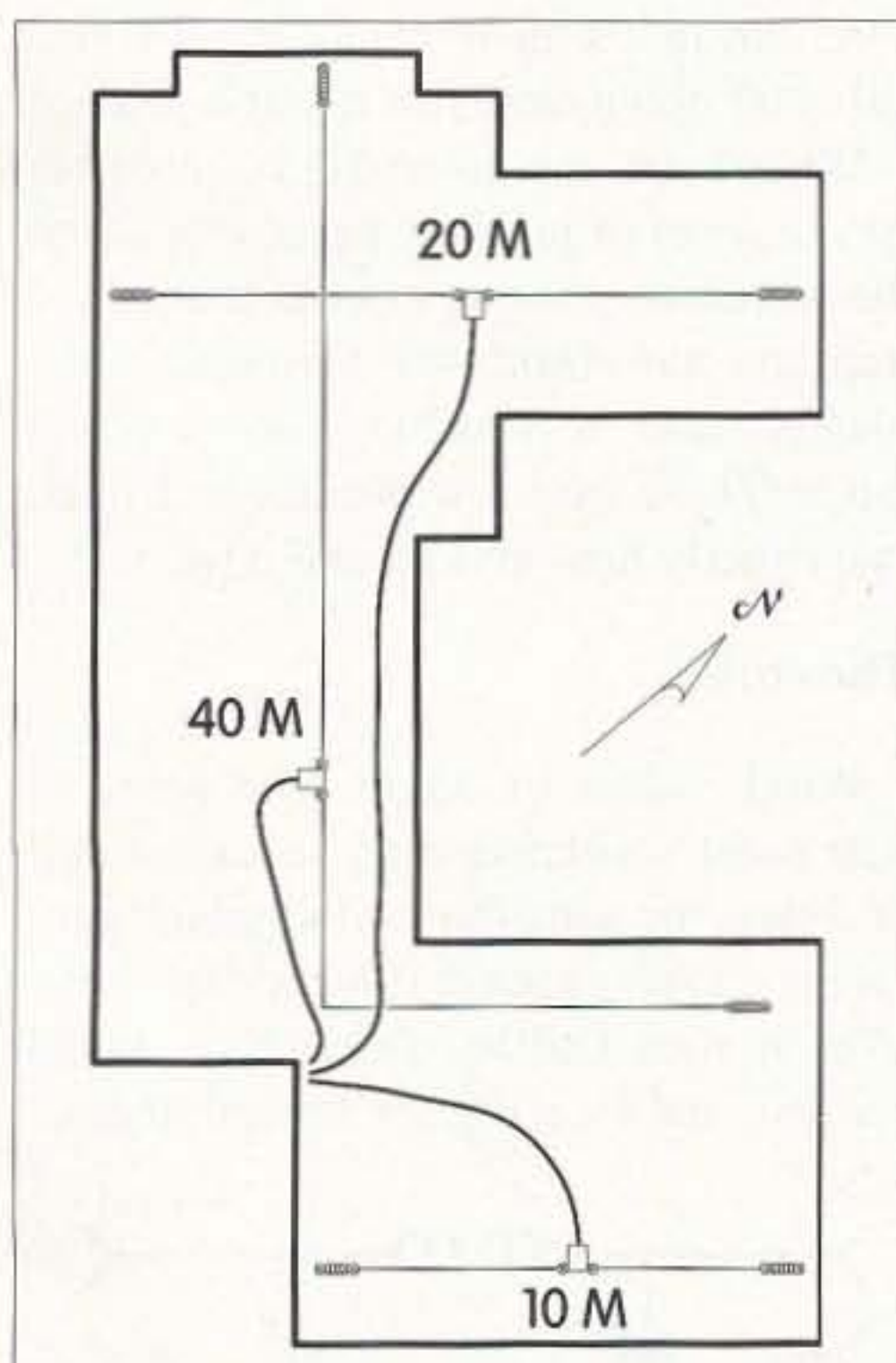

**Fig. 1.** The 20 meter dipole fitted perfectly into our front attic. I installed the 10 meter dipole in the back attic, leaving plenty of room for a 75 meter loop and a dipole for 15 and 40 meters.

# Off 2, 4 Good

*Cheap and easy fixes for TVI.*

Terry Staudt WØWUZ  
616 N. Sheridan Ave.  
Loveland CO 80537

Though I wasn't the father of the coaxial ground, a claim to being the first cousin is in order. I honestly felt, through personal experience and feedback from many other hams, that it was the end of TVI. That was until a neighbor acquired a projection TV and antenna designed for use on Wyoming ranches in the back of beyond.

My transmitter is clean, and I always check my stuff and ask around to see if anyone has a problem. If and when they do, it's usually evident when I'm standing there talking to them—so that lets me off the hook.

It would seem that my neighbor with the projection TV had a problem. Bear with me, as it's a little difficult. Channel 2 in Denver shows rather good movies with commercials that approach the threshold of pain, but know how to stop just in time.

TVI had gone from the old days, when wiping out the channel was cause for concern, to the present, when a 10% reduction in color is enough to cause the neighbors to storm your lawn with pitchforks and flaming torches. This calls for the best effort from all of us, considering the alternative.

Hey, I've got the same problem, I hear you cry. Here's the reason and some cheap positive steps to fix it.

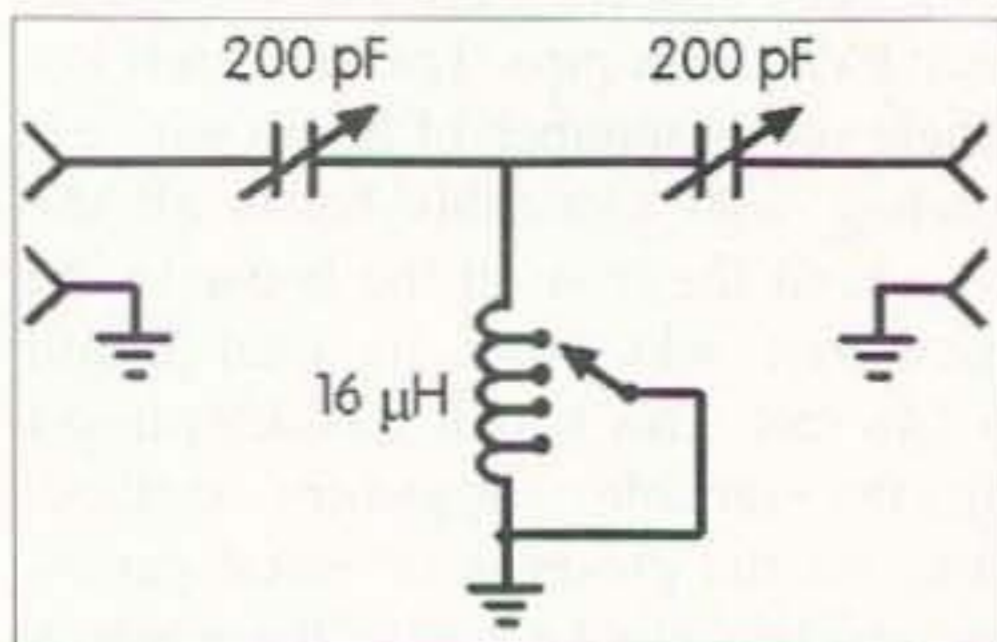

Fig. 1. The T-match.

## The pi-network

Like a lot of you, I use a T-match antenna tuner—a little MFJ-943 that works just fine and is identical to almost every unit on the market. The fault with the T-match is that while it's able to load a coat hanger, there is almost no harmonic attenuation, which I need to protect my neighbor with the sensitive TV. I use a modified G5RV, a 102-foot dipole fed with 300-ohm twinlead. Really, all you need with a resonant antenna is a line flattener. Using a T-match is overkill when a pi-network will do. In addition, the pi-match gives up to 30 dB of harmonic attenuation and tunes very smoothly. Best of all, it's easy to turn your T-match tuner into a pi-match device.

Fig. 1 shows the schematic of the T-match, listing some common values for the coil and caps. Fig. 2 shows a pi-network that takes about 45 minutes to accomplish with your existing T-match tuner—the only parts needed are a couple of plastic parts drawer dividers to place under the inductor after it's lifted from ground. The capacitors "float" in a T-match, so all you have to do is reconnect the input wire to the output wire and ground the other terminal to an existing chassis point on each.

The lifted ground on the inductor goes to the output lug on the second capacitor. In most cases, the ground wire, if you're using a tapped inductor with a rotary switch, is the one to be rerouted to the output capacitor. Fig. 3 shows the whole modification, which is easily reversible should your circumstances change. You've just spent 45 minutes, and reduced your potential harmonic output by 30 dB.

## Harmonic attenuation

OK. You're using a T-match, and the antenna is a squirrel. What to do? There's an old chestnut that calls for a capacitor of about 5-12 pF to go from the center of the "T" to ground for harmonic attenuation. The problem is that this high "Q," consisting of the capacitor and leads, is resonant *somewhere*—usually not in the area of interest, and about as sharp as a knife as far as bandwidth is concerned.

A check with my Heath solid-state dipper while transmitting on 10, holding it against the twin-lead coming out of the tuner, did indeed show a little something at 57 MHz. A few milliwatts, to be sure, but that's all it takes! The TV signal is far down from this in a fringe area!

What I did was to make a simple series trap out of junkbox parts; that cured the situation completely. A broadband trap lets me absorb the harmonic completely, and is tunable over a small range. There are a few pitfalls, so I'll tell you exactly how to do it and why.

## The cure

Wind a coil of about five turns of #20 solid insulated wire around a roll of dimes (or something of similar diameter), close-spaced (about 0.8 µH). Coat it with DuPont Duco™ or model cement, and let it dry for several hours.

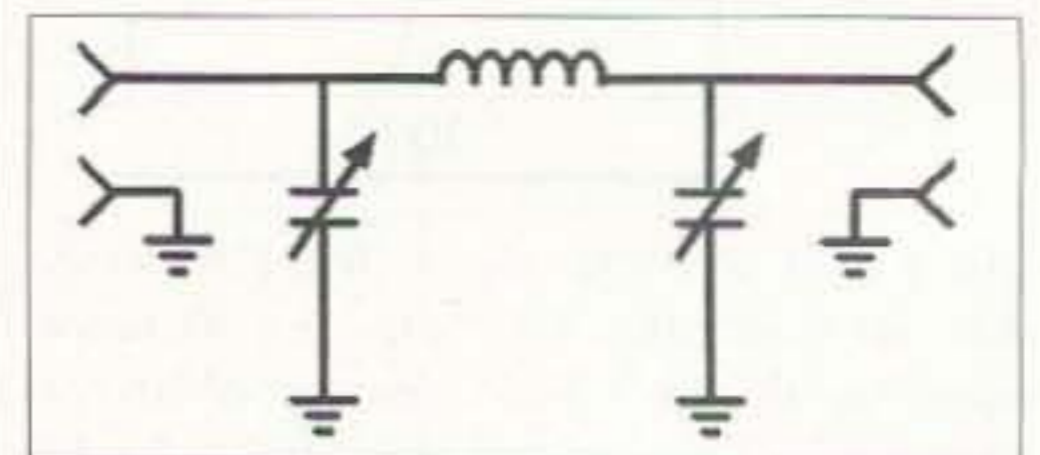

Fig. 2. Pi-match.



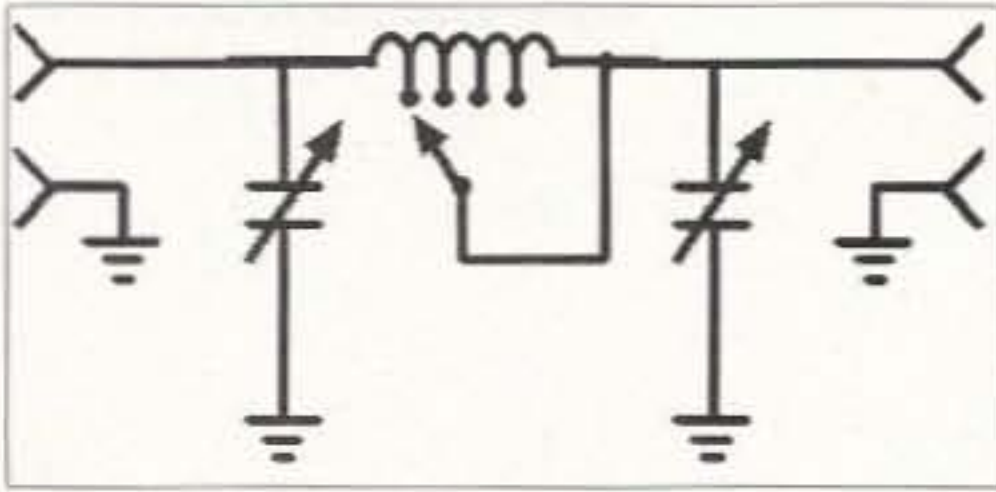

Fig. 3. "T"-to-"Pi" match.

This is a good time to scrounge the parts. You will need a compression mica, a glass piston or small air variable capacitor with a value of about 5-25 pF, a 0.001  $\mu$ F disc capacitor at 1 kV or higher if running more than 100 watts, and two 100 ohm, 2 watt resistors. These are assembled as shown in Fig. 4, with the two resistors in parallel, to make a 50 ohm load to absorb the harmonic. Just shunting the little devil to ground won't cut it, as all you've done is attach it to the chassis of the tuner to radiate in fine style.

The procedure is quite logical. While transmitting on 10 meters, using a dummy load if possible, hold the dipper coil near the trap coil and adjust the capacitor to null the harmonic out. It isn't terribly critical as the Q isn't sky high—on purpose. It's sacrificed for a bit broader bandwidth. This may be done with someone watching Channel 2 if you don't have access to a dipper. In my case, after I had done this, I put the dipper coil into the tuner inductor and checked from 50-250 MHz to see if there were any more snakes in the grass. If there were, they were hibernating.

### Proper grounding

What the heck is a coaxial ground? It's simply a method of shielding your

ground cable, so any signal radiated off the ground wire is shunted back to ground. Despite having been printed in four publications at least six times, many hams have never heard of it. These hams are also the same fellows who have monster RFI problems, while the local "experts" drink all their beer and tell them it's one of nature's unfathomable mysteries. The first thing these poor souls tell me is that they are *positive* every item in their shack is grounded! I don't doubt that a bit.

If manufacturers really wanted to save a little money, the ground connection on accessories would be a great place to start! What that little double-nutted screw on the back of an audio filter, or that #2 copper battery braid, does is set up ground loops that let your RF have the time of its life!

The *only* thing you ground is the *RF generator*—meaning the transmitter or receiver—*not* the linear, tuner, rotor box, preamp, low-pass filter, keyer, phone patch, EXT, VFO, AUX, or the dog. To use the water analogy for RF: *Keep it in the pipe (coax) and let the coax shield do the grounding automatically!* This is so obvious that no one does it.

To make a coaxial or "zero length" ground, you just need two 0.001  $\mu$ F 1kV disc capacitors and enough RG-8X to reach from your rig to the ground rod, which should be at least six feet, driven next to the foundation where moisture is retained. Using a stainless steel worm-driven auto fuel hose clamp, attach the bypassed center conductor of the coax to the rod. Waterproof it with glue, caulk,

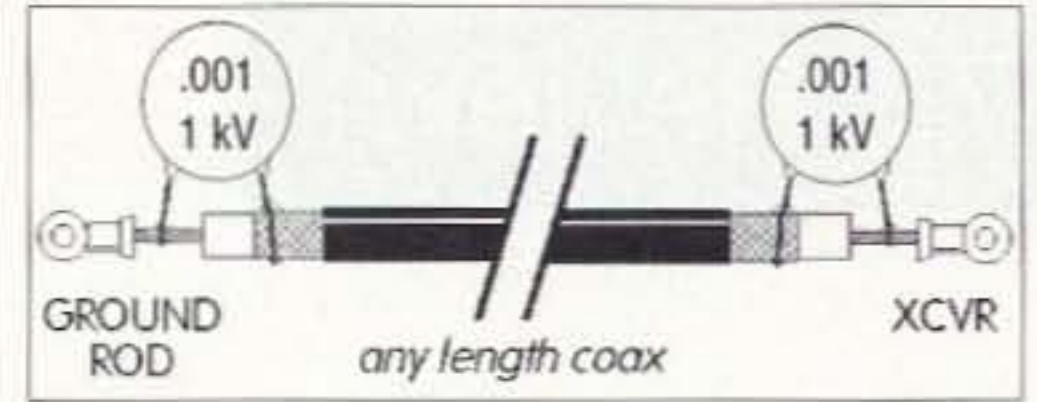

Fig. 5. The coaxial ground.

or acrylic spray. It doesn't matter if you're on the third floor; the ground length is still very short—just a matter of inches. The other end goes to the RF generator. That's the only ground connection you use (see Fig. 5). Use any or all of these methods in combination, and you'll definitely be off Channel 2 for good!

### My Indoor Antenna Farm

Continued from page 29

required pruning. The metal in the structure also detuned the 40 meter dipole, making it difficult to find the electrical center of the antenna. TVI has not been a problem. The small amount of interference introduced by the 20 meter antenna over the family room was quickly cured with a high-pass filter on the TV set itself. The only place where I haven't been able to cure the interference was with the burglar alarm. The sound of sideband audio emanating from the speaker is annoying, but hasn't damaged the unit or affected its operation.

Of course, the indoor loop is not as effective as a full-sized outdoor dipole. It is, however, just fine for working southern Oregon from San Francisco. My friends in Japan and Australia may be interested to know that this was the 20 meter indoor dipole I used to work them with my 20 watt MOSFET amplifier (References 1-2). It just goes to show that a resourceful ham, like the members of the French Resistance, can still make important contacts while keeping a very low profile!

### References

1. Vreeland, Robert W., W6YBT, "Transformerless Amplifier," *73 Amateur Radio Today*, August 1995, pp. 48-54.
2. Vreeland, Robert W., W6YBT, "More Gadgets for your MFJ-9020," *73 Amateur Radio Today*, October 1993, pp. 10-12.

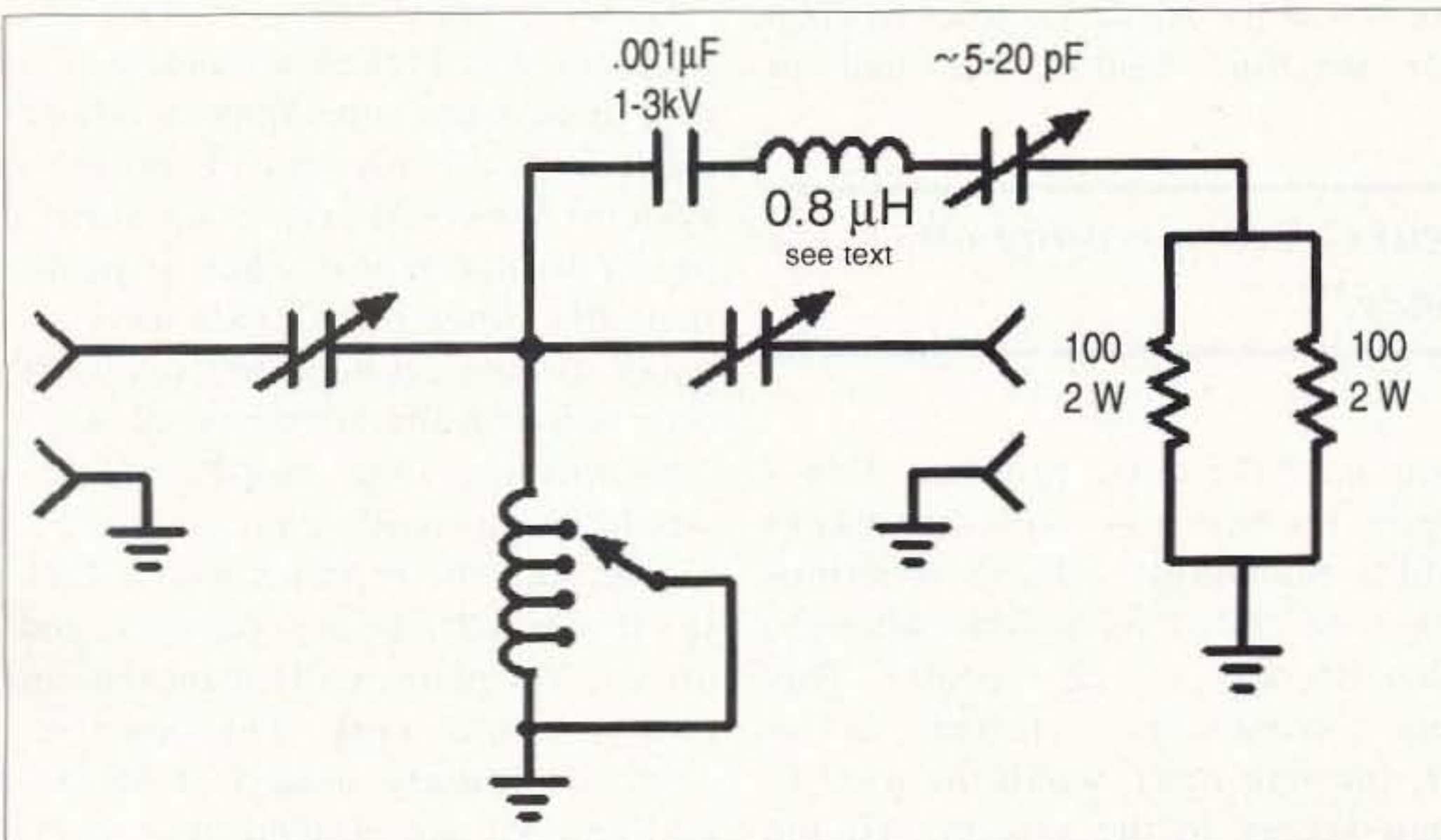

Fig. 4. Channel 2 trap.

## 73 Review

# TD-3 Subaudible Tone Decoder Module

*Hamtronics' kit saves one club's treasury—and provides a group project!*

Larry R. Antonuk WB9RRT  
P.O. Box 452  
Marlborough NH 03455

Our ham club's simple repeater system had been in service for almost five years. It was just a basic controller, with a CW ID, hooking together a couple of converted commercial mobile rigs. The duplexer was whipped up by a couple of the guys in their machine shop. We had pooled our money and come up with enough to buy a real antenna and had talked the cable TV guy into letting us have some space on his tower. Overall, it was a good machine—it rarely needed service, and covered all of the area we were interested in.

The trouble started one winter. We noticed the thing keying up by itself every once in a while. Mostly

RACES guys turned their scanners off at night. Eventually, we were able to make out a callsign or two—from another state. It wasn't just squelch noise we were hearing. The repeater was being keyed up by very weak signals from another distant repeater system.

But wait a minute! These guys were operating on *our* frequency! We were coordinated! As it turned out, *they* were coordinated, too. It was only when some of the mobiles were transmitting from the peaks of high hills that they were just strong enough to key up our machine.

### Finding a solution

Once we knew what the problem was, the solution was simple. At the next monthly club meeting, a proposal was put forth. In order to keep our machine usable, we had to

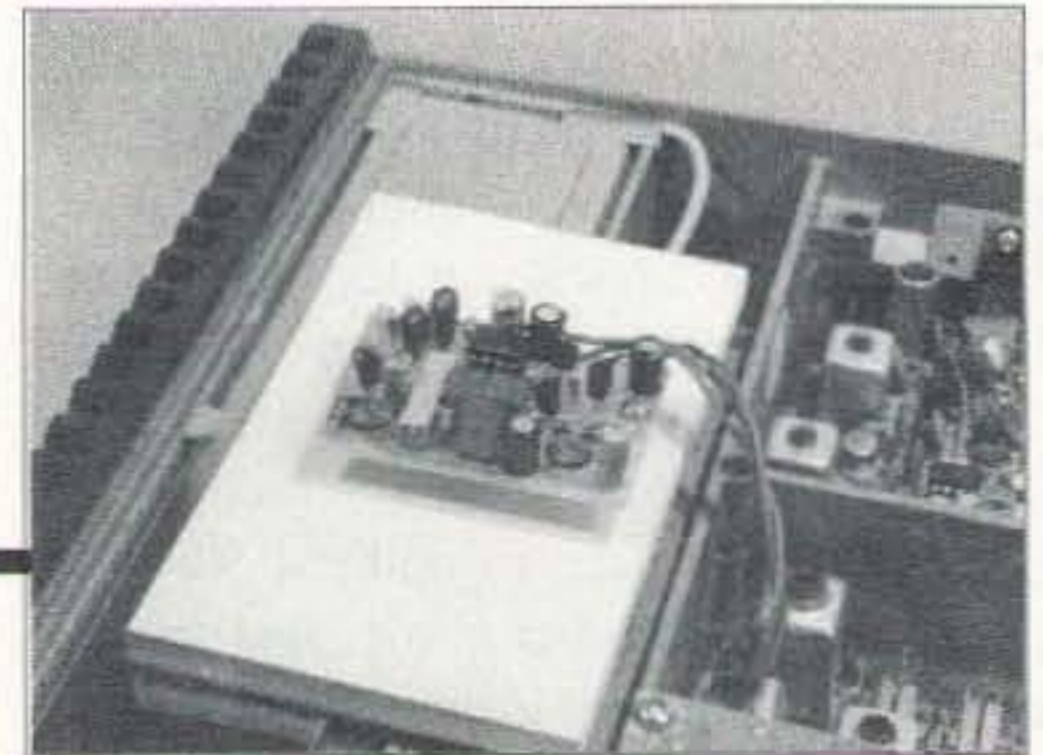

Photo A. The assembled TD-3 Encoder/Decoder ready for final installation in the repeater chassis.

this tone into their synthesized rigs, and they'd be all set. A show of hands, and the proposal was soundly defeated.

Wait a minute! Another show of hands, and the reason became obvious. Only about 10 percent of the active users had rigs that had PL capability. Most of the group had older synthesized rigs, and some still had crystal rigs. No one was willing to shell out the bucks to add a PL encoder to his radio, since they weren't really going to get any immediate benefits from it. The proposal was shelved until the next meeting.

Over the next week or two the problem was kicked around, and a new idea came up. What if those other guys already had PL on their system? We could just set up our repeater to *not* repeat when it heard their PL. Since our signals were always stronger, it wouldn't matter if they were on the air when we were transmitting. Our non-PL signal would just override their weaker PL signal, and the repeater would kick in. It seemed like a good idea, and after a few phone calls it turned out that it would work. The other repeater definitely used CTCSS decoding. All we needed was a PL decoder for the repeater.

---

***“But wait a minute! These guys were operating on our frequency!”***

---

noise, but now and then you could almost make out a voice. We checked the repeater from one end to the other—everything was right up to spec. The noise got worse until it got to the point where several of the locals were no longer monitoring the repeater frequency—it was just too irritating. Even the

eliminate the noise problem. Obviously, the best way to do that was to add a subaudible CTCSS (continuous tone coded subaudible squelch) tone decoder to the repeater. This tone, commonly referred to as PL (private line), would be used to gain access to the system. All the users would have to do was to dial

## Hamtronics to the rescue!

At the next coffee shop meeting of the Technical Advisory Board we looked over the specifications on the various CTCSS decoders. We had several requirements—quality, dependability, ease of use, and customer support. Since the club had an abundance of technical ability and a shortage of funds, we considered building the unit ourselves, but the most cost-effective solution turned out to be the TD-3 Subaudible Tone Decoder/Encoder Module from Hamtronics. The TD-3 was available as a low-priced kit, which made the treasurer happy. It was based on the time-tested NE567 IC, using a straightforward circuit, so there were no custom chips to worry about if it ever needed troubleshooting. It had a built-in encoder, so when the day came that we had to switch over to genuine "PL" operation we'd only have to move a

band, from 63 to 250 Hz, in six different ranges. The proper range is set by changing the value of a resistor connected to the NE567. Once the unit is set to the right frequency the sensitivity is adjusted. This is simply a matter of adjusting a pot until a signal with a minimum amount of tone (we used 200 Hz deviation) can be detected. Normal CTCSS systems like to see anywhere from 300 to 600 Hz of deviation. Adjusting for slightly less than the minimum value lets you accommodate radios that may be a little out of alignment, without being so sensitive that the unit falses on voice audio.

### The results

Once the TD-3 was assembled and tested, we went to the hill. The TD-3 was designed for use with the Hamtronics line of repeater controllers. It normally inhibits the COR signal from the repeater receiver, preventing repeater PTT until the

the PTT transistor, which prevents it from keying up the repeater.

As a final check, we put the repeater on the air and ran some tests with mobiles and handhelds in our area. We found that even when the repeater was inhibited by a distant signal, a local handheld was able to overpower the weaker signal and hold the repeater on without any dropouts or flutter. The operation was a complete success!

The TD-3 has been in service for quite a while now and has survived lightning strikes, power surges—and a small family of mice that moved into the repeater cabinet. We saved a good deal of money by building it ourselves and are fully prepared for the inevitable day when we'll have to switch over to conventional CTCSS operation. Most importantly, the repeater is quiet. If we hear something, it's a legitimate user using the system. The RACES team is once again monitoring the local channel. The TD-3 Subaudible Tone Module comes highly recommended.

For more information, contact Hamtronics, Inc. at 65 Moul Road, Hilton NY 14468-9535; phone (716) 392-9430. 73

---

*"The board was finished in about 45 minutes, even with the 'help' of three kibitzers."*

---

couple of wires. Best of all, the TD-3 was backed by the folks at Hamtronics—we were all familiar with their history of customer support. We gave the information to the treasurer, and he put a check in the mail to Hamtronics.

A week or two later the UPS truck dropped off the TD-3. That Saturday we met at the shop to build and install the unit. We opened the box and found just what we expected from Hamtronics: a high-quality glass-epoxy circuit board, high-quality parts, easy-to-follow instructions, and plenty of set-up and troubleshooting tips.

The board was finished in about 45 minutes, even with the "help" of three kibitzers. Testing and check-out were simple. We had access to a frequency counter, so we simply needed to hook the counter up to a test point and adjust a pot for the right tone frequency. The TD-3 covers any frequency in the CTCSS

TD-3 hears the proper tone. In our case, we needed just the opposite: We needed to inhibit PTT when we *did* hear the proper tone. This turned out to be a relatively simple task. The TD-3 uses an open-collector output transistor that goes low when no tone is detected, keeping the COR line low. Rather than using this on the COR line, we simply lifted the ground on the last PTT transistor before the transmitter and connected it to the open-collector output on the TD-3. The repeater operates the same as before, except that the ground for the PTT switch transistor comes from the TD-3. If the TD-3 is not detecting the proper tone the open-collector transistor is turned on, which grounds the output. This ground is fed to the PTT switch transistor, which puts the repeater into transmit. If the TD-3 is able to detect a tone, however, the open-collector transistor opens and removes the ground reference from

## Walking-Stick Beam?

Hold it in your hand—it's a walking stick made of aluminum with rubber ends. But inside are all the elements of a 4 element yagi that goes together in 2 minutes. Ready for the T-Hunt. Ready to get your signal out of a hole into the repeater. No little bits to drop and get lost. Everything fits clean and tight and tough. 2meters \$79, 70 cm \$49. Weighs only 1 lb. Add \$6 Shipping & Handling. Info \$1.

AntennasWest  
Box 50062-S Provo UT 84605

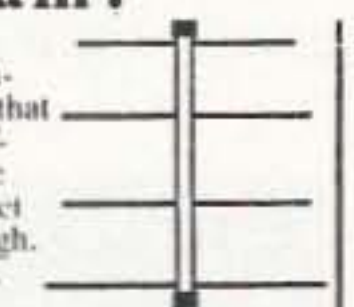

Order HotLine  
801 373 8425

CIRCLE 324 ON READER SERVICE CARD

## ELITE POWER

### 2300 MAH 12 VOLTS

Powers Hand Held Radios & Cellular Phones For Hours.



Excellent For  
Emergencies Field Day  
Hamfests Weekend Trips

Most HT Batteries are only 400 mah @ 7.2V  
Only able to use low power (2 watts or less)  
The Elite Power Battery can go for days on  
one charge using High power (5 watts)

**\$44.95** plus \$5.75

VSS / 800-420-7243

10134-B Mason  
Chatsworth CA 91311

Comes with AC Charger & Belt Clip  
1 Day Shipping Available in U.S.A.

CIRCLE 155 ON READER SERVICE CARD

# FRACVERT: Small Fractal Footprint Vertical

*Fractal counterpoise, or top hat too!*

Chip Cohen N1IR  
2 Ledgewood Place  
Belmont MA 02178

Ground planes and counterpoises seem to be one of those dark areas of knowledge for most hams. Here's a good rule of thumb: Only a few radials (most people use 1/4 wave) cause a radiating counterpoise (bad news); lots of radials make the vertical give off most of the RF (good news). Ultimately, an infinite ground plane is the best situation as it affords additional gain; however, for that, you can dream on.

I've been impressed by some of the weird ways that HFers have accommodated the ground counterpoise problem for HF and MF. Europeans seem particularly vexed by this problem since they usually have small lots, and all seem to

want to get on 160m and work W6s. Their radials are turned sideways, in hairpins, twirls or pretzels, or whatever. They seem to take up the entire lot. I'm not sure if these are genuine solutions;

## Try fractals

Fractals have provided a worthwhile answer. Here I present a radical radial counterpoise which appears to have all

---

*"The radiation resistance of this vertical is higher than a conventional system, hence the better SWR and bandwidth."*

---

you might be able to get these counterpoises to match for 50 ohms, but chances are they radiate badly (that is, very well)—and into the ground itself.

the benefits of a multiple (a dozen or more) 1/4-wave radial system. But it takes up less than 1/20 of the area. For those who want the NEC simulations and more technical details, these can be found elsewhere.<sup>1</sup> For now, here are simple details for making such a ground for HF verticals.

Technically, the fractal pattern of the radial ground counterpoise is called a "third-order ternary dendrite," as shown in Fig. 1. The vertical is attached at the center where the three primary "branches" meet. I made my counterpoise out of thick aluminum ground wire, then twisted and crimped the wire and covered it with aluminum tape. Many prefer to solder it (good luck soldering aluminum!). Copper wire is a good substitute, and easier to solder.

Electrically, the fractal counterpoise is equivalent to a lumped circuit of series/parallel-connected capacitors/inductors. The branching replaces the usual parallel arrangement of having many radials. In hindsight, it seems strange that branching hasn't been a well-known (if known at all) alternative in ground



**Photo A.** The author's 20m version of a fractal counterpoise; like a spiderweb, it's not as fragile as it appears.

counterpoises. Fractals provide a natural alternative solution to a counterpoise's equivalent circuit.

The fractal pattern is important, although a pinch of deviation will give negligible degradation. If you want to scale all the lengths properly, keep in mind that the system can be viewed as branches with branches with branches.

broad 700 kHz at 14.2 MHz center. Minimum VSWR is 1.3:1. The radiation resistance of this vertical is higher than a conventional system, hence the better SWR and bandwidth. The VSWR shows that the ground losses are minimal.

Some experimenting is still in order to see how well the fractal counterpoise works as a multiband system. Some

---

***"You can now put on radials for a 40m or 80m vertical in a small lot."***

---

There are three primary branches that start from the center and form the outermost extents. Each of these is 0.088 wavelengths. Use a ruler to scale the others as needed, and at your frequency of choice.

For my 20m version, shown in **Photo A**, the longest branch (there are three of these) was 5.8 feet. Compare this to the 16.5-foot lengths of conventional spoked radials for 20m and you can see the huge real estate savings. The counterpoise was on the ground, although it should work equally well when buried, or even better when raised a few feet above ground. If you're using a ground rod without radials now, this is an easy way to beef up your ground system. Unless you live on a postage stamp, this means you can now put on radials for a 40m or 80m vertical in a small lot. All you need is the vertical itself.

Speaking of the vertical, there is a minor change. Instead of being 1/4 wave long, it needs to be lengthened to 0.3 waves. On 20m that means increasing the length by 2.5 feet. The change is easily accommodated by a coil if needed on 80m or 160m.

### Performance

How does it perform? In a comparison test with a 20m vertical with four radials of 1/4 wave, it seems to have an S-unit (the mythical 6 dB S-unit) edge. This is higher than modeling would predict; it should make much less than a 1/2 S-unit difference, mostly because of the higher radiation resistance and less horizontal radiation from the fractal counterpoise. No matter; it works better, in addition to being smaller. It's comforting to know that less RF is going into the ground, heating the air, or worse. Incidentally, the bandwidth (2:1 SWR points) is a

quick checks show that a 30m counterpoise works on 10m, but I don't know yet if it radiates (sure don't want it to!). Experimenting is needed; new fractal territory ahead!

It is possible to make very small counterpoises and still have good verticals—but they need to be made 1/3 wavelength in height or more. A solid circle of the fractal's radius also works well at the dimensions given here. But at much smaller radial sizes, the fractal seems to have an advantage with a higher radiation resistance and bandwidth. This present combination provides an easily-made counterpoise with excellent 50 ohm match, but if you want a really *tiny* footprint, just shrink the fractal counterpoise and increase the vertical!

### Top hats

Finally, you may have noticed how verticals are getting turned upside down these days, with huge radial-like top hats capping them off. Top hats are a very old idea, and a very good one because they allow you to shorten the vertical height by about a factor of two or more. The radiation resistance drops to about 20-25 ohms (from 35 ohms), but for most of us that's not a problem; good efficiency is still attainable.

Top hats themselves don't radiate (much), and shouldn't. This is not their problem; their size is. Typically top hats run up to 1/4 wave. That's huge!

A more modest "cap" can be made using the ternary fractal. Placing the fractal at the top of the short vertical allows it to be matched. I am not a big fan of top hats, but for those who need them (160m-40m ops), the conventional top hat can be replaced with a ternary fractal. A direct comparison for several different sizes shows that

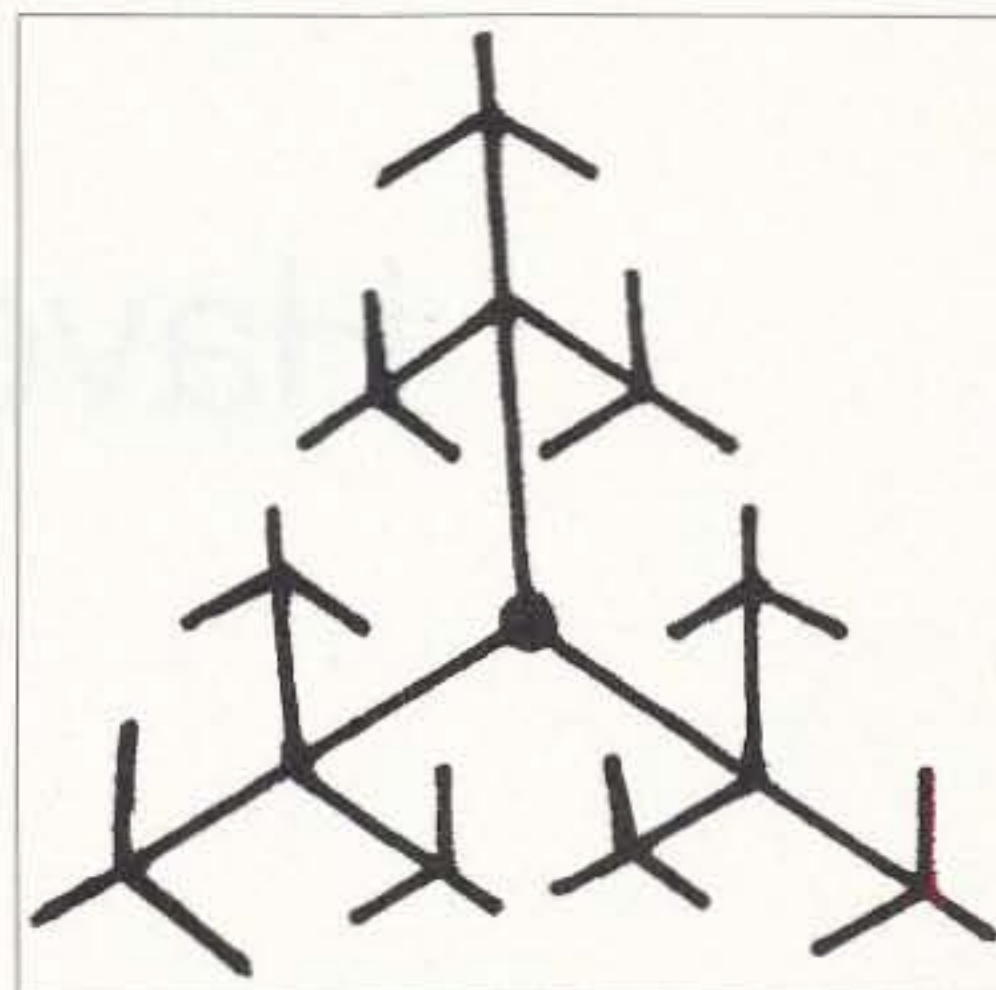

**Fig. 1.** The fractal pattern of the radial ground counterpoise, called a "third-order ternary dendrite."

for a given vertical electrical length and top hat comparison, size savings of 20%-50% are typical. Again, a bit of experimenting pays off. **Fig. 2** is a schematic of a 1/8-wave vertical with a ternary fractal top hat, next to a 1/4 wave. It provides almost equal performance. For the truly brave, there's a fractal hat and a fractal foot—but that's a subject for a later paper.

Jazz up your vertical with a ternary fractal counterpoise or top hat. Either way, the size savings will be substantial, and you'll have the most radical radial antenna around. 73

### Reference:

1. Cohen, N., "Fractal Antenna Gallery," *Communications Quarterly*, Summer 1996. Aspects of this work are patent pending.

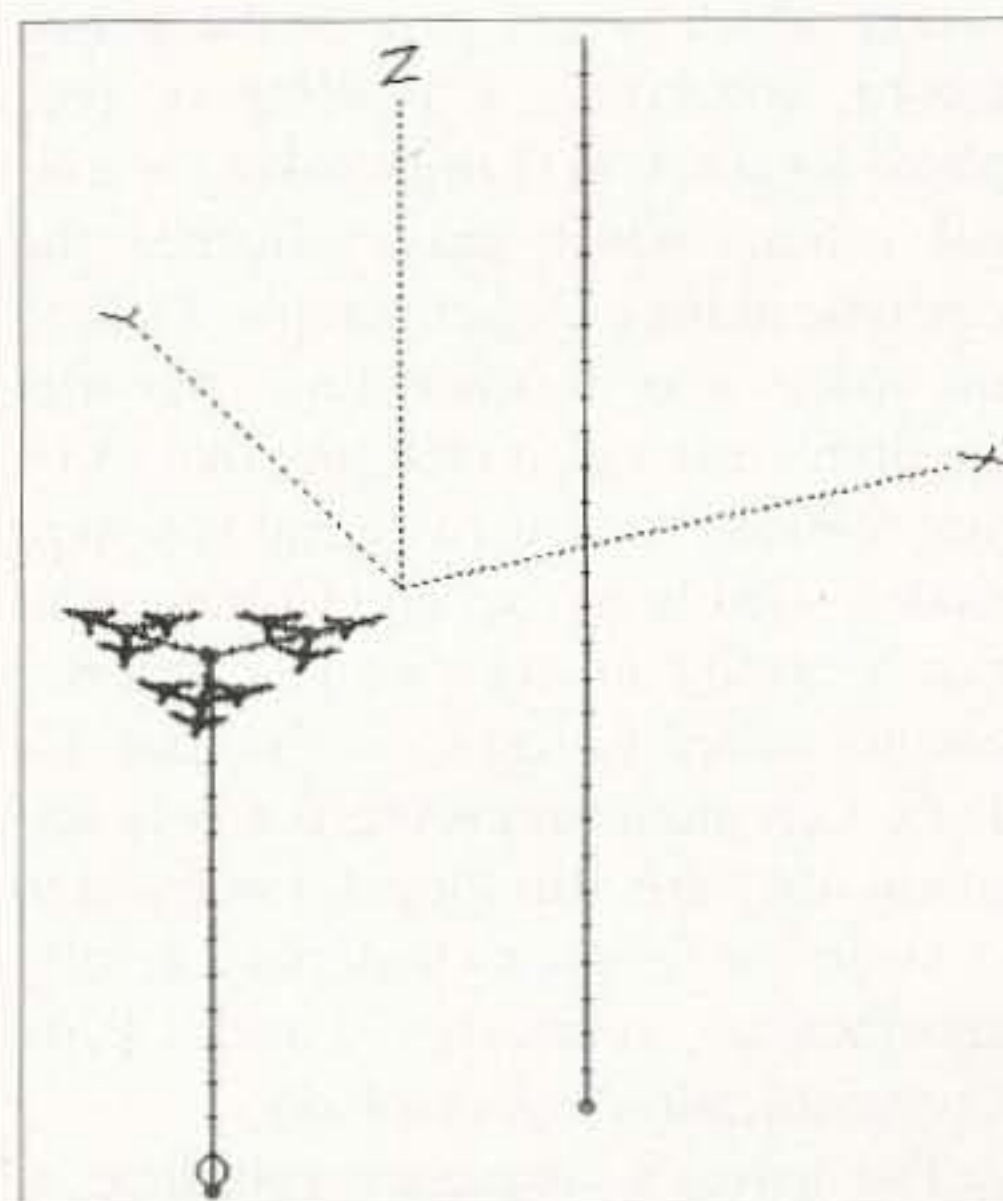

**Fig. 2.** Schematic of an 1/8-wave vertical with a ternary fractal top hat, shown next to a 1/4-wave.

# Have We Been Had?

*Again?*

William Wells WA8HSU  
The Indiana Repeater and Auxiliary  
Council, Inc.  
Box 1092  
Logansport IN 46947

I am sure that many of you have heard about what was called the "Big October Meeting." For those of you who have not, it was a meeting called by the ARRL for those of us in the frequency coordination community to discuss our problems and talk about setting up a national organization. I am Bill Wells WA8HSU, Chairman of the Indiana Repeater Council, and I attended that meeting. Why should you care about this? Well, this will have an impact on repeater coordination and band planning all over the country, so if you operate on the VHF/UHF bands or ever plan to operate on the VHF/UHF bands,

to respond to a request from the FCC that they (the FCC) be provided with a single point of contact to interface with the coordination community. In fact, we were sent a total of seven different agendas for this meeting if you count both those which arrived by Internet E-mail and those which arrived by good old USPS snail mail. All of these agendas contained the following item as agenda item number one:

1. Discussion and Decision: Response to FCC request that it be provided a single point of contact with the coordination community, through which the

chief, was there and gave a short address to the group following a pep talk by Rod Stafford. Following his address, Mr. Haller held a question and answer session. During the Q & A session, Steve Wilson WB9SHY, the vice chairman of the Indiana Repeater Council, put the following question to Mr. Haller: "... Did the FCC, YES or NO, request the single point of contact (discussion) for the Coordinators' Meeting?" Mr. Haller's answer was, "No, we did not request it." Several minutes later Steve Wilson, now holding up a copy of the meeting agenda said, "I am holding in my hand a copy of the meeting agenda which was published by the ARRL which states: 'Discussion and Decision: Response to FCC request that it be provided a single point of contact with the coordination community.' Did the FCC, YES or NO, request a single point of contact for the coordinators?" Mr. Haller's answer again was, "No, we did not request it." Following that answer Rod Stafford quickly assisted Mr. Haller down from the speaker's platform. There is a videotape of this available to anybody who doubts me on this point.

Several times during the meeting ARRL representatives stated that they (the ARRL) are not frequency coordinators and have no interest in becoming a frequency coordinator. If you have a very recent copy of the Amateur Radio Service Rules, please turn to 97.301 (e) (3). This rule now states: "No amateur station may transmit in the 219-220 MHz segment unless the licensee has given written notification of the station's specific geographic location for such transmission in order to be incorporated into a database that has been made available to the public. The notification must be given at least 30 days prior to

---

***"Book publishing is something which the ARRL does very well and they make a lot of money doing it."***

---

you'd better care! Before I continue, a definition of "Ex Parte Communications" might be helpful to you. An Ex Parte Communication is any communication which is not part of the public record, concerning a pending or proposed legal action (a rule-making is a legal action) which may influence the outcome of the action. Example: I talk to the judge who is conducting your trial for drunk driving and tell him that I saw you drinking with my wife and you were stoned. This is an Ex Parte Communication because I am not a witness; that is, I am not called to testify at the trial. Ex Parte Communications are not only immoral, they are also illegal. I ask you to consider the following material carefully and then ask yourselves if an Ex Parte Communication was involved.

The nation's frequency coordinators were called to this meeting in St. Charles, MO, by the ARRL. We were told that the first order of business was

FCC would recognize and support local and regional coordinators. (This was cut from an E-mail message which was sent on September 11, 1995, to the Coordinators Internet Remailer by Steve Mendelsohn WA2DHF, former ARRL Hudson division director, now the ARRL first vice president).

Well, this seems pretty clear-cut. We were told that the FCC had requested that the League set this thing up for them so we all went (some of us not very happily) to St. Charles MO, on October 7, 1995.

The ARRL had all their heavyweights there: President Rod Stafford, Executive Vice President Dave Sumner, General Council Chris Imlay, and half a dozen or so division directors and members of the executive council. This heavyweight presence would certainly belie the ARRL claim that they were only there to serve as meeting facilitator. Ralph Haller, the FCC deputy wireless bureau

making such transmission. The notification must be given to: The American Radio Relay League, 225 Main Street, Newington CT 06111-1494."

It sure sounds to me like the ARRL is in fact a frequency coordinator and has usurped coordination of 219-220 MHz from the local and regional frequency coordinators, such as the Indiana Repeater Council, which are defined in the FCC rules at 97.3 (a) (21).

When the meeting came to a close it appeared as if the ARRL had been appointed by the coordination community as the single point of contact with the FCC. The Indiana Repeater Council, seeing a secret agenda at work here, went away very dissatisfied with the outcome of the meeting. A weekly amateur radio tabloid broadcast erroneously reported that Indiana would never support the SPOC even though we had provided a written statement to its editor of the conditions under which we would support a SPOC.

I want to state for the record that the Indiana Repeater Council is satisfied with the work of the drafting committee which was appointed at the meeting and will support the new national organization which has been proposed.

As I stated, we saw a secret agenda at work so we decided to investigate. The Indiana Repeater Council filed a Freedom of Information Act request with the FCC, asking for information concerning the supposed FCC request for a SPOC. One document which we were sent was most interesting. It is a letter from the ARRL Rocky Mountain division director and Chairman of the ARRL Ad Hoc Repeater Committee to Ralph Haller.

The letter is herein quoted in full.

"Dear Mr. Haller:

I want to thank you for the most enjoyable visit Rod Stafford, Chris Imlay, and I had with you earlier this week. You were most cordial and *we appreciated your attention and input to our [emphasis added] repeater proposals.*

To summarize our meeting Monday, June 19, 1995:

1. The ARRL will hold a meeting in St. Louis, October 7, 1995.

## Amplifiers, ATV Down Converters & Hard to Find Parts

### LINEAR AMPLIFIERS

#### HF Amplifiers

PC board and complete parts list for HF amplifiers described in the Motorola Application Notes and Engineering Bulletins:

AN779H	(20W)	<b>2 Meter Amplifiers</b> (144-148 MHz) (Kit or Wired and Tested)
AN779L	(20W)	
AN 762	(140W)	
EB63	(140W)	
AR305	(300W)	35W - Model 335A, \$79.95/\$109.95 75W - Model 875A, \$119.95/\$159.95
AN 758	(300W)	
AR313	(300W)	<b>440-450 MHz Amplifiers</b> (SSB-FM-ATV)
EB27A	(300W)	
EB104	(600W)	
AR347	(1000W)	
		100W - Model KEB 67, \$159.95



#### ATV Down Converters

(Kit or Wired and Tested)  
Model ATV-3 (420-450)  
(Ga As - FET)  
\$49.95/\$69.95  
Model ATV-4 (902-926)  
(GaAs - FET)  
\$59.95/\$79.95

### HARD TO FIND PARTS

- RF Power Transistors
  - Broadband HF Transformers
  - Chip Caps - Kemet/ATC
  - Metalclad Mica Caps - Unelco/Semco
  - ARCO/SPRAGUE Trimmer Capacitors
- We can get you virtually any RF transistor!  
Call us for "strange" hard to find parts!

**DIGITAL FREQUENCY READOUT**  
For older analog transceivers  
TK-1 (Wired and Tested) \$149.95

For detailed information and prices, call or write for our free catalog!

### ADDITIONAL ITEMS

**Heat Sink Material**  
Model 99 Heat Sink (6.5" x 12" x 1.6"), \$24.00  
CHS-8 Copper Spreader (8" x 6" x 3/8"), \$24.00  
**Low Pass Filters (up to 300W) for harmonics**  
Specify 10M, 15M, 20M, 40M, 80M or 160M  
**HF Splitters and Combiners up to 2KW**

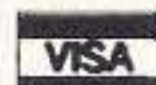

Add \$4.50 for shipping and handling  
**CCI Communication Concepts Inc.**

508 Millstone Drive • Beavercreek, Ohio 45434-5840  
Phone: (513) 426-8600 • FAX (513) 429-3811

CIRCLE 99 ON READER SERVICE CARD

Pico-J rolls up and hides in his 4-ounce pocket-sized holder, waiting like the Genie in a bottle till you need full-quieting signal pouch.

Call him forth and his glistening black weather sealed lines reveal a sleek end-fed halfwave antenna ready to hang anywhere. Suspend in the apartment closet or patio doorway. Attach Pico-J to window glass or curtain rod. He needs no radials for broadband low-angle omni halfwave gain.

Carry Pico-J with you for emergencies. Hang in the motel when on the road. He improves range, boosts reception, saves batteries. Pico-J comes ready for work with 72" isolated coaxial feedline and gold pin BNC. Typical edge-to-edge SWR under 1.2:1. Hand-crafted in the U.S.A.



Info \$1  
Box 50062-D  
Provo, UT  
84605

**Models**  
2 Meters  
440MHz  
Dual Band add \$6

**Antennas West**  
Order Hotline  
801-373-8425

19.95

CIRCLE 89 ON READER SERVICE CARD

### ULTIMATE MODIFICATION BIBLE VOL. V NEWEST AND MOST COMPLETE!!!

OVER 1000 MIKE WIRING CODES FOR CB AND HAM RADIOS  
OVER 500 CB POWER/MODULATION BOOST INSTRUCTIONS  
OVER 200 MODIFICATIONS FOR CB PLL'S  
OVER 225 MODIFICATIONS FOR HAM RADIOS  
OVER 50 COMPLETE SYNTHESIZED CRYSTAL CHARTS  
WITH INSTRUCTIONS  
OVER 20 PRECALCULATED MODIFICATION CRYSTAL CHARTS  
OVER 30 SCANNER MODIFICATIONS AND TEN METER RADIO MODIFICATIONS



LINEAR SCHEMATICS AND ANTENNA/COAXIAL GAIN/LOSS CHARTS \$29.95  
KDC SOUND ORDERS ONLY, 1-800-256-9895 MONEY ORDER, P.O. BOX 8622 ALL OTHER CALLS, 409-231-3753 MC/DISC/VISA OR CK.  
GRANGERLAND, TX 77302

CIRCLE 151 ON READER SERVICE CARD

# \$40 Special To Charge You Up...

## Periphex Power Packs for Longer QSO Time



replacements for	regular price
<b>FNB-12 YAESU 600ma</b>	\$ 54.50
<b>BP-84S ICOM 1400ma</b>	\$ 63.00
<b>PB-13S KENWOOD 1200ma</b>	\$ 49.75
<b>EBP-24S ALINCO 1500ma</b>	\$ 62.00

**Now Only \$40 Each**

- One Year Warranty
- Matched cell construction
- Case re-build service
- Long life, extended operating time

We also offer: Camcorder Batteries Accessories  
Cordless Phone Batteries • Custom Battery Packs • NiCad Cells • Lithium Cells  
Add \$4.00 Shipping & Handling for first battery.  
\$1.00 for each add'l battery - U.S. only  
Massachusetts residents add 5% tax

Available from your dealer...

# PERIPHEx inc.

the only thing low about our charge is the cost...

Special Expires September 30, 1996

**1-800-634-8132**

300 Centre Street • Holbrook, MA 02343 • (617)767-5516 • FAX (617)767-4599  
<http://home.navisoft.com/periphex>

CIRCLE 68 ON READER SERVICE CARD

2. We are inviting about 100 repeater coordinators to attend. The League will sponsor and chair the meeting as facilitator primarily for the benefit of the repeater coordinators. Secondly, we hope the FCC (you) may benefit from organization and cooperation worked out by the coordinators themselves to help you solve repeater coordination problems arising from time to time. Thirdly, ARRL is acting in the belief the meeting may benefit the League members and all amateurs through better cooperation and coordination of amateur repeaters.

3. It is our sincere hope that you personally will be able to attend.

4. We view as goals: A. Appointment of repeater coordinators—including recognition of present, non-challenged coordinators. B. Setting of qualifications and criteria for appointment of coordinators. C. Licensing of repeater stations, with coordination a prerequisite to licensing. D. *Single point of contact* [emphasis added], through which amateurs will contact the FCC. E. An accepted method of dispute resolution, including methods of appeal and review.

Consideration of whether the FCC should have a role in such resolution, and if desired, what such role should be.

5. The League neither proposes nor urges a role for itself beyond this single meeting. The League is acting solely as a facilitator, with the hope of seeing a national cooperative coordination resulting in widespread, effective use of repeater communication.

6. *We look for you (the FCC) to agree with the goals set forth above and propose such regulatory action as may be necessary* [emphasis added].

7. We look for an agreement among the coordinators that will provide the sort of self-regulating activity the Amateur Radio Service has traditionally enjoyed.

If you have any suggestions for the items covered in this letter, would you please send them to me, Chris or Rod.

Once again, thank you for your hospitality, kindness, and helpfulness to us and to the League."

There you have it. This letter shows that the SPOC was an ARRL idea, not an FCC idea. You add that to Mr. Haller's clear statement at the meeting that the FCC did not request the SPOC and you can see that this was an ARRL show all the way. Now, I am not a lawyer, but bearing in mind the definition of Ex Parte Communications which was presented at the beginning of this article, it would appear that if the ARRL Chairmen as well as Stafford and Imlay have not committed Ex-Parte Communications, they are at least well down that slippery slope and they have at least carried out a great deception on the coordination community as well as on the amateur community in general.

But why, you might ask, would the ARRL want to promote this deception? What do they get out of the deal?

One thing is greater stability in the coordination community. This, everybody agrees, would be a good thing. There is something else which they would get if they were appointed as the SPOC: control of all the coordination databases, which would guarantee that they could publish any repeater directory product they wanted and be forever free from any possibility of being charged a

WE SHIP WORLDWIDE

# Barry Electronics Corp.

WORLD WIDE AMATEUR RADIO SINCE 1950  
Your one source for all Radio Equipment!

**KITTY SAYS: WE ARE OPEN 7 DAYS A WEEK**  
\*Sat. 10-5 \*Sun. 11:30-5 \*M-F 9-6  
Come to Barry's for the best buys in town.  
SP10, SP50, P110, GP300, GP350, M120, GM300, GR300 repeaters, & SM50  
We serve: Governments • Consulates • Embassies • Overseas and • Domestic orders.

**MOTOROLA**  
CONTACT US FOR THE LATEST IN BUSINESS AND HAM RADIOS, SHORTWAVE RECEIVERS & SCANNERS, MOTOROLA, YAESU, ICOM, KENWOOD, ALINCO, STANDARD, MARCONI, PULSAR, JRC, KING, SONY, GRUNDIG  
BRAND NEW Long-Range Repeater service for business

**YAESU HAM & VERTEX BUSINESS RADIOS** FT51-R, FT-8500, FT-10, FT-11, FT-2500, FT-3000, FRG-100B, FT-1000D, FT-50R, FT-5200, FT-840, FT-900AT, FRG-100, VXR-5000 repeater 25 watts, VHF or UHF, Marine Mobile VXM-100.

**ICOM**  
HAM, MARINE, BUSINESS AND AVIATION RADIOS  
281-H, 2000-H, 2350-H, A-22, IC-77, IC-706, IC-707, NEW F30LT/F40LT, H16, U16, V100, and repeaters.  
SHORTWAVE RECEIVERS R-1, R-100, R-7000, R-9000, R-71, GP-22A.

**For the best buys in town call: 212-925-7000**  
Los Precios Mas Bajos en Nueva York  
WE SHIP WORLDWIDE!  
Export orders expedited.  
Special export prices.

**WHEREVER I GO, I TAKE MY RADIO.**  
SPECIALIST IN RADIOS:  
• BUSINESS • MARINE  
• AVIATION • HAM RADIOS  
• SCANNERS

**KENWOOD**  
ANTENNAS  
A-S, AES, Cushcraft, Hy-Gain, Hustler, KLM, METZ, Urban, MOUBLOX, TORNA, Butternut, Multi-Band

\*TS-50B\*, TS450S/AT, R-5000, TS-850B, TM 341/A41A, TR-751A, Kenwood Service Repair, TS140S, TS690S, RZ-1, TS-790A, TS950SD, TH-79A(D), TH28/46A, TM-941A, TM-741A, TM-733A, TM-641A, TM-742A.

**MARINE RADIOS**  
ICOM M7, M11, M56, M700TY, M800, AVIATION PORTABLE ICOM A22, MOTOROLA, TRITON MARINE

**Surveillance Devices Available**  
Ameritron, Icom, Kenwood, Yaesu

**Linear Amplifier**  
Ameritron, Icom, Kenwood, Yaesu

**Shortwave Receivers**  
Drake-Grundig-JRC-Sony-  
Yaesu-ICOM  
Call 212-925-7000  
Satellite telephone in suitcase for worldwide use

**CB Radios Stocked**  
148GTL, Washington, Ranger 2950-70, Antennas: Wilson, Arcton, etc.  
Power mikes w/beeps - ECHO - SilverEagle etc.

ALINCO DJ-580T, DJ-582T, etc.

**Privacy scramblers for radios and phones. CALL**

**ANTENNAS:**  
AEA, AlphaDelt, ANLI, Antenna Specialist, Barber & Williamson, Comet, Cushcraft, Diamond, GAP Hy-Gain, Hustler, Larsen, Etc. Wap-Meissers Stocked.

**GARMIN GPS RECEIVERS**

**NEW — 220 MHz BUSINESS RADIOS WITH REPEATERS**

**MOTOROLA RADIOS EXPORT & DOMESTIC CALL FOR PRICES**

**Scanners Our Specialty**  
Bearcat • ICOM • AOR • etc.  
Huge Stock Call

**Business Radios:**  
Motorola, ICOM, Maxon, Yaesu, FTH 2008/7008, etc. Uniden, Regency, Reim Marine ICOM: M10A, m1, etc. Aviation ICOM: A22, A200

**FM & AM BROADCAST TRANSMITTERS STOCKED**

**SATELLITE PHONES & BROADCAST EQUIPMENT**

Save money on batteries. Call for Special Prices.

Barry's supplies all MFJ products Call us direct.

Wide selection of SW & Amateur Publications

**Antenna Tuners:**  
MFJ, AEA AT-300, ICOM, KENWOOD, YAESU, VERTEX

**COMMERCIAL & HAM REPEATERS STOCKED. WRITE FOR QUOTES**

**KANTRONICS KAM PLUS Etc**

**MOTOROLA AUTHORIZED DEALER**  
KACHINA COMMUNICATIONS DEALER  
**AUTHORIZED DEALER**  
**SONY**  
Shortwave Radios Stocked  
DIGITAL FREQUENCY COUNTERS  
OPTOELECTRONICS model 1300 H/A, 0-1300MHz 2300, 2210 H, 0-2200 MHz, 2600H, UTC-3000, 2810

**Long-range Wireless telephone for overseas. CALL**

**BENCHER PADDLES BALUNS, LOW PASS FILTERS IN STOCK**

**MIRAGE/RFC Amplifiers**  
ASTRON POWER SUPPLIES  
Belden Wire & Cable, Int'l Wire  
OPTOELECTRONICS STOCKED

**Shortwave Radios**  
Drake, JRC, Lowe, ICOM, Kenwood, Yaesu, Sony, Grundig & Sangean.  
Write or Call for Prices

**Amplifiers, HF/VHF/UHF AMERITRON, etc.**

2 Meter, 440, 220MHz Band-Pass Filters from DCI

**Radios for Business, Government Stocked & Serviced Call or FAX for Great Prices!**

**Telephone Autopatch**  
Patches telephone calls from your radio to phone line. Great for making and receiving phone calls where there are no phone lines. Simple to use. Write or fax for inquires.

**Hy-Gain Towers will be shipped direct to you FREE of shipping cost.**

**Electron Tubes**  
3-500Z,  
572B, 6JS6C, 12  
BY7A, & 6146B

**Computer Interfaces**  
Stocked: MFJ-1270B, MFJ-1274, MFJ-1224, AEA, PK-88, MFJ-1278T, PK-900, PK-232 MBX W/FAX, DRSI PRODUCTS DSP 2232

**Domestic & Special Prices for Export**  
GP300, GM300, P110, FP50, etc.

**BIRD Wattmeters & Elements in Stock**

**Image Tubes**  
3-500Z,  
572B, 6JS6C, 12  
BY7A, & 6146B

BARRY ELECTRONICS CORP., 540 BROADWAY, NY, NY 10012 (Five blocks N. of Canal St., between Spring & Prince St.) FAX 212-925-7001 Phone 212-925-7000

**New York City's LARGEST STOCKING TWO WAY RADIO DEALER**  
COMPLETE REPAIR LAB ON PREMISES

"Aquí Se Habla Espanol"

BARRY INTERNATIONAL  
FAX 212-925-7001 Phone 212-925-7000  
For Orders Call 1-800-990-2929

Monday-Friday 9 AM to 6 PM  
Saturday 10-4 PM / Sunday 11:30-5 PM

Subways: #6 Spring St. stop, N. or R. train to Prince St. stop  
F train to Houston St. stop  
Bus: Broadway bus to Prince St. stop, Path train to 9th St./8th Ave.

SALES FINAL

Technical help offered upon purchase

FAX: 212-925-7001

We stock: AEA, Alinco, Ameco, Ameritron, Antenna Specialist, ARRL, Astatic, Astron, B&K, Belden, Bencher, Bird, Butternut, CES, Cushcraft, Codan, Daiwa, Eimac, Henry Heil, Hustler, Hy-Gain, Icom, KLM, Kantronics, Kenwood, Larsen, Maxon, MFJ, Mirage, Motorola, Nye, Palomar, RF Products, Shure, Standard, TUBES & Tube Cartrons, Uniden, Yaesu, Vibroplex, Duplexers, Repeaters, Scanners, Radio

WE NOW STOCK COMMERCIAL COMMUNICATIONS SYSTEMS  
DEALER INQUIRIES INVITED PHONE IN ORDER & BE REIMBURSED  
COMMERCIAL RADIOS STOCKED & SERVICE ON PREMISES.  
EXPORT orders shipped immediately. **CALL**

CIRCLE 41 ON READER SERVICE CARD

38 73 Amateur Radio Today • September 1996



royalty for use of the data. This would also place them in a position to prevent any other publisher from using those same databases. It would also place them in a position to eventually charge you a fee if you wanted to coordinate a repeater and to set a national band plan.

Now, I have no objection to the ARRL publishing a repeater directory. Book publishing is something which the ARRL does very well and they make a lot of money doing it. The *ARRL Repeater Directory* is in fact the ARRL's most profitable product. By publishing a repeater directory the ARRL is in fact doing me as a frequency coordinator a great service. However, we at the IRC, and most other frequency coordination councils, operate on a shoestring budget and the council officers often put up hundreds or even thousands of their own personal dollars to get the tools needed to provide the service which we provide to the amateur community.

A fair royalty charged to any publisher, including the ARRL, for the use of the coordination databases which we generate and maintain could fund the national organization which the ARRL seems to want as well as the underlying local and regional frequency coordination councils.

So I call on the drafting committee to keep the SPOC organization completely free of the ARRL and to negotiate for the coordination community a fair royalty for the product of our collective labor. I would say that a good starting point for this negotiation would be 10% of the sales revenue plus 20% of the advertising revenue generated by the product to be licensed to be divided between the national organization and its underlying local and regional frequency coordination councils. What the ARRL and all other publishers would get for their money is better frequency coordination, more accurate databases, and greater stability in the frequency coordination community. The ARRL and other publishers would therefore be able to produce a higher quality product for you, the amateur community. 73

**Field Day Antenna Installation System**

One person installs in minutes

Info \$1.00

Re-usable  
Ready for Action  
Fast & Easy to Use  
Eliminates Climbing

**ANTENNA LAUNCHING MADE EASY**

\$29.95  
add \$5 Air Ship

1-801-373-8425  
**AntennasWest**  
Box 50062 S. Provo, UT 84605

CIRCLE 304 ON READER SERVICE CARD

## NEVER SAY DIE

Continued from page 9

With all due respect to this year's banquet speaker, they should have spent whatever it took to get Jean Shepherd K2ORS/4 up there on the podium. I don't know of anyone else in ham radio who can entertain like Jean. Old-timers will remember him for years on WOR every night. They'll remember his stories in *Playboy*, his books, and his movies. Pry him out of Sanibel Island.

I may be doing Paul Shuch, this year's speaker, an injustice, but since I have a lot of trouble with his whole SETI idea, considering it a big waste of time and money for reasons I'll cover in my editorials, his talk didn't make me want to go to the banquet. Shep would get me to the banquet, if I were coming to the HamVention. And he might tip the scales, if all else was equal, to bring me to Dayton.

Hey, it's show biz, guys.

## SETI

Ask me why I'm sour on the search for extraterrestrial intelligence (SETI). Okay, glad you asked.

It has to do with cosmology and the age of the universe. Have you read any of the books on the subject on my recommended book list? Even if you accept the big-bang theory, which is more of a religious matter than one of scientific fact, the universe checks out to be at least 15-20 billion years old. And our earth is only a measly four billion or so.

And our poor old solar system is way out there on a remote arm of our galaxy. Thus, if you accept that life somehow is able to get started on new planets where the right conditions prevail, and considering that there are hundreds of billions of stars, presumably all or most with planets, the likelihood is that there are billions of worlds where life has developed to a fairly advanced stage. The likelihood is also that a bunch of these got started even billions of years before we did. Or even more, if you are not a worshipper of the big-bang theory.

Now let's switch to radio communications, which is a big deal right now. One hundred years ago scientists were managing short-range contacts with spark and Morse code. In a hundred years we've gone from spark to digital TV via satellites and global communications. Now, do you honestly believe that we are not going to make anything significant in the way of further communications developments in the next hundred years?

If you'd been a scientist a hundred years ago, how accurately could you have predicted the communications systems we have today, with cellular phones, paging, faxes, the Internet, and so on? Am I off-base to suggest that today's scientists have just as little chance of predicting what communications will be like in 2096 as those of a hundred years ago? And once you're with me on that, let's go to what communications systems

Continued on page 43

## HamCall™ US & International CD-ROM- Over 1,250,000 Listings

ICALL for DOS and Windows now allows EDITING! Data displayed for U.S. hams: call sign, class, name, address, issue date, expiration date, birth date, license class, county, lat/long, area code, time zone, grid square, previous call and class, hours past GMT.

New editing feature allows you to add new records, change addresses, add e-mail address, or add phone numbers. View photos/QSLs of many hams.

- Menu-driven • Print Labels • Latest public domain PC software • Unzip to hard/disk or floppy • Lookup TSR runs from text window • Updated at the end April & October • Windows 95 compatible • Dealer discount on 25 or more • MAC users can retrieve by call, name and zip.

Price remains \$50.00 plus shipping; \$5.00 U.S., \$8.00 International.

## Electronics Software Compendium™

The Electronics Software Compendium is a collection of shareware programs and data files that pertain to electronics, broadcasting, amateur radio and SWL activity.

Over 25,000 files in total. The disc is updated and issued annually in April. Over 300 megabytes of PC and 50 MB for MAC. Send for your new edition today! The price is still only \$25.00 plus shipping; \$5.00 U.S., \$8.00 International.

Try our call sign server [www.buck.com](http://www.buck.com)

**BUCKMASTER**  
6196 Jefferson Highway  
Mineral, VA 23117  
540-894-5777 • 800-282-5628  
540-894-9141 (FAX)  
Internet: [info@buck.com](mailto:info@buck.com)

CIRCLE 56 ON READER SERVICE CARD

## BROADCAST TRANSMITTER

The FMS2 studio quality transmitter is FULLY crystal controlled and programmable to any FM broadcast frequency.

Unit features: ALC, 2:1 compressor, audio buffer / amplifier, pre-emphasis, roll off filter, stereo generator, digital PLL tuning, 75 MHz-125MHz bandwidth, 500mW power output and a special introductory price of only \$295.00 US.

SCHEMATICS FOR UNIT \$27 CATALOG 800-504-1178  
FAX POLL INFO 416-243-1067 TEK LINE 416-243-2260

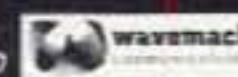

CIRCLE 245 ON READER SERVICE CARD

# FREE!

## NEW CATALOG

CALL TOLL FREE: 1-800-JAN-XTAL

Quality Crystals and Oscillators for:

AMATEUR BANDS • CB • MARINE VHF  
SCANNERS • MICROPROCESSORS • PAGERS  
P.O. Box 60017 • Fort Myers, Florida 33906

VISA (941) 936-2397 MasterCard

# JAN Crystals

## 160-10 G5RV QuicKits™

created by AntennasWest Box 50062 S. Provo, UT 84605

Fast & Easy to Build

- Fail-Safe visual instructions
- No measuring or cutting
- Everything included
- Finish antenna in minutes

Quality Components

- Presoldered Silver Fittings
- Kinkproof QuietFlex wire
- Fully insulated, wax sealed, no-corrode, low noise design

Tune All Bands Incl WARC

- Double Size G5RV 204 ft 160-10 Dipole \$59.95
- Full Size G5RV 102 ft 160-10 Dipole \$39.95
- Half Size G5RV 51 ft 80-10 Dipole \$29.95
- Quarter Size G5RV 26 ft 20-10 Dipole \$24.95
- ReadyMade 102 ft G5RV \$50.00
- ReadyMade 51 ft G5RV/2 \$40.00
- 200' Dacron 250W line \$11.95

Want Plans, Patterns, Data? Order TechNote #124-D \$6.95 ppd USA

Order Hot-Line: Add \$5 P&H 1-800-926-7373

CIRCLE 116 ON READER SERVICE CARD

## 73 Review

# Communicating on the Internet

*With Quarterdeck—license-free!*

Don Johnson K7UGQ  
23 David Street  
Enfield CT 06082

Once the little secret of college students and computer techies, the Internet has emerged as a popular method of communicating with hundreds of thousands of people. Unlike ham radio, where the media of transmission is RF energy, Internet communication takes place over the telephone lines. The Internet offers state-of-the-art, noise-free multimedia contacts with companies, hobbyists, and organizations, etc., without requiring a code test! In fact, it requires no license, test, or demonstration of computer or telephone knowledge. A true Plug-and-Play form of communication—or is it?

Several programs are necessary to complete the complement of software for full-up Internet communication. Individual ancillary Internet programs can be obtained from any number of software dealers or downloaded, often as developmental software. Some companies offer many of these programs, integrated as a suite of Internet applications. Bundled software often offers similarity of operations between applications, and/or commonality of file service. This translates to ease of set-up and operation. If you think setting the clock on your VCR is clumsy, try installing Internet software. A whole new world of terminology and technology is standard equipment when dabbling on the net. For example, the following statement was extracted from a browser's set-up sheet: "... make sure that you obtain a

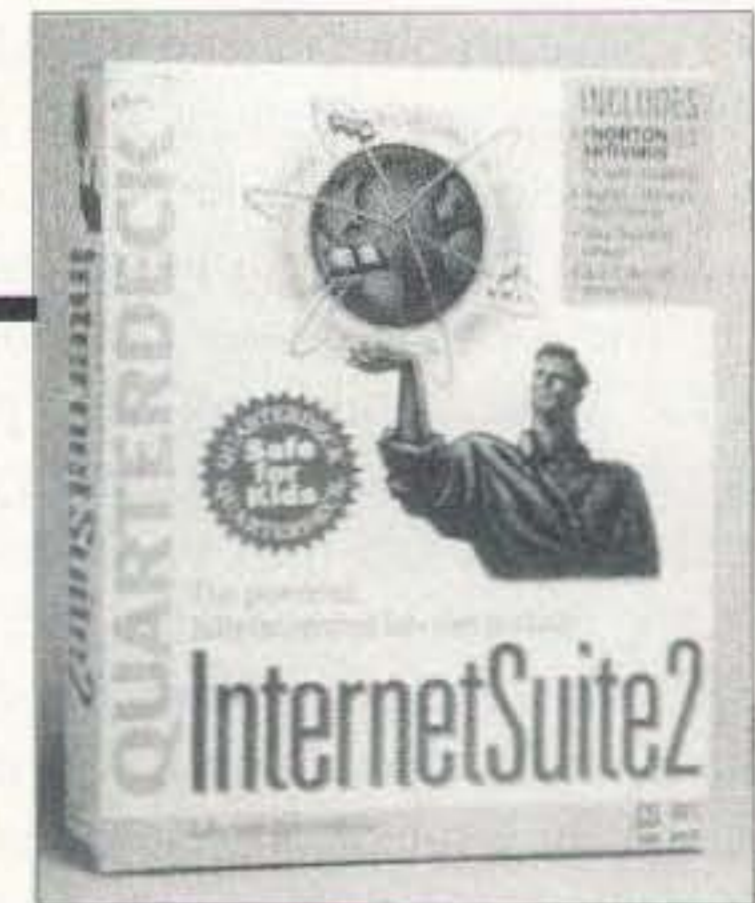

both on-line and off-line communications. Designed for Windows 3.X and Windows 95, this package supports both Internet and INTRANET (Internal Local Area Network) communications, and is loaded with goodies. Real Audio Players, QuickTime movie viewers, Adobe Acrobat viewers, full functional Internet Directory, and Norton Utilities anti-virus software are included with the package. A very nice addition is the Cyber-Sitter, providing parental control over sexually explicit matter. Not only is this an easy program to install and operate, but it's a safe one too!

*"This package has everything but the kitchen sink!"*

Prior to 1993, communicating via the Internet required learning obscure UNIX commands, coupled with several different executive programs for each of the different tasks performed on the net. Mail programs, telenet programs, dialers, and browsers were commonplace. In fact, you would never have used the words "multimedia," "program integration" and "Internet" in the same sentence. Talk about an oxymoron!

Like the rest of computer technology, Internet software continues to evolve rapidly. Although the improvements are transforming the way individuals communicate, the rapid pace of change is often frustrating, as is the possibility of choosing the wrong software for your needs. When software is quickly developed and brought to market, it's often difficult to use. Initially this was true with Internet software.

service provider that offers a local telephone number PPP capable of TCP/IP connection with full HTTP capability." Throw in set-up questions like: "List your domain address, your popd and smtp address and your IP address," and now you're ready to pull the plug.

One supplier of integrated Internet software has gone an extra mile to assure success for first-time Internet computer users. The Internet Suite II program by Quarterdeck Software™ not only offers a full multimedia browser, but all the optional Internet tools required to establish an Internet account, or use an existing account, with very little effort. In fact, the box should have a label reading something like "... prior Internet knowledge not required ..."

Quarterdeck's Internet Suite II© is an integrated set of essential (and then some) communication programs for

## Component highlights

**Qmosaic Browser:** The most common piece of Internet software and surely the most talked about is the browser (see sidebar). The Qmosaic Browser supports HTML 2 conventions with data security and full encryption, and provides very fast multiple document reads. Powerful drop-and-drag support eases organizing Internet addresses.

**Qmessage Center:** More than just an E-mail program, the true power of integration shows up here. Full-featured Electronic mail, Usenet and Newsgroups are among some of the message center features.

**QTerm (TELNET):** Emulates DEC VT52, VT100, VT220 data terminals.

**QFTP:** Point and click interface that works with Windows File Manager to allow downloading of software from other people's computers to your own.

**Global Chat:** Participate in live chat sessions using Internet Relay Chat (IRC). Chat rooms are similar to having a packet QSO.

**QWinsock:** Contains a multi-feature dialer that can coexist with other winsock programs installed. Automatically detects and identifies your modem and executes dial-up procedures whenever an Internet application is run.

**Location Manager:** Provides phone numbers the user can dial to access the Internet and handles all the details. Includes the initial "Connect and Play" feature, a list of over 80 percent of the leading Internet providers, including the phone numbers and set-up strings. Additionally, over 250 popular modem phone numbers and set-up strings are included.

Each module can be modified to satisfy your individual preferences. If it weren't for the default settings, the amount of user configuration could become a real headache. For the beginner, too much versatility may be a disadvantage. However, as you progress from the Newbie stage to becoming a more proficient user, you'll appreciate the power of a fully configurable program.

The users' guide consists of over 400 pages of tips, screen drawings and instructions to assist you toward success. The guide is also organized in a logical sequence, set up the way most people would discover each module in the suite. If you can't find something in the documentation, try asking Quarterdeck via any one of the avenues given.

While including so much, Quarterdeck did leave out a few, albeit minor, features. Internet Suite cannot handle newsgroup threads, level 3 HTML, or Java support (if you aren't sure what these features are, don't worry. They handle advanced initial on-line connection to the Internet and tie together news groupings by subject). Missing from the excellent user guide is assistance for the Cyber Sitter, Anti-virus, and real audio/video components of the package. There is, however, more than adequate on-line information to assist you with these advanced programs.

As I said, this package has everything but the kitchen sink! There are other Internet programs that offer a little better capability individually, but nothing as well integrated, as much fun, or as easy to get started as Internet Suite II. After you get logged on to the Internet, send

me an E-Mail. I'll send you a reply E-Mail confirming the QSO, a sort of QSL card from the state of Connecticut. Care to try for Internet WAS? Besides being another form of communication, it's a lot of fun!

Contact: Quarterdeck Corporation, 13160 Mindanao Way, Marina del Rey, CA 90292-9705; phone: (310) 309-3700, FAX: (310) 309-3217; E-mail: support@quarterdeck.com. 73

### Web Browsers

Web browsers provide a computer window into the Internet world of graphics and information. Before today's plethora of web browsers, Internet searches were text-based, offering no real multimedia excitement for the viewer. Credit for the first real web browser goes to the National Center for Super Computing Applications. As the creators of a program called MOSAIC, they almost single-handedly opened up the World Wide Web to public viewing and scrutiny. This one development is credited with sparking the phenomenal rush to get on the Internet.

Several commercial companies saw opportunity in improving the original MOSAIC program. Each company added their own bells and whistles; however, most browsers in use today are related to the original MOSAIC program.

**ONV SAFETY BELT**  
P.O. Box 404 • Ramsey, NJ 07446  
800-345-5634  
Phone & Fax 201-327-2462

---

**NEW FROM ONV**  
**FULL-BODY HARNESS**

ONV Safety Belt with Seat Harness



**\$89.95**  
+\$.00 UPS  
Visa/MC Check

**OSHA**  
We Ship Worldwide  
Order desk Open  
7 Day/Week

ONV Tool Pouch \$15.95



**\$89.95**

---

**WITHOUT SEAT HARNESS**

- Adjustable to 42" waist • Special Safety Lock
- 5,000 LB. TEST • OSHA

**\$74.95** Large to 56" add \$10.00  
ONV Tool Pouch \$15.95  
+\$.00 UPS  
Visa/MC Check

---

**TOWER CLIMBING LANYARDS**

3 feet with large gorilla hook to clip on ONV Safety Belts. For use on towers, ladders, etc.

**\$39.95** +\$.00 UPS

**NOW FEEL SAFE CLIMBING TOWERS**

## Get The Picture!



**VHF Wx Satellite Decoding**  
Call or write for our free catalog

**Software Systems Consulting**  
615 S. El Camino Real  
San Clemente, CA 92672  
Tel (714)498-5784 Fax (714) 498-0568  
CIRCLE 250 ON READER SERVICE CARD

### WANT TO LEARN CODE?

**Morse Tutor Gold from G.G.T.E. is the answer for beginners and experts alike.**

\*Get the software the ARRL sells and uses to create practice and test tapes; and Morse Tutor Gold is approved for VE exams at all levels.

\*Since 1987, GGTE has guided nearly 20,000 hams and prospective hams around the world through proven structured lessons and a variety of character, word and conversation drills. Straight forward menus make the process simple and fun.

\*This program features easy and speedy self installation; random character drills with the characters you select; and you can create your own drills or import text files. You can type what you hear or copy by hand and see the results one line at a time. Pick the Farnsworth or the standard method; select the tone frequency most comfortable for you or select your code speed in tenths of a word per minute. For all DOS computers. You are always in command.

Certified by



Morse Tutor Gold uses your internal speaker or sound board. And, if you use a sound board Morse Tutor Gold supports volume control.

Sound Blaster and the Sound Blaster Compatibility Logo are trademarks of Creative Technology Ltd.

Available thru dealers, the ARRL, or send \$29.95 + \$4 S&H (CA residents add \$2.32 tax) to:  
GGTE, P.O. Box 3405, Dept. MS, Newport Beach, CA 92659 Specify 5 1/4 or 3 1/2 inch disk.

CIRCLE 193 ON READER SERVICE CARD

**THE ASOTRON**  
COMPACT ANTENNAS FROM 160-10 METERS

NO TUNERS  
NO RADIALS  
NO RESISTORS  
NO COMPROMISE

**SIX EXCELLENT REVIEWS JUST DON'T HAPPEN BY CHANCE**  
**CALL US FOR A FREE CATALOG.**

\*See review in Oct. 73, 1984 \*Sept. 73, 1985 March 73, 1986  
CQ, Dec. 1988 Mar. W.R. 91 NOV. 73, 1994



**BILAL COMPANY**  
137 Manchester Drive  
Florissant, Colorado 80816  
(719) 687-0650



CIRCLE 42 ON READER SERVICE CARD

# An Antenna Plotting Oscillator

*Here's a handy one-chip piece of equipment you can build.*

Richard Q. Marris G2BZQ  
35 Kingswood House  
Farnham Road  
Slough SL2 1DA, England

**M**y interest in experimenting with small loop antennas, mainly for 80 and 160 meters, got me interested in building a small signal source to use for checking their radiation patterns. For years I used an old surplus BC-221 frequency meter as a source, but when I read about the Harris HA7210 low power crystal oscillator, available in an eight-pin IC, I knew it was time to upgrade my test equipment.

A big old BC-221 is okay for checking small rotatable antennas, but I wanted to be able to check the radiation patterns of larger low-band antennas, and that meant being able to move the signal source around, instead of the antenna. The HA7210 is a crystal-controlled Pierce oscillator which can be pro-

grammed to operate between 10 kHz and 10 MHz. All it requires is the addition of a parallel mode crystal and a 0.1  $\mu\text{F}$  bypass capacitor, plus a DC supply of up to 10 volts. The power consumption is well under 1 mA, so even a 9V transistor radio battery will do the job just fine. The circuit is shown in **Fig. 1**.

Changing the links between pins 6, 7, and 8 selects the desired subrange between 10 kHz and 10 MHz, as detailed in the Harris HA7210 specification sheets. I used three crystals, which are selected by SW2. The frequencies of these parallel mode crystals can be anywhere in the bands you want to check, from 160m up through 40m. This means that any convenient junk box or low cost surplus parallel mode crystals can be

## Parts List

IC	HA7210P - Harris semiconductor
Socket	Eight-pin socket for HA7210P
SW1	Mini-toggle on/off switch
SW2	One-pole/three-way small rotary switch
Crystals	160m, 80m, and 40m (HC49U okay)
C1	10 $\mu\text{F}$ capacitor
C2	0.1 $\mu\text{F}$ ceramic capacitor
C3	4.7 to 30 pF, if required
L1	1 mH small RF choke
Plug	Phono plug with plastic case
Jack	Phono jack
Box	Your choice
Whip, battery holder, etc.	

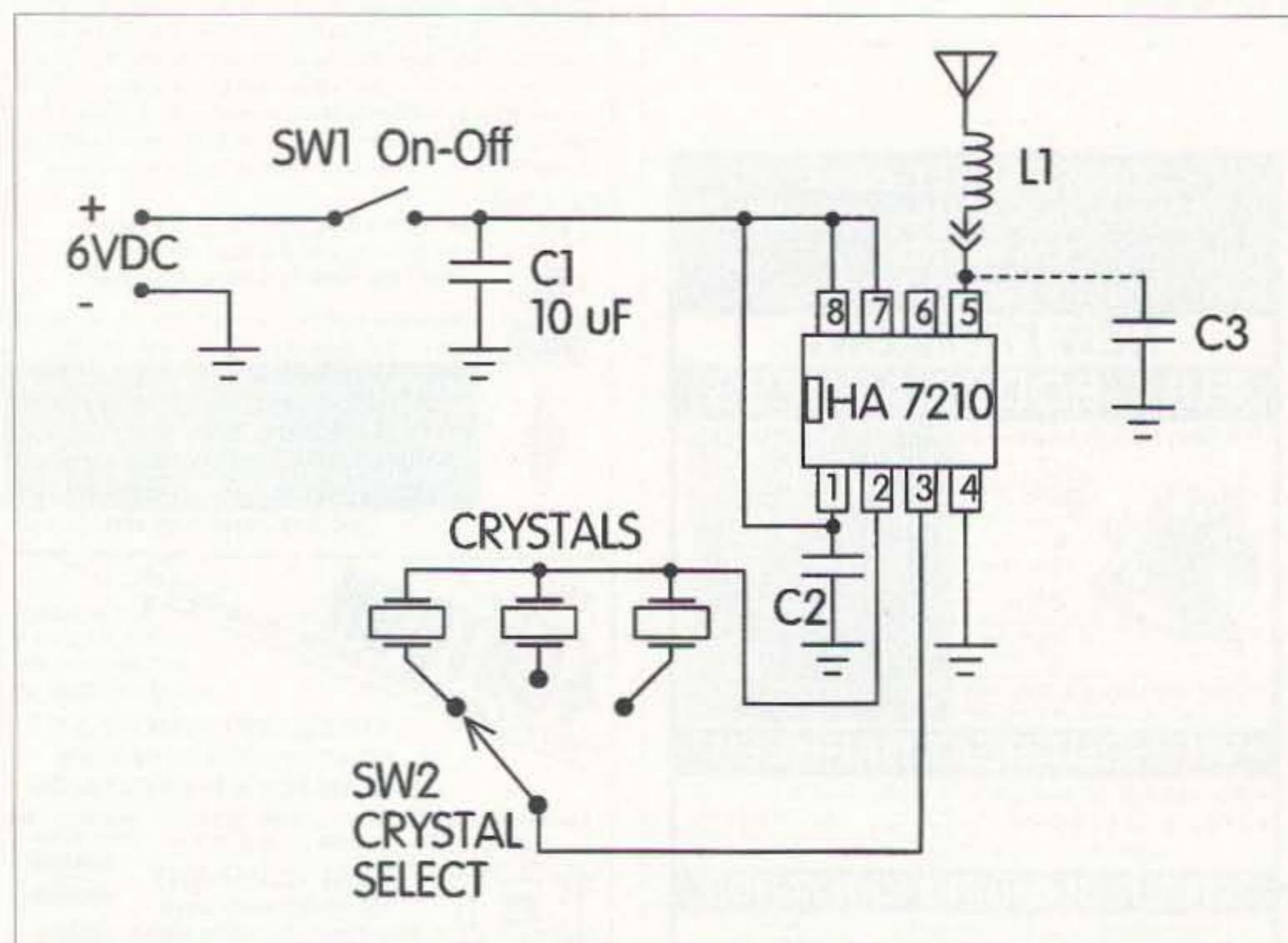

Fig. 1. The circuit.

used—for example, the prototype used 1 MHz, 1.850 MHz and, 3.5860 MHz. These were all HC49U type crystals.

This is a small gadget, so find something small in which to build it. Any of the common mini-boxes are suitable. The supply voltage I used was +6 volts DC, supplied by four AAA batteries in a battery holder. The consumption was between 450 and 800  $\mu\text{A}$ , depending on

the frequency and the output loading. Make sure that the leads to C2 (0.1  $\mu$ F) are as short as possible, and use a plain perforated board to avoid any possible ground plane effect you might get with a copper-clad board. Otherwise the layout is not critical. In the unlikely event of instability, add C3, trying from 4.7 to 30 pF with short leads. The oscillator will only radiate for a few feet so it won't cause QRM or TVI. If you need a stronger signal, use a longer whip. In my work with loop antennas I rotated them and plotted the signal strength. With fixed antennas you move the oscillator around the antenna in a circle while taking field strength measurements for your plotting points.

This new IC is well-documented by the manufacturer. Ask Harris Semiconductor, Box 883, Melbourne, FL 32902, for copies of their "BA7210 Low Power Crystal Oscillator," File No 3389.3, and their Application Note AN9317, "Micropower Clock Oscillator and Op Amps provide system control for battery operated circuits." 73

## NEVER SAY DIE

Continued from page 39

will be like in a thousand years. Ten thousand? A hundred thousand? A million?

Our first civilizations didn't get started until about 5,000 years ago, and I'll have more to say about that when I get Sirius.

Is it even remotely possible that some new communications medium will be developed that we don't even suspect today? Or perhaps, like telepathy, that we do suspect? One that doesn't have the bandwidth, interference, power, and time constraints of radio?

It seems to me that radio communications is just a passing technology that will eventually be replaced by something substantially better. It's a phase that many civilizations will go through for maybe a hundred years or so of their existence. Thus, trying to find worlds which are advanced enough to use radio, but have not yet moved on to better communications systems, a matter of perhaps a couple hundred years at best, out of millions, seems like a huge waste of money. We might do better to invest our efforts in researching other communications systems.

If, for some reason, you have some doubts about there being alien civilizations which have visited earth, then you are in serious need of some reading. Erich von Däniken in his *Chariots of the Gods* makes a good case for prehistoric alien visitors. As does Graham Hancock in his *Fingerprints of the Gods*. Now I'm reading *The Sirius Mystery* by Robert Temple. Maybe you've seen the TV exposé program on the Dogon tribe in *Continued on page 47*



# CABLE X-PERTS, INC.

## COAX (50 OHM "LOW LOSS" GROUP)

ITEM	100ft/up ...	500ft
*FLEXIBLE* 9913 FOIL +95% BRAID 2.7 dB @ 400 MHz	58ft	56ft
9913 EQUAL FOIL +95% BRAID 2.7 dB @ 400 MHz	42ft	40ft
LMR 240 DBL SHLD (8X SIZE) IIIA JACKET 1.7 dB @ 50 MHz	43ft	42ft
LMR 400 DBL SHLD IIIA JACKET 2.7 dB @ 450MHz	53ft	51ft
LMR 400 ULTRAFLEX DBL SHLD *TPE* JKT. 3.1dB @ 450 MHz	79ft	78ft
LMR 600 DBL SHLD IIIA JACKET 1.72dB @ 450MHz	1.25ft	1.22ft
LDF-50A 1/2" ANDREWS HELIX 1.5 dB @ 450 MHz (25 ft & up)	2.10ft	
FSJ-50 1/4" ANDREWS SUPERFLEX 2.23 dB @ 150MHz (25 ft & up)	1.50ft	

## COAX (50 OHM "HF" GROUP)

ITEM	100ft/up ...	500ft
RG213/U MIL-SPEC DIRECT BURIAL JKT. 5dB @ 50MHz	36ft	34ft
RG8/U FOAM 95% BRD UV RESISTANT JKT. 1.2dB @ 50MHz	32ft	30ft
RG8Mini(X) 95% BRD BLK UV RES JKT (GRY, CLR, or WHT JKT TOO)	15ft	13ft
RG58/U SOLID CENTER COND 95% BRAID	15ft	13ft
RG58/U SOLID CENTER COND 95% TC BRAID	17ft	15ft
450 Ohm SOLID 18Ga. CW LADDER LINE	12ft	10ft
450 Ohm STRD18Ga CW LADDER LINE	18ft	17ft
24Ga. SOLID 4PAIR UNSHLD LAN CABLE "LEVEL 5" PVC JKT	16ft	14ft
RG214/U DBL SILVER SHLD MIL-SPEC (25 Ft. & Up)	1.75ft	
RG142/U DBL SILVER SHLD MIL-SPEC "TEFLON" (25 Ft & Up)	1.25ft	

## ANTENNA WIRE (BARE COPPER)

ITEM	100ft/up ...	500ft
14Ga. 168 STRD "SUPERFLEX" (Quads, Port set-ups etc.)	12ft	10ft
14Ga. 7 STRD "HARD DRAWN" (permanent Dipoles, etc.)	08ft	07ft
14Ga. SOLID "COPPERWELD" (vary long spans, etc.)	08ft	07ft
14Ga. SOLID "SOFT DRAWN" (ground radials, etc.)	08ft	07ft
3/16" DBL BRD "DACRON" ROPE 770# TEST, WEATHERPROOF	12ft	09ft

## ROTOR & CONTROL CABLES

ITEM	100ft/up	500ft
5971 8/Cond. (2/18 6/22) BLK UV RES JKT. Rec up to 125 ft	20ft	18ft
4090 8/Cond. (2/16 6/22) BLK UV RES JKT. Rec up to 200 ft	35ft	34ft
1418 8/Cond. (2/14 6/18) BLK UV RES JKT. Rec up to 300 ft	47ft	45ft
1216 8/Cond. (2/12 6/16) BLK UV RES JKT. Rec up to 500 ft	78ft	74ft
18 Ga. Strd 4/Cond. PVC JACKET	20ft	18ft
18 Ga. Strd 5/Cond. PVC JACKET	22ft	20ft
18 Ga. Strd 6/Cond. PVC JACKET	23ft	21ft
18 Ga. Strd 7/Cond. PVC JACKET	25ft	23ft

## COAX W/SILVER TEFLON PL259's EA END (soldered & tested)

ITEM	PRICE
100ft "FLEXIBLE" 9913 FOIL +95% BRAID 2.7dB @ 400MHz	\$65.00/each
50ft "FLEXIBLE" 9913 FOIL +95% BRAID 2.7dB @ 400MHz	\$35.00/each
100ft RG213/U MIL-SPEC DIRECT BURIAL JKT. 1.5dB @ 50MHz	\$45.00/each
50ft RG213/U MIL-SPEC DIRECT BURIAL JKT. 1.5dB @ 50MHz	\$25.00/each
100ft RG8/U FOAM 95% BRD UV RES JKT. 1.2dB @ 50MHz	\$40.00/each
50ft RG8/U FOAM 95% BRD UV RES JKT. 1.2dB @ 50MHz	\$22.50/each
100ft RG8Mini (X) 95% BRD UV RES JKT. 2.5dB @ 50MHz	\$21.00/each

## FLEXIBLE 2/COND RED/BLK DC POWER "ZIP" CORD

10Ga. (rated 30 amps)	25ft \$10.50	50ft \$19.00	100ft \$36.00
12Ga. (rated 20 amps)	25ft \$8.00	50ft \$14.00	100ft \$26.00
14Ga. (rated 15 amps)	25ft \$6.00	50ft \$10.00	100ft \$18.00

## TINNED COPPER "FLAT" GROUNDING BRAID

1 INCH WIDE (equivalent to 7 Ga.)	25ft \$22.00	50ft \$43.00	100ft \$85.00
1/2 INCH WIDE (equivalent to 10 Ga.)	25ft \$12.50	50ft \$24.00	100ft \$48.00

## CONNECTORS

PL259 SILVER/TEFLON/GOLD TIP	10pc \$11.00	25pc \$25.00	50pc \$47.50	100pc \$90
N2PC SILVER/TEFLON/GOLD TIP	10pc \$32.50	25pc \$75.00	50pc \$143.75	100pc \$275

ORDERS ONLY: 800-828-3340

TECH INFO: 847-520-3003 FAX: 847-520-3444

416 Diens Dr., Wheeling, IL 60090

e-mail: cxp@ix.netcom.com

FOR COMPLETE LITERATURE SEND #10 S.A.S.E.

CABLE & WIRE CUT TO YOUR SPECIFIC LENGTH! CUSTOM CONNECTOR WORK, TOO.

## Pocket Morse Code Trainer

Learn Code Faster & Easier  
Better than code tapes  
Take it anywhere to practice  
Light weight & compact

### The Deluxe Pocket Morse Code Trainer

- \*Selectable code rates from 3 wpm to 33 wpm
- \*Plays standard or Farnsworth
- \*Size 1" x 3.8" x 2.4"
- \*Runs 40 hrs on one 9 v battery



- 1) Plays continuous fresh random code (Selectable letter groups, ie A-Z, 0-9, & more)
- 2) Preprogramed random character playing
- 3) Interactive training (Excellent for beginners)
- 4) Continous newly generated QSO (1 million different QSO like the General exam)
- 5) Preprogamed QSO to check accuracy
- 6) Continuous random words Playing

### The Ultimate Pocket Morse Code Trainer

- It has all the above features plus
- 1) A 16 character LCD display which allows you to check yourself during or after a QSO
  - 2) Internal amplified speaker.
  - 3) Selectable random character playing. (Select which character or numbers to practice)
- Call 214-350-0888 Price \$99.00  
Add 2.50 for a mono ear piece & 3.50 for a stereo head set  
Visa/MC accepted Add \$6.00 S/H + 8.25% Tx  
Computer Aided Technology, 4088 Lindberg Dr, Dallas, Tx 75244

CIRCLE 276 ON READER SERVICE CARD

## World's best ham weather station - only \$379

Others from \$179

New Model 2000:

Helps you alert others to weather extremes via A.P.R.S. or on SKYWARN and A.R.E.S. networks. Features accurate:

- barometric pressure • 3-hr. pressure change • indoor/outdoor humidity\*
- dew point\*
- wind speed/direction • indoor and outdoor temperature • wind chill temperature • rainfall\*

Instant access to: • current values • today's highs and lows • yesterday's highs and lows • long term highs and lows • time/date for all highs/lows • rain totals\* for today, yesterday and long term • alarms • 4-mode serial port, and more.

Patented design makes this complete weather monitoring system easy to install and simple to use. Informative, educational, and fun. The ULTIMETER 2000 is a great value, too—only \$379 + shipping. (\*Optional sensors add'l.)

Call or write for free brochures.

1-800-USA-PEET

or 908-531-4615 FAX: 908-517-0669

PEET BROS COMPANY

1308-6097 Doris Ave., Ocean, NJ 07712

Our 20th Year

© 1996 Peet Bros. Co.

# BARTER 'N' BUY

Turn your old ham and computer gear into cash now. Sure, you can wait for a hamfest to try and dump it, but you know you'll get a far more realistic price if you have it out where 100,000 active ham potential buyers can see it than the few hundred local hams who come by a flea market table. Check your attic, garage, cellar and closet shelves and get cash for your ham and computer gear before it's too old to sell. You know you're not going to use it again, so why leave it for your widow to throw out? That stuff isn't getting any younger!

The 73 Flea Market, Barter 'n' Buy, costs you peanuts (almost)—comes to 35 cents a word for individual (noncommercial) ads and \$1.00 a word for commercial ads. Don't plan on telling a long story. Use abbreviations, cram it in. But be honest. There are plenty of hams who love to fix things, so if it doesn't work, say so.

Make your list, count the words, including your call, address and phone number. Include a check or your credit card number and expiration. If you're placing a commercial ad, include an additional phone number, separate from your ad. This is a monthly magazine, not a daily newspaper, so figure a couple months before the action starts; then be prepared. If you get too many calls, you priced it low. If you don't get many calls, too high.

So get busy. Blow the dust off, check everything out, make sure it still works right and maybe you can help make a ham newcomer or retired old-timer happy with that rig you're not using now. Or you might get busy on your computer and put together a list of small gear/parts to send to those interested?

Send your ads and payment to: **73 Magazine, Barter 'n' Buy, 70 Rt. 202N, Peterborough NH 03458 and get set for the phone calls. The deadline for the October 1996 classified ad section is August 12, 1996.**

## Radio Bookshop

Phone 800-274-7373 or 603-924-0058, FAX 603-924-8613, or see order form on page 88 for ordering information.

### Books for Beginners

**TAB4354 Beginner's Handbook of Amateur Radio** by Clay Laster W5ZPV. 395 pages. Wonderful book for newcomers. It is basic and well illustrated. Even if you have all the other ham handbooks, you'll still find this one useful. \$22.00

**W5GWNV No-Code Video, Manual, Part 97 Rules** by Gordon West Learn how to be a ham radio operator \$29.95

**W5GWNV Technician Class License Manual: New No-Code** by Gordon West This book covers everything you need to become a Technician Class Ham. Every question and answer on the examination is found in this one book. FCC Form 610 application. \$9.95

**XTAL-1 The Crystal Set Handbook** by Phil Anderson WØXL Want to give a kid an exciting present? Or maybe yourself? Crystal sets are alive and fun. Here's a whole book packed with crystal set circuits that anyone can build. Now start saving those oatmeal boxes, okay? 133 pages. \$10.95

### Code Tapes

**73T05 Genesis 5 wpm code tape** This beginning tape takes you through the 26 letters, 10 numbers and necessary punctuation complete with practice every step of the way. \$5.95

**73T06 The Stickler 6 wpm code tape** This is the practice tape for those who survived the 5 wpm tape and it is also the tape for the Novice and Technician licenses. It is comprised of one solid hour of code. Characters are sent at 13 wpm and spaced at 5 wpm \$5.95

**73T13 Back Breaker 13 wpm code tape** Code groups again at a brisk 13+ wpm so you'll be really at ease when you sit down in front of a steely-eyed volunteer examiner who starts sending you plain language code at only 13 per. \$5.95

**73T20 Courageous 20+ wpm code tape** Go for the extra class license. \$5.95

**73T25 Mind Boggler 25+ wpm code tape.** \$5.95

**TEST EQUIPMENT:** HP 8410A Network Analyzer Mainframe \$120; HP 8413A Phase-Gain Indicator \$100; Systron-Donner 115 Pulse Generator \$75; Tektronix R453 50 MHz Oscilloscope \$225; Tektronix 453A 60 MHz Oscilloscope \$250; Tektronix 5110 Oscilloscope Mainframe \$75; Tektronix 5A18N Amplifier \$75; Tektronix 5B12N Time Base \$125; Tektronix 7313 Oscilloscope Mainframe \$150; Tektronix 7403N Oscilloscope Mainframe \$175; Tektronix 7A18 Amplifier \$75; Tektronix 7B50A Time Base \$125; Request long list of other equipment. Phone: (908) 722-6157, Fax: (908) 722-6391. **BNB2084**

**TIRED OF INTERFERENCE/SWR** problems from corroded circuit board or antenna connections? Want to add flair and value to your construction projects? Gold Electroplating booklet includes schematic for construction of plating device, sources for plating chemicals, process information and plating procedures. Send \$29.95 to: Acadia Mkt., 478 Arrowmount Place, Lake Mary, FL 32746-5101. **BNB4010.**

**BRIGHTEN UP YOUR SHACK!** Eleven-page Compendium filled with ideas, tips, and instructions for building Illuminated Maps. Send \$5.00 (TX res. add \$0.41 tax) to Pineapple Paradise Radio Co., P.O. Box 370692, El Paso, TX 79937-0692. **BNB6005**

**SURPLUS ELECTRONIC TEST EQUIPMENT** for sale at deep discounts. Write, phone, or fax to request the current list. **Jim Stevenson**, 3401 Sunny Slope Road, Bridgewater, NJ 08807. Phone: (908) 722-6157, Fax: (908) 722-6391. **BNB2084**

**WANTED: Western Electric Audio Equipment.** Amplifiers, pre-amps, tubes, speakers, parts, mixing boards, etc. 1-800-251-5454. **BNB1050**

**SUPERFAST MORSE CODE SUPEREASY.** Subliminal cassette, \$12. **LEARN MORSE CODE IN 1 HOUR.** Amazing supereasy technique, \$12. Both, \$20. Money-back guarantee. Free catalog: SASE. Bahr-T3, 150 Greenfield, Bloomingdale, IL 60108. **BNB1025**

**MAHLON LOOMIS, INVENTOR OF RADIO;** by Thomas Appleby, (Copyright 1967). Second printing available from JOHAN K.V. SVANHOLM, N3RF, SVANHOLM RESEARCH LABORATORIES, P.O. Box 81, Washington DC 20044. Please send \$25.00 donation with \$5.00 for S&H. **BNB420**

**WANTED: HAM EQUIPMENT AND RELATED ITEMS.** Donate your excess gear, new-old-in-any-condition, to the Radio Club of Junior High School 22, the nation's only full-time nonprofit organization working to get Ham Radio into schools around the country as a teaching tool using our EDUCOM—Education Thru Communication—program. Send your radio to school. Your donated material will be picked up ANYWHERE or shipping arranged, and this means a tax deduction to the full extent of the law for you as we are an IRS 501(c)(3) charity in our 16th year of service. It is always easier to donate and usually more financially rewarding, BUT MOST IMPORTANT your gift will mean a whole new world of educational opportunity for children nationwide. Radios you can write off, kids you can't. Make 1996 the year to help a child and yourself. Write, phone or Fax the WB2JKJ "22 Crew" today: **The RC of JHS 22**, P.O. Box 1052, New York, NY 10002. 24 hours call (516) 674-4072 or Fax (516) 674-9600. Join us on the WB2JKJ CLASSROOM NET, 7.238 MHz 1100-1230 UTC daily and 21.395 MHz from 1300 to 1900 UTC. Meet us at the ARRL National in Peoria. **BNB762**

**HEATH COMPANY** is selling photocopies of most Heathkit manuals. Only authorized source for copyright manuals. **Phone:** (616) 925-5899, 8-4 ET. **BNB964**

**IT'S BACK!** The return of the HW-8 Handbook! Second printing. Modifications for the Heath QRP rigs. First class mail \$11. DX add \$4 for air mail shipping. **Mike Bryce WB8VGE**, 2225 Mayflower NW, Massillon OH 44647. **BNB404**

**MORSE CODE COMPUTER INTERFACES** \$49.95, with CW Filter \$79.95, Free Shareware and Ham Catalog. **Dynamic Electronics**, Box 896, Hartselle, AL 35640, (205) 773-2758, FAX (205) 773-7295. **BNB1034**

**RF TRANSISTORS TUBES** 2SC2879, 2SC1971, 2SC1972, MRF247, MRF455, MB8719, 2SC1307, 2SC2029, MRF454, 2SC3133, 4CX250B, 12DQ6, 6KG6A, ETC. WESTGATE 1-800-213-4563. **BNB6000**

**ASTRON** power supply, brand-new w/warranty, RS20M \$99, RS35M \$145, RS50M \$209. Call for other models. **(818) 286-0118.** **BNB411**

**HOME AUTOMATION.** Become a dealer in this fast-growing field. 1-800-838-4051. **BNB2032**

**BREAK THE CODE BARRIER:** Psychologist & Extra Class operator has developed an amazing hypnosis tape that allows you to master any code speed easily and quickly. To order send \$14.95 + \$3.00 S&H to Dr. Hal Goodman, P.O. Box 184, Eastport, ME 04631. For more info. send SASE. **BNB2031**

**DSS BIBLE.** New Book Includes: Software, Schematics, Chip Programmer Plans, Reviews & More! \$49.95 VISA/MC **TELECODE** 1-520-726-2833. **BNB1024**

**QSL CARDS** Many Styles. Top quality. Order Risk Free. Plastic cardholders, T-Shirts, Personalized caps, mugs, shirts. Other ham shack extras. Information and samples. **Rusprint.** 1-800-962-5783. **BNB1021**

Invented anything ham-related lately? Call Joyce at 73 at 800-274-7373 if you'd like to write an article about it for 73 Magazine.

# UPDATES

## A Big Blushing OOPS!

You may have wondered, while reading N6JSX/9's article "The 'J' Antenna"

in the August issue, what you were supposed to be looking at. Well, the gremlins and goblins that frequently throw parties at our production outsourcer's place seem to have slipped the illustration of the J-Pole, that was the whole focus of the piece, back into the folder without its being placed. We are abject.

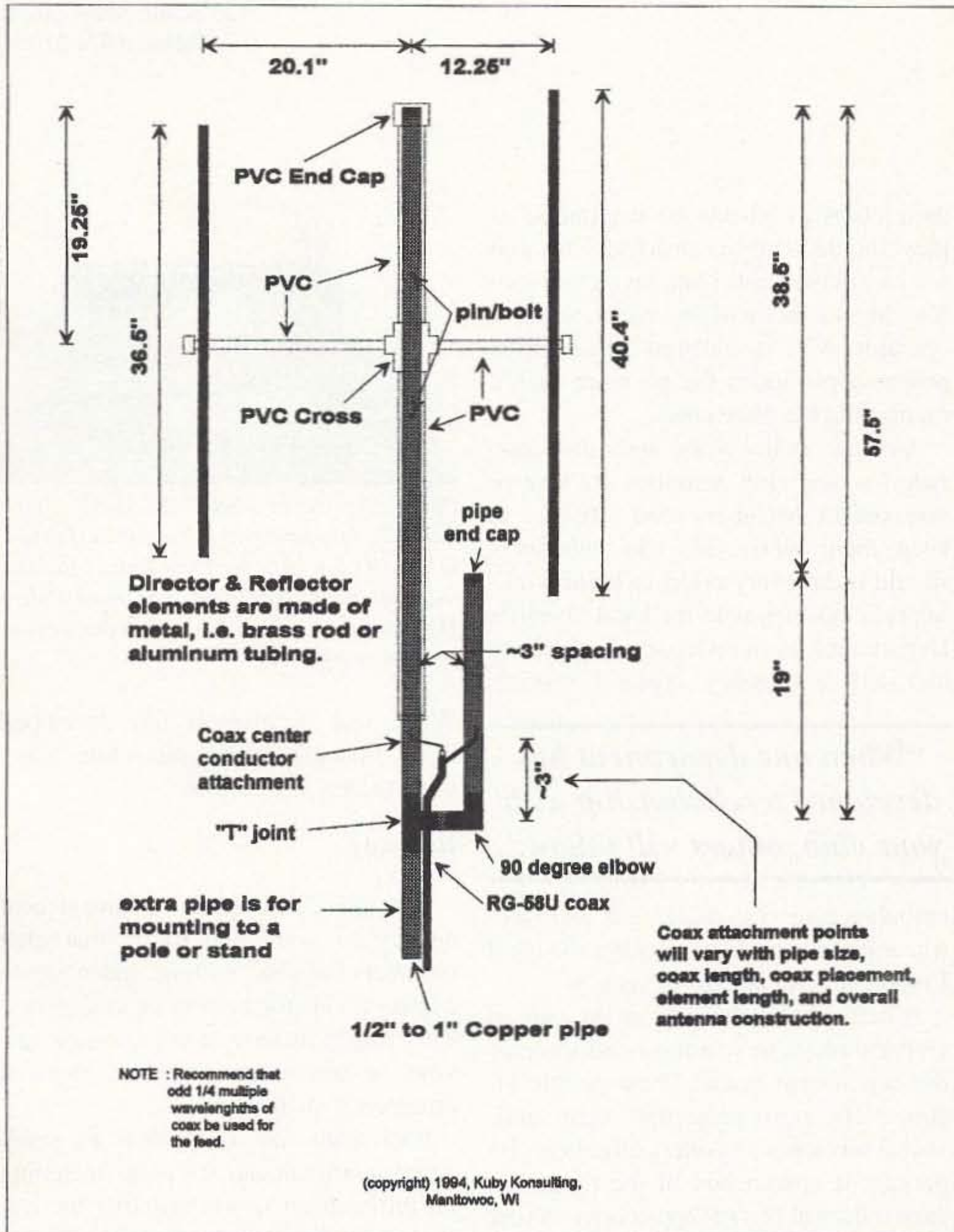

## More Power?

An "oops" note from William Jacobs WA8YCG about his article "Economic High Current Power Supply" which appeared in the June 1996 issue. Please note that in the parts lists and on the schematic, both appearing on page 52, R3 should be 3.3k, and R4 is 750Ω. Bill also wants to thank all the readers who have written with encouragement and good wishes.

## Ham Shack Unplugged

If you happened to be floating around in cyberspace recently, perhaps you came across those three runaway words that escaped from

our mainframe just before we sent the July issue off for printing.

Refer to Frank Brumbaugh's "Ham Shack Test Equipment" which starts on page 10 of issue #430. On page 83, in the second column, about two thirds of the way down, there is a space just big enough for the words "plug-in units." Coincidentally, those are the exact words that should be in that empty space.

## A Picture's Worth a Thousand Credits

The photo of the CMOS Super Keyer 3 on page 80 of the July '96 issue should be credited to Marshall Emm.

## EVERY ISSUE OF 73 Amateur Radio Today on Microfiche!

The entire run of 73 from October 1960 through last year is available.

You can have access to the treasures of 73 without several hundred pounds of bulky back issues. Our 24x microfiche have 98 pages each and will fit in a card file on your desk.

We offer a battery operated hand held viewer for \$75, and a desk model for \$260. Libraries have these readers.

The collection of over 600 microfiche, is available as an entire set, (no partial sets) for \$285 plus \$5 shipping (USA). Annual updates available for \$10.

Satisfaction guaranteed or money back!

### BUCKMASTER

6196 Jefferson Highway

Mineral, Virginia 23117

540:894-5777-800:282-5628

Internet: info@buck.com

Fax 540:894-9141



CIRCLE 168 ON READER SERVICE CARD

## Smart Battery Charger



JUN 87 QST

BY WARREN DION N1BBH

FOR GEL-CELLS or LEAD ACID BATTERIES. Features: Precision temperature tracking voltage reference & three mode charging sequence. Standard kit is for 12V @ 1/2 or 1 Amp, user selectable. Can be connected to the battery indefinitely, will not overcharge. Weighs 2 pounds and measures 4"W x 5 1/2"D x 2 1/2"H. Finished enclosure included in kit.

Complete Kit Only ..... \$59.95  
Assembled & Tested ..... \$79.95

CA Residents add 7.75% sales tax. S&H: \$5.00 (insured). Foreign orders add 20%. For more info or price list, send legal size SASE (55c) to:



**A&A Engineering**



2521 W. La Palma #K • Anaheim, CA 92801  
(714) 952-2114 • FAX: (714) 952-3280



## Handheld Repeater Controller

Spectrum Electronic Products 10 include voice IDer, DTMF introduces the world's first Control and programming, handheld repeater controller. hang and time-out timers, No larger than most hand- Digital Voice Operated held radios, the HRC-10 con- Squelch (DVOS™), telemetry verts a single or dual-band tones, and private voice mail radio into a full featured sim- slot. \$299  
plex or duplex repeater sys- http://www.spectrum-usa.com  
tem. Key features of the HRC- 800-566-2788 - fax 408-336-9461

CIRCLE 69 ON READER SERVICE CARD

# Saving Ourselves From Ourselves

*It's called getting involved.*

Charles M. Seay, Sr. KN4HL  
106 South Main Street  
Dickson TN 37055

**M**y license and yours were issued under Federal Commission Rule 97.1 in recognition and enhancement of the value of the amateur radio service to the public as a voluntary non-commercial communication service, particularly with respect to providing emergency communications.

Sometimes we forget that after receiving our licenses. We have a tendency to get caught up in our own little part of the amateur spectrum, not bothering to try new things. However, these licenses are a grant from the government and we need to channel more of our individual and club activity into public service.

## Interface with your community

One of the reasons that amateur radio has not been growing as fast as it could is that licensees have not made themselves and

their clubs as visible to the public as they should. Only occasionally do you see an amateur call plate on an automobile. Most states will provide an amateur operator with a call sign plate (upon proper application) for no more than a regular license plate costs.

Amateur radio clubs start and then fade because club activities are rare or nonexistent. Members need activities to keep them motivated. Club members should make every effort to build working relationships with the local Sheriff's Department, Police Department, county and city emergency medical service,

***"When one department has developed a relationship with your club, others will follow."***

ambulance service, water, gas and electric departments and especially the local Emergency Management Agency.

It will take hard work on the part of club members to win the confidence of the department heads. These people instinctively start protecting their individual turf when outsiders offer help. Be patient; if approached in the right way these folks will become appreciative of your efforts. Sheriffs' and Police Departments may be the most resistant to your efforts, but don't give up. Police Chiefs must be reassured that club members are not trying to be police officers. Approach the Chief with the idea of club members being a mobile neighborhood "watch on wheels." Invite the Chief or Sheriff to a club meeting two months before Halloween and offer to help Halloween night to crack down on vandalism, reckless driving, or other activities that the Chief or Sheriff may suggest. If he accepts your offer, plan your activities in conjunction with his office and follow his instructions explicitly.



*Photo A. Joyce Seay KC4RNX (now AD4EX), on patrol with "Operation Goblin" in association with the local Police Department. At Halloween each year, most Police Departments welcome extra eyes and ears to prevent vandalism.*

When one department has developed a relationship with your club, other departments will follow.

## Be ready

Let the emergency management agency in your area know that club members are able, willing, and ready to answer a call for help in an emergency. This might include storm damage surveys or providing communications at emergency shelters.

Each club should develop an emergency communications plan, including an information flow chart like the one shown in **Fig 1**. Make copies of this chart and add a brief description of the club capabilities in the event of an emergency. Deliver these charts to each of the department heads and invite them to a club meeting. Even if they don't use club members in their operations, the question and answer session will make a superb program for that meeting.

Inactivity in amateur radio clubs is a disease that is completely curable if club members will just get off their duffs. More people rust out than wear out—let's scrape off the rust and get involved! We owe that much to our communities.

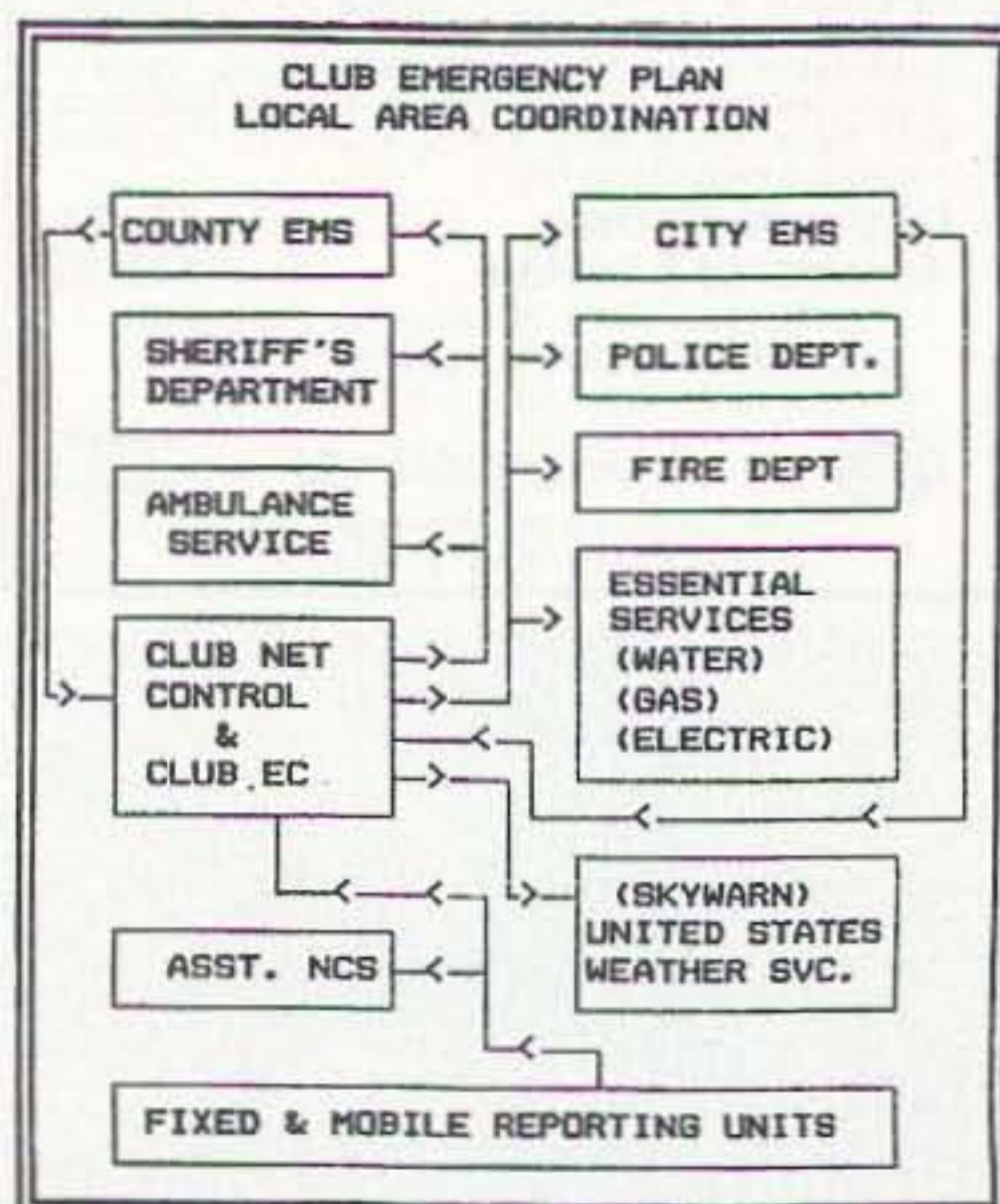

**Fig. 1.** Local amateur radio club organizational and information flow chart. Your own club's emergency plan should be reproduced and given to each department head in your community (this chart is from "Organizing a Club Emergency Plan," published in Radio Fun, June 1993).



**NEVER SAY DIE**  
Continued from page 43

Mali. Their religious rites are based on a visit from aliens about 5,000 years ago. The aliens were from a planet circling Sirius B. This is a star that was first spotted in 1970. It's a white dwarf that circles Sirius A, which is a very bright star. Well, you really ought to spend the \$17 for the book and be amazed at how closely the Dogon tribe's stories tie in with facts discovered only recently.

There's a strong suggestion that these visitors may have helped mankind start our first civilizations, which somehow sprang up almost overnight in several places ... like Egypt and Sumer. The more you read about the pyramids, the more believable is this story. How about temples built so Sirius A shines down a long corridor on New Year's Day to spotlight the altar? The Temple of Isis at Denderah is a good example. Coincidence, right?

Are the thousands of stories of current alien visits all hokum? And if so, why is our beloved government going to such extremes to shut up people who report having seen them?

Well, whether aliens are here with us now or not, it seems like a big waste of money and time for us to be listening for alien radio signals. Maybe we'll hear a spark rig from some new apes on the block.

**W4JJ**

A reader pointed out that Jerry Freeman's call was W4JJ, not K9AAH (in a May letter). Yes, I should have caught that! But I hadn't heard that Jerry, shortly after retirement, died of a brain tumor. I've had several friends die of brain tumors, so I've been particularly interested in reading books which go into how to avoid them, and how to get rid of them without the usual medical procedures. I sure wish Jerry had let me know that he had a problem. He was only 63, so he could have had at least another 40 healthy years or so ahead of him if he'd taken enough interest in his problem to discover some of the powerful alternatives to the medical industry's usual approaches. You just don't get cancer if your immune system is strong.

**More Celebs**

A note from my old friend Tim Chen BV2A, whom I used to visit every year when I was leading tour groups to the Asian electronics shows, reminds us that AC3PT, the King of Sikkim, should be added to the celebrity list. And Tim also points out that our DX Dynasty Award should now recognize Pratas Island BV9P. The rule is simple for the DXDA award: Any country accepted as such by a national ham organization of any country is recognized for DXDA credit. This makes it possible for someone with little else to do to work 400 countries.

In all fairness, I had a lot of fun working 350 countries. It took me a couple of years.

But I find I'm a "been there, done that" person, so I don't have a lot of enthusiasm for repeating things I've already done. Like one time for visiting most countries is fine. Maybe that's why, when I start a new magazine, I'm ready to sell it once I have it going well. A sort of seven-year itch thing, maybe.

Ted Chernin KH6GI faxed me a reminder that Wells Chapin W8GI had an article in the May 1969 73 on ham celebrities. Ted must have a lot better index of the back issues than I.

**NASA Update**

My review of René's *NASA Mooned America* (in the June issue), wherein he made a case for the whole Apollo moon program being a hoax, à la the movie *Capricorn One*, infuriated some readers and got a bunch more to read the book to see for themselves. This has kept René busy having more books printed for us, while keeping an eye out for CIA spooks.

A reader I've known and trusted for many years wrote to tell me about an experience he had while working at the NASA Goddard Space Flight Center in the mid-'70s, maintaining the computers and telemetry equipment. He was surprised at how antiquated the computers were, being mainly Univac M642Bs, an early generation which had been resurrected from Navy ship fire control systems. Data storage was on paper or mag tape.

One day he needed a mag tape for some work and none were available, so he poked around and found an old unmarked tape in a storeroom that looked okay to use. But when he checked to see what was on it he found it to be the info used to drive the displays in the Operations Control Center during an Apollo mission. It was a tape which was normally run during a mission to log all activity to tape for later analysis. So what's the big deal? The tape's creation date was well *before* the mission took place! However, considering how the system was set up, he knew it was impossible for a mistake to have been made in the creation date.

In addition, he noticed that the tape was too clean to be a legitimate log tape. Normally, the log tapes have a lot of data on them from the unexpected things that happen during "real world" operations. That's the purpose of the log tapes. Nor was it a simulation tape; those were only a few minutes long and not an entire mission tape such as he'd found.

Having done an in-depth report on that Apollo mission in school, he knew the dates were wrong. This has been worrying him ever since, but he prudently kept quiet about it.

Other than a few letters from angry readers who are convinced that our beloved government wouldn't lie to us, and who have no intention of reading the book, I haven't seen much to refute the 30 points René makes. I want René to be wrong, but he makes a very solid case. The book is \$25 (plus \$5 s/h) from Radio Bookshop.

Many of the readers who got his *Moon* book have since ordered his *Last Skeptic of*  
*Continued on page 48*

**FREE CONSTRUCTOR'S CATALOG!**



**Rack Chassis**

MODEL	WxDxH	A"	B"	MODEL	WxDxH	A"	B"
TRU5	19 x 7 x 1.75	35.00	45.50	TRU17	19 x 17 x 3.5	56.00	66.25
TRU7	19 x 7 x 1.75	37.75	50.00	TRU5	19 x 11 x 3.25	47.50	56.25
TRU10	19 x 10 x 1.75	40.00	51.50	TRU7	19 x 7 x 3.25	50.00	62.75
TRU12	19 x 12 x 1.75	42.75	53.00	TRU10	19 x 10 x 3.25	52.75	65.00
TRU15	19 x 15 x 1.75	50.00	63.25	TRU12	19 x 12 x 3.25	59.00	74.50
TRU17	19 x 17 x 1.75	53.25	65.50	TRU15	19 x 15 x 3.25	62.25	77.00
TRU5	19 x 5 x 3.5	37.75	48.00	TRU17	19 x 17 x 3.25	65.50	79.25
TRU7	19 x 7 x 3.5	40.00	51.50	TRU15	19 x 15 x 3.5	68.00	82.00
TRU10	19 x 10 x 3.5	42.50	54.75	TRU17	19 x 17 x 3.5	71.00	85.00
TRU12	19 x 12 x 3.5	45.00	58.00	TRU15	19 x 15 x 3.5	74.00	88.00
TRU15	19 x 15 x 3.5	52.75	65.00				

ORDER TODAY! (\$30.00 MINIMUM ORDER)  
PRICES INCLUDE WORLDWIDE SHIPPING!  
\*A = Cont. U.S., CANADA & MEXICO; \*\*B = Rest of World

ORDERS 800-634-3457 ■ FAX 800-551-2749  
OFFICE 702-565-3400 ■ FAX 702-565-4828  
SESCOM, INC. 2100 WARD DR., HENDERSON, NV 89015  
SESCOM, INC. is not responsible for inadvertent typographical errors and prices and specifications are subject to change without notice.

CIRCLE 167 ON READER SERVICE CARD

**Next Day** **QSLs**  
Two-Color Rainbow Assortment

Baraboo, Wisconsin  
Sauk County  
**K9ZZ**

Call Today & We Ship

	We Ship	Next Day	2nd Day	ASAP
100	\$29.95	\$24.95	\$19.95	
200	\$39.95	\$34.95	\$29.95	
400	\$49.95	\$44.95	\$39.95	
500	\$54.95	\$49.95	\$44.95	
1000	\$99.95	\$89.95	\$79.95	

Info 51  
Antennas West  
(801) 373-8425

All orders ppd 2nd day air/ priority mail.  
For overnight air delivery add \$10.  
Box 50062-S, Provo, UT 84605

CIRCLE 5 ON READER SERVICE CARD

**REPEATER HEADQUARTERS**

Make "Commercial Quality" repeaters from GE and Motorola Mobiles

- 45 Watt VHF Micor from \$99
- 40 Watt UHF Master II from \$199

Conversion Information Available!  
<http://www.versatel.com>

**VersaTel** COMMUNICATIONS  
Orders: 800 456 5548  
Info: 307 266 1700  
FAX: 307 266 3010

CIRCLE 259 ON READER SERVICE CARD

**CUBEX QUAD ANTENNA CO.**  
40 YEARS OF QUALITY ANTENNAS

SKYMASTER H.F. KITS FROM \$275.95  
PRE-TUNED H. F. QUADS FROM \$379.95  
Quad Antennas From 2 Through 40 Meters

2 METER 4 EL. PRE-TUNED \$44.95 + \$7.00 S&H  
6 METER 2 EL. PRE-TUNED \$69.95 + \$15.00 S&H

BEST PRICES ON DOUBLE BRAIDED "DACRON" ANTENNA ROPE  
visit our new web site <http://www.cubex.com>  
Write Or Call For Free Catalog  
2761 SATURN ST. "E" BRECA CA 92621  
(714) 577-9009 FAX (714) 577-9124

CIRCLE 166 ON READER SERVICE CARD

**FOR HAMS ONLY**

**ROBB KE3EE**  
**JERRY K3FKI**  
**DAVE KA3ZNY**

12123-1/2 Frankstown Rd., Pittsburgh PA 15235  
(412)-793-3939

FOR ORDERS ONLY CALL (800)854-0815  
Specializing in Preowned  
Amateur and Shortwave Equipment  
Buy • Sell • Repair • Love To Trade  
We Carry All Major Brands of New Equipment  
We Now Custom Design & Build Computers

For HAMS by HAMS  
All of The Latest Hardware & Software  
Call For Details

CIRCLE 329 ON READER SERVICE CARD

Science book (also \$28, including shipping). A couple readers have raised questions, but René has done his homework thoroughly, so nobody has stumped him on anything yet. No ice ages? Ridiculous! But René's explanation fits the facts and the whole idea of ice ages doesn't.

### Pirate Caught!

During the recent Sea-Pac convention in Oregon the Phantom Amateur Radio Group (PARG, from Beaverton) was enjoying their annual bonfire on the beach when one of the members, who was monitoring the police channel, heard someone break in cursing. They quickly turned on their direction-finding equipment and within five minutes had located the pirate at a nearby motel. They could see him on the third floor balcony talking into his HT. Another member stopped a nearby police cruiser and explained that three club members were on their way to the pirate's motel. Just before they arrived they saw the pirate come down the stairs and run off. A couple hours later the interference started again so the police went to the room the members had pointed out and caught the chap in the act. The pirate is reported to be KE6VNU, who was there for the convention. It turned out that he'd been released from jail just shortly before this incident. Yep, for causing malicious interference in his home area.

Now, will the FCC lift this guy's ham ticket?

### Calling Channel

A letter from Ralph Gaines WL7DU makes a good point. During an ARRL contest he was trying to maintain contact with a vessel in distress, only to have the boat's weak signal clobbered by contesters. My suggestion is for contest sponsors to set

aside parts of each band as out-of-bounds for contesting. Further, maybe it's about time to establish a "calling frequency" on each band where emergency traffic would have priority, but which could be used for establishing contacts the rest of the time. It would be a good channel to monitor, with callers checking in, as we do with repeaters. And once a contact is made, the QSO would move to another channel to continue.

On 20m we might set aside 14,275-14,300 for non-contest contacts, with 14,285 as the calling/priority frequency. 14,275 would be better, except that it's used for blind broadcasting many hours of the day by K1MAN. Or do you have a better suggestion?

### Talk Radio Lives!

Art Bell W6OBB called and asked if I would be a guest on his radio talk show again. Sure. I knew I'd get another big pile of mail like last time, but the upside was that I would have an opportunity to talk about ham radio on a program with tens of thousands of listeners.

The interview was on Friday night. On Monday morning a stack of letters 18" high arrived. And it kept up like that for almost two weeks before slowing down. Two months later I was still getting a dozen or so letters a day!

Art and I talked for four hours. His show is rated #1 in Los Angeles, Seattle, and many other markets, so it has a humongous audience. My first interview six months before brought over 2,500 letters. Friends in the Denver area said that I was on for six hours—the four hours I talked live, plus a repeat of the first two hours. And the program was repeated by many stations over the next couple of days.

Many of the letters from regular Art Bell listeners said this was his most interesting show ever. With the Dayton HamVention no longer asking me to talk, I needed confirmation that I'm still interesting. Well, I can understand the pressure the HamVention must be under from the ARRL, which views me not as a fellow ham or entertainer, but as a business competitor. And money rules, both in Newington and in Dayton.

Art and I talked a lot about how much fun we've had with ham radio. But I also couldn't help mentioning my 28-page list of 83 books you're crazy if you don't read, the Bioelectrifier, cold fusion, the René book about NASA, and so on. You know, all that stuff you grumble about me writing about in my editorials. I didn't even have time to get into dowsing, UFOs, contactees, reincarnation, and weirdo stuff like that.

Picture 300-500 letters a day to be opened, read, envelopes addressed, a 12-page list of my available booklets stuffed, and a quick answer to questions added. Well, if it'll help get us a few more hams, it's worth it. And I think it will help because subscriptions to 73 are pouring in. Yes, I did most of the work myself. In case you wondered, AM radio is alive and well. I wish I had time to do more interviews like that. I also wish I had the time to personally answer more of the letters. But if I can get people to start reading some of the books on my list they'll at

least have the information it takes to live longer, much healthier lives. However, I've found that health is way down on the list of important stuff for most people, at least until something goes so wrong they have to go to the doctor—who looks them over and then leans back and says, "Uh, o-oh."

Art sure has a lot of listeners. The mail poured in from Hawaii, Alaska, St. Thomas, and all around the country. All 50 states!

One thing surprised me. Though I did get a few letters from hams, when I think of the thousands of people I know personally through my work in the ham field, computers, the music industry, and so on, none of the mail came from people that I knew. Well, 350 million is an awful lot of people. Now, how can we reach more of them with our message of how much fun and adventure we have available for them in amateur radio?

### Missed You at Dayton

Not being asked to speak, plus deciding not to be tied to a booth, and not being able to get away for five days anyway, I skipped the HamVention again this year. That's maybe three skipped over the last 41 years. Well, it's turning more and more into a computer flea market, like most other hamfests. I haven't been a computer hobbyist since the TRS-80, one of the first integrated microcomputers, came out in 1977. I've been a user. I got a TRS-80 Model I the day it was introduced. And their Model 100 laptop the first day it was available, in 1983. But then Radio Shack did their \$50 billion-plus screwup, dropping from 40% market share to around 1%, so eventually I replaced my trusty old 100 laptop with a Macintosh PowerBook.

How was Dayton for you this year? Were the talks exciting and well-attended? What did you buy? What did you see that was new and interesting? What did I miss?

### 1960, When 73 Started

With my 74th birthday on September 3rd, and this issue winding up 36 years of 73 (will I make it to 40 years?), I couldn't help remembering 1960, the year I started it.

That was an eventful year for me. It started off briskly when I was fired on January 5th as the editor of *CQ*. Well, things had started destructing along about Christmas. A little matter of some differences with the publisher. Like he owed me a year's pay. And I'd discovered he was a year behind on paying my authors for articles, and a year and a half behind on paying my columnists. Worse, my assistant editor dug into the circulation manager's desk one night and gave me a copy of the actual paid circulation of the magazine, which was less than half of the sworn statement circulation figures. In the publisher's desk he found a financial statement which showed that *CQ* had made \$100,000 net profit in 1959, most of which had gone to pay for the publisher's new 58-foot yacht, which he had taken as a "business expense." Then, at Christmas, he gave me a \$5 Christmas bonus, "wishing it could be more."



But he'd let me know in many ways that as the only outsider on the staff I really shouldn't count on a future. It was a family-run business and I had been hired at a desperate moment when the previous editor quit and *CQ* was losing a lot of money.

After being fired, I tried working for an ad agency. But my love was amateur radio, so I decided to take a gamble. I sold everything I owned of value and got together just enough money to print the first issue of 73. Well, that's what entrepreneurs do.

At the same time I was working with the ARRL Hudson Division to put on a New York City ham convention. Chet K2EAF, a manufacturer's rep, and I sold all of the booths and helped with much of the organizing of the convention. Chet and I were disappointed at the convention banquet when Harry Daniels W2TUK took credit for everything, never mentioning our part. Honors apparently were very important to him, earned or not.

Also that year there was an article in *The Village Voice* newspaper about Mensa, a high-IQ club in England. They were looking for American members. I'd had my IQ checked in college so I knew I should qualify, so I sent for their test and became American member #15.

A few weeks later Peter Sturgeon, the brother of well-known writer Ted Sturgeon, called and asked if I was interested in forming an American Mensa group. Sure! So he, two other members and I met at his apartment in downtown Brooklyn and American Mensa was started. Since I had a mimeograph and an addressing machine, I became the first secretary. I got the list of people who had qualified from London and sent out meeting notices every month. The next two meetings were held at my house in Brooklyn, then we rotated to other members' homes. I decided to get the heck out of New York in June 1962, moving to New Hampshire, where I was the Mensa local secretary for many years. Peter later moved to Switzerland. The other two chaps who were there at the beginning disappeared. One was a schoolteacher and the other a reviewer for a book publisher.

If I'd stayed in New York I think Mensa would have turned out much differently. My goal was to get the members together in groups to brainstorm ideas to help solve our country's more serious social problems. I wanted to put those IQs to work, not just have a snob club. Mensa turned out to be totally useless and a sad waste of a potentially powerful resource. Well, that was my fault for moving to NH.

In addition to helping with the Hudson Division ARRL Convention and getting American Mensa started, I was also president of the Porsche Club and quite involved in organizing car rallies and club visits to the factory in Stuttgart to pick up new cars. I got the program started in 1958 and it was a great success. A hundred and fifty of us flew over on Lufthansa, picked up our new Porsches in front of the Solitude Castle, and then the

*Continued on page 53*

# MAGGIORE ELECTRONIC LAB.

## Hi Pro Repeater

Maggiore Electronic Lab.

Model R1

**INTRODUCES THE NEW Hi Pro "R1" REPEATER**  
 HERE IS A COMPLETE LOW COST VHF REPEATER, LESS CONTROLLER, PRICE \$589.00  
 A 35 WATT VHF REPEATER WITH VOICE, AUTO PATCH, AUTO DIALERS ETC. \$1145.00  
 THIS IS NOT A KIT BUT A COMPLETE REPEATER WITH A 2 YEAR WARRANTY  
 AVAILABLE IN BOTH VHF OR UHF. FOR MORE INFORMATION CALL OR WRITE,  
 MAGGIORE ELECTRONIC LAB., 600 WESTTOWN ROAD, WEST CHESTER, PA., 19382, Ph: 610-436-6051 Fax: 610-436-6268

### MAKE CIRCUIT BOARDS THE NEW, EASY WAY

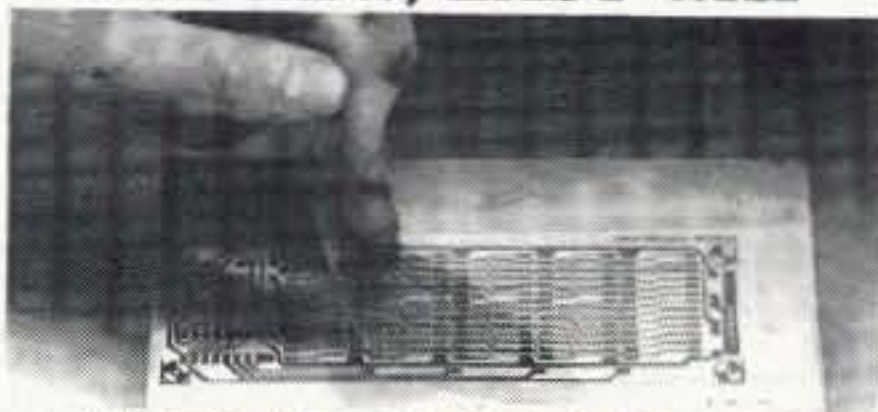

#### WITH TEC-200 FILM

JUST 3 EASY STEPS:

- Copy circuit pattern on TEC-200 film using any plain paper copier
- Iron film on to copper clad board
- Peel off film and etch

convenient 8 1/2 x 11 size  
 With Complete Instructions

**SATISFACTION GUARANTEED**

5 Sheets for \$4.95 10 Sheets only \$6.95  
 add \$2.00 postage

**The MEADOWLAKE Corp.**

Dept. M • PO Box 1555 • Oneco FL 34264

### INSURANCE

#### Computer & Radio Equipment

**HAMSURE coverage follows your equipment wherever you take it.** Theft from vehicles, earthquake, water damage and all other hazards including surges. Insure all your equipment and accessories (except towers and antennas but including rotors), media and purchased software.

**Low Premium Low Deductible**

#### HAMSURE

7901 Laguna Lane  
 Orland Park, IL 60462  
 800-988-7702 Anytime  
 E mail: hamsure@aol.com



Available only in the  
 48 continuous states



CIRCLE 78 ON READER SERVICE CARD

### TNT Today's No-Tune Multiband Antenna

<p>No pruning.          TNT is No-Tune on 80 cw, 40, 20, 17, 12, 10. TNT/2 is No-tune on 40, 20, 10. Work other bands w/ tuner. DX &amp; Gain rise w/ frequency.          Ready to Use          Includes isolation balun &amp; 99 ft RG8x</p>	<p>No tuning.          Kink-Proof          Wx-Sealed          Low Noise</p>	<p>No knobs to twist.          No traps or Resistors          Insulated to 3000 V          Rated 500 Watts</p>
---	---	--

The modern coax-fed version of the classic off-center fed window.

Technote 126-\$6.95 ppd

**AntennasWest**  
 Box 50062S, Provo, UT 84605

<p><b>TNT</b> \$89.95 +\$8          Window 135 ft. long PAH</p>	<p><b>TNT/2</b> \$79.95 +\$7          Window 67 ft. long PAH</p>	<p>Order          Hotline 800-926-7373</p>
---	--	--

CIRCLE 135 ON READER SERVICE CARD

## Down East Microwave Inc.

### Summer Special!

#### 6M, 2M, 222Mhz, & 70cm Transverter Packages!

A DEMI High Performance Transverter, The new Teletec Solid State Power Amplifier, and a K1FO design Yagi Antenna. All completely configured for your 28 MHz transceiver. Plug and Play! We can interface to most HF transceivers.

Write or call for complete product line catalog and/or product descriptions of above.

### Down East Microwave Inc.

954 Rt. 519  
 Frenchtown, NJ 08825  
 tel: (908) 996-3584  
 fax: (908) 996-3702

### All Aluminum

- |                    |                        |
|--------------------|------------------------|
| Chassis Kits       | Rack Shelves           |
| Cabinet Kits       | Rack Equipment         |
| Assembled Cabinets | Antenna Grounding Kits |
| Slope Box Kits     | Tower Mounted Box Kits |
| UHF & VHF Antenna  | Dipole Hangers         |
| Power Divider Kits | Other Enclosures       |

Small sheets Aluminum and Brass  
 UHF / VHF Antenna Parts

### Byers Chassis Kits

Charles Byers K3IWK  
 5120 Harmony Grove Road • Dover, PA 17315  
 Phone 717 - 292-4901  
 Between 6PM and 9:30PM EST. Eves.

CIRCLE 222 ON READER SERVICE CARD

## Amateur Radio Via Satellites

Andy MacAllister WA5ZIB  
14714 Knights Way Drive  
Houston TX 77083

### Houston, we have a problem—OSCAR 13's last Field Day.

Time is running out for AMSAT-OSCAR-13. While the satellite was online and working great for Field Day (June 22nd and 23rd) this year, next year it will only be a memory. Reentry should

orbit), and conditions were optimum.

A-O-13 was originally scheduled for a major orientation change just before Field Day to keep the solar panels aimed at the sun. Because of atmospheric drag around perigee (the orbit's low point), the orientation had shifted on its own to a point that was acceptable for a few more days. The radical orientation change was not needed until after Field Day,

---

*"In early November things will begin heating up on board the satellite."*

---

occur in mid-December. Many changes to A-O-13's orientation and operating schedule will begin soon, as ground-control stations stabilize the craft to prolong its useful life in the sky.

During Field Day 1996, most stations in the U.S. had only a few hours of access to the satellite in the early hours of Sunday morning, but it was worth it. The satellite was aimed at the center of the earth while at apogee (the highest point of its elliptical

so signals from the satellite were stronger than expected for the contest period.

An explanation of the orbital mechanics and physics involved with the demise of A-O-13 requires a lot of math and interpretation. James Miller G3RUH has covered the topic in detail, and the information can be found via the Internet at the AMSAT ftp (file transfer protocol) site. The URL (Uniform Resource Locator) for A-O-13 information is <ftp://ftp.amsat.org/>



Photo A. The K5DX analog satellite station was set up in this RV at the W5SJS Ranch in South Texas for Field Day 1996.



Photo B. N5DC and WA5ZIB outside the K5DX Field Day HF-SSB and digital satellite RV on the W5SJS Ranch.

[amsat/satinfo/ao13/](ftp://ftp.amsat.org/articles/g3ruh/). Published articles by James can be found at <ftp://ftp.amsat.org/articles/g3ruh/>. For our purposes, it is sufficient to simply describe some of the events that A-O-13 will experience until its end in December.

Subtle orbital changes began to occur in January of this year. The Mean Motion (number of orbits per day) started to decline due to atmospheric drag. By April, the satellite was losing about 80 ms per orbit. This may not sound like much, but old element sets begin to produce inaccurate computer predictions, and the problem gets worse each month. As with a low-orbit satellite, new element sets should be used whenever possible. The perigee was down to 300 km in May. By October it will be about 160 km.

From an operational point of view, normal A-O-13 orientation

to aim the high-gain antennas at the center of the earth at apogee is ALON/ALAT = 180/0. Due to the atmospheric drag and heating problems that begin in the fall, the satellite orientation will be set to ALON/ALAT = 90/0 beginning in late August or September. This means that the satellite's high-gain antennas will be aimed away from users almost all the time. Heating problems will be minimized and orientation problems due to drag will be stable. The mostly-flat motor side of the satellite will be facing the atmosphere around perigee. The high-gain antennas and solar panels will not be "into the wind" with their unsymmetrical proportions.

The omnidirectional antennas and Mode-B transponder (70 cm up and 2 meters down) will be activated full-time when the orientation changes

are implemented. The omnis will be correctly aligned for good use both at apogee and perigee.

In early November things will begin heating up on board the satellite. At the end of May, the solar panel temperature was about 53° F. At the beginning of November the temperature could be as high as 100° F around perigee. The reorientation to ALON/ALAT = 90/0 will keep this down a bit, but by the end of November, temperatures could go as high as 480° F. Thermal cycling between the hot time around perigee and the colder periods during the rest of the orbit will likely cause the panels to crack. Solder may have melted by this time and the transponders may be fried.

helium balloons for late-night activity. The motor homes (with air conditioning and microwave ovens) and generators performed flawlessly, and contacts were fast and continuous at the voice, CW, Novice, and VHF/UHF positions.

Two satellite positions were added to the extensive array of stations this year: one for analog (voice/CW) satellites under the American Radio Relay League rules, and another for digital satellites and the AMSAT Field Day rules. All of the available satellites and modes were pursued, with only a few exceptions.

#### More on Field Day

AMSAT-OSCAR-10 has been in orbit since 1983. This



Photo C. Mike WA5TWT finishes installation of the VHF/UHF array at one of the K5DX hamsat stations.

up and 2 meters down). Mode T operation was easier for many participants. Interference from nearby 10 meter Field Day stations had no effect on the 2 meter satellite downlink. RS-15 was operational for Mode A activity. Although the downlink signals were weak, passes were long for a LEO (low-earth orbit) hamsat and many successful Field Day contacts were logged.

During the daylight hours of Field Day, AMSAT-OSCAR-27 provided FM QSOs for those equipped for Mode J (2 meters up and 70 cm down). The satellite is not activated for nighttime passes. Since this satellite provides only a single voice channel, it sounded more like a local FM repeater with everyone trying to talk at once.

Fuji-OSCAR-20 was available for voice and CW contacts. The Mode J analog transponder offered good QSOs, even though the Doppler shift was a persistent factor. A new Fuji is scheduled for launch in August. It will have an analog transponder in addition to 9600-baud packet.

While the 1200-baud digital satellites like AMSAT-OSCAR-16 were active for Field Day, the 9600-baud birds like Kitsat-OSCARs-23 and 25 had more traffic. UoSAT-OSCAR-22 also carried digital Field Day messages. The ARRL rules do not recognize digital activity through these satellites, but the AMSAT competition counted every Field Day message download and upload as three points.

Thousands of amateur-radio stations listened patiently

---

***“The ARRL rules do not recognize digital activity through these satellites, but the AMSAT competition counted every Field Day message download and upload as three points.”***

---

As we approach the end of the useful life of A-O-13, many stations will be monitoring the telemetry. This will provide insight for future spacecraft designs, in addition to the educational potential. Don't forget to make some contacts via OSCAR-13 before the conclusion of the A-O-13 story.

#### The K5DX Field Day

The Houston AMSAT group went out with the Texas DX Society this year. The TDXS folks always have an incredible array of antennas, radios, and operating positions for HF work. Large yagis for 10 meters through 40 meters were raised on trailer-mounted towers. Guy wires were pressed into service as inverted V's for 75 and 80 meters, and a 75 meter delta loop was lifted by

13-year-old satellite is still performing very well. The computer memory is dead and the batteries are no longer functioning, but when the satellite is in sunlight the solar panels provide power and the Mode B transponder works well. Activity is usually very light, but for Field Day contacts were brisk and the downlink passband sounded like 20 meters. Signal strength was not as good as A-O-13, but after November, A-O-10 may be the only available high-orbit hamsat available for use.

The low-orbit RS satellites were packed. RS-10 with its Mode A transponder (2 meters up and 10 meters down) provided many quality contacts. Signals were strong and contacts were easy. RS-12 was active on both Mode K (15 meters up and 10 meters down) and Mode T (15 meters



Photo D. Andy WA5ZIB gets ready for a Kitsat-OSCAR-25 pass at the K5DX 1996 Field Day site in South Texas.



**Photo E.** The K5DX HF-CW station was simple, yet effective, with over 100 contacts per hour.

for the space shuttle. Mission STS-78 was up, but nothing was heard on the 145.55 MHz

the contest period. Hundreds of enthusiasts made voice and packet contacts during the

***“It was also a reminder to the long-time satellite enthusiasts of how much fun the hamsats are to work.”***

downlink. Shuttle experiments took precedence during

days that followed Field Day, but not during the weekend.



**Photo F.** An experiment worth trying: The K5DX HF team suspended an 80 meter delta loop with balloons from their South Texas Field Day site.

Field Day 1996 via satellite was an exciting event. Although it was the last for A-O-13, it provided many newcomers with an opportunity to experience satellite communications. It was also a reminder to the long-time

satellite enthusiasts of how much fun the hamsats are to work. In the months ahead we can monitor the demise of A-O-13 and renew activity via A-O-10, F-O-20 and the many other satellites still in orbit and working great. **73**

## QRP

Number 52 on your Feedback card

### Low Power Operation

Michael Bryce WB8VGE  
2225 Mayflower NW  
Massillon OH 44646

As QRP rigs become even more complex, using perfboard for their assembly has become the exception rather than the rule. Most of today's circuits require the use of a PC board. Also, you can just about forget the fingernail polish and resist pens. It's nearly impossible to lay out a PC board by hand using today's miniature parts.

By far, the easiest way to generate a PC board is to use one of several computer CAD programs. These programs are nothing more than fancy drawing software on steroids. I've used several in my time and currently use the DOS based CirCad.

Instead of focusing on how to make a PC board, I thought I would take a different approach.

Laying out the PC board is almost as complex as the circuit you're building.

#### Get your ducks in a row

After you have a working schematic, and your project works, the next step is to get all the parts mounted on a circuit board. I find it best to start off with a sheet of paper and a pencil or two. Oh, and a *big* eraser! This first step lays the groundwork for the computer. It also forces you to show, on paper, the input and output jacks required. If you need an antenna jack, power or speaker output, now is the time to put those down on paper. Also, if you plan to use a part with a unique footprint you need to show that location on your work sheet. Let's say you're planning to use a BNC right-angle

connector. Place this part on your work sheet in the general location you desire. You might also want to make a mental note that you can't locate parts under the BNC connector.

Move the parts around, trying to get everything connected with the shortest possible routes. But don't worry about all the connections; we'll let the computer work on those. Sometimes you can actually lay out the board to closely follow the schematic. The trial on paper give you a idea of how the PC board will look when it's finished.

#### Net lists

Most of the high-end PC board drafting programs include a sub program to generate net lists. To do this, you must first draw out your schematic within the CAD software. Sometimes the schematic drawing program is separate from the CAD software; in other cases it is built-in.

When you are sure the schematic is correct, you generate a net list, which contains all the connections you have drawn on

the schematic. The net list knows that R4 pin 1 is connected to pin 2 of C11, and that pin 1 of C11 goes to the base of Q4. The net list then becomes the "rule" for checking what you have on the schematic and what you will do on the PC board.

With net list in hand, you can start to lay out the board. With CirCad, you input the net list for your project. The net list also contains all the required outlines for the various parts.

Since the net list imported all the outlines for the parts, you're ready to begin. Most people will put tack marks to mark the corners of the board. You can also draw an outline the same size as the finished board. I do neither—I just jump in and start moving parts around.

It's best to use standard spaces. I use .1 mil grid for all parts, then drop to .025 mil if need be. Always use the "snap to grid" option. It may be called other names by different programs, but it does the same thing. With "snap to

grid" on, you can drop a component on the board and the software will automatically place it on the closest grid point.

If your layout requires odd-sized parts or special connectors, use your paper work sheet and place those parts on the board. That done, you have several options, depending on the power of your PC board software.

If your software generates net lists, then it will do what is known as "rats nest" wiring. Here the software will connect all the different points as required by the net list. Since the lines shown are not actual copper traces, they cross each other back and forth, hence the name "rat's nest" wiring.

The purpose of the rat's nest is to allow you to move the parts about, all the while connected to the rat wires. You move and rotate parts so you have the shortest and best routes for each signal.

### Routing and traces

Once you're happy with the layout, it's time to route the board.

I've gotten lazy with CirCad; I use the autorouter all the time. You can route the board by hand; however, if your software comes with an autorouter, by all means use it. Autorouters are not perfect, but they can help you design your board.

The autorouter may route your board correctly according to the net list, but the end result may not be the best design. Most autorouters that I have used are not smart enough to know the difference between a VCC line and a signal line. Also, if your project has an RF section, then the autorouter won't route the traces to ensure stability in this section. A good example is the emitter lead of a transistor used in the PA stage of a QRP transmitter. The autorouter may have in fact routed the emitter lead to ground, but the trace may be to one of several grounds on the board.

To ensure a stable PA stage, the emitter must be grounded using as large a trace as possible. This trace must also be as short as possible. The same problem occurs with VCC lines and heavy current. Large short traces are necessary to ensure proper operation. The collector of that power amplifier must have its trace wide

enough to handle the intended current required by the transistor. But at the same time, the trace must be short and as direct as possible to avoid adding unnecessary inductance.

You can sometimes ease routing time by using copper pouring. The CAD program allows you to "pour" copper into large areas of the board. Copper pouring is great for creating a ground plane in selected locations.

As far as trace width goes, I autoroute with 10 mil traces. These give the autorouter the easiest way to make connections. After the autorouter is done, I edit the lines, making them wider than the 10 mil traces. I like to use 20 mil width trace between signal pads, and up to 250 mil width for VCC traces. I like wide traces on my PC boards. Perhaps it's a throwback to the days of resist pens and nail polish—in the old days, a thin trace was quickly etched away with the rest of the copper!

### WB8VGE's tips

I know I don't know everything about laying out a PC board, but here are some tips I've picked up along the way. Perhaps you can use a few of these next time you lay out your PC board.

We place screw holes in the board so we can mount the board. Don't forget about the heads (or nuts) that will be inside those holes. If you place traces too close to the mounting holes, the screw head may in fact short the traces to ground.

There is the same amount of copper on the top as on the bottom. Unless you have a really simple project, think double-sided PC boards, even if you can't afford a double-sided board with plated-through holes. Lay out the board so connections on both sides of the board can be made by soldering a resistor lead on both sides. This will allow you to use sockets under the ICs, while using a board without plated-through holes.

If you do use plated-through holes, remember to take into account the .003 inches worth of plating inside the holes. If your mounting screws just barely make it though the holes now, after the

plating, they may not fit! I use .038 inch holes, which after plating leaves me with .035 holes. This is my standard for resistor leads. You can use smaller holes, but the .038 size leaves me plenty of wiggle room in case I need to remove the part. The vacuum desoldering tool works much better with the larger hole size.

Watch out for capacitors. It's not so much the lead spacing, but the actual physical size of the caps that can throw you a tomato worm. A .47 mF capacitor has the same .2 mil lead spacing but may be nearly four times as fat, so the guy won't fit in between the rest of the parts.

---

### "Here are some tips I've picked up along the way."

---

Keep an eye out for any kind of connector. It's easy to crowd the connector by getting parts too close to it. Really ruins your day when the first prototypes come in and, after you have the board stuff, you find out you can't get the connector's plug on!

Paper is cheap! I use paper from my recycling box that has been used on one side. Turn the paper over and run it through the laser printer one more time. Print all the time and as often as you can. The board looks a lot different on paper than it does on the screen. Check for traces that look just a tad too close. These may cause you trouble down the road.

Some software has the correct drivers to output to a color ink jet printer. That really makes it easy to check both sides on a double-sided board with one printout.

Don't worry about getting the board as small as you can. I know some of the QRP rigs have a built-in "cute" factor, but for first-time PC board makers, don't try for sub-miniature designs.

I'm out of room for this month. We'll take a break and pick up this thread in November. Next month, October, will be rather special. The October issue will mark ten years of this QRP column. Please join me at a look back at 10 years of "QRP."

## NEVER SAY DIE

*Continued from page 49*

famous Porsche racing team taught us how to race them on the Solitude race track. Wow! From there we drove to Locarno, where over 700 Porsche owners from all over Europe gathered for a huge party.

Yes, 1960 was an eventful year. I wonder how many of you still have that original October 1960 37¢ issue? The cover cartoon was drawn by Bandel Linn K8LAP, who had a daily talk program on WSPB in Sarasota, Florida, where I had been an engineer-announcer back in 1950.

### Nostrums

Being fairly vigorous and having an obvious interest in staying that way, I've been delving into the "how to get or stay healthy" literature. What a mess! There are dozens (maybe hundreds) of books claiming to have found the secret of health. Lordy! And if that isn't enough, every mail brings a booklet or colorful brochure advertising still more ways I can achieve robust health. And each camp, like our welter of commercial religions, has a group of dedicated true believers.

I've been helped a whole lot by readers who have recommended books or health approaches they've found beneficial. At any rate, in my role as a reporter and pseudo-teacher, and with my doctor and professor caps in the drawer out of sight, I've been doing my best to sort out what looks scientifically reasonable and repeatable in the health and longevity field.

Yes, I know, you probably don't care how long you live. Or even how long or healthily your children live. You know you and they are slowly committing suicide, heading towards heart attacks, cancer or a nursing home, or both, but then so are most other people, right? So you'll just get angry with me when I mention that I've found some promising solutions to being fat (which makes you tend to get sick and die earlier than average), and I've also found that you're poisoning your body in a dozen or so ways.

There are some good reasons to believe that the Bioenergizer may help solve the fat problem. Certainly the Comby book will.

*Continued on page 60*

# CARR'S CORNER

Joseph J. Carr K4IPV  
P.O. Box 1099  
Falls Church VA 22041  
E-mail: carrjj@aol.com

It is very difficult to get an antenna working properly without making some simple measurements. Although it would be nice to make azimuthal and elevation pattern measurements, those are beyond the reach of almost all of us. On the other hand, the "I worked [or heard] a guy on the other side of the world" type of measurement tells us little or nothing. Heck, during the peak of the sunspot cycle a breath of hot air on the antenna can be picked up on all continents. Little or nothing can be said about the antenna from working a single DX station. I recall one fellow back in the early 1960s (on the downslope of the sunspot cycle) who worked DXCC in less than a year using a 50-watt Heathkit DX-20 crystal-controlled transmitter feeding a three-band trap vertical. He made up for the lack of a loudenboomer blow-torch RF power amplifier and a large beam with more than a tad of operating skill.

There are some things about antennas that can and should be measured, however. For example, VSWR and the resonant frequency of the antenna are

readily accessible. It's also possible to measure the impedance of the antenna feed point. Hams can measure the VSWR either with a special VSWR meter (often built into transmitters or antenna tuning units), or by using an RF wattmeter.

By stepping through the band and testing the VSWR at various frequencies, you can draw a VSWR curve (Fig. 1) that shows how the antenna performs across the band. The resonant frequency is the point where the VSWR dips to a minimum. You can use the resonant frequency to figure out whether the antenna is too long (resonant frequency lower than the hoped-for design frequency) or too short (resonant frequency above the design frequency).

But resonant frequency and VSWR curves are not the entire story because they don't tell us anything about the impedance presented by the antenna. You can't get the VSWR to be 1:1 unless the antenna impedance and transmission line impedance are the same. For example, a dipole has a nominal textbook impedance of 73 ohms, so it makes a very good match to 75-ohm coaxial cable. But the actual impedance of a real dipole may vary from a few ohms to more than 100 ohms—if your antenna exhibits a feedpoint impedance of (say) 25 ohms, using 75-ohm coaxial cable to feed it produces a  $VSWR = 75/25 = 3:1$ . Not too great. Measuring the feed-point impedance is therefore quite important to making the antenna work properly.

There are any number of instruments on the market that will aid in making antenna measurements. Some of them are quite reasonably priced (or can be built), while others are beyond the reach of all but the most ardent and well-endowed enthusiasts. In this column we will look at a newer breed of more universal instrument called the *SWR analyzer*.

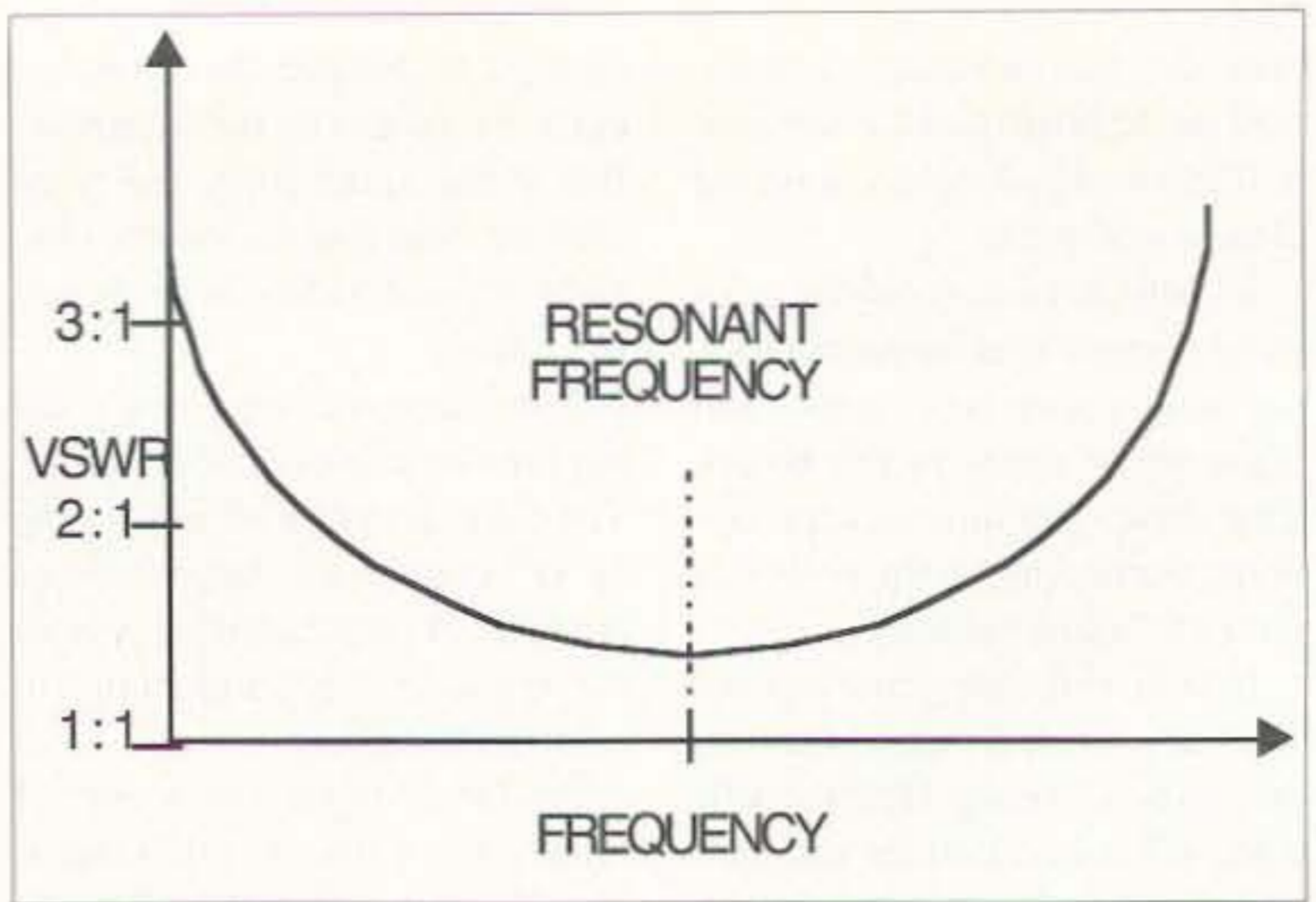

Fig. 1. VSWR vs. frequency curve.

## VSWR analyzers

One basic premise in this column is that the instruments used for measuring VSWR must be accessible to people who don't have a ham operator's license,

**“Unlike many lesser SWR meters, this instrument is not fooled by antennas.”**

as well as those who do (we must remember our SWL and scanner friends). Some of the instruments used by hams meet that requirement, but a relatively new breed of instrument called the SWR analyzer provides a lot of capability to the SWL, scanner operator and ham radio operator alike. It uses a low power RF signal generator and some clever circuitry to measure the VSWR of the antenna. One model also measures the feedpoint resistance.

The simple version shown in Photo A is for the high VHF band (154 to 174 MHz). It is a handheld battery-powered instrument made by MFJ Enterprises, Inc. (P.O. Box 494, Mississippi State, MS 39762). The meter reads the VSWR of the antenna at the frequency set by the TUNE dial. Alternatively, you can adjust the TUNE control until the minimum VSWR is found, and that is the actual (as opposed to desired) resonant frequency.

A somewhat more sophisticated instrument is the MFJ-249 (Photo B). This instrument combines a VSWR analyzer with a digital frequency counter, and operates over the range of 1.8 to 170 MHz. A bandswitch is set to the desired band, and then the TUNE control is set to the desired frequency. The meter will then read the VSWR at the design frequency. Alternatively, you can adjust the TUNE control until the minimum VSWR is found. This frequency is the actual, versus the desired, resonant frequency of the antenna.

An even more sophisticated version of this type of instrument is the MFJ-259 device (not shown). The front panel of the MFJ-259 has two meters: SWR and RESISTANCE. The SWR meter is calibrated up to 3:1, with a little uncalibrated scale to indicate higher SWRs. The RESISTANCE meter is calibrated from 0 to 500 ohms, which is



Photo A. VHF VSWR analyzer.



Photo B. MFJ-249 VSWR analyzer.



consistent with the SWR range. Two controls on the front panel are TUNE and FREQUENCY (MHZ) (a bandswitch). The MFJ-259 has a digital frequency meter to measure the operating frequency of the internal oscillator. This frequency counter can also be used to measure the frequency of external signal sources (do not connect the counter to the output of a transmitter—the instrument will be destroyed). The top end of the MFJ-259 has a number of controls and connectors. An SO-239 "UHF"-style coaxial connector is provided for the antenna connection. A BNC coaxial connector is provided to apply external signal to the frequency counter, while a push-button INPUT switch is available to switch the counter from internal to external signal sources. Another push-button switch is used to set the gate timing of the counter (a red LED on the front panel blinks every time the gate is triggered). The tuning is from 1.8 MHz to 174 MHz, while the counter will measure up to 200 MHz.

The MFJ-259 will work from an external 12 VDC source, or from an internal battery pack consisting of eight size-AA standard cells. MFJ recommends that either alkaline or rechargeable batteries, rather than ordinary zinc-carbon cells, be used in order to reduce the possibility of leakage that can damage the instrument (this is good practice in all battery powered instruments). I have a home-brew battery pack that uses eight size-D nickel cadmium batteries (4 Ah rating) that can be recharged from a 12 VDC power supply, and it works well with the MFJ-259.

Unlike many lesser SWR meters, this instrument is not fooled by antennas that have impedances consisting of both resistance and reactance elements. An example in the manual demonstrates an impedance of  $25 + j25$  ohms (i.e. R is 25 ohms and reactance, X, is also 25 ohms). When connected to a 50-ohm load one might be tempted to think the VSWR is 1:1, and some cheaper meters will so indicate. But the actual SWR is 2.6:1, which is what the MFJ-259 will read.



Photo C. MFJ-249 with dip meter adapter.

The resistance measurement assumes a resistive load (the measurement is made at the antenna's resonant frequency), and is referenced to 50 ohms. The VSWR and resistance measurements should be consistent with each other. If the VSWR is 2:1, then the resistance should be either 100 ohms ( $100/50 = 2:1$ ) or 25 ohms ( $50/25 = 2:1$ ). If the resistance is not consistent with the VSWR reading, then you should assume that the impedance has a significant reactive component and take steps to tune it out.

In addition to antenna measurements, the MFJ-259 is equipped to measure a wide variety of other things as well. It will measure the velocity factor of transmission line, help in tuning or adjusting matching stubs or matching networks, and measure capacitance or inductance and the resonant frequency of L-C networks.

Photo C shows an MFJ-249 equipped with the MFJ-66 dip meter adapter. It can be used to make the MFJ-249 or MFJ-259 work in the same manner as a dip meter. Using this adapter allows you to measure the resonant frequency of tank circuits using the dipper approach, as well as to measure things such as the coefficient of coupling between two L-C circuits, transformers and other radio circuits.

#### Connections ...

I can be reached at P.O. Box 1099, Falls Church, VA 22041, or via Internet E-mail at carrjj@aol.com.

## CAT-300 Repeater Controller

### Attention Repeater Owners

Finally a repeater controller with a TI voice synthesizer and full feature autopatch incredibly priced at \$299.00.

#### Features Include:

- ✓ Voice Synthesizer
- ✓ (412) Word Vocabulary
- ✓ Twelve Voice Messages
- ✓ Two Voice Identifiers
- ✓ CW Identifier
- ✓ Full Feature Autopatch
- ✓ User Speed Dials
- ✓ Emergency Speed Dials
- ✓ Reverse Autopatch
- ✓ DTMF Key Pad Test
- ✓ DTMF Repeater Access
- ✓ DTMF Repeater Muting
- ✓ (56) Control Functions
- ✓ Remote Control Switches
- ✓ Hardware Logic Inputs
- ✓ DVR Controller Ready
- ✓ Female Voice & Sound Effects
- ✓ Programmable Courtesy Tones
- ✓ Programmable Codes and Timers

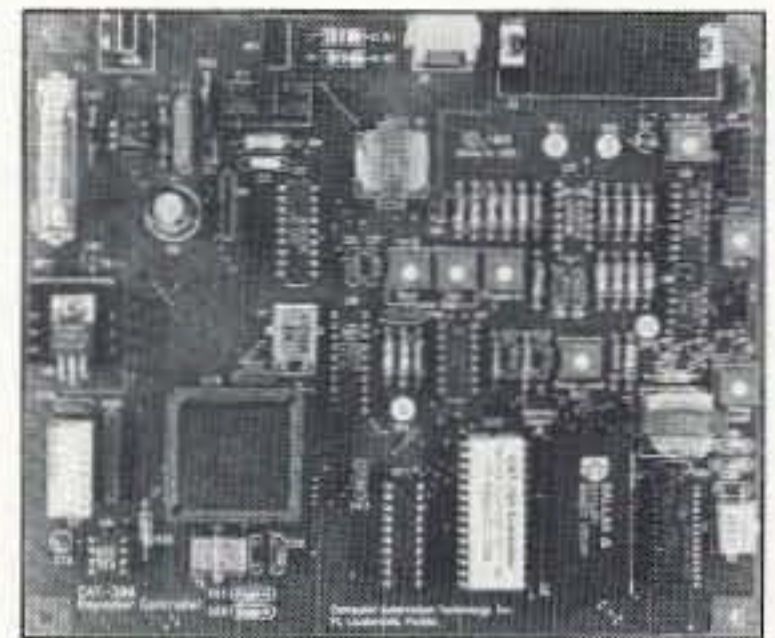

Write or Call for a brochure describing the CAT-300 Controller, including schematic, voice word list, and control functions.

CAT-300 Controller Board \$299.00 Wired and Tested

### Computer Automation Technology Inc.

4631 N.W. 31st Avenue, Suite 142

Fort Lauderdale, Florida 33309

Phone (305) 978-6171- Fax (407) 488-2894

<http://www.catauto.com>

CIRCLE 268 ON READER SERVICE CARD

## AMATEUR TELEVISION

### GET THE ATV BUG

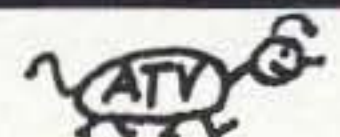

≥10 Watt pep  
Transceiver  
Only \$499  
Made in USA  
Full Color  
and sound



Snow free line of sight DX is 90 miles - assuming 14 dBd antennas at both ends. 10 Watts in this one box may be all you need for local simplex or repeater ATV. Use any home TV camera or camcorder by plugging the composite video and audio into the front phono jacks. Add 70cm antenna, coax, 13.8 Vdc @ 3 Amps, TV set and you're on the air - no computer or other radios necessary, it's that easy!

TC70-10 has adjustable RF out (1 to ≥10w p.e.p.) and sync stretcher to properly match RF Concepts 4-110 or Mirage D1010N-ATV amps for 100 Watts p.e.p. Specify 439.25, 434.0, 427.25 or 426.25 MHz, 2nd xtal add \$20. Hot GaAsfet downconverter varicap tunes whole 420-450 MHz band to your TV ch3. Transmit and camera video monitor output. 7.5x7.5x2.7".

Transmitters sold only to licensed amateurs, for legal purposes, verified in the latest Callbook or send copy of new license.

Hams, call for our complete 10 pg. ATV catalog  
Everything you need for 400, 900 or 1200 MHz ATV.

(818) 447-4565 M-Th 8am-5:30pm pst Visa, MC, UPS COD

P.C. ELECTRONICS Email: [tomsmb@aol.com](mailto:tomsmb@aol.com)

2522 Paxson Lane Arcadia CA 91007 24 Hr. FAX (818) 447-0489

# HAM TO HAM

Your Input Welcome Here

Dave Miller NZ9E  
7462 Lawler Avenue  
Niles IL 60714-3108

I'd like to thank all the contributors who've made the first year of "Ham to Ham" possible, and as we embark on the second year of the column, I invite all readers to keep sending in their favorite tips, ideas, suggestions, and shortcuts. Without your input, we couldn't continue to achieve our goal: many ideas passed on from many hams to many other hams, not just my own soliloquies. Having said that, however, here is one of my own "inventions" that I thought you might like to hear about, but you needn't stop there. Feel free to go ahead and make one for yourself.

## Just the right tool!

It's often been said that having the right tool for the job is half the battle. It's also true that a good assortment of tools is something that every ham and electronics hobbyist needs to enjoy the pastime to its fullest. Even today, when most of us buy many things ready-made, there are still those times when we have to build those little extras that no one else seems to offer.

I've built any number of these electronic accessories over the past 40 years in the hobby, but this tip isn't about building an electronic circuit (not exactly); rather, it's about making a tool that will help you build electronic projects.

I know you're thinking, "make my own tools ... no thanks!" Well, I'm not usually the type to consider making my own tools, either—that's definitely not my primary interest in electronics—but this tool is different. Follow along and you'll see why. Plus,

it's not all that difficult to fabricate—otherwise I certainly wouldn't have been able to do it! I've never seen one like it offered by any of the manufacturers who normally supply tools to the electronics hobbyists market so, as such, it qualifies for my own personal test of build-or-buy, which is: "If it's already made, I'm probably better off just buying it, but if it's not, then perhaps I should consider making one myself!"

Like most hams, I find myself using lots of the 1/8" (3.2 mm) miniature and 3/32" (2.4 mm) subminiature phone jacks on all sorts of different projects. These are the common panel-mount variety of small phone jacks sold by Radio Shack™ and others for bringing audio—and any number of other signals—into and out of a piece of equipment.

They're great; they're inexpensive, they do the job, and they're easy to wire. The problem I've always run into, however, is in how to tighten down those tiny slotted nuts that are used on these jacks, so that they aren't ruined functionally or in regard to appearance. Sound familiar? Most of us simply end up using a pair of ordinary pliers, or perhaps a very small straight-blade screwdriver, in an awkward attempt to tighten down the tiny mounting nuts on these little jacks. I almost always ended up marring the slotted nut itself, or the panel behind it, or both! I've done a pretty good number on some of these over the years ... but not anymore!

I've found it best to sit back and try to imagine what the perfect tool for the job would be.

That approach usually works, and when thinking about this one, I came up with what I call the

Slotted-Nut Tightening Tool. It's shown in Fig. 1 and Photo A.

Here's what I had pictured: The slotted nuts used on these jacks would require a tool of the correct diameter, with the correct size of mating pins (or projections) built into its end. It would have to be made of a material that's harder than the material that the nuts themselves are made of, and it should be reasonably easy to grip. With these parameters in mind, I began to develop the two tools shown.

Oh, that's right, you'll actually need two tools—one for 1/8" jacks, another for the 3/32" variety—but the 1/8" one is probably most often used, so we'll start with it (the 1/8" tool can also be used on some miniature toggle switches that use the same type slotted-nut mounting). Most of the information supplied here will apply to the smaller diameter 3/32" tool as well.

The slotted nuts used on the miniature panel jacks appear to be made of a nickel-plated brass. The first prototype tool that I made for myself was also brass, but I wouldn't recommend using a material that soft for the finished tool because it's too easily damaged—that particular one was strictly a prototype. Once I had proven to myself that the tool dimensions were correct, Bud Hollibaugh, a friend who's also an accomplished machinist, made several more for me out of steel. These have proven to be very serviceable. Tool-hardened steel isn't really necessary; just garden variety steel is fine, since those slotted nuts you'll be using it on aren't made of a very hard material.

Following the dimensions shown in Fig. 1, the steel rod should be about 5" long for an easy grip and good control. It's made of 5/16" (.3125") diameter steel rod with a 5/8" long 7/32" (.221") hole drilled directly in the center; this can be the tricky part. If you can locate a section of hollow steel tubing with these dimensions instead—such as steel fuel line tubing—it will make the job much easier for the average home constructor. Solid rod perhaps has a little bit better "feel" to it, since it's heavier, but tubing will work just as well.

Filing or grinding down one end of the tubing, so that two "male projections" remain, is the only other critical part. Take your time. Following the dimensions in Fig. 1, with the tool clamped tightly in a bench vise, you should have little trouble matching up the projections on the new tool with the slots on an 1/8" panel-jack nut.

That, of course, is the final determining factor: to make the tool mate as closely as possible with a representative sample slotted nut.

The remainder of the tool's "handle" can be covered with rubber tape, heat-shrink tubing, appropriately-sized cable jacket, or whatever you might have, to add some "grip" and "cushion" to it. If you have or know someone who has a lathe, a knurled handle gives it a professional touch.

In everyday use, the slotted nut is started onto the jack with your fingers, as you've no doubt always done, and only the final tightening, for installation or for initial loosening for removal, is accomplished with your new tool. It works like a charm, and like so many things, you'll wonder how you did without it for so long!

A variation, in the interest of simplicity, was to take a fairly wide, flat-blade screwdriver and simply notch out the material from the center of the blade, leaving two projections that fit over the slots of the slotted nut. It works, but doesn't seem to work as well as the tool described in the main body of the article—it can slip off too easily and damage the nut or the panel.

In my own experience, I've found that using the suggested configuration shown in Fig. 1 works best, and then one tool for each individual size of phone jack; one for 1/8" and another for 3/32" jacks.

This is the sort of item that you'll probably only ever need one of (for each size), and it should last nearly forever if it's made as shown. You'll thank yourself over and over again in the future for spending the small amount of time needed to make one of each of these now.

I must reserve the copyrights on multiple quantities of the tools shown here and for their commercial manufacture and marketing,

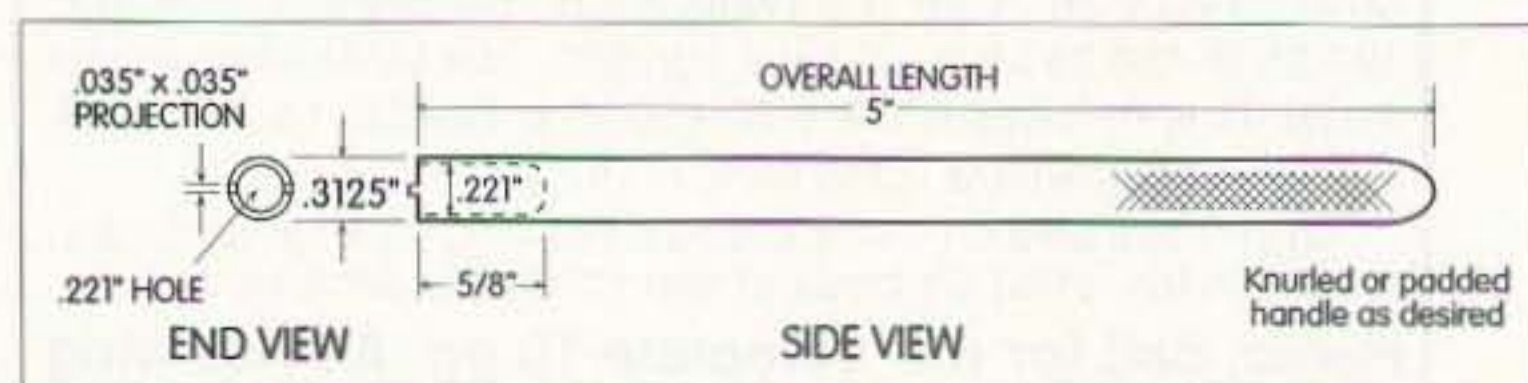
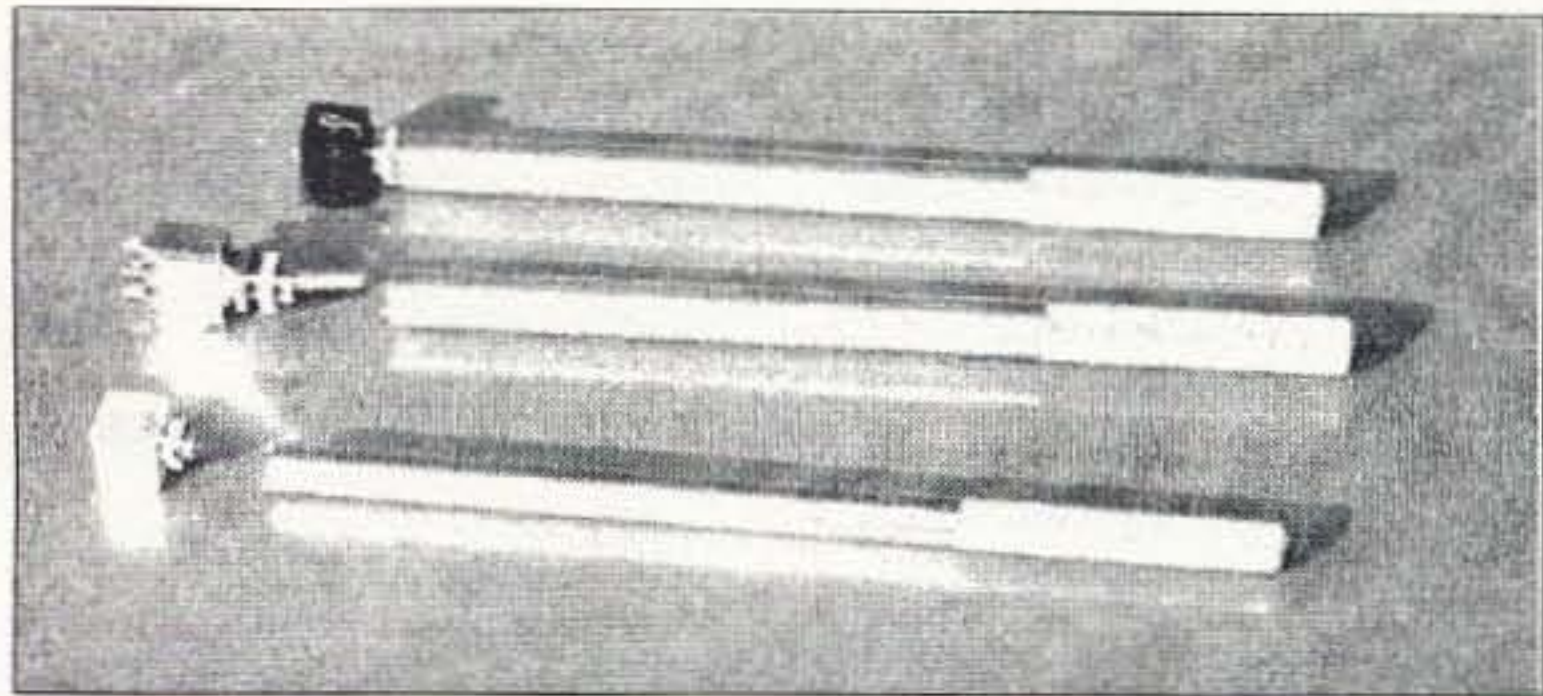

Fig. 1. End and side mechanical views of the Slotted-Nut-Tool© used for 1/8" miniature panel phone jacks. For the 3/32" Slotted-Nut-Tool, the hole (shown as .221") is bored to .144".



**Photo A.** From top to bottom: the 1/8" tool with phone jack nut; a 1/8" tool with an SPDT toggle switch nut; and a 3/32" with a subminiature phone jack nut.

but readers of this column should feel free to duplicate individual pieces for their own personal use.

### Measuring up!

Speaking of tools, here's one from Peter Bergman NØBLX of Brainerd, Minnesota: "The US has been very slow to accept the metric system, yet in ham radio circles we use metric terminology daily. For measuring wire antenna lengths and coax cable multiples, I often thought that it would be nice to have a tape measure that read out in both metric and English graduations. I found one, from Stanley Tools of New Britain, CT. I have one of their No. 30-575 (7.5-meter/25-foot) steel tapes, and have my eye on their No. 34-827 PVC coated Fiberglass™ 30-meter/100-foot jobs. Santa, take note!

"Most 'super home centers' don't seem to carry metric tapes, but if several radio club members can get together on a single order, you might try one of the smaller, family-owned hardware stores to see if they can special-order some of the Stanley tapes, or the metric replacement blades, that are shown in Stanley's catalog. Your next antenna project could go much more quickly, when you're confident that everything has been measured correctly."

*Moderator's note: I have an inexpensive 25-foot locking power tape made by Trophy (their No. 21925/T) that has continuous markings in centimeters, as well as in feet and inches, and Peter is right, it does make measuring for ham radio related cuts a good deal easier.*

### Well grounded ... continued

Last month, I talked about improving the RF grounding

properties of ham equipment enclosures and covers, and I referred to the Alinco DR-1200T as an example. I picked it (as opposed to picked *on* it) because I own a couple of them, and have had the opportunity to work on a couple of small problems I've run into. I noticed that in the wintertime in Illinois, when the air is very dry, the high-voltage static buildup that can be generated by sliding across an automobile's synthetic seat cover can cause the DR-1200T to "reset" its memories when the mike connector is touched. Fortunately, it didn't do any more damage!

When I examined the mike connector grounding technique inside the radio, I felt that it might be improved by taking a couple additional steps. Those steps are shown in **Figs. 2A** and **2B**.

First, place a dab of solder on the display shield tab, looking at the radio's top, on the control printed circuit board, rather than depending upon mechanical grounding connections only (see **Fig. 2A**). Don't overdo this step; you may need to remove the shield sometime in the future, and it's not a good idea to go overboard!

Next, from the bottom of the radio, solder the microphone connector grounding ring to the shell of the microphone connector itself. The nickel plating on the connector should be scraped off at the point of soldering, and a small amount of solder paste used, to ensure a good alloy bond. Also shown in **Fig. 2B** is an added short-insulated wire from the microphone connector grounding tab directly to the circuit board's corner (ground) mounting screw, via a toothed soldering lug. This eliminates any ground impedance

## TRANSMITTER LOCATION

### Direction Finding System Tracks Down

- Stuck Microphones
- Cable TV Leaks
- Jammed Repeaters & Cell Sites

Models available with computer interface, synthesized speech, for fixed or mobile use, covering 50 MHz to 1 GHz. Call or fax for details



CIRCLE 13 ON READER SERVICE CARD

**IN STOCK**

service \sər - vəs \ noun

- The occupation of performing work or functions that benefit and contribute to the welfare of others.  
syn. see Mouser Electronics

Call for your  
**FREE 324**  
page catalog  
**TODAY!**

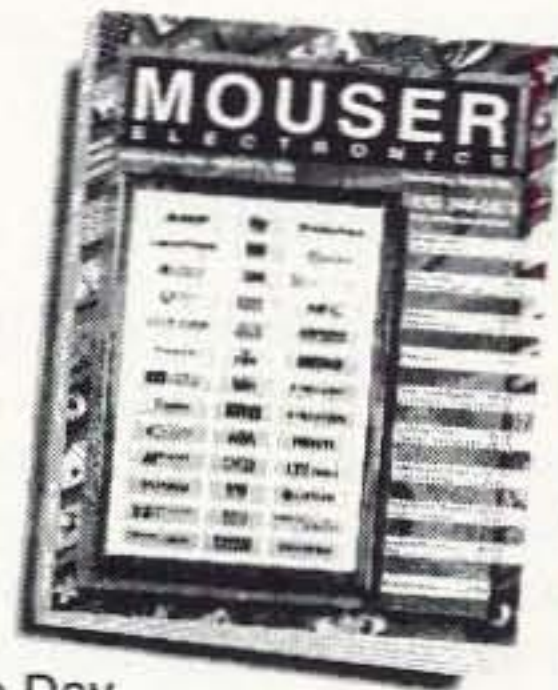

65,280 Products  
126 Manufacturers  
All Orders Ship Same Day

- Passive Components
- Semiconductors
- Electromechanical
- Connectors/Cable
- Surface Mount and Through Hole

**MOUSER**  
ELECTRONICS

**800-992-9943**  
FAX: 817-483-0931

<http://www.mouser.com>  
[sales@mouser.com](mailto:sales@mouser.com)

958 North Main St., Mansfield, TX 76063

CIRCLE 64 ON READER SERVICE CARD

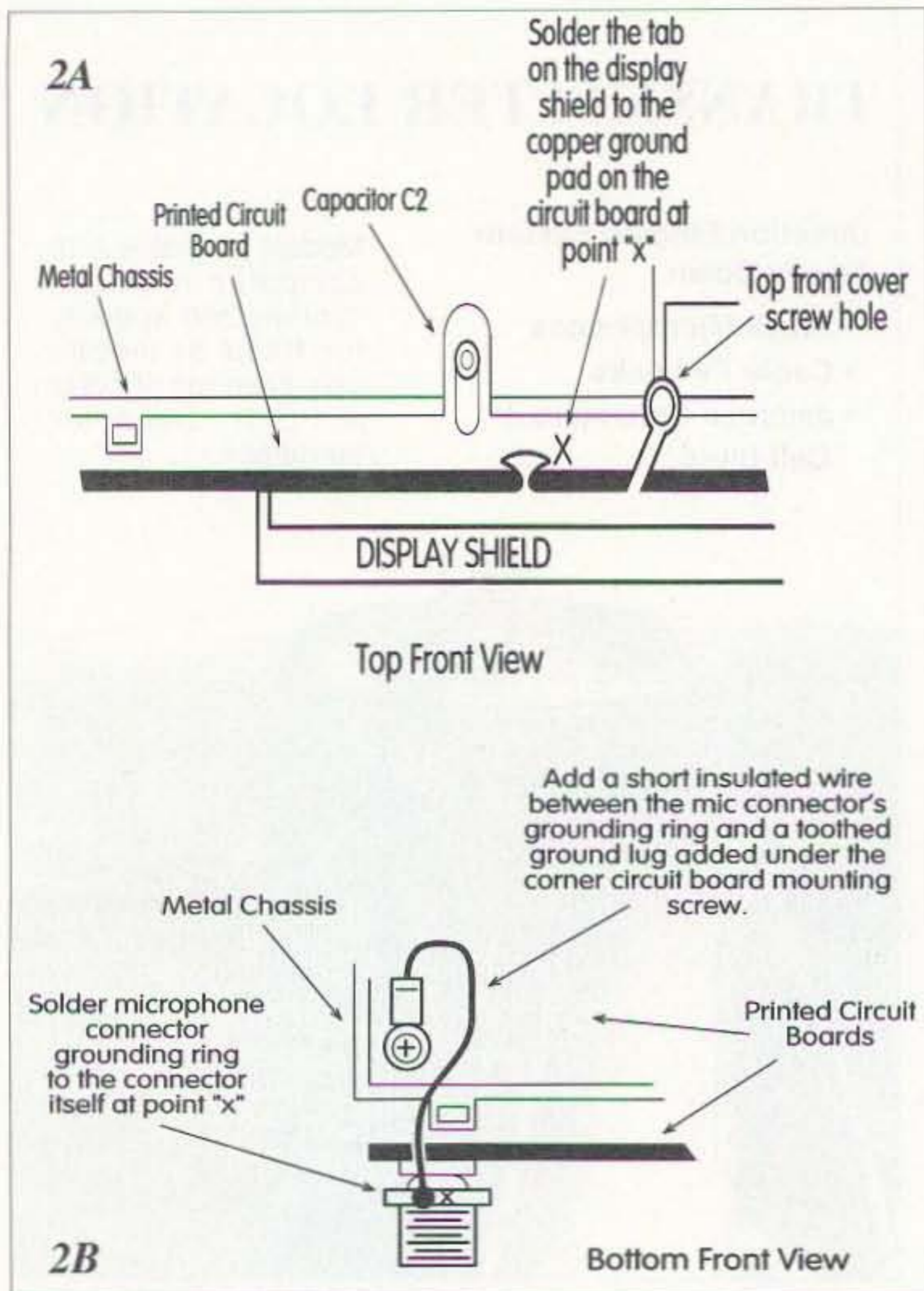

Figs. 2A & 2B. Alinco DR-1200T anti-static modification.

in the traces on the control PC board, and permits any static discharge to take the shortest possible path to chassis ground.

These two easy modifications should help to protect your DR-1200T's "innards" from unexpected zaps from the outside; at least they did on mine.

### The great equalizer

From William Thim N1QVQ: "If you find an inexpensive audio equalizer at a garage sale, flea market or hamfest, latch onto it and try inserting it between your transceiver's audio output jack and an external speaker. It can make a world of difference in improving the intelligibility of many signals you'll run across on the ham and shortwave bands.

"Since the human voice centers around the 1,000 Hz mark, bring that control up first, then adjust the other equalizing bands for the best clarity of overall sound. You can often eliminate much of the noise or other disturbing background, while accentuating the

intelligibility of the speech range. The more bands the unit has, the better. It won't replace a good DSP for noise and heterodyne reduction, but it can make a difference on a minimum budget."

*Moderator's note: If you do have a DSP, try an audio equalizer after it (as I have) and you'll probably find that it enhances the DSP's audio as well. Often, too, a second speaker located in another part of the room will make some signals "pop out of the mud" better than a single speaker. Varying room acoustics, and your own hearing "curve," make experimenting with various speakers and equalizer settings an inexpensive, intriguing continuing project.*

### Warm up your rotor

From Richard Mollentine WAØKKC: "An antenna rotor may bog down due to the grease on the gearing stiffening up with low temperatures. We cold-weather hams often have to wait for warmer, sunny days to coax

our rotors into turning again! Working that weak DX station off the back of the beam isn't necessary anymore if you install a magnetic automobile engine-block heater on the bottom gearcase of your rotor's housing now, during nice weather.

"The unit that I'm referring to is sold at many auto parts stores or via the popular JC Whitney/Warshawsky catalog and is in the \$18-\$25 range. It has a powerful permanent magnet on its base and a length of 120 volt AC cord for powering the heating element from a standard wall outlet. Simply stick it to the bottom portion of your rotor's casing and run the AC cord to a switched outlet. It will heat up your rotor's gearbox to a 'toasty' temperature in only 20 to 30 minutes ... just don't forget and leave it on when the outside temperatures rise much above freezing!"

*Moderator's note: Nice idea, Richard. In my own case, the housing on my antenna rotor is a non-ferrous casting, so a magnet-mount won't work, in and of itself. It could, however, be strapped to the rotor's base using an aluminum strap or two, or roof-eave and gutter exterior heat tape can be neatly wound around the rotor's base to warm up the rotor's gearbox in sub-freezing temperatures. You may have to experiment a bit with the idea to get it just right. Remember, however, don't get too close to the rotating top portion of the rotor housing or allow the rotating portion to rub against the heat tape, the engine block heater, or its AC cord. Be careful to follow all proper out-of-doors electrical practices if you need to extend the heater's AC cord or when plugging the heater into an exterior outlet. A ground-fault interrupter outlet may be required by your*

*local codes; please don't try to do without it. Even if the GFI tends to trip when you're on the air, your rotor's gears will probably be warm enough to turn easily for that particular ham radio session.*

### S-meter readings exposed

From Klaus Spies WB9YBM: "The following S-meter value table shows the correlation between actual signal strength in microvolts at the antenna terminals of a properly calibrated receiver vs. the S-unit reading on that receiver. Note that there is an older 'ham' standard, and a newer 'world' standard. Both values are shown in Table 1.

"Some of this information was heard on the 'Voice of Japan' in March of 1994, the rest was calculated from their 6 dB per S-unit specifications."

*Moderator's note: Each S-unit is 6 dB more as you go up the scale from S1 to S9. 6 dB represents a doubling of the voltage, but it takes four times the power to do that. To go up two S-units, the transmitting station would have to increase its power from 100 watts to 1600 watts, or 100 watts over the legal limit! That, of course, is assuming that the receiver's S-meter is right on the money. That's why it's difficult to put too much credence on some of the reports received over the ham bands. This is another of Klaus' handy tables that you might want to clip and paste somewhere over your workbench or at your operating position.*

### The importance of self-control

From Peter Albright AA2AD: "The primary purpose of a voltage regulator in a power supply, whether it's in an external, separate supply or in the ham

"S" Units	Old "Ham" Standard	Newer "World" Standard
S9	50.00uV	40.00uV
S8	25.06uV	20.04uV
S7	12.56uV	10.04uV
S6	6.29uV	5.03uV
S5	3.15uV	2.52uV
S4	1.58uV	1.26uV
S3	.79uV	.63uV
S2	.39uV	.31uV
S1	.19uV	.15uV

Table 1. Two current standards of S-meter readings relative to microvolts of input signal to the receiver.



**Photo B.** Chuck Wilson N6MUJ's "Sticky 2M Antenna" on the inside of his car's rear window.

transceiver/receiver itself, is to provide a source of stable, consistent voltage, either for reference or for powering the circuitry directly. Some circuits function quite well without power supply regulation and can afford to take power directly from the output of a power supply's output filter network, while others demand a more stable voltage or current for proper operation. It's always best to assume that the equipment designer knew which his equipment needed, and take any necessary measures to correct regulation problems that may develop, as soon as they're noticed.

"There are several symptoms that can indicate a faulty or defective power supply regulation circuit. If a short exists in the regulator, the fuse will generally blow, even though other sections of the power supply circuitry may be functioning normally—some devices use a so-called 'crowbar circuit' to blow the fuse deliberately in the event of an overvoltage condition. More commonly, however, voltage regulators tend to open, failing to supply their regulated output; only rarely, in very basic regulator circuits, do they supply full, unregulated output voltage (which is fortunate, since some circuits wouldn't tolerate the full unregulated output without developing additional problems). For that reason, don't be tempted to bypass a failed regulator unless you're absolutely sure of what you're doing.

"Here, then, are the common regulator configurations that might be found in ham power supplies and within the destination equipment itself:

"The simplest regulator is a zener diode—in series with a current-limiting resistor—from the power supply's output line to ground. Zener diodes begin to conduct at a set voltage, so that any excess voltage will be shunted to ground across the current-limiting resistor, and the diode itself, by brute force. Simple shunt zener regulators like this are for low-current demand applications only, and they provide no overvoltage protection in the event of a failure of the diode or its limiting resistor.

"To enhance the current-carrying capacity of the simple zener regulator, it's common to use the diode as part of the base circuit of a higher-powered 'pass' transistor, with the primary current flow between the emitter and collector of that transistor, and the zener acting strictly as a low-current control element in the transistor's base. 'Pass' transistors are generally mounted on a heat sink for greater heat dissipation capabilities and can be paralleled, with appropriate equalizing resistors, for even greater current-handling ability.

"Voltage regulators are available in handy-to-use integrated circuit packages, ranging from the simple three-terminal packages, available in both fixed and variable voltage outputs, that we've all seen (and perhaps used), to multi-pin programmable ICs. A fully automatic battery charger with voltage sensing capabilities would be one example of the latter (like the one that I recently built for my own needs).

"Just in case you're into 'older' wireless, I should briefly mention the 0A2 and 0B2 series of gas tube voltage regulators that might be found in some of these sets. They function in a similar manner to the simple zener shunt regulator circuit mentioned first, and are also strictly low-current regulators. The pleasant pink-blue color is unmistakable in the back of a tube-type rig, when 'real' radios had to glow to be working!"

*Moderator's note: Peter does a nice job (as always) of explaining the basic voltage regulators to be found in today's ham power supplies. It's safest to disconnect the circuitry that's being fed the output of the supply when repairing and initially testing the defective voltage regulator circuit. The regulator, if it's doing its job, should put out very close to its correct voltage with or without a load on it, and if it isn't, at least you might prevent further damage to the secondary circuitry. Also, as Peter mentioned, the present-day line of IC regulators is generally very handy, but be sure to follow the recommended input/output capacitor bypassing, along with any other special considerations, as stated by the manufacturer of the device. Regulator "chips" can oscillate under certain conditions, and in addition to not doing their job properly, can be a tough problem to troubleshoot.*

### A sticky antenna idea!

From Chuck Wilson N6MUJ: "My 1995 Volvo wagon came from the dealer with an antenna for the AM/FM radio stuck to the

inside of one of the rear windows. In an attempt to maintain the no-outside-antenna appearance of the vehicle, I decided to try the same approach for a 2 meter antenna on the opposite inside rear window. I used two 19-inch lengths of 1/2"-wide adhesive-backed copper ribbon, formed in a V shape, opened at the bottom of the V, and fed with 50 ohm coaxial cable, as shown in **Photo B.** and **Fig. 3.** I was able to easily access the repeater some 15 miles away from inside my garage, with just my HT and my new V antenna inside the car.

"I later replaced the 2 meter HT with a dual-bander, and the same antenna works well over the same distance on 440 MHz. I'm not sure what the SWR is—and I'm not sure that I want to know—but I do know that it works and that's really the bottom line, especially when I found that I could hit the same repeater from 40 miles away and from behind the hills that block its 'radio view.' It's an idea you might want to try if the XYL says 'negative' to an outside antenna on the new family buggy!"

*Moderator's note: The self-stick copper foil that Chuck mentioned is often available from craft supply stores that cater to stained-glass makers. The foil is used to hold the glass pattern together during assembly. It comes in several different widths and roll lengths. The advantage of using copper vs. aluminum-foil tape is in copper's ease of soldering and greater tensile strength.*

*If you have trouble locating it, Radio Shack sells 3/8" wide self-adhesive window "alarm" foil (cat. #49-502) and self-adhesive*

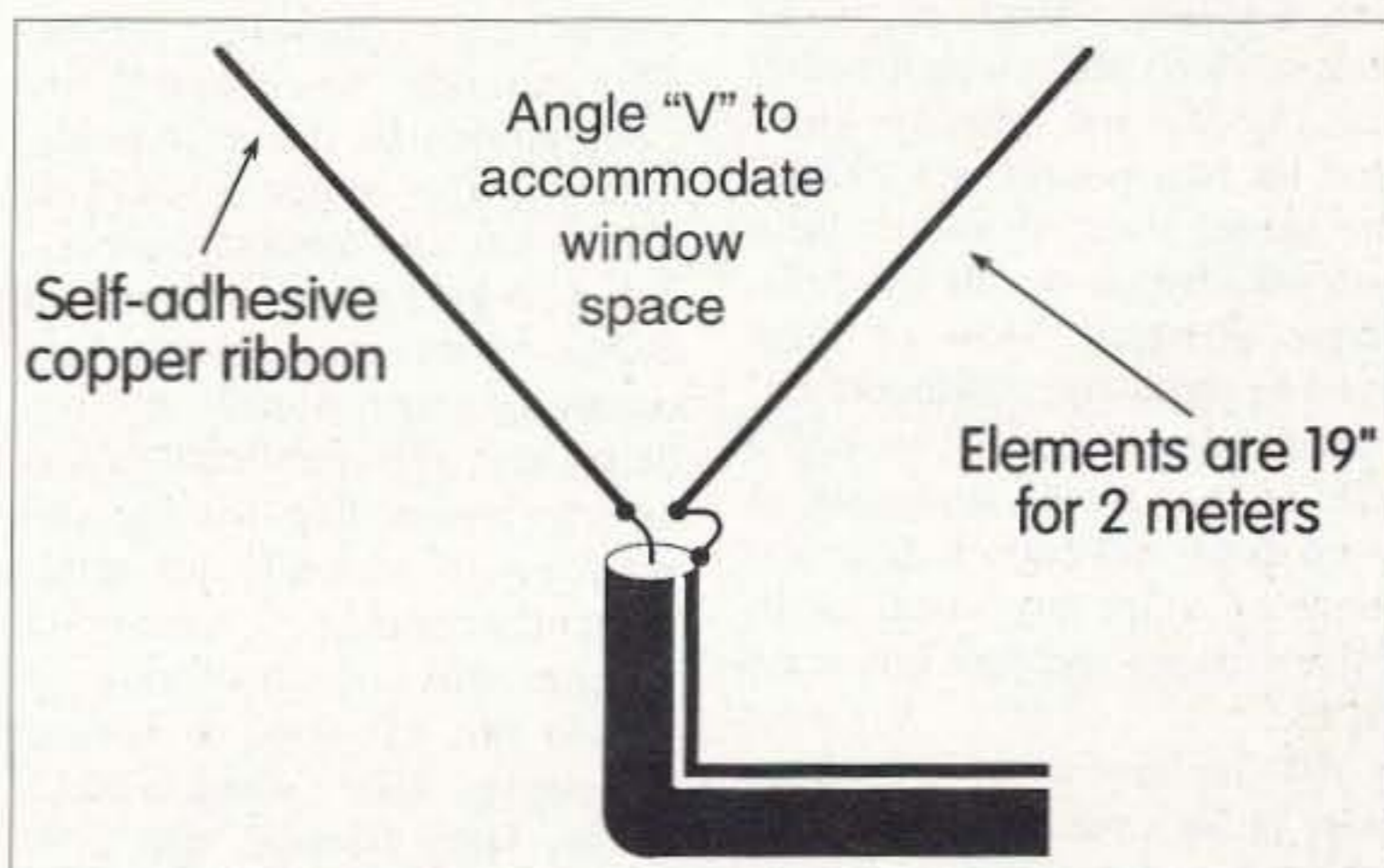

**Fig. 3.** N6MUJ's "Sticky Antenna."

foil connectors (cat. #49-504), that might be worth trying. By the way, 440 MHz is the third harmonic of 146 MHz, but a separate V for the 440 band, with about 6 3/4" of conductive tape in each leg, would most likely give even better results on that band. I would also only use low power—under 5 watts—into an antenna of this nature, both from an RF-in-the-car standpoint and from the standpoint of possible mismatch stress on the radio itself. I wonder how much the SWR would change with rain, ice, or snow on the windows?

### VHF harmonic bug spray

From Richard Measures AG6K: "Here's the solution to a problem that's often caused by

VHF harmonic energy leaking out via the external cabling from your transceiver. If you experience TVI from your amateur transceiver, even while transmitting into a well-shielded 50 ohm dummy load, this may well work for you. Try adding one or two VHF attenuator ferrite beads over each of the two active wires (hot and neutral) that make up the 120 volt AC line input.

"Just in case you haven't used ferrite beads before, they do not have to be in metal-to-metal contact with the wire that they're filtering to be effective, and in the case of the AC line cord, they definitely should not be. These ferrite products work by 'choking' the RF energy that's attempting to pass through the wire, and need only be around the wire's

something and measure your pulse 30 and 60 minutes later and see how much it goes up. If it does, you've found something you should avoid. Well, read the book, which was first published 40 years ago.

### Déjà Vu

There's a remarkable parallel between the beginning months of the personal computer and cold fusion. It's almost enough to encourage anyone with spunk to head for the cellar or garage and start experimenting.

Since I was there from day one of the microcomputer revolution and, maybe helped it to get started with my magazines and proselytizing, I know how it was.

When the MITS Altair 8800, the first microcomputer, was introduced to the market back in January 1975, the computer professionals looked at it and ridiculed it as a toy, and not worth even thinking about. This attitude was fanned by *Computerworld*, the main publication in the computer field. It made fun of microcomputers, doing its best to put them down as of no interest or value to true computer professionals. It's my belief that this publication was largely responsible for the destruction of virtually all mini-computer companies, eventually putting tens of thousands of people out of work. It helped companies like Wang, DEC, Prime, Data General, and hundreds of smaller firms miss the

*Continued on page 71*

insulated outer covering to function correctly. The beads are generally rod-shaped, with a center hole large enough to pass the insulated wire completely through the bead's core, so the insulated AC wire is simply separated and strung through the bead.

"It may also be helpful to add a 470 pF, 1 kV disc-ceramic bypass capacitor from the AC line side of each bead to ground. Replace any two-wire AC line cord with a three-wire grounding cord, connecting the 'green' or ground terminal of the new cord to the transceiver's chassis ground. This provides a low-impedance ground-return path for both the unwanted harmonic energy and the small 60 Hz AC current that flows through the bypass caps. If any exposed 120 volt AC connections exist within the radio when implementing this cure, be absolutely sure that they are contained within an insulated, well-marked covering of some sort."

*Moderator's note: Ferrite beads and choke cores are available from Radio Shack retail stores nationwide (#273-104 and #273-105), All Electronics (Tel: 1-800-826-5432), Amidon Associates (Tel: 714-850-4660), Palomar Engineers (Tel: 619-747-3343), as well as from other sources. 1 kV disc caps are obtainable from All Electronics and from Digi-Key Corp. (Tel: 1-800-344-4539). All Electronics and Digi-Key also carry a number of pre-made, packaged RF line filters at a slightly higher cost than doing-it-yourself, but they're often much easier and safer to use. Sometimes, simply wrapping a few turns of the AC line cord through a ferrite toroid core of sufficient diameter is all that's needed to quench VHF harmonics emanating from an amateur transceiver; try that as well. Other input/output cables to your transceiver might also benefit from being passed through a ferrite choke or core to suppress both in-band and out-of-band energy. It's very often a try-it-and-see situation.*

And this ends another month of "Ham To Ham." Thanks to all who've submitted their tips, ideas, suggestions, and operating short-cuts—you're the ones who make the column work. Let's hear from more of you ... the more input I

have, the better the results, and the more we can expand the column's scope in the future. Send whatever you would like to pass on to the address above; sending them to 73's offices in Peterborough directly only delays their use here.

As always, many thanks to this month's contributors:

Peter A Bergman NØBLX  
3517 Estate Drive SW  
Brainerd MN 56401

William Thim, Jr. NIQVQ  
50 Miller Road  
Broad Brook CT 06016-9676

Richard Mollentine WAØKKC  
7139 Hardy  
Overland Park KS 66204

Klaus Spies WB9YBM  
8502 N. Oketo Avenue  
Niles IL 60714-2006

Peter Albright AA2AD  
28 E. Summit Street  
Lakewood NY 14750

Chuck Wilson N6MUJ  
660 Santa Ysabel Ave.  
Baywood Park CA 93402-1144

Richard L. Measures AG6K  
6455 La Cumbre Road  
Somis CA 93066

Note: The ideas and suggestions contributed to this column by its readers have not necessarily been tested by the column's moderator nor by the staff of 73, and thus no guarantee of operational success is implied. Always use your own best judgment before modifying any electronic item from the original equipment manufacturer's specifications. No responsibility is implied by the moderator or 73 for any equipment damage or malfunction resulting from information supplied in this column.

Please send all correspondence relating to this column to 73's Ham To Ham column, c/o Dave Miller NZ9E, 7462 Lawler Avenue, Niles IL 60714-3108, USA. All contributions used in this column will be reimbursed by a contributor's fee of \$10, which includes its exclusive use by 73. We will attempt to respond to all legitimate contributors' ideas in a timely manner, but be sure to send all specific questions on any particular tip to the originator of the idea, not to this column's moderator nor to 73.

### NEUER SAYS DIE

*Continued from page 53*

And now I've run across another approach that looks just about surefire, and doesn't depend on your almost totally unused determination. Look for a paperback by Dr. Arthur Coca, *The Pulse Test*. Spend the lousy five bucks. With this little book you'll learn how simple it is to find out what you're allergic to just by taking your pulse. And when you avoid allergens your fat melts away, as does arthritis. It's ISBN 0-312-95699-1, published by St. Martin's Press.

I don't know how much of the stuff in my bulging health literature file really works, but I'll keep reading and talking with people in the field I trust so I can report to you on what looks most promising.

Coca claims that when you stop dosing your system with things you're allergic to, it can stop tobacco and alcohol addiction. Look, you already know that no two people are exactly the same, so it shouldn't be a news flash that we all have different allergies. Most of mine got triggered by childhood immunization shots, so I've had a life of hay fever and asthma from dogs and cats. Eating watermelon stops my vocal cords from working and sure raises my pulse.

All you have to do is measure your pulse several times a day. Mine rests at 60 per minute. Then you eat, drink, or breathe

# HOMING IN

Joe Moell P.E. K0OV  
PO Box 2508  
Fullerton, CA 92837

## Radio Direction Finding

### Foxhunt day, step by step

Is your foxhunt scheduled yet? Last month's "Homing In" led you through the process of planning and promoting an international-rules radio direction finding (RDF) contest. Foxhunts are a mainstream ham activity in Europe and Asia, but they won't gain a toehold here until more ham clubs and conventions get busy and sponsor them. It's great fun, and it might start a new tradition for your club's hamfests.

August's column covered advance work, including site selection, transmitting gear, promotion, education, and registration. My recommendations are based on experiences of the Southern California Six Meter Club (SC6MC), which sponsored foxhunts at the ARRL Southwestern Division convention (Hamcon-95) and the West Coast VHF/UHF Conference (VHF-96). This month, we'll cover what happens on hunt day.

### Special punches

Fox transmitters are concealed and unattended. Therefore, judges need a method of proving that the hunters find each fox. World Championship foxhunts employ a "punch" method, established by orienteers, that we've adopted (see **Photo A**). Orienteers verify that competitors visit the required checkpoints by having a special punch at each point. Each punch has a distinctive pattern with up to nine pins. Competitors carry a card with

numbered spaces for punching. Cards and punches can be bought by mail from outfitters such as J. Berman Orienteering Supply, Post Office Box 460, Sunderland MA 01375; (413) 665-7822. Twenty different punches are available; purchase as many as you need for less than three dollars each. Berman also sells Silva orienteering cards by the hundred.

Ukrainian hunts feature special machines at each fox that time-stamp the cards, much like punching a time clock. This would be important if rules demanded that the foxes be located in a particular order, but such is not usually the case. However, it is mandatory that hunters punch numbered spaces on the card correctly. The punch at fox #1 must be used to mark square #1 on the card, and so forth. Be sure to announce this requirement before the hunt; it was a source of contention at VHF-96. Some hunters were unaware of the rule and marked square #1 with whichever punch they found first, etc.

I like the special punches, but you don't have to use them. For practice hunts before I got the punches, I made up slips of paper with fox numbers printed on them to give to the hunters at the start. I put a different colored pen or pencil at each fox, which they used to circle the appropriate numbers.

It takes a team of volunteers to put on a well-run foxhunt. You will need timers at the starting line to send off the hunters at exact intervals, plus helpers at the finish line to collect the cards and mark finishing time on them. Things can get

hectic at these two locations, so two persons are better than one. Remember, these positions do not require licensed hams.

Have Course Marshals scattered in the woods to watch over the activities. Contestants know they should not help one another in any way or vandalize the foxes, but having Marshals helps prevent temptation. Marshals should also be on the lookout for any health problems that might develop during the hunt. Don't station them near foxes—that would be a giveaway. Have them keep moving along. Encourage them to carry cameras to document the fun for your club's newsletter or Web page. They can also serve as judges to check over the results before prizes are awarded.

The Region 1 ARDF Working Group requires starting corridors between 50 and 250 meters long at championship events. Competitors run into the corridor when instructed by the start timers. When they reach the end, they may turn on their RDF gear and take off into the forest. The end of the corridor should not be visible from the start point.

One purpose of a corridor is to prevent those waiting at the starting line from seeing which way hunters go. This is particularly important if the start point is in the middle of the venue. Rather than try to put up curtains or fences, try to find a natural corridor at your site. At VHF-96, we put the start point at the northwest corner of the park. Starters went over a small footbridge, up a hill, and disappeared into the woods—an ideal starting situation. At the Hamcon-95 hunt, we used a 50-yard walkway between two buildings.

Depending on your site, the finish line can be next to the start or at another location where family members can wait (and perhaps picnic). Mark the end point clearly on the course map. At international meets in very large forests, a transmitter on a separate frequency beacons regularly from the finish area. At our hunts, the finish line beacon frequency doubled as an emergency calling frequency, monitored by the finish line attendant. Hunters were forbidden to transmit on the hunt frequency. Note that competitors are not required to locate the exact placement of the finish line transmitter; no punch should be placed there.



**Photo A.** J. Scott Bovitz N6MI attaches an orange orienteering punch to a well-concealed fox transmitter at VHF-96.

International Amateur Radio Union (IARU) rules call for an ending corridor of 50 to 100 meters leading up to the finish line. I think an ending corridor is unnecessary, but you may want to have one if there are some elite runners and you're worried about a "photo finish." In any case, be sure your finish line or corridor is well marked.

### Bring your laptop

While you might prefer to announce age divisions in advance, we decided to wait until all registration was done. Then we chose division breakpoints and individual start times to even up the field. Upon registering, each hunter gave his/her name, callsign, date of birth (DOB), and team affiliation, all of which went into the computer.

Although I don't know of any software dedicated to foxhunt or orienteering competitions, I found that a spreadsheet program with date/time and sort capabilities works just fine. I chose Microsoft Excel for Hamcon-95 and VHF-96. After registration was complete and all hunters were entered, one person per line, I sorted and printed the data by name. This printout would be posted at the site and each hunter would be asked to verify that his/her data was correct.

Next, I sorted and printed a listing by age (**Fig. 1**). The committee used this sort to select age division breakpoints. The goal was to be fair from an abilities point of view, but also to avoid any division having many more competitors than the others, which would unduly extend the starting process. For both hunts, our divisions were Youth (17 and under), Prime (18 through 30), Masters (31 through 45), and

Name	Call	Team	DOB	Age	Div	Wave
Cloth, Terry	K0OVX	ARES	1/4/84	12	Y	1
Foolery, Tom	WE6ABC	PODUNK	8/4/80	15	Y	4
Camel, Joe	KG6ABC	PODUNK	11/26/73	22	P	2
Upendown, Bob	KZ6YY	RACES	6/29/65	30	P	3
Transmission, Emanuel	N6FSL	PODUNK	12/1/64	31	M	1
Gallery, Art		ARES	10/2/56	39	M	2
Love, April	WA6AA		6/6/50	45	M	3
Dressed, Natalie	WA6JFP	RACES	4/6/48	48	S	1
Tickly, Fran		RACES	3/19/45	51	S	4
Sez, Simon	W6XYZ	ARES	3/16/41	55	S	3

**Fig. 1.** A sample spreadsheet sorted by age. I'm sure our contestants don't want their birthdays listed in a widely-read magazine, so these are some made-up names.

Name	Call	Team	Div	Wave	2:12	Start	Finish	Time	T's	Rank
Printz, Wes	KA3DSE	DARC	M	1	2:15			#####		
Schwendtner, Dennis	WB6OBB	SBARC	S	1	2:15			#####		
Probert, Matthew	KE6JRR	SBARD	Y	1	2:15			#####		
Reginato, Nerella			M	2	2:18			#####		
Heather, Elizabeth	KC6OFS	DARC	P	2	2:18			#####		
Hare, Ed	KA1CV	ARRL	M	3	2:21			#####		
Mendenhall, Matt	KE6ALM	SGVRC	P	3	2:21			#####		
Goddard, Art	W6XD	ARRL	S	3	2:21			#####		
Reginato, Reg	KE6ZQY	SBARC	S	4	2:24			#####		
Mirabella, Tom	KD6AAN	OCRACES	Y	4	2:24			#####		

Fig. 2. First part of the start sequence spreadsheet, sorted by time. One competitor in each division starts in each wave. Age and DOB columns have been hidden.

Seniors (46 and over). To the spreadsheet, I added Division, Wave, and Start Time columns and entered the division designations when they had been decided upon.

Now it was time to determine the starting order. One to four hunters would start at a time, always from different divisions. The number of start times (waves) equals the number of competitors in the category having the greatest number.

Just as players are "seeded" in tennis tournaments, start times should be chosen with the anticipated abilities of the hunters in mind. Slowest hunters should start first, fastest last. This gets the event over sooner, so everyone can find out the results in a timely manner. Family members should not start at the same time; youth should go out early, parents later. This way, the kids are less likely to look for their parents on the course. We tried to separate family members and regular T-hunting partners by at least four waves on our hunts. We also avoided starting members of the same team in the same wave.

We chose three-minute starting intervals in the VHF conference hunt. With 11 waves and a two-hour time limit, the maximum event time would be two-and-a-half hours from first starter to disqualification time for the last starter. Since there were to be six foxes, half of the runners would start on fox #1 and half on fox #4. Some would say it is more fair to start at six-minute intervals (all on fox #1), but then the event could take three hours. We didn't want to finish that late.

Once the wave numbers and a dummy pre-start time were

entered in the spreadsheet, Excel calculated the scheduled start times for each competitor. I then did a sort by wave number, which gave a starting time lineup to be announced before the hunt. The printout of scheduled start times (Fig. 2) has added columns for Start and Finish. The Start column is there in case something goes wrong and the actual starting times end up being different from the scheduled times. If they turn out to be the same, it's easy to insert them in this column with the Fill Across command.

Be sure to allow plenty of time to get the hunt organized. Don't start the hunt until a full cycle of fox transmissions has been heard, so you'll know that all are working properly. Our VHF-96 entrants were sent from the assembly point to the site at 1 p.m. Guessing the time required to make announcements and get underway, I printed up sheets with scheduled times starting at 2 p.m., 2:15, and 2:30. Because of problems with the foxes, we ended up starting at 2:49.

As hunters arrive at the site, have them put all their RDF gear in the impound area. (We used a

big blue tarp on the ground.) They are not allowed to pick it up again until one minute before it is their turn to start, and may not turn it on until they reach the end of the start corridor. Gather everyone around for instructions, rules, and announcements (see Photo B and the sidebar).

I think it works best to have two people at the starting table. One watches the clock and officially starts the hunters, while the other calls the hunters by name in advance and makes sure they're on deck before their times. Be sure that clocks at the start and finish points are synchronized. IARU requires that less than one second difference between these clocks be verified, and insists that competitors be allowed to check their watches against the starting point clock.

As hunters cross the finish line, the attendant takes their punched cards, marks exact finish time, and number of foxes found on the cards, then gives the cards to the scorekeeper. The spreadsheet will do the subtraction to get elapsed times. Once all start/finish times are entered, it's easy to find the individual winners with one "sort"

Name	Call	Team	Div	Wave	2:46	Start	Finish	Time	T's	Rank
Garrabrant, Byon	KD6BCH	OCRACES	P	9	3:13	3:13	4:11:24	0:58:24	5	1
Barrett, Rick	KEYDKF	SGVRC	P	10	3:16	3:16	4:18:37	1:02:37	5	2
Mendenhall, Matt	KE6ALM	SGVRC	P	3	2:55	2:55	4:39:54	1:44:54	5	3
Barth, Scot	KA6UDZ	SGVRC	P	11	3:19	3:19	5:06	1:47:00	5	4
Holland, Randy	KO6KC	OCRACES	P	7	3:07	3:07	5:01	1:54:00	5	5
Heather, Bill	KB6WKT	DARC	P	5	3:01	3:01	5:01	2:00:00	4	6
Heather, Elizabeth	KC6OFS	DARC	P	2	2:52	2:52	4:52:42	2:00:42	3	7
Allen, Glenn	KE6HPZ	DARC	M	11	3:19	3:19	4:53:50	1:34:50	5	1
Printz, Wes	KA3DSE	DARC	M	1	2:49	2:49	4:42:55	1:53:55	4	2
Hare, Ed	KA1CV	ARRL	M	3	2:55	2:55	4:49:57	1:54:57	4	3

Fig. 3. First part of the VHF-96 spreadsheet, as sorted for individual winners. Be sure to disqualify any hunter whose time is over the limit.

command (Fig. 3). The first sort key is division, the second is number of foxes (descending), and the third is elapsed time (ascending). With another sort, you can find team winners: The first key is team; the second and third are as before. Once the judges verify the numbers, it's time to award prizes and certificates (Fig. 4).

### When is the next one?

Whew! It's over! Another successful foxhunt! You may find, as we did, that everyone is having so much fun they're not ready to go home yet, although all the activity has made them hungry. For our hunts, we arranged for a group discount at a nearby restaurant for a "Dutch treat" dinner, to prolong the good times and plan the next hunt.

If you would like to try the spreadsheet scoring method, I will provide my sample Excel tem-

### Rules, Rules, Rules

Important starting point announcements and instructions:

- Location of restrooms.
- Boundaries and forbidden areas, if any.
- No assistance on the course.
- Do not transmit unless an emergency occurs.
- Punch the right square for each fox on the card.
- No visitors on the course.
- Start times for each runner.
- Put your name and start time on your card.
- A lost card means disqualification.
- Verify your name, team, and DOB on the printout.



# What Can Dual DSPs Do For You?

**Eliminate power line noise before it enters the receiver**



## ANC-4 Antenna Noise Canceller

Eliminates power line noise before it enters the receiver to let you hear signals you did not know were there. Reduces any locally-generated noise typically 50dB. Usable between 100kHz and 80MHz. Noisewhip and wire antenna supplied with each unit. Auto xmit switchover up to 200W. Installed between the antenna and receiver. **\$175.00**



## NIR-12 Dual DSP Noise Reduction Unit

The NIR-12 is the most advanced DSP noise reduction unit available. Unparalleled performance, super-selective FIR filters, fully adjustable center frequency and bandwidth, **both Dynamic Peaking and Spectral Subtraction Noise Reduction**, spectral multi-tone NOTCH filter. All NIR-12 modes are usable simultaneously. Use on all operating modes including AMTOR and PACTOR. Installed between the receiver audio and external speaker. **\$349.95**



**JPS Communications Inc.**

**ORDER LINE: 800.533.3819**

<http://emporium.turnpike.net/J/JPS/jps.html>

P.O. Box 97757 • Raleigh NC 27624-7757 • USA

Tech Line: 919.790.1048

Fax: 919.790.1456

Email: [jps@nando.net](mailto:jps@nando.net)

plate if you send a 3.5" Macintosh or PC disk and a self-addressed stamped envelope to the address atop this column. I am also posting the template at the "Homing In" Web site. My template was written with Excel version 4.0 for Mac, but other versions may be able to read and run it.

A "Homing In" Web site? Yes, at long last my RDF pages on the World Wide Web are up and running. By the time you read this, most of the construction should be complete, at least for Version 1. The main purpose of having a site for "Homing In" is to post answers to the frequently asked questions that

## TEAM AWARD

West Coast VHF/UHF Conference  
International Style Transmitter Hunt  
May 5, 1996



THIRD PLACE TEAM MEMBER



**Fig. 4.** Find a computer-savvy person in your club to make up nice certificates for team awards and non-trophy individual places. Ours were designed by Christie Edinger KØIU.

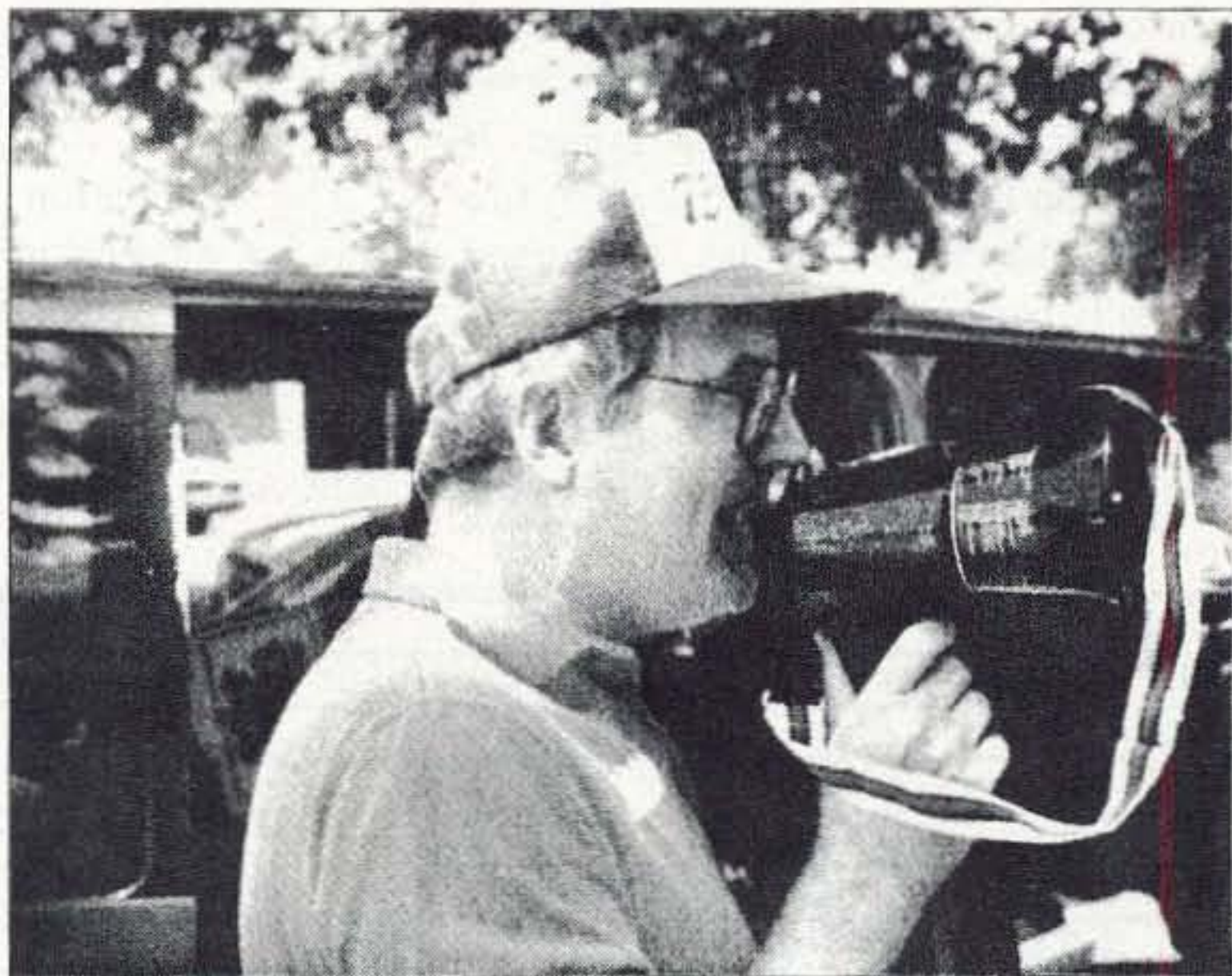

**Photo B.** Your columnist gives final instructions before the first VHF-96 hunter leaves the start corridor. (Photo by J. Scott Bovitz N6MI)

I presently spend lots of time handling via E-mail or snail-mail. Even if you don't have an RDF question, the site is worth visiting because you'll find updates to my T-hunt book and a complete "Homing In" index, listing topics for over 90 columns. URL <http://>

[members.aol.com/homingin/](http://members.aol.com/homingin/) should get your browser there.

Of course your mail, postal or electronic, is still welcome. Please note my new ZIP code atop this column. Send e-mail to: [Homingin@aol.com](mailto:Homingin@aol.com) or [75236.2165@compuserve.com](mailto:75236.2165@compuserve.com).

# Communications Simplified, Part 9

Peter A. Stark K2OAW  
PO Box 209  
Mt. Kisco NY 10549

As we mentioned last time, with more modulation, even more sidebands might be required to keep the amplitude constant. So we need to learn how to measure the amount of modulation. This can be done in two ways—using the deviation, or using a modulation index.

## Deviation

Deviation measures how far the carrier swings from its center or unmodulated value. For example, commercial FM broadcast stations are allowed to deviate up to  $\pm 75$  kHz from their center frequency. Thus a station on 96.3 MHz could swing its carrier down to 95.225 MHz (96.3 MHz minus 75 kHz) or up to 96.375 MHz. Police, fire, or ham FM radios, on the other hand, generally use  $\pm 5$  kHz deviation.

Note how we said that commercial FM broadcast stations are allowed to deviate up to  $\pm 75$  kHz. This is not a

technical limit—it would be easy to build equipment which deviates a lot more. Rather, 75 kHz is a maximum limit imposed by the FCC to prevent interference with adjacent stations. Likewise, 5 kHz deviation is used by fire, police, ham, and other communications equipment to avoid interference with other users. So, unlike the case of AM where 100% modulation is a limit which you simply cannot exceed for technical reasons, the maximum amount of FM deviation is more of a “good neighbor” policy, usually enforced by the government.

## Modulation index

The modulation index is the second way of measuring the amount of FM modulation. The modulation index (we will abbreviate it as *MI*, but there are several other symbols often used) is defined as:

$$MI = \frac{\text{deviation}}{\text{modulation frequency causing that deviation}}$$

For example, an FM station transmitting a 5 kHz audio signal (this is the modulation frequency) at a 15 kHz deviation would have a modulation index of 15/5, or 3.

You can see that, even if the deviation stays the same, the modulation index can vary all over the place. For example, if that FM station keeps the same 15 kHz deviation, but the audio frequency changes from 5 kHz to 50 Hz, the modulation index suddenly changes to 15,000 Hz divided by 50 Hz, or 300 (be careful to use the same units on both the top and bottom of the equation).

It's the modulation index that determines how many sidebands are needed to keep the amplitude of the FM signal constant. For example, if the modulation index is 0.2 or 0.3, then just one set of sidebands is needed; if the modulation index is 10, then 13 sidebands would be

needed on each side of the carrier to keep the amplitude constant. The calculations to determine how many sidebands are needed at any given modulation index are fairly complex, and involve something called Bessel functions. To avoid all this work, most people use a table like Table 1, which

MI	Carrier	Sideband												
		1st	2nd	3rd	4th	5th	6th	7th	8th	9th	10th	11th	12th	13th
0.0	1.00													
0.25	0.98	0.12												
0.5	0.94	0.24	0.03											
1.0	0.77	0.44	0.11	0.02										
1.5	0.51	0.56	0.23	0.06	0.01									
2.0	0.22	0.58	0.35	0.13	0.03									
2.5	-0.05	0.50	0.45	0.22	0.07	0.02								
3.0	-0.26	0.34	0.49	0.31	0.13	0.04	0.01							
4.0	-0.41	-0.07	0.36	0.43	0.28	0.13	0.05	0.02						
5.0	-0.40	-0.33	0.05	0.36	0.39	0.26	0.13	0.05	0.02					
6.0	0.15	-0.28	-0.24	0.11	0.36	0.36	0.25	0.13	0.06	0.02				
7.0	0.30	0.00	-0.30	-0.17	0.16	0.35	0.34	0.23	0.13	0.06	0.02			
8.0	0.17	0.23	-0.11	-0.29	-0.10	0.19	0.34	0.32	0.22	0.13	0.06	0.03		
9.0	-0.09	0.24	0.14	-0.18	-0.27	-0.06	0.20	0.33	0.30	0.21	0.12	0.06	0.03	0.01
10.0	-0.25	0.04	0.25	0.06	-0.22	-0.23	-0.01	0.22	0.31	0.29	0.20	0.12	0.06	0.03

Table 1. Carrier and sideband amplitudes (from Bessel functions).

actually provides more information than just the number of sidebands.

Let's look at an example. Let's assume we have an FM broadcast station which transmits a 4 kHz tone at a deviation of 2 kHz, giving us a modulation index of 0.5. For this modulation index, **Table 1** gives us the following information: MI = 0.5; Carrier = 0.94; 1st sideband = 0.24; and 2nd sideband = 0.03.

This tells us that there are two sets of sidebands on each side of the carrier: The carrier amplitude is 94% (0.94) of the unmodulated value, the first set of sidebands has an amplitude of 24% (0.24) of the unmodulated carrier, and the second set of sidebands has an amplitude of 3% (0.03) of the unmodulated carrier.

Notice that the carrier is now smaller than it would be if left unmodulated. Unlike in AM, where the carrier stays the same size no matter what the sidebands do, an FM carrier changes size as you modulate it. This makes sense when you realize that the total FM signal voltage and power (which consists of the carrier plus all the sidebands) has to stay the same all the time. When the sidebands appear, something else has to decrease to keep the total voltage and power the same.

Let's look at this in more detail. Suppose the original carrier (before modulation) was 10 volts rms, and was sent into 50 ohms. The total power would then be found from  $P = V^2/R$  to be 2 watts.

Now let's see what happens with the modulation index of 0.5.

The carrier voltage is now  $10 \times 0.94 = 9.4$  volts, and its power (still assuming a 50-ohm load) is:  $9.4^2/50$  or 1.7672 watts, less than before.

The first sideband is  $10 \times .24 = 2.4$  volts, and its power is:  $2.4^2/50$ , or .1152 watt. Remember, there are two of these sidebands (one upper and one lower), so their total power is twice that, or 0.2304 watt.

The second sideband is  $10 \times .03 = 0.3$  volts, and its power is:  $0.3^2/50$ , or .0018 watt. Again, there are two of these sidebands, so their total power is twice that, or 0.0036 watt.

When we add all of these powers together, the 1.7672, 0.2304, and 0.0036 watt add to almost exactly 2 watts (the slight error is because **Table 1** gives the coefficients to only two decimal places.) So the modulated carrier has the same power as the unmodulated carrier.

	Voltage (volts)	Power Each (watts)	Total Power (watts)
Carrier	- 4	.3200	.3200
1st SB	0.7	.0098	.0196
2nd SB	3.6	.2592	.5184
3rd SB	4.3	.3698	.7396
4th SB	2.8	.1568	.3136
5th SB	1.3	.0338	.0676
6th SB	0.5	.0050	.0100
7th SB	0.2	.0008	.0016
<b>Total power, carrier plus sidebands:</b>			<b>1.9904</b>

**Table 2.** The sum of an FM carrier wave and its sidebands.

Let's try another example. Suppose the unmodulated carrier is again 10 volts, the load is still 50 ohms, the modulating frequency (which would be the audio in an FM broadcast station) is 1 kHz, and the deviation is 4 kHz, giving a modulation index of 4. **Table 1** tells us that the carrier has an amplitude of -0.40, and that there are seven sidebands, of which the first also has a negative amplitude. Since amplitudes can't be smaller than zero, what do the minus signs mean?

The negative amplitude here simply means that the phase has reversed, so the carrier and the first sideband both have opposite phases from what they were at lower values of the modulation index. As far as the power is concerned, this doesn't matter, so we can still add up the total powers as in **Table 2**.

Again, the total power is about 2 watts, with a slight error because the Bessel values are accurate to only two decimal places. So the total power of the FM signal doesn't change with modulation, although the power gets shifted around between the carrier and the sidebands.

Let's look at the negative numbers in **Table 1** one more time. At a modulation index of 2, the carrier had a value of 0.22, while at an index of 2.5, the carrier became -.05. Obviously, somewhere between 2 and 2.5, the carrier value went from plus, through zero, to minus. At the zero (which occurs when the modulation index is 2.405) the carrier completely disappears, and all the power is in the sidebands. This point is useful because it lets us calibrate a deviation meter—we observe the signal on a spectrum analyzer and increase the deviation until the carrier disappears. Of course, we have to be careful because the carrier also disappears at other values, such as at a modulation index of 5.5 and 8.65.

We can see this a bit better if we graph the data from **Table 1**, as shown in **Fig. 1**. Here you can see how the carrier starts out with a magnitude of 1 when the modulation index is 0, then decreases until, at a modulation index of 2.405, it crosses the zero line and becomes negative. It then reaches a negative maximum at a modulation index of about 4, and then goes up again. It keeps oscillating, but generally gets smaller and smaller, while more and more sidebands appear at the right.

### Bandwidth

The more sidebands there are, the greater the bandwidth of the signal. At a very low modulation index (below 0.5), there is only one set of sidebands, which makes the total bandwidth about the same as AM. With larger modulation indexes, the number of sidebands increases and the bandwidth goes up.

Fortunately, something else is happening which keeps the total bandwidth reasonable. Remember how we defined the modulation index:

$$MI = \frac{\text{deviation}}{\text{modulation frequency causing that deviation}}$$

To get a large modulation index, you need a large deviation but a small modulation frequency. The modulation frequency, however, determines the

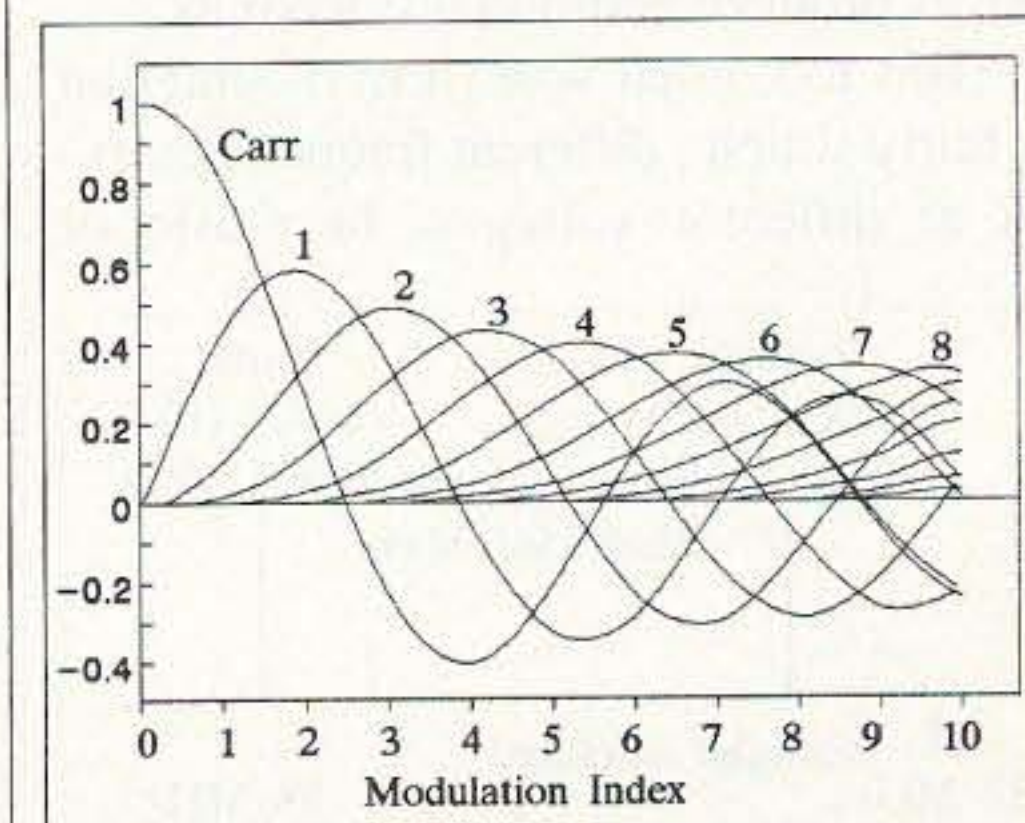

**Fig. 1.** FM carrier and sideband amplitudes.

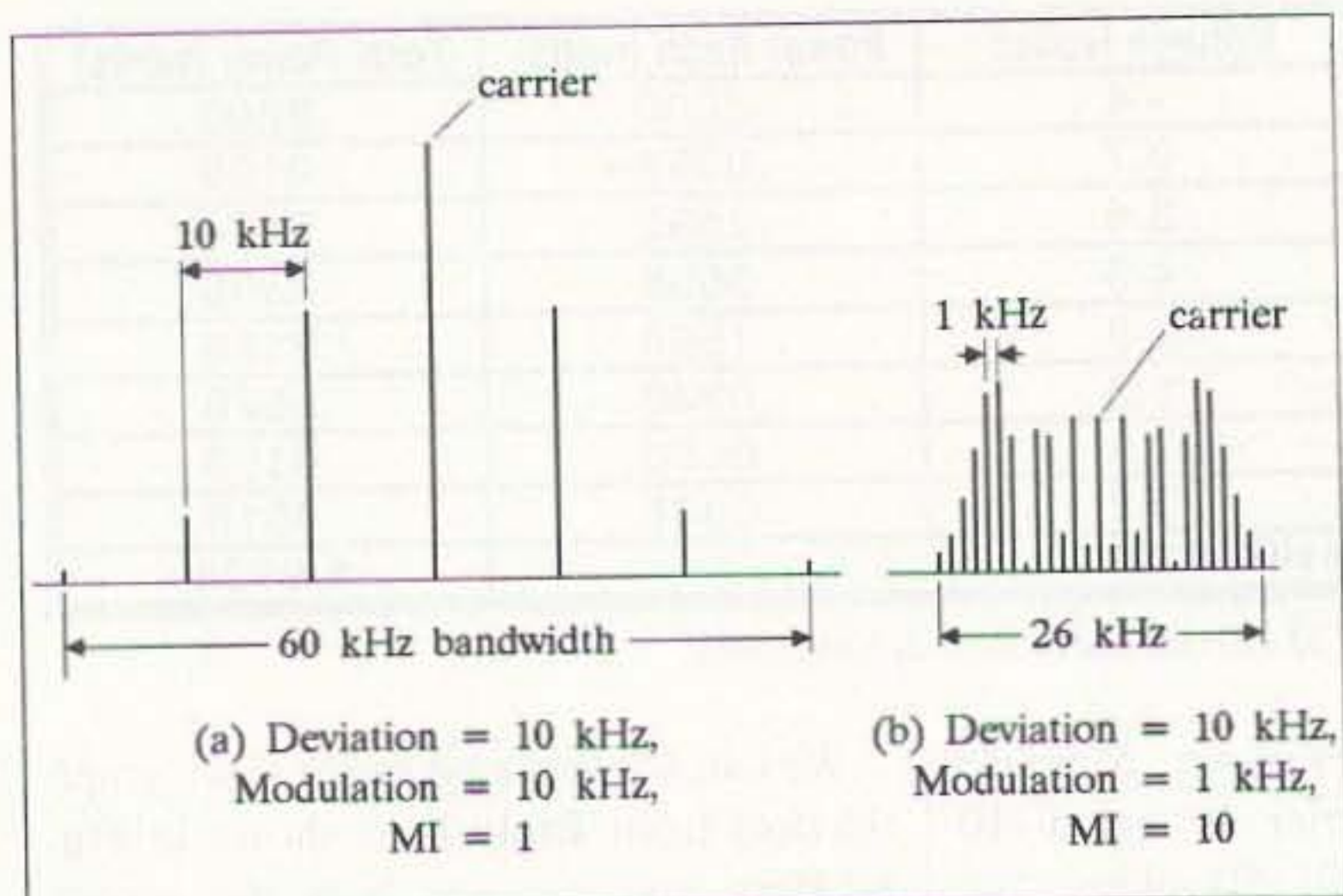

Fig. 2. FM, same deviation, different modulation index.

spacing between sidebands. So at a high modulation index, you may have many sidebands, but they will be close together, so the total occupied bandwidth will not be as large as you might think.

Fig. 2 shows an example. At left, we see the spectrum when the deviation is 10 kHz and the modulation frequency is also 10 kHz; the resulting modulation index is 1, and there are three sidebands on each side. Since they are 10 kHz apart, the total bandwidth is 60 kHz. On the right, the deviation is also 10 kHz but the modulation frequency is only 1 kHz. The modulation index is now 10 and there are 13 sidebands, but the sidebands are only 1 kHz apart, so the bandwidth is only 26 kHz.

In the real world, things are somewhat more complicated than what we've described so far. Our discussion so far has assumed that the FM transmitter is sending out pure tones—much like an announcer whistling a single note into the mike. In practice, regardless of whether we deal with voice, music, or data, the modulation signal consists of many different frequencies at the same time. The Bessel function analysis then becomes much more complicated, because the interactions between all these tones themselves produce additional sidebands.

Then too, even when the modulation is fairly simple, different frequencies exist at different voltages. In music or

voice, for example, the high frequencies tend to be much weaker than the lows. Even though FM stations often boost the highs (this is called *pre-emphasis*) to overcome noise, the highs are still generally weaker than the lows, and so produce lower deviation.

Commercial FM

broadcast stations therefore carefully adjust their audio response to utilize their assigned spectrum as fully as possible.

### Channels

As we mentioned earlier, commercial FM stations are allowed to deviate up to  $\pm 75$  kHz. Although the frequency response of their broadcast sound only extends to 15,000 Hz, they often transmit modulation up to almost 100 kHz (more on this later). The high-frequency material they may transmit up near 100 kHz is at a modulation index below 0.5 so it generates only one set of sidebands, but even this one single sideband set means their bandwidth may extend out to 100 kHz on each side of their center frequency. Hence, commercial FM broadcast stations are assigned a *channel* which is 200 kHz wide.

The U.S. FM broadcast band extends from 88 to 108 MHz; the lowest FM station on the band would be assigned a 200-kHz-wide channel from 88.0 to 88.2 MHz, with its center frequency at 88.1 MHz. The next station up could be centered at 88.3 MHz, with its channel extending from 88.2 to 88.4 MHz. This explains why all the FM stations in your area are at odd tenths of MHz: .1, .3, .5, .7, or .9 on the dial.

In practice, though, two stations in the same area cannot be assigned adjacent channels, because the bandwidth of the tuned circuits in FM radios is not narrow enough to separate two such adjacent stations. So rather than being spaced 200 kHz apart, FM stations in the same city are often 400 or even 600 kHz apart. The in-between channels are used by stations farther away.

TV channels are assigned in the same way. Each TV channel is 6 MHz wide. Starting at the low end, their frequencies are:

- Channel 2: 54 to 60 MHz
- Channel 3: 60 to 66 MHz
- Channel 4: 66 to 72 MHz
- Channel 5: 76 to 82 MHz
- Channel 6: 82 to 88 MHz
- Channel 7: 174 to 180 MHz, and so on.

Note several interesting things: There is no channel 1; channels are usually adjacent, but there is a 4 MHz break between channels 4 and 5; channel 6 is just under the FM band, which starts at 88 MHz; and there is a big break between the "low VHF" channels, channels 2 through 6, and the "high VHF" channels, numbered 7 through 13. The space between them contains the FM broadcast band, aircraft frequencies, the 2 meter amateur band, marine channels, and commercial two-way frequencies. The UHF channels begin at 470 MHz and extend up to 900 MHz.

In any given area, to avoid interference between them, two TV stations will never be assigned adjacent channels. In New York City, for example, there are TV stations on channels 2, 4, 5, 7, 9, 11, and 13. How can there be stations on both channels 4 and 5? Only because there is a 4-MHz-wide space between them—they are not really adjacent.

If you have cable TV, you may be wondering why there can be stations on adjacent cable channels. The reason is that most modern TV sets can (just barely!) separate two adjacent TV stations under the condition that they are both the same strength. The cable network has full control over the strength of all its channels, and can satisfy this condition. On-the-air signals, on the other hand, vary in strength depending on how far you are from the transmitter, and there can often be tremendous differences in signal strength between stations.

While we are discussing TV transmission, this might be a good place to again mention what kind of modulation is used for TV, and how the 6 MHz channel is divided up.

Fig. 3 shows a typical TV channel spectrum. We show channel 6, but all the VHF and UHF TV channels are laid out exactly the same way. Each TV channel takes exactly 6 MHz of bandwidth; channel 6 uses 82 to 88 MHz. The

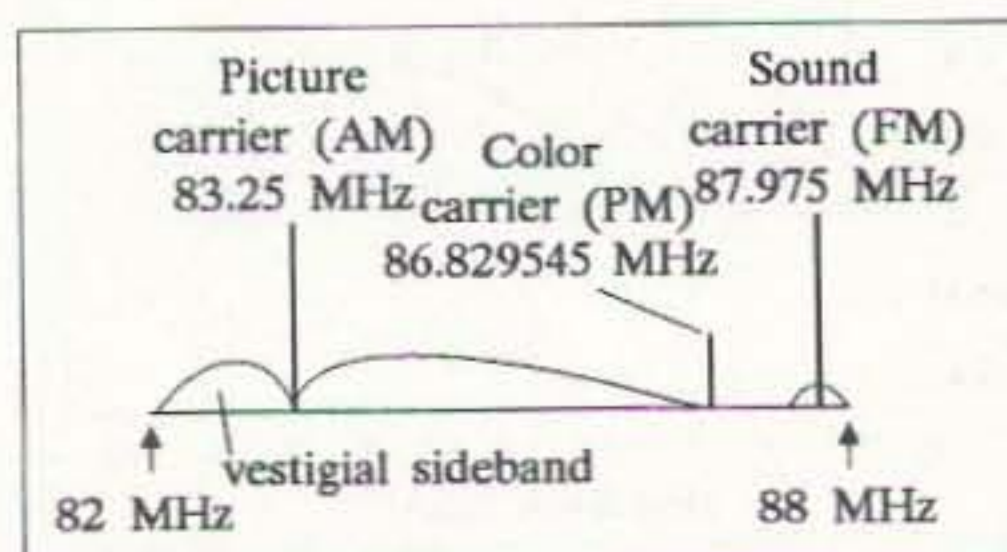

Fig. 3. TV channel 6 spectrum.

picture is sent using AM vestigial sideband modulation (which was discussed at the end of Part 7), with the AM carrier exactly 1.25 MHz from the bottom frequency of the channel; in channel 6, this places it at 83.25 MHz. The sound is sent on an FM carrier, whose frequency is exactly 4.5 MHz above the picture carrier; this places it at 87.75 MHz. In fact, if you live in an area with a channel 6, and if you have an FM radio which will tune slightly below the 88 MHz end of the FM band, you can hear the channel 6 TV sound.

3.579545 MHz above the picture carrier (which is 86.829545 MHz in this case) is a third carrier, which carries the color or *chroma* information. Since this carrier is sent as part of the picture signal, it is called a *subcarrier*. This signal uses phase modulation.

### Phase modulation

PM or *Phase Modulation* is so similar to frequency modulation that equipment designers often use a PM modulator to produce FM. Because of their similarity, it is difficult to clearly explain the difference between FM and PM, so read this section very carefully.

First, to make sure you fully understand FM, let's talk about a commercial FM broadcast station at 96.3 MHz. The frequency of its unmodulated FM carrier is its center frequency (96.3 MHz). When the audio signal starts, the frequency varies (deviates) from its center value. At any given instant of time, the frequency change at that instant is proportional to the audio voltage at that instant. For example, suppose the transmitter is designed to produce the full  $\pm 75$  kHz deviation with an input voltage of  $\pm 7.5$  volts. The signal frequency might then follow the structure of Table 3.

Whenever the audio voltage is +1 volt, the transmitter frequency at that instant will be 96.310 MHz. It doesn't matter how the audio voltage got there—the signal could be coming from a 1-volt DC battery, or it could be the peak of a 1-volt sine wave, or it could just be passing through the +1 volt value on its way up or down some strange-looking waveform. At any instant of time, the FM signal frequency depends only on the audio voltage at that same instant.

Another important concept to understand is that if the audio voltage remains

constant for a while, then the signal frequency is also constant (though it may not be at the center frequency). When the audio signal changes, the signal frequency changes, and the faster the audio changes, the faster the signal frequency changes.

Now, let us discuss phase. Phase measurements are used to compare two or more signals to see if they are "in step" with each other, and if not, how much they differ. Let's consider a real simple-minded example, in which someone talks about a parade and says "that marcher is 180 degrees out of step with the others." What is meant is that this particular marcher is doing the exact opposite of everyone else—when everyone else steps forward on their left foot, this marcher steps with his right foot, and so on. Zero degrees phase difference means being in step; 180 degrees difference means doing the exact opposite; 90 degrees difference would mean being "halfway out of step," and so on.

Although phase measurements usually compare two or more signals with each other, we can also use them to compare one signal to itself. Let's return to that parade marcher. Suppose you see him (or her) take two steps; based on this, you can predict when the third step should come. If the marcher takes that third step a little sooner than you expected, then that step occurs earlier in phase. To do that, the steps are coming closer together, so the frequency has also increased. So phase changes go with frequency changes.

Hence, frequency modulating a signal produces phase modulation, and phase modulation produces frequency modulation. So what is the difference?

Remember the definition of modulation index:

$$MI = \frac{\text{deviation}}{\text{modulation frequency causing that deviation}}$$

The difference between FM and PM is this: Suppose an announcer steps up to the microphone and whistles a low note (for instance, 500 Hz), followed by a high note (for instance, 1000 Hz) at the same volume (imagine a sound like "boop-beep"). In both FM and PM, these two notes produce

both frequency and phase modulation, but in FM the deviation for both notes would be the same (meaning that the modulation index is different), whereas in PM the modulation index is the same (meaning that the deviation is different).

In practice, things get a bit confused here, because radio stations routinely boost the treble to reduce the noise, so the deviation would change slightly even in FM, but let's ignore that little complication. So, for example, FM might produce 2000 Hz deviation for both notes; the modulation index would then be 2000/500, or 4 for the 500 Hz note, but only 2000/1000, or 2 for the 1000 Hz note.

In PM, on the other hand, the 500 Hz note might produce 1000 Hz deviation (for a modulation index of 1000/500, or 2), while the 1000 Hz note would produce 2000 Hz deviation (for a modulation index of 2000/1000, also equal to 2).

This greatly affects the bandwidth of the signal. In FM, lower frequencies produce a higher modulation index; this gives more sidebands, but they are closer together, so the total bandwidth stays pretty constant and doesn't depend on the audio frequency. In PM, on the other hand, the modulation index is independent of audio frequency, so the number of sidebands stays the same regardless of audio frequency, but with higher audio frequencies the sidebands are farther apart, so the bandwidth increases.

The bottom line is that PM is useful for communications-quality audio, whose audio content doesn't go much above 3000 Hz. It would not be good for real hi-fi audio, because the high frequencies in hi-fi audio would require too much bandwidth.

To finish up, here are two more points. First, you can generate FM with a PM transmitter, and vice versa. All you have to do is to process the audio going into the transmitter. For example, an FM transmitter produces too little deviation for high frequencies, so sending the

Audio Voltage (volts)	Frequency Change (kHz)	Signal Frequency (MHz)
+ 7.5	+ 75	96.375
+ 1.0	+ 10	96.310
0	0	96.300
- 7.5	- 75	96.225

Table 3. The signal frequency of a transmitter producing  $\pm 75$  kHz deviation with  $\pm 7.5$  volts input.

audio through a high-pass filter (which increases the high-frequency treble) will increase the deviation to that of a PM transmitter. Doing the opposite, cutting the treble with a low-pass filter, will make a PM transmitter send out frequency modulation. In fact, many FM transmitter designs do just that; it results in a more stable signal.

Finally, as we said earlier, things get a bit more complicated because of FM stations' efforts to reduce noise. Since most audio signals contain mostly mid-range signals and relatively little energy in the high frequencies, most commercial FM transmitters boost the treble; this process is called *pre-emphasis*. This makes the signal a bit more like PM, but it's okay because of the low amount of high frequencies to begin with. A *de-emphasis*

circuit in the receiver then reduces the treble back to the normal level. In the process, the de-emphasis circuit also reduces any hiss which crept into the signal.

### Conclusion

FM and PM are similar to each other, but fundamentally different from AM. All three have a carrier which is modulated in some way, and that modulation causes sidebands, but how those sidebands interact with the carrier is very different.

Because noise basically affects amplitude, you can remove it from an FM or PM signal by clipping (limiting) the signal to a fixed amplitude; this does not change the frequency or phase and so doesn't affect the modulation. However,

you cannot remove this noise from an AM signal without affecting the amplitude, and therefore the modulation itself. FM and PM can therefore provide the better signal-to-noise ratio that listeners want for good music, but getting the best signal-to-noise ratio also requires a wide deviation. Hence, FM signals used for music also have fairly much wider bandwidth than most AM signals.

In those communications applications where real hi-fi sound is not required, narrow-band FM (NBFM) with fairly small deviation and a small modulation index can produce bandwidths not much larger than AM. This is the mode that is used for most mobile communications such as amateur repeaters, police and fire communications, business users, and cellular telephones. 75

Number 68 on your Feedback card

# From Kilowatts To Femtowatts?

*Wrestling with those dog biscuits.*

Bill Parker W8DMR  
2738 Floribunda Drive  
Columbus OH 43209

**W**hile your transmitters may be able to provide up to a kilowatt of power to the transmission line connected to the antenna, how much of that power reaches another ham's receiving antenna? And how much is needed to make the receiver work?

Typically, 50 microvolts is needed at the antenna terminals of the receiver to produce an S-9 signal. One S-unit represents a nominal 6 dB (decibel) level change.

Assuming the input resistance of the receiver is 50 ohms, how much power will 50 microvolts provide? Let's consult Dr. Ohm.

$$P \text{ (watts)} = E^2/R.$$

Are we OK so far?

$$E = 50 \mu\text{V} = 50 \times 10^{-6}\text{V}.$$

$$\text{So } E^2 = (50 \times 10^{-6})^2 = 2,500 \times 10^{-12}.$$

$P = 2,500 \times 10^{-12}/50 = 50 \times 10^{-12}$  watts, which is 50 picowatts, or 50 trillionths of a watt.

An S-9 signal is actually a high level. So what if the level of signal is only S-3? With an S-9 level equal to 54 dB and S-3 equal to 18 dB, it's 36 dB below S-9. A reduction of 36 dB means the signal has been lowered by a factor of 4,000 or  $2^{12}$ . The 50 picowatts, when reduced by 6 S-units, lowers the input signal to 12.5 femtowatts. A femtowatt is  $1 \times 10^{-15}$  watt. What is the attenuation (in dB) if a

kW is radiated and 10 femtowatts arrive at the DX station's receiver?

$$\text{Attenuation} = 10 \text{ Log } (1 \text{ kW}/10 \text{ femtowatts}) = 10 \text{ Log } (1 \times 10^3 \text{ watts}/10 \times 10^{-15} \text{ watts}) = 170 \text{ dB}.$$

This amounts to one part in 100,000,000,000,000 of the original signal that started. Earth-moon-earth (EME) ham operators have attenuation paths of about 250 dB. High gain, narrowband receivers with low noise preamps are needed to work the 480,000 mile EME path.

As the signal travels in space it is also spreading, so only a very small fraction of the original kW is available to the ham located far away. The attenuation due to the signal spreading (the inverse-distance law) is called path loss. 75

# BC Band Antenna Switchover Relay

*A better way for Icom HF radios.*

Dave Miller NZ9E  
7462 Lawler Avenue  
Niles IL 60714-3108

Many of the Icom HF ham transceivers—those with general coverage shortwave reception capabilities—require physically changing the HF antenna connection on the rear apron of the transceiver to enable your ham antenna to also be used as a BC band antenna. The changeover also requires the use of an SO-239-to-RCA phono connector adapter to adapt the normal transmission line PL-259 connector to the phono jack input on the radio. This isn't very handy for most of us—there must be a better way!

Fig. 1 shows one better way. It's a totally automatic system that provides a way around this inconvenience in the Icom IC-745 transceiver specifically; however, the principle can be used in most other Icom transceivers, though the details may vary slightly from one set to another. The receive antenna path is normally looped out the rear of the transceiver to provide access for a separate receiver. This loop is broken, and controlled by a small relay that feeds it

to either the RX IN or BC IN inputs. You can use the schematic diagram in Fig. 1 as a guide for finding the correct BC band voltage pick-off point in your own particular Icom model of transceiver.

## The principles

Here then are the principles: The 8 volt "BC band enable" signal is tapped off of the junction of D-14, D-15, C-154, and L-43, and routed to an unused pin (# 24) on the IC-745's rear apron "accessory" Molex connector. It's then brought into a newly-built relay box containing a 9 volt SPDT relay which will be used to switch the HF antenna into the BC band antenna input on the radio anytime the BC band is selected on the dial (and all automatically). Quite a difference in convenience, while still maintaining the isolation of the BC band from the rest of the HF shortwave band as originally intended by Icom.

The three short output coax cables from the new relay box, which are terminated in RCA "phono" type connectors, do the RF

signal routing. The only addition inside the radio itself is the single DC wire to accessory connector J3, pin 24. RG-58 or the miniature RG-174 cable would be ideal, but any shielded cable works OK. The relay and its connections can be housed inside any small project box you choose, then tucked neatly away behind the radio and out of sight. The new relay box

only handles receiving level signals, so a power relay isn't needed and the transmitter's signal path is completely unaltered.

## Finishing touch

I housed the relay and cable connections inside a 1" x 2" x 1" Sescom MPB-1\* miniature aluminum project box and, in turn, mounted the box on one of the rear screws that hold the IC-745's

***"You'll never have to fumble with swapping cables on the back of your radio again!"***

heat-sink cover in place. Sescom's boxes are interesting because they are in "kit form," using flat aluminum sheet stock for the sides and end pieces, but held together with custom-made extruded aluminum angle at the four corners and then secured with four small Philips-head sheet metal screws on the top and bottom ends. They allow for nearly endless customization. This scheme affords a very neat, low-profile installation, and the aluminum box provides complete shielding for the relay and cable ends. The shielded cables between the box and the transceiver's inputs are literally just a few inches each so they don't affect the transceiver's performance. Once the switchover relay is installed the antenna will change input ports as soon as you go to the broadcast band. You'll never have to fumble with swapping cables on the back of your radio again!

\*The MPB-1 used by the author (and other boxes in the MPB series) are available from Sescom, Inc., 2100 Ward Drive, Henderson, NV 89015-4249 (1-800-634-3457 orders only or 1-702-565-3993 for information).

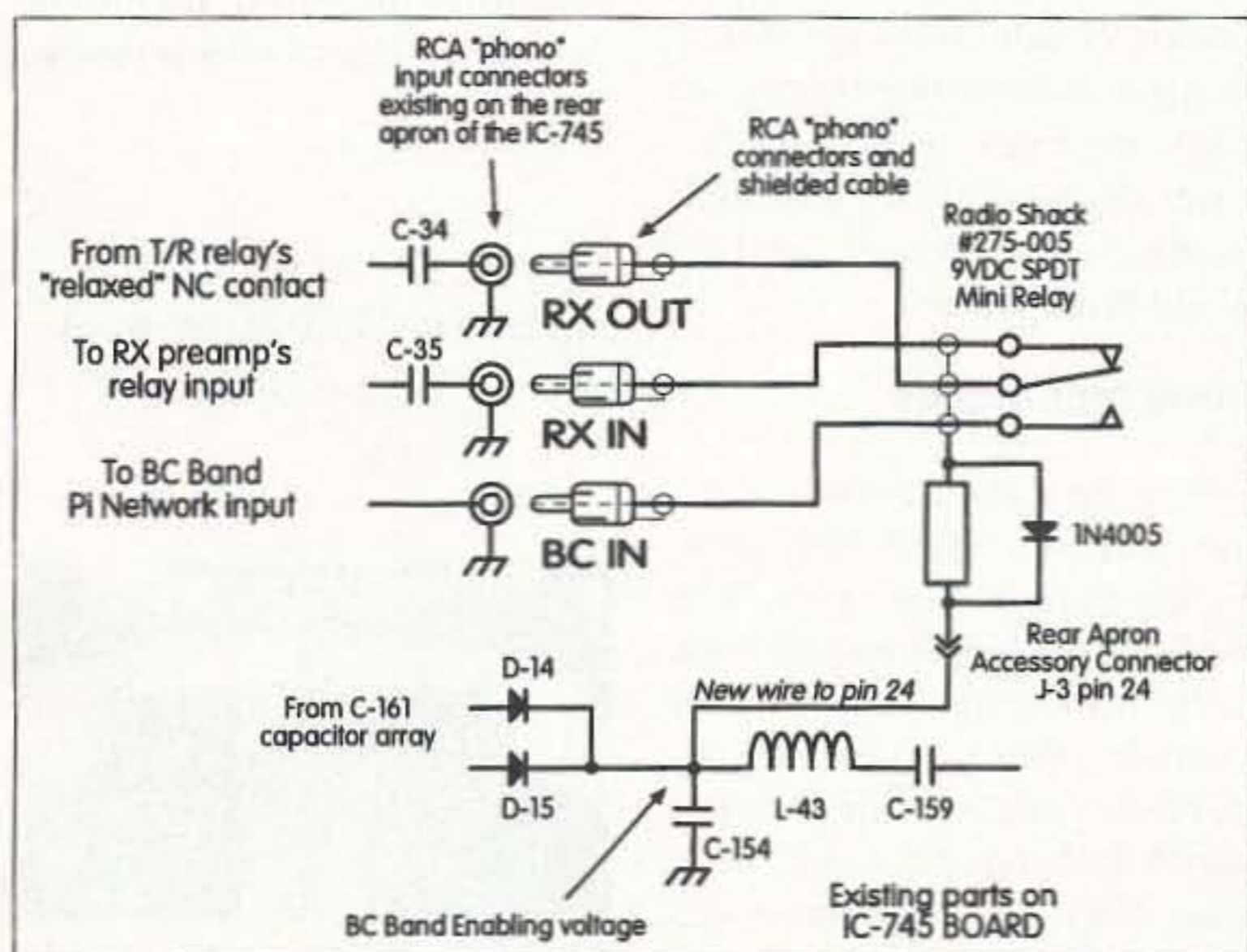

Fig. 1. Schematic diagram of the outboard switchover relay that enables the HF antenna to be used for BC band reception in the Icom IC-745.

# RTTY LOOP

## Amateur Radio Teletype

Marc I. Leavey, M.D., WA3AJR  
P. O. Box 473  
Stevenson MD 21153

Last month I discussed some of the ways that digital information can be impressed onto a single signal. What I left out, though, is the mechanism for putting that signal over a radio wave. After all, the name of this column is "RTTY Loop," not "TTY Loop"!

Recall for a moment that the schemes we came up with last month basically involved assembling a group of on and off pulses into a sequence that would represent one letter, number, or machine function. The idea is to transmit these pulses, sequentially, on an amateur radio frequency.

### Early modes

The first scheme tried, way back when radioteletype was first starting out, was called on-off keying. Very simple to understand, and conceptually the obvious first choice, on-off keying just keys the transmitter in step with the code pulses, creating what is in effect a very high speed CW signal. **Fig. 1** illustrates this technique; other figures are also grouped here for comparison. The advantages of this technique are related mainly to simplicity in transmitting: You merely hook the teleprinter to the key jack. Reception is also easy, with no need for the fancy circuits other techniques demand. The disadvantages of this simple mode relate primarily to interference susceptibility and fading. A nearby CW signal can wipe out an on-off TTY station, and fading can remove whole letters.

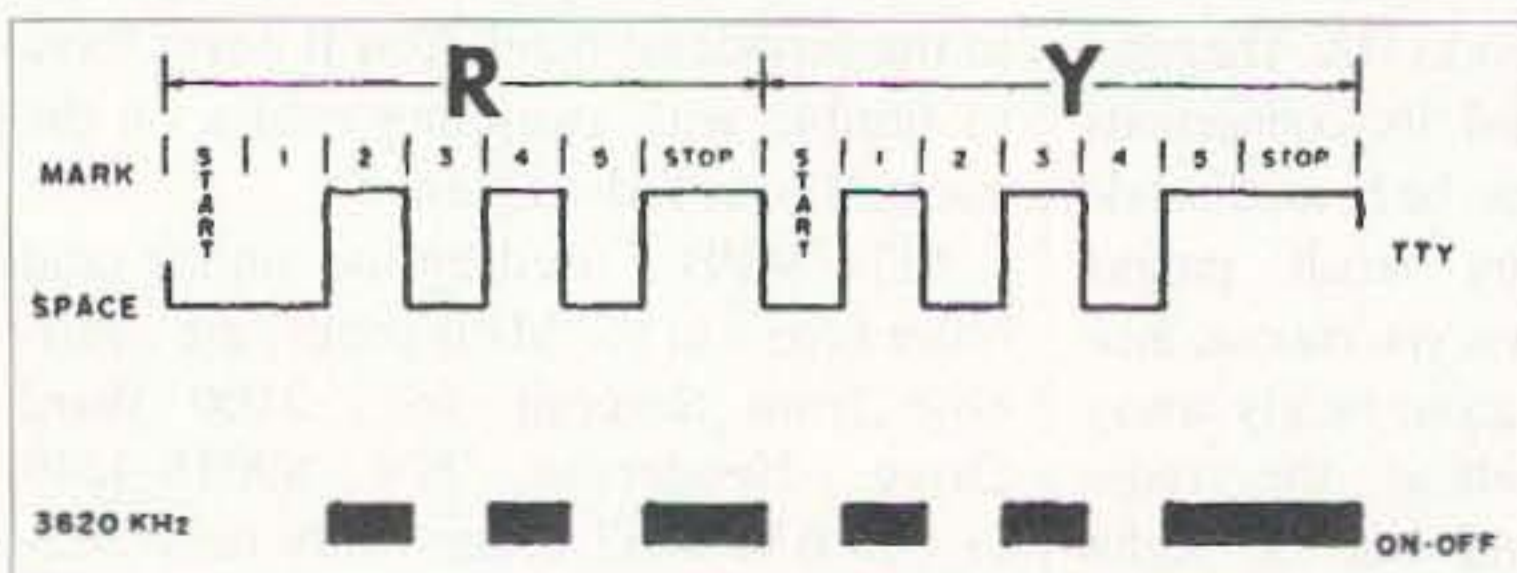

Fig. 1. On-off keying.

A better way to send RTTY is by presenting a constant signal for the MARK state, changing it in some way to represent the TTY signal. Changes may be introduced in amplitude, frequency, or by a superimposed modulating waveform. Direct amplitude modulation with the digital signal approximates on-off keying, with its attendant flaws.

### FSK and AFSK

Over the years, a frequency modulation technique has arisen as the most-used amateur mode,

***"The Radio Data Code Manual includes just about every teleprinter communications scheme that exists, explained and diagrammed."***

either with frequency modulation of the RF carrier frequency, FSK (or frequency shift keying), or with frequency modulation of a superimposed audio signal, AFSK (or audio frequency shift keying).

In FSK, a carrier is shifted in frequency to correspond to MARK and SPACE. **Fig. 2** diagrams this nicely. This system, as are all to follow, is a redundant system. That is, information is obtainable by looking at either MARK or SPACE, even in the absence of either one. Remember that in on-off keying, if you lose the SPACE you have a steady MARK, and if you lose the MARK you have nothing. Transmission of FSK is accomplished by shifting the transmitter VFO in step with the digital signal, and reception by decoding either or both the MARK and SPACE.

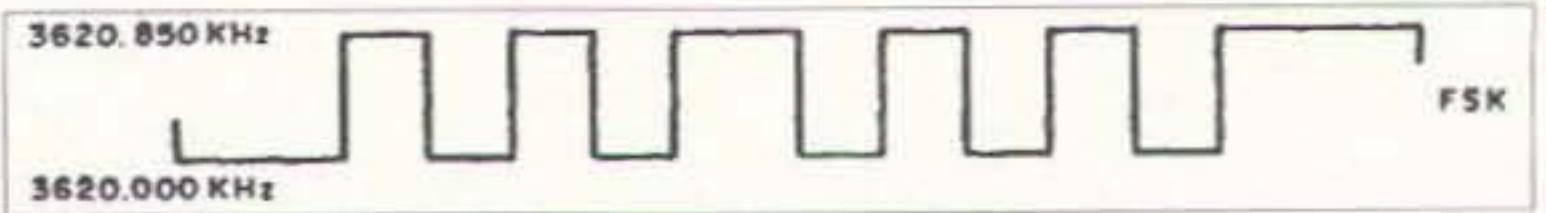

Fig. 2. In FSK, a carrier is shifted in frequency to correspond to MARK and SPACE.

Done properly, this system is virtually immune to interference and, since fading normally affects only one of the MARK or SPACE frequencies at a time, proper use of the built-in redundancy makes fading no problem either. The frequency shift involved may be anything from kilohertz to fractions of a hertz, which might be more properly called "phase shift." In amateur circles the original standard, before modern equipment, computers, and band cram, was 850 Hz; nowadays, most FSK signals are shifted only 170 Hz.

Unfortunately, FSK presumes very stable transmitters and receivers. The level of shift is certainly less than one kilohertz, and drift in either the transmitter or receiver of any significant degree would be intolerable. VHF transmitters, especially early ones, would not maintain this degree of stability. Use of an audio tone, shifted in frequency in a manner similar to FSK, became the standard on VHF links. This AFSK is more useful than it appears at first glance. Realize that transmitting tones over radio is not that different from transmitting tones over telephone wires, and this scheme forms the basis of all those computer modems, networks, and the World Wide Web.

### Other techniques

Now, how about some alternative schemes? Two such techniques employed along the way used brief pulses to encode data, rather than longer segments. For example, with a "standard" 60-word-per-minute radioteletype signal, each data pulse is 22 msec long. What if a brief pulse was sent during each 22-msec window, with either its amplitude or position within the window

representing the pulse's state? The resultant Pulse Amplitude Modulation (PAM), or Pulse Position Modulation (PPM), is shown in **Fig. 4**.

Having to transmit pulses sequentially imposes a limit on just how fast you can transmit, given that you can only divide a cycle so many ways.

The solution to that is to assign groups of pulse patterns to different frequencies. Thus, transmitting a sequence of frequency blips may encode quite a few more data bits. For example, rather than have one frequency for MARK and one for SPACE, suppose you had one frequency, say 500 Hz, for the bit pair "00," 1000 Hz for "01," 1500 Hz for "10," and 2000 Hz for "11." You could then send the "RY" sequence, 01010=R and 10101=Y, as 1011011011011 in five pulses rather than 10. With each pulse taking the same time, you can double the speed. It is not hard to see that by making this a tad more complex, by making each data word longer and assigning more tone steps, speed could be increased even further. Not only that, but by employing data compression, an instruction could lump that sequence of five 1011 data words into a control word which says repeat times five, and the data word only once. This is, basically, how many forms of data compression work, including those involving data transmission.

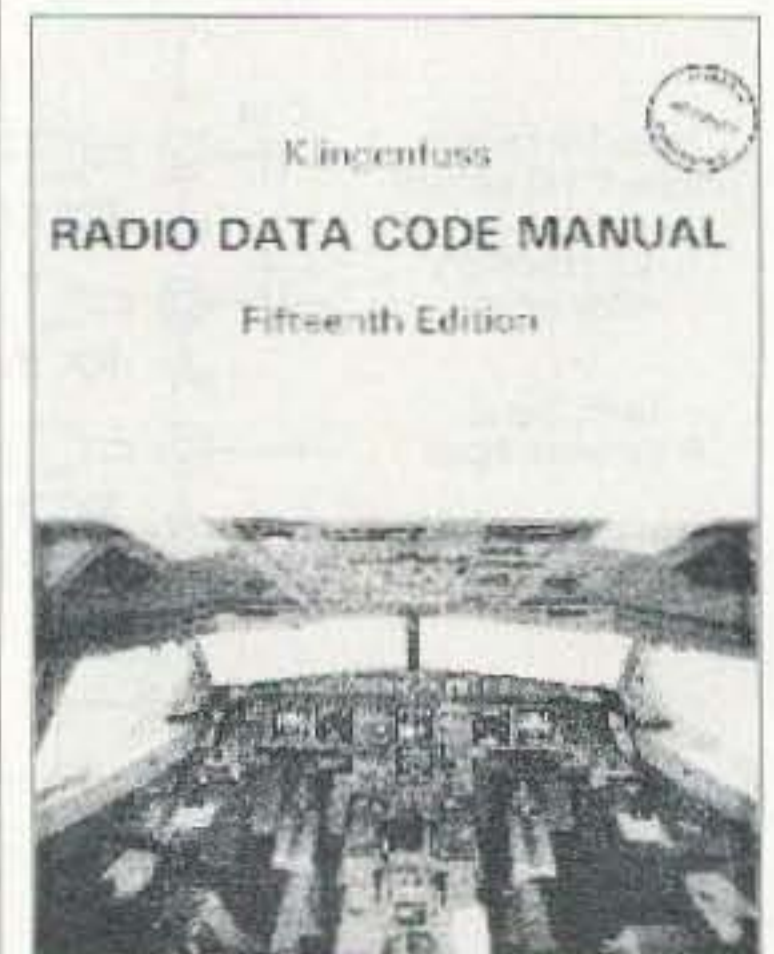

Photo A. The Radio Data Code Manual is available for DM70 from Klingenfuss Publications.



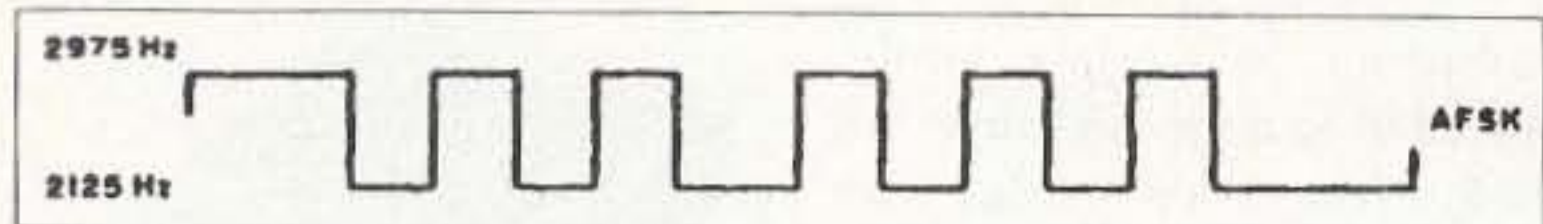

Fig. 3. AFSK, audio frequency shift keying.

All of these schemes have concerned themselves with only one end of the data transmission scheme. But transmission implies reception, and there are quite a few techniques for enhancing data interchange as well, other than the simple "I talk, then listen to you" model. This is where we get to packet, AMTOR, and the like, but this is also for a future discussion.

#### New reference book

Reference books have long been lacking in this area, but a new one has been published which includes just about everything the digital amateur could want in the way of such information. Our old friend, Joerg Klingenfuss, who has been writing authoritative tomes for about 30 years now, has published his 15th edition of the *Radio Data Code Manual*. It includes a raft of meteorological codes with detailed examples, over 10,000 meteorological stations indexed, aeronautical telecommunications abbreviations, company and aircraft designators, CW and RTTY alphabets for Arabic, Chinese,

Cyrillic, Greek, Hebrew, Japanese, and other non-Latin alphabets, and just about every teleprinter communications scheme that exists, explained and diagrammed.

**Photo A.** shows the cover of this 600-page publication, which is available for DM70 from Klingenfuss Publications. Check out Joerg's stuff on his home page at: <http://ourworld.compuServe.com/homepages/Klingenfuss/> or drop him a letter at Klingenfuss Publications, Hagenloher Str. 14, D-72070 Tuebingen, Germany.

Stop by the RTTY Loop home page as well, at: <http://www2.ari.net/ajr/trty/> for columns, features, and other items of interest to digital amateurs. The full listing for the RTTY Software collection is online there, but it is also available by sending a self-addressed, stamped envelope to the address at the head of this column, for those of you who are not yet online or who cannot download from the Web. I look forward to your comments and questions, as always, at [ajr@ari.net](mailto:ajr@ari.net), [MarcWA3AJR@aol.com](mailto:MarcWA3AJR@aol.com), or 75036.2501@compuserve.com. 73

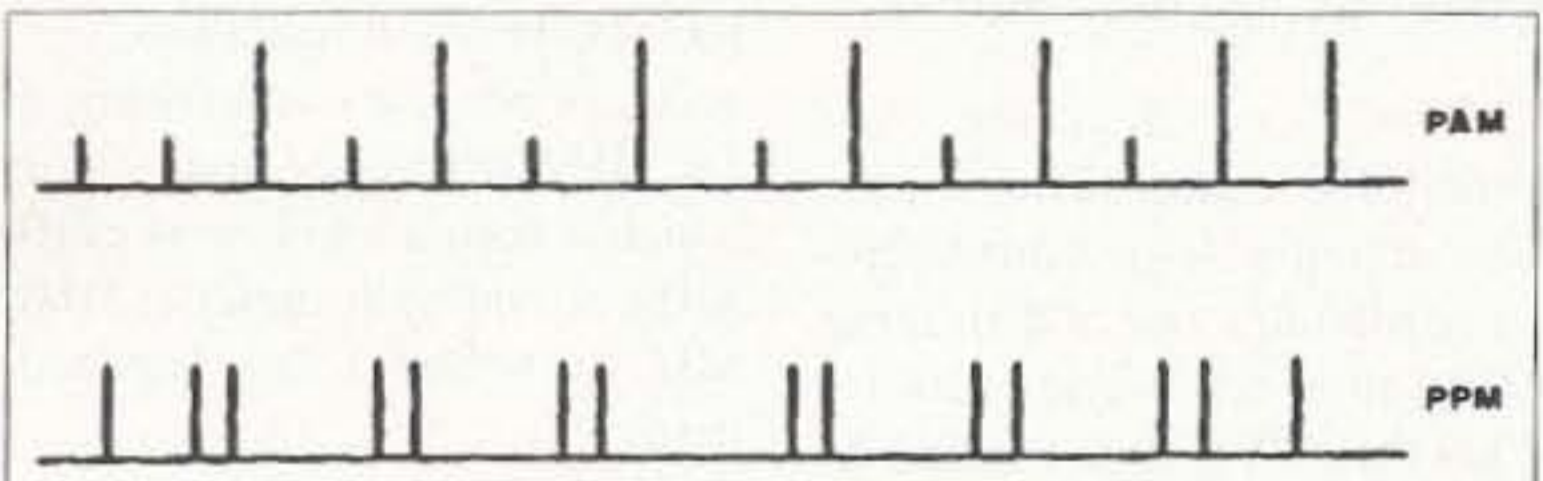

Fig. 4. Pulse Amplitude Modulation (PAM), or Pulse Position Modulation (PPM).

#### NEVER SAY DIE

*Continued from page 60*

personal computer revolution almost entirely.

Bill Gates and Steve Jobs, the two most successful personal computer pioneers, were both college-dropout entrepreneurs. They're both billionaires now, thanks to the blindness (aka stupidity) of the computer industry professionals.

Today this whole scene is being replayed in the world of physics and power. Will the future titans of power be today's cold fusion pioneers? It's most likely, given the refusal of

universities and power industry firms to recognize this new technology's potential. It's the same blindness that killed Centronics, which was the largest manufacturer of printers in the world—for minicomputers. Microcomputers blew them away.

When we're able to generate power at a tenth the cost of fossil fuels such as coal, oil, and natural gas, there will be no power bloc strong enough to stamp this out.

The fuel and power companies are working on the basis of "to hell with tomorrow, let's make all we can right now." So

*Continued on page 76*

**pauldon**  
ASSOCIATES

210 Utica Street Tonawanda, NY 14150 (716) 692-5451

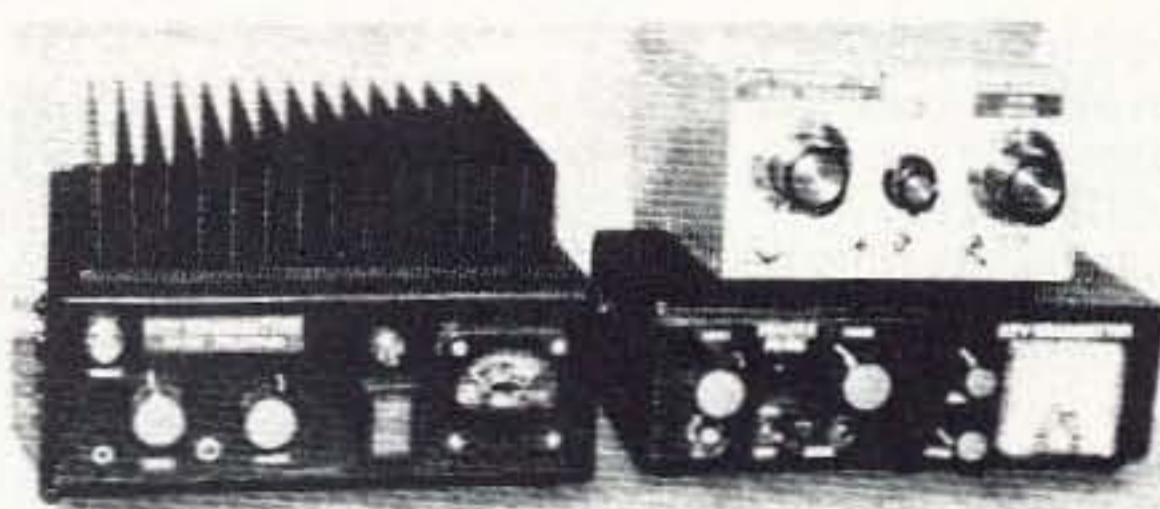

## POWER AMPS & PREAMPS

AM & FM 2.0 Mhz - 1.2 Ghz, 2.0 Mhz - 2.3 Ghz

**\$75.00 to \$450.00**

ATV TRANSMITTERS FOR FM 23CM & 33CM

ATV Transmitters - Transceivers -  
Down Converters 70 CM Up

Cable VIDEO MODULATORS INCLUDING

Power Amps. 3 W Output

DIGITAL READOUT on FREQUENCIES.

P.A. with or without T/R

\$275.00 NO T/R \$318.00 WITH T/R

Others products inc. ATV samplers

Write or call for catalog

CIRCLE 339 ON READER SERVICE CARD

**Motron** 310 Garfield St Suite 4  
PO Box 2748  
**ELECTRONICS** Eugene, Oregon 97402  
<http://www.motron.com>

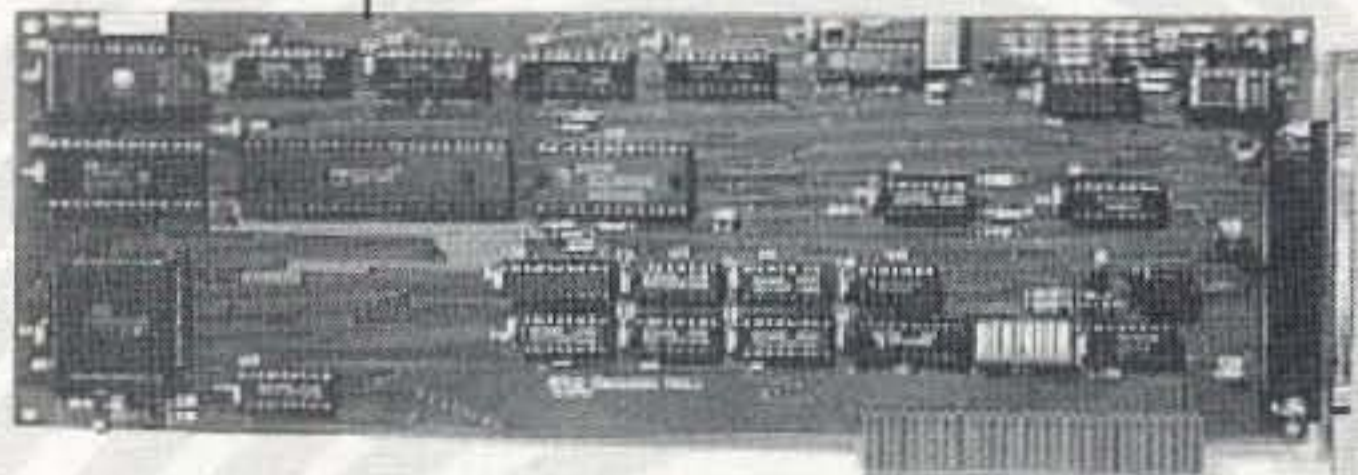

## TxID-1

TRANSMITTER FINGERPRINTING SYSTEM

TxID™ Software and IBM/Compatible circuit card.

Now Shipping VERSION 2 SOFTWARE  
WITH AUTOMATIC MATCH AND COMPARE!

**TxID™ TxPorter™**

EXTERNAL ADAPTER for Mobile Operation.

CONNECTS THE TxID TO YOUR LAPTOP COMPUTER!

**TxID-1** FINGERPRINTING SYSTEM with SOFTWARE **\$699.00** Plus  
**TxPorter™** Mobile OPERATION ADAPTER **\$249.00** S/H

Call for more information.

Info: (541) 687-2118 Fax: (541) 687-2492

CIRCLE 248 ON READER SERVICE CARD

# ABOVE & BEYOND

## VHF and Above Operation

C. L. Houghton WB6IGP  
San Diego Microwave Group  
6345 Badger Lake Ave  
San Diego CA 92119  
Internet: clhough@aol.com

### 2304 MHz—A Club Project

Members of the San Diego Microwave Group have embarked upon an ambitious construction program, aimed at increasing our amateur ranks with operational transceivers for the 2, 3, and 5 GHz amateur bands. Our intent was to put together the simplest basic transceiver for use at our monthly group meetings. Kerry N6IZW's intent was to construct a transceiver each month for the 2, 3, and 5.6 GHz bands. Sounds like a very ambitious construction project; however, the driving force was to make some of these rigs usable in the June VHF/UHF contest.

This project was not intended to be a backbreaker, but rather an interesting construction project in our lower microwave bands. Nothing was set in stone as a rigid design; the only requirement was that the rig should be capable of operation with either narrowband FM or SSB. This meant that the basic design has to be, at minimum, a local oscillator, a mixer, and an antenna. The most critical part of any system is the local oscillator, as its stability must be sufficient to support operation on narrowband FM as well as single-sideband.

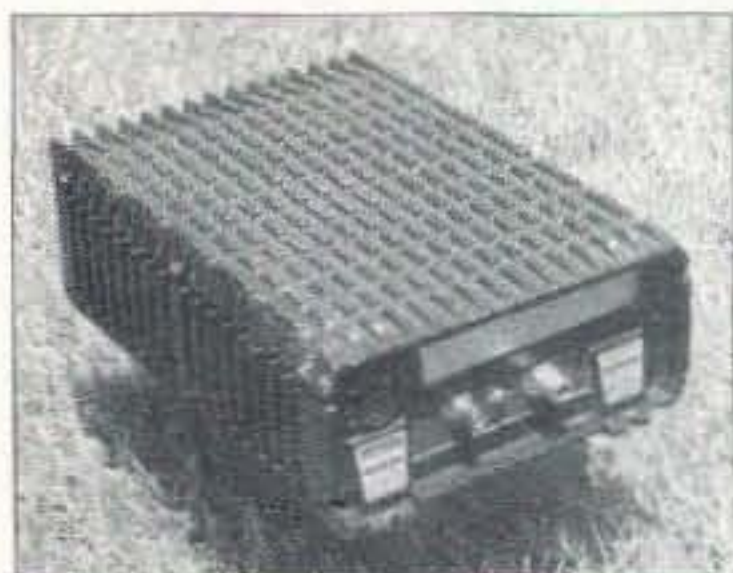

**Photo A.** Basic cabinet structure (old-style) from Qualcomm. Front panel contains DC power connector, input IF/output RF coax connectors. Toggle switch used for manual RX/TX transfer control.

The 10 GHz band that microwave equipment can be obtained for is just what this column is all about: different material being used to construct transceivers from scrounged material obtained from surplus, in addition to using the Qualcomm 3036 PLL synthesizer chip. This chip and the surplus PC boards our group has available have given us the ability to provide for frequency generation for these converters easily and inexpensively. It is fitting that the local oscillator (LO) is the basic building block of all converters. The main premise here is that if you can find an LO for use in a converter at one or several of our microwave bands, the other parts for construction of a transverter are not far behind.

### Our new project

The first rig to be constructed will be for 2304 MHz; the month following, it will be a rig for 3456 MHz; and the month after that, a rig for 5760 MHz. What shows up and who constructs a rig for which frequency has been left up to the individuals wishing to participate. I am sure those who participate will not produce a rig for each of the frequencies as this is quite ambitious, but I am also sure that there will be quite a few different rigs to make things interesting, just to see what shows up for testing in preparation for the June VHF/UHF contests.

The prime ingredients in any project are initiative and direction, and we seem to be blessed with lots of those qualities within our group. Pete W6DXJ had the head start on this frequency as his station was partly assembled prior to the beginning of our building program. Pete had been prodding us to get on 2304 as well as 1296 MHz, but when we announced the fast-paced drive to construct a 2304 MHz rig for next month, he scrambled just as fast as all of us to finish a 2304 MHz transceiver.

Well, the next month came and several 2 GHz rigs were constructed. Pete W6DXJ brought his

station, as did Kerry and I. This gathering, at Kerry's home, proved to be quite enjoyable. We made many contacts using both wideband FM and SSB operation. One funny aspect was that we all had selected the same IF frequency on 2 meters (144.1 MHz using a 2160 MHz local-oscillator frequency).

When we fired up the transceivers, we found that all stations being co-located produced very good contacts on 2 meter feedthrough. This produced quite a confusion factor at first, until we separated the 2 meter bleed-through from the 2304 MHz actual RF. We directionalized the test antennas at each other and when we obstructed the direct antenna's path we would get a 5 to 6 S-unit decrease in signal strength. We covered the antenna up with our hands on the receiving end of the path for this test. All stations were located inside the garage or out on the patio for initial tests.

On the next cut of operation, Kerry and I tested a path of some four miles, with an excess margin of 60 dB in signal on this short path. We were using about 25 mW transmit power and a 30-inch dish for this test. While this was a peanut-whistle, it was still a working station.

### Construction techniques

First, let's describe Pete W6DXJ's station. This station was started as a kit from Microwave Modules, one of their series of no-tune transverter kits for 2304 MHz. Pete had modified the original PC board circuitry; he removed the crystal oscillator multiplier circuits and replaced them with a microwave synthesizer that our group makes available. This modification was done to provide increased frequency stability for the local oscillator, making exact frequency setting at 2304 MHz a reality.

Now, there is nothing wrong with a crystal oscillator that operates near 100 MHz and its associated multiplier circuits used to increase its frequency to the microwave range. The problem is that the crystal has a frequency stability problem you should be aware of. As with any circuit,

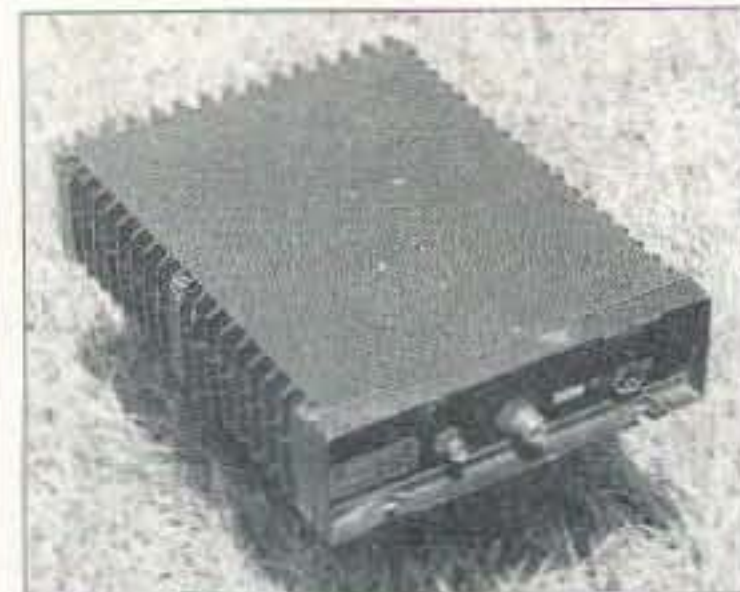

**Photo B.** New-style cabinet that is shorter in height than old-style cabinet. Cabinet provides a hardened interior for protection of microwave circuitry, and provides an RF tight-enclosure.

there are liabilities and attributes. On the crystal's side of things, it produces a very clean local oscillator signal (low-phase noise products). However, its frequency accuracy (stability) is of concern. Its error increases with frequency multiplication as it is subject to the effects of temperature and voltage shifts.

The solution that our San Diego Microwave Group chose was to replace the crystal circuitry with one of our Qualcomm surplus synthesizers, because we had the material and wanted to make use of it (the prime directive: locating inexpensive materials). The synthesizer was frequency-agile, so we reprogrammed it to provide 2160 MHz directly from a VCO-controlled oscillator co-located on the Qualcomm synthesizer PC board. It maintains high accuracy because it is driven by a 10 MHz reference oscillator which is accurate to 1 hertz in 10 MHz, providing accuracy at 2160 MHz to within a few hundred hertz.

This synthesizer output is about +10 dBm and is a direct connection to the mixer. However, all is not perfect here, as you must realize. While the synthesizer is quite frequency-agile, it does have some noise products. Phase noise is degraded in comparison to a crystal oscillator. With a synthesizer, phase noise is something you have to live with, compared to a crystal operating at 100 MHz and multiplied to the 10 GHz band (a test point for evaluation of the crystal and synthesizer). The crystal oscillator produces a spectral-clean local oscillator signal (at 10 GHz) with phase noise products down about 70 dB or

# ADVERTISERS' INDEX

R.S.#	page	R.S.#	page	R.S.#	page	R.S.#	page
• A & A Engineering	45	184 C & S Sales, Inc.	17	• Link Communications Inc.	9	• Radio Book Shop	87
351 Absolute Value Systems	19	• Cable X-Perts, Inc.	43	• Maggiore Electronics	49	• Radio Book Shop	88
• Advanced Info Group	19	99 Communication Concepts	37	• Meadowlake Corp.	49	58 Radio Engineers	19
194 All Electronics Corporation	21	276 Computer Aided Technology	43	86 MFJ Enterprises	11	• Raibeam Antennas	18
57 Antennas West	1	268 Computer Automation Technology	55	160 Micro Computer Concepts	17	34 Ramsey Electronics	5
324 Antennas West	33	• Cubex	47	193 Morse Tutor Gold	41	254 Ross Distributing	81
89 Antennas West	37	13 Doppler Systems	57	248 Motron Electronics	71	167 Sescom, Inc.	47
116 Antennas West	39	• Down East Microwave	49	64 Mouser	57	• Sirio Antenna	CV4
304 Antennas West	39	114 E. H. Yost	17	114 Mr. Nicd	17	250 Software Systems Consulting	41
5 Antennas West	47	• Electronics Book Club	7	102 ONV Safety Belt	41	69 Spectrum Electronics	45
135 Antennas West	49	329 For Hams Only	47	321 Patcomm	CV3	269 Tigertronics	75
332 Antennas West	81	193 GGTE	41	• P.C. Electronics	55	22 Tri-Ex Tower Corporation	75
340 Antennas West	81	78 Hamsure	49	• P. C. Electronics	77	• Universal Radio	81
16 Astron Corporation	13	• Hamtronics, Inc.	2	• Peet Bros.	43	259 Versatel Communications	47
41 Barry Electronics Corp	38	42 Isotron	41	68 Periphex	37	104 Vis Study Guides, Inc.	81
42 Bilal Company	41	• Jan Crystals	39	• Radio Book Shop	44	155 VSS Electronics	33
168 Buckmaster Publishing	45	158 Japan Radio Co.	CV2	• Radio Book Shop	84	191 W & W Associates	73
56 Buckmaster Publishing	39	• JPS Communications	63	• Radio Book Shop	85	245 Wavemach Communications	39
7 Buckmaster Publishing	28	151 KDC Sound	37	• Radio Book Shop	86		
222 Byers Chassis Kits	49	• Lightning Bolt Antennas	28				

When you buy products from these advertisers, please tell them that you saw their ads in 73.

Subscribe to 73 right now...call 800-274-7373 (9-5 Monday-Friday EST).

# BATTERIES

BUY DIRECT FROM US, THE MANUFACTURER!



YAESU

FNB-2	10.8v @	600 MAH
FNB-4	12v @	750 MAH
FNB-4A	12v @	1000 MAH
* FNB-10(S)	7.2v @	1200 MAH
FNB-12(S)	12v @	600 MAH
FNB-17	7.2V @	600 MAH
FNB-25	7.2v @	600 MAH
FNB-26	7.2v @	1200 MAH
**FNB-26(S)	7.2v @	1500 MAH
FNB-27	12v @	600 MAH
**FNB-27(S)	12v @	800 MAH
**1/4" longer than FNB-27		
FNB-31	4.8v @	600 MAH
FNB-33(S)	4.8v @	1500 MAH
FNB-35(S)	7.2v @	600 MAH
* FNB-35(S)(S)	7.2v @	1500 MAH
FNB-38	9.6v @	600 MAH

\*1 1/3" longer than FNB-38 case  
BATTERY ELIMINATORS AVAILABLE

## Special

FOR THE MONTH OF SEPTEMBER

## 10% OFF

on ALL

## ALINCO

Replacement Batteries

Look for October's Special of the Month

MONTHLY DISCOUNTS APPLICABLE TO END-USERS ONLY

## Powerpac<sup>+</sup>

6 V for Camcorders & 12 V for 2-way



Prices and specifications subject to change without notice.

## W & W ASSOCIATES

800 South Broadway, Hicksville, NY 11801

WORLD WIDE DISTRIBUTORSHIPS AVAILABLE. PLEASE INQUIRE.

In U.S.A. and Canada Call Toll Free:(800) 221-0732 • In NY State Call:(516) 942-0011 • Fax:(516) 942-1944

MADE IN THE U.S.A.  
SEND FOR FREE CATALOG AND PRICE LIST

CIRCLE 191 ON READER SERVICE CARD

more. Comparing this to the synthesizer when multiplied to 10 GHz (an equal playing field for measurements), we measured phase noise products 35 dB down.

Now, you say this is worse than the crystal oscillator. Well, yes it is, but consider the simplicity and ease of converting a system that has excellent frequency stability. The synthesizer has a frequency variance at 10 GHz of less than *several hundred hertz!* When used at lower frequencies, such as 2304 or 3456 MHz, it is quite superior to most anything else. (Yes, I make these surplus synthesizers available. When you have something that is relatively inexpensive and operates very well you can't stop beating its drum. These synthesizers can be converted from their original state to a new frequency much more easily and with minimal test equipment and cost, than other methods such as crystal oscillators and associated multiplier strings.)

### Crystal vs. synthesizer

There has been much discussion about the merits of crystal oscillator vs. synthesizer-

controlled oscillators, and many debates about each method's merits and problems. However, at the amateur level there are no "deep pockets." For me, the bottom line is that when a crystal can be made as accurate and inexpensive as the synthesizer, then I will move over to the crystal. If you have the crystal and it is the only oscillator you have, don't get me wrong—*use it.*

The synthesizer is a very good oscillator and works well when we forget about the mystical properties it is supposed to have. I hope I have helped to show that it can be used with relative ease by modifying commercial material for microwave frequency generation. The prime benefit is very high frequency stability, comparable to VHF radio operation. Having this stability in a system removes one more obstacle, making that rare or interesting contact easier.

Once you have tried high stability operation, you will not miss the hit-or-miss operation of tuning for contacts. It can be done, but take my word for this; when you say, "I'll meet you on 2304.100 MHz," I know I am there. When the other station so

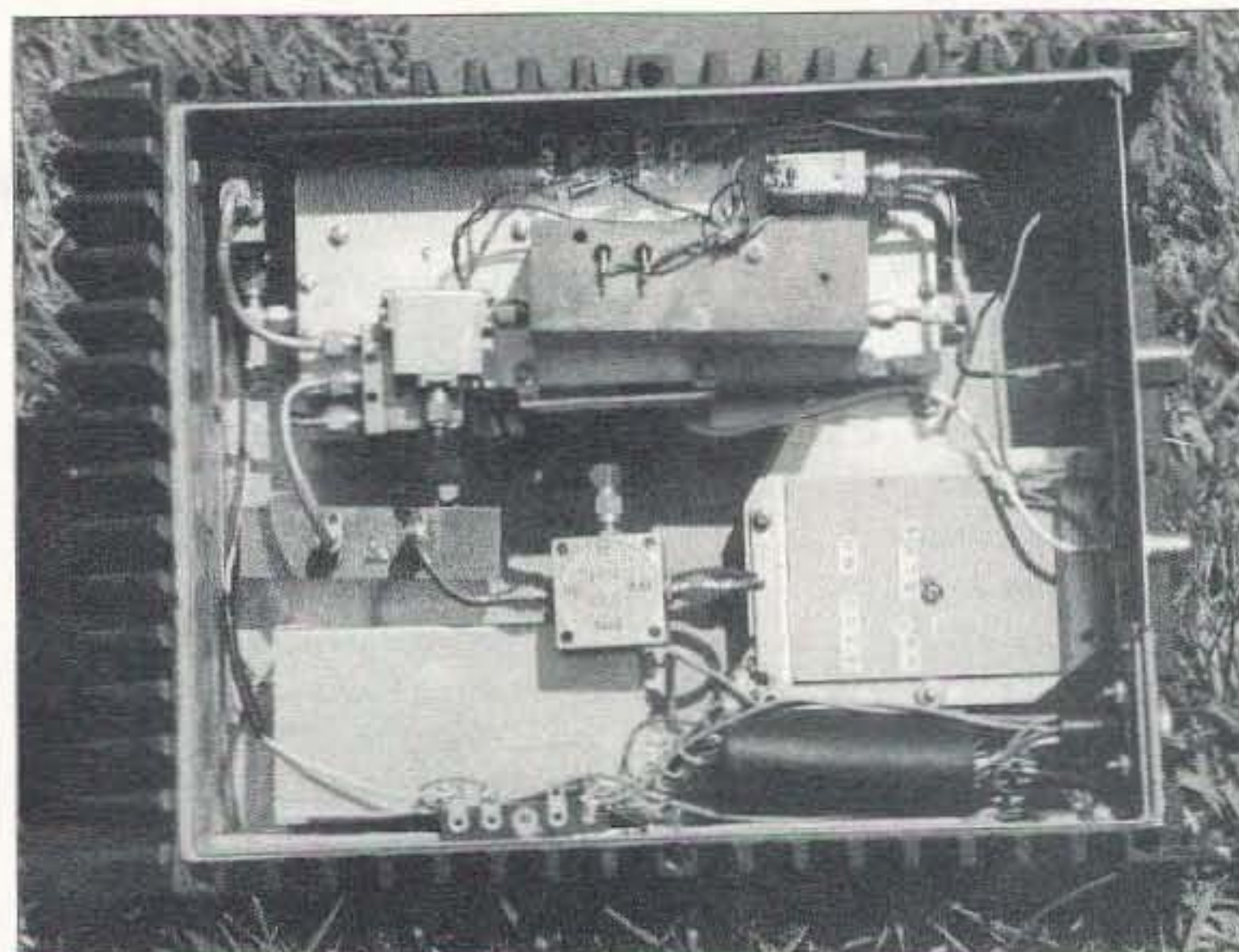

**Photo C.** Interior of 2304 MHz converter. The Qualcomm 3036 synthesizer is at bottom right in the metal container; the 10 MHz crystal is wrapped in black rubber for shock resistance. The amplifiers required -24 volts, so I used an LT-1070 switcher to convert from +12 volt to -24 volts. Top: receive and transmit amplifiers, mixer in the middle.

equipped transmits, I only have to adjust the clarifier to make contact. If only one station in your area operates with frequency synthesis, then certainly that station can be used to set others on frequency, removing that element from preventing you from making contacts. Your enjoyment will increase when frequency disparities can be reduced or eliminated. My recommendation is: don't rotate the dial up and down the band searching for a 2-kHz-wide signal in the vast megahertz bands.

Don't shoot down the vast frequency available on the microwave bands; these lend the amateur operator the ability to explore many new and different modes of communications. There has been much interest generated in the new computer innovations for packet operation using very high-speed modems with very large bandwidths. This type of system, as well as experimentation in video transmission, require megahertz-frequency bandwidths for test and development by amateurs using amateur microwave frequencies. That is one of the reasons that we have attempted to push forward construction on these bands. My construction project might be part of the development of other modes of operation yet to be envisioned.

The ability to do this work on the amateur bands has enabled a

free-thinking flow of new experimentation in electronics, for pure research and for developing untried concepts at the amateur level. I can't describe an exact product that has been developed in this manner. However, when ideas can take on this amateur electronics type of development, train and apply them to tests and implementation; new technology may be the result. Amateur radio is not just a hobby to a lot of amateurs employed in the electronics industry today. To many of us, it has become an outlet for personal satisfaction and enjoyment—pursuing new and interesting techniques. It is to these innovators that we owe much, and they provide a source for new and interesting material.

These are some of the benefits and problems associated with these different types of oscillators, like the synthesizer and the crystal-multiplied oscillator. Take a look at the concerns and decide for yourself. The bottom line on what to recommend is what you are able to locate and use inexpensively to construct your system. That's the real choice for the pure enjoyment of the task. That is what surplus is all about to the radio amateur: inexpensive alternatives to solving a circuit problem.

So much for innovation. Let's get back to the local oscillator and the rigs that were constructed.

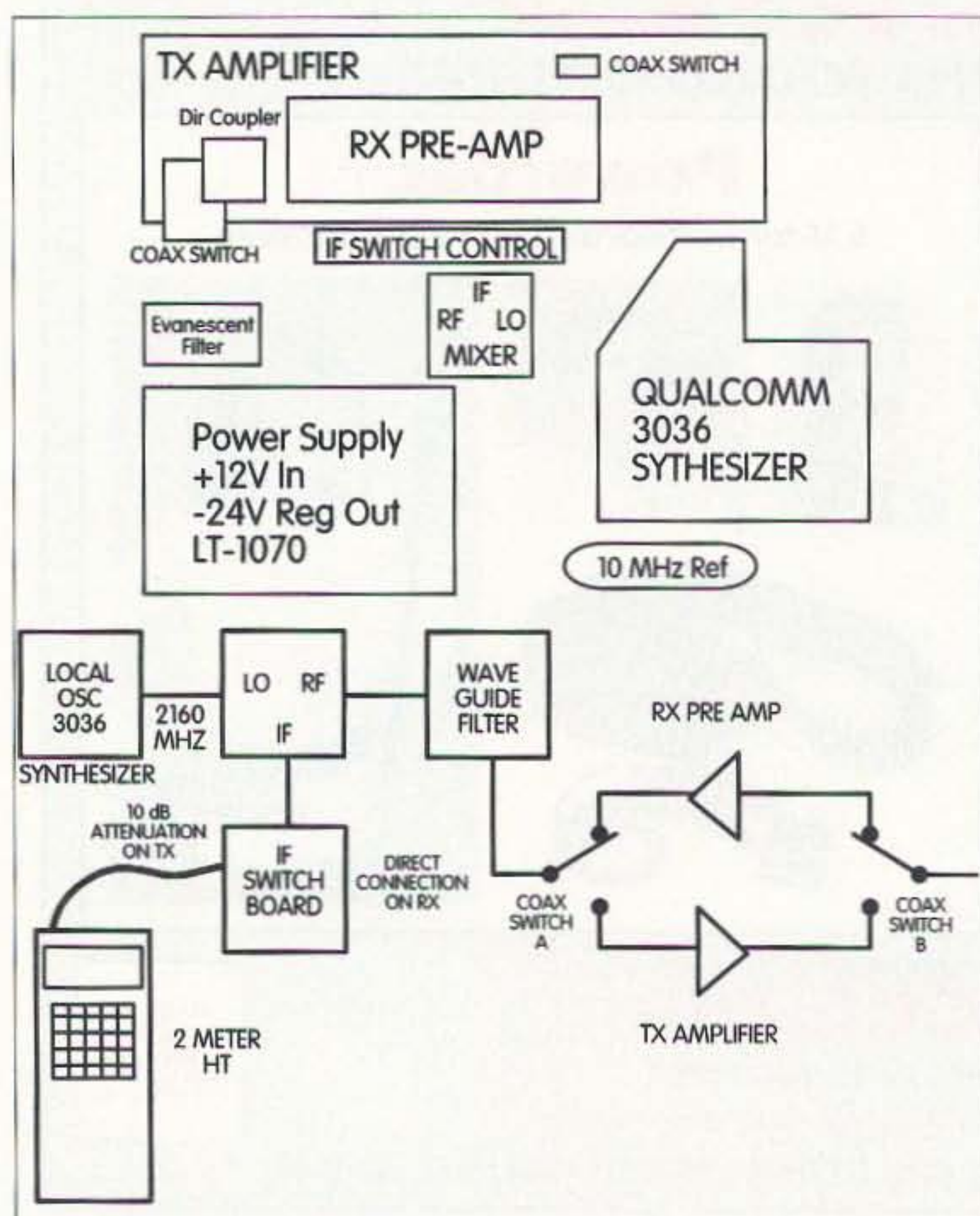

**Fig. 1.** Block diagram and parts placement diagram of the 2304 MHz converter shown in Photo C.

## W6DXJ's project

Pete W6DXJ had a long loop yagi antenna for use at 2304 MHz that coupled to his transverter, purchased from Microwave Modules. Pete made a few modifications to the Microwave Modules transverter's basic circuit. He included a low-pass filter consisting of an RFC and a 20 pF capacitor in the 144 MHz IF circuitry. He did not build the crystal multiplier oscillator string; he used one of the Qualcomm synthesizers instead. Luckily, the output frequency from the crystal string was a frequency that the synthesizer could generate: 2160 MHz.

The remainder of Pete's rig was original microwave modules circuitry. Pete commented that the synthesizer approach was quite easy, but he had plans for a much more personal pursuit for excellence in construction of a crystal oscillator string, providing external phase-locking of the crystal to a high-stability 10 MHz crystal reference. This more expensive approach would yield a great low phase noise oscillator and a frequency-accurate unit.

What Pete intends to construct is a phase-locked loop that will maintain the main oscillator crystal at a precise frequency, eliminating the frequency uncertainty of home-constructed oscillators. It is to be phase-locked to a sub-multiple of 10 MHz. Kerry and I developed the circuit many years ago to lock Frequency West "Brick"-type oscillators. This is too much to go into this month, so I will cover the synthesizer and the

phase-locked circuits next month, along with the 3456 MHz rigs.

Antenna switching was done with only one coaxial relay as the microwave module system used separate receiver and transmitter amplifier strings. Power supply requirements were easier in this system as almost all of the power could come from a single 12-volt DC-regulated unit.

The rigs that Kerry and I constructed were almost identical, mainly because we found two sets of commercial junk to use in our transceivers. An old Collins radio for 2.3 GHz provided us with both receiver preamplifiers and a 100 mW transmit amplifier. The remaining local oscillator and other circuits had to be constructed from scratch or modified from Qualcomm surplus material. We used surplus Qualcomm aluminum cabinets to contain our microwave circuitry. These cases are heavy heat-sinked, ripple-finished, and quite attractive. They afford a nearly bulletproof transportable case for field use of our microwave equipment.

The synthesizer we used was reprogrammed for 2160 MHz, driving a double-balanced mixer. The output of the mixer was fitted with a evanescent (waveguide below cutoff) filter that is reasonably sharp and easy to construct with simple tools.

Next month I will cover the detailed information on the evanescent filter and provide detailed information on converting the Qualcomm synthesizer for amateur radio use. Best, 73 Chuck WB6IGP; clhough@aol.com. **73**

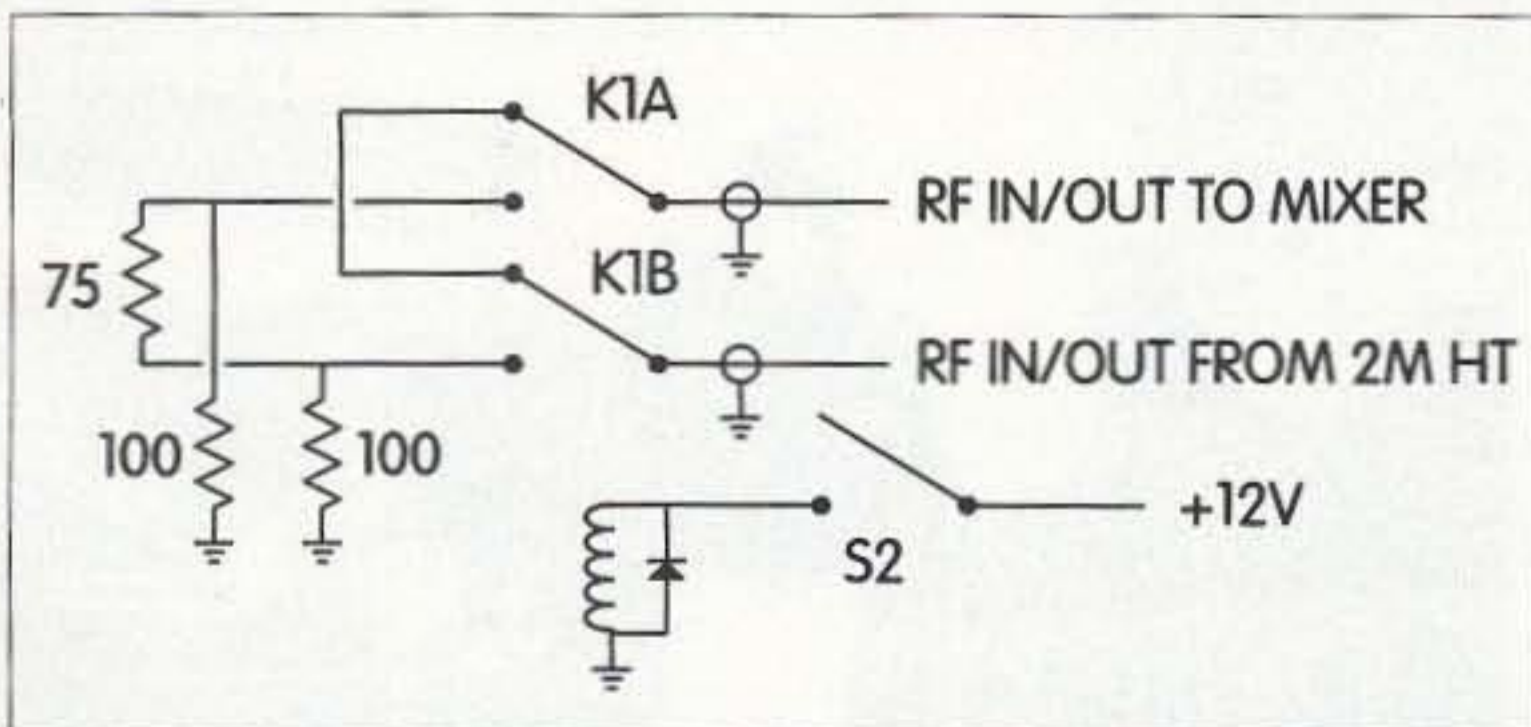

Fig. 2. Simplest IF switch for 144 MHz transfer of RX/TX IF switching. Operation uses toggle-switch actuated coaxial relay. Adjust value for transmitter attenuation. I used a 10 dB attenuator (two each 110-ohm resistors, shunted by 75 ohms); other values are possible (20 dB equals two each 68-ohm resistors, shunted by 270 ohms). Use carbon composition for RF use; 1/2 watt suitable for low power transceivers (less than 1 watt power output).

# MultiMode



## BayPac™



SITOR A/B  
ARQ/FEC  
BAUDOT  
PACKET  
NAVTEX  
FAX 480  
AMTOR  
WEFAX  
SYNOPSIS  
ASCII  
RTTY  
SSTV  
CW  
More...

BP-2 Packet Only \$49.95  
BP-2M MultiMode \$69.95  
+ \$5 Shipping & Handling

The best little packet modem just got better! Building on the tradition of the BP-1 Packet Modem, we are very proud to announce the BP-2 and BP-2M. The BP-2 is a new and improved version of our famous BP-1, while the BP-2M expands your horizons even further with MultiMode operation! So, whether you have been waiting to automate your CW, checkout AMTOR or just copy Weather Fax - Now is the time for you to jump in and join in all the fun!



Call Today! 1-800-8BAYPAC  
800-822-9722 (541) 474-6700 Fax 474-6703  
World Wide Web: <http://www.tigertronics.com>



Tigertronics, Inc. 400 Daily Ln. P.O. Box 5210 Grants Pass, OR 97527

CIRCLE 269 ON READER SERVICE CARD

## WE DON'T BUILD THE MOST, WE JUST BUILD THE BEST!

- Our LM-470D is now redesigned to hold 15 ft. of antennae at 70 mph!
- Tri-Ex builds the finest in crank-up, free-standing or guyed towers.
- All towers are complete with rigid concrete base mount.

CALL  
OR WRITE  
FOR A FREE  
CATALOGUE!

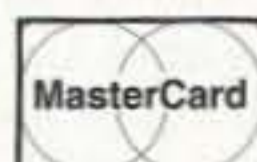

# Tri-Ex®

## TOWER CORPORATION

7182 Rasmussen Ave. • Visalia, CA 93291

Where engineering and quality come first!

TO ORDER CALL  
800-328-2393

TECH SUPPORT  
209-651-7859

FAX  
209-651-5157

CIRCLE 22 ON READER SERVICE CARD

how long will the coal last? Fifty-seven percent of our electric power in the US is generated by burning coal, and they're using over one billion tons of coal a year. A couple generations or so down the line our descendants will have to make do with a world stripped of coal, oil, and natural gas, just as most of the world has already been stripped of old-growth forests. It's interesting to fly over the Northwest's forests and see thousands of acres of what recently were forests, with every single tree cut down! Clear cutting. I'm thinking more and more as an ecologist, though I haven't been converted into a fanatic. But we sure do need to get cold fusion power generators researched and developed.

So, are you going to be one of the people who reads about what happens or are you going to be one who helps make things happen? Remember, just about every major breakthrough in science has been made by amateurs. Not all of the personal computer pioneers got to be billionaires, some just made millions. Oh, well, there are always winners and losers.

I urged my 73 readers to get into microcomputers 20 years ago and hundreds have thanked me for helping them to break loose from their jobs to start their own companies. I don't think there's ever a hamfest where one or two hams don't thank me for kicking them in the pants. Well, I'm still after you to do better ... for yourself, your kids, our country, and the world. I want you and your family to be healthy and prosperous. So I'm reading every book I can find that I think may help you toward wisdom and a longer life. And I'm finding some amazing books.

How difficult and expensive is it to be a cold fusion pioneer? The leader in America today is Dennis Cravens, a science teacher from a small Texas community college who put together a lab in his garage. His total investment was under \$5,000! He's recently moved to New Mexico and is helping Jim Patterson develop his Patterson Patented Cell. Jim is an inventor and he's my age. Dennis is in his 30s.

## A Waist Is a Terrible Thing to Mind

A somewhat sobering statistic emerged from my TV. I was tuned to a PBS health show and it was pointed out that of the few people who manage to live to 85, over 80% are seriously impaired. Is that what you want to look forward to? If you are one of the few to make it to 85? Most people drop dead of heart attacks and cancer long before that. Heck, I'm already to the age where half of my contemporaries are already dead.

The comforting thought is that hardly any fat people live that long, so if you've got a big gut you at least won't have to worry about being seriously impaired in your later years, because there aren't going to be any later years. Having been fat most of my life, I know all about the seesaw of diets that about 2% of fannies manage to overcome. I've been there and done that. Done it endlessly.

I know how delicious ice cream is. I know all about Danish and juicy hamburgers. But I also know I'm having enough fun irritating the heck out of you to stick around a while and keep in touch with my fat friends via my Ouija board instead of 75 or 20m. I know about the poisons which can knock down my immune system and allow cancer and other miseries to take over. Anyway, as I've mentioned before, a little over 20 years ago I finally decided that enough was enough. I went on a 1,500 calorie diet and stuck to it through thin and thin, dropping about two pounds a week until I'd lost 85 pounds. And, by changing my eating habits, I've kept it off.

Can the Bioelectrifier reset your appetat, causing your body to shed all that lard, as Bob Beck claims? I haven't heard of anyone else doing it yet, but it's still too early. Most of the research with it has been toward eliminating viruses, microbes, parasites, yeasts, and fungi in the blood. I am hearing from fairly healthy people who've experimented with the gadget and have achieved an even higher level of health. I hope that more doctors will try to overcome their indoctrination by the pharmaceutical industry and help research the potential for this approach.

If you want to learn more about what's going on, check out  
*Continued on page 77*

# ATV

## Ham Television

Bill Brown WB8ELK  
139 Angela Dr. Apt. B  
Madison AL 35738

### Record DX on 10 GHz

Although most ATV activity in the US exists on the 70 cm and 23 cm bands (some groups also utilize the 900 MHz band), it's rare to find much going on in the higher frequencies.

One of the best-kept secrets up here is the 10 GHz region. It's one of the final frontiers for ATV, a place where most equipment must be home-brewed. Fortunately, this is one of the easier bands to build equipment for, due to the availability of surplus Gunnplexers™ and satellite TV receivers. The 10 GHz band seems to be used mostly for short-haul dedicated links for repeater systems and special events,

but there are a few dedicated folks who enjoy pushing this band to the limit. Many ATVerS are deterred by the misconception that the distances that can be covered fall far short of what you can do on 70 cm. This may be true with low-power systems (the typical Gunnplexer™ system runs less than 100 milliwatts), but when you factor in tropospheric ducting, higher power, good antennas, and the ability to aim your antenna precisely, you can achieve remarkable DX on this band.

### Go the distance

On May 18th, F1JSR set up his 10 GHz system on the island of Corsica in the Serra di Pigno (grid square JN42RQ) at a height of 960 meters (3148 feet). His ATV system consisted of a DRO synthesized transmitter on 10.450 GHz fed into a TWT (Traveling Wave Tube) amplifier, which delivered 20 watts to a 40 cm diameter (15.7 inches) Ikea parabolic dish. For receive, he had an offset feed antenna of 85 cm diameter (33.5 inches), a non-modified Astra LNB, a +500 MHz converter which fed into a standard TVRO satellite receiver, in parallel with a voice receiver, to help aim the dish.

From his vantage point at Sierra de Montseny near Barcelona, Spain (grid square JN11ET and an altitude of 1650 meters, 5412 feet), Michel Vonlanthen HB9AFO set up his ATV system. He had a DRO transmitter on 10.480 GHz driving a 1 watt solid-state power amplifier, which fed a 40 cm (15.7 inches) diameter parabolic dish. His receive setup consisted of a 1 meter (39.38 inches) diameter dish with a high precision az/el gear system to point his antenna accurately.



*Photo A. Michel Vonlanthen HB9AFO successfully completes a two-way 10 GHz ATV QSO of 592 km (368 miles) with F1JSR on the island of Corsica on 10 GHz ATV, from his vantage point near Barcelona, Spain.*

## F1JSR/P/TK Serge Rivière



Photo B. F1JSR sets up his station on the island of Corsica.

This fed into a modified Astra LNB with a noise factor of 0.7 dB and a modified AR3000 receiver followed by a narrowband ATV FM demodulator, in parallel with a normal TVRO satellite receiver.

The distance between these two stations was 592 kilometers (368 miles). The 10 GHz FM ATV

same location on the island of Corsica) and HB9AFO from a different location on Pic de Nore, in the Department of Tarn in France (JN13FJ). This contact lasted more than two hours. Both contacts were made around sunset.

More details will be published in the French and Swiss ATV

**"You can achieve remarkable DX on this band."**

contact was two-way, with the signals varying between P0 and P5 with color. Quick signal fluctuations were observed during the contact, probably due to the strong wind, fog, and intermittent rain in Corsica. Two days earlier, a similar QSO was successful over a 574 kilometer path (357 miles) between F1JSR (at the

publications B5+ (ANTA) and in *Swiss ATV News*. A VHS video cassette will be available soon showing this QSO. If you would like a copy, write: Swiss ATV, P.O. Box 301, 1024 Ecublens, Switzerland. *Thanks to Michel Vonlanthen HB9AFO for the above information and the photos.* 73

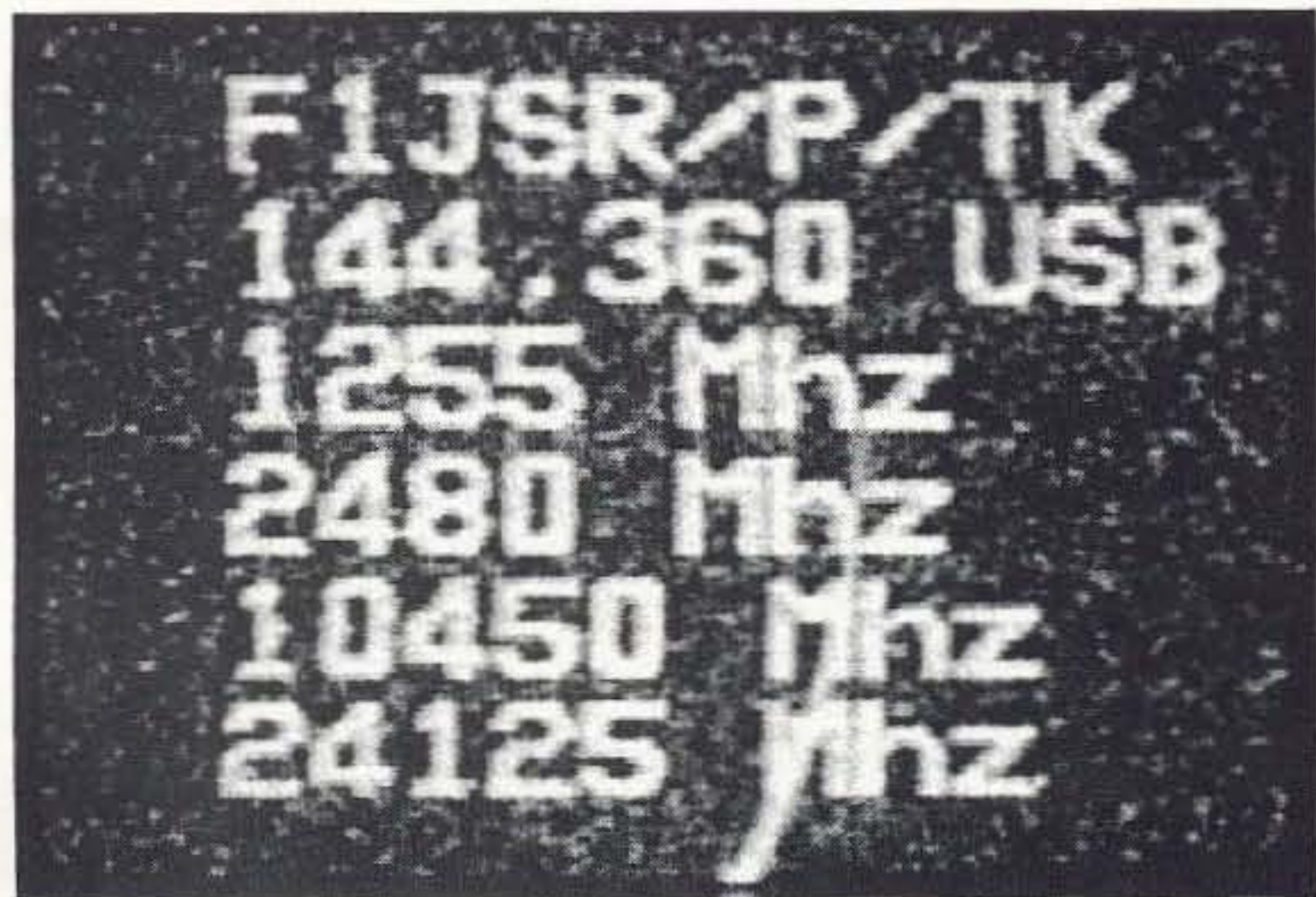
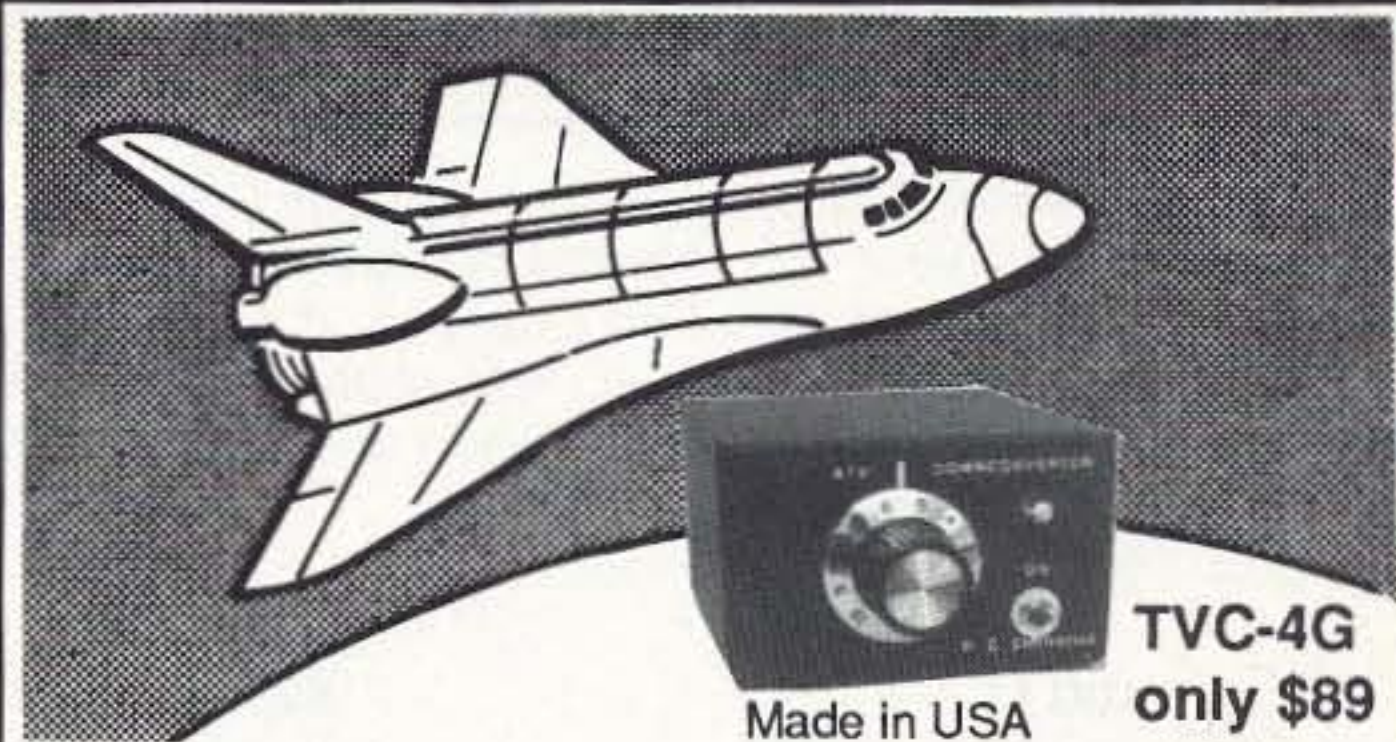

Photo C. After traveling 592 km (368 miles), this is the reception of F1JSR/P/TK's 10 GHz ATV picture as received by EA3/HB9AFO/P in the Sierra de Montseny, Spain.

## AMATEUR TELEVISION



### SEE THE SPACE SHUTTLE VIDEO AND GET THE ATV BUG

Many ATV repeaters and individuals are retransmitting Space Shuttle Video & Audio from their TVRO's tuned to Spacenet 2 transponder 9 or weather radar during significant storms, as well as home camcorder video from other hams. If it's being done in your area on 420 - check page 538 in the 95-96 ARRL Repeater Directory or call us, ATV repeaters are springing up all over - all you need is one of the TVC-4G ATV 420-450 MHz downconverters, add any TV set to ch 2, 3 or 4 and a 70 CM antenna (you can use your 435 Oscar antenna). You don't need computers or other radios, it's that easy. We also have ATV downconverters, antennas, transmitters and amplifiers for the 400, 900 and 1200 MHz bands. In fact we are your one stop for all your ATV needs and info. We ship most items within 24 hours after you call.

Hams, call for our complete 10 page ATV catalogue.

(818) 447-4565 M-Th 8am-5:30pm

Visa, MC, UPS COD

**P.C. ELECTRONICS**

Email: tomsmb@aol.com

2522 Paxson Ln, Arcadia CA 91007

24 Hr. FAX (818) 447-0489

## NEVER SAY DIE

*Continued from page 76*

the latest \$10 AIDS booklet from Radio Bookshop and invest \$10 more for a copy of Bob Beck's talk at the 1996 Global Science Congress. It's a lulu. He lost 85 pounds without dieting, and also regrew a full head of hair. And he was there as living proof. No more fat, bald old Bob. It took years off his age.

It's your choice: an early death via fat, a lingering death via poisons, or vibrant health when you're thumbing your nose at the Social Security people. But this is a choice you have to make now, not after you're in the hospital with cancer, a heart attack, stroke, or tied to a rocking chair in a nursing home as a gibbering veggie.

### Cancer

A high percentage of us are going to die of cancer, but how much do you really know about it? For instance, are you aware that despite the 25-year multibillion-dollar war on cancer we've waged, that "medical science" has not extended the

life of cancer patients one day?

In fact, prostate cancer patients have a longer probable life if they are not treated than if they are. Without treatment you can expect to live around 15 years. With treatment you'll probably live less than five years.

There are several alternative approaches which have been successful in curing cancer, but since they don't involve pills or shots, there is no way for the pharmaceutical industry to make money with them, so they have not been investigated. Plus there's no group to put up the \$250 million it now takes to get a new medication or procedure approved by the FDA ... a 10-15-year process which keeps thousands of government employees from getting more productive work.

How about it—will I be shaking your hand at Tampa in November?

### Lawyers, Lawyers!

Our media compatriots will no doubt try to make a big deal over our lawyer's decision to

*Continued on page 79*

# SPECIAL EVENTS

Listings are free of charge as space permits. Please send us your Special Event two months in advance of the issue you want it to appear in. For example, if you want it to appear in the December issue, we should receive it by September 30. Provide a clear, concise summary of the essential details about your Special Event.

## AUG 25

**WOODSTOCK, IL** The Tri-County Radio Group, Inc. will hold its Hamfest and Computer Show at the McHenry County Fairgrounds located just north of Rte. 14 on Rte. 47, beginning at 6:30 AM for the Flea Market and 8 AM for the exhibitors. Setup available on Sat. by appointment, or at 6:30 AM on Sun. Talk-in on 146.52 simplex. Reservation deadline is Aug. 11th. For more info, or reservations, write to T.C.R.G., P.O. Box 3107, Skokie IL 60077-6107; or call Robert N9KXG, (847) 658-1678.

## AUG 31

**ALAMOGORDO, NM** The Alamogordo ARC will hold their 12th annual Hamfest at Otero County Fairgrounds, on White Sands Blvd., 8 AM-4 PM. ARRL Forum, MARS Forum, Flea Market, VE Exams, Banquet. Talk-in on 146.80(-). For tables and info, call Larry Moore WA5UNO, (505) 434-0145; or Jim Patton N7IOM, (505) 439-8349.

## SEP 7

**ERIE, PA** The Erie Hamfest '96 will be sponsored by the Radio Assn. of Erie, 8 AM-2 PM, at Franklin Twp. Fire Hall. VE Exams will be held at 9 AM at Franklin Center Methodist Church (1 mi. north of the Hamfest on Rt. 98). Flea Market: vendor setup Fri. eve. 6 PM-midnight, and Sat., 6:30 AM. For reservations and info, contact Chris Robson KB3A, 5560 Bear Creek Rd., Fairview PA 16415. Tel. (814) 474-1211; E-mail: crobson @ moose.erie.net. Talk-in on 146.61(-) (W3GV).

**UNIONTOWN, PA** The Uniontown ARC will hold its 47th annual Gabfest at the club grounds located on Old Pittsburgh Rd., beginning at 8 AM. Free tailgate space with reg. Talk-in on 147.045(+) and 147.255(+). Contact Carl WA3HQK or Joyce KA3CUT Chuprinko, Rt. 6 Box 231-CC, Morgantown WV 26505. Tel. (304) 594-3779.

## SEP 8

**DARTMOUTH, MA** The Southeastern Mass. ARA, Inc., will hold their 20th annual Flea Market 9 AM-3 PM on their clubhouse grounds at 54 Donald St., behind the Stackhouse St. Fairgrounds. Setup begins at 7 AM. Talk-in on 147.00 Rptr. Contact Bill Miller, (508) 996-2969.

**DUBUQUE, IA** The Great River ARC, Iowa Antique RC and Historical Society, and the Tri-State Computer Users Group will sponsor a Hamfest/Radiofest/Computer Expo 8 AM-2 PM at the Dubuque County Fairgrounds on Old Highway Rd., west of Dubuque. Dealer, Flea Market, Tailgating and VE Exams at 10 AM. Talk-in on 147.84/.24. Contact Loren Heber NØYHZ, (319) 556-5755; Jerry Lange KBØVIK, (319) 556-3050; or Jerry Ehlers NØNLU, (319) 583-1016. Write to G.R.A.R.C., P.O. Box 546, Dubuque IA 52004-0546.

## SEP 13-15

**PEORIA, IL** The ARRL Nat'l. Convention at SuperFest '96 will be held at the Peoria Civic Center. It will showcase the latest innovations and technologies available to amateur radio operators. There will be forums and seminars on topics ranging from "Improvements for Club Operation" to "Exploring the Internet & the World Wide Web" to "Satellites & Antennas for HAMS." Exhibitors contact R&B Productions, (309) 693-9667. For general info, call Ron Morgan KB9NW, General Chairman, (309) 692-3378. E-mail: SuperFest @ AOL.com.

## SEP 14

**PRAIRIEVILLE, LA** The Ascension ARC will hold its annual "Gonzales Hamfest" at the Gourmet Catering Inc. bldg. on Hwy. 73. Setup at 7 AM; general admission at 8 AM. VE Exams, Fox Hunt. Dealer and swap tables available. Contact AARC, c/o Shane Dugas KK5LC, 37150

Swamp Rd., Prairieville LA 70769. Tel. (504) 673-8369.

## SEP 14-15

**MELBOURNE, FL** The Platinum Coast ARS will host their 31st annual Melbourne Hamfest in the Melbourne Auditorium, 625 E. Hibiscus Blvd., 8 AM-5 PM Sat., and 9 AM-4 PM Sun. Talk-in on 146.25/.85 Rptr. For info on tickets/tables, contact Larry Sexton KF4EJB, 7005 Dogwood Dr., Cocoa FL 32927. Tel. (407) 636-8826; or Al Hudson N4PTM at E-mail ahudson@iu.net.

## SEP 15

**HAMILTON TWP., NJ** FallFest '96 will be held by the Delaware Valley Radio Assn. at Tall Cedars of Lebanon picnic grove on Sawmill Rd. Open to sellers at 7 AM, buyers at 8 AM. Talk-in on 146.670(-) Rptr. For more info, call (609) 882-2240. No advance reg.

**MT. CLEMENS, MI** The L'Anse Creuse ARC will host their 24th annual Swap and Shop, 8 AM-2 PM, at L'Anse Creuse H.S. in Mt. Clemens. VE Exams at 11 AM; contact Don WA8IZV, (810) 294-1567, Prodigy ID SSTG41a. New and used amateur radio equip., electronic parts and equip., computer and software. Trunk sales. Sep. 7 is the deadline for advance prepaid reg. Talk-in on 147.08(+) and 146.52 simplex. Make checks payable to L'Anse Creuse ARC, and mail with SASE to Ralph Irish WA8GDT, P.O. Box 180122, Utica MI 48318-0122. For more details call (810) 731-6760 or (810) 651-7387.

**NEWTOWN, CT** The Western CT Hamfest will be held 9 AM-2 PM at the Edmond Town Hall, RT 6 (Exit 10 on I-84). Setup at 7 AM. Talk-in on 147.12/.72. New Equip. Dealers, Flea Market, Tailgating, Computers. Contact John Ahle N2DVX, P.O. Box 3441, Danbury CT 06813-3441. Tel. (203) 438-6782.

## SEP 21

**LEXINGTON, NE** An Amateur Radio and Antique Radio Consignment Auction will be sponsored by the Heartland ARA and the Mid-Nebraska Antique Radio Club, at Knights of Columbus Hall, 6th and Taft St. Doors open at 8 AM; auction begins at 11:30 AM. Talk-in on 147.135(+). Contact Hoppy W4YDN, (308) 987-2161; E-mail: rh84859@ltec.net; or Randy WB0SAO, (308) 987-2312.

**SANTA ROSA, CA** The Sonoma County Radio Amateurs, Inc. will hold their annual Swapmeet, Auction and VE Exams at the Holy Ghost Hall, one mi. north of Sebastopol CA, at the corner of Hwy. 116 and Mill Station Roads. Setup at 6:30 AM; general admission at 7:30 AM. For more details, contact Rick Reiner K6ZWB, 2120 Slater St., Santa Rosa CA 95404. Tel. (707) 575-4455. Or write to Sonoma County Radio Amateurs, Inc., P.O. Box 116, Santa Rosa, CA 95402.

## SEP 21-22

**ANCHORAGE, AK** The Anchorage ARC will celebrate its Silver Anniversary Hamfest at the Kincaid Park Outdoor Center in Anchorage. VE Exams, FCC Commercial Radio License Exams, Alaska QSL Bureau, Demos, Guest Speakers, and annual Country Store. For booths, contact Robert Wilson AL7KK, P.O. Box 110955, Anchorage AK 99511-0955. Tel. (907) 248-0976 or (907) 271-5304.

**VIRGINIA BEACH, VA** The 21st annual Virginia Beach HamFest & Computer Fair, ARRL Roanoke Div. Convention will be held at the Pavilion Convention Center in Virginia Beach. Forums, Guest Speakers. Show hours Sat., 9 AM-5 PM and Sun., 9 AM-4 PM. No smoking allowed in the Pavilion. For more details, contact Lewis B. Steingold W4BLO, (804) 486-3800, or (804) HAMFEST. FAX (804) 486-0757.

## SEP 22

**ADRIAN, MI** The Adrian ARC Hamfest and Computer Show will be open at the Lenawee County Fairground, 8 AM-2 PM. VE Exams, Forums, Trunk Sales. Talk-in on 145.37(-). Contact Brian Sarkisian KG8CO, 139 N. Main St., Adrian MI 49221. Tel. (517) 265-1537; or E-mail: gbishop@tc3net.com.

**COTTLEVILLE, MO** The St. Peters ARC Swapfest will run 7 AM-1 PM at St. Charles County Comm. College Campus, 4601 Mid Rivers Mall Dr. Flea Market, VE Exams. Talk-in on 145.41 MHz and 444.275 MHz. Contact Jay Underdown WØOGS, 58 Judy Dr., St. Charles MO 63301. Tel. (314) 723-4200.

## SEP 26-29

**ACAPULCO, MEXICO** The 55th Nat'l. Convention of the Federation of Mexican Radio Experimenters (member of the IARU) will be held in Acapulco. Conferences, Workshops, Extraordinary General Assembly,



Entertainment. For details, write to *Cesar Figueroa V. XE1KFV, FMRE, Apartado Postal 907, 06000 Mexico D.F., Mexico. Tel. 011-52-5-563-1405 (from the USA). Internet: FMRE@supernet.com.mx.* Stay over at the 5-star-rated Hotel Hyatt Regency Acapulco.

#### SEP 27-29

**WALLA WALLA, WA** The W7DP Walla Walla Valley ARC will host their 50th annual Hamfest and ARRL SE Washington Sec. Convention at the Washington Nat'l Guard Armory, 113 So. Colville (corner of Colville and Poplar Sts.) in Walla Walla. Skywarn Seminar, Scavenger Hunt, Flea Market, and more! Contact *David L. Pence KB7WRT, Hamfest Chairman "W7DP," P.O. Box 321, Walla Walla WA 99362; or call (509) 525-2529.* Talk-in on 146.960/.360.

#### SEP 28

**ELMIRA, NY** The Chemung County Fairgrounds in Horseheads NY will be the site for the 21st annual Elmira Internat'l Hamfest-Computerfest. The event is open 6 AM-3 PM. For VE Exams (on site at 0900), call *Bill (607) 962-1134.* Walk-ins accepted. Dealer inquiries will be handled by *Jay at (607) 733-0761.* For ticket info, contact *Dave Lewis, RD1 Box 191, Van Etten NY 14889. Tel. (607) 589-4523.* Talk-in on Rookies Rptr. 147.96/.36 or 444.20.

**HUDSONVILLE, MI** "Super Swap 96" will be presented by the Grand Rapids ARA Inc., 8 AM-1 PM, at Unity Christian H.S., 3487 Oak St. Talk-in on 147.26 Rptr. (94.8). Contact *Dave Devos KF8QL, 8111 Hanna Lake Rd., Caledonia MI 49316. Tel. (616) 698-7022.*

#### SEP 29

**FRAMINGHAM, MA** The Framingham ARA will hold its Fall Flea Market and Exams at Framingham H.S. on A St. Setup at 8 AM, general admission 9 AM-1 PM. To reserve tables, call *Martin Bayes AA1ON at (508) 435-0564,* and send check payable to *FARA, to FARA, P.O. Box 3005, Framingham MA 01701.* To register for exams, send a check for \$6.05, payable to *ARRL/VEC, to Dick Marshall WA1KUG, 37 Lyman Rd., Framingham MA 01701.* Walk-ins will not be accepted after 10 AM. Talk-in on 147.15(+) Rptr.

**YONKERS, NY** A Giant Electronic Flea Market will be presented by the

Metro 70 cm. Network, 9 AM-3 PM (rain or shine) at Lincoln H.S. on Kneeland Ave. Indoor Flea Market only. New and used equip. for CB operators, amateur radio operators, commercial 2-way radios, computers, stereo buffs, electronic parts and kits and much more will be on sale. VE Exams. Table setups at 7 AM. For registration call *Otto Supliski WB2SLQ, (914) 969-1053.* Talk-in on 449.425 MHz PL 156.7; 223.760 MHz PL 67.0; 146.910 Hz; and 443.350 MHz PL 156.7. Mail paid reservations to *Metro 70 CM Network, 53 Hayward St., Yonker NY 10704.*

#### OCT 4-5

**OTTAWA, CANADA** Chapter 70 will host the 1996 QCWA Internat'l Convention at the Citadel Inn at 101 Lyon St. in Ottawa. Many events are being offered to attendees. Queries may be made via *Internet: bo075@freenet.carleton.ca. Packet: VE3GFI@VE3FD.# eon.on.can.noam, or telephone (613) 826-2426.* Advance reg. must be received by Sept. 16th.

#### OCT 5

**TEMPLE, TX** "Ham Expo," a Tailgate Swapfest, plus commercial vendors, will be held 7 AM-3 PM at Bell County Expo Center, Belton TX. There will be a T-Hunt at 9 AM. VE Exams for all classes starting at 1 PM. Tailgaters setup Sat., Oct. 5th at 6 AM. Commercial vendors may set up Fri., Oct. 4th, 5 PM-10 PM. There is a \$10 table surcharge for early setup. Talk-in on 146.820(-) PL 123, and 147.300(-). Contact *Mike LeFan WA5EQQ, (817) 773-3590; or E-mail mlef@vwm.com.*

#### OCT 6

**SPRINGFIELD, OH** The Independent Radio Assn. of Springfield will hold its annual Hamfest at the Clark County Fairgrounds, located 1/4 mi. north of Interstate 70 (exit 59) and State Route 41. The event will be open 8 AM-3 PM. For details, call *Jerry KB8FMW, (513) 568-4070.* Talk-in on 145.45(-). For reservations call *Bernie NBXKF, 9 AM-6 PM, at (513) 882-6559; or Bill N8XIW, 7 PM-10 PM, at (513) 324-4082.*

#### SPECIAL EVENT STATIONS

#### AUG 24-25

**PETERSBURG, NE** The Albion ARC will use vintage radios and equip. to operate Station KB0TLX 1800 Aug. 24th-1800 Aug. 25th to help celebrate the Nebraska State Antique Tractor and Horse Plowing

Contest. Freqs.: 7.240, 14.240, 21.130 and 28.330. To receive a special QSL card, send name, address, and QSL to *Steve Wright KA0VEU, 929 Park, Albion NE 68620 USA.*

#### AUG 31-SEP 2

**NUTLEY, NJ** The Robert D. Grant United Labor ARA will operate KB2YCT, the Club station, along with other stations around the country, to honor the working men and women of this great nation. Connect on the General portion of 40m, 20m, 15m, and 28.420 phone-in on the Novice phone band. For a certificate, send an SASE to *station's call and P.O. Box 716, Nutley NJ 07110-0716 USA.*

#### SEP 9-14

**LINWOOD, NJ** Southern Counties ARA will operate K2BR Sept. 9th to Sept. 14th, from the Miss America Pageant in Atlantic City NJ. (IOTA: NA 111 - Absecon Island) Freqs.: Phone—25 kHz inside lower General class band edge. CW—65 kHz inside lower General class band edge. Novice—28.100-28.500 kHz. QSL with a #10 SASE via *SCARA, P.O. Box 121, Linwood NJ 08221 USA.*

#### SEP 14

**EFFINGHAM, IL** Effingham County, EM59. The Nat'l. Trail ARC will operate K9UXZ in conjunction with the annual Transportation Festival, -1 PM-8 PM CDT. Operation will be on lower General and Novice 10 meters. For a certificate and/or QSL card, SASE to *K9UXZ, Nat'l. Trail ARC, P.O. Box 903, Effingham IL 62401 USA.*

#### SEP 16

**DANVILLE, PA** Liberty-Valley Elementary School will operate KC3HP, WC3A, N3IRN, and N3LQS on the General portion of the 15m, 20m, 40m, and 75m bands, from 1300Z-1900Z. For a certificate, send QSL to *D. Miguez N3POB, Liberty-Valley School, 175 Liberty-Valley Rd., Danville PA 17821 USA.*

#### SEP 19-22

**LEAVENWORTH, WA** Ham radio operators will operate a Special Event Station during Salmon Festival 96 using the special prefix W7F. Operation will be from the fish hatchery located at Leavenworth. Sep. 19 & 20 will be for area schools to talk with out-of-area schools. There will be contact only with ham school stations on these two days. The station will make contact with

hams on the 21st & 22nd on 20m (14.252), 40m (7.252), and 75m (3855) bands. Certificates will be issued to stations contacted. Mail your QSL card to *FISH, General Delivery, Leavenworth WA 98826 USA.* All entries must be post marked before Oct. 1, 1996. There will be a prize drawing held on Sat., Oct. 5th.

#### SEP 28-29

**CAPE COD, MA** WB1U will operate 1400Z Sep. 28th-2100Z Sep. 29th, to commemorate Marconi Station's 95th Anniversary. Operation will be in the General portions of 15, 20, 40, and Novice portions of 10 and 80 meters (CW and SSB). For a certificate, send an SASE to *Ray Hilson, 6 Sherman Place, Norwalk CT 06851 USA.*

#### NEVER SAY DIE

*Continued from page 77*

legally end our old music business companies. This doesn't affect 73, other than it'll give me more time to get on the air and have some fun and to pursue my work with cold fusion. I enjoyed the music business, but "I've been there, done that." Ten years was more than enough.

I was not surprised by the recent class action suit against the six major music companies (five are foreign-owned) for price fixing. But then the whole industry is corrupt, as I've discussed in my past editorials. The big winners are the six majors and big record store chains. The big losers are 98% of the performers, 100% of the independent record companies, and 100% of the independent record stores. Capitalism works fine until companies get big enough or work in secret groups to control distribution and prices. Lobbyist payments to Congress keeps the Feds at bay. I've testified at Congressional hearings where it was quite clear that the committee chairman was safely in the music industry's pocket. The industry people, whom I knew well, laughed about it.

The majors were candid. They hated the impact I was having in my efforts to build the market share for independent record companies, but my *CD Review* was selling about \$30 million of

*Continued on page 83*

# Heathkit Mania

*And all bought at bargain prices!*

Shane P. Brady WB2WPM  
34 Rosewood Drive  
West Seneca NY 14224

I earned my Novice license 22 years ago, after seeing a ham radio demonstration as a Boy Scout some 10 years earlier. Recently married and unable to afford new equipment, when I heard that a local ham was selling a Heathkit SB-102, I went for it. That SB-102 and a 40 meter dipole were my introduction to actual QSOs.

I remember looking through the Heathkit catalogs, trying to imagine a station with all the matching accessories for my SB-102. The XYL got me started by giving me the matching SB-630 station console for Christmas. This had a 24-hour digital clock, a phone patch, an SWR meter, and a 10-minute timer, all in one. I then added the matching SB-600 station speaker. Not a shabby-looking station for a Novice in 1974. The SB-102 is a 13-tube HF SSB/CW transceiver, rated at 180 watts input—80 watts more than most of today's radios—running a pair of 6146Bs as finals.

When I upgraded to Advanced, the SB-102 got me contacts with UA, ZS, VK, and XX. I added the optional 400 Hz filter for CW, and what a difference that filter made!

Sure, I sold the SB-102 and went on to a solid-state synthesized radio with 100 memories and computer-controlled microprocessors, but I couldn't forget my vision: to have a complete line of Heathkit radios and accessories.

## Building the dream

Several years ago I heard about a retired ham with some old gear to sell. That visit changed my shopping habits at hamfests. There was an SB-102 and an SB-200 1 kW amplifier. The SB-200 is still an extremely popular 1 kW amplifier. It uses a pair of 572B tubes in parallel for finals. Together, the SB-102 and the SB-200 were a popular combination in the late '60s and early '70s. We worked out a great deal; he just wanted them to go to a good home and was not interested in the dollars.

## Finding the pieces

At a local ham auction, I ran across an SB-610 monitor scope which also matched the famous Heathkit "SB green line" of equipment. Now I had five matching pieces from the SB line. The station was starting to look like the Heathkit catalogs of 20 years ago. I was hooked. I had to have *all* the pieces to the Heathkit SB line!

Packet radio is a nice way to find "wanted" equipment, and I've had great success finding bargains for older equipment. A couple of messages out on

---

*"So what do I do with all of this outdated equipment? I have fun with it!"*

---

Clearing a spot on a side table, I made a new home for my old friends. I had kept my SB-600 speaker and SB-630 console; these too joined the new family.

As a Novice in the early '70s, it seemed to me that four out of five QSOs were with hams who had Heathkit equipment. Now, in the 1990s, I was trying to make contacts like I did 20 years ago, with so-called obsolete equipment.

Does that Heathkit combination still work? You bet it does! No, it doesn't have the 100 memories, and I do have to

wait a couple of minutes for the tubes to heat up. But what it does very well is make contacts. You're not going to hear signals coming in at less than 0.1  $\mu$ V on a crowded band, but how often are you really under those conditions? Remember, a clean signal from 20 years ago still sounds the same as a clean signal from a state-of-the-art transmitter today.

packet and soon I had added the SB-650 digital (nixie-tubes) frequency display and the SB-620 spectrum analyzer, for under \$25 each. Yes, they both worked when I plugged them in. Another packet request and I had two SB-500 2 meter transverters added to my collection (at next-to-nothing prices). The SB-500 also uses 6146 finals for 50 watts output for SSB and CW.

The next piece took some ads in the ham classifieds. I had only seen one SB-640 in my life, and that was years ago at Dayton. The SB-640 is a remote VFO that interfaces with the SB line of transceivers for working split frequency.

The hardest piece to locate was the SB-110 6 meter transceiver. Most people hang on to these '60s vintage rigs, which use 6146 tubes for finals for 180 watts PEP on SSB and 150 watts CW.

Hamfests will yield a bumper crop of old tube-type Heath equipment. I've purchased complete working HF rigs for \$20!

I've since added the SB-300 and SB-303 receivers, along with their



Photo A. WB2WPM's Heathkit collection.



Photo B. WB2WPM at his station.

Photos by WB2JFP.

matching SB-400 and SB-401 transmitters, to the collection. These twins were known as the "poor-man's Collins." HW-100s and HW-101s have joined the family as well, along with many green accessories such as wattmeters, phone patches, keyers, and SWR bridges.

No, not everything works when I get it, but in most cases all that is required is replacing a tube or two and a quick tune-up. At hamfests there are always boxes of tubes for sale. The average price for a tube is \$2, but many times they can be found for only \$1.

Manuals are worth their weight in gold when working on this older equipment. I make copies of all manuals and store them away. I'm even collecting

matching SB-644A remote VFO. All working, and all obtained at bargain prices.

So what do I do with all of this outdated equipment? I have fun with it! When visitors come to the shack, most are in awe of all those dials and gleaming knobs. It's almost a shame to tell them that, averaged out, I have less than \$35 per piece invested in this sub-hobby. That's less than a used state-of-the-art rig!

Am I finished with my collecting? No way. There is still an SB-313 shortwave receiver out there waiting for me, the last piece I'm missing for my collection! Besides, I still need more basket cases to combine with other basket cases, to come up with working units. Why do I

*"When visitors come to the shack, most are in awe of all those dials and gleaming knobs."*

manuals for equipment I don't have yet, just in case I come across it someday. With the manuals, tune-ups are a cinch, as in most cases all you need is a known frequency source and a VOM. Heathkit's famous step-by-step instructions will lead you through complete tune-ups, if need be.

Naturally, I've added Heath's last line of SB equipment to my collection. At another operating position, sits the all-solid-state SB-104A transceiver and its matching SB-604 speaker and power supply, the SB-614 monitor scope, and the SB-634 station console and its

need more and what am I going to do with all of these Heathkit radios? Funny, that's what N2INY, my XYL, asks. **73**

## Where's the Beam?



Unobtrusive DX Gain Antennas for 80 thru 10  
 • Easily hidden • Install Fast • Fixed or Portable •  
 There's a 20 meter antenna with real DX Punch hidden in this picture. You can't see it, and your neighbors can't either. But it works DX barefoot anyway. How about a low profile 80-40-30 tri-band? Or a 2 element monobander for the attic? All easily fit the pocketbook—Priced \$29 to \$99.

Work DX without telling the neighbors

Infopack \$1 **AntennasWest**  
 Box 50062-R, Provo, UT 84605 (801) 373-8425

CIRCLE 332 ON READER SERVICE CARD

## GRUNDIG YB-400



"The compact model most preferred by our panelists for listening to major worldband stations... audio quality is tops within its size class."

**Passport to Worldband Radio**

Here's everything you want at a price you can afford. The Grundig YB-400 covers LW, MW, FM and all of SW. An illuminated LCD reads to 1 kHz on SW. Enjoy smooth SSB with fine tuning knob. Tune your favorite stations instantly with keypad entry or 40 memories. Other features include: dual digital clock-timer with snooze and dial lock. Switches for: Wide-Narrow, Local-DX and Hi-Low Tone. Supplied with six AA cells, carry case, wind-up antenna, manual and Grundig Wave Guide. #0040 \$199.95 (+\$6)

Universal has a limited number of like-new **Factory Reconditioned YB-400s**. All accessories and same one year limited warranty. #1704 \$149.95 (+\$6)

For a limited time, we will include a **FREE radio stand** with your YB-400 purchase. An \$8.95 value!



### Universal Radio

6830 Americana Pkwy.  
 Reynoldsburg, OH 43068

◆ Orders: 800 431-3939

◆ Info: 614 866-4267

◆ FAX: 614 866-2339

<http://www.universal-radio.com>

Quality Communications Equipment Since 1942

## Desert Storm Solar

10 watt DesertStorm panel is size of open 73 magazine, weighs 1lb, and delivers 600mA for 12v charging or direct operation. Tough, Solid, with no glass to break. So rugged Uncle Sam used this for spotter communications and portable repeaters in Desert Storm. Ready to use. \$169. Add \$5 S&H. Info \$1.



**AntennasWest**  
 Box 50062 Provo UT 84605

Order HotLine  
 801 373 8425

CIRCLE 340 ON READER SERVICE CARD

## (208) 852-0830

**MFJ-815B**

Under \$50<sup>00</sup>



You Want It - We Got It

Similar savings on Standard, ICOM, Astron, Yeasu, Cruscraft, Kenwood, Alinco, Etc. All L.T.O.

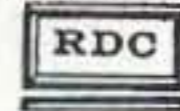

**ROSS DISTRIBUTING COMPANY**  
 78 S. State Street, Preston, Id. 83263

Hours Tue.-Fri. 9-6 - 9-2 Mondays. Closed some Saturdays (call for appointment)

## QUICK, AND SIMPLE!!!

Flash cards NOVICE thru EXTRA theory. Key-words underlined. COMPACT - EASY Over 9000 sets used.

A card for each question!

NOVICE \$11.95  
 TECHNICIAN \$10.95  
 GENERAL \$9.95  
 ADVANCED \$19.95  
 EXTRA \$14.45

Call Today!

1-800-OKK-HAMS

Shipping 1 - \$4.00  
 2 or more - \$5.00

**VIS STUDY GUIDES**

P.O. BOX 17377

HATTIESBURG, MS 39404

CIRCLE 104 ON READER SERVICE CARD

# Ask KABOOM

Number 82 on your Feedback card

Michael J. Geier KB1UM  
c/o 73 Magazine  
70 Route 202 North  
Peterborough NH 03458

## Things That Go "Woof"

This month, we're going to take a look at the kinds of problems that give service technicians nightmares; the ones which keep the antacid business booming. I'm talking about "tough dogs," those unusual repair problems that, in the long run, aren't unusual enough! Here are a few I recently ran into and solved.

### Yes and no

This one was a 2 meter HT that wouldn't transmit—sometimes. Sometimes it would work just fine, but then I'd press the PTT again and the transmit light would just flash for a fraction of a second and go out, resulting in no RF output. Receive was fine. Bad connection, right? I couldn't find one, and wiggling and tapping things had no effect. Once it started transmitting, it would continue for as long as the PTT was held down, but the next attempt might or might not work.

This baby was pretty much screaming "woof! woof!" but I was determined to figure it out. I poked, prodded and couldn't get anywhere. The mystery finally started to unravel, though, when I noticed that the problem only showed up when the radio was in simplex mode; using an offset in either direction made the transmitter work fine every time. Now I was getting somewhere! It had to be in the offset switch, I figured. I checked the switch, and even jumped it just to be sure, but it made no difference. I put the radio down on the bench and pondered that one for a while. OK, I had localized the problem, but what the heck could it be?

Localized ... hmmm, that had to be it! This was a pre-microprocessor radio. What difference could that make? Well, in a micro-controlled rig, offsets are selected in software; the radio simply retunes to the transmit

## Your Tech Answer Man

frequency every time you press the PTT. Before micros, though, that was impossible, necessitating another approach: There were three crystals, one for each offset (up 600 kHz, down 600 kHz, and simplex), that set the frequency of a local oscillator which was then mixed with the synthesized one you set with the thumbwheel controls. That way, the circuitry and crystal-generated frequencies required to create the offset were the same, no matter what frequency you selected for operation. (That's also why non-standard offsets weren't available, as separate crystals would have been required for each of them.)

It was the word "localized" that set me thinking in that direction. Of course, an unreliable simplex offset crystal would cause all these weird symptoms. The transmit light would go out because the synthesizer would detect that the final mixed frequency was not there.

Sure enough, that was the problem. Of course, it could have been a capacitor or something else easily obtainable, but any tech can tell you that the part that needs replacing is always the hardest part to get! Furthermore, failing crystals often act just this way. Their activity level goes down, so sometimes they'll start up and sometimes they won't. A quick blast on the crystal with the freezing spray made the rig work every time, until the crystal got back up near room temperature, at which point it got "temperature-amental" again. Case solved. Another tough dog muzzled.

### El Zappo

This one was a three-tube HF linear amplifier that used 8874 tubes, which are small high-power metal-ceramic types. The amp was used, and had just been shipped here. It had a serious problem: Turning it on blew its fuses almost instantly, even though the shipper swore it had worked just fine when it left! "Hard shorts" like this can be difficult to diagnose, mostly because

you can't put power on the circuitry to see what's going on. As soon as you do, it blows the fuses again, and you're left with a dead circuit.

This amp used step-start protection. That is, it avoided serious inrush current to the massive power transformer by first putting all the current through a couple of resistors, and then bypassing them a moment later with a relay. The first thing I wondered was whether the power transformer had a short. That's tough to know, because the DC resistance of the windings in such a big beast is pretty low to begin with, making

it! I fired it up and it worked normally, with the correct high voltage shown on the meter. So, it was a tube after all! Turns out this kind of tube failure is common after shipment. I guess those tubes are more fragile than I'd realized. Apparently, physical shock can cause internal elements to shift just enough so they'll short out when the tube is warmed by the filament and high voltage is applied. So, they look good on an ohmmeter, but they aren't. Putting the caps back on, one at a time, exposed the bad tube. Another weird one solved, though I can't take credit for it. Woof!

---

***"I'd heard of such a thing happening in various kinds of picture tubes, but had never actually seen it."***

---

simple ohmmeter measurement worthless. The windings read close to zero ohms on a good transformer anyway, so there's no way to tell. I suspected, though, that the transformer was good, for three reasons: First, they almost never go bad. Second, the step-start resistors weren't fried, suggesting that the problem was on the other side of the transformer and didn't kick in until full power was applied. Finally, the meter lights came on for a fraction of a second before the fuse blew. That told me that the primary probably had to be OK, or there wouldn't have been any power at all. Of course, there still could have been a short in the high-voltage winding (which is where I'd most expect to find it).

I went around and around on this one for one or two hours, on the assumption that the transformer had no shorts. The high-voltage diodes and capacitors were all OK, and I couldn't find any shorts anywhere else, either. What the heck was shorting out and taking all that current? Could it be a shorted tube? I checked from anode to ground with my ohmmeter, but they all read open, as they should.

A quick call to the manufacturer exposed my hasty mistake. They suggested I disconnect the anode caps from all the tubes and try turning the amp on. That did

### Déjà vu all over again

I should have recognized this problem, because I'd seen it before, albeit under very different circumstances. I have a projection TV set that came to me with similar trouble. It would turn on, but the red tube would glow so brightly it practically lit up the room, and the other two tubes barely ran at all. Of course, I couldn't leave it on long enough to work on the set because it would have destroyed the red tube. Projection tubes are about as expensive as transmitting tubes, and much harder to replace; it wouldn't have been worth keeping the set if I'd had to get a new tube.

After going over all the CRT circuitry in the red section and finding it to be the same as that in the other two (identical) sections, I concluded it had to be a short in the tube. I'd heard of such a thing happening in various kinds of picture tubes, but had never actually seen it. So, out came the old ohmmeter, but there was no short to be found; the elements all read open, as they should. Then, I had an idea. Perhaps it was a thermal short, just as I described in the linear amplifier story. I turned the set on, let it run for about 30 seconds, and then pulled the plug and yanked off the CRT socket on the red tube. Naturally, I wore

rubber gloves, because I wanted to live long enough to enjoy watching the set. I quickly measured between the filament and cathode, which were the closest two elements and the ones most subject to this sort of trouble. And there it was: My meter showed a short whose resistance quickly began to rise as the tube cooled off. Within a few seconds, it was gone! I'd found it; now, what could I do about it?

Unlike with transmitting tubes, this type of short can be circumvented in CRTs. All you have to do is isolate the filament, using a 6.3-volt filament transformer. That way, the tube is still shorted, but the short leads nowhere. The fix worked fine, and the set is still going strong. Woof, woof!

Well, I'm dog tired just from thinking about all these tough dogs! Over the years, I've struggled with countless woofers, and I've probably learned more from them than from anything else. Naturally, nobody enjoys tough dogs, but they're out there, and I promise you'll see your share if you keep working on electronic things. I also promise you'll learn a lot.

Until next time, 73 de KBIUM. 

## Manufacturers:

If you have a new product and want it considered for review in 73, please call 603-924-0058.

## NEVER SAY DIE

*Continued from page 79*

CDs a month, so they had to advertise. During this time the indie market share went from 4% to 14%, a gain of several billion dollars in sales.

I love music, but I didn't want to spend the rest of my life reviewing new CD releases and giving talks at music industry conferences all around the world. 

## LETTERS

*Continued from page 6*

American hams or organizations have the right to unilaterally impose a "Morse Forever" policy on the international community; besides, wouldn't it be nice to have more DX stations to talk to? If Americans truly feel the "Morse filter" works, they would be free to pursue it on a local basis; and if they later changed their mind, they would not be able to blame it on the "international treaty problem."

None of this is meant to diminish the accomplishments of the radio pioneers; CW needs an appropriate shrine next to spark and AM. You can argue in favor of a question or two on spark transmission techniques on the test. In a real emergency, I would not hesitate to kludge a spark rig for a distress call; somehow I find it hard to imagine anyone modifying a modern IC-filled broadcast receiver in an emergency environment for practical use as a transmitter. But this letter is about current and evolving practice, and so I offer the following reality checks:

1. The Coast Guard no longer monitors Morse transmissions.

2. The armed forces no longer need Morse operators.

3. The merchant marine use of Morse is vanishing.

4. The Boy Scouts have dropped the Morse merit badge.

5. The "Morse filter" doesn't work. Check the high ends of 75 and 20 meters or "2 meter CB" in any major metropolitan area. Check how many coded licensees have actions to revoke their license as compared to "those codeless Techs." Our ARRL affiliated club could not function without the new codeless members.

6. The path of choice into the hobby is no-code. About a third of US hams are codeless. Tragically, the hobby is stagnating in growth, primarily due to the Morse requirement for frequencies below 30 MHz. This does not bode well for hams or the hobby in general, or organizations or businesses who derive their income from a healthy, young, ham radio environment.

7. It is very difficult to interest young people enough to jump the

Morse hurdle, because it is an obsolete technology. Our club has been in three schools trying to start up clubs. For less money, a young person can learn a marketable job skill, gain access to useful academic information, and meet a wide range of interesting people on the Internet. If we thoughtfully consider the declining ability of our nation as a whole to compete internationally, wouldn't it be helpful to "grow" some technically savvy youngsters?

8. The ARRL has dropped the Novice Roundup (a CW contest for beginners).

For these and other reasons, I believe that no rational argument remains to retain the Morse code as an entry requirement at all. However, if the requirement remains in the ITU treaty, it is my strong feeling that the hobby would be best served by reducing the code requirements for most license classes in the US to a token recognition exam with no speed requirement at all, since that satisfies the "letter of the law." The few remaining "Morse Forever" diehards can still hang out at the low end of the band with their side-swipes, with no harm done. Don't get me wrong, I spend a lot of the limited operating time I have down there. But the choice was clear this year—buy myself a nice new rice box, or get my son the new P100 computer to succeed in school. I really worry because I find a lot of the guys I used to talk to frequently are not even on 2m, but at their keyboards. I urge all hams, the ARRL, the QCWA, and the IARU to do the right thing ... before it is too late.

There is a second important issue that should be taken up at the next WRC ('99). Forty meters, particularly in the northeast, north central, and eastern seaboard of the US after 3 p.m. local time is virtually useless for ham communication. The incursion of powerful foreign shortwave broadcasters, intentionally beaming their programs to North America in violation of agreements, is so pervasive that prosecuting any deliberate jamming of hams by hams is insignificant by comparison. The mess on 40

drives people down to the overcrowded 75m band, exacerbating the problems there. The time for dispassionate negotiation has past. This has been a problem since my entry into the hobby in 1960. As a Novice, I played by the rules and took my precious crystal apart and ground it with a slurry of Bab-O™ cleanser to get out from under the foreign BC. I suspect my friend was more rational; he didn't waste any more money on "rocks"—he built a VFO kit and used it illegally as a Novice (another example of regulations lagging far behind the state of the art).

I propose the following possible scenarios, individually or in combination:

1. Eliminate all amateur power restrictions on 7.15-7.3 MHz. This would provide those with the inclination an opportunity to gain experience constructing and operating some "world class" transmitting equipment. FCC type acceptance would prohibit band switches in commercial units at the 1.5 kW to 100 kW or higher power levels. American commercial manufacturers could turn a tidy profit with little foreign competition. Day/night restrictions, as on the old shared 160m band, could be imposed. If it creates massive QRM in Europe, tough noogies—two can play that game. This proposal is meant seriously, not in jest.

2. There is mandatory use of "split frequency" operation to work DX on 40 phone. This is simple waste of precious spectrum space. Also, the bandwidth restrictions of a compact beam rarely permit optimum performance on frequencies that are separated that far apart. Encouraging the use of optimum directive antennas would reduce interference in at least some directions. Some realignment, at least for upper-class licenses, with the international allocations seems the only sensible solution. To reduce complaints from DX operators, limit power in that segment to the same level they have: 300-400 W. It is probably heresy to suggest we extend that limit to all frequencies, as a matter of fairness. Also, it's impossible to

*Continued on page 88*

# NEW PRODUCTS



## Plug and Play Packet

Advanced Electronic Applications, Inc. (AEA) has the next progression in Packet Radio—an integrated Data Radio called the IDR-96. It integrates the proven technology of the PK-96 TNC with the simplicity and high switch-over speed of a crystal-controlled radio.

The IDR-96 is a 9600 bps TNC with the features Packet users demand: full-featured mailbox; Gateway node operation; advanced Global Positioning System commands; identification of

TCP/IP, TheNet, and NetROM stations; and more, for a suggested list price of \$499.

The integrated radio is built into the unit, so you avoid the connection and compatibility problems associated with 9600 bps Packet; and two software programs are included with every IDR-96: PC PakRatt Lite™ and APRS™. See your dealer for best price and availability. Call AEA's Literature Request Line at (800) 432-8873 for more information on all AEA products.

## MFJ-1729 Super\*Gain™

A powerful dual-band magnet mount antenna for ham radio is available from MFJ for only \$29.95!

The MFJ-1729 Super\*Gain™ gives you 6.3 dB on 440 MHz and 2.6 dB on 2 meters—the perfect choice for dual-band mobiles and handhelds. MFJ's exclusive 29 3/4-inch stainless steel SlimLineRadiator™ minimizes wind vibration for less SWR flutter, and besides the working advantages of the MFJ-1729, the thing just looks great! It's sleek, stylish, and the base has a pad to prevent scratches on your vehicle. Of course it comes with MFJ's *NO MATTER WHAT* one-year unconditional warranty.

For more information, contact your dealer or MFJ Enterprises, Inc., P.O. Box 494, Mississippi State MS 39762. Phone (601)

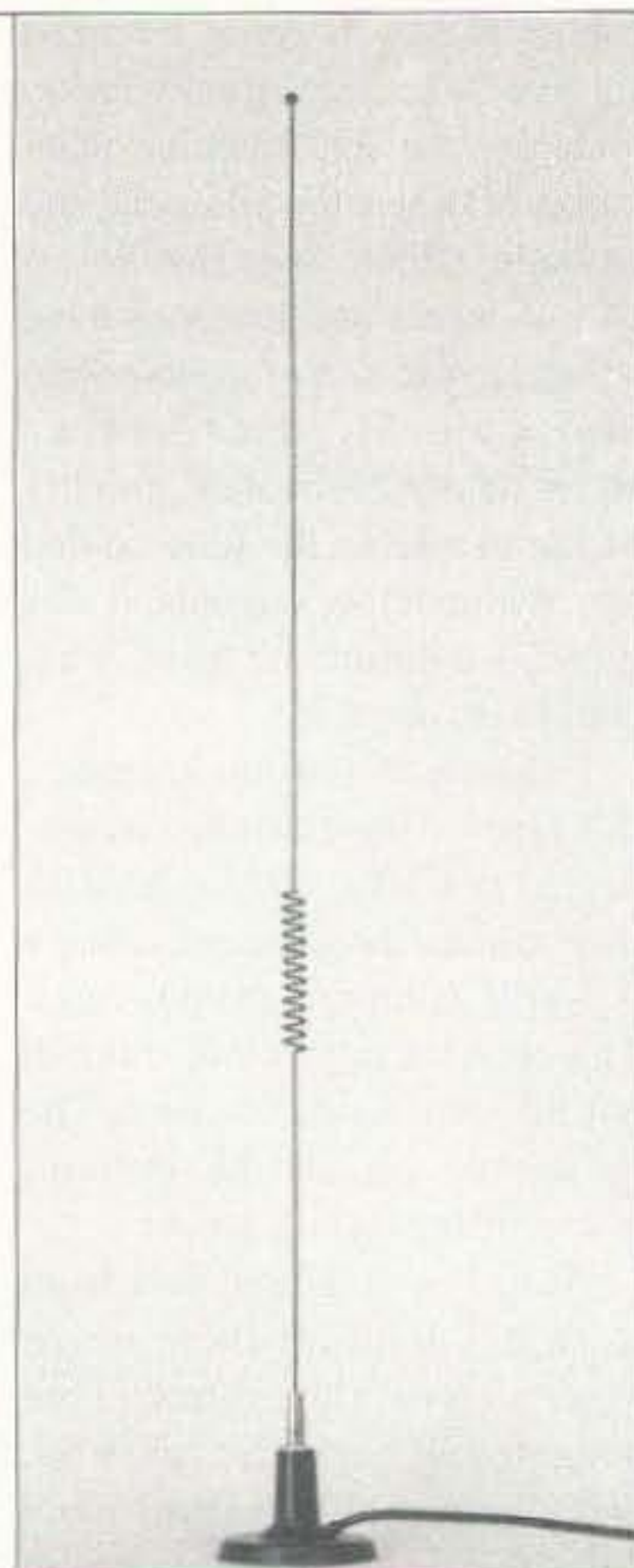

323-589, FAX (601) 323-6551, or order toll-free (800) 647-1800.



## Put This on Your Wish List

The Model 2950AR Atomic Resonance Rubidium Frequency Standard from Novatech Instruments, Inc. has simultaneous sinewave outputs of 10 MHz, 1 MHz, and 100 kHz, and at \$3,950.00, it's the lowest priced laboratory-type Rubidium Standard on the market. The 2950AR is ideal for use as a master oscil-

lator in labs and ground stations as well as for tests and calibration. For more information, contact: Novatech Instruments, Inc., 1530 Eastlake Avenue E. - Suite 303, Seattle WA 98102. Call (206) 322-1562, FAX (206) 328-6904, or view the complete data sheet on their Website at <http://www.eskimo.com/~ntsales>.



## More Power!

Get 50% more power on 2m and 75% more on 440 MHz than the nearest competitor offers—for \$60, less! Mirage Communications Equipment BD-35 is capable of boosting your power to new levels; it features auto-band selection, single connector for dual-band radios/antennas, full duplex operation, reverse polarity protection and much, much more.

This nifty compact amplifier works with all FM handhelds up to 7 watts. You get 45 watts capability on 2m and 35 watts capability on 440 MHz, and Mirage's

exclusive *FullDuplexAmp™*, which lets you talk on one band and listen on the other, just like a telephone conversation. The custom wraparound heatsink gives you excellent heat distribution and the reverse polarity protection will save your amp if you accidentally connect the power backward. A free mobile mounting bracket is included, and you get Mirage's legendary ruggedness and a full one year warranty—all for \$199!

Call your dealer or Mirage Communications at (800) 647-1800 to find the dealer nearest you.

## Handies are Dandies

Premier Communications has a couple of winners here, in the AT-

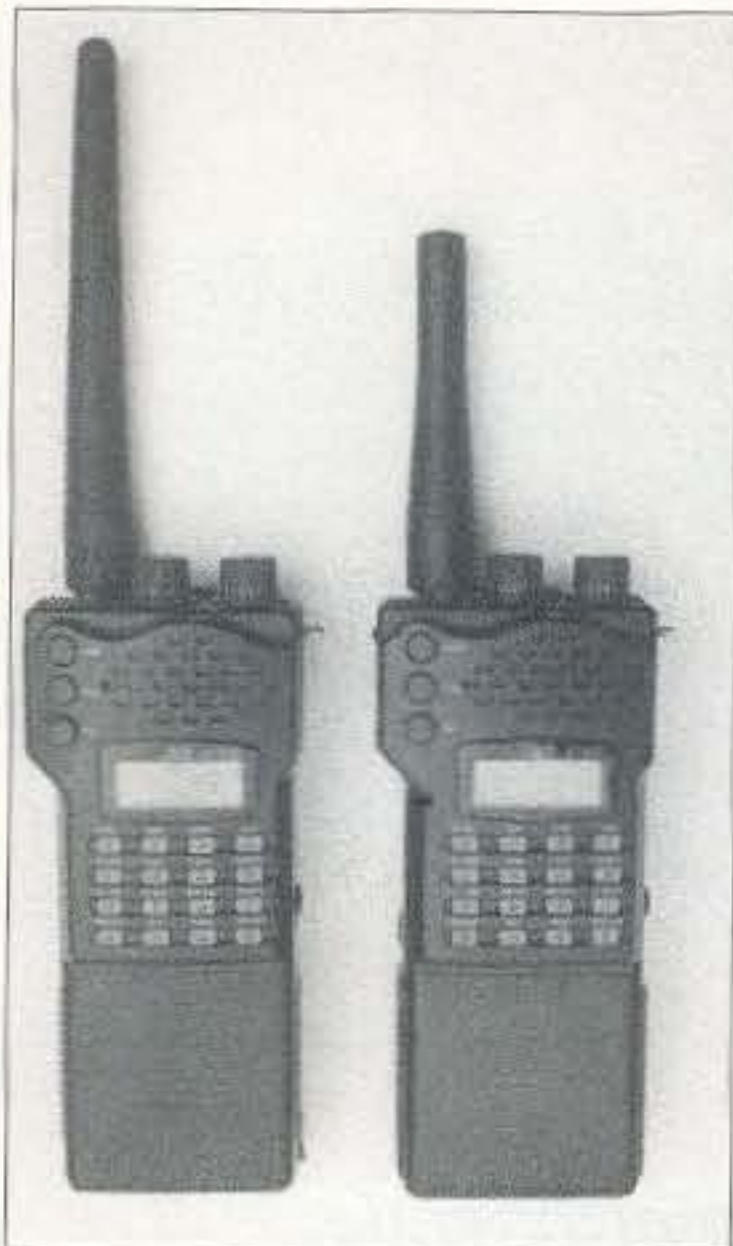

200/2 meter and the AT-400/70 cm FM handheld transceivers. Both are equipped with easy-dial VFO, 20 memories, backlit display and DTMF keypad, 4 scan modes, dual watch and call channel. They've also got 38 tone CTCSS encoders and decoders, and DTMF paging for silent monitoring, along with lots of other goodies, but Premier emphasizes their simplicity of operation and solid reliability, something everybody looks for in a handheld. A full line of mating accessories is available.

For more information, contact Premier Communications, 20277 Valley Blvd., Walnut CA 91789; telephone (800) 666-2654; FAX (909) 869-5710.

## Xtal Set History

"Crystal Radio: History, Fundamentals, and Design" is a new book from the Xtal Set Society, Box 3026, St. Louis MO 63130. This 124-page, \$11 paperback chronicles the history of the crystal detector. It also covers basics

such as antennas, lightning protection, grounding, tuned circuits, multi-tuned circuits, wave traps, and detection. Xtal set fans will probably also want to subscribe to the Society's (\$10 per year) newsletter.

## Neulink 9600 Is Now a Repeater

RF Neulink is now shipping its Neulink 9600 with repeater capability, a no-cost option available in all production transceiver modems. Neulink 9600 is a high-speed, 57.4 Kbps, 9.6 Kbps over-the-air, 2 watt transceiver modem. With its 65,000 unique ID codes, this synthesized UHF modem is capable of point to point and point to multipoint networking. It is an intelligent modem that has the capability to call up the entire network, group calling, or any individual remote in the system. Protocol is full handshake and includes RTS, CTS, DSR and DCD as well as error detection and correction.

For more information, contact RF Industries, Neulink Division, 7610 Miramar Road, San Diego

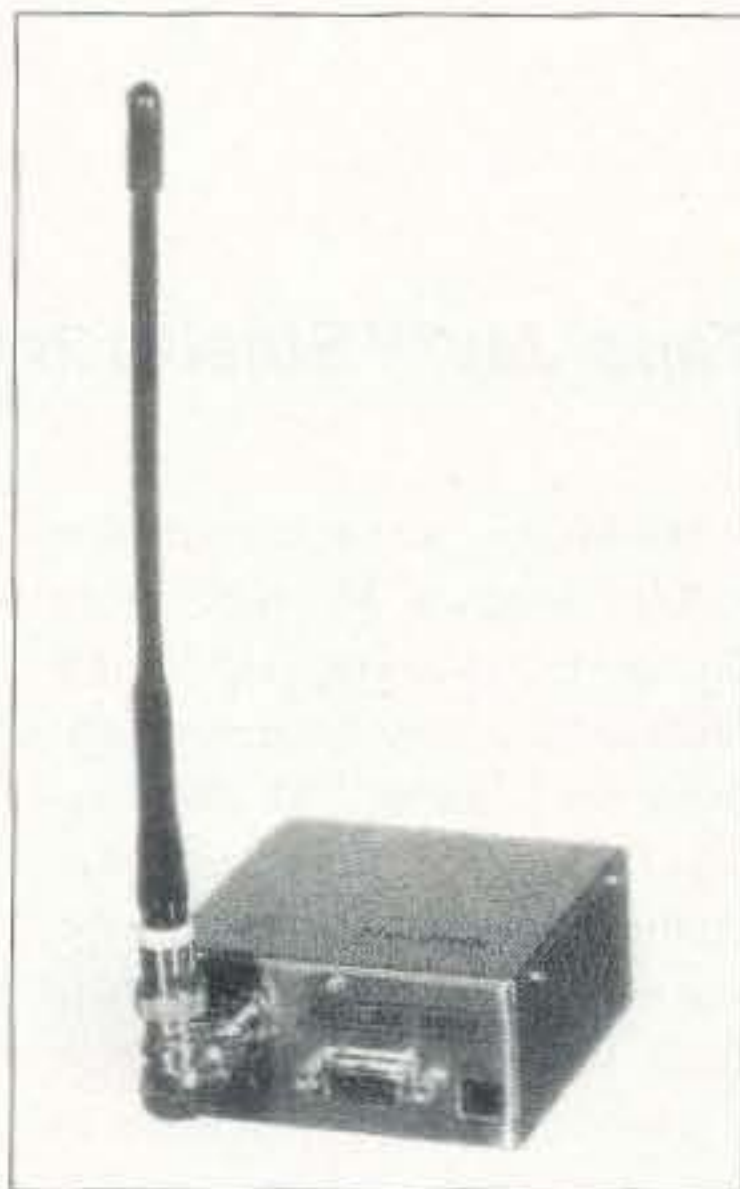

CA 92126-4202. Telephone (800) 233-1728, FAX (619) 549-6345, or E-mail: 102061.2261@compuserve.com.



## Signal Cube® from Nye Engineering

Here's a unique little gem from Nye—a 2.5" cube unit designed as a digital repeater of the receiver's S-meter. It connects to the terminals of the receiver's analog S-meter and is powered by a built-in 9V battery. The battery will supply the unit continuously, when the on/off switch is left on, for two months. The unit can be used with hundreds of feet of cable, if required.

The digital readings are in

S units 0 through 9 and in dB above S9 to 40 dB, exactly following the analog S-meter. The Signal Cube, with its half-inch digits and high resolution, is much easier to read than the regular analog S-meter.

The Signal Cube is available for \$189 from Nye Engineering Co. Inc., 4020 Galt Ocean Dr., Suite 606, Fort Lauderdale FL 33308. Phone (954) 566-3997 or FAX (954) 537-3534.



## New 75Ω Connectors

RF Connectors, a division of RF Industries, introduces its new line of 75 ohm connectors.

This series of coaxial connectors include 75 ohm BNC adapters and cable connectors. These connectors are available with both nickel and silver plating, Delrin and Teflon dielectric and all feature gold-plated captive center contacts.

These new connectors are available from RF Connector Distributors throughout the US, Canada and Mexico. For a complete listing of 75 ohm adapters and connectors, product specifications and availability, call (800) 233-1728 or E-mail: 102061.2261@compuserve.com.

## Radio Bookshop

Phone 800-274-7373 or 603-924-0058, FAX 603-924-8613, or see order form on page 88 for ordering information.

### Great ARRL Books!

AR1996 **The ARRL 1996 Handbook** includes the latest innovations in ham radio, plus all the fundamental data. \$38.00

AR1086-4 **ARRL Operating Manual** Information on how to make the best use of your station, including interfacing with home computers, OSCAR, UHF-VHF. \$18.00

AR4173 **Now You're Talking! All You Need To Get Your First Ham Radio License**—A complete study guide for the Technician and Novice written exam. Practical information every beginner needs is written clearly and simply and in small doses. \$19.00

AR4734 **ARRL Antenna Book**. Best and most highly regarded info on antenna fundamentals, transmission lines, design, and construction of wire antennas. \$30.00

AR4971 **ARRL Repeater Directory 1995-1996** Over 19,000 listings with digipeaters, bandplans, CTCSS(PL(TM)) tone chart, frequency coordinators, ARRL special service clubs, and beacon listings from 14MHz to 24GHz. \$7.00

AR0402 **Solid State Design** Good basic information, circuit designs and applications; descriptions of receivers, transmitters, power supplies, and test equipment \$15.00

AR3177 **ARRL Spread Spectrum Source Book** From a deceptively simple beginning, a group of experimenters set out to develop first theoretical and later practical systems for spread spectrum communications. This book consists of articles, papers and government reports that document the process whereby amateur spread spectrum progressed from the drawing board to the airwaves. \$20.00

AR4661 **ARRL's Antennas & Techniques for Low-Band DXing** can be your ticket to low-band success. \$20.00

AR3851 **Hints and Kinks** Ideas for setting up your gear for comfortable efficient operation. \$10.00

AR3185 **The Satellite Experimenter's Handbook** by Martin Davidoff K2UBC Expanded and revised. Focusing on satellites built by and for the international radio amateur community \$20.00

AR4645 **Satellite Anthology** The latest information on OSCARx 9 thru 13 as well as the RS satellites, the use of digital modes, tracking antennas, RUDAK, microcomputer, and more! \$10.00

## Radio Bookshop

Phone 800-274-7373 or 603-924-0058, FAX 603-924-8613, or see order form on page 88 for ordering information.

**The Last Skeptic of Science** by René. We all know there have been a bunch of ice ages, right? Wrongo, says René! And that the moon causes the tides. That volcanoes are caused by magma leaking from the earth's core. That the transmutation of elements is difficult. That the earth, with its iron core is a big magnet. Plus a bunch of other blasphemies, which René disproves most convincingly. Heck, we all know that two materials of different weight will fall at the same speed in a vacuum. Galileo proved that once and for all. Could Galileo have been wrong? You betcha. René spins out one after another of thoroughly accepted scientific truths and slays them. Boy, will you have things to talk about after reading this baby! 179p, 8 1/2 x 11. Order **SK** \$25 from Radio Bookshop.

**NASA Mooned America** by René. The proposition that the Apollo flights were all faked and NASA never got anyone to the moon is patently ridiculous. I'm still waiting to hear from anyone who has read this book and still believes the moon landings weren't the biggest hoax in history. René has done his homework thoroughly and cites 30 darned good reasons why he thinks we've all been lied to. 176p, 8 1/2 x 11. Order **NA** \$25 from Radio Bookshop.

**Cold Fusion.** Look, you ignored my blandishments to get involved with repeaters, which would have led you into getting rich via cellular telephones. Then you ignored my pleas to get involved with personal computers. So you're not a Bill Gates, Paul Allen, or Steve Jobs. You can't say I didn't try. The next biggie is going to be cold fusion. You can get an Overview report on the subject for \$2 (order **CFO**) from Radio Bookshop. Or you can jump in and subscribe for 12

issues. The special 73 subscriber rate is \$75 instead of \$98. Warning, some of the articles are technical, some are on experimental systems. Order **CF-sub** from Radio Bookshop. Motorola and Bechtel are already jumping in on this new technology, yet the leading American researcher in the field had his lab in his garage and had less than \$5,000 invested. He's now working for Clean Energy Technology Inc. (CETI).

**The Book List** by Wayne Green. This is a list of 83 books that I say you are absolutely crazy if you don't read. And none of this "I don't have time to read" crapola. These books are the best books I've found in a whole bunch of fields. Many were recommended by readers as being top notch. It's time to become educated on health matters, our school system, our corrupt government, history, science, communicating with plants and animals, child development, the occult, and so on. Order **BL** \$5 from Radio Bookshop.

**AIDS Cure.** Can a simple \$19 electrical (for the parts) gadget you should be able to build in an hour cure the dread "incurable" AIDS virus? Plus clean out any other virus, microbe, yeast, parasite, or fungus in the blood? This approach was discovered by the Albert Einstein College of Medicine and then kept secret. The medical industry's worst nightmare is a cheap cure for expensive diseases. Are tens of thousands of people dying unnecessarily? This has the original Beck device, plus a reprint of the May 73 Miller unit. Can this even cause a weight loss for fatties? And can the magnetic pulse unit used to zap the HIV virus out of lymph glands be used to regrow male pattern baldness? Order **AIDS** \$10 from Radio Bookshop.

## MORE NEW PRODUCTS

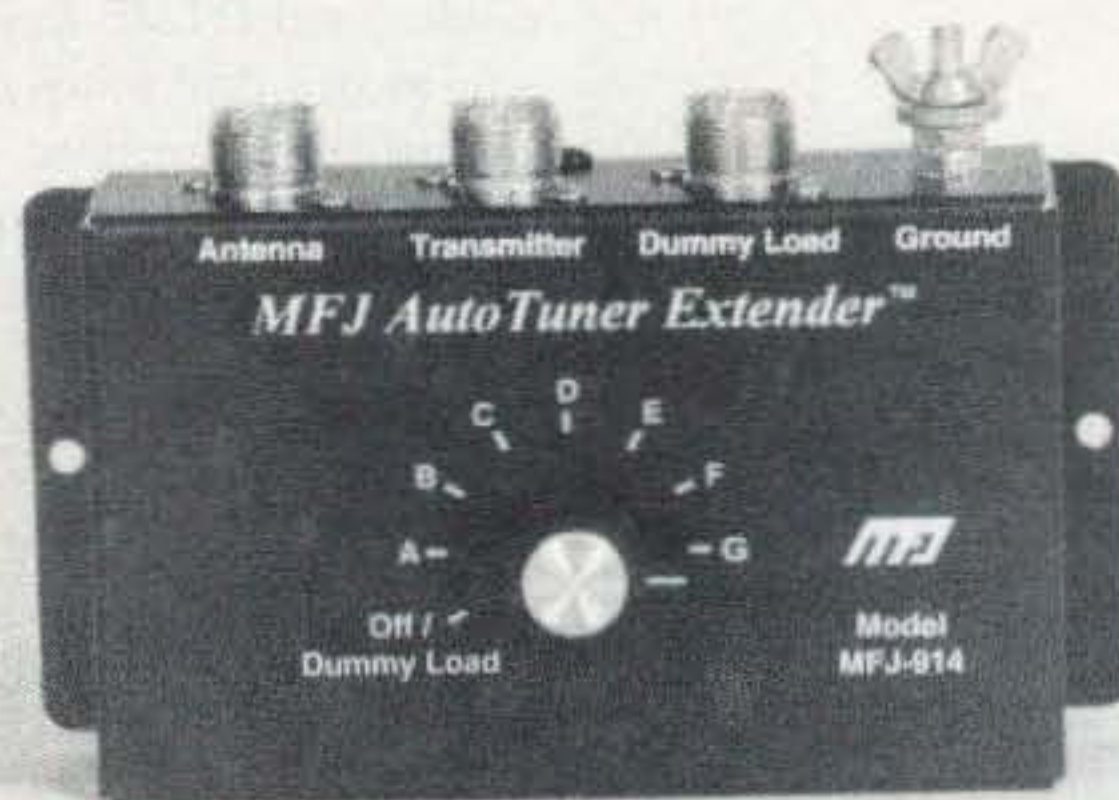

### MFJ-914 AutoTunerExtender™

Now you can match nearly any antenna automatically! The MFJ-914 is a heavy-duty wide-range impedance transforming device, carefully designed for the flattest frequency response and the lowest loss—it will transform your antenna impedance up or down by as much as ten times, and it's only \$59.95!

Extremely easy to use, the MFJ-914 can be used with any transceiver from 160 through ten

meters at up to 300 watts. It connects between your transmitter and antenna with supplied SO-239 connectors—just bypass your transmitter's auto tuner and adjust the knobs on the MFJ-914.

For more information or to order, contact your dealer or MFJ Enterprises, Inc., P.O. Box 494, Mississippi State MS 39762 or call (601) 323-5869, or (800) 647-1800; or FAX (601) 323-6551.

### Tape-Jay™ Stealth 2m J-Pole from HAMCO

HAMCO, an acronym for *Hidden Antenna Manufacturing Company*, is living up to the name with a new concealed antenna for 2-meter FM aficionados. *Tape-Jay* is just the ticket to get the HT and base units into the repeater from fringe areas. It is made from 3.5 mil sticky-back copper foil, and will adhere to almost any household material—windows, walls, chimneys, or even fabric, to make a portable roll-up J-Pole.

The easy-to-assemble kit comes with pre-cut elements, coax connector, cable clips and clear assembly instructions. No soldering, no special tools required. It's strong, durable, usable indoors or out, and like all HAMCO *TapeTenna*™ products, you can paint it to match your mounting surface and render it virtually invisible! Order for \$19 plus \$4 S&H by check or money order from HAMCO, Dept. A3, P.O. Box 25, Woodland Park CO 80866.



# PROPAGATION

Number 87 on your Feedback card

Jim Gray W1XU  
210 Chateau Circle  
Payson AZ 85541

September promises to be a good month for HF band propagation. Seasonal conditions are improving and, hopefully, solar flux will begin to rise again after a long period of 60s and 70s, although sunspot minimum has barely passed.

The only Poor (P) times this month surround the 14th and 27th, with possible atmospheric as well as ionospheric distur-

bances. As we're well aware, this is still hurricane season, so keep a sharp lookout for the possibility of tropical storms on or near these two days.

The week of the 6th to the 13th is likely to be the best week during the month, with Good (G) conditions on the HF bands. The remainder of the days are expected to be Fair or trending, as you can see from the calendar.

## EASTERN UNITED STATES TO:

GMT:	00	02	04	06	08	10	12	14	16	18	20	22
ALASKA						20	20					
ARGENTINA								15	15	15	15	15
AUSTRALIA						40	20	20			15	15
CANAL ZONE	20	40	40	40	40		20	15	15	15	15	20
ENGLAND	40	40	40				20	20	20	20		
HAWAII		20			40	40	20	20				15
INDIA						20	20					
JAPAN						20	20					
MEXICO		40	40	40	40		20	15	15	15	15	
PHILIPPINES						20	20					
PUERTO RICO		40	40	40			20	15	15	15	15	
SOUTH AFRICA									15	15	15	
U.S.S.R.						20	20					
WEST COAST			80	80	40	40	40	20	20	20		

## CENTRAL UNITED STATES TO:

ALASKA	20	20						15				
ARGENTINA									15	15	15	
AUSTRALIA	15	20				40	20	20				15
CANAL ZONE	20	20	40	40	40	40			15	15	15	20
ENGLAND		40	40					20	20	20	20	
HAWAII	15	20	20	20	40	40	40					15
INDIA								20	20			
JAPAN								20	20			
MEXICO	20	20	40	40	40	40			15	15	15	20
PHILIPPINES								20	20			
PUERTO RICO	20	20	40	40	40	40			15	15	15	20
SOUTH AFRICA										15	15	20
U.S.S.R.								20	20			

## WESTERN UNITED STATES TO:

ALASKA	20	20	20		40	40	40	40				15
ARGENTINA	15	20		40	40	40						15
AUSTRALIA		15	20	20			40	40				
CANAL ZONE			20	20	20	20	20	20				15
ENGLAND									20	20		
HAWAII	15	20	20	40	40	40	40					15
INDIA		20	20									
JAPAN	20	20	20			40	40	40			20	20
MEXICO			20	20	20	20	20					15
PHILIPPINES	15						40		20			
PUERTO RICO			20	20	20	20	20	20				15
SOUTH AFRICA										15	15	
U.S.S.R.									20			
EAST COAST		80	80	40	40	40	40	20	20	20		

## SEPTEMBER 1996

SUN	MON	TUE	WED	THU	FRI	SAT
1 G-F	2 F	3 F	4 F	5 F-G	6 G	7 G
8 G	9 G	10 G	11 G	12 G-F	13 F-P	14 P
15 P-F	16 F-G	17 G	18 G-F	19 F	20 F	21 F-G
22 G	23 G-F	24 F	25 F-P	26 P	27 P-F	28 F
29 F-G	30 G					

### 10-12 meters

Generally Poor, except for occasional transequatorial propagation with F2 openings on the best days—most likely South and Central America.

### 15-17 meters

DX to Africa and Latin America on the Good days possible, with short-skip out to about 1,000 miles or so in the U.S.

### 20 meters

Your best band for DX openings around the world from dawn to dark, and openings to the Southern Hemisphere after dark in evening hours. You can expect excellent short-skip during the daytime to 2,500 miles or so.

### 30-40 meters

These bands ought to be open for DX from just before sunset to just after sunrise. Signals from the east should peak until

midnight, and after midnight to other areas. Daylight short-skip of about 500 miles will be possible, and nighttime short-skip to 1,500 miles or more will be available.

### 80 meters

Occasional DX to various areas of the world should be possible between sunset and sunrise when QRN levels permit on Good (G) days (see calendar), and also short-skip during hours of darkness to 1,500 miles or more.

### 160 meters

Following the usual summertime slump, this band ought to begin to come alive again during the hours of darkness when QRN permits. Try the days marked (G) on the calendar for best results. DX toward the east until midnight, and to other areas afterwards until dawn. Short-skip to 1,500 miles will prevail when the band is quiet. W1XU. 73

## Radio Bookshop

Phone 800-274-7373 or 603-924-0058, FAX 603-924-8613, or see order form on page 88 for ordering information.

### Wayne Writes!

WG5 *Submarine Life In World War II* by Wayne Green W2NSD/1 60p. Wayne's stories of his adventures on the USS Drum SS-228 on five war patrols in the Pacific in 1943-1945. What's it really like on a submarine when you are being depth charged? And what's the day to day life on a submarine like? \$7.50

WG6 *Uncle Wayne's Caribbean Adventures* 96 pages. Wayne's adventures scuba diving all around the Caribbean, visiting ham operators, and sight seeing. If you are interested in how to travel economically, you'll get some great ideas from this. He starts out with his "Diving, the Wimp Sport." You'll love the visit to eleven islands in 21 days trip. A measly \$7.50

WG7 *Uncle Wayne's Travels*-52 p. Wayne travels to Russia, London, Aspen, and St. Pierre, Munich, Vienna, Krakow, and Prague without it costing nearly as much as you might think. Cheap for you too, at \$5.00

WG9 *Wayne Talks: 'Dayton' 1995*. -90 minute tape-What he would have said if he'd been asked to speak. \$5.00

WG4 *20/20 Foresight* -Twenty 16 updates on the *Declare War* book - 320p. Further proposals for solving critical American problems, such as a new approach to financing small businesses, how to finance Russia and other countries and make a profit doing it, the real dope on bioelectromagnetics, a new kind of polytechnical university, a new electronic technology, why Africa is in such a mess, why Perot bombed, how to have tuition free universities, a plan for making Congress turn honest, etc. Plenty more. Ridiculously priced at \$10.00

## LETTERS

Continued from page 83

enforce. But it would be a big step in reducing RFI to consumer goods and QRM due to habitual widespread use of more than the necessary power to sustain communications (even by well-known ARRL OO stations ... clean up your own act, guys!) Maybe a few surprise FCC inspections are in order after passing rules stating possession of such high power amplifiers is prima facie evidence of power limit violation.

3. In view of the declining Novice ranks, consider dropping the 40m Novice CW allocation and expanding the phone band downward for Generals. I am sure some other frequencies would be a fair exchange for the Novices—how about giving them 25 kHz of AM/SSB at 7.275-7.3 in exchange? It is open throughout the sunspot cycle, unlike 10m. The AM privileges might encourage them to restore or build simple equipment and progress in the hobby. Some real phone privileges might whet their appetite for a General upgrade. Otherwise, consider dropping the Novice class altogether or merging it with Tech, once the code requirement is eliminated. (In reality, there are too many classes of license. Novice and Tech should be merged, as an entry level class. Leave General the

way it is. Merge Advanced and Extra. Think up some names that are less goofy sounding, like class A, B, and C. The no-code Advanced guys won't clutter up the bottom 25 kHz code segment and bother us old buzzards anyway. Make the lower 25 kHz an exclusive CW-only segment to keep those pesky bit bangers out, if you are worried about it, but are you really sure that guy with the new call that blew your ears off with the 45 wpm CW wasn't using a key that said IBM on the front? Let's get real!

4. If the rumored expansion or trade of 6.9-7.0 MHz for the largely wasted upper end of 40 comes through, let's consider something sane this time for a change as far as subband operating modes. Consider something fresh, like making the low end from 6.9 for phone, a 7.0-7.025 a CW window, a digital modes segment, an "internationally aligned" segment phone portion for upper classes, possibly putting the general CW or digital segment on the top end, where they can compete successfully with the foreign broadcast. (Think of the strong commercial incentive to move to a quieter frequency when listeners complain about multiple 1 kHz beat notes from a bunch of kW CW stations. But with a good filter, they aren't going to bother hams at all. "Please" didn't work; let's try something new.)

5. Here is something really radical: Eliminate all subbands on 40 meters altogether. That way, the more popular modes will spread out as needed, without the constant expensive "tweaking" of regulations. It seems to work OK on 160m. During the 160 CW contest the "CW band" magically grew all the way past 1925 kHz. Two days later, it shrunk back to the old 20 kHz bottom. The sun still came up. In fact, many foreign countries don't have any subbands at all. The downside is that we might have to make up some meaningful license test questions instead of mindlessly memorizing the junk on a chart everyone keeps at their operating positions. Hmmm ... the other bands? Nahhh! Too easy!

These suggestions, while offered in a humorous way, are meant as serious alternatives to the perpetuating of a problem which has been around as long as

I have been in the hobby. Let's fix it this time, either through the ARRL and FASC, or take it on internationally if necessary, in spite of the resistance to change from here in the US. We could lose our frequencies due to lack of use, or due to selling of new ham gear (at truck stops) to bootleggers. I am bothered by the fact that I have not received any sort of opinion poll regarding the Morse issue, nor do I know anyone who has. I had to call ARRL HQ in order to find out who to write to, though the article I mentioned at the beginning of the letter seemed to invite comments. I hope this is not the sign of "business as usual" from the "Morse Forever" bunch. This could be our last opportunity to set a number of critical matters right.

*Troublemaker. You're trying to use reason to argue what is a religious matter. Waste of time...*  
Wayne 73



LOOK FOR ME HERE AT THE SWAP ---- I'M WEARING A BLUE CAP

## Radio Bookshop ORDER FORM

You may order by mail, telephone, or fax. All payments are to be in US funds. Allow 4 weeks for delivery. (Prices subject to change without notice if suppliers increase prices or new editions cost us more.)

ITEM	TITLE	QTY	PRICE	TOTAL

**Shipping:** All orders add \$5.00 handling \*plus there is an additional at cost shipping charge added to all foreign orders. We ship UPS where possible, please give us street address.

S&H\*  
TOTAL \$

Make checks payable to "Radio Bookshop."

Foreign Orders: Chose one  surface shipping  air shipping  
(Surface delivery may take 2-3 months.)

\*Note: The actual foreign shipping costs will be additional to the regular shipping and handling fees.

Name \_\_\_\_\_ Phone \_\_\_\_\_

Address \_\_\_\_\_

City \_\_\_\_\_ State \_\_\_\_\_ Zip \_\_\_\_\_ Country \_\_\_\_\_

\$10 minimum for credit card orders

Total Paid \$  Check/Money Order  AMEX  MC  VISA

Card # \_\_\_\_\_ Expires \_\_\_\_\_

Signature \_\_\_\_\_ Date \_\_\_\_\_

Telephone: 603-924-0058, 800-274-7373, FAX 603-924-8613

Mail: Radio Bookshop, Dept. 396, 70 Route 202 N, Peterborough NH 03458

YES, Send me 12 issues of 73 at the low rate of \$24.97 (save 47% over the cover price). Canada add \$7 plus \$1.40 GST; Foreign add \$19 surface; \$42 airmail.

# Patcomm introduces the PC-16000 HF Transceiver for \$1395<sup>00</sup>

**Featuring Built-In Keyboard/Digital Mode Interface & Digital Signal Processor**

Patcomm Corporation™ introduces the PC-16000™, a full featured HF Transceiver with a built-in keyboard interface. Plug a standard IBM-AT\* compatible keyboard into a PC-16000™ and instantly enjoy keyboard CW, RTTY (BAUDOT) and ASCII data communications. Incoming morse and RTTY data is decoded and displayed on the built-in LCD display. Data is also sent to an RS-232 serial port for display on a "dumb terminal" or equivalent.

The PC-16000™ offers the following features:

- Built-in AT keyboard interface (keyboard optional)
- General coverage receiver (1.5–29.9 MHz)
- Dual up conversion design
- USB/LSB/CW/FSK/AM & optional FM modes
- 160 thru 10m ham band coverage on transmit (CAP & MARS available)
- 100W output power
- DDS driven PLL synthesizer—1 Hz minimum step size
- Selectable variable speed/fixed 10Hz step VFO tuning

- Basic display lets you know exactly where you are.

```
14.03510-T 0930
14.03510-R 7000
```

- Standard Display shows RX/TX VFO freq's, time and current memory

- Send & Receive in:  
CW / RTTY(BAUDOT) / ASCII

```
TNX FER QSO, 73
```

← Incoming data

← Outgoing data appears here

### Digital Signal Processing Filtering System

- 2.4KHz, 1.8KHz, 500Hz, 250Hz & RTTY "Brick Wall" filters
- Auto notch filter removes multiple heterodynes on SSB signals automatically
- De-noiser reduces background noise

- Manual notch for CW operation
- Built-in digital power/SWR meter
  - 24 hour clock
  - Built-in 5–75 WPM IAMBIC keyer
  - Select 1 of 3 antennas from the front panel
  - Slow/fast AGC
  - IF shift

Specifications are subject to change without notice.

\* IBM AT is a registered trademark of the IBM Corporation.

ALL THIS  
FOR ONLY  
**\$1,395<sup>00</sup>**



Patent Pending

(Keyboard Optional)

**patcomm**  
corporation

**Call or Write for a Detailed Brochure  
Major Credit Cards Accepted**

Designed and manufactured in the U.S.A.  
Phone: (516) 862-6512 ■ Fax: (516) 862-6529  
7 Flowerfield M100, St. James NY 11780

CIRCLE 321 ON READER SERVICE CARD

# Connect to the world !!

*A full range of cellular antennas is available: hole mount, magnetic mount, on-glass and base station.*



**SKA 900 1/4**



**SKA 901 1/4**



**SKA 901 C**



**MICROCELL MAG**



**SKA 900 C**



**SGM 900**

**SIRIO**  
antenne

46049 VOLTA MANTOVANA - MN - ITALY - Tel. (39) 376/801515 - Fax (39) 376/801254  
NORTH AMERICA OFFICE: TORONTO - CANADA - TEL. (519) 650 9277 - Fax (519) 650 1779