

# 73

International Edition

July 1983 \$2.49 1/2  
Issue #274

# Amateur Radio's Technical Journal

A Wayne Green Publication

## Code-Lovers' Special Issue

9 Articles

## Antarctic Antennas

Page 80

## Home-Brew Prize-Winner

Page 32

## Pileup at Abu Ail

Page 94

1983

## Daytonia

Page 6

## What Happened at Heard?

Page 20

### You Can Build This Code Trainer

More than a mere code-practice oscillator, this CPU-controlled trainer features burned-in practice groups. Flick a switch and you have a keyer. .... K7ZOV 12

### The True Story Behind Heard Island

Fighting bad weather, shady ship owners, and bad press, the HIDXA expedition forged its way to the DXer's dream. But getting there was only half the battle. .... VK9NL 20

### More Stable Than a Rock

An Honorable Mention winner in 73's Home-Brew II Contest, this 10-MHz generator is a sure cure for the drifting frequency blues. .... DJ3NW 32

### Build the Billboard Keyboard Keyer

Get perfectly-tuned CW without a buffer. Then join the crowd at 60+ wpm. .... KD7S 44

### Construct the Lead-Foot Key

If you like your CW in the fast lane, you'll love this key. And it is guaranteed not to slip—at any speed. .... W5JQE 48

### The \$2 Infinite-Memory Keyer

Take a break. Your cassette recorder will send any message for you. .... W0XI 50

### Apple, Morse, and You

Simple software and cheap hardware make for a great CW keyboard recipe. Just add one operator. .... AF2M 54

### Micro McElroy

Is Pet BASIC fast enough for solid CW copy? You bet—and this program will work miracles with a sloppy fist. .... VK3BHM 56



Heard Island—20



QRP Keyer—58

### QRP Keyer for Misers

Get machine-perfect code with this keyboard. All it costs is 30 mW and a few dollars. .... VE7DHD 58

### The Easy FIFO Keyboard

First in, first out means you type as fast as you want to. It will send at the speed you set. .... N7BH 64

### Down-Under Depth Sounder

Get your feet wet with this Australian construction project. We promise that you won't get in over your head. .... Harleck, Dawson 82

### The ROM-less, RAM-less CQ Sender

Automatic CW can be yours for the price of a few diodes. And you can re-program without spending a dime. .... VU2VIZ 90

### Yasme and the Call of Abu Ail

It was just a speck in the Red Sea, but it created pileups as big as a mountain. .... W6KG, W6QL 94

Never Say Die—6  
73 International—70  
Ham Help—81, 100,  
122, 126  
Social Events—99  
FCC—101  
Letters—102  
Circuits—103  
Contests—104  
Awards—105

RTTY Loop—107  
Reader Service—114  
DX—116  
Corrections—117  
Satellites—117  
New Products—118  
Review—119  
Dealer  
Directory—146  
Propagation—146



# 1.2 GHz!

# NEW!

## Explore the world of 1200 MHz FM with ICOM's new IC-120 Mobile!



Now you can move out of the crowded 144 and 440 MHz bands into the wide spectrum of 1200 MHz because ICOM gives you the opportunity to explore the spectrum from 1260 to 1300 MHz ... 40 MHz ... with all the features found on popular 2 meter and 440 MHz rigs plus some:

**Memories.** Six memory channels plus 2 VFO's provide storage of most used frequencies in this wide band. Each memory allows memory of frequency, offset direction, offset frequency, and tone encoder frequency. Internal memory backup available.

**Scanning.** Scan the memories, scan all 40 MHz or program a segment to be scanned. All scanning has the option of scanning for a busy or open channel.

**Duplex.** Be able to work different repeater offsets, with ICOM's programmable offset system, as they become available.

**3 Tuning Rates.** Tuning increments of 10 KHz, 20 KHz or 1 MHz are available for rapid or slow tuning of the band.

**RIT.** RIT on FM? Yes,  $\pm 5$  KHz on either side of the transmit frequency allows you to tune signals offset from yours.

**Readout.** Four digit green LED readout for easy visibility day or night.

The ICOM IC-120 gives you all of this plus a very quiet PLL circuit, with excellent signal to noise ratio, high sensitivity and a stabilized power amplifier to provide full power over its temperature and voltage ranges, and the IC-120 is small, only 2"H x 5 1/2"W x 8 1/8"D.



## NEW 1.2 GHz Repeater

Complete your system with the IC-RP1210 repeater.

- PLL frequency selection (198 channel, 10 KHz steps, DIP switch)
- High stability PLL (0.5PPM/-30° to +60°C)
- Repeater access via CTCSS
- DTMF control functions
- Selectable hang time
- ID'er.

# ICOM

## The World System



# 5-STORE BUYING POWER *in action!*

Unlike some retailers, when Ham Radio Outlet guarantees satisfaction there'll be no question. **YOU CAN COUNT ON IT!**

## KENWOOD SPECIALS!!



**TS-930S w/Antenna Tuner**  
Plus 3 Free Bonus Items

1)-SP-930 SPKR.  
2)-MC-60A MIC.  
3)-YK-88C-1 FILTER.

Reg. \$2029 Value  
**\$1799**  
A \$230.00 SAVING  
Free Shipment UPS (Brown).



**TR-2500/  
TR-3500  
SAVE!**

**SUBSTANTIAL  
SAVINGS**

**TS-430S**

Check our low prices and don't forget Free Shipment UPS (Brown).



**ALL ETO ALPHA  
SPECIAL  
SALE PRICES**



Example: **76PA**  
**\$1699.95**

**NEW!** MIL-SPEC 1030 **signal/one**



General coverage: 10kHz-30MHz.  
Power output: 150W PEP.  
Built-in AC/DC, speaker,  
RF clipping, Pre-IF adjustable  
noise blanker. Synthesized  
passband tuning. IF notch filter.  
Seven digit readout. Much more.

Ask for details.



**IC-740 w/ FREE  
EX-238 Power Supply**  
Plus

**\$50**

FACTORY REBATE  
LIMITED TIME ONLY

**CHECK  
LOW, LOW  
PRICE**



**KT-34A  
SALE \$299**  
**KT-34XA  
SALE \$459**

PRICES ARE FOR CALIF  
EXCEPT FOR CERTAIN  
COMBINATIONS.  
PLEASE INQUIRE



**W-51  
SALE \$799**  
**W-36  
CALL FOR PRICE**  
**LM-470D  
CALL FOR PRICE**



**B-3016 REG. \$239.95  
SALE \$199.95**    **B-108 REG. \$179.95  
SALE \$159.95**  
**B-1016 REG. \$279.95  
SALE \$249.95**    **B-23S REG. \$89.95  
SALE \$79.95**



**FT-208R**



**FT-708R**

**CALL FOR  
LOW PRICES  
ON  
HAND-HELDS  
and all  
YAESU ITEMS**



**NEW!  
FT-980**

**FREE SHIPMENT (U.P.S. Brown)**  
CONTINENTAL U.S.A.

ON MOST ITEMS THAT CAN BE SHIPPED UPS BROWN.  
THERE ARE SOME EXCEPTIONS IN ALPHA, TRI-EX AND KLM

**FREE  
PHONE 800 854-6046**

9:30AM to 5:30PM PACIFIC TIME.

**OVER-THE-COUNTER, 10AM to 5:30PM.  
MONDAY THROUGH SATURDAY**

CALIFORNIA CUSTOMERS PLEASE PHONE OR VISIT LISTED STORES.

**ANAHEIM, CA 92801**

2620 W. La Palma,  
(714) 761-3033 (213) 860-2040  
Between Disneyland & Knott's Berry Farm

**BURLINGAME, CA 94010**

999 Howard Ave., (415) 342-5757  
5 miles south on 101 from S.F. Airport.

**SERVING HAMS  
BETTER.**

North...south...east...west.

Bob Ferrero, W6RJ  
Jim Rafferty, N6RJ  
other well known hams  
give you courteous,  
personalized  
service.



**HAM  
RADIO  
OUTLET**



**OAKLAND, CA 94609**  
2811 Telegraph Ave., (415) 451-5757  
Hwy 24 Downtown. Left 27th off-ramp.

AEA • ALLIANCE • ALPHA • AMECO • AMPHENOL • ARRL • ASTRON  
AVANTI • BELDON • BENCHER • BERK-TEC • BIRD • B & W  
BUTTERNUT • CALLBOOK • CDE • COLLINS • CURTIS • CUSHCRAFT

**SAN DIEGO, CA 92123**

5375 Kearny Villa Road (619) 560-4900  
Hwy 163 & Clairemont Mesa Blvd.

DAIWA • DRAKE • DX EDGE • DX ENGINEERING • EIMAC  
HUSTLER • HY-GAIN • ICOM • J. W. MILLER • KENWOOD • KLM  
LARSEN • LUNAR • METZ • MFJ • MICRO-LOG • MINI-PRODUCTS

**VAN NUYS, CA 91401**

6265 Sepulveda Blvd., (213) 988-2212  
San Diego Fwy at Victory Blvd.

MIRAGE • NYE • PALOMAR • ROBOT • ROHN • SHURE  
SIGNAL-ONE • TEMPO • TEN-TEC • TRISTAO • VOCOM • YAESU  
and many more!



Prices, specifications, descriptions subject to change without notice. Calif residents please add sales tax.

## R-X Noise Bridge



- Learn the truth about your antenna.
- Find its resonant Frequency.
- Adjust it to your operating frequency quickly and easily.

If there is one place in your station where you cannot risk uncertain results it is in your antenna.

The Palomar Engineers R-X Noise Bridge tells you if your antenna is resonant or not and, if it is not, whether it is too long or too short. All this in one measurement reading. And it works just as well with ham-band-only receivers as with general coverage equipment because it gives perfect null readings even when the antenna is not resonant. It gives resistance and reactance readings on dipoles, inverted Vees, quads, beams, multiband trap dipoles and verticals. No station is complete without this up-to-date instrument.

Why work in the dark? Your SWR meter or your resistance noise bridge tells only half the story. Get the instrument that really works, the Palomar Engineers R-X Noise Bridge. Use it to check your antennas from 1 to 100 MHz. And use it in your shack to adjust resonant frequencies of both series and parallel tuned circuits. Works better than a dip meter and costs a lot less.

The price is \$59.95 in the U.S. and Canada. Add \$3.00 shipping/handling. California residents add sales tax.



Send for FREE catalog describing the R-X Noise Bridge and our complete line of SWR Meters, Preampifiers, Toroids, Baluns, Tuners, VLF Converters, Loop Antennas and Keyers.

# Palomar Engineers

Box 455, Escondido, CA 92025  
Phone: (619) 747-3343

# MAXIMIZER

NEW

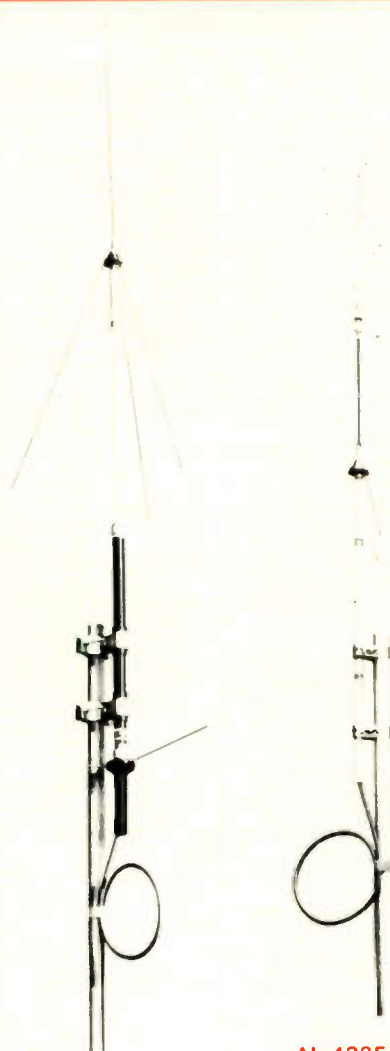

AL-144GF

AL-432F II

AL-460F II

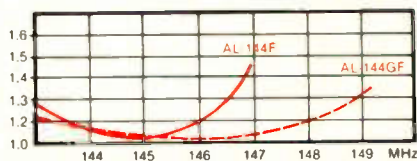

AL-144GF - 1/2λ + 1/4λ collinear for 2 meters. Supplied with ground plane radial kit to deliver superior performance and full band coverage.

AL-432FL - 5/8λ + 5/8λ collinear base station antenna for 430-440 MHz. Built-in ground plane. Excellent gain, ideal for reaching fringe areas.

## KLM

Electronics Inc.

See your KLM Dealer or write for our complete catalog  
P.O. Box 816,  
Morgan Hill,  
California 94035

# INFO

## Manuscripts

Contributions in the form of manuscripts with drawings and/or photographs are welcome and will be considered for possible publication. We can assume no responsibility for loss or damage to any material. Please enclose a stamped, self-addressed envelope with each submission. Payment for the use of any unsolicited material will be made upon acceptance. All contributions should be directed to the 73 editorial offices. "How to Write for 73" guidelines are available upon request.

## Editorial Offices:

Pine Street  
Peterborough NH 03458  
Phone: 603-924-9471

## Advertising Offices:

Elm Street  
Peterborough NH 03458  
Phone: 603-924-7138

## Circulation Offices:

Elm Street  
Peterborough NH 03458  
Phone: 603-924-9471

## Subscription Rates

In the United States and Possessions:  
One Year (12 issues) \$25.00  
Two Years (24 issues) \$38.00  
Three Years (36 issues) \$53.00

## Elsewhere:

Canada and Mexico—\$27.97/1 year only, U.S. funds. Foreign surface mail—\$44.97/1 year only, U.S. funds drawn on U.S. bank. Foreign air mail—please inquire.

## To subscribe, renew or change an address:

Write to 73, Subscription Department, PO Box 931, Farmingdale NY 11737. For renewals and changes of address, include the address label from your most recent issue of 73. For gift subscriptions, include your name and address as well as those of gift recipients.

## Subscription problem or question:

Write to 73, Subscription Department, PO Box 931, Farmingdale NY 11737. Please include an address label.

73, *Amateur Radio's Technical Journal* (ISSN 0745-080X) is published monthly by Wayne Green, Inc., 80 Pine Street, Peterborough NH 03458. Second class postage paid at Peterborough NH 03458 and at additional mailing offices. Entire contents copyright © 1983, Wayne Green, Inc. All rights reserved. No part of this publication may be reprinted or otherwise reproduced without written permission from the publisher. Microfilm Edition—University Microfilm, Ann Arbor MI 48106. Postmaster: Send address changes to 73, Subscription Services, PO Box 931, Farmingdale NY 11737.



# WE WANT YOU!

TO CALL TOLL FREE



# 1-800-325-3636

## FOR A TRADE-IN QUOTE

**We Trade  
on New or Used Equipment**

(Check for prices on available used equipment)

# HAM RADIO CENTER

8340-42 Olive Blvd. • P.O. Box 28271 • St. Louis, MO 63132



In Missouri Call 1-314-993-6060



# W2NSD/1 NEVER SAY DIE

editorial by Wayne Green



## THE DAYTON DAZE

Two of the manufacturers exhibiting at Dayton were in a heated argument as I passed by, with one holding that the Hamvention officials were lying through their teeth about the attendance. . . that there certainly were no more than 27,000 hams there instead of the 30,000 official count at that time. Well, during the rainy early Saturday morning, I'll tell you this: You could hardly move from one place to another.

Once the sun came out, the hordes poured into the flea-market area and eased the pressures a tad. It was still crowded inside, but at least you could move around.

After trying to communicate with a packed roomful of people last year, fighting the thunderous noises from the two adjacent meeting rooms and what seemed like 100° heat and humidity, I wasn't even going to try this year. But the Hamvention people suggested I give it another try in a more isolated room. . . and at a more isolated time. So I got up there on the podium Friday afternoon, before many of the brethren had yet arrived for the hamfest, and did my stint. It was better, but still marginal. Next year, I'm told that there will be some new meeting rooms where we'll have quiet.

Since many of those present indicated that they preferred a stiff code test as part of our amateur entry fee—never mind what the lack of growth has done to our country, with the loss of one consumer electronics industry after another, a loss getting up into the dozens of billions of dollars a year. . . and never mind what this is doing to us in the way of military weakness (it's better to lose the

country than acknowledge the changes in technology and cope with them)—keeping that in mind, I came out strongly in favor of Morse code and was met with great enthusiasm.

Fine. . . let's by all means go with what everyone wants, no matter how destructive it is. Let's make it so that we put our licenses where our mouths are. . . if code really is important, then let's make sure that each and every ham has to requalify every year and prove the ability to copy.

None of this silly five words per minute. *That* isn't code! That's baloney. The ability to copy code starts at 13 per, so that should again be made the irreducible minimum. That should be the starting speed. But then, remembering that we are now agreeing that code is of high importance, can we honestly support anything other than a new "incentive licensing" plan which will move us on up to at least 35 words per minute? Any ham really worthy of being a ham should be able to get to that speed in a few weeks. . . so let's set that as the ticket for holding your license.

Many of those present were nodding eagerly in total agreement, licking their chops at the thought of being able to knock 90% or more of the hams out of the hobby and back into CB where they belong. When I suggested 50 wpm for everyone, they were wildly enthusiastic. That could easily knock out 98% and QRM would be a thing of the past. Good grief, we might even have enough room so that we could go back to spark!

A couple of spoilsport women, obviously too lazy to really care about being hams, got mad over this and stormed out of the

room. They probably never learned the code anyway. . . being licensed by a good friend who overlooked that little requirement.

The talk was fun.

In looking around the exhibits, I noticed that good old Bash was there, but everyone was giving this booth a wide berth. There were even some chaps talking about a "trash Bash" move to stop this prostituting of the ham ticket. And not a few hams came to me wondering what all the fuss about no-code was when with the new Bash code tapes one could pass the code test without even being able to copy the code. I had a good friend who got his Extra ticket that way. He had only slight ability to copy code. . . and virtually no theory understanding. He just wanted to see if one could Bash one's way to success without knowing a damned thing and was greatly surprised when he walked out with a lovely one-letter call suffix.

The development of ever smaller Morse-code readers has brought us to the tiny hand-held decoder. With that, anyone can copy code at almost any speed. . . certainly up to around 100 words per minute. If we can take that in with us for the license exam, that should solve the whole code problem. . . right? Oh, I can hear the purists bitching. . . "Yes, but what if the battery burns out?" We heard the same complaint when kids started using hand calculators instead of learning their multiplication tables. The answer to that is so simple: *solar power*.

They have inexpensive solar power cells which can run the decoder just from the glare of a Morse-code fanatic's eye. So

# STAFF

**PUBLISHER/EDITOR**  
Wayne Green W2NSD/1

**EXECUTIVE VICE PRESIDENT**  
Sherry Smythe Green

**ASSISTANT PUBLISHER/EDITOR**  
Jeff DeTray WB8BTH

**MANAGING EDITOR**  
John Burnett

**ASST. MANAGING EDITOR**  
Susan Philbrick

**EDITORIAL ASSISTANTS**  
Nancy Noyd  
Richard Phenix  
Steve Jewett

**TECHNICAL EDITOR**  
Avery L. Jenkins WB8JLG

**ASSISTANT TO THE PRESIDENT**  
Matthew Smith KA1IEI

**ASSOCIATES**  
Robert Baker WB2GFE  
John Edwards K12U  
Bill Gosney KE7C  
Sanger Green  
Chod Harris VP2ML  
Dr. Marc Leavey WA3AJR  
J. H. Nelson  
Bill Pasternak WA6ITF  
Peter Stark K2OAW

**PRODUCTION MANAGER/PUBLICATIONS**  
Nancy Salmon

**ASST. PRODUCTION MANAGER/PUBLICATIONS**  
Michael Murphy

**ADVERTISING GRAPHICS MANAGER**

Scott W. Philbrick

**CREATIVE DIRECTOR**  
Jonathan Graves

**DESIGN DIRECTOR**  
Christine Destrempe

## PRODUCTION

Frances Benton

Linda Drew

Denzel Dyer

Michael Ford

Phil Geraci

Donna Hartwell

Kimberly Nadeau

Paula Ramsey

Dianne K. Ritson

Anne Rocchio

Deborah Stone

Theresa Verville

David Wozmak

Karen Wozmak

## PHOTOGRAPHY

Thomas Villeneuve

Sandra Dukette

Laure Jennisson

Sturdy Thomas

Irene Vall

Robert M. Villeneuve

## TYPESETTING

Sara Bedell

Darlene Bailey

Melody Bedell

Michele DesRochers

Prem Krishna Gongaju

Lynn Haines

Linda Locke

Debbie Nutting

Lindy Palmisano

Heidi Thomas

## GENERAL MANAGER/VICE PRESIDENT

Debra Wetherbee

## CONTROLLER/VICE PRESIDENT

Roger J. Murphy

## ACCOUNTING MANAGER

Knud Keller KV4GG/1

## CIRCULATION MANAGER

Patricia Ferrante

603-924-9471

## BULK SALES MANAGER

Ginnie Boudrieau

1-(800)-343-0728

## ADVERTISING

603-924-7138

Jim Gray W1XU, Mgr.

Nancy Ciampa, Asst. Mgr.

Ross Kenyon KA1GAV

Cornelia Taylor, Office Coordinator



# Scan the World.

# NEW



**SSB, CW, AM, FM, digital VFO's, 10 memories, band and memory scan, optional 118-174 MHz coverage...**

## R-2000

The R-2000 is an innovative all-mode SSB, CW, AM, FM receiver that covers 150 kHz-30 MHz, with an optional VC-10 VHF converter unit to provide coverage of the 118-174 MHz frequency range. New microprocessor controlled operating features and an "UP" conversion PLL circuit assure maximum flexibility and ease of operation to enhance the excitement of listening to stations around the world.

### R-2000 FEATURES:

- **Covers 150 kHz-30 MHz in 30 bands.** Uses innovative UP-conversion digitally controlled PLL circuit. UP/DOWN band switches (1-MHz step). VFO's continuously tuneable across the band and from band to band.
- **Optional 118-174 MHz coverage.** Through use of innovative microprocessor technology, frequency, band, and mode data of stations in the 118-174 MHz range may be tuned, displayed (full frequency, i.e., 146.000.0), stored in memory, recalled, and scanned, using the R-2000 front panel controls and frequency display, allowing maximum convenience and ease of operation.  
The optional VC-10 VHF converter unit may be easily installed on the rear panel of the R-2000.
- **All mode: USB, LSB, CW, AM, FM.** Provides expanded flexibility in receiving various signal types. Front panel mode selector keys, with LED indicators.
- **Digital VFO's for best stability.** 50-Hz step, switchable to 500-Hz or 5-kHz. F. LOCK switch provided.

- **Ten memories store frequency, band, and mode data.** Complete information on frequency, band, and mode is stored in memory, assuring maximum ease of operation. Each memory may be tuned as a VFO. Original memory frequency may be recalled. AUTO. M switch for automatic storage of current operating data, or, when off, selective storage of data using M. IN switch.
  - **Lithium battery memory back-up.** (Est. 5 yr. life.)
  - **Programmable memory scan.** Scans all memories, or may be programmed to scan specific memories. HOLD switch interrupts scanning. Frequency, band, and mode are automatically selected in accordance with the memory channel being scanned. The scanning time is approximately 2 seconds per channel.
  - **Programmable band scan.** Scans automatically within the programmed bandwidth. Memory channels 9 and 0 establish upper and lower scan limits. HOLD switch interrupts scanning. Frequency may be adjusted, using the tuning control, during scan HOLD.
  - **Fluorescent tube digital display (100-Hz resolution).** Built-in 7 digit fluorescent tube digital display indicates frequency or time, plus memory channel number. DIM switch provided. The display may be switched to indicate CLOCK-2, FREQUENCY, CLOCK-1, and timer ON or OFF by the front panel FUNCTION switch.
  - **Dual 24-hour quartz clocks, with timer.**
  - **Three built-in IF filters with NARROW/WIDE selector switch.** (CW filter opt.) 6-kHz wide or 2.7-kHz narrow on AM. 2.7-kHz automatic on SSB. 2.7-kHz wide on CW, or, with optional YG-455C filter installed, 500-Hz narrow, 15-kHz automatic on FM.
  - **Squelch circuit, all mode, built-in, with BUSY indicator.**
  - **Noise blanker built-in.**
  - **Large front mounted speaker.**
  - **Tone control.**
  - **RF step attenuator.** (0-10-20-30 dB.) Four step attenuator, plus antenna fuse.
  - **AGC switch.** (Slow-Fast.)
  - **"S" meter, with SINPO "S" scale.**
  - **100/120/220/240 VAC, or 13.8 VDC operation** (with opt. DCK-1 cable kit).
- Other features.**
- RECORD output jack.
  - Audible "beeper" (through speaker).
  - Carrying handle.
  - Headphone jack.
  - External speaker jack.
- Optional accessories:**
- VC-10 118-174 MHz converter.
  - HS-4, HS-5, HS-6, HS-7 headphones.
  - DCK-1 DC cable kit.
  - YG-455C 500-Hz CW filter.
  - HC-10 World digital quartz clock.
  - AL-2 Surge Shunt
- VC-10 subject to FCC approval
- More information on the R-2000 is available from all authorized dealers of Trio-Kenwood Communications  
1111 West Walnut Street  
Compton, California 90220.

**KENWOOD**  
...pacesetter in amateur radio

Specifications and prices are subject to change without notice or obligation.





### QSL OF THE MONTH

This eye-catching card from Lalo Santos HK3EQJ in Bogota, Colombia, easily outshined the competition to win this month's QSL card contest. This colorful card features a modernistic shack resembling Mission Control, a motif which is reinforced by the large dish in the background and a quad antenna which literally sparkles. Further back, the stars shine over a haloed sun setting into the Andes mountains—a scene which would be beautiful from any shack.

If you would like to enter 73's QSL of the Month Contest, enclose your card in an envelope and send it to 73, Pine Street, Peterborough NH 03458, Attn: QSL of the Month. Entries without an envelope or book choice will not be considered.

let's stop worrying about the code, okay? It has turned out that kids do just fine without memorizing the multiplication tables. Those calculators don't wear out much... and solar power keeps 'em charged.

Speaking of the code, for those who think the code can be fun, AEA has a new gadget which will drive you crazy. They showed the first version of it last year at Dayton and this little bugger simulates a CW contact with you. Now they've updated it and you're in there fighting with a bunch of other stations trying to work some rare DX... all done by computer. I see this as a great gadget for hamfests to use for simulated DX contests. Hotshot DX ops can sit down at a DX simulator and see what kind of a score they can make in ten to twenty minutes of operating. That should be a ball.

With more and more of the CW ops using keyboards and code copiers, unless we stress the fun of the code, we may find that few, if any, hams are actually able to copy the code anymore. Almost all of the high-speed CW you hear on the bands these days is computer-generated and copied. The Novice bands still have a few people hanging around chirping out half-hour CQs, hoping that no one will answer.

### OTHER DAYTONIA

Out in the outer fringes of exhibitors, I was surprised to find a

booth run by the CIA. It seems they are pepping up their communications facilities and are in need of technicians. I've got some pretty good friends who went into this kind of work and they've certainly had interesting lives as a result. If you're the kind of person who likes to travel and see unusual places, this might be worth checking out.

Icom was wowing 'em with their 1200-MHz repeater. It's set up for FM use, but I'll bet if they modify it a bit so that it will handle television, they'll have a bunch of customers. Ham television really should be up on 1200 MHz and not crammed onto one channel on 420 MHz.

And both Kenwood and Yaesu had new rigs which were showstoppers. You'll be seeing reviews of 'em here as soon as we can get our mitts on the rigs to check them out. Ten-Tec had a nice little 2m HT which I suspect is going to be very popular. We've been promised one of those soon, too.

The Hamvention is always a seething mass of hams going around the exhibits and then scouring the enormous flea market for bargains. If the show gets any bigger, I don't know where they could put it. The poor old Hara Arena in Dayton is just plain overwhelmed. Cars fill almost every neighboring field and the huge lots at the arena and line the streets for almost a mile around. The people in the neighborhood are uptight over

the cars, but when about 30,000 hams descend on one place, it takes a lot of parking to handle 'em.

There was some sort of hassle over the flea market not being opened on Friday and a good deal of flak went up over that. And just to make the situation worse, the opening on Saturday was accompanied by a deluge. It cleared off in the afternoon just fine, but there were an awful lot of very unhappy fleas for a while.

Ohio has a new law aimed at getting tax payments on sales by flea-market exhibitors. This is mainly for the few professional flea-market salespeople who make a living at it and have been thus avoiding paying the stiff Ohio sales tax. The Hamvention crew shelled out \$5 each for the flea-market exhibitors to keep the authorities off their backs. I think they remembered the problems at Rochester, where the police came in and virtually closed down the flea market... and the regular exhibitors, too. That disaster almost ruined the Rochester Hamfest, which has been struggling to get back to strength ever since then.

For a show of its size, the Hamvention went very smoothly. It's three days long and it takes you that much time to really see just the inside exhibits, much less cover the flea market... which had about 600 exhibitors this year, I understand. Nine in the morning until eight at night is a grueling job for the poor exhibitors, but perhaps it's worth it so that everyone has more of a chance to see everything. It's only once a year.

### REAL HAMS

One thing the mail about the proposed code changes has made crystal clear is that there still are a substantial number of Real Hams around, despite the decimation of our ranks by what the communists called "incen-tive licensing."

For instance, the Real Ham does not use sideband... that's for wimps. The Real Ham sticks to the Real Ham communications mode: CW. Oh, the Real Ham gets on two meters, too, but no Real Ham signs his call more than once every half hour or so. After all, the Real Ham only talks to damned good friends... other Real Hams... and everyone knows who's who by the voices, so who needs an

ID? The more often you sign your call, the more of a wimp you are. And no one but a leaping faggot would prissily demand that the breaker identify himself.

Real Hams, when they develop Parkinson's Disease, which a growing number of them have, and can no longer make that old straight key talk, do go on phone... but you can be damned sure they go on AM, not wimpy sideband with the ducks and other fruits.

Real Hams have a key in one hand and a six pack of cool 807s by the other. They eat pretzels while hamming and steak and potatoes for dinner. Pringles? You've got to be kidding! You ought to have your keying hand mashed in the door for even thinking such an obscene thought.

### DANGEROUS DXING

Alas, I didn't see any mention of amateur radio in the news reports of the ill-fated Spratly DXpedition. You've probably read about it. It had to do with a group of German DXers heading to Spratly on a catamaran. They unfortunately managed to find the islands and were shot out of the water by the Vietnamese, who killed one of the DXpeditioners. The other five drifted for nine days in a dinghy, with one dying of dehydration before the rest were picked up.

As I recall, the last bunch of DXers who tried to get Spratly off the endangered DX list got shot at, but not with quite such disastrous results. You'd think that DXers would take a look at history before going to Spratly.

The first ham to put Spratly on the air, back in the 60s, the chap who invented the 1S call (much to the annoyance of the ITU), figured out how to get all the contacts he wanted from there without all that danger. As far as I know, he did his entire Spratly exercise from up in central Thailand, the same place he used to make his Burma and Cambodia exercises, I suspect. I have the cards from those operations and they are acceptable for DXCC.

DXpeditioning used to be a lot easier... and more fun... when the ARRL didn't put hams in danger of their lives. No one really gave a damn whether the DXpedition was exactly precisely where it claimed to be or not.

*Continued on page 124*





# CLEANLINESS... a unique **CORSAIR** virtue

Cleanliness in the TEN-TEC CORSAIR means unusual spectral purity of both received and transmitted signals.

In Receive mode, even with the r.f. preamp in operation, the 3rd order intercept (at 20 kHz tone spacing) is +5 dBm. With the preamplifier off, the 3rd order intercept rises to a superlative +18 dBm and remains constant even at 3 to 6 kHz away from the pass-band.

In Transmit mode, if you look at the output of the CORSAIR on a spectrum analyzer, you note an almost complete absence of phase noise—a phenomenon which plagues most PLL transceivers. At 20 kHz from the carrier, the generated phase noise in the CORSAIR is a spectacular -148 dBc/Hz, and at 1 kHz it is -132 dBc/Hz.\*

This breakthrough in circuit design, using proven crystal mixed oscillators with the latest USA solid state technology, is setting new standards of cleanliness and purity of signals. All of which means enhanced reception with less fatigue, lower noise floor, no overloading and more DX worked. And your signal will be a bit easier to read under adverse conditions. Compare.

Other virtues of the CORSAIR include:

- All solid state, broadband design
- All 9 hf bands
- Triple conversion receiver with 0.25  $\mu$ V sensitivity on all bands and better than 90 dB dynamic range
- Variable bandwidth plus Passband tuning
- Dual range, Triple mode, Offset tuning
- Variable Notch filter
- Built-in Speech Processor
- Built-in Noise Blanker
- 200 W input, 100% duty cycle
- Dual-speed QSK (full or semi)
- Many operating conveniences including headphone attenuator, cw signal spotter, 5-function meter, WWV reception, adjustable ALC threshold lighted status indicators, selectable AGC, adjustable pitch and volume of sidetone, complete interfacing.
- Full accessory line including remote VFO, keyers, microphones, power supplies, antenna tuners, ssb and cw filters.
- Reliable American manufacture and service, fully warranted.

See CORSAIR at your TEN-TEC dealer, or write for full details.  
TEN-TEC, Inc., Sevierville, TN 37862

*\*Specifications measured by independent laboratory*



# MFJ RTTY / ASCII / CW COMPUTER INTERFACE

Lets you send and receive computerized RTTY/ASCII/CW. Copies all shifts and all speeds. Copies on both mark and space. Sharp 8 Pole active filter for 170 Hz shift and CW. Plugs between your rig and VIC-20, Apple, TRS-80C, Atari, TI-99, Commodore 64 or most other personal computers. Uses Kantronics software and most other RTTY/CW software.

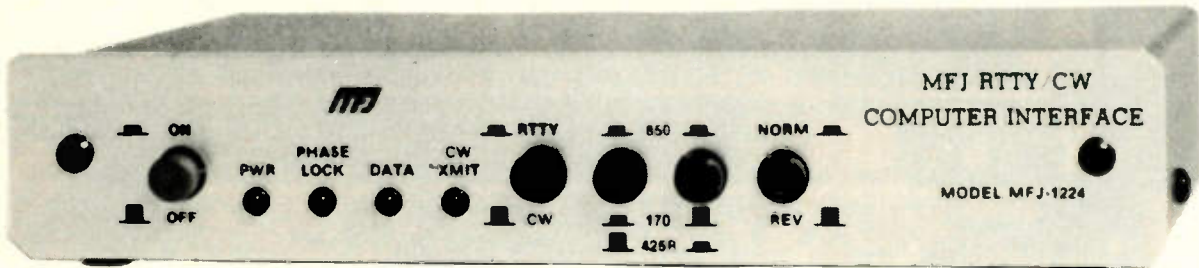

- Copies on both mark and space tones.
- Plugs between rig and VIC-20, Apple, TRS-80C, Atari, TI-99, Commodore 64 and most other personal computers.
- Uses Kantronics software and most other RTTY/CW software.

**\$ 99<sup>95</sup>**  
MFJ-1224

This new MFJ-1224 RTTY/ASCII/CW Computer Interface lets you use your personal computer as a computerized full featured RTTY/ASCII/CW station for sending and receiving.

It plugs between your rig and your VIC-20, Apple, TRS-80C, Atari, TI-99, Commodore 64, and most other personal computers.

It uses the Kantronics software which features split screen display, 1024 character type ahead buffer, 10 message ports (255 characters each), status display, CW-ID from keyboard, Centronic type printer compatibility, CW send/receive 5-99 WPM, RTTY send/receive 60, 67, 75, 100 WPM, ASCII send/receive 110, 300 baud plus more.

You can also use most other RTTY/CW software with nearly any personal computer.

A 2 LED tuning indicator system makes tuning fast, easy and positive. You can distinguish between RTTY/CW without even hearing it.

Once tuned in, the interface allows you to copy any shift (170, 425, 850 Hz and all shifts between and beyond) and any speed (5 to 100 WPM on RTTY/CW and up to 300 baud on ASCII).

Copies on both mark and space, not mark only or space only. If either the mark or space is lost the MFJ-1224 maintains copy on the remaining tone. This greatly improves copy under adverse conditions.

A sharp 8 pole active filter for 170 Hz shift and CW allows good copy under crowded, fading and weak signal conditions. Uses FET input op-amps.

An automatic noise limiter helps suppress static

crashes for better copy.

A Normal/Reverse switch eliminates retuning while stepping thru various RTTY speeds and shifts.

The demodulator will even maintain copy on a slightly drifting signal.

A +250 VDC loop output is available to drive your RTTY machine. Has convenient speaker output jack.

Phase continuous AFSK transmitter tones are generated by a clean, stable Exar 2206 function generator. Standard space tones of 2125 Hz and mark tones of 2295 and 2975 Hz are generated. A set of microphone lines is provided for AFSK out, AFSK ground, PTT out and PTT ground.

FSK keying is provided for transceivers with FSK.

High voltage grid block and direct outputs are provided for CW keying of your transmitter. A CW transmit LED provides visual indication of CW transmission. There is also an external hand key or electronic keyer input jack.

In addition to the Kantronics compatible socket, an exclusive general purpose socket allows interfacing to nearly any personal computer with most appropriate software. The following TTL compatible lines are available: RTTY demod out, CW demod out, CW-ID input, +5 VDC, ground. All signal lines are buffered and can be inverted using an internal DIP switch.

For example, you can use Galfo software with Apple computers, or RAK software with VIC-20's. Some computers with some software may require some external components.

DC voltages are IC regulated to provide stable

AFSK tones and RTTY/ASCII/CW reception.

Aluminum cabinet. Brushed aluminum front panel. 8x1 1/4x6 inches. Uses 12-15 VDC or 110 VAC with optional adapter, MFJ-1312, \$9.95.

## RTTY/ASCII/CW Receive Only SWL Computer Interface



**\$ 69<sup>95</sup>**  
MFJ-1225

Use your personal computer to receive commercial, military and amateur RTTY/ASCII/CW traffic.

The MFJ-1225 automatically copies all shifts (850, 425, 170 Hz shift and all others) and all speeds.

It plugs between your receiver and VIC-20, Apple, TRS-80C, Atari, TI-99, Commodore 64 and most other personal computers.

It uses Kantronics software which features CW receive 5-99 WPM, RTTY receive 60, 67, 75, 100 WPM, and ASCII receive 110, 300 baud, plus more.

An automatic noise limiter helps suppress static crashes for better copy, while a simple 2 LED tuning indicator system makes tuning fast, easy and positive.

In addition to the Kantronics compatible socket, a general purpose socket provides RTTY out, RTTY inverted out, CW out, CW inverted out, ground and +5VDC for interfacing to nearly any personal computer with most appropriate software.

Audio in, speaker out jacks. 4 1/2 x 1 1/4 x 4 1/4 in. 12-15 VDC or 110 VAC with adapter, MFJ-1312, \$9.95.

ORDER ANY PRODUCT FROM MFJ AND TRY IT-NO OBLIGATION. IF NOT DELIGHTED, RETURN WITHIN 30 DAYS FOR PROMPT REFUND (LESS SHIPPING).

- One year unconditional guarantee • Made in USA.
- Add \$4.00 each shipping/handling • Call or write for free catalog, over 100 products.

# MFJ

MFJ ENTERPRISES, INC.  
Box 494, Mississippi State, MS 39762

TO ORDER OR FOR YOUR NEAREST DEALER, CALL TOLL-FREE  
**800-647-1800.** Call  
601-323-5869 in Mississippi and out-  
side continental U.S.A. Telex 53-4590.





# HUSTLER

## DELIVERS RELIABLE ALL BAND HF PERFORMANCE

Hustler's new 6-BTV six-band trap vertical fixed station antenna offers all band operation with unmatched convenience. The 6-BTV offers 10, 15, 20, 30, 40, and 75/80 meter coverage with excellent bandwidth and low VSWR. Its durable heavy gauge aluminum construction with fiberglass trap forms and stainless steel hardware ensures long reliability.

Thirty meter kits (30-MTK) for 4-BTV and 5-BTV are also available.



Don't miss our 30 meter excitement.

**HUSTLER -  
STILL THE STANDARD OF PERFORMANCE.**

**HUSTLER**

3275 North "B" Avenue  
Kissimmee, Florida 32741

An **AMERICAN** Company

# DURA-FLEX™

## shock mounts silence spring-generated RF noise.

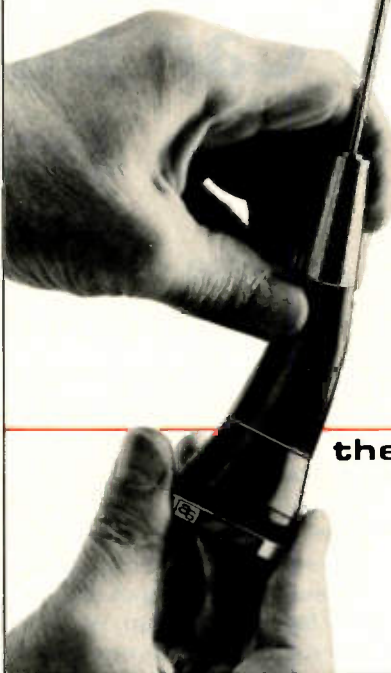

- **DURA-FLEX neoprene elastomer** significantly advances antenna shock absorption technology.
- **Eliminates RF noise** in duplex radio systems from metal-to-metal contact in conventional steel springs.
- **Drastically cuts whip vibration** which can damage or break antennas with steel springs on high-vibration vehicles.
- **Solid brass adaptors** molded into neoprene; braided totally isolated through center cavity.
- **Field-proven** against heat, cold, humidity and abrasion extremes.
- **Models** for roof, trunk or magnetic mounting. 2 meter, 220 MHz or UHF.

the antenna specialists co.



✓ 63

a member of The Allen Group Inc.  
12435 Euclid Avenue, Cleveland, Ohio 44106  
Export 55 Main St., Freeport, N.Y. 11520  
Canada: A. C. Simmonds & Sons, Ltd.

**we design solutions.**

### MEASURE MORE WITH YOUR DMM

\$14.50

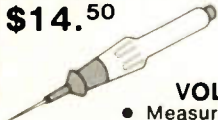

**MODEL P1  
X10 HIGH  
VOLTAGE PROBE**

- Measures up to 10,000 volts
- 90 Megohms in probe works with 10 Megohm meters to divide voltage by ten.
- 1% accuracy
- Safe operation with insulating probe of high impact plastic

\$12.50

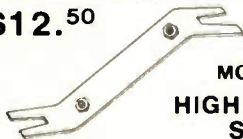

**MODEL M2  
HIGH CURRENT  
SHUNT**

- Measures to 400 amps intermittently, 50 amps continuously.
- Manganin alloy for stable 1% accuracy
- Measures AC and DC currents
- Direct reading .001 ohm shunt, each millivolt read by DMM is one ampere
- Meter probes plug into jacks in the shunt
- Shunt attaches to binding posts and to car battery terminals

**ORDER FROM  
SCIENTIFIC INSTRUMENTS**

3379A Papermill Road  
Huntingdon Valley, PA 19006

ADD \$2 FOR SHIPPING AND HANDLING

### \$15 DTMF DECODER \$15

The LJM2RK decoder kit converts your receiver into a special receiver or control. When a user-selected time-tone combination is received, the output provides a relay control for activating speakers or other devices.

INPUT: Audio from transceiver, scanner, etc.  
OUTPUT: SPST (N.O.) relay.

**FEATURES:** Single or dual tones adjustable over the 16 digit Touch Tone range • Adjustable response time • Relay output • Manual or auto reset • Single tone ON latching with different single tone reset OFF • Operates on 12VDC • Interfacing of multiple boards for multi-digit sequential activation and reset.

**APPLICATIONS:** Call-up system • Repeater or commercial controls • Etc. limited only to your imagination •

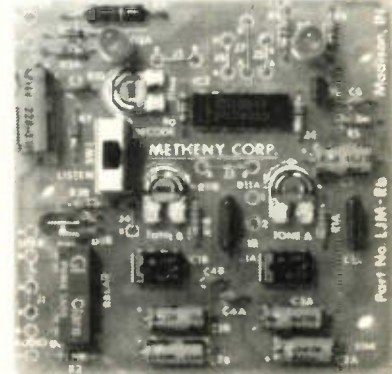

Actual Size 3"x3" - Shown Assembled

LJM2RK decoder kit includes all component, relay, and P.C. Board. . . \$15 plus \$1.50 shipping.

LJM2RC enclosure kit includes molded case, speaker, input cable. . . \$5 plus \$1.50 shipping.

For information and to order write:

**THE METHENY CORPORATION**  
204 Sunrise Drive, Madison, IN 47250 ✓ 205



# You Can Build This Code Trainer

*More than a mere code-practice oscillator, this CPU-controlled trainer features burned-in practice groups. Flick a switch and you have a keyer.*

If you are a ham who wants to upgrade or a ham to be, or if you know someone who wants to be a ham, there is now a low-cost, single-chip microcomputer for you. It is called the CPP1. The CPP1 is a single-chip microcomputer that contains copyrighted software for teaching Morse code. It also doubles as an electronic keyer (iambic) for added versatility.

The unit can be built in one evening. This makes it ideal for the time-pressed person who would rather be involved with amateur radio than with computer technology. Virtually everything is contained on the chip except the dot clock and the tone generator. These are built around the low-cost 555 timer chip.

Learning Morse code using tapes and records is a frus-

trating experience. It's difficult to concentrate when you have to keep stopping and rewinding to the beginning of a particular practice group. Also, tapes and records never seem to have the

right speeds to practice at. They are either too fast or too slow.

Personal computers are far better. However, their cost is a problem, especially

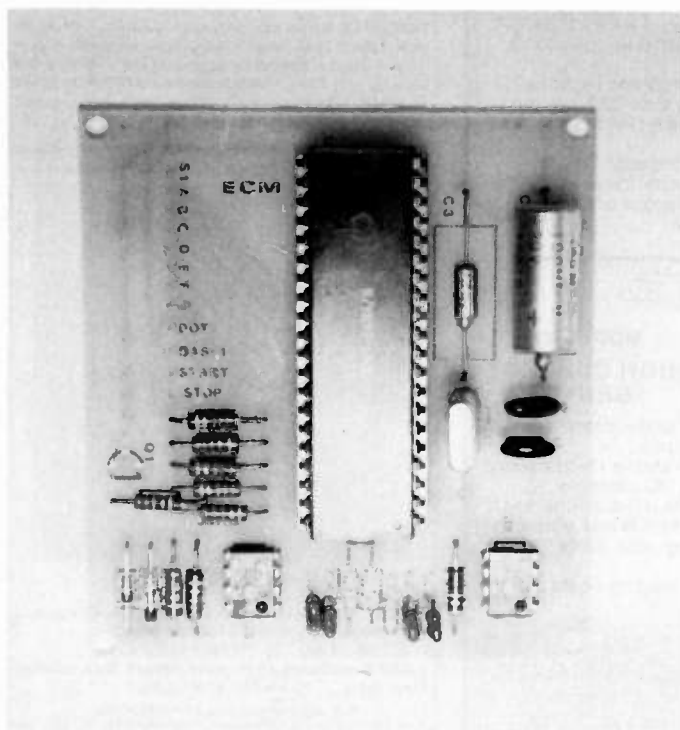

Photo A. The CPP1 circuit board.

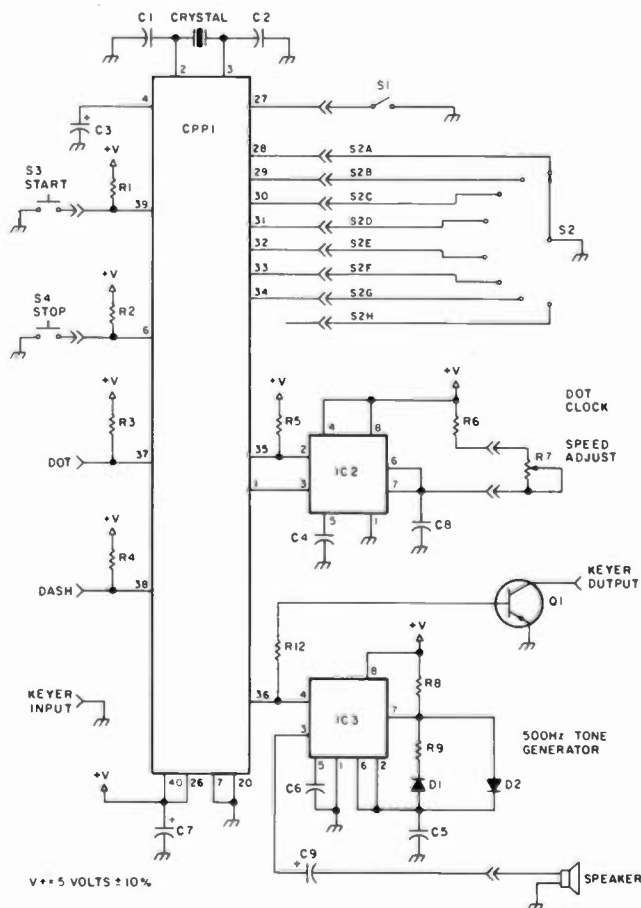

Fig. 1. Schematic.



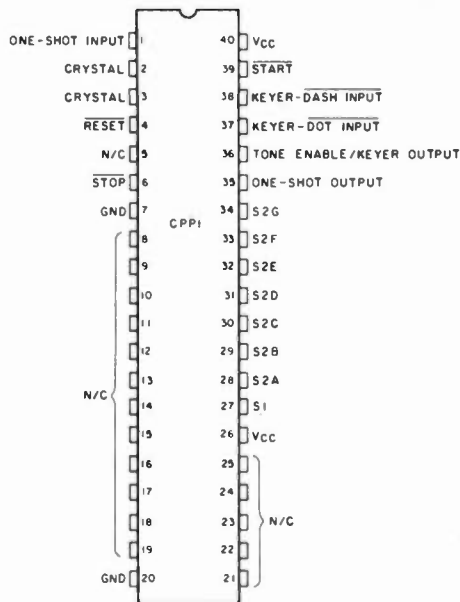

Fig. 2. Pin description.

if your budget is tight. In addition, most people do not have the technical or software knowledge to make this approach viable.

The CPP1 solves both of these problems. The chip contains 15 practice tables. They are organized to provide for ease of learning. When a particular table is selected, it will repeat until the user decides to move on. Speed is virtually unlimited, however; with the components called out later, the processor will send perfect code from 2 wpm to over 40 wpm. Finally, it is simple to use. No need for a degree in computer sciences to use it; just select and go.

### Circuit Description

The heart of the code trainer/keyer is the CPP1. Contained in this 40-pin package are 128 bytes of RAM, 2K of ROM, an 8-bit CPU, a reset circuit, a clock, and predefined I/O ports. It is a true system on silicon.

To get the CPP1 to function requires a simple crystal/capacitor addition to pins 2 and 3 of the processor (see Fig. 1). The crystal can be from 1 to 6 MHz. A 3.57-MHz color-burst crystal is recommended because of its availability and low cost.

In order to ensure proper start-up, the chip contains a

reset circuit that holds the processor in a known state until power is stable. The chip must stay reset for at least 50 milliseconds. This is accomplished by capacitor C3 on pin 4 of the CPP1. When power is applied, the capacitor will hold this line low. An internal pull-up resistor will then start charging the capacitor. When the capacitor reaches a high level, the processor function will start.

The processor at this time will set the I/O ports up per its internal program. It will then start testing the start button for a closure (pulled to ground). When a valid switch closure is recognized, the program will next test switch S1 to see if it is open or closed.

Switch S1 determines which table is to be executed (see Tables 1 and 2). If switch S1 is open, Table 1 will be selected. If switch S1 is closed, Table 2 will be utilized.

Next, the processor will test switch S2 to determine which subgroup to run. There are a total of 8 subgroups per selected group. Seven require that one of the pins, 28 through 34, be pulled to ground through switch S2. The eighth group is selected when all eight pins are open.

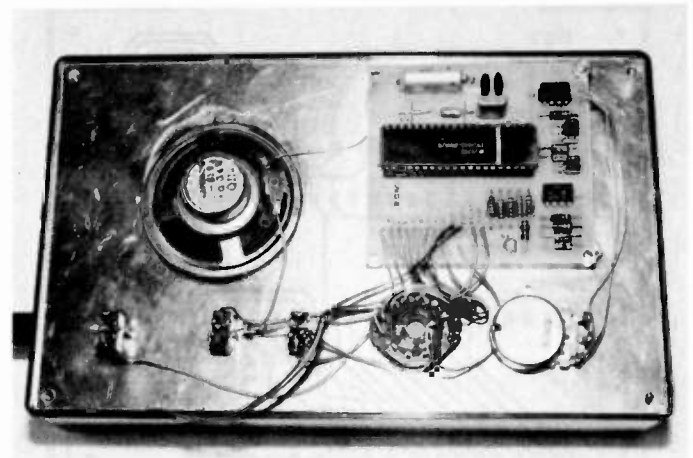

Photo B. The inside top panel of the CPP1.

Upon determining which subgroup has been selected, the processor will start sending at the rate of the dot clock, IC2. All timing is based on the dot clock.

The processor will send out a short pulse from pin 35 of the CPP1 to fire the one-

shot (IC2). It will then test pin 1 for it to time out. This is one dot time. For dashes, it will do this three times.

The tone is generated by IC3, a simple 500-Hz tone generator. Pin 36 of the CPP1 will go to a high level whenever the tone is on; it

S1 Open		
S2A closed E I S H 5 U F	S2B closed T N D B 6 - K Y	S2C closed ? 2 V 3 4 A R
S2D closed () C ; X / -- M G	S2E closed L W P J 1 . "	S2F closed Z 7 0 0 9 8 : Q ,

[ - hyphen; ? question mark; () parentheses; ; semicolon; / fraction bar; --break; . period; " quotation mark; : colon; , comma ]

### S2G closed

E?LTZ I2WN() SVPD7 JOT1A H3BCJ 654.X KUAIO YFR'M ,GVK9 A;JQ-- /80EL :-ZBI Z()7JX OM9--L ITNDC .1"KQ EBLWP B4ARV J0Z?2 V35UF G;8-E ISH6K Y,A: XLCQP V2FEK :J--DK WR?U-6/79N "LAZ5 8HAM() T1B40 3;S,Z O1.EB JVGIY

### S2H closed

Electronic Keyer Option

### Practice Groups With Morse Code Pattern

S2A closed	S2B closed	S2C closed
E .	T -	? ..---
I ..	N -.	2 ...---
S ...	D -. .	V ...-
H ....	B -..	3 ....-
5 .....	6 -...	4 .....-
U ..-	- -.-.-	A ..-
F ...-	K -.-	R -.-
	Y -.-	
S2D closed	S2E closed	S2F closed
0 -.-.-	L -..	Z ---
C -.-.	W ---	7 ---.
; -.-.-	P ---.	0 ----
X -.-	J ----	9 -----
/ -.-.	1 -----	8 -----
-- -.-.-	. -.-.-	: -----
M --	" -.-.	Q ---.
G ---		

Table 1.

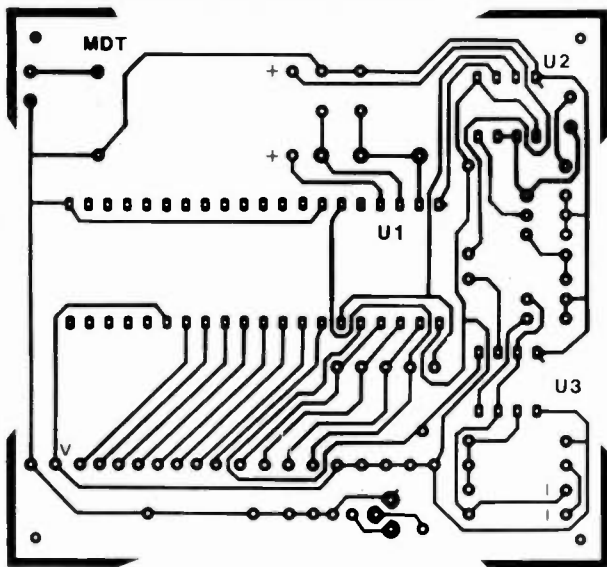

Fig. 3. Circuit board, foil side.

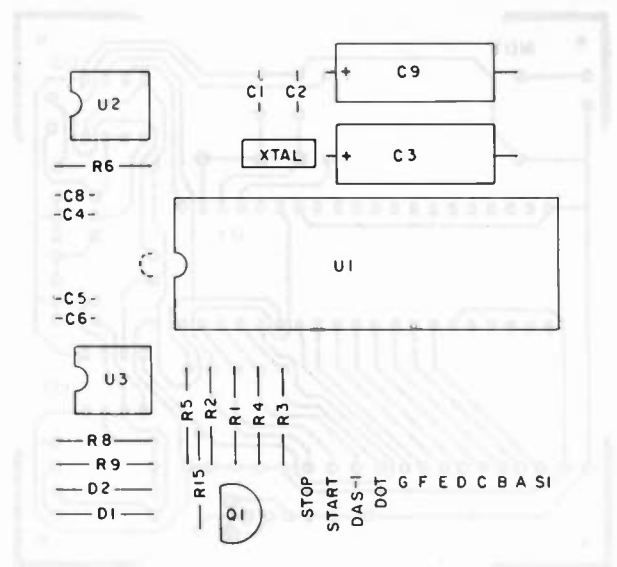

Fig. 4. Circuit board showing parts placement.

goes low to turn it off. To stop the sequence, pin 6 of the CPP1 must be pulled to ground through the stop button. (It should be noted that the start and stop buttons can be either normally-open push-buttons, as shown in Fig. 1, or toggle switches.) At this time, the processor will start testing the start

pin again, except in the keyer mode.

In the keyer mode (switch S1 and S2 open), when the start is pressed, the chip will enter the keyer mode. To leave it, the power must be turned off. This is to eliminate any chance of the keyer going out during transmission.

### Construction

Assembly is very straightforward. The circuit can be hand-wired in about an hour or two, or a simple single-sided PC board can be used.

The crystal should be located as close as possible to the CPP1. This is standard for any microprocessor.

C7 must not be left out.

This stabilizes the power to the chip when the tone is on. If it is left out, it is possible that the internal program will jump out of sequence.

Custom tailoring the CPP1 to your particular needs can also be done. Some examples are:

- replacing the speed control with a rotary switch with fixed resistors,
  - replacing R9 with a potentiometer for tone control, and
  - adding a volume control.
- These are just a few of the many variations possible.

### Operation

The CPP1 is extremely easy to use. Apply power. Set switch S1 to the appropriate practice table. Set switch S2 to the desired subgroup. Press start and adjust speed. That's it!

Your selected practice group will cycle until stop is pressed. At this time, another practice group can be selected. Speed may be adjusted any time.

To use the keyer function, set both switches S1 and S2 to the open position. Then press start. You are now in the keyer mode.

When pin 37 is brought to ground, a series of dots will be sent. When pin 38 is brought to ground, a series of dashes will be sent. Finally, when both pins 37

S1 Closed								
<b>S2A closed</b>								
HEFSU	5IEUH	H5EIF	USH5H	I5SFE	EI5S5	FEIHS	SUI5F	UEFHE
FUI5E	SIFHE	5UESH	HEFIU	FEH5I	USEFI			
<b>S2B closed</b>								
B-YTD	N6KBY	-KTD6	TYNKD	BKNT-	DY6D-	TBDKT	YKTND	-6KYK
BN-TB	KYTDN	6-KYD	D6YTK	YBTND	K6NYT			
<b>S2C closed</b>								
V4R2A	?3R42	A?VR3	24VA?	3A?V3	A23?3	24RAV	RRVV?	43?4A
V?A23	RAV42	3R2V4	AVR?2	V4R2V	?RV42			
<b>S2D closed</b>								
X;()GC	/--MXG	()XGCM	M/XM--	;C()--X	CGM--X	GXCM--	()MGX()	
;-X/C	X/()M;	MXCGM	--X;C/	GM/;C	CXM--G	M;/()X		
<b>S2E closed</b>								
J.L1P	"WPJ1	LW1."	L1JWP	.PJWL	P1"PL	1J.WW	LPJ1W	.W11J
J"LWP	LJWP1	".JPL	1PWJL	LJ"P1	W.1JP			
<b>S2F closed</b>								
0;ZO	798Q:	ZQO87	O9;8	,OQ9Z	0:78Z	ZQ8,9	,8O:Q	:9Q9O
07ZO,	ZOQ9:	Q,9:Z	9OZ70	QZ0:9	8O7,Q			
<b>S2G closed</b>								
92837	46510	49628	53709	96821	13579	25680	95062	13467
53751								
<b>S2H closed</b>								
..-"/	-:(?)	-:;--	()"/:	;;--?	?")/:	-:;--	:(0;:	
?"-;/	()"/-?							

Table 2.



# At Last.

A microthin, synthesized,  
programmable, sub-audible  
tone encoder that fits inside  
the ICOM IC-2AT.

Need we say more?

\$29<sup>95</sup>



**COMMUNICATIONS  
SPECIALISTS** ✓15

426 West Taft Avenue, Orange, CA 92667  
800/854-0547 California: 714/998-3021

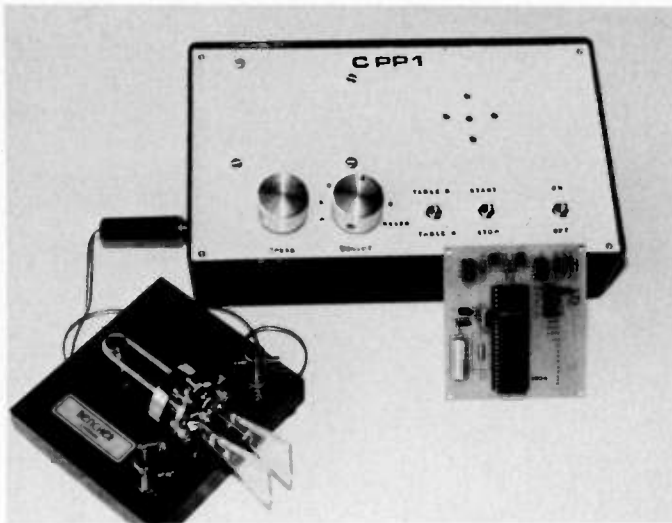

Photo C. Adding a key turns the CPP1 into an iambic keyer.

and 38 are held to ground, alternating dots and dashes will be sent.

A final operating note concerning speed: Selecting the proper speed for prac-

tice may be done in one of two ways. The simplest way is counting dots. This is accomplished by setting the CPP1 to the keyer mode and pressing start. Hold the dot input line low and count the dots for one second. Once the number of dots per second has been determined, it is a simple case of calculating the speed by the following formula: speed (wpm) = 2.4 × dots/sec. For example, if 5 dots are counted in one second, then speed = 2.4 × 5 dots/sec = 12 wpm.

The second method is based on a known fixed resistor value. Since all timing is based on a dot time, it is a simple matter of using the following formula for deter-

mining the one-shot time: dot = 1.1 × (R6 + R7) × C8.

### Conclusion

Learning Morse code, or increasing one's speed, has been a problem since the early days of ham radio. Learning Morse code should be fun and easy. However, traditional means using tapes and records generally make it less than desirable.

The CPP1 puts learning Morse code into the computer age without the hassle. Using the CPP1 makes learning code fun and easy. Using this device 15 or 20 minutes a day, followed by listening to actual ham conversations for about the same amount of time, will make code learning exciting and rewarding. ■

### Parts List

QTY	ICs	
1	IC1	CPP1 code practice processor
2	IC2, IC3	NE555 timer
<b>Capacitors</b>		
2	C1, C2	22 pF ceramic
1	C3	1 uF, 10 V dc
3	C4, C6	.01 uF
2	C5, C8	.1 uF
1	C9, C7	100 uF, 10 V dc
<b>Resistors</b>		
9	R1-R5, R8-R9	15k, ¼ Watt
1	R6	220k, ¼ Watt
1	R7	2 meg potentiometer
<b>Miscellaneous</b>		
2	D1, D2	1N914 or equivalent
1	S1	SPDT toggle switch
1	S2	8-position rotary switch
2	S3, S4	normally-open push-buttons
1	crystal	1.6 MHz (3.57 MHz nominal)
1	speaker	8-Ohm speaker
<b>Keyer Option</b>		
1	R12	4.7k, ¼ Watt
1	Q1	2N3904 or equivalent

The CPP1 code practice processor chip is available from Micro Digital Technology, PO Box 1139, Mesa AZ 85201, for \$19.95 ppd., PCB, \$5.00. Checks, Visa, and Mastercard accepted. On credit card orders, please include card number, expiration date, telephone number, and full name. For phone orders, call (602)-897-2534. OEM and dealer inquiries welcome. Complete parts kits available from the following distributors:

Greenbrier Marketing  
International, Inc.  
509 S. 48th St., Suite 105  
Tempe AZ 85201.  
Price: \$49.95 postpaid.

Chaney Electronics  
PO Box 27038  
Denver CO 80227  
(303)-781-5750

Circuit Specialists  
PO Box 3047  
Scottsdale AZ 85287  
(800)-528-1417

Radiokit  
Box 411  
Greenville NH 03048  
\$47.00 (kit)

Gigatech\*  
9520 Chesateake Dr.  
San Diego CA 92123  
(714)-268-8131

\*will be selling completed units in addition to kits.

### "KEEP IN TUNE WITH THE WORLD"

\*\*TECHNICAL ASSISTANCE BY F.C.C. LICENSED TECHNICIANS USING THE FINEST TEST & ALIGNMENT EQUIPMENT AVAILABLE:

- repairs
- alignments
- modifications
- installation of custom circuits

### \*\*PRODUCTS AVAILABLE:

- QSK keying
- VOX
- Power supplies—[memory keep alive]

\*All above circuits for solid state equipment manufactured by

**PARSEC**  
COMMUNICATIONS

12325 Madonna Dr. Lansing, Michigan 48917

(517) 627-2650 (8 am-5 pm)  
(517) 627-2879 (6-10 pm) (EST)

Geff N8CE



### ILLINOIS' OLDEST HAMFEST

Sponsored by

## The Fox River Radio League

Sunday - August 21, 1983

Kane County Fairgrounds - St. Charles, IL

Commercial Exhibits • Flea Market • ARRL Booth  
• Contests • Demonstrations • Hot Food

Tickets: \$2.00 in advance - \$3.00 at gate

Send SASE: G. Frieders, W9ZGP, 1501 Molitor Road, Aurora, IL 60505

Dealers Contact: G. R. Isely, WD9GIG  
736 Fellows Street  
St. Charles, IL 60174



**The BEST is still  
"made in U.S.A."**



# MIRAGE

**American made RF Amplifiers and Watt/SWR Meters  
of exceptional value and performance.**

• 5 year warranty • prompt U.S. service and assistance

## RF AMPLIFIERS

### 2 METERS-ALL MODE

**B23** 2W in=30W out \$89.95  
(useable in: 100 mW-5W)

**B108** 10W in=80W out \$179.95  
(1W=15W, 2W=30W) RX preamp

**B1016** 10W in=160W out \$279.95  
(1W=35W, 2W=90W) RX preamp

**B3016** 30W in=160W out \$239.95  
(useable in: 15-45W) RX preamp  
(10W.=100W)

### 220 MHz ALL MODE

**C106** 10W in=60W out \$199.95  
(1W=15W, 2W=30W) RX preamp

**C1012** 10W in=120W out \$289.95  
(2W=45W, 5W=90W) RX preamp

**C22** 2W in=20W out \$89.95  
(useable in: 200mW-5W)

### RC-1 AMPLIFIER

**REMOTE CONTROL** \$24.95  
Duplicates all switches, 18' cable

## WATT/SWR METERS

- peak or average reading
  - direct SWR reading
  - MP-1** (HF) 1.8-30 MHz
  - MP-2** (VHF) 50-200 MHz
- \$119.95

### 430-450 MHz ALL MODE

**D24** 2W in=40W out \$199.95  
(1W=25W)

**D1010** 10W in=100W out  
(1W=25W, 2W=50W) \$319.95

Available at local dealers throughout the world.

**MIRAGE**  
COMMUNICATIONS EQUIPMENT, INC.

P.O. Box 1393, Gilroy, CA 95020 (408) 847-1857

# CES INTRODUCES THE NEW 510SA "SMART PATCH"

## The State of the Art Simplex Interconnect

Communications Electronics Specialties introduces the CES 510SA "Smart" Simplex Autopatch, with many important new features never available before:

- Three digit control codes with user programming.
- A sophisticated toll restrict provides positive long distance lock out.
- Time-out and COR activity timers with warning beeps and digital programming.
- Rotary or DTMF dialing.
- Phone line in-use detector prevents interrupting a call in progress, and sends unique CW sequence.
- Phone ring detection logic enables unique CW sequence.
- Digital programming of the sample rate and width, and noise gate sensitivity control, for easy interfacing with most radios.

Simple and direct connections to radio.

Options available: • Smart CW identifier with unique CW messages for each patch function.

- FCC type accepted phone line coupler.
- Special tone squelch kit to operate patch through repeaters.



The 510SA — the newest advance in interconnect technology, from the innovators at: Communications Electronics Specialties, Inc.  
Post Office Box 507 • Winter Park, Florida 32790  
(305) 645-0474 • Toll-free (for orders only): (800) 327-9956 ✓462

## ALL HF BANDS !



### The SLINKY DIPOLE® Antenna

A broadband, low SWR dipole that really works in apartments, small yards, attics, anywhere a small antenna is a must. Indoors or out, you can work ANY HF BAND, including 10 MHz. No gimmicks or add-ons. Imagine 80M in as little as 24 ft.! Complete kit and instructions, plus 50 ft. of coax. Easy to set up and adjust. More information available - just call or write.

**Blacksburg Group**  
Box 242 Suite 500  
Blacksburg, Virginia 24060  
703/951-9030

**\$67.95 postpaid** (in U.S.A.)  
Money Back Guarantee  
Virginia residents  
add 4% sales tax

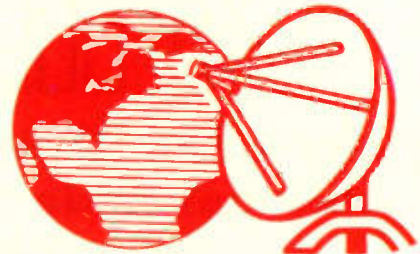

## SATELLITE TELEVISION SYSTEMS

**WE WILL NOT BE UNDERSOLD!!**

Complete Systems, Antennas,  
Receivers, LNA's & Accessories

**CALL US TODAY!**

✓320

**812-238-1456**

**hoosier electronics**

"Nation's Largest Total Communications Distributor"  
P.O. BOX 3300 • TERRE HAUTE, INDIANA 47803



# TECHNOLOGICAL BREAKTHROUGH!



# NEW

AMERICA'S SECOND GENERATION MICROWAVE RECEIVER

# SATURN-15 XHP

## JDL Leads Again

The Saturn-15 XHP, an engineering breakthrough from JDL laboratories, has new State-of-the-Art technology never before incorporated in amateur band general microwave receivers. This technology increases reception from distances never before achieved. By designing totally new circuitry, and using new ultra-sensitive components, coupled with a precision tuned 30 inch receiving dish, a system gain of 68 decibels makes the Saturn-15 XHP the leader in microwave receivers. In field tests, the Saturn-15 XHP received clear, crisp pictures, where other units tested were snowy. During these tests the Saturn-15 XHP's highly sensitive downconverter probe was able to receive a color picture without a dish. No other unit tested could pass this test.

## Free Movies for You

That's right! Free movies, sports, and special events, 24 hours a day and all commercial free. The Saturn-15 XHP super deep fringe microwave receiver can be used by homeowners outside the service area of local over-the-air pay TV stations (ex. HBO, Showtime). Yes, if the local pay TV station installs microwave receivers on homeowners TV mast, you too can receive those unscrambled signals free by installing the Saturn-15 XHP on your TV mast in minutes. A signal can be received up to 100 miles, depending on the height and power of the local transmitter, and the installed height of the Saturn-15 XHP. If you have waited to own a microwave receiver, or own a low power unit, call and order your Saturn-15 XHP and own the most powerful receiver available today. Free TV—yours for a call. Note: General microwave receivers cannot be used for receiving scrambled signals. Nor can they pick up from cable TV or their relay towers.

## A Total Unit

The Saturn-15 XHP comes complete with a 30 inch precision tuned receiving dish, advance design downconverter, power tuner, 60 feet

coaxial cable, necessary adapters, mounting hardware, and installation instructions. A six month parts and service warranty covers the Saturn-15 XHP.

## Information for your Area

By calling our information number (916) 454-2190 and talking to one of our trained technicians, we can help determine if the Saturn-15 XHP will work for you.

## A Very Special Introductory Offer!!!!

As JDL Industries has and continues to provide the very best in products and customer service, we want everyone to be able to enjoy our new system, Saturn-15 XHP. The regular price for the Saturn-15 XHP is \$285.00. Order C.O.D., pay only \$260.00 and save \$25.00. Trade in your old unit, from any manufacturer or home built, working or not, with your order, pay only \$235.00—save \$50.00. Or if you own our original Saturn-5 and wish to upgrade to the Saturn-15 XHP, return your unit and pay only \$210.00—a savings of \$75.00. We also accept Visa and Mastercharge at the regular price, \$285.00. Sorry—no personal checks. Shipping (\$9.50) and 6% sales tax for Calif. residents not included. Trade-in units become the property of JDL Industries and cannot be returned under any circumstances.

Call our toll free number for placing orders only.

Information is not available at this number.

1-800-824-7927

U.P.S.—C.O.D./Volume prices on request —

(916) 454-2190

Microwave Systems

**JDL**

INDUSTRIES, INC.

4558 Auburn Blvd., Suite 208, Sacramento, CA 95841

Saturn-15 XHP must be returned within 14 days of delivery for refund if not satisfied, and is subject to a 25% restocking charge.

# The True Story Behind Heard Island

*Fighting bad weather, shady ship owners, and bad press,  
the HIDXA expedition forged its way to the DXer's dream.  
But getting there was only half the battle.*

The idea of a possible DXpedition to Heard Island came to Jim VK9NS while he was still P29JS and living in Papua New Guinea. Heard Island, in the southern Indian Ocean, is situated in one of the world's stormiest seas, uninhabited, inhospitable, and not really "en route" to any-

where. So the only way to get there would be to catch a lift or charter a vessel for the voyage. The vessel would have to be sturdy and suitable, with an experienced skipper for those waters. The cost for such a lengthy trip would be high, but if the money could be found, such a DXpedition

could take place. So the Heard Island DX Association (HIDXA) was formed early in 1980, and the long and stormy road to Heard Island commenced.

Assistance was asked for, and many an amateur contributed. Jim, in his dealings with the authorities, met with goodwill and interest

from all concerned. A set of guidelines was formulated for private expeditions visiting Heard Island, and he got permission to visit, pending a firm proposal. License for Heard Island was issued —VKØJS.

Meanwhile, the hunt for a suitable vessel was on, and word was out for interested operators. The season for visiting Heard Island is very short, involving January through March of each year. A vessel was in fact found for the 1981 season, but the enormous cost involved could not be met at the time, and this very suitable charter and experienced skipper had to be abandoned.

Unfortunately, HIDXA was now led astray by promises regarding a West Australian shipping firm who said that they intended to send a fishing-survey ship to Heard Island waters in the 1981 season and would take a group of amateur radio operators along for a reasonable sum of money. This proposal sounded just too good to be true, and of course, as we all know, it turned out to be just that.



*Preparing for departure.*





Equipment and stores in the hold of *Cheynes II*.

Months of not knowing and being put off with "we will know for sure next week" persisted until the season was over. During 1981, it was a continuation of "next week for sure," regarding plans for 1982, until it became clear that "next week" would never come. We heard that Dr. Lewis might be going to Heard Island on the *Dick Smith Explorer* in 1982 and we had berths booked on that ship should they be headed that way. As it turned out, they went to Antarctica instead.

So the hunt for a vessel for 1983 went on. The problem was mainly financial. People do not really want to give money to a project which is not 100% guaranteed. Money might be promised *after* the expedition, but shipowners want payment in advance. So we were really faced with a sort of "catch 22."

Now came the surprising news that IDXF and NCDXF had pledged \$20,000 in order to send 2-3 operators along with a group of mountaineers who were planning an expedition to Heard Island to climb Big Ben. At the same time, concentrated efforts to discredit HIDXA and statements that Jim would never go to Heard Island and had no intention of even trying began to appear on the bands. Jim had always stated that if the expedition did not take place, he would refund do-

nations. Four out of 300-odd persons who had donated to HIDXA asked for their money back; so it goes to show that most people do not take as gospel truth whatever they hear on the grapevine.

SoJo VK0SJ spent Easter of 1982 on Norfolk Island. He and Jim spent long days working on the Heard Island project. SoJo proved himself to be just what we needed most—someone with know-how, interest, and "get up and go." He went back to Tasmania and started looking for a vessel. Jim was reluctant to go on the air and say "we are going in 1983" until he was fairly certain that this time it would happen. So it was not until early September of 1982, when the contract with the owners of the ex-whale-chaser *Cheynes II* had been signed, that we could really start our publicity campaign. We sent out masses of brochures, "stuffers," and letters. Now that the vessel was secured, it was smooth sailing ahead. The beauty of this contract was that the vessel was big enough to take up to 20 passengers. So, if we could find even 10-12 people with other interests, and 6-8 operators, with all of us paying \$3000 out of our own pockets, we could pay nearly the whole charter cost.

Universities were informed of this chance to visit Heard Island and adver-



Jim and Tom VK6MK in Albany.

tisements were placed in several Australian newspapers. Gradually, the team started to take shape. A firm proposal to the government was drawn up. This was several pages long since it had to include details of all personnel, equipment, landing gear, supplies, etc. But once submitted, it did not take long for the official blessing to come through in writing.

Meanwhile, on the bands, word had it still that we would never go and were just daydreaming, that the ship was a floating coffin, it was no good, etc. Some of the DX outlets took the trouble to print some of the material we had sent along, but others must have filed it straight into the wastepaper basket since their publications were quite innocent of any mention of HIDXA. IDXF and NCDXF, on the other hand, were never out of the news!

There was talk of "the race to Heard Island" in those publications in which we did rate a mention. It was of course never a race. It was a matter of two groups, with different objectives, going more or less at the same time. We were just continuing what Jim had started in 1980. No doubt the mountaineering group had also been planning for some time, but without amateur-radio involvement, the world of ham radio would not know. Heard Island was high on the "want-

ed" list and you could probably put five successive groups on the island, all of whom would work tremendous pileups. For goodness sake, we work endless pileups from Norfolk Island where there are 6 licensed resident amateurs! So this "race" idea was a bit silly. One publication topped that by advising its readers to "put their money" on IDXF/NCDXF, as if we were horses. It passes all understanding, for sure.

We got a lot of support from individual amateurs in many countries, and we received a lot of encouraging letters with the donations, so we knew we had the support of the individual amateur. Some of the small DX clubs also contributed, but the big clubs did not come forward; an approach to NCDXF proved futile. The lack of publicity left many in doubt as to our intentions. When we received \$100 from LIDXA, it was with a stern request to send the money back should the expedition not take place. We had already paid \$6700 as a deposit on the *Cheynes II*, but they received our money-back guarantee in writing.

The cost of an expedition to such a place as Heard Island is immense. Apart from the remainder charter cost which was paid by the expeditioners themselves, HIDXA had to find money for fuel, landing gear, food, generators, tents, tarpaulins,



Do we go on or don't we? Chief Mate and Skipper make the decision.



Battling headwinds on the way to Heard Island.

gas cookers, gas, and a number of bits and pieces. A suitable first-aid kit and supply of pharmaceuticals had to be provided. Rigs and antennas were mostly on loan, but with a guarantee to return or replace them if lost, thus requiring expensive insurance in addition to the freight cost. It made me wonder about certain people's sanity when I heard inane remarks about "going on an expedition to get rich." The idea that a green stamp with a QSL card is clear profit and it costs nothing to mail a card back is fondly believed by some people.

Life became very busy from September through December. Jim left for Tasmania in November to be on the spot for all the last-minute arrangements that had to be made. I remained on Norfolk Island to handle in-

coming correspondence and hold the fort. We kept in touch via radio or telephone, but with everything else on our minds, we both forgot our wedding anniversary on December 5; 2 years — you would think we had been married for 20.

I arrived in Tasmania on December 29. Those last few days before departure were very hectic. What with the holiday season and all the festivities, it seemed impossible to organize the final details, and departure had to be postponed for a couple of days. The rest of the team had already arrived. We were 17 people, including 5 scientists, 5 mountaineers, a journalist, and a cinecameraman. A mixed group for sure, but as it turned out, a very balanced group. We all got on well with each other. Maybe

the fact that each and every one of the expeditioners was required to pay \$3000 ensured that no one who was not very strongly motivated and did not really want to go to Heard Island was included in the expedition. We could have filled the ship with people who wanted to come for nothing, but our policy did not permit any freeloaders who might cause arguments and backbiting if the going got rough. A very wise move as it turned out.

Our troubles should now have been over, but this was not to be. We departed Hobart January 4 and struck a strong gale immediately. After battling ahead for 24 hours, the skipper advised that due to the high rate of fuel consumption and slow progress, we should return to Hobart to await more reasonable weather. Turning around in those mountainous seas was a frightening experience. The *Cheyne II*, which had been tossing around violently for hours already, now laid over momentarily to a 40° angle which sent everything crashing and broke the lashings on the two dinghies stowed on the foredeck. During the night, a wave had shot up under the boat deck and knocked a 3" plank clean out, so it was a slightly battered *Cheyne II* that returned to Hobart the following morning.

We now had three days of

hanging around Hobart, impatiently waiting for the weather to improve. It did improve somewhat, but we still stayed with no explanation forthcoming. Finally, we were scheduled to leave on Sunday morning, but Saturday evening we learned that departure had been postponed once again since the skipper/owner had decided not to come with us. A new skipper was found, and on Sunday afternoon, Captain Laurin MacEwan arrived and we were off again.

The southern route was abandoned. We took a westerly course while the skipper made himself familiar with the vessel. He soon found that the fuel consumption was alarmingly high. It bore no relationship to facts and figures quoted on our dealings with the company. In fact, Captain MacEwan found that we could not go to Heard Island from Hobart. The ship just did not have the range, in spite of all the expert advice and calculations which had been done by professionals. The only thing to do now was either to cancel the expedition or go to Albany, in western Australia, to refuel and make Heard Island from there. Naturally, we all agreed it would have to be Albany. There was no question of the ship not having the range for that distance. The mystery of the fuel consumption followed us all the way. Tanks were dipped



Peter VK6VR, Walter OE1LO, Kirsti VK9NL, Sojo VK0SI, Bernie VK6KJ, and Walt W7SE at Albany.





Our home on Heard Island.



VKØJS shack.

and charts consulted. Nothing seemed to add up. It was a worry for several days before they thought they had the problem licked.

We continued our voyage after refueling in Albany, and for some days everything ran smoothly. We settled down to a routine for shipboard life. All expeditioners were rostered for duty in the galley or on the bridge. Three would do the cooking, with cooks changing each day, and normal 4-hour watches were kept on the bridge, around the clock. The expeditioners got to know each other and the crew of 8, and with so many people with different backgrounds and experiences, there was always a lot to talk about.

Unfortunately, one of the operators, Walt W7SE, found it necessary to withdraw from the expedition in Albany. By then we were already so much delayed that he just could not risk further delays which would make him late back for work. Another scientist joined us in Albany so the number of people remained the same.

It now became apparent that we did not have enough water on board for the boilers. This was another mystery, but nevertheless a fact. We were supposed to carry 170 tons of water, but in fact, had only about 80 tons, another reason why the vessel did not have the range. The only thing to do

now was to call in at Kerguelen Islands to take on water. This would cost us extra fuel which we could ill afford. Arrangements were made with the owner that he would meet us on the way back with the necessary fuel to take us back to port in Australia.

Thus, we made a stop at Kerguelen. The French were kind and helpful. It seemed to us that we had been at sea for a lifetime, when in fact, it had been just two weeks since Albany. We had a lot to learn yet! The French invited us all ashore for lunch, and we savored every morsel of that meal. There was of course no chance of operating from Kerguelen. It was an unplanned-for port of call, and the necessary license could only have been issued in Paris, well in advance. In any case, we stayed only a few hours, so time would not have permitted operating from there.

Once again the expedition nearly came to a full stop. The *Cheyne II* dragged anchor and we could hardly believe our eyes when we dismally observed her drifting onto the rocks. It was very fortunate that nothing vital was damaged and we were able to continue on to Heard Island.

Finally, on February 5, there it was: Heard Island. We arrived in rain and mist, but it was reasonably calm, so unloading commenced

right away. Plans for landing equipment and personnel had been made during the voyage. All gear and food had been wrapped securely in plastic and sealed, so off-loading went smoothly. We had had breakfast at 4:30 am in order to make an early start.

Now began a back-breaking day. We had two Arboc huts for our use. The scientists and film crew settled into the one closest to the beach, and the hams had the other, smaller one up the hill. These huts are mere shells of unlined metal. They are completely devoid of furniture or amenities. But, they were waterproof even if somewhat drafty. Our hut was about 500 meters away and every bit of equipment, antennas, food, gas, cookers, generators, etc., had to be hand-carried all the way from the beach. The trips to and fro

were many, and I think we had all reached the stumbling stage by the end of the day. It rained; the black volcanic sand stuck to everything and the path was rocky and uneven. Finally, the beach was empty and we could think about getting a rig on the air and see about sleeping space and something to eat.

It was dusk by now. Our hut did not have a door. In spite of the rain which now came in torrents, the icy wind in the doorway, and the cramped conditions inside the hut, we got ourselves into some sort of order. Bob got one of the generators going and with a vertical antenna he was ready to open up from VKØJS. His first QSO went to ZS6IW. He worked some Europeans, but with the rain pouring down onto the unprotected generator, there suddenly was a power surge



The day the sun came out; Big Ben.



Tarpaulins made makeshift sails for the Cheynes II.

which put a stop to operations. We all retired to our sleeping bags. Being utterly exhausted, we slept extremely well.

I was the first one awake the next morning. Jim, SoJo, and Bob looked like three blue elephant seals in their sleeping bags. It had stopped raining, and soon we were all busy putting up more antennas, making the hut more livable, and getting properly organized. A 3-element ten-meter beam and a 3-element 15-meter beam were unpacked and erected without any trouble. We had brought a Minooka Special for 160 meters, but unfortunately, even with all expeditioners lending a hand, putting up this huge vertical proved too much in the strong wind. She bent beyond repair and had to be abandoned. The TH3 tribander was the last one to go up, complete with rotor. The other beams had a hand-operated turning arrangement. One of the tents

was put up to house the generators, and inside the hut, Jim hung other tents to keep some of the draft out, the final one being hung in the doorway to act as a door. We had four rigs ready for use and had brought spare rigs just in case.

A solar flare made radio conditions extremely poor. I suppose we were lucky it did not put a full stop to propagation for the duration of our stay, but it was very unfortunate that it had to happen at all. We worked. One of us would monitor the bands and call CQ regularly. If there was an opening, we knew about it and made the most of it. Openings sometimes lasted only a few minutes, but after a few days, we found that 20 meters was usually open to America in the early morning hours. Europe was around in the evenings, and Asia and Pacific at odd times during the day. Night-time was a bit unpredict-

able, but we kept watch on the bands around the clock.

We were now joined by Walter OE1LO, who had been helping the mountaineers get started on their climb up Big Ben on a new route from Mechanics Bay. With the poor band conditions, we were more than enough operators, and some of us actually just sat idle most of the day. SoJo was in charge of all RTTY and SSTV gear and made the first QSO ever from Heard Island on these two modes. He also made the first satellite QSO from Heard Island. So, by making use of every little opening, the number of QSOs crept up. VKØJS made about 12,400 QSOs, with VKØNL making about 2000. This was not a bad score in poor conditions.

The *Anaconda II* operators were also active. This meant that only one of our stations could operate on whatever band happened to be open. If VKØCW was on 20 meters CW, then we could only be on 20 meters SSB instead of having one station on CW and one on SSB. This, of course, applied to the other group as well.

Bob took charge of the generators. He kept them going, serviced them, refueled, and did some repairs. None of us got a tremendous lot of sleep. The shack was noisy, cold, and cramped. But the days passed quickly. We were more or less self-contained in our hut, being able to do the basic cooking there and not having to leave the bands to turn up for meals in the other hut. Not very sociable, but time did not allow for socializing. In fact, when the other three ladies of the expedition were invited aboard the *Anaconda II* for dinner one evening, I was not even asked. At least I like to think that this was because everyone knew the hams were too busy to socialize! (It could have been those shapeless oilskins combined with my ad-

vanced years, of course.)

So we worked. The scientists took samples from penguins, counted them, measured temperatures on rocks and under rocks, collected samples of this and that, and generally had a very successful time on the island. The mountaineers climbed their new route towards the summit of Big Ben, keeping in touch by VHF skeds twice daily. The film crew filmed everyone and everything and will have an excellent documentary of the whole fantastic voyage and stay on the island, to be released on Australian TV in June/July, 1983. It is expected that this film will also be released overseas in due course.

We had hoped to extend our stay a few more days, but due to the precarious fuel situation on the *Cheynes II*, this could not be. So we were due to depart February 15 at 1600. In preparation for this, we started to carry some things to the beach, intending to keep one rig on the air till the bitter end. However, the wind was quite strong, and by lunchtime, a full storm blew up. This was the Heard Island we had feared. Atlas Cove boiled; sea spray was blown far inland. Ashore, the black volcanic sand whipped and blasted. The *Anaconda II* operators lost their beam; the mast just buckled effortlessly. It became clear that departure was impossible and we made our way down to the beach to make sure the gear already there was secure. Here, we found that the seas were rising and everything had to be moved further up—an enormous task in that wind. Gusts were measured up to 80 knots and some of us were literally blown off our feet. At one stage, I was sent flying and ended up underneath the tarpaulin which we used to cover the goods. The *Cheynes II* had to get up steam to keep from drifting





# ICOM

# - Check the Savings at AES®!



**HF Transceivers:** Regular SALE  
 IC-740\* 9-band 200w PEP Xcvr..... \$1099.00 949<sup>95</sup>  
 \*plus FREE PS-740 Internal power supply &  
**\$50 Factory Rebate** until 7-31-83

- |  |          |                   |
|--|----------|-------------------|
| PS-740 Internal power supply.....      | \$159.00 | 149 <sup>95</sup> |
| EX-241 Marker unit.....                | 20.00    |                   |
| EX-242 FM unit.....                    | 39.00    |                   |
| EX-243 Electronic keyer unit.....      | 50.00    |                   |
| FL-44 SSB filter (2nd IF).....         | 159.00   | 129 <sup>95</sup> |
| FL-45 500 Hz CW filter (1st IF).....   | 59.50    |                   |
| FL-54 270 Hz CW filter (1st IF).....   | 47.50    |                   |
| FL-52 500 Hz CW filter (2nd IF).....   | 96.50    | 89 <sup>95</sup>  |
| FL-53 250 Hz CW filter (2nd IF).....   | 96.50    | 89 <sup>95</sup>  |
| MB-12 Mobile mount.....                | 19.50    |                   |
| HM-10 Mobile scan microphone.....      | 39.50    |                   |
| IC-730 8-band 200w PEP Xcvr w/mic..... | \$829.00 | 649 <sup>95</sup> |
| FL-30 SSB filter (passband tuning)...  | 59.50    |                   |
| FL-44 SSB filter (2nd IF).....         | 159.00   | 129 <sup>95</sup> |
| FL-45 500 Hz CW filter.....            | 59.50    |                   |
| EX-195 Marker unit.....                | 39.00    |                   |
| EX-202 LDA interface; 730/2KL/AH-1     | 27.50    |                   |
| EX-203 150 Hz CW audio filter.....     | 39.00    |                   |
| EX-205 Transverter switching unit....  | 29.00    |                   |
| HM-10 Mobile scan microphone.....      | 39.50    |                   |
| MB-5 Mobile mount.....                 | 19.50    |                   |
| IC-720A 9-band Xcvr/.1-30 MHz Rcvr \$  | 1349.00  | 999 <sup>95</sup> |
| FL-32 500 Hz CW filter.....            | 59.50    |                   |
| FL-34 5.2 KHz AM filter.....           | 49.50    |                   |
| MB-5 Mobile mount.....                 | 19.50    |                   |
| IC-7072 transceiver interface, R-70 .. | 112.50   |                   |

- New Model!** Regular SALE
- |                                       |     |  |
|---------------------------------------|-----|--|
| IC-751 9-band xcvr/.1-30 MHz Rcvr ... | TBA |  |
| Internal power supply.....            | TBA |  |
| FL-52A 500 Hz CW filter.....          | TBA |  |
| FL-53A 250 Hz CW filter.....          | TBA |  |
| FL-33 AM filter.....                  | TBA |  |
| HM-12 Hand microphone.....            | TBA |  |
| SM-6 Desk microphone.....             | TBA |  |
| External frequency controller.....    | TBA |  |
| High stability reference crystal..... | TBA |  |

- Accessories: 720/730/740** Regular SALE
- |  |          |                   |
|--|----------|-------------------|
| PS-15 External 20A power supply.....     | \$149.00 | 134 <sup>95</sup> |
| EX-144 Adaptor; CF-1/PS-15.....          | 6.50     |                   |
| CF-1 Cooling fan for PS-15.....          | 45.00    |                   |
| PS-20 20A switching ps w/speaker.....    | 229.00   | 199 <sup>95</sup> |
| CC-1 Adaptor; HF radio to PS-20          | 10.00    |                   |
| CF-1 Cooling fan for PS-20.....          | 45.00    |                   |
| SM-5 8-pin electret desk mic.....        | 39.00    |                   |
| SP-3 External speaker.....               | 49.50    |                   |
| Speaker/phone patch (specify radio)..... | 139.00   | 129 <sup>95</sup> |
| AT-100 100w 8-band automatic ant tuner   | 349.00   | 314 <sup>95</sup> |
| AT-500 500w 9-band automatic ant tuner   | 449.00   | 399 <sup>95</sup> |
| AH-1 5-band mobile ant w/tuner.....      | 289.00   | 259 <sup>95</sup> |

- HF Linear Amplifier** Regular SALE
- |  |         |      |
|--|---------|------|
| IC-2KL 160-15m/WARC solid state linear | 1795.00 | 1299 |
|--|---------|------|



**VHF/UHF Multi-modes:** Regular SALE  
 IC-251A 2m FM/SSB/CW Xcvr/AC ps... \$749.00 569<sup>95</sup>  
**\$50 Factory Rebate** until 7-31-83

- |  |              |                   |
|--|--------------|-------------------|
| IC-551D 80w 6m Xcvr.....                 | \$699.00     | 599 <sup>95</sup> |
| PS-20 20A switching ps/spkr.....         | 229.00       | 199 <sup>95</sup> |
| CF-1 Cooling fan for PS-20.....          | 45.00        |                   |
| EX-106 FM adaptor.....                   | 125.00       | 112 <sup>95</sup> |
| IC-451A 430-440 SSB/FM/CW Xcvr/ps        | 899.00       | 769 <sup>95</sup> |
| IC-451A/High 440-450 MHz Xcvr/ps         | 899.00       | 769 <sup>95</sup> |
| AG-1 15 db preamp, IC-451A/45A...        | 89.00        | 79 <sup>95</sup>  |
| VHF/UHF FM:                              | Regular SALE |                   |
| IC-25A 2m, 25w, up-dn-tp mic, grn leds   | \$359.00     | 319 <sup>95</sup> |
| IC-25H as above, but 45 watts.....       | 389.00       | 349 <sup>95</sup> |
| IC-25A '82 model; 25w, ttp mic, red leds | 349.00       | 289 <sup>95</sup> |
| IC-45A 440 FM xcvr, 10w, TTP mic.....    | 399.00       | 359 <sup>95</sup> |
| IC-22U 10w 2m FM non-digital Xcvr...     | \$299.00     | 249 <sup>95</sup> |
| EX-199 Remote frequency selector ..      | 35.00        |                   |

- VHF/UHF Multi-modes:** Regular SALE
- |                                     |          |                   |
|-------------------------------------|----------|-------------------|
| IC-290A 2m FM/SSB, TTP mic.....     | \$549.00 | 389 <sup>95</sup> |
| IC-290H 25w 2m SSB/FM Xcvr, TTP mic | 549.00   | 489 <sup>95</sup> |
| IC-560 10w 6m SSB/FM/CW Xcvr.....   | 489.00   | 439 <sup>95</sup> |
| IC-490A 10w 430-440 SSB/FM/CW Xcvr  | 649.00   | 579 <sup>95</sup> |

- VHF/UHF Portables:** Regular SALE
- |                                      |          |                   |
|--------------------------------------|----------|-------------------|
| IC-202S 2m port. SSB Xcvr, 3w PEP    | \$279.00 | 249 <sup>95</sup> |
| IC-505 3/10w 6m port. SSB/CW Xcvr    | 449.00   | 399 <sup>95</sup> |
| BP-10 Internal nicad battery pack... | 79.50    |                   |
| BC-15 AC charger.....                | 12.50    |                   |
| EX-248 FM unit.....                  | 49.50    |                   |
| LC-10 Leather case.....              | 34.95    |                   |
| IC-3PS Power supply.....             | 95.00    | 89 <sup>95</sup>  |
| IC-20L 2m amp, 10w PEP or FM.....    | 98.00    | 89 <sup>95</sup>  |
| IC-30L 432 amp, 10w PEP/FM.....      | 105.00   | 94 <sup>95</sup>  |
- New models!** Regular SALE
- |                                    |     |  |
|------------------------------------|-----|--|
| IC-120 1.2 GHz FM mobile.....      | TBA |  |
| RP-1210 1.2 GHz, 10w repeater..... | TBA |  |
| IC-271A 2m, 25w multimode.....     | TBA |  |
| IC-471A 430-450 MHz, 10w base..... | TBA |  |
| RP-3010 440 MHz repeater.....      | TBA |  |



- Shortwave receiver** Regular SALE
- |                                       |          |                   |
|---------------------------------------|----------|-------------------|
| R-70 100KHz-30MHz digital receiver... | \$749.00 | 649 <sup>95</sup> |
| EX-257 FM unit.....                   | 38.00    |                   |
| IC-7072 Transceiver interface, 720A   | 112.50   |                   |
| FL-44 SSB filter (2nd IF).....        | 159.00   | 129 <sup>95</sup> |
| FL-63 250 Hz CW filter (1st IF).....  | 48.50    |                   |
| SP-3 External speaker.....            | 49.50    |                   |
| EX-299 (CK-70) 12V option.....        | 9.95     |                   |
| MB-12 Mobile mount.....               | 19.50    |                   |



## ICOM Handhelds

The Transceivers. The IC-2A features full coverage of the 2 meter ham band. The IC-3A covers 220 to 224.99 Mhz, and the IC-4A, 440 to 449.995 Mhz. Each comes with BP-3 rechargeable battery, AC wall charger, flex antenna, earphone, wrist strap, and belt clip. Accessories are interchangeable. Slide on, removable battery pack allows quick change and may be charged while removed from transceiver.

- 2 meters:** Regular SALE
- |                                       |        |                   |
|---------------------------------------|--------|-------------------|
| IC-2A .15/1.5w 2m HT/batt/wall cgr \$ | 239.50 | 214 <sup>95</sup> |
| IC-2AT .15/1.5w 2m HT/batt/cgr/TTP... | 269.50 | 219 <sup>95</sup> |
- 220 MHz:**
- |                                     |        |                   |
|-------------------------------------|--------|-------------------|
| IC-3A 220 HT/batt/wall cgr.....     | 269.95 | 229 <sup>95</sup> |
| IC-3AT .15/1.5w 220 HT/batt/cgr/TTP | 299.95 | 239 <sup>95</sup> |
- 440 MHz:**
- |  |        |                   |
|--|--------|-------------------|
| IC-4A .15/1.5w 440 HT/batt/wall cgr... | 269.95 | 229 <sup>95</sup> |
| IC-4AT .15/1.5w 440 HT/batt/cgr/TTP    | 299.95 | 239 <sup>95</sup> |

- Hand-held Accessories:** Regular
- |  |         |  |
|--|---------|--|
| BC-25U Extra 15-hour wall charger.....       | \$10.00 |  |
| BC-30 1/15-hour drop-in charger for BP-2/3/5 | 69.00   |  |
| BP-2* 450 ma, 7.2v 1w ext. time battery      | 39.50   |  |
| BP-3 Extra std. 250ma 8.4v 1.5w battery      | 29.50   |  |
| BP-4 Alkaline battery case.....              | 12.50   |  |
| BP-5* 450 ma, 10.8v 2.3w hi-power battery... | 49.50   |  |

- \*BC-30 required to charge BP-2 & BP-5
- |   |          |  |
|---|----------|--|
| FA-2 Extra 2m flexible antenna.....                   | 10.00    |  |
| CA-2 Telescoping 1/4-wave 2m antenna.....             | 10.00    |  |
| CA-5 1/4-wave telescoping 2m antenna.....             | 18.95    |  |
| CA-3 Extra 220 flexible antenna.....                  | 9.12     |  |
| CA-4 Extra 440 flexible antenna.....                  | 9.12     |  |
| CP-1 Cigarette lighter receptacle chgr for BP-3...    | 9.50     |  |
| DC-1 DC operation module.....                         | 17.50    |  |
| HM-9 Speaker/microphone.....                          | 34.50    |  |
| LC-2A Leather case without TTP cutout.....            | 34.95    |  |
| LC-2AT Leather case with TTP cutout.....              | 34.95    |  |
| ML-1 2m 2.3/10w HT amp. (Reg. \$89).. SALE            | 79.95    |  |
| ML-25 2m 20w HT amp. (Reg. \$199 <sup>95</sup> ) SALE | 179.95   |  |
| IC-M12 12 ch Marine hand-held .. SPECIAL              | \$199.95 |  |

- Misc. accessories:** Regular
- |   |         |  |
|---|---------|--|
| 24-PP 24-pin accessory plug.....              | \$ 4.00 |  |
| BC-10A Memory back-up; 551/720/730/740..      | 8.50    |  |
| BC-20 Nicads & DC-DC charger for portables... | 57.50   |  |
| BU-1 Memory back-up; 25A/290A/490A.....       | 38.50   |  |
| EX-2 Relay box w/marker; 720A/730/701.....    | 34.00   |  |
| HM-3 Deluxe mobile mic, specify radio         | 17.50   |  |
| HM-5 Noise canx mobile microphone, 4 pin....  | 34.50   |  |
| HM-7 Amplified mobile microphone, 8 pin....   | 29.00   |  |
| HM-8 Touch-tone mic; 255A/260A, 8 pin.....    | 49.50   |  |
| HM-10 Scan mic.; 255A/260A/290A/25A.....      | 39.50   |  |
| HM-11 Scan mic.; 490/25A/290A.....            | 39.50   |  |
| HM-14 Scanning/TTP mic; IC-25A/45A.....       | 49.50   |  |
| SM-2 4-pin electret desk microphone; 551D.... | 39.00   |  |
| SM-5 8-pin electret desk mic.; 251A/451A..... | 39.00   |  |
| Mobile mount, specify radio.....              | 19.50   |  |
| GC-4 World clock.....                         | 99.95   |  |



## Order Toll Free: 1-800-558-0411

In Wisconsin (outside Milwaukee Metro Area)  
 1-800-242-5195

# AMATEUR ELECTRONIC SUPPLY® Inc.

4828 W. Fond du Lac Avenue; Milwaukee, WI 53216 - Phone (414) 442-4200

## AES BRANCH STORES

- |  |   |   |
|--|---|---|
| <b>WICKLIFFE, Ohio</b> 44092<br>28940 Euclid Avenue<br>Phone (216) 585-7388<br>Ohio WATS 1-800-362-0290<br>Outside Ohio 1-800-321-3594 | <b>ORLANDO, Fla.</b> 32803<br>621 Commonwealth Ave.<br>Phone (305) 894-3238<br>Fla. WATS 1-800-432-9424<br>Outside Florida 1-800-327-1917 | <b>CLEARWATER, Fla.</b> 33575<br>1898 Drew Street<br>Phone (813) 461-2267<br>No In-State WATS<br>No Nationwide WATS |
|--|---|---|

## STORE HOURS

Mon - Fri 9-5:30; Sat 9-3  
 Order evenings! - Call  
 Toll Free 1-800-558-0411  
 'til 8 pm Milwaukee time;  
 Monday thru Thursdays.



*In oilskins and mittens, doing the dogwatch while under sail.*

onto the rocks, and the skipper told me later that he had never before seen the wind actually blowing big holes in the sea the way it did that day.

Things could have been worse. The storm could have lasted until the *Cheyne II* was out of fuel for that matter. As it was, she burned up a considerable amount that day and the next, but the wind did abate and we were finally able to get on board on the 16th at lunchtime.

It was a hurried, cold, and blustery departure. The island looked extra miserable with sleet and snow settling on the black hills. The ride out to the ship was bumpy and frightening for those who cared. I did not; I was exhausted and retired to my bunk and refused to come out for the remainder of the day!

Heard Island is a unique island, black and white with a bit of moss covering some of the rocks. There are no insects to speak of, just a wingless fly and a wingless moth. Seals and penguins are the permanent residents, and there are many birds. We found time to go for short walks and see the sights. One day when the weather was very mild with sun breaking through, the island looked beautiful in its own stark way. But the climate is miserable. As I had it explained to me: It is not that it gets so cold, it is just that it does not get warm enough for things to grow. There is very little sun—mostly rain and mist. With a summer temperature around +5° C, only 8 vascular plants and some mosses and lichen represent the growth of millions of years.

I would not mind going

back some day, but on a guaranteed vessel—guaranteed not to run out of fuel and to be unsinkable. The *Cheyne II* is probably very close to unsinkable. She proved that she could perform some amazing feats—standing up on her hind legs and laying over on her side, all in one quick motion. But... there was the fuel/water problem. I was dimly aware of talk of sails and so forth but had been too busy to think about it. Now it had to be faced. After two days steaming, the engines were shut down and sails were hoisted on the foremast. The "sails" were actually our tarpaulins which were made fast to yardarms welded together on board from bits and pieces. With no engine, we had no electricity, so the emergency steering gear on the open afterdeck came into use. The wheel itself was enormous; it took two people to turn it before the grease worked its way through. A compass was laid to rest on a lifebelt inside a drawer which was tied in front of the wheel. A small wind sock above indicated how the wind was in relation to the sails (which we could not see), and appropriate chalk marks on the tiller flat showed how much helm we had. Thus, 400 tons and 160 feet of iron steamship became a square-rigged sailing vessel!

We were still far south since this was where the prevailing wind and current could be used to our advantage. Sometimes the speed was less than 1.5 knots, but at other times, we reached a stunning 4.5 knots. The albatrosses settled down to paddling in our wake, and we kept studying the foam alongside to try to guess if we were moving or not. It was very uncomfortable, cold, and dark, with watch-keeping done on the afterdeck more frequently now since two of us had to be on duty each period.

Incredibly, we inched our way ahead. I think the worst of it all was the bitter, cold wind and the dark. The diesel generator would run for 3-4 hours each evening to charge the batteries on the bridge. This was the highlight of the day when I would rush to our cabin and switch on the bed lamp in the hope that the warmth from the globe would perhaps yield a bit of warmth to the pillow before bedtime.

After 13 days of this, the boilers were fired up and the engine restarted, since we expected to meet the owner with the promised fuel and water in a couple of days time. However, after two days steaming, we learned that the refueling ship had been delayed. This was a great disappointment. Another 3 days of sailing, and at last, after 855 nautical miles under sail, we made the rendezvous. Another pie in the sky; there was no refueling—we were to be towed home. A 1000-foot line was attached, and we continued our cold and dark existence for yet another 7 days although we did not have to stand watch on the open deck.

For reasons best known to himself, the owner now instructed the skipper to forbid amateur radio on *Cheyne II*. He "did not want any talk about what was going on" was the comment we heard. No other reason was given. I am not sure exactly what it was he did not want us to talk about, but it seemed pretty silly, since anyone could make a Radcom call and talk his mouth off to anyone. And the news media were interested. They even hired a plane to come out and see for themselves, a couple of hundred miles off the coast.

We had started to run out of some foods. The variation in meals was not great in the end, but we were not in any immediate danger of starving. It was a matter of look-



*The Saxon Onward takes us in tow.*



**STOP PRESS**  
**AMTOR NOW OFFICIALLY**  
**APPROVED IN U.S.A.**

# AMT-1

## The Definitive AMTOR Terminal Unit



**\$499<sup>95</sup> Introductory Price**

AMTOR is the system of error correcting RTTY which has been rapidly overtaking conventional RTTY in Europe, just as its marine equivalent, SITOR, has been taking over in ship to shore communications.

It was originated by Peter Martinez, G3PLX (see June 1981 QST, p. 25). He first interpreted the international marine CCIR 476-1 specification for amateur use. Virtually all of the 400+ stations presently on AMTOR world wide are using software/hardware designs originated by Peter. The AMT-1 is a proven product which represents his latest and most highly refined design. It represents the culmination of over three years of development and on the air testing and sets the standard against which all future AMTOR implementations will be judged.

Not only does it incorporate the latest AMTOR specification, but it gives superlative performance on normal RTTY, ASCII and CW (transmit only). As well as some fairly incredible real time microprocessor software, the AMT-1 boasts a four pole active receive filter, a discriminator type demodulator, a crystal controlled transmit tone generator, and a 16 LED frequency analyzer type tuning indicator, which is very easy to use.

Driven from a 12 volt supply, the AMT-1 connects to the speaker, microphone and PTT lines of an HF transceiver and to the RS-232 serial interface of a personal computer or ASCII terminal. All mode control is via ESCAPE and CONTROL codes from the keyboard (or computer program).

It used to be that CW was the ultimate mode for "getting through" when QRM and fading were at their worst. That's no longer true — AMTOR will get through with perfect error-free copy when all other conventional transmission modes become useless.

### OMAR ELECTRONICS

11989 East Lansing Road  
Durand, MI 48425

(517) 288-2789

265

**AEA** Brings you the  
**Breakthrough!**

ing at the bright side. For instance, without butter, margarine, or cooking oil, washing up in seawater became mere child's play since we had no greasy dishes. And with not much to cook, the cooking chore became fairly simple. As the trip was supposed to have lasted a maximum of 42 days, and we had eaten well for 72 days, I would say that in this important area at least calculations had been liberal. Even when we finally berthed in Albany, West Australia, there were baked beans, tinned tomatoes, and packet soup left over. We could in fact have spent a few more days at sea but were certainly happy not to be obliged to do so.

During all our trials the group stayed together. The mood in the mess room remained lighthearted and cheerful, and no one allowed him/herself to show any short-tempered ill feel-



Nearly home and relaxing in the sun: Jim VK9NS, Kirsti VK9NL, Walter OE1LO, Sojo VK0SJ, and Bob WA8MOA.

ings which so easily could have jeopardized the easy-going comradeship which reigned. In any case, any short temper would have been caused by minor irritations and would not have been worth showing off. We were literally "all in the same boat" and knew it.

The whole expedition had been an uphill battle with

problems arising one after another for months before we even left Hobart. To top it off, we found that evil tongues had been wagging on the amateur bands while we were battling our way home. "They have lost the logs" was the cry. Was there no end to it all? Jim took the unprecedented step of having the logs sighted by Tom

VK6MK, in Albany, as proof that we had not lost them. Tom subsequently advised WIA that the logs were intact. How can anyone stoop so low as to start such rumors? Especially someone sitting snug and comfortable in his safe home thousands of miles away from Heard Island or *Cheyne's II*? How do they explain their "knowledge"? The only explanation I can think of is that someone is determined to discredit HIDXA at any cost—even at the cost of their own honor and credibility. Why? What are they afraid of? Is amateur radio a hobby or has it become big business?

The Heard Island and *Cheyne's II* experience was no picnic. We did it because we wanted to activate Heard Island and had said we would do so. And as my granny used to say: "What does not kill you will make you stronger!" ■

## MICROWAVE TV ANTENNA SYSTEMS

Freq. 2.1 to 2.6 GHz • 34 db Gain +

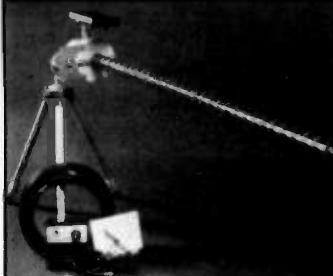

TWO YEAR WARRANTY  
PARTS & LABOR

### COMPLETE SYSTEMS

(as Pictured)

Commercial 40"

Rod Style \$89.95

Parabolic 20"

Dish Style \$79.95

### COMPONENTS

Down Converters

(both types) \$ 34.95

Power Supplies

(12V to 16V) \$ 24.95

Data Info (Plans) \$ 9.95

CALL OR WRITE FOR  
KITS, PARTS, INDIVIDUAL  
COMPONENTS

We Repair All Types Down  
Converters & Power Supplies

**Phillips-Tech  
Electronics** ✓246

P.O. Box 34772  
Phoenix, AZ 85067  
(602) 265-8255

Special Quantity Pricing  
Dealers Wanted



# KCS

## ELECTRONICS CORPORATION

### SEMICONDUCTOR PARTS & PRODUCTS

#### FACTORY PRIME DEVICES INCLUDE:

- Capacitors  
all types & styles
- Chokes & Coils
- Connectors
- Digital & Linear IC's
- Hardware & Accessories
- IC Sockets
- Memory
- Microwave Semiconductors
- Resistors  
fixed & variable
- Transformers
- Transistors & MORE!

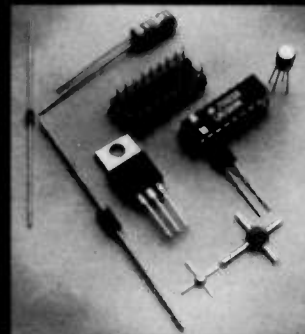

**MANUFACTURERS SUCH AS:** Motorola, National, NEC, J.W. Miller, Texas Instruments and more!

**WE STOCK & SUPPLY DEVICES FOR:** OEM's, Distributors, Hobbyists, Magazine Projects, Engineers, Schools, Technicians & You!

Call or Write for Quantity Pricing  
and FREE Catalog. ✓230

P.O. Box 33205  
Phoenix, AZ 85067 **(602) 274-2885**



# step up to the best...

Without doubt LR-1 is the repeater value leader! Compare its outstanding performance with any repeater -- then look at its price. LR-1 features include individual die-cast shielding of receiver and transmitter plus a separately shielded 6-stage receiver prefilter for peak performance in harsh RF environments • Front panel metering of all vital functions • CW identifier • Symmetric hard limiting for clean natural audio • Low power MOS control logic • Even the cabinet is included -- just plug in and go!

**LINKING?** The LR-1 is also available with control circuitry for Link Transceiver operation. Now link repeater sites with the flexible control capability you've always wanted.

**HIGH POWER?** Our PA-75 power amplifier is the champion! Ruggedly built to give years of dependable operation in continuous duty repeater service.



Mark 3C repeaters and controllers have no equal in performance. Both units feature auto patch, reverse autopatch, autodial, 13 Morse messages and a total of 39 functions. Both feature microprocessor control and both have been proven in the field from icy Alaska to tropical Brazil. A Mark 3C supercontroller can make any repeater a super performer. The Mark 3CR repeater is in a class by itself. It combines superbly designed RF circuitry in one handsome package. It is without doubt the world's most advanced repeater!

CALL OR WRITE FOR FULL DETAILS

## MICRO CONTROL SPECIALTIES

49

23 Elm Park • Groveland, Massachusetts 01834 • Telephone (617) 372-3442

# The Interface

## Software Available for Six Computers

The versatility of the personal computer gives you a whole new world with the Kantronics Interface™ and Hamsoft™ or Hamtext™. The Interface™ connects to any of six popular computers with Hamsoft™ or Hamtext™ giving you the ability to send and receive CW/RTTY/ASCII. An active filter and ten segment LED bargraph make tuning fast and easy. All programs, except Apple, are on program boards that plug directly into the computer.

Hamtext™, our new program, is available for the VIC-20 and Commodore 64, with all the features of Hamsoft™ plus the ability to save received information to disc or tape, variable buffer sizes, VIC printer compatibility, and much more. Our combination of hardware and software gives you the system you want, with computer versatility, at a reasonable price.

### Hamsoft™ Features

Split Screen Display  
1026 Character Type Ahead Buffer  
10 Message Ports-255 Characters each  
Status Display  
CW-ID from Keyboard  
Centronics Type Printer Compatibility  
CW send/receive 5-99 WPM  
RTTY send/receive 60, 67, 75, 100 WPM  
ASCII send/receive 110, 300 Baud

### Hamsoft™ Prices

Apple Diskette	\$29.00
Atari Board	\$49.95
VIC-20 Board	\$49.95
TRS-80C Board	\$59.95
TI-99 Board	\$99.95

### Hamtext™ Prices

VIC-20 Board	\$99.95
Commodore 64 Board	\$99.95

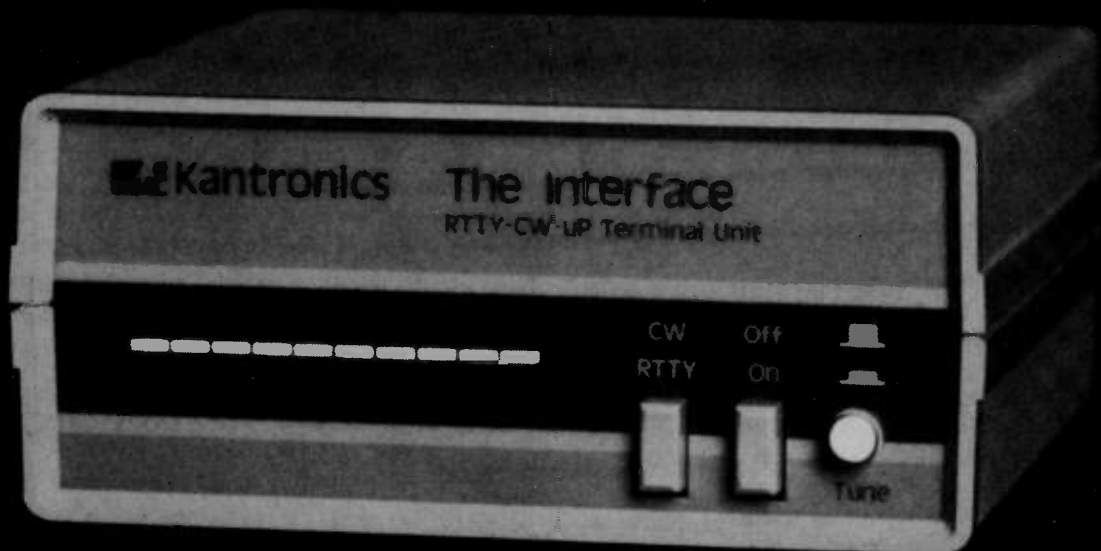

**Suggested Retail \$169.95**

For more information contact your local Kantronics Dealer or:  
Kantronics 1202 E. 23rd Street Lawrence, KS 66044



# Proven Success

Our best salesmen don't even work for Kantronics

Dear Sirs:

I am writing first of all to say how much I enjoy my Kantronics Interface and the software that I bought for my VIC-20 micro-computer. For a very reasonable price I have had a whole new world of amateur radio--not to mention some commercial transmissions I have been able to copy--opened to me.

P.S.  
Am #ticked pink"with this setup and having a ball. Thanks for a nice product !

Dear Phil:

I recently purchased a VIC 20 computer and your companies "Interface" and software for RTTY and CW and I must say it does a magnificent job. I have worked over twenty countries on RTTY on 15 and 20 meters in one month. The copy on CW is unbelievably excellent.. adding a new dimension to amateur radio for me. "you done good,"as we say here in Tennessee.

I must tell you, I have the equipment in operation and it works super good! I think it is an outstanding piece of electronics.

Your directions f  
CW state the

Gentlemen:

It's nice to find someone like you that responds to user suggestions - keep up the good work.

The Interface is available with software for six popular computers. Hamsoft is our original program for the Apple II, II+, or IIE; Atari 400 or 800; Radio Shack Color Computer, VIC-20, or Texas Instruments TI-99/4A. Hamtext, our advanced program, works with the Apple II, II+, or IIE; VIC-20, or Commodore 64.

The Interface and Hamsoft or Hamtext combination has put computerized communications at a reasonable price. Contact your local Kantronics dealer or write us for more information.

 **Kantronics**

(913)842-7745  
1202 E. 23rd Street  
Lawrence, Kansas 66044

# More Stable Than a Rock

*An Honorable Mention winner in 73's Home-Brew II Contest, this 10-MHz generator is a sure cure for the drifting frequency blues.*

Ralf Beyer DJ3NW  
Opferkamp 14  
3300 Braunschweig  
Federal Republic of Germany

**H**ave you ever followed the conversation of two guys on the same frequency using identical several-thousand-dollar transceivers but reading off different frequencies from their digital displays? Or did

you ever wonder how to estimate the drift of your own frequency counter when making frequency-drift measurements on your new rig or project just finished?

Of course, there are various means to overcome these problems. Temperature-controlled ovens as an option for your frequency counter, for example, are readily available. They will give the crystal in your frequency counter a short-term

frequency stability on the order of 0.1 ppm. However, they lead to an increasing uncertainty about the actual accuracy due to the aging process in the crystal—and they cost 50 dollars or more.

On the other hand, precise frequency reference signals are delivered more or less free of charge to our shacks by the National Bureau of Standards or by means of TV signals synchronized with a cesium standard.

It is not to everyone's taste, however, to deal with fading signals from a distant standard-frequency transmitter or to hook up a TV set to a frequency counter. So there must be another way

to take advantage of precise reference signals generated elsewhere but which are already easily available in the ham shack.

## The Basic Idea

In almost every populated area of the country, at least one AM-broadcast station in the 450-1800-kHz band is available which is strong enough to be heard even in the basement of a building or in the concrete jungle of city centers. All the care necessary to maintain a stable transmitting frequency has been taken at the radio station already, so there is no need to start all over again.

Usually, the radio stations maintain a stable frequency

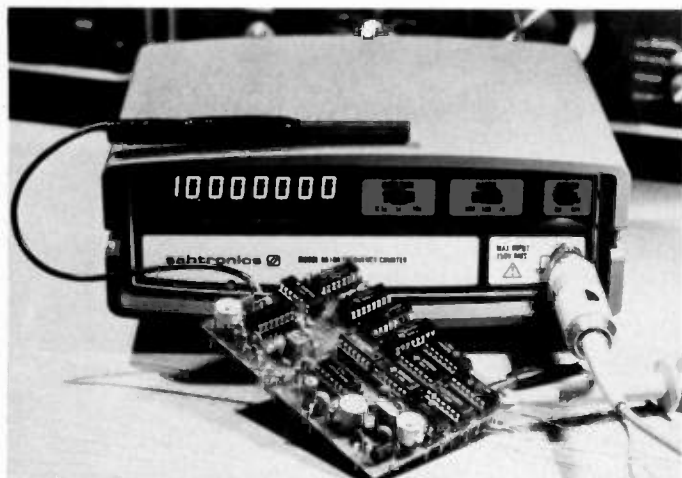

The circuit in actual operation, with the ferrite antenna on top of the counter. Output frequency is 10 MHz, phase-locked to a selectable AM-broadcast station.

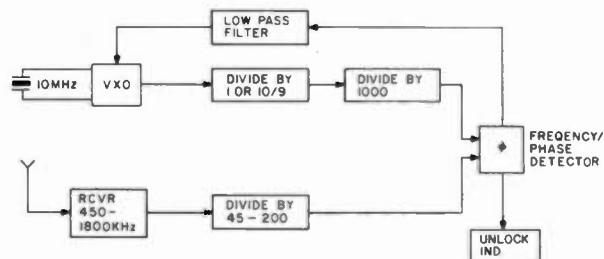

Fig. 1. Basic concept.



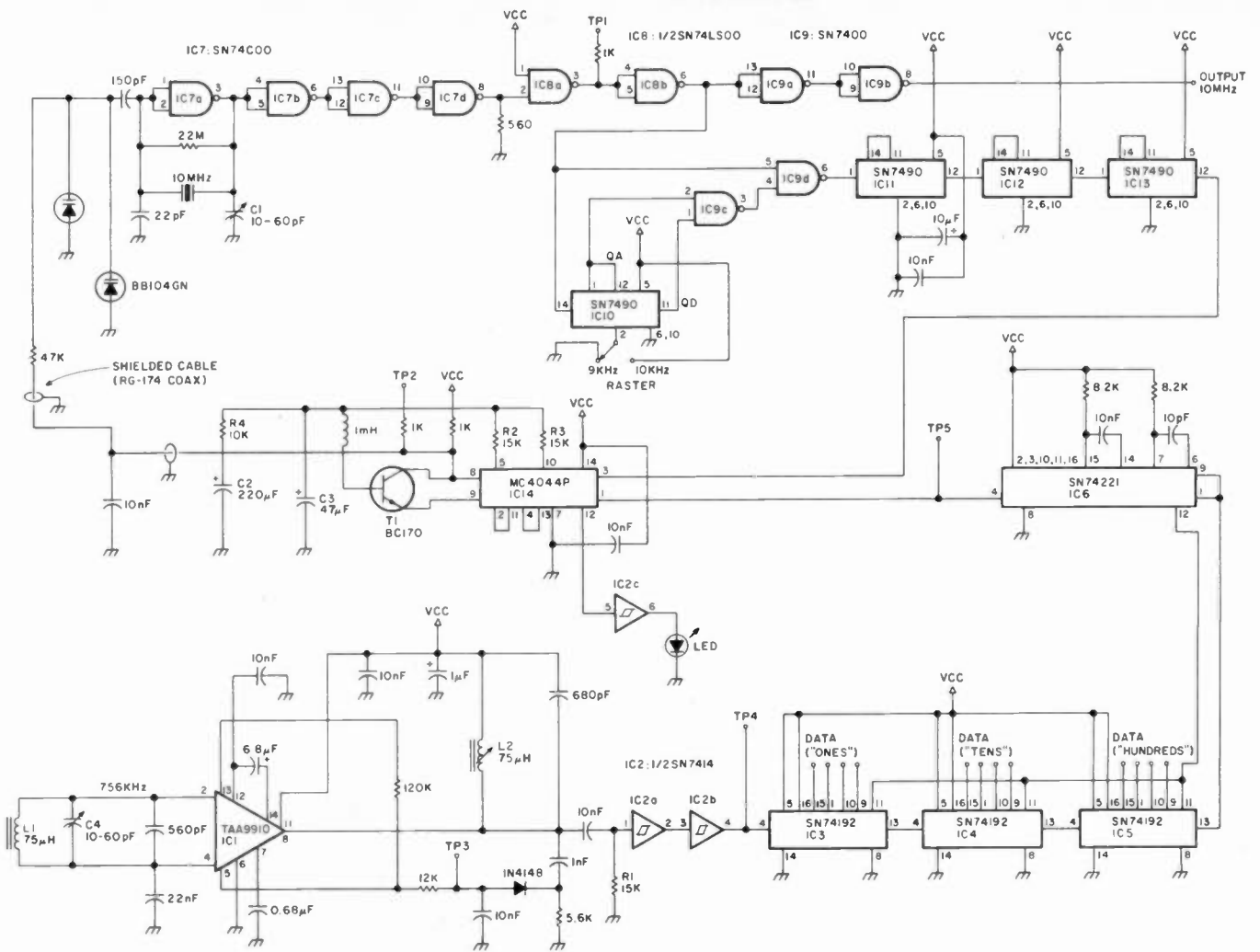

Fig. 2. Schematic diagram.

by means of a crystal oscillator whose frequency is regularly checked against and aligned with a reference frequency from the National Bureau of Standards or a secondary source of a reference frequency of similar accuracy. Even better, the ultimate step has already been taken by phase-locking the radio transmitter frequency to a reference frequency of the National Bureau of Standards.

The transmitting frequency of the Deutschlandfunk (DLF), phase-locked to a frequency standard generated by the PTB, the German National Bureau of Standards (Physikalisch-Technische Bundesanstalt), is one example. The PTB transmission on 77.5 kHz has a frequency stability of better than  $10^{-6}$  ppm per day ( $10^{-12}$ ).

Due to variations of prop-

agation, the frequency of the signal received 300 km away from the transmitter still is accurate to better than 0.01 ppm ( $10^{-8}$ ) or 0.001 ppm ( $10^{-9}$ ) for measuring periods of 1 and 10 seconds, respectively.<sup>1</sup> But while a short-term stability of station DLF on the order of 0.0001 ppm ( $10^{-10}$ ) is achieved by a well-regulated crystal oscillator, the small variations of the received reference frequency are filtered out by a very slow response of the frequency-control circuit resulting in a long-term stability in the same order of the broadcast-transmission frequency.

Most frequency counters and secondary frequency standards use a 10-MHz crystal oscillator as a master clock from which other time signals or frequencies are

derived. And many frequency counters and signal generators already have a provision for synchronization or triggering by an external frequency standard.

My basic idea, therefore, was to build a 10-MHz crystal oscillator, phase-lock it to an AM-broadcast transmitter of high frequency stability, and use it as a virtually drift-free frequency/time signal generator of high accuracy for frequency counters, calibrations, etc. Some of the design specifications were:

- The unit should be programmable to accommodate the AM-broadcast frequencies of interest.
- It should be small enough to fit into existing equipment without employing large external antennas, thus maintaining portability of the equipment.

- It should generate a 10-MHz TTL signal with an accuracy similar to the accuracy of the AM-broadcast transmitter employed, i.e., with a short-term stability of at least 0.01 ppm (ten times better than an oven-stabilized crystal oscillator) and an even higher long-term stability.

- It should be programmable for the 10-kHz raster of AM-broadcast transmission frequencies employed in the US and for the 9-kHz raster already in existence in Europe.

The basic concept is shown in Fig. 1. A simple receiver picks up a signal of an AM-broadcast transmitter in the 450-1800-kHz range. The carrier frequency is isolated from the modulation and fed to a frequency divider with a programmable division ratio of 1:45 to 1:200.

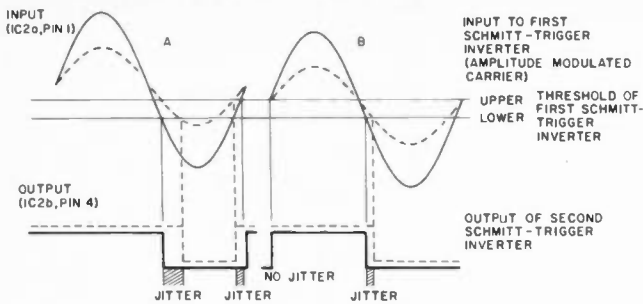

Fig. 3. Operation of the two Schmitt-trigger inverters. (a) Without a pull-down resistor, the input signal resides on the high input level of the first Schmitt trigger. Both edges of the output pulse of the second Schmitt trigger are jittering due to the amplitude modulation of the input signal. (b) The high input level of the first Schmitt trigger is pulled down by a resistor. Triggering occurs at the zero-crossing point of the rising edge of the input signal resulting in a jitter-free rising edge of the output pulse of the second Schmitt trigger.

For the 10-kHz raster of AM-broadcast frequencies employed in the US, a range of division ratios from 45 to 180 is selected to yield a 10-kHz signal at the output of the divider. For example, for station WJR in Detroit on 750 kHz, the division ratio would be set to 75, and so on. For the European raster, a range of division ratios from 50 to 200 is selected to yield a 9-kHz output signal. A ratio of 84, for example, divides the carrier frequency of station DLF on 756 kHz to 9 kHz. The 10- or 9-kHz output signal is fed to a frequency/phase detector as the reference frequency.

The desired 10-MHz signal is generated by a variable crystal oscillator (vxo) whose output signal is frequency-divided in a pre-divider by 1 (US) or by 1.111... (Europe) and then divided again, by the main divider chain, by 1000 to yield an output signal with a frequency of 10 kHz (US) or 9 kHz (Europe). This variable frequency is fed to the frequency/phase detector, too, which produces a corresponding error signal if variable frequency and reference frequency do not coincide regarding frequency and/or phase.

The error signal is passed through a low-pass filter in order to remove the 10-kHz (9-kHz) components. The dc component of the error sig-

nal is applied to a varactor diode in the vxo to pull its frequency up or down as required. This dynamic process comes to a rest when both frequency and phase of the variable frequency from the vxo and the (constant) reference frequency coincide on the 10(9)-kHz level, which in turn produces a steady control voltage for the varactor diode in the vxo.

Any tendency to leave this steady state due, for example, to a change of ambient temperature and its impact on the vxo frequency is immediately balanced by an appropriate change of the amplitude of the error signal, thereby keeping the vxo on phase and frequency with respect to the reference frequency (phase-locked loop). An "unlock" indicator signals if phase-lock has not been achieved.

### The Circuit

The complete schematic diagram of the circuit is presented in Fig. 2. The simple AM-broadcast receiver consists of the integrated circuit (IC1) designed for the front end of AM/FM receivers. Various types of applicable ICs are on the market. The TAA991D chosen here operates from a 4.5-11-volt supply; it has a voltage gain of 90 dB and an agc range of 60 dB.<sup>2</sup> The TAA991D amplifies

the signal of the AM-broadcast station received by the ferrite antenna, L1, to about  $4 V_{SS}$  at its output.

The very efficient gain control accommodates a wide range of input-signal amplitudes and can cope even with very strong signals of nearby broadcast stations. Furthermore, the time constant of the gain control is kept so short that it also compensates carrier-amplitude variations due to the modulation. Measurements showed that an amplitude modulation of the carrier frequency of more than 90% is reduced to less than 5% by the circuit, resulting in an almost steady carrier signal at its output.

Most AM stations modulate far less than 90%, however. The output signal of the gain-controlled amplifier is ac-coupled to a Schmitt-trigger inverter, IC2, which is pulled down at its input by resistor R1 to a level of about 1.3 volts.<sup>3</sup> The value of R1 should be adjusted so that the rising edge of the sinusoidal carrier signal triggers the Schmitt trigger at or near its zero-crossing point (see Fig. 3). Thereby, the modulation of the carrier is removed almost completely, resulting in a jitter-free falling edge of the Schmitt-trigger output signal. At the output of the second Schmitt trigger, IC2B, a jitter-free rising edge is obtained which triggers the programmable divider which follows.

The programmable divider is a chain of three binary-coded decimal (BCD) up/down counters, IC3-IC5.<sup>3</sup> Generally, the incoming carrier frequency can be divided by any integral number from 001 to 999. However, as mentioned earlier, only the range from 045 to 200 is needed. The "ones" of this number are represented by the first counter (IC3), the "tens" by the second counter (IC4), and the "hundreds" by the third counter (IC5). Pins 15, 1, 10, and 9 of each

counter accept the respective digit number in BCD form. If these pins are in logic state 1 (i.e., connected to  $V_{CC}$ ), their contribution to the digit number is 1, 2, 4, and 8 respectively. If they are in logic state 0, they do not contribute at all.

For example, if the carrier frequency of station WJR on 750 kHz is to be divided down to 10 kHz, the number to be programmed is 075. In this case, the logic states of pins 15, 1, 10, and 9 are 0, 0, 0, 0 for IC5, 1, 1, 1, 0 for IC4, and 1, 0, 1, 0 for IC3, in that order ( $0 \times 1 + 0 \times 2 + 0 \times 4 + 0 \times 8 = 0$ ,  $1 \times 1 + 1 \times 2 + 1 \times 4 + 0 \times 8 = 7$ , and  $1 \times 1 + 0 \times 2 + 1 \times 4 + 0 \times 8 = 5$  all together corresponding to 075). As the three counters are wired as down-counters, the number 075 loaded this way is reduced by 1 for each cycle of the incoming carrier signal.

If number 000 has been reached, an output pulse at the output of the counter chain (pin 13 of IC5) is generated which is used to reset the counters to the state programmed initially (075 in the example). The very short output pulse is stretched to approximately 50 nanoseconds by one of the monostable multivibrators of IC6 and applied to reset pin 11 of each counter.<sup>3</sup>

Because only one output pulse is generated for 75 input pulses, a division of the carrier frequency by 75 is achieved. The other monostable multivibrator of IC6 which follows stretches the length of the 10-kHz output pulse to about 50  $\mu$ s for further processing. For the European raster of AM-broadcast stations, the same considerations apply. The carrier frequencies are multiples of 9, however, and a reference frequency of 9 kHz is obtained by division of the carrier frequencies by integral numbers from 50 to 200 in order to utilize AM stations in the range from 450 to 1800 kHz for the same purpose.



# We stock: RADIOS

Aden  
Icom  
KDK  
Kenwood  
Santec  
Ten-Tec  
Yaesu

# ANTENNAS

AEA Isopoles  
Antenna Specialists  
Avanti  
Butternut  
Cushcraft  
Hustler  
Hy-Gain  
KLM  
Larsen  
Mini-Products  
Mosley  
VoCom

# ACCESSORIES

AEA Keys, Code Readers  
Alliance Rotors  
Ameritron Amplifiers  
ARRL Publications  
Astron Power Supplies  
B & W  
Bencher Paddles  
Callbooks  
CDE (Telex) Rotors  
Daiwa/MCM/J.W. Miller  
Kantronics  
MFJ  
Benjamin Michael Clocks  
Microlog  
Mirage Amplifiers & Meters  
Saxon Cable  
Telex Headsets  
Tokyo Hy-Power Amplifiers  
VoCom Amplifiers

# ege, inc.

13646 Jefferson Davis Highway  
Woodbridge, Virginia 22191  
Store Hours: M-W-F 12 noon-8 p.m.  
T-Th-S 10 a.m.-4 p.m.  
Information and Virginia Orders:  
(703) 643-1063  
Call for Quotes  
Dealer Inquiries Invited

Your SWL & Marine Communications Dealer

## ORDER TOLL FREE 1-800-336-4799 (Orders Only, Please)

Order Hours: M-F 11 a.m. to 7 p.m.;  
Saturday 10 a.m. to 4 p.m.  
Bonus: 2% Discount  
for Prepaid Mail Orders  
(Cashiers Check or Money Order)

Send stamp for a flyer.  
Terms: Prices do not include  
shipping. VISA and Master Charge  
accepted. 2% discount for prepaid  
orders (cashier's check or money  
order). COD fee \$2.00 per order.  
Prices subject to change without  
notice or obligation. No personal  
checks accepted. Returns  
subject to 10% restocking fee.



# TET ANTENNA SYSTEMS

"THE PERFECT MATE FOR YOUR SOLID-STATE"

### FEATURES

- Dual-Drive For Total Broadband
- Machined Aluminum Boom-To-Mast And Element Mounts
- Lightweight Yet Rugged
- Excellent Gain & F/B Balun (Non Ferrite) Included
- All Elements Active
- Stainless Steel Electrical Hardware Included
- Air Dielectric Coaxial Trap Capacitors
- Precision Machined Aluminum Alloy
- Easy One Afternoon Assembly
- Lower Wind Load
- U.P.S. Shippable

TRIBAND YAGIS		
HB33SP	3 El.-13'2" Boom-27 Lb. 3KW Max. Pwr. - Compact	\$189.95 +ship
HB43SP	4 El.-19'8" Boom-38 Lb. 3KW Big Signal Performance	\$249.95 +ship
HB34D	4 El.-16'5" Boom-34 Lb. 3KW Slightly Larger Than 33SP	\$219.95 +ship
HB35T	5 El.-24'7" Boom-50 Lb. 3KW "THE ULTIMATE"	\$349.95 +ship

ALSO AVAILABLE		
HB40NL3	3 El. 40M Monoband	\$379.95
HB40NL2	2 El. 40M Monoband	\$254.95
AX210NW	2 X 20 El. 2M Array Twin "Cross Yagi" Cir. Polar.	\$209.95 +ship
KR-400	Med. Duty Rotor	\$119.95
KR-500	Elevation Rotor	\$189.95
GDX-2	4 Band Disccone Ant. 6M Thru 70CM	\$ 69.95 +ship

\*CASH, CHECK, M.O., VISA & MASTERCARD\*

"Swiss Quads" - Thrust Bearings - Rotors  
Many Other Models Available  
Call Or Write For Complete Catalog:

(513)376-2700

# SULTRONICS

15 Sexton Dr., Xenia, Ohio 45385

SEND FOR THIS  
FREE CATALOG NOW



SAVE MONEY  
HIGH QUALITY  
FAST DELIVERY  
We are utilizing the  
latest equipment and  
technology to maintain  
our quality at  
reasonable prices.

# JAN CRYSTALS

- General Communication
- Industry
- Marine VHF
- Scanners
- Amateur Bands
- CB Standard
- CB Special
- Microprocessor

Call or Write  
JAN CRYSTALS  
P.O. Box 06017  
Fl. Myers, Fl. 33906-6017  
All Phones (813) 936-2397

# HI-Q BALUN

- For dipoles, yagis, inverted vees & doublets
- Replaces center insulator
- Puts power in antenna
- Broadbanded 3-40 MHz
- Small, lightweight and weatherproof
- 1:1 Impedance ratio
- For full legal power and more
- Helps eliminate TVI
- With SO 239 connector



only \$13.95

## HI-Q ANTENNA CENTER INSULATOR



Small, rugged, lightweight, weatherproof  
Replaces center insulator  
Handles full legal power and more  
With SO 239 connector

\$6.95

## HI-Q ANTENNA END INSULATORS



Rugged, lightweight, Injection molded of top quality material, with high dielectric qualities and excellent weatherability. End insulators are constructed in a spiral unending fashion to permit winding of loading coils or partial winding for tuned traps.

- May be used for
- Guy wire strain insulators
- End or center insulators for antennas
- Construction of antenna loading coils or multiband traps

\$4.95

## DIPOLES

MODEL	BANOS	LENGTH	PRICE WITH HI-Q BALUN	
			WITH HI-Q CENTER INSULATOR	WITH HI-Q CENTER INSULATOR
<b>Standard Dipoles</b>				
D-80	80,75	130	\$31.95	\$27.95
D-40	40,15	66	28.95	24.95
D-20	20	33	27.95	23.95
D-15	15	22	26.95	22.95
D-10	10	16	25.95	21.95
<b>Shortened dipoles</b>				
SD-80	80,75	90	35.95	31.95
SD-40	40	45	32.95	28.95
<b>Parallel dipoles</b>				
PD-8010	80,40,20,10,15	130	43.95	39.95
PD-4010	40,20,10,15	66	37.95	33.95
PD-8040	80,40,15	130	39.95	35.95
PD-4020	40,20,15	66	33.95	29.95
<b>Dipole shorteners - only, same as included in SO models</b>				
S-80	80,75		\$11.95 pr	
S-40	40		\$10.95 pr	

All antennas are complete with a HI-Q Balun or HI-Q Antenna Center Insulator, No. 14 antenna wire, ceramic insulators, 100 nylon antenna support rope (SD models only 50) rated for full legal power. Antennas may be used as an inverted V and may also be used by MARS or SWLS.

Antenna accessories—available with antenna orders  
Nylon guy rope 450# test 100 feet \$4.49  
Ceramic (Dogbone Type) antenna insulators \$1.50 pr  
SO-239 coax connectors .55

All prices are postpaid USA 48  
Available at your favorite dealer or order direct from

Dealer Inquiries Invited  
**Van Gorden Engineering**

BOX 21305 B, SOUTH EUCLID, OHIO 44121

The vxo consists of a low-cost microprocessor crystal and one CMOS gate (IC7, same pinout as IC8<sup>3</sup>) as the active device. The double-varactor diode, BB104 green, has a capacity swing from 35 pF at 3 volts to 14 pF at 30 volts of reverse bias. Any other varactor diode of similar characteristics is applicable. For a voltage swing from 1.5 to 5.0 volts at TP2, a frequency deviation of approximately +60/-95 Hz from the nominal frequency of 10 MHz was measured. Initially, trimmer capacitor C1 is adjusted so that an error voltage of about 3 volts is measured at TP2 for a vxo output frequency of 10,000,000.0 MHz.

Several inexpensive crystals were tried out with appropriate readjustment of C1, and they gave similar good results. The CMOS level of the vxo signal is converted to TTL level by the combination of one low-power Schottky gate (IC8A) and a 560-ohm pull-down resistor at its input.<sup>3</sup> Another gate (IC8B) is used for buffering the 10-MHz signal. It is further buffered by TTL gates IC9A and IC9B and passed to the 10-MHz output terminal.

As the 10-MHz signal is going to be checked against a reference frequency of 10 (US) or 9 (Europe) kHz, it must first be divided by 1 or 1.111... giving a frequency of 10 or 9 MHz. The chain of three decade counters (IC11-IC13<sup>3</sup>) which follows divides that frequency down to 10 or 9 kHz and this signal is passed to the frequency/phase detector as the variable frequency together with the 10- or 9-kHz reference frequency from the AM-broadcast receiving branch of the circuit.

The alternative division by 1 or 1.111..., respectively, is achieved by the combination of decade counter IC10 and gates IC9C and IC9D.<sup>3</sup> If pin 2 of the decade counter is high, i.e., at V<sub>CC</sub> level, the counter is disabled

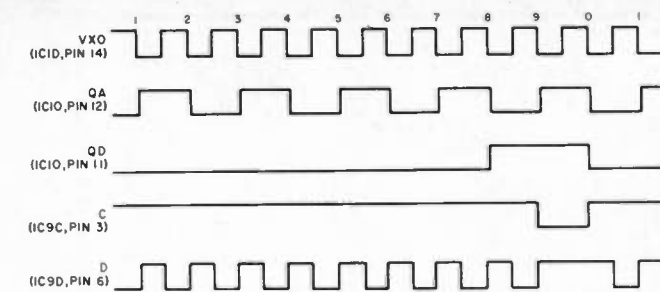

Fig. 4. Operation of the divide-by-1.111... module as explained in the text.

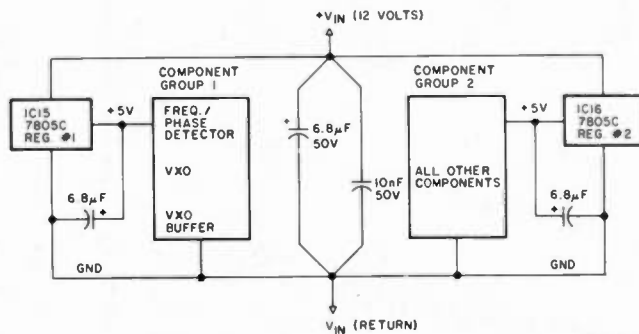

Fig. 5. Power supply.

and its output terminal (pin 11) is in a low state. Consequently, the output of gate IC9C remains high constantly, enabling gate IC9D which passes the pulses from the output of gate IC8B directly to the input of the chain of decade counters. No frequency division takes place in this case (division by 1). However, when pin 2 of the decade counter is in a low state (grounded), the counter is operative. Its action is explained in Fig. 4.

The counter contains a chain of four flip-flops with designations Q<sub>A</sub> for the output of the first and Q<sub>D</sub> for the output of the last flip-flop. For the arrangement shown in the schematic, the first flip-flop is triggered by each negative transition of the vxo pulse sequence. Q<sub>D</sub> assumes a high state after 8 input pulses and is reset to a low state after 10 pulses. This constitutes one complete cycle of the decade counter. The logic combination of outputs Q<sub>A</sub> and Q<sub>D</sub> by gate IC9C produces signal C at its output. And the logic combination of signal C and the signal of the vxo by gate IC9D generates a sequence

of pulses (D) similar to the signal of the vxo with the exception that for every 10 pulses of the vxo one pulse is missing. Therefore, 9 pulses are generated at the output of gate IC9D for 10 pulses of the vxo, constituting a division by 10/9 = 1.111...

The frequency/phase detector, IC14,<sup>4</sup> checks the frequency/phase difference between the reference frequency and the variable frequency, i.e., the AM-station carrier frequency and the vxo frequency, respectively, both divided down to 10 (US) or 9 (Europe) kHz. 10(9)-kHz pulses appear on pins 5 and/or 10 with a duty cycle corresponding to the difference. These pulses are filtered by a low-pass filter (R2, R3, R4, C2, C3, 1-mH choke) and buffered by transistor T1.

Any small signal transistor is applicable here provided it has a gain high enough to meet the following specifications: no frequency/phase difference generates a voltage of about 3 volts at TP2; a higher frequency or a leading phase of the variable frequency (vxo) with respect to the reference frequency generates voltages

of down to 1.5 volts or up to 5 volts in the contrary case.

This error voltage is applied to the varactor diode of the vxo which pulls the crystal frequency to achieve zero frequency difference and a very small but constant phase difference. At pin 12 of IC14, negative-going pulses are generated whose duration is proportional to the phase difference of variable and reference frequency. They trigger the Schmitt-trigger inverter, IC2C, which turns on an LED in case of a wide pulse width indicating that a no-lock condition exists.

### The Power Supply

In the power supply, two regulators are used. One serves the most critical component group, i.e., the frequency/phase detector, the vxo, and the vxo buffer, IC8A/B. The other serves a group containing the remaining components. All ground-return leads in each one of the two groups are returned to their common ground—and a heavy wire is recommended here. Fig. 5 presents the general arrangement of the power supply. Regulator #2 needs a bit of heat-sinking. At V<sub>IN</sub> = +12 volts, regulator #1 has to deliver approximately 50 mA to component group 1 while regulator #2 delivers approximately 330 mA to component group 2. Total power consumption is 4.6 Watts (12 volts at 380 mA).

### Construction

The whole circuit was mounted on a perforated board of 68 × 100 mm (2-5/8" × 3-7/8") size with solder eyes and 0.1-inch spacing. The discrete components were soldered directly on the board in an arrangement which minimized the number of additional interconnecting wires. For the integrated circuits, wire-wrap sockets were used, and this part of the circuit was wire-wrapped.

Miniature binding posts



WE SHIP WORLOWIDE

# Barry Electronics Corp.

WORLD WIDE AMATEUR RADIO SINCE 1950

Your one source for all Radio Equipment!

For The Best Buys In Town  
Call: 212-925-7000

KITTY SAYS: WE ARE NOW OPEN 7 DAYS A WEEK.

**Saturday & Sunday 10 to 5 PM**

Monday-Friday 9 to 6:30 PM

Come to Barry's for the best buys in town. For  
Orders Only Please Call: 1-800-221-2683.



"Come On Down For Our  
July 4th SELL-A-BRATION"



**ICOM**

IC-R70, IC-720A, IC-730, IC-740, IC-25A/H, IC-35A  
IC-45A, C-251A, IC-2KL, IC-451A, IC-290H



**YAESU**

FT-ONE, FT-980, FT-102, FT-77, FT-707, FT-230R  
FT-726 FT-480R, FT-720RU, FT-290R, FRG-7700, FT-625RD



**ROCKWELL/COLLINS  
KWM-380**

VoCom/Mirage  
Tokyo Hy-Power  
Amplifiers &  
5/8λ HT Gain  
Antennas IN STOCK

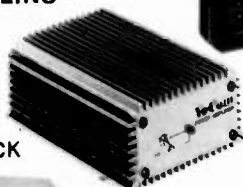

**YAESU  
FT-208R  
FT-708R**

**ICOM  
IC2AT  
IC3AT  
IC4AT**

Land-Mobile H/T  
Wilson Mini-Com II  
Yaesu FTC-2203, FT-4703  
Icom IC-M12 (Marine)  
IC-H12

**DRAKE TR-5, TR-7A, R-7A, L-7, L-15, Earth  
Satellite Receiver ESR-24, THETA 9000E & 500,  
EARTH SATELLITE STATION ESS-2250**



**SMART PATCH**

CES Simplex Autopatch 510-SA Will Patch FM  
Transceiver To Your Telephone. Great For  
Telephone Calls From Mobile To Base. Simple  
To Use - \$319.95.

**SANTEC  
ST-220/UP  
ST-144/UP  
ST-440/UP**



**NEW IMPROVED**

**MURCH Model  
UT2000B**

**MFJ Models  
900, 940B, 941C & 982.**



**KANTRONICS  
Field Day 2, Mini-Reader,  
Interface, Software &  
Code Tapes**

**AEA CP-1 Computer Patch**



**SPECTRUM  
COMMUNICATIONS REPEATERS  
SCR-1000, 4000 & 77  
Commercial & Amateur In Stock**

**DENTRON AMPLIFIERS  
GLA-1000C**



**BIRD  
Wattmeters &  
Elements  
In Stock**

**AEA 144 MHz  
AEA 440 MHz  
ANTENNAS**

**Complete Butternut Antenna  
Inventory In Stock!**

**Communications Specialists  
Encoders In Stock!**

**Smallest Wireless  
Telephone Available  
800 ft. range w/encoder \$135.00**

**BENCHER PADDLES &  
Vibroplex Keys In Stock!!**

**New TEN-TEC  
Corsair In Stock**

**DIGITAL  
FREQUENCY  
COUNTER**

Trionyx-  
Model TR-1000  
0-600 MHz  
Digimax Model  
D-510 50 Hz-1GHz



**Tri-Ex Towers  
Hy-Gain Towers  
& Antennas,  
and Rotors  
will be shipped direct  
to you FREE of shipping cost.**

MAIL ALL ORDERS TO BARRY ELECTRONICS CORP., 512 BROADWAY, NEW YORK CITY, NY 10012.

**New York City's** LARGEST STOCKING HAM DEALER  
COMPLETE REPAIR LAB ON PREMISES

**"Aqui Se Habla Espanol"**

BARRY INTERNATIONAL TELEX 12-7670  
TOP TRADES GIVEN ON YOUR USED EQUIPMENT  
STORE HOURS: Monday-Friday 9 to 6:30 PM  
(\$1.50 parking across the street)  
Saturday & Sunday 10 to 4 PM (Free Parking)  
AUTHORIZED DIST. MCKAY DYMEK FOR  
SHORTWAVE ANTENNAS & RECEIVERS.

IRT/LEX-"Spring St. Station"  
Subways: BMT-"Prince St. Station"  
IND-"F" Train-Bwy. Station"

Bus: Broadway #6 to Spring St.

We Stock: AEA, ARRL, Alpha, Ameco, Antenna Specialists, Astatic, Astron, B & K, B & W, Bash, Bencher, Bird, Butternut, CDE, CES, Collins, Communications Spec. Connectors, Covercraft, Cubic (Swan), Cushcraft, Daiwa, Dentron, Digimax, Drake, ETO (Alpha), Eimac, Encomm, Henry, Hustler (Newtronics), Hy-Gain, Icom, KLM, Kantronics, Larsen, MCM (Daiwa), MFJ, J.W. Miller, Mini-Products, Mirage, Newtronics, Nye Viking, Palomar, RF Products, Radio Amateur Callbook, Robot, Rockwell Collins, Saxton, Shure, Swan, Telex, Tempo, Ten-Tec, Tokyo Hi Power, Trionyx TUBES, W2AU, Waber, Wilson, Yaesu Ham and Commercial Radios, Vocom, Vibroplex, Curtis, Tri-Ex, Wacom Duplexers, Repeater, Phelps Dodge, Fanon Intercoms, Scanners, Crystals.

WE NOW STOCK COMMERCIAL COMMUNICATIONS SYSTEMS  
DEALER INQUIRIES INVITED. PHONE IN YOUR ORDER & BE REIMBURSED.

COMMERCIAL RADIOS stocked & serviced on premises.

**Amateur Radio & Computer Courses Given On Our Premises, Call  
Export Orders Shipped Immediately. TELEX 12-7670**

✓ 305

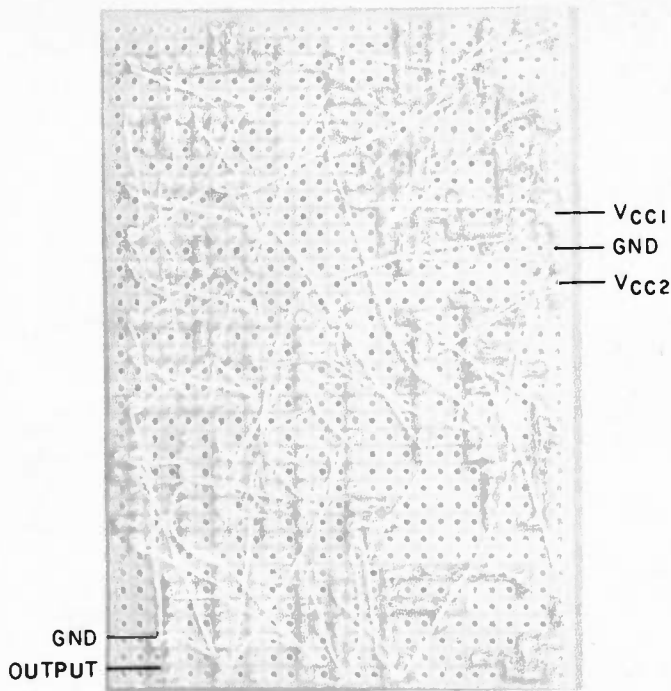

Bottom side of board.

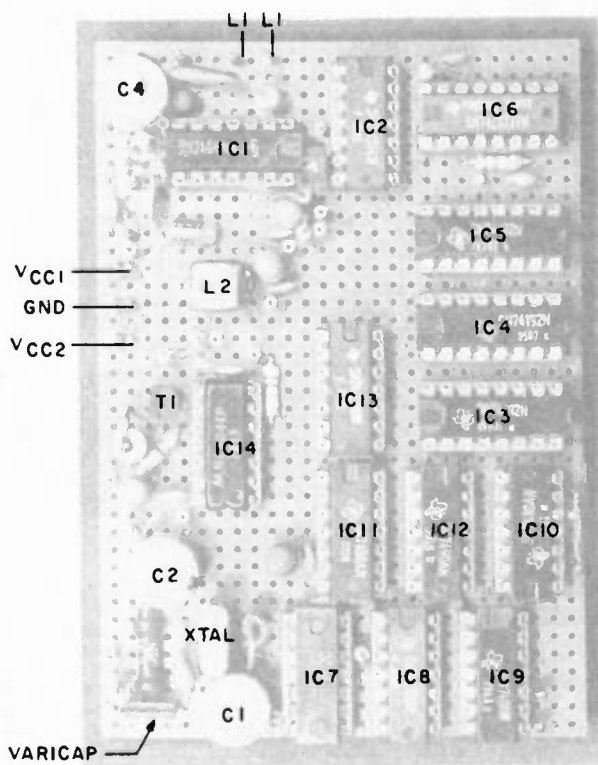

Top side of board.

were inserted in the perforated board where needed. The whole circuit board may be mounted in a miniature cabinet 71 mm long  $\times$  102 mm wide  $\times$  28 mm high (2-3/4"  $\times$  4"  $\times$  1-1/8"). In this case, both regulators are mounted directly on the inner surface of the cabinet. However, the board may be

installed directly into existing equipment. In case of a metal cabinet, the ferrite antenna must be mounted externally.

#### Alignment

The test instruments used for alignment were a VOM with an internal resistance of 20k Ohms/volt, a Sab-

tronics model 8610A frequency counter with an HP 10006 A 10:1 test probe (14 pF/10 megohms), and a small pocket receiver to check whether the broadcast station to be utilized is on the air.

First, the receiver is aligned by measuring its agc voltage at TP3 and tuning the input and output circuit of the receiver for maximum agc voltage. The negative agc voltage should be at least 0.6 volts and may run as high as several volts depending on the strength of the AM station received. The component values shown in the schematic diagram were chosen to receive a station on 756 kHz.

With the frequency counter at TP4, one should obtain a stable indication of the carrier frequency of the AM-broadcast station selected. If the display is not stable within one bit of the last digit of the frequency counter, make sure that the counter is not disturbed by residual modulation of the carrier, line noise, or other signals.

Next, program the appropriate number into the three count-down counters (IC3-IC5) which follow to obtain a 10(9)-kHz reading on the frequency counter at TP5.

Now connect the frequency counter to TP1 and the VOM to TP2 and adjust C1 so that the frequency counter displays 10-20 Hz more than 10 MHz (if the VOM indicates more than 3 volts) or 10-20 Hz less than 10 MHz (if the VOM indicates less than 3 volts initially). Allow the frequency/phase detector up to 30 seconds to recover from saturation and observe the VOM. The error voltage measured at TP2 should stabilize at about 3 volts within 60 seconds with the unlock indicator turned off and the frequency counter displaying 10,000,000 Hz, 9,999,999.9 Hz, or an overflow to (1)0,000,000.0 Hz depending on its accuracy. If the error

voltage stabilizes elsewhere, adjust C1 of the vxo to achieve an indication of 3 volts.

Finally, adjust C1 so that an error voltage of 3.2 volts is indicated. This finishes the alignment of the circuit.

#### Performance

The performance measurements were made with the same test equipment already used for the alignment of the circuit. First, the frequency counter together with the 10:1 test probe was checked. An undesirable sensitivity of its internal clock generator to TTL signals at its input could not be found. However, it was sensitive to heavy line noise, so a 12-volt car battery was used to power the frequency counter.

The frequency counter had an internal voltage regulator for 5 volts, but no drop of battery voltage occurred during the time of measurement. After warm-up, the counter was connected to TP1 of the circuit and its internal clock aligned for a display of 10,000,000 Hz for a measuring period of 1 second. Then it was aligned for an overflow to (1)0,000,000.0 Hz (representing 10,000,000.0 Hz) using a measuring period of 10 seconds. Using this test setup and applying a VOM to TP2, the following performance measurements were made:

- 1) The frequency counter displayed no other values than (1)0,000,000.0 (overflow) or 9,999,999.9 during more than one hour of measurement and for consecutive measuring intervals of 10 seconds at room temperature.
- 2) No other values than (1)0,000,000.0 (overflow) or 9,999,999.9 were displayed for intermittent shorts of the 10-MHz output terminal to ground. Also, the error voltage of 3.2 volts at TP2 remained constant in this case.
- 3) No other values than (1)0,000,000.0 (overflow) or



# CHAMPAGNE RTTY/CW on a Beer Budget

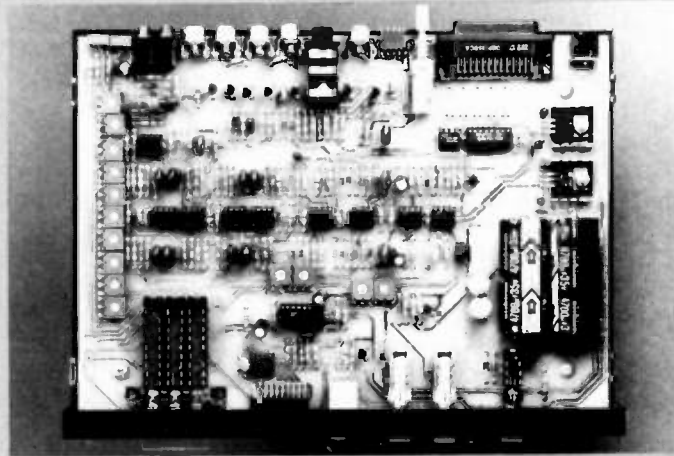

## CP-1 Computer Patch™ Interface

The AEA Model CP-1 Computer Patch™ interface will let you discover the fastest growing segment of Amateur Radio: computerized RTTY and CW operation.

When used with the appropriate software package (see your dealer), the CP-1 will patch most of the popular personal computers to your transceiver for a complete full-feature RTTY/CW station. No computer programming skills are necessary. The CP-1 was designed with the RTTY neophyte in mind, but its sophisticated circuitry and features will appeal to the most experienced RTTY operator.

The CP-1 offers variable shift capability in addition to fixed 170 Hz dual channel filtering. Auto threshold plus pre and post limiter filters allow for good copy under fading and weak signal conditions.

Transmitter AFSK tones are generated by a clean, stable function generator. Plus (+) and minus (-) output jacks are also provided for CW keying of your transmitter. An optional low cost RS-232 port is also available. The CP-1 is powered with 16 VAC which is supplied by a 117 VAC wall adaptor included with the CP-1.



**FREE PHONE 800-854-6046** (outside Calif. only)

**ANAHEIM, CA 92801**  
2620 W. La Palma  
(714) 761-3033 (213) 860-2040

Between Disneyland & Knott's Berry Farm

**BURLINGAME, CA 94010**  
999 Howard Ave., (415) 342-5757  
5 miles south on 101 from S.F. Airport

**OAKLAND, CA 94609**  
2811 Telegraph Ave., (415) 451-5757  
Hwy. 24 Downtown. Left 27th off-ramp

**SAN DIEGO, CA 92123**

5375 Kearny Villa Road, (619) 560-4900  
Hwy. 163 & Clairemont Mesa Blvd.

**VAN NUYS, CA 91401**

6265 Sepulveda Blvd., (213) 988-2212  
San Diego Fwy. at Victory Blvd.



Prices and specifications subject to change without notice or obligation.



9,999,999.9 were displayed for ambient temperatures of 3° C (refrigerator) or 50° C (stove). No significant change of the error voltage at TP2 was noticed. (The measurements were made quickly after the 1-hour cooling/heating procedure outside the refrigerator/stove since their metal cabinets prevented the circuit from receiving the AM-broadcast station.)

4) No other values than (1)0,000,000.0 (overflow) or 9,999,999.9 were displayed for a change of  $V_{in}$  in steps of 10 volts in the range of 7-27 volts.

5) If the circuit is operated employing the European raster of AM-broadcast frequencies, phase modulation of the 10-MHz signal may be expected due to the quasi-periodic/aperiodic operation of the divide-by-1.111... module. However, due to the long time constant of the low-pass filter following the output of the frequency/phase detector, ac components of the error voltage are filtered out to a large degree and a low phase modulation of less than 4% peak-to-peak was measured with an oscilloscope.

6) The output frequency settled to a display of (1)0,000,000.0 (overflow) or 9,999,999.9 within 60 seconds after power was applied to the circuit.

7) The circuit is sensitive to heavy line noise which in severe cases requires additional line filtering in front of the power supply. It also is sensitive to major disturbances of the AM signal. For example, during a thunderstorm the frequency of the 10-MHz output signal dropped by some Hz several times but recovered within a few seconds. A complete loss of the AM signal causes a drop of the output frequency to the lower bound of the phase-locked-loop capture range on the order of 100 Hz below 10 MHz.

### Parts List

Integrated Circuits	
1 MC4044P (Motorola)	\$5.00
1 SN74LS221N (Quest Electronics)	1.19
1 SN7414N (Quest Electronics)	.55
1 SN7400N (Quest Electronics)	.19
4 SN7490N (Quest Electronics)	1.40
3 SN74192N (Quest Electronics)	2.37
1 SN74C00 (Quest Electronics)	.35
1 SN74LS00N (Quest Electronics)	.25
1 TAA991D (Siemens-Ref. 2)	2.50
2 7805C regulators (R.F. Electronics)	2.78
Crystal	
1 10-MHz crystal (Quest Electronics)	3.95
Semiconductors	
1 LED, red TO-18 (Quest Electronics)	.15
1 Transistor BC170 or equivalent	.20
1 Varactor diode BB104gn or equivalent	.50
1 Diode 1N4148	.10
IC sockets	
4 Wire-wrap, 16 pin (Quest Electronics)	2.28
10 Wire-wrap, 14 pin (Quest Electronics)	5.50
Resistors (all 1/10 Watt)	
1 560 Ohm	
3 1k Ohm	
1 5.6k Ohm	
2 8.2k Ohm	
1 10k Ohm	
1 12k Ohm	
3 15k Ohm	
1 47k Ohm	
1 120k Ohm	
1 22 megohm	
Capacitors (15 V except where indicated)	
1 10 pF	.12
1 22 pF	.12
1 160 pF	.12
1 680 pF	.12
1 560 pF	.12
1 1 nF	.15
8 10 nF	1.60
1 10 nF/50 V	.40
1 22 nF	.30
1 .68 uF	.40
1 1 uF, electrolytic	.40
3 6.8 uF, electrolytic	3.00
1 6.8 uF/50 V, electrolytic	1.00
1 10 uF, electrolytic	1.00
1 47 uF, electrolytic	1.00
1 220 uF, electrolytic	1.00
2 Trimmer capacitors 10-60 pF	1.00
Other	
1 Ferrite rod 115 x 8 mm (R33-050-400)	1.95*
1 Perforated board	1.80
1 Miniaturized filter (L2) (L-43-1)	1.50*
1 1-mH choke	.50
16 Terminal posts for board Wire, solder etc.	.50 1.40
	\$49.96
Total for all 1.20	

\*Amidon Associates, 12033 Otsego St., North Hollywood CA 91607.

### Conclusions

As it was considered unlikely that during the performance tests variations of

the output frequency of the circuit were counterbalanced by identical errors of different sign of the frequen-

cy counter, the following conclusions were drawn:

● The circuit can provide a 10-MHz reference frequency with a short-term stability of at least 0.01 ppm and a much higher long-term stability.

● Its accuracy and stability are directly dependent upon the quality of the AM-broadcast signal used as a reference frequency. Most AM-station frequencies are accurate to this and even to a higher degree.

● In contrast to a vxo in a thermostat, the circuit needs no warm-up period, it has no drift due to aging, it provides at least one order of magnitude better stability, and it does not cost more.

● It also has all the provisions necessary to accommodate a 9-kHz raster of broadcast frequencies if the FCC should go along this way in the future.

Use the circuit as an external reference, install it as the main clock in the existing space of your frequency counter, or use it as a calibration standard for your station. In every case, you are bringing a degree of frequency accuracy and stability to your ham shack which is maintained for you by other people day and night and brought to your home free of charge. Enjoy it! ■

### References

1. Hetzel, P., "Empfang der Normalfrequenz des Trägers von DCF77," *Physikalische Technische Bundesanstalt*, Braunschweig, Fed. Rep. of Germany, March, 1979.
2. Siemens AG, "Lineare Schaltungen," *Datenbuch 1974/75*, Band 2, Order No. B12/1213, Siemens Corp., Components Group, 186 Wood Avenue South, Iselin NJ 08830.
3. Texas Instruments, *The TTL Data Book for Design Engineers*, Second Edition, Marketing and Information Services, PO Box 5012 MS 308, Dallas TX 75222.
4. Motorola, Inc., *Phase-Locked Loop Systems Data Book*, Second Edition, August, 1973, PO Box 20912, Phoenix AZ 85036.



We're changing what repeaters can do ... for YOU!

Whether you're a repeater owner, control op. or user, the RC-850 controller offers you capabilities you've only dreamed of. Like natural sounding speech synthesis ... easy, remote Touch-Tone programming ... talking meter readback ... synthesized remote base operation ... and an autopatch with features you have to hear to believe.

Most important of all, upgrade through software, prevents obsolescence. Which lets us bring you new features, like our scheduler, for automatic changeover of repeater status by time and day of week ... And our mailbox, for leaving messages for your friends. Plus much, much more!

The RC-850 Repeater Controller—The New Standard in High Performance!

Ask anyone that owns an RC-850 controller. Or ask us for our demo tape, so you can hear for yourself.



advanced computer controls

Call or write for detailed specifications on the RC-850 Repeater Controller.

10816 Northridge Square • Cupertino, CA 95014 • (408) 749-8330

Introducing our Latest Model — NOVAX II  
SIMPLEX / DUPLEX  
AUTOPATCH



NOW TWO MODELS TO SERVE YOU BETTER  
YOUR OWN PRIVATE AUTOPATCH



NOVAX interfaces your standard 2 meter, 220; 450; etc. Base station and telephone, using a high speed scan switching technique so that you can direct dial from your automobile or with your HT from the backyard or poolside — Automatically ... Easy installation transceivers, featuring solid state switching, offer best results ... Available interfaced with an ICOM 22U.

FEATURES	NOVAX I	NOVAX II
• 3 min. Call duration timer	YES	YES
• Up to 45 sec. activity timer	YES	YES
• Single digit Access Control	YES	NO
• OTMF (Touch Tone)* phone connection	YES	YES
• 4 digit Access Control	NO	YES
• Toll Restrict	NO	YES
• LED Digital Display	NO	YES
• Vinyl covered alum. case size	5" x 6" x 2"	10" x 8" x 1 1/2"
• Directly Interfaces with Repeater	NO	YES
• Rotary Dial System (incl. Last digit dial)	NO	YES—"Option"
• Ring Back (reverse autopatch) "Option"	YES	Kit YES—Wired

\* Trademark IIT

To order, send check, money order to:  
MASTER CHARGE AND VISA ACCEPTED

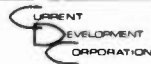

Box 182 - Tudman Rd.  
Westmoreland, N.Y. 13490  
or Phone 315-829-2785

# MORE GAIN Than a Varactor UHF Tuner

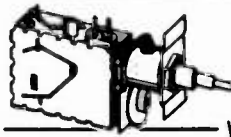

\$15<sup>00</sup>

SATISFACTION GUARANTEED  
Frequency Range 470-899 MHz Channels 14-83. Output Channel 3, Ch 2 or 4 Avail.

PART #B20  
WHAT'S IN IT?

\$15<sup>00</sup>

To make a regular UHF tuner into a GILCO HIGH GAIN TUNER, each and every one of the following steps is painstakingly taken by a certified technician:

1. The first thing GILCO does is change the standard diode to a hot carrier diode.
2. The tuner's output is then measured on our JERROLD field strength meter and compared to a computer derived chart from which we determine the correct value coil to add across the IF output for maximum pre-peaked gain.
3. The tuner is then fed a standard 10db 300 ohm antenna input and while monitoring the output on our HEWLETT PACKARD spectrum analyzer, the tuner is tuned to the desired channel and its oscillator is offset for the desired output frequency as follows:

Channel 2: 58 Mhz, Channel 3: 63 Mhz, Channel 4: 68 Hhz

We call this step peaking because the tuner's output looks like a peak on our spectrum analyzer and the highest point of that peak is actually adjusted for the desired output. 4. The last step is one more measurement on the field strength meter which is again compared to our performance chart to calculate the correct value of the second coil which is added to the tuners internal connections.

This procedure was developed by GILCO and it is our computer derived performance charts that make our tuner better, that's because almost every tuner gets a different value coil before it's peaked and again a different value coil after it's peaked. The combinations are endless and the way we determine the values is our secret...

## GILCO PARTS KIT & PRINTED CIRCUIT BOARD

- Use with GILCO High Gain Tuner
- Requires NO Modification to Your Television
- Individually Packaged and Labeled Parts Save Guesswork

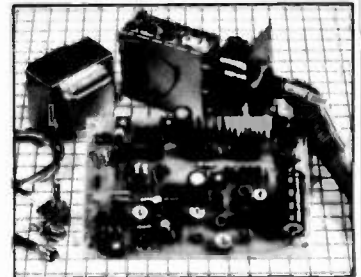

- The only tools required for assembly are: screwdriver, soldering iron, voltmeter. No drilling is required to the P/C board.
- This kit was designed to take advantage of the GILCO high gain tuner which means its circuitry is simpler and more efficient than those circuits that require inferior varactor tuners.

Pre-drilled, pre-screened, plated through the holes P/C board. All hardware, connectors, 22 page illustrated instruction manual, & Gilco Hy-Gain tuner. Kit assembles in just 4 hours.

FREE 22 Page Instruction Book included with each P/C Board or Parts Kit. This instruction book will guide the builder through every step of the assembly. Nearly every page is illustrated. With this Instruction Book, estimated assembly time is 4 hours.

## HERE'S WHAT YOU GET FROM GILCO

Part No. B21 Printed Circuit Board

\$17<sup>00</sup>

1. This Printed Circuit Board uses only one jumper, others use nine.
2. The component layout is screen printed on the component side of the P/C board.
3. The solder side of the P/C board is covered with high temperature solder resist. This prevents solder bridges.
4. Newest Addition: the P/C board is plated through the holes. This allows for easier and more positive soldered contact between the parts and the P/C board.

Part No. B22 Complete Electronic Parts Kit

\$80<sup>00</sup>

All resistors (30), Potentiometers (1-5K, 3-10K), Panel Mount Potentiometer (10K), Electrolytic Capacitors (6), Ceramic and Mylar Disc Capacitors (35), Variable Capacitors (4), All Integrated Circuits (7), Voltage Regulator, Heat Sink, Diodes (4), IC Sockets (4-8 pin, 3-14 pin), Power Transformer (24V, 1A), Coil Kit with No. 26 wire (4), Speaker (4", 3oz.), Standoffs, Coaxial Cable, All Miscellaneous Hardware, Etc. All parts are individually packaged and labeled.

All components including the Wire, Hardware, Coaxial Cable and Heat Sinks are included in the parts kit. This means your assembly time from start to finish is just 4 hours.

## GILCO ACCESSORIES & AMPLIFIER KITS

- #A02 New 2 stage, low noise, 28db gain RF amplifier kit KR \$18<sup>00</sup>
- #A03 New 1 stage, low noise, 14db gain RF amplifier KR \$10<sup>50</sup>

## GILCO ORDER FORM

- #B20 GILCO Hy-Gain Modified Tuner \$15<sup>00</sup>
  - #B21 GILCO Pre-drilled, Screen Printed, Circuit Board \$17<sup>00</sup>
  - #B22 GILCO Parts Kit (Less P/C Board) \$80<sup>00</sup>
  - #B20, B21, B22 Complete P/C Board and Parts Kit (all three) \$110<sup>00</sup>
  - #A02 Two stage, 28 db gain, Amplifier Kit \$18<sup>50</sup>
  - #A03 One stage, 14db gain, Amplifier Kit \$10<sup>50</sup>
- Name \_\_\_\_\_ Total \_\_\_\_\_  
Address \_\_\_\_\_ Tax \_\_\_\_\_  
City \_\_\_\_\_ State \_\_\_\_\_ Zip \_\_\_\_\_ Ship \_\_\_\_\_

Mail Order Only. Send check or money order to:  
GILCO INTERNATIONAL, INC.

P.O. Box 8817, Coral Gables, Florida 33124

CALL (305) 823-5891 for COD orders PLEASE WRITE FOR OUR FREE CATALOG  
SHIPPING: Orders under \$50 add 10%, Orders over \$50 add 5%, FL residents + 5% Tax



# AIR-1

## SPECIFICATIONS

**INPUTS:** Receiver audio, in & out phono jacks for easy speaker connections. Hand key input allows code practice that reads your sending and drives the transmitter keying outputs.

**OUTPUTS TO TRANSCEIVER:** Positive and negative switching for CW & FSK keying, solid state or tube type transmitters, AFSK tones at microphone compatible levels, T/R(PTT) transmitter control.

**PRINTER OUTPUT:** Uses standard VIC printer for "Hard-Copy" of both receive and transmit data regardless of on-the-air mode. Also has hi voltage transistor switch on board for driving current-loop type printers.

**DISC & TAPE INTERFACE:** Uses standard VIC DISC & DATASET for recording off the air and making long "brag tapes." Another handy feature is the ability to save and re-load your "here-is" memories easily. Since this function is also compatible with your VIC disc drive, it's especially nice for quick start-up.

**VARIABLE MEMORY UTILIZATION:** A unique Microlog feature allows you to select the size of your text buffer and 8 "HERE-IS" messages from the available computer RAM. It automatically takes into account any memory expansion cartridges you've added. The unexpanded VIC has about 3000 characters for you to allocate. You could for example choose eight 300 character messages and a 600 character text buffer. If you don't tell it otherwise, the system will default to eight 100 character "HERE-IS" memories and a 2200 character text buffer. The expanded VIC will have different default memory sizes, depending on the amount of added memory. The programmable "HERE-IS" memories can be loaded or inserted into the text buffer for transmission at any time.

**TEXT BUFFER:** Allows you to type ahead while receiving. Text entered into the buffer is visible above the split-screen line for correction before sending.

**AUTO-START:** Inhibits the display of non-RTTY data.

**TUNING INDICATORS:** On screen visual tuning aid and audio (pitch) reference tone for RTTY and CW. (Audio is heard thru your tv or monitor's sound channel, just like any other VIC generated audio.)

**W R U (Who Are You?):** Automatically responds with your call sign when a user programmable sequence up to 15 characters is received.

**SEL-CALS:** Two 15 character user programmable sequences. Receipt of selcal #1 enables the printer, disc or tape. Receipt of #2 disables these outputs for unattended message store (mailbox).

**FULL SPEED OPERATION:** Transmit and receive Morse — 5 to 199 WPM, Baudot — 60, 66, 75, 100, 132 WPM, ASCII — 100 & 300 baud.

**MORSE SPEED TRACKING:** Automatic and speed lock modes, keyboard selectable.

**VIDEO DISPLAY:** Color keyed display makes optimum use of the computer's color capability. Uses standard VIC format of 23 lines of 22 characters.

**SPLIT-SCREEN:** Displays text buffer input above and receive/real-time transmit text below the split line.

**TOP LINE DISPLAY:** Constant display of Time, Mode, Speed/Code in use, and status indicators.

**TEST MESSAGES:** Quick brown fox and RYRY's in Baudot, U\*U\* in ASCII, and VVV in Morse.

**SPECIAL SYNC-LOCK MODE:** Allows improved ASCII operation and "Paced Output" in Baudot RTTY.

**T/R(PTT):** Fully automatic control of your XMTR via the Push-to Talk line in both RTTY and Morse.

**UN-SHIFT on SPACE:** Automatically shifts back to "LETTERS" upon receipt or transmission of a Baudot space. Keyboard command on/off.

**SYNC:** Transmits "Blank Fill" in RTTY and BT in Morse when the text buffer is empty and unit is in transmit. Keyboard command on/off.

**OUTPUT MODES:** CHAR — outputs each character as typed. WORD — outputs full word when spacebar is typed. LINE — outputs full line when carriage return is typed. BUFFER — outputs full buffer, on command.

**REAL-TIME CLOCK:** Uses the VIC's internal clock for constant on screen display of time which can be inserted into text buffer on keyboard command.

**WORD WRAP AROUND:** Prevents splitting words at the end of a line. Works in receive as well as transmit.

**MORSE TONE DETECTOR:** Single tone, 800 Hz center frequency, with effective bandwidth of 300 Hz. Pitch reference regenerated audio tone for easy tuning.

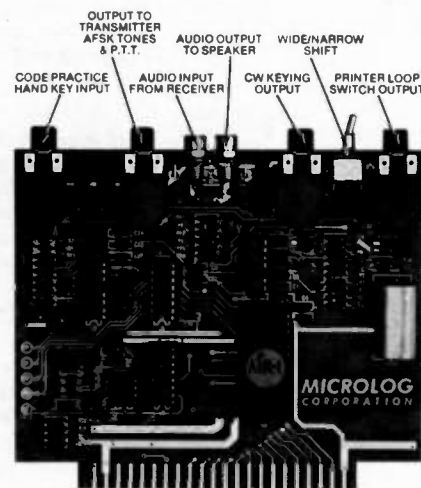

**RTTY DEMODULATOR:** True dual tone computer enhanced demodulator circuit on standard 2125/2295 Hz tone pair compatible with HF RTTY and VHF FM operation. Switch selected wide and narrow shift.

**CODE PRACTICE:** Random five character code group generator sends at any speed you set via the keyboard. Hand key input for sending practice and manual morse transmission.

**CW ID & NORMAL ID:** Two independent 16 character memories for either 2 calls or one normal and one with auto-CW ID for RTTY.

**MECHANICAL:** Printed circuit board is G-10 epoxy, double sided with plated thru holes. Board is solder masked and silk-screened with parts locations for easy troubleshooting. Size is 5 3/4" wide by 4 1/2" deep by 3/4" high. Fits directly into VIC expansion port and is compatible with popular expander boards in use.

**NO EXTERNAL POWER REQUIRED:** Unit is completely powered by host computer, eliminating the need for outboard power supply. (Entire system; VIC, Microlog AIR-1, & video monitor can easily run from 12 VDC power for remote or emergency battery operation.)

**CONNECTIONS:** All inputs/outputs are convenient 1/4" 3 circuit phone or RCA phono types. Mating plugs are all provided.

Note: VIC, VIC-20 and DATASET are trademarks of Commodore Electronics, Ltd.

# MICROLOG

INNOVATORS IN DIGITAL COMMUNICATION

MICROLOG

**AIR-1**

MICROLOG

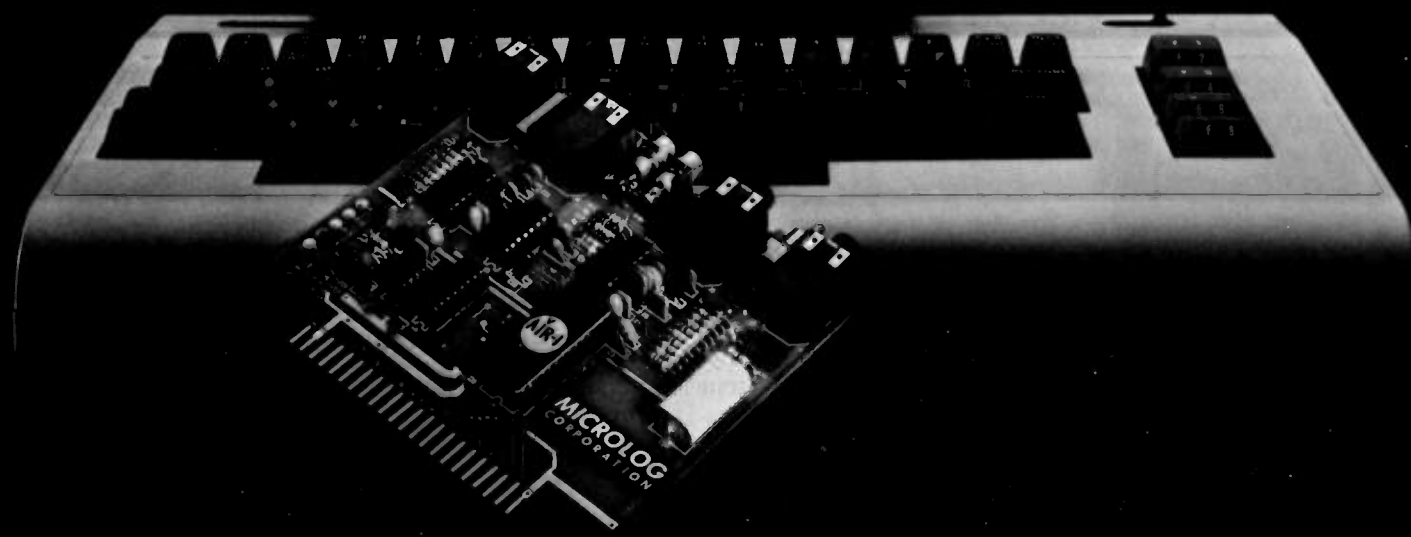

## Connect your computer to the air!

The "AIRWAVES" that is, thru the Microlog AIR-1, a single board terminal unit AND operating program that needs no external power supply or dangling extras to put your VIC-20 computer on CW & RTTY. And what a program! The famous Microlog CW decoding algorithms, superior computer enhanced RTTY detection, all the features that have made Microlog terminals the standard by which others are compared. Convenient plug-in jacks make connection to your radio a snap. On screen tuning indicator and audio reference tone make it easy to use. The simple, one board design makes it inexpensive. And Microlog know-how makes it best!

There's nothing left out with the AIR-1. Your VIC-20, America's most popular computer, can team-up with Microlog, America's most successful HAM terminal, to give you an unbeatable price and performance combination for RTTY & CW. If you've been waiting for the right system at the right price, or you've been disappointed with previous operating programs, your time is now. At \$199, the complete AIR-1 is your answer. Join the silent revolution in RTTY/CW and put your VIC-20 ON-THE-AIR! See it at your local dealer or give us a call at Microlog Corporation, 18713 Mooney Drive, Gaithersburg, Maryland. TEL (301) 258 8400. TELEX 908153.

Note: VIC-20 is a trademark of Commodore Electronics, Ltd.

**MICROLOG**

✓51

INNOVATORS IN DIGITAL COMMUNICATION

# Build the Billboard Keyboard Keyer

Get perfectly-timed CW without a buffer.  
 Then join the crowd at 60+ wpm.

**A**mid a flurry of activity to make modern amateur radio equipment extremely sophisticated, there are some indications of a welcome trend in the opposite direction. This is evidenced by the popularity of direct conversion receivers, low-power transmitters, and, in some in-

stances, keyers. Magazine editors are begging for manuscripts describing equipment the average amateur can build without a laboratory full of expensive test gear or an engineering degree in solid-state physics.

One area which has not felt the full impact of this simple design philosophy

has been that of the keyboard keyer. Some attempt has been made in this direction, but it has fallen far short of most people's expectations.

One early example of a rather uncomplicated device appeared in CQ a few years ago.<sup>1</sup> Unfortunately, there was a flaw in the de-

sign which would have rendered the unit inoperable had the builder not seen a following article describing an add-on memory which was published in a subsequent issue of the same magazine.<sup>2</sup> The same author more recently described a fairly simple keyboard keyer which appears to have whetted the appetite of many home-brew artists, judging from the number of units heard on the air recently.<sup>3</sup> Even so, this most recent design requires some fourteen integrated circuits which would intimidate the less experienced builder in most cases.

Described here is a keyboard keyer which requires only five commonly available CMOS integrated circuits. It is capable of generating all letters, numbers, punctuation, and special characters such as AR, BT, SK, and AS. The keys are electronically disabled during character generation, which eliminates disrupting that character once it has been initiated. Further-

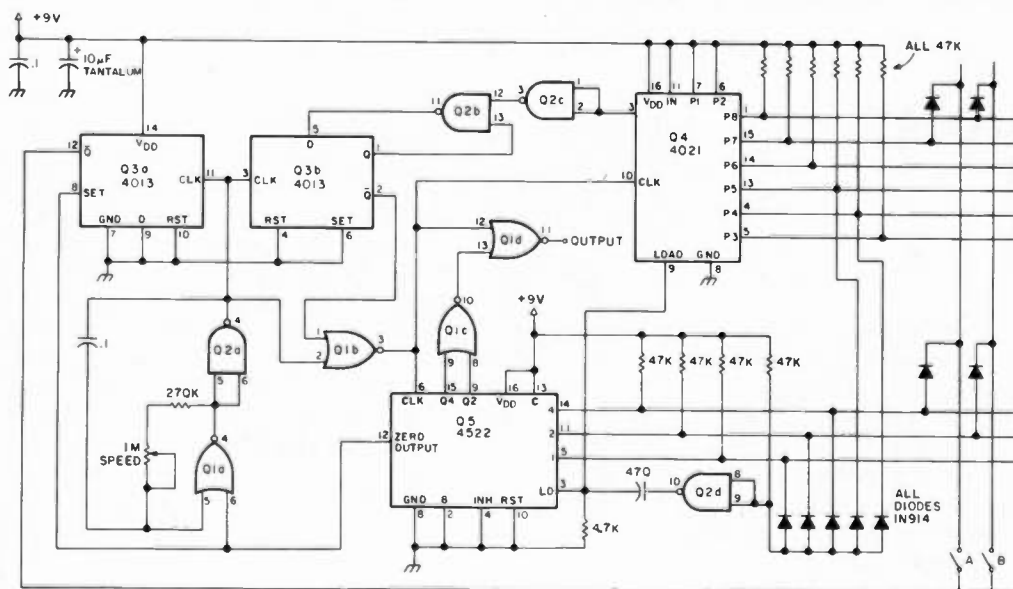

Fig. 1. Schematic of the "Billboard" keyboard keyer. Integrated circuit Q1 is a CD4001B and Q2 is a CD4011B. Although not shown on the schematic, pins 14 of these chips should be connected to +9 volts and pins 7 should be grounded.



more, automatic letter spacing has been built into the design so that sending machine-perfect CW is no longer a rich man's game.

The last two features, keyboard lock-out and automatic letter spacing, are extremely important considerations when you give some thought as to how they are used. Take the combination "CQ" as an example. The operator momentarily depresses the "C" key and that character begins. He may then immediately depress the "Q" key and hold it down until the letter "C" and the space following it have been completed. Then and only then will the letter "Q" begin, at which time the operator releases the key and a perfect "CQ" will be generated. With very little practice, this method can be used for all words transmitted, thus reducing or eliminating altogether the need for expensive and complicated buffer memories.

It is my opinion that buffers do nothing more than compensate for poor typing ability in much the same way some operators use linear amplifiers to compensate for poor operating practices. If you are loud enough, somebody will surely answer you. If the operator is willing to practice for a bit with a bufferless keyboard, it is quite easy to fool other keyboarders into believing you actually do have such a buffer installed. Enough said.

Finally, no provisions for automatic word spacing have been included, as it was not felt necessary. Most operators can simulate near-perfect word spacing by ear. Again, this results in a meaningful reduction in cost and complexity.

### Design Philosophy

Simplicity by itself is worthless unless consideration to reliability has been given. We have all seen the

deceptively simple design which works poorly or not at all. The author was determined that this device not fall into that category. For that reason, schematics and parts lists were circulated to selected amateurs who represented a cross-section of building abilities and experience. Each was encouraged to build his keyboard as he saw fit. In each case, performance was identical to that of the two originals I built. A defective capacitor caused one unit to operate erratically until the culprit was found and relegated to the garbage can. Another builder used integrated circuits of dubious heritage and experienced some problems when operating in high ambient temperatures. Barring this sort of trouble, others building this keyboard keyer should have absolutely no difficulty in getting it to work, perfectly, the first time.

### Circuit Operation

A diode matrix is used to encode the keyswitches to information which the electronic circuitry needs to form Morse code characters. Some designers prefer to use toroid transformers for this purpose. It is a moot question as to which method is superior as both have advantages as well as disadvantages. Diodes were chosen here mainly for the high degree of reliability they afford. They are widely available and inexpensive as well.

Integrated circuit Q4 is a parallel in/serial out shift register. Its output (Q8) is used to control Q2C, Q2B, and Q3B which comprise a dash generator. Any time a logic zero is present at pins 1 and 2 of Q2C, a dash will be generated. Otherwise, only dots will be formed. Logic zeros are programmed into the shift register by placing a diode on

the appropriate input line and strobing pin 9 (load) high. As the clock input of the shift register (pin 10) is pulsed, any logic zero programmed will eventually work its way to the output and cause a dash to be sent.

Integrated circuit Q5 is a programmable down-counter. It is preloaded to one number higher than dots or dashes in the appropriate Morse character. The purpose of this is to keep the keyed clock (Q1A and Q2A) running for the additional time necessary to complete the automatic letter spacing. The counter is preloaded in identical fashion to the shift register.

Gate Q1C enables the output gate, Q1D, in all cases except when the counter has reached the number one or zero so that the letter space will not appear as a code element.

The other half of the dual-D flip-flop, Q3A, per-

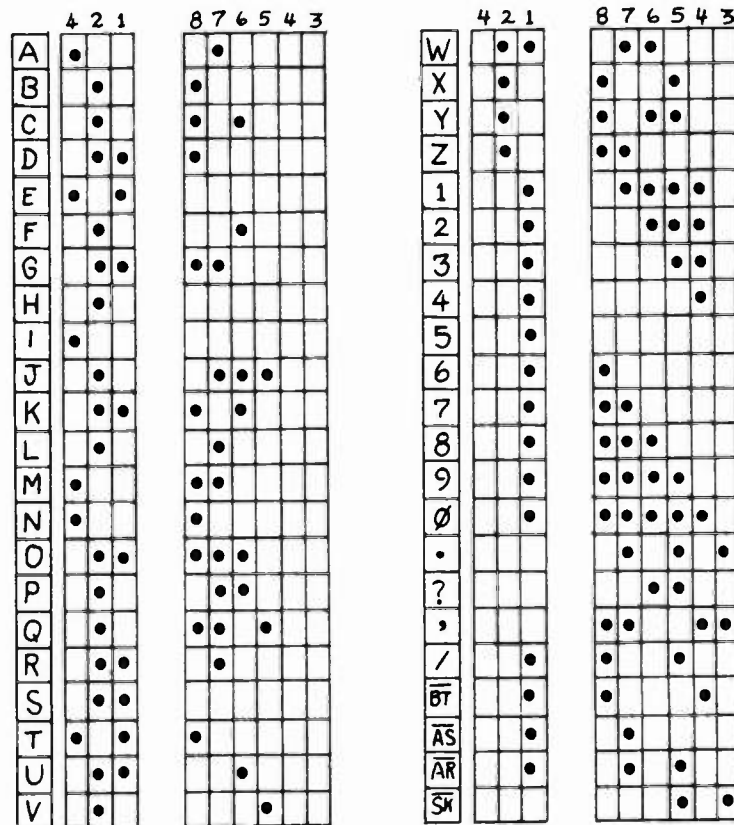

Fig. 2. Placement guide for diodes in the diode matrix. The first column refers to the CD5422 down-counter. The second column is for the CD4021 shift register. A dot indicates that a diode is to be placed in the appropriate line. All diodes are silicon switching types such as 1N914s or 1N4148s. The use of germanium diodes such as 1N34s is not recommended.

forms the keyboard lock-out function by presenting a logic one to the common terminal of all keyswitches during character generation. Only after a character and its space are completed will the Q output go low, allowing another character to be started.

All this may seem rather complicated at first, but a couple of trips through the logic should bring everything together in short order. Consider each section separately instead of trying to visualize the action simultaneously. There are a lot of things going on at the same time, which may tend to confuse the reader who tries to understand the circuit as a single unit.

It can be seen from the schematic that everything is used. That is, there are no unused gates laying around doing nothing, no flip-flops standing idle. Nothing is wasted, which is one reason this kind of performance can be had with only five active devices.

The addition of a sidetone generator is left up to the individual builder. Most modern transceivers already have them built in. On the other hand, it is useful to have some method of monitoring your progress as you practice sending without the rig being activated. In my latest version, a Radio Shack Piezo Buzzer (part #273-060) was driven by a 2N2222A-type transistor and served the function of a sidetone generator simply and inexpensively. The singular drawback to this device is that the pitch is rather high for this application. Alternately, a 555 timer wired as an audio oscillator could be driven by a transistor in a similar manner to the Radio Shack device. Whatever method you choose, remember, the driving capability of CMOS integrated circuits is limited to extremely high impedance loads. Consult the

CMOS Cookbook by Lancaster for additional information.

Transmitter keying is best done with a transistor instead of a reed relay to reduce the overall current drain. Since the entire keyer is capable of operating for extended periods of time from a single nine-volt transistor radio battery, it would be a shame to throw this feature away in order to use a relay. My rig is all solid state and requires keying a positive voltage to ground. Again, the 2N2222A was brought into play and performs the task well. For those rigs which require keying a high negative voltage to ground, something similar to the circuit used in the CMOS version of the Accu-Keyer should do well.<sup>4</sup> A recent paragraph in *QST* described a system which is designed to key both kinds of rigs without worrying about switching and could probably be adapted to this keyboard with little effort.<sup>5</sup> In any event, considerations should again be given to the limited current-driving capabilities of CMOS integrated circuits.

### Construction

Due to the simplicity of the design, it was decided that no printed circuit board layout was necessary. Instead, the prototype models were constructed on perfboard using point-to-point wiring. This method has proven most satisfactory in this and other projects I have designed. One local builder used wire-wrap, which also worked out well although it was slightly more expensive.

Sockets were used for the integrated circuits to aid the builder should troubleshooting become necessary. The small additional cost is usually well justified, as many years of building experience has borne out.

The diode matrix is easily wired by running "lines" of number eighteen bare copper wire horizontally on one side of the board and vertically on the other. The author terminated the vertical wires with miniature flea clips purchased from the local Radio Shack store. Wires from the individual keyswitches were then soldered to the clips, resulting in a neat and orderly package.

Some number eighteen wire may tend to be springy and difficult to handle as it comes off the spool. By placing one end in a vise and pulling on the other end, the wire may be stretched slightly which will cause it to go limp and perfectly straight. Try this trick and you will be pleased with how well it works.

My unit was housed in a cast-off computer keyboard enclosure garnered at the local surplus emporium for a cost of under five dollars. An earlier version was built into a home-brew box which was not very attractive but quite functional. It is difficult to justify putting a twenty-dollar circuit into a twenty-five-dollar box with my limited budget. If that sort of thing doesn't bother you, there are some very nice commercial enclosures available. Just remember to make it metal for shielding the circuit from strong rf fields.

The actual keyswitches were purchased from Jameco Electronics of Belmont, California. They come as a unit molded into a plastic base thirteen inches long. Because I had need for only forty-four keys instead of the sixty-three supplied, the unit was cut down to ten and one-half inches long prior to wiring. This modification allowed space inside the enclosure for additional circuitry which will be described in a subsequent article.

As with any project, the finished unit is only as good as the parts which go into it. Cutting corners usually results in compromised operation. If a silver mica capacitor is specified, use one. The same applies to tantalum capacitors. They were chosen for a reason. Also, wherever possible, use "B" series integrated circuits as they are more reliable and better suited for this application. The erratic operation in high ambient temperature environments discussed earlier was cured by switching from "A" series to "B" series chips from a reliable vendor. Nine-volt transistor radio batteries are ideal power sources for CMOS designs. However, one should take care to get a quality unit. Don't waste your money on the dimestore cheapies. Don't rob the one out of the kid's handie-talkie. Buy a fresh alkaline cell for best results. It is money well spent.

If there is a keyboard keyer in your future but the family budget won't allow the several hundred dollars a commercial job requires, consider rolling your own. You will be the winner all the way around in dollars saved and pride of using a piece of equipment you built yourself. As an added bonus, most keyboarders find their code speed increasing steadily and rapidly. Perhaps the "Billboard" described here is the key to an Extra class license for you. ■

### References

1. Helfrick, "An Integrated Circuit Morse Code Keyboard," *CQ*, September, 1973.
2. Helfrick, "A Memory for the Integrated Circuit Morse Keyboard," *CQ*, November, 1973.
3. Helfrick, "An Inexpensive Morse Keyboard," *QST*, January, 1978.
4. Hinkle, "An Accu-Keyer for QRPP Operation," *QST*, January, 1976.
5. Balla, "Automatic Output Polarity for the Accu-Keyer," *QST*, April, 1979.

ALL ITEMS ARE  
GUARANTEED OR SALES  
PRICE REFUNDED.  
PRICES F.O.B.  
HOUSTON  
PRICES SUBJECT TO  
CHANGE WITHOUT  
NOTICE.  
ITEMS SUBJECT TO  
PRIOR SALE.

# MADISON

## Electronics Supply



Houston COM-VENTION '83  
The 1983 ARRL  
National  
Oct. 7-9, 1983  
Astro Village Hotel

### VHF SPECIAL

- KENWOOD TR7950/**  
TT Mike . . . . List \$399.95 - Call  
TR2500 + PB25H  
battery . . . . . 289.00
- ICOM IC25H** . . . . . 349.00  
IC25A Green 309.00 Red 279.00  
IC271A New . . . . . Call
- YAESU**  
FT208RA/FT708RA  
Handie . . . . . 269.00  
FT625RD (limited) . . . . . 600.00
- CUSHCRAFT 3219** . . . . . 79.00  
6176B . . . . . 179.00  
214B/214FB . . . . . 69.00  
416TB . . . . . 59.00
- SANTEC**  
HT1200 w/battery &  
DC Charger cord . . . . . 250.00  
ST7T . . . . . 230.00  
ST440µP . . . . . 299.00  
ST144µP w/free  
DC cord . . . . . 279.00
- KDK 2030 FM** . . . . . 259.00
- TRIPPLITE Regulated**  
20A/12V DC supply . . . . . 100.00
- DB ENTERPRISES**  
New Quads . . . . . Call
- AEA MBARO** . . . . . 269.00  
MBARC . . . . . 399.00
- VIBROPLEX** . . . . . 10% Off List  
Cases stocked
- TOKYO HYPOWER &  
WELZ** . . . . . 10% Off List
- ETO Alpha 77DX** . . . . \$3785.00  
77SX (export) . . . . . Call  
Alpha work and all mods by  
authorized factory technician
- DRAKE TR5** . . . . . 639.00  
RV7 VFO . . . . . 269.00
- ICOM IC740** . . . . . 949.00  
\$50.00 rebate + free AC  
supply thru 7/31/83
- ICOM IC751A**  
Top of the line . . . . . Call
- YAESU FT77 - FT 980** . . . . Call  
FT ONE + Accessories 2300.00
- HUSTLER 6BTV** . . . . . 139.00
- HAL ST5000** . . . . . 225.00  
ST6000 . . . . . 649.00
- ALPHA DELTA &  
SHERWOOD** . . . . . 10% Off List
- TOKYO HYPOWER HC2000**  
Tuner or HL160V amp. . . . . 299.00

We will open and inspect  
all equipment at your  
request. Accessories  
purchased will be installed  
and tested without charge.

**IF IT'S  
NOT LISTED,  
CALL ME!!**

### COMPUTERS + RADIO = RTTY/MORSE

- #1** Kantronics VIC-20 HAMSOFT  
VIC-20 Computer  
AEA CP-1 Computer Patch  
with Cables to match your  
radio. \$325.00
- #2** Above w/KANTRONICS  
HAMTEXT \$375.00
- #3** VIC-64 + HAMTEXT + CP 1  
+ cables CALL!

NYE MB-V 3000 Watt Antenna Tuner  
w/ant switching  
List \$485.00 Net \$435.00

**HYGAIN TH7DX** \$369.00, 103bas \$59.00,  
105bas \$119.00  
153bas \$79.00, 155bas \$179.00,  
203bas \$139.00

**CUSHCRAFT A3** \$179.00, R3/A4 \$229.00,  
204CD \$239.00, 154CD \$109.00,  
104CD \$89.00, 402CD \$279.00

### ROBOT SINGLE FRAME COLOR SSTV

400C SSTV Converter . . . . . Call  
1200C High Resolution Converter . . . . . Call  
800C RTTY/CW TX/RX . . . . . Call  
Update C Kit 400C/800C . . . . . \$155.00

### DON'S CORNER

New Program: We can have our computer  
specialists call you at no charge for complete  
"hand-hold" help to computerize your  
operations after you purchase your system  
from us. Remember, the new MFJ Interface  
compatible with the Kantronics software. Note  
from Tang . . . one of the big four in Japan has a  
new 500 Watt rig for HF. It's the ??1030s. Keep  
watching!

## BELDEN

### BELDEN COAX - WIRE

- 8214 RG8 foam . . . . . 39¢/ft  
8237 RG8 regular . . . . . 36¢/ft  
8241 RG11 regular . . . . . 36¢/ft  
8267 RG213 mil . . . . . 46¢/ft  
8268 RG214 mil . . . . . \$2.50/ft  
8235 300 Ohm kW twin . . . . . 20¢/ft  
8000 14GA ant wire stranded . . . . . 10¢/ft  
9405 Heavy rotor cable . . . . . 46¢/ft  
9888 Dbl. shield RG8 foam . . . . . 69¢/ft  
8448 Rotor cable . . . . . 27¢/ft  
8216 RG174u . . . . . 19¢/ft  
8240 RG58u . . . . . 13¢/ft  
8241 RG59u . . . . . 13¢/ft  
9258 RG8x . . . . . 19¢/ft

### Big LCD Clock

GMT/Local twin display, black frame with  
large, easy-to-read display (.6" high)  
Batteries included. \$29.95 + \$1.50 shipping.



### HAM TAGS

\$12.95 + \$1.50 shipping



1508 McKINNEY  
HOUSTON, TEXAS 77010

**\*CALL FOR QUOTES**  
713-658-0268

We stock what we advertise, and much more.  
**TOLL FREE - ORDERS ONLY**  
1-800-231-3057



# Construct the Lead-Foot Key

*If you like your CW in the fast lane, you'll love this key.  
And it is guaranteed not to slip—at any speed.*

**Editor's Note:** Melting lead can be dangerous! Not only can you get burned, but the fumes can be toxic, too. Use caution and plenty of ventilation.

J. H. Owens W5JQE  
Rte. 1, Box 218-T  
Pottsboro TX 75076

**H**ave you ever considered building your own keying-paddle, only to be stopped short by lack of a heavy metal base? Me, too. Then, one day after

eating some sardines, I was about to throw the can away, when I took a second look and got a great idea. Why not fill the sardine can with melted lead and use it for the base?

Thinking about it for a while, I could find no flaws, so I scrounged some used automobile tire-balancing weights and melted them into the can with my pro-

pane torch. The metal clamps floated to the surface where I picked them off with pliers. The sludge also floated to the surface, and I scraped it off with the lid from the can. (A friend of mine used lead pipe and melted it in the can over a kitchen range burner. But, before that, he drilled a hole in each end of the can, and put a sheet metal screw through it, this to hold the lead casting and the can securely together.) So far, so good.

After the lead-filled can cooled down, I washed off the traces of sardine oil with solvent (you can use lantern fuel, paint thinner, acetone, etc.), then roughed the surface with fine sandpaper, and gave it a coat of paint. Not bad. The upside-down can was smooth and nicely contoured. Heavy

too...it weighed four pounds.

A little later on, I found that it was also very adaptable for mounting the keying hardware. All I had to do was drill pilot holes through the can and into the lead casting—very slowly. If you don't have a hand-drill or variable-speed electric drill, use your regular electric drill, but turn it on and off repeatedly to keep it from running fast. I used a #4 drill, 3/32" in diameter, and kept it oiled. Now I was able to mount the parts with #6 × 1/4" sheet-metal hex-head screws. Neat.

## The Paddle Arm

The biggest challenge I found in making the paddle arm was finding the right material. I went through the usual list of leaf switches, hacksaw blades, etc., only to find out that those

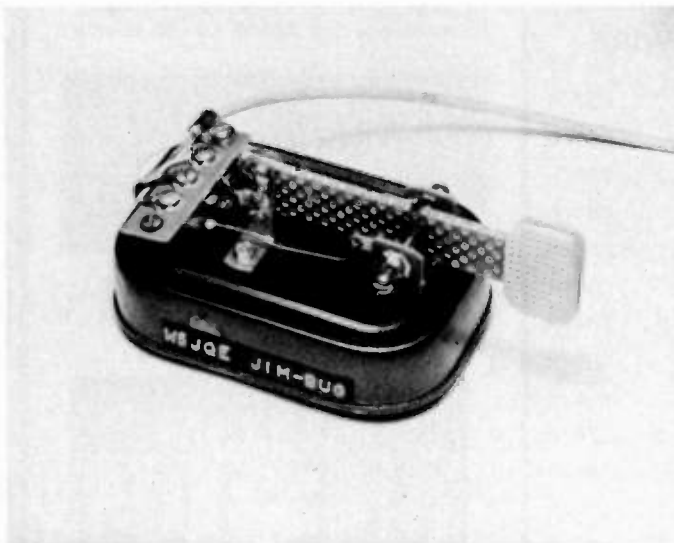

The finished model with glass-epoxy paddle arms, which give it a "hard" feel, like the commercial paddles. Phenolic arms are more flexible and give it a "soft" feel. If you like a really soft feel, make the arms an inch longer. Hey! If you don't like sardines, you can get smoked clams or oysters in the same size can!

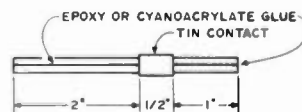

**Fig. 1. Paddle construction.** Clamp glued ends together until cement has cured. Use same technique for tin-plate ground contact.



**Fig. 2. Keying stanchions.** To begin, gap the points at 0.010".

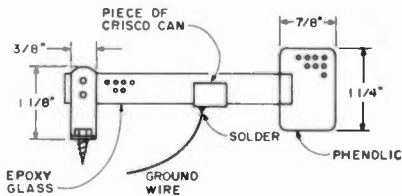

Fig. 3. Details of paddle-arm assembly.

springy gadgets have *minds of their own!* They keep on bounding back and forth after you want them to stop, and good electrical contacts they ain't. So, after many trial-and-error experiences, I got down to some basic reasoning.

What I really needed was a lightweight material, having low mechanical Q, or high damping factor, something rigid in one plane and flexible in the other. But what? Then it hit me. How about a strip of perfbord or, better still, two pieces? After some experimenting, I ended up with two strips of 3/64" (0.0468) glass-epoxy board, about 5/8" wide and 3 1/2" long, glued together at the last half-inch on each end with epoxy cement. You also can use cyanoacrylate cement. See Fig. 1.

This assembly provided the desired damping factor, and more. Let me explain. When you bend the arm, one of the perfbord pieces is *stretched* and the other one is *compressed*, and the friction between the two absorbs the stored kinetic energy quickly. If you want to test this, clamp one end in a vise, and flick the other end with a finger. Listen closely, and note the time it takes for the vibration to stop. Now try this same test with a hacksaw blade and you will find that the vibrations last *ten* times as long. No minor difference here, but a major improvement. OK?

### The Dit-Dah Electrical Contacts

Still another challenge was finding a satisfactory substitute for the precious-metal contacts used on the

finer commercial models. No big problem with the stanchion contacts—6-32 nickel-plated brass screws, about one inch long, worked OK. I made the stanchions by cutting a terminal-strip into two pieces, and mounting them to the base with half-inch angle brackets. See Fig. 2.

The common, or ground contact, on the paddle arm was a little trickier. The best thing I could find was shiny tin-plate, such as used for Crisco and other hydrogenated vegetable-oil cans. S-o-o-o, I raided the refrigerator and transferred the cooking grease from its container into a plastic storage box. Then I cut off a piece of the can material about a half inch wide and an inch long, cleaned all the grease off it, bent it around the paddle arm, and glued it in place. See Figs. 3 and 4.

Next, I soldered the flexible ground wire to the bend point. Finally, I sprayed the contact surface for lubrication and corrosion resistance... WD-40 or TV tuner spray works well. Voilà! Soft-touch contacts. Not gold, but so much *much* better than blued steel.

### The Non-Slip Feet

One thing I hadn't planned on was a 4-pound paddle slipping around on my operating desk, even with rubber feet on it. I talked with some other hams and they told me that they had the same problem with their bugs and paddles. Some glued them to their desks, others drilled holes and screwed them down.

Well, I kept trying different things until one day I hit the jackpot with poly-

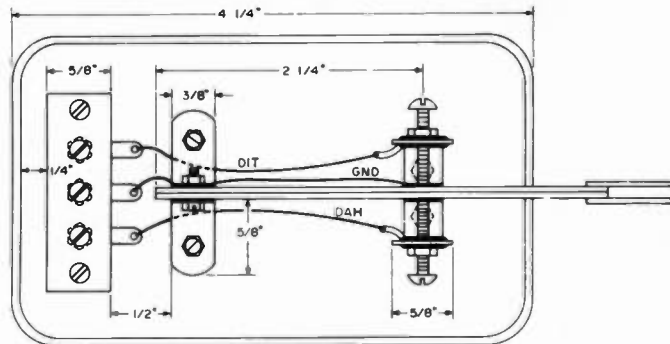
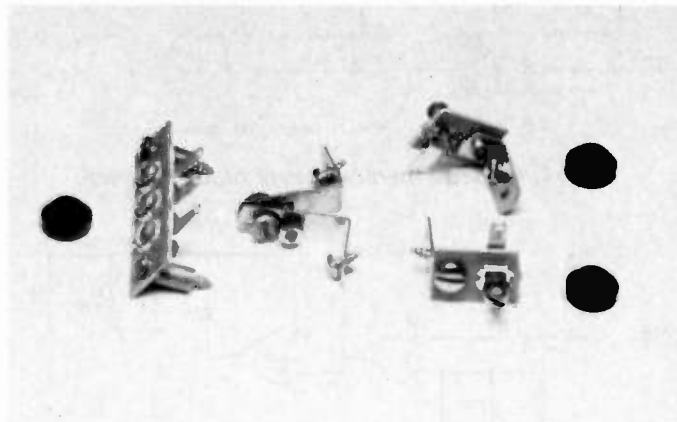

Fig. 4. Top view of the completed key. The dimensions were measured on one of the models, but need not be exact.

urethane foam. This is the stuff used for cushioning fragile items for mailing. It also is used as weatherstripping tapes. It worked, beautifully. Dime-size pieces, about one-quarter inch thick, glued to the lead base, did the job. The final choice was two strips, about a half inch wide, glued with rubber cement along each underside of the base. This stuff works on the commercial paddles, too. Just slip a little piece under each one of the rubber feet to make contact with the desk surface. I know, because I own one of those commercially-built paddles, a fine piece of precision machinery.

So, why did I go through

all of this work to build a paddle? Well, the problem is that the manufactured paddle is *iambic*, and I am *non-iambic*. That's incompatibility. I just couldn't avoid closing both the dit and dah contacts at the same time, too often in the wrong order. Mistakes, mistakes, mistakes. So, I decided that the "squeeze" system, as well as the squeeze paddles, were not for me. Unfortunately, I could find no non-squeeze, non-iambic paddle on the market. So, I built my own. Maybe this article will stimulate some manufacturer to take a step *backward*. Anything to cut down on the keying mistakes on the air would be a blessing. ■



Hardware for the key. The contact stanchions were made from a second terminal board (same as the one on the left) cut into two pieces. The angle brackets for the contact stanchions shown had pierced-and-threaded holes, but their base ends had to be cut off to leave only one hole. Ordinary 1/2" x 1/2" angle brackets would serve as well. The sink-faucet washers may be glued to the base to raise it higher if desired. The sheet metal screws for the terminal board have to be 1/2" to 5/8" long to account for the standoff spacers.

# The \$2 Infinite-Memory Keyer

*Take a break. Your cassette recorder will send any message for you.*

If you have a cassette tape recorder and like to operate CW, you can add an infinite memory keyer to your station for about two

dollars. The idea is to place your CW messages on cassette tapes and play them back to key your transmitter. The demodulator

presented in this article will convert the CW tones from the tape player into keying signals to drive the transmitter.

For repetitive messages such as CQ CQ DE . . . , you can use a continuous cassette tape. These come in 1/2-, 1-, 2-, and 3-minute durations. The tape in the cassette is looped back on itself and thereby forms a continuous tape. For code practice or message broad-

casts, the usual C15, C30, or C60 cassettes could be used.

Code can be placed on a cassette by using an audio oscillator or your transmitter sidetone. Best results are obtained if the code is transmitted directly from the oscillator circuit to the mike input of the cassette tape recorder rather than recorded by microphone pickup. Too much background noise results from the latter.

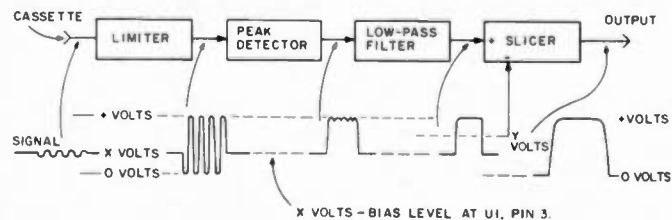

Fig. 1. Cassette memory keyer block diagram.

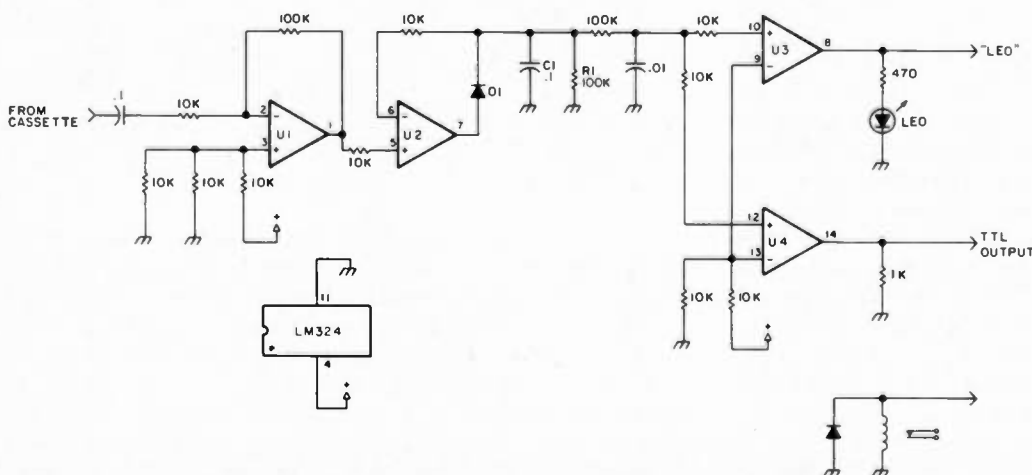

Fig. 2. Schematic of keyer system.

## Demodulation

Before presenting the cassette keyer, let's look at the general demodulation process. As shown in Fig. 1, it consists of four steps: limiting, peak detecting, low-pass filtering, and slicing. The limiter is used to amplify the cassette CW tones and to provide sufficient drive for the peak detector. Also, the limiter will smooth out any small variations in the amplitude of the tones. This process is similar to FM detection ex-



cept that the filter or discriminator is discarded.

The peak detector is set to convert the limited tones to positive-going pulses. It acts as a half-wave rectifier but retains the positive peaks for a short duration; hence, the pulses have a slight ripple pattern at their tops. The circuit ignores the negative-going portions of the tones.

The low-pass filter is then added to remove these ripples. The system will work without the filter as long as input tones are clean and strong. It aids operation, however, when tape output is marginal.

The slicer converts the peak-detected pulses into TTL-compatible signals that go from 0 volts in the off state to about 3.5 volts in the on state.

#### Circuit Schematic

Now, let's examine the circuit schematic, Fig. 2. All

of the signal processing is done with a single operational amplifier chip, an LM324, which contains four separate op amps. The circuit can be operated from a 5- or 9-volt dc supply. All resistors are 1k, 10k, or 100k, with the exception of one 470-Ohm resistor.

#### Circuit Operation

Cassette tones enter at the left and the TTL-compatible output is at bottom right. The circuit can also drive a low-voltage relay if it is substituted in place of the 1k output resistor at pin 14.

The limiter, U1, has a gain of ten and is biased at pin 3 to one-third of the supply voltage. This bias also sets the dc voltage level at pins 1, 5, 6, 10, and 12.

The peak detector, U2, charges capacitor C1 to the peak voltage of the tones that appear at pin 5. When

the voltage at pin 5 exceeds the voltage on C1 and hence also at pin 6, U2 forward biases diode D1 and further charges C1. When the voltage at pin 5 drops, U2 turns off and C1 holds its charge until the bleeder resistor, R1, discharges it. C1 and R1 are set so that the ripple at C1 is small but the pulse formed from the code signals follows the code quickly; this is always a compromise.

The ripple is then removed by the RC low-pass filter. It does a sufficient job and frees up the fourth op amp in the LM324 IC to be used as a tuning indicator.

U3 and U4 work as slicers, or comparators, and convert the pulses from the peak detector into TTL-compatible signals. A dc restore circuit could be used here as an alternative. The advantages of the slicer are

that it cleans up some ripple that may still remain and generates sharp and clean rise and fall edges for the keying output. The bias for U3 and U4 is set about one volt above the bias for U1 and U2. Therefore, when a pulse is generated at U2, the voltage crosses over the bias voltage of U3 and U4, generating positive pulses at their outputs. That is, when the voltage at pin 12 exceeds the bias voltage at pin 13, pin 14 will have an output nearly equal to the supply voltage.

The output of U3 is used to drive an LED indicator. This makes tuning and circuit verification of proper operation easy. The circuit as a whole could be used for receiver CW demodulation if a CW filter is placed between U1 and U2. You may want to consider that when planning circuit construction. Happy cassette keying! ■

## GLB HIGH PERFORMANCE PRESELECTOR-PREAMP

The solution to most interference, intermod, and desense problems in AMATEUR and COMMERCIAL systems.



Typical rejection:  
± 600 KHz @ 144 Mhz: - 28dB  
± 1.6 Mhz @ 220 Mhz: - 40dB  
± 5 Mhz @ 450 Mhz: - 50dB

### COMPARE OUR CURVES!

- 40 to 1000 Mhz - tuned to your frequency
- 5 large helical resonators
- Low noise - High overload resistance
- 8 dB gain - ultimate rejection > 80 dB
- 10 to 15 volts DC operation
- Size - 1.6 x 2.6 x 4.75" exc. connectors
- FANTASTIC REJECTION!

Price - \$79.95 bipolar w/RCA jacks  
Connector options: BNC \$5, UHF \$6, N \$10

**SUPER HOT! GaAs Fet option \$20**

We offer a complete line of transmitter and receiver strips and synthesizers for amateur and commercial use.

### CUSTOM DESIGN & ENGINEERING

Allow \$2 for UPS shipping - MasterCard and VISA welcome

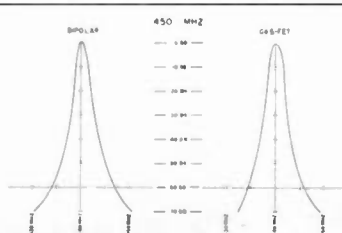
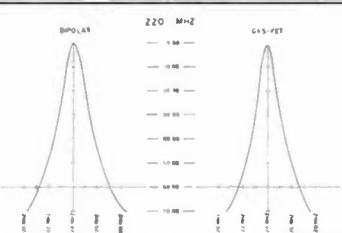
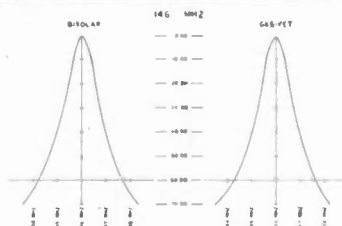

## AUTOMATIC IDENTIFIERS



ID-1

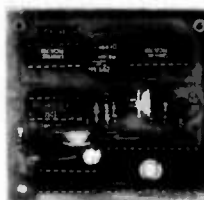

ID-2

- For transceivers & repeaters
- Automatic operation
- Adjustable speed & amplitude
- Small size - 7 to 15 volts DC
- 8 selectable, reprogrammable messages - each up to 2 minutes long
- Wired & tested
- Programmed with your message(s)
- LOW COST  
Model ID-1 - \$39.95 Model ID-2 w/2 to 10 min. timer \$59.95

# GLB ELECTRONICS

1952 Clinton St., Buffalo, NY 14206  
716-824-7936, 9 to 4

✓ 143

Call or Write  
for Free  
1983 Catalog

# Ampersand electronics



## Oscilloscope Probe Kit

This passive probe incorporates a three-position slide switch in the head and has a cable length of 1.5 meters.

Bandwidth: D.C. to 100 MHz.

TO ORDER: Mail Order Only, check or money order. Add 6% sales tax on California orders. Add \$1.20 per probe shipping & handling. Other models available starting at \$27.00.

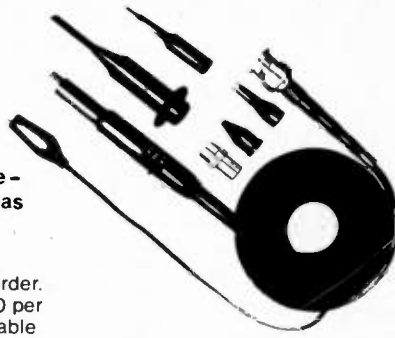

Model SP100.... \$39.95

6065 Mission Gorge Rd. #66 • San Diego, CA 92120

Don't Be Left Out in the Cold with the Russian Woodpecker

# GET A MOSCOW MUFFLER™

Another first from AEA. The Woodpecker Blanker, WB-1 really works. This unit effectively blanks the pulsing interference of the Russian Woodpecker. Two versions are available, the WB-1 for use with communication receivers and WB-1C for use with all popular transceivers.



This extremely useful accessory is designed for direct insertion between your receiver (or transceiver) and the antenna. It is both MORE EFFECTIVE than I.F. type blankers and requires NO MODIFICATIONS to your receiver! The unit operates from a 13 VDC ± 2 VDC power source at less than 575 mA. (AEA AC wall unit AC-1 will operate the blanker.)

The blanker works well on both CW and SSB modes that are being interfered with by a woodpecker. Controls on the front panel include; four push button switches, a synchronize control and a width control. The WB-1 also features a low-noise untuned broadbanded 6 db gain pre-amp which can be selected with or without the blanker enabled. The WB-1C uses the same circuitry but includes a carrier operated relay (COR). This provides protection to the receiver section during transmissions from the attached transceiver.

Prices and Specifications subject to change without notice or obligation.

## BRITT'S TWO-WAY RADIO

2508 N. Atlanta Rd.  
Smyrna, GA 30080  
(404) 432-8006  
1-800-241-2027

✓223

**AEA** Brings you the Breakthrough!

3% CASH DISCOUNT--CASHIERS CHECK OR M/O

## AZDEN

PCS-300 2 METER HANDHELD.....285.00  
PCS-4000 25 WATT MICRO-COMPUTER.....285.00

## BUTTERNUT ANTENNAS

2MVC-5 2 METER 5/2 WAVE COLLINEAR.....31.00  
2 MCV 2 METER COLLINEAR.....30.75  
HF6V 10-80 PLUS 30 METER VERTICAL.....110.00  
HF6VX SAME AS ABOVE/SMALLER PACKAGE.....127.00  
TBR-160 HF 160 METER ADD ON KIT.....45.00

## CUSHCRAFT

A3 10-15 & 20 MHZ 3 ELEMENT BEAM.....176.95  
A4 10-15 & 20 MHZ 4 ELEMENT BEAM.....228.50  
A35K/A45K S/S HARDWARE FOR A3/A4'S.....41.50  
A32-19 144-146 MHZ 19 ELEMENTS.....83.00  
AV-4 10-15-20-40 M 1/4 WAVE VERTICAL.....83.00  
AV-5 10-15-20-40-80 M 1/4 WAVE VERTICAL.....90.78  
10-30D 28 MHZ 3 ELEMENT SKY WALKER BEAM.....76.50  
10-40D 28 MHZ 4 ELEMENT SKY WALKER BEAM.....90.00  
15-30D 21 MHZ 3 ELEMENT SKY WALKER BEAM.....97.00  
15-40D 21 MHZ 4 ELEMENT SKY WALKER BEAM.....104.50  
20-30D 14 MHZ 3 ELEMENT SKY WALKER BEAM.....174.50  
20-40D 14 MHZ 4 ELEMENT SKY WALKER BEAM.....242.50  
AMS-147 146-148 MHZ MOBILE MAG MOUNT.....27.95  
ATS-147 146-148 MHZ MOBILE TRUNK MOUNT.....27.95  
A147-11 146-148 MHZ 11 ELEMENT BEAM.....38.00  
A147-20T 144-146 MHZ 20 ELEMENT BEAM.....63.00  
ARX-2B 134-164 MHZ RONGO RANGER.....34.95  
A144-11 144 MHZ 11 ELEMENT BEAM.....38.00  
A144-10T 144 MHZ 10 ELEMENT BEAM.....38.00  
A144-20T 144 MHZ 20 ELEMENT TWIST.....69.50  
214B 144-146 MHZ 14 ELEMENT BOOMER.....69.50  
214FB 144 ELEMENT BOOMER.....69.50  
617-6B 6 METER 6 ELEMENT BOOMER.....180.00  
MANY OTHER ANTENNAS IN STOCK AT SAVINGS

## DIAWA/MILLER

CS-201 2 POSITION COAX SWITCH.....21.00  
CS-401 4 POSITION COAX SWITCH.....62.95  
CN-520 1.8-60 MHZ SWR/POWER METER.....69.75  
CN-540 50-148 MHZ SWR/POWER METER.....77.25  
CN-620-B 1.8-150 MHZ SWR/POWER METER.....108.00  
CN-603 140-450 MHZ SWR/POWER METER.....129.80  
CN-720-B 1.8-150 MHZ SWR/POWER METER.....155.00  
CN1001A AUTOMATIC ANTENNA TUNER.....311.00

## ROTORS & CABLES

HD-73 ALLIANCE W/METER USES 6C CABLE.....99.00  
RG213 (RGG MIL-SPEC) CABLE PER 100 FT.....28.00  
UI00 ALLIANCE W/AUTOMATIC DIAL SET.....45.25  
HDR-300 MYGAIN DELUXE DIGITAL.....430.49  
AR22XL TELEX AUTOMATIC BELL ROTOR.....60.00  
CD4511 TELEX METERED ROTOR.....103.00  
HAM IV TELE METERED W/LEDGE BRAKE.....199.75  
TXZ SUPER DUTY METERED & WEDGE BRAKE.....248.49  
B CONDUCTOR ROTOR CABLE PER 100 FT.....17.00  
B CONDUCTOR ROTOR CABLE ALL 8 GAGE PER FT.....33  
100 FT RGG SUPERFLEX W/PL259 INSTALLED.....29.80  
MINIATURE RGG (RGGX) PER 100 FT.....16.00  
RB11 75 OHM CABLE PER FOOT.....25

## HY-GAIN

TH7DS 7 ELEMENT TRIBAND BEAM.....369.00  
TH3MK3 3 ELEMENT TRIBAND BEAM.....218.85  
TH3JRS 3 ELEMENT TRIBAND BEAM.....154.50  
HQ-2 10-15-20M HY-QUAD BEAM.....259.00  
TH7 KIT FOR HY-QUAD SWR/POWER METER.....132.00  
V2-S 2M VERTICAL COLLINEAR BASEW/SS W/M.....38.50

## KDK 2 METER RADIOS

FM2030 2 METER SYNTHESIZED RADIO.....293.50

## MINI-PRODUCTS

HQ-1 MINIATURE 4 BAND QUAD.....132.00

## MACO POWER SUPPLIES

2006 S/L 8 AMP 1/L & 6 AMP C/L 4 AMP.....48.00  
2010 S/L 12 AMP 1/L 10 AMP C/L & 6 AMP.....61.50  
2020 S/L 24 AMP 1/L 20 AMP C/L 12 AMP.....73.80  
2030 S/L 36 AMP 1/L 30 AMP C/L 18 AMP.....115.65

## MFJ PRODUCTS

MFJ-102 12/24 HOUR CLOCK.....30.69  
MFJ-202 RF NOISE BRIDGE.....52.00  
MFJ-262 1 KW DRY DUMMY LOAD.....57.25  
MFJ-308 8 BAND SW CONVERTER.....87.40  
MFJ-311 154-158MHZ CONV. FOR 2 M SYN.....435.80  
MFJ-481 MEMORY KEYS 50 CHARACTER MESS.....79.00  
MFJ-494 SUPER KEYBOARD 50 CHARACTERS.....245.50  
MFJ-496 SUPER KEYBOARD 256 CHARACTERS.....297.00  
MFJ-722 SUPER CW/SSB FILTER/OPTIMIZER.....61.00  
MFJ-825/B30 SWR/PEK WATTMETER W/B30.....104.00  
MFJ-941C ANT TUNER/SWR METER 1:4 BAL.....79.00  
MFJ-989 3KW TUNER LOADED.....289.00  
MFJ-16010 RANDOM WIRE TUNER.....34.90

## MIRAGE AMPLIFIERS

B-23 144-148 2 IN 30 OUT.....78.50  
B-108 144-148 10 IN 80 OUT.....157.00  
B-1016 144-148 10 IN 160 OUT.....244.00  
B-3016 144-148 30 IN 160 OUT.....403.25  
D-1010N 430-450 10 IN 100 OUT.....286.95  
D-1010U 430-450 10 IN 100 OUT.....286.95  
MP-1 WATTTRER H/F.....100.00

## TEMPO RADIOS & AMPS

S-1 2 MTR. SYN. 143-147 MHZ.....255.00  
S-1 T 2 MTR. SYN. W/TT PAD.....271.00  
S-15 2 MTR. 5 WATT M/M 140-150 MHZ.....265.00  
S-15BEXP 2 MTR. 5 WATT M/M 150-160 MHZ.....307.00  
S-13T SAME AS S-15 WITH TT PAD.....293.50  
S-13TBEXP SAME AS S-15B WITH TT PAD.....322.50  
AC-15 AC QUICK CHARGER FOR S-15'S.....54.00  
CC-15 LEATHER CASE FOR S15'S.....25.00  
SPARE BATTERY PACK FOR S-15'S.....30.50  
HM-15 SPEAKER/MICROPHONE.....36.50  
S-30 30 WATT POWER AMP. FOR WALKIES.....84.00  
S-80 80 WATT POWER AMP. FOR WALKIES.....148.79

## TEN-TEC

560 CORSAIR 1.8-30 MHZ NEW TEN-TEC.....1035.00  
MA114 1 ATT SSB/CW 10-BOM ANALOG.....1070.00  
545 200 WATT SSB/CW 10-BOM ANALOG.....738.00  
580 DELTA 200 WATT SSB/CW 10-160M DIG. 765.00  
444 HERCULES 1 KW AMP W/POWER SUPPLY.....1659.00

## VOCOM PRODUCTS

2C025-2W 2 IN 25 OUT 2 METER AMPLIFIER.....69.98  
2C050-2W 2 IN 50 OUT 2 METER AMPLIFIER.....101.30  
2C100-2/25 W IN 80 TO 100 WATTS OUT.....170.00

## WILSON BY MACO

SY-33 3 ELEMENT 10, 15, 20 METERS.....207.87  
SY-36 6 ELEMENT 10, 15, 20 METERS.....285.36  
33-6MK ADD ON 40 METERS TO TRIBANDS.....88.50  
GR-1 GROUND KIT FOR WV-1A.....27.00  
WV-1A 4 BAND TRAP VERTICAL 10-40 METERS.....88.50

CALL FOR QUOTES ON  
OTHER RELATED PRODUCTS  
FOB ORIGIN

Amateur  
Equipment,  
Accessories  
& Antennas.  
Export Anywhere.



2317 Vance Jackson Rd.  
San Antonio TX 78213

(512) 733-0334

COD Available

(Toll free number 800-531-5405)

**Appliance  
& Equipment  
Company inc.**

Hours: 8:30 a.m. to 5:00 p.m. Monday thru Friday  
9:00 a.m. to 2:00 p.m. Saturday - CST  
Prices Subject to Change without notice.

## HURDLE THE HUMP



WITH TWIN OAKS CW TRAINING PROGRAMS

### CW TEACHING SYSTEMS

Twin Oaks Associates is a partnership of mental health professionals who are hams interested in helping others to learn CW. Twin Oaks has developed three Morse code teaching systems on tape which represent the careful application of psychological principles to learning. They help students learn to recognize and copy Morse characters at a very high speed.

The first set of tapes is called System 12 ©. It is designed for the ham who may have a Novice or Technician class license but can't "get over the hump" to pass the General class code test. System 12 takes students past 15 words per minute on five carefully-structured, successive-demand, 60-minute cassettes.

The second training program is called System 24 ©. It assumes that the student is able to copy comfortably at 9 or 10 words per minute but would like to go after the amateur Extra class license. This program is on five 60-minute cassettes and carries the student past 30 words per minute.

The third teaching system, the System 12 Alphabet Book ©, is designed for persons who know absolutely nothing about Morse code. It may be used, however, by persons who are not thoroughly comfortable at 5 words per minute, and it is useful for either classroom or self-instruction.

Each program, or system, comes with its own carefully-written study guide. Systems 12 and 24 cost \$30 each, and the System 12 Alphabet Book costs \$15.



GET HUMPIN'—  
ORDER TODAY!

TWIN OAKS ASSOCIATES  
ROUTE 5, BOX 37 ✓ 197  
KNOXVILLE IA 50138.

## PACKET RADIO

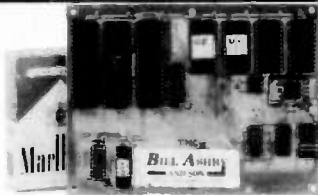

### ASCII—USA/AX.25 HDLC CONVERTER

USA/AX.25 is AMRAD/ARRL approved digital format STANDARD used on amateur packet radio networks

PAC/NET board only \$80.00  
Assembled/Tested. No ICs. 90 day warranty

Package of all ICs except 2-2716 EPROMs \$80.00

## PAC/NET SYSTEM

PAC/NET SYSTEM \$240.00  
System Tested 4.5 x 6" board complete with all ICs and programmed EPROMs personalized for each purchaser. Requires only single 8-10 volt 1/2 amp power. 1 year guarantee of hardware/software/AX.25 standard RS232 serial ASCII at any user baud rate. RS232 HDLC for 202 modem used for AFSK or direct to RF equipment for FSK.

Custom Systems Custom Programming

**BILL ASHBY**  
— AND SON —

K2TKN—KA2OEG 201-658-3087  
BOX 332 PLUCKEMIN N.J. 07978

## NO MORE MISSED CALLS OR ANNOYING CHATTER.

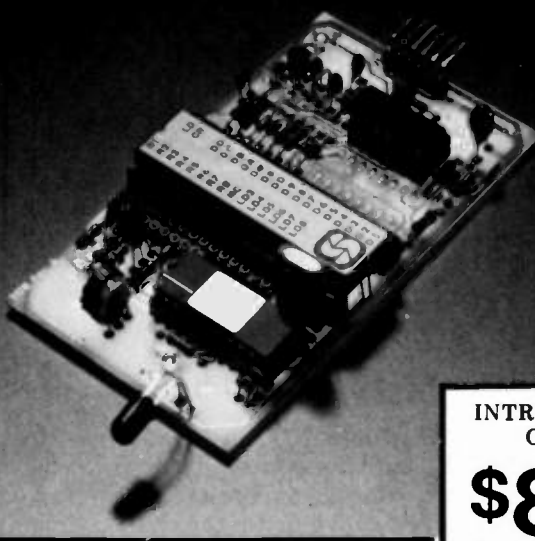

INTRODUCTORY  
OFFER!

**\$89.**

shipping & handling  
charges included

### Speedcall's new DTMF commercial-grade kit lets you take control!

Now it's possible for individuals and repeater groups to have a personal (or emergency) commercial-quality DTMF system, at very low cost. Speedcall's new 312K decoder kit easily assembles into a compact, high-performance unit. Features include a virtually unfalsable "Wrong Digit Lockout" circuit which permits only correct signals to be accepted as valid. And the 312K decodes all sixteen digits, permitting expanded flexibility and special control applications.

Commercial versions of the 312K are used to perform selective calling of mobile fleet operations, on-off control of remote facilities (such as power, valves, pumps, etc.), and to receive the status of single functions (repeater site failure or intrusion, equipment vandalism, power failure, valve or compressor function change, etc.) Speedcall Corporation manufactures a complete line of DTMF signaling and control systems. For more information write or call Speedcall at 415/783-5611.

Output: Single open collector output. 200mA.  
Input Signal Range: 20mV to 6V (flat input).  
Code Capacity: 3 to 8 digit address plus select any of the 16 touch-tone digits as desired.  
Battery Voltage: 13.8VDC Nom. (9 to 16VDC) @ 30mA nominal on standby.  
Assembled Dim: 3/4" H x 2-1/8" W x 3-3/4" L  
With Enclosure: 1" H x 2-1/2" W x 4-5/8" L



Kit with Enclosure,  
Reset Push Button  
and Buzzer ... \$104.

To order, send check or money order to:

DEPARTMENT "K"  
**SPEEDCALL**  
CORPORATION ✓ 3

2020 National Avenue • Hayward, California 94545  
415-783-5611

(California Residents add 6% Sales Tax)



# Apple, Morse, and You

*Simple software and cheap hardware make for a great CW keyboard recipe. Just add one operator.*

**H**ave you been looking for a CW keyboard program in BASIC for your Apple II computer with Applesoft? The program provided here will enable you to use the Apple as a CW keyboard with sidetone and speeds adjustable from around 5 words per minute to about 70. The program is easily modified to provide for any special characters you might wish to have.

Lines 1000 to 1460 contain the Morse data. The data lines consist of the ASCII value for the character followed by a Morse representation. A 3 signifies a dash, a 1 stands for a dot, and a 0 marks a space. For example, line #1110 says the following:

1110 DATA 65,130

The number 65 is the ASCII code for an upper-

case A. The 130 means didah, followed by a short space to keep it from running into the next letter.

When the program is run, the computer will take the data listed between lines 1000 to 1460 and load it into the string matrix CODE\$. The location within CODE\$ is the ASCII value of the character; in other words, location 65 in CODE\$ contains the data for the Morse letter A. When characters are sent to the computer from the keyboard, the computer changes the letters to their ASCII value (using the BASIC ASC(\$)) command) and looks in CODE\$ (<ASCII value of letter>) for the Morse data. The Morse data is then dissected character for character using the BASIC MID\$(X\$,X,X) command.

POKE a machine language subroutine which will enable the Apple to send the CW through the internal speaker. The value POKEd into decimal location 768 on line 70 determines the pitch of the sidetone.

Line 130 gets a single character input from the keyboard. This character is then checked to see if it is a control character used for a special purpose on lines 140 to 160. In this program, the control characters A, B, Y, and Z are used for special functions.

The subroutine at line 200 is what takes the Morse data from the proper location in CODE\$ and generates the Morse signal from it. The Morse character can be heard on the Apple speaker. Also, the annunciator TTL output number 0 will be toggled on and off in Morse code. This signal

Lines 80 to 90 are for the CW sidetone. These lines

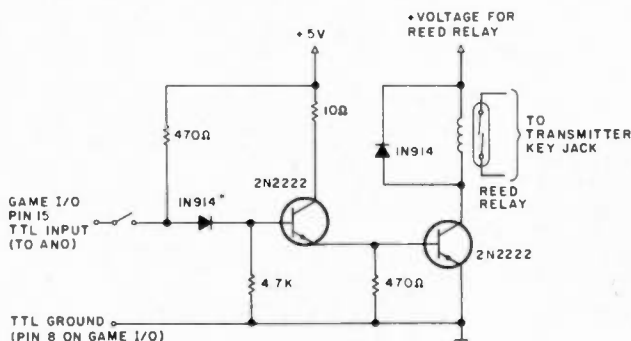

Fig. 1. No parts values are critical. \*Any small switching diode can be used.

can be used to drive your transmitter through a suitable driving circuit. The circuit used must take the TTL output and use it to drive a reed relay which, in turn, keys the transmitter. An example of such a circuit is shown in Fig. 1. The lines which turn AN0 on and off are located at line 235 and line 245. Line 240 is a call to the machine language sidetone routine.

Using the program is a simple procedure. When the program is run, the screen will clear and the following will appear: MESSAGE—>

After this prompt, type in a message for the memory. This message can be played back at any time while in the keyboard mode of operation by simply pressing either CTRL A or CTRL B. The message may be up to 254 characters in length. If the message contains commas, enclose it in quotes.

The next thing to appear on the screen is: SPEED

Type in a number between 1 and 85. Note that 85 is the slowest speed. The fastest usable speed is about 6. At speeds faster than this, the transmitter does not key accurately. When set for a speed of 7, the code speed as measured on a Kantronics Field Day II code reader was in excess of 75 words per minute.

After the above two items are entered in, the program will operate as a CW keyboard. When a letter is typed on the keyboard, it is sent through the speaker and AN0 in Morse code and displayed on the monitor. If you want to play back the pre-programmed message, hit control A or B. To reset the speed, use CTRL Z. If you want to change the message, hit the CTRL Y keys.

I gave the following keys special functions: ESC produces the Morse error code (eight dits), and the colon (:)

is the CQ key. To add a special function to any key of your choice, all you must do is determine the ASCII value of the character and put it on a DATA line followed by the Morse representation of what you want sent. For example, if your name were Joe and you wanted the computer to send your name whenever CTRL N was pressed, you would add the following line:

DATA 19, 1333003330010

The line number can be any unused one, as long as it comes before the end of data marker at line 1460.

Because of the structure of this program, it is quite easy to make some useful changes. One thing that would be quite easy to implement would be to have the program output American Morse instead of International Morse. To get the longer dashes used in Continental code, use a 4 or a 5 instead of a 3 for the dash character. This will limit the top speed number that can be entered in to a 51. It also would be necessary to change the end of line 50 to read:

IF S \* 5 > 255 THEN 50

```

1 09 = PEEK (49240): REM TURN XMITTER OFF!!
5  REM :WRITTEN BY ROBERT SMIRSKY
10  DIM CODE$(128)
20  HOME
30  INPUT "MESSAGE-->":M$
40  IF M$ = "" THEN M$ = " "
50  HOME : INPUT "SPEED":S: IF S * 3 > 255 THEN 50
60  RESTORE
70  POKE 768,50
75  REM :SIDETONE
80  POKE 770,173: POKE 771,48: POKE 772,192: POKE 773,136: POKE 774,208: POKE
    775,5: POKE 776,206: POKE 777,1: POKE 778,3: POKE 779,240: POKE 780,9
    : POKE 781,202
90  POKE 782,208: POKE 783,245: POKE 784,174: POKE 785,0: POKE 786,3: POKE
    787,76: POKE 788,2: POKE 789,3: POKE 790,96: POKE 791,0: POKE 792,0
100 REM
110 GOSUB 310
120 HOME
130 GET R$
140 IF ASC (R$) < 3 THEN GOSUB 370
150 IF ASC (R$) = 26 THEN 50
160 IF ASC (R$) = 25 THEN 20
170 D = ASC (R$)
180 GOSUB 200
190 GOTO 130
200 FOR X = 1 TO LEN (CODE$(D))
210 G$ = MID$(CODE$(D),X,1)
220 IF VAL (G$) = 0 THEN GOTO 350
230 POKE 769,(5 * VAL (G$))
235 X9 = PEEK (49241)
240 CALL 770
245 X9 = PEEK (49240)
250 FOR X1 = 1 TO 3: NEXT
260 NEXT
270 PRINT R$:
280 FOR X1 = 1 TO S * 1.3: NEXT X1
290 RETURN
300 END
310 READ F,F$
320 IF F = - 1 THEN RETURN
330 LET CODE$(F) = F$
340 GOTO 310
345 REM :SPACE
350 FOR X1 = 1 TO S * 1.7: NEXT
360 GOTO 260
370 FOR H1 = 1 TO LEN (M$)
380 LET R$ = MID$(M$,H1,1)
390 D = ASC (R$)
400 GOSUB 200
410 NEXT H1

```



## \*\*\*NEW\*\*\* FOR THE TRS-80\* COLOR COMPUTER MORSE CODE

Here's a way to turn your Color Computer into a complete CW Morse Code terminal.

—KA9FSQ CW MODEM Interfaces the computer to your transceiver via the ROM-PAC slot.

Cartridge: \$50.00

—Three CW programs to choose from.

—KA9FSQ TRANSLATOR (Machine language)

TX programmable from 5-60 WPM, RX to 60 WPM. Features split screen operation, a 255 character keyboard buffer, and automatic CQ using your own call letters.

Cassette: \$24.95

—W9AV TRANSLATOR (Extended Color Basic)

TX programmable 5-50 WPM, RX to 30 WPM. Includes 9 message memories, and a CW practice mode which sounds over your TV.

Cassette: \$14.95

—W9AV QSO ROBOT (Extended Color Basic)

TX programmable 5-50 WPM, RX to 30 WPM. Use the keyboard or Auto Mode. Makes complete CW QSO's without human intervention including exchange of calls, RST, QTH, and names. Also keeps a log.

Cassette: \$19.95

For additional information & programming, write to:

**MITRONIX**

Mike Rice KA9FSQ  
5953 N. Teutonia Ave.  
Milwaukee WI 53209

\*Trademark Tandy Corp.

please include 5% postage #240

This is needed to accommodate the longer dash character.

I hope you will enjoy using this program. If you own a micro other than an Apple II, you can use the

same fundamental program as long as your BASIC contains string manipulation functions. The sidetone and keying of the rig will vary greatly on different types of computers. ■

### Program Listing.

```

420 R$ = ""
430 RETURN
1000 DATA 49,133330
1010 DATA 50,113330
1020 DATA 51,111330
1030 DATA 52,111130
1040 DATA 53,11111
1050 DATA 54,31111
1060 DATA 55,33111
1070 DATA 56,33311
1080 DATA 57,33331
1090 DATA 48,33333
1100 DATA 32,00
1110 DATA 65,130
1120 DATA 66,31110
1130 DATA 67,31310
1140 DATA 68,3110
1150 DATA 69,10
1160 DATA 70,11310
1170 DATA 71,33100
1180 DATA 72,11110
1185 DATA 47,311310
1190 DATA 73,110
1200 DATA 74,13330
1210 DATA 75,31300
1220 DATA 76,13110
1230 DATA 77,03300
1240 DATA 78,310
1250 DATA 79,03300
1260 DATA 80,13310
1270 DATA 81,33130
1280 DATA 82,1310
1290 DATA 83,11100
1300 DATA 84,00300
1310 DATA 85,11300
1320 DATA 86,11130
1330 DATA 87,13300
1340 DATA 88,31130
1350 DATA 89,31330
1360 DATA 90,33110
1370 DATA 46,131313
1380 DATA 27,11111111
1390 DATA 12,31113
1400 DATA 44,331133
1410 DATA 38,10111
1420 DATA 45,31112
1430 DATA 58,313003313
1440 DATA 63,113311
1450 DATA 18,13131
1460 DATA -1,-1

```

# Micro McElroy

*Is Pet BASIC fast enough for solid CW copy? You bet—  
and this program will work miracles with a sloppy fist.*

Mike de la Dette VK3BHM  
79 Bedford Road  
East Ringwood, Vic. 3135  
Australia

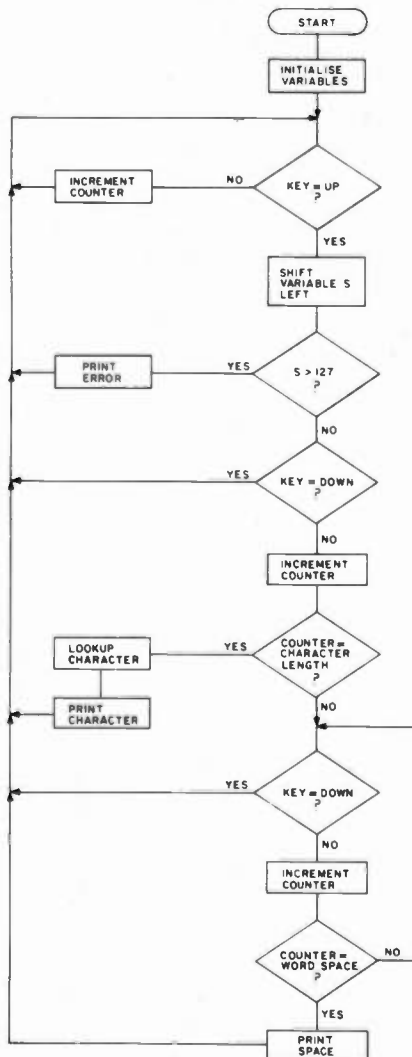

Flowchart.

Most CW reception programs are written in assembly language to optimize speed and efficiency. This is a good idea, but makes conversion of the program to run on another computer very difficult and time-consuming. Also, while many people are very proficient in high-level languages such as BASIC, not everyone is prepared to devote the time required to program directly in assembly or machine language.

Having written a routine in machine language to decode CW on my Commodore Pet™, it occurred to me to try a direct translation into BASIC. Would it work? Surely BASIC would be too slow and inefficient.

The results were very surprising. The routine is very short (under 500 bytes) and handles speeds of up to about forty words per minute. This limitation on speed is imposed by the BASIC interpreter in the Pet. Higher speeds could be ob-

tained on versions of BASIC which employ a compiler rather than an interpreter. Armed with the BASIC listing and flowchart, anyone reasonably familiar with their machine's assembly-language instruction set should be able to write an equivalent machine-language program, if speeds in excess of 40 wpm are contemplated.

The memory location in my Pet for input/output is at 59471 (decimal). With a key connected between pin L on the user port and ground, the value obtained by PEEKing this location will change from 255 to 127. These values are set in line 5 of the listing. Variables U and D give the values for key UP and key DOWN respectively and variable P contains the input port address. You will need to change these three variables to match your computer's arrangements.

Variables F and T determine the receiving-speed



**LACOMBE**  
DISTRIBUTORS

Louisiana's  
Only  
Authorized

**ICOM**  
Dealer

Large selection  
of Amateur and  
Marine Communications  
Equipment Available

Call for Quotes

**800-336-4799**

Lacombe Distributors  
Davis & Jackson Road ✓ 204  
P.O. Box 293  
Lacombe LA 70445  
(504) 882-5355



**V-J**  
POWER UP

## 2 METER 90 WATT OUTPUT AMPLIFIER WITH 18 DB GAIN PREAMP

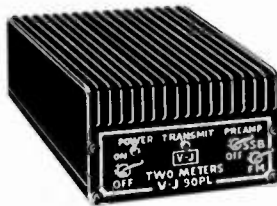

Model 90PL  
FOR ONLY  
FACTORY DIRECT

**\$139.95\***  
PLUS SHIPPING

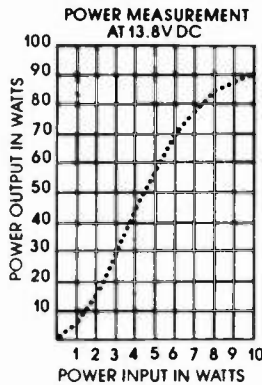

- FREQUENCY range 144 - 148 MHz
- OPERATION FM or SSB (completely linear) Class AB1
- RF DRIVE 1 to 30 watts
- KEYING RF activated with high quality relays
- SSB operation built in delay
- POWER REQUIREMENTS typical 10 watts drive, 13 amps at 13.8 VDC
- IOLE current 20 mills
- MOBILE or FIXED operation
- PREAMP 18DB gain minimum
- NOISE FIGURE less than 1.5 DB
- PREAMP KEYING independent — separately RF activated relays
- CONSTRUCTION wrap around aluminum heat sink 2 pieces 360 degrees cooling
- SIZE 7"(w) x 6"(d) x 3"(h) — WEIGHT 3 lbs. 9 ozs.
- IMMEDIATE SHIPMENT

### SPECIAL OFFER

Matching Power Supply

**\$99.95\***  
PLUS SHIPPING

15 AMP SUPPLY wt. 13 lbs. size 8"(w) x 5"(h) x 6"(d)  
IMMEDIATE SHIPMENT  
ALL PARTS AND LABOR WARRANTED ONE FULL YEAR

VJ90PL Amplifier \$139.95 plus \$3.00 shipping  
VJ15 POWER Supply \$99.95 plus \$7.00 shipping  
\*Prices USA only

VISA, MASTER CHARGE, M.O. or C.O.D. • PHONE (713) 477-0134

**V-J PRODUCTS, INC.** 505 East Shaw, Pasadena, Texas 77506

SERVING THE ELECTRONICS INDUSTRY SINCE 1965

"window" and are set in line 10. This gives a center speed of approximately 20 wpm on the Pet. As these values will vary according to the execution speed of your computer's BASIC, I have not supplied a conversion constant or table. You will need to experiment with differing values for variable F to obtain a constant which can be divided by the speed required to produce a new value for F. The algorithm used will decode CW over a wide range of speeds without altering these variables, but word spacing will suffer.

If using a hand key or electronic keyer directly into your computer, place a .1- $\mu$ F capacitor across the key contacts to smooth out the inevitable bounces, especially if using a relay.

After trying things out on local copy, you will need to make up a demodulator to

convert your receiver's audio into a signal which switches between ground and +5 volts. A one-IC PLL circuit is a good place to start and will cost very little. If you plan to use a RTTY demodulator, disable the limiter — hard limiting will bring up the background noise to the point at which copy is impossible. Also, you will not be able to use your receiver's CW filter if the demodulator is set up to accept only the standard 2125/2295-Hz RTTY frequencies. This is no great matter, but you will need to set your receiver to a somewhat higher-pitched tone than is usual for CW. Ideally, a separate demodulator with anti-noise circuitry, slow agc, and filtering centered around 1000 Hz should be used.

The algorithm used will cope with odd dot/dash ratios, "swing," and other irregularities. However, like most CW decoding systems,

it is easily confused by very poor inter- and intra-character spacing. If the other guy's CQ sounds more like NNMA, then it's time to put your headphones on and switch over to the computer

Ted R. McElroy used all those years ago. That's the one with enormous memory, fantastic speed, and incredibly complex I/O; you'll find it right under the headphones! ■

```

1 REM THIS LISTING EXPANDED FOR READABILITY
2 REM DELETE UNNECESSARY SPACES WHEN ENTERING
10 N=0: Q=1: F=2: T=3
20 P=59471: U=127: D=255
30 A$=" ETIANMSURWDKGOHVFI LAPJBCYZQO05483FF?2
40 A$=A$+"!.@....16-/~...#.7...8.90.....*....U.?
50 S=Q
60 X=N: Z=N
70 IF PEEK (P)=D GOTO 100
80 Z=Z+Q: IF Z=T THEN X=X+Q: Z=N
90 GOTO 70
100 IF X=N GOTO 60
110 S=S*2: IF X<F GOTO 130
120 S=S+Q
130 IF S>127 THEN PRINT ". ";: GOTO 200
140 X=N
150 IF PEEK (P) = U GOTO 60
160 Z=Z+Q: IF Z=T THEN X=X+Q: Z=N
170 IF X>F GOTO 190
180 GOTO 150
190 PRINT MID$(A$,S,Q);
200 X=N
210 IF PEEK (P)=U GOTO 50
220 Z=Z+Q: IF Z=T THEN X=X+Q: Z=N
230 IF X> F*2 THEN PRINT " ";: GOTO 200
240 GOTO 210

```

Program listing.

# QRP Keyer for Misers

Get machine-perfect code with this keyboard.  
All it costs is 30 mW and a few dollars.

**W**hat on Earth is a QRP keyer? A very reasonable question. If you run a kilowatt, your keyer could draw five Watts, but if you run less than two Watts, you start looking for another keyer: a low-power, or QRP, keyer. Any keyer you have should be consistent with the power of transceiver that you are using. In my case, being a convert to the QRP doctrine, the keyer must be in the very low milliwatt range. Specifically, the following design draws 30 milliwatts and has nearly as many features as it has milliwatts.

Well, now that you are reading about QRP keyers, a

word about why a low-power keyer was conceived.

The project was initiated for two reasons: one, to have a keyboard for portable and vacation operation, and the other, to have a good electronic keyer to use for the instruction of a Novice class. My experience with teaching code using a computer and seeing the advantages of properly-sent Morse at known speeds and intervals has confirmed me as a keyboard-keyer user. The problem was not that there were no circuits to do most of the above, but that they each had some good features and some undesirable ones.

In reviewing the more re-

cent articles, several are of note. K1GN<sup>1</sup> describes an excellent keyboard unit which incorporates an instructor function that is capable of sending random five-letter groups with variable delay between characters. However, the method of encoding the Morse character with diodes is not appealing. Also, the lack of any type-ahead buffer would make the sending of Morse for extended periods quite trying.

Steber's<sup>2</sup> Morse-a-Keyer has many more desirable features. It has type-ahead, it has a simple encoding scheme, and it was designed with readily available parts. The major drawback is the use of a 1702A PROM to convert the ASCII to Morse. The ASCII keyboard, the PROM, and its associated negative voltage inverter consume 95% of the power required to run the keyer.

K2BLA's<sup>3</sup> unit offers a good solution to the problem of encoding the Morse characters—a scanned keyboard. However, the limited capability for type-ahead of only two characters is hardly in the realm of a unit for "armchair operation."

After this survey of keyboards, several criteria became apparent for a good

portable/instructional keyboard:

- it must be low power
- it must have a type-ahead buffer
- it must have an accurate speed indicator
- the buffer must have a useful indicator of "how full"
- it must be small in size and self-contained
- it should have a store feature for preloading the buffer
- it should have an Escape key to quit operation if break is required
- it should have an indicator for battery condition
- it should have switchable sidetone

With this list of "desirable features," the QRP keyer was attempted and the following was the result.

## The Keyboard

The keyboard is a surplus unit with all the electronics removed. (Similar units are advertised in the \$20-to-\$25 range in this magazine and other amateur journals.) The keys, their mounting frame, and the PC are retained; all excess printed-circuit traces are cut away with a hobby knife and pliers, leaving only the keypads on the PC board.

The push-and-lock switches such as the shift lock and

Photos by E. Grambart



Photo A. Complete keyer with lid of case removed.

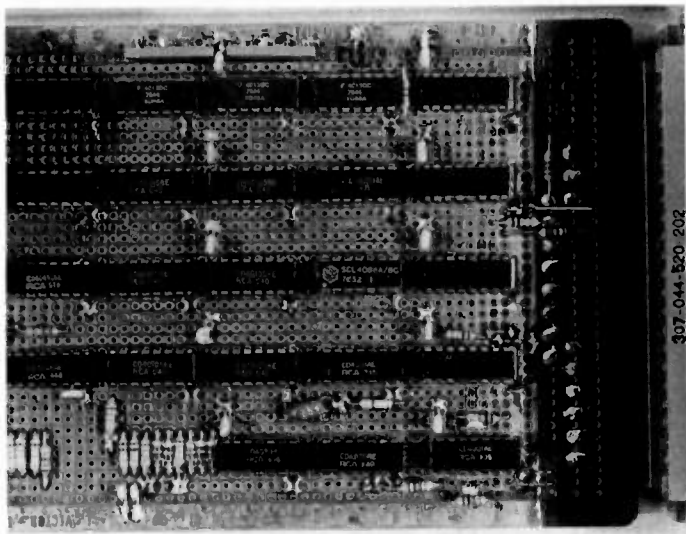

Photo B. Logic card—located in top right of case.

similar functions were moved to the back row, as these are useful for analog functions which are described later. After all this carving of the PC board was done, the keyboard was rewired with small-gauge wire as outlined in Table 1.

Fig. 1 gives details and references for the following discussions. The keyboard encoder is a 16-by-8 matrix which allows for all of the common Morse characters to be encoded. Additional wiring is required for special characters and functions that are not encoded by the scanned keyboard but are essential just the same. These include Escape, Space, Tune, Speaker, Meter, and Store. The rewired keyboard is interconnected to the electronics card by a 50-conductor cable. I used a length of surplus telephone switchboard cable. (For a description of the operation of a scanned keyboard, see Reference 4, as this is the probable source of most scanned keyboards.) The QRP keyer's design extends the Lancaster keyboard to a 16-by-8 and also makes it a Morse unit rather than ASCII.

#### Type-Ahead Buffer

A highly desirable feature in a keyer is the type-ahead buffer, providing the ability to type on the keyboard at

high speed and have the keyer send at a slower speed. With this capability, the timing of your letters and spaces is not tied to your uneven hunt-and-peck at the keys. The type-ahead in this keyer differs from previous units in that it has a segmented buffer. The 48-character buffer is in three parts, each of which indicates on a meter. While you are typing, the keyer keeps track of how much space has been used with each keystroke. When you are one-third full, the meter will indicate one-third full scale and multiples of one-third up to a full buffer at which time characters will be lost if you keep on typing. The 16-character type-ahead buffer in Reference 2 does not give meaningful indications as it only lights an LED when the buffer is full; you are left to guess whether it was the last key you pressed or one or several before.

I find that with the 48-character buffer there is little problem with overflow of the buffer. In practice, I type on the keyer until the meter indicates two-thirds full and then I finish my sentence and wait until the keyer empties the buffer to one-third or less and start typing again.

The circuit for indicating the fill of the buffer is straightforward. The data-in

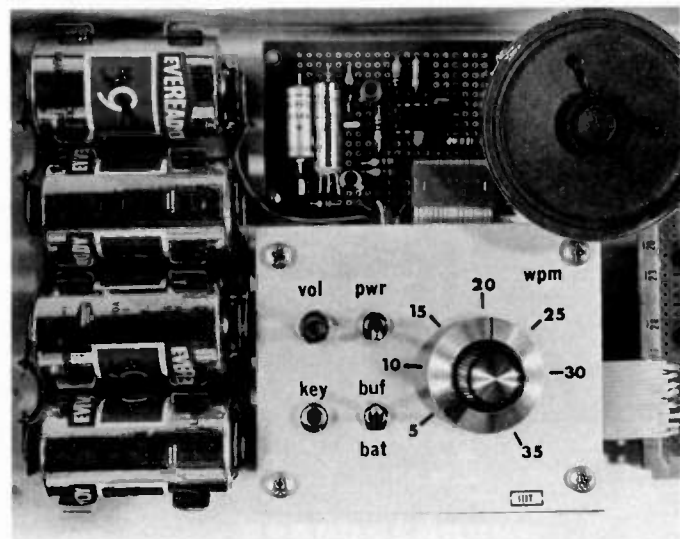

Photo C. Control panel, speaker, batteries, and sidetone/relay board.

ready flag on the 40105 FIFO (first-in, first-out memory) indicates whether the particular 16-character segment is full. If it is full, the flag line goes low and this indication is fed via an inverting buffer to a summing network of all three FIFO segments. The summed voltage point of the three FIFOs is fed to a meter. The meter serves a dual purpose

since it indicates the condition of the batteries when the switch is moved to the Bat position.

#### The Keyer

The heart of the keyer is the PISO section (parallel-in, serial-out). The PISO takes the parallel two 4-bit parts of the Morse word from the buffer and sequentially shifts these bits through a



Photo D. Keytops and meter (black keys have new tops).





Photo E. QRP station—QRP keyer and HW-8 (the keyer lid was removed to make a base for the transceiver).

set of four dual flip-flops (ICs 10, 15, 19, 23), testing for dots, dashes, spaces, or whether the last element of the word has been sent. The space character is not, of course, a Morse character, but must be represented by some unique 8-bit word that can be stored in memory like any other character. The space is not generated by the scanned part of the keyboard, but is a jammed character. It is encoded by resetting the scan register (IC2) to all lows and, via gates IC11a and 11b, bits 0 and 3 are set high which in effect generates a space word. The space has its own keyboard strobe circuitry also; it is a part of IC6. (It would have been possible to generate the space character if a larger matrix for the scanned keyboard were used, but the additional logic for the jammed character was less and therefore was used.)

### The Wpm Clock

The QRP keyer uses a more complicated clock than previous units. Most common wpm clocks are interconnected gates which

rely on RC time constants and are predictably non-linear. The clockwise rotation of a linear potentiometer to control speed has far too much travel on the slow end and is cramped up on the high-speed end. A log control was tried, but the improvement was not sufficient. I am sure you can remember how important it was to you when you were learning the code that your instructor be able to tell you exactly how fast he was sending. Well, to this end I put a better wpm clock in the QRP keyer.

A voltage-controlled oscillator was used for the wpm timer; this type of oscillator produces a linear scale and has nearly constant duty cycle. There is some slight shift in speed as the batteries age, but with good batteries you can say with some confidence that you know the speed to be over 10 or 15 wpm (or whatever) for a least a year.

### Calibration of Wpm

The easiest way to calibrate the wpm clock is to prestore the word PARIS

	Octal	A	B		Octal	A	B
E	004	10	0	5	100	8	4
T	006	11	0	6	102	9	4
I	010	12	0	AS	104	10	4
				7	106	11	4
SP	011		special	8	116	15	4
N	112	13	0				
A	014	14	0	/	122	9	5
M	016	15	0	AR	124	10	5
S	020	8	1	KN	132	13	5
D	022	9	1	9	136	15	5
R	024	10	1				
G	026	11	1				
U	030	12	1	4	140	8	6
K	032	13	1	Brk	142	9	6
W	034	14	1				
O	036	15	1	3	160	8	7
H	040	8	2	2	170	12	7
B	042	9	2	1	174	14	7
L	044	10	2	0	176	15	7
Z	046	11	2				
F	050	12	2	Error	200	0	0
C	052	13	2	?	230	4	1
P	054	14	2	:	216	7	0
				:	262	5	1
V	060	8	3	SK	320	0	5
X	062	9	3	.	324	2	5
D	066	11	3				
Y	072	13	3	()	332	5	5
J	074	14	3	,	346	3	6

Table 1. Keyboard rewiring. A = the 16 rows of the keyboard matrix and B = the 8 columns of the matrix. All like numbers of the rows are connected together and likewise all the columns, and then each set is connected to its appropriate 4051 scanner.

five times with spaces between each and time how long the keyer takes to send the set of words. After timing, apply the formula: code speed (wpm) = 300/T (sec). If, for example, the set takes 15 seconds, your code speed is 20 wpm.

### Keying Relay and Sidetone

The relay circuit and the sidetone generator are derived from earlier designs, but a couple of features have been added. The sidetone is now switchable. This allows the sidetone to be silenced when the keyer is used with a transceiver which has built-in sidetone. The sidetone oscillator is turned off at its power connection to conserve power, as the audio section of the keyer draws more than the logic section.

### Escape and Store Keys

The Escape key allows you to abort sending if you hear a break or if you want

to change that which has already been entered into the buffer. The store function allows you to pre-type into the buffer, but not to send its contents. This is useful when you are just finishing your copy of the other station and you can pre-type in your call signs while your contact is still sending the required identification.

### Physical Layout

The keyer was built into an old but somewhat elegant box which held a tool kit for a chemical instrument. I hope you can be as lucky and find something similar. If not, a small attaché case is ideal both from a size and cost standpoint. A baseplate for the keyer was fabricated from 1/16" aluminum sheet, just big enough to fit inside the case. Photo A shows the whole unit with the cover on. As you can see, the keyboard is not enclosed. It is on spacer blocks (3/4") which

\*\*\*\*\*  
**2300 MHz VARIABLE DOWNCONVERTER**  
 \*\*\*\*\*

**ANTENNA KIT**

**\$16.95**

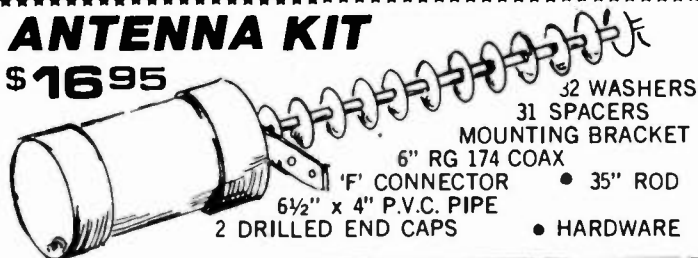

- 32 WASHERS
- 31 SPACERS
- MOUNTING BRACKET
- 6" RG 174 COAX
- 35" ROD
- HARDWARE

**POWER SUPPLY KIT**

**\$16.95**



- POWER TRANSFORMER
- COURSE TUNE POT.
- FINE TUNE POT.
- 3 'F' CONNECTORS
- RESISTORS & CAPS
- LED WITH HOLDER
- TERMINAL STRIP

- P.C. BOARD
- RF CHOKE
- KNOB
- WIRE
- 2 SWITCHES
- 4 DIODES
- LM 317 REG.

**WOOD GRAIN CABINET WITH SILK SCREENED front and back \$10.95 Extra**  
**BUILT POWER SUPPLY \$34.95**

Complete Down Converter System  
 INCLUDES ANTENNA KIT  
 POWER SUPPLY KIT  
 CONVERTER KIT  
**SPECIAL \$49.95**

**QUANTITY DISCOUNTS**  
 Any Price in Adv.

10 pcs.	12% off
25 pcs.	18% off
50 pcs.	25% off
100 pcs.	30% off
1000 pcs.	35% off

No Mixing for Quantity Discount

**PARTS**

- Converter P.C. Board Plated through holes for stability.....\$4.95
- Power Supply P.C. Board .....2.95
- MRF 901 .....2.00
- NEO2135 .....4.95
- 2835 Diodes ..... .95
- .001 Chip Caps. .... 10/3.95
- Choke Set of 4.....1.95
- LM 317 Regulator 1.25
- 'F' Connectors Chassis ..... .50
- Wall Transformer 12 VAC 700 MA....4.95
- 'U' Bolt ..... .95
- BALUN 75 to 300 ohm.....1.95
- BALUN for rabbit ears....2.95
- \*RG 59/U COAX WITH CONNECTORS FACTORY MADE
- 100 Ft. ....\$17.50
- 50 Ft. .... 9.50
- 25 Ft. .... 5.75
- 3 Ft. .... 2.50

**CONVERTER KIT**

**\$16.95**



P.C. BOARD PRE-DRILLED SOLDER PLATED WITH PLATED THROUGH HOLES FOR A MORE STABLE PICTURE.

- NEW!! 2137 HOT TRANS...*
- 3 MRF 901 TRANSISTOR
  - 2 HP 2835 Diodes
  - 6 .001 Chip Caps.
  - 9 Resistors
  - 4 Prewound chokes
  - 1 Electrolytic Cap.
  - 1 Pre Made Probe



**\* WIRED P.C. BOARD TESTED, READY TO CONNECT TO CAN WITH PROBE & CABLE CONNECTOR ATTACHED. \$24.95**

We will tune converter board for \$12.50  
 trouble shoot add .....7.50  
 trouble shoot power supply. \$12.50  
 plus any parts needed.

We will accept telephone orders for Visa & Mastercard  
 No C.O.D. Orders  
**TO ORDER CALL 317-291-7262**  
 800-428-3500  
 Complete kit weighs 10 lbs. Please add sufficient postage  
 6254 LaPas Trail  
 Indianapolis, Indiana 46268

**ELECTRONIC RAINBOW**

**Orbit**



**ORBIT** is the Official Journal for the Radio Amateur Satellite Corporation (AMSAT), P.O. Box 27, Washington, DC 20047. Please write for application.

For a **FREE SAMPLE COPY** please send \$1 to cover First Class Postage and handling to: Orbit, 221 Long Swamp Road, Wolcott, CT 06716.

**TERMINALL**

**NOW FOR ATARI\* 400/800/1200**

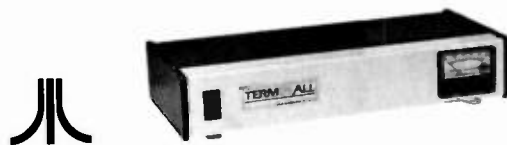

**SEND & RECEIVE CW & RTTY**

TERMINALL T4 is a hardware and software system which converts your Atari Computer into a state of the art communications terminal.

- TERMINALL is easy to use. Plug into your receiver headphone jack and copy Morse code or radioteletype. Plug into your CW key jack and send Morse code. Attach a microphone connector and send Baudot or ASCII using audio tones (AFSK). That's all there is to hooking it up.
- Fantastic Morse reception. No adjustments are necessary to receive Morse code. It's fully automatic! Six stage active filter demodulator and auto adaptive Morse algorithm copies the weak and sloppy ones.
- Separate RTTY and CW demodulators, built in crystal controlled AFSK, CW and PTT keying, 60 mil loop Interconnect, RS232 IN and OUT, hand key input and side tone output.
- Cursor Editing - use cursor control keys

to insert, delete and write over any text in all buffers (break, message and history).

- Save to Disk - full save to disk or cassette capabilities. TERMINALL files are compatible with many word processors including Text Wizard.
- Built in parallel printer driver software.
- Multiple user defined WRU functions. You select initiate sequence, terminate sequence, what to transmit back and whether to save on tape or disk.
- Word wrapping, word mode editing, diddle, ignore carriage returns, user programmable end of line sequence, adjustable carriage width, auto adaptive transmit delay, break mode and more.
- Complete with software on diskette, and cassette, assembled and tested hardware, and extensive instruction manual.
- 15 day money back trial period on factory direct orders. One year limited parts and labor warranty.

Call or write for details.  
**(209) 667-2888**



**MACROTRONICS, Inc.**  
 1125 N. Golden State Blvd.  
 Turlock, CA 95380  
 C.O.D.

\*Atari is a registered trademark of Atari, Inc. and Text Wizard is a registered trademark of DataSoft, Inc.

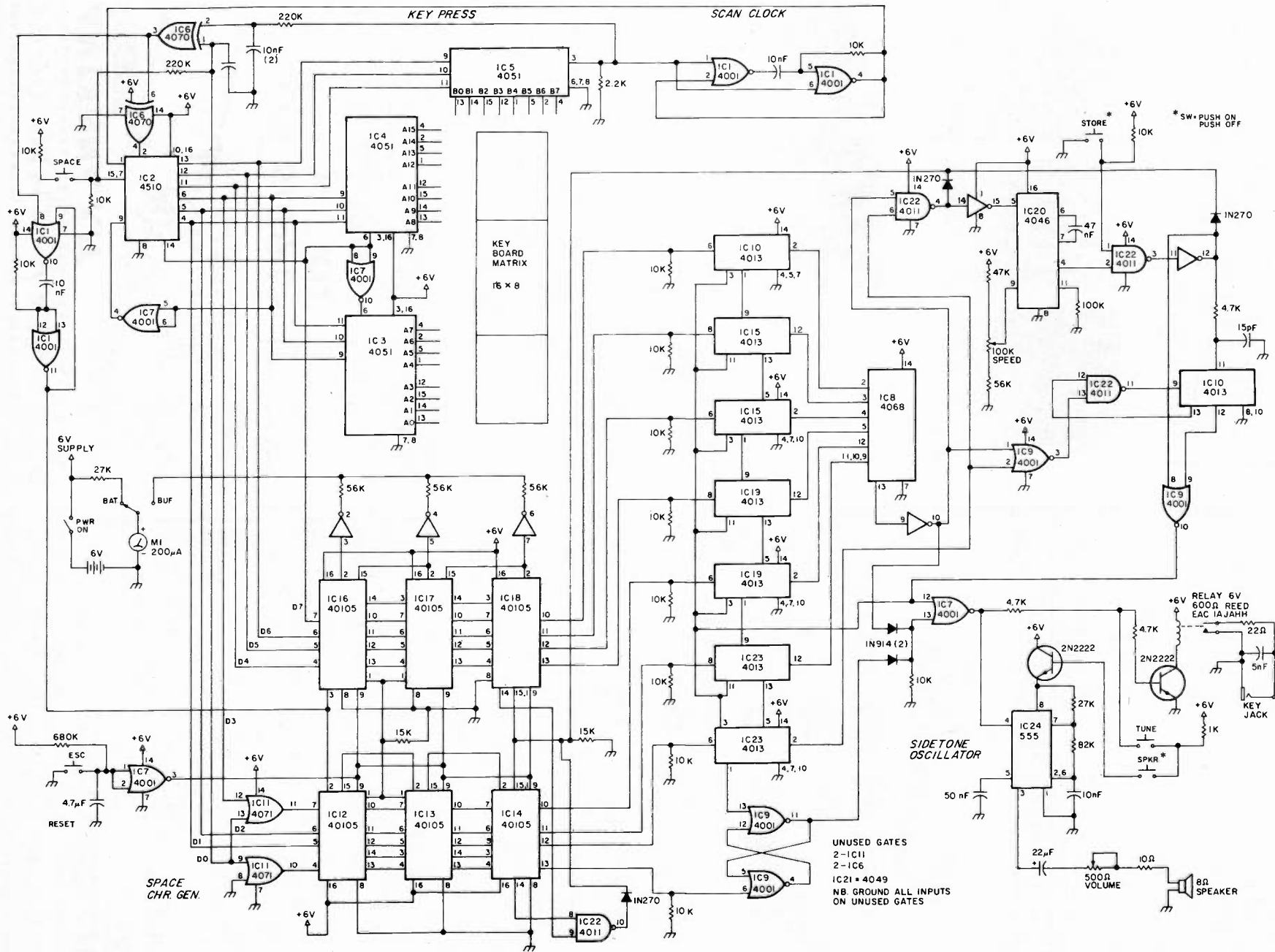

Fig. 1. QRP schematic.

provide sufficient clearance for the PC board on the bottom of the keys and its associated new wiring.

The electronics is in three parts: the main logic board and its connections to the keyboard. The small 16-conductor cable which connects together the con-



trol panel, the card, and the sidetone board is on the lower left side of the card. (See Photo C for exact placement.)

Photo C shows the control panel which has the speed control, the power switch, the battery/buffer switch, the volume control, and the miniature key jack. The panel is mounted on small standoffs which allow the speed control to clear the baseplate. As is shown in Photo A, the speed control knob is just level with the top of the panel. (In effect, the panel is in a well cut out of the cover.) Size C batteries were used as space permitted, and annual battery changes are desirable.

Photo D shows the special keytops and the Bat/Buf meter. The meter was mounted on a small plate and fitted to cover the hole for the old keyboard encoder IC which is not now used. The meter's placement is not just cosmetic,

but also practical, as you can watch the meter easily while typing, as it is near the space bar.

### Keytops

The keytops for the special keys are worth a few words. I have made several other keyboard controllers and was always stuck on how to label the special function keys effectively. I have tried painting the keys and using press-on lettering covered with several coats of lacquer, but this lasts only several months. On this keyer, I tried something which is much better.

The original keys were concave, and after roughing them up with fine sandpaper, a thin "float" of black epoxy was applied. With a little warming with a heat gun (or hair dryer), the epoxy conforms to the shape of a keytop, slightly convex but conforming to the top. After this was completely dry, the keys were

labeled with the special functions using white press-on lettering. Next was applied a clear "float" of epoxy on the lettering. After this was set and was lightly sanded to remove any droplets or uneven areas, the tops were polished with a plastic or fine metal polish, and "professional" keytops of specific designations were the result.

As epoxy formulations vary, try the whole procedure on a small scrap of metal to ensure the compatibility of the epoxy and the lettering. I used 5-minute-type epoxy and allowed 24 hours between coats. Another possibility is to use graphite to tint the clear epoxy, but I found that the curing time for the 5-minute type extended to 48 hours due to the inhibiting action of the graphite. If you can wait, you can save some money.

### Using the Keyer

When the keyer is first

turned on, hit the space bar and then a letter; this initializes the logic. I usually hit an E, as this gives the fastest check that all is well when I hear the dit. If you hit the Escape key to abort sending, repeat the above procedure as this will ensure that you are loading or sending exactly what you intended.

Probably one of the most important things to remember is to send only at a speed you can receive. The temptation will be great to send faster, but just sit back and enjoy the comfort of the keyer sending while you have a sip of coffee. ■

### References

1. Spindel, R. C. (KIGN), "Double-Duty CW Keyboard," *73 Magazine*, December, 1980.
2. Steber, G., "Build a Morse-A-Keyer," parts I, II, *Popular Electronics*, January, 1981.
3. Helfrick, A. (K2BLA), "An Inexpensive Morse Keyboard," *QST*, January, 1978.
4. Lancaster, D., *CMOS Cookbook*, Sams & Co.

1982-1983

**AMATEUR  
RADIO**

**CALL  
DIRECTORY**

THE BARGAIN AT **\$14.95**  
Plus Shipping



A no frills directory of over 411,000 U.S. Radio Amateurs. 8½ x 11, easy to read format. Completely updated.

Also available for the first time ever—  
(Alphabetically arranged—Sold separately)

**Geographical Index**  
by State, City and Street No. and Call  
**Name Index**  
by Name and Call

Ordering Information:

- Directory—\$14.95
- Geographical Index—\$25.00
- Name Index—\$25.00

Add \$3.00 Shipping to all orders.

Dealers/Clubs inquiries welcome

Send your order—enclosing check or money order in U.S. dollars to:

**Buckmaster Publishing**

70-J. Florida Hill Road  
Ridgefield, CT 06877 U.S.A. ✓226

# Buy Hi-Res Monitors Direct!

**\$109.95**  
plus \$4.75  
shipping

**Model TM-12PC-GX 12" P31 GRAPHICS**

- 1200 line resolution
- 18.9 MHz band width

Compatible with: IBM-P.C. / APPLE II & III / VIC-20  
COMMODORE 64 / ROBOT-800 KEYBOARD  
TRS-80\* / Z-81\* / ZX-80 / Any Composite Video Computer

RGB Color Monitors available @ \$299.95 / \$9.50 shipping.

\*Slight modification w/st. enclosed.



VISA, MasterCard & American Express accepted. No C.O.D.

Call Toll Free 1-800-258-6370  
18 Bridge Street, Salem, NH 03079

# The Easy FIFO Keyboard

*First in, first out means you type as fast as you want to.  
 It will send at the speed you set.*

**H**ome-brew keyboard designs are now readily available and construction need be no more costly than a regular keyer. However, some home-brew designs, while effective, are limited to the basics of

character generation. The operator must provide the proper timing to maintain a certain conversational speed and rhythm. This task can easily be left to the keyboard itself by the addition of a relatively inexpensive buffer memory.

The Fairchild 3341 first-in, first-out (FIFO) is a serial memory that operates in basically the same manner as a shift register. Data is entered, is shifted to the output, and is removed. However, there is an important difference between the two. The conventional shift register will retain data in

its first register position until additional data enters the system and forces the previously entered data to the next register position. In the FIFO, data entering the register is immediately shifted to the first open position at the output end. This feature automatically allows buffering between two systems that operate at different data rates. The 3341 is asynchronous in that data input and output are completely independent. The 3341 can also control system speed.

Fig. 1 is a block diagram of the 3341 control logic.

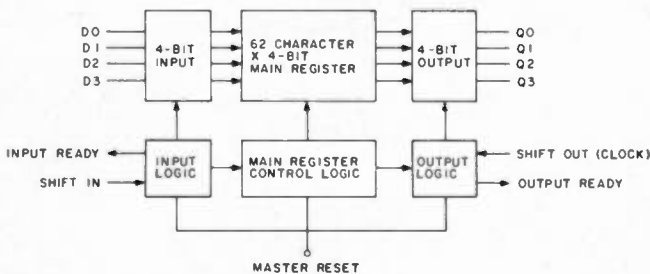

Fig. 1. The Fairchild 3341 MOS FIFO buffer block diagram.

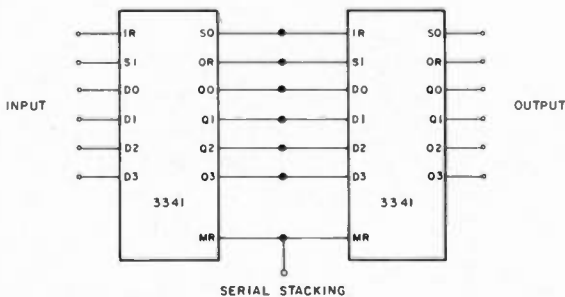

Fig. 2. FIFO serial stacking to expand a buffer memory to 128 or more characters.

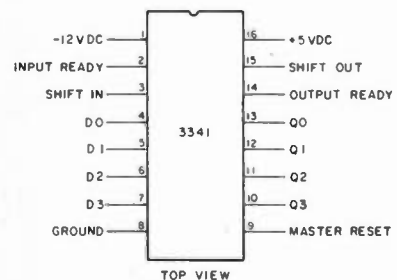

Fig. 3. 3341 connection diagram.

The main register contains sixty-two 4-bit characters, with one 4-bit character contained in each of the input and output registers, for a total of sixty-four character memory positions. Information may enter the input register on the D0 to D3 inputs when both Input Ready (IR) and Shift In (SI) logic is high. When data has entered the input register, IR goes low. Data remains in the input register a preset interval, at which time SI goes low. Data is then shifted into the main register. When the transfer is completed, IR will go high, indicating that the next entry may be accepted. If the main register is full, IR will stay low, blocking further entries. SI will now go high and the next character is accepted into the input register.

Information entering the main register is immediately shifted to the first open data position at the main register output. Transfer of a character from the main register to the output register occurs when both Output Ready (OR) and Shift Out (SO) logic is low. When the transfer has occurred, OR will go high, indicating that information is present at output pins Q0 to Q3. Transfer out of the FIFO takes place when SO logic goes high. OR logic now goes low, followed by a low on SO which again allows a character to enter the output register. SO logic can be controlled by a clock to provide an output speed control.

The 3341 FIFO may be expanded in sixty-four character steps by stacking individual chips. Fig. 2 indicates the serial stacking method. No external logic is required. If character data of more than 4 bits is required, the FIFO may also be expanded in parallel to increase capability in 4-bit steps. In this case, external logic is required to ensure

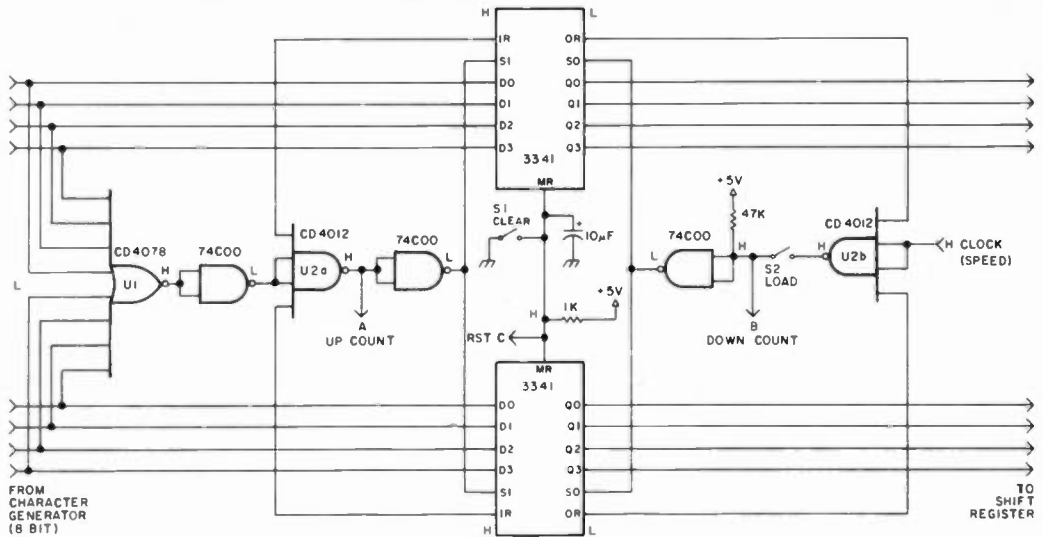

Fig. 4. FIFO parallel stacking to accommodate an 8-bit character. Logic indicated is with circuit at rest.

that the input and output logic on each chip is ready before character transfer is attempted.

Refer to Fig. 3 for the 3341 connection diagram. Note that both a +5V-dc and a -12V-dc power source is required.

The typical home-brew keyboard probably employs either the diode matrix or the toroid transformer method of character generation. Both methods generate several parallel data pulses, the number depending on the specific CW character, which are fed into a shift register. The shift register converts the parallel data bits into serial data bits. These serial data bits form the CW character.

The FIFO is inserted between the character generator and the parallel-to-serial shift register. System speed is controlled by a clock input to the FIFO to control SO rates. A register content indicator is an option to inform the operator when the FIFO is approaching full memory status.

One keyboard design,<sup>1</sup> recently available as a PC board kit, is an excellent example of FIFO application to the toroid transformer method of character generation. Referring to Fig. 4, note that the character

generator is 8 bits wide, requiring that two FIFO chips stacked in parallel be used. The required input logic begins with U1. A high pulse

on any one of the eight character bits will cause a low U1 output. This low is inverted to a high at the input of U2A. When the IR in-

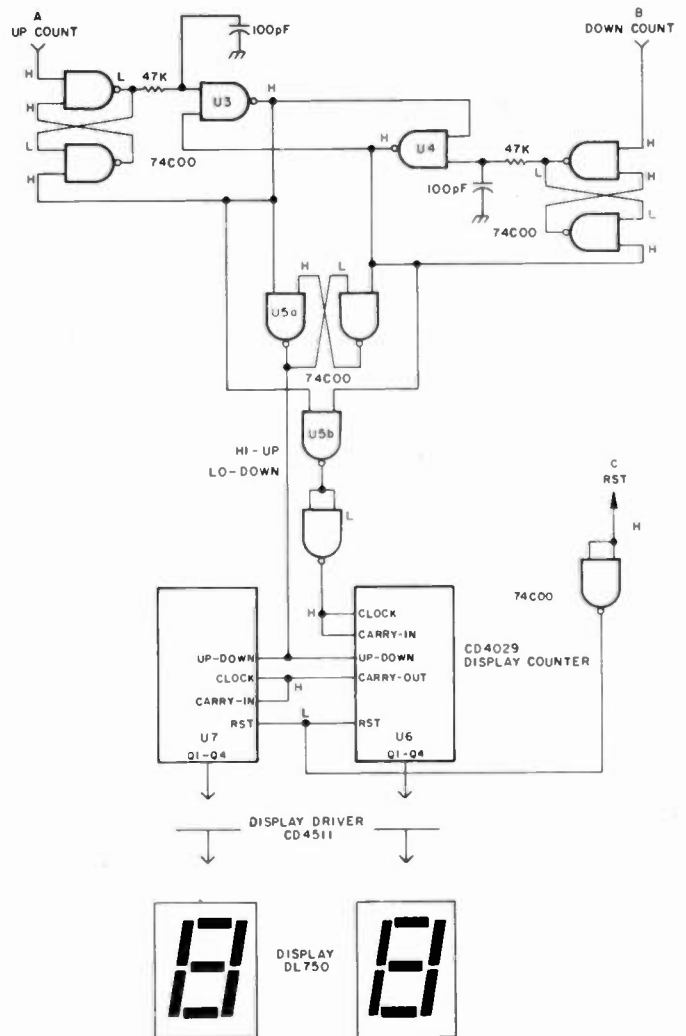

Fig. 5. FIFO register content count. Logic indicated is with circuit at rest.



puts to U2A from each FIFO are high, indicating the FIFO is ready to accept data, the output of U2A goes low. This low is inverted and appears as a high at the S1 input at each FIFO, indicating that data may enter the input register. This logic ensures a coordinated flow of data into the FIFO stack.

Characters stacking up at the FIFO output are shifted out according to the speed control setting. When OR goes high on both FIFOs, indicating a character is present in the output register, a low will appear at the output of U2B. This low will occur at clock speed as long as information is flowing into the output register. If S2 is closed, the low is inverted and places a high on the SO pins of both FIFOs, and information may flow into the parallel-to-serial shift register. If S2 is open, the low cannot be inverted and the FIFO will fill to capacity.

This feature allows the operator to pre-load a message into the FIFO for later transmission at the flip of a switch. The FIFO can be completely cleared by S1.

A memory content indicator, while not an absolute necessity, is certainly a worthwhile convenience. The previously mentioned design also provides an excellent example of one method of memory count logic. Referring again to Fig. 4, note that up-count, down-count, and reset inputs to the memory counter are obtained at points A, B, and C. Counter logic is displayed in Fig. 5.

U3 receives and inverts an up-count pulse from the input gating. The low output from U3 inhibits a down-count from U4 and drives the output of U5A high. A high appearing at the up/down terminal of the display counter will initiate an up-count, provided clock and carry in logic is

low. The low from U3 also appears at the input to U5B, which causes the output to go high. This high is inverted and provides the necessary low at the clock and carry in terminals of the counter. This process is repeated for a down-count except that a low appears at the up/down counter input. When the count in U6 reaches its maximum count, carry out logic will go low. This low appears at the clock and carry in terminals of U7, which initiates a ten count at the next up-count command.

A buffer-equipped keyboard is truly a joy to operate. When sending at speeds below your typing ability, just fill the buffer, then sit back and compose your next sentence. The down-count will tell you when to resume typing. You can easily tell when you are approaching speeds that tax your typing ability. Just keep an eye on the memory

count. If you cannot build up a lead, turn down the speed control and give the buffer room to function. Quite often your contact will sign his call after each transmission. This time can be used to fill the buffer and be set to go at first opportunity.

All logic for the example design is readily available through advertisers in this magazine. The buffer section requires one each of the 74C00, CD4012, and CD4078 logic in addition to the two FIFOs. Currently, this will cost about \$15. The two each of the CD4511, CD4029, and DL750, and the three 74C00s in the counter section will cost about \$10.

If you have a question on this article, an SASE will bring a prompt reply. ■

#### Reference

'Skipjack, AJR Electronics, PO Box 5722, Evansville, Indiana 47715.

## QUALITY SPECIALS

### WIDEBAND RF TRANSFORMERS

10 KHz to 800 MHz, MICROMINIATURE

RATIO	MODEL	PRICE	MODEL	PRICE
1:1	T1:1	\$4.95	FANU-1:1	\$4.95
2:1	T2:1	\$4.95	FANU-2:1	\$4.95
4:1	T4:1	\$4.95	FANU-4:1	\$4.95
8:1	T8:1	\$4.95	FANU-8:1	\$4.95
16:1	T16:1	\$5.95	FANU-16:1	\$4.95

T MODELS ARE PLASTIC. TWO MODELS ARE HERMETICALLY SEALED METAL CASES FOR GOOD EMI SHIELDING. NEW FROM MINI-CIRCUIT LABS.

### FERRITE BEADS

HOLE DIAMETER OR EQUIV. WIRE GAUGE	MATERIAL TYPES	PRICE
18 GAUGE	A, B, C	\$0.15
16 GAUGE	A, B	.20
12 GAUGE	A, B	.25
107 INCH (10000)	A, B	.50
240 INCH (10000)	B	.40
310 INCH (10000)	E	.25
22 GAUGE HOLES IN SPECIAL 6 HOLE BEAD	B, C	.25
128 INCH BEAD MOUNTED ON #22 SERIAL WIRE LEADS (ISOLDERABLE)	H	.20

### BALUN CORES

HOLE DIAMETER OR EQUIV. WIRE GAUGE	MATERIAL TYPES	PRICE
22 GAUGE	A, B, E	\$0.25
14 GAUGE	A, B, D	.50
8 GAUGE	D, E	.75

**2 HOLE**

HOLE DIAMETER OR EQUIV. WIRE GAUGE	MATERIAL TYPES	PRICE
22 GAUGE	A, B, E	\$0.25
14 GAUGE	A, B, D	.50
8 GAUGE	D, E	.75

**4 HOLE**

SPECIAL 4 HOLE CORE	D	PRICE
18 GAUGE HOLE SIZE	D	\$.10

ORDER BY SPECIFYING HOLE SIZE AND MATERIAL DESIRED

MATERIAL TYPE	BEST Q IN TUNED CIRCUIT	GENERAL EMI ATTENUATION APPLICATIONS
TYPE A	100MHz to 1.5GHz	RF LOW IMPEDANCE
TYPE B	100MHz to 1.5GHz	RF LOW IMPEDANCE
TYPE C	500MHz to 4.5GHz	RF LOW IMPEDANCE
TYPE D	5MHz to 500MHz	RF LOW IMPEDANCE
TYPE E	200MHz to 1.5GHz	RF LOW IMPEDANCE

**SEND FOR FREE CATALOG OF NEW DEVICES**

## GOLDSMITH SCIENTIFIC

CORPORATION  
P.O. BOX 318B, COMMACK, NY 11725  
PHONE ORDERS WELCOME—(516) 978-7944

MASTER CARD AND VISA ACCEPTED  
NEW YORK STATE RESIDENTS ADD SALES TAX  
POSTAGE—ADD 5% PLUS \$1.50 INSURANCE C.O.D. \$2.00 EXTRA  
AVAILABILITY OF CERTAIN ITEMS MAY BE LIMITED.

## DIRECTION FINDING?

- ★ Doppler Direction Finding
- ★ No Receiver Mods
- ★ Mobile or Fixed
- ★ Kits or Assembled Units
- ★ 135-165 MHz Standard Range



- ★ Circular LED Display
- ★ Optional Digital Display
- ★ Optional Serial Interface
- ★ 12 VDC Operation
- ★ 90 Day Warranty

**New Technology** (patent pending) converts any VHF FM receiver into an advanced Doppler Direction Finder. Simply plug into receiver's antenna and external speaker jacks. Use any four omnidirectional antennas. Low noise, high sensitivity for weak signal detection. Kits from \$270. Assembled units and antennas also available. Call or write for full details and prices.



**DOPPLER SYSTEMS,**

5540 E. Charter Oak, (602) 998-1151  
Scottsdale, AZ 85254

✓ 425

### SEMICONDUCTORS :

MRF-208 - 12.00	MHW-252 - 50.00	EB-18A - 12.00	AN-762 - 14.00
MRF-240 - 15.50	MHW-710-1 - 61.00	EB-27A - 14.00	AN-791 - 10.00
MRF-247 - 34.80	MPSH-81 - .50	EB-63 - 14.00	EB-67 - 14.00
MRF-309 - 27.60	MV2205 - .58	KEMET CHIP CAPACITORS: 56 pf, 82 pf, 100 pf, 390 pf, 470 pf; -.50 ea	
MRF-422 - 41.40	78L08CP - .50	680 pf, 1000 pf; -.55 ea	
MRF-454 - 20.00	2N4401 - .75	5600 pf, 6800 pf, .1 uf; -1.00 ea	
MRF-901 - 1.75	2N5190 - 1.50	.33 uf; -1.90 ea .68 uf; -3.90 ea	

SBL-1 Double-Balance Mixer - 6.50

CAMBION RF CHOKES: .15 uh, .22 uh, .33 uh, 4.7 uh, 10 uh - 1.20 ea

BROADBAND TRANSFORMERS PER MOTOROLA BULLETINS: AN-762, EB-27A, EB-63

UNDERWOOD/SEMCO METAL-CLAD MICA CAPACITORS: 5pf, 10pf, 15pf, 25pf, 30pf, 40pf, 56pf, 60pf, 68pf, 91pf, 100pf, 200pf, 250pf, 390pf, 470pf, 1000pf

We also carry a line of VHF, UHF amplifiers and ATV equipment.  
Call or write for our free catalog.



## Communication Concepts Inc.



2648 North Aragon Ave • Dayton, Ohio 45420 • (513) 296-1411 ✓ 14

# MAXIMIZE YOUR POTENTIAL WITH 73!

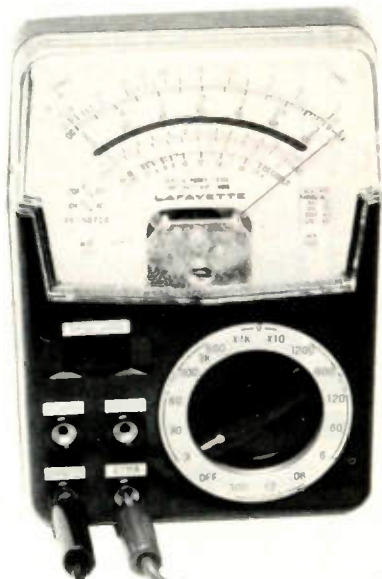

73: Amateur Radio's Technical Journal gives you more easy-to-build construction projects and circuit designs than any other magazine of its kind. Informative articles by the dozens, on all phases of amateur radio, written by hams for hams.

73 always keeps you one step ahead with...

- Scores of useful building projects you'll enjoy by the hour.
- In-depth equipment reviews, guaranteed to save you time, trouble and money.
- "73 International"—delivers all the facts you need about licensing laws, club news, contests, and awards all around the globe.
- DXing—valuable tips for newcomers, the personalities behind the callsigns, what's happening on the DXpedition scene and much much more!
- New Ham Bands—timely reports on the new WARC bands, how to modify your rig to access them, what to do about antennas.
- Satellite TV—keep up with the technology and all the latest developments in satellite communications.

## PLUS

- RTTY—the phenomenon of over 30,000 hams owning microcomputers puts RTTY in a very important place. 73 gives you more articles on RTTY than all the other magazines combined.
- "HAM HELP"—puts you in touch with other readers to get hard-to-find parts, schematics and owner's manuals.
- Contests—rules and results keep you informed about ham radio's competitive side.

Subscribe to 73 today! We'll keep you involved, informed, and completely entertained. To order, simply send in the attached order form, the coupon, or call toll free 1-800-258-5473.



Yes, I want to subscribe to 73:  
Amateur Radio's Technical Journal

- Please send me 12 issues of 73 for \$19.97  
 Check enclosed/MO  MC  VISA  AE  Bill me

Card# \_\_\_\_\_  
 Exp. Date \_\_\_\_\_ Interbank# \_\_\_\_\_  
 Signature \_\_\_\_\_  
 Name \_\_\_\_\_  
 Address \_\_\_\_\_  
 City \_\_\_\_\_ State \_\_\_\_\_ Zip \_\_\_\_\_

Canada & Mexico \$22.97/1 yr only US funds  
 Foreign surface \$39.97/1 yr only US funds drawn on US bank  
 Foreign airmail please inquire  
 Please allow 6-8 weeks for delivery

337F6

73: Amateur Radio's Technical Journal • PO Box 931 • Farmingdale, NY 11737



# Super Loaded Or "Basic" Repeater / Link Systems -

Spectrum's

Got Back!

VHF/UHF  
LINK/CONTROL  
RCVR.

COMMERCIAL VHF/UHF  
TRANSCIVERS

SCR77

Shown in  
Optional Cabinet



Spectrum now makes 2 lines of Repeaters—the world famous 'Super Deluxe' SCR1000/4000, and our new Low Cost line of SCR77 Repeaters/Link Transceivers.

The New SCR77 10-30 Wt. Repeaters maintain the quality of design, components and construction which have made Spectrum gear famous *throughout the world* for years. However, all of the "bells & whistles" which you may not need or want have been eliminated—at a large cost savings to you! The SCR77 is a real "workhorse" basic machine designed for those who want excellent, super-reliable performance year after year—but *no frills!* ("PL", 12 Pole IF Filter, Front End Preselector, and a 30 Wt. Transmitter are the only 'built-in' options available; but Autopatch, Remote Control, and other equipment can be connected via the rear panel jack.)

Of course, if you do want a full featured/Super Deluxe Repeater, with higher power (30-75 Wts.), and a full list of 'built-in' options, then you want our SCR1000 or 4000—'The Ultimate in Repeaters'. Available with: Full Autopatch/Reverse Patch/Land-Line Control; Touch Tone Control of various repeater functions; 'PL'; "Emergency Pwr. ID"; various Tone & Timer Units, etc. Rack mount Link Rcvrs & Xmtrs also available.

## For UHF Rptrs.

- Ultra Sharp, Very Wide, Dynamic Range Helical Resonator RX Front End.
- 100 Wt. Rack Mount Amp. & Pwr. Sply. Unusually Heavy Duty!

Call or write today for data sheets & prices! Sold Factory Direct or through Export Sales  
Peeps only. Get your order in A.S.A.P.!

F.C.C. TYPE ACCEPTED FOR  
COMMERCIAL SERVICES.



**SPECTRUM**  
Export Orders Welcomed

1055 W. GERMANTOWN PK., DEPT S7



# Spec Comm Repeater Boards & Sub-assemblies

These are Professional "Commercial Grade" Units—Designed for Extreme Environments (-30 to +60° C)  
All equipment assembled & tested. For 2M, 220 MHz & 450 MHz!

## SCR200 & SCR 450 BOARD

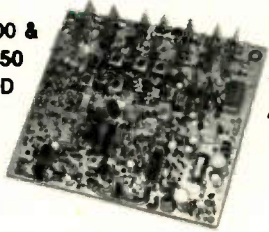

10M ALSO AVAILABLE



FL-6

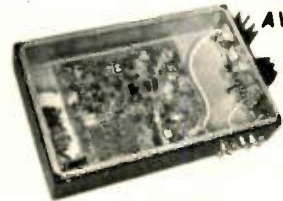

10M ALSO AVAILABLE

SCT410 XMT. ASSY.

## SCR200 VHF Receiver Board

- **Totally New Advanced Design!**
- 8 Pole Front End Filt. + wide dynamic range—reduces overload, spurious Resp. & IMs!
- Sens. 0.3 uV/12dB SINAD typ.
- Sel. -6dB @ ± 6.5 KHz -130dB @ ±30KHz (8 Pole Crystal + 4 Pole Ceramic Filtrs.
- 'S Meter,' Discriminator & Deviation Mtr. Outputs!
- Exc. audio quality! Fast squelch! w/0.0005% Crystal. ("Super Sharp" IF Filt. also avail.)

## SCR200 Receiver Assembly

- SCR200 mounted in shielded housing
- Completely asmbld & tested, w/F.T. caps, SO239 conn.
- As used in the SCR1000. Ready to drop into your system! *Highly recommended!*
- Also available in 19" Rack Mount SCR450 UHF Receiver Bd. or Assy.
- Similar to SCR200, except 420-470MHz



## SCAP Autopatch Board

- Provides all basic autopatch functions
- Secure 3 Digit Access; 1 Aux On-Off function, Audio AGC; Built-in timers, etc. Beautiful Audio!
- Q/1 Inhibit bd. also available
- Write/call for details and a data sheet

## RPCM Board

- Used w/SCAP board to provide "Reverse Patch" and Land Line Control of Repeater
- Includes land line answering circuitry

## Lightning Arrester For SCAP

- Gas Discharge Tube shunts phone line surges to ground
- Handles up to 20,000 Amps!
- The Best device available to protect Autopatch equipment from lightning damage. \$14.00 + S/H.



## FL-6 Rcvr. Front-End Preselector

- 6 Hi Q Resonators with Lo-Noise Transistor Amp (2M or 220 MHz).
- Provides tremendous rejection of "out-of-band" signals *w/out the usual loss!* Can often be used instead of large expensive cavity filters
- Extremely helpful at sites with many nearby VHF transmitters to "filter-out" these "out-of-band" signals

## CTC100 Rptr. COR Timer/Control Bd.

- Complete solid state control for rptr COR, "Hang" Timer, "Time-Out" Timer, TX Shutdown/Reset, etc.
- Includes Inputs & Outputs for panel controls & lamps

## Repeater Tone & Control Bds. — For SCR1000/4000 & CTC100/10250 only

### TRA-1 "Courtesy Tone Beeper" Board

- Puts out a tone beep apx. 1 sec. after RX sig drops—thus allowing time for breakers
- Resets T.O. Timer after "beep"

### TMR-1 "Kerchunker Killer" or "Time Out Warning Tone" Bd.

- For One of above 2 functions
- "Kerchunker Killer" provides adj. delay (0-10 sec.) for initial rptr. access. Auto-Reset at end of QSO.
- T.O. Warning Tone provides alerting "warble tone" apx. 10 sec. before "time out."



## PSM-1 Repeater Power Supply Mod Kit

- For SCR-1000 or SCR-4000
- Replaces Darlington Pass Tr. —for improved reliability
- Includes new overvoltage "Crowbar" shutdown circuit.
- Complete kit, w/assembled PC board. \$19.50 + \$3.50 shipping/handling

## PRM200 Power Supply Filter Cap/Regulator/Metering Board

- As used in the SCR1000 as main part of 13.8VDC/8A Pwr. Sply.
- Includes 14,000 µF Filter Cap, Reg. IC and Driver Trans., V/I Meter shunts and cal pots.
- Requires Xtmr., Br. Rect., Pass Tr./Heat Sink, (Optional Meter), for complete supply.

## SCT110 VHF Xmtr/Exciter Board

- 10 Wts. Output 100% Duty Cycle!
- Infinite VSWR proof.
- True FM for exc. audio quality.
- Designed specifically for continuous rptr service. Very low in "white noise"
- Spurious -70 dB Harmonics -60 dB
- With .0005% xtal.
- BA-10 30 Wt. Amp board & Heat Sink, 3 sec. L.P. Filter & rel. pwr. sensor. BA75 75 Wt. unit also available.

## SCT110 Transmitter Assembly

- SCT110 mounted in shielded housing.
- Same as used on SCR1000
- Completely asmbld. w/F.T. caps. SO239 conn.
- 10, 30, or 75 Wt. unit.

## SCT 410A UHF Transmitter Bd. or Assy.

- Similar to SCT110. 10 Wts. nom.
- Now includes "on board" proportional Xtal Osc./Oven circuitry for very high stability!
- BA-40 40W. UHF AMP. BD. & HEAT SINK.

## PCB-1 Xmtr. Power Control Board

- For SCT110 or SCT410 Exciters
- Varies B+ to control Pwr. Out
- Switchable Hi, Low, or Med. Pwr. out, locally or remotely. Adj. levels.

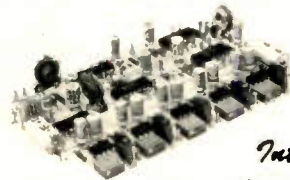

TTC100 Touchtone

Control Board

Interface to any Radio or AT system!

- 3 digit ON, 3 digit OFF control of a single repeater function, or (optional) 2 functions (2 digits ON/OFF each).
- Can be used to pull in a relay, trigger logic, etc.
- Typically used for Rptr., ON/OFF, HI/LO Pwr PL ON/OFF, Patch Inhibit/Reset, etc.
- Stable anti-falsing design 5s limit on access
- For add'l function(s), add a "Partial TTC" board

# COMMUNICATIONS CORP.

INQUIRE ABOUT 'SURPLUS' RX & TX BOARDS. REDUCED PRICE!

✓68

Call, or Send for Data Sheets!

Norristown, PA 19401 • (215) 631-1710



# 73 INTERNATIONAL

Each month, 73 brings you amateur radio news from around the world. In this collection of reports from our foreign correspondents, we present the latest news in DX, contests, and events, as well as keep you abreast of the technical achievements of hams in other countries.

If you would like to contribute to your country's column, write to your country's correspondent or to 73: Amateur Radio's Technical Journal, Pine Street, Peterborough NH 03458, USA, Attn: Avery L. Jenkins WB8JLG.



INDIA

The Bangalore Amateur Radio Club had its club night on Sunday, March 12, 1983. This annual function is specially held to bring ham families together. This year, the function coincided with the 70th birthday of OM Girimaji VU2GX. He was given an autographed memento by all the hams present. (See photos.)

## GARDEN CITY CONTEST

This is an annual CW contest jointly organized by the Bangalore Amateur Radio Club (VU2ARC) and Visvesvaraya Industrial and Technical Museum (VU2VTM). This contest is essentially conducted to promote the DX capabilities of VU2 hams. It is held in the third week of December every year between 1200 GMT on Saturday and 1200 GMT on Sunday. The frequencies of operation used are 7 and 14 MHz.

**Message Exchange:** RST report with a three-digit serial number of contact (599039 = 39th contact).

**Eligibility:** Contest is open to all licensed amateurs worldwide.

**Type of Operation:** Single operator.

**Classes of Entry:** Group A for VU2s holding grade I license, Group B for VU2s holding grade II license. For non-VU2 hams, no group classifications.

**Scoring:** Points earned by VU2s for making complete contact with Asia, including India—1; Europe, Africa, and Australia—2; North and South America—3. DX stations score 1 point for every VU2 contacted.

All entries to the contest must be post-marked not later than 15th January and addressed to: The Convenor, Garden City Contest, Bangalore Amateur Radio Club, PO Box 5053, Bangalore-560 001, India.

There is no entry fee. True copy of a contest log must be submitted with sender's name, call, address, etc.

The three top scorers in each class will be awarded the winning certificates. All contestants submitting valid logs will also receive certificates of participation.



NEW ZEALAND

Des Chapman ZL2VR  
459 Kennedy Road  
Napier, New Zealand

June in New Zealand is the month when the shortest day occurs (signifying the middle of the winter season) and also the month when the New Zealand Association of Radio Transmitters (NZART) holds its Annual Conference and Convention. It is the time when the members get together to attend the Annual General Meeting and discuss the policies concerning the running of our Association. Also held are the annual meetings of the various sections of the NZART: WARO, the Women's Amateur Radio Operators, OTC, the Old-Timers Club, AREC, the Amateur Radio Emergency Corps, and forums of the VHF groups, the Novice Radio Training Scheme, and the DX buffs.

The weekend program also includes plenty of social- and radio-oriented activities—trade displays, trading tables for hams and XYLs and YLs, a dinner dance, a



Photo A. (left to right) Back row: VU2IR, 3 SWLs, VU2KVR, VU2AUS, 2 SWLs, VU2RVS, VU2RRN, VU2RO, SWL, VU2GX, SWL, VU2GSM, and VU2YZ. Center row: families and VU2UV. Front row: VU2NRS, VU2USA, VU2KAX, SWL, VU2RXZ, VU2RAH, VU2VNS, and VU2VIZ.

fox hunt on 2 meters, a mobile rally on 80 and 2 meters, and, over the past couple of years, several technical seminars and forums as well as the usual rag-chewing that always forms part of any ham get-together.

The venues of the Annual Conferences are set about two years in advance so that the branch responsible for the organization of the Conference has plenty of time for the planning of it. The Conference is held in a different city or town every year; last year it was the turn of my hometown, Napier, because it was the 50th anniversary of the formation of the Amateur Radio Emergency Corps (AREC), our emergency communication network. The AREC was born about 12 months after the devastating earthquake which hit Napier and the surrounding areas in February, 1931, when several amateur radio operators, including three within the devastated areas, maintained emergency communications for several days after the first shocks of the earthquake. As a matter of interest, some of the emergency signals were received in the United States and were the subject of an article in QST in 1931 or 1932.

As a result of these emergency operations, the amateurs of New Zealand saw the necessity for some form of emergency group to be available at any time to pro-

vide emergency radio communications. Since its inception, the AREC has assisted in hundreds of emergency situations including earthquakes, floods, land subsidences, aircraft crashes, mountain and bush rescues, and shipping disasters. This year's Conference was held over the first weekend in June (which is a long holiday weekend in New Zealand) at Dunedin, the main city in ZL4-land.

Next year's Conference is scheduled for Palmerston North, a university city in the center of the lower half of New Zealand's North Island. The city has some wonderful conference facilities, both in the city itself and at the university, and boasts of pleasant public gardens and recreational facilities. Overseas visitors are always welcome at our Conferences, and we have had visitors from VK, VE, W, and some of the Pacific islands in past years. So, if you are contemplating a ZL holiday, what better time to come to our fair land than at Conference time in June? If you are interested, a letter to NZART or myself will supply you with the necessary information. Even though it's winter time, a very warm welcome awaits you; the winters are reasonably mild in ZL since only the high country areas and the mountains are snow areas.

## NZART NATIONAL FIELD DAY

NZART holds an annual Field Day contest each year during February, when



Photo B. VU2GX presenting Pat (XYL of VU2AUS—ex-VK3KHL/NUI) a 6-kg watermelon. Others seen: VU2GSM, Mathu (SWL), VU2RAH, and VU2UV.

### AMATEUR AND COMMERCIAL COMMUNICATION SERVICES

\*\*Technical assistance by F.C.C. licensed technicians using the finest repair, test, and alignment equipment to give you results you can count on.

•REPAIRS

•ALIGNMENTS

•TESTS

•MODIFICATIONS

•INSTALLATIONS

•EVALUATIONS

\*\*F.C.C. Licenses:

- General Radiotelephone (ship radar endorsed)
- Second Class Radiotelegraph (ship radar and aircraft radiotelegraph endorsed)
- Amateur Extra Class

(517) 627-2650 (8 am to 6 pm)      12325 Madonna Dr, Lansing, MI 48917  
 (517) 627-2879 (6 pm to 10 pm) (est)      Geff N8CE



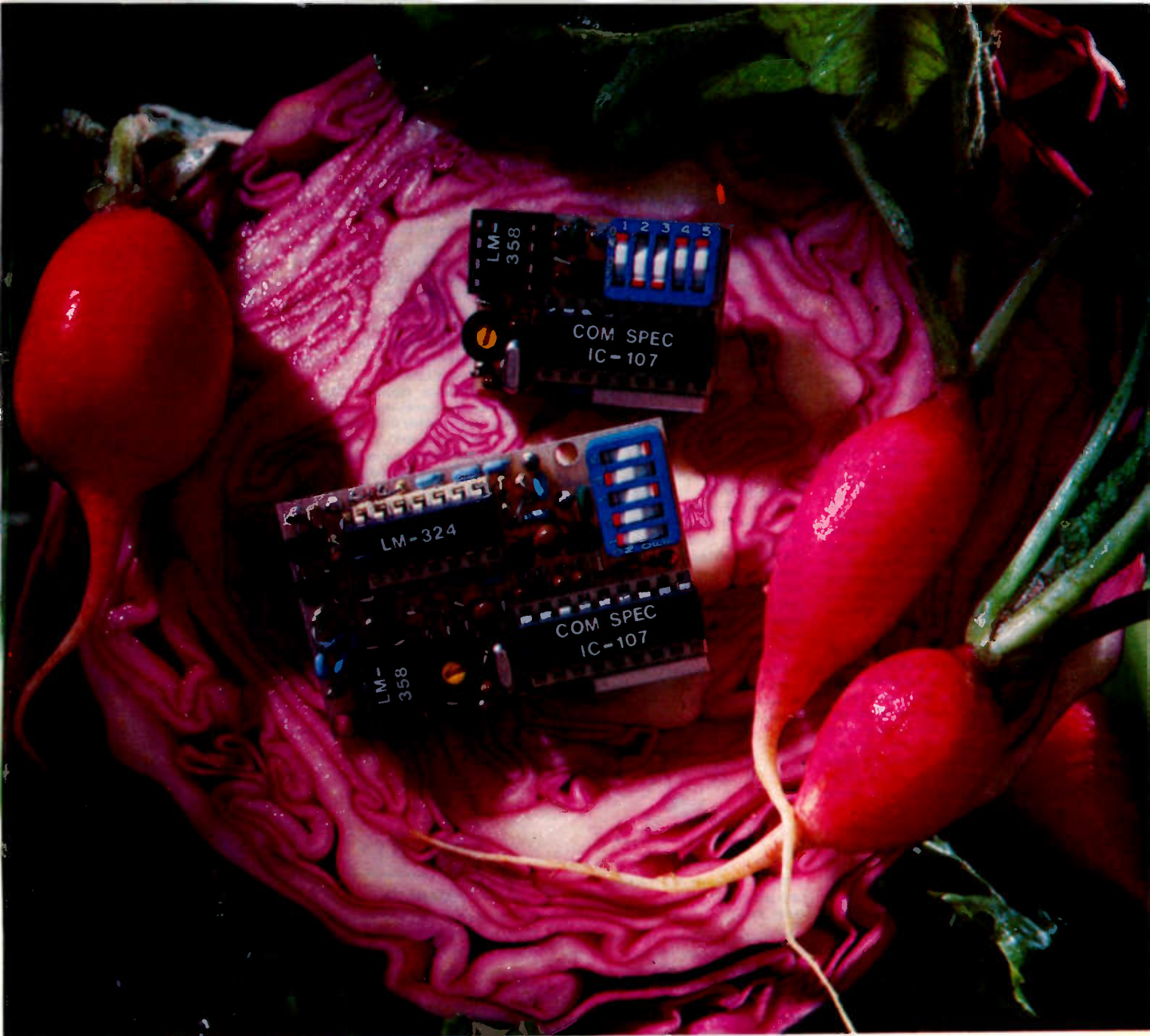

# A fresh idea!

Our new crop of tone equipment is the freshest thing growing in the encoder/decoder field today. All tones are instantly programmable by setting a dip switch; no counter is required. Frequency accuracy is astonishing  $\pm .1$  Hz over all temperature extremes. Multiple tone frequency operation is a snap since the dip switch may be removed. Our TS-32 encoder/decoder may be programmed for any of the 32 CTCSS tones. The SS-32 encode only model may be programmed for all 32 CTCSS tones plus 19 burst tones, 8 touch-tones, and 5 test tones. And, of course, there's no need to mention our one day delivery and one year warranty.

 **COMMUNICATIONS SPECIALISTS**

426 West Taft Avenue, Orange, California 92667  
(800) 854-0547 / California: (714) 998-3021

✓ 15

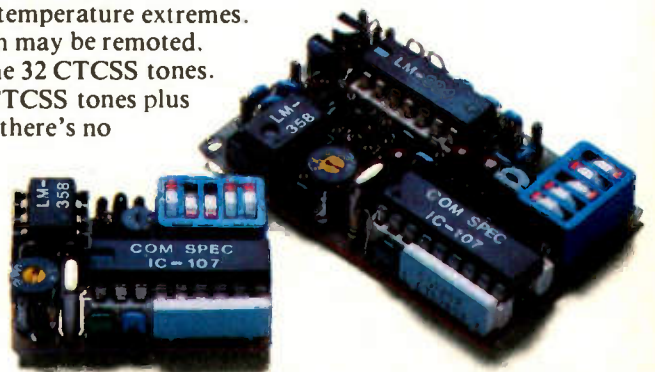

SS-32 \$29.95, TS-32 \$59.95



NZART branches go portable in the field. The contest is over two days, Saturday and Sunday, the operating periods being from 1500NZST to 2400NZST, Saturday, and 0600NZST to 1500NZST, Sunday, and the frequencies used are 80 and 40 meters, CW and phone.

Field-Day stations must operate from a portable power supply, in a tent or trailer (caravan), or some other portable location, e.g., a car or mobile home, on antennas erected for the Field Day no earlier than 1200NZST on Saturday.

Our Field-Day contest this year was one of the most successful for some time. In all, over 56 branch stations operated during the two days, out of a possible 80 branches. Contacts are on phone and CW in each hourly period, with points allotted for contacts and multiplier points for the number of branches worked on each band and mode. Some overseas contacts are admissible, with stations in VK and some of the near Pacific islands only.

My local branch station was set up on the banks of the Tutekuri River, about 3 miles from the center of town. The station was set up in a tent and a mobile camper. We used tall poplars about 120 feet high for antenna supports, placing pilot lines over the top of the trees with a surf-casting rod and line. We had 80- and 40-meter dipoles at about 80 feet, a delta loop on 40 meters, and a long-wire about 500 meters long across the river as our other 80-meter antenna.

The team had 1500 contacts, for 181 multipliers, giving us a total of just over 1,000,000 points; we did not think that we were the winners, as there were two or three teams ahead of us! The station was operated from the club's portable motor generator, supplying 230 volts to the four rigs used: a Kenwood TS-930S, a Yaesu FT-101, a Yaesu FT-901, and a FTDX-401—a rig on each of the modes on the two bands used.

I hope to be able to include some of the photographs taken at Field-Day locations in a future column to illustrate the similarity between our Field-Day exercises and yours (wherever you live), as hams around the world have a lot in common concerning our hobby.

#### BITS 'N' PIECES

June was the diamond jubilee for one of New Zealand's original ham operators, Dan Wilkinson ZL2AB, who was allotted his call sign in June of 1923. His was the third to be granted, and he still holds the same original call today. Who knows, that could be some sort of a record. Incidentally, the first call was issued to Jack Orbell 3AA, and #2 was 4AB, the Otago Radio Society. Another early call issued in 1923 was 1AC to Len Spackman, and he, too, still holds that same call sign and is active on the Old-Timers Club Net, so his diamond jubilee will be due later this year. Dan ZL2AB is also heard regularly on the Old-Timers Net on Sunday mornings on 40 meters.

#### AREC PHILATELIC COVERS

A small quantity of special commemorative philatelic covers is available. Issued to commemorate the 50th anniversary of the foundation of the Amateur Radio Emergency Corps, the covers were postmarked with a special cachet in June of last year, at the time of the Annual Conference and Convention. They are unaddressed and will be sent under a separate outer cover to avoid damage.

Please send 6 IRCs for one cover by return 2nd class airmail. Send applications to Napier Branch 25, NZART, PO Box 4030, Napier, New Zealand.

#### DX NEWS

**Chatham Islands.** . . Allan ZL2BKM has been operating from the Chatham Islands since April and will continue until August 29, 1983, all bands, CW and phone. Allan is a radio operator in the New Zealand Post Office, and he is doing a tour of duty at the Chatham Island Coast Radio Station run by the NZ Post Office. Allan's rig is a TR-430S. When he leaves the Chathams, he will be traveling to the States with a group of New Zealand hams to attend the Seattle NEZCHEQ get-together over the US Labor Day weekend, September 2-3.

**Niue Island.** . . Peter ZL2IK has taken the position of Director of Telecommunications, Niue, a two-year tour of duty which started in mid-May. Peter is a 160 buff and will be endeavoring to work DXCC on 80 and, if it is possible, 160 during his stay in Niue. He also will operate on the other HF bands. His rig is an IC-720; he will be ZK2IK.

Also operating from Niue at present are two other ZL operators, Bob ZK2RS and John ZK2JS, both telecommunications technicians on tours of duty in the Islands. Both of these operators are also active on the HF bands, and when these two are joined by Peter, they probably will make quite an impact on the DX front. So the DX boys will be sure of Niue being active for some time in the future—at least until 1985 when the present ZLs' tours of duty will finish. But then let's hope more hams from ZL will take their places when they return to New Zealand.

**Penrhyn Island.** . . Warwick ZL3AFH has been active operating from Penrhyn, in the Northern Cook Islands, as ZK1WL. He will operate until some time around the middle of this year.



KOREA

J. Michael Wengert HL9KTIKH2AC  
CPO Box 2961  
Seoul, Korea

In the spring, a young ham's fancy turns to operating portable! Koreans are natural outdoorsmen and love to climb rocks and mountains, camp at the seashore, and generally commune with nature. A dream situation for a young Korean ham might be camping in the mountains with his favorite rig and perhaps YL. Realizing that dream, however, has been a difficult thing for Korean hams.

In the past, portable/mobile operation required permission from the MOC (Korean Ministry of Communications) in the form of a special call sign, but such operation was possible. An important restriction was that operation was not permitted in certain areas near the demilitarized zone (DMZ) that separates the hostile states of the Republic of Korea and North Korea, for obvious security reasons. Well, no matter where you go, there is a "wrong-way Charlie," and Korea is no exception. Violation of this taboo by a single ham resulted in cancellation of the privilege for all.

Efforts to regain the portable/mobile privilege are expected to come to fruition sometime this year. VHF handie-talkies are popular here but have been prohibited for use outside the shack. Most 2-meter FM operation is with Japanese mobile-type transceivers, so the changeover to mobile operation would be easy. Along with the question of permitting portable/mobile operation in Korea, the MOC is also considering issuing licenses for repeaters. In Korea's mountainous ter-

rain, repeaters are a necessity for serious mobile work.

When portable/mobile operation is finally a reality, it will have been in no small part because of the efforts of Mr. Lee Hae Soo HL1BO, one of the pioneer hams in Korea and several-times director of the KARL. He has devoted much of his time and energies to regaining those privileges. He was instrumental in setting up the Korean National Red Cross regional club station system for use in time of national disaster and introducing the concept of amateur radio as a public service rather than a self-serving hobby. Much of this work has served to convince the Korean authorities of the value of amateur radio to society and encouraged them to liberalize the rules and regulations applying to amateur operation. A 73 International salute to HL1BO!

Much confusion regarding QSL Bureaus took place when the Korean hams changed over from HM to HL prefixes as a result of the 1973 WARC. Until that time, only US Forces/United Nations Command personnel used the HL prefix. To further complicate things, at about the same time, the USFK/UNC QSL address changed.

Following is the correct information: HL9 stations—American Amateur Radio Club of Korea, c/o Dependent Mail Section, APO San Francisco CA 96301; all other HL stations (1,2,3,4,5,8,0)—Korean Amateur Radio League, CPO Box 162, Seoul, Korea.

One final note . . . when signing with a Korean station, if you really want that QSL card, never say *Sayonara!* Koreans are completely different people from the Japanese. The correct farewell would be *Ahn-young!*

Well then, Ahn-young and 73 from the Land of the Morning Calm.



CANADA

(Reprinted from the CARF News Service  
CARF News No. 7183 by permission of the  
Canadian Amateur Radio Federation, Inc.)

As the old saying goes, you win some, you lose some, and here's some proof. The same Privy Council Office which held up proposed license increases so long that they could not be implemented this year has been sitting on proposed revisions to the amateur regs since last May. The proposed changes which surfaced a couple of weeks ago were some of those which resulted from recommendations made to DOC (Department of Communications) by amateurs at the 1981 CARF Symposium. Included were revisions which would lift power restrictions on 160 meters, permit repeaters on 10 meters, allow European amateurs to use all of the two-meter band while operating in Canada under a reciprocal operating agreement, and redefine permitted bandwidths for AM, FM, FSK, and ATV. DOC hopes that now that these drafts which it had submitted to the Privy Council have been found, they will be approved fairly soon.

British Columbia amateurs were involved in a novel way in the recent Royal Tour activities in Vancouver. During the ceremonies connected with the upcoming 1984 World Exposition, held in the new BC Place, the Queen's speech on March 9 was relayed by a 450-MHz link to Vancouver repeater VE7RPT and retransmitted on 20 and 40 meters. To mark the event, BC amateurs were allowed to use the prefix XO. A special QSL card is avail-

able to listeners who report hearing the broadcast. VE7 stations who used the XO prefix can obtain a special QSL card free from the BC government.

#### TOWERS COLLAPSE

The worst ice storm in Manitoba's history hit in early March and put Brandon and Baldy Mountain repeaters out of business when the broadcast towers holding their antennas collapsed. Many amateurs lost their antennas and some had the tough luck to lose their towers as well, according to VE4MG.

#### CORDLESS TELEPHONES

The cordless telephone, like CB radio, is rapidly becoming a fad, and like CB radio, it already poses problems for amateurs. QRM from these devices is already showing up from their harmonics in the 40- and 80-meter bands and some of them are, according to a US source, being crystallized in the 160-meter band. DOC is currently working on some regulations concerning them. Just to complicate the scene, there is apparently a 25-Watt amplifier now on the market. The phones themselves operate duplex, using 49 meters and 1.6 to 1.8 MHz, although the latter slot is going to the broadcast-band expansion in a couple of years. These things work well, but the Consumers' Association of Canada points out that with some models which have dial-out facilities, it is possible to access another telephone line and rack up toll-line charges on it.

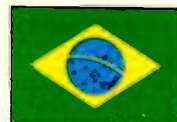

BRAZIL

Carlos Vianna Carneiro PY1CC  
Rua Afonso Pena 49, Apt. 701  
20270 Rio de Janeiro, RJ  
Brazil

#### YL FROM BRAZIL

Need a "sure QSL" from Brazil? Looking for a YL contact for your YL award? Well, all you have to do is come to 14.248 kHz every Wednesday from 1900 to 2100 UTC and join the BRYLA (Brazilian YL) net. The net has existed since March, 1976, and is directed by Inge PY2JY. The net attracts YLs from all of the Brazilian states on both SSB and CW.

Inge has held her license only since 1970, but she fell so in love with amateur radio that she now has 290 countries and holds this BRYLA net to stimulate DX operations with Brazilian YLs and to spread the BRYLA Award to all places and continents. 159 of these awards have been sent to 35 countries of the 105 countries filled by the net.

Listen to PY1YL, PY1AIP, PY1LMS, PY1MF, PY1DVQ, PT2ML, PT2SV, PT2LS, PT2TF, PT2DCR, PY2ATL, PY2DLZ, PY2FL, PY2JY, PY4AKL, PY4ML, PY4DY, PY4RA, PY2ACR, PY5BZC, PY7AVN, PY7VBG, PY8SSB/7, PS8YL, and many others on the BRYLA net, and most of the requirements for the BRYLA Award will be fulfilled.

The BRYLA Award was created by Therезinha PT2TF, and it is great! DX stations must prove a two-way QSO with 12 YLs from different countries on three continents, plus 8 YL stations from Brazil—on any band, any mode, and all QSOs from 1975 on are valid.

The log must be certified by a radio association and must include the station, date, time, mode, report, and band. SWLs also may qualify. Send QSLs for files and



When it comes to

# QSL's...



it's the  
**ONLY BOOK!**

US or Foreign Listings

1983  
**callbooks**

Here they are! The latest editions of the world-famous Radio Amateur Callbook are available now. The U.S. edition features over 400,000 listings, with over 75,000 changes from last year. The Foreign edition has over 370,000 listings, over 50,000 changes. Each book lists calls and the address information you need to send QSL's. Special features include call changes, census of amateur licenses, world-wide QSL bureaus, prefixes of the world, international postal rates, and much more. Place your order for the new 1983 Radio Amateur Callbooks, available now.

	Each	Shipping	Total
<input type="checkbox"/> US Callbook	\$19.95	\$3.05	\$23.00
<input type="checkbox"/> Foreign Callbook	\$18.95	\$3.05	\$22.00

Order both books at the same time for \$41.95 including shipping.

Order from your dealer or directly from the publisher. All direct orders add shipping charge. Foreign residents add \$4.55 for shipping. Illinois residents add 5% sales tax.



### SPECIAL OFFER!

Amateur Radio  
Emblem Patch  
only \$2.50 postpaid

Pegasus on blue field, red lettering. 3" wide x 3" high. Great on jackets and caps.

**ORDER TODAY!**

✓61

RADIO AMATEUR  
**callbook** INC.



Dept. B  
.....  
925 Sherwood Drive  
Lake Bluff, IL 60044, USA

# MAXIMIZERS

**NEW**

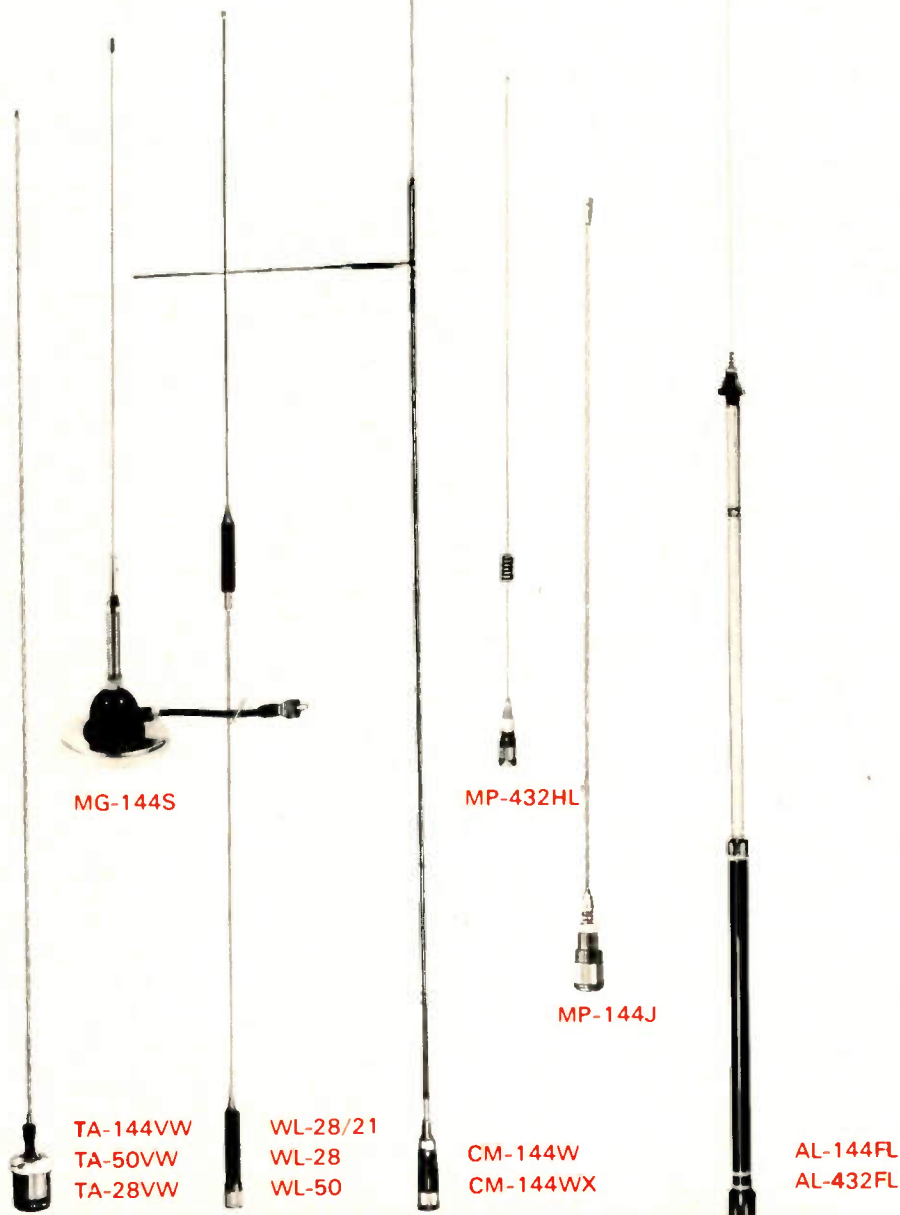

MG-144S

MP-432HL

MP-144J

TA-144VW  
TA-50VW  
TA-28VW

WL-28/21  
WL-28  
WL-50

CM-144W  
CM-144WX

AL-144FL  
AL-432FL

Get the most out of going mobile with KLM's hot new **MAXIMIZER** base/mobile and handi antenna series. Single and multiband models from 21 to 440 MHz deliver **MAXIMUM** coverage and performance without frills or compromise.

**MAXIMIZER** mobile sampler: TA-series: 1/2λ whips for 144, 220, and 440 MHz voltage protection.

**MG 144S:** 1/4λ monopole with powerful magnet mount.

**WL-series:** center loaded whips for 28/21, 28 and 50 MHz

**MP-432HL:** 5/8λ + 3/8λ whip for 432 MHz

**CM-series:** multiband whips for 15/10/6/2 meters or 10/6/2 meters.

**AL-series:** high gain 1/4λ for mobile/handie applications.

There's more! See your KLM dealer or write for a catalog.

KLM Electronics, Inc. P.O. Box 816,  
Morgan Hill, CA 95037 (408) 779-7363

# KLM

## Electronics Inc.

10 IRCs to BRYLA, c/o Ziza PT2LS, PO Box 07/0004, 70000 Brasilia, DF, Brazil, South America.

On the BRYLA net, you can find Eva PY2PE, DXCC Honor Roll member, Tessa PSBYL and Marilia PY4AKL, who both have more than 300 countries, Inge PY2JY with 290 countries, and PY2ADI with 172 countries. Ziza is BRYLA Award Manager with hundreds of first-class awards including 5 BRYLA Awards which were endorsed all CW.

When propagation is fine, Japan, Hawaii, New Zealand, Australia, and many other first-class DX stations are available.

A general CQ is called aiming the beam to South Africa, Asia, or Europe, and traffic is passed just like other international nets. Each YL is listed and one by one they QSO the other participants. No "chats" are allowed during these two hours so all calls can be answered. Only a call and report will be given by each YL.

Another very funny award was created by Inge, the WBYL (Worked Brazilian YL) Award, and it has been offered since the first day of 1981, with the first request coming from South Africa. Just contact 8 Brazilian YL stations and form the words "BRASIL YL" using any one letter from each suffix. One of the YL stations must be a PY2. Any band, any mode. The standard log is required, including station worked, date, time, mode, report, and band. SWL entries are also accepted. Send QSLs with 10 IRCs for return postage to Inge Tobias de Aguiar PY2JY, Rua Texas 448, 04557 Brooklin Novo, Sao Paulo, Brazil, South America.

Inge is so enthusiastic for radio, she was the first YL to operate VHF from a hot air balloon flying over Sao Paulo, on August 18, 1974. She was with her husband Jose PY2JO and Vitorio Truffi, balloonist and proprietor.

She also participated in two DXpeditions to Arvoredo Island in 1975 and 1980. This island is the most beautiful small island in the world and is located at 46° 10' W and 23° 58' S, 176 miles from Rio de Janeiro. It was developed and maintained by Fernando Edward Lee.

There are hundreds of birds and fishes which come from distant places to the island. The island also has the largest wind alternator in the world, a lighthouse, solar water heating, a rainwater reservoir with a 1-million-liter capacity, and coconut trees which give 12,000 liters of coconut milk each year. There is also a 70-ton crane which can easily lift a 3-ton yacht into a specially-designed tank. Paradise on Earth, says Inge.

A new net is being planned and studied for 14288 kHz on Wednesdays at 2330 UTC. It will be beaming toward the USA and Canada.



## **LIBERIA**

Brother Donard, Steffes, C.S.C.  
EL2ALWBHFY  
Brothers of Holy Cross  
St. Patrick High School  
PO Box 1005  
Monrovia, Republic of Liberia

Liberia is on the westernmost point of the great continent of Africa. Most of the country is nearly at sea level, although there are parts of the interior that rise to somewhat over a thousand feet. For whatever reason, the amateurs in this country enjoy excellent communications condi-

tions with the United States, all of Europe, and in the direction of Russia during the greater part of the year. It seems to be well situated geographically and it is in the GMT time zone.

The amateurs in the country number less than a hundred and most are not natives. The reason for this situation is simply that Africans have had little opportunity to learn amateur radio and, for the most part, they do not have the money to purchase and operate radio equipment. Very few of the cities have electrical power and those that do have it for only a part of the day.

The Liberian Amateur Radio Association (LARA), under the direction of Mr. Benjamin Walcott, is doing everything in its power to reverse those statistics. Radio classes are being run in increasing numbers and the response is very gratifying. In Monrovia, a course is being taught currently at St. Patrick High School, and the turnout is over a hundred persons of all ages and includes both men and women. These classes operate under great difficulty since textbooks are not available and things like code oscillators are rare. The students must rely on class notes and on duplicated pages which are prepared and handed out by the instructor. Many of the people have tape recorders, which are a great help.

When the students are licensed, there is the problem of equipment for them to use. The association plans to gradually set up club stations in strategic areas so that those who do not have their own equipment may have access to a club station. At the present time, there is one such club station in operation. The equipment for these club stations will have to come from amateur friends in other parts of the world. The station which is presently operational was donated by a radio club in Barberton, Ohio.

The Telecommunications Ministry here in Monrovia has neither the personnel nor the funds to test and evaluate applicants for amateur licenses. The government relies on the LARA to do this job for them. The LARA instructs persons interested in amateur radio, tests them, and when they have met the requirements, recommends them to the Ministry for licensing. This system is working remarkably well and the cost to the government is minimal.

Amateur radio in Liberia is proud of its record of performance in times of emergency and disaster. It measures up to the high standards of amateur radio around the world, and it is the aim of the LARA to expand the numbers of operators, increase amateur activity, and at the same time maintain the high standards at which it now functions.

(Brother Donard is Secretary of the Liberian Amateur Radio Association.—Ed.)



## **GREAT BRITAIN**

Jeff Maynard G4EJA  
10 Churchfields  
Widnes WA8 9RP  
Cheshire, England

The continuing growth of interest in amateur radio in the United Kingdom was evidenced recently when the Radio Society of Great Britain (RSGB) held a National Amateur Radio Convention at the National Exhibition Center near Birmingham. The NEC is a prestige exhibition and conference center with its own airport,

railway station, and hotel complex situated more or less in the center of England and well served by motorways (freeways).

I had previously visited NEC for trade shows such as Communications 83 and the International Business Show and had found parking easy and queues minimal. Not so with the RSGB, who, although using a hall of adequate size, had arranged for only two ticket counters to be open. This meant a wait of some twenty minutes in a fresh breeze which at least sharpened our minds for the coming fray.

The majority of major importers were exhibiting the latest in Japanese microprocessor-controlled black boxes. I tried, unsuccessfully, to find a new rig that performed better than my FT-101 rather than just outdid it in numbers of knobs. There are no longer any indigenous manufacturers of HF gear in the UK. However, we do have some able representatives in the specialist scene including Microwave Modules and Wood & Douglas. MM displayed its range of converters for 2 meters and 70 centimeters, together with linear amplifiers for these and higher bands. Perhaps their most innovative product (and one that always attracts attention) is the Morse Talker. This microprocessor-controlled device sends random Morse at a user-selected rate and then speaks the letters sent for the pupil to check his copying. As an option, the model two will interpret (but not comment upon!) pupil-sent Morse.

Wood & Douglas exhibited a range of 70 cm, 2-, 4-, and 6-meter kits, and modules for the construction-minded operator. As well as traders, the exhibition hall included the various support groups such as the RSGB (showing its extensive range of books), AMSAT-UK, selling the newly-published *Technical Handbook*, Navy and Air Force Amateur Radio Societies, the Radio Amateur Invalid and Bedfast Club, and BARTG (the British Amateur Radio Teleprinter Group).

With most of the stands 5 deep in excited people clutching for leaflets, it was something of a relief to take a break for lunch. This is an area in which we have a little to learn from the US. The choice at NEC was to queue for half an hour for a very soggy beefburger or (as we did) walk over to the attached Metropole Hotel and pay over the odds for an average meal.

Many believe that the intense interest in amateur radio is a spin-off from the recently legalized CB service (27 MHz, FM, 4 Watts) which many are finding frustrating and uninteresting (surprise, surprise!). Lots of ex-CBers are furiously studying for the radio amateurs' examination, which twice yearly opens the doors to those answering the questions correctly.

Some early problems with CBers spreading into the 10m band have now largely disappeared. My own local cowboy was discouraged from using 28.1 for SSB by some 200-Watt RTTY tests I ran! There is, however, some worry over here about the 10m band and its lack of use during quiet sunspot periods. Moves are afoot to encourage FM around 29.6 for mobile-to-mobile working (many 2m repeaters are very busy indeed).

Cheap CB rigs (\$25.00 to \$50.00) are being snapped up and converted from 27 to 29 MHz quite easily. Although low in price, some of these are from well-known names such as Icom and offer a range of facilities including 40 channels.

The RSGB is encouraging 10m usage by promoting a new 28-MHz Counties Award. This requires confirmed contacts on 10m (any mode) with 40 UK counties/Scottish regions from the total of 77. Contacts must be made after April 1, 1983. The award is free to RSGB members and \$3.00 to others.



## **FRANCE**

Claude Guee FDGY  
11 Rue Emile Labiche  
28100 Dreux, France

### **2M FM REPEATERS**

About 25 FM repeaters are located in France. Placed on 15 channels in 25-kHz steps, they can be found between 144.725 and 145.175 MHz, with a +600-kHz offset. ERP is between 20 W and 200 W. Some are very busy.

### **70-CM FM REPEATERS**

France has about 10 of these repeaters. Present channels of the machines will be moved, but all have a -1600-MHz offset.

### **AWARD: DIPLOME VILLE DE PARIS**

HF bands: Class 1—contact 20 arrondissements, Class 2—contact 15 arrondissements, Class 3—contact 10 arrondissements. All contacts after January 1, 1946. A log book certified by an officer of the national organization is required. Fee: 30 FF (IRC).

For YL: 10 arrondissements, or 20 for "diplome d'honneur."

Diplome manager: Bernard Louis F5BL, 15 Place d'Aligre, 75012 Paris, France.

### **WORLD COMMUNICATIONS YEAR**

For this event, French stations are authorized to use a TO prefix.

### **SATELLITE ACTIVITY**

RACE (Radio Amateur Club de l'Espace) is supporting ARSENE (Ariane Radio Amateur Satellite Enseignement Espace). This satellite is scheduled to be launched by Ariane IV by the end of 1985. Two modes are planned: B and F (2.4 GHz and 435 MHz). The orbit will be an equatorial ellipse. The president of RACE is F8ZS and the vice president is F8YY.



## **SWITZERLAND**

Peter W. Frey HB9MQM  
PO Box 1127  
CH-5401 Baden  
Switzerland

As in most other Western countries, repeaters are an important aspect of amateur radio in Switzerland. However, in the last couple of years, many amateurs in this country have grown increasingly skeptical about what some call "garbage-in-garbage-out machines." They charge, for example—not entirely unfounded—that repeaters tend to promote bad operating practices and that the difference between what you hear on 27 MHz and on 145 MHz has become rather marginal. Monitoring a 2-meter repeater like HB9AN near Zurich, the biggest Swiss city, for a day can indeed be a frustrating experience: QSOs abound with CB-type lingo and their content is only too often in violation of the rules. (Remember, for example, that third-party traffic of any kind is an absolute no-no in almost all of Europe!)

So far, repeater jammers in Switzerland haven't had to fear much in terms of getting caught. Some repeaters, like HB9P on top of Mount Schilthorn (known to James Bond 007 movie addicts as "Piz Gloria") in



## KENWOOD TS-430S



- All Bands
- Dual VFO's
- General Coverage
- 8 Memories
- 200 Watts

## ICOM IC-740



- 1.8 to 30 MHz
- 200 Watts
- Super Receiver
- Selectable IF / PBT Tuning

## YAESU -NEW FT-77



- Extremely Compact
- 3.5 to 30 MHz
- 200 Watts
- Inexpensive

## ANTENNA SALE

CUSHCRAFT	HYGAIN TOWERS	BUTTERNUT	HYGAIN
A-3 \$175	HG375S \$ 649	HF6V \$109	TH5MK25 \$318
A-4 \$226	HG525S \$ 919		TH7DXS \$378
R-3 \$226	HG54HD \$1429	KT34A \$299	TH3MK3S \$218
AV-5 \$ 90	HG70HD \$2339	KT34XA \$449	TH3JRS \$158
214-FB \$ 69	HG50MTS \$ 749	144-148LBA \$ 69	TH2MKS \$138
32-19 \$ 82			18AVT/WS \$ 94
40-2CD \$260	LARSEN CALL	AEA CALL	18HTS \$335
			V2S \$ 37

CALL "TOLL FREE" FOR ALL ANTENNAS & ACCESSORIES

CALL FOR HYGAIN TOWER PACKAGES.

2900 N.W. VIVION RD. / KANSAS CITY, MISSOURI 64150 / 816-741-8118

## new TUNABLE TRAP ANTENNA

Model AT-80 for 80, 40, 15, 10 meters



PRICE  
**\$49.50**

SHIPPING AND HANDLING ADD \$3

- Length only 88 feet.
- New Patented Traps.
- Weatherproof.
- Traps and Antenna are continuous wire, no connections to fail.
- Install as an inverted V or flat top dipole.
- Antenna tuning is accomplished by sliding a wire through trap and along antenna wire.
- No wire trimming or soldering.
- Built in 1/4 wave matching section, with weatherproof center insulator terminated with an SO-239 connector.
- Antenna completely assembled including 25 feet nylon guy rope on each end.
- Power capability 1 kw input.
- Low SWR at resonance.

ALL OUR PRODUCTS MADE IN USA

**B-W BARKER & WILLIAMSON**  
Quality Communication Products Since 1932

At your Distributors, write or call:  
10 Canal Street, Bristol, Pa. 19007  
(215) 768-5581



## BITTEN BY THE ATV BUG?

Let P.C. put you on the air and SAVE!

Complete System price  
**\$249.00 SAVE \$13.00**

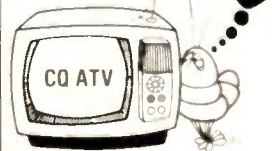

**TXA5-4 Exciter/Modulator** . . . . . \$89.00 ppd.  
Wired and tested module designed to drive PA5 10 watt linear amplifier. The 100 MHz crystal design keeps harmonics out of two meters for talk back. Video modulator is a full 8 MHz for computer graphics and color. Requires 13.8 VDC reg @ 70 ma, 80 mw output power. Tuned with crystal on 439.25, 434 or 426.25 MHz. Dual frequency model available . . . . . \$115.00 ppd.

**PA5 10 Watt ATV Power Amplifier** . . \$89.00 ppd.  
The PA5 will put out 10 watts RMS power on sync tips when driven with 80 mw by the TXA5 exciter. 50 ohms in and out plus bandwidth for the whole band with good linearity for color and sound. Requires 13.8 VDC reg @ 3 amps.

**FMA5 Audio Subcarrier Generator** . \$29.00 ppd.  
Puts audio on your camera video just as broadcast does at 4.5 MHz. Puts out 1 V p-p to drive TXA5. Requires low Z mike, 150 to 600  $\Omega$  and 12 to 18 VDC @ 25 ma. Works with any transmitter with 5 MHz video bandwidth.

**TVC-2 ATV Downconverter** . . . . . \$55.00  
Stripline MRF 901 preamp and double balanced mixer digs out the weak ones and resists intermod and overload. Connects between UHF antenna and TV set. Output channels 2 or 3. Varicap tuner 420 to 450 MHz. Requires 12 to 18 VDC @ 20 ma.  
Supersensitive TVC 2L with NE64535 preamp (.9 db N.F.) . . . . . \$69.00 ppd.

Call or write for our complete catalog of specifications, station setup diagrams, and optional accessories which include: antennas, modulators, test generators, cameras and much, much more. See Ch. 14 1983 ARRL Handbook.

TERMS: VISA or MASTERCARD by telephone or mail, or check or money order by mail. All prices are delivered in USA. Allow three weeks after order for delivery.

(213) 447-4565 Charge card orders only

**P.C. ELECTRONICS** 2522 Paxson Lane,  
Tom W6ORG Maryann WB6YSS Arcadia, California 91006



the Bernese Oberland or HB9RW on top of the Parpaner Rothorn in the southeastern part of the country, are situated well above 9000 feet. They cover a great part of Switzerland and considerable portions of neighboring countries, thus making it a rather difficult task to locate and track down a jammer. On top of that, the radio surveillance people of the Swiss PTT can't provide as much help as the amateurs sometimes expect. They are facing enough problems already in coping with the messy 27-MHz situation in this country.

For the officials of the Swiss national society, repeaters are a constant item on the agenda. It's the business of repeater coordinating that sometimes gives them headaches. If you thought repeater coordinating was difficult in the US, imagine just how it is to coordinate repeater frequencies when societies and authorities of some five countries are involved!

The 2-meter band plan of the International Amateur Radio Union Region 1 (Europe, the Soviet Union, and Africa) provides only for ten repeater channels designated R0 to R9 with inputs located between 145.000 MHz and 145.225 MHz and outputs 600 kHz higher. You don't need to be a repeater-coverage expert to see that it is close to impossible to cater to all wishes with only ten channels available. Therefore, repeater problems are an everyday fare for the VHF managers of Europe's national societies.

A few years ago, one could even witness a "repeater war" in Central Europe. The French national society unilaterally decided to put into operation a couple of repeaters on frequency pairs well apart from the internationally-agreed-on channels and with inputs right in the middle of the 2-meter-beacon band. The Austrians closely followed suit. Through a lot of negotiating across country borders and shuffling around of channels, the problem is now in the process of being resolved. However, when you're experimenting with HB9W, the flea-power (36 mW!) S-meter calibrating beacon on Zurich's Mount Uto, you still stand a good chance that your test is rendered useless because of constant interference. The input of an Austrian repeater on Mount Valluga just across the border is on exactly the same frequency.



### DENMARK

Hanne Nielsen OZ1CID  
Hvidovrevej 468  
2650 Hvidovre  
Denmark

In Denmark we are 8000 radio amateurs strong, and about 7000 are members of EDR (Experimenterende Danske Radioamatører). Under EDR we have 60 local divisions of varying size.

The Copenhagen Division, or as we call it, club, is the biggest, with 300 members. We have our own house bought in 1974. The club was founded in 1932 and we have just celebrated our 50th jubilee.

During the week, we have many activities. Monday evenings we have a common meeting with lectures upon different technical sides of our hobby and afterwards comfortable talks over a cup of coffee and some eatables. Of course, the club station is on the air with the call OZ5EDR.



The EDR Copenhagen Division QTH.

Tuesday we have laboratory evening, where members can receive technical assistance for their problems with stations or construction projects or, as a group, we start some new projects. Four to five days every week, except in the summer time, we have technical courses and CW courses for those who want to have a license or upgrade their present license.

In the clubhouse, we have a laboratory, library, VHF/UHF shack, HF shack, instruction room, office, dining room, three apartments for leasing to members, a workshop, material rooms, and a newly established museum for radio amateurs. Outside the house, we have an antenna mast with HF/VHF/UHF beams.

Many weekends we join into the different national and international contests on both CW and SSB. Joining in Field Days and the Jamboree on the Air are also some of our activities. We also do a lot in award hunting. That special side of our hobby hasn't been going on for more than 4 years, but through many QSOs and a fine award manager, we now have got 104 different awards decorating our walls, many from 73 magazine. We have also founded 2 awards: The Copenhagen Award founded many years ago, and the OZ Prefix Award founded on the occasion of the 1982 jubilee.

The house we own is very old. Every weekend some members work on it as there is always something to do and we are not able to pay workers from outside.

It's very nice, as a chairman, to see that our hobby, amateur radio, is flowering, not only in the Copenhagen Division of EDR, but everywhere. If any radio amateur in the USA should visit Copenhagen, you would be very welcome to visit our club.



### SWEDEN

Rune Wande SM0COP  
Frejavigen 10  
S-155 00 Nykvarn  
Sweden

### SCANDINAVIAN HORIZON

"Do you always carry your radio with you whenever you travel?" the customs lady asked me at Logan Airport in Boston, Massachusetts, when I unloaded the two 40-pound boxes with ham gear in addition to our 5-person family luggage. "Yes, I always do," I replied, and she let us pass through.

Most of us hams like to have our radios with us when we travel. It sure is fun to experience how the bands sound at a distant location from home. A 2-meter FM handheld can give you lots of opportunities to meet local hams during a vacation in a foreign country. Many of you Americans have been fortunate enough to be able to use ham radio far away from home while in the service overseas. However, only some twenty years ago or less, a citizenship in the licensing country was required. Luckily, this has changed in recent years. Many countries now have formal reciprocal agreements for temporary licenses for foreign visitors.

### A DREAM COMES TRUE

You are planning your trip to some foreign country and you would like to operate ham radio while staying there. Start your

planning well in advance. If you have no information on licensing in the country concerned, write to their telecommunications authority or the amateur radio organization in that country for information. Addresses can be found in ham magazines and in the *Callbook*. The easiest way, though, is to write to your own national amateur radio organization for reciprocal licensing information.

Generally speaking, the following things are common in most European countries:

- A reciprocal licensing agreement between the two countries
- Application required
- Processing time, one to three months
- License issued for a period of maximum three months each calendar year
- Operating privileges in accordance with the class of license in the country you visit which is closest to your own license
- You have to follow the regulations in the country you visit which can differ a lot from what you are used to back home, especially maximum power limits and frequencies used

There are some important differences from country to country. The following is currently valid for each of the Scandinavian (Nordic) countries.

**Denmark.** An application with the following data should be sent to Radiotekniske Tjenste, Tilladelsessektionen, Islands Brygge 83 C, DK-2300 Kobenhavn S, Denmark: Name and address of applicant, date of birth and town, citizenship, callsign and class of license, time period for the stay in Denmark, address in Denmark, any remarks, and date and signature.

A photocopy of your license, certified by two persons, should be attached to your application. This procedure is accepted for applicants from the USA, Canada, Brazil, Australia, Portugal, Switzerland, France, Spain, Luxembourg, Belgium, West Germany, Great Britain, Holland, Iceland, Sweden, Norway, and Finland. Amateurs from other countries have to supply documents stating the requirements for a ham license in their country in addition to the license document.

The fee, 20 Danish kroner (around \$2.50), shall be paid when arriving in Denmark. A special money order form sent with the license should be used. The same procedure applies for the Faroe Islands, prefix OY.

**Finland.** The Finnish amateur radio organization, SRAL, has a somewhat different status than what is common in other countries. It is mandatory to be a member of the SRAL when being a ham in Finland. Your application sent to the SRAL will be handled faster than if sent directly to the licensing authority. The address is Suomen Radioamatööriliitto r.y., Postioikero 306, SF-00101 Helsinki 10, Finland.

The application shall state your complete name and address, citizenship, fixed station address in Finland, time period for the stay in Finland, any remarks, and date and signature.

A photocopy of your license and personal identification (photocopy of passport or similar document) is required. Finland requires reciprocal agreements. Non-Finnish citizens are prohibited from working mobile ham radio.

The fee is 38 Finnish Markka (around \$8.50) and the license is sent COD.

**Norway.** Norway also requires a reciprocal agreement, and application shall be mailed to Norwegian Telecommunications Administration, Radio Inspection Office, PO Box 6701 St. Olavs Plass, N-0slo 1, Norway.

Preferably, you should send for their ap-





# RTTY

**NEW**



## TU-470

- Full featured RTTY to 300 baud plus CW terminal unit.
  - 3 Shifts, active filters, remote control, xtal AFSK, FSK, plus much more.
- Suggested retail price...\$499.95  
Introductory offer.....**\$429.95**  
Offer Expires 9-1-83



## TU-300

- RTTY terminal unit to 300 baud.
  - 3 Shifts, active-filters, xtal AFSK, FSK, plus more.
- kit **\$289.95**  
wired \$399.95



## TU-170A

- Single shift RTTY terminal unit.
  - Xtal AFSK, FSK, active-filters and more.
- Kit **\$189.95**  
wired \$289.95



## TU-170

- Single shift RTTY terminal unit.
  - Low cost, AFSK, active-filters.
- \$149.95**  
(Kit only)



## DM-170

- Single shift RTTY demodulator.
  - Low cost, active-filters, autostart.
- \$47.95**  
(Kit only)

SALES ONLY

**1-800-HAM-RTTY**



Flesher Corporation  
P.O. BOX 976  
TOPEKA, KS. 66601

✓23

**MAXIMIZER**

**NEW**

## VSWR CHART

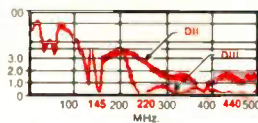

## IMPEDANCE

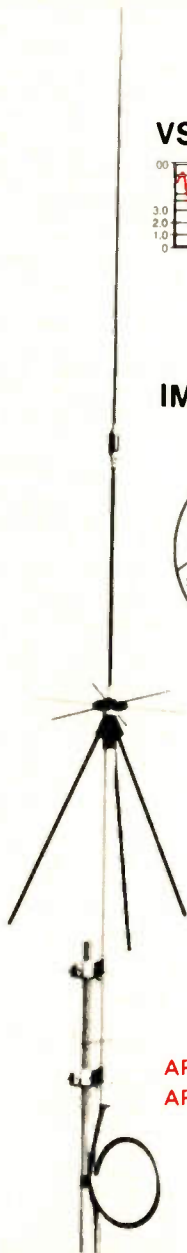
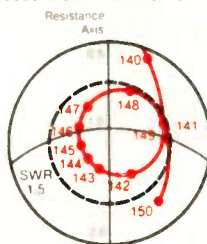

AP-144D II  
AP-144D III

AP-144DII - this 5/8λ + 5/8λ collinear base station vertical for 2 meters delivers significant gain over a groundplane. Built-in lightning/static arrester. Rugged construction suitable for marine applications, too.

APP-1434DIII - UHF disc radials extend gain performance to 430-440 MHz.

**KLM**

Electronics Inc.

See your KLM Dealer or write for our complete catalog.  
P.O. Box 816,  
Morgan Hill,  
California 94035

## LISTEN TO THIS!

UL2M is a FM Transmitter that plugs into the phone jack of most H.F., V.H.F. and U.H.F. radios. You can now monitor your favorite H.F., V.H.F. or U.H.F. frequency up to 100' away using the UL2M and your H.T.

The UL2M is a XTAL controlled F.M. transmitter built inside a standard 1/4" phone plug. The UL2M will transmit the audio from your H.F., V.H.F. or U.H.F. radio to your H.T.

The UL2M requires your H.F., V.H.F. or U.H.F. radio to have a 1/4" phone jack and output impedance of 3.2, 8 or 16 ohms. For radio having an 1/8" headphone jack, use a 1/8" to 1/4" adaptor.

When ordering specify operating frequency of your H.T.

**ONLY \$19.95**



To order, send check or money order to:

**S and T Electronics** ✓259  
1401 Rae Lane  
Madison, WI 53711  
For C.O.D. order call  
Carol at 608/274-2599.

satisfaction guaranteed or full refund.



plication form which includes about the same data to be filled out as for the other countries. If you intend to operate mobile, the registration number of your vehicle shall be stated. If you intend to rent a car, you can state that. One important difference is that you have to enclose a Certificate of Good Conduct issued by your local police authority.

If you are a foreign citizen but a resident in Norway, you can apply for a license one year at a time. The prefix then is LA0. Operations from the Norwegian territories JW0, JX0, and 3Y0 are under separate regulations.

The fee is 50 Norwegian kroner (around \$8.00), and shall be included with the application.

Sweden. Together with Denmark, Sweden is one of a few countries that does not require reciprocal agreements. We have agreements, however, due to the reason that otherwise we would not be able to operate in countries where they require such formal agreements. The application form includes the regular data and shall be sent to The Swedish Telecommunications Radio Department, Licensing Section, S-123 86 Farsta, Sweden. The application can be written in Swedish, Danish, Norwegian, English, French, or German. A copy of your valid license and a Certificate of Good Conduct (impunity) issued by the police authorities in your

native country must be included. In certain countries, such a certificate cannot be obtained. A certificate issued by the applicant's amateur radio organization must then be included.

The fee is 80 Swedish kroner (around \$13.50), and shall be sent after you have received your temporary permit. They prefer not to receive payments in advance.

Any foreign national with permanent residence in Sweden for a considerable time (currently 3 years) can get a permanent Swedish license. If holding a foreign license, the equivalent Swedish license will be issued without any further exams. However, one obstacle to getting the highest class of license, class A, is the code proficiency requirements. Most countries have 12 wpm as their highest code speed. A code exam at 16 wpm will solve that problem.

In both Finland and Sweden, you use your call followed by /OH or /SM and a number stating the district where the radio transmitter is used temporarily.

LSGLG and SJ9WL. These two call signs belong to the same station located on the border of Norway and Sweden, not very far from Oslo, the capital city of Norway. The place is called Morokulen, a name combined of the word "fun" in those two languages. It is not a separate DXCC country, but you can operate this amateur station

without any reciprocal agreements. The only requirement is that you show your valid ham license when visiting the station. You can rent the house with the station if you would like to spend a few vacation days there. However, if you want to rent, you are advised to make reservations.

#### COMPARISON WITH THE US

As a comparison, the reciprocal licensing for visiting hams in the US is very favorable. There is no fee, the license is issued for up to one year at a time and is renewable, and the processing time is short (usually sent by return mail), although the application form states 60 days. However, if your country does not have a reciprocal license agreement with the US and you want to operate from there, you can take the exams at an FCC (Federal Communications Commission) office. US citizenship is not required, and you can go through all exams at the same time if agreed upon by the local FCC office. You start with (e.g.) the 20-wpm code and then take the combined Technician/General class 70-question exam. If you pass, you can continue with the Advanced written exam and finish with the Extra. Then you just wait for the mail.

#### CONCLUSION

If you plan to visit a foreign country, apply for a license and you get a chance to

meet the people. That is much more rewarding than all the tourist attractions in the world.



#### WEST GERMANY

Hans J. Schalk DJ8BT  
Hamarskjold-Ring 174  
D 6000 Frankfurt 50  
West Germany

#### FROM AMSAT/DL

The ESA (European Space Agency) fixed—as of this writing—the launching date for the ARIANE flight as June 3, 1983. Expected for this flight was the carrying of the European communication satellite ECS 1 as well as the AMSAT Phase-IIIB satellite. Further ARIANE starts are scheduled for August and November, 1983, as well as January, 1984.

See box for contest results.

#### ANTARCTIC EXPEDITION

Presently on a visit to the Antarctic is Loy Y44YK. He is scheduled to be QRV as Y83ANT in the near future. His equipment: two transceivers with 150-W input, Type

#### RESULTS OF THE 15TH EUROPEAN DX CONTEST WAEDC 1982 RTTY

##### Single Operator

Call	QSO	QTC	Multi	Score
1. Y39XO	298	561	222	190698
2. I1TXD	253	467	195	140400
3. DK8NG	245	328	245	140385
4. IT9ZWS	265	461	174	126324
5. SM6ASD	243	441	184	125856
6. W3FV	196	324	209	108680
7. IC8POF	229	417	152	98192
8. OH1IJ	248	418	147	97902
9. DJ2YA	160	386	172	93912
10. 4Z4KB	176	150	191	62266
11. I8JRA	139	280	124	51956
12. KB2VO	173	109	131	36942
13. YO3AC	123	265	94	36472
14. OE2SNL	123	174	117	34749
15. DJ6QT/CT3	106	89	171	33345
16. Y79XN	143	254	78	30966
17. 4N7NS	111	230	76	25916
18. HC5EA	137	61	122	24156
19. ON7KK	154	0	154	23716
20. UV3FD	168	140	77	23716
21. EA3BLQ	107	244	65	22815
22. EA3OL	247	0	82	20254
23. YV1GU	126	0	138	17388
24. DL8QP	73	168	69	16629
25. EA1AEB	154	0	101	15554
26. DJ9IR	79	152	54	12474
27. DJ1XT	78	136	56	11984
28. EA8ZZ	73	84	75	11775
29. K1LPS	73	27	94	9400
30. KJ2N	67	88	60	9300
31. OK2BJT	74	127	46	9246
32. DF1LX	61	113	52	9048
33. OK2SPS	83	147	35	8050
34. K6WZ	60	54	65	7410
35. DF6AI	66	98	41	6724
36. DJ2YE	90	0	70	6300
37. DF6ZY	52	123	35	6125
38. F6DBY	71	0	82	5822
39. Y23VB	76	50	46	5796
40. KP4BJD	66	0	77	5082
41. EA5CVR	73	0	67	4891
42. SM6BUV	51	77	34	4352
43. WB4UBD	34	53	46	4002
44. EA9JZ	67	0	57	3819
45. W3AOH	75	0	50	3750
46. LU3DSU	51	0	73	3723
47. EA7BBK	74	0	42	3108

48. SM5BRG	40	101	18	2538
49. EA3DMP	49	0	45	2205
50. DL8CX	44	0	46	2024
51. VK2BQS	20	41	30	1830
52. DK5KJ	30	25	26	1430
53. Y33UO	37	11	28	1344
54. YO8FR	48	0	27	1296
55. Y22UL	22	40	18	1116
56. Y33TA	21	39	13	780
57. DK4IS	23	0	12	276
58. VK8BE	13	0	20	260
59. YJ8TT	13	0	18	234
60. JA7KM	4	0	8	32

##### Multi-Operator

1. LZ1KDP	367	742	196	217364
2. I2DMI	329	576	209	189145
3. OH2AA	327	519	188	159048
4. G3UUP	272	497	188	144572
5. HG5A	257	508	178	136170
6. OH8TA	274	428	160	112320
7. EB1BM	310	10	310	99200
8. YO3KPA	209	306	108	55620
9. UK4LAM	136	169	58	17690
10. YO5KLK	157	0	79	12403
11. DK0OW	49	86	50	6750
12. OK3RJB	79	25	63	6552
13. JA2YKA	34	20	44	2376
14. JA6YDH	05	10	02	30

##### SWL

Name	QSO	QTC	Multi	Score
1. Stig Kahr (OZ)	302	469	180	138780
2. Alexander I. Yurchenko (UB5)	283	440	165	119295
3. Hans Waterstraat (Y2)	207	226	189	81837
4. Werner Ludwig (DL)	209	236	174	77430
5. Vaclav Cesak (OK)	166	148	143	44902
6. Frans van Oostenbrugge (PA)	111	86	79	15563
7. Jaromir Marisler (OK)	140	47	71	13277
8. Jindrich Bozek (OK)	82	76	19	3002
9. V. I. Yermolenko (UC2)	35	41	24	1824

Trophy winners, Single Operator—Y39XO (Europe), W3FV (North America), 4Z4KB (Asia), DJ6QT/CT3 (Africa), HC5EA (South America), and VK2BQS (Oceania); Multi-operator—LZ1KDP (Europe), and JA2YKA (Asia); SWL—Stig Kahr (Europe).

Checklogs: DE1KWD, DE4TTY, DL1VR, OK3JKF, K8CV, PE1HQR, Y43WK, Y55ZF, YU7AM, and SWL-W8 John Mathews. Contest manager: DF7FB, tnx to D E B U S .

TOLL FREE ORDERS • 1-800-826-5432  
AK, HI, CA OR INFORMATION • (213) 380-8000

**MINIATURE 6 VDC RELAY**  
  
 SUPER SMALL SPDT RELAY. GOLD COBALT CONTACTS.  
 RATED 1 AMP AT 30 VDC. HIGHLY SENSITIVE. TTL DIRECT DRIVE POSSIBLE. OPERATES FROM 4.3 TO 6 V. COIL RES. 220 OHM.  
 1 3/16" x 13/32" x 7/16"  
 AROMAT • RSD-6V  
**\$1.50 EACH**  
 10 FOR \$13.50

**13 VDC RELAY**  
  
 CONTACT: S.P.N.C. 10 AMP @ 120 VAC ENERGIZE COIL TO OPEN CONTACT ... COIL: 13 VDC 650 OHMS  
**SPECIAL PRICE \$1.00 EACH**

**KEY ASSEMBLY 5 KEY**  
  
**\$1.00 EACH**  
 CONTAINS 5 SINGLE-POLE NORMALLY OPEN SWITCHES MEASURES 3 3/4" LONG

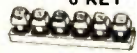
**6 KEY**  
  
**\$1.25 EACH**  
 CONTAINS 6 SINGLE-POLE NORMALLY OPEN SWITCHES MEASURES 4 1/4" LONG

**120V INDICATOR**  
  
 NEON INDICATOR. RATED 120 V 1/3 W. MOUNTS IN 5/16" HOLE. RED LENS.  
**75¢ EACH**  
 10 FOR \$7.00  
 100 FOR \$65.00

**L.E.D.'S STANDARD JUMBO DIFFUSED**  
  
 RED 10 FOR \$1.50  
 GREEN 10 FOR \$2.00  
 YELLOW 10 FOR \$2.00

**METERS 1 MA**  
  
 2 5/16" SQUARE PANEL METER MOUNTS IN 2 1/8" HOLE  
**\$5.50 EACH**

**FLASHER LED 5 VOLT OPERATION RED JUMBO SIZE \$1.00 EACH**  
  
**BI POLAR LED 2 FOR \$1.70**  

**0 - 15 V.D.C.**  
  
 THIS 2-1/4" SQUARE METER MEASURES 0-15 VDC.  
**\$4.50 EACH**

**LED HOLDERS**  
 TWO PIECE HOLDER FOR JUMBO LED  
 10 FOR 65¢ 200 FOR \$10.00

**POWER SUPPLY W/ PRE-AMP**  
  
 THIS SUPPLY WAS USED TO POWER AN 8 TRACK/CASSETTE UNIT. IT WILL SUPPLY APPROX. 18 VDC AND INCLUDES A SMALL PRE-AMP TO BOOST SIGNAL LEVEL. RCA PLUGS FOR LINE IN/OUT.  
**\$4.50 EACH**

SEND FOR FREE 40 PAGE CATALOG!

**COMPUTER GRADE CAPACITORS**  
  
 1700 mfd. 150 VDC \$2.00  
 2 1/2" DIA x 4 3/4" HIGH  
 3,600 mfd. 40VDC \$1.00  
 1 3/8" DIA x 3" HIGH  
 6,400 mfd. 60 VDC \$2.50  
 1 3/8" DIA x 4 1/4" HIGH  
 18,000 mfd. 75 VDC \$4.00  
 2 1/2" DIA x 4 1/2" HIGH  
 22,000 mfd. 15 VDC \$2.00  
 2" DIA x 2 1/2" HIGH  
 22,000 mfd. 40 VDC \$3.00  
 2" DIA x 6" HIGH  
 24,000 mfd. 30 VDC \$3.50  
 1 3/4" DIA x 4" HIGH  
 31,000 mfd. 15 VDC \$2.50  
 1 3/4" DIA x 4" HIGH  
 72,000 mfd. 15 VDC \$3.50  
 2" DIA x 4" HIGH  
 180,000 mfd. at 6V \$1.50  
 2 1/2" DIA x 4 1/2" HIGH  
 CLAMPS TO FIT CAPACITORS 50¢ ea

**TRANSFORMERS 120 volt primaries**  
  
 5.6 VOLTS at 750 MA \$3.00  
 6 VOLTS at 150 MA \$1.25  
 16.5 V. at 3 AMPS \$6.50  
 18 V at 650 MA \$3.50  
 18 VOLTS at 1 AMP \$4.50  
 18 V.C.T. at 2 AMP \$5.50  
 24 VOLTS at 250 MA \$2.50  
 24 VCT at 1 AMP \$4.50  
 42 V.C.T. at 1/2 AMP \$4.50

**DC WALL TRANSFORMER**  
  
 ALL ARE 115 VAC PLUG IN  
 4 VDC at 70 MA \$2.50  
 9 VDC at 225 MA \$3.00  
 16.5 VAC at 10 VA \$3.50  
 17 VAC at 500 MA \$4.00  
 22 VDC at 60 MA \$2.50

**MINIATURE TOGGLE SWITCHES ALL ARE RATED 5 AMPS @ 125 VAC**

**S.P.D.T. (on-on)**  
  
 P.C. STYLE. NON-THREADED BUSHING. 75¢ EACH 10 FOR \$7.00

**S.P.D.T. (on-on)**  
  
 SOLDER LUG TERMINALS \$1.00 EACH 10 FOR \$9.00 100 FOR \$80.00

**S.P.D.T. (on-off-on)**  
  
 SOLDER LUG TERMINALS \$1.00 EACH 10 FOR \$9.00 100 FOR \$80.00

**S.P.D.T. (on-off-on)**  
  
 NON-THREADED BUSHING P.C. STYLE 75¢ EACH 10 FOR \$7.00

**S.P.D.T. (on-on)**  
  
 P.C. LUGS, THREADED BUSHING \$1.00 EACH 10 FOR \$9.00 100 FOR \$80.00

**D.P.D.T. (on-on)**  
  
 SOLDER LUG TERMINALS \$2.00 EACH 10 FOR \$19.00 100 FOR \$180.00

**ALL ELECTRONICS CORP.**  
 905 S. VERMONT • P.O. BOX 20406 • LOS ANGELES, CA 90006

- QUANTITIES LIMITED
- MINIMUM ORDER \$10.00
- USA: \$2.50 SHIPPING NO C.O.D.
- FOREIGN ORDERS: INCLUDE SUFFICIENT SHIPPING
- CALIF. RES. ADD 8 1/4%

# PERFECT ANTENNA?

FOR 10-15-20 METERS

- VERTICAL
- OMNI-GAIN
- HALF WAVE
- END FED
- NO RADIALS
- NO REFLECTED POWER
- BROADBAND
- FIXED OR PORTABLE
- REMOTE TUNING
- 2 KW PEP
- UPS SHIPPABLE

# R3

R3 may be the perfect antenna for condominiums, apartments, small lots or any limited space situation. It is a great antenna for hams who are concerned about neat appearance and maximum performance.

R3's self supporting radiator is only 21ft-6.4m high x 1ft .304m wide at the base. Assembly is quick and easy for portable, marine, field day, DX-peditions, or fixed installations. It is complete with remote tuner.

AVAILABLE THROUGH DEALERS WORLDWIDE



**THE ANTENNA COMPANY**  
 P.O. Box 4680  
 Manchester, NH 03108 USA  
 TELEX 953050

# THE ELEGANT SOLUTION...

**Problem:**

How to get top dollar, omnidirectional, performance, lightning protection and economy on 2 meters?



**Solution:**

Butternut's 2-MCV -5

"Super Trombone"™ with patented "Trombone"® phasing sections, an unbroken 15.75 ft. all D.C. grounded radiator, pre-set gamma match, stainless steel hardware and many other features.

For more information, contact your dealer or write for our free catalog.

Name \_\_\_\_\_  
 Address \_\_\_\_\_  
 \_\_\_\_\_  
 City \_\_\_\_\_  
 St./Prov. \_\_\_\_\_  
 PC/Zip \_\_\_\_\_

**BUTTERNUT ELECTRONICS CO.**  
 GARY AIRPORT BOX 356E Rte. 2  
 SAN MARCOS, TX 78666



"Teltow 215." For antennas—dipoles and fixed quads.

The club station of the West German South Pole expedition (DP0AA) is presently not QRV owing to illness of the operator, DF3LK.



## GREECE

Anastasio D. Panos SV1IG  
4 Voltairou St., N. Kosmos  
Athens 411  
Greece

The Ministry of Communications, which is responsible for issuing licenses for new amateurs, announced that 43 hobbyists passed the tests in March. Exams are held twice a year in Athens, during March and September. Negotiations between radio amateur officials of the Radio Amateur Association of Greece (RAAG) and the Ministry of Communications are being made so that at least once a year exams are held in northern Greece (Thessaloniki). Newcomers to the hobby are issued a C class ticket which allows them to operate with 50 Watts on the HF and 5 Watts on the VHF bands, and this is the only limitation. They are free to operate any frequency in all bands and in any mode.

Elections for RAAG's new board of directors were held in February with about 1000 members, but only the 360 licensed members have the right to vote. The new board of directors is as follows: Evangelos Moustakas SV1AN, president; Kostas Fimerellis SV1DH, vice president; Kostas Thanopoulos SV1DC, secretary; Manolis Darkadakis SV1IW, treasurer; Dimitrios Konstantinou SV1GL, member; and Dimitrios Alexandris SV1LL, member.

Elections are held once every two years and candidates for the board of directors must be licensed members for at least 5 years. Members with the right to vote must be licensed and have at least one year in the association.

After a long waiting time, the new repeater R3 (145.075 in, 145.675 out) was placed at Heraklion, Crete Island. There are some problems with the antenna system, but these will be solved soon. Similar problems, plus interference in the input of the R2 repeater in Athens forced it out of operation, and it is in the fine hands of Dimitrios SV1GL. Besides the necessary adjustments and the placement of a duplexer, he is thinking of changing the frequencies from R2 to R7.

Kostas SV1OE, is quite an active radio amateur, one of the few hams who are working RS satellites, and the only one in Greece who makes moonbounce QSOs. His location is close to Hymetus Mountain, about 6 kilometers from the center of Athens. His shack is composed of Kenwood and Yaesu VHF rigs and he uses a Kenwood transceiver for HF. His antennas are a set of four (F9FT) yagis and several dipoles for HF. He is active on the 1296-MHz nets, using the yagi and a parabolic antenna of his own construction. Kostas transmits the A5 mode and his 3-D pictures were really impressive. He is anxious to work the Phase III satellite.

A visit to the Voice of America Installation was made by the radio amateurs of Greece. At this visit, a demonstration of high-power transmitters and antennas was given at the transmitter site of Xanthi, Greece. Most of northern Greece's radio amateurs attended, and Bad SV0BK, deputy director of the station, was pres-

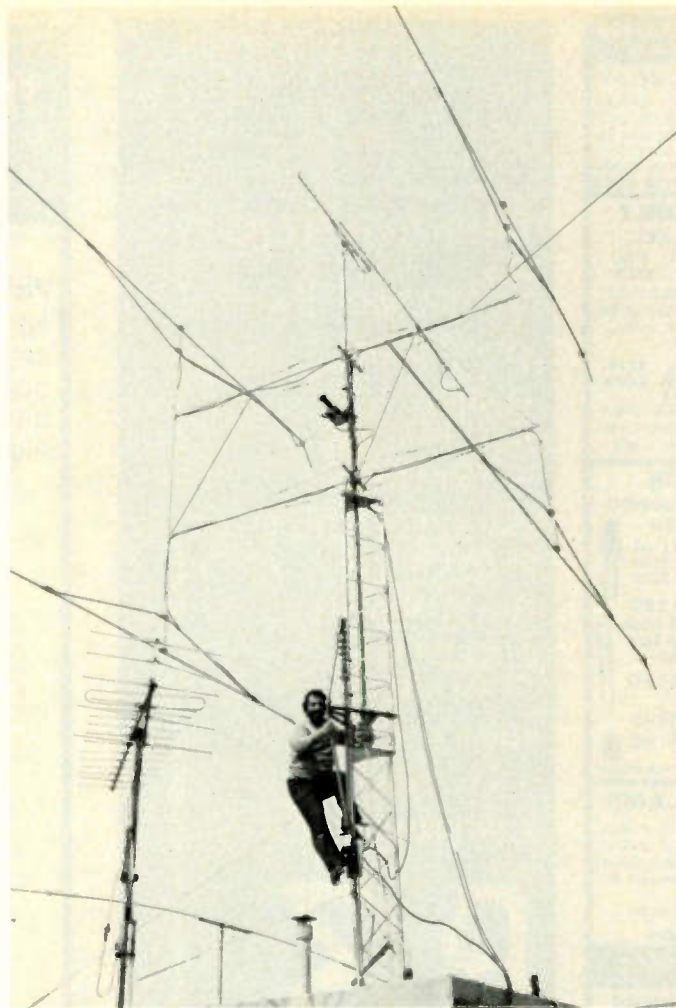

Konstantinos Gioulseren SV1OE.

ent at the dinner. He showed them the big complex of antennas used and the transmitters and the voltage generators that keep VOA independent from power lines.

Attention: Here is required reading for any radio amateurs coming into Greece and bringing their gear. It is against the law to bring a radio into the country if a permit has not been issued by the Ministry of Communications. If caught, you may be charged with illegal possession and/or use of radio, with up to two years imprisonment and/or up to a \$2,500 fine as punishment.



## ITALY

Mario Ambrosi I2MQP  
Via Stradella, 13  
20129 Milano, Italy

On April 20, 1983, San Marino amateurs changed their prefix. The new one is T77. You will also have the possibility to work them with a T71 prefix that will be released only during contests and through the club station, T70A.

The Yaesu FT-980 has been released for the Italian market; the price should be around \$2400. If you are interested in buying something here, some of the most common prices in the market are: TS-930—\$2200, TH7DXX—\$550, 3-500Z—\$145, KLM 34XA—\$750, and Callbooks—\$60. Luckily for us, our salaries are generally

lower than the American ones. Otherwise we could end up buying too many rigs!

In Italy, the new WARC bands have not yet been released, though we do hope to get them shortly. Some of us have been authorized to use 160 meters during contests in 1982/83, but now this frequency is again completely off limits. We do not have even 50 and 220 MHz, and as a result, the 2-meter band is incredibly crowded (only two MHz are used, from 144 to 146).

Repeaters are working in the 145.500/145.600 segment, with a 600-kHz split. The 432-MHz frequency is starting to become quite common, and repeaters are starting to be installed in the main cities.

We have two classes of licenses, a VHF one that does not require any code proficiency test and allows you to use 144 MHz and up with a maximum input power of 10 W, and an HF class with a code proficiency test of 8 wpm which permits use of all frequencies with a maximum input power of 300 W. As a result of the easiness to obtain the first license, there is a lot of activity in the VHF sector. To give you an idea, here are some of the distance records of the local VHFers on 144 MHz: I4EAT, 7788 km, using F2 propagation, I0AKP, 3628 km, using sporadic E, and I4EAT, 2500 km, using meteor scatter.

I4EAT has a personal record of 57 countries worked, and 22 other hams have obtained more than 20 countries.

A recent announcement has been made about the discovery of a new elementary particle. It is called the W particle. The discovery has been made in Geneva by a team of 134 European and American scientists headed by an Italian. Many other Italians participated in this W particle project; a ma-

ior position is held by Giorgio Goggi I2KMG from Pavia, a city close to Milano. I2KMG has just been credited with his country 342/318, thanks to the BY1PK card that was his last missing one, and that places him in the first position on the DXCC Honor Roll.

It's amazing to discover that I2KMG has been able to perform such an impressive achievement on the air and in the lab considering also that his QRL is more than 200 miles from his QTH and that he can devote time to DX only during the weekends.

Of the new particles, it has been said that it is not yet 100% proven they really are Ws, but that they "walk like Ws and talk like Ws"; let's hope they will not make too much QRM during pileups!

A new award was introduced in March by the Italian Amateur Association (ARI), the Italian Islands Award. To obtain the award, you must reach 10 points contacting different islands (for the same one on different bands). Full details on this award and others will be made available to you in the future in this column. If you have a particular interest in Italian awards, write to: Award Manager, ARI, Via Scariatti 31, 20124 Milano, Italy.

During the first quarter of 1983, most of the interest of active hams in this country was devoted to the various contests—in particular, the 73 40- and 80-meter contest, the ARRL DX contest, and the WPX. Big guns participate in them, fighting for the first positions, and small fishes take advantage of the situation to hunt for new states or for new prefixes.

This year, propagation has not been too good on the higher bands, but good openings have been found on 40 and 80; W6s and W7s have been worked easily without too much power or big antennas. Good scores have been claimed and some records surely will be broken.

Other records are: on 432 MHz, I0MNI with 1520 km; on 1296 MHz, I0SVS with 1520 km; on 2304 MHz, I1PE with 267 km; on 5670 MHz, I1RIP with 183 km; on 10 GHz, I0SNY with 1166 km; and on 24 GHz, I3SOY with 73 km.



## ANTARCTICA

Harry A. Mills W4FD  
Box 409 Bullard Route  
Dry Branch GA 31020

Gene Brizendine W4ATE  
600 Hummingbird Dr. SE  
Huntsville AL 35803

Brian Combs KA3JXR/KC4 contacted us in mid-October, 1982, seeking a high-performance, low-angle antenna suitable for long-haul amateur communications at the South Pole. Happily, the Controlled-Current Distribution antenna, (see Refs. 1,2,3), which has been in continual development by W4FD since 1959, amply fills these requirements.

Excitement ran rampant among the three of us, because Brian would have an outstanding antenna, and our CCD would be in the spotlight for the world to see what it can do.

Since Brian's scheduled departure time was October 25, W4FD immediately began the assembly of three CCD dipoles, for 7, 14, and 21 MHz. Each was of very rugged construction, necessary to endure the load of the incessant west wind, massive snowstorms, and temperatures which plunge to 100° F below zero.

Siple Station is located at the base of



the Antarctic Peninsula at 75° 55' S, 83° W on ice and over 4000 feet above sea level. Since the ice is salt-free, it provides a really tall antenna-supporting insulator.

Here, the National Science Foundation will continue to investigate the response of the Earth's magnetosphere to the injection of coherent ultra-low-frequency (ULF) waves in the 2-3-kilohertz range. This response includes wave growth, spectral broadening, development of sidebands, triggering of ULF emissions, wave coupling, and particle scattering. The existing doublet for injecting the ULF waves lies on top of the accumulated snow and is 13 miles (21.4 kilometers) long. During the present Austral summer, the enormous antenna will be raised above the surface and its length doubled.

During 1983, transmissions will be made to such satellites as the Dynamics Explorer-1, the ISIS-1, and the ISIS-2 and to support the SEEP (Stimulated Emission of Energetic Particles) experiment. This is an extremely brief glimpse of the Antarctic investigations under the direction of scientists at Stanford University, the University of Minnesota, the University of New Hampshire, Bell Telephone Laboratories, and Utah State University, in cooperation with the British Antarctic Survey.

Brian KA3JXR/KC4 is age 32, married, and the son of a minister. He has a great interest in QRP operating, the outdoors, and boating. On October 26, he departed California for New Zealand, for fitting of winter clothing. He then went to McMurdo Base to await weather suitable for a safe landing at Siple Station.

Until about the end of January, mail service is through FPO, San Francisco, New Zealand, and McMurdo Base. From there it is distributed to Siple and South Pole Stations by C-130 aircraft.

Brian writes (Nov. 30): "We have now gone over a week without mail or any planes. However, life here is not hard. We are warm and comfortable, with plenty of food, which is all that anyone could ask. During the Austral summer months, we may have as many as 40 people at the station, doing various construction projects, the major one being to extend the ULF dipole to 26 miles. By the end of January, only eight of us who are staying for the winter will be left, to keep the station running on our own without outside help.



The P-Band antenna at Siple Station, Antarctica, is used to receive data from Nike-Tomahawk rockets launched into the magnetosphere (US Navy photograph).

"I am looking forward to using the three CCD antennas. I expect to be on the bands regularly; also, other members of the station will be using the equipment, so the overall use should be quite high, because there will be no mail until November, 1983. The CCD antennas also sound just right for my QRP operations on CW around 21.170 MHz, beginning around the end of December.

"We have plenty of coax and fittings of all sizes that we will likely need.

"During the present heavy work schedule, several plans for amateur construction are being considered. The problem is that the conduit carrying the coaxial transmission lines to the tower is under 40 feet of snow. The major idea at present is to utilize the aurora hut for a shack, where we would install a Collins KWM-2 and the HW-8. This plan gives a reasonable overground run to the tower. A patch board would be constructed, to mix and match equipment.

"Due to commercial schedules, we are not able to meet the Sunday and Wednesday schedules originally planned for amateur operating. We do come up a couple of times per week, after 2000 hours our time, on the Maritime Mobile net on 14.313 MHz SSB (catch us there for any traffic). All our linears are one kilowatt. I had not heard that 10 MHz had opened up. We will try to find a crystal for that band.

"We did not expect the 7-MHz CCD antenna which you provided; it should make life very interesting, indeed. Forty meters doesn't really open up for us until sunset begins. This 24 hours of daylight is quite hard on communications. Twenty meters is our best band by far. It is the only one that we can count on. Several hams have asked me on the air about the CCD antenna; they all want to learn more about it. It should be an interesting year!

"I have had my first experience with a pileup! For a newly-licensed ham who is still trying to master the basics (like moving from a net and finding the other station), a pileup is quite something. When it happened, I had to shut down before giving every station a QSO. Patience seems to be the key to keeping everything reasonably under control (perhaps some Valium wouldn't be a bad idea, either).

Perhaps I could work more stations if I only gave RST reports. But I don't think that is fair, so I spend some time with every QSO.

"I expect to use off-duty time for studying to fill the gaps in my knowledge, so that I can take the commercial examination for radio telegraphy and maritime endorsements and the exam for the amateur Extra.

"The weather so far has been remarkably good. We have gone 9 days with clear sunny skies. But very soon we will be getting 5-6-day snows and winds. That is the "whiteout" that you have heard of, when you often can't see more than a few feet in front of you; still, there is work out there to be done. The Antarctic is easily one of the most beautiful places that I have been. The work is hard and often long, but we are getting a lot done."

The zero humidity in Antarctica results in violent lightning and atmospheric disturbances, as well as auroral effects, which subject antennas to many-thousand-volt stresses. For this reason, drain resistors were installed across the capacitors in the largest (7-MHz) CCD dipole. The heavy wind loading is a major structural consideration which was met by assembling each antenna on a length of 500-pound-test monofilament fishing line as a supporting messenger. Two 300-pound-test monofilament lines were then spiralled around the entire length of the antenna, in opposite directions, with frequent ties. Survival of the antennas now depends upon the monofilament lines remaining flexible and not crystallizing in the extreme sub-zero temperatures. Ends of the 500-pound-test messenger lines extend beyond the antenna ends to serve as insulators and also to provide a means for anchoring.

Ideally, the CCD dipole is fed by 300- or 450-Ohm transmission line through a 1:4 balun located directly at the transmitter output. This provides the best current balance and bandwidth, and band-changing is then only a matter of turning the transmitter bandwidth. No matching network or tuner is needed. However, at Siple, the violent winds dictated the use of coaxial line, which has a better chance for survival than even the heavy commercial-size twinlead-line types. Also, the antenna tower being over 100 feet away, a considerable run of line is exposed to possible damage by nature's elements.

The call KC3AAD will be used by another staff member at Siple Station. Phone patches to families and friends will be made on 14 and 21 MHz and have first priority. Brian asks only that callers wait until these are cleared, then general contacts on SSB and CW are welcomed. The most reliable band in the Antarctic has been 14 MHz, so more activity is expected there. All contacts will be confirmed by Brian's QSL upon his arrival home following the 15-month tour.

A CCD antenna net was recently formed by a group of enthusiastic users in the Oklahoma area. Anyone interested in a better antenna is invited to join N6ATS and the group on 7.203 MHz (3.843 MHz, alternate) at 0100 UTC daily.

For construction data for the improved CCD, send an SASE to either of the authors.

#### References

1. Harry A. Mills W4FD and Gene Brizendine W4ATE, "Antenna Design, something New," 73, October, 1978, page 282.
2. Harry A. Mills W4FD and Gene Brizendine W4ATE, "The CCD Antenna—Another Look," 73, July, 1981, page 50.
3. Harry Longrich W4ANL, "The CCD Antenna Revisited," 73, May, 1982, page 40.

## HAM HELP

I would like to get in touch with any hams knowledgeable in using the Timex/Sinclair 1000 computer for Morse, RTTY, and other applications.

**Martin E. McCoy WB0TCZ/7**  
1365 N. 9th  
Laramie WY 82070

If anyone can supply me with the manual and schematic for a Lafayette HE-89 vfo, I will pay for the copying and postage.

**Greg Dickerson N4DBS**  
12453 Northwood Rd.  
Savannah GA 31406

I am compiling a list of access codes for repeaters, and I need input from 73's readers. Access codes for open auto-patches will be listed with permission; access codes for closed (member-only) auto-patches will not, but information about

how to join will be included. Also, please indicate repeater power, antenna height, coverage, and autopatch exchange. Lists will be sent to all who contribute, and others may receive it for an SASE and copying costs. I would also like to hear from others in the EMS and forensic medicine fields (I am a CEMT and Deputy Coroner).

**Jeff Howell WB9PFZ**  
PO Box 187  
Milton KY 40045

I need someone to design and build a frequency converter to convert frequencies in the male voice range to the female voice range. I need to be my own secretary.

**H. J. Hannifan N5EX1**  
PO Box 821  
Shawnee OK 74801

Neville G. Harleck  
Monitor Instruments  
PO Box 116, Rosebery  
Sydney, 2018  
NSW Australia

Colin Dawson  
Electronics Australia  
PO Box 163  
Chippendale, 2008  
NSW Australia

# Down-Under Depth Sounder

*Get your feet wet with this Australian construction project.  
We promise that you won't get in over your head.*

Reprinted with permission from the November, 1982, issue of *Electronics Australia*, PO Box 163, Chippendale, 2008, NSW Australia.

**D**epth sounders on pleasure craft are primarily used for simply measuring water depth, although some more elaborate (and expensive) models can locate fish

or even produce a scan of the sea bottom so that reefs and other sunken objects can be located. The unit described here falls into the former category and, as

such, is designed to be easy to construct and to operate.

After all, what could be easier than reading a few numbers off a digital display?

The circuit was developed by Sydney engineer Neville Harleck whose company, Monitor Instruments, can supply complete kits for the project. We at *Electronics Australia* simply assembled the unit depicted here and prepared the constructional details.

Once assembled, the kit certainly looks the part. Two printed circuit boards—a display board and a main board—accommodate virtually all the electronics, and these are housed in a white molded plastic case. Overall case dimensions are a compact 125 mm W × 140 mm D × 58 mm H.

While the case is not watertight, it is reasonably weatherproof and should stand up well to the rigors of the marine environment. Its compact size also means that you should have no difficulty in finding a suitable mounting position for the device regardless of the type of boat you own.

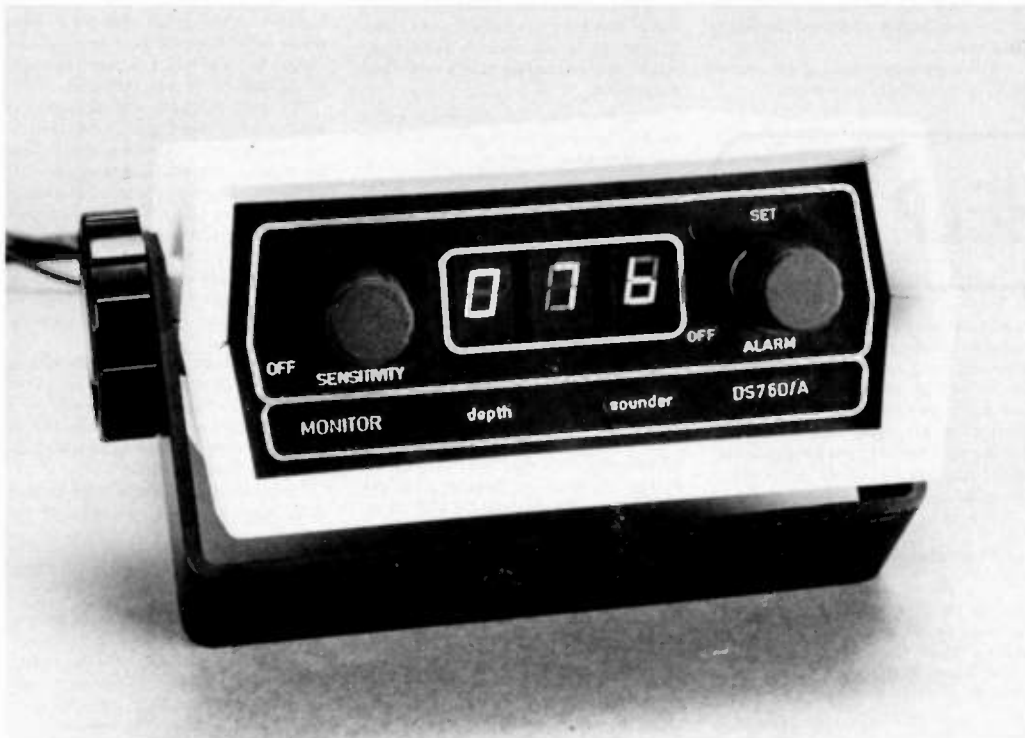
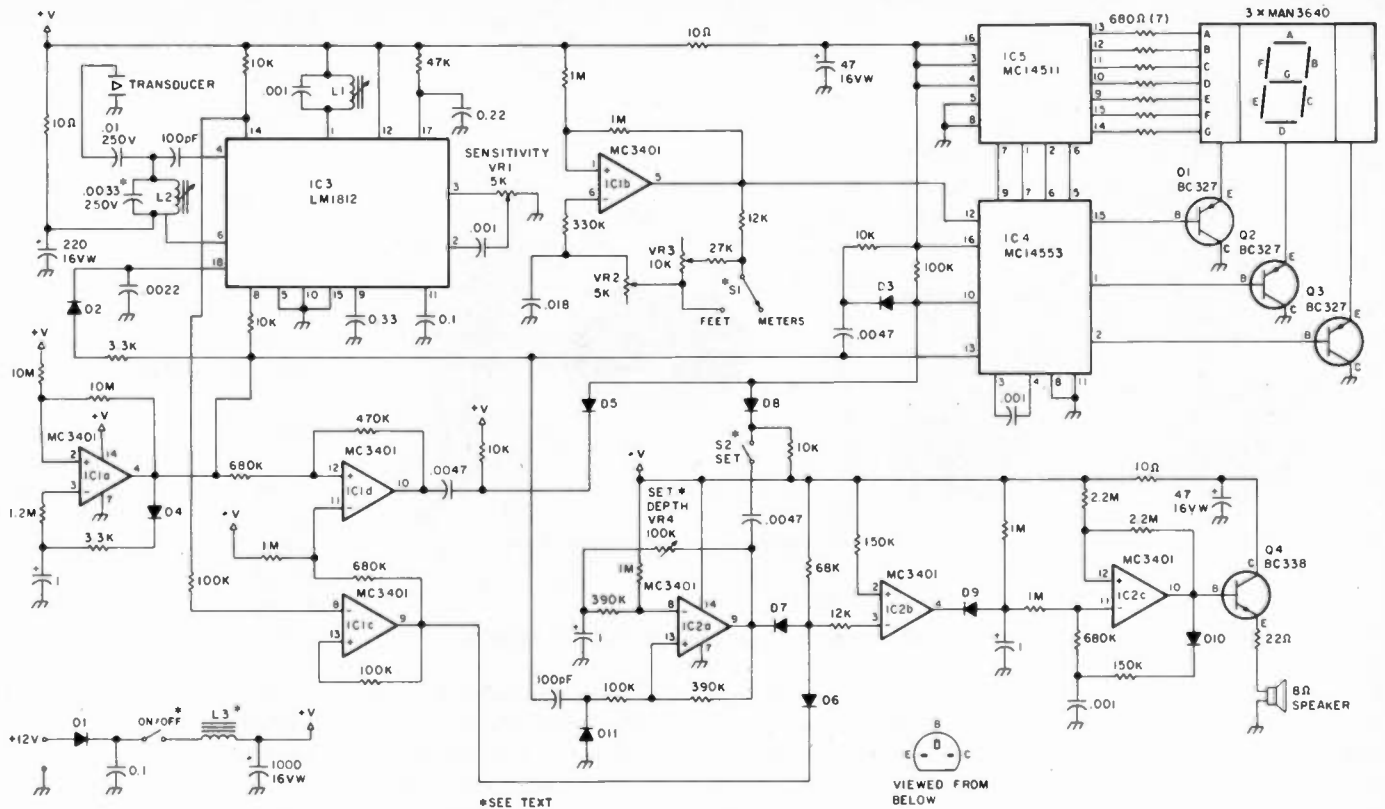

Photo A. The digital depth sounder.



Circuit diagram for the digital depth sounder.

Other features include a bright 3-digit LED display, a sensitivity control, an alarm-depth-set control, and a feet/meters switch mounted on the rear panel. A U-shaped mounting bracket allows the case to be tilted to provide a convenient viewing angle.

The audible alarm function is a particularly useful feature. When selected, it sounds whenever the water depth decreases below a preset level, thus eliminating the need for continuous visual monitoring. The danger of running aground is never greater than when the fish are biting, or you are otherwise preoccupied!

### Basic Principle

The principle on which a depth sounder operates is quite straightforward. An ultrasonic sound pulse is directed into the water and the time taken for the signal to be reflected from the bottom is measured. Since the speed of sound in water is reasonably constant, the distance the sound pulse has traveled, and hence the

water depth, can be easily calculated. Fig. 1 shows the essential elements of a depth-sounder system.

First, the transmitter generates a short pulse of 200-kHz energy and, at the same time, starts the clock. The receiver subsequently detects the reflected signal and produces a pulse that stops the clock. If the clock is counting at the correct rate, then the display will indicate the water depth directly in the appropriate units (meters or feet).

Most of the important functions of the transmitter and receiver circuits are incorporated into a single IC

made by National Semiconductor. This IC, designated the LM1812, has been around for some years now and greatly simplifies the design task for a practical depth sounder. Fig. 2 shows the block diagram of the complete unit and should be studied in conjunction with the circuit diagram in order to understand how the instrument operates.

### Circuit Description

Our circuit description starts with IC1a, which functions as the timebase clock. This generates a 1-ms pulse approximately every 800 ms. This pulse activates the transmitter and resets the display and alarm functions.

IC1a, part of an MC3401 quad op amp, is wired as an astable multivibrator which

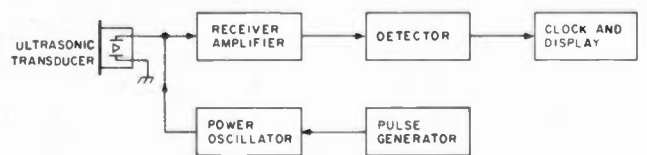

Fig. 1. Basic scheme for an ultrasonic depth-sounder circuit.

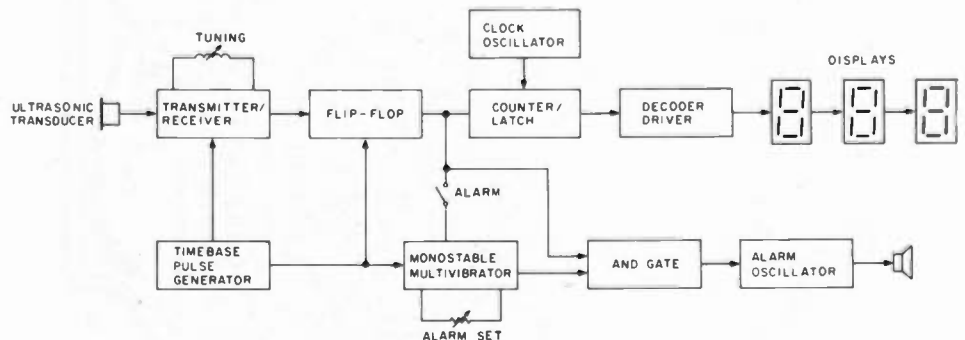

Fig. 2. Block diagram of the complete depth-sounder circuit. The transmitter/receiver is based on a single IC.



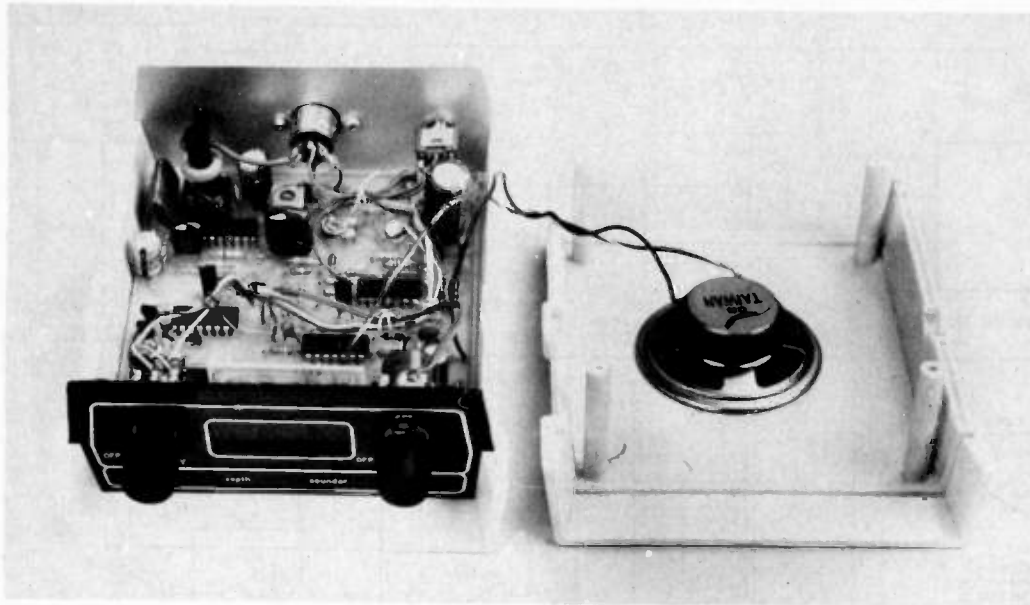

Photo B. Virtually all the circuitry is accommodated on two PC boards.

functions as follows: At switch-on, both the non-inverting input (pin 2) and the output (pin 4) are high. The  $1\text{-}\mu\text{F}$  timing capacitor now charges via diode D4 and its series  $3.3\text{k-}\Omega$  resistor. When the voltage across the capacitor (and hence on pin 3 of IC1a) reaches a critical level, the output of IC1a goes low.

Since diode D4 is now reverse biased, the timing capacitor discharges via the

$1.2\text{-megohm}$  resistor into pin 3 of IC1a. When the voltage on pin 3 goes low enough, pin 4 switches high again and the whole cycle is repeated. The  $10\text{-megohm}$  resistor between pins 2 and 4 provides positive feedback to speed up the switching transitions.

The output of IC1a thus consists of a train of short positive-going pulses. These pulses are coupled to ultra-

sonic transceiver IC3, counter IC4, and to the non-inverting input of IC2a which controls the alarm function.

IC3 is the LM1812 transceiver chip referred to earlier. Both the transmitter and receiver sections share a common tuned circuit, consisting of L1 and the  $.001\text{-}\mu\text{F}$  capacitor, which makes for easy tuning. Readers are referred to the *National Semiconductor Linear Databook*

for a detailed description of this IC, as only a general description of its operation will be given here.

The timebase pulse from IC1a is applied to pin 8 of IC3 via a  $10\text{k-}\Omega$  resistor. This causes the transmitter to "fire" at a frequency determined by the tuned circuit, the output signal appearing at pin 6. This is coupled to the transducer via L2, a parallel  $3300\text{-pF}$  capacitor, and a  $.01\text{-}\mu\text{F}$  blocking capacitor. The signal appearing across the transducer thus consists of a  $1\text{-ms}$  burst of  $200\text{-kHz}$  energy of about  $150\text{-}200\text{ V}$  peak-to-peak. At the end of the  $1\text{-ms}$  clock pulse, IC3 reverts to the receive mode.

Signals picked up by the transducer are coupled into the first receiver stage at pin 4 via a  $100\text{-pF}$  capacitor. Following amplification, the signal appears at pin 3 and is coupled into the next amplifier stage via VR1, the sensitivity control. It is this stage that is tuned by the LC network on pin 1.

As far as the user is concerned, the signal is not seen again until it appears at pin 14, and by this time it has been amplified, detected, shaped, clamped, and clipped so that we get a nice clean negative-going pulse from the supply voltage to ground.

The functions of a few other pins on IC3 should also be considered before moving on to the next section. It will be noticed that the timebase pulse is also fed into pin 18 via a  $3.3\text{k-}\Omega$  resistor and series diode D2. This is done to inhibit the detector during the transmit time and thus prevent a false output signal appearing at pin 14. The  $47\text{k-}\Omega$  resistor and  $0.22\text{-}\mu\text{F}$  capacitor connected to pin 17 provide a measure of impulse noise rejection.

The  $0.33\text{-}\mu\text{F}$  capacitor on pin 9 is charged during the transmit period and serves to inhibit the second stage of the receiver. As the

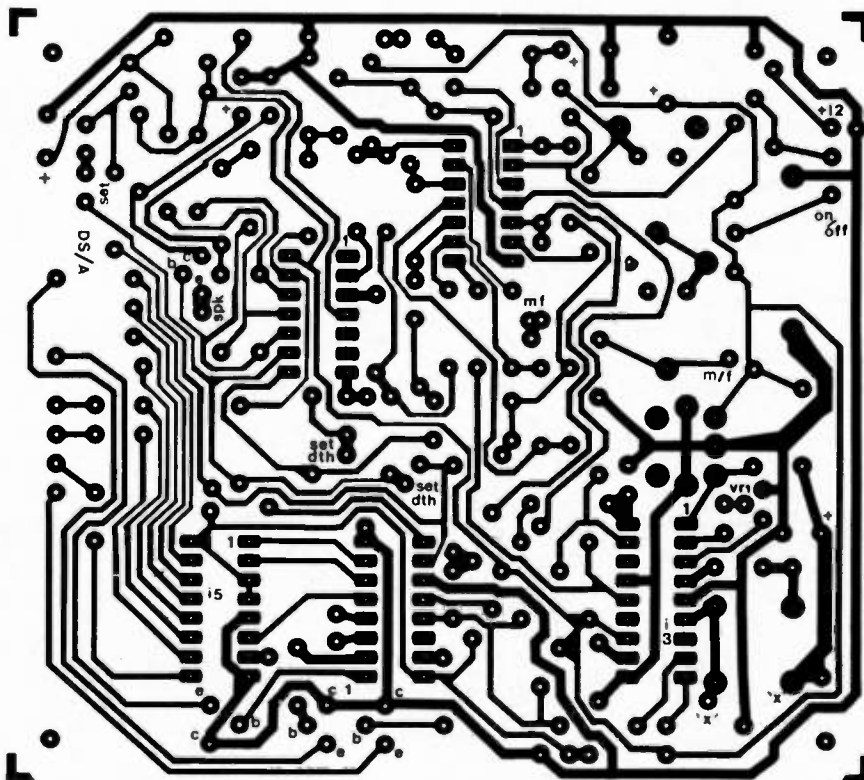

Fig. 3. PC board for the depth sounder.



quite a wide range of temperature and salinity. It will therefore take 1 second to receive an echo in 750 meters of water, since the sound pulse has to go down and up. Thus, if the clock is set to 750 pulses per second, the counter will count up to 750 and the water depth will be displayed directly in meters.

If we want the display to read in feet, then the oscillator frequency can be found simply by multiplying 750 by 3.28 (the conversion factor from meters to feet), which gives 2460 Hz. Thus, the clock must run at 2460 Hz for feet and 750 Hz for meters. A fathoms display could be achieved with a clock of  $2460/6 = 410$  Hz.

Finally, we come to the alarm function. The depth at which the alarm sounds is set using front-panel alarm-set control VR4. First, the alarm-set control is pulled out to display the alarm setting. The control is then rotated until the display reads the required alarm depth and then pushed in again. The display immediately reverts to the water depth and, if this is less than the alarm setting, an audible warning is produced.

All alarm functions are controlled by IC2, an MC3401 quad op amp. IC2a functions as a monostable multivibrator, the period of which is determined by VR4 and the 1- $\mu$ F timing capacitor. The monostable is triggered by the timebase pulse which is coupled in via a 100-pF capacitor and causes pin 9 to go high, thus reverse biasing diode D7.

If an echo is received while the monostable out-

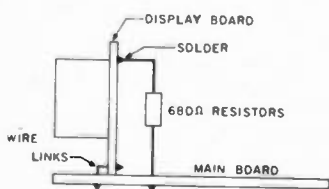

Fig. 5. Diagram showing how four of the 680-Ohm resistors are mounted.

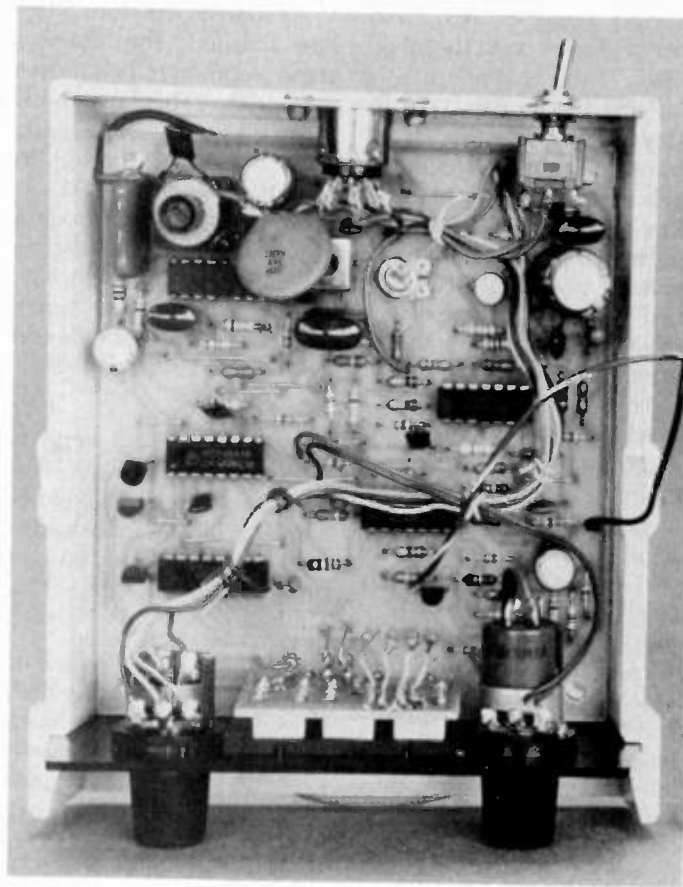

Photo C. Close-up view of the completed PCB assembly. Note that the seven 680-Ohm resistors adjacent to the display board are mounted end on.

put is high, then both D6 and D7 will be reverse biased for the duration of the echo pulse (i.e., for as long as pin 9 of IC1c remains high). This causes pin 3 of IC2b to go high and the pin 4 output to go low. Since it is now forward biased, the anode of diode D9 also goes low, enabling oscillator IC2c to start up.

IC2c is a voltage-controlled oscillator whose frequency depends on the voltage at the anode of D9, i.e., the charge on the 1- $\mu$ F capacitor. Initially, the 1- $\mu$ F capacitor is discharged and

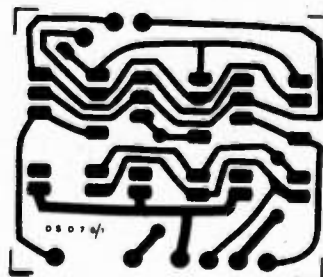

Fig. 6. PC board for the display.

the oscillator starts at a high frequency. When the echo pulse ends, D9 is reverse biased again and the 1- $\mu$ F capacitor charges towards the positive supply rail via a 1-megohm resistor. As the voltage across this capacitor rises, the discharge current from the .001- $\mu$ F capacitor slows and the output frequency drops lower and lower until eventually the oscillator stops.

3 x MAN 3640

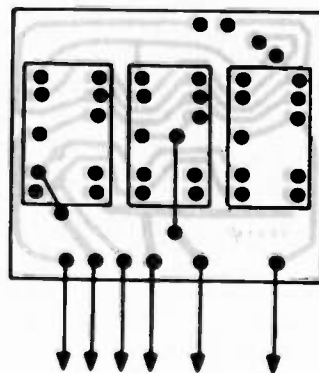

Fig. 7. Parts placement for the display PCB.

NPN transistor Q4 simply functions as a buffer and drives a small loudspeaker in its emitter circuit via a 22-Ohm resistor. The result is a siren-like note pulsed at the timebase frequency.

The alarm can sound only if an echo pulse is received while the output of monostable IC2a is high. Thus, it is the monostable pulse width that determines the alarm depth and this is displayed by using the trailing edge of the pulse to trigger the latch enable (pin 10) of counter IC4.

First, however, the echo pulse must be disabled, and this is done by setting the sensitivity control (VR1) to minimum. The output of monostable IC2a is differentiated by the .0047- $\mu$ F capacitor and the negative-going pulse produced at the trailing edge coupled via switch S2 (on the back of VR4) and diode D8 to the latch enable of IC4. Since the timebase simultaneously resets IC4 and enables IC2a, the display will now show the alarm depth in the appropriate units.

Power for the circuit is derived from a 12-V battery (normally fitted to the boat). Diode D1 provides protection against reversed supply polarity, while 0.1- $\mu$ F and 1000- $\mu$ F capacitors provide supply decoupling and filtering. Choke L3 is not supplied as part of the kit and is not fitted unless problems are encountered with ignition interference (see Construction).

### Construction

Construction can begin with the assembly of the main PCB according to the overlay diagram. Insert the wire links first, followed by the resistors, capacitors, coils, diodes, and transistors. Take care to ensure that all polarized components are mounted the right way round.

The ICs should be inserted last. Note that IC4 and IC5 are CMOS devices and



should be treated accordingly. When soldering these devices, ground the barrel of your soldering iron to the ground track on the PCB (use a small clip lead) and solder the supply pins (8 and 16) last.

The display PCB should be assembled next. Watch the orientation of the displays and note that the links must go in first. The display board is mounted on the main board using six tinned copper-wire links along the bottom edge. In addition, four of the 680-Ohm current-limiting resistors are mounted between the main PCB and the display PCB and, if these are bent as shown in Fig. 3, will provide additional support.

The front-panel controls can now be mounted in position and the red perspex window cemented in place using epoxy adhesive. This done, wire the controls to the main PCB and fit the DIN socket and feet/meters switch to the rear panel.

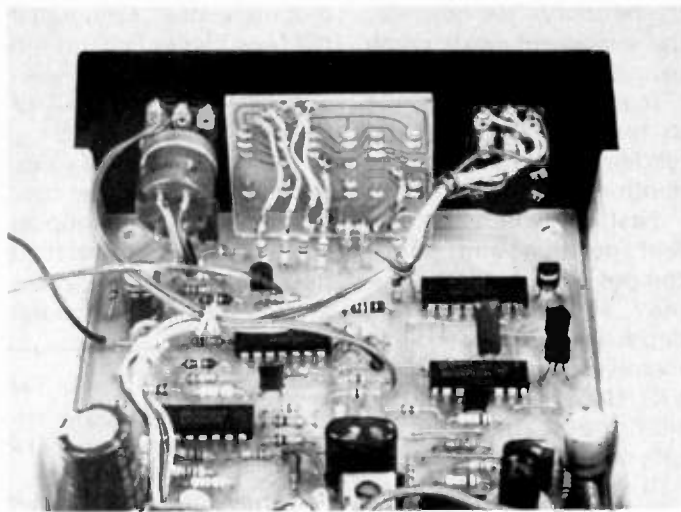

Photo D. Front panel and display PCB details. Note that the spare switch pole on the alarm-set control can be used to automatically disable the echo pulse (see text).

Complete the wiring according to the main wiring diagram and Fig. 3.

Although not part of the original design, the circuit can be easily modified so that the echo signal is automatically disabled whenever S2 is closed. As supplied, there is a spare switch pole on the back of VR4,

and this may be used to disable the echo signal by connecting it between pin 2 of IC3 and ground. With this simple modification, you won't have to fiddle with the sensitivity control each time you wish to display the alarm depth.

The loudspeaker is fitted to the top half of the case (over

the slots) by gluing it in place with contact adhesive. A piece of cloth is provided to cover the slots. Connect up the speaker, fit the transducer DIN plug with a couple of flying leads for the power connections, and you are ready for the smoke test!

Apply power (12 V) and switch on. All being well, you should be greeted by a chirp from the speaker and the display should read 000 or 001. Make sure that the alarm-set control is pushed in and fully anticlockwise (i.e., alarm off).

Now set the sensitivity control to minimum (to disable the echo pulse) and pull out the alarm-set control. Slowly rotate the alarm-set control clockwise and check that the display shows progressively higher numbers. If this check is OK, operate the feet/meters switch and check that the display changes by a 3:1 ratio. With the alarm-set control fully clockwise, the display should read a maximum of approximately 30

#### TRANSDUCER ASSEMBLY

Begin the transducer assembly by gluing together the two plastic pieces forming the element housing. These are molded in ABS, so use a suitable styrene adhesive. Apply adhesive sparingly to the top edges of the "fried-egg"-shaped piece and then press the two parts together, ensuring that the mounting holes are correctly aligned. Allow sufficient time for the adhesive to dry.

The barium titanate element must be prepared next. Carefully tin a small spot close to the edge of the element on each side and solder a short length of hookup wire to each spot. Be very careful with this operation, as too much heat will burn the silver off the surface of the element. Wrap the circumference of the element in plastic tape, using the tape to hold one of the wires against the edge.

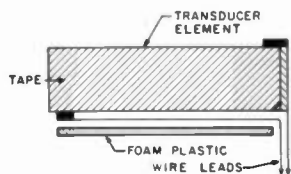

The surface where the two wires emerge is now the rear face of the transducer. Now lay the wire from the rear surface against the transducer and place the plastic foam disc in position. Use more tape to secure it in place. The two wires should now emerge from one side as shown and should be reasonably well supported by the tape. Leave about 25 mm of wire free and strip and tin 3 mm at the end of each wire.

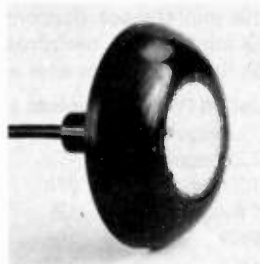

Force one end of the coaxial cable through the hole in the stem of the housing and strip and tin the ends of the braid and the center conductor. Carefully solder the coax to the wires coming out of the transducer assembly and insulate the joints with more plastic tape.

The transducer assembly must now be pushed into the housing, carefully pulling the coax down to avoid building up a loop of cable behind the transducer.

Push the transducer down in the housing so that its front surface is about 3 mm below the lip of the housing cavity. Check the cable at the other end for shorts; if all is well, put your meter on a low ac voltage range and tap the transducer with a screwdriver handle. You should see the meter give a kick, indicating that the transducer is functioning correctly. If not, check your connections carefully.

Support the transducer assembly face up, where it can be left overnight, and you are ready for the epoxy resin encapsulation. Do not use 5-minute epoxy. You must obtain some epoxy resin with a 6-12-hour setting time and carefully mix up enough to fill the transducer housing. After mixing, allow it to stand for about 20 minutes to allow the air bubbles to escape, then pour it into the transducer housing.

Fill the housing right to the top so that the transducer element is completely immersed and keep an eye on it for an hour or so, topping it as it runs down behind the element. Use a pin to prick any air bubbles that emerge. Take care here, as any air bubbles can drastically degrade transducer performance.

On no account should you use polyester resin—you must use epoxy. Epiglass 40 resin is quite satisfactory.

Finally, fit the DIN plug to the end of the cable, and fit the red and black supply leads.

meters (VR2 and VR3 roughly midrange).

Now turn the alarm off and the display should go back to zero. Turn the sensitivity control fully clockwise and lightly tap the face of the transducer with a screwdriver handle. The display should flicker and momentarily read some random numbers. If the alarm is now set to maximum depth, it may be possible to trigger it by tapping the transducer face as above. (It will trigger only if you "hit" upon an echo reading of less than the alarm setting.)

### Calibration

If all the above tests work, your depth sounder is functioning and will give readings if taken out in a boat. However, it has to be tuned and calibrated if we are to obtain maximum sensitivity and if the readings are to be accurate. If you have access to the appropriate test gear, this can be done easily on the bench; if you don't have test gear, the only way is to take the instrument out on the water.

Assuming that you don't have test gear, the procedure is as follows:

● **Tuning.** Advance the sensitivity control until an echo is obtained, then back it off until the echo is just lost. Now tune L1 carefully until the echo reappears (display reading). Reduce the sensitivity again and continue the process until the optimum setting is found for L1. L2 can be tuned in the same way, but as this has a low Q, its setting is not so critical. Most units will tune with the slug of L2 about flush with the top of the former.

● **Calibration.** Once the tuning is done, the calibration can be set if you have a chart. The problem is to find a known depth of water and set VR2 and VR3 to the known depth. Do not forget to allow for the fact that the transducer may not be at the surface if it is mounted on

the bottom of the boat; i.e., the instrument reads depth beneath the transducer.

It may even be possible to resort to the good old lead line to get an accurate depth measurement.

First, set switch S1 to the feet position and adjust trimpot VR2 until the display shows the correct depth. This done, set S1 to meters and adjust trimpot VR3. Note that VR2 must be set first as it affects the setting of VR3.

If you have access to an oscilloscope, a signal generator, and a frequency meter, the procedure is somewhat different:

● **Tuning.** Connect the oscilloscope probe to pin 1 of IC3 and couple in a 200-kHz signal to L2 via the .01- $\mu$ F capacitor. Now adjust L1 and L2 for maximum signal strength.

If no signal generator is available, then it is possible to get a signal echo in air. Clamp the transducer to the underside of the workbench and check that the unit is over a hard floor (carpet will not reflect ultrasound). Once an echo is being received, simply tune L1 and L2 for maximum signal strength. (Note: Because of the much lower velocity of sound in air than in water, the display will read about four and a half times the actual distance.)

● **Calibration.** A frequency meter connected to pin 5 of IC1b will allow precise setting of VR2 and VR3 to 2460 Hz and 750 Hz respectively. Alternately, you can use a CRO or a frequency meter to set the periods to 406  $\mu$ s and 1.333 ms respectively.

Once the unit is tuned and calibrated, it may be mounted in the case. To do this, lay the top half of the case (the half with the speaker in it) upside down on the bench and sit the circuit board on the four mounting pillars. Fit the front and back panels into the slots provided and fit the large brass nuts into the cav-

ities in the sides. Ensure that the board holes line up with the mounting pillar holes and fit the bottom half of the case.

The two halves will fit together closely and the four 12 mm  $\times$  no. 4 self-tapping screws may be fitted through the bottom holes and screwed into the mount-

ing pillars. The U-shaped mounting bracket may now be attached with the large plastic knob-headed screws. Fit the front-panel control knobs, and your instrument is ready for use.

### Operation

The transducer is the key to satisfactory operation of

#### Parts List

- 1 printed circuit board, 111 x 100 mm
- 1 printed circuit board, 41 x 35 mm
- 1 SPST toggle switch
- 1 5-pin DIN socket and plug
- 1 plastic case, 125 x 140 x 58 mm
- 1 front panel to suit
- 1 8- $\Omega$  loudspeaker
- 2 knobs
- 1 U-shaped mounting bracket
- 2 mounting knobs for bracket
- 1 ultrasonic transducer kit
- 2 slug-tuned coils, L1 & L2

#### Semiconductors

- 2 LM3900, MC3401 quad op amps
- 1 LM1812 ultrasonic transceiver
- 1 MC14553 3-digit BCD counter
- 1 MC14511 BCD-to-7-segment decoder
- 3 2N5819 PNP transistors
- 1 2N5818 NPN transistor
- 11 1N4001 silicon diodes
- 3 MAN3640 7-segment LED displays

#### Capacitors

- 1 1000  $\mu$ F/16VW PC electrolytic
- 1 220  $\mu$ F/16VW PC electrolytic
- 2 47  $\mu$ F/16VW PC electrolytic
- 3 1  $\mu$ F/16VW tantalum
- 1 0.33  $\mu$ F mylar™
- 1 0.22  $\mu$ F mylar
- 2 0.1  $\mu$ F mylar
- 1 .018  $\mu$ F mylar
- 1 .01  $\mu$ F/250 V disc ceramic
- 3 .0047  $\mu$ F mylar
- 1 .0033  $\mu$ F/250 V disc ceramic
- 1 .0022  $\mu$ F mylar
- 4 .001  $\mu$ F mylar
- 2 100 pF disc ceramic

#### Potentiometers

- 1 100k linear potentiometer with DPST pull-on switch
- 1 10k mini-trimpot, horizontal mounting
- 1 5k mini-trimpot, horizontal mounting
- 1 5k linear potentiometer with SPST rotary switch

#### Resistors (1/4 W, 5% unless specified)

- 2 10 megohm
- 2 2.2 megohm
- 1 1.2 megohm
- 6 1 megohm
- 3 680k
- 1 470k
- 2 390k
- 1 330k
- 2 150k
- 4 100k
- 1 68k
- 1 47k
- 1 27k
- 2 12k
- 5 10k
- 2 3.3k
- 7 680 Ohms
- 1 22 Ohms
- 3 10 Ohms

#### Miscellaneous

Rainbow cable, tinned copper wire, solder, styrene adhesive, epoxy resin

any depth sounder, and a few tips on mounting may not go astray. Many people have mounted transducers inside the hull in a "water-box" and it is possible to get satisfactory results with this method. However, some sound attenuation will occur and this will reduce the range of the instrument. In the worst case, it may not work at all.

The best mounting method is on the outside of the hull, roughly in the middle third of the boat and as close to the center line as possible. It must be clear of any fittings and in an area of clear water flow. Turbulence and bubbles under the transducer will reduce its performance. In yachts, hull-heeling under sail will cause the transducer to fire its sound beam out at an angle and this will reduce sensitivity; if the boat heels far enough, the echo may be lost altogether. Mind you, when this happens, the crew

is usually too busy to be looking at echo sounders!

Installation of the unit should be straightforward, but keep the transducer and all leads as far away from the engine as possible to avoid ignition interference. If ignition interference does prove a problem (i.e., the display reading fluctuates randomly), choke L3 will have to be fitted in place of

the appropriate link on the PCB. This should be a power supply choke of around 10 mH in value.

Because this choke is not available from Monitor Instruments, it will have to be purchased separately, if required.

The maximum depth range attainable with this instrument will vary considerably and depends on a num-

ber of factors including tuning accuracy, transducer mounting, water turbulence, and bottom reflectivity. Bottom reflectivity will be high with a flat sandy bottom and may be nil with heavy weed growing over soft mud.

A typical unit should give a depth range of from 80-120 meters without any difficulty and possibly more with careful tuning and installation.

Note that apparently strange readings can occur with this type of instrument because the display is triggered by the first echo received. For example, echoes may be received from cold layers in the water, undersea currents, propeller wash from other boats, and even fish. The usual effect of this is a steady bottom reading of 30 meters, say, with occasional readings of much less, e.g., a fish at 20 meters or a salinity or cold water layer at 15 meters, etc. ■

#### KITS AND PARTS AVAILABLE

The sole supplier of the PCB, a proprietary design, is Monitor Instruments, PO Box 116, Rosebery, Sydney, 2018, NSW Australia. Any of the following ordered, when orders are received with payment, will be shipped within 5 days. Amounts are in US dollars.

Fully assembled and tested Depth Sounder—\$180.00<sup>1</sup>  
 Complete kit (add \$12.00 for postage)—\$138.00  
 Transducer kit (add \$7.00 for postage)—\$40.00  
 Molded plastic case/mounting (add \$5.00)—\$25.00<sup>2</sup>  
 Set of circuit boards (add \$5.00)—\$20.00  
 Set of coils (add \$5.00)—\$12.50  
 Set of semiconductors, complete (add \$5.00)—\$25.00<sup>3</sup>

<sup>1</sup>Postpaid.

<sup>2</sup>Includes front and back panels, control knobs, and gimbal mounting bracket/knobs.

<sup>3</sup>Does not include the displays.

## LINEAR 2 TO 400 MHZ PLANBOOK

15 to  
 1000 WATT

14 Different Models, 100 pgs  
 \$11.95

**A.P. Systems**

Box 263 sm.

Newport, RI 02840 (401) 846-5627



✓169

## PROGRAMMABLE CTCSS ENCODER/DECODER

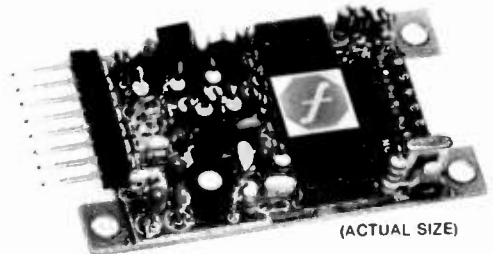

(ACTUAL SIZE)

- All 37 EIA Tones
- Quartz Accurate
- Universal

**\$54.<sup>95</sup>**

**IMMEDIATE DELIVERY AVAILABLE  
 FROM NEW YORK AND CALIFORNIA  
 DISTRIBUTION CENTERS**

For more information call TOLL-FREE

(800) 828-6884

NY: (800) 462-7242

CANADA: (416) 884-3180

✓218



**FERRITRONICS**  
 MOBILE DATA SYSTEMS

1319 PINE AVE.  
 NIAGARA FALLS NY 14301

### AZDEN PCS-4000

ADVANCED MICROCOMPUTER  
 CONTROL - 16 MEMORIES -  
 25 WATTS - SUPER COMPACT  
 142-150 MHZ - ANY SPLITS  
 - ONE-YEAR WARRANTY -

ALSO: PCS-300 HT,  
 PCS-2800 10M FM,  
 accessories, etc.

### KDK FM-2030

EASY TO OPERATE - SINGLE-  
 KNOB TUNING - RIT - 10  
 MEMORIES - 25 WATTS -  
 SCAN BAND OR MEMORIES -  
 TT MIC. WITH UP/DOWN  
 FREQ. CONT. - ANY SPLITS  
 BEEPS AT MEMORY BAND  
 LIMITS FOR EYES-OFF  
 OPERATION

**Special discounts - call for quote**

**B. G. CARL ELECTRONICS**

11128 Claire Ave. Northridge, CA 91326

Call: 1-213-363-1216 (anytime) Bryan AG6R



# The ROM-less, RAM-less CQ Sender

*Automatic CW can be yours for the price of a few diodes.  
 And you can reprogram without spending a dime.*

Morse code can be generated automatically by various methods using memory chips like RAMs, PROMs, and EPROMs. If

RAMs (Random Access Memory) are used in the design, the memory is temporary. That means if the unit is switched off, all the mem-

ory contents will be blanked unless there is a standby battery connected permanently. Providing a standby battery is not economical, at least for hams.

ROMs (Read Only Memory) are programmed by the manufacturer according to the consumer's requirement and cannot be altered once programmed. But the programming is permanent, hence does not require a standby battery.

PROMs (Programmable ROMs) are identical to ROMs except that they can be programmed by the user. The big disadvantage is that the programming cannot be altered once programmed. Hence it will become useless if the callsign of the user is changed. Moreover, PROMs require a complicated setup to program. The IC becomes useless if greatest care is not taken while programming.

One is able to program EPROMs (Erasable PROMs) any number of times. They do not require standby power to retain their memory. The contents can be erased by exposing the IC to UV lights (UVEPROMs) or by electrical energy

(EEPROMs). However, for each programming, a complicated separate circuitry with different voltage supplies and UV light to erase the contents are required. Many builders do not have and cannot afford to have what is required for this. Also, the EPROMs themselves are very costly.

Keeping all this in my mind, I have designed a "CQ Sender" which is equivalent to EPROM design in operation yet uses no EPROMs, PROMs, ROMs, or RAMs. My design has got all the facilities you can get using EPROMs, yet it does not require any separate programming circuitry or the UV light for erasing the contents! At first you may think that it is not possible, but I did it!

The block diagram of "CQ Sender" is shown in Fig. 1 and the schematic diagram in Fig. 2. It consists of the following:

- Clock-pulse generator, 7400 IC
- Address scan ( $\pm 256$  counter),  $2 \times 7493$
- 4-line-to-16-line 74154 demultiplexer
- Diode matrix — all 1N914 diodes

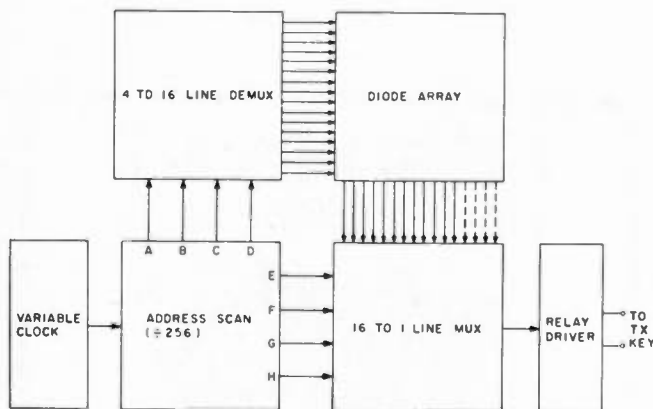
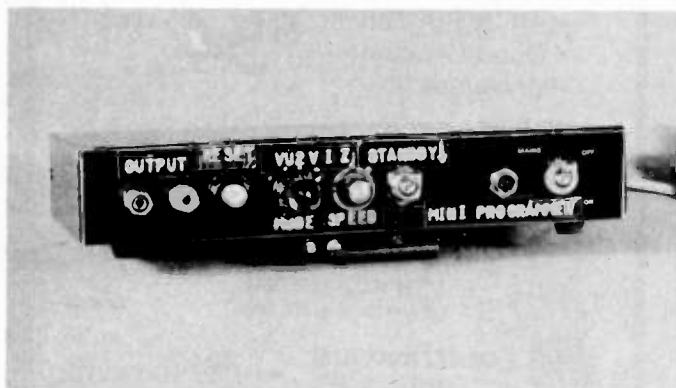

Fig. 1. Block diagram of CQ Sender.



The reprogrammable automatic CQ Sender.

- 16-line-to-1-line 74150 multiplexer
- Switching transistor SL100 and relay

The *clock-pulse generator* is constructed using 2 inverters (a NAND is used as an inverter). The clock frequency is variable, enabling us to set the CW speed at any desired level.

The *address scan* is constructed using two cascaded 7493 chips (each  $\div 16$  mode). An address scan is nothing but a  $\div 256$  counter. It counts from 0 to 255 (256 states) and resets to 0 and starts counting once again. The clock output is fed to this counter's clock input. This means for every one clock pulse (falling edge) the counter advances by one count. The counter has 8-bit output lines (to represent 255 in binary form we need 8 bits), and out of these 8 lines the first 4 lines (starting from LSB) are applied to the demultiplexer IC and the remaining 4 lines to the multiplexer IC.

The *4-line-to-16-line demultiplexer* accepts a 4-bit binary output address and has 16 output lines. If a 4-bit binary output address like 0110 is applied to it, then the corresponding output line (no. 6) will go to the low level leaving all the remaining 15 output lines at high level. Since 4 output lines of the 7493 IC are fed to the "output address" of this demul-

tiplexer, each of its output lines will go low and remain there for a duration determined by the clock frequency.

The *diode matrix*: While programming, each dot is considered as 1 unit, each dash is considered as 3 units, a character gap is 1 unit, a letter gap is 3 units, and a word gap is 5 units. Whenever a dot is required, the output from the appropriate line of the demultiplexer is taken through a diode. If a dash is required, then the outputs from 3 consecutive lines are taken through individual diodes and these diodes are bunched together. These bunches (columns) of diodes are then connected to the different input lines of the 74150 multiplexer.

Referring to the schematic diagram (Fig. 2), the first diode column consists of 8 diodes and the second column consists of 10 diodes. In the first column, the outputs of lines 2, 3, and 4 are taken to generate a dash and the output of line 5 is not taken (for 1 unit space). Then the output of line 6 is taken for a dot, while line 7 is not used (for a unit space). The outputs of lines 8, 9, and 10 are taken through diodes (for a dash), the output of line 11 is not used (for a unit space), and the output of line 12 is taken for a dot. This arrangement produces the

code — — which is equivalent to the letter C. As per convention, a 3-unit space

is given after the letter C (the outputs of lines 13, 14, and 15 are not used). In the

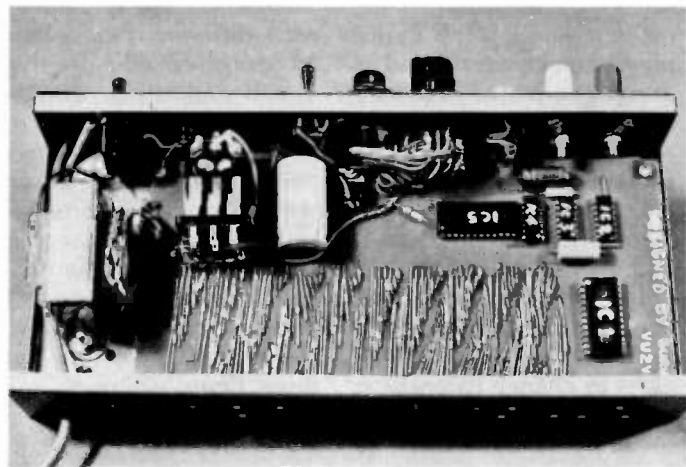

Interior view of the reprogrammable automatic CQ Sender.

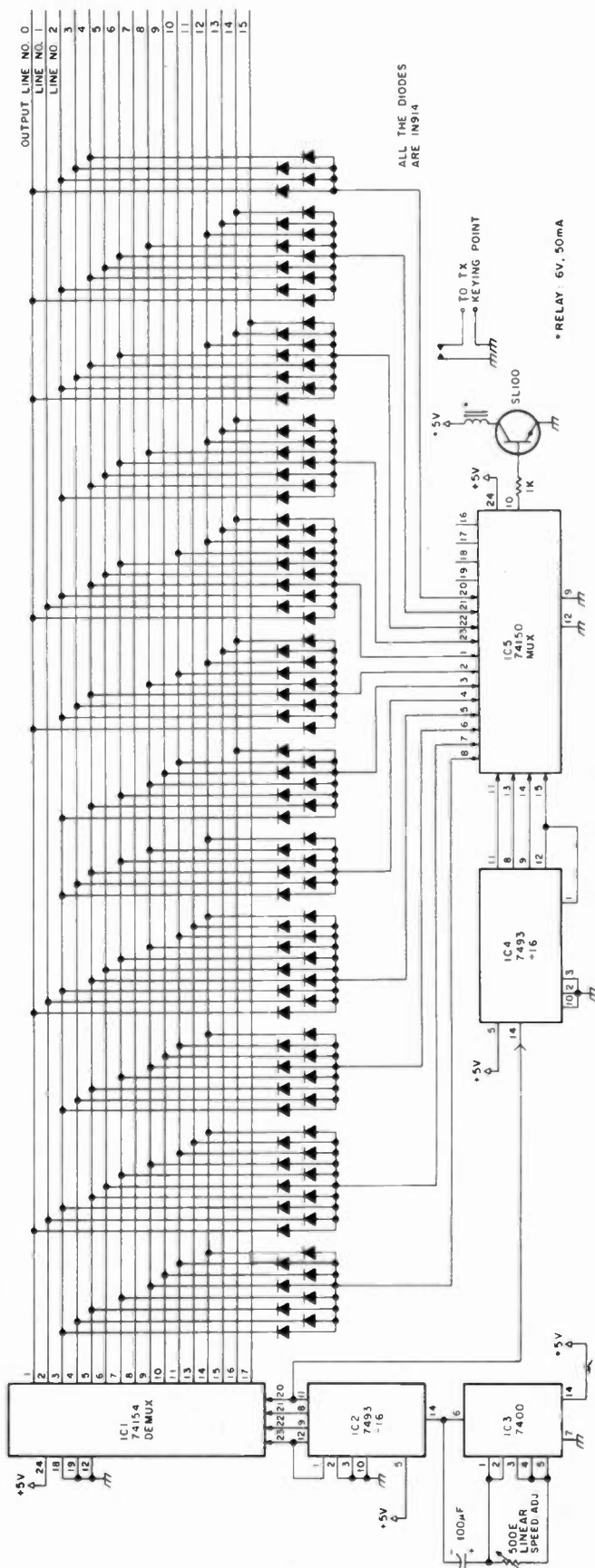

Fig. 2. Schematic diagram of the CQ Sender, programmed to call "CQ CQ DE VU2ARC AR K."

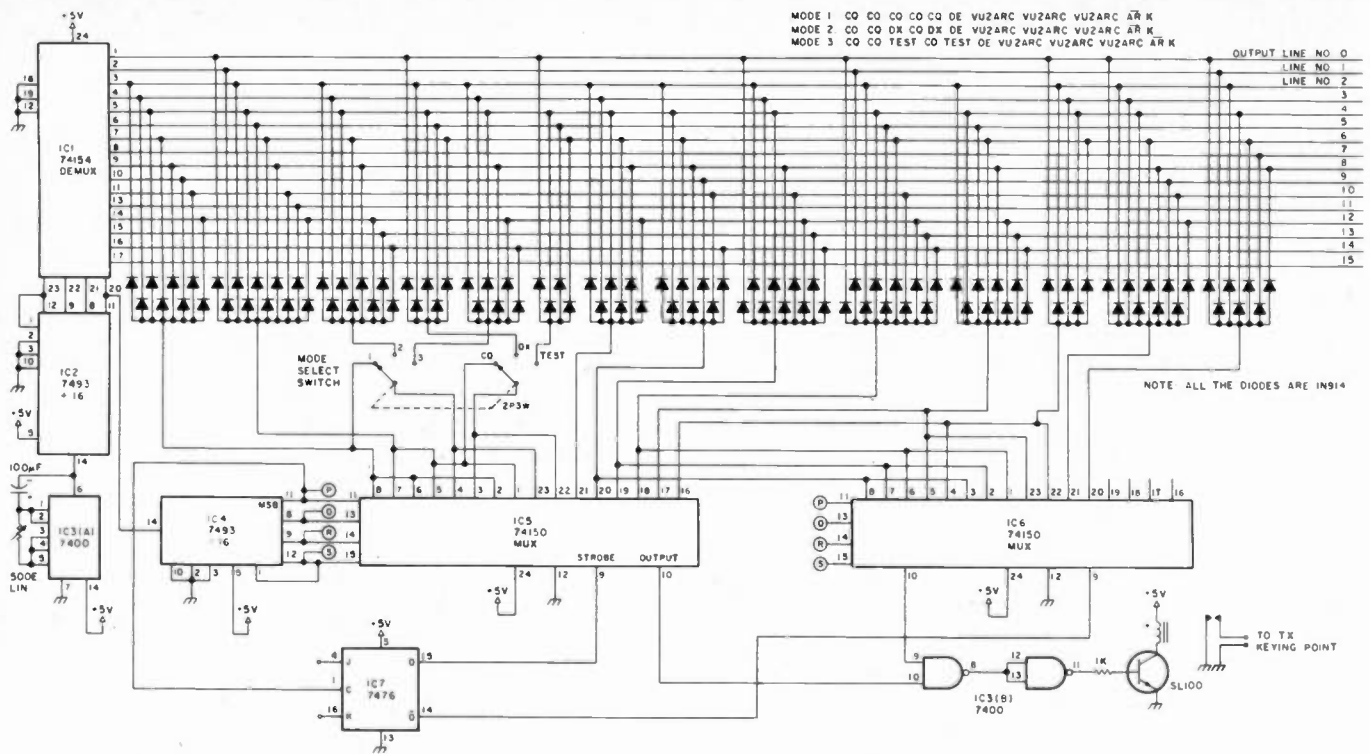

Fig. 3. Improved CQ Sender with different modes.

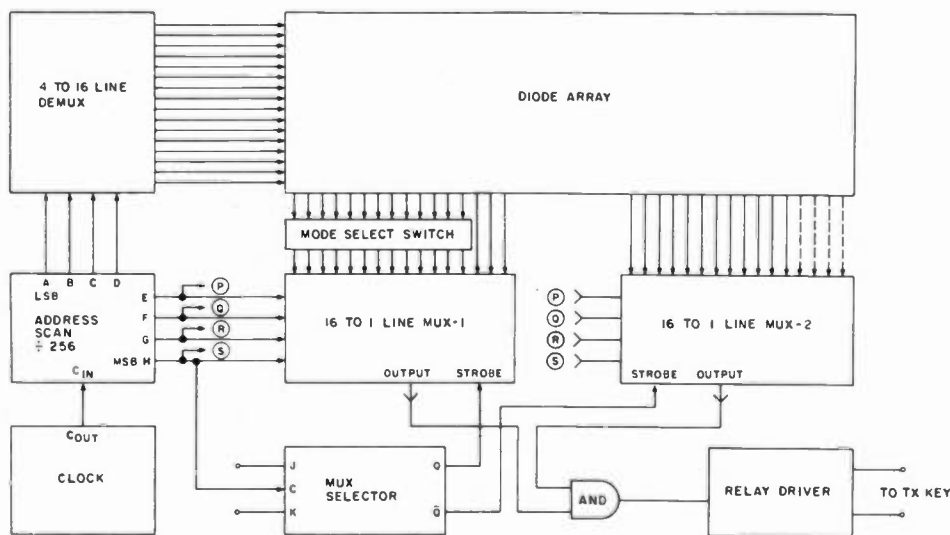

Fig. 4. Block diagram of the "improved" CQ Sender with different modes.

second column of diodes you will notice the letter Q is generated, in the third column again C (notice the 5-unit word space before this C), and in the fourth column Q is generated. In the fifth column the word DE is programmed and so on. All these columns are connected to the individual input lines of the 74150 multiplexer.

The 74150 multiplexer has 16 data-input lines, one output line, and 4 input addresses. If a 4-bit binary

code is applied to its input address, then the data-input line which is the decimal equivalent of the applied binary input address will be connected to its output line. Suppose a binary code like 1000 is applied to its input address. Then data-input line 8 would be connected to its output line (pin 10 of the 74150 IC), and during this period, whatever data is fed to this input line would be made available at its output line (after an inversion, of course). To

make it simpler, this multiplexer can be considered as a single-pole, 16-way (1P16W) bandswitch. As soon as the unit is switched on, the pole will be connected to its first "way" (bandswitch in position 1) and at the end of the 16th pulse (from the clock), this bandswitch receives a command through its input address to change its position from the first band to the second band. At the end of the 32nd pulse, this bandswitch moves to the third

position and so on. At the 16th position, the bandswitch remains for a 16-pulse duration, then switches back to its first band position and the cycle repeats.

The output of this multiplexer will be a continuous stream of 0s and 1s. This output will then be applied to a switching transistor, SL100. For each 1 the relay will be actuated (holds) and for a 0 the relay will not operate. The relay contacts are used to key the transceiver (alternately, a switching transistor like 2N3696 could be used).

An improved CQ Sender with different modes and an increased memory (Fig. 3) will add either "DX" or "test" to the call and will repeat the callsign three times. The memory of the modified sender is doubled by the addition of a second 74150, a 7476, and an AND gate to create a 32-line-to-1-line multiplexer. This allows the callsign to be repeated three times, although it is programmed only once in the diode matrix.

A double-pole, three-way switch selects the message



to be sent. As it is programmed in Fig. 3, the enhanced CQ Sender will send "CQ" five times, "DE," and then "VU2ARC" three times if the switch is in position 1. In position 2, the message will be "CQ CQ DX CQ DX" with the same sign-off, and in position 3 the sender will emit "CQ CQ TEST CQ TEST," again adding the same ending. In all three modes, it will complete the transmission with AR K.

(In the prototype, the word QRZ was also included as the fourth mode. Later on, it was found not very important and hence it is not shown in Fig. 3.)

### Conclusion

With the RC values shown for the clock oscillator, the generated Morse speed can be varied anywhere between 8 and 15 wpm. After calling "CQ CQ DE VU2ARC AR K" once, a pause of about 8 seconds

(at 8 wpm) occurs before it starts calling the CQ message once again. During this 8-second gap the transceiver will be in the receive mode to receive a possible reply. The relay output (normally-open contacts) can be connected in parallel with a straight key or to an automatic keyer.

The power supply for this unit was designed using the 7805 3-terminal 5-V voltage-regulator IC.

The programming can be altered simply by rearranging the diode positions in the diode matrix.

The circuit was assembled on a PCB and housed in a ready-made slim metal box and was demonstrated at our club meeting and also at the BEL ARC exhibition held recently in Bangalore. The design was much appreciated by the engineers and by many senior hams like VU2GSM, VU2GZ, and VU2IR. ■

## BUY FACTORY DIRECT & SAVE!!! DEALERS & DISTRIBUTORS

THE ONE STOP SOURCE FOR:

- \*COAXIAL CABLE—RG-8/U, 213, 214 ETC.
- \*MULTI CONDUCTOR CABLE—SHIELDED & UN-SHIELDED
- \*ROTOR CABLE—4, 5 & 8 CONDUCTOR ETC.

\*CONNECTORS—TYPE N, UHF, BNC, ADAPTERS ETC.

WRITE FOR COMPLETE CATALOG OR CALL COLLECT FOR THE MOST COMPETITIVE PRICES.



**CZ Labs**

(914) 947-1554-1555

P.O. Box 95-55 Railroad Ave.  
Garnerville, New York 10923

### 2 GHz Microwave Receiving Systems

The new Micro-System features a machined 18" parabolic reflector for maximum efficiency, a linear feed-point downconverter with ceramic high performance RF preamplifier transistor, a variable 12 to 18 volt regulated power supply and 50' of 75Ω coaxial downlead, including a 3' jumper and matching transformer. The Micro-System includes a full 6 month warranty.

- Micro-System (MS-021) ..... \$159<sup>99</sup>
- Micro-System (MS-578) ..... \$169<sup>99</sup>
- Micro-System (MS-645) ..... \$179<sup>99</sup>
- Shipping & Handling: USA... \$4<sup>00</sup> AK, HI & PR... \$10<sup>00</sup>

### Data Service Company

612-636-9469

346 3110 Evelyn Street  
Roseville, MN • 55113



### Hy-Gain Antennas

TH7DXS 7 element triband beam	\$ 376.00
TH5MK25 5 element triband beam	309.00
TH3MK35 3 element triband beam	215.00
TH3JrS 750W PEP 3 el tribander	156.00
TH2MK35 2 element triband beam	134.00
TH6 to TH7DXS conversion kit	135.00
20SBAS 20m 5 element "Long John"	292.00
15SBAS 15m 5 element "Long John"	175.00
10SBAS 10m 5 element "Long John"	114.00
18AVT/WBS 80-10m trap vertical	87.50
14AVQ/WBS 40-10m trap vertical	51.00
V25 2m colinear gain vertical	37.50
BN-86S Beam mount 1:1 balun	17.00

Full line available at big savings!

### Hy-Gain Crank-up Towers

HG-33MT2 Side supported	\$ 744.00
HG-35MT2 Side supported	546.00
HG-50MT2 Side supported	754.00
HG-37SS Self-supporting	642.00
HG-52SS Self-supporting	923.00
HG-54HD Self-supporting	1500.00
HG-70HD Self-supporting	2351.00

Crankups freight prepaid in continental US

### Hustler

5BTV 80-10m vertical	\$ 100.00
4BTV 40-10m vertical	79.00
G7-144 2m colinear vertical	99.00
G6-144B 2m colinear vertical	68.00
MO-1,2 HF mobile masts	18.50
RN-10 10m resonator	9.00
RN-15 15m resonator	9.00
RN-20 20m resonator	12.00
RN-40 40m resonator	13.75
RN-75 75m resonator	14.75
RN-80 80m resonator	14.75
BM-1 Bumper mount	13.00
SSM-2 S.S. ball mount	14.00
HOT "Hustloff" mount	14.00
SF-2 2m 5/8 mobile whip	9.00

Entire line at super savings!

### THE ANTENNA BANK

6460H General Green Way  
Alexandria, Virginia 22312  
703-569-1200

All prices subject to change without notice

### Rohn Towers

20G 10 ft section	\$ 29.50
20AG0 top section	32.75
25G 10 ft section	41.00
25AG0 top section	53.50
45G 10 ft section	93.75
45AG0 top section	104.75
BX48 6 sq ft max	204.00
HBX48 10 sq ft max	253.00
HDBX48 18 sq ft max	316.00
FK2548 48 ft foldover	794.00
FK4544 44 ft foldover	1117.00

### Diawa/Miller

CS-201 2 way coax switch	\$ 20.00
CS-401 4 way coax switch	62.00
CN-520 HF SWR/Power meter	59.00
CN-540 VHF SWR/Power meter	69.00
CN-550 UHF SWR/Power meter	76.00
CN-620B HF/VHF SWR/Power meter	107.00
CN-720B HF/VHF SWR/Power meter	150.00
CNW-418 auto tuner/meter	168.00
CNW-518 auto tuner/meter	285.00

### Mini-Products

HQ-1 "Mini-Quad" 6,10,15,20m	\$ 129.95
B-24 "Mini-Beam" 6,10,15,20m	99.00
RK-3 3rd element for B-24	67.00

ORDERS ONLY: 800-336-8473

All others call: (703) 569-1200

No COD - We ship UPS

Allow two weeks for delivery

Shipping cost not included

We reserve the right to limit quantities

We gladly accept VISA and MASTERCARD

### Cushcraft Antennas

A4 4 element triband beam	\$ 224.50
A3 3 element triband beam	172.50
R3 Gain triband vertical	224.50
AV5 80-10m trap vertical	88.50
AV4 40-10m trap vertical	81.50
AV3 20-10m trap vertical	44.20
32-19 19 element 2m "Boomer"	81.50
214B 14 element 2m "Jr Boomer"	68.00
214FB 14 element FH "Jr Boomer"	68.00
A147-11 11 element 2m beam	37.50
A144-10T 10 element 2m twist beam	44.20

Full line available at great savings!

### Rotors

HDR-300 Digital readout 25 sq ft	\$ 427.00
T2X "Tailtwister" 20 sq ft	244.00
HAK-IV 15/7.5 sq ft	195.00
CD-45 8.5/5 sq ft	102.75
AR-22XL 3/1.5 sq ft	49.95
HD-73 Dual speed 10.7 sq ft	89.00
U-100 Approx. 3 sq ft	42.00
8 cond rotor cable	.16/ft
6 cond rotor cable	.15/ft
4 cond rotor cable	.075/ft

### MFJ Enterprises

MFJ-900 200 Watt Versa Tuner	\$ 41.95
MFJ-941C 300 watt Versa Tuner II	77.55
MFJ-949B 300 watt Versa Tuner III	117.55
MFJ-962 1500 watt Versa Tuner III	193.15

Other MFJ products at similar savings!

### Coax and Wire

RG-213/u Hillspec 95% shield	.28/ft
RG-8/u "Superflex" foam	.24/ft
Mini-8 foam	.12/ft
RG-58/u "Superflex" foam	.12/ft
#14 stranded copper 50,75,100, or 150 ft	.05/ft
#14 copperweld 50 ft multiples	.075/ft

# Yasme and the Call of Abu Ail

*It was just a speck in the Red Sea,  
but it created pileups as big as a mountain.*

Lloyd Colvin W6KC  
Iris Colvin W6QL  
Yasme Foundation  
Box 2025  
Castro Valley CA 94546

**Y**asme was the name of the boat on which a radio amateur named Danny Weil went forth in 1954 on a continuous worldwide trip devoted primarily to communication with other radio amateurs throughout the

world. He was the first person in the world to make such an expedition. The Yasme Foundation was formed and, over the last two decades, nearly 100 Yasme DXpeditions to rare and semi-rare countries have been made with various operators participating.

This is the story of the December, 1982, Yasme DXpedition to Abu Ail, which is one of the rarest DX countries in the world. Preparations and correspondence pertaining to the trip were in the making for three years.

Abu Ail (with Jabal At

Tair) is listed as a separate country by the ARRL. They are both islands with a lighthouse and people on them. Abu Ail is a 350-foot-high rock located in the Red Sea, on the major water route from the Indian Ocean through the Red Sea to the Suez Canal and on north to the Mediterranean. The island is well named (Arabic words meaning "Father Ail") because its lighthouse watches over and guides the many ships away from the rocks. None of them stop, and the lighthouse keeper stays there eight months at a

time without leaving the lighthouse.

Abu Ail is an international island owned by no one nation. On a clear day, Ethiopia can be seen to the west and North Yeman to the east.

Permission was eventually obtained from the administrators of the islands, The Compagnie Maritime Auxiliaire d'Outre-Mer in Djibouti—who are associated with Red Sea Lights of London—to visit the island and operate an amateur radio station there, thus making a DXpedition to Abu Ail possi-

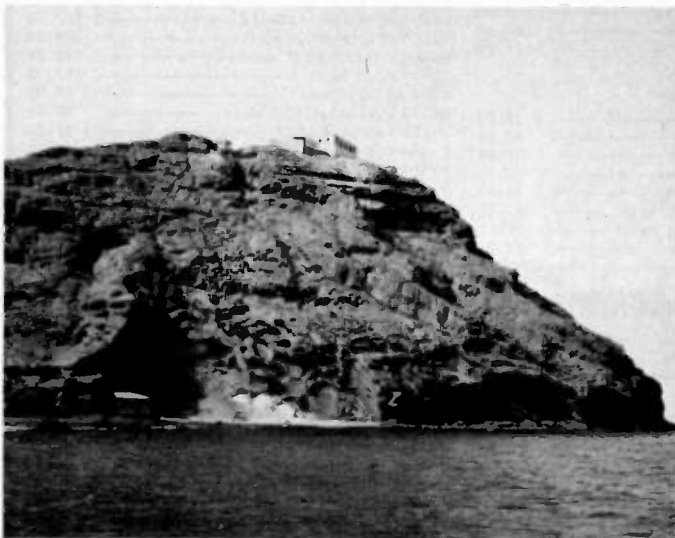

Abu Ail and the cliff up which everything had to be carried.



Lloyd and Iris in the landing cove with a generator and some gasoline. The Fahnous is in the background.

ble. We have been going on Yasme DXpeditions for many years and did most of the planning of the trip up to this point. Additional help then was needed, and fortunately, two French amateurs, Christian Dumont F0ECV and Jean Michel Gabouriaud F6GBQ, were recruited. (They are J28DP and J28DL in Djibouti.) They supplied generators and additional needed radio gear.

All four of us had to sign agreements that we and our heirs and assigns accepted full responsibility for any casualty or mishap that might occur. We agreed not to interfere with the functions of the lighthouse in any way whatsoever. We agreed to take with us anything that we needed in the way of food, water, generators, gasoline, and anything else that we might use.

Arrangements were made for passage on the *Fahnous* (Arabic word meaning "lamp"), the supply ship that services the island monthly with food, water, and supplies. We agreed to pay for our passage and for the diversion of the ship from its regular route, putting us ashore on Abu Ail, continuing on to Jabal At Tair, and then returning 48 hours later to pick us up. We fully understood that the ship could not remain anchored near the island and that we must be ready and waiting to board quickly when the ship arrived.

We made a list of essentials, keeping in mind that time was limited and that everything must be carried up the steep cliff. The list included food and water for 48 hours, sleeping bags, gifts for the lighthouse keeper, and our radio equipment, consisting of two generators (one 1.5 kW and one 500 Watts), gasoline, antennas, coax, a Yaesu 707, a Kenwood 520, a Yaesu 902DM transceiver, and a Heathkit 230 amplifier.

The good ship *Fahnous* left Djibouti with the four of

us and our equipment aboard at about 3:00 pm on December 4, 1982. The seas were extremely high during the night but were somewhat calmer when we arrived at Abu Ail at 8:00 am the following morning. All of our equipment and ourselves had to be transferred from the ship to a small dinghy. The seas were still rough, and the dinghy was bouncing up and down alongside the ship as much as 6 feet with each wave. Both the loading of the dinghy and the landing ashore were dangerous and tricky. It would have been very easy to have lost our equipment or suffered injury ourselves. Fortunately, the only mishap was to the dinghy, which hit a reef during the landing, causing some damage to its side. After landing, we started the ascent up the cliff with our equipment, giving priority to the actual radio gear. The wind blew continuously, making the trek up even more difficult.

By about 10 am, G5ACI/AA was on the air, using the vertical antenna, the Yaesu 707, and the small generator. A little after noon, both stations were in operation. The four of us took turns operating for sessions of approximately two hours each. At the same time, work was continued to bring the rest of the supplies up the hill and to put up doublets for 40 meters and the new 30-meter band.

We encountered a number of minor setbacks and delays. The limited space at the top of the rock made it impossible to locate the two stations far enough apart for both to operate on some frequencies simultaneously without interference. The guys for the TH3 had to be located over the edge of the cliff, which slowed the process of erecting the beam. We also ran into some difficulties in getting either the Yaesu 707 or the Kenwood 520 on CW operation.



Jean F6GBQ (left) and Lloyd W6KC erecting an antenna on Abu Ail. It is 350' almost straight down to water behind them.

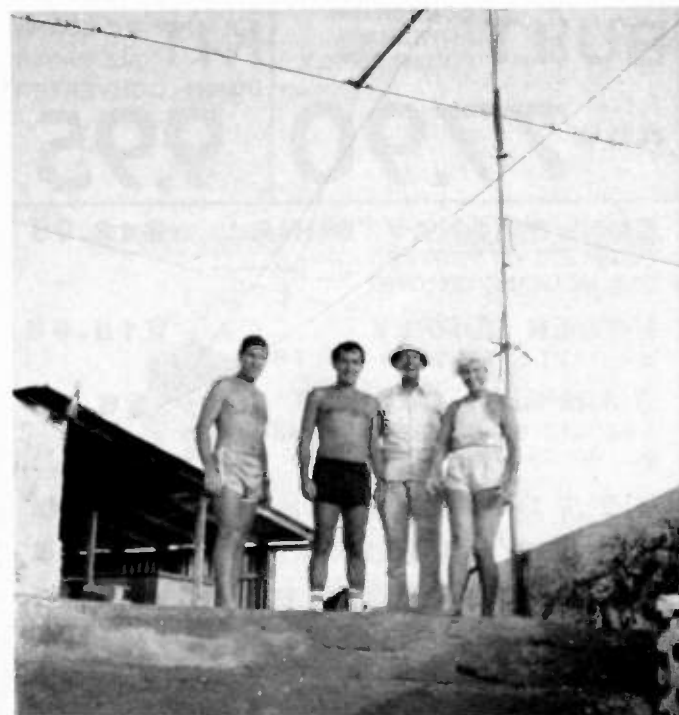

The crew at G5ACI/AA. Left to right, Jean Michel Gabouriaud F6GBQ, Christian Serge Dumont F0ECV, Lloyd Colvin W6KC, and Iris Colvin W6QL.



All obstacles were eventually overcome. We stayed on the air continuously, operating on 5 bands, both phone and CW. We made contact with over 4000 amateurs in 105 different countries.

At about 6:00 am on the morning of December 7th, we sighted the *Fahnous* approaching. We began dismantling the stations and pulling down the antennas. We bid farewell to the lighthouse keeper, who said that our visit was an exciting change from his usual routine. The descent was somewhat easier and faster than the ascent. The gasoline had been used up, and any extra food was left behind.

As we boarded the *Fahnous*, we felt tired and exhausted—but we also were very happy over the successful completion of Operation Abu Ail.

A few observations and recommendations to any-

one going on a similar DXpedition are listed:

1. Be sure that you obtain proper authorization and licensing, in writing, well in advance.

2. If possible, set up the complete operation, including all equipment (generators, etc.), at your home base before going on the DXpedition. We did this and discovered and corrected a number of time-consuming problems on the test run. These included how to solve problems of guying antennas, what interference we could expect to find, and what frequencies to use when simultaneously operating several stations close to each other. We found that we could operate a station on SSB and a station on CW simultaneously on the 10-meter band—but this could not be done on the other bands.

3. If you are going to climb a steep mountain car-

rying 50 to 80 pounds, figure out in advance the easiest way to do this. We found that the best thing was to reduce weight. Do not carry one pound of anything that is not required!

4. Try to think of everything in advance. We had small lights to use for nighttime operation, but we forgot to carry shades for the days. We had to waste some DXpedition time fabricating makeshift shades.

5. Don't forget to bring earphones—we almost did. With the noise from generators and two stations operating at once, the use of headphones was essential.

6. Remember to bring a soldering iron. Something will come up when it will be needed. We used ours on two occasions.

7. Figure out in advance how you are going to keep your logs. We were so anxious to get on the air that we got our log-keeping of the

two stations a little mixed up at the start.

8. If you are going by sea, bring seasick pills and use them. We had the pills OK, but one of our operators thought that he wouldn't need them. He did.

9. If you have any equipment requiring batteries, bring along extras. Both of our keyers and one flashlight required battery changes.

We were very lucky as to the ability of our operators. All four operators carried their fair share of both the physical work and the operating. All operators were trained, experienced DXers, and the handling of the pile-ups was no major problem.

The Yasme Foundation and everyone connected with it wish to thank the DX operators of the world for the general courtesy they showed in standing by until they could work the rare country of Abu Ail. ■

# 2300 MHz

**BUILT** CONVERTER ANTENNA POWER SUPPLY **KIT** PC BOARD ALL PARTS DOWN CONVERTER **NOW 77.90 9.95**

**DISK YAGI ANTENNA \$12.95**

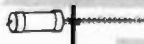
COMPLETE KIT WITH PVC AND MOUNTING BRACKET 

**POWER SUPPLY \$15.95**

VARIABLE 4 TO 15 VOLTS 

**ALUMINUM CABINET \$6.95**

ANODIZED BLACK WITH BRUSHED FINISH ALL HOLES ARE PRE-PUNCHED

**BUILT CONV BOARD \$22.50**

**BUILT P/S & CABINET \$34.95**

**COMPLETE SYSTEM BUILT \$77.90**

**TRIONYX INC**  

ADD \$5.00 FOR

6219 COFFMAN RD 104 SHIPPING & HANDLING INDIANAPOLIS, INDIANA 46268 NO COD

3 17 2 91 7 2 8 0 PHONE OR MAIL ORDER

## WORK THE U.H.F. BANDS

Add a transverter or converter to your existing 10m, 6m or 2m equipments. Choose from the largest selection of modules available for DX, OSCAR, EME, ATV.

### TRANSVERTERS



MMT 50-144 \$209.95  
MMT 144-28 \$199.95  
MMT 432-28 (S) \$299.95  
MMT 439-ATV \$349.95  
MMT 1296-144 \$374.95  
OTHER MODELS AVAILABLE write for details

### POWER AMPLIFIERS

all models include RF VOX & Low Noise RX Pre-Ampl. (no pre-amp in MML432-100)

2 Meters: 100W output MML144-100-LS 1W or 3W in \$284.95  
100W output MML144-100-S 10W input \$264.95  
50W output MML144-50-S 10W input \$239.95  
30W output MML144-30-LS 1W or 3W in \$124.95  
25W output MML144-25 3W input \$114.95

432 MHz: 100W output MML432-100 10W input \$444.95  
50W output MML432-50 10W input \$239.95  
30W output MML432-30-L 1W or 3W in \$209.95

1268-1296 MHz: Coming soon. Watch for details.

### ANTENNAS (incl. 50 ohm balun)

2 Meter J-Beams: 12.3 dBd gain   
8 over 8 Horizon'l pol D8-2M \$63.40  
8 by 8 Vertical pol D8-2M-vert \$76.95  
1250-1300 MHz Loop-Yagi 1296-LY \$44.95 70/MBM 48  
70 cm/MBM 48 \$75.75  
70 cm/MBM 88 \$105.50

Send 36¢ stamps for full details of all our VHF/UHF items.

Pre-selector filters Antennas  
Low-pass filters Transverters Crystal Filters  
Varactor triplers Converters

**si**

Spectrum International, Inc.  
Post Office Box 1084S  
Concord, Mass. 01742 USA 436





**FAST**  
**SCAN**

**\$399**

**Have you tried it yet?**  
**ATV TRANSMITTER/CONVERTER**



**TC-1**

- \*10 Watts Output
- \*Standard Frequencies Available
- \*Broadcast Standard Sound
- \*High-resolution & color video
- \*Regulated AC Supply Built In
- \*Tuneable Downconverter & Preamp

Connect to the antenna terminals of any TV set, add a good 450 MHz antenna, a camera and there you are... Show the shack, home movies, computer games, video tapes, etc.

**ATV DOWNCONVERTER**

For those who want to see the ATV action before they commit to a complete station, the TVC-4 is for you. Great for public service setups, demos, and getting a buddy interested. Just add an antenna and a TV set tuned to CH. 2, 3, or 4 and plug in to 117 volts a.c. **\$89.00**



**TVC-4**

**TVC-4L extra low-noise version... \$105 delivered in USA**

**HOMEBREWERS: ASK FOR OUR BASIC FOUR-MODULE PACKAGE**

CALL OR WRITE FOR OUR COMPLETE LIST OF SPECIFICATIONS, station set-up diagrams, and optional accessories which include antennas, modulators, detectors, test generators, cameras, etc. WE ARE A FULL-LINE SUPPLIER OF ALL YOUR ATV NEEDS.

TERMS: VISA or MASTER CARD by telephone or mail, or check or money order by mail. All prices are delivered in USA. Allow three weeks after order for delivery.

**P.C. ELECTRONICS** (213) 447-4565  
2522 Paxson Lane,  
Tom W6ORG Maryann WB6YSS Arcadia, California 91006

**YOU'LL NEVER GET  
A BETTER DEAL**

**HUSTLER ANTENNAS**

SF2 - "Buck Buster" 5/8" Wave  
2 Meter Antenna w/3/8 x 24"  
Threaded Base -  
3dB gain **\$895**

CG144  
5.2dB gain **\$2395**  
Collinear  
w/3/8 x 24"  
Threaded Base

**HOT - EASY ON/OFF  
TRUNK MOUNT**  
with 3/8 x 24" Swivel Ball  
for CG144 & SF-2

G6144 - 6dB  
Base Antenna **\$6850**



**\$1495**

G7144 - 7dB  
Commercial  
Grade Base Antenna **\$9800**

**And many other Hustler Antennas & Mounts**

BBL144 .....	25 <sup>95</sup>	MRK-1 .....	13 <sup>25</sup>
BBLT144 .....	35 <sup>00</sup>	SFM .....	24 <sup>25</sup>
BBLT440 .....	24 <sup>75</sup>	THF .....	13 <sup>65</sup>
HLM .....	13 <sup>95</sup>	UHT-1 .....	8 <sup>95</sup>

**CECO STOCKS THE ENTIRE HUSTLER  
VHF/UHF & COMMERCIAL LINE  
DEALER INQUIRIES INVITED**



**COMMUNICATIONS, INC.**

2115 AVENUE X  
BROOKLYN, N.Y. 11235  
(212) 646-6300  
(800) 221-0860  
TELEX: 235125

**TS430S FILTER DEAL**

For superior performance at lower cost, use top-rated 8-pole Fox Tango crystal filters to fill the optional spots in your rig. For example, our 1800 Hz FT2808 equivalent of the YK88SN has a 60/6dB shape factor of 1.7 compared with 2.0, a price of \$55 vs \$63, and squarer shoulders at the top with steeper skirts all the way down to more than -80dB.

For more pleasant audio use our 2100 Hz for SSB and/or our 6000 Hz for AM. For CW, our 400 Hz unit is better than the YK88C, while our 250 Hz is sharper than the YK88CN. The more you buy, the more you save!

**BIGGER IS BETTER!**

Fox Tango filters are better because of their discrete crystal (not monolithic) construction. This makes them slightly larger than YK filters so they are patched into the circuit with short lengths of coax. Installation is easy - no drilling or circuit changes. Order with confidence.

**INTRODUCTORY PRICES - Complete Kit**

- Any ONE filter..... \$55
- Any TWO filters..... \$100 (Save \$10)
- Any THREE filters..... \$145 (Save \$20)

Includes all needed cables, parts, detailed instructions. Specify the type(s) desired.

- AM - FT2811 (6000 Hz Bandwidth)
- CW - FT2801 (250 Hz); FT2802 (400 Hz)
- SSB - FT2808 (1800 Hz); FT2809 (2100 Hz)

Shipping \$3 per order. (\$5 air) FL Sales Tax 5%

**ONE YEAR WARRANTY**

**GO FOX-TANGO-TO BE SURE!**  
Order by Mail or Telephone.  
**AUTHORIZED EUROPEAN AGENTS**

Scandinavia MICROTEC Makeden 26  
3200, Sandefjord, NORWAY  
Other INGOIMPEX, Postfach 24 49  
D-8070, Ingolstadt, W. GERMANY



**FOX TANGO CORPORATION**  
Box 15944 H, W. Palm Beach, FL 33416  
(305) 683-9587



**RELIABILITY  
& ACCURACY.**

Precision Quartz Crystals 70 KHz to 200 MHz. International is a major supplier to the commercial, industrial, and amateur crystal market.



For complete information contact our sales department.

**INTERNATIONAL CRYSTAL MFG. CO., INC.**

10 North Lee, P.O. Box 26330, Oklahoma City, Oklahoma 73126 (405) 236-3741

36

# Make A Name For Yourself In Technical Publishing.

Wayne Green Books announces a September 1, 1983 deadline for submitting manuscript proposals for the upcoming publication list. Ideas for book-length manuscripts about any microcomputer system or area of electronics will be considered. In addition to payment and royalties, we offer our distribution channels and the marketing support your book deserves.

Send proposals or requests for a copy of our Writer's Guide to: Editor, Wayne Green Books Peterborough, NH 03458. Or call toll-free 1-800-343-0728.

# Dealers SELL

Selling 73 Magazine will make money for you. Consider the facts:

**Fact #1:** Selling 73 Magazine increases store traffic—our dealers tell us that 73 Magazine is the hottest-selling amateur radio magazine on the newsstands.

**Fact #2:** There is a direct correlation between store traffic and sales—increase the number of people coming through your door and you'll increase sales.

**Fact #3:** Fact #1 + Fact #2 = INCREASED SALES, which means more money for you. And that's a fact.

For information on selling 73 Magazine, call 800-343-0728 and speak with Ginnie Boudrieau, our bulk sales manager. Or write to her at 73 Magazine, 80 Pine St., Peterborough, NH 03458.

**73** Amateur Radio's  
Technical Journal

80 Pine Street Peterborough, NH 03458  
800-343-0728

# MAKE SAVING MONEY A WAY OF LIFE

With **LIVING ON A SHOESTRING**: A Scrounge Manual for the Hobbyist. Almost anything you find can be put to good use if you follow the techniques of a master scrounger. George Ewing shows you how to:

- Find electronic parts
- Scrounge by the rules
- Scrounge a vehicle
- Locate tools and other surplus
- Read up on scrounging
- Scrounge a place to live

Cartoons and case histories of scroungers add a humorous touch. With **LIVING ON A SHOESTRING**, you can't always get something for nothing, but you can certainly get it for less.

\$7.97 Softcover, 7x9, 128 pp. approx., ISBN 0-88006-059-X

Call TOLL FREE 1-800-258-5473 for credit card orders. Or mail your order with payment or complete credit card information. Include \$1.50 for shipping and handling. Send to:

Wayne Green Inc.  
Attn: Book Sales  
Peterborough, NH 03458

A Wayne Green Publication

Dealer Inquiries Invited

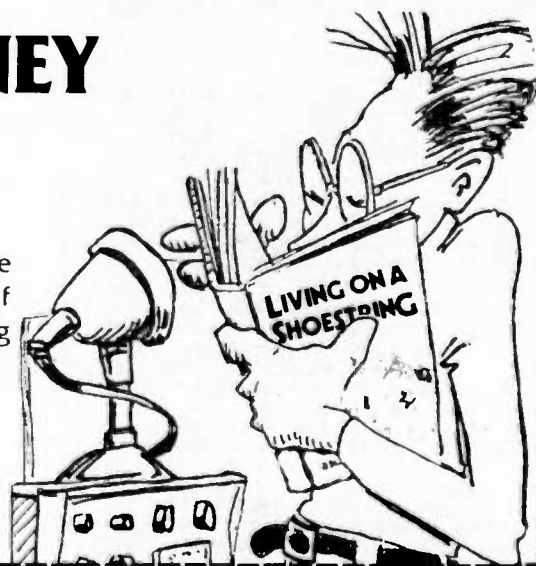

**YES, I want to scrounge!** 337B6L

Send me \_\_\_\_\_ copies of **LIVING ON A SHOESTRING**. Enclosed is \$7.97 (BK7393) per copy plus \$1.50 shipping and handling.

MASTERCARD bank # \_\_\_\_\_  VISA  AMEX

Card # \_\_\_\_\_ Expires \_\_\_\_\_

Signature \_\_\_\_\_

Name \_\_\_\_\_

Address \_\_\_\_\_

City \_\_\_\_\_ State and Zip \_\_\_\_\_



# SOCIAL EVENTS

Listings in this column are provided free of charge on a space-available basis. The following information should be included in every announcement: sponsor, event, date, time, place, city, state, admission charge (if any), features, talk-in frequencies, and the name of whom to contact for further information. Announcements must be received by 73 Magazine by the first of the month, two months prior to the month in which the event takes place. Mail to Editorial Offices, 73 Magazine, Pine St., Peterborough NH 03458.

## MAPLE RIDGE BC CAN JUL 2-3

The Maple Ridge ARC will hold its Hamfest '83 on July 2-3, 1983, at the Maple Ridge Fairgrounds, 30 miles east of Vancouver on Highway #7. The registration fee for hams is \$5.00 and for non-hams over 12, \$2.00. Features will include a swap and shop, bunny hunts, ladies' and children's programs, and displays. Food and lots of camper space (some with hydro) will be available. Talk-in on 146.20/.80 and 146.34/.94. For registration information (20% off for pre-registration), contact Bob Haughton VE7BZH, Box 292, Maple Ridge BC V2X 7G2, Canada.

## SHELLSVILLE PA JUL 4

The Harrisburg Radio Amateur Club will sponsor the annual Firecracker Hamfest on Monday, July 4, 1983, at the Shellsville VFW picnic grounds, Exit #27 (follow signs 2 miles to Shellsville), I-81, north of Harrisburg. Admission is \$3.00, XYLs and children will be admitted free, and there will be no charge for tailgating. There will be plenty of parking, shade trees, tables, and a pavilion. Talk-in on .16/.76 or .52/.52 simplex. For additional details and table reservations, contact KA3HZW, 131 Livingston Street, Swatara PA 17113, or phone (717)-939-4957.

## SPOKANE WA JUL 8-10

The 5-state ARRL Northwestern Division

Convention will be held on July 8-10, 1983, at the Spokane Convention Center, Spokane WA. The Spokane Swapfest (normally in April) will be combined this year with the convention as will be the flea market. Registration is \$5.00 and swap tables are \$10.00. Events will include displays by manufacturers and dealers, seminars on antennas, computers, VHF/EME, weather, traffic handling, and repeater operation. There will be ARRL and advisory committee forums. Ladies' programs will include a luncheon and style show. The Saturday-night banquet will feature Roy Neal, NBC news correspondent, and the Royal Order of the Wouff Hong ceremony will follow at midnight (\$1 admission). The DX breakfast and church services will be on Sunday morning. Close-in RV parking is available. For additional information, write Northwest '83, PO Box 3933, Spokane WA 99220.

## FARIBAULT MN JUL 9

The Faribault Amateur Radio Club will hold its 2nd annual swapfest on Saturday, July 9, 1983, from 9:00 am to 3:00 pm, at the Rice County Fairgrounds on the north edge of Faribault MN. General admission is \$1.50, admission and selling space is \$3.00 (indoor or outdoor), and tables (7-foot and by pre-registration only) are \$3.00 each. Lunch and free parking will be available. There will be amateur radio and computer gear as well as electronic equipment displayed. Talk-in on 146.19/.79. For more information, contact Donald Kiler, 1118 NW 8th Street, Faribault MN 55021.

## OAK CREEK WI JUL 9

The South Milwaukee Amateur Radio Club will hold its annual swapfest on Saturday, July 9, 1983, from 7:00 am to approximately 5:00 pm, at the American Legion Post #434, 9327 South Shepard Avenue, Oak Creek WI. Admission is \$3.00 per person and includes a "Happy Hour" with free beverages. Parking, a public picnic area,

hot and cold sandwiches, and liquid refreshments will be available on the grounds. There will be free overnight camping. Talk-in on 146.94. For more details, including a local map, write South Milwaukee Amateur Radio Club, Inc., PO Box 102, South Milwaukee WI 53172-0102.

## STATE COLLEGE PA JUL 9

The Nittany Amateur Radio Club will hold a hamfest and computer fair on Saturday, July 9, 1983, beginning at 8:00 am, at the Pleasant Gap Firemen's Park, Route 144, Pleasant Gap PA (just off Route 26, east of State College). Tickets are \$3.00; tailgating spaces are \$5.00. Talk-in on 146.16/.76 and 146.25/.85. For further information, write Dave Buckwalter KC3CL, 1635 Circleville Road, State College PA 16801, or phone (814)-234-0759.

## MILTON ONT CAN JUL 9

The Burlington Amateur Radio Club, Inc., will host the ninth annual Ontario Hamfest on Saturday, July 9, 1983, at the Milton Fairgrounds. For more information, write Burlington Amateur Radio Club, Inc., PO Box 836, Burlington ONT L7R 3Y7, Canada.

## CROSSVILLE TN JUL 9-10

The Plateau Amateur Radio Club will hold the Crossville Hamfest on July 9-10, 1983, at the Cumberland County Community Complex, Highway 70 North, Crossville TN. Admission is \$1.00 for adults. Exhibit and flea-market space will be available on a first-come basis. There will be a Dutch-treat dinner on Saturday night. Talk-in on 147.93/.33. For further information, contact the Plateau Amateur Radio Club, PO Box 2621, Crossville TN 38555.

## ALEXANDER NY JUL 10

The Genesee Radio Amateurs, Inc., will hold the ARRL-approved third annual Batavia Hamfest on Sunday, July 10, 1983, from 6:00 am to 5:00 pm, at the Alexander Firemen's Grounds, Rte. 98, Alexander NY (9 miles south of Batavia). Registration is \$2.00 in advance and \$3.00 at the gate. Features will include a large exhibit area,

OM and YL programs, contests, a boat-anchor auction, and overnight camping. Food will be available. Talk-in on 6.52 or 4.71/5.31 (W2RCX). For more information or advance tickets (make checks payable to Batavia Hamfest), write c/o GRAM, PO Box 572, Batavia NY 14020.

## INDIANAPOLIS IN JUL 10

The Indiana State Amateur Radio Convention, in conjunction with the Indianapolis Hamfest and Computer Show, will be held on Sunday, July 10, 1983, at the Marion County Fairgrounds at the south-eastern intersection of I-74 and I-465. Gate tickets are \$4.00 and entitle you to all activities. There will be inside and outside flea markets, a separate computer show and flea market, a commercial vendor's display area, technical forums, club activities, ladies' activities, and professional food services. There will be setups after 12:00 noon on Saturday, July 9th. Security will be provided Saturday night and Sunday, and camper hookup facilities will be available on the grounds. For further information, contact Indianapolis Hamfest, Box 11086, Indianapolis IN 46201.

## DOWNERS GROVE IL JUL 10

The DuPage Amateur Radio Club Hamfest/Computerfest will be held on Sunday, July 10, 1983, from 9:00 am to 4:00 pm, at the American Legion Post grounds, Downers Grove IL. Tickets are \$2.00 and will be available only at the gate. There will be food, drinks, and plenty of parking space, as well as a large outdoor flea market. Talk-in on 144.89/145.49. For more information, send an SASE to W9DUP, PO Box 71, Clarendon Hills IL 60514, or call (312)-971-1156.

## MONTANA-ALBERTA CAN JUL 15-17

The 49th Glacier-Waterton International Hamfest will be held on July 15-17, 1983, at Waterton Homestead Campground, just north of Waterton National Park entrance on Highway 6 (Alberta, Can.). There will be a bunny hunt, technical sessions, entertainment, and swap tables. For more information and pre-registration, write PO Box 148, Milk River, Alberta T0K 1M0, Can.

Continued

# SWR and POWER METER

## DPM-1

MACAW's DPM-1 SWR/Power Meter has a frequency range of 1.8 to 150 MHz and a power range of 0-20, 200 and 1000W in three ranges. The DPM-1 is compact, lightweight and measures SWR and power simultaneously, only \$49.95. Freight Prepaid Anywhere in U.S. Order by telephone or mail:

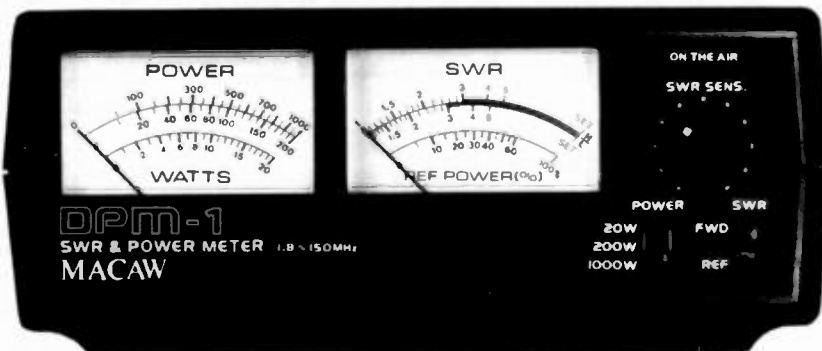

# MACAW

**ELECTRONICS INC.**  
5355 Avenida Encinas • Dept. B  
Carlsbad, CA 92008 • (619) 438-2326

VISA  
MASTERCHARGE

~236

**CARY NY  
JUL 16**

The Cary Amateur Radio Club will hold its eleventh annual Mid-Summer Swapfest on Saturday, July 16, 1983, from 9:00 am to 3:00 pm, at the Lion's Club Shelter (next to Cary Senior High School), Cary NC. There is no admission or commission charge. Featured will be an open auction at 1:00 pm. Talk-in on 146.28/88, 147.75/15, and 146.52 simplex.

**SHEBOYGAN WI  
JUL 16**

The annual Sheboygan County Amateur Radio Club Lakeshore Swapfest and Brat Fry will be held on July 16, 1983, from 10:00 am to 4:00 pm, at the Wilson Town Hall, south of Sheboygan WI. Tables are free and camping is available at Terry Andre State Park. There will also be a public auction. For a flyer and other information, write PO Box 895, Sheboygan WI 53081, or phone (414)-457-3203.

**AUGUSTA NJ  
JUL 16**

The Sussex County Amateur Radio Club will hold its fifth annual hamfest, SCARC '83, on Saturday, July 16, 1983, at the Sussex County Farm and Horse Show grounds, Plains Road, off US Highway 206, Augusta NJ, just north of Newton. General registration is \$2.00. There will be acres of free parking and outdoor flea-market space. Pre-registration for sellers is \$4.00 (\$5.00 at the gate). There will be a huge building for indoor sellers and pre-registration is \$5.00 (\$6.00 at the gate). Talk-in on 147.90/30 and 146.52. For more information or registration, write Lloyd Buchholz WA2LHX, 10 Black Oak Drive, RD 1, Vernon NJ 07462.

**MANCHESTER NH  
JUL 16**

The New Hampshire FM Association will hold an electronics flea market on Saturday, July 16, 1983, beginning at 9:00 am, at the Manchester Municipal Airport. General admission is \$1.00 per person (sellers, \$5.00). Sellers should tailgate or bring their own table. Commercial displays are welcome. Refreshments will be available. Talk-in on 146.52 FM. For pre-registration, write NHFMA, Inc., 30 Meadowglen Drive, Manchester NH 03103. For further information, contact Dick Desrosiers W1KQZ at (603)-668-8880 or Doug Alken K1WPM, 30 Meadowglen Drive, Manchester NH 03103, at (603)-622-0831.

**EUGENE OR  
JUL 16-17**

The 8th annual Lane County Ham Fair will be held on July 16-17, 1983, at the

Oregon National Guard Armory, 2515 Centennial, Eugene OR. Registration is \$4.00 and swap tables are \$5.00 each (2 maximum). Doors will open at 8:00 am both Saturday and Sunday and there will be a potluck supper at 6:00 pm on Saturday. Features will include a 2-meter bunny hunt, computer demos, technical seminars, swap tables, bingo, a Kiddie Korner, and women's activities. An all-day snack bar and free parking for RVs (no hookups) will be available. Talk-in on .52/52, 146.28/88, and 147.86/26. For tickets or swap tables, send a check payable to Lane County Ham Fair to Tom Temby WB7WPU, Treasurer, 3227 Crocker Road, Eugene OR 97404, or phone (503)-689-1761.

**PALMYRA IL  
JUL 16-17**

The Quad-Co. Amateur Radio Club will sponsor the 26th annual Hamfest of the Breakfast Club on July 16-17, 1983, at Terry Park, 3/4 mile east of Palmyra IL. Pre-registration until July 7, 1983, is \$1.50 (at the gate \$2.00). Camping facilities will be open from Friday afternoon until Monday morning. There will be games, contests, golfing, fishing, gear swapping, and on Saturday night, dancing and movies. Bring your own basket lunch; sandwiches and soft drinks will be available on the grounds. Talk-in on 3973 kHz from noon Saturday until 11:00 am Sunday. For more information, write Hamfest, c/o Quad-Co. ARC, 602-D East Walnut, Chatham IL 62629.

**LAPORTE IN  
JUL 17**

The combined LaPorte-Michigan City Amateur Radio Clubs will hold their Summer Hamfest on Sunday, July 17, 1983, from 8:00 am to 2:00 pm, at the LaPorte County Fairgrounds, State Road 2, west of LaPorte IN. The donation is \$3.00 at the gate. Good food, cold drinks, and paved outdoor parking will be available. For reservations for indoor tables (40¢/foot), write PO Box 30, LaPorte IN 46350.

**EDGEWATER PARK NJ  
JUL 17**

The 5th annual West Jersey Radio Amateurs Hamfest will be held on Sunday, July 17, 1983, 9:00 am to 3:00 pm, rain or shine, at the Super 130 Drive-In Theatre, Route 130, Edgewater Park NJ (2 miles south of Burlington, 8 miles north of Palmyra). Registration is \$3.00 and tailgating is \$3.00 (sellers must bring their own tables). Early setup for vendors only is at 7:00 am. Talk-in on 147.75/15, 144.87/47, and 146.52. For further information or to order tickets, send an SASE

to Mary Lou Shontz N2CLX, 107 Spruce Lane, Route 16, Mount Holly NJ 08060, or phone (609)-267-3063.

**CANTON OH  
JUL 17**

The Tusco ARC (W8ZX) and the Canton ARC (WB8AL) will present the 9th annual Hall of Fame Hamfest on Sunday, July 17, 1983, at the Nimishillen Grange, 6461 Easton Street, Louisville OH. Tickets are \$2.50 in advance, \$3.00 at the gate, and children under 16 will be admitted free. Flea-market parking is \$2.00 and tables are available on a reserved basis at \$3.50 each. A check must accompany reservations. There will be forums, dealers, a flea market, food, and XYL activities. Talk-in on 146.52 and 147.72/12. For reservations or more information, contact Butch Lebold WA8SHP, 10877 Hazelview Avenue, Alliance OH, or phone (216)-821-8794.

**BOWLING GREEN OH  
JUL 17**

The 19th annual Wood County Ham-A-Rama will be held on Sunday, July 17, 1983, beginning at 8:00 am, at the Wood County Fairgrounds, Bowling Green OH. Admission and parking are free. Trunk sales and food will be available. Advance table rentals are \$5.00 and are for dealers only. Saturday will be available for setups until 8:00 pm. Talk-in on .52. For more information or dealer rentals, send an SASE to Wood County ARC, c/o Craig Henderson, Box 366, Luckey OH 43443.

**POUGHKEEPSIE NY  
JUL 23**

The Mt. Beacon Amateur Radio Club will hold its annual ARRL hamfest on July 23, 1983, from 8:00 am to 3:00 pm, at the Arlington Senior High School, Poughkeepsie/LaGrange, Dutchess County NY. Admission is \$2.00 (XYL and your children will be admitted free), tailgating space is \$3.00 (includes one free admission), and a table space is \$4.00 (includes one free table and admission). Hot food, beverages, and free parking will be available. There will be an auction beginning at 2:00 pm. Talk-in on 146.37/97 and 146.52. For additional information, write Art Holmes WA2TIF, 2 Straub Drive, Pleasant Valley NY 12569, (914)-635-2614, or Walt Sutkowski K2DPL, W. Redoubt Road, Fishkill NY 12524, (914)-897-5158.

**GLENWOOD SPRINGS CO  
JUL 23**

The Ski Country Amateur Radio Club will hold its second annual swapfest on July 23, 1983, at Colorado Mountain College, 1402 Blake Avenue, Glenwood Springs CO. There is no admission charge. Tables are \$5.00 each. Talk-in .07/67. For further information, contact Frank WA0BBI, Box 280, El Jebel CO 81628.

**WELLINGTON OH  
JUL 23**

The Northern Ohio Amateur Radio Society will hold NOARSFEST on Saturday, July 23, 1983, from 8:00 am to 5:00 pm, at the Lorain County Fairgrounds, Route 18, 1/2 mile west of Route 58, Wellington OH. Donations are \$2.50 in advance and \$3.50 at the gate. Children under 12 will be admitted free. Parking for the flea market is \$1.00 per car space. Flea-market setup is from 6:00 am to 8:00 am. Plenty of free parking will be available in a large general parking area. Indoor exhibit spaces with an 8-foot table are \$8.00 each. Send check for advance registration to Don Winner WD8RZG, 8927 Torrance Avenue, Brook-

lyn OH 44144, or phone (216)-749-6594. There will be refreshments and 807s will be furnished by NOARS. Campers may park overnight Friday at no charge but no hookups will be available. Talk-in on 146.52/52 (K8KRG) and 144.55/145.15. For admission tickets, write NOARSFEST, PO Box 354, Lorain OH 44052.

**SEATTLE WA  
JUL 29-31**

The Western Washington DX Club (W7FR) will host the 31st annual Northwest DX Convention on Friday, Saturday, and Sunday, July 29-31, 1983, at the Double Tree Plaza Hotel, located near the South Center Shopping Mall and the Seattle-Tacoma Airport. There will be a Saturday night banquet and a Sunday morning breakfast, as well as speakers, slides, symposia, and awards. Talk-in on 146.40/147.00 (W7FR). For registration, contact Ruth Bennett WA7RVA, 6729 Beach Drive SW, Seattle WA 98116, or phone (206)-932-1335. For further information, contact WA7RVA or Roy Foote N7AIF, Chairman, 3029 48th Avenue SW, Seattle WA 98116, or phone (206)-935-8041.

**OKLAHOMA CITY OK  
JUL 29-31**

The Central Oklahoma Radio Amateurs will hold the ARRL State Convention at Ham Holiday '83 on July 29-31, 1983, at the Myriad Convention Center, Oklahoma City OK. Pre-registration is \$6.00 (\$7.00 at the door). Children age 12 and under will be admitted free with a parent. Every pre-registrator may buy one flea-market table for \$1.00. In addition to the noncommercial flea market, there will be displays, forums, programs, special group meetings, and a buffet and dance on Saturday night. Ample parking will be available and hotel accommodations with special Ham Holiday rates are nearby. For further information or pre-registration forms, write CORA, PO Box 14268, Oklahoma City OK 73113.

**CUMBERLAND ME  
JUL 30**

The Blackstrap Repeater Association will hold the second annual Greater New England Hamfest on Saturday, July 30, 1983, from 8:00 am to 5:00 pm, at Cumberland Fairgrounds, Cumberland ME. Tickets are \$1.00 in advance and \$2.00 at the gate. There will be forums, exhibits, meetings, speakers, dealers, and a giant flea market. Food and free camping will be available. Talk-in on 147.69/09, 146.52, 3.940, and 146.13/73. For more information, call Ed Williams KA1FZD at (207)-846-3509.

**ISHPEMING MI  
JUL 30**

The Hlawatha Amateur Radio Association of Marquette County, in celebration of its 50th anniversary, will sponsor the 35th annual Upper Peninsula Hamfest on July 30, 1983, from 9:00 am to 5:00 pm, at the Michigan National Guard Armory in Ishpeming. Registration is \$1.00 and tables will be available for \$3.00 each. Features will include a computer demonstration and net meetings. Talk-in on 148.16/76. For more information, contact George Lehtinen WB1OC, 100 N. Dalsy, R2, Ishpeming MI 49849, or phone (906)-485-5038.

**ASHEVILLE NC  
JUL 30-31**

The Western Carolina Amateur Radio Society will sponsor the WCARS Hamfest and Computer Fair on July 30-31,

# HAM HELP

I need the schematic and circuit data for the Comdel speech processor.

J. T. Maloney W2BE  
152 Hawkins Rd.  
Centereach NY 11720

Could someone provide me with QSL information for 9J2DS and TYA11?

Rick Todd N8CWX/DU2  
PSC #2 Box 12956  
APO San Francisco CA 96311

I am looking for the schematic for an SBE Touch-Com 40.

Lisle T. Hines K2QLA  
4 Ellwood Ave.  
Cortland NY 13045

I need a source for a 1N23B diode used in a General Radio Slotted Line 874.

Rudolf E. Six KA8OBL  
30725 Tennessee  
Roseville MI 48066

1983, beginning at 9:00 am, at the Buncombe County Fireman's Training Center, Asheville NC. Features will include an ARRL booth and seminar by Bob Grove WA4PYQ, McElroy Memorial CW competition, a flea market, bingo, RV parking and free camping (no hookups), and computer hardware and software. Talk-in on .31/.91, .61/.76, and .52 simplex. For ticket information, write Garland Lance NC4N, 854 Sandhill Road, Asheville NC 28806.

**OLIVER BC CAN  
JUL 30-31**

The Okanagan International Hamfest will be held on July 30-31, 1983, at Oliver Centennial Park, Oliver BC. Registration will be at 9:00 am (PDT) on Saturday, July 30th and the activities will be from 1:00 pm on Saturday through 2:30 pm on Sunday. YLs may bring crafts, hobbies, and flea-market items for sale or display. There will be a potluck luncheon on Sunday, as well as entertainment and bunny hunts. Talk-in on the .34/.94 repeater or .76/.76. For further information (no advance reservations), write John Juul-Andersen VE7DTX, 8802 Lakeview Drive, Vernon BC V1B 1W3 or Lota Harvey VE7DKL, 584 Heather Road, Penticton BC V2A 1W8.

**ALEXANDRIA LA  
JUL 30-31**

The Central Louisiana Amateur Radio Club will hold its hamfest on Saturday and Sunday, July 30-31, 1983, at the Bolton Avenue Community Center, Alexandria LA. Swap tables will be available.

**BELVIDERE IL  
JUL 31**

The Belvidere Amateur Radio Association will hold its annual hamfest on July 31, 1983, at the Boone County Fairgrounds, Route 76, Belvidere IL. Admission is \$2.00 in advance and \$2.50 at the door. Tables may be reserved for \$2.00. There will be plenty of free flea-market

spaces and, if it rains, there will be inside space available. There will be camping on Saturday night. Talk-in on 146.52. For more information, contact Bob Anderson K9DCG, 910 Locust Street, Belvidere IL 61008.

**CENTREVILLE MI  
JUL 31**

The Amateur Radio Public Service Association of Saint Joseph County MI will hold its 5th annual swap and shop on Sunday, July 31, 1983, at the Saint Joseph County Fairgrounds, Centreville MI. Doors will open at 8:00 am. Tickets are \$2.00 in advance and \$3.00 at the gate. Indoor tables are \$3.00; trunk sales are free. Camping will be available on Saturday night only for \$6.00. Talk-in on .52. For more information, contact Warren Harder N8EOX, 14820 Broadway Road, Three Rivers MI 49093.

**JACKSON WY  
AUG 5-7**

The 1983 ARRL Rocky Mountain Division Convention, in conjunction with the 51st WIMU Hamfest, will be held on August 5-7, 1983, at the Virginian Motel, Jackson WY. Talk-in on 146.22/.82 and .3923 kHz. For reservations, call the Virginian at (307)-733-2792. For more information, phone R. L. "Pete" Stull WB7AMP at (307)-382-9032 or Dave Gregory N7COA at (307)-875-5324.

**MOBERLY MO  
AUG 7**

The NEMO ARC of Kirksville MO and the Tri-County ARC of Moberly MO will hold the 5th annual North Missouri Hamfest on Sunday, August 7, 1983, at the Moberly Municipal Auditorium, Moberly MO. The auditorium has 12,000 square feet of air-conditioned space for the inside flea market and there will be a limited number of tables available free. Tickets are \$1.50 in advance or \$2.50 at the door. Doors will open for the flea market and distributors beginning at 8:00 am and for the

hamfest, from 9:00 am until 3:00 pm. There will be forums, films, sandwiches, and drinks, as well as donuts and coffee for the early birds. Talk-in on 147.69/.09. For more information and/or tickets, contact Sam Fischer KA0ILO, PO Box 341, Moberly MO 65270.

**ANGOLA IN  
AUG 7**

The Steuben County Radio Amateurs will hold their 25th annual FM Picnic and Hamfest on Sunday, August 7, 1983, at Crooked Lake, Angola IN. Admission is \$2.50. Features will include picnic-style BBQ chicken, inside tables for exhibitors and vendors, a large electronics flea market, and overnight camping (fee charged by county park). Talk-in on 146.52 and 147.81/.21.

**AUSTIN TX  
AUG 12-14**

The Austin Amateur Radio Club and the Austin Repeater Organization will sponsor Austin Summerfest '83 on August 12-14, 1983, at the Austin Marriott Hotel, Interstate 35 at Highway 290. Admission is \$5.00 in advance and \$6.00 at the door. Swapfest tables are available on a first-come, first-served basis, but each seller may also reserve one table in advance for \$1.00. Summerfest '83 will combine the Texas VHF-FM Society Convention with forums, meetings, an indoor swapfest, dealer exhibits, and many outside activities for the family at Austin's annual Aqua Festival. Talk-in on 146.34/.94. For more information, write Austin Summerfest '83, PO Box 13473, Austin TX 78711.

**DUNKIRK NY  
AUG 13**

The Lake Erie International Hamfest Association will hold its fifth annual Lake Erie International Hamfest on Saturday, August 13, 1983, beginning at 8:00 am, at the Chautauqua County Fairgrounds, Dunkirk NY. Admission is \$2.50 in advance and \$3.00 at the gate. Each flea-market space is \$1.00

plus admission. There will be indoor dealer exhibits as well as a large flea market. Talk-in on 146.25/.85 and 146.52. For more information, write Lake Erie International Hamfest, PO Box 455, Dunkirk NY 14048.

**POMONA CA  
AUG 13**

The Tri-County Amateur Radio Association will sponsor the TCARA 13th Annual Hamfest and Picnic on Saturday, August 13, 1983, from 8:00 am to 2:00 pm, at the Los Angeles County Fairgrounds in Pomona CA. Tables will be available for ham/computer exhibits and displays. There will be sandwiches and soft drinks available. For more information, contact Tony Skvarek W6ELZ, 1514 W. Mission #14, Pomona CA 91766.

**BURLINGTON VT  
AUG 13-14**

The Burlington Amateur Radio Club will hold its annual International Hamfest and Flea Market on August 13-14, 1983, at the Old Lantern Campgrounds, Charlotte VT. For both days, tickets are \$4.00, outdoor flea-market spaces are \$2.00, and indoor spaces are \$5.00. Food and drink will be available. Talk-in on .34/.94, .01/.61, and .52 simplex. For further information, contact Frank W1CTM, Burlington Amateur Radio Club, PO Box 312, Burlington VT 05402.

**WILLOW SPRINGS IL  
AUG 14**

The Hamfesters Radio Club, Inc., will hold their 49th annual hamfest and picnic on Sunday, August 14, 1983, at Santa Fe Park, 91st and Wolf Road, Willow Springs IL (southwest of Chicago). Tickets are \$2.00 in advance and \$3.00 at the gate. Featured will be the famous swappers' row. There will be exhibits for OMs and XYLs. For advance tickets, send a check or money order and an SASE to Hamfesters, PO Box 42792, Chicago IL 60642.

**FCC**

**10-YEAR LICENSES**

Hoping to save both time and money, the FCC has proposed that the length of amateur licenses be extended to 10 years, with a 2-year grace period for renewing expired licenses. In its comments, the Commission noted that license renewals, which were up to 36,000 in 1982, would be reduced to about 12,000 per year. In addition, the number of licenses which are allowed to lapse inadvertently would decrease, according to the FCC.

Here is the Commission's proposed Part 97 amendment, as it appeared in the *Federal Register*.

**PART 97—(AMENDED)**

**Appendix**

It is proposed to amend Part 97 of the Commission Rules, 47 CFR Part 97, as follows:

1. In § 97.13, paragraph (d) would be revised to read as follows:

§ 97.13 **Renewal or modification of operator license.**

(d) If a license is allowed to expire, application for renewal may be made

during a period of grace of two years after the expiration date. During this two year period of grace, an expired license is not valid. A license renewed during the grace period will be dated currently and will not be backdated to the date of its expiration. Application for renewal shall be submitted on FCC Form 610 and shall be accompanied by the applicant's expired license.

(2) In Section 97.47, paragraph (b) would be revised to read as follows:

§ 97.47 **Renewal and/or modification of amateur station license.**

(b) If a license is allowed to expire, application for renewal may be made during a period of grace of two years after the expiration date. During this two year period of grace, an expired license is not valid. A license renewed during the grace period will be dated currently and will not be backdated to the date of expiration. An application for an individual station license shall be submitted on FCC Form 610. An application for an amateur club or military recreation station license shall be submitted on FCC Form 610-B. In every case the application shall be accompanied by the applicant's expired license or a photocopy thereof.

(3) In Section 97.59, paragraphs (a) and (b) would be revised to read as follows:

§ 97.59 **License term.**

(a) Amateur operator licenses are normally valid for a period of ten years from the date of issuance of a new, modified or renewed license.

(b) Amateur station licenses are normally valid for a period of ten years from the date of issuance of a new, modified or renewed license. All amateur station licenses, regardless of when issued, will expire on the same date as the licensee's amateur operator license.

**20M PHONE EXPANSION**

After a three-year battle, the 20-meter phone-band expansion went into effect on May 22. The new frequency allocation gave General-class operators use of the frequencies between 14.225 MHz and 14.275 MHz. Advanced-class licensees have phone privileges between 14.175 and 14.225 MHz, and Extra-class ticket holders are allowed to operate phone from 14.150 to 14.175 MHz. The Commission's amendments to Part 97, as published in the *Federal Register*, are shown below.

**PART 97—(AMENDED)**

Part 97 of the Commission's Rules and Regulations, 47 CFR Part 97, is amended as follows:

1. In § 97.7, paragraph (a) is revised to read as follows:

§ 97.7 **Privileges of operator licenses.**

(a) Amateur Extra and Advanced Class. All authorized amateur privileges including exclusive frequency operating authority in accordance with the following table:

Frequencies	Class of license authorized
3500-3525 kHz	Amateur extra only.
3775-3800 kHz	Do
7000-7025 kHz	Do.
14,000-14,025 kHz	Do
14,150-14,175 kHz	Do
21,000-21,025 kHz	Do
21,260-21,270 kHz	Do
3600-3890 kHz	Amateur extra and advanced.
7150-7225 kHz	Do.
14,175-14,225 kHz	Do.
21,270-21,350 kHz	Do.

§ 97.61 [Amended]

2. In § 97.61, in the table in paragraph (a), the row beginning with "14000-14200 (kHz)" is revised by beginning the row with "14000-14150 (kHz)" so that the entire row reads as follows:

14000-14150..... F1

3. Also in § 97.61, in the table in paragraph (a), the row beginning with "14200-14350 (kHz)" is revised by beginning the row with "14150-14350 (kHz)" so that the entire row reads as follows:

14150-14350..... A3, A4, A5, F3, F4, F5



# LETTERS

## E.T. FEEDBACK

My wife and I both enjoyed the article on "How E.T. Really Called Home." When we saw the movie and Elliott and E.T. set the communicator up, I said, "That looks like something a ham would build." Looks like I was right!

Stephen Wimmer WB0GGT  
Raymond NE

## THE ELITE MODE

The solution to the question of code or no code can be answered to the satisfaction of everyone. The proponents of code offer the ability to "get through with CW when voice is unintelligible," narrower bandwidth, etc., as proof that CW is the ultimate skill that everyone should have as their goal. The thing I don't understand is, if CW is so damned good, why isn't it reserved for the select group that can master it and that have the technical expertise necessary to pass the Advanced and Extra-class tests?

Instead of reserving CW for those who are most deserving of its fantastic benefits, the CW proponents prefer restricting those least deserving of its benefits to using only CW.

It just plain seems backwards. What needs to be done is to restrict Novices and Techs to voice until they've earned the right to use the far superior method of communi-

cating, namely CW. Under this system, the highest class licensees would be able to use the best possible means of communicating, up to and including CW, while the lower class licensees would be restricted to the less efficient methods, i.e., voice.

What could be simpler or fairer? People who can't master or have no interest in mastering CW wouldn't be saddled with it while those who do enjoy it would have the added satisfaction of having the "best," to some extent, reserved for them.

James Delton N7ECC  
Tempe AZ

*Troublemaker.—Wayne.*

## FOR VIETNAM VETS

An open letter to all veterans of the US military during the Vietnam era who are now amateur radio operators:

We are trying to form a net of radio operators for each state to participate in communication with each other and with the nonprofit organization, Vietnam Veterans of America. Our objective is to reach all the vets of that era and band together for the purpose of brotherhood, benefits, and discussion of the effects of chemical warfare on us.

We will be publishing a newsletter and participating in the First Annual Convention for the Vets of the Era, in Washington, DC, on November 7-10. If you are interested in participating, contact Mike Kelly, 2101 Crescent Avenue, Eau Claire WI 54701.

(715)-834-1738, or Larry Miltman N9AUG, Box 158, Rt. 5, Eau Claire WI 54701, (715)-874-6473.

Vietnam Veterans of America is a non-profit combat veterans organization certified by the Congress of the United States.

Mike Kelly  
Eau Claire WI

## GUEST SPEAKER

You mentioned in the December, 1982, issue the woeful lack of good speakers at hamfests. I would like to offer my services to any interested hamfest/radio club. I am the Kentucky state coordinator for the Radio Amateur Satellite Corporation (AMSAT), and I have been active in amateur satellite communication for five years. I have a set of slides and I have a simple non-technical program which will explain the past, present, and future of amateur space activity. I also served a stint as technical editor of 73, and I can talk about what it's like to work for the best magazine in amateur radio. If your club has any aspiring authors, I can tell you what makes an article worth buying.

I will travel anywhere there is a hamfest or club meeting. The only fee that I require is my travel expenses. I have access to a private plane so I can go anywhere in the eastern USA.

Charles E. Martin AB4Y  
Box 3370  
Bowling Green KY 42101

## BEACON UPDATE

Here is an update on ten-meter beacons for the readers of 73. The KA1YE/B beacon in southeastern Connecticut has been joined by at least two others in the US. They are: WA1IOB/B in the Boston area on 28.208 MHz, and W3VD/B in Laurel, Maryland, on 28.295 MHz. I haven't heard the IOB beacon here, but W3VD/B can be heard on backscatter.

Reception of the KA1YE and WA1IOB beacons has been reported in Great Britain in *Practical Wireless* magazine. In the May, 1983, issue there is a listing of 19 beacons worldwide with a graph displaying dates of reception in the UK. The beacons are from all continents, with VE2TEN being the only other North American beacon listed.

A listing of active beacons is being maintained by Willih HB9AVE. I have sent him the information on my beacon, and he would appreciate information from other individuals and groups operating ten-meter beacons. There is a limited amount of space

allocated for unattended operation of beacons on ten meters here in the US, so some prior listening and coordination is highly recommended before putting on a beacon. This also holds for other bands.

I am willing to act as a clearinghouse for US beacons, keeping a file on activities and other information. If anyone is planning to put a beacon on ten, or knows of any other beacons active or planned, I would appreciate hearing about them. Please drop me a line. Thanks very much.

W. Keith Hibbert KA1YE  
25 Hillcrest Road  
Niantic CT 06357

## BEST MAG

Your editorial and technical construction material is the best. I just renewed for two more years!

Russ Tower K1DOW  
Arcadia FL

## A DREAM COME TRUE

On March 30, 1983, I walked into the FCC field office at Syracuse, New York, with a Technician-class license. I walked out with a General-class interim permit. That permit is a dream come true and it has been a 27-year wait.

The reasons why I passed the code test were that I studied the code each day and I used your "Back Breaker" (C77313) code tape. After two previous failures of the code test, I decided to use your tape. So, thank you very much for the help. Please keep up the good work at 73.

(Re no-code licensing: I'm dead against it.)

Ben Alabastro WA2PXR  
Frankfort NY

*Right on there, Ben. If you and I have to suffer, then why shouldn't everyone? And think of the money I'll lose if they pass a no-code license and my code tapes stop selling. That 13-per tape is a rough one... I made that almost impossible so that you'd have clear sailing once you mastered it.—Wayne.*

## MODEM MAGIC

You're always interested in new technical ideas, so here's one you can think about. How about using our standard computer modems over the air and standardizing on these shift frequencies for computer-to-computer communications?

A modem for the VIC-20 is about \$100, while commercial RTTY modems start at \$150. The phone-line (Bell 103) modems use frequencies of 1070/1270 and 2025/2225 Hz. We could standardize on the lower two frequencies, since they're easily passed by receivers and transmitters, and the 200-Hz shift is within the FCC limits.

The only difficulty is that we'd have to shift the modems from the ORIGINATE position during transmit to the ANSWER position during receive. A relay could do this, and it seems to be a small price to pay to get one modem to serve double duty.

Anyone interested in giving it a try?

Jonathan A. Titus KA4QVK  
Blacksburg VA

*Hey! Do it and write an article! And you people in Nashua NH, you write one, too!—Wayne.*

## MULTI-BAND SLOPERS

160, 80, and 40 meters

Outstanding DX performance of slopers is well known. Now you can enjoy 2 or 3 band BIG-SIGNAL reports! Automatic bandswitching · Very low SWR · Coax feed · 2 kw power · Compact · Ground or tower feed · Hang from any support 25 ft. high or higher · Easy to install · Very low profile · Complete instructions · Immediate shipment · Check ok

3 BAND SLOPER - 160, 80, & 40 Meters - 60 ft. long \$ 43.00 frt ppd

2 BAND SLOPER - 80 & 40 Meters - 41 ft. long \$ 30.00 frt ppd

3-BAND NO TRAP DIPOLE - 160, 80, & 40M - 113 ft. long \$ 66.00 frt ppd

2-BAND NO TRAP DIPOLE - 80, & 40M - 84 ft. long \$ 49.00 frt ppd

FOR ADD'L INFO on these and other unique antennas: send SASE

W9INN ANTENNAS  
BOX 393-S MT. PROSPECT, IL 60056



... at last ...  
**your shack organized!**

A beautiful piece of furniture — your XYL will love it!

**\$184.50 S-F RADIO DESK**

**Deluxe - Ready to Assemble**

Designed with angled rear shelf for your viewing comfort and ease of operation.

FINISHES: Walnut or Teak Stain.

Floor Space: 39" Wide by 30" Deep

Additional Information on Request.

Checks, Money Orders, BankAmericard and Master Charge Accepted.

F.O.B. Culver City. (In Calif. Add 6% Sales Tax.)

DEALER INQUIRIES INVITED

**S-f Amateur Radio Services**

4384 KEYSTONE AVENUE • CULVER CITY, CALIF. 90230 — PHONE (213) 837-4870

# CIRCUITS

Do you have a technique, modification, or easy-to-duplicate circuit that your fellow readers might be interested in? If so, send us a concise description of it (under two pages, double-spaced) and include a clear diagram or schematic if needed.

In exchange for these technical gems, 73 offers you the choice of a book from the Radio Bookshop, to be sent upon publication. Submit your idea (and book choice) to: *Circuits*, Editorial Offices, 73 Magazine, Peterborough NH 03458. Submissions not selected for publication will be returned if an SASE is enclosed.

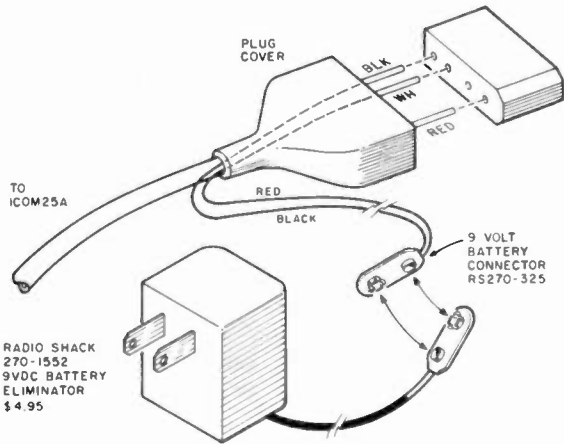

**MEMORY BACKUP FOR THE ICOM 25A:** To retain the memory in the Icom 25A when the power is disconnected, slip back the cover of the power plug and wire a 9-V battery connector to the white (positive) and black (negative) leads. When removing the

rig from its power source, snap on a 9-V transistor battery or connect it to a plug-in transformer—Paul Van Bolhuis W4ZBD, Bradenton FL.

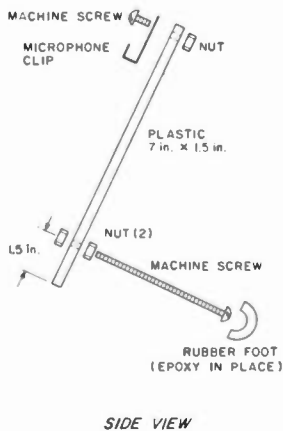

**MICROPHONE HOLDER FOR MOBILE RIGS:** Keep your operating area organized and neat when you are using a mobile rig as a base station. This holder will keep your microphone within easy reach yet out of the way, and the parts for it can be found in almost any junk box.—Thomas Hart AD1B, Westwood MA.

**EASY COAX CONNECTIONS:** Much time and effort can be saved when working with large-diameter coax such as RG-8/U by using a small, inexpensive tubing cutter to help with the stripping. These cutters can be obtained at most local hardware stores and are listed as  $\frac{1}{8}$ - to  $\frac{1}{4}$ -inch copper tubing cutters. Use the cutter to score the jacket of the coax and then simply peel off the jacket. This eliminates the nicked and damaged braid that often accompanies coax work. When the jacket has been removed and the braid exposed, use a soldering gun or high-wattage iron to quickly tin the braid in place. Now, use the tubing cutter to cut through the rigid braid just as if it were tubing. Cut deep enough to remove the braid but do not damage the inner insulation. The inner insulation can also be cut with the tubing cutter but I find it easier just to use a knife at this point. The resulting job is very neat, virtually guarantees no nicks, and makes it very easy to attach a PL-259 connector since the braid is already tinned.—Craig Crichton K7UKW, The Dalles OR.

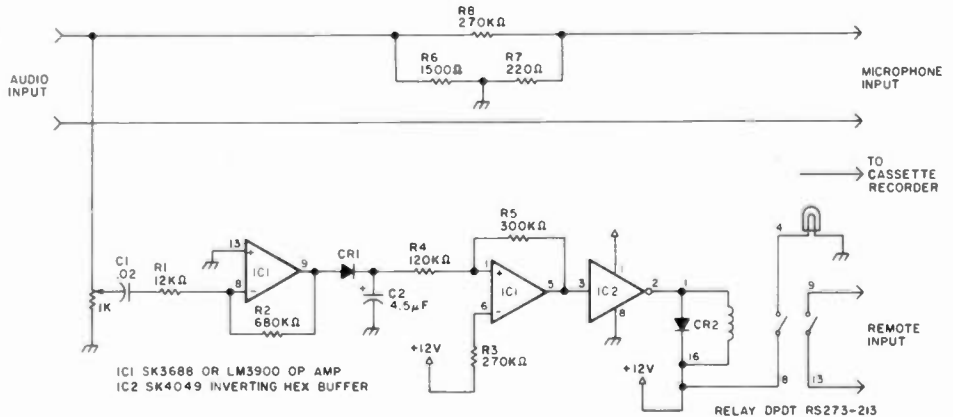

**AUTOMATIC TAPE RECORDING:** Don't miss the action while you're away from the rig. This circuit turns on a tape recorder whenever the receiver's squelch is broken. After signal loss, the recorder will shut off following a slight delay.—Gary Anderson KE7H, Nampa ID.

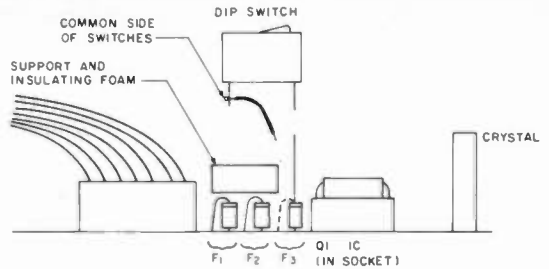

Fig. 1. Side view

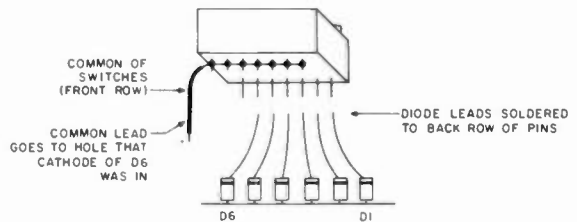

Fig. 2. End view (parts omitted for clarity).

**SWITCH-SELECTABLE TONES FOR THE KENWOOD 7950/7930:** The TU-79 tone unit for the Kenwood 7950/7930 provides for the selection of 3 preprogrammed tones from the keyboard. With the following modification, the third frequency may be programmed by setting a DIP switch rather than cutting or soldering diodes. First, program the tones for F1 and F2 and verify that they work. Unsolder the cathode leads of the diodes in row F3 and position them as shown in the diagrams. Then mount a piece of stiff insulating foam over the diodes in rows F1 and F2, securing it firmly in place. Orient a 6- or 7-position rocker-type DIP switch so that the pole numbers align with the diode numbers 1 through 6 on the PC board. Solder a common wire to all of the leads on one side of the switch as shown in Fig. 1. Solder diode leads 1 through 6 to the corresponding switch pins; solder the common wire to the hole which previously held the cathode wire from D6. Be careful when making the modification; on my instruction sheet, diodes D1 through D6 were shown in reverse order, but the markings on the PC board were correct.—Clint Williams KB8SY, Portage MI.

# CONTESTS

**Robert Baker WB2GFE**  
**15 Windsor Dr.**  
**Atco NJ 08004**

## VENEZUELAN WORLDWIDE CONTEST

**SSB—Starts: 0000 GMT July 2**  
**Ends: 2400 GMT July 3**

**CW—Starts: 0000 GMT July 30**  
**Ends 2400 GMT July 31**

The Radio Club of Venezuela invites all amateurs to participate in the 21st year of the Venezuelan Independence Worldwide Contest. Use all bands, 80 through 10 meters. Operating classes include: single operator, one band (for each band); single operator, multi-band; multi-operator, multi-band, one transmitter; and multi-operator, multi-band, multi-transmitter.

### EXCHANGE:

RS(T) plus a three-digit QSO number starting with 001.

### SCORING:

Contacts between stations of different countries count two points. Contacts with stations within one's own country do not count but are valid as multipliers for each band. Count one multiplier for each Venezuelan and USA call area and each country (including own) worked on each band. Use the ARRL DXCC country list. Final score is the total QSO points times the total multiplier points.

### AWARDS:

For stations outside Venezuela there will be a plaque presented to the highest scorer in each class. Medals go to the highest scorer in each continent and among the Bolivarian countries (Bolivia, Columbia, Ecuador, Panama, and Peru) in the single

operator, multi-band class. Certificates to all stations in the Americas working 15 YV stations and 10 different countries, all European and African stations working 10 YV stations and 10 different countries, and all Asia and Oceania stations working 5 YV stations and 10 different countries.

### ENTRIES:

Logs must show date and time in GMT, station worked, reports exchanged and respective numerical order, multipliers, and points. Use different sheets for each band worked. Include a separate summary sheet showing name(s) of operator(s), call sign, and address. Each participant must include \$2.00 US or IRC equivalent with their logs. Entries must be postmarked no later than August 15 for SSB and September 15 for CW and should be addressed to: RCV, PO Box 2285, Caracas 1010-A, Venezuela.

## INTERNATIONAL WORLDWIDE DX SSTV CONTEST

**Starts: 0000 GMT July 15**  
**Ends: 2400 GMT July 17**

This is the third annual DX SSTV contest sponsored by *A5 Magazine*. It is a 48-hour SSTV video contest using 80 through 10 meters within the recommended SSTV calling/operating frequencies listed below. To encourage allband contest usage and promotion, extra bonus points are granted on the 10-, 15-, 40-, and 80-meter band segments. Single- and multi-operator stations are recognized with crossband contacts not permitted. Individual contacts count only once per band with repetitive multi-band contacts acceptable.

Barring any unforeseen changes from last year's rules, call signs and video reports must be in "video" form. Mugsshots of the station operator, family, or friends can count only once. Slower clock-rate

speeds are encouraged in either 128/16.5- or 256/31-second time bases. Color work must contain a minimum of a 2-color overlay to qualify with standard RGB frame transmissions. Motion SSTV must have a minimum of 2 frames sent with automatic receive switching circuitry or manually operated switching by the receiving operator and 64 x 64 "quadrant" storage of no less than 4 separate pictures with replays.

### SCORING:

Each SSTV two-way contact is worth 5 points within the same country, 10 points for DX out of country. Contact bonus points are available as follows: Mugsshots—1 point, slow speed—2 points, quad frame—3 points, motion SSTV—4 points, high resolution—5 points, and color SSTV (RGB)—10 points. A band multiplier of 3 can be claimed for contacts on 40 and 80 meters, 2 for contacts on 6, 10, and 15 meters. Stations with over 25 DX countries worked add 25 points, over 50 DX countries add 50 points, over 100 countries add 100 points!

### FREQUENCIES:

Advanced/Extra—3845, 7220, 14230, 21340, 28680, 50.150.

General—3990, 7290, 14340, 21440, 28680, 50.150.

### AWARDS:

First-place winner receives a 3-year subscription (worth \$60) to *A5 ATV Magazine* with front-cover picture plus a gold certificate. Second- and third-place winners receive one-year subscriptions and gold certificates. All entries regardless of score receive gold certificates suitable for framing. Results will be in the November issue of *A5 ATV Magazine*.

### ENTRIES:

Submission of logs and totaled scores must be postmarked no later than August 1 and submitted to: Contest Manager, *A5 ATV Magazine*, PO Box H, Lowden IA 52255-0408. Logs will be returned as well any photos, etc. Some log sheets and DX country lists are available from WB0QCD.

# RESULTS

## VERMONT QSO PARTY—1983

State	Call	Award	Score	Name	County/Province
AR	WB5RYB	*	36	Johnson, B.	
AZ	AK7J	*	8	Eliason, C.	
CA	N6CPO	*	1	Kitchens, J.	
FL	K4DDB	*	90	Earp, R.	
FL	N4FBY	*	40	Mach, T.	
IL	W9QWM	*	4	Shrock, H	
IN	W9XD	*	9	Drudge, D	
KS	N0CLV	*	10	Gregory, B.	
LA	W5WG	*	85	Owen, W.	
MA	KA1HFN	*	36	Harris, D.	
MA	K1BA	*	24	Bacon, A.	
MD	WA3EOP	*	24	Pyne, W.	
MD	W3QYL	*	4	Frelmann, D.	
MO	WB0SET	*	45	Hawley, P.	
MS	W5UCY	*	48	Croysdale, L.	
NH	W1OC	*	120	Littlefield, N.	
				(multi-op)	
NH	AF1T	*	35	Clement, D.	
NJ	N2CJJ	*	32	Langston, R.	
NJ	WA2ASO	*	4	Hausleben, P.	
NM	KB5DQ	*	1	Ridley, D.	
NY	WB2TKD	*	40	Harodecki, M.	
NY	N2BFG	*	20	Moseson, R.	
OK	N5AFV	*	50	Mattis, A.	
OR	WD6EAW	*	8	Hamilton, T.	
PA	KA3DSW	*	2	Riegel, K.	
PA	WA3JXW	*	2	Christian, D.	
SD	KC0ZU	*	55	Kleinsasser, G.	
TN	KD4PP	*	8	Chaffin, D.	
TX	W5PWG	*	80	Short, D.	
TX	WA5DTK	*	36	Brewer, J.	
VA	N4GTU	*	24	Frankland, B.	
VA	KF4LY	*	6	Treadwell, B.	
VT	W1AIM	*	32460	Taylor, G.	Washington
VT	WA1KPJ	**	29172	Vanat, J.	Lamolle
VT	N1BRT	***	26727	Woodworth, F.	Washington
VT	W2DMC/1	#	24656	Crystal ARC	Windham
				(multi-op)	
VT	K1HKI	*	24000	Deforge, R.	Orange
VT	KK1U	*	8134	Nevin, D.	Washington
VT	W1POB	*	770	Read, B.	Windsor
VT	WA1GYS	*	120	Merrick, K.	Orange
WA	KN7L	*	33	Parker, C.	
WY	WB7EMA	*	28	Culver, A.	
WY	KC7QE	*	18	Sutherland, W.	
LU	LU5AMF	*	4	Anselmi, H.	

### Legend:

- \* = 1st in state/county
- \*\* = 2nd in state
- \*\*\* = 3rd in state
- # = 1st multi-op (VT only)

# CALENDAR

Jul 2-3	Venezuelan Worldwide Contest—SSB
Jul 9-10	IARU Radiosport Championship
Jul 15-17	<i>A5 Magazine</i> SSTV DX Contest
Jul 23-24	Brothers and Sisters QSO Party
Jul 30-31	Venezuelan Worldwide Contest—CW
Jul 30-Aug 1	Armadillo Run
Jul 30-Aug 1	CW County-Hunter's Contest
Aug 6-7	ARRL UHF Contest
Aug 19-21	<i>A5 Magazine</i> UHF FSTV DX Contest
Aug 20-21	SARTG Worldwide RTTY Contest
Aug 27-28	Occupation Contest
Sep 3	DARC Corona 10-Meter RTTY Contest
Sep 9-11	Connecticut Oyster Festival
Sep 10-11	ARRL VHF QSO Party
Sep 10-11	Cray Valley Radio Society SWL Contest
Sep 17-19	Washington State QSO Party
Oct 1-3	Oregon QSO Party
Oct 8-9	ARRL QSO Party—CW
Oct 9-10	ARRL QSO Party—Phone
Oct 15-16	ARRL Simulated Emergency Test
Oct 22-23	MF Runde SW Activity Weekend
Oct 22-23	Clara Ac-Dc Contest
Nov 5-6	ARRL Sweepstakes—CW
Nov 6	DARC Corona 10-Meter RTTY Contest
Nov 19-20	ARRL Sweepstakes—Phone
Dec 3-4	ARRL 160-Meter Contest
Dec 10-11	ARRL 10-Meter Contest



## BROTHERS AND SISTERS QSO PARTY

The Central Oregon Radio Amateurs (CORA) are sponsoring the contest that will run from 0600 PST Saturday, July 23, until 1200 PST Sunday, July 24. Operations will be from WN70DD in Brothers, Oregon, and N7CSH in Sisters, Oregon. Phone frequencies will be 10 kHz up from the bottom portion of the General bands. CW will be 15 kHz up from the bottom portion of the Novice bands. QSL via CORA, PO Box 723, Bend OR 97709. Enclose a business-size SASE for return QSL cards.

## CW COUNTY-HUNTER'S CONTEST

**Starts: 0000 GMT July 30**  
**Ends: 0200 GMT August 1**

The CW County-Hunter's Net invites all amateurs to participate in this year's contest. All mobile and portable operation in less active counties is welcomed and encouraged. Stations may be worked once per band and again if the station has changed counties. Portable or mobile stations changing counties during the contest may repeat contacts for QSO points.

### EXCHANGE:

QSO number; category (P for portable, M for mobile); RST; state, province, or country; and US county. Stations on county lines give and receive only one QSO number, but each county is valid for a multiplier.

### FREQUENCIES:

3575, 7055, 14065, 21065, and 28065. It is strongly requested that only P- or M-category stations call CQ or QRZ on 40 meters below 7055 and on 20 meters below 14065, with all other stations spreading out above those frequencies.

### SCORING:

QSOs with fixed stations are 1 point, QSOs with portable or mobile stations are 3 points. Multiply the number of QSO points times the number of US counties worked. Mobiles and portables calculate their score on the basis of total contacts within a state for the state certificate, and on all operation if they operated from more than one state in competition for the High Portable or High Mobile Trophy.

# THE ARC LITE

## NEWSLETTER OF THE MONTH

To create a good club newsletter, you don't have to have fancy graphics, typeset text, or professional writers—just a desire to inform and entertain your readers and a willingness to work at it. *The Arc Lite*, newsletter of the Garland Amateur Radio Club in Garland, Texas, is a perfect example of what can be done with simple resources and a little elbow grease.

*The Arc Lite* is neither typeset nor printed, but the first impression you get is that it is very clean. Obvious care has been taken in its layout, making the most advantageous use of white space without creating an empty look. Each page is bordered with a black line, and stories of special note—such as a recent issue's news flash of the expanded 20-meter phone band—are boxed, giving the newsletter the ambience of a tabloid newspaper.

Each section has been painstakingly labeled with a handsome headline and when a story jumps from one page to another, you are told where it has been continued.

Oddly enough, *The Arc Lite*'s contents are not that variant from the offerings of most other newsletters. Minutes of the last meeting, club news, and information on the club's repeater and station are all standard fare. But there is a difference. The sentences are complete. Misspellings are rare. For newsletter editor Gary Engleman K5HGL, the world of grammar and syntax is obviously not uncharted territory.

In his editorial, "de: Editor," Gary notes that he is selling advertising to help support the new *Arc Lite* format which he created. Gary has obviously seen a need for improvement and engineered a way to make the new idea work.

If your club takes pride in its newsletter, it wants to see it. To enter in '73's contest, send a copy of the newsletter to 73, Pine Street, Peterborough NH 03458, Attn: Newsletter of the Month.

### AWARDS:

Certificates will be awarded in three categories:

- 1) Highest fixed or fixed portable station in each state, province, and country, with 1,000 or more points.
- 2) Highest station in each state operating portable from a county which is not his normal point of operation, with 1,000 or more points.
- 3) Highest station in each state operating mobile from 3 or more counties, with a minimum of 10 QSOs in each of at least 3 counties.

Plaques will be awarded to the highest mobile and portable stations in the USA who meet the above requirements for certificates. Additional awards will be issued where deemed appropriate.

### ENTRIES:

Logs must show category, date/time in GMT, station worked, band, exchanges, QSO points, location, and claimed score.

All entries with 100 or more QSOs must include a check sheet of counties worked or be disqualified from receiving awards. Enclose a large SASE if results are desired. Logs must be postmarked by September 3 and sent to: CW County-Hunter's Net, c/o Jerry Burkhead N6QA, 7525 Baltic St., San Diego CA 92111.

## ARMADILLO RUN

**Starts: 0001 GMT July 30**  
**Ends: 0200 GMT August 1**

The Texas DX Society announces its contest to assist CW operators in gaining USA-CA All Counties Award status. The TDXS will activate all Texas counties by dispatching mobile stations from Houston and activating these stations during the County-Hunter's CW Contest. Several fixed stations will also be activated. To ensure that the largest number of entrants receive equal opportunity to work the mobile sta-

tions, operating will generally be restricted to 20 meters.

Entry class for the Armadillo Run is single operator from out of Texas only. Operators must operate from their own station. Mobile operation will generally be restricted to 14055-14075 MHz. Operation on other bands will be in accordance with the County-Hunter's CW Contest rules. During the contest, call CQ TDXS on 14050, 7085, or 3585 and a control station (W5DOZ, K5NAI/2, N6HUP) will answer your call and try to answer questions. Information regarding which station will activate specific counties may be received by writing or calling KZ5M between 6:30 and 8:00 pm CDST at (713)343-1060.

### EXCHANGE:

So as not to distract from the County-Hunter's CW Contest, use the same exchange as that required by that contest; QSO number; category (P-portable, M-mobile); RST; state, province, or country; and county for USA stations.

### SCORING:

The contest score will be equal to the total number of Texas counties contacted during the contest period. Ties will be broken by the Texas QSO count.

### AWARDS:

A unique plaque will be awarded to the station operator contacting the most Texas counties during the contest period. The plaque winner will be flown to Houston for the 1983 ARRL National Convention to receive the award if he contacted over 175 Texas counties. Certificates will be awarded to entrants contacting at least 50 counties. Endorsements will be issued for the following county levels: 100, 150, 175, 200, 225, and 250, as well as All Texas Counties.

### ENTRIES:

To qualify for award consideration, log information containing Texas stations worked, time (GMT), band, and the county the station was operating from shall be sent to: the Armadillo Run Chairman, Dennis Motschenbacher KZ5M, PO Box 82, Thompsons TX 77481. Mailing deadline is August 31, 1983. Entrants may forward QSLs to the above address for Texas QSOs made during the contest period. The TDXS will make special efforts to ensure that QSLs received are answered!

# AWARDS

**Bill Gosney KE7C**  
**Micro-80, Inc.**  
**2665 North Busby Road**  
**Oak Harbor WA 98277**

## JORDANIAN AWARDS

### The Arabian Knights Awards

This award is issued by the Arab Radio Amateur League (ARAL) members and presented by His Majesty King Hussein (JY1) of Jordan.

To qualify for this recognition of achievement, amateurs must have proof of having contacted at least ten Arab countries, and one contact must be with either JY1 or JY2. All contacts must be made on or after January 1, 1971, on any authorized mode of communications. There are no special endorsements.

To apply for the Arabian Knights Award, the applicant must prepare a list of claimed contacts in prefix order. Each entry must also include the date and time in GMT, the band and mode of operation, and the station worked.

Do not send QSL cards, as photocopies will be accepted. As an alternative, you may have your list verified by two local amateurs, a local radio club secretary, or a notary public.

Enclose this list along with an award fee of ten IRCs and send to the attention of: JY1 Award Manager, PO Box 1055, Amman, Jordan.

### The Royal Jordanian Awards

To amateurs throughout the world who qualify, JY1, His Majesty King Hussein I of Jordan, will issue a very elegant award of

achievement to recognize one of two levels of accomplishment.

First, the Silver Award is offered in recognition of having worked six different JY prefixes. There are no band or mode restrictions; however, all contacts must be on or after January 1, 1971, to count.

The second and probably the toughest award of all to obtain is the Coral Award, which is issued to amateurs who visit Jordan and make a QSO from Aqaba. Simple, huh? Anyone for a charter trip this winter?

As with all awards sponsored by our Jordanian friends, applicants must prepare a list of claimed contacts made, citing the usual logbook information including RS(T).

Forward this list, stating which award it is you are applying for, along with an award fee of ten IRCs to: JY1 Award Manager, PO Box 1055, Amman, Jordan.

## DX AWARDS FROM ITALY

A very good DX friend of yours and mine, John Paul I8KDB, wrote a very complimentary letter about our awards column and asked that we share the awards

### ARAB COUNTRIES

JY1	King Hussein
JY2	Royal Jordanian Family
A4X	Oman
A6X	United Arab Emirates
A7X	Qatar
A9X	Bahrain
CN	Morocco
HZ, 7Z	Saudi Arabia
J2	Djibouti
JY	Jordan
OD5	Lebanon
ST	Sudan
SU	Egypt
YK	Syria
YI	Iraq
3V8	Tunisia
4W	Yemen
5A	Libya
5T5	Mauritania
60	Somali
70	South Yemen
7X	Algeria
9K2	Kuwait

program sponsored by the Associazione Radiotecnica Italiana (ARI). John Paul noted that the following general rules apply to all HF awards issued by the ARI and recommended that they be read together with the conditions governing each individual certificate.

All Inquiries and/or applications should be addressed to the ARI Awards Manager, Giampaolo Nucciotti I8KDB, Via Francanzano, 31-80127 Napoli, Italy, and include 2 IRCs for airmail reply.

ARI awards will be issued to any amateur who submits a letter, dated and signed, with applicant's name, address, and call. He must certify that he has complied with all rules governing amateur radio in his country and that he has operated with fair play and good sportsmanship; he must include a complete list of QSLs, with callsign, date, frequency, reports, time, and type of emission (CW, AM, SSB, RTTY); and he must submit QSLs for checking. QSL cards must be submitted without corrections, erasures, or additions and must be clearly readable; include US \$1.00 or 10 IRCs for foreign applicants. The Marconi Award is free; only a mailing fee is charged.

To get an award in a specific class, the cards must show the corresponding data in a clear format. Foreign applicants may avoid sending QSL cards by submitting a checklist of the cards duly certified by an appointed or elected official or a national amateur-radio-affiliated society or club. The ARI Award Manager reserves the right to check, on request, one or more claimed contacts, as necessary.

#### Certificato Del Mediterraneo (CDM)

The CDM is issued to those amateurs who can show confirmation of a two-way contact on the HF bands since June 1, 1952, with (a) one fixed station in each of at least 22 countries of the list shown below, and (b) at least 50 amateur stations located in peninsular Italy—an accumulated total of 72 QSLs.

The same station may be worked only once. Two classes of CDM are offered: mixed (AM, SSB, CW, RTTY) or phone only (AM, SSB). The minimum reports allowed to qualify are RS 33 and RST 338.

Countries list: Spain, Balearic Islands, Ceuta and Melilla, Morocco, France, Algeria, Corsica, Sardinia, Sicily, Lebanon, Egypt, Greece, Dodecanese Islands, Crete, Mount Athos, Turkey, Syria, Yugoslavia, Albania, Malta, Gibraltar, Cyprus, Monaco, Tunisia, and Libya.

#### Worked All Italian Provinces (WAIP)

This province award is issued to those amateurs who can show confirmation of a two-way contact on the HF bands since January 1, 1949, with one fixed station in each of at least 60 provinces of the Italian Republic for foreign amateurs, or one in each of 75 provinces for Italian amateurs. The same station may be worked twice or more if it's in a different province each time. Minimum reports acceptable are RS 33 and RST 338. Starting January 1, 1978, this award may also be endorsed for single band and/or for all 95 provinces.

List of Italian provinces: Agrigento, Alessandria, Ancona, Aosta, Arezzo, Ascoli Piceno, Asti, Avellino, Bari, Belluno, Benevento, Bergamo, Bologna, Bolzano, Brescia, Brindisi, Cagliari, Caltanissetta, Campobasso, Caserta, Catania, Catanzaro, Chieti, Como, Cosenza, Cremona, Cuneo, Enna, Ferrara, Firenze, Foggia, Forlì, Frosinone, Genova, Gorizia, Grosseto, Imperia, Isernia, L'Aquila, La Spezia, Latina, Lecce, Livorno, Lucca, Macerata, Mantova, Massa, Matera, Messina, Milano, Modena, Napoli, Novara, Nuoro, Oristano, Padova, Palermo, Parma, Pavia, Perugia, Pesaro, Pescara, Piacenza, Pisa,

#### LIST OF QUALIFYING CONTACTS FOR DGM

Country	Specific region or city	Prefix
Capo Verde Island	Any	D4C
Portugal	Lisbon	CT1
Madeira Island	Any	CT3
Morocco	Any	CN8
Spain	Cadice	EA7
Ireland	Any	EI
France	Any	F
Corsica	Any	FC
England	London	G
England	Flatholm Island	GB
England	Wight Island	G
Northern Ireland	Any	GI
Scotland	Any	GM
Switzerland	Any	HB
Vatican	Any	HV
Italy	Bologna	I4
Italy	Any	I5
Italy	Rome	I0
Italy	Fondaz G. Marconi	IY4FGM
Italy	Torre, Tigullio Marconi	IP1TTM
Italy	Sicily	IT9
Italy	Sardinia	IS0
Japan	Any	JA
Argentina	Buenos Aires	LU-A-B-C
Belgium	Any	ON
Brazil	Rio de Janeiro	PY
Sweden	Stockholm	SM
Sweden	Gotland Island	SM1
USSR	Leningrad	UA1
Canada	Any	VE1
Newfoundland	Any	VO1
Labrador	Any	VO2
Australia	Sydney	VK2
Bermuda	Any	VP9
USA	Massachusetts	W1
USA	New York State	W2
USA	New Jersey	W2
USA	Missouri	W0
USA	Illinois	W9
India	Any	VU
Gibraltar	Any	ZB
Yugoslavia	Any	YU2
Libya	Tripoli	5A
Any	Memorial Stations	Any

Pistoia, Pordenone, Potenza, Ragusa, Ravenna, Reggio Calabria, Reggio Emilia, Rieti, Roma, Rovigo, Salerno, Sassari, Savona, Siena, Siracusa, Sondrio, Taranto, Teramo, Terni, Torino, Trapani, Trento, Treviso, Trieste, Udine, Varese, Venezia, Vercelli, Verona, Vicenza, and Viterbo.

#### Diploma Guglielmo Marconi (DGM)

This award celebrates the experiments carried out by Marconi in various parts of the world and brings them once again to the attention of radio amateurs. The DGM will be awarded to those who make contacts with the localities in which Marconi once conducted his experiments. To qualify, it is necessary to forward to the ARI all details of your contacts and a) 40 QSLs chosen from the list of contacts for DGM, or b) 35 QSLs chosen from the list plus the QSL from the official commemorative station, I44FGM, and one from any other G. Marconi memorial station, for a total of 37 QSLs.

When required (i.e., G = London, I4 = Bologna), the QSLs must indicate the city or region of the locality. The DGM is made available for AM, SSB, CW, RTTY, SSTV, and mixed modes. There is no band limitation; however, all contacts must be made on or after January 1, 1973.

#### QRP INTERNATIONAL

Being somewhat of a 10-meter QRP enthusiast, using a converted CB rig, I contacted Hugh Aeiker WA8CNN, who happens to be the Awards Custodian for the QRP Amateur Radio Club International. After hearing everyone on the band

claiming to run QRP or QRPp, I figured once and for all I would get the true definition of these terms from one of the originators of an organized QRP group. Not only did I get this group's point of view as stated in their constitution and by-laws, but also I became the recipient of a full packet of information concerning their awards program.

It appears that this QRP fraternity, founded in 1961 by K6JSS, set the QRP standard to mean 100 Watts CW/AM or 200 Watts PEP input. As for QRPp status, we find the group recognizing this power only in the 5-Watt or less range. Now this is not to be confused with standards set by other QRP societies, such as the Michigan QRP Club International, which also defines QRPp as under 5 Watts output, yet QRP is much less than 100 Watts.

As for their awards program, it is packed full of incentives, as you'll witness by reading on.

The main objective of the QRP ARC International Awards Program is to demonstrate the use of limited power which creates less QRM on the amateur bands, while still allowing us to enjoy the usefulness of the hobby. The club issues the following awards which are available to any amateur meeting the requirements as set forth for each below.

#### QRP-25

This award is issued to any amateur working at least 25 members of the QRP ARC International. Endorsements are issued for 50, 100, 200, and every addi-

tional increment of 100. To apply, send copies of logbook data, \$1.00 or 5 IRCs, and a signed statement that you limited your power to 100 Watts input (200 Watts PEP SSB). Your list should also include the membership numbers of each station worked. There are no restrictions on band or mode recognition.

#### WAC-QRP

This award is issued to any amateur for confirmed contacts with low-power stations in all six continents. Power inputs again must be carefully adhered to and a statement must be made certifying the power was within rules governing the program. Keep in mind also that both your own station and the station you are contacting must be using QRP to qualify. Your QSL cards received must state the station's power used. Fee is \$1.00 or 5 IRCs.

#### WAS-QRP

This WAS award is issued to any amateur using QRP power who contacts stations, one in each of the 50 US states, who are also using QRP power or less. Award fee is \$1.00 or 5 IRCs. GCR apply.

#### DXCC-QRP

This DX award is issued to any amateur who utilizes QRP power and contacts 100 different countries, each of which must also be using low power as must be stated on their QSL card. To apply, send log data and \$1.00 or 5 IRCs. GCR apply.

#### KM/W 1000-Mile-Per-Watt Award

This award is issued to any amateur transmitting from or receiving the transmissions of a low-power station, such that the Great Circle bearings between both sides divided by the power input of the low-power station equals or exceeds 1000 miles per Watt. Confused? Ah, it's not all that bad! Special endorsements are given for single-band or mode achievements. To apply, send copies of full log data including power used on both sides, signal reports exchanged, band and mode, and specific location of QTH on both sides. Include \$1.00 or 5 IRCs. GCR apply.

#### DXCC-QRPp

Issued to any amateur for confirmed contacts with stations in 100 DX countries; power levels of 5 Watts or less must be used by the applicant. Reading the rules closely, I find no power restriction on the stations you must work. To apply, send log-book data, including power used and type of equipment used. Enclose \$1.00 or 5 IRCs. GCR apply.

#### WAS-QRPp

Issued to any amateur for confirmed contacts with each of the 50 US states while operating 5 Watts maximum output. To apply, forward all pertinent log data and \$1.00 or 5 IRCs to the Award Manager. GCR apply. Application for the award may be made when the first 10 states have been worked, with further recognition at the 20, 30, 40, and, finally, 50 levels.

As with all awards offered by the QRP ARC International, in order not to delay processing of your award, please furnish not only the data, but also the power levels used for each award and the type of equipment used.

All award applications should be sent to: Hugh Aeiker WA8CNN, 5 Keiffer Drive, St. Albans WV 25177.

My special thanks go out to Ade W0RSP/K8EEG, QRP editor for *CQ Magazine*, who recently provided me with the latest up-to-date information concern-

ing some very popular awards being offered by amateur fraternities.

#### DXCC-QRPp

This award, initiated in 1971 by the *Milliwatt: National Journal of QRPp*, offers a very distinctive challenge to dedicated QRPp stations the world over.

The award requires contacts with DX stations in 100 different countries of the world with the aid of list- or net-type operations. The rules clearly state that power must be limited to five Watts or less output. To apply, the applicant must submit a log in alphabetical order of callsign prefix of the station worked, indicating date, time, and frequency of each contact. QSL cards must accompany your listing and a signed declaration must be made as to the maximum power and type of equipment used. Application fee is \$15.00 to help defray the cost of the large 30-inch engraved trophy.

#### DXCC Milliwatt

This award is also sponsored by the *Milliwatt: National Journal of QRPp*. The same rules apply for this award as for the DXCC-QRPp except that all indications of power level should read "under one Watt output." Applications are the same as for DXCC-QRPp.

#### The Milliwatt Field Day Trophy

Initiated in 1970, this trophy is awarded to the highest-scoring QRPp station in the ARRL Field Day event held each year in the month of June. To enter, you must submit an ARRL summary sheet, plus a listing of the stations you worked, band by band. You must state in your application the power level used, the type of equipment, and your method of measuring output power. If you use 1-5 Watts, you may multiply your score by four.

For power levels less than one Watt, you may multiply your score by 5. In addition, another 1.5 times your score may be added for operating your QRPp station in-

dependent of power mains. Another 150 bonus points are earned for full portable setup away from your QTH.

All three awards, the DXCC-QRPp, the DXCC Milliwatt, and the *Milliwatt* Field Day Trophy, are obtainable by making application to: Adrian Welss W0RSP, 83 Suburban Estates, Vermillion SD 57069.

### XV WORLD JAMBOREE MONDIAL

The Calgary Amateur Radio Association will be operating VE6WSJ from the site of the XV World Jamboree Mondial on July 1-16, 1983. The station will operate all bands and modes. Suggested frequencies: 7.030 MHz CW on the half hour; 14.190 SSB on the hour.

### NATIONAL TOM SAWYER DAYS

The Hannibal Amateur Radio Club, Inc., will issue a third annual special certificate from the National Tom Sawyer Days celebration in Mark Twain's boyhood hometown, Hannibal, Missouri, on July 3-4, 1983. Hours: 1500-2100 UTC both days. Frequencies: phone—7.245, 14.290, 21.400, and 28.770; CW—7.125 and 21.125 MHz. Help us celebrate! To receive the certificate, send a large (8 x 10) SASE and your personal QSL card confirming the contact to Hannibal Amateur Radio Club, Inc., W0KEM, 2108 Orchard Avenue, Hannibal MO 63401. For further information, contact Tony McUmber at the above address or call (314)-221-6199.

### SPACE DAY '83

The Cascades Amateur Radio Society (CARS), in conjunction with the Michigan Space Center in Jackson, Michigan, is offering a Space Day certificate to all stations who work WB8CSQ during Space Day activities. Look for WB8CSQ on 3.900, 7.235, 14.285, 21.360, and 28.510 starting at 0000 GMT July 9 through 1700 GMT July

10. A one-dollar contribution is asked to cover cost of postage and materials. Mail your log information and \$1.00 to CARS, Space Day '83, PO Box 512, Jackson MI 49204.

### USS COD

Having started in June, members of the Northern Ohio Amateur Radio Society will be operating daily through Labor Day from the *USS Cod*, a World War II submarine on permanent display at the port of Cleveland, Ohio.

Using the callsign K8KRG, NOARS members will be operating in the lower portion of the General band on 80 through 10 meters. Special Novice operations will be conducted on July 9 and 10 and August 20 and 21. On those dates, signals from the *USS Cod* will be found in the middle of the Novice band.

A special 8 x 11 certificate will be available upon request. Please send a QSL confirming the contact and \$1 for handling and postage to WD8RZG, 8927 Torrance Ave., Brooklyn OH 44144.

### ANNIE OAKLEY SPECIAL EVENT STATION

Again, it is the pleasure of W8UMD, the Treaty City Amateur Radio Association, Inc., to bring you the Annie Oakley Special Event Station from Greenville, Ohio, on Saturday, July 30, and Sunday, July 31, 1983. We will be operating from the Garst Museum which houses two rooms of memorabilia, guns, trophies, and costumes of "Little Sharpshooter," the name given to Annie by Chief Sitting Bull. Operating times will be 1400 to 0100 UT on Saturday and 1400 to 2200 UT on Sunday. Frequencies will be 20 kHz up from the General phone portion of the 40- and 20-meter bands, with excursions into the Novice segments of 40 and 15 meters. Your QSL and an SASE to TCARA, PO Box 91, Greenville OH 45331, will bring you a

beautiful certificate and a pamphlet about Annie Oakley.

### DETROIT ARSENAL

The Tank-Automotive Command ARC will operate W8JPW on 30 July 1983 from 1300-2000Z to commemorate the 42nd year of the Detroit Arsenal, home of the nation's first defense plant and the US Army Tank-Automotive Command. Frequencies: phone—7.250-7.274, 21.400, and 146.49 MHz; CW—7.055 from 1500-1700Z. Please put your QSO number and frequency on upper left-hand corner of your outer envelope. For an unfolded certificate, send a 9" x 12" SASE to: W8JPW, US Army Communications Command, Attn: CCNC-TAC-M, 28251 Van Dyke, Warren MI 48090.

### BIX BIEDERBECK

The Davenport Radio Amateur Club will operate W0BXR to commemorate the great jazz player Bix Biederbeck and the city of Davenport during the Bix Biederbeck Memorial Jazz Festival, from 1600Z July 30 to 0300Z July 31, and from 1600Z to 2300Z on July 31. Operation on phone and CW, all bands above 10 kHz up from lower end of General-class band edges. To receive a certificate, send a large SASE to DRAC, c/o David Johansen W80FBP, 2131 Myrtle St., Davenport IA 52804.

### LINCOLN BOYHOOD MEMORIAL

The Pike County Amateur Radio Club will operate station W9CZH from the Lincoln Boyhood Memorial, Lincoln City, Indiana, from 1700Z July 30 to 1700Z July 31. Special QSLs will be issued for your QSL and an SASE to Richard Bailey KC9VH, Box 311 RR 1, Winslow IN 47598. Frequencies will be: 3.925, 7.265, 14.305, and 21.395 phone; 14.090 RTTY; 146.52 FM; and 7.133 CW.

## RTTY LOOP

Marc I. Leavey, M.D. WA3AJR  
c/o T3  
Peterborough NH 03458

I'm going to start out this month by answering a question I raised last month, one that I'm sure has been just burning in the minds of many of you. Just what does Mr. Ferrell do with stations lacking a callsign in the alphabetical listings in his new *Guide To RTTY Frequencies*?

Well, shortly after last month's column was put to bed, I received a full copy of this new book, and I now can tell you the answer—they are not included in the alphabetical-by-callsign list. Only those stations with callsigns are! Reviewing the pages in the missing signature also shows a neat, short treatise on callsign origins and some other trivia in the same vein. Makes a good bit of reading. The second edition *Guide To RTTY Frequencies* is available from Gilfer Associates, Inc., PO Box 239, 52 Park Avenue, Park Ridge, New Jersey 07656, for \$9.95. As always, plug this column when you write, ok?

Never in all my wildest expectations did I anticipate the veritable flood of responses to my offer of a 6800 and/or 6502 RTTY terminal program. In the past, sever-

al such comments have drawn but a lukewarm response, but not now! With more letters received than on any other single topic in the more than six years of this column, over half of the letters pleaded for 6800 software, with the majority of the others backing the 6502-based Atari 400/800. Let's take a look at a sample of what some of you said.

Philip Deem K9PD, Indianapolis, Indiana: "Let me identify myself as one of the very interested! (people worldwide interested in the 6800). I do, however, disagree that the 6800 is a dead system. This is possibly the only microcomputer ever offered whose purchasers have been able to make relatively inexpensive mods to remain current with the state of the art."

Horace Hall WB4OGM, Peterson AFB, Colorado: "In response to your request for comments... I, for one, would certainly be interested! I really don't think the 6800 is dead, though the ham fraternity may wish to hear more about the department-store computers since they are so readily available and the prices are so good. If all is lost for the 6800 and the new department-store computers are what RTTY hams want to hear about, then at least choose one with an honest-to-gosh keyboard. After all, we are going to have to

type on them to get our messages across, so let's try to do so comfortably."

Weldy Moffatt VESNM, Regina, Saskatchewan, Canada: "Please don't set the 6800 aside. There are a large number of these machines about and most are in the hands of persons that like to get into the innards. The 6800 on the S-50 bus is the ideal machine for the hobbyist that wants to tinker with hardware and software."

Joseph Ryan WB5LLM, Florence, Mississippi: "About dropping interest in 6800-based micros: Stop! Please don't give up on 6800-based micros. 6800 assembly-language programs can be cross-assembled to 6809 language."

Nick Hulbert KG5N, Lubbock, Texas: "The 6800 with the S-50 bus is an experimenter's dream. A person who likes to build and add to his system can simply put whatever he wants on the 30-pin card and plug it in. In fact, if I want to go to the 6809 or even the 6502, I can get a CPU card to do this and plug it into my 6800 mainframe. A far cry from what you can do with some of the other machines (easily). I'm trying to say that the 6800 is *not dead* and there are a bunch of units out there."

John Davison W0ZFN, Kirkwood, Missouri: "I am very much interested in anything you want to print on the 6800. It might be dead, but mine is very much alive! It is a D-1 Motorola evaluation board."

Thomas Hand WD4IUG, Louisville, Kentucky: "I am interested in a RTTY program for the 6800-type computer. I have an APF computer which I enjoy very much."

Of course, not everyone is so universal-

ly behind the 6800 as the ideal CPU. For example...

Howard Busson W8WGB, Akron, Ohio: "I quit reading your column when you got off on the 6800 kick. I would suggest that you lean more towards the el cheapos (like the color computer)."

Stephen Carter K0GVZ, Rifle, Colorado: "It is truly unfortunate that the market did not support the 6800-6809 microprocessors, because they were easy to program and had really quite elegant architecture. However, realities being what they are, I suspect that any article based on a 6800 would have an extremely limited audience. On the other hand, if you used the TImex-Sinclair, VIC-20, Atari, or Radio Shack Color Computer, the low prices of

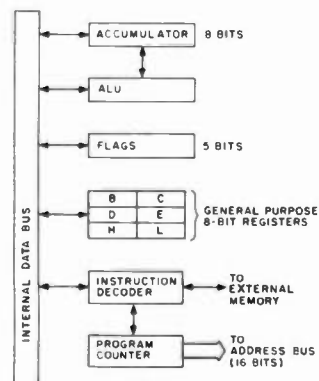

Fig. 1. 6800 block diagram.



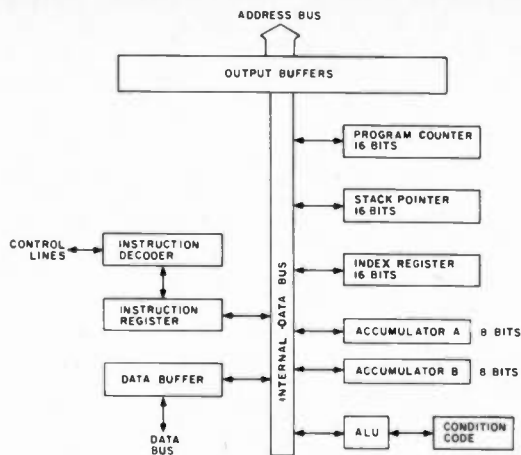

Fig. 2. 6800 block diagram.

these computers would make it feasible to buy one and dedicate it only to ham radio." I might point out to Steve that the CoCo is 6809-based.

James Theisen WB8REH, Gaylord, Michigan: "I am trying to understand machine code and hope to write or modify an existing RTTY program for the Pet." Stay tuned!

Rich Gehle N4DPQ, Nicholasville, Kentucky: "If you are considering a program for Atari on RTTY, please go for it. The present program is so restrictive and inconvenient, we are looking for relief."

It occurs to me that, to a large extent, a good deal of the above may be beyond the ken of many readers. 6800, 6809, 6502, 8080, Z-80—these are the substances of articles in *Byte* or *68 Micro Journal*, material rarely consumed by the average amateur. The truth is, for most commercially-

available systems, the software offered is far more important than the central processing unit, or CPU, which is what all those numbers above were all about. But, if we will be writing software, we are going to have to commit to a particular CPU, or at least a similar group. Perhaps a look at history will be revealing.

In the beginning, there was no microprocessor, only big computers with tubes or discrete solid-state devices. After much work, trying to produce a general-purpose calculator integrated circuit, the Intel 4004 was born. This four-bit handler was the forefather of today's microcomputer breed. The next step was increasing the data capacity to eight bits, and the 8008 was born. I still remember the Mark-8 computers, home-brewed to use this chip in the early 1970s. An updated 8008 was introduced by Intel in 1973, called the

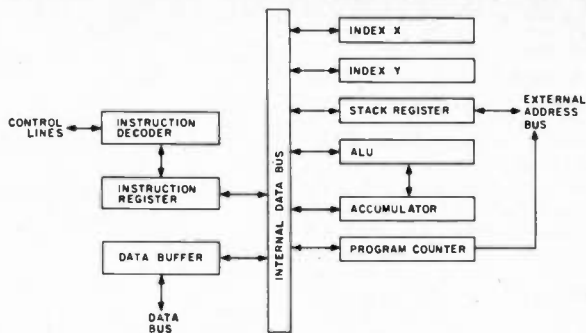

Fig. 3. 6502 block diagram.

8080, and within two years the microcomputer revolution was off and running.

The design philosophy of the 8080 was an attempt to implement a calculator-type architecture on one chip, tracing back to the 4004 roots. Six general-purpose registers, stack and program counters, and a flag register work with one accumulator to provide internal data manipulations. Input and output is directed over special I/O channels. A block diagram of the Intel 8080 is shown in Fig. 1.

A year after the introduction of the 8080, Motorola presented its version of the eight-bit microprocessor, the 6800. Rather than the register orientation of the 8080, the 6800 is memory-oriented, that is, any memory location can serve as data, instructions, a register, or even an input/output device. By freeing up the organization, the 6800 becomes easier to program, and the more flexible addressing allowed by the 6800 makes this series, and ones to follow in this line, inherently more powerful. Fig. 2 shows the simple organization

of the Motorola 6800, which contains two accumulators, an index register, stack and program counters, and condition code, or flag, register.

The next move was taken by several employees of Motorola who joined forces with a calculator chip manufacturer, MOS Technology, to produce an enhanced 6800. The index register, a two-byte pointer in the 6800, was broken into two eight-bit index registers, and new modes of addressing were added. The B accumulator was discarded, and other refinements were made to some of the internal architecture. The result was the 6502, the block diagram of which is shown in Fig. 3.

The net result is that there are two major families among popular microcomputers: the 8080, with its enhanced version, the Z-80, and the 6800, 6502, and lately the 6809, an enhanced 6800, series. Although important differences exist between members of these groups, as a rule programs that are written for one may be translated, not always directly, from one to the other.

## HAL-TRONIX

HAL 2304 MHz DOWN CONVERTERS (FREQ. RANGE 2000/2500 MHz)  
 2304 MODEL #1 KIT BASIC UNIT W/PREAMP LESS HOUSING & FITTINGS... \$19.95  
 2304 MODEL #2 KIT (with preamp)..... \$29.95  
 2304 MODEL #3 KIT (with High Gain preamp)..... \$39.95

MODELS 2 & 3 WITH COAX FITTINGS IN & OUT AND WITH WEATHER-PROOFED DIE CAST HOUSINGS

BASIC POWER SUPPLY..... \$19.95  
 POWER SUPPLY KIT FOR ABOVE WITH CASE..... \$24.95

ANTENNAS & OTHER ACCESSORIES AVAILABLE. SEND FOR MORE INFO.



### 2100-2500 MHZ

\*HMR-II COMPLETE UNIT  
 COMPLETE SYSTEM AS SHOWN NOT A KIT INCLUDES  
 A PC BOARD, POWER SUPPLY, CABLES &  
 CONNECTORS—PRE-ASSEMBLED AND TESTED 24dB  
 GAIN OR GREATER

1 UNIT..... \$149.95  
 2 UNITS..... \$139.95 ea.  
 3 OR MORE UNITS..... \$129.95 ea.

\*HAM MICROWAVE RECEIVER

### PRE-SCALER KITS

HAL 300 PRE (Pre-drilled G-10 board and all components)..... \$14.95  
 HAL 300 A/PRE (Same as above but with preamp)..... \$24.95  
 HAL 600 PRE (Pre-drilled G-10 board and all components)..... \$29.95  
 HAL 600 A/PRE (Same as above but with preamp)..... \$39.95

### PRE-AMPLIFIER

HAL-PA-19 WIDE BAND PRE-AMPLIFIER, 2-200 MHz BANDWIDTH (-3dB POINTS),  
 19dB GAIN FULLY ASSEMBLED AND TESTED \$48.95

HAL-PA-1.4 WIDE BAND PRE-AMPLIFIER, 10 MHz TO 1.4 GHz, 12dB GAIN  
 FULLY ASSEMBLED \$12.95

HAL-PA-2.1 GHz 2 STAGE PRE-AMPLIFIER, DESIGNED FOR 2304 DOWN CONVERTER.  
 MADE TO PIGGIE-BACK ON THE 2304 BOARD. OFFERS 20 dB GAIN. ALSO HAS AN IM-  
 AGE REJECTION FILTER. \$34.95

SHIPPING INFORMATION. ORDERS OVER \$25 WILL BE SHIPPED POST-PAID EXCEPT  
 ON ITEMS WHERE ADDITIONAL CHARGES ARE REQUESTED. ON ORDERS LESS THAN  
 \$25, PLEASE INCLUDE ADDITIONAL \$2.50 FOR HANDLING AND MAILING CHARGES.  
 SEND 20¢ STAMP FOR FREE FLYER.

**HAL-TRONIX INC.**  
 P.O. BOX 1101

SOUTHGATE, MICH. 48195  
 PHONE (313) 285-1782



## ALL NEW H.F. 10/160 METER SOLID STATE P.L.L. TRANSCEIVER



Model 10/160 M

USB-LSB

4 Memories  
 3 Way Auto-Scan  
 Includes New Bands  
 3-Step Tuning Speed  
 IF Tune ± 1 KHZ  
 Built-in Dual VFO  
 Narrow CW filter optional

CW-W CW-N

200 W. PEP (160M-12M)  
 100 W. PEP (10M)  
 Built-in Power Supply  
 AC-120 VAC  
 DC-13.8 V.-Ground  
 External ALC & Relay  
 RTTY, FAX, ASCII

Mfg. Sug. Amateur price

**\$1,059.00**

**NOW ONLY \$949.50**

JUST SLIGHTLY AHEAD



1275 N. GROVE ST.  
 ANAHEIM, CA 92806  
 Cable: NATCOLGLZ

TO ORDER OR  
 DLR INFO. CALL  
 (714) 630-4541

NOTE: Price, Specifications subject to change  
 without notice and obligation

254

# The Spider™ Antenna

The modern multi-band mobile antenna — switch to 10, 15, 20 or 40 meters without stopping to change resonators.

## Features of the Spider™ Antenna

- The Spider™ Antenna is less than six feet high and the longest resonator projects out from the mast 24 inches. This gives a slim profile, low height and light weight, offering little wind resistance and eliminating the need for a spring mount.

- Each resonator is tuned to the desired portion of the band by a tuning sleeve which slides over the outside of the resonator.

- SWR is approximately 1:1 at the selected resonant frequency.

- Base impedance approximately 50 ohms, requiring no matching network.

- Ideal for use on vans, campers, motor homes, travel trailers; also in mobile home parks, apartment houses and condominiums.

**The Spider™ Adapter** converts any mono-band antenna with a half-inch mast into a modern four-band antenna.

**The Spider™ Maritimer™** is the ultimate for marine use. Made of non-magnetic stainless steel and nickel-chrome plated bronze, using regular Spider™ resonators and tuning sleeves.

**Accessories** — Bumper, ball, angle and stud mounts. Quick disconnects. RG-58A/U coaxial cable and connectors. Ground radial systems. Copper foil and copper braid ground straps.

For further information, prices write or call

## MULTI-BAND ANTENNAS

7131 OWENSMOUTH AVENUE, SUITE 463C  
CANOGA PARK, CALIF. 91303  
TELEPHONE: (213) 341-5460 ✓173

812-422-0231

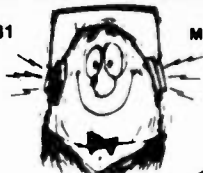

Mon-Fri 9AM-6PM  
Sat 9AM-3PM

## The HAM SHACK

808 N. Main  
Evansville, IN 47711

AEA Prices and Availability Subject to Change

CP-1 New Computer Interface	call
MBA-RO Reader	\$259.00
BT-1 Trainer	72.00
<b>ALLIANCE</b>	
HD73 (10.7 sq. ft.) Rotator	\$99.00
U-100 Small Rotator	45.00
<b>ASTRON</b>	
RS7A 5-7 Amp Power Supply	\$49.00
RS10A 7.5-10 Amp Power Supply	59.00
RS12A 9-12 Amp Power Supply	69.00
RS20A 16-20 Amp Power Supply	89.00
RS20M 16-20 Amp w/meter	109.00
RS35A 25-35 Amp	135.00
RS35M 25-35 Amp w/meter	149.00
RS50A 37-50 Amp	199.00
RS50M 37-50 Amp w/meter	225.00
<b>AZDEN</b>	
PCS 4000 2M Xcvr	\$280.00
PCS 300 Handheld	275.00
<b>BAW</b>	
Folded Dipole 80-10 Meter	\$135.00
<b>BENCHER</b>	
BY-1 Paddle/BY-2 Chrome	\$36.00/\$45.00
ZA-1-A Balun	16.50
<b>BUTTERNUT</b>	
HF6V 80-10 Meter vertical	\$119.00
<b>CUSHCRAFT</b>	
A3 Tribander 3 EL	\$179.00
A4 Tribander 4 EL	225.00
214FB Boomer 14 EL FM	89.00
32-19 Super Boomer 19 EL 2M	83.00
AFX-2B Ringo Ranger II 2M	39.00
<b>DAIWA</b>	
CN 520 1.8-80 MHz SWR/Pwr Mtr.	83.00
CN-820B 1.8-150 MHz SWR/Pwr Mtr.	110.00
<b>DRAKE</b>	
TR7A Xcvr	\$1,375.00
R7A Receiver	1,349.00
TR5 Xcvr	875.00
12 Inch Green Monitor	135.00
<b>ENCOMM (SANTEC)</b>	
ST-144µP	call
<b>ETO</b>	
Alpha 78	\$2,495.00
<b>HAL</b>	
DS3100/MPT/ST6000	\$2,825.00
CT2200/KB2200	949.00
<b>HY-GAIN</b>	
Explorer 14 Tribander	call
TH7 DXS 7EL Tribander	\$375.00
TH5 MK2S 5EL Tribander	319.00
V2S 2 Meter Vertical	39.00
Ham IV 15 sq. ft. Rotator	195.00
T2X 20 sq. ft. Rotator	249.00
<b>ICOM</b>	
R70 General Coverage Receiver	\$629.00
720A General Coverage Xcvr	989.00
740 Xcvr/Pwr Supply & Rebate	945.00
730 Xcvr	645.00
2AT 2M Handheld	215.00
3AT/AAT Handhelds	235.00
25A new display & mic	305.00
25H 45W Mobile	349.00
290H 2M All Mode	479.00
271A 2M All Mode	call
<b>KLM</b>	
KT34A 4EL Triband Beam	\$305.00
KT34XA 6 EL Triband Beam	485.00
144-148-13LBA 2M Long Boomer	79.00
<b>KANTRONICS</b>	
The Fantastic Interface for CW, RTTY, ASCII Software available for VIC 20, VIC 64, APPLE, ATARI, TR80C & TI99. Call for package pricing.	
<b>LARSEN</b>	
NLA-150-MM 5/8 Wave 2M Mag. Mt.	\$39.00
<b>MFJ</b>	
989 3KW Roller Inductor Tuner	\$280.00
941C Tuner	81.00
900 Tuner	45.00
313 VHF Conv for HT	36.00
<b>MIRAGE</b>	
B1018	239.00
B3018	199.00
<b>ROHN</b>	
25G	\$42.00
<b>SHURE</b>	
444D Desk Mic	\$50.00
414A Hand Mic	36.00
<b>TEN-TEC</b>	
New 2M Handheld	call
Corsair Fantastic Rig!	call
Digital Argosy	\$539.00
2KW Tuner Kit	185.00
<b>TOKYO HY-POWER</b>	
HL30V 25W Amp	\$63.00
HL82V 80W Amp	139.00
HL160V 160W Amp	289.00
HC2000 2KW Tuner	289.00

YAESU  
Now in stock. Call for Prices

Send SASE for Our New & Used Equipment List  
Prices are FOB Evansville

# ELECTRICITY FROM SUNLIGHT

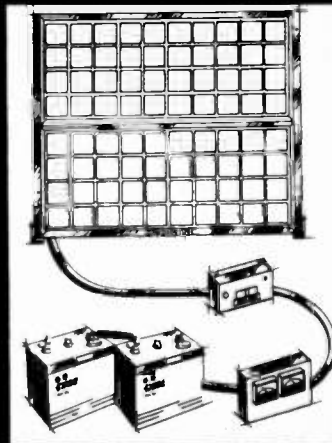

## We Make Photovoltaic Systems, Components, Hardware & Accessories A REALITY TODAY

Send \$3.50 for Catalog to:  
**ENCON PHOTOVOLTAICS**  
Distributors of Solarex Photovoltaics  
Dept. 73 27584 Schoolcraft  
Livonia, MI 48150  
(313) 261-4130 ✓172

# AZDEN®

## PHASE II TWIN ANTENNA

- SUPER 80- POUND, 100- MPH GRAY MAGNETIC MOUNT WITH MYLAR BASE
- 5/8 WAVE FOR PHASE II SIGNAL AND
- 1/4 WAVE FOR CLOSE-IN AND RESTRICTED HEIGHT AREAS
- INSTANT CHANGE-OVER
- SUPERIOR PERFORMANCE
- STAINLESS STEEL SPRING AND WHIP
- CHROME ON BRASS BASE- COMPARE!
- BOTH ANTENNAS ARE FREQUENCY ADJUSTABLE
- COMPLETE WITH 17 FEET OF FOAM COAX AND PL-259 CONNECTOR
- MADE IN U.S.A

INTRODUCTORY PRICE:

**\$29.95**

COMPARE!!

TWO ANTENNAS FOR THE PRICE OF ONE!

### AMATEUR-WHOLESALE ELECTRONICS

8817 S.W. 129th Terrace, Miami, Florida 33176

Telephone (305) 233-3631 • Telex: 80-3356

HOURS: 9 - 5 Monday thru Friday

• U.S. DISTRIBUTOR • DEALER INQUIRIES INVITED



✓243

ORDER NOW TOLL FREE

**800-327-3102**

THE WORLD FAMOUS  
**ETCO**  
CATALOG OF ELECTRONICS

**FREE** LOW PRICES

- VIDEO
- TELEPHONE
- CABLE TV
- PARTS
- AUDIO
- ELECTRONICS
- and much more!

1000's OF FASCINATING FACTORY CLEAROUTS SURPLUS SPECIALS AND BARGAIN OFFERS NOT FOUND IN STORES OR CATALOGS ANYWHERE!

**ETCO ELECTRONICS** ✓248  
DEPT. 590  
Mailing List Control Center  
Box 840  
Champlain, N.Y. 12919

I Enclose \_\_\_\_\_ (cash OK);  
Please rush postpaid

\$1 for 1 year subscription to the world famous ETCO catalog.

\$3 Canadian & Foreign 1 year subscription to the ETCO catalog.

304 page handbook "BUILD YOUR OWN EARTH STATION". (TA025) \$10.00

360 pages MASTER HANDBOOK OF TELEPHONES. (TA001) \$11.00

FREE - sample copy of the bargain packed ETCO catalog. (USA only)

Name \_\_\_\_\_  
Address \_\_\_\_\_  
City \_\_\_\_\_  
State \_\_\_\_\_ Zip \_\_\_\_\_

# THE SELECTRIC™ INTERFACE

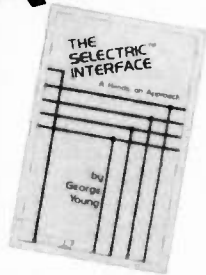

## Daisy wheel quality without daisy wheel expense.

You need the quality print that a daisy wheel printer provides but the thought of buying one makes your wallet wilt. *The Selectric™ Interface*, a step-by-step guide to interfacing an IBM Selectric I/O Writer to your microcomputer, will give you that quality at a fraction of the price. George Young, co-author of *Microcomputing* magazine's popular "Kilobaud Classroom" series, offers a low-cost alternative to buying a daisy wheel printer.

*The Selectric™ Interface* includes:

- step-by-step instructions
- tips on purchasing a used Selectric™
- information on various Selectric™ models, including the 2740, 2980, and Dura 1041
- driver software for Z80, 8080, and 6502 chips
- tips on interfacing techniques

With *The Selectric Interface* and some background in electronics, you can have a high-quality, low-cost, letter-quality printer. Petals not included.

Credit card orders call TOLL-FREE 1-800-258-5473. Or mail your order with payment plus \$1.50 shipping and handling to: Wayne Green Inc. Attn: Retail Book Sales, Peterborough, NH 03458.

Dealer inquiries invited.

ISBN 0-88006-051-4

128 pages

**\$12.97**

Yes, I want **Selectric Interface** (BK7388). Enclosed is \$12.97 per copy plus \$1.50 for shipping and handling.

MASTER  VISA  AMEX

Card # \_\_\_\_\_ Expires \_\_\_\_\_

Signature \_\_\_\_\_

Name \_\_\_\_\_

Address \_\_\_\_\_

City \_\_\_\_\_

State and Zip \_\_\_\_\_ 337B6S

All orders shipped LUPS if complete street address is given.

# MOVING?

Let us know 8 weeks in advance so that you won't miss a single issue of 73 Magazine.

Attach old label where indicated and print new address in space provided. Also include your mailing label whenever you write concerning your subscription. It helps us serve you promptly. Write to:

**73** Amateur Radio's Technical Journal  
Subscription Department  
P.O. Box 931  
Farmingdale NY 11737

- Extend my subscription one additional year for only \$19.97  
 Payment enclosed  Bill me

Canada and Mexico \$22.97, US funds, Foreign Surface \$39.97; US funds, drawn on US banks, Foreign Airmail, please inquire.

If you have no label handy, print OLD address here.

AFFIX LABEL

Name \_\_\_\_\_

Address \_\_\_\_\_

City \_\_\_\_\_ State \_\_\_\_\_ Zip \_\_\_\_\_

print NEW address here:

Name \_\_\_\_\_

Address \_\_\_\_\_

City \_\_\_\_\_ State \_\_\_\_\_ Zip \_\_\_\_\_

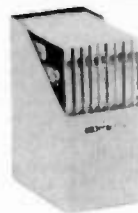

MAKE IT  
EASY  
TO  
SAVE



your copies of  
**73 Magazine**

Your magazine library is your prime reference source—keep it handy and keep it neat with these strong library shelf boxes. They are made of white corrugated cardboard and are dust resistant. Use them to keep *all* your magazines orderly yet available for constant reference.

Self-sticking labels are available for the following:

80 Micro	73 Magazine	Radio Electronics
Microcomputing	QST	Personal Computing
inCider	CQ	Byte
Desktop Computing	Ham Radio	Interface Age

One box (BX1000) is \$2.00, 2-7 boxes (BX1001) are \$1.50 each, and 8 or more boxes (BX1002) are \$1.25 each. Be sure to specify which labels we should send.

Call TOLL-FREE for credit card orders:  
**1-800-258-5473**

Or use the order form in this magazine and mail to:

**73 Magazine**

Attn: Book Sales, Peterborough, NH 03458

SHIPPING AND HANDLING CHARGES \$2.00 per order



# RADIO BOOKSHOP

## FOR THE NOVICE

New, updated editions  
of our famous novice  
license study guide and novice study tapes.

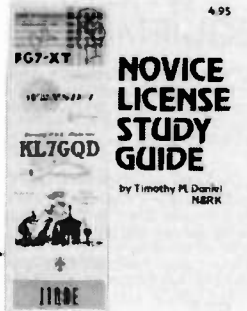

73

Code Tapes  
any four tapes for  
\$15.95! \$4.95 each

● **NOVICE LICENSE STUDY GUIDE**—by Timothy M. Daniel N8RK. Here is the most up to date novice guide available. It is complete with information about learning Morse Code, has the latest FCC amateur regulations and the current FCC application forms. This guide is *not* a question/answer memorization course but rather it emphasizes the practical side of getting a ham license and putting a station on the air. It reflects what the FCC expects a Novice to know without page after page of dull theory. The most current information still available at last year's price. SG7357 \$4.95.\*

● **NOVICE STUDY TAPES**—If you are just getting started in ham radio, you'll find these tapes indispensable! This up-to-the-minute revision of the 73 Study Course is the perfect way to learn everything you need to breeze through the Novice written exam. Theory, FCC regulations, and operating skills are all covered, and you'll be amazed at how fast you learn using these tapes!

Once the test is behind you, these tapes will go right on being useful, because they are packed with the latest information on setting up your own ham station, and getting on the air.

Thousands of people have discovered how easy learning from cassette can be—order now and enter the fascinating world of ham radio! CT7300 Set of 3—\$15.95.\*

Scientists have proven that you learn faster by listening than by reading because you can play a cassette tape over and over in your spare time—even while you're driving! You get more and more info each time you hear it. You can't progress without solid fundamentals. These three hour-long tapes give you all the basics you'll need to pass the Novice exam easily. You'll have an understanding of the basics which will be invaluable to you for the rest of your life! Can you afford to take your Novice exam without first listening to these tapes?

Special Offer! Both Novice License Study Guide  
and Novice Study Tapes \$19.95 Order NP7300.

## GENERAL LICENSE STUDY GUIDE

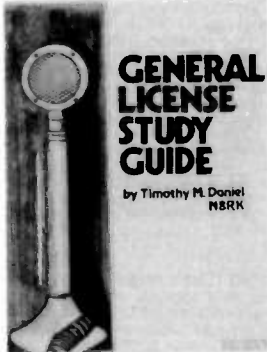

**GENERAL LICENSE STUDY GUIDE**—By Timothy M. Daniel N8RK This is the complete guide to the General License. Learning rather than memorizing is the secret. This is not a question-and-answer guide that will gather dust when the FCC issues a new test. Instead, this book will be a helpful reference, useful long after a ham upgrades to General. Includes up-to-date FCC rules and an application form. Order yours today and talk to the world. SG7358 \$6.95



Style W

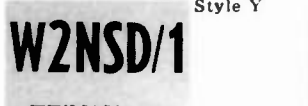

Style Y



Style X

● **QSL CARDS**—73 turns out a fantastic series of QSL cards at about half the cost of having them done elsewhere because they are run as a fill-in between printing books and other items in the 73 Print Shop. 250 Style W—QW0250—for \$8.95\*; 500 Style W—QW0500—for \$13.95\*; 250 Style X—QX0250—for \$8.95\*; 500 Style X—QX0500, 250 Style Y—QY0250—for \$8.95\*; 500 Style Y—QY0500—for \$13.95\*. Allow 6-12 wks. for delivery.

**LIBRARY SHELF BOXES**—These sturdy white corrugated, dirt boxes each hold a full year of 73, *Microcomputing* or *80 Micro Desktop Computing*, *InCider*. With your order, request self-sticking labels for any of the following: 73, *Microcomputing*, *80 Micro*, *CQ*, *QST*, *Ham Radio Personal Computing*, *Radio Electronics*, *Interface Age*, and *Byte*. Order 1—BX1000—for \$2.00\*; order 2-7—BX2002—for \$1.50 each\*; order 8 or more—BX1002—for \$1.25 each\*.

\* Use the order card in this magazine or itemize your order on a separate piece of paper and mail to: 73 Radio Bookshop • Peterborough NH 03458. Be sure to include check or detailed credit card information. No C.O.D. orders accepted. \$1.50 for the first book, \$1.00 each additional book for U.S. delivery and foreign surface. For foreign airmail \$10.00 per book. Please allow 4-6 weeks for delivery. Questions regarding your order? Please write to Customer Service at the above address. (Prices subject to change on books not published by 73 Magazine.)

### "GENESIS"

5 **WPM**—CT7305—This is the beginning tape for people who do not know the code at all. It takes them through the 26 letters, 10 numbers and necessary punctuation, complete with practice every step of the way using the newest blitz teaching techniques. It is almost miraculous! In one hour many people—including kids of ten—are able to master the code. The ease of learning gives confidence to beginners who might otherwise drop out.

### "THE STICKLER"

6+ **WPM**—CT7306—This is the practice tape for the Novice and Technician licenses. It is made up of one solid hour of code, sent at the official FCC standard (no other tape we've heard uses these standards, so many people flunk the code when they are suddenly—under pressure—faced with characters sent at 13 wpm and spaced for 5 wpm). This tape is not memorizable, unlike the zany 5 wpm tape, since the code groups are entirely random characters sent in groups of five.

### "BACK BREAKER"

13+ **WPM**—CT7313—Code groups again, at a brisk 14 per so you will be at ease when you sit down in front of the steely-eyed government inspector and he starts sending you plain language at only 13 per. You need this extra margin to overcome the panic which is universal in the test situations. When you've spent your money and time to take the test, you'll thank heaven you had this back-breaking tape.

### "COURAGEOUS"

20+ **WPM**—CT7320—Code is what gets you when you go for the Extra class license. It is so embarrassing to panic out just because you didn't prepare yourself with this tape. Though this is only one word faster, the code groups are so difficult that you'll almost fall asleep copying the FCC stuff by comparison. Users report that they can't believe how easy 20 per really is with this fantastic one hour tape.

### "OUTRAGEOUS"

25+ **WPM**—CT7325—This is the tape for that small group of overachieving hams who wouldn't be content to simply satisfy the code requirements of the Extra Class license. It's the toughest tape we've got and we keep a permanent file of hams who have mastered it. Let us know when you're up to speed and we'll inscribe your name in 73's CW "Hall of Fame."

## For Your Ham Shack 73 Magazine Binders

● Preserve and protect your collection for a lifetime! Order these handsome red binders with gold lettering. \$7.50 for 1, 3 for \$21.75, 6 for \$42.00. (Postpaid within USA, please add \$2.50 per order outside USA.) Check or money orders only, no phone or C.O.D. orders. 73 Binders, P.O. Box 5120, Philadelphia, PA 19141.

\*NOTE—Above address for Binders only.

**BACK ISSUES**—Complete your collection; many are prime collectables now, classics in the field! A full collection is an invaluable compendium of radio and electronics knowledge!

73300	73 BACK ISSUE—BEFORE JULY 1980	\$ 3.00
73350	73 BACK ISSUE JULY 1980 THRU OCT. 1981	\$ 3.50
73350P	73 BACK ISSUE NOV. 1981 TO PRESENT	\$ 3.50
73005	73 BACK ISSUE—5 YOUR CHOICE	\$10.75
73010	73 BACK ISSUE—10 YOUR CHOICE	\$16.00
73025	73 BACK ISSUE—25 YOUR CHOICE	\$27.00
73125	73 BACK ISSUE—25 OUR CHOICE	\$14.00

Shipping: Please add \$1.00 per magazine. Orders of ten magazines or twenty-five magazines add \$7.50 per order.

FOR TOLL FREE ORDERING CALL 1-800-258-5473

# RADIO BOOKSHOP

## HAND BOOKS FOR NEW! THE HAMSHACK

**AMATEUR RADIO CALL DIRECTORY, 1982-1983 Edition.** Compiled by Jack A. Speer N1BIC and Ashok K. Anand. Here it is, and at a price you can afford! A directory of over 410,000 radio amateurs in the United States (as licensed by the U.S. Gov't). Completely updated for 1983. Easy to handle 8 1/2 x 11 format. BK1254 \$14.95

**THE TEN METER FM HANDBOOK**—by Bob Hell K9EID. This handbook has been published to help the ten meter enthusiast learn more about the many methods of conversions and tricks that are used to make existing units work better. Join the great "tinkers" of the world on ten FM and enjoy the fantastic amount of fun in communicating with amateur stations worldwide on ten meter FM. BK1190 \$4.95.

**THE COMPLETE SHORTWAVE LISTENER'S HANDBOOK, 2nd EDITION** by Hank Bennett and Harry L. Helms. This comprehensive volume contains loads of new information from all over the world on the latest developments in SWL technology clubs, associations, practices and stations. A thorough guide to stations of the world by general continental area and frequency is included. BK1241 \$9.95

**THE PRACTICAL HANDBOOK OF AMATEUR RADIO FM REPEATERS**—by Bill Pasternak WA6ITF (author of 73 Magazine's monthly column "Looking West") This is the book for the VHF/UHF FMer, compiled from material submitted by over a hundred individuals, clubs, organizations and equipment manufacturers. A "must have" for your ham shack shelf. BK1185 \$12.95.

## THE 73 TEST EQUIPMENT LIBRARY

**VOL. II AUDIO FREQUENCY TESTERS**—Jam-packed with all kinds of audio frequency test equipment. If you're into SSB, RTTY, SSTV, etc., this book is a must for you... a good book for hi-fi addicts and experimenters, too! LB7360 \$1.95.

**VOL. III RADIO FREQUENCY TESTERS**—Radio frequency waves, the common denominator of amateur radio. Such items as SWR, antenna impedance, line impedance, RF output, and field strength; detailed instructions on testing these items includes sections on signal generators, crystal calibrators, grid dip oscillators, noise generators, dummy loads, and much more. LB7361 \$1.95.

**VOL. IV IC TEST EQUIPMENT**—Become a troubleshooting wizard! Here are 42 home construction projects for building test equipment to work with your ham station and in servicing digital equipment. Plus a cumulative index for all four volumes for the 73 TEST EQUIPMENT LIBRARY. LB7362 \$1.95.

**ALL THREE OF THE ABOVE ONLY \$4.95 ORDER LB7365**

**RF AND DIGITAL TEST EQUIPMENT YOU CAN BUILD**—BK1044—Rf burst, function, square wave generators, variable length pulse generators—100 kHz marker, i-f and rf sweep generators, audio osc, af/rf signal injector, 146 MHz synthesizer, digital readouts for counters, several counters, prescaler, microwave meter, etc. 252 pages. BK1044 \$5.95.

## FOR THE CONTESTER

**THE CONTEST COOKBOOK**—This book reveals the secrets of that elite group of operators who top the list when the contest results are published. It contains detailed suggestions for the first-time contesteer as well as tips for the advanced operator. Domestic, DX, and specialty contests are all discussed, complete with photographs and diagrams showing the equipment and operating aids used by the top scorers. For the serious contesteer. BK7308 \$5.95.

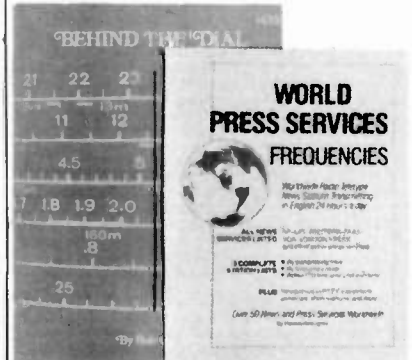

## 2 NEW RTTY BOOKS

**WORLD WIDE RADIO TELETYPE STATIONS IN FREQUENCY ORDER**—8th EDITION Compiled by Universal Electronics, Inc. Contains 2198 frequencies of stations that have been logged in 1982. Frequency, call sign, name of station, ITU country symbol, times of reception and details are included. All types of RTTY stations are listed including schedules of 82 press and news agencies operating on 637 frequencies. Includes 77 meteorological stations on 279 frequencies. Covers all RTTY stations from 3 MHz to 30 MHz, air, metro, government, military, diplomatic, covers all services. This is the most accurate RTTY list there is and a must for the serious RTTY enthusiast. BK1270 \$10.95.

**WORLDWIDE RADIO TELETYPE CALL SIGN LIST OF UTILITY STATIONS**—8th EDITION Compiled by Universal Electronics, Inc. Contains more than 4000 call signs in alphanumeric order. All types of stations are listed. 183 utility station mnemonics and name abbreviations. Plus abbreviations for regional states in Australia, Canada, USA and USSR. All ITU Symbols designating countries or geographical areas. Table of allocation of international call sign series. Revised radio regulations on identification of stations, including formation or call signs. All services listed. BK1271 \$4.95

**70 YEARS OF RADIO TUBES AND VALVES**—by John Stokes "Great, the best book on the history of radio tubes that I've ever seen!" raved 73's technical editor. Written by an expert who has been involved in radio since '29, this book will be of special interest to "old-timers" and will provide those younger hams with a unique sense of the history of their hobby. BK1272 \$21.95

**EVERYTHING YOU ALWAYS WANTED TO KNOW ABOUT AMATEUR TELEVISION, (but were afraid to ask)**—By Mike Stone WB0CQ. This book is a complete guide to setting up your own amateur radio television station. It contains—A history, what equipment you need, video theory, cameras, recorders, lighting, special effects, sound ATV DXing, mobile FSTV, ATV repeaters, ATV groups, building projects, test equipment, dealer directory, a cumulative index of over 1000 articles on amateur TV and much more. This is the new, 1982 edition. From the publishers of *Amateur Television Magazine*. BK1244 \$9.95

**WORLD PRESS SERVICE FREQUENCIES**—by Thomas Harrington Can't wait to hear the evening news, or are you wondering about the news that you aren't hearing? Receive by Radio Teletype (RTTY) all the world news and financial happenings from the world capitals on a 24 hour a day basis. This book gives you the frequencies and times of broadcast of such news services as AP, UPI, Reuters, TASS, VOA and London Press. Also included is an introduction to RTTY with information on equipment, antennas, abbreviations—everything you need to get started in RTTY. BK1202 \$7.95

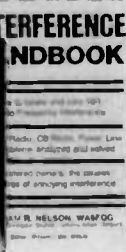
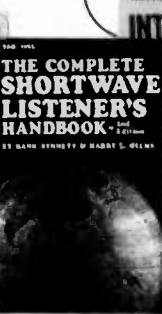
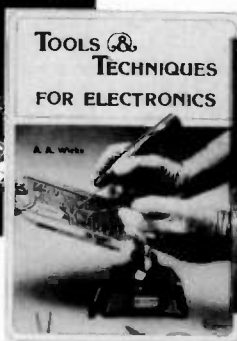

## THE 73 TECHNICAL LIBRARY

**TOOLS & TECHNIQUES FOR ELECTRONICS**—by A. A. Wicks is an easy-to-understand book written for the beginning kit-builder as well as the experienced hobbyist. It has numerous pictures and descriptions of the safe and correct ways to use basic and specialized tools for electronic projects, as well as specialized metal-working tools and the chemical aids which are used in repair shops. BK7348 \$4.95.

**BEHIND THE DIAL**—This book explains, in detail, what's going on on all the frequencies, from shortwave up to microwave. It gives the reader a good idea of what he can find and where to find it, including some of the secret stations such as the C.I.A. and the F.B.I. Everything is covered short of microwave monitoring. Anyone interested in purchasing a shortwave receiver should have a copy of this book, surveillance, station layout consideration, antenna systems, interface, and the electromagnetic spectrum, are included. BK7307 \$4.95

**THE NEW WEATHER SATELLITE HANDBOOK**—by Dr. Ralph E. Taggart WB8DQT. Here is the completely updated and revised edition containing all the information on the most sophisticated and effective spacecraft now in orbit. This book serves both the experienced amateur satellite enthusiast and the newcomer. It is an introduction to satellite watching, providing all the information required to construct a complete and highly effective ground station. Solid hardware designs and all the instructions necessary to operate the equipment are included. For experimenters who are operating stations, the book details all procedures necessary to modify equipment for the new series of spacecraft. Amateur weather satellite activity represents a unique blend of interests encompassing electronics, meteorology and astronautics. Join the privileged few in watching the spectacle of earth as seen from space on your own monitoring equipment. BK7383 \$8.95.

**PROPAGATION WIZARD'S HANDBOOK**—by J. H. Nelson. When sunspots riddled the worldwide communications networks of the 1940s, John Henry Nelson looked to the planets for an answer. The result was a theory of propagation forecasting based upon interplanetary alignment that made the author the most reliable forecaster in America today. The book provides an enlightened look at communications past, present, and future, as well as teaching the art of propagation forecasting. BK7302 \$6.95.

**SSB... THE MISUNDERSTOOD MODE**—by James B. Wilson. Single Sideband Transmission... thousands of us use it every day, yet it remains one of the least understood facets of amateur radio. J. B. Wilson presents several methods of sideband generation, amply illustrated with charts and schematics, which will enable the ambitious reader to construct his own sideband generator. A must for the technically-serious ham. BK7351 \$5.50.

**INTERFERENCE HANDBOOK**—by William R. Nelson, WA6EQG—This timely handbook covers every type of RFI problem and gives you the solutions based on practical experience. Covers interference to TV, radio, hi-fi, telephone, radio amateur, commercial and CB equipment. Power line interference is covered in depth—how to locate it, cure it, work with the public, safety precautions, how to train RFI investigators. Written by an RFI expert with 33 years of experience, this profusely illustrated book is packed with practical easy-to-understand information. BK1230 \$11.95.

**OWNER REPAIR OF RADIO EQUIPMENT**—by Frank Glass K6RO. Here's a book that will teach you an approach to troubleshooting without a shack full of test equipment. Written in a narrative, non-mathematical style, it will encourage you to successfully fix your own rig problems 80 to 90% of the time. Even if you don't want to fix, you can learn a lot about how things work and fail. Add to your library and personal expertise. BK7310 \$7.95.

\*Use the order card in this magazine or itemize your order on a separate piece of paper and mail to: 73 Radio Bookshop • Peterborough NH 03458. Be sure to include check or detailed credit card information. No C.O.D. orders accepted. \$1.50 for the first book, \$1.00 each additional book for U.S. delivery and foreign surface. For foreign airmail \$10.00 per book. Please allow 4-6 weeks for delivery. Questions regarding your order? Please write to Customer Service at the above address. (Prices subject to change on books not published by 73 Magazine.)

FOR TOLL FREE ORDERING CALL 1-800-258-5473

# RADIO BOOKSHOP

## ANTENNA BOOKS

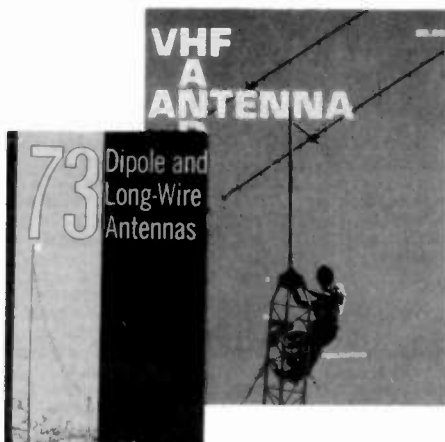
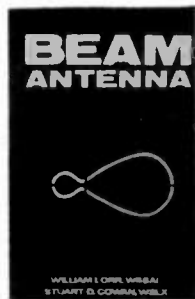
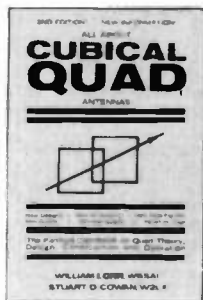

**VHF ANTENNA HANDBOOK**—The new *VHF Antenna Handbook* details the theory, design, and construction of hundreds of different VHF and UHF antennas... a practical book written for the average amateur who takes joy in building, not full of complex formulas for the design engineer. Packed with fabulous antenna projects you can build. BK7368 \$5.95.\*

**ALL ABOUT CUBICAL QUAD ANTENNAS (2nd edition)**—The "Classic" on Quad design, theory, construction, and operation. New 2nd edition contains new feed and matching systems and new data. BK1196 \$6.95.

**THE RADIO AMATEUR ANTENNA HANDBOOK**—All about wire antennas, beams, tuners, baluns, coax, radials, SWR and towers. Clear and complete information. BK1199 \$7.95

**SIMPLE, LOW-COST WIRE ANTENNAS FOR RADIO AMATEURS**—All new data and everything you want to know about low-cost, multi-band antennas, inexpensive beams, "invisible" antennas for hams in "tough" locations. BK1200 \$7.95

**HOW TO DEFEND YOURSELF AGAINST RADAR**—by Bruce F. Bogner and James R. Bodnar, a lawyer and radar expert. This book gives you the ammunition to challenge the radar "evidence" that usually leads to a speeding conviction. The major part of the book details the inner workings of radar—you'll become more of an expert than most police officers and judges. The remainder of the book outlines how to defend yourself against a speeding ticket—the observations, measures and testimony you must obtain to defend yourself without the help of a lawyer. The price is a lot less than a fine! BK1201 \$6.95.\*

## MICROCOMPUTER BOOKS

**THE SELECTRIC INTERFACE**—by George Young. You need the quality print that a daisy wheel printer provides but the thought of buying one makes your wallet wilt. **SELECTRIC™ INTERFACE**, a step-by-step guide to interfacing an IBM Selectric I/O Writer to your microcomputer, will give you that quality at a fraction of the price. George Young, co-author of *Kilobaud Microcomputing* magazine's popular "Kilobaud Klassroom" series, offers a low-cost alternative to buying a daisy wheel printer. **SELECTRIC INTERFACE** includes: step-by-step instructions, tips on purchasing a used Selectric, information on various Selectric models, including the 2740, 2980, and Dura 1041, driver software for Z80, 8080, and 6502 chips, tips on interfacing techniques. With **SELECTRIC INTERFACE** and some background in electronics, you can have a high-quality, low-cost, letter-quality printer. Petals not included. BK7388 \$12.97

**40 COMPUTER GAMES FROM KILOBAUD MICROCOMPUTING**—Forty games in nine different categories. Games for large and small systems, and a section on calculator games. Many versions of BASIC used and a wide variety of systems represented. A must for the serious computer gamesman. BK7381 \$7.95\*

**KILOBAUD KLASROOM**—By George Young and Peter Stark. Learning electronics theory without practice isn't easy. And it's no fun to build an electronics project that you can't use. *Kilobaud Klassroom* the popular series first published in *Kilobaud Microcomputing*, combines theory with practice. This is a *practical* course in digital electronics. It starts out with very simple electronics projects, and by the end of the course you'll construct your own working microcomputer! BK7386 \$14.95

\*Use the order card in this magazine or itemize your order on a separate piece of paper and mail to: 73 Radio Bookshop • Peterborough NH 03458. Be sure to include check or detailed credit card information. No C.O.D. orders accepted. \$1.50 for the first book, \$1.00 each additional book for U.S. delivery and foreign surface. For foreign airmail \$10.00 per book. Please allow 4-6 weeks for delivery. Questions regarding your order? Please write to Customer Service at the above address. (Prices subject to change on books not published by 73 Magazine.)

**73 DIPOLE AND LONG-WIRE ANTENNAS**—by Edward M. Noll W3FQJ. This is the first collection of virtually every type of wire antenna used by amateurs. Includes dimensions, configurations, and detailed construction data for 73 different antenna types. Appendices describe the construction of noise bridges, line tuners, and data on measuring resonant frequency, velocity factor, and swr. BK1016 \$5.50.\*

**BEAM ANTENNA HANDBOOK (New 5th edition)**—by William I. Orr & Stuart D. Cowan. Yagi beam theory, construction and operation. Information on wire beams, SWR curves and matching systems. A "must" for serious DXers. BK1197 \$7.95.

## COOK BOOKS

**TTL COOKBOOK**—by Don Lancaster. Explains what TTL is, how it works, and how to use it. Discusses practical applications, such as a digital counter and display system, events counter, electronic stopwatch, digital voltmeter and a digital tachometer. BK1063 \$9.50.\*

**CMOS COOKBOOK**—by Don Lancaster. Details the application of CMOS, the low power logic family suitable for most applications presently dominated by TTL. Required reading for every serious digital experimenter! BK1011 \$10.50.\*

**TVT COOKBOOK**—by Don Lancaster. Describes the use of a standard television receiver as a microprocessor CRT terminal. Explains and describes character generation, cursor control and interface information in typical, easy-to-understand Lancaster style. BK1064 \$9.95.\*

**IC OP-AMP COOKBOOK**—by Walter G. Jung. Covers not only the basic theory of the IC op amp in great detail, but also includes over 250 practical circuit applications, liberally illustrated. 592 pages, 5 1/2 x 8 1/2, softbound. BK1028 \$14.95.\*

## THE WELL EQUIPPED HAM SHACK

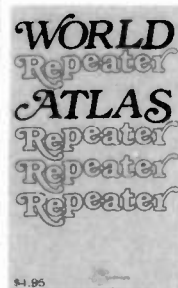

**WORLD REPEATER ATLAS**—Completely updated, over 230 pages of repeater listings are indexed by location and frequency. More than 50 maps pinpoint 2000 repeater locations throughout the USA. Foreign listings include Europe, the Middle East, South America, and Africa. BK7315 \$2.00

**THE MAGIC OF HAM RADIO**—by Jerrold Swank WBHXR. Under various call signs, WBHXR has been heard on the ham bands since 1919. He has watched amateur radio grow from the days of Model A spark coils to an era of microprocessors and satellite communications. Jerry has responded to calls for help from earthquake-stricken Managua and tornado-ravaged Xenia, Antarctica, one of man's loneliest outposts, has been a bit less lonely, thanks to Jerry's tireless phonepatching efforts. Drawing on his own colorful experiences and those of many other hams, Jerry has compiled this word-picture of ham radio during the past six decades. BK7312 \$4.95

**A GUIDE TO HAM RADIO**—by Larry Kahaner WB2NEL. What's Amateur Radio all about? You can learn the basics of this fascinating hobby with this excellent beginner's guide. It answers the most frequently asked questions in an easy-going manner, and it shows the best way to go about getting an FCC license. A Guide to Ham Radio is an ideal introduction to a hobby enjoyed by people around the world. BK7321 \$4.95.\*

**WORLD RADIO TV HANDBOOK 1983, 26TH EDITION**—This book is the bible of international broadcasters, providing the only authoritative source of exact information about broadcasting and TV stations world wide. This 1983 edition is completely revised, giving comprehensive coverage of short, medium and long wave, 560 pages of vital aspects of world listening. BK1184 \$16.50

FOR TOLL FREE ORDERING CALL 1-800-258-5473





**ASSOCIATED RADIO**

**913-381-5900**

8012 CONSER BOX 4327  
OVERLAND PARK, KANSAS 66204

# BUY—SELL—TRADE

All Brands New & Reconditioned



**YOU WANT A DEAL — WE WANT TO DEAL  
CALL NOW!!!**



## SAVE—SAVE—SAVE



**NOTE: SEND \$1.00 FOR OUR CURRENT CATALOG OF NEW AND RECONDITIONED EQUIPMENT  
SEND \$1.00 FOR OUR WHOLESALE LIST OF UNSERVICED & OVERSTOCK ITEMS.  
SEND \$2.00 FOR BOTH. THEY WILL BE MAILED SEPARATELY.**

**\$39.95**  
Assembled

**Communications Design, Inc.**

1504 E. Thompson St. - West Memphis, AR 72301  
501-738-4568

## MORSE ONE KEYS

Iambic Operation for Squeeze Keys  
Self Completing Dots & Dashes  
Adjustable Volume & Side Tone  
All CMOS Design  
Relay Keying — Fast Acting Reed  
Keys Any Rig

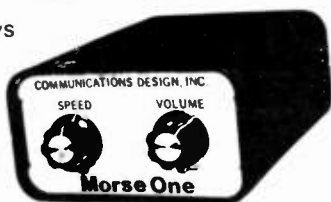

Sturdy Black Anodized Aluminum Cabinet  
Self Contained Power Supply (9 v Battery)

Call Or Write For Free Catalog Of Other CDI Products

## “BEEPER III”



**“THE PROFESSIONAL TOUCH  
COMES TO AMATEUR RADIO!”**

BP-3 automatically provides a gentle high frequency beep at the beginning of each transmission and a low beep at the end. Virtually eliminates “talk-over”! Operates for up to one year on a single 9-V battery (not supplied). Can be directly interfaced to any transceiver which is keyed by grounding the PTT line (the PTT line voltage must be positive, not greater than 24 VDC, nor the current greater than 100 ma.) Works with virtually all modern gear. You’ve heard it, now you can have it!

## “ADD THE BEEP!”

BP-3A Complete with case, cable, Standard 4-pin connectors . . . **39.95 pp**  
BP-3B As above except without connectors. Add your own . . . **36.95 pp**  
BP-3C Circuit-board version for custom installation . . . **29.95 pp**  
All units assembled/tested. OH residents add 6% Sales Tax!

## Radio World

CENTRAL NEW YORK'S MOST COMPLETE HAM DEALER

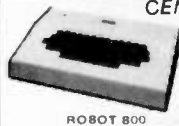

ROBOT 800



ICOM IC-720



KENWOOD TS830S



DRAKE TR7-DR7



YAESU FT707

Featuring Kenwood, Yaesu, Icom, Drake, Ten-Tec, Swan, Dentron, Alpha, Robot, MFJ, Tempo, Astron, KLM, Hy Grain, Mosley, Larsen, Cushcraft, Hustler, Mini Products, Bird, Mirage, Vibroplex, Bencher, Info-Tech, Universal Towers, Callbook, ARRL, Astatic, Shure, Collins, AEA. *We service everything we sell!*

Write or call for quote. **You Won't Be Disappointed.**

We are just a few minutes off the NYS Thruway (I-90) Exit 32

OUT OF STATE  
ORDER TOLL FREE  
800-448-9338

ONEIDA COUNTY AIRPORT TERMINAL BUILDING  
ORISKANY, NEW YORK 13424

N.Y. Res. Call (315) 736-0184

Warren - K21XN  
Bob - WA2MSH  
Al - WA2MSI

397

**FAXSCAN INC.**

3148 Dart Drive • Dayton, Ohio 45418

85

TM

# DX

Chod Harris VP2ML  
Box 4881  
Santa Rosa CA 95402

## WAS YOURS BIG ENOUGH?

The middle of the summer provides a time for reflection and anticipation for the DXer. DXing is at its worst of the year, with high absorption on the higher bands and static and noise on the lower bands. So the DXer reflects on "the ones that got away" last year and anticipates the next DX season.

In fact, the weather might even be nice enough to entice the DXer away from static crashes of the rig and outside for a critical look at the skyhook.

Have you ever heard of a DXer who is totally satisfied with his antenna farm? Summer brings thoughts of a "real" antenna. A big one! Wouldn't it be great to be known as a Big Gun... to be first in the pileups!

Alas, the limitations of the lot, the neighbors, and the pocketbook seem to rule out instant Honor Roll status, but perhaps a small upgrading is in order. After all, the bands are only going to get worse over the next few years, and there are many more DXers today than at the last sunspot minimum in 1975-6. Competition will be intense. More antenna and refinement of operating skills are the only defenses against deteriorating sunspot numbers.

"If your antenna lasted the winter, it wasn't big enough," the saying goes. Unfortunately, there are many amateurs whose antennas were indeed large enough for this past winter. For them, summer brings the chore of rebuilding, perhaps a little better than before, and on a stronger tower, of course.

Now that we're all in the mood for some serious antenna work, I must share the following. Picture an amateur sitting at a desk, laboriously writing a letter to an insurance company:

"I am writing in response to your request for additional information in block number three of the accident-reporting form. I put 'poor planning' as the cause of my accident. You said in your letter that I should explain more fully, and I trust that the following details will be sufficient. I am an amateur radio operator. On the day of the accident I was working alone on the

top section of my new 80-foot tower. When I had completed my work, I discovered that I had, over the course of several trips up the tower, brought up about 300 pounds of tools and spare hardware. Rather than carry the now unneeded tools and material down by hand, I decided to lower the items down in a small barrel by using a pulley, which fortunately was attached to the gin pole at the top of the tower.

"Securing the rope at ground level, I went to the top of the tower and loaded the tools and material into the barrel. Then I went back to the ground and untied the rope, holding it tightly to ensure a slow descent of the 300 lbs. of tools. You will note in block number eleven of the accident-reporting form that I weigh only 155 lbs.

"Due to my surprise at being jerked off the ground so suddenly, I lost my presence of mind and forgot to let go of the rope. Needless to say, I proceeded at a rather rapid rate of speed up the side of the tower. In the vicinity of the 40-foot level, I met the barrel coming down. This explains my fractured skull and broken collarbone. Slowed only slightly, I continued my rapid ascent, not stopping until the fingers of my right hand were two knuckles deep into the pulley.

"Fortunately, by this time, I had regained my presence of mind and was able to hold on to the rope in spite of my pain. At approximately the same time, however, the barrel of tools hit the ground and the bottom fell out of the barrel. Devoid of the weight of the tools, the barrel now weighed approximately 20 pounds. I refer you again to my weight in block number eleven. As you might imagine, I began a rapid descent down the side of the tower. In the vicinity of the 40-foot level, I met the barrel coming up. This accounts for the two fractured ankles and the lacerations of my legs and lower body.

"The encounter with the barrel slowed me enough to lessen my injuries when I fell onto the pile of tools and, fortunately, only three vertebrae were cracked. I am sorry to report, however, that as I lay there on the tools in pain, unable to stand, and watching the empty barrel 80 feet above me... I again lost my presence of mind... I let go of the rope."

So now you are forewarned! I came across this gem in the Kansas City DX As-



Lloyd W6KG and Iris W6QL Colvin accept their 9K2QL license in the office of the Minister of Communications in Kuwait.

sociation's newsletter. W0FI's column, *The Preacher's Corner*, credits the Sterling-Rock Falls newsletter. Anyone know the author of this delightful piece?

Seriously, antenna and especially tower work is dangerous stuff. Even a task as simple as changing the coax to the antenna can lead to life-threatening consequences. So take a little extra care the next time you climb your tower. Remember, the secret to DX success is longevity, not hardware. Live to DX another day!

Some of you have asked what happened to the DX column the last two months. A fierce relapse of the same pneumonia which curtailed my African DXpedition to 9L1CA, C5AAQ, and 6W8MM laid me low recently. Sorry about not being able to write the columns, and thanks for your cards and notes. I'll try to have some extra-special columns in the rest of the year.

## NOTES FROM ALL OVER

**Tahiti FO0** Did you work Jay or Jan O'Brien W6GO and K6HHD while they operated from Tahiti in 1982? The husband and wife team racked up nearly 9000 contacts in their two-week stay in FO0 last October, sponsored in part by the International DX Foundation. About half of the team's contacts were with stateside stations, and another quarter of their QSOs came out of Japan. Ten meters was their most productive band, producing about half of their contacts. The 9000 contacts included 128 countries! The O'Briens survived a misplaced antenna and 100-kph winds during their DXpedition. Jay writes, "Had we not lost our 40- and 80-meter antennas to the winds, our totals [on these

bands] would be higher, as this is where the demand exists." Jay and Jan made more than 4000 contacts in the CQ WW SSB contest.

QSL cards for FO0OJ (QSL via Jan K6HHD) and FO0JO (QSL via Jay W6GO) have been sent out in answer to cards received. If you haven't received yours yet, try another card. Incidentally, Jay and Jan, who publish a list of QSL managers, *The W6GO/K6HHD List*, got their FO0 call-signs reversed in the advance publicity. No problem; QSL either call through Box 700, Rio Linda CA 95673.

Lloyd W6KG and Iris W6QL Colvin made another Yasme-backed DXpedition this past year, hitting, among other places, Saudi Arabia, Qatar, and Kuwait. They report:

**Saudi Arabia HZ** "We visited HZ1TA and HZ1TC in the capital of Riyadh, which is a large modern city. It is unusual in that it is not uncommon to see stores closed, with many items that they sell left in front of the store unguarded. Also, stores can occasionally be found open with no attendant present. One reason for this is that the people are very religious, and secondly, if a thief is caught, his hand is cut off! We also visited HZ1AB in Dhahran. There are 30 operators there, and they agreed to let us make a Yasme DXpedition for the two days of the ARRL International CW DX Contest, 19-20 February, 1983. We made some 1500 QSOs in that period, with four of the regular operators helping. All QSLs for HZ1AB for these two days should go to Yasme, PO Box 2025, Castro Valley CA 94546."

**Kuwait 9K2** "Our next stop was Kuwait, where we were extremely fortunate to re-



Jay W6GO/FO0JO installs the tribander at Moorea.



Jan K6HHD/FO0OJ made nearly 1500 contacts during her stay in Tahiti.



ceive the special call 9K2QL. This is the only special call issued to visiting amateurs in a long while. The first few days we stayed at the Marriott Hotel, which is a converted ocean liner, similar to the *Queen Mary* in Long Beach. The problem of operating there was that the portholes could not be opened and there was no way to get the coax line into the stateroom. We finally moved to one of the chalets nearby. We convinced the manager that our 3-element

beam would be a desirable addition to the swimming pool and garden area of his 5-star hotel! We made 6500 contacts with amateurs in 125 countries from 9K2QL." Qatar "Qatar is similar to Oman because it is a recently rich oil country with tremendous new expansion. Although the treatment of women here is more liberal than in the past, only approximately 5% of the people seen on the streets or in the restaurants of the modern city of Doha are

women. The biggest supermarket in town has one day set aside just for women and their families. It is not felt appropriate to have single men and single women go shopping together!" "For the first time ever, we operated from a skyscraper building. Our antennas were located on top of a 14-story hotel with a perfectly clear view in all directions. The great height seemed to help us both on transmission and reception; we

averaged consistently about two QSOs per minute while on the air. In three weeks of operating, we made 8000 QSOs with amateurs in 135 countries, on both SSB and CW, 10-40 meters. "Visiting personnel of all kinds, especially radio amateurs, are not encouraged to visit in the Arabian countries. We are extremely grateful to Mike A71AD who has helped us enter and operate in several Arab countries."

# CORRECTIONS

The fine photographs in my article "Build this Classic Transmitter" in the May, 1983, issue were taken by Steve Finberg W1GSL. It is with regret that I notice due credit was inadvertently omitted from the published article.

Penn Clower W1BG  
Andover MA

In the time since publication of "Confessions of a Counter Evolutionary," in the August and September, 1982, issues of 73, several errors have come to my attention. Some corrections were listed in the October, 1982, issue on page 142. The following is a list of the remaining known corrections:

Table 1: IC10-11 goes to IC1-1, not IC1-38.

Fig. 7: IC10-11 should be 20 Hz to IC1-1, not 50 Hz.

Fig. 7: IC3 is actually wired as IC2-7 to IC3-14, IC3-12 to IC3-1, and IC3-11 to IC5-15.

Fig. 11(a): IC24-8 to IC13-4 is correct, but the connector is not "E". Delete "E".

Fig. 13: "PM" IC23-4 connects only to IC14-12, not to IC36-1 and not to IC23-12.

Fig. 13: Gate omitted from schematic:



Fig. 16: IC36-1 should not connect to "PM", but to IC20-8, as above.

Fig. 16: Input to IC18-1 should be IC3-14, not IC1-3.

Fig. 23: IC13 is a 74C74, not a 4013.

Part I, page 107, column 1, line 11 reads: "A 50-kHz signal is picked off the TBOD chain." Replace with: "A 100-kHz signal is picked off the TBOD chain. Because the gate control circuit, Fig. 11(a), operates on a 50% duty cycle, the 100-kHz signal becomes, in effect, a 50-kHz clock."

IC24-1,2,3 is an unused gate.

Thanks to WA1CST/7 and K2SHL for pointing out several of the above errors.

## Display-Scan Modification

After a year of heavy use, the prototype WA2FPT counter blew a 75491 segment driver chip. It was replaced, but the new one failed after only a few weeks. I discovered empirically that Texas Instruments brand 75491 devices work more reliably in the published display scan circuit (see part I, page 105, Fig. 9) than National or ITT chips.

Sound engineering design practice should minimize such vendor dependency for circuit reliability, so I relented and added eight 10-Ohm, 1/4-W resistors, each in series with one of the eight segment lines to limit the current from the 75491 segment drivers, IC21 and IC25.

The resistors are mounted on a DIP header, socketed directly below IC35 and designated H2. See part II, page 52, Fig. 23. The resistors are mounted like this:



Here are the wiring changes for the display-scan modification.

SIGNAL	AS PUBLISHED	MODIFICATION
Segment a	IC25-9 to CONN-16	IC25-9 to H2-1 H2-16 to CONN-16
Segment b	IC25-6 to CONN-15	IC25-6 to H2-2 H2-15 to CONN-15
Segment c	IC25-2 to CONN-14	IC25-2 to H2-3 H2-14 to CONN-14

Segment d	IC21-13 to CONN-13	IC21-13 to H2-4 H2-13 to CONN-13
Segment e	IC21-9 to CONN-12	IC21-9 to H2-5 H2-12 to CONN-12
Segment f	IC21-6 to CONN-11	IC21-6 to H2-6 H2-11 to CONN-11
Segment g	IC21-2 to CONN-10	IC21-2 to H2-7 H2-10 to CONN-10
Segment D.P.	IC25-13 to CONN-9	IC25-13 to H2-8 H2-9 to CONN-9
Scan rate	IC6-15 to IC1-39 (1 kHz)	IC2-7 to IC1-39 (100 kHz)
Scan reset	IC10-11 to IC1-1 (20 Hz)	IC6-15 to IC1-1 (1 kHz)
D.P. clock	IC2-7 to IC18-1 (100 kHz)	IC2-15 to IC18-1 (1 MHz)
No name	IC35-7 to GND	IC20-6 to IC35-7 IC27-4 to IC20-4,5

The last four wiring changes altered the original scan display cycle to eliminate the 20-Hz flicker. The "no name" signal change resulted in the addition of another gate to Fig. 16:



Thank you for the favorable responses. If there are other errors or problems "encountered," please write and I will make every effort to resolve them.

D. N. (Nick) Ellis WA2FPT  
57 Memorial Ave.  
Alice Springs NT 5750  
Australia

# SATELLITES

## Amateur Satellite Reference Orbits

Date	OSCAR 8		RS-5		RS-6		RS-7		RS-8		Date
	UTC	EQX	UTC	EQX	UTC	EQX	UTC	EQX	UTC	EQX	
Jul 1	0041	95	0028	311	0110	327	0149	333	0006	305	1
2	0046	96	0023	311	0054	324	0139	333	0003	305	2
3	0050	97	0018	311	0039	322	0129	332	0001	306	3
4	0054	98	0012	312	0024	320	0120	331	0158	337	4
5	0059	99	0007	312	0008	317	0110	330	0155	338	5
6	0103	100	0002	312	0151	345	0100	329	0152	339	6
7	0107	102	0156	342	0136	342	0051	328	0149	339	7
8	0112	103	0151	342	0121	340	0041	327	0146	340	8
9	0116	104	0145	343	0105	338	0031	326	0143	341	9
10	0120	105	0140	343	0050	335	0022	325	0141	342	10
11	0125	106	0134	343	0034	333	0012	324	0138	343	11
12	0129	107	0129	343	0019	331	0002	324	0135	344	12
13	0133	108	0124	343	0004	328	0152	353	0132	344	13
14	0138	109	0118	344	0147	356	0142	352	0129	345	14
15	0142	111	0113	344	0132	354	0133	351	0126	346	15
16	0003	86	0108	344	0116	351	0123	350	0123	347	16
17	0008	87	0102	344	0101	349	0113	349	0121	348	17
18	0012	88	0057	344	0045	347	0104	348	0118	348	18
19	0016	89	0052	344	0030	344	0054	347	0115	349	19
20	0021	90	0046	345	0015	342	0044	346	0112	350	20
21	0025	91	0041	345	0158	9	0035	346	0109	351	21
22	0029	93	0036	345	0143	7	0025	345	0106	352	22
23	0034	94	0030	345	0127	5	0015	344	0104	353	23
24	0038	95	0025	345	0112	2	0006	343	0101	353	24
25	0042	96	0020	346	0056	0	0155	12	0058	354	25
26	0047	97	0014	346	0041	358	0146	11	0055	355	26
27	0051	98	0009	346	0026	355	0136	10	0052	356	27
28	0055	99	0003	346	0101	353	0126	9	0049	357	28
29	0100	100	0158	16	0153	21	0117	8	0047	357	29
30	0104	102	0152	16	0138	18	0107	7	0044	358	30
31	0108	103	0147	17	0123	16	0057	7	0041	359	31
Aug 1	0113	104	0142	17	0107	14	0048	6	0038	360	1
2	0117	105	0136	17	0052	11	0038	5	0035	1	2
3	0121	106	0131	17	0036	9	0028	4	0032	1	3
4	0126	107	0126	17	0021	7	0019	3	0029	2	4
5	0130	108	0120	18	0006	4	0009	2	0027	3	5
6	0134	109	0115	18	0149	32	0000	1	0024	4	6
7	0139	110	0110	18	0134	29	0149	30	0021	5	7
8	0000	86	0104	18	0118	27	0139	29	0018	6	8
9	0004	87	0059	18	0103	25	0130	28	0015	6	9
10	0009	88	0053	19	0047	22	0120	28	0012	7	10
11	0013	89	0048	19	0032	20	0110	27	0010	8	11
12	0017	90	0043	19	0017	18	0101	26	0007	9	12
13	0022	91	0037	19	0001	16	0051	25	0004	10	13
14	0026	92	0032	19	0144	43	0041	24	0001	10	14

# NEW PRODUCTS

## ELECTRONIC SOLDERING SYSTEM

The new Electronic System 9000 temperature-controlled soldering system from the Ungar Division of Eldon Industries enables a tip temperature to be varied from 420 to 800 degrees F with an accuracy of  $\pm 10$  degrees.

Solid-state circuitry, including microcircuit chips, samples the tip temperature 120 times per second. LEDs on the temperature-controller instantly display each 20-degree temperature increment reached, creating an illuminated bar chart that clearly represents the tip temperature to within  $\pm 10$  degrees F.

Ungar's recently announced Thermo-duric™ heating element, which combines a highly efficient heater and sensitive tip-temperature sensor, recovers tip temperature after each solder joint in less than one-half the time of other systems. The smaller heating element also makes possible a micro handle that is cooler than other models.

Electronic circuitry in the controller prevents tip-temperature overshoot that could easily cause faulty solder joints.

The controller can be calibrated by a front-panel adjustment, using room temperature as a reference. For ultra-precise soldering, any temperature within the temperature range can be calibrated to be accurate within  $\pm 5$  degrees F.

Following the modular concept of Ungar Irons, the controller is separate from the soldering-iron holder assembly. The controller can be mounted on a wall, side of a bench, or other convenient location. A tray, useful for holding parts or small tools, is exposed on the stand when the controller is removed. The iron holder can quickly be changed to the left or right side of the stand.

The system is electrically conductive from the tip to a grounded wall plug to prevent static electricity damage to microcircuits.

Further information is available from Ungar, 100 W. Manville St., Compton CA 90220; (213)-774-5950. In Canada: Eldon Industries of Canada, Markham, Ont. L3R 1H5, Canada; (416)-495-9407. Reader Service number 483.



Electronic soldering system from Ungar.

## CONTROL CHIP

Digital Microsystems, Inc., a Massachusetts-based firm which has been active in the microcomputer and software business for seven years, has announced a family of custom-integrated circuits aimed primarily at the amateur and hobbyist markets. The integrated circuits make use of the latest in sophisticated Large Scale Integration (LSI) technology. Each is designed to be tailored to its application by the user through a wide range of programmable features. The first product to be announced is a single-chip repeater control circuit designed to meet amateur and industrial needs for low cost, high reliability, and high performance control of repeater stations. The new chip will be offered initially in commercial and extended temperature versions. A full military device is planned.

The single-chip repeater control features crystal-controlled timing accuracy for ID, tail, and time-out timers. The period of each timer is programmable by the user. In addition, each chip features an audio generator for generating the repeater station's call sign as well as several useful control messages such as "TEST" and "PF." The chips are equipped to interface directly with PL decoders and also feature a PL enable input.

Additional features include a tune input for holding the transmitter on while making adjustments, a "force ID" input for manual trigger of an ID sequence, user-selectable Morse code transmission rates, and compatibility with a planned autopatch controller.

For additional information, contact Digital Microsystems, Inc., 607 Sudbury St., Marlboro MA 01752. Reader Service number 484.



Control chip from Digital Microsystems, Inc.

## HEIL TRANSVERTER

A unique 2-meter-to-10-meter linear translator has been introduced by Heil, Ltd. This new product allows a transceiver covering 144.00 to 146.00 to transmit and receive from 28.00 to 29.70 MHz. The translator is limited to a 1-Watt input.

The model 210 is primarily designed for use in the 29.30-to-29.70-MHz FM mobile band, using a 1-Watt handie-talkie or mobile transceiver for excitation, but it is also usable on SSB, CW, AM, and RTTY by exciting with an all-mode 2-meter rig. The model 210 has three SO-239 connectors on the rear panel—a 2-meter 1-Watt input, a 2-meter antenna, and a 10-meter antenna. With the front-panel function switch in the Out position, the 2-meter antenna is connected to the 2-meter transceiver or handie-talkie. Switching to the In position will cause the transverter to operate and produce a signal in the 10-meter band. The receive sensitivity is .3  $\mu$ V for 10 dB quieting. The output power is approximately 4 Watts out at 29.60 MHz.

For more information, contact Heil Sound, Ltd., Heil Industrial Blvd., Marissa IL 62257. Reader Service number 480.

## AUTOPATCH AND DTMF DECODER MODULES

Hamtronics™ recently released two new modules to complement their line of VHF and UHF repeaters. The Autopatch Module provides full telephone patch and reverse autopatch functions for a repeater or duplex rural radiotelephone installation. In addition, it allows primary repeater control via phone line and secondary control via the repeater receiver, and it allows a control operator to monitor the repeater receiver by telephone even when the transmitter is shut off.

The Autopatch features a choice of either automatic answer or on-air tone ringing when a party calls the reverse patch function. It also features automatic level limiting, time-out timer, tape-receiver relay for logging, and access-code-tone muting for security.

The DTMF Decoder/Controller Module can be used with the Autopatch, or it can be used alone for control of repeaters and other devices by radio link. It has outputs to control two on/off functions independently. Typically, it is used to control a repeater and autopatch, but there are many other remote-control jobs it can perform in radio, industrial, mining, and scientific applications. The decoder uses a four-digit DTMF code, and several safety features are provided for security against falsing or tampering. The unit is all solid-state (no relays) and uses commonly available ICs.

For more information, ask for *Autopatch Data Sheet* and a complete free catalog including information on transmitters, receivers, converters, repeaters, etc.; contact Hamtronics, Inc., 65F Moul Rd., Hilton NY 14468-9535; (716)-392-9430. (For overseas mailing, please enclose \$1 or 4 IRCs.) Reader Service number 482.

## TVRO RECEIVER

A TVRO receiver was introduced recently at the Satellite TV Trade Show by Gillaspie and Associates, Inc., of Sunnyvale, California. The Gillaspie 9600 completes the manufacturer's uniquely designed six-foot system package—the first in the industry to offer a combination of optimized components that are each clearly defined and made to work with each other.

The receiver introduces several new features, including an Infrared remote-control channel selector, customer-oriented controls, built-in polarity switch-

ing and tuning, and state-of-the-art video demodulation circuitry. Its design includes a walnut wood cabinet.

Gillaspie and Associates, Inc., expects to be able to manufacture 10,000 to 20,000 receiver units a month by the end of 1983. The product will be distributed through the company's exclusive distributors—North American Satellite Antenna in Fresno, California, Nevada Satellite in Las Vegas, Nevada, Satellite Communications Corporation in Silver Lake, Kansas, and Multivision in Oak Ridge, Tennessee—and a network of 800 dealers.

For additional information, contact Gillaspie and Associates, Inc., 365 San Aleso Ave., Sunnyvale CA 94086; (408)-703-2500. Reader Service number 485.

## HF/VHF ANTENNA LINE

Ten-Tec, Inc., the amateur/commercial radio transceiver manufacturer of Sevierville, Tennessee, has just announced acquisition of the Bassett antenna line. The new Ten-Tec antenna line includes both multiband fixed-station and single-band mobile antennas.

The fixed-station trapped dipole antennas are offered in 13 models of two, three, four, and five band systems covering 10 through 75 meters. All models use helium-filled traps and baluns, stainless-steel hardware, and copperweld wire. Each model operates as a fundamental broadside dipole, band change is automatic, and no tuner is required to achieve vswr of 1.5:1 or less. Power ratings are 2 kW PEP.

The single-band mobile whip antennas feature helical inductors sealed in helium-filled lower sections with stainless-steel top whips. Models are available for all bands from 2 through 75 meters. Average weight is just 6 oz., yet they remain vertical and resonant at all highway speeds and are impervious to weather. Power ratings are 750 Watts PEP.

Accessories include a single-hole 5/8" fiberglass Mobile Deck Mount and a non-inductive 5-band switchable Mobile Matcher to match 3-30-MHz mobile antennas to 50-Ohm coax. The balun, which features a helium-filled high-efficiency air core rated to 5 kW PEP, is also available separately, as are the helium traps for 30 meters.

The new acquisition also permits Ten-Tec to supply custom commercial mobile and fixed-station antennas.

For complete information, write Ten-Tec, Inc., Sevierville TN 37862; (615)-453-7172.

## SWISS QUAD FOR 6 METERS

TET Antenna Systems announces its model SQ-61. The Swiss Quad is a two-element quad with both elements driven. The elements and the phasing line between them are made of aluminum tubing. The larger diameter of the tubing gives improved bandwidth over conventional wire-element quads. The elements are self-supporting, thus eliminating the usual support structure. This makes a lightweight antenna with low wind resistance.

The gain is higher than a 3-element yagi, but the turning radius is half that of a yagi. It is ideal when space is restricted. Both elements have trombone sections so they are easy to tune to favor any part of the band. Both elements are grounded to the boom, giving static discharge and lightning protection. The feed system matches 50-Ohm coaxial cable without need for a balun.

For further information, contact TET Antenna Systems, 1942E W. Mission Road, Escondido CA 92025. Reader Service number 477.



Yaesu's FT-726R multi-mode transceiver.

## FT-726R TRIBAND MULTI-MODE TRANSCEIVER

Yaesu Electronics Corporation has announced the availability of the FT-726R, the world's first amateur HF/VHF/UHF transceiver capable of full duplex operation for satellite work.

The basic FT-726R comes equipped for 2-meter operation on SSB, CW, and FM. Optional units may then be plugged in, enabling operation on 10 or 6 meters, 430-440 or 440-450 MHz on 70 cm. The optional SU-276 Satellite Unit allows cross-band full duplex operation, for simultaneous uplink transmit and downlink receive operation on amateur satellites.

Controlled by an eight-bit microprocessor, the FT-726R features a dual vfo plus memory frequency management system, with independent frequency/mode storage on each vfo or memory; mode-inverting satellite transponders are therefore covered with ease. The transmit and receive frequencies may be varied during satellite work to allow easy zero-beat capability while following Doppler shift.

Equipped with many features found only on HF transceivers, the FT-726R includes an SSB speech processor, i-f shift, variable i-f bandwidth tuning, i-f noise blanker, RIT, multi-mode squelch, and a receive audio tone control. A CW filter, DTMF encoding microphone (YM-48), desk microphone (MD-1B8), external speaker (SP-102), and CTCSS units are all available as options.

For more details about the FT-726R, contact Yaesu Electronics Corp., PO Box

49, Paramount CA 90723; (213)-633-4007. Reader Service number 479.

## TEST LEADS

Two test lead sets have recently been placed on the market by Non Linear Systems, Inc. They consist of flexible silicone rubber leads, 48 inches in length, with a rated working voltage of 1000 volts ac rms and a maximum of 10 Amperes.

Each type is terminated at one end with insulated stainless-steel prods which may be extended by more than two inches. Extension, retraction, or locking the prods is easily accomplished by rotating a knurled ring on the probe from left to right. Testing in remote circuit areas is easy through the extendable-prod feature.

P/N 51-160 test leads are terminated at the other end with standard banana plugs for use with the NLS Touch Test 20 series digital multimeters or other instruments with standard banana-plug receptacles. P/N 39-895 test leads are terminated with mini banana plugs for use with NLS LM-type meters.

Both sets of test leads are available nationwide from local NLS electronics distributors. For additional information, contact Non Linear Systems, Inc., PO Box N, Del Mar CA 92014. Reader Service number 478.

## RECEIVER MULTICOUPLER

Two shortwave receivers may be operated from one antenna, thanks to a new multicoupler just released by Grove Enter-

prises, manufacturer of accessories for listening.

The CPL-2 multicoupler acts as a signal splitter, providing equal signal levels to two receivers simultaneously from one antenna.

Designed for flat response from 3-30 MHz, the inexpensive splitter comes equipped with interconnecting cables and adapters for different types of lead-in connections.

A scanner version of the multicoupler is also available as model CPL-1.

For further information, contact Grove Enterprises, 140 Dog Branch Road, Brass-town NC 28902; (800)-438-8155 (except NC). In NC, call (704)-837-2216. Reader Service number 476.

## 30-METER ANTENNA COIL

Microwave Filter Company has released its KW-30 antenna coil which allows trapped dipole coverage of the new 30-meter band. The resonant frequency is designed to provide a perfect half-wave dipole. The KW-30's power handling capability is 2 kW PEP, and the tensile strength is 800 pounds. An acrylic lacquer waterproof coating and all-aluminum hardware

Microwave Filter Company's 30-meter antenna coil.

help to resist interface corrosion on the 5.5" x 1.8" coil.

For additional information, contact Microwave Filter Company, Inc., 6743 Kinne St., East Syracuse NY 13057; (800)-448-1666. Reader Service number 481.

VHF signal travels. For those not familiar with the ways in which weather is studied, appropriate concepts such as dew point, adiabatic changes, and vapor pressure are explained, with particular attention paid to their effect on communications. The more bizarre forms of propagation—sporadic-E, meteor trail, and auroral—also are explained, using current theory.

Fortunately for the reader, the authors make frequent use of visual aids and include real-world examples. This is an attribute I noticed throughout the book. Drawings are frequently provided in conjunction with the schematics, providing better insight.

The manual is not all theory, however; in subsequent sections, some good old down-to-earth construction projects are described. The construction-oriented chapters make up the bulk of the book, and they cover receivers and transmitters, converters, filter, microwaves, and test equipment. The authors' selection of circuits runs a wide range, from timeout timers and simple tube converters to synthesized 2-meter equipment.

With the continent's generally more stringent regulations concerning EMI, the circuits cited in the manual are considered to be fairly clean designs. As a homebrewer, I was also concerned about the availability of foreign components used in the circuits. But most of those included in the manual use standard European nomenclature for transistors, and a conversion chart can quickly give you the US equivalent. And regardless of where you are, an Ohm is still an Ohm.

Other projects offered include SSB equipment, ATV signal processors, and 144-MHz amplifiers. 432-MHz gear is also well represented, but because of the European focus of the book, relatively few opportunities for the 220-MHz buff present themselves.

The manual's treatment of antennas, the last refuge of the experimenter on a budget, is equal parts theory and construction; some sound design parameters are offered, but you are not likely to find any radical departures from tradition here.

Space communications, which may prove to be this decade's mode (as 2-meter FM was in the '70s), has been

# REVIEW

## VHF/UHF MANUAL

Well, old chap, brew up a spot of tea and settle in your easy chair. The *VHF/UHF Manual* is here from the Radio Society of Great Britain, and quite a good read it is.

Edited by G.R. Jessop G6JP, this is the fourth edition of the manual, and it includes the latest in theory and circuits for the modern experimenter's paradise. The book runs to a healthy 528 pages, which is somewhat larger than the last edition. Subjects range from propagation to space communications, hitting tuned circuits, antennas, and test equipment along the way.

The authors begin the book with a germane point—that VHF/UHF communications is no longer the arcane art that most amateurs believe it to be. Indeed, they suggest that those frequencies provided the backbone of some of Marconi's earliest experiments, and that in 1924, the magnetron made 900-MHz oscillation possible.

By the '30s, the basic techniques for these frequencies had been developed, and since that time, the progress of solid-state equipment has provided a more comfortable environment for VHF/UHF experimentation. And with the proliferation of 2-meter equipment, there is no longer any excuse for amateurs not to know their way around the rarified atmosphere of 144 MHz and above.

The chapter on propagation leaves no stone unturned in its coverage of the odd twists and turns of VHF/UHF signals. Since propagation here is dependent on the troposphere rather than the ionosphere, meteorology comes into play when attempting to understand how the

est experiments, and that in 1924, the magnetron made 900-MHz oscillation possible.



somewhat slighted as well. The manual has provided the basic information on understanding, tracking, and designing amateur satellites, but little about the nuts and bolts of designing your own satellite station. To their credit, the authors included up-to-date information on Phase III, and the rapidly changing face of satellite communications may have forced the authors to be sparing in their suggestions.

Moombounce has been relegated to a mere two pages of text—which is exactly where it belongs, for few hams have the money, space, or time to fiddle with the demanding requirements of EME.

Overall, this book is a winner, whether you want to home-brew your own VHF/UHF gear or just understand what goes on inside your black box. And as proof positive that this book is in tune with the times, many of the old tube circuits have been left in. No contradiction here; according to the editor, tubes are about 100 times less susceptible to damage from EMP radiation—which is one of the by-products of an atomic explosion.

For more information, contact the Radio Society of Great Britain, 35 Doughty St., London WC1N 2AE, England. Reader Service number 488.

Avery L. Jenkins WB8JLG  
73 Staff

## GORDON WEST CODE TAPES

The concept of using tapes to teach the code is almost as old as the Morse code itself, and almost all of the variations of tape-taught code have been tried. I thought I had seen them all until I encountered Gordon West's Radio School code cassettes.

Gordon West WB4NOA has managed to come up with a new idea—his tapes are in stereo, with one channel consisting only of code and the other channel containing a voice translation of what is being sent. This is an interesting idea, particularly for the beginning student who needs to know if he is getting his characters straight.

The tapes I reviewed are for the first-time student who has no knowledge of the code. The four-tape series is divided into an equal number of 90-minute "modules," each representing a higher level of achievement (or difficulty, depending on how you look at it). The first two modules introduce the student to all of the letters, numbers, and punctuation marks in common usage. The remaining modules work toward reinforcing the previous lessons.

West begins lessons by introducing a few new characters, repeating them several times, and then sending a series of the new characters on one channel while identifying them in voice on the second channel. The purpose of the stereo is to allow you to listen to the code only and then go back and check your copy. Or, on your first round through that lesson, you can listen to both channels until you feel confident with the new characters being introduced.

Each lesson works gradually into more complex sequences. As more characters are introduced, the strings of letters become words and then sentences. The longer strings and sentences are not simultaneously translated on the voice channel. Instead, West identifies the end of each string with a period. This marker tells you to turn up the other channel for the voice translation of what was being sent.

Between lessons, West identifies possible trouble spots and offers tips to help beginners learn the code. From the sound and inflection of his voice, it is obvious that West has had broadcasting or announcing experience. His voice is easy to

## WHAT DO YOU THINK?

Have you recently purchased a new product that has been reviewed in 73? If you have, write and tell us what you think about it. 73 will publish your comments so you can share them with other hams, as part of our continuing effort to bring you the best in new product information and reviews. Send your thoughts to Review Editor, 73: *Amateur Radio's Technical Journal*, Peterborough NH 03458.

listen to and the script is delivered in an informal, chatty manner.

The tapes may also be played on a monoaural system. The only difference will be that both channels will be played and you cannot blank out the voice-over as you can with a stereo cassette deck.

However, this compatibility with both mono and stereo systems is also one of the tapes' drawbacks. Since not all of the practice sessions are simultaneously repeated on the voice channel, the advantages of the stereo capability are not used to full advantage. Throughout much of the tape, the only difference between the West tapes and a standard mono tape is that you have to turn up the volume of one channel to catch the answers to the practice session.

After several hours of use on both stereo and mono tape players, I found that it was almost easier to listen to the tapes on the mono cassette player. The advantage to the separate channels occurs primarily when new letters are being introduced.

Another aspect of the West system which I did not like was the use of words and sentences. Unless random code groups are used, it becomes too easy to memorize the characters being sent rather than improve your recognition. After only a few trials on the tape, I could predict with fair accuracy the upcoming characters. Granted, I was not trying to learn the code at the same time, but the same process would occur at a slower rate with a beginning student.

West uses the standard system of teaching the code, beginning with the easiest characters such as *i* and *e* and progressing to the more difficult ones. Repetition—the key to successful memorization—is used to great advantage here. However, he does not send the characters themselves at a higher speed so that the student can get used to the sound of the code at 10 or 15 wpm. Time and again, it has been shown that this technique provides the best results because the student does not have to relearn the code each time he or she advances in speed.

I did not find that there were any clear advantages to West's stereo system. The tapes are professionally produced, and

West has paid a lot of attention to the psychological factors of learning. His breaks are well-timed to coincide with the length of time most people can concentrate, and his informal manner to a certain extent overcomes the impersonality of tape-teaching.

But in his attempt to make the tapes compatible with both stereo and mono systems, West has somewhat weakened the effect of this novel technique.

West's code tapes list for \$39.95 for a set of four. For more information, contact Gordon West's Radio School, 2414 College Drive, Costa Mesa CA 92626; (714) 549-5000. Reader Service number 486.

Avery L. Jenkins WB8JLG  
73 Staff

## AEA'S KT-2 KEYS/TRAINER

OK, all you would-be General- and Extra-class hams out there—you no longer have any excuses for not upgrading. At least, not since the people at AEA came out with their KT-2 keyer/trainer. The KT-2 is a flexible unit which doubles as a code-practice device (CPO) and a keyer. In short, it will not quickly outlive its usefulness.

As quality equipment should be, the outside of AEA's little black box is deceptively simple, with only an on/off/volume knob and a DTMF keypad as external controls. On the back, there are jacks for headphones, a key, and outputs to either cathode-keyed or grid-keyed transceivers. However, the many capabilities of the KT-2 belie its plain appearance.

As a training unit, the KT-2 has several special features of note to the person trying to move his or her code speed up to that elusive 13 wpm. One of these features is the optional use of the Farnshaw method of practice.

The Farnshaw technique has proven to be one of the most successful ways of learning the code. More commonly known as "fast" practice, the Farnshaw style consists of sending the characters at a fast speed—say, 15 wpm—while maintaining a longer inter-character spacing to create a lower overall speed. In this way, the student does not have to relearn the sound of the characters as he advances in speed. You can, therefore, program the

trainer to send its random code at 10 wpm, while keeping the character speed at 20 wpm. Actually, the trainer has the capability of sending from 5 wpm to 98 wpm, with a character speed of up to 99 wpm. Not too bad for a little black box.

## Pumping Iron

Coupled with this option is the ability to program the keyer to automatically increase the code speed during a training session. I dubbed this the "pumping iron" technique since it parallels the method used by professional body-builders to develop muscles. On power-up, the trainer is set to start out at 5 wpm and accelerate to 20 wpm over 10 minutes; as workouts go, that's nothing to laugh at. But through the keypad, you can adjust both the starting and finishing speeds as well as the duration of the session.

More programming gives you further options. If you prefer the traditional method, hitting two keys on the pad will give you the code at exactly the speed you choose—no reduced intra-character spacing and no acceleration. Or if, like me, you prefer to listen to 20-wpm characters sent at 13 wpm with no speed-up to overload you, that can be arranged, too.

## Randomize, Don't Memorize

Nine pseudorandom sequences may be chosen, and no sequence will repeat itself until about 34,000 characters have been sent. Even if you manage to memorize all of those without bringing your code speed up to where you want it, AEA has provided an escape valve. Starting a practice session with the "\*" sequence will randomly select your starting point.

The length of word groups may be random or 5 characters per group. And if you really want to get tough on yourself, the KT-2 is divided into two character sets—a common set which includes the alphabet, numerals, and six frequently-used punctuation marks, and a second set which includes CW abbreviations and little-used punctuation. Those with an intense desire to copy apostrophes and parentheses won't be left out.

Though the sequences of keys you have to press to program and begin the trainer look complex, I found that I had them down pat after only a few sessions. None of the commands take more than four key-strokes, and AEA thoughtfully provides an easily-used table for quick reference.

Another advantage to using the KT-2 is that, unlike on-the-air practice, you don't have to guess at the speed. The KT-2 is calibrated to be extremely accurate, using the PARIS method. The word "PARIS" has 10 dots, four dashes, nine intra-character spaces, four inter-character spaces, and one word space for a total of 50 code elements. In adjusting code speed—for different dot-space and dash-space ratios—PARIS is used as a reference to determine the actual speed of the code.

## The Keyer

The KT-2 is no contest keyer, but not all CW buffs are contesters—and as a keyer, the KT-2 offers you the options you need most.

First of all, it can be used with an iambic paddle, a bug, or a straight key. With the latter two, you simply key the dash input and the KT-2 produces a sidetone. As a full iambic keyer, this unit shines. Both dot-space and dash-space ratios (weighting) are adjustable from the normal 3:1. And when you change the weighting, the keyer will adjust the output automatically so that you will be sending at precisely the speed you set.

The keyer sidetone (as with the trainer) is adjustable from its power-up frequency of 1111 Hz, and the KT-2 also has dot and



AEA's KT-2 keyer/trainer.

## YOUR SICK RADIO NEEDS US!

We're the High Technology Service Center and we specialize in 2-Meter FM transceiver repair. We have the expertise, trained staff, and equipment for this because we have been the national authorized warranty and non-warranty Azden service center for many years now. But now, for the first time ever, our service facilities are open to other brands of 2-Meter FM transceivers. Our expert staff of trained technicians have been trained to service the models specified below, and all major replacement parts for these models are now in stock. So don't hesitate to make your sick radio better. Send it to the specialists - High Technology Service Center.

### Models we are now accepting

Kenwood	Yeasu
TR7400	FT-227R
TR7730	
ICOM	KDK
IC-2	FM2016
IC-25A	FM2025
IC-255A	

### Service Rates

First hour is \$39.00. Each additional hour is \$29.00. Shipping and parts are additional. Radios with common component failure will not exceed one hour. Radios that we cannot find a problem with will be subject to a ten dollar charge to cover the extensive testing we will perform to try to make the problem show up. All repairs will receive a 90 day warranty on work performed. We reserve the right to refuse any repair for any reason at no charge to you.

**High Technology Service Center**  
 8825 S.W. 129 Terrace ✓184  
 Miami, Florida 33176  
 (305) 255-7660



# MFJ 24 HOUR CLOCKS

Your choice: dual 24 hour LCD display, or 24/12 hour with ID timer, or 12 inch quartz analog.



**\$39.95** DUAL 24 HOUR LCD  
MFJ-104

Two independent 24 hour LCD displays! Read both GMT and local times at a glance.

Six digit main display has seconds readout. Four digit auxiliary. Switch reverses main/aux.

Alarm plays 4 selectable melodies. Alarm "ON" indicator. Snooze button.

Quartz timing. Synchronizable to WWV. Flip-top cover serves as stand.

Night light. Forward/reverse. fast/slow set buttons. Lock function prevents mis-setting. Display main time only, main/auxiliary or main/ alarm time. Includes battery. 4x2x1/2 inches.



24/12 HOUR. ID TIMER **\$32.95**  
MFJ-102

Switchable 24 hour GMT or 12 hour format. ID timer sounds every 9 minutes after reset. Switchable seconds readout.

Observed timer. Just start clock from zero and note time of event up to 24 hours.

Bright blue 0.6" vacuum fluorescent digits. Alarm with snooze function. Synchronizable with WWV. Fast/slow set buttons. Lock function prevents mis-setting. Power out, alarm "ON" indicators. 110 VAC, 60 Hz (50 Hz with simple modification). UL approved.

Black, brushed aluminum top/front. 6x2x3".

24 HOUR QUARTZ  
MFJ-105

**\$49.95**

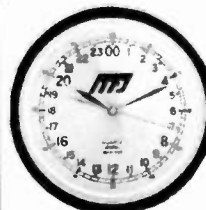

True 24 hour quartz wall clock has huge 12 inch diameter face. Gives excellent visibility across computer /radio room.

Fifteen seconds per month accuracy.

Single "AA" battery provides over one year operation, immunity from power line failure and eliminates power cord.

Sweep second hand. Brown hi-impact case. Glass front. 24 hour military time format.

Order from MFJ and try it. If not delighted, return within 30 days for refund (less shipping). One year unconditional guarantee.

Order yours today. Call toll free 800-647-1800. Charge VISA, MC. Or mail check, money order. Add \$4.00 each for shipping and handling.

**CALL TOLL FREE 800-647-1800**

Call 601-323-5869 In Miss., outside continental USA, tech/repair info. Telex 53-4590 MFJ STKV

**MFJ ENTERPRISES, INCORPORATED**

Box 494, Mississippi State, MS 39762 ✓233

## PORTAPEATER™

\$179.00 assembled unit

### M100 A INSTANT REPEATER ANY BAND ANY MODE

\$99.00 assembled board

• 4 Channel PROM CW I Der

• VOX or COR operation

• 250 volt switching capability

• An Instant Repeater



• Works with any type radios

• Complete Timer Functions

• Built In Test Functions

• 20 Page Technical Manual

(Fully tested, programmed, assembled) ✓302

**W-S ENGINEERING P.O. BOX 58, PINE HILL, N.J. 08021**  
 (201-852-0269)

## NICAD MEMORY ERASE - WHAT??

- Complete automatic operation
- Erases - Charges - Checks
- Rapid charges in 35 min. (typically)
- Automatically repairs shorted cells
- No dangerous heat build up
- Front panel selects up to 3 different packs
- Unlimited battery combinations with program modules (user programmable)
- LED status indicators
- Supplied with universal EZ hook wire leads

Specify Voltage of Battery Pack(s) with order. One program module included - optional modules \$2.25 each.

**\$89.00 plus \$4.00 Shipping**  
 (PA Residents add 6% sales tax)

Now Available - A commercial version of the GMS 401. Designed to charge up to and including the commercial 15 volt Nicad packs, \$139.00 plus same shipping and module cost as the GMS 401.



The GMS 401 is a complete automatic NICAD conditioner and rapid charger. Never before has this been offered anywhere at any price and it's so good it's being patented. NICAD memory characteristics must be dealt with otherwise your battery pack is not delivering all it could. The GMS 401 will automatically erase and rapid charge any type NICAD pack from 1 to 10 cells.

**CONTROL PRODUCTS UNLIMITED, INC.**  
 P.O. Box 10, Downingtown, PA 19335  
 215-383-6395 ✓25

dash memories. The memories allow you to insert a dot in a string of dashes (or vice versa) just by squeezing the appropriate paddle. Without this feature, you would have to release the dash paddle, squeeze the dot paddle, and then key the dash side again. But if you prefer old-style sending, you can turn this option off.

And for tune-up, the keyer has a lock-on position which produces a solid tone while you fiddle with your finals. You can cancel the tone by hitting any button on the keypad.

The manual for the KT-2 is well-written. AEA provides an initial testing procedure to ensure that your unit is operating correctly, and the operating instructions are clear and concise. In addition, there is a complete schematic, parts list, and PC board layout. The unit uses a 12-V supply, and AEA sells a wall-plug adapter, a cigarette lighter cord, and a nicad pack to accompany it.

At the list price of \$139.95, even Ted McElroy would have bought the KT-2.

For additional information, contact Advanced Electronic Applications, PO Box C2160, Lynnwood WA 98036. Reader Service number 487.

Avery L. Jenkins WB8JLG  
73 Staff

## CUSHCRAFT A3/A73 TRIBANDER

After years of helping to build (and use) other people's ham stations, I finally settled down and found a home that was compatible with ham radio. It didn't take long before a tower started growing in the backyard. No more semi-verticals and very random wires for me!

But having a tower meant that I had to find something to put on top of it—and monobanders were out (at least until next year!). I decided on the Cushcraft A3 tribander beam with an A73 40-meter add-on kit. The A3 is a three-element beam for 10, 15, and 20 meters, and the A73 kit adds an additional set of traps and some length to the driven element so that the antenna will work as a rotatable dipole for 40 meters. With the A3/A73, I can cover four bands with one antenna and feedline, and that makes designing an antenna farm a lot easier.

The A3 is a small antenna with a boom length of only 14 feet, although the driven element (with the A73 kit installed) is about 35 feet long and uses a truss and cord to reduce element sag. The beam went together easily, and the instructions, which consist almost entirely of diagrams, were simple to follow. Element dimensions for use on the CW, phone, or mid-band segments are given so that the antenna can be tuned up in your favorite part of the band. I used the CW settings for mine.

The wind load of the A3/A73 is 4.94 square feet (4.63 sq. ft. if set up for 30 meters). The antenna is well built and should survive any reasonable wind.

After assembly, the crew (two on the ground and WA9SRW on the tower) hoisted the antenna up to its final resting place at 70 feet without any trouble. Some quick swr checks indicated that everything was as it should be, and off I went to work the world.

About a month after the A3 was installed, disaster struck. While operating with a kilowatt input on 20-meter CW, I watched with horror as the swr rose from its usual 1.1 to 1 up to 3+ to 1. After letting things cool down a bit, I tried again, this time using 100 Watts output. When first keyed, the swr was right where it should be, but I could watch it rise

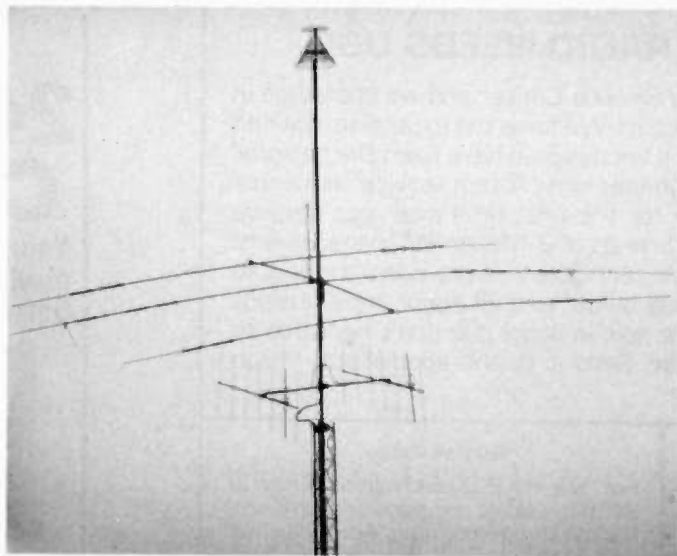

AG9V's stack: 2 x 7-ell/146 MHz at 67', the Cushcraft A3 at 70', and home-brew Discone for 144/220/450 at 80'. (Photo by K9UQE)

until, after about 45 seconds, it was back up to 3 to 1.

A check of other bands showed that 40 meters also was affected, but that 10 and 15 meters were not. This led to the suspicion (confirmed by a phone call to Cushcraft) that I had a bad 40/20-meter trap on the driven element. Analyzing the failure, it appeared that there had been an arc in the trap. The failure occurred on a damp, misty night, and apparently the moist air provided the path that began the arc-over. Cushcraft whipped up a modified set of traps with increased clearances that should eliminate any such problems.

Once the weather cooperated and we got the new traps installed (these things always seem to happen in the middle of winter!), everything was back to normal. Subsequent misty nights have proven to be no problem. Cushcraft has informed me that these modifications will be used in future production A3/A73s.

Now for the \$64,000 question—how does the A3 perform? Considering the compromises that are inevitable in a multiband beam, the answer is very well indeed.

Let's look at the compromises first. There are two problems with a small, trapped beam. First, traps aren't 100 percent efficient and they do introduce some loss, but more important, they shorten the elements by adding inductance to the antenna circuit. Of course, this has the advantage of creating a smaller antenna, but it also means that like most shortened antennas, the bandwidth will be reduced and the swr curve will be sharper.

Second, the spacing between elements is a compromise—if the elements aren't too widely spaced for 10 meters, they will be closely spaced for 20 meters. Closely-spaced elements tend to reduce gain, front-to-back ratio, and bandwidth.

Gain and front-to-back bandwidths usually get narrower along with swr bandwidth, and particularly on 20 meters, these measurements won't be near their peak values at the end of the band away from where the A3 is tuned.

These compromises most affect the lowest frequency band in use, and on the highest band, performance should be very close to that of a full-sized beam. In practical terms, the trade-offs don't make a tribander (or in this case, a "quadbander") like the A3 an inferior performer, and they certainly result in a very practical antenna design.

The A3's swr bandwidth, most noticeably on 20 and 40 meters, is much narrower than that of a full-sized antenna, and if the A3 is tuned for CW, you'd better figure on dealing with a rather high swr at the top of the phone band. On 40 meters, in fact, the 2 to 1 bandwidth is only about 125 kHz. Narrow swr bandwidth itself isn't a serious problem unless your rig won't load into the mismatch—and that's what antenna tuners are for. According to Cushcraft, the A3 will handle a full kW if the swr at the antenna (and not measured through a transmatch) is less than 3 to 1. An swr that high should occur only on 40 meters.

In use, the A3 isn't noticeably inferior to a full-sized antenna. The gain on 20 meters may be a dB or two below that of a monobander, but it's still a lot louder than a dipole! I spend most of my operating time haunting the bottom end of 20 CW, and I don't feel that the A3 is a handicap. If a pileup is so huge that I can't get through, it would take a lot more than a bigger antenna to make much difference.

My CW-tuned antenna does have lower gain and front-to-back ratio at the top of 20 than at the bottom. Setting the elements to mid-band dimensions would tend to even things out, but at some loss of CW performance. This is where the monobander has the edge, and where an operator demanding optimum performance across the entire band might be

unhappy with the A3 or with any small tribander.

Of course, if you get into the battles on 20 phone or if you contest in a big way, you'll need all the antenna you can get, but I think that most of us can live quite nicely with an antenna like the A3—particularly when you consider the cost of an A3 and the modest tower it takes to support it versus the cost of a stack of monobanders, a huge rotor, and a heavy, guyed tower. That ultimate dB is very, very expensive!

I haven't talked to many folks who use a tribander with a 40-meter add-on, so I was very interested in how the A3/A73 would work for DXing from the midwest, a couple of thousand miles further from the DX than are you lucky coastal types. My other 40-meter antenna is a half-delta loop over a pretty good ground. It seems to work very well, and I've worked a fair amount of DX with it.

Well, folks, the A3/A73 beats the half-delta every time. It hears less noise and seems to talk as well or better than the other antenna. The nulls off the end of the rotatable dipole are very noticeable, and it is possible to null out European broadcasters by 10 to 20 dB merely by rotating the antenna 90 degrees away from Europe.

Of course, having the antennas at 70 feet doesn't hurt any, and at a lower height, the dipole might well lose to the half-delta. But in any installation, the A3/A73 has an advantage because it puts the 40-meter antenna up where it can perform best. It will nearly always be installed as high as it possibly can be, and unlike most wire dipoles, it will be in the clear and away from guy wires and other antennas. Under these conditions, a dipole can do an amazingly good job on the lower bands, particularly since fewer of the gang are using beams on 40 meters.

Incidentally, the A73 kit may also be set up to cover the new 30-meter band instead of 40, so it's an easy way to add a new band to your station without a lot of hassle if you already have an antenna for 40.

The A3/A73 antenna will provide respectable performance on 40 through 10 meters without unreasonable cost or complexity. It's a good choice for the ham who has limited space and/or funds for antennas, yet who wants to be able to punch through a pileup now and again.

For further information, contact Cushcraft Corp., PO Box 4680/48 Perimeter Road, Manchester NH 03108. Reader Service number 489.

John Ackermann AG9V  
Green Bay WI

## HAM HELP

I am interested in setting up a regular sked with other hams who are interested in working with historical photographic processes such as Carbro, Bromoil, or Oil Transfer.

Tracy Diers W2OQK  
58-14-84th St.  
Elmhurst NY 11373

I need a modulation transformer for a Johnson Viking Valiant transmitter. I will gladly pay shipping.

Mitchell Sisak  
10180 Marquette St.  
Montreal, Quebec  
Canada H2C 3E4

I would like to find the pinouts and any other information on the American Microsystems S 2566 rhythm generator.

Dirck Spicer  
Wildwood Lane  
Durham CT 06422

I am disabled with a stroke, and in the past two years I have had cancer surgery three times. Reading would help me regain my health, and if anyone could send me some magazines, old or new, I sure could use them.

Bobby Welch N4GWO  
2903 Azalea Dr.  
Flatwoods KY 41139





# W2NSD/1 NEVER SAY DIE

editorial by Wayne Green

from page 8

After all, what's the real difference? Radio waves go everywhere, so from a radio point of view, it is of little consequence whether the operator is in Burma, Thailand, or Sri Lanka. For that matter, one of the best DXpeditions of all time, Heard Island, was done from up near Vancouver, Canada. Just think of the trouble everyone was saved on that!

When you move the DXpedition nearer the US like that, you don't let propagation or distance screw up the contacts. You save a fortune on boat charges and have a much lower chance of getting killed. You save weeks of sailing, a bunch of gas, and in every way cut costs enormously. And your QSL cards are as valuable as if you'd gone to all that silly trouble and expense.

No, today's DXpeditioners seem to have lost their spark of originality and imagination. Poor Lloyd and Iris Colvin had to go through all sorts of trouble to get into the Persian gulf countries and get on the air. It cost 'em a bundle, too. And for what? Just to give a few thousand of us a card from a new country...one which would have been infinitely easier to get if they'd operated from some place nearer home. All you need is to make the contacts, provide some good-looking documentation to the ARRL, and thousands of hams are happy as clams.

The first truly imaginative DXpeditioner is still with us. I see him almost every year at Dayton. He set up and gave us contacts from a bunch of African countries while happily sitting in Casablanca. Once he broke the ice, we saw many of the previous DXpeditioning problems solved. That did away with quite a few arduous boat trips, eased country restrictions, eliminated customs problems for equipment, and so on.

Why take a chance on braving the wild South Atlantic storms when you can save tremendous

time and keep out of danger by operating from near Venezuela? That's where a pair of well-known DXers did it. And, you know, it isn't much easier to blast through pileups to Peter and Paul Rocks if they have been moved, for convenience, to Venezuela instead of the Atlantic. Those same Texas and Missouri DXers are still in there tail-ending for twenty minutes, alternating calls so no one can tell if the DX station is transmitting or not.

I say let's get more fun into DXing by going back to the old system. Let's get a nice little DXpedition for Spratly going...with the spoilsport ARRL chaps who are making people get killed on the boat out of Singapore and the rest of us out on Catalina Island running two Watts to a wet string.

## DIGITAL PERSPECTIVE

Having gotten bitten by the digital bug some 35 years ago when I got involved with amateur radio teletype, I haven't had as much trouble getting into the digital revolution as many of the more conservative (tube-oriented) old-timers. And now we're reading about the marvels of digital audio, the coming revolution in compact laser-playing disks...maybe even digital television.

As much of a fan of new ideas and pioneering as I am, I'm not yet totally convinced about the laser disk idea. The basic idea of digital audio is great. With this technology it's possible to make recordings where you have zero noise from the recording medium. Yep, no tape hiss...zero. No record groove hiss, snap, crackle, and pop. The idea is just fine. And the technology makes it possible to extend the dynamic range of recordings from 60 dB out to 90 dB. Remember, if you will, that every three dB means a doubling of power, so that extra 30 dB will buy you a thousandfold increase in power capability. Whooley, thousand-Watt audio amplifiers?

Digital audio has some bene-

fits and some drawbacks. For the audiophile, the results of DA are so spectacular that he has no choice but to go digital. But this means a lot of expense, because while digital disk players will work with analog preamplifiers and amplifiers, a purist would blanch at anything less than digital right on through to the speaker. Digital speakers? No, little of this technology has even been invented yet, but it will be along. This will be a wonderful area for small entrepreneurs to get going, working toward starting megabuck corporations on the coattails of yet another budding high-tech industry.

The messy part of this whole scam lies in that vaunted laser disk. The problem is that we're way behind on inventing storage media for data. We're still horsing around with round, flat records which have to be spun...a hang-over from the early recordings of Edison. You'd think we would get the message on this when we see \$3,000 record players. And even those aren't as good as the early model laser digital players. Look at all the agonies we are going through with Winchester disks for data storage in computers! It's almost time to start seriously working on a mass memory system which is not mechanical.

They're talking about being able to put laser disk players into cars. It's laughable. Do you know that the silly record player they've invented to play those four-inch laser disks has to change speed as you go from the inside grooves to the outside from 600 rpm down to 200 rpm? And once you know that, you realize that the speed of the record player has to be different for every single groove it plays. Talk about a mechanical monster!

We may have to use some mechanics to retrieve data from a transportation medium, but spinning a record at an infinite number of speeds doesn't seem optimum. Perhaps we can come up with a card which can be read as it moves by a reader, using a memory cache to smooth out the flow of data. Or we might want to go to some sort of optical/film data storage system which might give us higher density of storage than micro holes blasted in thin films of metal.

On the bright side, there's no way that cassettes will be able to handle the data storage requirements, so we may see a drop in the copying of records.

These are wonderful days for amateurs...and we should remember that most of the really important breakthroughs in technology have historically been made by amateurs. If you've worked in any R&D firms, you know why this is as well as I...and I've done my homework on this one, too. I worked for an R&D lab at one time and saw with my own eyes why virtually no significant developments in technology can emerge.

The key lies in the funding process. R&D labs do not hire people to do what is called basic research...at least few of them do. Basic research is experimenting for the hell of experimenting, with no commercial product in mind. We used to spend a lot of money this way before WWII, but when the war came we stopped this "wasteful" spending and only worked on projects where there was a good potential for results.

It's still this way. If the lab manager is able to convince management that there is an almost certain chance for a profitable product to emerge, the research funds can be found. Iffy projects are tabled. The amateur, of course, with no one to stop him, can work on anything his heart desires. And if he comes up with something fantastic, he's got it made. If not, well, at least he's had the fun of trying. This is why hams in the past have come up with most of the real breakthroughs in radio technology.

It's getting time to experiment over the air with some digital audio. We might even want to try some digital stereo and see what we can do with it. A sampling rate of 10 kHz might work out fine for our type of communications rather than the 44 kHz they use for high-fidelity music. That's a little broad, but, after all, we're just experimenting. We might be able to get that down to 6 kHz and still have better voice communications than we have now.

The objective is to get a maximum of information through for a given band of frequencies and a given time, so whether we find it better to do with a 50-kHz-wide band or a 2-kHz band isn't as relevant as the throughput. If we can digitize voice and then send it in short blasts at high speed with error-correcting, we could end up with a very efficient communication medium.

The world of digital audio is

## NEW ELECTRONIC KITS

### ALL IN ONE RTTY DEMODULATOR KIT

**FEATURES** . . . ON BOARD POWER SUPPLY  
AFSK GENERATOR . . . PROVISIONS FOR LOOP  
SUPPLY . . . ACTIVE FILTERS OR OPTIONAL  
TOROID FILTER . . . AUTOSTART . . . ANTISPACER  
PCB KIT NO. 23-1778 SB-60 \$139.95

### RTTY SPEED CONVERTER

CONVERTS 40, 75 & 100 WPM BAUDOT CODE  
TO 100 WPM CODE FOR BAUDOT MACHINES  
REVERSES SAME FOR SENDING. FEATURES  
SELCAL BUFFERING AND INTERFACE FOR  
BAUDOT PTR. PCB KIT 23-1816 \$69.95

### BAUDOT/ASCII CONVERTER

MICRO BASED RTTY CONVERTER CONVERTS  
BAUDOT TO ASCII FOR RECEIVE. ASCII  
TO BAUDOT FOR TRANSMITTING. FEATURES  
SELCAL BUFFERING AND INTERFACE FOR  
110 BAUD PTR. PCB KIT 23-1815 \$69.95

### AUTO CWID KIT

FEATURES ON BOARD TEN MINUTE TIMER  
WITH TTL PLUS/MINUS 12 INTERFACE  
AND UP TO 32 DOTS DASHES OR SPACES  
PCB KIT NO. 23-1721 4-1/2X6 \$29.95

### RTTY DEMODULATORS

DM-60 ACTIVE OR OPTIONAL TOROID  
FILTER AUTOSTART. ANTISPACER. SINGLE  
SHIFT (UP DATED ST. & ON ONE BOARD.)  
PCB KIT NO. 23-1712 \$49.95

DM-60 PLL TU DESIGN WITH ACTIVE  
FILTER FRONT END. PCB 23-1719 \$29.95

### AFSK GENERATOR FOR RTTY

ROCK SOLID CRYSTAL CONTROLLED AFSK  
GENERATOR. VIRTUALLY DIRTY FREE. TWO  
POPULAR SIZES . . . SPECIFY SIZE  
PCB KIT NO. 23-1717 2-1/2X6 \$29.95  
PCB KIT NO. 23-1710 4-1/2X6 \$31.95

TU BANDPASS FILTER ACTIVE FILTER AP60 PCB 23-1718 \$ 9.95	INTERFACES KIT OPTO/RS-232/XSTR LOOP TO TTL TTL TO LOOP PCB 23-1722 \$13.95
---	---

LOGIC/GLITCH PROBE FREEZES HIGH SPEED PULSE OR LOGIC LVL PCB 23-1706 \$15.95	RS232 LINE MONITOR FREEZES HIGH SPEED RS-232 LINE W/LED. PCB 23-1707 \$19.95
---	---

DONT MISS OUR 1983 CATALOG WITH OVER  
1200 ITEMS SEND \$1.00 [REFUNDABLE  
ON FIRST ORDER] FOR OUR CATALOG. OR  
SEND TWO STAMPS FOR OUR FREE 2P FLAYER  
ALL KITS INCLUDE PARTS FOR PRINTED  
CIRCUIT BOARD ONLY  
PLEASE ADD \$2.00 FOR SHIPPING ADD  
\$5 ADDITIONAL FOR ORDERS UNDER \$5  
CHECKS . . . MASTER CARD VISA . . . COD

**Daytapro Electronics, Inc.**

1039 N WILSHIRE LN., ARLINGTON HTS. ILL. 60004

312-870-0555

# MFJ NOISE BRIDGE

Adjust antenna for maximum performance. Measure resonant frequency, radiation resistance, reactance. Individually calibrated resistance scale, expanded capacitance range, built-in range extender gives accurate extended measuring range.



- Individually calibrated resistance range
- Built-in range extender
- Expanded capacitance range

# \$59<sup>95</sup>

**NEW FEATURES:** Individually hand calibrated resistance scale, expanded capacitance range ( $\pm 150$  pf), built-in range extender gives accurate measurements and much extended measuring range, 1-100 MHz, Simple to use. Comprehensive computer proven manual.

This New MFJ-202B Noise Bridge lets you quickly adjust your single or multiband dipole, inverted vee, beam, vertical, mobile whip or random system for maximum performance.

Tells resonant frequency and whether to shorten or lengthen your antenna for minimum SWR over any portion of a band

Works with any receiver or transceiver. SO-239 connectors. 5x2x4 inches. Use 9 volt battery.

Other uses: tune transmatch; adjust tuned circuits; measure inductance, RF impedance of amplifiers, baluns, transformers; electrical length, velocity factor, impedance of coax; synthesize RF

impedances with transmatch and dummy load

Order from MFJ and try it—no obligation. If not delighted, return it within 30 days for a refund (less shipping). This bridge is unconditionally guaranteed for one year.

To order, simply call us TOLL FREE 800-647-1800 and charge it to your VISA or Master Charge account or mail us a check or money order for \$59.95 plus \$4.00 shipping and handling for MFJ-202B. Order today.

Put this MFJ Noise Bridge to work improving your antenna. Order from MFJ or see your dealer.

**CALL TOLL FREE . . . 800-647-1800**

Call 601-323-5869 in MS, outside continental USA or for tech./order/repair info. Telex 53-4590 STKV.

**MFJ ENTERPRISES, INCORPORATED**

Box 494, Mississippi State, MS 39762

## CALL LETTER

### HATS — T SHIRTS

101 & Elm Street, Suite 4 Peterborough, NH 03458



### HATS

Only \$6

HAT COLORS  
Royal Blue Navy Blue  
Red Gold Green

Hats Are One Size Fits All - Nylon Mesh Back



### T SHIRTS

Only \$8

SHIRT SIZES  
Adult - Sm Med Large X Large  
Child - 2 4 6-8 10-12 14 16

### SHIRT COLORS

Lgt Blue Lgt Green Tan  
Wht/Red Trim Wht/Blue Trim

CALL LETTER HATS 101 & Elm Street Suite 4 Peterborough, NH 03458 187

Name \_\_\_\_\_ Phone \_\_\_\_\_  
Address \_\_\_\_\_  
City \_\_\_\_\_ State \_\_\_\_\_ Zip \_\_\_\_\_  
Ck  Money Order  Charge Card  \_\_\_\_\_  
Signature To Validate Order \_\_\_\_\_ Exp. Date \_\_\_\_\_

ORDER BLANK Add \$2 To Total For Shipping Charges

## Introducing The SRT-3000 RTTY Communications Send-Receive Terminal

SRT-3000

List

\$995.00

Introductory

Price

\$795.00



- Built-in demodulator & AFSK modulator for 170,425,850 Hz shifts, high and low tone pairs • 60,66,75,100,132 WPM Baudot, 110,300 Baud ASCII, 5-99 WPM Morse • 1000 character text buffer with BREAK feature • Ten 80 character message memories with battery backup • Selectable display formats, 24 lines x 72 characters (2 pages), 24 lines x 36 characters (4 pages), 16 lines x 36 characters (6 pages) • Split screen operation • On screen status line displays a tuning bar, mode, speed, shift, tone pair, normal/reverse, USOS, WRU, SELCAL, buffer mode and buffer count • Cassette interface for long "Brag Tapes" or unattended message storage • Baudot and ASCII printer outputs • Built-in audio monitor • Built-in 110 VAC power supply • Other features—PTT control, WRU, SELCAL, sync idle, CW ID, USOS, auto-start, full or half duplex, scope outputs, weight control, intercharacter spacing, reverse video, RS-232, word wrap around • Compact size only 13.3 x 10.3 x 4 inches • Made in USA.

Send For  
Free Information

**DGM ELECTRONICS, INC.**

787 Briar Lane, Beloit, Wis. 53511  
(608) 362-0410



just getting going. It is going to turn into an enormous business. Are you going to be one of the winners in this?

## DENTRON

A piece in *Newsweek* a few weeks ago about a suit by Ron Hubbard's son to take over the Hubbard Scientology empire, claiming that no one has seen Hubbard for over two years and that he is presumed dead, brought to mind a recent rumor that DenTron had been bought by Scientology.

Having more than a casual interest in Hubbard and Scientology, I called DenTron to see what was up. Scientology has been getting a lot of flak of late, with exposés on television, books exposing it, and so on. Well, having been around when it began and having personally known Hubbard, I like to keep up with what's going on.

Scientology got started back in 1950 with the publication of an article in *Analog* magazine (science fiction). I'd been reading the magazine for many years and was particularly interested in an article on a new book being published by Hubbard on Dianetics, a new science of the mind. I got the book, started right in experimenting with some of the techniques described therein, and had some truly amazing experiences.

Hubbard's book was flamboyant and his claims extravagant, but since the fundamentals of it made more sense than any other approaches to the mind, I decided to look into it further. I took a six-week course at the

Hubbard Dianetic Research Foundation in Elizabeth, New Jersey, and became an accredited Dianetic Auditor.

The school was fascinating. There was the element of baloney with the Hubbard claims of producing "clears" who had eidetic recall and were in most respects perfect people. We never saw anyone like that. But the concept was a good one and the techniques did produce the most incredible results in a hurry.

The story going around the school was that the whole idea for Dianetics was developed by someone else and that Hubbard had come across the manuscript for the work when the real author was in a hospital and died. So the claim went that Hubbard took the extensive research as his own, adding what he thought might result from the therapy—clears—as an accomplished fact.

Now Hubbard is, or was, a very magnetic person. He was a good writer and a persuasive BS artist. But the quick success of Dianetics seemed to distress him. It didn't take long before there were many people using the techniques from his book with more success than he enjoyed. Keeping in mind his enormous ego and the weight on him of the success of the therapy which he claimed to have discovered, I was not at all surprised when he came up with a new approach which was mostly his own... and which he called Scientology.

It's emotionally difficult to be a guru pretending something is

your own when it isn't, so he came up with his own. This was cloaked as a religion, both as a way to get around laws against medical treatment by non-doctors and as a way of brainwashing the impressionable.

Having been at the HDRF, I remained on the Scientology mailing lists for years, getting their literature and receiving hundreds of letters suggesting I come in for updating. I kept answering all letters with the question: If you are able to really do such marvelous things, please show me one single example of a person who has been so improved by Scientology that he or she now stands out in some way over the rest of us. I never saw any indication that Scientology could even come close to Dianetics in effectiveness... and so no one seemed to emerge as outstanding in talents from the process.

Large numbers of Scientologists were used to write personal letters to prospective recruits. They had to write by hand... sincere... and encourage the correspondent to come in for a "test run."

One of the results of just about any type of mental therapy is the feeling that one has improved. Just as the sugar pill placebo given by doctors is capable of remarkable cures of some illnesses, the application of almost any psychotherapy seems to make some people feel better. Trading on this response, the Scientologists quickly get newcomers involved with their strange perception of reality, and they find it difficult to get loose.

Hubbard was able to build up his Church of Scientology into a multinational organization, with the headquarters at St. Hill, a huge estate in England. When governmental pressures from some countries grew too great, he moved his personal HQ to a converted cargo ship served by the elite of his group. I remember the glowing brochures asking for volunteers for this. Golly, the enthusiasm and excitement of those brochures was fun and almost too much to resist.

The church is now a large, rich organization with branches all over the world. And, I suspect, judging from the DenTron example, they are investing in businesses these days, not just in their own growth. I was assured by the president of DenTron that the Scientologist who had worked with them had

recently left and that there was no more connection.

Getting back to Dianetics... I've kept in touch with most of the better known psychotherapies over the last thirty years and I know of none which works with the ease, speed, and thoroughness of Dianetics. I got to be quite good with the techniques involved and found that I was able to discover the roots of most problems people were having and could help them substantially in a matter of hours. But I also found that very few people really want to be helped. They've adjusted to some degree to their mental problems and are defensive about them.

Many of the basics of Dianetics were pooh-poohed by the establishment back in 1950, so it has been interesting for me to keep abreast of the development of these other schools of therapy and see them gradually accepting the very concepts which they found so totally ridiculous in 1950.

One of the basic concepts had to do with the way the brain ties up part of its ability to think when faced with a painful situation, either physical or mental. The most fundamental rule for any organism is to survive and thus pain signals are interpreted as a threat to survival. By deconditioning these painful moments in the past, we found that IQs increased and the ability to think zoomed upward.

Fortunately for our peace of mind, all of these pain memories and the subconscious responses they force upon us are carefully hidden from our conscious mind, with behavior, no matter how weird, rationalized.

Well, sorry for the usual digression, but I don't think I've ever written about Scientology or Dianetics before, and I suspect that very few people alive know about the possibly true roots of this amazing psychotherapy. And, yes, I'm familiar with Freudian analysis, the Karen Horney school, Gestalt psychology, Korzybsky, Examiner Therapy, Integration Therapy, and so on.

Did Hubbard come across the manuscript for Dianetics in a hospital in Burma during the war and pick it up from the dying real author? If Hubbard is dead, we may never know. But we do know that he was able to use that start to build a multi-billion dollar empire reaching around the globe.

# HAM HELP

I am looking for the schematic and instruction manual for the Hewlett Packard 170A oscilloscope. I will pay all costs.

John Goodyear W6HVB  
2985 Saratoga St.  
Riverside CA 92503

I need the manual for the Knight G-30 grid-dip meter. I will pay reproduction and postage costs.

J. E. Smith K5PTC  
2504 Conflans  
Irving TX 75061

I would like to use my Atari 800 computer for RTTY, both Baudot and ASCII. Can anyone help me find information and hardware?

Ron Griesback WD9HDO  
1712 N. Harriman  
Appleton WI 54911

I am looking for schematics and operating manuals for the following equipment: a US Navy 4.0-27.0-MHz RBC-1 receiver; a Lakeshore Industries "Band Hopper" SSB vfo; and a Central Electronics model 20-A multi-phase exciter. I will pay for manuals or copying costs.

Peter Doherty W1VO7  
PO Box 291  
Port Townsend WA 98368

My flea-market Eldice transmitter, model SSB 100ML, manufactured by Eldice Electronics of Mineola NY, did not come with a manual or circuit diagrams. I would like to buy a manual from someone who has a spare set or borrow some that I could copy.

Richard E. Downing W1TXS  
16 Woodside Terrace  
Springfield MA 01108

**SYNTHESIZED SIGNAL GENERATOR**

**MADE IN USA**



MODEL SG100D  
\$349.95  
plus shipping

- Covers 100 to 185 MHz in 1 kHz steps with thumb-wheel dial
- Accuracy 1 part per 10 million at all frequencies
- Internal FM adjustable from 0 to 100 kHz at a 1 kHz rate
- Spurs and noise at least 60 dB below carrier
- RF output adjustable from 5-500 mV at 50 ohms
- Operates on 12 Vdc @ 1/2 Amp
- Available for immediate delivery
- \$349.95 plus shipping
- Add-on Accessories available to extend freq. range, add infinite resolution, voice and sub-audible tones, AM, precision 120 dB calibrated attenuator
- Call for details • Dealers wanted worldwide.

**VANGUARD LABS** ✓311  
196-23 Jamaica Ave., Hollis, NY 11423  
Phone: (212) 468-2720

*Custom Mailing Lists on Labels!*

**Amateur Radio Operator NAMES**

Custom lists compiled to your specifications  
—Geographic by ZIP and/or State; by Age or Birthdate; by Licence Issue or Expiration Date—on labels of your choice.

**Total List: 411,000 Price: \$25/Thousand**  
Call 203: 438-3433 for more information

**Buckmaster Publishing** ✓255  
70 Florida Hill Rd., Ridgetfield, CT 06877

**NEMAL ELECTRONICS**

**COAXIAL CABLE SALE**

**This Month's Specials**

**Same Day Shipping**

<b>POLYETHYLENE DIELECTRIC</b>	
RG213 noncontaminating 95% shield mil spec.	36¢/ft.
RG174/U mil spec. 96% shield.	10¢/ft.
RG11U 96% shield, 75-ohm mil spec.	25¢/ft.
RG8U 96% shield, mil spec.	\$27.95/100 ft. or 31¢/ft.
RG6A/U double shield, 75-ohm.	25¢/ft.
RG58AU stranded mil spec.	12¢/ft.
RG58 mil spec. 96% shield.	11¢/ft.
<b>LOW LOSS FOAM DIELECTRIC</b>	
RG8X 95% shield	\$14.95/100 ft. or 17¢/ft.
RG8U 80% shield	18¢/ft.
RG58U 80% shield	07¢/ft.
RG58U 95% shield	10¢/ft.
RG59U 100% foil shield, TV type	\$7/100 ft. 10¢/ft.
RG8U 97% shield 11 ga. (equiv. Belden 8214)	31¢/ft.
Heavy Duty Rotor Cable 2-16 ga. 6-18 ga.	36¢/ft.
Rotor Cable 8-con. 2-18 ga. 6-22 ga.	19¢/ft.

<b>CONNECTORS MADE IN USA</b>	
Amphenol PL-259	79¢
PL-259 Teflon/Silver	\$1.59
PL-259 push-on adapter shell	10/\$3.89
PL-259 & SO-239	10/\$5.89
Double Male Connector	\$1.79
PL-258 Double Female Connector	98¢
1 ft. patch cord w/RCA type plugs each end	3/\$1.00
Reducer UG-175 or 176	10/\$1.99
UG-255 (PL-259 to BNC)	\$3.50
Elbow (M359)	\$1.79
F59A (TV type)	10/\$2.15
UG 21D/U Amphenol Type N Male for RG8	\$3.00
BNC UG88C/U male	\$1.25
3/16 inch Mike Plug for Collins etc.	\$1.25
UG273 BNC to PL-259	\$3.00

**FREE CATALOG**  
COD add \$2.00—FLA. Res. add 5% Sales Tax

Orders under \$30.00 add \$2.00

**Connectors—shipping 10% add'l, \$3.00 minimum** ✓412  
**Cable—shipping \$3.00 1st 100 ft. \$2.50 each add'l 100 ft.**

1327 NE 119th Street, Dept. 73, No. Miami, FL 33161 Call (305) 893-3924

**HAMEG OSCILLOSCOPE**



**COMPLETE WITH PROBES**  
**\$555**  
**ONE YEAR WARRANTY**

- 20 MHz Dual Trace
- 2 x 20 MHz, Max. 2 mV/cm
- Built-in Component Tester
- Timebase 40 ns - 0.2 s/cm
- X-Y Operation (1:1 Ratio)
- Trigger Bandwidth 30 Mhz

-133 *Rivendell Assoc.*   
RFD-5 DERRY, N.H. 03038 WARNER HILL (603) 434-5371

**MICROWAVE**

ATV TRANSMITTER 2.3 TO 2.45 GHZ  
4.5 SUB-CARRIER GENERATOR  
VIDEO MODULATOR  
PHASE III OSCAR

**GIZMO ELECTRONICS**

Box 164 Radley, KS 66768 ✓229  
(316) 724-6505

Free Shipping in U.S. Kansas residents 3% sales tax

**Subscription Problem?**

73 Magazine does not keep subscription records on the premises, therefore calling us only adds time and doesn't solve the problem.

Please send a description of the problem and your most recent address label to:

**73** Amateur Radio's Technical Journal  
Subscription Dept.  
PO Box 931  
Farmingdale, NY 11737

Thank you and enjoy your subscription

**PRESERVE**

**73 WITH**

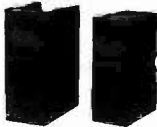

**BINDERS & FILE CASES.**

Keep your issues of 73 Magazine handy and protected in handsome and durable library file boxes or binders. Both styles are bound in red leatherette with the magazine logo stamped in gold.

File boxes: each file box holds 12 issues, with spines visible for easy reference.  
\$5.95 each, 3 for \$17.00, 6 for \$30.00

Binders: each binder holds 12 issues and opens flat for easy reading.  
\$7.50 each, 3 for \$21.75, 6 for \$42.00

(USA postage paid. Foreign orders must include \$2.50 per item.)

Please state years desired (1977 to 1984).  
Send check or money order to:  
Jesse Jones Box Corp., P.O. Box 5120, Philadelphia, PA 19141; please allow 6 to 8 weeks for delivery.  
Sorry, no C.O.D. or phone orders.

**CONTACT-80...**



TTYU your TRS-80 with CONTACT 80 MARK II for 1983!

TRS-80, MOD III INTERFACE (included with system) gives keyboard STATION CONTROL and connects with the TTY TU of your choice.  
(No other equipment needed for CW operation)

**Cassette & Disk Features:**

- BAUDOT, ASCII & MORSE
- CW RX speed AUTOSYNC & unique FIST-FIXER
- TRI-SPLIT screen (user sets HIS way)
- "Unlimited" STORED MSG. sizes
- Automatic DYNAMIC BUFFER ALLOCATION
- Live HARDCOPY plus other Line-printing
- AUTO-ID, TIME/DATED transmissions
- On screen "OSCILLOSCOPE", CLOCK, COUNTERS
- Unique EDITOR, CLOCKED-KEYING, NAME-LINE
- AUTO-DIDDLE, K/B ROLLOVER, REPEATING KEYS
- Fast CASSETTE I/O and many other features

**Additional Disk Features:**

- Two-way message SELCALL A "PERSONAL MSO"
- AUTO-MONITOR frequency activity to disk
- SAVE, LOAD, KILL & DIR plus other I/O

INTRODUCTORY SPECIAL

DISK VERSION	\$199.00
CASSETTE VERSION	\$179.00
CASSETTE, later upgrade to DISK	\$20.00

Guaranteed-include Amateur CALLSIGN-POST PAID

**ROYAL**  
407 Conkle Road ✓150  
Hampton, CA 30228 Telephone: (404) 946-9314

# WAYNE GREEN BOOKS

## KILOBAUD CLASSROOM

by George Young and Peter Stark

Makes learning electronics fun and easy. First published as a series in *Kilobaud Microcomputing*, the book combines the learning of essential theory with practical, hands-on experience. The course begins with basic electronic projects and culminates in the construction of your own programmable microcomputer. The direct instructional methods of authors Young & Stark make KILBAUD CLASSROOM a simple way for you to acquire a solid background in digital electronics.

BK7386 (419 pages)..... \$14.95

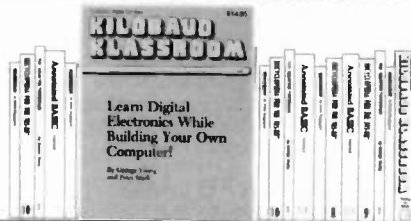

## THE SELECTRIC INTERFACE by George Young

You need the quality print that a daisy wheel printer provides but the thought of buying one makes your wallet wilt. The SELECTRIC™ INTERFACE, a step-by-step guide to interfacing an IBM Selectric I/O Writer to your microcomputer, will give you that quality at a fraction of the price. George Young, co-author of *Kilobaud Microcomputing* magazine's popular "Kilobaud Klassroom" series, offers a low-cost alternative to buying a daisy wheel printer. The SELECTRIC INTERFACE includes: step-by-step instructions, tips on purchasing a used Selectric, information on various Selectric models, including the 2740, 2980, and Dura 1041, driver software for Z80, 8080, and 6502 chips, tips on interfacing techniques. With The SELECTRIC INTERFACE and some background in electronics, you can have a high-quality, low-cost, letter-quality printer. Petals not included.

BK7388 (125 pages)..... \$12.97

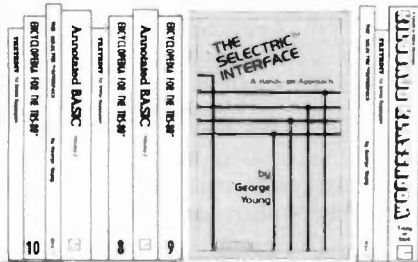

## GENERAL LICENSE STUDY GUIDE

By Timothy M. Daniel N8RK

This is the complete guide to the General License. Learning rather than memorizing is the secret. This is not a question-and-answer guide that will gather dust when the FCC issues a new test. Instead, this book will be a helpful reference, useful long after a ham upgrades to General. Includes up-to-date FCC rules and an application form. Order yours today and talk to the world.

SG7358 (87 pages)..... \$6.95

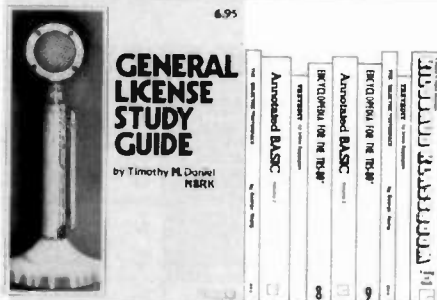

## NOVICE LICENSE STUDY GUIDE

By Timothy M. Daniel N8RK

Here is the most up-to-date novice guide available. It is complete with information about learning Morse code, has the latest FCC amateur regulations and the current FCC application forms. This guide is *not* a question/answer memorization course but rather it emphasizes the practical side of getting a ham license and putting a station on the air. It reflects what the FCC expects a Novice to know without page after page of dull theory. The most current information still available at last year's price.

SG7357 (98 pages)..... \$4.95

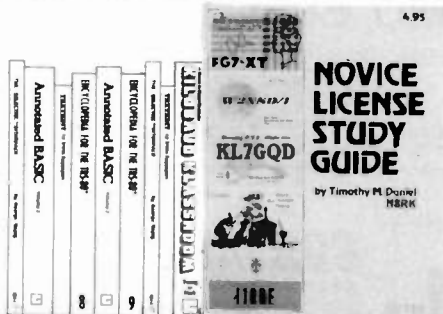

## THE NEW WEATHER SATELLITE HANDBOOK by Dr. Ralph E. Taggart WB8DQT

Here is the completely updated and revised edition of the best-selling *Weather Satellite Handbook*—containing all the information on the most sophisticated and effective spacecraft now in orbit. Dr. Taggart has written this book to serve both the experienced amateur satellite enthusiast and the newcomer. The book is an introduction to satellite watching, providing all the information required to construct a complete and highly effective ground station. Not just ideas, but solid hardware designs and all the instruction necessary to operate the equipment are included. For the thousands of experimenters who are operating stations, the book details all procedures necessary to modify their equipment for the new series of spacecraft. Amateur weather satellite activity represents a unique blend of interests encompassing electronics, meteorology and astronautics. Join the privileged few in watching the spectacle of earth as seen from space on your own monitoring equipment.

BK7383 (132 pages)..... \$8.95

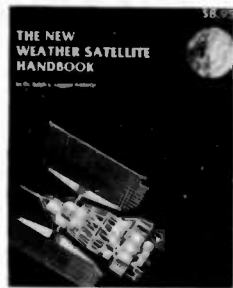

## FOR TOLL-FREE ORDERING CALL 1-800-258-5473 WAYNE GREEN BOOKS • PETERBOROUGH NH 03458

Itemize your order on a separate piece of paper and mail to Wayne Green Books, Attn: Sales, Peterborough, NH 03458. Be sure to include check or detailed credit card information. (Visa, MC or AMEX accepted.) No C.O.D. orders accepted. All orders add \$1.50 for the first book, postage and handling; \$1.00 each additional book; \$10.00 per book foreign air mail. Please allow 4-8 weeks after publication for delivery. Questions regarding your order? Please write to Customer Service at the above address.



**BUY! SELL! TRADE!**

COMPUTER & HAM EQUIPMENT

**COMPUTER®  
TRADER**

**ANNUAL  
SUBSCRIPTION**

**\$15.00**

Low Ad Rates — Mailed Monthly

Foreign Subscriptions - \$30.00 Year

FREE 50 Word Classified Ad with Subscription Order

**COMPUTER TRADER®**

Chet Lambert, W4WDR

1704 Sam Drive • Birmingham, AL 35235  
(205) 854-0271

Sample Copy — \$1.00



CALL LETTERS  
OR 73 LOGO  
BELT BUCKLE

Navajo call-letter belt buckle. Hand crafted. Inlaid call-letters of blue turquoise, rust coral, white abalone, ironwood brown, or mother of pearl. The lightning bolts are yellow. Size: Med. 2.6" x 3.6" oval. Large: 3" x 4" oval. Style: Ladies or mens. The mens attaches to the left side, and the ladies to the right side of the belt.

Send: Call-name-and address.

Color of call-letters (or 73 logo).

Style: Ladies or mens.

\$48.50 check or M/O for medium.

\$61.50 check or M/O for large.

To: **LEE-ART, INC.**

112 n. Main Street  
Shamrock, Texas 79079

We pay U.S. postage. (Foreign-add \$2.50/item).  
Money-back guarantee. Allow 4-6 weeks delivery.

**CB TO TEN METER  
CONVERSION KITS**

**10 METER FM**—Limiter discriminator board with specific instructions to fit over 80 different AM & SSB chassis

**SSB-AM KITS**—Now in stock kits for most CB models—23 or 40 channels

**NEW & USED**—FM—SSB—AM converted C.B.'s in stock  
**ANEXTER MARK ANTENNAS**

—You saw them at Dayton. Now in stock the HW-3 three band heliwhip that covers 10—15—20 meters with no traps

**FREE CATALOG**—Write or call today

**INDEPENDENT**

**CRYSTAL SUPPLY COMPANY**

141 Rt. 6A, Box 183  
Sandwich, Ma. 02563-0183  
(617) 888-4302

✓ 78

**New Life  
for  
Tired Receivers**



Lunar's line of RF actuated in-line receiving preamplifiers can spark up that otherwise dead band. Missing those weak ones? Become an elephant with new ears. Models available from 28-220 MHz bands. Simply insert between your transceiver and antenna. apply 12 VDC and enjoy. Standard SO-239 connectors on RF ports - BNC available. Typical performance at 144 MHz: 1.4 dB NF 10 dB gain. Low noise performance from Lunar - simply, the best.

**LUNAR electronics** 2775 Kurtz Street, Suite 11  
San Diego, Ca 92110  
(619) 299-9740 • Telex 181747

**COLLINS RECEIVERS**

R-390/URR

0.5 to 32 MHz in 32 bands. AM, CW, Tone FSK through use of BFO. IF selectivity 100 Hz to 16 kHz. Impedance 600 ohms. Power input 110/220 VAC, 50/60 Hz, single phase. Dimensions 12 1/2 x 19 x 6 1/2 inches. Weight 75 lbs. Used, good working condition. Includes partial manual reproduction.

\$285



R-392/URR

0.5 to 32 MHz in 32 bands. AM and CW. Bandwidth 2, 4, and 8 kHz. B+ and Filament voltages 24 VDC. Power input 24 VDC @ 3 Amps. Dimensions 14 x 12 x 11 1/2 inches. Weight 52 lbs. Used, good working condition. Includes partial manual reproduction.

\$235



Prices F.O.B. North Hollywood. Allow for shipping. Write for free 56-page catalog

**Davilyn Corporation**

13406 Salicoy Street  
North Hollywood, CA 91605  
(213) 787-3334



✓ 256



M/C  
Visa

**\$129.95**

**NEW! HF WATTMETER**

- Digital Resolution (0.1 or 1 Watt)
- Wideband (160 through 10 meters)
- Wide range (QRP to 1999 Watts)
- Detachable (RF Sampler un-plugs)
- Battery Saver turns off minutes after RF disappears
- Price Includes — Readout, HF Sampler, battery, VSWR nomogram and complete schematics.
- 90 day warranty



write or call:  
**e-tec** P.O. Box 625, Marietta, OH 45750  
1-(614)-374-2280

**APPLE II MORSE CODE  
INTERFACE**

CW SOFTWARE FOR THE APPLE II  
NO OTHER HARDWARE REQUIRED

- TONE DETECTION THROUGH CASSETTE INPUT
- SOFTWARE TUNEABLE CENTER FREQUENCY
- AUTOMATIC SPEED TRACKING: 6 TO 60 WPM
- SPLIT SCREEN DISPLAYS
- SEPARATE EIGHT LINE RX AND TX BUFFERS
- TX SPEED VARIABLE FROM 15 TO 60 WPM
- TX TONE THROUGH CASSETTE OUTPUT
- OPTIONAL SIDETONE THROUGH APPLE SPEAKER
- D.C. TX KEYING VIA GAME CONNECTOR
- TX/RX SWITCHING VIA GAME CONNECTOR
- BUILT IN PRINTER DRIVER
- REQUIRES DOS 3.3

CODE MACHINE.....\$29.95

RECEIVE ONLY VERSION

MODEM.....\$14.95

SHIPPING INCLUDED. CALIFORNIA RESIDENTS  
ADD SALES TAX. NO C.O.D. ORDERS PLEASE.  
FOREIGN SHIPPING ADD \$4.00.

**COTEC**

13462 HAMMONS AVE.--- SARATOGA, CA 95070

**RTTY  
FOR THE  
VIC 20  
SIMPLE AND INEXPENSIVE  
FULL-FEATURED RTTY**

- BAUDOT And ASCII. All Common Speeds
- CW ID With Your Call Pre-Programmed
- Transmit/Receive (PTT) Control
- Use With Any Terminal Unit - Simple Hookup Instructions Supplied
- Highly Readable Screen Formatting

**8K VERSION** Also has 10 Message Buffers. Automatic CO. Start and End Messages. Status Display, many other Features

RTTY3K (req 3K memory expansion) \$19.95

RTTY8K (req 8K memory expansion) \$24.95

both versions supplied on cassette

Send Check or Money Order To:  
**MICROFISH SOFTWARE PRODUCTS**  
P.O. Box 920342 ✓ 257  
Norcross, Georgia 30092

**FIELD DAY  
TRANSCIVERS**

**RT-77/GRC-9**, portable 2-12 Mhz unit; 7 watts (AM), 15 W (CW) output. 2E22 tube in PA; 10 other tubes. Requires 580 V 100 ma, 6.6 V 2 amp, 120 V 45 ma, 1.5 V 500 ma, & 6.9 V 575 ma. 16x13x8", 35 lbs. sh. Used **\$39.95** MANUAL **\$8.50**; CONNECTORS, \$4 ea w/set purchase.



**GN-58 HANDCRANK GENERATOR** w/legs & seat; powers RT-77 at reduced outputs 3.6 W (AM), 10 W (CW). 40 lbs. Used **\$35.**

**RT-671/PRC-47**, 2-12 Mhz USB, CW; 100 watts max. Solid-state; Collins mfg. Requires 26 VDC. Includes handset, antenna, other accessories; 180 lbs. sh. in transit case. Used-clean **\$395.00**

**R-389/URR VLF RECEIVER**, 15-1500 KHz in two ranges. 7 bands; 455 KHz IF. 36 tubes; requires 115/230 VAC. Units are sold less line and carrier level meters. Used-repairable **\$250.** MANUAL, partial repro **\$17.**

Prices F.O.B. Lima, O. • VISA, MASTERCARD Accepted. Allow for Shipping • Send for New FREE CATALOG '83 Address Dept. 73 • Phone: 419/227-6573

**FAIR RADIO SALES** ✓ 22  
1016 E. EUREKA • Box 1105 • LIMA, OHIO 45302

AC5D  
 COMPUTER PROGRAMS  
 FOR TEX. INST. 99/4-4A  
 TAPE OR DISK  
 CW RECEIVE/TRANSMIT  
 CW PRACTICE (SENDING)  
 CW PRACTICE (RECEIVING)  
 CW FOR YOUNGSTERS  
 W.A.S. & 6 BAND W.A.S.  
 DXCC & 6 BAND DXCC  
 1010 NUMBER SEARCH  
 AMATEUR CALL LOCATOR  
 SSTV KEYBOARD DISPLAY  
 BARNYARD MATH FOR KIDS  
 WRITE  
 SAM H. MOORE, SR. ✓6  
 P. O. BOX 368  
 STIGLER, OKLA. 74462

\*\*\*\*\*  
 \* QUALITY MICROWAVE TV SYSTEMS \*  
 \* Complete Systems From \$69.95 \*  
 \* 1.9 to 2.5 GHz Antennas \*  
 \* Galaxy Electronics \*  
 \* 6007 N. 61st Ave. \*  
 \* Glendale, Az. \*  
 \* 85301 \*  
 \* 1-602-247-1151 \*  
 \* 1-800-247-1151 \*  
 \* CDD's / Dealers Wanted \*  
 \*  ✓178 \*  
 \*  \*  
 \*\*\*\*\*



**RELIABLE MICROWAVE TV ANTENNAS**  
**2.1 to 2.6 GHz Frequency Range**  
**34db System Gain (or Greater)**

Complete System (as pictured) \$119.95  
 Down Converter Probe Style (Assembled and Tested) \$ 49.95  
 Power Supply (12V to 16V DC+) (Assembled and Tested) \$ 39.95



**PETERSON ELECTRONICS**  
 4558 Auburn Blvd.  
 Sacramento, CA 95841  
 (916) 486-9071 ✓182  
 C.O.D.'s  
 SPECIAL QUANTITY PRICING  
 Dealers Wanted

1 YEAR WARRANTY PARTS & LABOR  

**NEW!**  
**DDRR Space Beaters!**  
*The Repeater Beaters*

- BASE STATION QUALITY, from a mobile!
- Say good-bye to mobile flutter (picket fencing)!
- Say good-bye to Inter-Mod!
- Say good-bye to whip "wipe-out"!
- OPEN THE TOUGH ONES! by adding the optional CR2X or CR3X Range Extender.

ALL THIS PLUS

CR2A\* (144 MHz) \$39 plus shipping  
 CR3A (220 MHz) \$2 shipping

CR2X \$12 plus shipping  
 CR3X \$2 shipping  
 (continental USA)

\*AS REVIEWED IN 73 MAGAZINE OCTOBER 1982

**COM-RAD, INC.**  
 1635 WEST RIVER PARKWAY  
 GRAND ISLAND, NEW YORK 14072  
 (716) 773-1445



  ✓163



**THE BEST PLACE To Look For New & Used Equipment Buy-Sell-Trade Our 4th Year**

**NUTS & VOLTS MAGAZINE**

PO BOX 1111-G • PLACENTIA, CA 92670  
 (714) 632-7721 ✓137

JOIN THOUSANDS OF READERS NATIONWIDE, EVERY MONTH

U.S.A. SUBSCRIPTIONS  
 \$ 7.00 - 1 YR. 3RD CLASS MAIL  
 \$12.50 - 1 YR. 1ST CLASS MAIL  
 \$25.00 - LIFETIME - 3RD CLASS

 With Free Classified Ad 



**SALE! SALE! SALE! SALE!**

**HAM save! GEAR**

**USED EQUIPMENT TESTED BY 73 STAFF OTHERWISE LIKE NEW**

Icom 451A Transceiver	\$692.00
Icom PS 15 Power Supply	\$121.50
Icom 560 Transceiver	\$395.00
Icom 290H Transceiver	\$427.50
Icom 490A Transceiver	\$506.00
Icom 4AT HT	\$211.50
Icom 3AT HT	\$211.50
Yaesu FT408R 2m Transceiver	\$396.00
Yaesu FT208R HT	\$260.00
Robot Research Model 400	\$315.00

Check or Money Order  
 Contact: (603) 924-9471  
**MATT SMITH**  
**73 MAGAZINE**  
**PINE STREET**  
**PETERBOROUGH NH**  
**03458**



**YOU EARNED YOUR CALL!**  
 NOW DISPLAY IT PROUDLY IN A TOP QUALITY LACOSTE-TYPE KNIT SHIRT.

ONLY \$14.00 With your call in rich embroidery.  
 \$1.50 extra for first name. Choose from 10 great colors: rust, cream, brown, green, yellow, navy, lt. blue, aqua, white, and black.

Adult sizes only S-M-L-XL Club and dealer inquiries invited. Please add \$2.00 for P/H. Make check or money order payable to:

**Coin Int'l Inc.**  
 2305 N.W. 107 Ave.  
 Miami, Fl. 33172 ✓13



Allow 4 weeks for delivery Fl. residents add sales tax

**ALL BAND TRAP ANTENNAS!**

PRETUNED - COMPLETELY ASSEMBLED - ONLY ONE NEAT SMALL ANTENNA FOR ALL BANDS! EXCELLENT FOR CONDO'S - APARTMENTS - LIGHT - STRONG - ALMOST INVISIBLE!

FOR ALL MAKES & MODELS OF AMATEUR TRANSCEIVERS 1 GUARANTEED FOR 2000 WATTS SSB INPUT FOR NOVICE AND ALL CLASS AMATEURS! IMPROVED DESIGN!

COMPLETE with 90 ft. RG58U-52 ohm feedline, and PL259 connector, insulators, 30 ft. 300 lb. test dacron end supports, center connector with built in lightning arrester and static discharge - molded, sealed, weatherproof, resonant traps 1"X6" - you just switch to band desired for excellent worldwide operation - transmitting and receiving! Low SWR over all bands - Tuners usually NOT NEEDED! Can be used as inverted V's - slopers - in attics, on building tops or narrow lots. The ONLY ANTENNA YOU WILL EVER NEED FOR ALL BANDS - WITH ANY TRANSCEIVER - NEW - NO BALUNS NEEDED!

80-40-20-15-10 - 2 trap - 104 ft. - Model 998BUC .. \$89.95  
 40-20-15-10 -- 2 trap -- 54 ft. - Model 1001BUC .. \$88.95  
 20-15-10 meter - 2 trap - 26ft. - Model 1007BUC .. \$87.95

SEND FULL PRICE FOR POSTPAID INSURED. DEL. IN USA. (Canada is \$5.00 extra for postage - clerical - customs etc) or order using VISA - MASTER CARD - AMER. EXPRESS. Give number and ex. date. Ph 1-308-236-5333 9AM - 6PM week days. We ship in 2-3 days. ALL PRICES MAY INCREASE ORDER NOW! All antennas guaranteed for 1 year. 10 day money back trial if returned in new condition! Made in USA. FREE INFO. AVAILABLE ONLY FROM

WESTERN ELECTRONICS ✓80  
 Dept. A7-7 Kearney, Nebraska, 68647

**Have an Apple?**  
**Want to work RTTY?**  
**Know about Super-Ratt?**  
**You should.**



**US** Call or write for details.

**UNIVERSAL SOFTWARE SYSTEMS, INC.**  
 9 SHIELDS LANE - RIDGEFIELD, CT 06877  
 (203) 438-3117 ✓189

We now have available a bunch of goodies too good to bypass. Items are limited so order today

716-586-3950

Call your Phone Order in Today, TERMS: Satisfaction guaranteed or money refunded. C.O.D. add \$2.50. Minimum order \$6.00. Orders under \$10.00 add \$1.50. Add 6% for postage, insurance, handling. Overseas add 15%. N.Y. residents add 7% tax.

**MINI KITS - YOU HAVE SEEN THESE BEFORE NOW  
HERE ARE OLD FAVORITE AND NEW ONES TOO.  
GREAT FOR THAT AFTERNOON HOBBY.**

**FM MINI MIKE**

A super high performance FM wireless mike kit! Transmits a stable signal up to 300 yards with exceptional audio quality by means of its built in electret mike. Kit includes case, mike, on-off switch, antenna, battery and super instructions. This is the finest unit available.

FM-3 Kit **\$14.95**  
FM-3 Wired and Tested **19.95**

**Color Organ**

See music come alive! 3 different lights flicker with music. One light each for high, mid-range and lows. Each individually adjustable and drives up to 300 W. runs on 110 VAC.

Complete kit, ML-1 **\$8.95**

**Video Modulator Kit**

Converts any TV to video monitor. Super stable, tunable over ch 4-6. Runs on 5-15V. accepts std video signal. Best unit on the market! Complete kit, VD-1 **\$7.95**

**Super Sleuth**

A super sensitive amplifier which will pick up a pin drop at 15 feet! Great for monitoring baby's room or as general purpose amplifier. Full 2 W rms output, runs on 6 to 15 volts, uses 8-45 ohm speaker. Complete kit, BN-9 **\$5.95**

**Led Blinky Kit**

A great attention getter which alternately flashes 2 jumbo LEDs. Use for name badges, buttons, warning panel lights, anything! Runs on 3 to 15 volts. Complete kit, BL-1 **\$2.95**

**CPO-1**  
Runs on 3-12 Vdc. 1 watt out. 1 KHZ good for CPO. Alarm, Audio Oscillator. Complete kit **\$2.95**

**CLOCK KITS**

Your old favorites are here again. Over 7,000 Sold to Date. Be one of the gang and order yours today!



Try your hand at building the finest looking clock on the market. Its satin finish anodized aluminum case looks great anywhere, while six 4" LED digits provide a highly readable display. This is a complete kit, no extras needed, and it only takes 1-2 hours to assemble. Your choice of case colors: silver, gold, black (specify).  
Clock kit, 12/24 hour, DC-5 **\$24.95**  
Clock with 10 min ID timer, 12/24 hour, DC-10 **\$29.95**  
Alarm clock, 12 hour only, DC-8 **\$29.95**  
12V DC car clock, DC-7 **\$29.95**

For wired and tested clocks add \$10.00 to kit price. SPECIFY 12 OR 24 HOUR FORMAT

**FM Wireless Mike Kit**

Transmits up to 300' to any FM broadcast radio, uses any type of mike. Runs on 3 to 9V. Type FM-2 has added sensitive mike preamp stage.

FM-1 kit **\$3.95** FM-2 kit **\$4.95**

**Whisper Light Kit**

An interesting kit, small mike picks up sounds and converts them to light. The louder the sound, the brighter the light. Includes mike controls up to 300 W. runs on 110 VAC. Complete kit, WL-1 **\$6.95**

**Tone Decoder**

A complete tone decoder on a single PC board. Features 400-5000 Hz adjustable range via 20 turn pot, voltage regulation, 567 IC. Useful for touch-tone burst detection, FSK, etc. Can also be used as a stable tone encoder. Runs on 5 to 12 volts. Complete kit, TD-1 **\$5.95**

**Universal Timer Kit**

Provides the basic parts and PC board required to provide a source of precision timing and pulse generation. Uses 555 timer IC and includes a range of parts for most timing needs.

UT-5 Kit **\$5.95**

**Mad Blaster Kit**

Produces LOUD ear shattering and attention getting siren like sound. Can supply up to 15 watts of obnoxious audio. Runs on 6-15 VDC.

MB-1 Kit **\$4.95**

**Siren Kit**

Produces upward and downward wail characteristic of a police siren. 5 W peak audio output, runs on 3-15 volts, uses 3-45 ohm speaker. Complete kit, SM-3 **\$2.95**

**60 Hz Time Base**  
Runs on 5-15 VDC. Low current (25ma) 1 min. month accuracy. TB 7 Kit **\$5.95**  
TB 7 Assy **\$9.95**

**SATELLITE TV KIT**



Image rejection, fully tunable audio to recover 'hidden' subcarriers, divide by two PLL demodulator for excellent threshold performance, tight tracking AFC to assure drift free reception, and of course, full 24 channel tunable coverage.

Build your satellite TV system around the R2B, close to ten thousand others already have and now it's available in kit form at a new low price. Order yours today.

THE POPULAR SAT-TEC RECEIVER IN KIT FORM!

Featured in a Radio Electronics magazine cover story (May 82), the reliable R2B Sat-tec TV receiver is now operating in thousands of locations. The R2B is easy to build, pre-etched, populated boards with screened component layout assures accurate component placement and the critical IF section and local oscillator are pre-assembled and aligned! All parts are included for the R2B, attractive case, power supply, descriptive operating manual as well as complete assembly instructions. Features of the receiver include: dual conversion design for best

A complete Satellite TV System requires a dish antenna, LNA (low noise amplifier), Receiver and Modulator.  
R2B Receiver Kit **\$359.00**  
R2B Receiver, Wired and Tested **\$595.00**  
120" K AvanteK LNA **\$495.00**  
RM3 RF Modulator **\$49.95**  
Prices include domestic UPS shipping and insurance.

**PARTS PARADE**

**IC SPECIALS**

LINEAR	TTL
301 <b>\$ .35</b>	74S00 <b>\$ .40</b>
324 <b>\$1.50</b>	7447 <b>\$ .65</b>
380 <b>\$1.50</b>	7475 <b>\$ .50</b>
555 <b>\$ .45</b>	7490 <b>\$ .50</b>
556 <b>\$1.00</b>	74196 <b>\$1.35</b>
565 <b>\$1.00</b>	
566 <b>\$1.00</b>	
567 <b>\$1.25</b>	
741 <b>10/\$2.00</b>	
1458 <b>\$ .50</b>	
3900 <b>\$ .50</b>	
3914 <b>\$2.95</b>	
8038 <b>\$2.95</b>	
CMOS	SPECIAL
4011 <b>\$.50</b>	11C90 <b>\$15.00</b>
4013 <b>\$.50</b>	10116 <b>\$ 1.25</b>
4046 <b>\$1.85</b>	7208 <b>\$17.50</b>
4049 <b>\$.50</b>	7207A <b>\$ 5.50</b>
4059 <b>\$9.00</b>	7216D <b>\$21.00</b>
4511 <b>\$2.00</b>	5107 <b>\$12.50</b>
4518 <b>\$1.35</b>	5375AB/G <b>\$ 2.95</b>
5639 <b>\$1.75</b>	7001 <b>\$ 6.50</b>
READOUTS	FERRITE BEADS
FND 359 4 C.C. <b>\$1.00</b>	With info and specs <b>\$181.00</b>
FND 507-510 5'C.A. <b>1.00</b>	6 Hole Balun Beads <b>\$/1.00</b>
MAN 72-HP7730 33'C.A. <b>1.00</b>	
HP 7651 43'C.A. <b>2.00</b>	
TRANSISTORS	Sockets
2N3904 NPN C-F <b>\$1.00</b>	8 Pin <b>10/\$2.00</b>
2N3906 PNP C-F <b>\$1.00</b>	14 Pin <b>10/\$2.00</b>
2N4403 PNP C-F <b>\$1.00</b>	16 Pin <b>10/\$2.00</b>
2N4410 NPN C-F <b>\$1.00</b>	24 Pin <b>4/\$2.00</b>
2N4916 PNP C-F <b>\$1.00</b>	28 Pin <b>4/\$2.00</b>
2N4918 PNP C-F <b>\$1.00</b>	40 Pin <b>3/\$2.00</b>
2N5377 NPN Silicon <b>\$1.50</b>	
2N5179 UHF NPN <b>\$1.00</b>	
Power Tab NPN 40W <b>\$1.00</b>	
Power Tab PNP 40W <b>\$1.00</b>	
MPF 102 2N5484 <b>\$1.50</b>	
NPN 3904 Type T-R <b>\$0.50</b>	
PNP 3906 Type T-R <b>\$0.50</b>	
2N3055 <b>\$1.00</b>	
2N2646 UJT <b>\$1.00</b>	
	<b>25 AMP 100V Bridge \$1.50 each</b>
	<b>Mini-Bridge 50V 1 AMP 2 for \$1.00</b>

Resistor Ass't	Crystals
Assortment of Popular values - 1/2 watt. Cut lead for PC mounting. 1/2" center. 1/2" leads. bag of 300 or more <b>\$1.50</b>	3 579545 MHZ <b>\$1.50</b> 10 00000 MHZ <b>\$5.00</b> 5 248800 MHZ <b>\$5.00</b>
Switches	AC Adapters
Mini toggle SPDT <b>\$1.00</b> Red Pushbuttons N.O. <b>3/\$1.00</b>	Good for clocks, nicad chargers, all 110 VAC plug one and 8.5 vdc @ 20 mA <b>\$1.00</b> 16 vac @ 160mA <b>\$2.50</b> 12 vac @ 250mA <b>\$3.00</b>
Earphones	Solid State Buzzers
3' leads 8 ohm good for small tone speakers, alarm clocks etc. <b>5 for \$1.00</b>	Small buzzer 450 Hz 85 dB sound output on 5-12 vdc at 10-30 mA TTL compatible <b>\$1.50</b>
Mini 8 ohm Speaker	AC Outlet
Approx 2" diam Round type for radios, mike etc. <b>3 for \$2.00</b>	Panel Mount with Leads <b>4/\$1.00</b>
Slug Tuned Coils	Capacitors
Small 3/16" Hex Slugs turned coil 3 turns <b>\$1.00</b>	<b>TANTALUM</b> Opped Epoxy 1.5 uF 25V 3/\$1.00 1.8 uF 25V 3/\$1.00 2.2 uF 25V 3/\$1.00
	<b>ALUMINUM</b> Electrolytic 1000 uF 16V Radial <b>\$3.00</b> 500 uF 20V Axial <b>\$3.00</b> 150 uF 16V Axial <b>\$1.00</b> 10 uF 15V Radial <b>10/\$1.00</b>
	<b>DISK CERAMIC</b> 01 16V disk <b>20/\$1.00</b> 1 16V <b>15/\$1.00</b> 001 16V <b>20/\$1.00</b> 100PF <b>20/\$1.00</b> 047 18V <b>20/\$1.00</b>
DC-DC Converter	Ceramic IF Filter
-5 vdc input prod -9 vdc @ 30ma -9 vdc prod -15 vdc @ 35ma <b>\$1.25</b>	Mini <b>SOLD OUT</b> kHz B/W <b>\$1.50 ea.</b>
25K 20 Turn Trim Pot <b>\$1.00</b> 1K 20 Turn Trim Pot <b>\$ .50</b>	Trimmer Caps Sprague - 3-40 pf Stable Polypropylene <b>50 ea.</b>
Crystal Microphone	Mini RG-174 Coax
Small 1" diameter 1/2" thick crystal mike cartridge <b>\$ .75</b>	10 ft. for <b>\$1.00</b>
Coax Connector	9 Volt Battery Clips
Chassis mount BNC type <b>\$1.00</b>	Nice quality clips <b>5 for \$1.00</b> 1/2" Rubber Grommets <b>10 for \$1.00</b>
Parts Bag	Connectors
Asst of chokes, disc caps, tantal resistors, transistors, diodes, MICAs caps etc. 8m bag (100 pc) <b>\$1.00</b> ig bag (300 pc) <b>\$2.50</b>	6 pin type gold contacts for mA-1003 car clock module <b>75 ea.</b>
Leds	Varactors
- your choice, please specify Mini Red, Jumbo Red, High Intensity Red, Illuminator Red <b>8/\$1</b> Mini Yellow, Jumbo Yellow, Jumbo Green <b>6/\$1</b>	Motorola MV 2209 30 PF Nominal cap 20-80 PF - Tunable range - <b>.50 each or 3/\$1.00</b>

**Audio Prescaler**

Make high resolution audio measurements, great for musical instrument tuning, PL tones, etc. Multiplies audio UP in frequency, selectable x10 or x100, gives 0.1 HZ resolution with 1 sec gate time! High sensitivity of 25 mv, 1 meg input z and built-in filtering gives great performance. Runs on 9V battery, all CMOS. PS-2 kit **\$29.95**  
PS-2 wired **\$39.95**

**600 MHZ PRESCALER**

Extend the range of your counter to 600 MHz. Works with all counters. Less than 150 mv sensitivity specify 10 or 100. Wired, tested, PS-1B **\$59.95**  
Kit, PS-1B **\$44.95**

**30 Watt 2 mtr PWR AMP**

Simple Class C power amp features 8 times power gain. 1 W in for 8 out, 2 W in for 15 out, 4 W in for 30 out. Max output of 35 W, incredible value, complete with all parts, less case and T-R relay. PA-1, 30 W pwr amp kit **\$22.95**  
TR-1, RF sensed T-R relay kit **6.95**

**Power Supply Kit**

Complete triple regulated power supply provides variable 6 to 18 volts at 200 ma and -5 at 1 amp. Excellent load regulation, good filtering and small size. Less transformers, requires 6 3 V 1 A and 24 VCT. Complete kit, PS-3LT **\$6.95**

**RF actuated relay senses RF (1W) and closes DPDT relay**

For RF sensed T-R relay TR-1 Kit **\$6.95**

**OP-AMP Special**

BI-FET LF 13741 - Direct pin for pin 741, compatible, but 500,000 MEG input z, super low 50 pF power drain. 50 for only **\$9.00** 10 for **\$2.00**

**Regulators**

7812 **\$1.00**  
7815 **\$1.00**  
7905 **\$1.25**  
7912 **\$1.25**  
7915 **\$1.25**

**Shrink Tubing Nubs**

Nice pre-cut pcs of shrink size 1" x 1/4" shrink to 1/2". Great for splices **50/\$1.00**

**Mini TO-92 Heat Sinks**

Thermalloy Brand **5 for \$1.00**  
TO-220 Heat Sinks **3 for \$1.00**

**Opto Isolators - 4N28 type**

Opto Reflectors - Photo diode + LED **\$1.00 ea.**

**Molex Pins**

Molex already pre-cut in length of 7. Perfect for 14 pin sockets **20 strips for \$1.00**

**COS Photocells**  
Resistance varies with light. 250 ohms to over 3 meg **3 for \$1.00**



**FACIT 4555 SERIAL PAGE PRINTER**

The Facit 4555 alphanumerical serial printer is complete. Equipped with RS232C Interface, printing mechanism, control electronics, drive electronics, power supply and character generator. The adaptation electronics can be modified in four versions: Bit-parallel data transfer, CCITT (EIA, RS232C) for bit-serial data transfer and the current loop (TTY) interface also for bit serial data transfer. The Facit 4555 prints on ordinary paper and is adjustable for different paper widths and formats, 9.5" paper width with 66 lines per page or DIN A4 with 70 lines per page.

**SPECIFICATIONS**

Print speed	up to 60ch.s.	Char. spacing	2.54mm/1/10" 80ch/line
Printing mode	Incremental.		1.55mm/0.06" 132ch/line
Max. # of ch/line	80 alt. 132.	Char. Code	ECMA-6 7-bit coded char. set
Matrix	7 X 5 dot matrix.	Char. Set	63 Char. various national versions.
Char. Size Height	2.7mm/1/8"	Feed mechanism	Sprocket feed.
Char. Size Width	1.3mm/0.05" 132ch/line		
	2.1mm/0.083" 80ch/line		

THESE UNITS WERE PULLED OUT OF SERVICE IN GOOD WORKING CONDITION. WE CHECK EACH UNIT ON A RADIO SHACK TRS-80 COLOR COMPUTER.



PRINTER ONLY \$129.99

Printer with linecord, box of paper, inter-connect cable for TRS-80 COLOR COMPUTER.

\$149.99

**GENEVA CALCULATOR WATCH**

This attractive watch has the following modes:  
 Normal Time Setting,  
 Calendar Setting,  
 Daily Alarm Time Setting,  
 Weekly Alarm Time Setting,  
 Chronograph,  
 Calculator.



Featured in Black Plastic \$24.99

or

Featured in Stainless Steel \$29.99

**SILICON DIODES**

MR751	100vdc	6Amps	10/\$5.00	100/\$38.00
MR510	1000vdc	3Amps	10/\$3.75	100/\$24.00
HEP170	1000vdc	2Amps	20/\$2.00	100/\$15.00
IN3209	100vdc	15Amps	\$2.00	10/ \$15.00
BYX21/200	200vdc	25Amps	\$2.00	10/ \$15.00
IN2138A	600vdc	60Amps	\$5.00	10/ \$40.00
DS85-04C	400vdc	80Amps	\$10.00	10/ \$80.00
IN3269	600vdc	160Amps	\$15.00	10/\$120.00
275241	300vdc	250Amps	\$20.00	10/\$175.00
7-5754	300vdc	400Amps	\$30.00	10/\$250.00
RCD-15	15KVDC	20ma.	\$3.00	10/ \$20.00
SMFR20K	20KVDC	20ma.	\$4.00	10/ \$30.00
IN4148	signal		30/\$1.00	100/ \$3.00

**FEED THRU SOLDER RF CAPACTORS**

470pf +-20%
5/\$1.00 or 100/\$15.00 or 1000/\$100.00
1000pf/.001uf +-10%
4/\$1.00 or 100/\$20.00 or 1000/\$150.00

**E PROMS**

2708 1024x1	\$2.00 each
2716 2048x8	\$4.00 each
27L32/25L32	\$10.00 each

**FAIRCHILD 4116 16K DYNAMIC RAMS 200ns. Part # 16K75**

25 For \$25.00 or 100 For \$90.00 or 1000 For \$750.00

**HEWLETT PACKARD MICROWAVE DIODES**

IN5711	(5082-2800)	Schottky Barrier Diodes	\$1.00 or 10 for \$ 8.50
IN5712	(5082-2810)	" " "	\$1.50 or 10 for \$10.00
IN6263	(H5CH-1001)	" " "	\$ .75 or 10 for \$ 5.00
5082-2835		" " "	\$1.50 or 10 for \$10.00
5082-2805	Quad Matched	" " "	per set \$5.00 or 10 for \$40.00

**Toll Free Number  
 800-528-0180  
 (For orders only)**

**MHz electronics**

"All parts may be new or surplus, and parts may be substituted with comparable parts if we are out of stock of an item."

**PRICES SUBJECT TO CHANGE WITHOUT NOTICE**

# "MIXERS"

## WATKINS JOHNSON WJ-M6 Double Balanced Mixer

LO and RF 0.2 to 300MHz	IF DC to 300MHz	\$21.00
Conversion Loss (SSB)	6.5dB Max. 1 to 50MHz	
Noise Figure (SSB)	8.5dB Max. .2 to 300MHz	WITH DATA SHEET
	same as above	
Conversion Compression	8.5dB Max. 50 to 300MHz	
	.3dB Typ.	

## NEC (NIPPON ELECTRIC CO. LTD. NE57835/2SC2150 Microwave Transistor

NF Min F=2GHz	dB 2.4 Typ.	MAG F=2GHz	dB 12 Typ.	\$5.30
F=3GHz	dB 3.4 Typ.	F=3GHz	dB 9 Typ.	
F=4GHz	dB 4.3 Typ.	F=4GHz	dB 6.5 Typ.	

Ft Gain Bandwidth Product at Vce=8v, Ic=10ma. GHz 4 Min. 6 Typ.  
 Vcbo 25v Vceo 11v Vebo 3v Ic 50ma. Pt. 250mw

## UNELCO RF Power and Linear Amplifier Capacitors

These are the famous capacitors used by all the RF Power and Linear Amplifier manufacturers, and described in the RF Data Book.

5pf	10pf	18pf	30pf	43pf	100pf	200pf	1 to 10pcs.	\$1.00 ea
5.1pf	12pf	22pf	32pf	51pf	110pf	220pf	11 to 50pcs.	\$.90 ea
6.8pf	13pf	25pf	33pf	60pf	120pf	470pf	51 up	pcs. \$.80 ea
7pf	14pf	27pf	34pf	80pf	130pf	500pf		
8.2pf	15pf	27.5pf	40pf	82pf	140pf	1000pf		

## NIPPON ELECTRIC COMPANY TUNNEL DIODES

		MODEL 1S2199	1S2200	\$7.50
Peak Pt. Current ma.	Ip	9min. 10Typ. 11max.	9min. 10Typ. 11max.	
Valley Pt. Current ma.	Iv	1.2Typ. 1.5max.	1.2Typ. 1.5max.	
Peak Pt. Voltage mv.	Vp	95Typ. 120max.	75Typ. 90max.	
Projected Peak Pt. Voltage mv.	Vpp Vf=Ip	480min. 550Typ. 630max.	440min. 520Typ. 600max.	
Series Res. Ohms	rS	2.5Typ. 4max.	2Typ. 3max.	
Terminal Cap. pf.	Ct	1.7Typ. 2max.	5Typ. 8max.	
Valley Pt. Voltage mv.	VV	370Typ.	350Typ.	

## FAIRCHILD / DUMONT Oscilloscope Probes Model 4290B

Input Impedance 10 meg., Input Capacity 6.5 to 12pf., Division Ratio (Volts/Div Factor) 10:1, Cable Length 4Ft., Frequency Range Over 100MHz.

These Probes will work on all Tektronix, Hewlett Packard, and other Oscilloscopes.

PRICE \$45.00

## MOTOROLA RF DATA BOOK

Lists all Motorola RF Transistors / RF Power Amplifiers, Varactor Diodes and much more.

PRICE \$7.50

**Toll Free Number**  
**800-528-0180**  
**(For orders only)**

**MHz electronics**

"All parts may be new or surplus, and parts may be substituted with comparable parts if we are out of stock of an item."

**PRICES SUBJECT TO CHANGE WITHOUT NOTICE**

# RF TRANSISTORS, MICROWAVE DIODES

PART	PRICE	PART	PRICE	PART	PRICE
1S2199	\$ 7.50	2N6083	\$ 13.25	CA2612 (TRW)	\$ 25.00
1S2200	7.50	2N6084	15.00	CA2674 (TRW)	25.00
2N1561	25.00	2N6094 /M9622	11.00	CA2881-1 (TRW)	25.00
2N1562	25.00	2N6095 /M9623	12.00	CA4101 (TRW)	25.00
2N2857	1.55	2N6096 /M9624	15.50	CA4201 (TRW)	25.00
2N2857JAN	2.55	2N6097	17.25	CA4600 (TRW)	25.00
2N2876	11.00	2N6136	21.85	CD1889	20.00
2N2947	18.35	2N6166	40.25	CD2545	20.00
2N2948	15.50	2N6201	50.00	CMD514AB	20.00
2N2949	3.90	2N6459	18.00	D4959	10.00
2N2950	4.60	2N6603	12.00	D4987M	20.00
2N3375	8.00	2N6680	80.00	D5147D	10.00
2N3553	1.57	2SC756A	7.50	D5506	10.00
2N3632	13.80	2SC781	2.80	D5827AM	20.00
2N3818	5.00	2SC1018	1.00	DMD6022	30.00
2N3866	1.30	2SC1042	12.00	DMS-2A-250	40.00
2N3924	3.35	2SC1070	2.50	HEP76	4.95
2N3927	17.75	2SC1239	2.50	HEPS3002	11.30
2N3950	25.00	2SC1251	12.00	HEPS3003	30.00
2N4072	1.80	2SC1306	2.90	HEPS3005	10.00
2N4127	21.00	2SC1307	5.50	HEPS3006	19.90
2N4427	1.30	2SC1760	1.50	HEPS3007	25.00
2N4428	1.85	2SC1970	2.50	HEPS3010	11.34
2N4957	3.45	2SC2166	5.50	HTEF2204 H.P.	112.00
2N4958	2.90	8B1087 (M.A.)	25.00	5082-0112 H.P.	14.20
2N4959	2.30	A50-12	20.00	5082-0253 H.P.	105.00
2N5090	13.90	A283B	5.00	5082-0320 H.P.	58.00
2N5108	4.00	ALD4200N (AVANTEK)	395.00	5082-0386 H.P.	POR
2N5109	1.70	AM123	97.35	5082-0401 H.P.	POR
2N5160	3.45	AM688	100.00	5082-0438 H.P.	POR
2N5177	21.62	BB105B	.52	5082-1028 H.P.	POR
2N5179	1.00	BD4/4JFBD4 (G.E.)	10.00	5082-2711 H.P.	23.15
2N5583	4.00	BFQ85	1.50	5082-3080 H.P.	2.00
2N5589	8.65	BFR90	1.30	5082-3188 H.P.	1.00
2N5590	10.35	BFR91	1.65	5082-6459 H.P.	POR
2N5591	13.80	BFW92	1.50	5082-8323 H.P.	POR
2N5635	10.95	BFX89	1.00	35826E H.P.	POR
2N5637	15.50	BFY90	1.00	35831E H.P.	29.99
2N5641	9.20	BGY54	25.00	35853E H.P.	71.50
2N5642	10.95	BGY55	25.00	35854E H.P.	75.00
2N5643	15.50	BGY74	25.00	HPAO241 H.P.	75.60
2N5645	13.80	BGY75	25.00	HXTR3101 H.P.	7.00
2N5646	20.70	BL161	10.00	HXTR3102 H.P.	8.75
2N5691	18.00	BLX67	11.00	HXTR6101/2N6617 H.P.	55.00
2N5764	27.00	BLY568CF	25.00	HXTR6104 H.P.	68.00
2N5836	5.45	BLY87	13.00	HXTR6105 H.P.	31.00
2N5842	8.00	BLY88	14.00	HXTR6106 H.P.	33.00
2N5849	20.00	BLY89	15.00	QSCH1995 H.P.	POR
2N5913	3.25	BLY90	20.00	JO2000 TRW	10.00
2N5922	10.00	BLY351	10.00	JO2001 TRW	25.00
2N5923	25.00	C4005	20.00	JO4045 TRW	25.00
2N5941	23.00	CA402 (TRW)	25.00	K3A	10.00
2N5942	40.00	CA405 (TRW)	25.00	MA450A	10.00
2N5944	9.20	CA612B (TRW)	25.00	MA41487	POR
2N5945	11.50	CA2100 (TRW)	25.00	MA41765	POR
2N5946	19.00	CA2113 (TRW)	25.00	MA43589	POR
2N6080	9.20	CA2200 (TRW)	25.00	MA43636	POR
2N6081	10.35	CA2213 (TRW)	25.00	MA47044	POR
2N6082	11.50	CA2418 (TRW)	25.00	MA47651	25.50

**Toll Free Number**  
**800-528-0180**  
**(For orders only)**

"All parts may be new or surplus, and parts may be substituted with comparable parts if we are out of stock of an item."

PRICES SUBJECT TO CHANGE WITHOUT NOTICE

**MHz electronics**



# GaAs, TUNNEL DIODES, ETC.

PART	PRICE	PART	PRICE	PART	PRICE
MA47100	\$ 3.05	MRF503	\$ 6.00	PT4186B	\$ POR
MA47202	30.80	MRF504	7.00	PT4209	POR
MA47771	POR	MRF509	5.00	PT4209C	POR
MA47852	POR	MRF511	8.65	PT4566	POR
MA49558	POR	MRF605	20.00	PT4570	POR
MB4021	POR	MRF629	3.47	PT4571	POR
MBD101	1.00	MRF644	23.00	PT4571A	POR
MDO513	POR	MRF816	15.00	PT4577	POR
MHW1171	42.50	MRF823	20.00	PT4590	POR
MHW1182	48.60	MRF901	3.00	PT4612	POR
MHW4171	49.35	MRF8004	2.10	PT4628	POR
MHW4172	51.90	MS261F	POR	PT4640	POR
MHW4342	68.75	MT4150 Fair.	POR	PT4642	POR
MLP102	25.00	MT5126 Fair.	POR	PT5632	POR
MM1500	32.32	MT5481 Fair.	POR	PT5749	POR
MM1550	POR	MT5482 Fair.	POR	PT6612	POR
MM1552	50.00	MT5483 Fair.	POR	PT6626	POR
MM1553	50.00	MT5596 Fair.	POR	PT6709	POR
MM1614	10.00	MT5764 Fair.	POR	PT6720	POR
MM2608	5.00	MT8762 Fair.	POR	PT8510	POR
MM3375A	11.50	MV109	.77	PT8524	POR
MM4429	10.00	MV1401	8.75	PT8609	POR
MM8000	1.15	MV1624	1.42	PT8633	POR
MM8006	2.30	MV1805	15.00	PT8639	POR
MO277L	POR	MV1808	10.00	PT8659	POR
MO283L	POR	MV1817B	10.00	PT8679	POR
MO3757	POR	MV1863B	10.00	PT8708	POR
MP102	POR	MV1864A	10.00	PT8709	POR
MPN3202	10.00	MV1864B	10.00	PT8727	POR
MPN3401	.52	MV1864D	10.00	PT8731	POR
MPN3412	1.00	MV1868D	10.00	PT8742	POR
MPSU31	1.01	MV2101	.90	PT8787	POR
MRA2023-1.5 TRW	42.50	MV2111	.90	PT9790	41.70
MRF212/208	16.10	MV2115	1.55	PT31962	POR
MRF223	13.25	MV2201	.53	PT31963	POR
MRF224	15.50	MV2203	.53	PT31983	POR
MRF237	3.15	MV2209	2.00	PTX6680	POR
MRF238	12.65	MV2215	2.00	RAY-3	24.99
MRF243	25.00	MWA110	7.45	40081	POR
MRF245	34.50	MWA120	7.80	40281	POR
MRF247	34.50	MWA130	8.25	40282	POR
MRF304	43.45	MWA210	7.80	40290	POR
MRF315	23.00	MWA220	8.25	RF110	25.00
MRF420	20.00	MWA230	8.65	SCA3522	POR
MRF421	36.80	MWA310	8.25	SCA3523	POR
MRF422	41.40	MWA320	8.65	SD1065	POR
MRF427	16.10	MWA330	9.50	SS43	POR
MRF428	46.00	NEC57835	5.30	TP1014	POR
MRF450/A	13.80	ON382	5.00	TP1028	POR
MRF453/A	17.25	PPT515-20-3	POR	TRW-3	POR
MRF454/A	19.90	PRT8637	POR	UT0504 Avantek	70.00
MRF455/A	16.00	PSCQ2-160	POR	UT0511 Avantek	75.00
MRF458	19.90	PT3190	POR	V15	4.00
MRF463	25.00	PT3194	POR	V33B	4.00
MRF472	1.00	PT3195	POR	V100B	4.00
MRF475	2.90	PT3537	POR	VAB801EC	25.00
MRF477	11.50	PT4166E	POR	VAB804EC	25.00
MRF502	1.04	PT4176D	POR	VAS21AN20	25.00

**Toll Free Number**  
**800-528-0180**  
**(For orders only)**

"All parts may be new or surplus, and parts may be substituted with comparable parts if we are out of stock of an item."

## MHz electronics

PRICES SUBJECT TO CHANGE WITHOUT NOTICE

COAXIAL RELAY SWITCHES SPDT

Electronic Specialty Co./Raven Electronics FSN 5985-556-9683 \$49.00  
 Part # 25N28 Part # SU-01  
 26Vdc Type N Connector, DC to 1 GHz.



Amphenol  
 Part # 316-10102-8  
 115Vac Type BNC DC to 3 GHz.

FXR  
 Part # 300-11182  
 120Vac Type BNC DC to 4 GHz.  
 FSN 5985-543-1225

FXR  
 Part # 300-11173  
 120Vac Type BNC Same  
 FSN 5985-543-1850

\$29.99

\$39.99

\$39.99

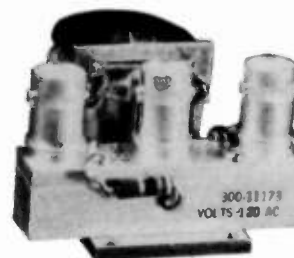
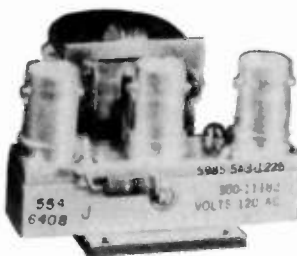
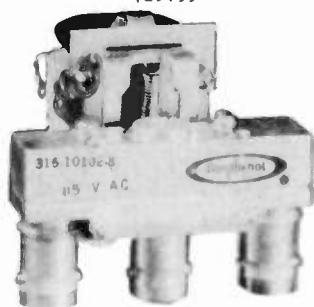

BNC To Banana Plug Coax Cable RG-58 36 inch or BNC to N Coax Cable RG-58 36 inch.

\$7.99 or 2 For \$13.99 or 10 For \$50.00

\$8.99 or 2 For \$15.99 or 10 For \$60.00



SOLID STATE RELAYS

P&B Model ECT1DB72 5vdc turn on  
 PRICE EACH \$5.00

Digisig, Inc. Model ECS-215 5vdc turn on  
 PRICE EACH \$7.50

Grigsby/Barton Model GB7400 5vdc turn on  
 PRICE EACH \$7.50

120vac contact at 7amps or 20amps on a 10"x 10" .124 aluminum. Heatsink with silicon grease.

240vac contact 14amps or 40amps on a 10"x 10" .124 aluminum. Heatsink with silicon grease.

240vac contact at 15amps or 40amps on a 10"x 10" .124 aluminum. Heatsink with silicon grease.

NOTE: \*\*\* Items may be substituted with other brands or equivalent model numbers. \*\*\*

**MHz** electronics

"All parts may be new or surplus, and parts may be substituted with comparable parts if we are out of stock of an item."

**Toll Free Number**  
**800-528-0180**  
**(For orders only)**

**PRICES SUBJECT TO CHANGE WITHOUT NOTICE**

RECALL PHONE MEMORY TELEPHONE WITH 24 NUMBER AUTO DIALER

The Recall Phone Telephone employs the latest state of art communications technology. It is a combination telephone and automatic dialer that uses premium-quality, solid-state circuitry to assure high-reliability performance in personal or business applications. \$49.99



ARON ALPHA RAPID BONDING GLUE

Super Glue #CE-486 high strength rapid bonding adhesive. Alpha Cyanoacrylate. Set-Time 20 to 40 sec., 0.7 fl. oz. (20gm.) \$2.00



TOUCH TONE PAD

This pad contains all the electronics to produce standard touch-tone tones. New with data.

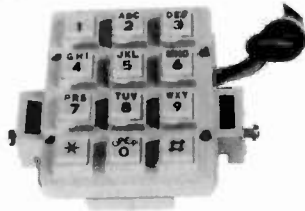

\$9.99 or 10/\$89.99

MITSUMI UHF/VHF VARACTOR TUNER MODEL UVE1A

Perfect for those unscrambler projects. New with data.

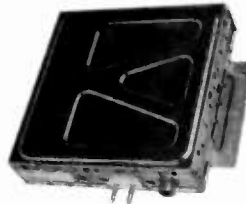

\$19.99 or 10/\$149.99

INTEGRATED CIRCUIT.

		1 to 10	11up
MC1372P	Color TV Video Modulator Circuit.	\$ 4.42	\$2.95
MC1358P	IF Amp., Limiter, FM Detector, Audio Driver, Electronic Attenuator.	5.00	4.00
MC1350P	IF Amplifier	1.50	1.25
MC1330A1P	Low Level Video Detector	1.50	1.15
MC1310P	FM Stereo Demodulator	4.29	3.30
MC1496P	Balanced Modulator/Demodulator	1.50	1.25
LM565N	Phase Locked Loop	2.50	2.00
LM380N14	2Watt Audio Power Amplifier	1.56	1.25
LM1889N	TV Video Modulator	5.00	4.00
NE564N	Phase Locked Loop	10.00	8.00
NE561N	Phase Locked Loop	10.00	8.00

FERRANTI ELECTRONICS AM RADIO RECEIVER MODEL ZN414 INTEGRATED CIRCUIT.

Features:

1.2 to 1.6 volt operating range., Less than 0.5ma current consumption. 150KHz to 3MHz Frequency range., Easy to assemble, no alignment necessary. Effective and variable AGC action., Will drive an earphone direct. Excellent audio quality., Typical power gain of 72dB., TO-18 package. With data. \$2.99 or 10 For \$24.99

NI CAD RECHARGEABLE BATTERIES

AA Battery Pack of 6 These are Factory New. \$5.00

SUB C Pack of 10 2.5Amp/Hr. \$10.00

Gates Rechargeable Battery Packs

12vdc at 2.5Amp/Hr. \$11.99  
12vdc at 5Amp/Hr. \$15.99



**MHz electronics**

"All parts may be new or surplus, and parts may be substituted with comparable parts if we are out of stock of an item."

**Toll Free Number  
800-528-0180  
(For orders only)**

**PRICES SUBJECT TO CHANGE WITHOUT NOTICE**



# "SOCKETS AND CHIMNEYS"

## EIMAC TUBE SOCKETS AND CHIMNEYS

SK110	Socket	\$POR
SK300A	Socket For 4CX5000A,R,J, 4CX10,000D, 4CX15,000A,J	\$520.00
SK400	Socket For 4-125A,250A,400A,400C,4PR125A,400A,4-500A,5-500A	260.00
SK406	Chimney For 4-250A,400A,400C,4PR400A	74.00
SK416	Chimney For 3-400Z	36.00
SK500	Socket For 4-1000A/4PR1000A/B	390.00
SK600	Socket For 4CX250B,BC,FG,R,4CX350A,F,FJ	51.00
SK602	Socket For 4CX250B,BC,FG,R,4CX350A,F,FJ	73.00
SK606	Chimney For 4CX250B,BC,FG,R,4CX350A,F,FJ	11.00
SK607	Socket For 4CX600J,JA	60.00
SK610	Socket For 4CX600J,JA	60.00
SK620	Socket For 4CX600J,JA	66.00
SK626	Chimney For 4CX600J,JA	10.00
SK630	Socket For 4CX600J,JA	66.00
SK636B	Chimney For 4CX600J,JA	34.00
SK640	Socket For 4CX600J,JA	36.00
SK646	Chimney For 4CX600J,JA	71.00
SK700	Socket For 4CX300A,Y,4CX125C,F	225.00
SK711A	Socket For 4CX300A,Y,4CX125C,F	225.00
SK740	Socket For 4CX300A,Y,4CX125C,F	86.00
SK770	Socket For 4CX300A,Y,4CX125C,F	86.00
SK800A	Socket For 4CX1000A,4CX1500B	225.00
SK806	Chimney For 4CX1000A,4CX1500B	40.00
SK810	Socket For 4CX1000A,4CX1500B	225.00
SK900	Socket For 4X500A	300.00
SK906	Chimney For 4X500A	57.00
SK1420	Socket For 5CX3000A	650.00
SK1490	Socket For 4CV8000A	585.00

## JOHNSON TUBE SOCKETS AND CHIMNEYS

124-111/SK606	Chimney For 4CX250B,BC,FG,R, 4CX350A,F,FJ	\$ 10.00
122-0275-001	Socket For 3-500Z, 4-125A, 250A, 400A, 4-500A, 5-500A	(pair)15.00
124-0113-00	Capacitor Ring	15.00
124-116/SK630A	Socket For 4CX250B,BC,FG,R, /4CX350A,F,FJ	55.00
124-115-2/SK620A	Socket For 4CX250B,BC,FG,R, /4CX350A,F,FJ	55.00
	813 Tube Socket	20.00

## CHIP CAPACITORS

.8pf	10pf	100pf*	430pf
1pf	12pf	110pf	470pf
1.1pf	15pf	120pf	510pf
1.4pf	18pf	130pf	560pf
1.5pf	20pf	150pf	620pf
1.8pf	22pf	160pf	680pf
2.2pf	24pf	180pf	820pf
2.7pf	27pf	200pf	1000pf/.001uf*
3.3pf	33pf	220pf*	1800pf/.0018uf
3.6pf	39pf	240pf	2700pf/.0027uf
3.9pf	47pf	270pf	10,000pf/.01uf
4.7pf	51pf	300pf	12,000pf/.012uf
5.6pf	56pf	330pf	15,000pf/.015uf
6.8pf	68pf	360pf	18,000pf/.018uf
8.2pf	82pf	390pf	

PRICES: 1 to 10 - .99¢ 101 to 1000 .60¢ \* IS A SPECIAL PRICE: 10 for \$7.50  
 11 to 50 - .90¢ 1001 & UP .35¢ 100 for \$65.00  
 51 to 100 - .80¢ 1000 for \$350.00

## TUBE CAPS (Plate)

HR1, 4	\$11.00
HR2,3, 6 & 7	13.00
HR5, 8	14.00
HR9	17.00
HR10	20.00

WATKINS JOHNSON WJ-V907: Voltage Controlled Microwave Oscillator \$110.00

Frequency range 3.6 to 4.2GHz, Power output, Min. 10dBm typical, 8dBm Guaranteed.  
 Spurious output suppression Harmonic (nfo), min. 20dB typical, In-Band Non-Harmonic, min. 60dB typical, Residual FM, pk to pk, Max. 5KHz, pushing factor, Max. 8KHz/V, Pulling figure (1.5:1 VSWR), Max. 60MHz, Tuning voltage range +1 to +15volts, Tuning current, Max. -0.1mA, modulation sensitivity range, Max. 120 to 30MHz/V, Input capacitance, Max. 100pf, Oscillator Bias +15 +/-0.05 volts @ 55mA, Max.

**Toll Free Number**  
**800-528-0180**  
**(For orders only)**

"All parts may be new or surplus, and parts may be substituted with comparable parts if we are out of stock of an item."

# MHz electronics

PRICES SUBJECT TO CHANGE WITHOUT NOTICE



# "FILTERS"

COLLINS Mechanical Filter #526-9724-010 MODEL F455Z32F

455KHZ at 3.2KHz wide. May be other models but equivalent. May be used or new, \$15.99

ATLAS Crystal Filters

- 5.595-2.7/8/LSB, 5.595-2.7/LSB  
8 pole 2.7KHz wide Upper sideband. Impedance 800ohms 15pf In/800ohms 0pf out. 19.99
- 5.595-2.7/8/U, 5.595-2.7/USB  
8 pole 2.7KHz wide Upper sideband. Impedance 800ohms 15pf In/800ohms 0pf out. 19.99
- 5.595-.500/4, 5.595-.500/4/CW  
4 pole 500 cycles wide CW. Impedance 800ohms 15pf In/800ohms 0pf out. 19.99
- 9.0USB/CW  
6 pole 2.7KHz wide at 6dB. Impedance 680ohms 7pf In/300ohms 8pf out. CW-1599Hz 19.99

KOKUSAI ELECTRIC CO, Mechanical Filter #MF-455-ZL/ZU-21H

- 455KHz at Center Frequency of 453.5KC. Carrier Frequency of 455KHz 2.36KC Bandwidth.
- Upper sideband. (ZU) 19.99
- Lower sideband. (ZL) 19.99

\*\*\*\*\*

CRYSTAL FILTERS

NIKKO	FX-07800C	7.8MHz	\$10.00
TEW	FEC-103-2	10.6935MHz	10.00
SDK	SCH-113A	11.2735MHz	10.00
TAMA	TF-31H250	CF 3179.3KHz	19.99
TYCO/CD	001019880	10.7MHz 2pole 15KHz bandwidth	5.00
MOTOROLA	4884863B01	11.7MHz 2pole 15KHz bandwidth	5.00
PTI	5350C	12MHz 2pole 15KHz bandwidth	5.00
PTI	5426C	21.4MHz 2pole 15KHz bandwidth	5.00
PTI	1479	10.7MHz 8pole bandwidth 7.5KHz at 3dB, 5KHz at 6dB	20.00
COMTECH	AL0300	45MHz 2pole 15KHz bandwidth	6.00
FRC	ERXF-15700	20.6MHz 36KHz wide	10.00
FILTECH	2131	CF 7.825MHz	10.00

\*\*\*\*\*

CERAMIC FILTERS

AXEL	4F449	12.6KC Bandpass Filter 3dB bandwidth 1.6KHz from 11.8-13.4KHz	10.00
CLEVITE	TO-01A	455KHz+2KHz bandwidth 4-7% at 3dB	5.00
	TCF4-12D36A	455KHz+1KHz bandwidth 6dB min 12KHz, 60dB max 36KHz	10.00
MURATA	BFB455B	455KHz	2.50
	BFB455L	455KHz	3.50
	CFM455E	455KHz +5.5KHz at 3dB, +8KHz at 6dB, +16KHz at 50dB	6.65
	CFM455D	455KHz +7KHz at 3dB, +10KHz at 6dB, +20KHz at 50dB	6.65
	CFR455E	455KHz +5.5KHz at 3dB, +8KHz at 6dB, +16KHz at 60dB	8.00
	CFU455B	455KHz +2KHz bandwidth +15KHz at 6dB, +30KHz at 40dB	2.90
	CFU455C	455KHz +2KHz bandwidth +12.5KHz at 6dB, +24KHz at 40dB	2.90
	CFU455G	455KHz +1KHz bandwidth +4.5KHz at 6dB, +10KHz at 40dB	2.90
	CFU455H	455KHz +1KHz bandwidth +3KHz at 6dB, +9KHz at 40dB	2.90
	CFU455I	455KHz +1KHz bandwidth +2KHz at 6dB, +6KHz at 40dB	2.90
	CFW455D	455KHz +10KHz at 6dB, +20KHz at 40dB	2.90
	CFW455H	455KHz +3KHz at 6dB, +9KHz at 40dB	2.90
	SFB455D	455KHz	2.50
	SFD455D	455KHz +2KHz, 3dB bandwidth 4.5KHz +1KHz	5.00
	SFE10.7MA	10.7MHz 280KHz +50KHz at 3dB, 650KHz at 20dB	2.50
	SFE10.7MS	10.7MHz 230KHz +50KHz at 3dB, 570KHz at 20dB	2.50
	SPG10.7MA	10.7MHz	10.00
NIPPON	LF-B4/CFU455I	455KHz +1KHz	2.90
	LF-B6/CFU455H	455KHz +1KHz	2.90
	LF-B8	455KHz	2.90
	LF-C18	455KHz	10.00
TOKIN	CF455A/BFU455K	455KHz +2KHz	5.00
MATSUSHIRA	EFC-L455K	455KHz	7.00

\*\*\*\*\*

SPECTRA PHYSICS INC., Model 088 HeNe LASER TUBES

POWER OUTPUT 1.6MW. BEAM DIA. .75MM BEAM DIR. 2.7MR 8KV STARTING VOLTAGE DC  
68K OHM 1WATT BALLAST 1000VDC +100VDC At 3.7MA \$59.99

ROTRON MUFFIN FANS Model MARK4/MU2A1

115 VAC 14WATTS 50/60CPS IMPEDENCE PROTECTED-F 88CFM at 50CPS  
105CFM at 60CPS THESE ARE NEW \$ 7.99

# MHz electronics

PRICES SUBJECT TO CHANGE WITHOUT NOTICE

**Toll Free Number**  
**800-528-0180**  
**(For orders only)**

"All parts may be new or surplus, and parts may be substituted with comparable parts if we are out of stock of an item."



# HEWLETT PACKARD SIGNAL GENERATORS

606A	50KHz to 65MHz in 6 bands $\pm 1\%$ Output level adjustable 0.1uV to 3V into 50 ohms. Built-in crystal calibrator. 400 -1000Hz modulation.	\$ 650.00
606B	Same as above but has frequency control feature to allow operation with HP 8708A Synchronizer.	\$1100.00
608C	10MHz to 480MHz, 0-1uV-1V into 50 ohms, AM, CW, or pulse modulation, calibrated attenuator.	\$ 500.00
608D/ TS510	10MHz to 420MHz, 0.1uV-0.5V into 50 ohms, $\pm 0.5\%$ accuracy, built-in crystal calibrator, AM-CW or pulse output.	\$ 375.00
608E	Improved version of popular 608C. Up to 1V output. Improved stability, low residual FM.	\$1450.00
608F	10MHz to 455MHz in 5 bands $\pm 1\%$ frequency accuracy with built-in crystal calibrator. Can be used with HP 8708A Synchronizer. Output continuously adjustable from .1uV to .5V into 50 ohms.	\$1100.00
612A	450-1230MHz, 0.1uV-0.5V into 50 ohms, calibrated output.	\$ 750.00
614A	900-2100MHz with many features including calibrated output and all modulation characteristics.	\$ 500.00
616A/ TS403	Direct reading and direct control from 1.8 to 4.2GHz. The H.P. 616A features $\pm 1.5$ dB calibrated output accuracy from -31.27dBm to -dBm. The output is directly calibrated in microvolts and dBm with continuous monitoring. Simple operation frequency diad accuracy is $\pm 1\%$ and stability exceeds 0.005% / C change in ambient temperature. Calibrated attenuator is within $\pm 1.5$ dB over entire output band. 50 ohm impedance unit has internal pulse modulation with rep rate variable from 40 Hz to 4KHz, variable pulsewidth (1 to 10uSec) and variable pulse delay (3 to 300uSec). External modulating inputs increase versatility.	\$ 375.00
616B	Same as above but later model.	\$ 600.00
618B	3.8 to 7.6GHz range, with calibrated output and selection of pulse-FM or square wave modulation.	\$ 600.00
618C	Same as above but later model.	\$2200.00
620A	7 to 11GHz range, with calibrated output and selection of pulse-FM or square wave modulation.	\$ 750.00
620B	Same as above but later model.	\$2200.00
626A	10 to 15GHz, 10mw output power with calibrated output and pulse-square wave or FM modulation.	\$4200.00
8708A	Synchronizer used with 606B, 608F. The synchronizer is a phase-lock frequency stabilizer which provides crystal-oscillator frequency stability to 430MHz in the 608F signal generator. Phase locking eliminates microphonics and drift resulting in excellent frequency stability. The 8708A includes a vernier which can tune the reference oscillator over a range of $\pm 0.25\%$ permitting frequency stability to 2 parts in 10 to the seventh. Provides a very stable signal that satisfies many critical applications.	
	(With HP 606B or 608F)	\$ 350.00
	(Without)	\$ 450.00
EMC-10	ELECTROMETRICS EMC-10 RFI/EMI RECEIVER Low frequency analyzer covering 20Hz to 50KHz frequency range. Extendable to 500 KHz in wideband mode.	\$2500.00
NF-105F	Empire Devices Field Intensity Meter. Has NF-105/TA, NF-105/TX, NF-105/T1, NF-105/T2, NF-105/T3. Covers 14KHz to 1000MHz.	\$2100.00

ALL EQUIPMENT CARRY A 30 DAY GUARANTEE.

EQUIPMENT IS NOT CALIBRATED.

#### ORDERING INSTRUCTIONS

**DEFECTIVE MATERIAL:** All claims for defective material must be made within sixty (60) days after receipt of parcel. All claims must include the defective material (for testing purposes), our invoice number, and the date of purchase. All returns must be packed properly or it will void all warranties.

**DELIVERY:** Orders are normally shipped within 48 hours after receipt of customer's order. If a part has to be backordered the customer is notified. Our normal shipping method is via First Class Mail or UPS depending on size and weight of the package. On test equipment it is by Air only. FOB shipping point.

**FOREIGN ORDERS:** All foreign orders must be prepaid with cashier's check or money order made out in U.S. Funds. We are sorry but C.O.D. is not available to foreign countries and Letters of Credit are not an acceptable form of payment either. Further information is available on request.

**HOURS:** Monday thru Saturday: 8:30 a.m. to 5:00 p.m.

**INSURANCE:** Please include 25¢ for each additional \$100.00 over \$100.00. United Parcel only.

**ORDER FORMS:** New order forms are included with each order for your convenience. Additional forms are available on request.

**POSTAGE:** Minimum shipping and handling in the US, Canada, and Mexico is \$2.50 all other countries is \$5.00. On foreign orders include 20% shipping and handling.

**PREPAID ORDERS:** Order must be accompanied by a check.

**PRICES:** Prices are subject to change without notice.

**RESTOCK CHARGE:** If parts are returned to MHz Electronics due to customer error, customer will be held responsible for all extra fees, will be charged a 15% restocking fee, with the remainder in credit only. All returns must have approval.

**SALES TAX:** Arizona must add 5% sales tax, unless a signed Arizona resale tax card is currently on file with MHz Electronics. All orders placed by persons outside of Arizona, but delivered to persons in Arizona are subject to the 5% sales tax.

**SHORTAGE OR DAMAGE:** All claims for shortages or damages must be made within 5 days after receipt of parcel. Claims must include our invoice number and the date of purchase. Customers which do not notify us within this time period will be held responsible for the entire order as we will consider the order complete.

OUR 800 NUMBER IS STRICTLY FOR ORDERS ONLY  
NO INFORMATION WILL BE GIVEN. 1-800-528-0180.

**TERMS: DOMESTIC:** Prepaid, C.O.D. or Credit Card

**FOREIGN:** Prepaid only, U.S. Funds—money order or cashier's check only.

**C.O.D.:** Acceptable by telephone or mail. Payment from customer will be by cash, money order or cashier's check. We are sorry but we cannot accept personal checks for C.O.D.'s.

**CONFIRMING ORDERS:** We would prefer that confirming orders not be sent after a telephone order has been placed. If company policy necessitates a confirming order, please mark "CONFIRMING" boldly on the order. If problems or duplicate shipments occur due to an order which is not properly marked, customers will be held responsible for any charges incurred, plus a 15% restock charge on returned parts.

**CREDIT CARDS:** WE ACCEPT MASTERCARD VISA AND AMERICAN EXPRESS.

**DATA SHEETS:** When we have data sheets in stock on devices we do supply them with the order.

**MHz electronics**



(602) 242-3037

(602) 242-8916

2111 W. CAMELBACK ROAD  
PHOENIX, ARIZONA 85015

Toll Free Number  
800-528-0180  
(For orders only)

✓ 48

"All parts may be new or surplus, and parts may be substituted with comparable parts if we are out of stock of an item."

## NEW LOW-NOISE PREAMPS

New low-noise microwave transistors make preamps in the 0.9 to 1.0 dB noise figure range possible without the fragility and power supply problems of gas-fet's. Units furnished wired and tuned to ham band. Can be easily returned to nearby freq.



Models LNA ( ), P30, and P432 shown

Model	Tunable Freq Range	Noise Figure	Gain	Price
LNA 28	20-40	0.9 dB	20 dB	\$39.95
LNA 50	40-70	0.9 dB	20 dB	\$39.95
LNA 144	120-180	1.0 dB	18 dB	\$39.95
LNA 220	180-250	1.0 dB	17 dB	\$39.95
LNA 432	380-470	1.0 dB	18 dB	\$44.95

## ECONOMY PREAMPS

Our traditional preamps, proven in years of service. Over 20,000 in use throughout the world. Tuneable over narrow range. Specify exact freq. band needed. Gain 16-20 dB. NF = 2 dB or less. VHF units available 27 to 300 MHz. UHF units available 300 to 650 MHz.

- P30K, VHF Kit less case \$14.95
- P30C, VHF Kit with case \$20.95
- P30W, VHF Wired/Tested \$29.95
- P432K, UHF Kit less case \$18.95
- P432C, UHF Kit with case \$24.95
- P432W, UHF Wired/Tested \$33.95

P432 also available in broadband version to cover 20-650 MHz without tuning. Same price as P432; add "B" to model #.

## HELICAL RESONATOR PREAMPS

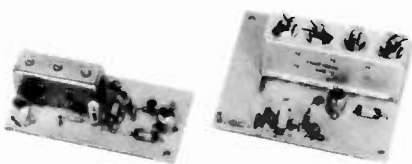

Our lab has developed a new line of low-noise receiver preamps with helical resonator filters built in. The combination of a low noise amplifier similar to the LNA series and the sharp selectivity of a 3 or 4 section helical resonator provides increased sensitivity while reducing intermod and cross-band interference in critical applications. See selectivity curves at right. Noise figure = 1 to 1.2 dB. Gain = 12 to 15 dB.

Model	Tuning Range	Price
HRA-144	143-150 MHz	\$49.95
HRA-220	213-233 MHz	\$49.95
HRA-432	420-450 MHz	\$59.95

## RECEIVING CONVERTERS



Models to cover every practical rf & if range to listen to SSB, FM, ATV, etc. NF = 2 dB or less.

	Antenna Input Range	Receiver Output
<b>VHF MODELS</b>	28-32	144-148
	50-52	28-30
Kit \$44.95	50-54	144-148
Less Case \$39.95	144-146	28-30
Wired \$59.95	145-147	28-30
	144-144.4	27-27.4
	146-148	28-30
	144-148	50-54
	220-222	28-30
	220-224	144-148
	222-226	144-148
	220-224	50-54
	222-224	28-30

	Antenna Input Range	Receiver Output
<b>UHF MODELS</b>	432-434	28-30
Kit \$54.95	435-437	28-30
Less Case \$49.95	432-436	144-148
Wired \$74.95	432-436	50-54
	439.25	61.25

**SCANNER CONVERTERS** Copy 72-76, 135-144, 240-270, 400-420, or 806-894 MHz bands on any scanner. Wired/tested Only \$79.95.

**SPECIAL FREQUENCY CONVERTERS** made to custom order \$119.95. Call for details.

## SAVE A BUNDLE ON VHF FM TRANSCEIVERS!

FM-5 PC Board Kit - **ONLY \$159.95** complete with controls, heatsink, etc. 10 Watts, 5 Channels, for 6M, 2M, or 220



Cabinet Kit, complete with speaker, knobs, connectors, hardware. Only \$59.95

**REPEAT OF A SELLOUT!**

While supply lasts, get \$59.95 cabinet kit free when you buy an FM-5 Transceiver kit.

Where else can you get a complete transceiver for only \$159.95?

## TRANSMIT CONVERTERS

For SSB, CW, ATV, FM, etc. Why pay big bucks for a multi mode rig for each band? Can be linked with receive converters for transceive. 2 watts output.

	Exciter Input Range	Antenna Output
For VHF, Model XV2 Kit \$79.95 Wired \$119.95 (Specify band)	28-30	144-146
	28-29	145-146
	28-30	50-52
	27-27.4	144-144.4
	28-30	220-222
	50-54	220-224
	144-146	50-52
	50-54	144-148
	144-146	28-30

For UHF, Model XV4 Kit \$99.95 Wired \$149.95	28-30	432-434
	28-30	435-437
	50-54	432-436
	61.25	439.25
	144-148	432-436*

\*Add \$35 for 2M Input

**FREE OFFER**

For limited time, buy a transmit converter above with 40-45W PA (\$129.95) and get \$39.95 cabinet FREE.



## LOOK AT THESE ATTRACTIVE CURVES!

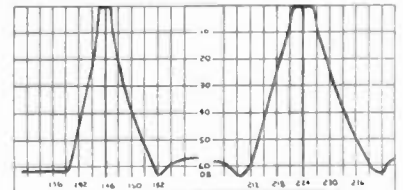

R144 & R220 Front Ends. HRA 144/220, & HRF-144/220

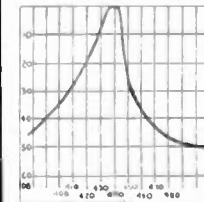

R451 Receiver Front End

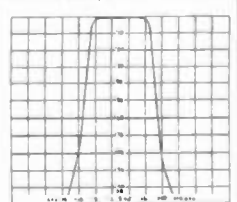

Rcvr I-F Selectivity

Typical Selectivity Curves of Receivers and Helical Resonators

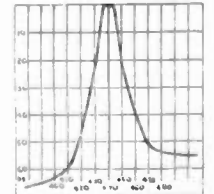

HRA-432, HRF-432

- Call or Write for **FREE CATALOG** (Send \$1.00 or 4 IRC's for overseas mailing)
- Order by phone or mail ● Add \$2 S & H per order (Electronic answering service evenings & weekends)
- Use VISA, MASTERCARD, Check, or UPS COD.

**hamtronics, inc.**

65-W MOUL RD. ● HILTON NY 14468  
Phone: 716-392-9430

Hamtronics® is a registered trademark

**AT LAST —  
A REPEATER  
YOU CAN AFFORD!**

For years, Hamtronics® Modules have been used by individual hams and manufacturers to make repeaters. Now, in the Hamtronics tradition of top quality and superb value, we are proud to offer a complete repeater package.



**JUST LOOK AT THESE PRICES!**

Band	Kit	Wired/Tested
6M, 2M, 220	\$595	\$745
440	\$645	\$795

Both kit and wired units are complete with all parts, modules, hardware, and crystals.

**CALL OR WRITE FOR COMPLETE DETAILS.**

Also available for remote site linking/crossband & 10M.

**FEATURES:**

- SENSITIVITY SECOND TO NONE; TYPICALLY 0.15 uV ON VHF, 0.3 uV ON UHF.
- SELECTIVITY THAT CAN'T BE BEAT! BOTH 8 POLE CRYSTAL FILTER & CERAMIC FILTER FOR GREATER THAN 100 dB AT ± 12KHZ. HELICAL RESONATOR FRONT ENDS. SEE R144, R220, AND R451 SPECS IN RECEIVER AD BELOW.
- OTHER GREAT RECEIVER FEATURES: FLUTTER-PROOF SQUELCH, AFC TO COMPENSATE FOR OFF-FREQ TRANSMITTERS, SEPARATE LOCAL SPEAKER AMPLIFIER & CONTROL.
- CLEAN, EASY-TUNE TRANSMITTER; UP TO 20 WATTS OUT.

**HIGH QUALITY MODULES FOR  
REPEATERS, LINKS, TELEMETRY, ETC.**

**INTRODUCING —  
NEW 1983 RECEIVERS**

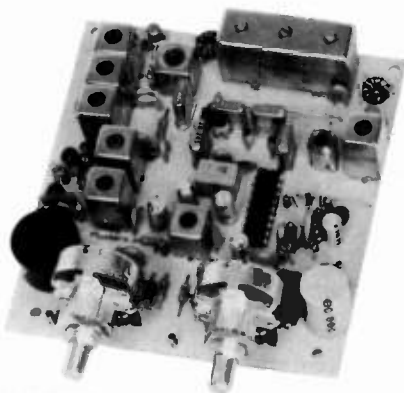

R144 Shown

- **R144/R220 FM RCVRs** for 2M or 220 MHz. 0.15uV sens.; 8 pole xtal filter & ceramic filter in i-f, helical resonator front end for exceptional selectivity (curves at left). AFC incl., xtal oven avail. Kit only \$119.95
- **R451 FM RCVR** Same but for uhf. Tuned line front end, 0.3 uV sens. Kit only \$119.95.
- **R76 FM RCVR** for 10M, 6M, 2M, 220, or commercial bands. As above, but w/o AFC or hel. res. Kits only \$109.95. Also avail w/4 pole filter, only \$94.95/ kit.
- **R110 VHF AM RECEIVER** kit for VHF aircraft band or ham bands. Only \$84.95
- **R110 UHF AM RECEIVER** for UHF uses, including special 259 MHz model to hear SPACE SHUTTLE. Kit \$94.95

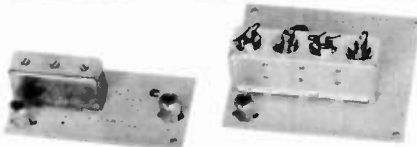

- **HELICAL RESONATOR FILTERS** available separately on pcb w/connectors.  
 HRF-144 for 143-150 MHz \$34.95  
 HRF-220 for 213-233 MHz \$34.95  
 HRF-432 for 420-450 MHz \$44.95  
 (See selectivity curves at left.)

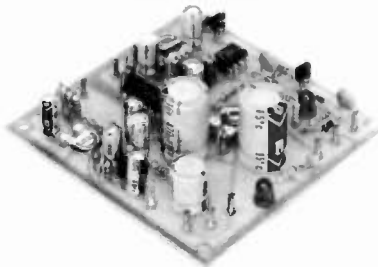

- **COR KITS** With audio mixer and speaker amplifier. Only \$29.95.
- **CWID KITS** 158 bits, field programmable, clean audio. Only \$59.95.
- **DTMF DECODER/CONTROLLER KITS.** Control 2 separate on/off functions with touchtones®, e.g., repeater and autopatch. Use with main or aux. receiver or with Auto-patch. Only \$89.95.
- **AUTOPATCH KITS.** Provide repeater autopatch, reverse patch, phone line remote control of repeater, secondary control via repeater receiver. Many other features. Only \$89.95. Requires DTMF Module.
- **A16 RF TIGHT BOX** Deep drawn alum. case with tight cover and no seams. 7 x 8 x 2 inches. Only \$18.00.

**TRANSMITTERS AND  
ACCESSORIES**

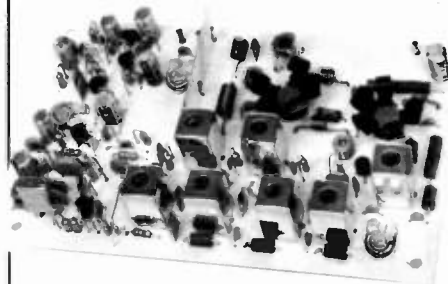

- **T51 VHF FM EXCITER** for 10M, 6M, 2M, 220 MHz or adjacent bands. 2 Watts continuous. Kits only \$59.95



- **T451 UHF FM EXCITER** 2 to 3 Watts on 450 ham band or adjacent. Kits only \$69.95
- **VHF & UHF LINEAR AMPLIFIERS.** Use on either FM or SSB. Power levels from 10 to 45 Watts to go with exciters & xmtg converters. Kits from \$69.95.

**hamtronics®**





# Model IC-R70 General-Coverage Receiver



**NOW! A COMMERCIAL GRADE Communications Receiver That Everyone Has Been Asking For... At A Price You Can Afford!**

Call or write for our super July special price!

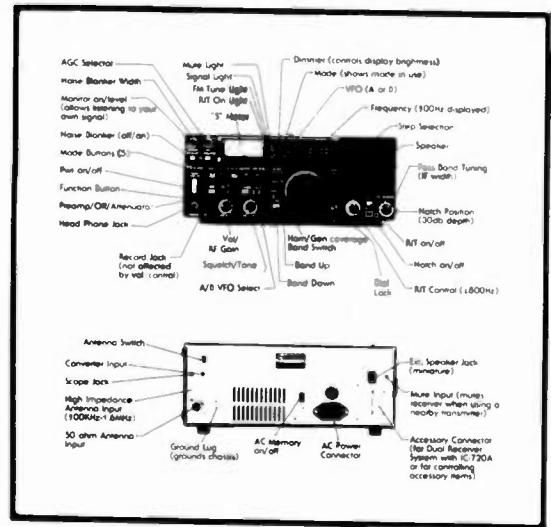

Spectronics is proud and excited to announce ICOM's long rumored and awaited professional general coverage receiver, the IC-R70.

It features more functions than other less sophisticated general coverage receivers on the market; features that the serious shortwave listener or ham operator would want, such as squelch on sideband, adjustable width noise blanker, adjustable speed AGC, passband tuning as standard, and adjustable notch filter as standard.

Other convenient features are high stability, synthesized tuning and 3 tuning speeds, optional AM/FM mode, variable CW filter widths, dial lock, two VFO's with data transfer, plus many others. Also, the IC-R70 will operate transceive with the IC-720A, making an ideal combination for the serious DX'er or CW buff.

**GENERAL COVERAGE RECEPTION AT ITS BEST** Listen to the world of HF with the R70, a 100KHz to 30MHz commercial grade receiver designed by ICOM Incorporated, the leader in advanced receiver design. Built from knowledge gained by designing receivers for commercial, marine, and amateur use, the R70 surpasses other receivers on the market...even receivers costing more than twice as much.

Utilizing ICOM's DFM (Direct Feed Mixer), the R70 is a receiver which in normal usage is virtually immune to intermodulation distortion or cross modulation, yet still maintains superior sensitivity. Whether you are a Short Wave Listener, Amateur Radio Operator, Maritime operator or commercial user, the R70 provides the features you need.

**DESIGN** The R70 incorporates an UP conversion system, utilizing a direct feed mixer proven to be the best design for minimizing interference from strong adjacent signals. A preamp is provided for making the weakest of signals readable. High grade filters in conjunction with the built-in PBT (pass band tuning) system and notch filter, provide the ultimate in interference rejection. Selectable AGC (fast/slow/off), noise blanker (wide or narrow), and tone control improve readability under the worst conditions. An AGC derived squelch, operative in all modes, adds to operating ease.

Dual VFO's with three tuning rates provide quick QSRY (frequency change), memory for an important station or by equalizing the VFO's (A - B), a digital RIT, 13.8 VDC operation is provided as an option, 117 VAC is standard.

**SWL** — For the short wave listener, the readout section of the R70 gives all the information for logging a station to be returned to at a later time. Frequency, mode, VFO, signal strength are all displayed. A dial lock prevents accidental loss of a signal.

A front mounted speaker provides 3 watts of crisp clear audio. A record jack allows easy attachment of a tape recorder.

### SPECIFICATIONS

**Frequency Coverage:** 100KHz - 30MHz. **Receiving Modes:** SSB (A3J), CW(A1), RTTY(F1), AM(A3), \*FM(F3). **Receiver Type:** SSB, CW, RTTY, AM - double conversion superhetrodyne. \*FM - Triple conversion. **IF Frequencies:** 1st - 70.4515MHz, 2nd - SB - 9.0115MHz, CW, RTTY: 9.0106MHz, AM, \*FM - 9.0100MHz. **PBT - 455KHz** 3rd p \*FM 455KHz. **Sensitivity:** SSB, CW, RTTY - 0.16uV for 10 dB S/N (100KHz-1.6MHz = 1uV for 10 dB S/N), AM - 0.5uV for 10 dB S/N, \*FM - 0.32uV for 12 dB SINAD (1.6 - 30 MHz only). **Selectivity:** SSB, CW, RTTY: 2.3 KHz @ -6dB/4.2KHz @ -60dB. CW-N, RTTY-N: 500 Hz @ -6dB/1.5 KHz @ -60dB. AM: 6KHz @ -6dB/18KHz @ -60dB. FM: 15KHz @ -6dB/25KHz @ -60dB. **Stability:** ±500Hz over -10° to +60°C, ±250Hz from 1 min. to 1 hr. after turn on, ±50 Hz thereafter. **Spurious Responses:** -60dB down. **Dynamic Range:** 100 dB @ 500Hz IF Bandwidth. **PBT Range:** SSB, CW, RTTY ± 1.8 KHz AM ± 3.3KHz. **RIT Range:** ±800 Hz from center position. **Notch Depth:** 30dB. **Audio Power:** 3 watts into 8 ohms with 10% distortion (5.8 watts into 4 ohms). **Power Supply:** Built in AC type for 100, 117, 220 to 240 volts ± 10% (50/60 Hz), 13.8V ± 15% DC supply capability optional. **Weight:** 16.28 lbs. **Size:** 11.25 (11.92)"W x 4.33(5.0)"H x 10.86(12.56)"D. **Antenna Impedance:** 50 ohms (100KHz - 1.6MHz a long wire is used - terminal is provided). **Ground:** Chassis is at ground potential, ground lug provided. **Power Consumption:** AC, Volume minimum 24VA (20W); AC, Volume max. 30VA (25W), DC, Volume min. 0.7A; DC, Volume max. 1.0A. **Operating Temperature Range:** -10° to +60°C.

**TO ORDER:** CALL OR WRITE. MASTER CARD, VISA, MONEY ORDERS, PERSONAL CHECKS TAKE 3 WEEKS TO CLEAR, ACCEPTED. INTERNATIONAL ORDERS WELCOME, PLEASE REQUEST PRO FORMA INVOICE. ILLINOIS RESIDENTS ADD 6% SALES TAX.

**HOURS:** MON. THRU WED. 9:30-6:00, THURS-FRI. 9:30-8:00, SAT. 9:30-3:00

**STOP BY AND VISIT WHEN IN THE CHICAGOLAND AREA!!**



**SPECTRONICS, INC.**  
1009 GARFIELD ST. OAK PARK, IL. 60304

PHONE  
**(312) 848-6777**



ANTENNA SPECIALISTS · AVANTI · AARL PUBS · AMECO · BASH · BEARCAT · BENCHER · B & W · BIRD · CALLBOOK · COMMUNICATIONS

LARSEN · MFJ · MORGAIN · PANASONIC · RAMSEY · SHURE · SONY · TELEX · TEN TEC · TRAC · TRANSCOM · VAN GORDON · VOICOM

# ramsey the first name in Counters!



## 9 DIGITS 600 MHz \$129<sup>95</sup> WIRED

**PRICES:**

CT-90 wired, 1 year warranty	\$129.95
CT-90 Kit, 90 day parts warranty	109.95
AC-1 AC adapter	3.95
BP-1 Nicad pack + AC Adapter/Charger	12.95
OV-1 Micro power Oven time base	49.95
External time base input	14.95

The CT-90 is the most versatile, feature packed counter available for less than \$300.00! Advanced design features include: three selectable gate times, nine digits, gate indicator and a unique display hold function which holds the displayed count after the input signal is removed. Also, a 10MHz TCXO time base is used which enables easy zero beat calibration checks against WWV. Optionally, an internal nicad battery pack, external time base input and Micro-power high stability crystal oven time base are available. The CT-90, performance you can count on!

**SPECIFICATIONS:**

Range:	20 Hz to 600 MHz
Sensitivity:	Less than 10 MV to 150 MHz Less than 50 MV to 500 MHz
Resolution:	0.1 Hz (10 MHz range) 1.0 Hz (60 MHz range) 10.0 Hz (600 MHz range)
Display:	9 digits 0.4" LED
Time base:	Standard-10.000 mHz, 1.0 ppm 20-40°C Optional Micro power oven-0.1 ppm 20-40°C
Power:	8-15 VAC @ 250 ma

## 7 DIGITS 525 MHz \$99<sup>95</sup> WIRED



**SPECIFICATIONS:**

Range:	20 Hz to 525 MHz
Sensitivity:	Less than 50 MV to 150 MHz Less than 150 MV to 500 MHz
Resolution:	1.0 Hz (5 MHz range) 10.0 Hz (50 MHz range) 100.0 Hz (500 MHz range)
Display:	7 digits 0.4" LED
Time base:	1.0 ppm TCXO 20-40°C
Power:	12 VAC @ 250 ma

The CT-70 breaks the price barrier on lab quality frequency counters. Deluxe features such as: three frequency ranges - each with pre-amplification, dual selectable gate times, and gate activity indication make measurements a snap. The wide frequency range enables you to accurately measure signals from audio thru UHF with 1.0 ppm accuracy - that's .0001%! The CT-70 is the answer to all your measurement needs, in the field, lab or ham shack.

**PRICES:**

CT-70 wired, 1 year warranty	\$99.95
CT-70 Kit, 90 day parts warranty	84.95
AC-1 AC adapter	3.95
BP-1 Nicad pack + AC adapter/charger	12.95



## 7 DIGITS 500 MHz \$79<sup>95</sup> WIRED

**PRICES:**

MINI-100 wired, 1 year warranty	\$79.95
AC-Z AC adapter for MINI-100	3.95
BP-Z Nicad pack and AC adapter/charger	12.95

Here's a handy, general purpose counter that provides most counter functions at an unbelievable price. The MINI-100 doesn't have the full frequency range or input impedance qualities found in higher price units, but for basic RF signal measurements, it can't be beat! Accurate measurements can be made from 1 MHz all the way up to 500 MHz with excellent sensitivity throughout the range, and the two gate times let you select the resolution desired. Add the nicad pack option and the MINI-100 makes an ideal addition to your tool box for "in-the-field" frequency checks and repairs.

**SPECIFICATIONS:**

Range:	1 MHz to 500 MHz
Sensitivity:	Less than 25 MV
Resolution:	100 Hz (slow gate) 1.0 KHz (fast gate)
Display:	7 digits, 0.4" LED
Time base:	2.0 ppm 20-40°C
Power:	5 VDC @ 200 ma

## 8 DIGITS 600 MHz \$159<sup>95</sup> WIRED



**NEW READ FREQUENCY**

**SPECIFICATIONS:**

Range:	20 Hz to 600 MHz
Sensitivity:	Less than 25 mv to 150 MHz Less than 150 mv to 600 MHz
Resolution:	1.0 Hz (60 MHz range) 10.0 Hz (600 MHz range)
Display:	8 digits 0.4" LED
Time base:	2.0 ppm 20-40°C
Power:	110 VAC or 12 VDC

The CT-50 is a versatile lab bench counter that will measure up to 600 MHz with 8 digit precision. And, one of its best features is the Receive Frequency Adapter, which turns the CT-50 into a digital readout for any receiver. The adapter is easily programmed for any receiver and a simple connection to the receiver's VFO is all that is required for use. Adding the receiver adapter in no way limits the operation of the CT-50, the adapter can be conveniently switched on or off. The CT-50, a counter that can work double-duty!

**PRICES:**

CT-50 wired, 1 year warranty	\$159.95
CT-50 Kit, 90 day parts warranty	119.95
RA-1, receiver adapter kit	14.95
RA-1 wired and pre-programmed (send copy of receiver schematic)	29.95



## DIGITAL MULTIMETER \$99<sup>95</sup> WIRED

**PRICES:**

DM-700 wired 1 year warranty	\$99.95
DM-700 Kit, 90 day parts warranty	79.95
AC-1, AC adaptor	3.95
BP-3, Nicad pack + AC adapter/charger	19.95
MP-1, Probe kit	2.95

The DM-700 offers professional quality performance at a hobbyist price. Features include: 26 different ranges and 5 functions, all arranged in a convenient, easy to use format. Measurements are displayed on a large 3 1/2 digit, 1/2 inch LED readout with automatic decimal placement, automatic polarity, overrange indication and overload protection up to 1250 volts on all ranges, making it virtually 100% proof! The DM-700 looks great, a handsome, jet black, rugged ARS case with convenient retractable tilt bail makes it an ideal addition to any shop.

**SPECIFICATIONS:**

DC/AC volts:	100uV to 1 KV, 5 ranges
DC/AC current:	0.1uA to 2.0 Amps, 5 ranges
Resistance:	0.1 ohms to 20 Megohms, 6 ranges
Input impedance:	10 Megohms, DC/AC volts
Accuracy:	0.1% basic DC volts
Power:	4 'C' cells

### AUDIO SCALER

For high resolution audio measurements, multiplies UP in frequency.

- Great for PL tones
- Multiplies by 10 or 100
- 0.01 Hz resolution!

\$29.95 Kit \$39.95 Wired

### ACCESSORIES

Telescopic whip antenna - BNC plug	\$ 7.95
High impedance probe, light loading	15.95
Low pass probe, for audio measurements	15.95
Direct probe, general purpose usage	12.95
Tilt bail, for CT 70, 90, MINI-100	3.95
Color burst calibration unit, calibrates counter against color TV signal	14.95

### COUNTER PREAMP

For measuring extremely weak signals from 10 to 1,000 MHz. Small size, powered by plug transformer-included.

- Flat 25 db gain
- BNC Connectors
- Great for sniffing RF with pick-up loop

\$34.95 Kit \$44.95 Wired

ramsey electronic's, inc.



PHONE ORDERS  
CALL 716-586-3950

**TERMS:** Satisfaction guaranteed. Examine for 10 days. If not pleased return in original form for refund. Add 5% for shipping insurance to a maximum of \$10. Overseas add 15%. COD add \$2. Orders under \$10 add \$1.50. NY residents add 7% tax.

2575 Baird Rd. Penfield, NY 14526

# DEALER DIRECTORY

## Culver City CA

Jun's Electronics, 3919 Sepulveda Blvd., Culver City CA 90230, 390-8003. Trades 463-1886 San Diego. 827-5732 (Reno NV).

## Fontana CA

Complete lines ICOM, DenTron, Ten-Tec, Mirage, Cubic, Lunar, over 4000 electronic products for hobbyist, technician, experimenter. Also CB radio, landmobile. Fontana Electronics, 8628 Sierra Ave., Fontana CA 92335, 822-7710.

## Sacramento CA

TOWERS—galvanized steel stack/crankup and accessories. Northern California factory direct to you. California Antenna Systems, 6020 Windy Ridge Road, Shingle Springs CA 95662, 677-9540.

## San Jose CA

Bay area's newest Amateur Radio store. New & used Amateur Radio sales & service. We feature Kenwood, ICOM, Azden, Yaesu, Ten-Tec, Santelec & many more. Shaver Radio, Inc., 1378 So. Bascom Ave., San Jose CA 95128, 998-1103.

## New Castle DE

Factory Authorized Dealer! Yaesu, ICOM, Ten-Tec, KDK, Azden, AEA, Kantronics, Santelec. Full Line of Accessories. No Sales Tax in Delaware. One mile off I-95. Delaware Amateur Supply, 71 Meadow Road, New Castle DE 19720, 328-7728.

## Preston ID

Box WB7BYZ has the Largest Stock of Amateur Gear in the Intermountain West and the Best Prices. Call me for all your ham needs. Ross Distributing, 78 So. State, Preston ID 83263, 852-0830.

## Bloomington IL

ROHN TOWERS—Wholesale direct to users. All products available. Write or call for price list. Also we are wholesale distributors for Antenna Specialists, Regency, and Hy-Gain. Hill Radio, 2503 G.E. Road Box 1405, Bloomington IL 61701-0887, 663-2141.

## Terre Haute IN

Your ham headquarters located in the heart of the Midwest. Hoosier Electronics, Inc., #9 Meadows Center, P.O. Box 3300, Terre Haute IN 47803, 238-1456.

## Western KY

Sell new and used equipment & service. L&S Radio, 307 McLean Ave., Hopkinsville KY 42240, 885-9071.

## Littleton MA

The Reliable Ham Store Serving N.E. Full line of ICOM & Kenwood, Yaesu HTs, Drake, Daiwa, B&W accessories. Curtis & Trac keyers. Larsen, Hustler, Telex/Hy-Gain products. Mirage amps. Astron P.S., Alpha Delta protectors, ARRL & Kantronics instruction aids. Whistler radar detectors. Full line of coax fittings. TEL-COM Electronic Communications, 675 Great Rd. (Rt. 119), Littleton MA 01460, 486-3400/3040.

## Ann Arbor MI

See us for products like Ten-Tec, R. L. Drake, DenTron and many more. Open Monday through Saturday, 0830 to 1730. WB8VGR, WB8UXO, WD8OKN and W8RP behind the counter. Purchase Radio Supply, 327 E. Hoover Ave., Ann Arbor MI 48104, 668-8686.

## Somerset NJ

New Jersey's only factory-authorized ICOM and Yaesu distributor. Large inventory of new and used specials. Most major brands in stock. Complete service and facilities. Radios Unlimited, 1760 Easton Avenue, P.O. Box 347, Somerset NJ 08873, 469-4599.

## Buffalo NY WESTERN NEW YORK

Niagara Frontier's only full stocking Amateur dealer. Also Shortwave, CB, Scanners, Marine, Commercial. Operating displays featuring Kenwood and others. Towers, Antennas, Sales and Service. DX Communications, 3214 Transit Road, West Seneca NY, 668-8873.

## Amsterdam NY UPSTATE NEW YORK

Kenwood, ICOM, Drake, plus many other lines, Amateur Dealer for over 35 years. Adirondack Radio Supply, Inc., 185 West Main Street, Amsterdam NY 12010, 842-8350.

## Syracuse-Rome-Utica NY

Featuring: Kenwood, Yaesu, ICOM, Drake, Ten-Tec, Swan, DenTron, Alpha, Robot, MFJ, Tempo, Astron, KLM, Hy-Gain, Mosley, Larsen, Cushcraft, Hustler, Mini Products. You won't be disappointed with equipment/service. Radio World, Oneida County Airport-Terminal Building, Oriskany NY 13424, 736-0184.

## Columbus OH

The biggest and best Ham Store in the Midwest featuring quality Kenwood products with working displays. We sell only the best. Authorized Kenwood Service. Universal Amateur Radio Inc., 1280 Aida Dr., Reynoldsburg (Columbus) OH 43068, 866-4267.

## Scranton PA

ICOM, Bird, Cushcraft, Beckman, Fluke, Larsen, Hustler, Antenna Specialists, Astron, Avanti, Belden, W2AU/W2V5, AEA, Vibroplex, Ham-Key, Amphipol, Sony, B&W, Coax-Seal, Cover Craft, J.W. Miller/Daiwa, ARRL, Ameco, Shure. LaRue Electronics, 1112 Grandview St., Scranton PA 18509, 343-2124.

## Mountaintop PA WILKES-BARRE AREA

VHF/UHF Equipment & Supplies—From HTs to kW Amplifiers, Transverters, Connectors, VHF/UHF/Microwave Linear Amplifiers, GaAs-FET Preamps, OSCAR Equipment, Low Noise Preamps, Antennas, Power Supplies. From: Lunar, Microwave Modules, UHF Units/Parabolic, ARCOS, Astron, F9FT-Tonna, Tania, DenTron, KLM, Mirage, Santelec, Tokyo Hy-Power, Amphipol. Two Stamps for catalog. The VHF SHOP, Dept. S, RD 4, Box 349, Mountaintop PA 18707, 868-6565.

## Dallas TX

IBM PC/Apple aftermarket products, hobbyists' electronics project kits: \$50.00 complete modem kit, subscription/satellite TV decoder kits, EPROM programmer/duplicator, popular memory IC testers, data sheets, application notes, and more than 8000 parts in stock. Semiconductors, discretes, video products, tools. Please write for your free literature/catalog. Independent Electronics, 6415-06 Airline Rd., Dallas TX 75205.

## Baltimore/Washington

Avantek transistors, amplifiers, oscillators and LNAs. Coaxial cable and connectors. Blonder Tongue dealer with Microwave laboratory. Applied Specialties, Inc., 10101G Bacon Drive, Beltsville, Maryland 20705. Wash. 585-5393, Balt. 792-2211, 7:30 a.m. to 6:00 p.m. Monday thru Friday.

## DEALERS

Your company name and message can contain up to 25 words for as little as \$150 yearly (prepaid), or \$15 per month (prepaid quarterly). No mention of mail-order business or area code permitted. Directory text and payment must reach us 60 days in advance of publication. For example, advertising for the Sept. '83 issue must be in our hands by July 1st. Mail to 73 Magazine, Peterborough NH 03458. ATTN: Nancy Ciampa.

# PROPAGATION

J. H. Nelson  
4 Plymouth Dr.  
Whiting NJ 08759

## EASTERN UNITED STATES TO:

GMT:	00	02	04	06	08	10	12	14	16	18	20	22
ALASKA	14	14A	14	7	7	7	7	7	14	14	14	14
ARGENTINA	21	14A	14	14	7A	7	7A	14	14	14	21	21A
AUSTRALIA	21	14A	14	14B	7B	7B	7	7	7	7B	14	14A
CANAL ZONE	21	14	14	7	7	7	14	14	14	14	21	21
ENGLAND	14	7A	7	7	7	7A	14	14	14A	14A	14	14
HAWAII	14A	14A	14	7	7B	7B	7	7	14	14	14	14
INDIA	14	14	14B	7B	7B	7B	14	14	14	14	14	14
JAPAN	14	14	14B	7B	7B	7B	7	14	14	14	14	14
MEXICO	14A	14	14	7A	7	7	7A	14	14	14	21	14A
PHILIPPINES	14	14	14	7B	7B	7B	7B	14B	14	14	14	14
PUERTO RICO	14A	14	14	7	7	7	14	14	14	14A	14A	14A
SOUTH AFRICA	7B	7B	7B	7A	14	14	14A	14A	7	21	14	14B
U. S. S. R.	7A	7A	7	7	7	7A	14	14	14	14	14	14
WEST COAST	14A	14	14	7	7	7	7	14	14	14	14A	14A

## CENTRAL UNITED STATES TO:

ALASKA	14	14	14	7	7	7	7	7	14	14	14	14
ALASKA	14	14	14	7	7	7	7	7	14	14	14	14
ARGENTINA	21	14A	14	14	7A	7	7A	14	14	21	21A	21
AUSTRALIA	21	14A	14	14B	7B	7B	7	7	7	7B	14	14A
CANAL ZONE	21	14A	14	7	7	7	14	14	14	14	21	21
ENGLAND	14	7A	7	7	7	7	7A	14	14	14A	14	14
HAWAII	14A	14A	14	7	7	7	7	14	14	14	14	14
INDIA	14	14	14	7B	7B	7B	7B	14B	14	14	14	14
JAPAN	14	14	14	7B	7B	7B	7	14	14	14	14	14
MEXICO	14	14	14	7	7	7	7	14	14	14	14	14
PHILIPPINES	14	14	14	7B	7B	7B	7B	14B	14	14	14	14
PUERTO RICO	21	14A	14	7	7	7	14	14	14	14A	14A	14A
SOUTH AFRICA	7B	7B	7B	7B	7B	7B	14B	14	14	14A	14	14B
U. S. S. R.	7A	7A	7	7	7	7	7B	14B	14	14	14	14

## WESTERN UNITED STATES TO:

ALASKA	14	14	14	7	7	7	7	7	14	14	14	14
ALASKA	14	14	14	7	7	7	7	7	14	14	14	14
ARGENTINA	21	14A	14	14	7A	7	7A	14	14	21	21A	21
AUSTRALIA	21	14A	14	14B	7B	7B	7	7	7	7B	14	14A
CANAL ZONE	21	14A	14	7	7	7	14	14	14	14	21	21
ENGLAND	14	7A	7	7	7	7	7A	14	14	14	14	14
HAWAII	21A	21A	21	14	14	14	7	7	14	14	14	21
INDIA	14	14	14	7B	7B	7B	7B	14B	14	14	14	14
JAPAN	14A	14	14	14B	7B	7	7	14	14	14	14	14A
MEXICO	14A	14	14	7	7	7	7	14	14	14	14	14A
PHILIPPINES	14A	14A	14	14	14B	7B	7B	14B	14	14	14	14A
PUERTO RICO	21	14A	14	14	7	7	7	14	14	14	14A	14A
SOUTH AFRICA	7B	7B	7B	7B	7B	7B	14B	14	14	14	14	14B
U. S. S. R.	7A	7A	7	7	7	7	7B	14B	14	14	14	14
EAST COAST	14A	14	14	7	7	7	7	14	14	14A	14A	14A

A = Next higher frequency band may also be useful.

B = Difficult circuit this period.

First letter = night waves. Second = day waves.

G = Good, F = Fair, P = Poor. \* = Chance of solar flares.

# = Chance of aurora.

NOTE THAT NIGHT WAVE LETTER NOW COMES FIRST.

## JULY

SUN	MON	TUE	WED	THU	FRI	SAT
					1	2
					G/G	G/G
3	4	5	6	7	8	9
F/F*	P/F*	F/G	F/G	F/F	F/F	P/F
10	11	12	13	14	15	16
F/G	G/G	G/G	G/G	G/G	F/G	F/F
17	18	19	20	21	22	23
F/F	F/G	F/G	F/G	F/F	F/F	F/F
24	25	26	27	28	29	30
F/G	G/G	G/G	F/F	P/F	F/G	G/G



# FT-77 The Rig for All Seasons!

Answering the call for an HF rig that goes everywhere, sounds great, and is cost-effective, Yaesu proudly introduces the FT-77 Compact HF Transceiver System.



## Computerized Design and Manufacture

The FT-77 design engineers utilized the latest computerized circuit board layout methods, resulting in a compact, reliable transceiver with maximum utilization of available space. Automated insertion techniques are used in assembly, providing improved reliability and quality control over earlier designs.

## Operating Versatility

The FT-77 is equipped for operation on all amateur bands between 3.5 and 29.7 MHz, including the three new WARC bands. Fully operational on SSB and CW, the FT-77 includes a dual width noise blanker (designed to minimize the "Woodpecker" or ignition noise), full SWR metering, R.I.T., and optional CW filter with wide/narrow selection. The optional FM-77 permits operation on the FM mode, with front panel squelch sensitivity control.

## Expandable Station Concept

Ideal for mobile operation because of its compact size and light weight, the FT-77 forms the nucleus of a versatile base station. Available as options for the FT-77 are the FP-700 AC Power Supply, FV-700DM Synthesized External VFO and Memory System, FTV-707 VHF/UHF Transverter, and FC-700 Antenna Coupler, providing top performance at an extraordinarily low price.

## Best of All, It's a Yaesu!

With most experience in transceiver design and manufacture, the Yaesu trademark is your guarantee of quality and durability. We've got all-new technology and an all-new warranty policy to back it up.

**See the FT-77 and the all new line of Yaesu HF, VHF, and UHF transceivers, receivers and accessories at your Yaesu Dealer today! It's time you tried a Yaesu!**

Price And Specifications Subject To  
Change Without Notice Or Obligation

**YAESU**  
**The radio.**



0283

✓ 83

YAESU ELECTRONICS CORPORATION, 6851 Walthall Way, Paramount, CA 90723 ● (213) 633-4007  
YAESU Cincinnati Service Center, 9070 Gold Park Dr. Hamilton, Ohio 45011 ● (513) 874-3100



**NEW**

# "DX-traordinary."



**Superior dynamic range, auto. antenna tuner, QSK, dual NB, 2 VFO's, general coverage receiver.**

## TS-930S

The TS-930S is a superlative, high performance, all-solid state, HF transceiver keyed to the exacting requirements of the DX and contest operator. It covers all Amateur bands from 160 through 10 meters, and incorporates a 150 kHz to 30 MHz general coverage receiver having an excellent dynamic range. Among its other important features are, SSB slope tuning, CW VBT, IF notch filter, CW full break-in, automatic antenna tuner, and a higher voltage operated solid state final amplifier. It is available with or without the AT-930 automatic antenna tuner built-in.

### TS-930S FEATURES:

- **160-10 Meters, with 150 kHz-30 MHz general coverage receiver.**  
Covers all Amateur frequencies from 160-10 meters, including new WARC bands, on SSB, CW, FSK, and AM. Features 150 kHz-30 MHz general coverage receiver. Separate Amateur band access keys allow speedy band selection. UP/DOWN bandswitch in 1-MHz steps. A new, innovative, quadruple "UP" conversion, digital PLL synthesized circuit provides superior frequency accuracy and stability, plus greatly enhanced selectivity.
- **Excellent receiver dynamic range.**  
Receiver two-tone dynamic range, 100 dB typical (20 meters, 50-kHz spacing, 500 Hz CW bandwidth, at sensitivity of 0.25  $\mu$ v, S/N 10 dB), provides the ultimate in rejection of IM distortion.
- **All solid state, 28 volt operated final amplifier.**  
The final amplifier operates on 28 VDC for lowest IM distortion. Power input rated at 250 W on SSB, CW, and FSK, and at 80 W on AM. Final amplifier protection circuits with cooling fan, SWR/Power meter built-in.
- **CW full break-in.**  
CW full break-in circuit uses CMOS logic IC plus reed relay for smooth, quiet operation. Switchable to semi-break-in.

- **Automatic antenna tuner, built-in.**  
Covers Amateur bands 80-10 meters, including the new WARC bands. Tuning range automatically pre-selected with band selection to minimize tuning time. "AUTO-THRU" switch on front panel.
- **Dual digital VFO's.**  
10-Hz step dual digital VFO's include band information. Each VFO tunes continuously from band to band. A large, heavy, flywheel type knob is used for improved tuning ease. T.F. Set switch allows fast transmit frequency setting for split-frequency operations. A=B switch for equalizing one VFO frequency to the other. VFO "Lock" switch provided. RIT control for  $\pm 9.9$  kHz.
- **Eight memory channels.**  
Stores both frequency and band information. VFO-MEMO switch allows use of each memory as an independent VFO, (the original memory frequency can be recalled at will), or as a fixed frequency. Internal Battery memory back-up, estimated 1 year life. (Batteries not Kenwood supplied).
- **Dual mode noise blanker ("pulse" or "woodpecker").**  
NB-1, with threshold control, for pulse-type noise. NB-2 for longer duration "woodpecker" type noise.
- **SSB IF slope tuning.**  
Allows independent adjustment of the low and/or high frequency slope of the IF passband, for best interference rejection. HIGH/LOW cut control rotation not affected by selecting USB or LSB modes.
- **CW VBT and pitch controls.**  
CW Variable Bandwidth Tuning control tunes out interfering signals. CW pitch controls shifts IF passband and simultaneously changes the pitch of the beat frequency. A "Narrow/Wide" filter selector switch is provided.
- **IF notch filter.**  
100 kHz IF notch circuit gives deep, sharp, notch, better than -40 dB.
- **Audio filter built-in.**  
Tunable, peak-type audio filter for CW.
- **AC power supply built-in.**  
120, 220, or 240 VAC, switch selected (operates on AC only).

- **Fluorescent tube digital display.**  
Six digit readout to 100 Hz (10 Hz modifiable), plus digitalized sub-scale with 20-kHz steps. Separate two digit indication of RIT frequency shift. In CW mode, display indicates the actual carrier frequency of received as well as transmitted signals.
- **RF speech processor.**  
RF clipper type processor provides higher average "talk-power," improved intelligibility.
- **One year limited warranty on parts and labor.**
- **Other features:**
  - SSB monitor circuit, 3 step RF attenuator, VOX, and 100-kHz marker.
- **Optional accessories:**
  - AT-930 automatic antenna tuner.
  - SP-930 external speaker with selectable audio filters.
  - YG-455C-1 (500 Hz) or YG-455CN-1 (250 Hz) plug-in CW filters for 455-kHz IF.
  - YK-88C-1 (500 Hz) CW plug-in filter for 8.83-MHz IF.
  - YK-88A-1 (6 kHz) AM plug-in filter for 8.83-MHz IF.
  - SO-1 commercial stability TCXO (temperature compensated crystal oscillator). Requires modifications.
  - MC-60A deluxe desk microphone with UP/DOWN switch, pre-amplifier, 8-pin plug.
  - TL-922A linear amplifier (not for CW QSK).
  - SM-220 station monitor (not for pan-adaptor).
  - HS-6, HS-5, HS-4, headphones.

More information on the TS-930S is available from all authorized dealers of Trio-Kenwood Communications, 1111 West Walnut Street, Compton, California 90220.

# KENWOOD

...pacesetter in amateur radio



Specifications and prices are subject to change without notice or obligation.